

Healthcare Furniture

Pricing effective January 1, 2023 - Canada

Revised May 13, 2024



PRICE LIST
healthcare



introduction

Since 1985, Global has been a primary source for furniture in hospitals and elder care facilities.

We offer a comprehensive line of products and services. Our customers appreciate and recognize our value-added consulting and problem-solving resources as this enables them to protect their investments long-term.

Global's healthcare products are specifically designed to promote enhanced levels of wellness. Our furniture solutions are migrating into commercial spaces due to the significant increase in the aging population and the need for properly designed solutions.

Our vertically integrated manufacturing supply chain allows Global to manage the process and to access and monitor the quality of materials and production standards. This vertical integration allows us to control manufacturing and delivery cycles.

We make what you need. Our solutions are suitable for high traffic, challenging public and private spaces. The product development process focuses on ensuring the product is suitable for use and can meet the many faceted challenges of today's public shared spaces.

Hospitals, medical practice centers, senior care facilities, public housing, treatment programs even veterinary clinics can have peace of mind when using healthcare furniture solutions.

We are Canadian - we share Canadian values and pride for who we are. Global continuously strives to achieve excellence in what we do. We are proud to have played a major role in setting some of the highest quality standards in the industry.

We partner with clients to ensure we understand their needs, culture and goals. We often modify our products when special requirements dictate the need, in order to provide the best possible solution for an application.

We are committed to producing products in the most sustainable ways ensuring they pass strict quality testing. See below for GREENGUARD and level certification information.

We value our clients and strive to build lifelong partnerships through trust, respect and successful outcomes.

SYMBOL IDENTIFICATION

Each seating product with an RTA code identifies the assembly requirements.

RTA 00 FULLY ASSEMBLED

RTA 1 SIMPLE ASSEMBLY (no tools required)

Parts to install:

- casters
- base
- pneumatic cylinder/cover can

RTA 2 MODEST ASSEMBLY (tools supplied, if necessary)

Parts to install:

- casters
- base
- pneumatic cylinder/cover can
- back

RTA 4 MODERATE ASSEMBLY (tools supplied)

Parts to install:

- casters
- base
- pneumatic cylinder/cover can
- back
- armrest

RTA 8 FULL ASSEMBLY (tools supplied)

Parts to install:

- casters
- base
- pneumatic cylinder/cover can
- back
- armrest
- mechanism



All products with this designation are suitable for courier shipment throughout Canada.

TABLE OF CONTENTS

SEATING	SEATING (cont'd)	BARIATRIC SEATING
Adeline.....67	Primacare151	Frolick.....85
Bishop.....69	product map152	GC Belong.....107
Calidon70	benches189	GC Comet122
Coast75	dining.....154	GC Sidero131
Collingwood76	guest.....157	Nourish.....148
Desmond77	lounge.....176	Primacare lounge176
Desmond HT.....78	lounge, fully upholstered181	Primacare lounge, fully upholstered.....182
Dreme.....80	patient167	Primacare modular, guest/patient197
Erin83	recliners.....185	Primacare modular, lounge211
Frolick.....85	sleepers.....187	Primacare ottoman.....190
GC Beach.....90	tables.....59	Primacare patient.....165
GC Belong.....91	wingback183	Primacare wingback.....183
GC Citi118	Primacare modular, guest/patient196	Strand.....226
GC Comet121	product map194	
GC Islands124	sample layouts192	
GC Prairie125	tables.....203	
GC Sidero126	Primacare modular, lounge211	
GC Sirena136	product map209	
GC Sonic.....138	tables.....217	
GC Vitrola142	River+223	
GC Wind.....143	Senator.....224	
Heather.....145	Sleep-Eez.....225	
Janna.....146	Splash.....88	
Nourish.....147	Strand.....226	
Oakville.....150	Willow.....232	
	Wingback245	
		WORK + TASK SEATING
		Ergonomic features and benefits.....247
		Mechanism adjustments.....248
		Doctor Buddy.....249
		Foot activated stools.....251
		Gala II252
		Gala II TS.....254
		GC Tritek.....256
		GC Tritek TS.....258
		GC Vion.....260
		Harmony262

TABLE OF CONTENTS

PATIENT + RESIDENT ROOM FURNITURE

Aldon	7
accessories.....	33
bedside cabinets	10
dressers	15
wardrobe cabinets	16
Sonoma	20
accessories.....	33
bedside cabinets	23
dressers.....	30
wardrobe cabinets	31

TABLES - CAFETERIA & DINING

Enable arm tablets.....	39
Enable tables.....	40
Enable tapered legs	40
Floral dining tables.....	41
Occasional dining tables, rectangular	51
Occasional dining tables, square.....	50
Overbed tables.....	53
Tablet tables.....	62

TABLES - OCCASIONAL & RECEPTION

Calidon Tables.....	36
GC Belong coffee tables	42
GC Belong end tables.....	42
Occasional coffee tables, oval.....	47
Occasional coffee tables, rectangular	47
Occasional coffee tables, round	48
Occasional end tables, rectangular	44
Occasional end tables, round.....	46
Occasional end tables, square.....	45
Occasional sofa tables, rectangular	49
Primacare tables	59
Primacare HT tables.....	60
River+ tables	61
Willow linking tables	242
Zook children's tables	64

OTTOMANS AND THROW PILLOWS

Ottomans.....	277
Throw pillows.....	278

REFERENCES

Healthcare definitions.....	4
Seating application guidelines	66
Arm selections	271
Caster selections.....	273
Base and cylinder selections	275
COM/GPM authorization form	284
Textiles and Finishes.....	280
Terms and Conditions.....	285
Lifetime Warranty.....	288
Index.....	289

GLOBAL HEALTHCARE DEFINITIONS

Global Healthcare often requires solutions to address unique and diverse requirements within the vast range of healthcare applications. The following definitions describe the Global healthcare product solutions available.

ADDITIONAL WEIGHT

For unique and demanding challenges in behavioral health facilities, products are weighted to reduce the ease of movement or lifting product to use as a weapon. The product selection and application identified will assist in determining the amount of additional weight required. Weighted product is designed for facilities looking to create safe and secure environments, while ensuring the furniture can withstand intensive use. To determine the amount of additional weight to be added to a product, contact your Global representative.

BED BUG RESISTANT

Due to an increase in the presence of bed bugs within healthcare facilities, solutions have been developed to deal with the bed bug issue. The product design directly affects the level of resistance that can be achieved. For more detailed information, visit the Dealer Centre and click on "Bed Bug Resistant Seating" on the left sidebar or contact your Global representative.

CONTRABAND RESISTANT

Making a product contraband resistant is a potential solution if you want upholstered and comfortable products to be finished in a manner that offers a greater level of safety.

Contraband resistant finishing is added to products in high risk areas where individuals might attempt to hide contraband such as weapons (for self-harm or to cause harm to others), drugs or alcohol. It can also be part of a solution for protecting any area of the product from becoming a ligature point.

The product surfaces and upholstery will be evaluated and the appropriate solutions will be applied to ensure all surfaces are sealed and safely protected. Depending on the product design, this could mean any combination of the following applications: sealed seams, sealed underside, tamperproof fasteners and/or sealed zippers. After being evaluated, solutions are applied based on the application and population being served. The result of this process would enable the caregiver to identify a potential threat as it would be apparent that the product surface was tampered with. To further assist product selection and what is required specific to a product, please contact your Global representative.

HIGH DENSITY ULTRACELL FOAM

High density Ultracell foam is a non-allergenic foam manufactured from natural seed-based oils such as soybean. It significantly decreases the dependence on fossil fuels like petroleum and reduces greenhouse gas emissions. The high density of the foam provides comfortable sitting for many years before any sagging or indents appear underneath upholstery. Simply, there is more material available to allow for enhanced performance.

MENTAL HEALTH FURNITURE

Mental health furniture can range from simple to complex, depending on the application and population. Global understands the unique nature and the need to offer a vast range of solutions to deal with the safety of staff and patients while respecting budgets and individual needs. This allows the client to select a product from our complete offering and then build it up to ensure the right features are included. Here are some of the optional features available: tamperproof fasteners, additional weight, floor mount brackets, puncture resistant textile and other contraband resistant features that are needed for the application. Whatever the demand, the correct solution can be built-in. For more detailed information, contact your Global representative.

MOISTURE BARRIER

Moisture barrier is a textile lining with moisture repellent qualities. Moisture barrier lining is applied on the seat cushion between the upholstery cover and foam to prevent any form of moisture from getting to the foam. It is recommended when the fabric being used does not have moisture repellent qualities or when additional protection from penetration of moisture is desired. For coated textiles, the additional moisture barrier option may not be selected in conjunction with sealed seams. The cost for adding the moisture barrier lining is noted with each series.

MOISTURE AND TAMPER RESISTANT ZIPPER

Moisture and tamper resistant zippers are available as part of the solution when requesting bed bug resistant furniture and contraband resistant solutions. In addition, this special zipper prevents liquid and moisture seepage through the zipper teeth, providing additional peace of mind. For more detailed information based on the product selection, contact your Global representative.

SEALED UNDERSIDE

Sealed underside refers to the process of finishing the underside of a product to ensure no potential openings from the textile surface to the product interior on seat and/or back seams. The sealed underside solution is requested for achieving higher levels of infection prevention control for the product being ordered. The sealed underside option is noted in the price list notes with the upcharge for the respective product. For more detailed information and to determine if the sealed underside process is available on a particular product selection where it is not noted, contact your Global representative.

SEALED SEAMS

The heat-sealed seams process involves sealing the back of a seam with a specially designed tape. Sealing the seam increases the integrity of the seam reducing the likelihood of seams opening over time. This tape provides additional protection against moisture seepage and prevents insects from entering the product through the stitch holes and seams. The sealed seam process is available for use on most coated textiles and is not available on woven textiles. Some coated textiles do not allow sealed seams to be used. In the event sealed seams are to be used, contact Customer Service to confirm sealed seams are approved for the coated textile selected in advance of order placement. Sealed seams can't be specified if using the moisture barrier lining. The sealing of seams requires testing the textile to ensure acceptance of the heat-sealed tape for performance and aesthetics. For detailed instructions on textile testing and approval, contact your Global representative. The cost for adding sealed seams is noted in the 'Build It tool'.

TAMPERPROOF

Tamperproof fasteners can be requested for a higher level of safety. Using tamperproof fasteners ensures the fasteners cannot be interfered with (changed, opened or removed) without use of a special tool. This will prevent the tampering with, or disassembly of the product which could lead to injuries or unsuspecting harm to others. For more detailed information contact your Global representative.

GLOBAL FABRIC SAMPLE CARDS DISPLAY THE FOLLOWING ACT FABRIC PERFORMANCE SYMBOLS:

THE ASSOCIATION FOR CONTRACT TEXTILES (ACT) HAS DEVELOPED THE FOLLOWING PERFORMANCE GUIDELINES TO MAKE FABRIC SPECIFICATION EASIER. THE FIVE SYMBOLS GIVE ARCHITECTS, DESIGNERS AND END USERS A VAST AMOUNT OF PERFORMANCE INFORMATION IN A SUCCINCT, VISUAL WAY. THIS CHART LISTS THE REQUIRED TESTS THAT CORRESPOND TO SPECIFIC END USES. AN EXPLANATION OF THE SYMBOL ALSO APPEARS.

FIRE RETARDANCY



Flammability testing determines a fabric's performance and resistance to burning.

APPLICATION

Upholstery
Panels and upholstered walls

PASSES

California bulletin 117, section E.
ASTM E 84-03 Class A or Class 1 (unadhered method).

COLOR FASTNESS TO WET & DRY CROCKING



Color fastness to wet & dry crocking refers to the rubbing off of color from the fabric onto clothing, hands or other materials and can occur under wet or dry conditions.

APPLICATION

Upholstery
Panels and upholstered walls

PASSES

AATCC 8-2001 Dry crocking. Class 4 minimum.
Wet crocking, Class 3 minimum.
AATCC 8-2001 E 84 (unadhered method).

COLOR FASTNESS TO LIGHT



Color fastness to light is the degree to which fabric will retain its color when exposed to light.

APPLICATION

Upholstery
Panels and upholstered walls

PASSES

AATCC option 2-2003 or AATCC - option 3-2003.
Class 4 minimum of 40 hours.
AATCC option 2-2003 or AATCC - option 3-2003.
Class 4 minimum of 40 hours.

PHYSICAL PROPERTIES



Three physical property tests include: 1 - Brush pill test to determine a fabric's pilling (the formation of fuzzy galls of fiber on the surface of a fabric). 2 - Breaking/tensile strength is the ability of a fabric to withstand tension without breaking or tearing. 3 - Seam slippage is the pulling apart of fabrics at the seams.

APPLICATION

Upholstery
Panels and upholstered walls

PASSES

Brush pill ASTM D3511-02, 3 minimum.
Breaking strength ASTM D5034-95 (2001) 50 lbs. minimum in warp & weft.
Seam slippage ASTM D4034 25 lbs. minimum in warp & weft.
Breaking strength ASTM D5034-95 (2001) (grab test).
35 lbs. minimum in warp & weft.

ABRASION



Abrasion is the ability of a fabric to withstand damage from wear and rubbing. There is a general contract specification as well as a heavy duty specification.

APPLICATION

General contract upholstery
Heavy duty upholstery

PASSES

ASTM D4157-02 (#10 cotton duck) 15,000 double rubs, Wyzenbeek method.
ASTM D4966-98 (12 KPA pressure) 20,000 double rubs, Martindale method.
ASTM D4157-02 (#10 cotton duck) 30,000 double rubs, Wyzenbeek method.
ASTM D4966-98 (12 KPA pressure) 40,000 double rubs, Martindale method.

patient + resident room furniture

Aldon

Accessories	33	Dressers.....	15
Bedside cabinets.....	10	Wardrobe cabinets	16

Sonoma

Accessories	33	Dressers.....	30
Bedside cabinets.....	23	Wardrobe cabinets	31



The Aldon series offers affordable and personalized furniture solutions for patient or resident rooms. Highly durable, Aldon's clean lines and simple design provide built-in quality to meet the demands of any healthcare environment. Tops, gables and backs are engineered for on-site maintenance and replacement to ensure long-term performance. The design incorporates smooth surfaces with a straight profile and durable finish options, demonstrating respect for housekeeping and infection prevention control practices. A 3mm PVC edge on tops, drawer and door fronts provides peace of mind for greater performance. The vast array of product and finish selections allow for individual choices while complementing the design objective. Aldon is the ideal balance of value and style.

Features and Benefits

- Tops standard with 1" thermally fused laminate with coordinating 3mm PVC edge.
- Chassis, back panels, drawer fronts, shelves and doors are constructed of ¾" thermally fused laminate.
- Constructed with NAUF (no added urea formaldehyde) particle board.
- Laminate finishes are available in a variety of colors.
- Thermofoil finishes are available on bedside cabinets.
- All chassis panels and tops can be replaced if damaged.
- Drawers are mounted on high quality precision steel full extension ball bearing slides.
- Optional high impact polystyrene insert liner can be removed for ease of room transfer and cleaning.
- Handle is attractive, easy-to-grip, arc style. Standard in Tungsten finish.
- Locks are optional on bedside cabinets, dressers and wardrobes.
- Metal legs and plinth bases available on all models.
- Casters are available on bedside cabinets.
- For proper ventilation, all units have cut-outs with grommets in the back.
- For environmental certifications, please visit globalfurnituregroup.com.

TOPS

- Tops are field replaceable.
- Tops on all models are standard with a 1" thermally fused laminate with coordinating 3mm PVC edge.
- 1" high pressure laminate tops with coordinating 3mm PVC edge are available on bedside cabinets and dressers. For a quotation, please submit a Special Request Form to your Global representative.
- Thermofoil and solid surface finishes are available on bedside cabinets only. See right column for finishes.

CHASSIS

- Constructed from ¾" thermally fused laminate.
- Return on investment is enhanced through the ability to replace chassis panels or tops should they become damaged.

BACK

- Back panels are constructed from ¾" thermally fused laminate.
- Back panels are field replaceable should they become damaged.

DRAWERS

- Drawer fronts are constructed from ¾" thermally fused laminate with 3mm PVC edge.
- Thermofoil finishes are available on bedside cabinets only. See right column for finishes.
- Mounted on high quality precision steel full extension ball bearing slides.
- Box drawer is 6" high with inside depth of 15.48".
- Drawer interiors are made of PVC-free Black vinyl particle board.
- Bottom drawer interior is fully wrapped in a Black colored durable vinyl covering.
- Soft close drawer is optional, specify **(SF)** at time of order. **Add \$46** per drawer.

DRAWER INSERTS

- The optional bedside cabinet drawer liner insert is constructed of high impact polystyrene, standard in White. Molded in one piece with no seams or joints to collect dust or bacteria, satin smooth and with rounded corners for easy clean up.
- Optional high impact polystyrene insert liner can be removed for ease of transferring personal belongings and cleaning.

SHELVING

- Structural fixed shelves and adjustable shelves are constructed from ¾" thermally fused laminate with coordinating 3mm PVC edge.
- Structural fixed shelves and adjustable shelves are supported with metal brackets.

DOORS

- Constructed from ¾" thermally fused laminate with 3mm PVC edge.
- Mounted using commercial quality hinges that provide a 110° opening span for easy access to personal belongings.

LOCKS

- Locks are optional on bedside cabinets, dressers and wardrobes. They must be specified at time of order. Please check each model number for optional locks offered and applicable upcharges.
- Keying is available with random key, please specify **(RK)**, or keyed alike.
- For key alike numbering sequence, please specify key number 101-120. No upcharge.

EDGE

- Tops, door fronts and drawer fronts have coordinating 3mm PVC edge.
- Fixed and adjustable shelves have coordinating 3mm PVC front edge.
- Top radius is 1" on bedside cabinet edges.

VENTILATION

- All units have cut-outs with grommets in the back for ventilation, reducing odor and bacteria growth.

BASE OPTIONS

- Metal legs, casters and plinth base are field replaceable and interchangeable on Aldon where applicable.

Metal Legs

- Available on bedside cabinets, dressers and wardrobes.
- Standard powder coated paint finishes are Black **(BLK)**, Blizzard **(BZD)**, Charcoal **(CHR)**, Kalua **(TKA)**, Latte **(TLA)**, Mocha **(TMO)**, Nevada **(NEV)**, Sierra **(SCA)**, Silver **(SIL)**, Taupe **(TPE)**, Toast **(TOA)** and Tungsten **(TUN)**.
- 3" high. Levelers offer .5" to .75" adjustment for increased stability and leveling.

Casters

- Available on bedside cabinets only.
- Constructed of commercial quality, swivel dual wheel.
- Front casters are manually locking, swivel dual wheel.
- When ordering two locking casters the casters will be in the front of the unit for ease of access, non-locking casters will be in the back.

Plinth Base

- Available on bedside cabinets, dressers and wardrobes.
- 3" high and standard in thermally fused laminate.
- Levelers offer .5" to .75" adjustment for increased stability and leveling.

STANDARD LAMINATE FINISHES

- | | |
|------------------------------|----------------------------------|
| (ACJ) Absolute Acajou | (HLN) Hayden Linen |
| (ASN) Asian Night | (QTM) Quartered Mahogany |
| (AWC) Avant Cherry | (NBL) Noce Biondo |
| (AWH) Avant Honey | (NGL) Noce Grigio |
| (BLK) Black | (NEL) Noce Leggero |
| (BZD) Blizzard | (NML) Noce Medio |
| (BMX) Blizzard Matrix | (SBY) Sheer Beauty |
| (BRC) Brushed Cobalt | (SDT) Stonedust |
| (CMB) Clear Maple | (SLN) Stone Linen |
| (CGY) Custom Grey | (SOG) Storm Grey |
| (DES) Dark Espresso | (STG) String |
| (DWT) Designer White | (SWX) Studio White Matrix |
| (GRX) Grey Matrix | (WHE) Walnut Heights |
| (FAS) Fashionista | (WHC) White Chocolate |
| (FCL) First Class | (WCR) Winter Cherry |

THERMOFOIL FINISHES - FRONT & TOP

- Thermofoil finishes are available on bedside cabinets only.
 - Please specify by adding **"TH"** to the end of the model code.
- | | |
|------------------------------|------------------------------|
| (ACJ) Absolute Acajou | (FAS) Fashionista |
| (CMB) Clear Maple | (FCL) First Class |
| (CGY) Custom Grey | (SBY) Sheer Beauty |
| (DES) Dark Espresso | (SOG) Storm Grey |
| (DWT) Designer White | (WHC) White Chocolate |

SPILL COLLECTOR

- Spill collector **(SC)** is optional on the edge of bedside cabinets with Thermofoil finish only.



HANDLES

- Handles require a 128mm center point if custom styles are desired.
- Handle style must be specified at time of order.
- **A1** handle is standard, also offered in seven options below:



A1
Arc - Sierra



A3
Arc - Matte Chrome



B1
Bow - Matte Chrome



CM1
Contemporary Metal Pull -
Matte Chrome



CM2
Contemporary Metal Pull -
Matte Black



TM1
Transitional Metal Pull -
Brushed Nickel



TM2
Transitional Metal Pull -
Matte Black



RPH1 (add \$57/handle)
Recessed - Silver

- Handles can be ordered separately (except for recessed handle). **Add \$31.**

Please specify:

(GC-A1): Arc - Sierra

(GC-A3): Arc - Matte Chrome

(GC-B1): Bow - Matte Chrome

(GC-CM1): Contemporary Metal Pull - Matte Chrome

(GC-CM2): Contemporary Metal Pull - Matte Black

(GC-TM1): Transitional Metal Pull - Brushed Nickel

(GC-TM2): Transitional Metal Pull - Matte Black

- Recessed handle (**RPH1**) must be specified at time of order. **Add \$57** per handle.
- For additional finish options, please contact your Global sales representative.
- To view the healthcare handle finish options, visit globalfurnituregroup.com and go to the Aldon finishes section.

SOLID SURFACE FINISHES - TOP ONLY

- See models ending in "**C1**" or "**C2**".

Grade 1 (**C1**)

Designer White (SWH)

Grade 2 (**C2**)

Beige Tempest (SBT)

Hot Stone (SHS)

Black Onyx Mirage (SBX)

Milk Glass Spectra (SMG)

Frosty White Mirage (SFW)

Northern Melange (SNM)

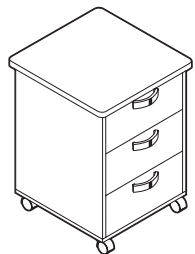

Standard - Laminate
top, front and case



TH - Thermofoil top and front
with laminate case



THSC - Thermofoil top with spillguard,
fronts and laminate case

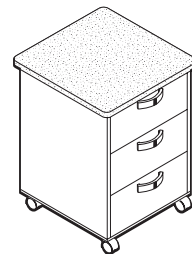

C1/C2 - Solid surface top with
laminate front and case

CUSTOM

- Global welcomes the opportunity to provide special request quotations for project business. For pricing, visit the Dealer Centre and click on "Specials" on the left sidebar to submit your request.

SHIPPING

- All products are shipped assembled, one per carton.
- Allow 4-6 weeks for delivery

BEDSIDE CABINETS

MODEL # DIMENSIONS ^{IN}_{MM} WEIGHT ^{LB}_{KG} VOLUME ^{FT³}_{MT³} LIST PRICE

W x D x H



Bedside Cabinet

GCEXBT01CN	21.38 x 22.14 x 30 543 x 562 x 762	96 43.54	8.5 0.24	\$1004
GCEXBT01CNTH w/Thermofoil top and front				\$1378
GCEXBT01CNTHSC w/Thermofoil top with spillguard and front				\$1378
GCEXBT01CNC1 w/solid surface top (grade 1)				\$2044
GCEXBT01CNC2 w/solid surface top (grade 2)				\$2219

Three drawers on four casters. Standard with no lock. Shipped assembled, 1 per carton.
 • For lock on top drawer, specify **(LK)**. Add \$62. Specify random key **(RK)** or key number 101-120.



Bedside Cabinet

GCEXBT01LN	21.38 x 22.14 x 30 543 x 562 x 762	96 43.54	8.5 0.24	\$1069
GCEXBT01LNTH w/Thermofoil top and front				\$1478
GCEXBT01LNTHSC w/Thermofoil top with spillguard and front				\$1478
GCEXBT01LNC1 w/solid surface top (grade 1)				\$2109
GCEXBT01LNC2 w/solid surface top (grade 2)				\$2284

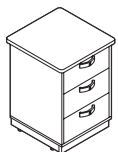

Three drawers with metal legs. Standard with no lock. Shipped assembled, 1 per carton.
 • For lock on top drawer, specify **(LK)**. Add \$62. Specify random key **(RK)** or key number 101-120.



Bedside Cabinet

GCEXBT01PN	21.38 x 22.14 x 30 543 x 562 x 762	96 43.54	8.5 0.24	\$1108
GCEXBT01PNTH w/Thermofoil top and front				\$1486
GCEXBT01PNTHSC w/Thermofoil top with spillguard and front				\$1486
GCEXBT01PNC1 w/solid surface top (grade 1)				\$2146
GCEXBT01PNC2 w/solid surface top (grade 2)				\$2322

Three drawers on plinth base. Standard with no lock. Shipped assembled, 1 per carton.
 • For lock on top drawer, specify **(LK)**. Add \$62. Specify random key **(RK)** or key number 101-120.

BEDSIDE CABINETS	MODEL #	DIMENSIONS ^{IN} _{MM}	WEIGHT ^{LB} _{KG}	VOLUME ^{FT³} _{MT³}	LIST PRICE
 <p>Bedside Cabinet</p>	GCEXBT04CN	21.38 x 22.14 x 30 543 x 562 x 762	94 42.63	8.5 0.24	\$963
	GCEXBT04CNTH	w/Thermofoil top and front			\$1291
	GCEXBT04CNTHSC	w/Thermofoil top with spillguard and front			\$1291
	GCEXBT04CNC1	w/solid surface top (grade 1)			\$2001
	GCEXBT04CNC2	w/solid surface top (grade 2)			\$2177
<p>One open fixed shelf and two drawers, on four casters. Standard with no lock. Shipped assembled, 1 per carton.</p> <ul style="list-style-type: none"> • For lock on top drawer, specify (LK). Add \$62. Specify random key (RK) or key number 101-120. 					
 <p>Bedside Cabinet</p>	GCEXBT04LN	21.38 x 22.14 x 30 543 x 562 x 762	94 42.63	8.5 0.24	\$1027
	GCEXBT04LNTH	w/Thermofoil top and front			\$1394
	GCEXBT04LNTHSC	w/Thermofoil top with spillguard and front			\$1394
	GCEXBT04LNC1	w/solid surface top (grade 1)			\$2066
	GCEXBT04LNC2	w/solid surface top (grade 2)			\$2242
<p>One open fixed shelf and two drawers, with metal legs. Standard with no lock. Shipped assembled, 1 per carton.</p> <ul style="list-style-type: none"> • For lock on top drawer, specify (LK). Add \$62. Specify random key (RK) or key number 101-120. 					
 <p>Bedside Cabinet</p>	GCEXBT04PN	21.38 x 22.14 x 30 543 x 562 x 762	94 42.63	8.5 0.24	\$1054
	GCEXBT04PNTH	w/Thermofoil top and front			\$1386
	GCEXBT04PNTHSC	w/Thermofoil top with spillguard and front			\$1386
	GCEXBT04PNC1	w/solid surface top (grade 1)			\$2093
	GCEXBT04PNC2	w/solid surface top (grade 2)			\$2269
<p>One open fixed shelf and two drawers, on plinth base. Standard with no lock. Shipped assembled, 1 per carton.</p> <ul style="list-style-type: none"> • For lock on top drawer, specify (LK). Add \$62. Specify random key (RK) or key number 101-120. 					

BEDSIDE CABINETS



Bedside Cabinet

MODEL #	DIMENSIONS ^{IN} _{MM}	WEIGHT ^{LB} _{KG}	VOLUME ^{FT³} _{MT³}	LIST PRICE
GCEXBT06CLN	21.38 x 22.14 x 30 543 x 562 x 762	92 41.73	8.5 0.24	\$913
GCEXBT06CLNTH w/Thermofoil top and front				\$1318
GCEXBT06CLNTHSC w/Thermofoil top with spillguard and front				\$1318
GCEXBT06CLNC1 w/solid surface top (grade 1)				\$1951
GCEXBT06CLNC2 w/solid surface top (grade 2)				\$2127

Top position drawer, one **left** opening door (hinges on left) with 3-position adjustable shelf behind door, on four casters. Standard with no locks. Shipped assembled, 1 per carton.

- For lock on drawer, specify **(LK)**. Add \$62.
- For lock on door, specify **(L3)**. Add \$62.
- For locks on drawer and door, specify **(L5)**. Add \$123.
- Specify random key **(RK)** or key number 101-120.

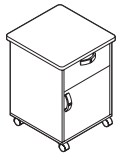

Bedside Cabinet

GCEXBT06CRN	21.38 x 22.14 x 30 543 x 562 x 762	92 41.73	8.5 0.24	\$913
GCEXBT06CRNTH w/Thermofoil top and front				\$1318
GCEXBT06CRNTHSC w/Thermofoil top with spillguard and front				\$1318
GCEXBT06CRNC1 w/solid surface top (grade 1)				\$1951
GCEXBT06CRNC2 w/solid surface top (grade 2)				\$2127

Top position drawer, one **right** opening door (hinges on right) with 3-position adjustable shelf behind door, on four casters. Standard with no locks. Shipped assembled, 1 per carton.

- For lock on drawer, specify **(LK)**. Add \$62.
- For lock on door, specify **(L4)**. Add \$62.
- For locks on drawer and door, specify **(L6)**. Add \$123.
- Specify random key **(RK)** or key number 101-120.

BEDSIDE CABINETS	MODEL #	DIMENSIONS ^{IN} _{MM}	WEIGHT ^{LB} _{KG}	VOLUME ^{FT³} _{MT³}	LIST PRICE
------------------	---------	---	---------------------------------------	---	------------

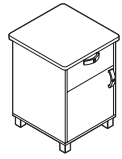

Bedside Cabinet

	W x D x H			
GCEXBT06LLN	21.38 x 22.14 x 30	92	8.5	\$955
	543 x 562 x 762	41.73	0.24	
GCEXBT06LLNTH				\$1421
w/Thermofoil top and front				
GCEXBT06LLNTHSC				\$1421
w/Thermofoil top with spillguard and front				
GCEXBT06LLNC1				\$1994
w/solid surface top (grade 1)				
GCEXBT06LLNC2				\$2169
w/solid surface top (grade 2)				

Top position drawer, one **left** opening door (hinges on left) with 3-position adjustable shelf behind door, with metal legs. Standard with no locks. Shipped assembled, 1 per carton.

- For lock on drawer, specify **(LK)**. Add \$62.
- For lock on door, specify **(L3)**. Add \$62.
- For locks on drawer and door, specify **(L5)**. Add \$123.
- Specify random key **(RK)** or key number 101-120.

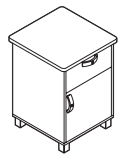

Bedside Cabinet

GCEXBT06LRN	21.38 x 22.14 x 30	92	8.5	\$955
	543 x 562 x 762	41.73	0.24	
GCEXBT06LRNTH				\$1421
w/Thermofoil top and front				
GCEXBT06LRNTHSC				\$1421
w/Thermofoil top with spillguard and front				
GCEXBT06LRNC1				\$1994
w/solid surface top (grade 1)				
GCEXBT06LRNC2				\$2169
w/solid surface top (grade 2)				

Top position drawer, one **right** opening door (hinges on right) with 3-position adjustable shelf behind door, with metal legs. Standard with no locks. Shipped assembled, 1 per carton.

- For lock on drawer, specify **(LK)**. Add \$62.
- For lock on door, specify **(L4)**. Add \$62.
- For locks on drawer and door, specify **(L6)**. Add \$123.
- Specify random key **(RK)** or key number 101-120.

BEDSIDE CABINETS

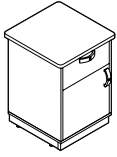

Bedside Cabinet

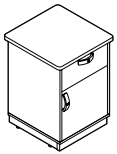

Bedside Cabinet

MODEL #	DIMENSIONS ^{IN} _{MM}	WEIGHT ^{LB} _{KG}	VOLUME ^{FT³} _{MT³}	LIST PRICE
---------	---	---------------------------------------	---	------------

W x D x H

GCEXBT06PLN	21.38 x 22.14 x 30 543 x 562 x 762	92 41.73	8.5 0.24	\$974
GCEXBT06PLNTH w/Thermofoil top and front				\$1414
GCEXBT06PLNTHSC w/Thermofoil top with spillguard and front				\$1414
GCEXBT06PLNC1 w/solid surface top (grade 1)				\$2013
GCEXBT06PLNC2 w/solid surface top (grade 2)				\$2189



Top position drawer, one **left** opening door (hinges on left) with 3-position adjustable shelf behind door, on plinth base. Standard with no locks. Shipped assembled, 1 per carton.

- For lock on drawer, specify **(LK)**. Add \$62.
- For lock on door, specify **(L3)**. Add \$62.
- For locks on drawer and door, specify **(L5)**. Add \$123.
- Specify random key **(RK)** or key number 101-120.

GCEXBT06PRN	21.38 x 22.14 x 30 543 x 562 x 762	92 41.73	8.5 0.24	\$974
GCEXBT06PRNTH w/Thermofoil top and front				\$1414
GCEXBT06PRNTHSC w/Thermofoil top with spillguard and front				\$1414
GCEXBT06PRNC1 w/solid surface top (grade 1)				\$2013
GCEXBT06PRNC2 w/solid surface top (grade 2)				\$2189

Top position drawer, one **right** opening door (hinges on right) with 3-position adjustable shelf behind door, on plinth base. Standard with no locks. Shipped assembled, 1 per carton.

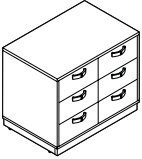
- For lock on drawer, specify **(LK)**. Add \$62.
- For lock on door, specify **(L4)**. Add \$62.
- For locks on drawer and door, specify **(L6)**. Add \$123.
- Specify random key **(RK)** or key number 101-120.

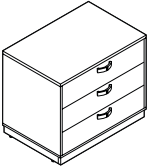
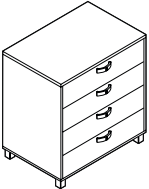
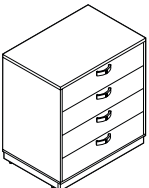
DRESSERS	MODEL #	DIMENSIONS ^{IN} _{MM}	WEIGHT ^{LB} _{KG}	VOLUME ^{FT³} _{MT³}	LIST PRICE
 <p>Double Dresser</p>	GCEXDD01LN	36.19 x 24.13 x 30	180	18	\$1799
		919 x 613 x 762	81.64	0.5	
<p>Three drawers on each side, on metal legs. Standard with no locks. Shipped assembled, 1 per carton.</p> <ul style="list-style-type: none"> • For lock on top right drawer, specify (LR). Add \$62. • For lock on top left drawer, specify (LL). Add \$62. • For lock on top right and left drawers, specify (L8). Add \$123. • Specify random key (RK) or key number 101-120. 					
 <p>Double Dresser</p>	GCEXDD01PN	36.19 x 24.13 x 30	180	18	\$1857
		919 x 613 x 762	81.64	0.5	
<p>Three drawers on each side, on plinth base. Standard with no locks. Shipped assembled, 1 per carton.</p> <ul style="list-style-type: none"> • For lock on top right drawer, specify (LR). Add \$62. • For lock on top left drawer, specify (LL). Add \$62. • For lock on top right and left drawers, specify (L8). Add \$123. • Specify random key (RK) or key number 101-120. 					
 <p>3-Drawer Dresser</p>	GCEXDR02LN	35.63 x 24.13 x 30	142	17	\$1482
		905 x 613 x 762	64.41	0.48	
<p>Three drawers on metal legs. Standard with no lock. Shipped assembled, 1 per carton.</p> <ul style="list-style-type: none"> • For lock on top drawer, specify (LK). Add \$62. 					
 <p>3-Drawer Dresser</p>	GCEXDR02PN	35.63 x 24.13 x 30	142	17	\$1543
		905 x 613 x 762	64.41	0.48	
<p>Three drawers on plinth base. Standard with no lock. Shipped assembled, 1 per carton.</p> <ul style="list-style-type: none"> • For lock on top drawer, specify (LK). Add \$62. 					
 <p>4-Drawer Dresser</p>	GCEXDR07LN	35.63 x 24.13 x 38.5	153	22	\$1707
		905 x 613 x 978	69.39	0.62	
<p>Four drawers on metal legs. Standard with no lock. Shipped assembled, 1 per carton.</p> <ul style="list-style-type: none"> • For lock on top drawer, specify (LK). Add \$62. 					
 <p>4-Drawer Dresser</p>	GCEXDR07PN	35.63 x 24.13 x 38.5	153	22	\$1788
		905 x 613 x 978	69.39	0.62	
<p>Four drawers on plinth base. Standard with no lock. Shipped assembled, 1 per carton.</p> <ul style="list-style-type: none"> • For lock on top drawer, specify (LK). Add \$62. 					

DRESSERS

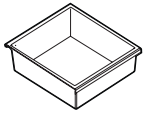

Bedside Drawer Liner

MODEL #	DIMENSIONS ^{IN} _{MM}	WEIGHT ^{LB} _{KG}	VOLUME ^{FT³} _{MT³}	LIST PRICE
GCExLLP01	16.5 x 15.5 x 4.5	3.5	1	\$65
	419 x 394 x 114	1.58	0.02	

High impact polystyrene insert liner for bedside cabinet 6" drawers. Can be removed for ease of room transfer and cleaning. Shipped assembled, 1 per carton.

WARDROBE CABINETS

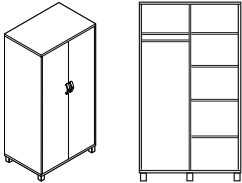

Wardrobe Cabinet

MODEL #	DIMENSIONS ^{IN} _{MM}	WEIGHT ^{LB} _{KG}	VOLUME ^{FT³} _{MT³}	LIST PRICE
GCExWD03LN	35.63 x 24.13 x 72	305	43	\$2104
	905 x 613 x 1829	138.34	1.21	

Inside dimensions:
 • Left side top shelf: 12.85" • Left side clothing rail area: 53.2" • Right side with adjustable shelves area: 66.59"

Divided wardrobe with J-style safety clothing rail and shelves, on 5 metal legs. Two doors covering interior divided in two with an upper fixed shelf and J-style safety clothing rail on the left side. The right side has four adjustable shelves. For safety, anti-tip hardware is recommended. Anti-tip security kits are available separately; order product code GCAT400 and quantity required. Standard with no lock. Shipped assembled, 1 per carton.

- For one lock fastening both doors, specify **(LB)**. Add \$62. Specify random key **(RK)** or key number 101-120.

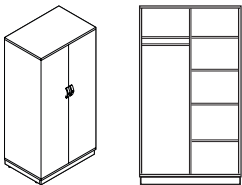

Wardrobe Cabinet

GCExWD03PN	35.63 x 24.13 x 72	305	43	\$2185
	905 x 613 x 1829	138.34	1.21	

Inside dimensions:
 • Left side top shelf: 12.85" • Left side clothing rail area: 53.2" • Right side with adjustable shelves area: 66.59"

Divided wardrobe with J-style safety clothing rail and shelves, on plinth base. Two doors covering interior divided in two with an upper fixed shelf and J-style safety clothing rail on the left side. The right side has four adjustable shelves. For safety, anti-tip hardware is recommended. Anti-tip security kits are available separately; order product code GCAT400 and quantity required. Standard with no lock. Shipped assembled, 1 per carton.

- For one lock fastening both doors, specify **(LB)**. Add \$62. Specify random key **(RK)** or key number 101-120.

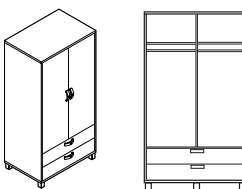

Wardrobe Cabinet

GCExWD04LN	35.63 x 24.13 x 72	316	43	\$2594
	905 x 613 x 1829	143.33	1.21	

Inside dimensions:
 • Left side top shelf: 7" • Right side top shelf: 7" • Top drawer: 8.25"
 • Left side clothing rail area: 42" • Right side clothing rail area: 42" • Lower drawer: 8.25"

Divided wardrobe with J-style safety clothing rail and two full drawers below, on 5 metal legs. Two doors covering interior divided in two with an upper fixed shelf and J-style safety clothing rail on both sides. Two exposed drawers below. For safety, anti-tip hardware is recommended. Anti-tip security kits are available separately; order product code GCAT400 and quantity required. Standard with no locks. Shipped assembled, 1 per carton.

- For lock on right door, specify **(L4)**. Add \$62.
- For lock on left door, specify **(L3)**. Add \$62.
- For lock on both right and left doors, specify **(L2)**. Add \$123.
- For lock on top drawer, specify **(LK)**. Add \$62.
- For lock on right door and top drawer, specify **(L6)**. Add \$123.
- For lock on left door and top drawer, specify **(L5)**. Add \$123.
- For lock on right door, left door and top drawer, specify **(L9)**. Add \$185.
- Specify random key **(RK)** or key number 101-120.

WARDROBE CABINETS **MODEL #** **DIMENSIONS** ^{IN} _{MM} **WEIGHT** ^{LB} _{KG} **VOLUME** ^{FT³} _{MT³} **LIST PRICE**

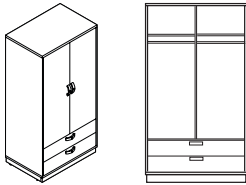

Wardrobe Cabinet

MODEL #	DIMENSIONS ^{IN} _{MM}		WEIGHT ^{LB} _{KG}	VOLUME ^{FT³} _{MT³}	LIST PRICE
	W x D x H				
GCEXWD04PN	35.63 x 24.13 x 72		316	43	\$2677
	905 x 613 x 1829		143.33	1.21	

Inside dimensions:

- Left side top shelf: 7"
- Left side clothing rail area: 42"
- Right side top shelf: 7"
- Right side clothing rail area: 42"
- Top drawer: 8.25"
- Lower drawer: 8.25"

Divided wardrobe with J-style safety clothing rail and two full drawers below, on plinth base. Two doors covering interior divided in two with an upper fixed shelf and J-style safety clothing rail on both sides. Two exposed drawers below. For safety, anti-tip hardware is recommended. Anti-tip security kits are available separately; order product code GCAT400 and quantity required. Standard with no locks. Shipped assembled, 1 per carton.

- For lock on right door, specify **(L4)**. Add \$62.
- For lock on left door, specify **(L3)**. Add \$62.
- For lock on both right and left doors, specify **(L2)**. Add \$123.
- For lock on top drawer, specify **(LK)**. Add \$62.
- For lock on right door and top drawer, specify **(L6)**. Add \$123.
- For lock on left door and top drawer, specify **(L5)**. Add \$123.
- For lock on right door, left door and top drawer, specify **(L9)**. Add \$185.
- Specify random key **(RK)** or key number 101-120.

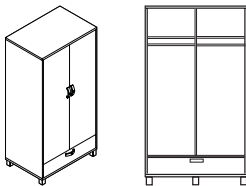

Wardrobe Cabinet

GCEXWD05LN	35.63 x 24.13 x 72		305	43	\$2566
	905 x 613 x 1829		138.34	1.21	

Inside dimensions:

- Left side top shelf: 7"
- Left side clothing rail area: 50.4"
- Right side top shelf: 7"
- Right side clothing rail area: 50.4"
- Drawer: 8.25"

Divided wardrobe with J-style safety clothing rail and one full drawer below, on 5 metal legs. Two doors covering interior divided in two with an upper fixed shelf and J-style safety clothing rail on both sides. One exposed drawer below. For safety, anti-tip hardware is recommended. Anti-tip security kits are available separately; order product code GCAT400 and quantity required. Standard with no locks. Shipped assembled, 1 per carton.

- For lock on right door, specify **(L4)**. Add \$62.
- For lock on left door, specify **(L3)**. Add \$62.
- For lock on both right and left doors, specify **(L2)**. Add \$123.
- For lock on top drawer, specify **(LK)**. Add \$62.
- For lock on right door and top drawer, specify **(L6)**. Add \$123.
- For lock on left door and top drawer, specify **(L5)**. Add \$123.
- For lock on right door, left door and top drawer, specify **(L9)**. Add \$185.
- Specify random key **(RK)** or key number 101-120.

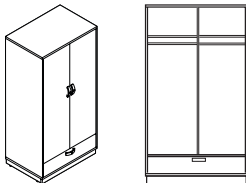

Wardrobe Cabinet

GCEXWD05PN	35.63 x 24.13 x 72		305	43	\$2586
	905 x 613 x 1829		138.34	1.21	

Inside dimensions:

- Left side top shelf: 7"
- Left side clothing rail area: 50.4"
- Right side top shelf: 7"
- Right side clothing rail area: 50.4"
- Drawer: 8.25"

Divided wardrobe with J-style safety clothing rail and one full drawer below, on plinth base. Two doors covering interior divided in two with an upper fixed shelf and J-style safety clothing rail on both sides. One exposed drawer below. For safety, anti-tip hardware is recommended. Anti-tip security kits are available separately; order product code GCAT400 and quantity required. Standard with no locks. Shipped assembled, 1 per carton.

- For lock on right door, specify **(L4)**. Add \$62.
- For lock on left door, specify **(L3)**. Add \$62.
- For lock on both right and left doors, specify **(L2)**. Add \$123.
- For lock on top drawer, specify **(LK)**. Add \$62.
- For lock on right door and top drawer, specify **(L6)**. Add \$123.
- For lock on left door and top drawer, specify **(L5)**. Add \$123.
- For lock on right door, left door and top drawer, specify **(L9)**. Add \$185.
- Specify random key **(RK)** or key number 101-120.

NARROW WARDROBE CABINETS

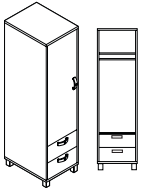

Narrow Wardrobe Cabinet

MODEL #	DIMENSIONS ^{IN} _{MM}	WEIGHT ^{LB} _{KG}	VOLUME ^{FT³} _{MT³}	LIST PRICE
GCEXWN02LLN	18.63 x 24.13 x 72	136	24	\$1887
	473 x 613 x 1829	61.68	0.67	

Inside dimensions:

- Top shelf: 7" • Clothing rail area: 42" • Top drawer: 8.25" • Lower drawer: 8.25"

Narrow wardrobe with J-style safety clothing rail and two drawers below, on four metal legs. One **left** door (hinges on left) covering upper fixed shelf and J-style safety clothing rail. Two exposed drawers below. For safety, anti-tip hardware is recommended. Anti-tip security kits are available separately; order product code GCAT400 and quantity required. Standard with no locks. Shipped assembled, 1 per carton.

- For lock on drawer, specify **(LK)**. Add \$62.
- For lock on door, specify **(L3)**. Add \$62.
- For locks on door and drawer, specify **(L5)**. Add \$123.
- Specify random key **(RK)** or key number 101-120.

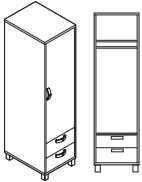

Narrow Wardrobe Cabinet

GCEXWN02LRN	18.63 x 24.13 x 72	136	24	\$1887
	473 x 613 x 1829	61.68	0.67	

Inside dimensions:

- Top shelf: 7" • Clothing rail area: 42" • Top drawer: 8.25" • Lower drawer: 8.25"

Narrow wardrobe with J-style safety clothing rail and two drawers below, on four metal legs. One **right** door (hinges on right) covering upper fixed shelf and J-style safety clothing rail. Two exposed drawers below. For safety, anti-tip hardware is recommended. Anti-tip security kits are available separately; order product code GCAT400 and quantity required. Standard with no locks. Shipped assembled, 1 per carton.

- For lock on top drawer, specify **(LK)**. Add \$62.
- For lock on door, specify **(L4)**. Add \$62.
- For locks on door and top drawer, specify **(L6)**. Add \$123.
- Specify random key **(RK)** or key number 101-120.

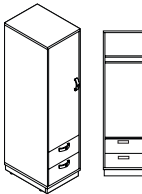

Narrow Wardrobe Cabinet

GCEXWN02PLN	18.63 x 24.13 x 72	136	24	\$1784
	473 x 613 x 1829	61.68	0.67	

Inside dimensions:

- Top shelf: 7" • Clothing rail area: 42" • Top drawer: 8.25" • Lower drawer: 8.25"

Narrow wardrobe with J-style safety clothing rail and two drawers below, on plinth base. One **left** door (hinges on left) covering upper fixed shelf and J-style safety clothing rail. Two exposed drawers below. For safety, anti-tip hardware is recommended. Anti-tip security kits are available separately; order product code GCAT400 and quantity required. Standard with no locks. Shipped assembled, 1 per carton.

- For lock on top drawer, specify **(LK)**. Add \$62.
- For lock on door, specify **(L3)**. Add \$62.
- For locks on door and top drawer, specify **(L5)**. Add \$123.
- Specify random key **(RK)** or key number 101-120.

NARROW WARDROBE CABINETS **MODEL #** **DIMENSIONS** ^{IN} / ^{MM} **WEIGHT** ^{LB} / ^{KG} **VOLUME** ^{FT³} / ^{MT³} **LIST PRICE**

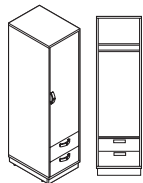

Narrow Wardrobe Cabinet

	W x D x H			
GCEXWN02PRN	18.63 x 24.13 x 72	136	24	\$1784
	473 x 613 x 1829	61.68	0.67	

Inside dimensions:

- Top shelf: 7"
- Clothing rail area: 42"
- Top drawer: 8.25"
- Lower drawer: 8.25"

Narrow wardrobe with J-style safety clothing rail and two drawers below, on plinth base. One **right** door (hinges on right) covering upper fixed shelf and J-style safety clothing rail. Two exposed drawers below. For safety, anti-tip hardware is recommended. Anti-tip security kits are available separately; order product code GCAT400 and quantity required. Standard with no locks. Shipped assembled, 1 per carton.

- For lock on top drawer, specify **(LK)**. Add \$62.
- For lock on door, specify **(L4)**. Add \$62.
- For locks on door and top drawer, specify **(L6)**. Add \$123.
- Specify random key **(RK)** or key number 101-120.



Replacement Lock Set

GCEXCOREK	20 x 22 x 35	16	0.01	\$62
	508 x 559 x 889	7.3	-	

Replacement core and key.



Replacement Key

GCEXKEY	24.5 x 29 x 41	35	0.1	\$15
	622 x 737 x 1041	15	-	

Replacement key for bedside cabinets, dressers and wardrobes. Specify key number 101-120.

ACCESSORIES

For Aldon accessories, please refer to the models listed under Sonoma:

- Safety garment hook: page 33
- Headboards/footboards: page 34
- Wardrobe mirror (for door 11"W x 29"H): page 34



Sonoma offers superior construction detail in an extensive selection of furniture pieces to fit the personal storage requirements of various lifestyle environments including long-term care, retirement, senior living residences and hospitals.

Features distinctive aluminum extrusions on all leading corners allowing for a continuous connection of chassis panels from top-to-bottom providing enhanced performance and durability. The aluminum extrusions offer increased protection from the impact of mobile equipment and furniture used in demanding healthcare environments.

Products have ventilation and drainage features built into the unique design providing air circulation and drainage where required. Products are freestanding allowing access underneath for cleaning.

Features decorative fascia options to enhance the decor of any environment with the additional benefit of providing a safety guard to prevent items from falling behind units.

Wardrobe cabinets offer a safety garment hook with a safety feature to support a maximum of 75 lbs. The J-style safety clothing rail ensures maximum wellbeing and peace of mind from accidents.

Multiple needs and requirements are met with the several styles and a variety of interior configurations.

Features and Benefits

- Tops for units 37.5" or lower are constructed with 1" high pressure laminate.
- Tops for units above 37.5" in height and structural fixed shelves are constructed of 1" thermally fused laminate.
- Chassis, back panels, drawer fronts, adjustable shelves, doors and fascia profiles are constructed of 0.75" thermally fused laminate.
- 3mm polymer edge with top over side panel design.
- Constructed with NAUF (no added urea formaldehyde) particle board.
- Laminate finishes are available in a variety of colors.
- Thermofoil finishes are available on bedside cabinets. See notes for order requirements.
- All chassis panels and tops can be replaced if damaged.
- Drawers are mounted on high quality precision steel full extension ball bearing slides.
- Locks are optional on the top drawer position of all units.
- Aluminum extrusions, legs and plastic parts are available in twelve paint finishes.
- Casters are available on bedside units.
- Handles are offered in six styles.
- For environmental certifications, please visit globalfurnituregroup.com.

ACCESSORIES

- A complementary line of accessories is available to complete and enhance any room or setting.
- Bookcases offer the same superior construction utilizing aluminum extrusions on each corner and are available in several heights.

TOPS

- Units of 37.5" or lower are constructed with 1" high pressure laminate with coordinating 3mm polymer edge.
- Units above 37.5" in height are constructed with 1" thermally fused laminate with coordinating 3mm polymer edge.
- Thermofoil and solid surface finishes are available on bedside cabinets only. See page 22 for finishes.

CHASSIS

- Constructed from 0.75" thermally fused laminate.
- Connected using aluminum extrusions allowing for a continuous connection top-to-bottom.
- Return on investment is enhanced through the ability to replace chassis panels or tops should they become damaged.

BACK

- Back panels are constructed from 0.75" thermally fused laminate.

DRAWERS

- Drawer fronts are constructed of 0.75" thermally fused laminate with 3mm PVC edge.
- Thermofoil finishes are available on bedside cabinets only. See page 22 for finishes.
- Mounted on high quality precision steel full extension ball bearing slides.
- Drawer depth is determined by the individual product size:
20" deep cabinets feature 15.5" drawers.
22" and 26" deep products feature 17.25" drawers.
- Bottom drawer interior is fully wrapped in a White colored durable vinyl covering. This vinyl wrap offers superior durability and performance in demanding environments.
- Soft close drawer is optional, specify **(SF)** at time of order. **Add \$46** per drawer.

DRAWER INSERTS

- The optional bedside cabinet drawer liner insert and personal organizer tray sets are constructed of high impact styrene plastic in a neutral color (French Vanilla). See page 34 for purchase information.
- High impact styrene plastic liners have been specially designed to saddle the drawer edges for a perfect fit while eliminating gaps and potential traps.
- High impact styrene plastic insert liner and organizer tray set can be removed for ease of room transfer and cleaning.

SHELVING

- Structural fixed shelves are constructed of 1" thermally fused laminate with coordinating self edge.
- Adjustable shelves are constructed of 0.75" thermally fused laminate with coordinating self edge.
- Shelf pins are offered for securing shelf with self-drilling screws to prevent accidental movement.

DOORS

- Constructed of 0.75" thermally fused laminate with 3mm PVC edge.
- Mounted utilizing commercial quality hinges that provide a 170° opening span for easy access to personal belongings.

SPILL COLLECTOR

- Spill collector **(SC)** is optional on the edge of bedside cabinets with Thermofoil finish only.



LOCKS

- A lock is optional on the top drawer position of all units with drawers. Must be specified at time of order.
- Random keying will be provided as standard when locks are ordered.
- For key alike numbering sequence, please specify keys number 401-440.
- For specifying lock on top drawer, indicate **(LS)** (lock set) after model number. **Add \$62**.

ALUMINUM EXTRUSIONS/LEGS/PLASTIC PARTS

- Aluminum extrusions form the structural integrity of the product, ensuring a continuous solid connection for the unit chassis as well as providing leg support.
- The aluminum extrusion connection/leg is extended to allow clearance under each unit for access during cleaning.
- The aluminum extrusion connection/leg is standard with Charcoal color plastic glide and a non-marking leveler.
- Levelers offer 0.5" adjustment for increased stability and leveling.
- Standard powder coated paint finishes are Black **(BLK)**, Blizzard **(BZD)**, Charcoal **(CHR)**, Kalua **(TKA)**, Latte **(TLA)**, Mocha **(TMO)**, Nevada **(NEV)**, Sierra **(SCA)**, Silver **(SIL)**, Taupe **(TPE)** and Toast **(TOA)**.
- Tungsten **(TUN)** finish is available at a **10% upcharge**.
- Custom powder coated paint finishes are available. Please contact your Global sales representative for further details.

CASTERS

- Available only on specific units.
- Products allowing use of casters are identified by the product code followed by a **(C)**.
- Casters must be specified at time of order.
- Casters cannot be retrofitted in the field.
- Casters are commercial quality, swivel dual wheel manual locking.
- When ordering two locking casters the casters will be in the front of the unit for ease of access, non-locking casters will be in the back.

HANDLES

- Handles require a 128mm center point if custom styles are desired.
- **A1** Arc handle is standard, also offered in six options below:



A1
Arc - Sierra



B1
Bow - Matte Chrome



CM1
Contemporary Metal Pull -
Matte Chrome



CM2
Contemporary Metal Pull -
Matte Black



TM1
Transitional Metal Pull -
Brushed Nickel



TM2
Transitional Metal Pull -
Matte Black



RPH1 (add \$57/handle)
Recessed - Silver

- Handles can be ordered separately (except for recessed handle). **Add \$31**.
Please specify:
(GC-A1): Arc - Sierra **(GC-CM2):** Contemporary Metal Pull - Matte Black
(GC-B1): Bow - Matte Chrome **(GC-TM1):** Transitional Metal Pull - Brushed Nickel
(GC-CM1): Contemporary Metal Pull - Matte Chrome **(GC-TM2):** Transitional Metal Pull - Matte Black
- Recessed handle **(RPH1)** must be specified at time of order and is not available for use on GCSNBT01Sxx, GCSNBT01CSxx and GCSNBT014CSxx. **Add \$57** per handle.
- For additional finish options, please contact your Global sales representative.
- To view the healthcare handle finish options, visit globalfurnituregroup.com and go to the Sonoma finishes section.

OPTIONAL DECORATIVE TOP FASCIA

- Top fascia is available on bedside cabinets only and keeps items from falling off the back of the unit. The top fascia profile is installed on site.
- Top fascia is available only in laminate, in two styles Linear (LN) or Arc (AR). **Add \$69.**
- Fascia profiles are constructed of 0.75" thermally fused laminate, with all leading edges offering a coordinating self edge finish.
- Top fascia is not available with Thermofoil or solid surface finishes.
- Fascia style must be specified at time of order.



Arc (AR)



Linear (LN)

- Custom designed fascia options are available, please contact your Global sales representative.

LAMINATE FINISHES - TOP AND CHASSIS

- All laminate finishes are available with coordinating 3mm polymer edge:

(ACJ) Absolute Acajou	(BMX) Blizzard Matrix	(FAS) Fashionista	(NGL) Noce Grigio	(SOG) Storm Grey
(ASN) Asian Night	(BRC) Brushed Cobalt	(FCL) First Class	(NEL) Noce Leggero	(STG) String
(AWC) Avant Cherry	(CMB) Clear Maple	(GRX) Grey Matrix	(NML) Noce Medio	(SWX) Studio White Matrix
(AWH) Avant Honey	(CGY) Custom Grey	(HLN) Hayden Linen	(SBY) Sheer Beauty	(WHE) Walnut Heights
(BLK) Black	(DES) Dark Espresso	(QTM) Quartered Mahogany	(SDT) Stonedust	(WHC) White Chocolate
(BZD) Blizzard	(DWT) Designer White	(NBL) Noce Biondo	(SLN) Stone Linen	(WCR) Winter Cherry

THERMOFOIL FINISHES - TOP AND FRONT (INCLUDING BOTTOM FASCIA)

- Thermofoil finishes are available on bedside cabinets only.
- Please specify by adding "TH" to the end of the model code.

(ACJ) Absolute Acajou	(CGY) Custom Grey	(DWT) Designer White	(FCL) First Class	(SOG) Storm Grey
(CMB) Clear Maple	(DES) Dark Espresso*	(FAS) Fashionista	(SBY) Sheer Beauty	(WHC) White Chocolate

*Thermofoil has slight grain variation from laminate.

SOLID SURFACE FINISHES - TOP ONLY

- Solid surface finishes are available on bedside cabinets only. See models ending in

Grade 1 (C1)	Grade 2 (C2)
(SWH) Designer White	(SBT) Beige Tempest
	(SBX) Black Onyx Mirage
	(SFW) Frosty White Mirage
	(SHS) Hot Stone
	(SMG) Milk Glass Spectra
	(SNM) Northern Melange

CUSTOM

- Global welcomes the opportunity to provide quotation on special requests for project business.
- For pricing, visit the Dealer Center and click on "Specials" on the left sidebar to submit your request.

SHIPPING

- All products are shipped partially assembled, 1 per carton.
- Fascia, shelves and accessories are to be installed on site.
- Allow 4-6 weeks for delivery.

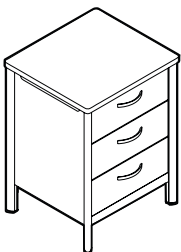

Standard - Laminate top, front and case

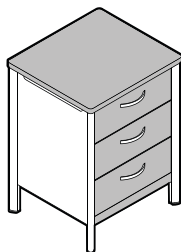

TH - Thermofoil top and front with laminate case



THSC - Thermofoil top with spillguard, fronts and laminate case

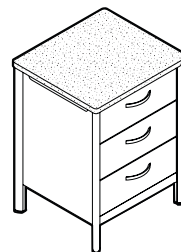



C1/C2 - Solid surface top with laminate front and case

BEDSIDE CABINETS

Notes: Please specify all substitutions and options.

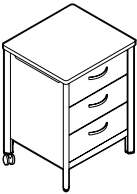
- Bedside cabinets incorporate the unique aluminum extrusion connection/leg construction.
- The aluminum extrusion offers superior strength and durability from impact with mobile equipment and furniture used in the space.
- Ventilation openings have been strategically incorporated into each unit where needed.
- See Sonoma™ - Notes pages for details on tops, chassis, finish and detail selections.
- Must specify detail information at time of order. See Sonoma™ - Notes pages.
 1. Laminate finish
 2. Aluminum extrusion/leg paint finish
 3. Handle style and finish
- An optional key lock is available for top drawer position only and must be specified at time of order.
- To specify lock on top drawer, indicate **(LS)** (lock set) after model number. Add \$62.
- Casters are available as specified on models and cannot be retrofitted in the field.

BEDSIDE CABINETS	MODEL #	DIMENSIONS ^{IN} _{MM}	WEIGHT ^{LB} _{KG}	VOLUME ^{FT³} _{MT³}	LIST PRICE	
	No casters					
	GCSNBT01	22.5 x 20.5 x 30 572 x 521 x 762	97 43.99	11 0.31	\$1272	
	GCSNBT01TH	w/Thermofoil top and front			\$1505	
	GCSNBT01THSC	w/Thermofoil top with spillguard and front			\$1505	
	GCSNBT01C1	w/solid surface top (grade 1)			\$2296	
	GCSNBT01C2	w/solid surface top (grade2)			\$2472	
	Rear casters					
	GCSNBT01C	22.5 x 20.5 x 30 572 x 521 x 762	100 45.35	11 0.31	\$1310	
	GCSNBT01CTH	w/Thermofoil top and front			\$1539	
	GCSNBT01CTHSC	w/Thermofoil top with spillguard and front			\$1539	
	GCSNBT01CC1	w/solid surface top (grade 1)			\$2334	
	GCSNBT01CC2	w/solid surface top (grade2)			\$2509	
	Four casters					
	GCSNBT014C	22.5 x 20.5 x 30 572 x 521 x 762	100 45.35	11 0.31	\$1326	
	GCSNBT014CTH	w/Thermofoil top and front			\$1554	
	GCSNBT014CTHSC	w/Thermofoil top with spillguard and front			\$1554	
	GCSNBT014CC1	w/solid surface top (grade 1)			\$2349	
	GCSNBT014CC2	w/solid surface top (grade2)			\$2525	
		Three drawers. Shipped partially assembled, 1 per carton.				
		• Model GCSNBT01C has two manual locking swivel casters on back.				
• Model GCSNBT014C has four manual locking swivel casters.						

Bedside Cabinet

BEDSIDE CABINETS **MODEL #** **DIMENSIONS** ^{IN}/_{MM} **WEIGHT** ^{LB}/_{KG} **VOLUME** ^{FT³}/_{MT³} **LIST PRICE**

W x D x H

No casters

GCSNBT01S	22.5 x 20.5 x 34 572 x 521 x 864	104 47.17	11 0.31	\$1673
GCSNBT01STH w/Thermofoil top and front				\$1906
GCSNBT01STHSC w/Thermofoil top with spillguard and front				\$1906
GCSNBT01SC1 w/solid surface top (grade 1)				\$2696
GCSNBT01SC2 w/solid surface top (grade 2)				\$2872

Rear casters

GCSNBT01CS	22.5 x 20.5 x 34 572 x 521 x 864	107 48.53	11 0.31	\$1719
GCSNBT01CSTH w/Thermofoil top and front				\$1917
GCSNBT01CSTHSC w/Thermofoil top with spillguard and front				\$1917
GCSNBT01CSC1 w/solid surface top (grade 1)				\$2742
GCSNBT01CSC2 w/solid surface top (grade 2)				\$2918

Four casters

GCSNBT014CS	22.5 x 20.5 x 34 572 x 521 x 864	108 48.98	11 0.31	\$1746
GCSNBT014CSTH w/Thermofoil top and front				\$1940
GCSNBT014CSTHSC w/Thermofoil top with spillguard and front				\$1940
GCSNBT014CSC1 w/solid surface top (grade 1)				\$2769
GCSNBT014CSC2 w/solid surface top (grade 2)				\$2945

Three drawers and one pull-out shelf. Shipped partially assembled, 1 per carton.

- Model GCSNBT01CS has two manual locking swivel casters on back.
- Model GCSNBT014CS has four manual locking swivel casters.

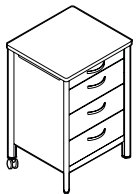

Bedside Cabinet

BEDSIDE CABINETS	MODEL #	DIMENSIONS ^{IN} _{MM}	WEIGHT ^{LB} _{KG}	VOLUME ^{FT³} _{MT³}	LIST PRICE
------------------	---------	---	---------------------------------------	---	------------

W x D x H

No casters

GCSNBT02	22.5 x 20.5 x 30 572 x 521 x 762	58 26.3	11 0.31	\$745
GCSNBT02TH w/Thermofoil top and front				\$913
GCSNBT02THSC w/Thermofoil top with spillguard and front				\$913
GCSNBT02C1 w/solid surface top (grade 1)				\$1769
GCSNBT02C2 w/solid surface top (grade 2)				\$1944

Rear casters

GCSNBT02C	22.5 x 20.5 x 30 572 x 521 x 762	60 27.21	11 0.31	\$771
GCSNBT02CTH w/Thermofoil top and front				\$921
GCSNBT02CTHSC w/Thermofoil top with spillguard and front				\$921
GCSNBT02CC1 w/solid surface top (grade 1)				\$1795
GCSNBT02CC2 w/solid surface top (grade 2)				\$1971

Four casters

GCSNBT024C	22.5 x 20.5 x 30 572 x 521 x 762	60 27.21	11 0.31	\$794
GCSNBT024CTH w/Thermofoil top and front				\$936
GCSNBT024CTHSC w/Thermofoil top with spillguard and front				\$936
GCSNBT024CC1 w/solid surface top (grade 1)				\$1818
GCSNBT024CC2 w/solid surface top (grade 2)				\$1994

One adjustable shelf. Shipped partially assembled, 1 per carton.

- Model GCSNBT02C has two manual locking swivel casters on back.
- Model GCSNBT024C has four manual locking swivel casters.

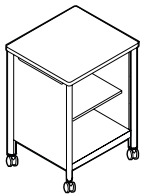
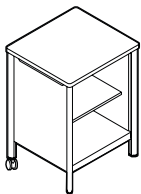
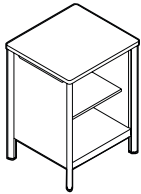

Bedside Cabinet

BEDSIDE CABINETS **MODEL #** **DIMENSIONS** ^{IN}/_{MM} **WEIGHT** ^{LB}/_{KG} **VOLUME** ^{FT³}/_{MT³} **LIST PRICE**

W x D x H

No casters

GCSNBT03	22.5 x 20.5 x 30 572 x 521 x 762	76 34.47	11 0.31	\$1077
GCSNBT03TH w/Thermofoil top and front				\$1139
GCSNBT03THSC w/Thermofoil top with spillguard and front				\$1139
GCSNBT03C1 w/solid surface top (grade 1)				\$1910
GCSNBT03C2 w/solid surface top (grade 2)				\$2086

Rear casters

GCSNBT03C	22.5 x 20.5 x 30 572 x 521 x 762	78 35.38	11 0.31	\$1092
GCSNBT03CTH w/Thermofoil top and front				\$1154
GCSNBT03CTHSC w/Thermofoil top with spillguard and front				\$1154
GCSNBT03CC1 w/solid surface top (grade 1)				\$1925
GCSNBT03CC2 w/solid surface top (grade 2)				\$2104

Four casters

GCSNBT034C	22.5 x 20.5 x 30 572 x 521 x 762	78 35.38	11 0.31	\$1111
GCSNBT034CTH w/Thermofoil top and front				\$1173
GCSNBT034CTHSC w/Thermofoil top with spillguard and front				\$1173
GCSNBT034CC1 w/solid surface top (grade 1)				\$1940
GCSNBT034CC2 w/solid surface top (grade 2)				\$2120

One drawer, one adjustable shelf. Shipped partially assembled, 1 per carton.

- Model GCSNBT03C has two manual locking swivel casters on back.
- Model GCSNBT034C has four manual locking swivel casters.

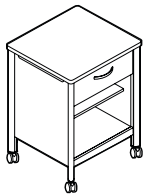
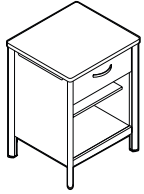

Bedside Cabinet

BEDSIDE CABINETS	MODEL #	DIMENSIONS ^{IN} _{MM}	WEIGHT ^{LB} _{KG}	VOLUME ^{FT³} _{MT³}	LIST PRICE
------------------	---------	---	---------------------------------------	---	------------

W x D x H

No casters

GCSNBT04	22.5 x 20.5 x 30 572 x 521 x 762	90 40.82	11 0.31	\$1123
GCSNBT04TH w/Thermofoil top and front				\$1356
GCSNBT04THSC w/Thermofoil top with spillguard and front				\$1356
GCSNBT04C1 w/solid surface top (grade 1)				\$2146
GCSNBT04C2 w/solid surface top (grade 2)				\$2322

Rear casters

GCSNBT04C	22.5 x 20.5 x 30 572 x 521 x 762	92 41.73	11 0.31	\$1150
GCSNBT04CTH w/Thermofoil top and front				\$1375
GCSNBT04CTHSC w/Thermofoil top with spillguard and front				\$1375
GCSNBT04CC1 w/solid surface top (grade 1)				\$2174
GCSNBT04CC2 w/solid surface top (grade 2)				\$2349

Four casters

GCSNBT044C	22.5 x 20.5 x 30 572 x 521 x 762	92 41.73	11 0.31	\$1196
GCSNBT044CTH w/Thermofoil top and front				\$1394
GCSNBT044CTHSC w/Thermofoil top with spillguard and front				\$1394
GCSNBT044CC1 w/solid surface top (grade 1)				\$2219
GCSNBT044CC2 w/solid surface top (grade 2)				\$2395

One fixed shelf, two drawers. Shipped partially assembled, 1 per carton.

- Model GCSNBT04C has two manual locking swivel casters on back.
- Model GCSNBT044C has four manual locking swivel casters.

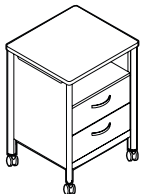
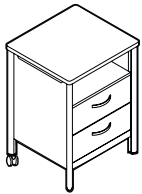
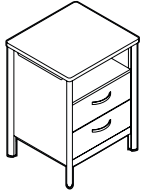

Bedside Cabinet

BEDSIDE CABINETS MODEL # DIMENSIONS IN MM WEIGHT LB KG VOLUME FT³ MT³ LIST PRICE

W x D x H

No casters

GCSNBT06L	22.5 x 20.5 x 30	82	11	\$1139
	572 x 521 x 762	37.19	0.31	
GCSNBT06LTH	w/Thermofoil top and front			\$1524
GCSNBT06LTHSC	w/Thermofoil top with spillguard and front			\$1524
GCSNBT06LC1	w/solid surface top (grade 1)			\$2162
GCSNBT06LC2	w/solid surface top (grade 2)			\$2338

Rear casters

GCSNBT06CL	22.5 x 20.5 x 30	84	11	\$1169
	572 x 521 x 762	38.1	0.31	
GCSNBT06CLTH	w/Thermofoil top and front			\$1539
GCSNBT06CLTHSC	w/Thermofoil top with spillguard and front			\$1539
GCSNBT06CLC1	w/solid surface top (grade 1)			\$2192
GCSNBT06CLC2	w/solid surface top (grade 2)			\$2368

Four casters

GCSNBT06L4C	22.5 x 20.5 x 30	84	11	\$1196
	572 x 521 x 762	38.1	0.31	
GCSNBT06L4CTH	w/Thermofoil top and front			\$1551
GCSNBT06L4CTHSC	w/Thermofoil top with spillguard and front			\$1551
GCSNBT06L4CC1	w/solid surface top (grade 1)			\$2219
GCSNBT06L4CC2	w/solid surface top (grade 2)			\$2395

Top position drawer, one left opening door with adjustable shelf. Shipped partially assembled, 1 per carton.

- Model GCSNBT06CL has two manual locking swivel casters on back.
- Model GCSNBT06L4C has four manual locking swivel casters.

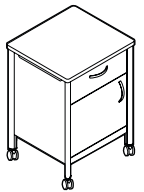
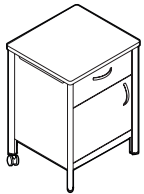
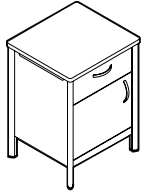

Bedside Cabinet

BEDSIDE CABINETS	MODEL #	DIMENSIONS ^{IN} _{MM}	WEIGHT ^{LB} _{KG}	VOLUME ^{FT³} _{MT³}	LIST PRICE
------------------	---------	---	---------------------------------------	---	------------

W x D x H

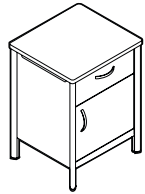

No casters

GCSNBT06R	22.5 x 20.5 x 30 572 x 521 x 762	74 33.56	11 0.31	\$1139
GCSNBT06RTH w/Thermofoil top and front				\$1528
GCSNBT06RTHSC w/Thermofoil top with spillguard and front				\$1528
GCSNBT06RC1 w/solid surface top (grade 1)				\$2162
GCSNBT06RC2 w/solid surface top (grade 2)				\$2338

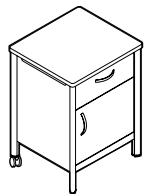

Rear casters

GCSNBT06CR	22.5 x 20.5 x 30 572 x 521 x 762	77 34.92	11 0.31	\$1169
GCSNBT06CRTH w/Thermofoil top and front				\$1539
GCSNBT06CRTHSC w/Thermofoil top with spillguard and front				\$1539
GCSNBT06CRC1 w/solid surface top (grade 1)				\$2192
GCSNBT06CRC2 w/solid surface top (grade 2)				\$2368

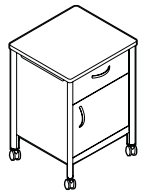

Four casters

GCSNBT06R4C	22.5 x 20.5 x 30 572 x 521 x 762	78 35.38	11 0.31	\$1196
GCSNBT06R4CTH w/Thermofoil top and front				\$1551
GCSNBT06R4CTHSC w/Thermofoil top with spillguard and front				\$1551
GCSNBT06R4CC1 w/solid surface top (grade 1)				\$2219
GCSNBT06R4CC2 w/solid surface top (grade 2)				\$2395

Bedside Cabinet



Top position drawer, one **right** opening door with adjustable shelf. Shipped partially assembled, 1 per carton.

- Model GCLBT06CRN has two manual locking swivel casters on back.
- Model GCLBT06R4CN has four manual locking swivel casters.

DRESSERS

Notes: Please specify all substitutions and options.

- Dresser units incorporate the unique aluminum extrusion connection/leg construction.
- The aluminum extrusion offers superior strength and durability from impact with mobile equipment and furniture used in the space.
- Ventilation openings have been strategically incorporated into each unit where needed.
- See Sonoma™ - Notes pages for details on tops, chassis, finish and detail selections.
- Must specify detail information at time of order. See Sonoma™ - Notes pages.
 1. Laminate finish
 2. Aluminum extrusion/leg paint finish
 3. Handle style and finish
- An optional key lock is available for top drawer position only and must be specified at time of order.
- To specify lock on top drawer, indicate **(LS)** (lock set) after model number. Add \$62.

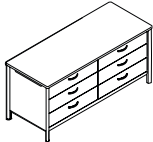
DRESSERS	MODEL #	DIMENSIONS ^{IN} _{MM}	WEIGHT ^{LB} _{KG}	VOLUME ^{FT³} _{MT³}	LIST PRICE
 <p>22.5" Deep Dresser</p>	GCSNDR02	34.5 x 22.5 x 30	141	20	\$1700
		876 x 572 x 762	63.95	0.56	
Three drawers. Shipped partially assembled, 1 per carton.					
 <p>22.5" Deep Dresser</p>	GCSNDR04	34.5 x 22.5 x 37.5	173	24	\$2223
		876 x 572 x 953	78.47	0.67	
Four drawers. Shipped partially assembled, 1 per carton.					
 <p>22.5" Deep Dresser</p>	GCSNDR06	34.5 x 22.5 x 37.5	165	24	\$2063
		876 x 572 x 953	74.84	0.67	
Three drawers with open storage space above. Cord access in back. Shipped partially assembled, 1 per carton.					
 <p>Double Dresser</p>	GCSNDD01	66.75 x 22.5 x 30	281	40	\$2911
		1695 x 572 x 762	127.45	1.13	
Double dresser with three drawers. 26" deep at each side. Shipped partially assembled, 1 per carton.					

WARDROBE CABINETS

Notes: Please specify all substitutions and options.

- Wardrobe cabinets incorporate the unique aluminum extrusion connection/leg construction.
- The aluminum extrusion offers superior strength and durability from impact with mobile equipment and furniture used in the space.
- Doors are mounted utilizing commercial quality hinges that provide a 170° opening span for comfortable access to personal belongings.
- Ventilation and draining have been strategically incorporated into each unit where needed.
- Wardrobe cabinets offer a safety garment hook as standard and a J-style safety clothing rail to ensure maximum well being and peace of mind from accidents.
- See Sonoma™ - Notes pages for details on tops, chassis, finish and detail selections.
- Must specify detail information at time of order. See Sonoma™ - Notes pages.
 1. Laminate finish
 2. Aluminum extrusion/leg paint finish
 3. Handle style and finish
- Optional door lock is available. Must be quoted on a project opportunity as a special.
- See accessories for additional options to enhance personal storage features.

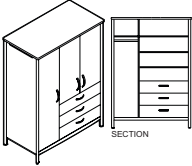
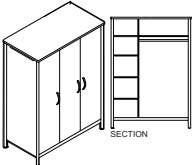
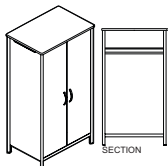
WARDROBE CABINETS	MODEL #	DIMENSIONS ^{IN} _{MM}	WEIGHT ^{LB} _{KG}	VOLUME ^{FT³} _{MT³}	LIST PRICE
 <p>Wardrobe Cabinet</p>	GCSNWC01	50 x 26.5 x 72 1270 x 673 x 1829	442 200.48	71 2.01	\$4473
	<p>Inside dimensions:</p> <ul style="list-style-type: none"> • Left side top shelf: 14.75"W x 20.75"D x 8.625"H • Left side clothing rail area: 14.75"W x 20.75"D x 55.6"H • Right side top shelf: 30.75"W x 20.75"D x 8.625"H • Right side middle section with adjustable shelf: 30.75"W x 20.75"D x 32"H • Right side bottom section: 30.75"W x 20.75"D x 24"H • Drawers: 28.5"W x 5.125"D x 17.25"H <p>Three doors. Interior left side offers an upper shelf with a J-style safety clothing rail below. The right side of the cabinet has two half length doors with two fixed and two adjustable shelves. Three drawers below. A safety garment hook is standard on the cabinet interior door. For greater security, the Anti-Tip Security Kit is recommended on units above 60" (see page 33). Shipped partially assembled, 1 per carton.</p>				
 <p>Wardrobe Cabinet</p>	GCSNWC02	50 x 26.5 x 72 1270 x 673 x 1829	428 194.13	71 2.01	\$3705
	<p>Inside dimensions:</p> <ul style="list-style-type: none"> • Left side top shelf: 14.75"W x 20.75"D x 8.625"H • Left side middle section with adjustable shelf: 14.75"W x 20.75"D x 38.7"H • Left side bottom section: 14.75"W x 20.75"D x 15.8"H • Right side top shelf: 30.75"W x 20.75"D x 8.625"H • Right side clothing rail area: 30.75"W x 22.75"D x 55.6"H <p>Three full length doors. Interior left side offers two adjustable and two fixed shelves. Interior right side offers an upper shelf with a J-style safety clothing rail below. A Safety Garment Hook is standard on the cabinet interior door. For greater security, the Anti-Tip Security Kit is recommended on units above 60" (see page 33). Shipped partially assembled, 1 per carton.</p>				
 <p>Wardrobe Cabinet</p>	GCSNWD01	38.5 x 26.5 x 72 978 x 673 x 1829	261 118.38	55 1.55	\$2525
	<p>Inside dimensions:</p> <ul style="list-style-type: none"> • Top shelf: 34.75"W x 22.7"D x 8.625"H • Bottom portion: 34.75"W x 22.7"D x 50.6"H <p>Two doors, full span J-style safety clothing rail below a fixed shelf. A safety garment hook is standard on the cabinet interior door. For greater security, the Anti-Tip Security Kit is recommended on units above 60" (see page 33). Lock not available on door. Shipped partially assembled, 1 per carton.</p>				

WARDROBE CABINETS

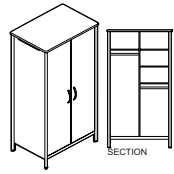

Wardrobe Cabinet

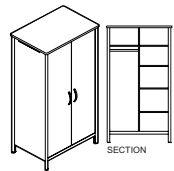

Wardrobe Cabinet

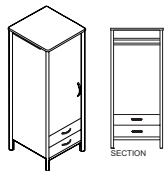

Narrow Wardrobe Cabinet

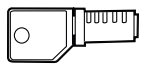

Replacement Lock Set



Replacement Key

MODEL #	DIMENSIONS ^{IN} _{MM}	WEIGHT ^{LB} _{KG}	VOLUME ^{FT³} _{MT³}	LIST PRICE
GCSNWD02	38.5 x 26.5 x 72 978 x 673 x 1829	282 127.91	55 1.55	\$3152

Inside dimensions:

- Left side top shelf: 17"W x 20.7"D x 8.625"H
- Left side clothing rail area: 17"W x 20.7"D x 55.6"H
- Right side top shelf: 17"W x 20.7"D x 8.625"H
- Right side clothing rail area: 17"W x 20.7"D x 36.6"H

Two doors. Interior is divided in two with an upper shelf and a J-style safety clothing rail on the **left** side. The **right** side has one adjustable and two fixed shelves with a J-style safety clothing rail below. A safety garment hook is standard on the cabinet interior door. For greater security, the Anti-Tip Security Kit is recommended on units above 60" (see page 33). Shipped partially assembled, 1 per carton.

GCSNWD03	38.5 x 26.5 x 72 978 x 673 x 1829	297 134.71	55 1.55	\$3281
----------	--------------------------------------	---------------	------------	---------------

Inside dimensions:

- Left side top shelf: 17"W x 20.7"D x 8.625"H
- Left side clothing rail area: 17"W x 20.7"D x 55.6"H
- Right side top shelf: 17"W x 20.7"D x 8.625"H
- Right side middle section with adjustable shelf: 17"W x 20.7"D x 38.7"H
- Right side bottom section: 17"W x 20.7"D x 15.8"H

Two doors. Interior is divided in two with an upper shelf and a J-style safety clothing rail on the **left** side. The **right** side has two adjustable and two fixed shelves. A safety garment hook is standard on the cabinet interior door. For greater security, the Anti-Tip Security Kit is recommended on units above 60" (see page 33). Shipped partially assembled, 1 per carton.

Left

GCSNWN01L	22.5 x 24.5 x 72 572 x 622 x 1829	216 97.97	30 0.84	\$2384
-----------	--------------------------------------	--------------	------------	---------------

Right

GCSNWN01R	22.5 x 24.5 x 72 572 x 622 x 1829	216 97.97	30 0.84	\$2384
-----------	--------------------------------------	--------------	------------	---------------

Inside dimensions:

- Top shelf: 18.7"W x 20.7"D
- Top drawer: 16.5"W x 5.125"D x 15.5"H
- Clothing rail area: 18.7"W
- Lower drawer: 16.5"W x 5.125"D x 15.5"H

One door covering upper shelf and J-style safety clothing rail. Two exposed drawers below. For greater security, the Anti-Tip Security Kit is recommended on units above 60" (see page 33). Shipped partially assembled, 1 per carton.

GCSNCOREK	20 x 22 x 35 508 x 559 x 889	16 7.3	0.01 -	\$62
-----------	---------------------------------	-----------	-----------	-------------

Replacement core and key.



WL2EK	24.5 x 29 x 41 622 x 737 x 1041	35 15	0.1 -	\$4
-------	------------------------------------	----------	----------	------------

Replacement key for all units with drawers. Specify key number 401-440.

ACCESSORIES

Notes: Please specify all substitutions and options.

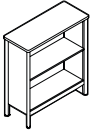
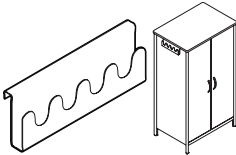
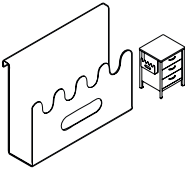
- Bookcase units incorporate the unique aluminum extrusion connection/leg construction.
- The aluminum extrusion offers superior strength and durability from impact with mobile equipment and furniture used in the space.
- See Sonoma™ - Notes pages for details on tops, chassis, finish and detail selections.
- Must specify detail information at time of order. See Sonoma™ - Notes pages.
 1. Laminate finish
 2. Aluminum extrusion/leg paint finish

ACCESSORIES	MODEL #	DIMENSIONS ^{IN} _{MM}	WEIGHT ^{LB} _{KG}	VOLUME ^{FT³} _{MT³}	LIST PRICE
 <p>Anti-Tip Security Kit</p> <p>Helps to prevent furniture from tipping over. This cabinet stabilization hardware is made from steel and galvanized steel aircraft cable. Full installation instructions are included. Recommended for all 72" high units.</p> <ul style="list-style-type: none"> • Two kits are required for LWA, LWC, LWD, LWG and LWN units. 	GCAT400	-	0.24	0.1	\$46
		-	0.1	-	
 <p>Bookcase</p> <p>37.5" high. 1 adjustable shelf. Shipped partially assembled, 1 per carton.</p>	GCSNBC02	34.5 x 14.5 x 37.5	75	16	\$1043
		876 x 368 x 953	34.01	0.45	
 <p>Multiple Hook</p> <p>Fits into ventilation opening of wardrobes providing additional storage for frequently worn or accessed items.</p> <ul style="list-style-type: none"> • Standard powder coated paint finish color: Sierra (SC). 	GCSNHA01	13 x 2 x 4.25	1	0.2	\$80
		330 x 51 x 108	0.45	-	
 <p>Magazine/Tissue Holder</p> <p>Fits into ventilation opening of bedside cabinet or dresser providing additional storage of frequently accessed items.</p> <ul style="list-style-type: none"> • Standard powder coated paint finish color: Sierra (SC). 	GCSNHA02	13 x 3.75 x 10	1.5	0.6	\$114
		330 x 95 x 254	0.68	-	
 <p>Safety Garment Hook</p> <p>Garment hook provides additional hanging storage on the inside right and center wardrobe doors as standard. Engineered with the safety feature to support a maximum weight of 75 lbs.</p> <ul style="list-style-type: none"> • Standard powder coated paint finish color: Sierra (SC). 	GCSNHA03	1.5 x 1 x 3.25	1.5	0.2	\$23
		38 x 25 x 83	0.68	-	

ACCESSORIES	MODEL #	DIMENSIONS ^{IN} _{MM}	WEIGHT ^{LB} _{KG}	VOLUME ^{FT³} _{MT³}	LIST PRICE
-------------	---------	---	---------------------------------------	---	------------

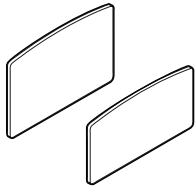

Headboard and Footboard Fascia Profile: Arc (TPAR)

	W x D x H			
GCSNHF01 Set	37 x 1 x 25 940 x 25 x 635	47 21.31	1.9 0.05	\$978
GCSNHB01 Headboard	37 x 1 x 25 940 x 25 x 635	26 11.79	1.9 0.05	\$669
GCSNFB01 Footboard	37 x 1 x 20 940 x 25 x 508	21 9.52	1.7 0.04	\$309

Headboard and footboard are provided as a set or can be ordered individually. 1" thick high pressure laminate with 3mm edge.

- No predrilled holes.
- No mounting brackets or hardware included.
- Verify board application and dimensions before ordering.

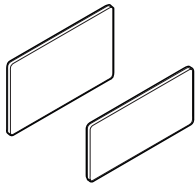

Headboard and Footboard Fascia Profile: Linear (TPLN)

GCSNHF04 Set	37 x 1 x 25 940 x 25 x 635	47 21.31	1.9 0.05	\$970
GCSNHB04 Headboard	37 x 1 x 25 940 x 25 x 635	26 11.79	1.9 0.05	\$600
GCSNFB04 Footboard	37 x 1 x 20 940 x 25 x 508	21 9.52	1.7 0.04	\$374

Headboard and footboard are provided as a set or can be ordered individually. 1" thick high pressure laminate with 3mm edge.

- No predrilled holes.
- No mounting brackets or hardware included.
- Verify board application and dimensions before ordering.

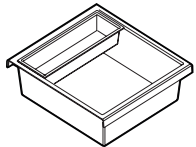

Bedside Drawer Liner and Personal Organizer

GCSNLP01	18 x 16.5 x 5.25 457 x 419 x 133	2 0.9	1.3 0.03	\$153
----------	-------------------------------------	----------	-------------	--------------

Constructed from high impact styrene plastic. Plastic liners have been specially designed to saddle the drawer edges for a perfect fit while eliminating gaps and potential traps. Removable.

- Neutral color (French Vanilla) coordinates with drawer interiors.

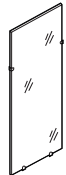

Wardrobe Mirror

GCSNWM01	11 x 0.25 x 29 279 x 6 x 737	40 18.14	1.5 -	\$164
----------	---------------------------------	-------------	----------	--------------

Installed on the **left** inside of the door. Backed with shatterproof safety tape, tested for shatter resistance. Double mounted with both rubber lined mirror clips and heavy duty foam tape. Edges are polished. 1 per carton.

tables

Cafeteria + Dining + Occasional + Reception

Calidon Tables.....	36	Overbed tables.....	53
Enable	40	Primacare.....	59
Floral Dining	41	Primacare HT.....	60
GC Belong	42	River+ tables.....	61
Occasional.....	44	Tablet.....	62

CALIDON TABLES



Square End Table - 22" model GC36314



Rectangular Coffee Table model GC36317

Calidon seating



For Calidon seating, refer to page 70.

EXAMPLE CALIDON TABLE ORDER CODE:

GC36314	-HP	-ACJ	-CNT
Model #	Top material	Laminate finish	Power

STANDARD FEATURES

- A variety of wood leg tables are available. The wood legs/aprons are specifiable in the same wood seating finishes.
- Table tops are 1" thick, available in thermally fused laminate (LP), high pressure laminate (HP), and solid surface (CO). Upcharges vary, see model for pricing.
- Laminate top tables include color coordinating 2 mm PVC edgeband.
- Tandem/bridge table models (GC36318 to GC36321) connect to guest seating only.
- Tandem tables are specified left or right, as seated.

OPTIONAL FEATURES

- A tamper resistant power/USB unit is optional for laminate top, tandem in-line, 30 degree, 90 degree and freestanding square end tables only. Unit is black; includes one AC outlet, two 10-watt USB-A ports, matching faceplate and a 10 ft long 3-prong power cord. The power unit is centered 1.5" from the edge of the surface. See power location diagrams for reference.

SUGGESTED APPLICATIONS

- Lounge rooms
- Patient rooms
- Resident rooms
- Treatment/Exam room

Please add option codes in the following order:

- Model number**
GC36314 Freestanding end table, 20.25"H
GC36324 to GC36326 Freestanding end tables, 23"H
GC36315 to GC36317 Freestanding coffee tables, 17,25"H
GC36318 to GC36321 Tandem/bridge tables (refer to page 74)
- Top material**
(LP) Thermally fused laminate. Specify finish - see LP finishes.
(HP) High pressure laminate. Upcharges vary - see model. Specify finish - see HP finishes.
(CO) Solid surface. Upcharges vary - see model. Specify finish - see Solid Surface finishes.
- Leg finish**
(AAM) Absolute **(MWM)** Medium Walnut
(CJM) Charcoal Java **(ASM)** Night
(ACM) Cherry **(NBM)** Noce Biondo
(EMM) Empire Mahogany **(NGM)** Noce Grigio
(EOM) English Oak **(NEM)** Noce Leggero
(ECM) Espresso Cafe **(NMM)** Noce Medio
(TFM) Fruitwood **(SBM)** Sandy Beach
(HGM) Grey **(SKM)** Shaker Cherry
(HOM) Harvest Oak **(SOM)** Silver Oak
(AHM) Honey **(TWM)** Walnut
(JOM) Jet Onyx **(WTM)** WC Cream
(LHM) Light Honey **(WHM)** White
(TMM) Mahogany **(WCM)** Winter Cherry
(AVM) Maple
- Power/USB unit position** (laminate tandem and end tables only).
(NPM) No power
(CNT) Center top power. Add \$232.
- Power/USB unit position** (laminate corner tables only).
(NPM) No power
(LBP) Left back power. Add \$232.
(RBP) Right back power. Add \$232.

TABLE TOP FINISHES:

Thermally fused laminate (LP):

- (ACJ)** Absolute Acajou
- (ASN)** Asian Night
- (AWC)** Avant Cherry
- (AWH)** Avant Honey
- (BLK)** Black
- (BZD)** Blizzard
- (BRC)** Brushed Cobalt
- (CMB)** Clear Maple
- (CGY)** Custom Grey
- (DES)** Dark Espresso
- (DWT)** Designer White
- (FAS)** Fashionista

- (FCL)** First Class
- (NBL)** Noce Biondo
- (NGL)** Noce Grigio
- (NEL)** Noce Leggero
- (NML)** Noce Medio
- (QTM)** Quartered Mahogany
- (SBY)** Sheer Beauty
- (SDT)** Stonedust
- (WHE)** Walnut Heights
- (WHC)** White Chocolate
- (WCR)** Winter Cherry

High pressure laminate (HP):





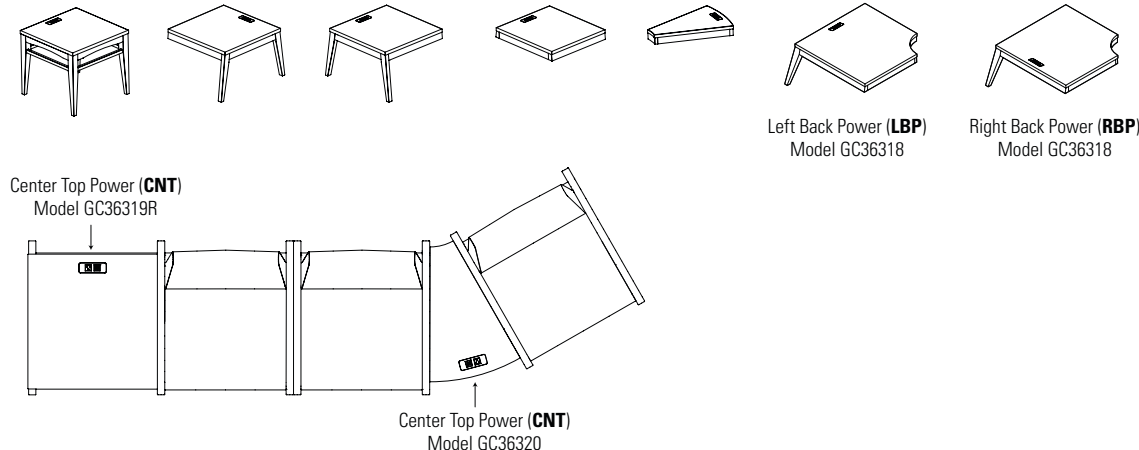

- (ACJ)** Absolute Acajou
- (ASN)** Asian Night
- (W357)** Avant Cherry
- (W356)** Avant Honey
- (BLK)** Black
- (BZD)** Blizzard
- (BRC)** Brushed Cobalt
- (CMB)** Clear Maple
- (CGY)** Custom Grey
- (DES)** Dark Espresso
- (DWT)** Designer White
- (FAS)** Fashionista

Solid surface (CO)

- Grade 1**
(SWH) Designer White
- Grade 2**
(SBT) Beige Tempest
(SBX) Black Onyx Mirage
(SFW) Frosty White Mirage
(SHS) Hot Stone
(SMG) Milk Glass Spectra
(SNM) Northern Melange

POWER LOCATION DIAGRAM



TABLES	MODEL #	DIMENSIONS ^{IN} _{MM}	WEIGHT ^{LB} _{KG}	VOLUME ^{FT³} _{MT³}	LIST PRICE
 <p>Square 22" End Table - 20.25"H</p>	GC36314	22 x 22 x 20.25	29	7.75	\$595
		559 x 559 x 514	13.2	0.21	
<ul style="list-style-type: none"> • For a thermally fused laminate top (LP), specify model GC36314-LP. • For a high pressure laminate top (HP), specify model GC36314-HP. Add \$42. • For a solid surface top (CO), specify model GC36314-CO. For grade 1, add \$810. For grade 2, add \$1010. <p>Coordinating edge and solid wood frame. 1 per carton. Power and data can be added on the surface of the table (CNT). Add \$232.</p>					
 <p>Square 22" End Table - 23"H</p>	GC36324	22 x 22 x 23	34	10.75	\$772
		559 x 559 x 584	15.45	0.3	
<ul style="list-style-type: none"> • For a thermally fused laminate top (LP), specify model GC36324-LP. • For a high pressure laminate top (HP), specify model GC36324-HP. Add \$42. • For a solid surface top (CO), specify model GC36324-CO. For grade 1, add \$810. For grade 2, add \$1010. <p>Coordinating edge and solid wood frame. 1 per carton. Power and data can be added on the surface of the table (CNT). Add \$232.</p>					
 <p>Rectangular End Table - 23"H</p>	GC36325	12 x 22 x 23	23.5	6.75	\$665
		305 x 559 x 584	10.68	0.19	
<ul style="list-style-type: none"> • For a thermally fused laminate top (LP), specify model GC36325-LP. • For a high pressure laminate top (HP), specify model GC36325-HP. Add \$42. • For a solid surface top (CO), specify model GC36325-CO. For grade 1, add \$690. For grade 2, add \$840. <p>Coordinating edge and solid wood frame. 1 per carton. Power and data can be added on the surface of the table (CNT). Add \$232.</p>					
 <p>Corner 30° End Table - 23"H</p>	GC36326	25 x 24 x 23	34	12.75	\$840
		635 x 610 x 584	15.45	0.36	
<ul style="list-style-type: none"> • For a thermally fused laminate top (LP), specify model GC36326-LP. • For a high pressure laminate top (HP), specify model GC36326-HP. Add \$55. • For a solid surface top (CO), specify model GC36326-CO. For grade 1, add \$869. For grade 2, add \$1159. <p>Coordinating edge and solid wood frame. 1 per carton. Power and data can be added on the surface of the table (CNT). Add \$232.</p>					
 <p>Square 24" Coffee Table</p>	GC36315	24 x 24 x 17.25	37	9.5	\$591
		610 x 610 x 438	16.78	0.26	
<ul style="list-style-type: none"> • For a thermally fused laminate top (LP), specify model GC36315-LP. • For a high pressure laminate top (HP), specify model GC36315-HP. Add \$42. • For a solid surface top (CO), specify model GC36315-CO. For grade 1, add \$917. For grade 2, add \$1237. <p>Coordinating edge and solid wood frame. 1 per carton.</p>					
 <p>Square 36" Coffee Table</p>	GC36316	36 x 36 x 17.25	65	18.25	\$806
		914 x 914 x 438	29.48	0.51	
<ul style="list-style-type: none"> • For a thermally fused laminate top (LP), specify model GC36316-LP. • For a high pressure laminate top (HP), specify model GC36316-HP. Add \$89. • For a solid surface top (CO), specify model GC36316-CO. For grade 1, add \$2071. For grade 2, add \$2771. <p>Coordinating edge and solid wood frame. 1 per carton.</p>					

TABLES	MODEL #	DIMENSIONS ^{IN} _{MM}	WEIGHT ^{LB} _{KG}	VOLUME ^{FT³} _{MT³}	LIST PRICE
--------	---------	---	---------------------------------------	---	------------

W x D x H

GC36317	48 x 24 x 17.25	56	16.5	\$774
	1219 x 610 x 438	25.4	0.46	



Rectangular Coffee Table

- For a thermally fused laminate top (**LP**), specify model GC36317-LP.
- For a high pressure laminate top (**HP**), specify model GC36317-HP. Add \$83.
- For a solid surface top (**CO**), specify model GC36317-CO. For grade 1, add \$1857. For grade 2, add \$2487.

Coordinating edge and solid wood frame. 1 per carton.

Notes: Please specify all substitutions and options.

- Offers a solution to users with limited mobility.
- The Enable table top allows for two fixed tablets and two height adjustable tablets to be installed on opposite sides into the predrilled holes with metal inserts on the underside of the top.
- The fixed and or height adjustable tablets can be added to the table surface as needed to accommodate change in a persons physical abilities for continued enjoyment during mealtime and activities.
- Height adjustable tablet surface has a 13.5" range of motion. When attached to the underside of the table top to motion range is 22.5" to 36" for accommodating a larger range of mobility issues and devices (wheelchairs, geriatric chairs, walkers).
- Heavy duty tapered steel leg finish must be specified at time of order (see below).
- Legs are available with Black (BLK) plastic glides offering 1.5" adjustment as standard except Tungsten (TTU) which has Tungsten glides.
- Legs with Black manual locking casters are available and can be specified as needed in the "Build It" tool.
- To support the need to move tables for cleaning, repositioning or placing in storage, tables can be ordered with two standard legs and two legs with casters. Add (LF) to model #.
- This allows for specifying the top with four legs on glides or two legs on casters, two leg with glides or four legs with manual locking casters.
- Shipped easy to assemble.
- 2mm edging color coordinated with laminate finish is standard for all tops. Finish must be specified at time of order.
- Tops are 1" thick and available in thermally fused laminate (LP) and high pressure laminate (HP). Please select the appropriate model number for the finish you prefer.
- Counterweights are available as an option when additional weight is required for increased safety. For a 13 lb. counterweight, specify (CW13) - add \$286. For 26 lb. counterweight, specify (CW26) - add \$484.
- Refer to the following lists when selecting a finish color. Must specify both a top color and leg finish at time of order.
- For custom laminate or contrasting edge, please contact your Global sales representative for a special quotation.

Thermally Fused Laminate (LP)

- (ACJ) Absolute Acajou
- (ASN) Asian Night
- (AWC) Avant Cherry
- (AWH) Avant Honey
- (BLK) Black
- (BZD) Blizzard
- (BRC) Brushed Cobalt
- (CMB) Clear Maple
- (CGY) Custom Grey
- (DES) Dark Espresso
- (DWT) Designer White
- (FAS) Fashionista
- (FCL) First Class
- (NBL) Noce Biondo
- (NGL) Noce Grigio
- (NEL) Noce Leggero
- (NML) Noce Medio
- (QTM) Quartered Mahogany
- (SDT) Stonedust
- (SBY) Sheer Beauty
- (SOG) Storm Grey
- (WHE) Walnut Heights
- (WHC) White Chocolate
- (WCR) Winter Cherry

High Pressure Laminate (HP)

- (ACJ) Absolute Acajou
- (ASN) Asian Night
- (W357) Avant Cherry
- (W356) Avant Honey
- (BLK) Black
- (BZD) Blizzard
- (BRC) Brushed Cobalt
- (CMB) Clear Maple
- (CGY) Custom Grey
- (DES) Dark Espresso
- (DWT) Designer White
- (FAS) Fashionista
- (FCL) First Class
- (NBL) Noce Biondo
- (NGL) Noce Grigio
- (NEL) Noce Leggero
- (NML) Noce Medio
- (QTM) Quartered Mahogany
- (SDT) Stonedust
- (SBY) Sheer Beauty
- (SOG) Storm Grey
- (WHE) Walnut Heights
- (WHC) White Chocolate
- (WCR) Winter Cherry

Leg Finish

- (TBL) Black
- (TIV) Cloud
- (TDW) Designer White
- (TFO) Fog
- (TFR) Frost
- (TKA) Kalua
- (TLA) Latte
- (TMO) Mocha
- (TNE) Nevada
- (TSN) Sand
- (TSH) Shadow
- (TOA) Toast
- (TTU) Tungsten



TABLETS	MODEL #	DIMENSIONS IN MM	WEIGHT LB KG	VOLUME FT ³ MT ³	LIST PRICE
---------	---------	------------------	--------------	--	------------



E-Z Lift Dual Arm Tablet

W x D x H					
GC3-DAHN	36 x 13 x 7-13	31	4.9	\$1438	
	914 x 330 x 178-330	14.06	0.13		
GC3-DALN	36 x 13 x 7-13	31	4.9	\$1210	
	914 x 330 x 178-330	14.06	0.13		

- For a high pressure laminate top (HP), specify model GC3-DAHN.
- For a thermally fused top (LP), specify model GC3-DALN.

Adjust up or down by the use of a single paddle actuator. Tablet remains level during adjustment and has a positive locking, smooth counterbalanced operation through the use of a gas cylinder. Tablet range when attached to the underside of the table top to motion range is 22.5" to 36". Guard at the back prevents items from falling. 2 cartons.

- Allowance between arms is 22.5" for use with wheelchairs.
- Adds 15" per tablet to the depth of the table.
- Fits predrilled inserts on 42" table sides only. Thumbscrew hardware for attaching to table top is included.
- Mechanism and tablet bracket are available in Black only.



Tablet

GC3-NUGH	24 x 10 x 1	15	0.8	\$398	
	610 x 254 x 25	6.8	0.02		
GC3-NUG	24 x 10 x 1	15	0.8	\$361	
	610 x 254 x 25	6.8	0.02		

- For a high pressure laminate top (HP), specify model GC3-NUGH.
- For a thermally fused top (LP), specify model GC3-NUG.

Attachable fixed height tablet for Enable tables. Adds 10.5" per tablet to the depth of the table. Heavy duty Black mounting bracket slips onto the table top on the 36" sides. Thumbscrews are included and attach into predrilled metal inserts for metal to-metal fastening and security. 2 cartons.

TABLE TOPS WITH LEGS

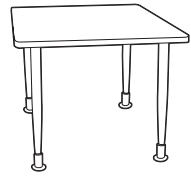

Table Top with Legs - 36"

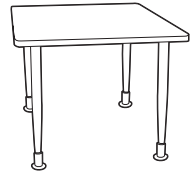

Table Top with Legs - 42"

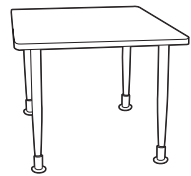

Table Top with Legs - 48"

MODEL #	DIMENSIONS ^{IN} _{MM}	WEIGHT ^{LB} _{KG}	VOLUME ^{FT³} _{MT³}	LIST PRICE
GCEN3642H	36 x 42 x 28.25	89	5.7	\$1516
	914 x 1067 x 718	40.36	0.16	
GCEN3642L	36 x 42 x 28.25	89	5.7	\$1261
	914 x 1067 x 718	40.36	0.16	

- For a high pressure laminate top (HP), specify model GCEN3642H.
- For a thermally fused top (LP), specify model GCEN3642L.

Allows for EZ-lift arm tablets to be installed on the 42" wide ends and fixed arm tablets on the 36" sides. 2 cartons.

GCEN4242H	42 x 42 x 28.25	102	6	\$1649
	1067 x 1067 x 718	46.26	0.16	
GCEN4242L	42 x 42 x 28.25	102	6	\$1389
	1067 x 1067 x 718	46.26	0.16	

- For a high pressure laminate top (HP), specify model GCEN4242H.
- For a thermally fused top (LP), specify model GCEN4242L.

GCEN4848H	48 x 48 x 28.25	121	6.6	\$1900
	1219 x 1219 x 718	54.88	0.18	
GCEN4848L	48 x 48 x 28.25	121	6.6	\$1639
	1219 x 1219 x 718	54.88	0.18	

- For a high pressure laminate top (HP), specify model GCEN4848H.
- For a thermally fused top (LP), specify model GCEN4848L.

TAPERED LEGS



Tapered Leg with Caster

LCL291	5.25 x 5.25 x 27.75	4.8	0.52	\$106
	133 x 133 x 692	2.17	0.01	
LCL294	5.25 x 5.25 x 27.75	18.4	2.1	\$419
	133 x 133 x 705	8.34	0.05	

Tapered leg with locking caster. Hardware for assembly is included

- LCL291: 1 per carton.
- LCL294: 4 per carton.
- Finish must be specified at time of order.



Tapered Leg with Glide

LLL291	5.25 x 5.25 x 27.25	4.8	0.52	\$106
	133 x 133 x 692	2.17	0.01	
LLL294	5.25 x 5.25 x 27.25	18.4	2.1	\$419
	133 x 133 x 692	8.34	0.05	

Tapered leg with glide offers 1.5" glide range adjustment. Legs are available and can be ordered separately from the top. Hardware for assembly is included.

- LLL291: 1 per carton.
- LLL294: 4 per carton.
- Finish must be specified at time of order.

Notes: Please specify all substitutions and options.

- Attractive top design offers an inward curve at each corner allowing comfortable access if assistance with eating is required.
- Adjustable 1.5" range Black plastic glides are standard except Tungsten (TTU) which has Tungsten glides.
- Heavy duty tapered steel leg finish must be specified at time of order (see below).
- Optional leg on caster available if required.
- Shipped easy to assemble.
- 2mm edging color coordinated with laminate finish is standard for all tops. Finish must be specified at time of order.
- Tops are 1" thick and available in thermally fused laminate (LP) and high pressure laminate (HP). Please select the appropriate model number for the finish you prefer.
- Refer to the following lists when selecting a finish color. Must specify both a top color and leg finish at time of order.
- For custom laminate or contrasting edge, please contact your Global sales representative for a special quotation.

Thermally Fused Laminate (LP)

- (ACJ) Absolute Acajou
- (ASN) Asian Night
- (AWC) Avant Cherry
- (AWH) Avant Honey
- (BLK) Black
- (BZD) Blizzard
- (BRC) Brushed Cobalt
- (CMB) Clear Maple
- (CGY) Custom Grey
- (DES) Dark Espresso
- (DWT) Designer White
- (FAS) Fashionista
- (FCL) First Class
- (NBL) Noce Biondo
- (NGL) Noce Grigio
- (NEL) Noce Leggero
- (NML) Noce Medio
- (QTM) Quartered Mahogany
- (SBY) Sheer Beauty
- (SDT) Stonedust
- (SOG) Storm Grey
- (WHE) Walnut Heights
- (WHC) White Chocolate
- (WCR) Winter Cherry

High Pressure Laminate (HP)

- (ACJ) Absolute Acajou
- (ASN) Asian Night
- (AWC) Avant Cherry
- (AWH) Avant Honey
- (BLK) Black
- (BZD) Blizzard
- (BRC) Brushed Cobalt
- (CMB) Clear Maple
- (CGY) Custom Grey
- (DES) Dark Espresso
- (DWT) Designer White
- (FAS) Fashionista
- (FCL) First Class
- (NBL) Noce Biondo
- (NGL) Noce Grigio
- (NEL) Noce Leggero
- (NML) Noce Medio
- (QTM) Quartered Mahogany
- (SBY) Sheer Beauty
- (SDT) Stonedust
- (SOG) Storm Grey
- (WHE) Walnut Heights
- (WHC) White Chocolate
- (WCR) Winter Cherry

Leg Finish

- (TBL) Black
- (TIV) Cloud
- (TDW) Designer White
- (TFO) Fog
- (TFR) Frost
- (TKA) Kalua
- (TLA) Latte
- (TMO) Mocha
- (TNE) Nevada
- (TSN) Sand
- (TSH) Shadow
- (TOA) Toast
- (TTU) Tungsten

DINING ROOM TABLES	MODEL #	DIMENSIONS IN MM	WEIGHT LB KG	VOLUME FT ³ MT ³	LIST PRICE
--------------------	---------	------------------------	--------------------	--	------------



Floral Dining Room Table - 42"

W x D x H					
GCF-42H	42 x 42 x 28.25	1067 x 1067 x 718	79	4.15	\$1416
GCF-42L	42 x 42 x 28.25	1067 x 1067 x 718	79	4.15	\$1216

- For a high pressure laminate top (HP), specify model GCF-42H.
- For a thermally fused top (LP), specify model GCF-42L.

42" x 42" thermally fused laminate top. Four legs.
 • Additional leg heights are available. Special quote is required.
 • 2 cartons.



Floral Dining Room Table - 48"

GCF-48H	48 x 48 x 28.25	1219 x 1219 x 718	98	4.7	\$1795
GCF-48L	48 x 48 x 28.25	1219 x 1219 x 718	98	4.7	\$1335

- For a high pressure laminate top (HP), specify model GCF-48H.
- For a thermally fused top (LP), specify model GCF-48L.

48" x 48" thermally fused laminate top. Four legs.
 • Additional leg heights are available. Special quote is required.
 • 2 cartons.

Notes: Please specify all substitutions and options.

- Elliptical metal tube frame finish must be specified at time of order (see below).
- Freestanding tables coordinate with GC Belong and Strand seating series. Please refer to the seating section for information on ganging tables.
- Tables are 16" high.
- Shipped easy to assemble.
- 2mm edging color coordinated with laminate finish is standard for all tops. Finish must be specified at time of order.
- Tops are 1" thick and available in thermally fused laminate (**LP**) and high pressure laminate (**HP**). Please select the appropriate model number for the finish you prefer.
- Refer to the following lists when selecting a finish color. Must specify both a top color and leg finish at time of order.
- For custom laminate or contrasting edge, please contact your Global sales representative for a special quotation.

Thermally Fused Laminate (LP)



- (ACJ) Absolute Acajou
- (ASN) Asian Night
- (AWC) Avant Cherry
- (AWH) Avant Honey
- (BLK) Black
- (BZD) Blizzard
- (BRC) Brushed Cobalt
- (CMB) Clear Maple
- (CGY) Custom Grey
- (DES) Dark Espresso
- (DWT) Designer White
- (FAS) Fashionista
- (FCL) First Class
- (NBL) Noce Biondo
- (NGL) Noce Grigio
- (NEL) Noce Leggero
- (NML) Noce Medio
- (QTM) Quartered Mahogany
- (SBY) Sheer Beauty
- (SDT) Stonedust
- (SOG) Storm Grey
- (WHE) Walnut Heights
- (WHC) White Chocolate
- (WCR) Winter Cherry

High Pressure Laminate (HP)

- (ACJ) Absolute Acajou
- (ASN) Asian Night
- (AWC) Avant Cherry
- (AWH) Avant Honey
- (BLK) Black
- (BZD) Blizzard
- (BRC) Brushed Cobalt
- (CMB) Clear Maple
- (CGY) Custom Grey
- (DES) Dark Espresso
- (DWT) Designer White
- (FAS) Fashionista
- (FCL) First Class
- (NBL) Noce Biondo
- (NGL) Noce Grigio
- (NEL) Noce Leggero
- (NML) Noce Medio
- (QTM) Quartered Mahogany
- (SBY) Sheer Beauty
- (SDT) Stonedust
- (SOG) Storm Grey
- (WHE) Walnut Heights
- (WHC) White Chocolate
- (WCR) Winter Cherry

Leg Finish

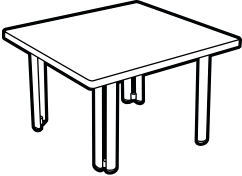
- (TBL) Black
- (TIV) Cloud
- (TDW) Designer White
- (TFO) Fog
- (TFR) Frost
- (TKA) Kalua
- (TLA) Latte
- (TMO) Mocha
- (TNE) Nevada
- (TSN) Sand
- (TSH) Shadow
- (TOA) Toast
- (TTU) Tungsten

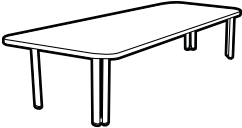
TABLES	MODEL #	DIMENSIONS IN MM	WEIGHT LB KG	VOLUME FT ³ MT ³	LIST PRICE	
 <p>Rectangular End Table</p>	W x D x H					
	GC4281-HP	18 x 22 x 16	25	3.4	\$701	
		457 x 559 x 406	11.4	0.09		
	GC4281-LP	18 x 22 x 16	25	3.4	\$619	
		457 x 559 x 406	11.4	0.09		
	<ul style="list-style-type: none"> • For a high pressure laminate top (HP), specify model GC4281-HP. • For a thermally fused laminate top (LP), specify model GC4281-LP. <p>Coordinating 2mm edge. Oval steel tube legs. 1 per carton.</p>					
 <p>Square End Table</p>	GC4282-HP	30 x 30 x 16	28	6	\$870	
		762 x 762 x 406	12.7	0.16		
	GC4282-LP	30 x 30 x 16	28	6	\$777	
		762 x 762 x 406	12.7	0.16		
	<ul style="list-style-type: none"> • For a high pressure laminate top (HP), specify model GC4282-HP. • For a thermally fused laminate top (LP), specify model GC4282-LP. <p>Coordinating 2mm edge. Oval steel tube legs. 1 per carton.</p>					
	 <p>Rectangular Coffee Table</p>	GC4283-HP	22 x 54 x 16	30	6	\$1007
		559 x 1372 x 406	13.6	0.16		
GC4283-LP		22 x 54 x 16	30	6	\$840	
		559 x 1372 x 406	13.6	0.16		
<ul style="list-style-type: none"> • For a high pressure laminate top (HP), specify model GC4283-HP. • For a thermally fused laminate top (LP), specify model GC4283-LP. <p>Coordinating 2mm edge. Oval steel tube legs. 1 per carton.</p>						

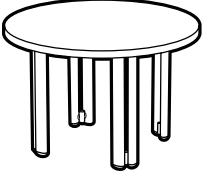
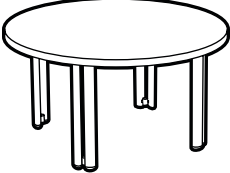
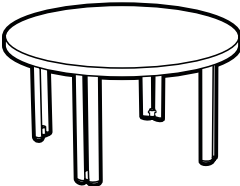
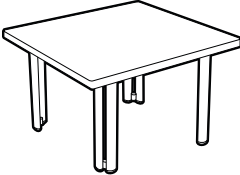
TABLES	MODEL #	DIMENSIONS ^{IN} _{MM}	WEIGHT ^{LB} _{KG}	VOLUME ^{FT³} _{MT³}	LIST PRICE
	GC4284-HP	36 x 36 x 16	30	6	\$932
		914 x 914 x 406	13.6	0.16	
	GC4284-LP	36 x 36 x 16	30	6	\$799
		914 x 914 x 406	13.6	0.16	
<ul style="list-style-type: none"> • For a high pressure laminate top (HP), specify model GC4284-HP. • For a thermally fused laminate top (LP), specify model GC4284-LP. <p>Coordinating 2mm edge. Oval steel tube legs. 1 per carton.</p>					
	GC4285-HP	24 x 24 x 16	27	3.4	\$844
		610 x 610 x 406	12.3	0.09	
	GC4285-LP	24 x 24 x 16	27	3.4	\$781
		610 x 610 x 406	12.3	0.09	
<ul style="list-style-type: none"> • For a high pressure laminate top (HP), specify model GC4285-HP. • For a thermally fused laminate top (LP), specify model GC4285-LP. <p>Coordinating 2mm edge. Oval steel tube legs. 1 per carton.</p>					
	GC4286-HP	30 x 30 x 16	29	6	\$888
		762 x 762 x 406	13.2	0.16	
	GC4286-LP	30 x 30 x 16	29	6	\$827
		762 x 762 x 406	13.2	0.16	
<ul style="list-style-type: none"> • For a high pressure laminate top (HP), specify model GC4286-HP. • For a thermally fused laminate top (LP), specify model GC4286-LP. <p>Coordinating 2mm edge. Oval steel tube legs. 1 per carton.</p>					
	GC4287-HP	36 x 36 x 16	30	6	\$934
		914 x 914 x 406	13.6	0.16	
	GC4287-LP	36 x 36 x 16	30	6	\$876
		914 x 914 x 406	13.6	0.16	
<ul style="list-style-type: none"> • For a high pressure laminate top (HP), specify model GC4287-HP. • For a thermally fused laminate top (LP), specify model GC4287-LP. <p>Coordinating 2mm edge. Oval steel tube legs. 1 per carton.</p>					
	GC4288-HP	23 x 23 x 16	25	3.4	\$738
		584 x 584 x 406	11.4	0.09	
	GC4288-LP	23 x 23 x 16	25	3.4	\$707
		584 x 584 x 406	11.4	0.09	
<ul style="list-style-type: none"> • For a high pressure laminate top (HP), specify model GC4288-HP. • For a thermally fused laminate top (LP), specify model GC4288-LP. <p>Coordinating 2mm edge. Oval steel tube legs. 1 per carton.</p>					

Notes: Please specify all substitutions and options.

- Select from chippendale (**C**), post (**P**), or tapered (**T**) leg options to coordinate with traditional or contemporary decor.
- Solid wood legs and aprons are standard.
- Shipped easy to assemble.
- 2mm edging color coordinated with laminate finish is standard for all tops. Finish must be specified at time of order.
- Tops are 1" thick and available in thermally fused laminate (**LP**), high pressure laminate (**HP**) or solid hardwood (**W**). Please select the appropriate model number for the finish you prefer.
- Thermally fused laminate (**LP**) and high pressure laminate (**HP**) tops come with a 2mm edging color coordinated with laminate finish. Top finish must be specified at time of order.
- Solid hardwood tops come with decorative edge detail to coordinate with leg selected. Chippendale legs come with beveled edge. Post leg comes with bullnose edge. Tapered leg comes with knife cut edge. See pictures below.
- Refer to the following lists when selecting a finish color. Must specify both a top color and base color at time of order all tables.
- Thermally fused and high pressure laminate tops cannot be manufactured with the exact finish color on the base.
- For custom laminate, custom wood stain or contrasting edge, please contact your Global sales representative for a special quotation.

Thermally Fused Laminate (LP)

- (ACJ) Absolute Acajou
- (ASN) Asian Night
- (AWC) Avant Cherry
- (AWH) Avant Honey
- (BLK) Black
- (BZD) Blizzard
- (BRC) Brushed Cobalt
- (CMB) Clear Maple
- (CGY) Custom Grey
- (DES) Dark Espresso
- (DWT) Designer White
- (FAS) Fashionista
- (FCL) First Class
- (NBL) Noce Biondo
- (NGL) Noce Grigio
- (NEL) Noce Leggero
- (NML) Noce Medio
- (QTM) Quartered Mahogany
- (SBY) Sheer Beauty
- (SDT) Stonedust
- (SOG) Storm Grey
- (WHE) Walnut Heights
- (WHC) White Chocolate
- (WCR) Winter Cherry

Suggested coordinating wood finish

- (AAM) Absolute
- (ASM) Night
- (ACM) Cherry on Maple
- (AHM) Honey on Maple
- (JOM) Jet Onyx
-
- (LHM) Light Honey on Maple
- (AVM) Maple on Maple
-
- (ECM) Espresso Cafe on Maple
- (WHM) White
-
- (NBM) Noce Biondo
- (NGM) Noce Grigio
- (NEM) Noce Leggero
- (NMM) Noce Medio
- (TMM) Tiger Mahogany on Maple
-
-
- (NLW) Natural Walnut
- (WTM) WC Cream
- (WCM) Winter Cherry on Maple

High Pressure Laminate (HP)

- (ACJ) Absolute Acajou
- (ASN) Asian Night
- (W357) Avant Cherry
- (W356) Avant Honey
- (BLK) Black
- (BZD) Blizzard
- (BRC) Brushed Cobalt
- (CMB) Clear Maple
- (CGY) Custom Grey
- (DES) Dark Espresso
- (DWT) Designer White
- (FAS) Fashionista
- (FCL) First Class
- (NBL) Noce Biondo
- (NGL) Noce Grigio
- (NEL) Noce Leggero
- (NML) Noce Medio
- (QTM) Quartered Mahogany
- (SBY) Sheer Beauty
- (SDT) Stonedust
- (SOG) Storm Grey
- (WHE) Walnut Heights
- (WHC) White Chocolate
- (WCR) Winter Cherry

Suggested coordinating wood finish

- (AAM) Absolute
- (ASM) Night
- (ACM) Cherry on Maple
- (AHM) Honey on Maple
- (JOM) Jet Onyx
-
- (LHM) Light Honey on Maple
- (AVM) Maple on Maple
-
- (ECM) Espresso Cafe on Maple
- (WHM) White
-
- (NBM) Noce Biondo
- (NGM) Noce Grigio
- (NEM) Noce Leggero
- (NMM) Noce Medio
- (TMM) Tiger Mahogany on Maple
-
-
- (NLW) Natural Walnut
- (WTM) WC Cream
- (WCM) Winter Cherry on Maple

Wood finishes (W) - top, base, legs & apron

- Absolute (AAM)
- Charcoal Java on Maple (CJM)
- Cherry on Maple (ACM)
- Empire Mahogany on Maple (EMM)
- English Oak on Maple (EOM)
- Espresso Cafe on Maple (ECM)
- Grey (HGM)
- Harvest Oak on Maple (HOM)
- Honey on Maple (AHM)
- Jet Onyx on Maple (JOM)
- Light Honey on Maple (LHM)
- Mahogany on Maple (TMM)
- Maple on Maple (AVM)
- Medium Walnut on Maple (MWM)
- Natural Walnut (NLW)
- Night (ASM)
- Noce Biondo (NBM)
- Noce Grigio (NGM)
- Noce Leggero (NEM)
- Noce Medio (NMM)
- Sandy Beach on Maple (SBM)
- Shaker Cherry on Maple (SKM)
- Silver Oak on Maple (SOM)
- Tiger Fruitwood on Maple (TFM)
- Tiger Walnut on Maple (TWM)
- WC Cream (WTM)
- White on Maple (WHM)
- Winter Cherry on Maple (WCM)

Table edges - wood tops

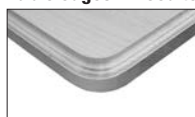

Beveled edge



Bullnose edge

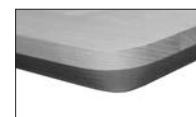

Reverse knife cut edge

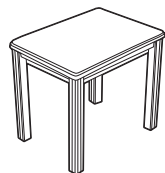
RECTANGULAR END TABLES	MODEL #	DIMENSIONS IN	WEIGHT LB	VOLUME FT ³	LIST PRICE
		W x D x H			
	GC3760-HC	18 x 24 x 21	26.26	5.25	\$801
		457 x 610 x 533	11.91	0.14	
	GC3760-LC	18 x 24 x 21	26.26	5.25	\$692
		457 x 610 x 533	11.91	0.14	
	GC3760-WC	18 x 24 x 21.25	27.12	5.25	\$836
		457 x 610 x 540	12.3	0.14	

- For a high pressure laminate top (HP), specify model GC3760-HC.
- For a thermally fused top (LP), specify model GC3760-LC.
- For a wood top (W), specify model GC3760-WC.

Features **chippendale** legs. 21" high. Standard with solid wood legs and apron. 1 per carton.

RECTANGULAR END TABLES

MODEL #	DIMENSIONS ^{IN} _{MM}	WEIGHT ^{LB} _{KG}	VOLUME ^{FT³} _{MT³}	LIST PRICE
GC3760-HP	18 x 24 x 21	26.3	5.25	\$1187
	457 x 610 x 533	11.92	0.14	
GC3760-LP	18 x 24 x 21	26.3	5.25	\$1075
	457 x 610 x 533	11.92	0.14	
GC3760-WP	18 x 24 x 21	27.1	5.25	\$1224
	457 x 610 x 533	12.29	0.14	

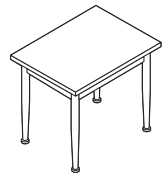

Rectangular End Table

- For a high pressure laminate top (HP), specify model GC3760-HP.
- For a thermally fused top (LP), specify model GC3760-LP.
- For a wood top (W), specify model GC3760-WP.

Features **post** legs. 21" high. Standard with solid wood legs and apron. Post legs are 1.33" in diameter. 1 per carton.

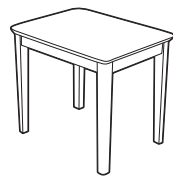

Rectangular End Table

GC3760-HT	18 x 24 x 21	24.69	5.25	\$801
	457 x 610 x 533	11.19	0.14	
GC3760-LT	18 x 24 x 21	24.69	5.25	\$692
	457 x 610 x 533	11.19	0.14	
GC3760-WT	18 x 24 x 21.25	25.55	5.5	\$836
	457 x 610 x 540	11.58	0.15	

- For a high pressure laminate top (HP), specify model GC3760-HT.
- For a thermally fused top (LP), specify model GC3760-LT.
- For a wood top (W), specify model GC3760-WT.

Features **tapered** legs. 21" high. Standard with solid wood legs and apron. 1 per carton.

SQUARE END TABLES

GC3761-HC	21 x 21 x 21	26.48	5.5	\$801
	533 x 533 x 533	12.01	0.15	
GC3761-LC	21 x 21 x 21	26.48	5.5	\$692
	533 x 533 x 533	12.01	0.15	
GC3761-WC	21 x 21 x 21.25	27.36	5.5	\$836
	533 x 533 x 540	12.41	0.15	

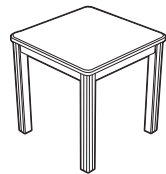

Square End Table

- For a high pressure laminate top (HP), specify model GC3761-HC.
- For a thermally fused top (LP), specify model GC3761-LC.
- For a wood top (W), specify model GC3761-WC.

Features **chippendale** legs. 21" high. Standard with solid wood legs and apron. 1 per carton.

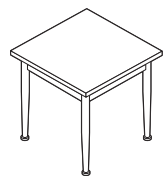

Square End Table

GC3761-HP	21 x 21 x 21	26.5	5.5	\$1187
	533 x 533 x 533	12.02	0.15	
GC3761-LP	21 x 21 x 21	26.5	5.5	\$1075
	533 x 533 x 533	12.02	0.15	
GC3761-WP	21 x 21 x 21	27.4	5.5	\$1224
	533 x 533 x 533	12.42	0.15	

- For a high pressure laminate top (HP), specify model GC3761-HP.
- For a thermally fused top (LP), specify model GC3761-LP.
- For a wood top (W), specify model GC3761-WP.

Features **post** legs. 21" high. Standard with solid wood legs and apron. Post legs are 1.33" in diameter. 1 per carton.

SQUARE END TABLES



Square End Table

MODEL #	DIMENSIONS ^{IN} ^{MM} W x D x H	WEIGHT ^{LB} ^{KG}	VOLUME ^{FT³} ^{MT³}	LIST PRICE
GC3761-HT	21 x 21 x 21	24.91	5.5	\$801
	533 x 533 x 533	11.29	0.15	
GC3761-LT	21 x 21 x 21	24.91	5.5	\$692
	533 x 533 x 533	11.29	0.15	
GC3761-WT	21 x 21 x 21.25	25.79	5.5	\$836
	533 x 533 x 540	11.69	0.15	

- For a high pressure laminate top (HP), specify model GC3761-HT.
- For a thermally fused top (LP), specify model GC3761-LT.
- For a wood top (W), specify model GC3761-WT.

Features **tapered** legs. 21" high. Standard with solid wood legs and apron. 1 per carton.

ROUND END TABLES



Round End Table

GC3762-HC	24 x 24 x 21	26.12	7	\$858
	610 x 610 x 533	11.84	0.19	
GC3762-LC	24 x 24 x 21	26.12	7	\$712
	610 x 610 x 533	11.84	0.19	
GC3762-WC	24 x 24 x 21.25	27.02	7	\$902
	610 x 610 x 540	12.25	0.19	

- For a high pressure laminate top (HP), specify model GC3762-HC.
- For a thermally fused top (LP), specify model GC3762-LC.
- For a wood top (W), specify model GC3762-WC.

Features **chippendale** legs. 21" high. Standard with solid wood legs and apron. 1 per carton.

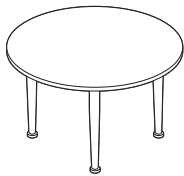

Round End Table

GC3762-HP	24 x 24 x 21	26.1	7	\$1249
	610 x 610 x 533	11.83	0.19	
GC3762-LP	24 x 24 x 21	20	7	\$1097
	610 x 610 x 533	9	0.19	
GC3762-WP	24 x 24 x 21	27	7	\$1294
	610 x 610 x 533	12.24	0.19	

- For a high pressure laminate top (HP), specify model GC3762-HP.
- For a thermally fused top (LP), specify model GC3762-LP.
- For a wood top (W), specify model GC3762-WP.

Features **post** legs. 21" high. Post legs are 1.33" in diameter. 1 per carton.



Round End Table

GC3762-HT	24 x 24 x 21	24.55	8.5	\$858
	610 x 610 x 533	11.13	0.24	
GC3762-LT	24 x 24 x 21	20	8.5	\$712
	610 x 610 x 533	9.1	0.24	
GC3762-WT	24 x 24 x 21.25	25.45	8.5	\$902
	610 x 610 x 540	11.54	0.24	

- For a high pressure laminate top (HP), specify model GC3762-HT.
- For a thermally fused top (LP), specify model GC3762-LT.
- For a wood top (W), specify model GC3762-WT.

Features **tapered** legs. 21" high. Standard with solid wood legs and apron. 1 per carton.

RECTANGULAR COFFEE TABLES

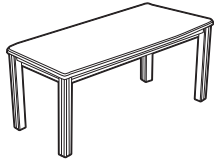

Rectangular Coffee Table

MODEL #	DIMENSIONS ^{IN} ^{MM} W x D x H	WEIGHT ^{LB} ^{KG}	VOLUME ^{FT³} ^{MT³}	LIST PRICE
GC3763-HC	22 x 48 x 19	43.73	11.75	\$1084
	559 x 1219 x 483	19.83	0.33	
GC3763-LC	22 x 48 x 19	43.73	11.75	\$840
	559 x 1219 x 483	19.83	0.33	
GC3763-WC	22 x 48 x 19.25	45.83	11.75	\$1150
	559 x 1219 x 489	20.78	0.33	

- For a high pressure laminate top (HP), specify model GC3763-HC.
- For a thermally fused top (LP), specify model GC3763-LC.
- For a wood top (W), specify model GC3763-WC.

Features **chippendale** legs. 19" high. Standard with solid wood legs and apron. 1 per carton.

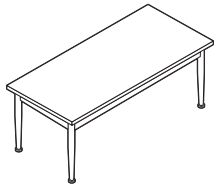

Rectangular Coffee Table

GC3763-HP	22 x 48 x 19	43.7	11.75	\$1483
	559 x 1219 x 483	19.82	0.33	
GC3763-LP	22 x 48 x 19	43.7	11.75	\$1230
	559 x 1219 x 483	19.82	0.33	
GC3763-WP	22 x 48 x 19	45.8	11.75	\$1554
	559 x 1219 x 483	20.77	0.33	

- For a high pressure laminate top (HP), specify model GC3763-HP.
- For a thermally fused top (LP), specify model GC3763-LP.
- For a wood top (W), specify model GC3763-WP.

Features **post** legs. 19" high. Standard with solid wood legs and apron. Post legs are 1.33" in diameter. 1 per carton.



Rectangular Coffee Table

GC3763-HT	22 x 48 x 19	42.27	11.75	\$1084
	559 x 1219 x 483	19.17	0.33	
GC3763-LT	22 x 48 x 19	42.27	11.75	\$840
	559 x 1219 x 483	19.17	0.33	
GC3763-WT	22 x 48 x 19.25	44.38	11.75	\$1150
	559 x 1219 x 489	20.13	0.33	

- For a high pressure laminate top (HP), specify model GC3763-HT.
- For a thermally fused top (LP), specify model GC3763-LT.
- For a wood top (W), specify model GC3763-WT.

Features **tapered** legs. 19" high. Standard with solid wood legs and apron. 1 per carton.

OVAL COFFEE TABLES

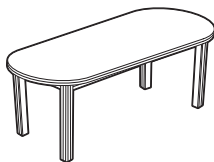

Oval Coffee Table

GC3764-HC	22 x 46 x 19	38.58	11.5	\$1048
	559 x 1168 x 483	17.49	0.32	
GC3764-LC	22 x 46 x 19	38.58	11.5	\$805
	559 x 1168 x 483	17.49	0.32	
GC3764-WC	22 x 46 x 19.25	38.4	11.5	\$1118
	559 x 1168 x 489	17.41	0.32	

- For a high pressure laminate top (HP), specify model GC3764-HC.
- For a thermally fused top (LP), specify model GC3764-LC.
- For a wood top (W), specify model GC3764-WC.

Features **chippendale** legs. 19" high. Standard with solid wood legs and apron. 1 per carton.

OVAL COFFEE TABLES

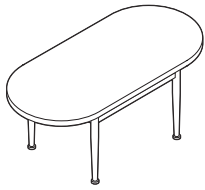

Oval Coffee Table

MODEL #	DIMENSIONS ^{IN} ^{MM}	WEIGHT ^{LB} ^{KG}	VOLUME ^{FT³} ^{MT³}	LIST PRICE
GC3764-HP	22 x 46 x 19	38.6	11.5	\$1447
	559 x 1168 x 483	17.5	0.32	
GC3764-LP	22 x 46 x 19	38.6	11.5	\$1192
	559 x 1168 x 483	17.5	0.32	
GC3764-WP	22 x 46 x 19	38.4	11.5	\$1516
	559 x 1168 x 483	17.41	0.32	

- For a high pressure laminate top (HP), specify model GC3763-HP.
- For a thermally fused top (LP), specify model GC3763-LP.
- For a wood top (W), specify model GC3763-WP.

Features **post** legs. 19" high. Standard with solid wood legs and apron. Post legs are 1.33" in diameter. 1 per carton.

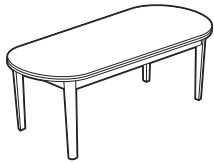

Oval Coffee Table

GC3764-HT	22 x 46 x 19	37.13	11.5	\$1048
	559 x 1168 x 483	16.84	0.32	
GC3764-LT	22 x 46 x 19	37.13	11.5	\$805
	559 x 1168 x 483	16.84	0.32	
GC3764-WT	22 x 46 x 19.25	36.94	11.5	\$1118
	559 x 1168 x 489	16.75	0.32	

- For a high pressure laminate top (HP), specify model GC3764-HT.
- For a thermally fused top (LP), specify model GC3764-LT.
- For a wood top (W), specify model GC3764-WT.

Features **tapered** legs. 19" high. Standard with solid wood legs and apron. 1 per carton.

ROUND COFFEE TABLES

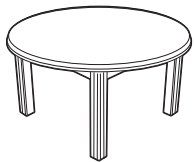

Round Coffee Table

GC3765-HC	32 x 32 x 19	35.15	11.5	\$1070
	813 x 813 x 483	15.94	0.32	
GC3765-LC	32 x 32 x 19	35.15	11.5	\$828
	813 x 813 x 483	15.94	0.32	
GC3765-WC	32 x 32 x 19.25	36.76	11.5	\$1140
	813 x 813 x 489	16.67	0.32	

- For a high pressure laminate top (HP), specify model GC3765-HC.
- For a thermally fused top (LP), specify model GC3765-LC.
- For a wood top (W), specify model GC3765-WC.

Features **chippendale** legs. 19" high. Standard with solid wood legs and apron. 1 per carton.

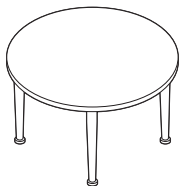

Round Coffee Table

GC3765-HP	32 x 32 x 19	35.2	11.5	\$1471
	813 x 813 x 483	15.96	0.32	
GC3765-LP	32 x 32 x 19	35.2	11.5	\$1216
	813 x 813 x 483	15.96	0.32	
GC3765-WP	32 x 32 x 19	36.8	11.5	\$1542
	813 x 813 x 483	16.69	0.32	

- For a high pressure laminate top (HP), specify model GC3765-HP.
- For a thermally fused top (LP), specify model GC3765-LP.
- For a wood top (W), specify model GC3765-WP.

Features **post** legs. 19" high. Standard with solid wood legs and apron. Post legs are 1.33" in diameter. 1 per carton.

ROUND COFFEE TABLES

MODEL #	DIMENSIONS	WEIGHT	VOLUME	LIST PRICE
	IN MM	LB KG	FT ³ MT ³	
GC3765-HT	32 x 32 x 19	33.69	11.5	\$1070
	813 x 813 x 483	15.28	0.32	
GC3765-LT	32 x 32 x 19	33.69	11.5	\$828
	813 x 813 x 483	15.28	0.32	
GC3765-WT	32 x 32 x 19.25	35.3	11.5	\$1140
	813 x 813 x 489	16.01	0.32	

- For a high pressure laminate top (HP), specify model GC3765-HT.
- For a thermally fused top (LP), specify model GC3765-LT.
- For a wood top (W), specify model GC3765-WT.

Features **tapered** legs. 19" high. Standard with solid wood legs and apron. 1 per carton.



Round Coffee Table

RECTANGULAR SOFA TABLES

MODEL #	DIMENSIONS	WEIGHT	VOLUME	LIST PRICE
	IN MM	LB KG	FT ³ MT ³	
GC3766-HC	16 x 42 x 29	37.62	11.5	\$942
	406 x 1067 x 737	17.06	0.32	
GC3766-LC	16 x 42 x 29	37.62	11.5	\$774
	406 x 1067 x 737	17.06	0.32	
GC3766-WC	16 x 42 x 29.25	38.07	11.5	\$978
	406 x 1067 x 743	17.26	0.32	

- For a high pressure laminate top (HP), specify model GC3766-HC.
- For a thermally fused top (LP), specify model GC3766-LC.
- For a wood top (W), specify model GC3766-WC.

Features **chippendale** legs. 29" high. Standard with solid wood legs and apron. 1 per carton.

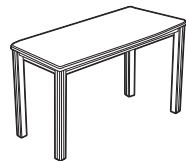

Rectangular Sofa Table

MODEL #	DIMENSIONS	WEIGHT	VOLUME	LIST PRICE
	IN MM	LB KG	FT ³ MT ³	
GC3766-HP	16 x 42 x 29	37.6	11.5	\$1481
	406 x 1067 x 737	17.05	0.32	
GC3766-LP	16 x 42 x 29	37.6	11.5	\$1306
	406 x 1067 x 737	17.05	0.32	
GC3766-WP	16 x 42 x 29	38.1	11.5	\$1514
	406 x 1067 x 737	17.28	0.32	

- For a high pressure laminate top (HP), specify model GC3766-HP.
- For a thermally fused top (LP), specify model GC3766-LP.
- For a wood top (W), specify model GC3766-WP.

Features **post** legs. 29" high. Standard with solid wood legs and apron. Post legs are 1.33" in diameter. 1 per carton.

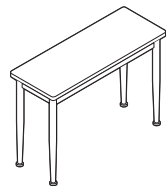

Rectangular Sofa Table

MODEL #	DIMENSIONS	WEIGHT	VOLUME	LIST PRICE
	IN MM	LB KG	FT ³ MT ³	
GC3766-HT	16 x 42 x 29	34.58	11.5	\$942
	406 x 1067 x 737	15.68	0.32	
GC3766-LT	16 x 42 x 29	34.58	11.5	\$774
	406 x 1067 x 737	15.68	0.32	
GC3766-WT	16 x 42 x 29.25	35.92	11.5	\$978
	406 x 1067 x 743	16.29	0.32	

- For a high pressure laminate top (HP), specify model GC3766-HT.
- For a thermally fused top (LP), specify model GC3766-LT.
- For a wood top (W), specify model GC3766-WT.

Features **tapered** legs. 29" high. Standard with solid wood legs and apron. 1 per carton.

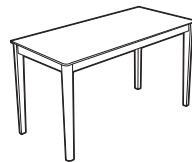

Rectangular Sofa Table

SQUARE DINING TABLES

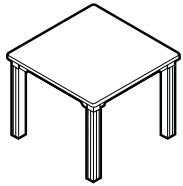

Square Dining Table

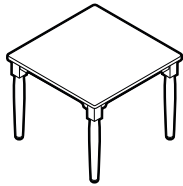

Square Dining Table

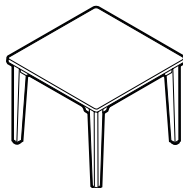

Square Dining Table

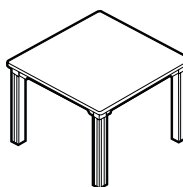

Square Dining Table

MODEL #	DIMENSIONS ^{IN} _{MM}	WEIGHT ^{LB} _{KG}	VOLUME ^{FT³} _{MT³}	LIST PRICE
GC3772-HC	36 x 36 x 29	50	3.9	\$1672
	914 x 914 x 737	22.67	0.11	
GC3772-LC	36 x 36 x 29	50	3.9	\$1496
	914 x 914 x 737	22.67	0.11	
GC3772-WC	36 x 36 x 29	50	3.9	\$2391
	914 x 914 x 737	22.67	0.11	

- For a high pressure laminate top (HP), specify model GC3772-HC.
- For a thermally fused top (LP), specify model GC3772-LC.
- For a wood top (W), specify model GC3772-WC.

Features **chippendale** legs. 29" high. Standard with solid wood legs and apron. 1 per carton.

GC3772-HP	36 x 36 x 29	50	3.9	\$1672
	914 x 914 x 737	22.67	0.11	
GC3772-LP	36 x 36 x 29	50	3.9	\$1496
	914 x 914 x 737	22.67	0.11	
GC3772-WP	36 x 36 x 29	50	3.9	\$2391
	914 x 914 x 737	22.67	0.11	

- For a high pressure laminate top (HP), specify model GC3772-HP.
- For a thermally fused top (LP), specify model GC3772-LP.
- For a wood top (W), specify model GC3772-WP.

Features **post** legs. 29" high. Standard with solid wood legs and apron. Post legs are 1.33" in diameter. 1 per carton.

GC3772-HT	36 x 36 x 29	50	3.9	\$1672
	914 x 914 x 737	22.67	0.11	
GC3772-LT	36 x 36 x 29	50	3.9	\$1496
	914 x 914 x 737	22.67	0.11	
GC3772-WT	36 x 36 x 29	50	3.9	\$2391
	914 x 914 x 737	22.67	0.11	

- For a high pressure laminate top (HP), specify model GC3772-HT.
- For a thermally fused top (LP), specify model GC3772-LT.
- For a wood top (W), specify model GC3772-WT.

Features **tapered** legs. 29" high. Standard with solid wood legs and apron. 1 per carton.

GC3773-HC	42 x 42 x 29	68	5.5	\$1852
	1067 x 1067 x 737	30.84	0.15	
GC3773-LC	42 x 42 x 29	68	5.5	\$1610
	1067 x 1067 x 737	30.84	0.15	
GC3773-WC	42 x 42 x 29	68	5.5	\$2900
	1067 x 1067 x 737	30.84	0.15	

- For a high pressure laminate top (HP), specify model GC3773-HC.
- For a thermally fused top (LP), specify model GC3773-LC.
- For a wood top (W), specify model GC3773-WC.

Features **chippendale** legs. 29" high. Standard with solid wood legs and apron. 1 per carton.

SQUARE DINING TABLES

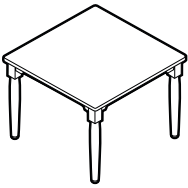
	MODEL #	DIMENSIONS	WEIGHT	VOLUME	LIST PRICE
		IN MM	LB KG	FT ³ MT ³	
	GC3773-HP	42 x 42 x 29	68	5.5	\$1852
		1067 x 1067 x 737	30.84	0.15	
		GC3773-LP	42 x 42 x 29	68	
		1067 x 1067 x 737	30.84	0.15	
	GC3773-WP	42 x 42 x 29	68	5.5	\$2900
		1067 x 1067 x 737	30.84	0.15	

Square Dining Table

- For a high pressure laminate top (HP), specify model GC3773-HP.
- For a thermally fused top (LP), specify model GC3773-LP.
- For a wood top (W), specify model GC3773-WP.

Features **post** legs. 29" high. Standard with solid wood legs and apron. Post legs are 1.33" in diameter. 1 per carton.

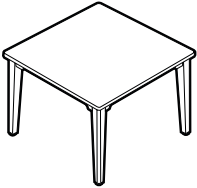
	GC3773-HT	42 x 42 x 29	68	5.5	\$1852
		1067 x 1067 x 737	30.84	0.15	
		GC3773-LT	42 x 42 x 29	68	
		1067 x 1067 x 737	30.84	0.15	
	GC3773-WT	42 x 42 x 29	68	5.5	\$2900
		1067 x 1067 x 737	30.84	0.15	

Square Dining Table

- For a high pressure laminate top (HP), specify model GC3773-HT.
- For a thermally fused top (LP), specify model GC3773-LT.
- For a wood top (W), specify model GC3773-WT.

Features **tapered** legs. 29" high. Standard with solid wood legs and apron. 1 per carton.

RECTANGULAR DINING TABLES

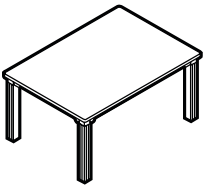
	GC3774-HC	42 x 60 x 29	97	7.5	\$2182
		1067 x 1524 x 737	43.99	0.21	
		GC3774-LC	42 x 60 x 29	97	
		1067 x 1524 x 737	43.99	0.21	
	GC3774-WC	42 x 60 x 29	97	7.5	\$3634
		1067 x 1524 x 737	43.99	0.21	

Rectangular Dining Table

- For a high pressure laminate top (HP), specify model GC3774-HC.
- For a thermally fused top (LP), specify model GC3774-LC.
- For a wood top (W), specify model GC3774-WC.

Features **chippendale** legs. 29" high. Standard with solid wood legs and apron. 1 per carton.

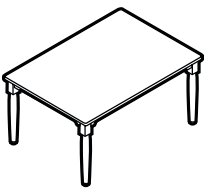
	GC3774-HP	42 x 60 x 29	97	7.5	\$2182
		1067 x 1524 x 737	43.99	0.21	
		GC3774-LP	42 x 60 x 29	97	
		1067 x 1524 x 737	43.99	0.21	
	GC3774-WP	42 x 60 x 29	97	7.5	\$3634
		1067 x 1524 x 737	43.99	0.21	

Rectangular Dining Table

- For a high pressure laminate top (HP), specify model GC3774-HP.
- For a thermally fused top (LP), specify model GC3774-LP.
- For a wood top (W), specify model GC3774-WP.

Features **post** legs. 29" high. Standard with solid wood legs and apron. Post legs are 1.33" in diameter. 1 per carton.

RECTANGULAR DINING TABLES

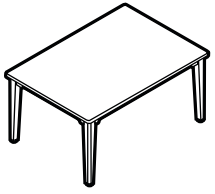

Rectangular Dining Table

MODEL #	DIMENSIONS ^{IN} _{MM}	WEIGHT ^{LB} _{KG}	VOLUME ^{FT³} _{MT³}	LIST PRICE
GC3774-HT	42 x 60 x 29	97	7.5	\$2182
	1067 x 1524 x 737	43.99	0.21	
GC3774-LT	42 x 60 x 29	97	7.5	\$1839
	1067 x 1524 x 737	43.99	0.21	
GC3774-WT	42 x 60 x 29	97	7.5	\$3634
	1067 x 1524 x 737	43.99	0.21	

- For a high pressure laminate top (HP), specify model GC3774-HT.
- For a thermally fused top (LP), specify model GC3774-LT.
- For a wood top (W), specify model GC3774-WT.

Features **tapered** legs. 29" high. Standard with solid wood legs and apron. 1 per carton.

Notes: Please specify all substitutions and options.

- Tops are available in various shapes: rectangular, kidney, peanut and jellybean shapes.
- Bases are available in three styles: H-base, U-base and C-base.
- Bases feature a shock-absorbent gas spring cylinder for easy height adjustment and exposed steel with no plastic cover for easy cleaning of base and casters.
- Manufactured with the lowest base (less than 2”H) in the industry, overbed tables can easily be moved under any patient bed or seating.
- Thermofoil top comes standard with seamless spillguard edge that holds up to 36 oz of liquid. For no spillguard, specify **(NS)**. **Add \$62.**
- Overbed tables come standard with four non-locking casters.
- For two locking and two non-locking casters, specify **(2L)** when ordering the overbed table. **Add \$148.**
- For four locking casters, specify **(LC)** when ordering the overbed table. **Add \$295.**
- Refer to the following lists when selecting a finish color. Must specify both a top color and base color at time of order all tables.

Thermofoil Tops

- Candlelight (TCL)
- Chocolate Pear (TCP)
- Hard Rock Maple (THM)
- Medium Cherry (TMC)
- Medium Oak (TMO)

Bases

- Almond (AL)
- Graphite Grey (GG)
- Nevada (NV)

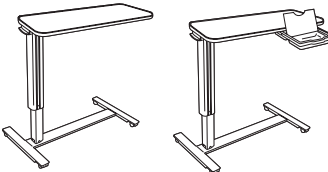
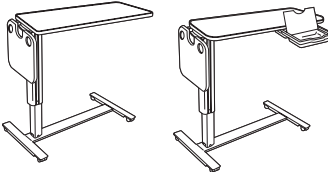
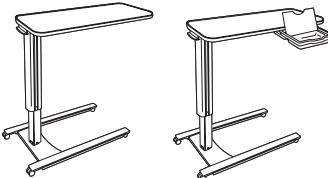
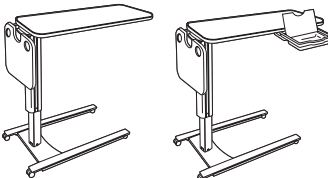
OVERBED TABLES W/THERMOFOIL TOP	MODEL #	DIMENSIONS	WEIGHT	VOLUME	LIST PRICE
	GC3554	34 x 18 x 28-42 864 x 457 x 711-1067	35 15.87	13.4 0.37	\$1372
	GC3554V	34 x 18 x 28-42 864 x 457 x 711-1067	37 16.78	13.4 0.37	\$1606
	w/Vanity drawer				
<p>Rectangular Thermofoil Spillguard Top w/H-Base</p>					<ul style="list-style-type: none"> • Dual vanity drawer with mirror slides out from either side of the table. <p>Thermofoil top with seamless spillguard edge. Height adjustable steel base. 1 per carton.</p>
	GC3554F	48 x 18 x 28-42 1219 x 457 x 711-1067	40 18.14	13.4 0.37	\$1976
	GC3554VF	48 x 18 x 28-42 1219 x 457 x 711-1067	42 19.05	13.4 0.37	\$2210
	w/Vanity drawer				
<p>Rectangular Thermofoil Spillguard Top w/Flip-Top Surface and H-Base</p>					<ul style="list-style-type: none"> • Dual vanity drawer with mirror slides out from either side of the table. <p>Thermofoil top with seamless spillguard edge. One-hand activation flip-top provides a secondary surface with two cupholders, can hold up to 10 lbs. Height adjustable steel base. 1 per carton.</p>
	GC3555	34 x 19 x 28-42 864 x 483 x 711-1067	35 11.91	13.4 0.37	\$1294
	GC3555V	34 x 19 x 28-42 864 x 483 x 711-1067	37 16.78	13.4 0.37	\$1528
	w/Vanity drawer				
<p>Rectangular Thermofoil Spillguard Top w/U-Base</p>					<ul style="list-style-type: none"> • Dual vanity drawer with mirror slides out from either side of the table. <p>Thermofoil top with seamless spillguard edge. Height adjustable steel base. 1 per carton.</p>
	GC3555F	46 x 19 x 28-42 1168 x 483 x 711-1067	40 18.14	13.4 0.37	\$1898
	GC3555VF	46 x 19 x 28-42 1168 x 483 x 711-1067	42 19.05	13.37 0.37	\$2132
	w/Vanity drawer				
<p>Rectangular Thermofoil Spillguard Top w/Flip-Top Surface and U-Base</p>					<ul style="list-style-type: none"> • Dual vanity drawer with mirror slides out from either side of the table. <p>Thermofoil top with seamless spillguard edge. One-hand activation flip-top provides a secondary surface with two cupholders, can hold up to 10 lbs. Height adjustable steel base. 1 per carton.</p>

OVERBED TABLES W/THERMOFOIL TOP

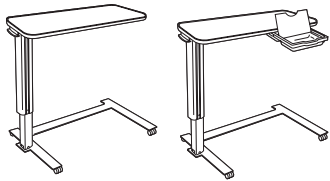

Rectangular Thermofoil Spillguard Top w/C-Base

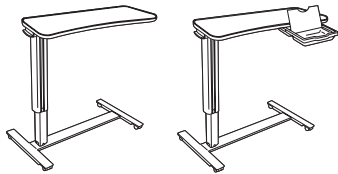

Kidney Shaped Thermofoil Spillguard Top w/H-Base - LEFT

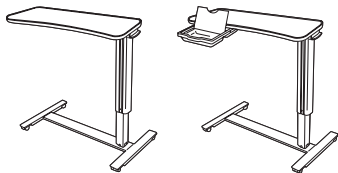

Kidney Shaped Thermofoil Spillguard Top w/H-Base - RIGHT

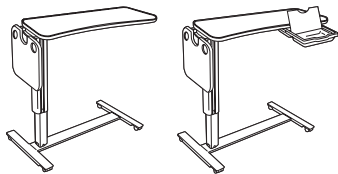

Kidney Shaped Thermofoil Spillguard Top w/Flip-Top Surface and H-Base - LEFT

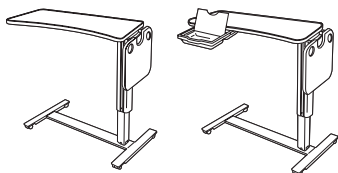

Kidney Shaped Thermofoil Spillguard Top w/Flip-Top Surface and H-Base - RIGHT

MODEL #	DIMENSIONS ^{IN} _{MM}	WEIGHT ^{LB} _{KG}	VOLUME ^{FT³} _{MT³}	LIST PRICE
GC3556	33 x 21 x 28-42	35	19	\$1476
	838 x 533 x 711-1067	15.87	0.53	
GC3556V w/Vanity drawer	33 x 21 x 28-42	37	19	\$1711
	838 x 533 x 711-1067	16.78	0.53	

- Dual vanity drawer with mirror slides out from either side of the table.

Thermofoil top with seamless spillguard edge. Height adjustable steel base. 1 per carton.

GC3557L	34 x 19 x 42	35	13.4	\$1451
	864 x 483 x 1067	15.87	0.37	
GC3557LV w/Vanity drawer	34 x 19 x 42	37	13.4	\$1684
	864 x 483 x 1067	16.78	0.37	

- Dual vanity drawer with mirror slides out from either side of the table.

Left hand side table. Thermofoil top with seamless spillguard edge. Height adjustable steel base. 1 per carton.

GC3557R	34 x 19 x 28-42	35	13.4	\$1451
	864 x 483 x 711-1067	15.87	0.37	
GC3557RV w/Vanity drawer	34 x 19 x 28-42	37	13.4	\$1684
	864 x 483 x 711-1067	16.78	0.37	

- Dual vanity drawer with mirror slides out from either side of the table.

Right hand side table. Thermofoil top with seamless spillguard edge. Height adjustable steel base. 1 per carton.

GC3557LF	48 x 19 x 28-42	40	13.4	\$2210
	1219 x 483 x 711-1067	18.14	0.37	
GC3557LVF w/Vanity drawer	48 x 19 x 28-42	42	13.4	\$2445
	1219 x 483 x 711-1067	19.05	0.37	

- Dual vanity drawer with mirror slides out from either side of the table.

Left hand side table. Thermofoil top with seamless spillguard edge. One-hand activation flip-top provides a secondary surface with two cupholders, can hold up to 10 lbs. Height adjustable steel base. 1 per carton.

GC3557RF	48 x 19 x 28-42	42	13.4	\$2210
	1219 x 483 x 711-1067	19.05	0.37	
GC3557RVF w/Vanity drawer	48 x 19 x 28-42	42	24.75	\$2445
	1219 x 483 x 711-1067	19.05	0.7	

- Dual vanity drawer with mirror slides out from either side of the table.

Right hand side table. Thermofoil top with seamless spillguard edge. One-hand activation flip-top provides a secondary surface with two cupholders, can hold up to 10 lbs. Height adjustable steel base. 1 per carton.

OVERBED TABLES W/THERMOFOIL TOP	MODEL #	DIMENSIONS ^{IN} ^{MM}	WEIGHT ^{LB} ^{KG}	VOLUME ^{FT³} ^{MT³}	LIST PRICE
---------------------------------	---------	---	---------------------------------------	---	------------

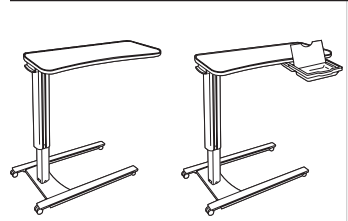

Kidney Shaped Thermofoil Spillguard Top w/U-Base - LEFT

	W x D x H			
GC3558L	34 x 19 x 28-42	35	13.4	\$1372
	864 x 483 x 711-1067	15.87	0.37	
GC3558LV	34 x 19 x 28-42	37	13.4	\$1606
w/Vanity drawer	864 x 483 x 711-1067	16.78	0.37	

- Dual vanity drawer with mirror slides out from either side of the table.

Left hand side table. Thermofoil top with seamless spillguard edge. Height adjustable steel base. 1 per carton.

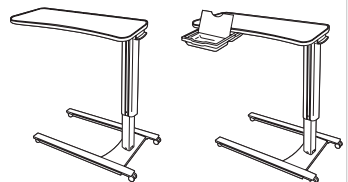

Kidney Shaped Thermofoil Spillguard Top w/U-Base - RIGHT

GC3558R	34 x 19 x 28-42	35	13.4	\$1372
	864 x 483 x 711-1067	15.87	0.37	
GC3558RV	34 x 19 x 28-42	37	13.4	\$1606
w/Vanity drawer	864 x 483 x 711-1067	16.78	0.37	

- Dual vanity drawer with mirror slides out from either side of the table.

Right hand side table. Thermofoil top with seamless spillguard edge. Height adjustable steel base. 1 per carton.

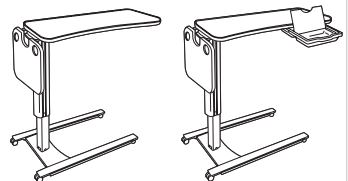

Kidney Shaped Thermofoil Spillguard Top w/Flip-Top Surface and U-Base - LEFT

GC3558LF	48 x 19 x 28-42	40	13.4	\$2132
	1219 x 483 x 711-1067	18.14	0.37	
GC3558LVF	48 x 19 x 28-42	42	13.4	\$2366
w/Vanity drawer	1219 x 483 x 711-1067	19.05	0.37	

- Dual vanity drawer with mirror slides out from either side of the table.

Left hand side table. Thermofoil top with seamless spillguard edge. One-hand activation flip-top provides a secondary surface with two cupholders, can hold up to 10 lbs. Height adjustable steel base. 1 per carton.

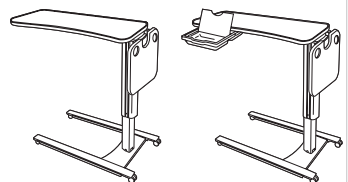

Kidney Shaped Thermofoil Spillguard Top w/Flip-Top Surface and U-Base - RIGHT

GC3558RF	48 x 19 x 28-42	40	13.4	\$2132
	1219 x 483 x 711-1067	18.14	0.37	
GC3558RVF	48 x 19 x 28-42	42	13.4	\$2366
w/Vanity drawer	1219 x 483 x 711-1067	19.05	0.37	

- Dual vanity drawer with mirror slides out from either side of the table.

Right hand side table. Thermofoil top with seamless spillguard edge. One-hand activation flip-top provides a secondary surface with two cupholders, can hold up to 10 lbs. Height adjustable steel base. 1 per carton.

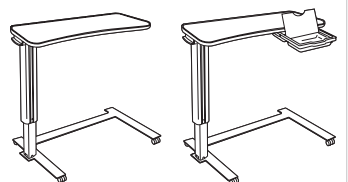

Kidney Shaped Thermofoil Spillguard Top w/C-Base - LEFT

GC3559L	33 x 22 x 28-42	35	19	\$1554
	838 x 559 x 711-1067	15.87	0.53	
GC3559LV	33 x 22 x 28-42	37	19	\$1789
w/Vanity drawer	838 x 559 x 711-1067	16.78	0.53	

- Dual vanity drawer with mirror slides out from either side of the table.

Left hand side table. Thermofoil top with seamless spillguard edge. Height adjustable steel base. 1 per carton.

OVERBED TABLES W/THERMOFOIL TOP

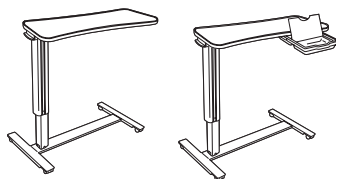

Peanut Shaped Thermofoil Spillguard Top w/H-Base

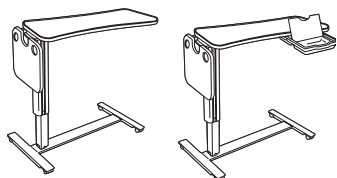

Peanut Shaped Thermofoil Spillguard Top w/Flip-Top Surface and H-Base

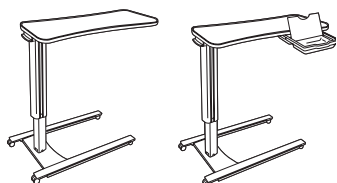

Peanut Shaped Thermofoil Spillguard Top w/U-Base

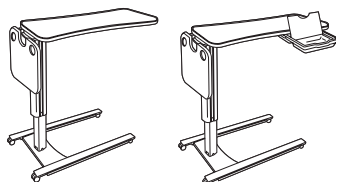

Peanut Shaped Thermofoil Spillguard Top w/Flip-Top Surface and U-Base

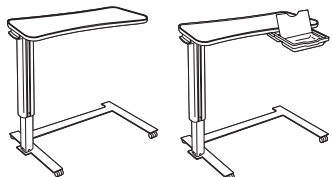

Peanut Shaped Thermofoil Spillguard Top w/C-Base - LEFT

MODEL #	DIMENSIONS ^{IN} _{MM}	WEIGHT ^{LB} _{KG}	VOLUME ^{FT³} _{MT³}	LIST PRICE
GC3560	34 x 19 x 42	35	13.4	\$1451
	864 x 483 x 1067	15.87	0.37	
GC3560V w/Vanity drawer	34 x 19 x 42	37	13.4	\$1684
	864 x 483 x 1067	16.78	0.37	

- Dual vanity drawer with mirror slides out from either side of the table.

Thermofoil top with seamless spillguard edge. Height adjustable steel base. 1 per carton.

GC3560F	48 x 19 x 28-42	40	13.4	\$2210
	1219 x 483 x 711-1067	18.14	0.37	
GC3560VF w/Vanity drawer	48 x 19 x 28-42	42	13.4	\$2445
	1219 x 483 x 711-1067	19.05	0.37	

- Dual vanity drawer with mirror slides out from either side of the table.

Thermofoil top with seamless spillguard edge. One-hand activation flip-top provides a secondary surface with two cupholders, can hold up to 10 lbs. Height adjustable steel base. 1 per carton.

GC3561	34 x 19 x 28-42	35	13.4	\$1372
	864 x 483 x 711-1067	15.87	0.37	
GC3561V w/Vanity drawer	34 x 19 x 28-42	37	13.4	\$1606
	864 x 483 x 711-1067	16.78	0.37	

- Dual vanity drawer with mirror slides out from either side of the table.

Thermofoil top with seamless spillguard edge. Height adjustable steel base. 1 per carton.

GC3561F	48 x 19 x 28-42	40	13.4	\$2132
	1219 x 483 x 711-1067	18.14	0.37	
GC3561VF w/Vanity drawer	48 x 19 x 28-42	42	13.4	\$2366
	1219 x 483 x 711-1067	19.05	0.37	

- Dual vanity drawer with mirror slides out from either side of the table.

Thermofoil top with seamless spillguard edge. One-hand activation flip-top provides a secondary surface with two cupholders, can hold up to 10 lbs. Height adjustable steel base. 1 per carton.

GC3562	33 x 22 x 28-42	35	19	\$1554
	838 x 559 x 711-1067	15.87	0.53	
GC3562V w/Vanity drawer	33 x 22 x 28-42	37	19	\$1789
	838 x 559 x 711-1067	16.78	0.53	

- Dual vanity drawer with mirror slides out from either side of the table.

Left hand side table. Thermofoil top with seamless spillguard edge. Height adjustable steel base. 1 per carton.

OVERBED TABLES W/THERMOFOIL TOP	MODEL #	DIMENSIONS ^{IN} _{MM}	WEIGHT ^{LB} _{KG}	VOLUME ^{FT³} _{MT³}	LIST PRICE
---------------------------------	---------	---	---------------------------------------	---	------------

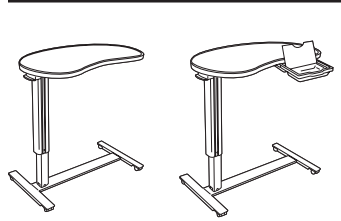

Jellybean Shaped Thermofoil Spillguard Top w/H-Base - LEFT

	W x D x H			
GC3563L	35 x 22 x 42.5	35	13.4	\$1663
	889 x 559 x 1080	15.87	0.37	
GC3563LV	35 x 22 x 42.5	37	13.4	\$1899
w/Vanity drawer	889 x 559 x 1080	16.78	0.37	

- Dual vanity drawer with mirror slides out from either side of the table.

Left hand side table. Thermofoil top with seamless spillguard edge. Height adjustable steel base. 1 per carton.

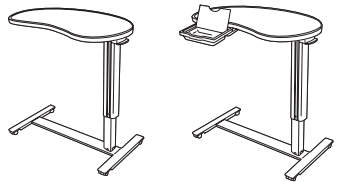

Jellybean Shaped Thermofoil Spillguard Top w/H-Base - RIGHT

GC3563R	35 x 22 x 28.5-42.5	35	13.4	\$1663
	889 x 559 x 724-1080	15.87	0.37	
GC3563RV	35 x 22 x 28.5-42.5	37	13.4	\$1899
w/Vanity drawer	889 x 559 x 724-1080	16.78	0.37	

Dual vanity drawer with mirror slides out from either side of the table.

Right hand side table. Thermofoil top with seamless spillguard edge. Height adjustable steel base. 1 per carton.

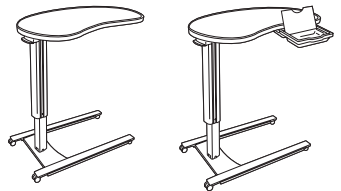

Jellybean Shaped Thermofoil Spillguard Top w/U-Base - LEFT

GC3564L	35 x 22 x 28.5-42.5	35	13.4	\$1585
	889 x 559 x 724-1080	15.87	0.37	
GC3564LV	35 x 22 x 28.5-42.5	37	13.4	\$1821
w/Vanity drawer	889 x 559 x 724-1080	16.78	0.37	

- Dual vanity drawer with mirror slides out from either side of the table.

Left hand side table. Thermofoil top with seamless spillguard edge. Height adjustable steel base. 1 per carton.

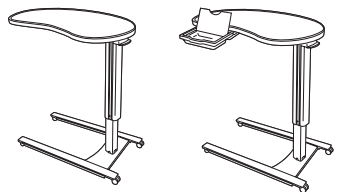

Jellybean Shaped Thermofoil Spillguard Top w/U-Base - RIGHT

GC3564R	36 x 22 x 28.5-42.5	35	13.4	\$1585
	914 x 559 x 724-1080	15.87	0.37	
GC3564RV	36 x 22 x 28.5-42.5	37	13.4	\$1821
w/Vanity drawer	914 x 559 x 724-1080	16.78	0.37	

- Dual vanity drawer with mirror slides out from either side of the table.

Right hand side table. Thermofoil top with seamless spillguard edge. Height adjustable steel base. 1 per carton.

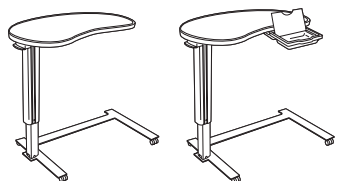

Jellybean Shaped Thermofoil Spillguard Top w/C-Base - LEFT

GC3565L	35 x 22 x 28.5-42.5	35	19	\$1768
	889 x 559 x 724-1080	15.87	0.53	
GC3565LV	35 x 22 x 28.5-42.5	37	19	\$2003
w/Vanity drawer	889 x 559 x 724-1080	16.78	0.53	

- Dual vanity drawer with mirror slides out from either side of the table.

Left hand side table. Thermofoil top with seamless spillguard edge. Height adjustable steel base. 1 per carton.

ACCESSORIES AND PARTS

MODEL #	DIMENSIONS ^{IN} _{MM}	WEIGHT ^{LB} _{KG}	VOLUME ^{FT³} _{MT³}	LIST PRICE
GC3566	10 x 6 x 9	2	0.4	\$235
	254 x 152 x 229	0.9	0.01	



Storage Basket

Storage basket hooks on either side of the integrated accessory rail of the overbed table. 1 per carton.

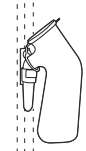

Urinal Hook

GC3567	1.5 x 2 x 3	1	0.01	\$78
	38 x 51 x 76	0.45	-	

Hooks on either side of the integrated accessory rail of the overbed table. Bottle not included. 1 per carton.

Notes: Please specify all substitutions and options.

- Primacare table legs complement and work seamlessly with Primacare seating.
- Solid wood legs and apron.
- All connections are metal-to-metal inserts and fasteners.
- Thermofoil and solid surface material options are available on request, please contact your Global sales representative for a special quotation.
- Shipped easy to assemble.
- 2mm edging color coordinated with laminate finish is standard for all tops. Finish must specified at time of order.
- Tops are 1" thick and available thermally fused laminate (LP) and high pressure laminate (HP). Please select the appropriate model number for the finish you prefer.
- Refer to the following lists when selecting a finish color. Must specify both a top color and leg finish at time of order.
- For custom laminate or contrasting edge, contact your Global sales representative or visit the Dealer Center and click on "Specials" on the left sidebar to submit your request.

Wood Legs/Apron

- (AAM) Absolute
- (CJM) Charcoal Java
- (ACM) Cherry
- (EMM) Empire Mahogany
- (EOM) English Oak
- (ECM) Espresso Cafe
- (TFM) Fruitwood
- (HGM) Grey
- (HOM) Harvest Oak
- (AHM) Honey
- (JOM) Jet Onyx
- (LHM) Light Honey
- (AVM) Maple
- (TMM) Mahogany
- (MWM) Medium Walnut
- (NLW) Natural Walnut
- (ASM) Night
- (NBM) Noce Biondo
- (NGM) Noce Grigio
- (NEM) Noce Leggero
- (NMM) Noce Medio
- (SBM) Sandy Beach
- (SKM) Shaker Cherry
- (SOM) Silver Oak
- (TWM) Walnut
- (WTM) WC Cream
- (WHM) White
- (WCM) Winter Cherry

Thermally Fused Laminate (LP) Tops

- (ACJ) Absolute Acajou
- (ASN) Asian Night
- (AWC) Avant Cherry
- (AWH) Avant Honey
- (BLK) Black
- (BZD) Blizzard
- (BRC) Brushed Cobalt
- (CMB) Clear Maple
- (CGY) Custom Grey
- (DES) Dark Espresso
- (DWT) Designer White
- (FAS) Fashionista
- (FCL) First Class
- (NBL) Noce Biondo
- (NGL) Noce Grigio
- (NEL) Noce Leggero
- (NML) Noce Medio
- (QTM) Quartered Mahogany
- (SBY) Sheer Beauty
- (SDT) Stonedust
- (SOG) Storm Grey
- (WHE) Walnut Heights
- (WHC) White Chocolate
- (WCR) Winter Cherry

High Pressure Laminate (HP) Tops

- (ACJ) Absolute Acajou
- (ASN) Asian Night
- (AWC) Avant Cherry
- (AWH) Avant Honey
- (BLK) Black
- (BZD) Blizzard
- (BRC) Brushed Cobalt
- (CMB) Clear Maple
- (CGY) Custom Grey
- (DES) Dark Espresso
- (DWT) Designer White
- (FAS) Fashionista
- (FCL) First Class
- (NBL) Noce Biondo
- (NGL) Noce Grigio
- (NEL) Noce Leggero
- (NML) Noce Medio
- (QTM) Quartered Mahogany
- (SBY) Sheer Beauty
- (SDT) Stonedust
- (SOG) Storm Grey
- (WHE) Walnut Heights
- (WHC) White Chocolate
- (WCR) Winter Cherry

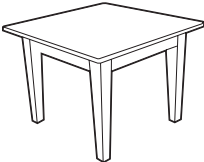
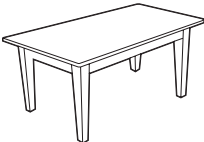
TABLES	MODEL #	DIMENSIONS ^{IN} _{MM}	WEIGHT ^{LB} _{KG}	VOLUME ^{FT³} _{MT³}	LIST PRICE	
 <p>Square End Table</p>	GC3664-HP	22 x 22 x 17	22	6.75	\$963	
		559 x 559 x 432	9.97	0.19		
	GC3664-LP	22 x 22 x 17	22	6.75	\$876	
		559 x 559 x 432	9.97	0.19		
	<ul style="list-style-type: none"> • For a high pressure laminate top (HP), specify model GG3364-HP. • For a thermally fused top (LP), specify model GG3364-LP. • Power and data can be added on surface of the table. Order power/data module GC36410, see page 208 list price. <p>Coordinating edge and solid wood frame. 1 per carton.</p>					
	 <p>Rectangular Coffee Table</p>	GC3665-HP	21 x 42 x 15	35	11	\$1251
533 x 1067 x 381			15.87	0.31		
GC3665-LP		21 x 42 x 15	35	11	\$1132	
		533 x 1067 x 381	15.87	0.31		
<ul style="list-style-type: none"> • For a high pressure laminate top (HP), specify model GC3665-HP. • For a thermally fused top (LP), specify model GC3665-LP. • Power and data can be added on surface of the table. Order power/data module GC36410, see page 208 for list price. <p>Coordinating edge and solid wood frame. 1 per carton.</p>						

Notes: Please specify all substitutions and options.

- Primacare table legs complement the lines of design to work seamlessly with Primacare seating.
- Legs are metal with laminate skirt.
- All connections are metal-to-metal inserts and fasteners.
- Thermofoil and solid surface material options are available on request, please contact your Global sales representative for a special quotation.
- Shipped easy to assemble.
- 2mm edging color coordinated with laminate finish is standard for all tops. Finish must specified at time of order.
- Tops are 1" thick and available in thermally fused laminate (LP) and high pressure laminate (HP). Please select the appropriate model number for the finish you prefer.
- Refer to the following lists when selecting a finish color. Must specify both a top color and leg finish at time of order.
- For custom laminate or contrasting edge, contact your Global sales representative or visit the Dealer Center and click on "Specials" on the left sidebar to submit your request.

Thermally Fused Laminate (LP)

- (ACJ) Absolute Acajou
- (ASN) Asian Night
- (AWC) Avant Cherry
- (AWH) Avant Honey
- (BLK) Black
- (BZD) Blizzard
- (BRC) Brushed Cobalt
- (CMB) Clear Maple
- (CGY) Custom Grey
- (DES) Dark Espresso
- (DWT) Designer White
- (FAS) Fashionista
- (FCL) First Class
- (NBL) Noce Biondo
- (NGL) Noce Grigio
- (NEL) Noce Leggero
- (NML) Noce Medio
- (QTM) Quartered Mahogany
- (SBY) Sheer Beauty
- (SDT) Stonedust
- (SOG) Storm Grey
- (WHE) Walnut Heights
- (WHC) White Chocolate
- (WCR) Winter Cherry

High Pressure Laminate (HP)

- (ACJ) Absolute Acajou
- (ASN) Asian Night
- (AWC) Avant Cherry
- (AWH) Avant Honey
- (BLK) Black
- (BZD) Blizzard
- (BRC) Brushed Cobalt
- (CMB) Clear Maple
- (CGY) Custom Grey
- (DES) Dark Espresso
- (DWT) Designer White
- (FAS) Fashionista
- (FCL) First Class
- (NBL) Noce Biondo
- (NGL) Noce Grigio
- (NEL) Noce Leggero
- (NML) Noce Medio
- (QTM) Quartered Mahogany
- (SBY) Sheer Beauty
- (SDT) Stonedust
- (SOG) Storm Grey
- (WHE) Walnut Heights
- (WHC) White Chocolate
- (WCR) Winter Cherry

Metal Legs

- (TBL) Black
- (TIV) Cloud
- (TDW) Designer White
- (TFO) Fog
- (TFR) Frost
- (TKA) Kalua
- (TLA) Latte
- (TMO) Mocha
- (TNE) Nevada
- (TSN) Sand
- (TSH) Shadow
- (TOA) Toast
- (TTU) Tungsten

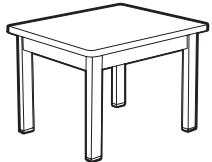
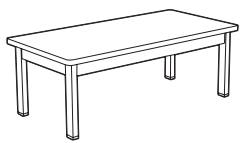
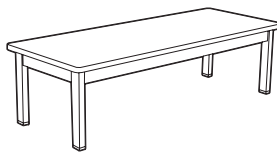
TABLES	MODEL #	DIMENSIONS IN MM	WEIGHT LB KG	VOLUME FT ³ MT ³	LIST PRICE
 <p>Square End Table</p>	W x D x H				
	GC3661-HP	24 x 20 x 17	29	9.75	\$920
	GC3661-LP	610 x 508 x 432	13.2	0.27	\$821
		24 x 20 x 17	29	9.75	
		610 x 508 x 432	13.2	0.27	
		<ul style="list-style-type: none"> • For a high pressure laminate top (HP), specify model GG3361-HP. • For a thermally fused top (LP), specify model GG3361-LP. • Power and data can be added on surface of the table. Order power/data module GC36410, see page 208 for list price. <p>Coordinating edge. 1.25" x 2" rectangular metal frame. 1 per carton.</p>			
 <p>Rectangular Coffee Table</p>	GC3662-HP	42 x 21 x 15	44	14.5	\$1183
	GC3662-LP	1067 x 533 x 381	20	0.41	\$1055
		42 x 21 x 15	44	14.5	
		1067 x 533 x 381	20	0.41	
		<ul style="list-style-type: none"> • For a high pressure laminate top (HP), specify model GC3662-HP. • For a thermally fused top (LP), specify model GC3662-LP. • Power and data can be added on surface of the table. Order power/data module GC36410, see page 208 for list price. <p>Coordinating edge. 1.25" x 2" rectangular metal frame. 1 per carton.</p>			
	 <p>Rectangular Coffee Table</p>	GC3663-HP	21 x 54 x 15	50	18.5
GC3663-LP		533 x 1372 x 381	22.7	0.52	\$1304
		21 x 54 x 15	50	18.5	
		533 x 1372 x 381	22.7	0.52	
		<ul style="list-style-type: none"> • For a high pressure laminate top (HP), specify model GC3663-HP. • For a thermally fused top (LP), specify model GC3663-LP. • Power and data can be added on surface of the table. Order power/data module GC36410, see page 208 for list price. <p>Coordinating edge. 1.25" x 2" rectangular metal frame. 1 per carton.</p>			



Meet River+™, the next generation of our highly popular lounge series. Now with industry-leading support for workplace, education and healthcare, River+ performs at three times the BIFMA standard for true 24/7 applications in demanding environments. All models have been active weight tested to 600 lbs. including bariatric use. Multiple back and seat heights, 120-degree configurations and modular Aluminum arms are just a few of the many options that will make it yours.

To see the River+ tables, please refer to the Seating price list at globalfurnituregroup.com/ca/resources/pricelists.

Features and Benefits

- A modular series that is composed of straight, curved and corner sections.
- Units can be linked together to create a wide variety of layouts. Ganging hardware is standard and is factory installed. Ganging hardware swivels out of the way when not in use.
- Front and back faces of end (linking) tables angles slightly inwards. This inward slant matches the inward angles of River seating so all units coordinate in visual appearance.
- The tapered legs are made of welded steel, with each leg bolted directly to the unit frame. Standard leg height is 6.5" with an optional 8" height. The leg height makes it easy to clean under the product.
- Tables are made with high pressure laminate.
- Legs of coffee and end (linking) tables are available in 3" and 8" heights. All heights are available with fixed-to-floor option.
- All tables (except freestanding units) can be specified with power/USB modules, which include one power outlets, one double USB terminals and a Black 120" 3-prong power cord..

Notes: Please specify all substitutions and options.

- Metal legs with adjustable glides. Heavy duty steel legs are available in Black (**TBL**), Shadow (**TSH**), Toast (**TOA**) and Tungsten (**TTU**). Please specify leg finish color at time of order.
- To support the need to move tables for cleaning, repositioning or placing in storage, tables can be ordered with two standard legs and two legs with casters. Add (**LF**) to model #.
- Adjustable 1.5" range Black plastic glides are standard. Except Tungsten (**TTU**) which has Tungsten glides.
- Tablet tables are designed to accept the fixed tablet on all sides.
- Shipped easy to assemble.
- 2mm edging color coordinated with laminate finish is standard for all tops. Optional Black (**BLK**) edging is also available. Finish must be specified at time of order.
- Tops are 1" thick and available in thermally fused laminate (**LP**) and high pressure laminate (**HP**). Please select the appropriate model number for the finish you prefer.
- Refer to the following lists when selecting a finish color. Must specify both a top color and leg finish at time of order.
- For custom laminate or contrasting edge, please contact your Global sales representative for a special quotation.

Thermally Fused Laminate (LP)

- (**ACJ**) Absolute Acajou
- (**ASN**) Asian Night
- (**AWC**) Avant Cherry
- (**AWH**) Avant Honey
- (**BLK**) Black
- (**BZD**) Blizzard
- (**BRC**) Brushed Cobalt
- (**CMB**) Clear Maple
- (**CGY**) Custom Grey
- (**DES**) Dark Espresso
- (**DWT**) Designer White
- (**FAS**) Fashionista
- (**FCL**) First Class
- (**NBL**) Noce Biondo
- (**NGL**) Noce Grigio
- (**NEL**) Noce Leggero
- (**NML**) Noce Medio
- (**QTM**) Quartered Mahogany
- (**SBY**) Sheer Beauty
- (**SDT**) Stonedust
- (**SOG**) Storm Grey
- (**WHE**) Walnut Heights
- (**WHC**) White Chocolate
- (**WCR**) Winter Cherry

High Pressure Laminate (HP)

- (**ACJ**) Absolute Acajou
- (**ASN**) Asian Night
- (**AWC**) Avant Cherry
- (**AWH**) Avant Honey
- (**BLK**) Black
- (**BZD**) Blizzard
- (**BRC**) Brushed Cobalt
- (**CMB**) Clear Maple
- (**CGY**) Custom Grey
- (**DES**) Dark Espresso
- (**DWT**) Designer White
- (**FAS**) Fashionista
- (**FCL**) First Class
- (**NBL**) Noce Biondo
- (**NGL**) Noce Grigio
- (**NEL**) Noce Leggero
- (**NML**) Noce Medio
- (**QTM**) Quartered Mahogany
- (**SBY**) Sheer Beauty
- (**SDT**) Stonedust
- (**SOG**) Storm Grey
- (**WHE**) Walnut Heights
- (**WHC**) White Chocolate
- (**WCR**) Winter Cherry

SQUARE DINING TABLES



Dining Table - 36"



Dining Table - 42"

MODEL #	DIMENSIONS ^{IN} _{MM}	WEIGHT ^{LB} _{KG}	VOLUME ^{FT³} _{MT³}	LIST PRICE
W x D x H				
GC3-36LH	36 x 36 x 28.25	63.4	3.68	\$1100
	914 x 914 x 718	28.75	0.1	
GC3-36L	36 x 36 x 28.25	63.4	3.68	\$932
	914 x 914 x 718	28.75	0.1	
<ul style="list-style-type: none"> • For a high pressure laminate top (HP), specify model GC3-36LH. • For a thermally fused top (LP), specify model GC3-36L. <p>Standard Black edge. 36" x 36" top accepts a tablet on all sides. Heavy duty steel legs are standard in Black Gloss (TBL). A variety of optional finishes are also available. Please specify.</p> <ul style="list-style-type: none"> • Additional leg heights are available. Special quote is required. • 2 cartons. 				
GC3-42LH	42 x 42 x 28.25	79.65	4.2	\$1416
	1067 x 1067 x 718	36.12	0.11	
GC3-42L	42 x 42 x 28.25	79.65	4.2	\$1216
	1067 x 1067 x 718	36.12	0.11	
<ul style="list-style-type: none"> • For a high pressure laminate top (HP), specify model GC3-42LH. • For a thermally fused top (LP), specify model GC3-42L. <p>Standard Black edge. 42" x 42" top accepts a tablet on all sides. Heavy duty steel legs are standard in Black Gloss (TBL). A variety of optional finishes are also available. Please specify.</p> <ul style="list-style-type: none"> • Additional leg heights are available. Special quote is required. • 2 cartons. 				

SQUARE DINING TABLES	MODEL #	DIMENSIONS ^{IN} _{MM}	WEIGHT ^{LB} _{KG}	VOLUME ^{FT³} _{MT³}	LIST PRICE
 <p>Dining Table - 48"</p>	GC3-48LH	48 x 48 x 28.25	99	4.9	\$1795
		1219 x 1219 x 718	44.9	0.13	
	GC3-48L	48 x 48 x 28.25	99	4.9	\$1335
		1219 x 1219 x 718	44.9	0.13	

- For a high pressure laminate top (HP), specify model GC3-48LH.
- For a thermally fused top (LP), specify model GC3-48L.

Standard Black edge. 48" x 48" top accepts a tablet on all sides. Heavy duty steel legs are standard in Black Gloss (TBL). A variety of optional finishes are also available. Please specify.

- Additional leg heights are available. Special quote is required.
- 2 cartons.

TABLETS	MODEL #	DIMENSIONS ^{IN} _{MM}	WEIGHT ^{LB} _{KG}	VOLUME ^{FT³} _{MT³}	LIST PRICE
 <p>Tablet</p>	GC3-NUGH	24 x 10 x 1	15	0.8	\$398
		610 x 254 x 25	6.8	0.02	
	GC3-NUG	24 x 10 x 1	15	0.8	\$361
		610 x 254 x 25	6.8	0.02	

- For a high pressure laminate top (HP), specify model GC3-NUGH.
- For a thermally fused top (LP), specify model GC3-NUG.

Attachable tablet for above tablet tables. Attaches on any side, adding 10" per tablet. Heavy duty steel mounting bracket is standard in Black. 2 cartons.

TAPERED LEGS	MODEL #	DIMENSIONS ^{IN} _{MM}	WEIGHT ^{LB} _{KG}	VOLUME ^{FT³} _{MT³}	LIST PRICE
 <p>Tapered Leg with Caster</p>	LCL291	5.25 x 5.25 x 27.75	4.8	0.52	\$106
		133 x 133 x 692	2.17	0.01	
	LCL294	5.25 x 5.25 x 27.75	18.4	2.1	\$419
		133 x 133 x 705	8.34	0.05	

Tapered leg with locking caster. Hardware for assembly is included

- LCL291: 1 per carton.
- LCL294: 4 per carton.
- Available in Black (TBL), Shadow (TSH), Toast (TOA) and Tungsten (TTU). Finish must be specified at time of order.

 <p>Tapered Leg with Glide</p>	LLL291	5.25 x 5.25 x 27.25	4.8	0.52	\$106
		133 x 133 x 692	2.17	0.01	
	LLL294	5.25 x 5.25 x 27.25	18.4	2.1	\$419
		133 x 133 x 692	8.34	0.05	

Tapered leg with glide offers 1.5" glide range adjustment. Legs are available and can be ordered separately from the top. Hardware for assembly is included.

- LLL291: 1 per carton.
- LLL294: 4 per carton.
- Available in Black (TBL), Shadow (TSH), Toast (TOA) and Tungsten (TTU). Finish must be specified at time of order.

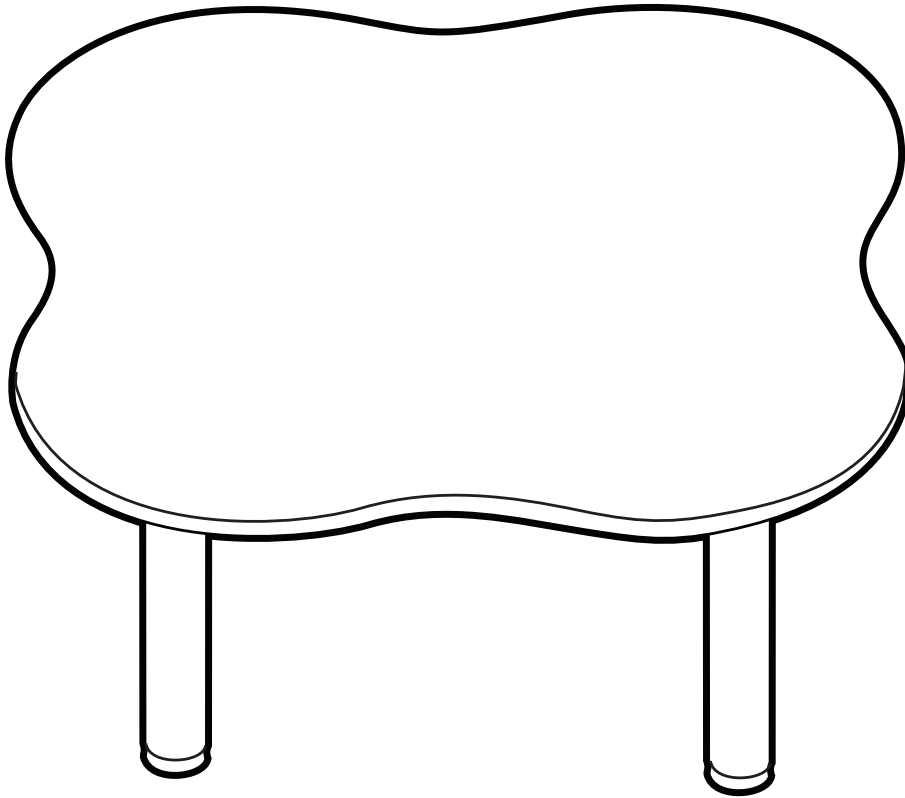

Zook™ children's tables designed for waiting rooms and playroom settings make children's areas more playful and supportive. With gentle curves and 20"H overall, creating inviting and safe environments is easy.

Choose from a variety of durable finishes in thermally fused laminate or high pressure laminate options with matching or complementary edge band and an array of painted finishes for metal legs.

Tops are available in 1" thick thermally fused laminate or 1 1/16" high pressure laminate with 2mm PVC edgebanding or optional ergo friendly edge. 3" diameter metal legs provide support and stability.

To see the Zook children's tables, please refer to the Desking + Tables price list at globalfurnituregroup.com/ca/resources/pricelists.

Features and Benefits

- 20"h, the perfect height for children.
- Choose tables for groups of 4 to 6 people.
- Tops are 1" thick thermally fused laminate or 1 1/16" high pressure laminate.
- Top core construction is 45 lb. density particle board.
- 2mm PVC edgebanding or optional ergo friendly edge.
- Organic shaped tops with gentle curves around perimeter.
- Surfaces include factory installed metal inserts for solid and secure leg connections.
- 3" diameter tubular steel legs.
- Easy to assemble.

seating

Private + Public + Individual + Group Applications

Application guidelines	66	GC Sidero.....	126
Adeline.....	67	GC Sirena.....	136
Bishop.....	69	GC Sonic.....	138
Calidon.....	70	GC Vitrola.....	142
Coast.....	75	GC Wind.....	143
Collingwood.....	76	Heather.....	145
Desmond.....	77	Janna.....	146
Desmond HT.....	78	Nourish.....	147
Dreme.....	80	Oakville.....	150
Erin.....	83	Primacare.....	151
Frolick.....	85	River+.....	223
GC Beach.....	90	Senator.....	224
GC Belong.....	91	Sleep-Eez.....	225
GC Citi.....	118	Splash.....	88
GC Comet.....	121	Strand.....	226
GC Islands.....	124	Willow.....	232
GC Prairie.....	125	Wingback.....	245

Work + Task

Doctor Buddy.....	249	GC Trittek.....	256
Ergonomic features.....	247	GC Trittek TS.....	258
Foot activated stools.....	251	GC Vion.....	260
Gala II.....	252	Harmony.....	262
Gala II TS.....	254	Mechanism adjustments....	248

SERIES	WOOD	METAL	BARIATRIC SEATING	DINING / CAFETERIA	GUEST SEATING	LOBBIES	LOUNGE / WAITING	OFFICE / MEETING	PATIENT ROOMS	RESIDENT ROOMS	STACKING	TASK	TREATMENT / EXAM ROOMS
ADELINE		•	•		•	•	•		•	•			•
BISHOP	•					•	•			•			
CALIDON	•		•		•	•	•		•	•			•
COAST	•						•		•	•			
COLLINGWOOD	•			•	•	•	•		•	•			
DESMOND	•			•	•	•	•	•	•	•			
DESMOND HT		•		•	•	•	•	•	•	•			
DOCTOR BUDDY		•		•				•	•	•		•	•
DREME									•	•			
ERIN	•	•		•	•	•	•		•	•			
FOOT ACTIVATED STOOLS		•		•				•	•	•		•	•
FROLICK		•	•	•	•	•	•	•	•	•	•		•
GALA II		•						•				•	•
GALA II TS		•						•				•	•
GC BEACH	•			•	•	•	•	•	•	•			
GC BELONG		•	•		•	•	•		•	•			•
GC CITI		•			•	•	•			•			
GC COMET		•	•	•	•	•	•	•	•	•	•		•
GC ISLANDS	•			•	•	•	•	•	•	•			
GC PRAIRIE	•					•	•			•			
GC SIDERO		•	•	•	•	•	•	•	•	•	•		•
GC SIRENA	•			•	•	•	•	•	•	•			
GC SONIC		•		•	•	•	•	•	•	•	•		•
GC TRITEK		•						•				•	•
GC TRITEK TS		•						•				•	•
GC VION		•						•				•	•
GC VITROLA	•				•	•	•		•	•			
GC WIND		•				•	•	•	•	•			
HARMONY		•	•					•				•	•
HARMONY TS		•						•				•	•
HEATHER	•			•	•	•	•		•	•			
JANNA	•			•	•		•	•	•	•			•
NOURISH		•	•				•		•	•			•
OAKVILLE	•				•	•	•		•	•			
OTTOMANS	•	•			•	•	•		•	•			•
PRIMACARE	•		•	•	•	•	•		•	•			•
PRIMACARE HT		•	•	•	•	•	•		•	•			•
PRIMACARE MODULAR	•		•	•	•	•	•						
PRIMACARE WINGBACK	•	•	•		•	•	•		•	•			
RIVER+		•			•	•	•						
SENATOR	•	•				•	•		•	•			
SLEEP-EEZ		•				•	•	•	•	•			•
SPLASH		•		•	•	•	•	•	•	•	•		•
STRAND		•	•		•	•	•		•	•			•
THROW PILLOWS						•	•			•			
WILLOW		•	•	•	•	•	•	•	•	•	•		•
WINGBACK	•				•	•	•		•	•			

HEAVY DUTY + 24/7 MODELS

The following series feature specific models for Heavy Duty + 24/7 use:

GC Belong, Nourish, Primacare, Sleep-Eez, Strand, GC ritek, Bariatric models of GC Comet, Frolick and Harmony, and heavy duty 24 hour (TS) models of Gala II, Harmony and GC Tritek.

ADELINE



model GC7680

STANDARD FEATURES



- Flex back moves with the user, providing comfort and support while seated.
- Sleek oval tube steel frame is available in Black (TBL), Kalua (TKA), Latte (TLA), Mocha (TMO), Nevada (TNE), Shadow (TSH), Toast (TOA) and Tungsten (TTU). Please specify.
- Urethane armcaps are available in Black (BLK), Kalua (KAL), Latte (LAB), Mocha (J52), Shadow (SHW) and Toast (TOA). Please specify.
- Standard seat height on all models is 18".
- For healthcare textiles and finish options, visit the website at globalfurnituregroup.com.
- For added comfort, seats are standard with high density Ultracell foam.
- The textile covered side panel on bariatric model GC7694 is covered in a coated textile in a choice of Ink Black (A16F), Warm Smoke (A08F), Chocolate Sundae (A23F), Gibraltar (A12F) or Illusion (A01F). Please specify.
- Standard glide is plastic.
- Shipped fully assembled.



OPTIONAL FEATURES

- For hard surface floors, please specify opaque non-marking glides (**NM**). No upcharge.
- To add sealed seams to your product contact Customer Service. Upcharges vary.
- For moisture barrier on seat, please specify (**MB**). Add \$81. For bariatric models add \$122.
- For improved housekeeping and infection control practices, please add (**SU**) to model number. The underside of the seat will be finished with vinyl and sealed to prevent penetration of liquids. For standard models: Add \$39. For bariatric models: Add \$59.

SUGGESTED APPLICATIONS

- Bariatric seating
- Guest seating
- Lobbies
- Lounge/Waiting
- Patient rooms
- Resident rooms
- Treatment/Exam rooms

DESCRIPTION	MODEL# / FEATURES	STANDARD TEXTILE GRADES												
		COM	2	3	4	5	6	7	8	9	10	11	12	
 <p>Curved High Flex Back Armchair COM: 2 YD 1.83 M Unit weight: 35 LB 15.9 KG Carton weight: 40 LB 18.14 KG Carton volume: 20 FT³ 0.56 MT³</p>	GC7680	1012	1076	1130	1192	1294	1388	1482	1564	1666	1762	1892	2076	
	Active weight 350 lbs.	IN			25.5	28	45	SEAT DIMENSIONS			BACK DIMENSIONS			
		MM			648	711	1143	19.5	18	18	18	27		
		RTA 00			1 per carton									
 <p>Curved High Fixed Back Armchair COM: 2 YD 1.83 M Unit weight: 40 LB 18.2 KG Carton weight: 46 LB 20.87 KG Carton volume: 20 FT³ 0.56 MT³</p>	GC7681	1064	1128	1182	1244	1346	1440	1534	1616	1718	1814	1944	2128	
	Active weight 350 lbs.	IN			25.5	28	45	SEAT DIMENSIONS			BACK DIMENSIONS			
		MM			648	711	1143	19.5	18	18	18	27		
		RTA 00			1 per carton									
 <p>High Fixed Straight Top, Armchair COM: 2 YD 1.83 M Unit weight: 38 LB 17.3 KG Carton weight: 45 LB 20.41 KG Carton volume: 20 FT³ 0.56 MT³</p>	GC7692	1012	1076	1130	1192	1294	1388	1482	1564	1666	1762	1892	2076	
	Active weight 350 lbs.	IN			25.5	26.5	45	SEAT DIMENSIONS			BACK DIMENSIONS			
		MM			648	673	1143	19.5	18.5	18	20	27		
		RTA 00			1 per carton									

DESCRIPTION	MODEL# / FEATURES	STANDARD TEXTILE GRADES											
		COM	2	3	4	5	6	7	8	9	10	11	12
 <p>Low Fixed Straight Top Armchair, Bariatric COM: 3.25 YD 2.97 M Unit weight: 61 LB 27.7 KG Carton weight: 71 LB 32.21 KG Carton volume: 23 FT³ 0.65 MT³</p>	GC7694	1696	1800	1888	1989	2154	2307	2460	2593	2759	2915	3126	3425
		OVERALL DIMENSIONS			SEAT DIMENSIONS			BACK DIMENSIONS					
		W	D	H	W	D	H	W	H				
		IN 32.5	26.5	40.5	28	18.5	18	27	23.5				
		MM 826	673	1029	711	470	457	686	597				
		RTA 00	1 per carton										
 <p>High Flex Back Straight Top, Armchair COM: 2 YD 1.83 M Unit weight: 36 LB 16.4 KG Carton weight: 43 LB 19.5 KG Carton volume: 20 FT³ 0.56 MT³</p>	GC7696	1012	1076	1130	1192	1294	1388	1482	1564	1666	1762	1892	2076
		OVERALL DIMENSIONS			SEAT DIMENSIONS			BACK DIMENSIONS					
		W	D	H	W	D	H	W	H				
		IN 25.5	26.5	45	19.5	18.5	18	20	27				
		MM 648	673	1143	495	470	457	508	686				
		RTA 00	1 per carton										
 <p>High Fixed Straight Top Armchair, Sled Base COM: 2 YD 1.83 M Unit weight: 40 LB 18.2 KG Carton weight: 47 LB 21.32 KG Carton volume: 20 FT³ 0.56 MT³</p>	GC7693	1077	1141	1195	1257	1359	1453	1547	1629	1731	1827	1957	2141
		OVERALL DIMENSIONS			SEAT DIMENSIONS			BACK DIMENSIONS					
		W	D	H	W	D	H	W	H				
		IN 25.5	26.5	45	19.5	18.5	18	20	27				
		MM 648	673	1143	495	470	457	508	686				
		RTA 00	1 per carton										

BISHOP



model GC3751

STANDARD FEATURES

- Bishop offers a classic, traditional, rolled arm style design.
- Features removable and replaceable seat cushions.
- Wood frame and hardwood block legs are available in a variety of finishes. Available in Maple wood species only (refer to finishes ending in "M").
- For added comfort, seat and back are standard with high density Ultracell foam.
- Opaque non-marking glides are standard.
- For healthcare textiles and wood finish options, visit the website at globalfurnituregroup.com.
- Can be upholstered in standard Global textiles if Healthcare compliance is not required.
- Shipped fully assembled.

OPTIONAL FEATURES

- For non-slip glides, please specify **(NS)**. Add \$22.
- To add sealed seams to your product contact Customer Service. Upcharges vary.
- For moisture barrier on seat, please specify **(MB)**. See upcharges below.

SUGGESTED APPLICATIONS

- Lobbies
- Lounge/Waiting
- Resident rooms

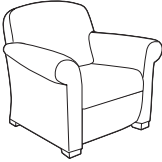
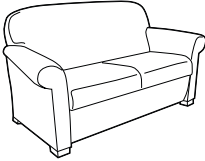
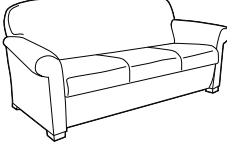
DESCRIPTION	MODEL# / FEATURES	STANDARD TEXTILE GRADES											
		COM	2	3	4	5	6	7	8	9	10	11	12
 <p>Lounge Chair COM: 7.25 YD 6.63 M Unit weight: 69 LB 31.4 KG Carton weight: 75 LB 34.02 KG Carton volume: 30.25 FT³ 0.85 MT³</p>	GC3751	1977	2209	2405	2630	2999	3340	3681	3978	4348	4696	5167	5834
		OVERALL DIMENSIONS			SEAT DIMENSIONS			BACK DIMENSIONS					
		W	D	H	W	D	H	W	H				
		IN 37	32	34.5	21	18.5	17	28	17.5				
		MM 940	813	876	533	470	432	711	445				
Active weight 300 lbs.													
Removable seat cushion.													
Add \$122 for (MB) .		RTA 00											1 per carton
 <p>Two Seat Sofa COM: 8.75 YD 8 M Unit weight: 107 LB 48.6 KG Carton weight: 112 LB 50.8 KG Carton volume: 55.75 FT³ 1.57 MT³</p>	GC3752	2793	3073	3309	3581	4027	4438	4849	5208	5654	6074	6643	7448
		OVERALL DIMENSIONS			SEAT DIMENSIONS			BACK DIMENSIONS					
		W	D	H	W	D	H	W	H				
		IN 63.5	32	34.5	47.5	18.5	17	55	17.5				
		MM 1613	813	876	1207	470	432	1397	445				
Active weight 300 lbs/seat.													
Removable seat cushions.													
Add \$245 for (MB) .		RTA 00											1 per carton
 <p>Three Seat Sofa COM: 12 YD 10.97 M Unit weight: 145 LB 65.9 KG Carton weight: 155 LB 70.31 KG Carton volume: 74.75 FT³ 2.11 MT³</p>	GC3753	3554	3938	4262	4634	5246	5810	6374	6866	7478	8054	8834	9938
		OVERALL DIMENSIONS			SEAT DIMENSIONS			BACK DIMENSIONS					
		W	D	H	W	D	H	W	H				
		IN 90	32	34.5	74	18.5	17	82	17.5				
		MM 2286	813	876	1880	470	432	2083	445				
Active weight 300 lbs/seat.													
Removable seat cushions.													
Add \$366 for (MB) .		RTA 00											1 per carton

CALIDON



model GC36301



Tandem Side Table
model GC36319R

Calidon freestanding tables



For Calidon freestanding tables, please see page 76 .

EXAMPLE CALIDON ORDER CODE:

GC36308	-NS	-PU75	-NS
---------	-----	-------	-----

Model # Sealed back seams Back/arm textile Sealed seat seams

-PU75	-AAM	-TPM-J-SLT	-NM	-NB
-------	------	------------	-----	-----

Seat textile Frame finish Power Glides Moisture barrier

CONTRASTING TEXTILES APPLICATION

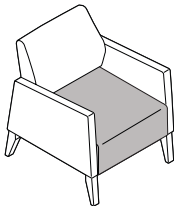

Back and arms are separate from seat.

POWER LOCATION DIAGRAM

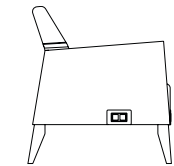

Right Side Power (SRT)
Models GC36308, GC36309 and GC36310

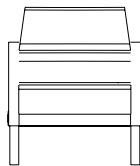

Front Power Not Available
Model GC36308

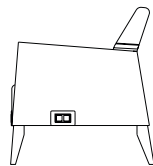

Left Side Power (SLT)
Models GC36308, GC36309 and GC36310

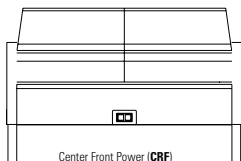

Center Front Power (CRF)
Model GC36309 only

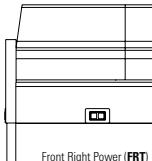

Front Right Power (FRT)
Model GC36310 only

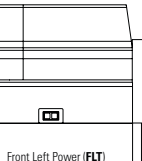

Front Left Power (FLT)
Model GC36310 only

STANDARD FEATURES

- Calidon series consists of wood frame guest, lounge, bariatric and bench seating, in addition to fully upholstered lounge seating. Calidon freestanding and tandem/bridge tables complement the line.
- Calidon is designed for the rigors of high use environments. Lounge units include metal frame supports.
- Frame design features a wall saver leg to prevent back contact and damage to walls.
- All guest and lounge chairs feature a clean out between seat and back, and tall legs for ease of cleaning.
- For added comfort, seats are standard with high density Ultracell foam.
- Active weight capacity up to 400 lbs./seat for standard seating; up to 600 lbs. for bariatric seating.
- For healthcare textiles, visit the website at globalfurnituregroup.com.
- Textiles with a minimum of 100,000 double rubs must be specified to meet Global 24/7 warranty coverage.
- Can be upholstered in standard Global textiles if Healthcare 24/7 application compliance is not required.
- Tandem table models (GC36319 to GC36321) connect to guest seating only. Tandem tables are specified left or right, as seated. Refer to page 76 for more details.
- No seating or bench models gang together.

OPTIONAL FEATURES

- All guest and lounge models can be specified with armcaps, securely fastened with metal-to-metal connectors, allowing for field replacement if required. Urethane armcaps are available on open (wood) arm models. Solid surface armcaps are available on open (wood) and fully upholstered arm models. Armcaps cannot be retrofitted in the field on units with no existing armcaps.
- Fully upholstered lounge seating can be specified with a tamper resistant power/USB unit, which includes one AC outlet, two 10-watt USB ports and a 10 ft long, 3-prong power cord. The power unit is Black with matching face plate and cord. Power is factory installed and must be specified at time of order. Add \$160. Power locations vary by model. See power location diagram.
- For contrasting textile specification, the back and arms are specified in one textile. The seat is specified separately. Use the Build-it tool on globalfurnituregroup.com for pricing.

SUGGESTED APPLICATIONS

- Bariatric seating
- Guest seating
- Lobbies
- Treatment/Exam rooms
- Patient rooms
- Resident rooms
- Lounge rooms

Please add option codes in the following order:

- **Model number**
GC36301 to GC36303 Guest chairs
GC36304 Bariatric guest chair
GC36305 to GC36307 Lounge chairs
GC36308 to GC36310 Fully upholstered lounge
GC36311 to GC36313 Benches
GC36318 to GC36320 Tandem/bridge tables
- **Sealed back seams**
(NS) No sealed back seams.
(SS) Sealed back seams. Upcharges vary, see model.
- **Back and arm textile**
Specify textile code.
- **Sealed seat seams**
(NS) No sealed seams.
(SS) Sealed seat seams. Upcharges vary, see model.
- **Seat textile**
Specify textile code.
- **Armcap option**
(FNA) No armcaps.
(FAC) With armcaps.
- **Frame finish**
(AAM) Absolute **(MWM)** Medium Walnut
(CJM) Charcoal Java **(ASM)** Night
(ACM) Cherry **(NBM)** Noce Biondo
(EMM) Empire Mahogany **(NGM)** Noce Grigio
(EOM) English Oak **(NEM)** Noce Leggero
(ECM) Espresso Cafe **(NMM)** Noce Medio
(TFM) Fruitwood **(SBM)** Sandy Beach
(HGM) Gray **(SKM)** Shaker Cherry
(HOM) Harvest Oak **(SOM)** Silver Oak
(AHM) Honey **(TWM)** Walnut
(JOM) Jet Onyx **(WTM)** WC Cream
(LHM) Light Honey **(WHM)** White
(TMM) Mahogany **(WCM)** Winter Cherry
(AVM) Maple
- **Armcap finish** (guest chairs only with **FAC** specified)
(SSU) Urethane armcaps (for wood arm guest and lounge with **FAC** specified). Upcharges vary, see model.
Urethane finishes
(BLK) Black **(J52)** Mocha
(KAL) Kalua **(SHW)** Shadow
(LAB) Latte **(TOA)** Toast
(CO) Solid surface. (for all wood and fully upholstered arm models with **FAC** specified). Upcharges vary, see model.
Solid surface finishes
Grade 1:
(SWH) Designer White
Grade 2:
(SBT) Beige Tempest
(SBX) Black Onyx Mirage
(SMG) Milk Glass Spectra
(SFW) Frosty White Mirage
(SHS) Hot Stone
(SNM) Northern Melange
- **Power/USB unit position** (fully upholstered, lounge models only, as specified below).
(NPM) No power.
(TPM) Tamper resistant power unit.
(J) Black
(SRT) Side right. Add \$160.
(SLT) Side left. Add \$160.
(FLT) Front left (three seater only). Add \$160.
(FRT) Front right (three seater only). Add \$160.
(CRF) Center front (two seater only). Add \$160.
(SLR) Side left and right. Add \$322.
(FLR) Front left and right. Add \$322.
- **Glides**
(NM) Non-marking
(NS) Non-slip. Guest single seat, bariatric and lounge chairs, add \$22. Guest two seater, add \$32. Guest three seater, add \$43.
- **Moisture Barrier** (seat only)
(NB) No moisture barrier.
(MB) Moisture barrier. Upcharges vary, see model.

DESCRIPTION	MODEL# / FEATURES	STANDARD TEXTILE GRADES											
		COM	2	3	4	5	6	7	8	9	10	11	12
 <p>Wood Guest Single Seat COM: 1.9 YD 1.74 M Unit weight: 26 LB 11.8 KG Carton weight: 38 LB 17.24 KG Carton volume: 16.5 FT³ 0.46 MT³</p>	GC36301	1109	1170	1221	1280	1377	1466	1556	1633	1730	1822	1945	2120
	Active weight 400 lbs.	OVERALL DIMENSIONS			SEAT DIMENSIONS			BACK DIMENSIONS					
		W	D	H	W	D	H	W	H				
	Solid surface GRD1 armcaps, add \$290. IN 23.5 26.5 34.5 21.5 18 18 21.5 16.5 Solid surface GRD2 armcaps, add \$310. MM 597 673 876 546 457 457 546 419 Urethane armcaps, add \$96. Moisture barrier (MB), add \$81. Sealed back seams (SS), add \$27. Sealed seat seams (SS), add \$19.												
							RTA 00		1 per carton				

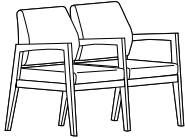
DESCRIPTION	MODEL# / FEATURES	STANDARD TEXTILE GRADES											
		COM	2	3	4	5	6	7	8	9	10	11	12
 <p>Wood Guest Two Seater, Full Center Arm COM: 3.8 YD 3.47 M Unit weight: 50 LB 22.7 KG Carton weight: 68 LB 30.84 KG Carton volume: 31.75 FT³ 0.89 MT³</p>	GC36302	2087	2209	2311	2429	2623	2801	2980	3136	3330	3512	3759	4109
	Active weight 400 lbs./seat	OVERALL DIMENSIONS			SEAT DIMENSIONS			BACK DIMENSIONS					
		W	D	H	H	W	D	H	H	WH			
	Solid surface GRD1 armcaps, add \$435. IN 46 26.5 34.5 21.5 18 18 21.5 16.5 Solid surface GRD2 armcaps, add \$465. MM 1168 673 876 546 457 457 546 419 Urethane armcaps, add \$144. Moisture barrier (MB), add \$161. Sealed back seams (SS), add \$55. Sealed seat seams (SS), add \$38.												
							RTA 00		1 per carton				

DESCRIPTION	MODEL# / FEATURES	STANDARD TEXTILE GRADES											
		COM	2	3	4	5	6	7	8	9	10	11	12
 <p>Wood Guest Three Seater, Full Center Arms COM: 5.7 YD 5.21 M Unit weight: 75 LB 34.1 KG Carton weight: 101 LB 45.81 KG Carton volume: 47.5 FT³ 1.34 MT³</p>	GC36303	3067	3249	3403	3580	3871	4139	4407	4640	4931	5205	5575	6099
	Active weight 400 lbs./seat	OVERALL DIMENSIONS			SEAT DIMENSIONS			BACK DIMENSIONS					
		W	D	H	W	D	H	W	H				
	Solid surface GRD1 armcaps, add \$580. IN 68 26.5 34.5 21.5 18 18 21.5 16.5 Solid surface GRD2 armcaps, add \$620. MM 1727 673 876 546 457 457 546 419 Urethane armcaps, add \$192. Moisture barrier (MB), add \$243. Sealed back seams (SS), add \$82. Sealed seat seams (SS), add \$57.												
							RTA 00		1 per carton				

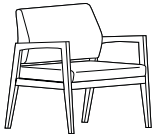
DESCRIPTION	MODEL# / FEATURES	STANDARD TEXTILE GRADES											
		COM	2	3	4	5	6	7	8	9	10	11	12
 <p>Wood Guest Bariatric Chair COM: 2.5 YD 2.29 M Unit weight: 41 LB 18.6 KG Carton weight: 55 LB 24.95 KG Carton volume: 22.25 FT³ 0.63 MT³</p>	GC36304	1617	1697	1765	1843	1969	2087	2205	2307	2435	2555	2717	2947
	Active weight 600 lbs.	OVERALL DIMENSIONS			SEAT DIMENSIONS			BACK DIMENSIONS					
		W	D	H	W	D	H	W	H				
	Solid surface GRD1 armcaps, add \$290. IN 32.75 26.5 34.5 31 18 18 30.5 16.5 Solid surface GRD2 armcaps, add \$310. MM 832 673 876 787 457 457 775 419 Urethane armcaps, add \$96. Moisture barrier (MB), add \$122. Sealed back seams (SS), add \$30. Sealed seat seams (SS), add \$19.												
							RTA 00		1 per carton				

DESCRIPTION	MODEL# / FEATURES	STANDARD TEXTILE GRADES											
		COM	2	3	4	5	6	7	8	9	10	11	12
 <p>Wood Lounge Single Seat COM: 2.5 YD 2.29 M Unit weight: 37 LB 16.8 KG Carton weight: 49 LB 22.23 KG Carton volume: 18.25 FT³ 0.51 MT³</p>	GC36305	1501	1581	1649	1727	1853	1971	2089	2191	2319	2439	2601	2831
	Active weight 400 lbs.	OVERALL DIMENSIONS			SEAT DIMENSIONS			BACK DIMENSIONS					
		W	D	H	W	D	H	W	H				
	Solid surface GRD1 armcaps, add \$305. IN 25.75 29.5 32.5 24 21 16 23.5 16.5 Solid surface GRD2 armcaps, add \$329. MM 654 749 826 610 533 406 597 419 Urethane armcaps, add \$144. Moisture barrier (MB), add \$81. Sealed back seams (SS), add \$31. Sealed seat seams (SS), add \$24.												
							RTA 00		1 per carton				

DESCRIPTION	MODEL# / FEATURES	STANDARD TEXTILE GRADES											
		COM	2	3	4	5	6	7	8	9	10	11	12

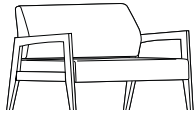

Wood Lounge Two Seater
 COM: 4 YD | 3.66 M
 Unit weight: 60 LB | 27.3 KG
 Carton weight: 77 LB | 34.93 KG
 Carton volume: 32.75 FT³ | 0.92 MT³

MODEL# / FEATURES	COM	2	3	4	5	6	7	8	9	10	11	12
GC36306	2086	2214	2322	2447	2650	2838	3026	3190	3394	3586	3846	4214

Active weight 400 lbs./seat	OVERALL DIMENSIONS			SEAT DIMENSIONS			BACK DIMENSIONS	
	W	D	H	W	D	H	W	H
Solid surface GRD1 armcaps, add \$305. IN	47.5	29.5	32.5	45	21	16	44.5	16.5
Solid surface GRD2 armcaps, add \$329. MM	1207	749	826	1143	533	406	1130	419
Urethane armcaps, add \$144. Moisture barrier (MB), add \$161. Sealed back seams (SS), add \$45. Sealed seat seams (SS), add \$34.	RTA 00			1 per carton				

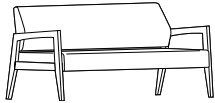

Wood Lounge Three Seater
 COM: 5.25 YD | 4.8 M
 Unit weight: 86 LB | 39.1 KG
 Carton weight: 109 LB | 49.44 KG
 Carton volume: 50.75 FT³ | 1.43 MT³

MODEL# / FEATURES	COM	2	3	4	5	6	7	8	9	10	11	12
GC36307	2608	2776	2918	3081	3349	3595	3842	4057	4325	4577	4918	5401

Active weight 400 lbs./seat	OVERALL DIMENSIONS			SEAT DIMENSIONS			BACK DIMENSIONS	
	W	D	H	W	D	H	W	H
Solid surface GRD1 armcaps, add \$305. IN	70.5	29.5	32.5	68	21	16	67.5	16.5
Solid surface GRD2 armcaps, add \$329. MM	1791	749	826	1727	533	406	1715	419
Urethane armcaps, add \$144. Moisture barrier (MB), add \$243. Sealed back seams (SS), add \$58. Sealed seat seams (SS), add \$45.	RTA 00			1 per carton				

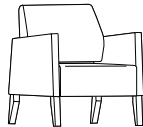

Fully Upholstered Lounge Single Seat
 COM: 4 YD | 3.66 M
 Unit weight: 46 LB | 20.9 KG
 Carton weight: 58 LB | 26.31 KG
 Carton volume: 18.75 FT³ | 0.53 MT³

MODEL# / FEATURES	COM	2	3	4	5	6	7	8	9	10	11	12
GC36308	1631	1759	1867	1992	2195	2383	2571	2735	2939	3131	3391	3759

Active weight 400 lbs.	OVERALL DIMENSIONS			SEAT DIMENSIONS			BACK DIMENSIONS	
	W	D	H	W	D	H	W	H
Solid surface GRD1 armcaps, add \$335. IN	27.5	29.5	33.5	24	21	16	23.5	17.5
Solid surface GRD2 armcaps, add \$355. MM	699	749	851	610	533	406	597	445
Moisture barrier (MB), add \$81. Sealed back and arm seams (SS), add \$104. Sealed seat seams (SS), add \$26. Power/USB module available.	RTA 00			1 per carton				

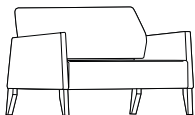

Fully Upholstered Lounge Two Seater
 COM: 5.75 YD | 5.26 M
 Unit weight: 72 LB | 32.7 KG
 Carton weight: 89 LB | 40.37 KG
 Carton volume: 33.75 FT³ | 0.95 MT³

MODEL# / FEATURES	COM	2	3	4	5	6	7	8	9	10	11	12
GC36309	2217	2401	2557	2735	3028	3298	3569	3804	4098	4374	4747	5276

Active weight 400 lbs./seat	OVERALL DIMENSIONS			SEAT DIMENSIONS			BACK DIMENSIONS	
	W	D	H	W	D	H	W	H
Solid surface GRD1 armcaps, add \$335. IN	49.5	29.5	33.5	44.5	18	16	45.5	17.5
Solid surface GRD2 armcaps, add \$355. MM	1257	749	851	1130	457	406	1156	445
Moisture barrier (MB), add \$161. Sealed back and arm seams (SS), add \$118. Sealed seat seams (SS), add \$37. Power/USB module available.	RTA 00			1 per carton				

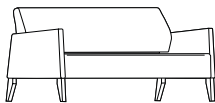

Fully Upholstered Lounge Three Seater
 COM: 7 YD | 6.4 M
 Unit weight: 99 LB | 45 KG
 Carton weight: 123 LB | 55.79 KG
 Carton volume: 52 FT³ | 1.47 MT³

MODEL# / FEATURES	COM	2	3	4	5	6	7	8	9	10	11	12
GC36310	2738	2962	3151	3369	3725	4054	4383	4670	5027	5363	5818	6462

Active weight 400 lbs./seat	OVERALL DIMENSIONS			SEAT DIMENSIONS			BACK DIMENSIONS	
	W	D	H	W	D	H	W	H
Solid surface GRD1 armcaps, add \$335. IN	71.5	29.5	33.5	66.5	18	16	67.5	17.5
Solid surface GRD2 armcaps, add \$355. MM	1816	749	851	1689	457	406	1715	445
Moisture barrier (MB), add \$243. Sealed back and arm seams (SS), add \$132. Sealed seat seams (SS), add \$47. Power/USB module available.	RTA 00			1 per carton				

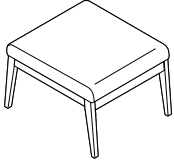
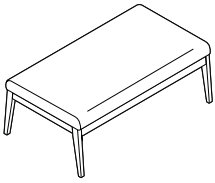
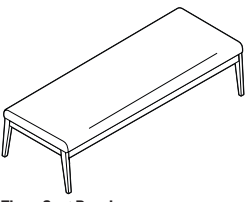
DESCRIPTION	MODEL# / FEATURES	STANDARD TEXTILE GRADES											
		COM	2	3	4	5	6	7	8	9	10	11	12
 <p>Single Seat Bench COM: 1 YD 0.91 M Unit weight: 31 LB 14.1 KG Carton weight: 41 LB 18.6 KG Carton volume: 10 FT³ 0.28 MT³</p>	GC36311	1275	1307	1334	1365	1416	1463	1510	1551	1602	1650	1715	1807
		OVERALL DIMENSIONS			SEAT DIMENSIONS			BACK DIMENSIONS					
		W	D	H	W	D	H	W	H				
	Active weight 400 lbs.	IN 24 MM 610	28 711	18 457	24 610	26.75 679	18 457	-	-				
	Moisture barrier (MB), add \$81. Sealed seat seams (SS), add \$22.	RTA 00	1 per carton										
 <p>Two Seat Bench COM: 2 YD 1.83 M Unit weight: 43 LB 19.5 KG Carton weight: 61 LB 27.67 KG Carton volume: 18.75 FT³ 0.53 MT³</p>	GC36312	1860	1924	1978	2040	2142	2236	2330	2412	2514	2610	2740	2924
		OVERALL DIMENSIONS			SEAT DIMENSIONS			BACK DIMENSIONS					
		W	D	H	W	D	H	W	H				
	Active weight 400 lbs./seat	IN 48 MM 1219	28 711	18 457	48 1219	26.75 679	18 457	-	-				
	Moisture barrier (MB), add \$161. Sealed seat seams (SS), add \$44.	RTA 00	1 per carton										
 <p>Three Seat Bench COM: 3 YD 2.74 M Unit weight: 75 LB 34.1 KG Carton weight: 97 LB 44 KG Carton volume: 27.75 FT³ 0.78 MT³</p>	GC36313	2167	2263	2344	2437	2590	2731	2872	2995	3148	3292	3487	3763
		OVERALL DIMENSIONS			SEAT DIMENSIONS			BACK DIMENSIONS					
		W	D	H	W	D	H	W	H				
	Active weight 400 lbs./seat	IN 72 MM 1829	28 711	18 457	72 1829	26.75 679	18 457	-	-				
	Moisture barrier (MB), add \$243. Sealed seat seams (SS), add \$65.	RTA 00	1 per carton										

TABLES	MODEL #	DIMENSIONS ^{IN} _{MM}	WEIGHT ^{LB} _{KG}	VOLUME ^{FT³} _{MT³}	LIST PRICE
--------	---------	---	---------------------------------------	---	------------

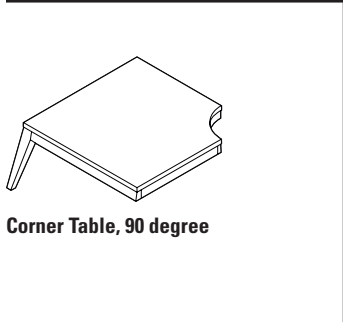

Corner Table, 90 degree

W x D x H					
GC36318	31.25 x 31.25 x 15.75	34	14.5	\$677	
	794 x 794 x 400	15.5	0.41		

- For a thermally fused laminate top (LP), specify model GC36318-LP.
- For a high pressure laminate top (HP), specify model GC36318-HP. Add \$72.
- For a solid surface top (CO), specify model GC36318-CO. Add \$1970 for Grade 1. Add \$2250 for Grade 2.

Coordinating edge and solid wood frame. Must be connected to a guest chair. Includes one set of U-channel connectors and hardware. 1 per carton. Power and data can be added on the surface of the table (LBT) or (RBT). Add \$232. See power location diagram for placement on page 76.

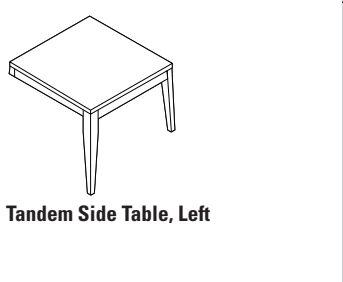

Tandem Side Table, Left

GC36319L	22.25 x 26.5 x 15.75	15	6.75	\$451	
	565 x 673 x 400	6.8	0.19		

- For a thermally fused laminate top (LP), specify model GC36319L-LP.
- For a high pressure laminate top (HP), specify model GC36319L-HP. Add \$42.
- For a solid surface top (CO), specify model GC36319L-CO. Add \$869 for Grade 1. Add \$1159 for Grade 2.

Coordinating edge and solid wood frame. Must be connected to a guest chair. Includes one set of U-channel connectors and hardware. 1 per carton. Power and data can be added on the surface of the table (CNT). Add \$232.

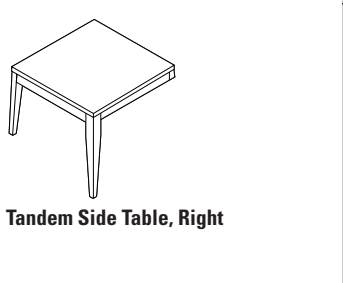

Tandem Side Table, Right

GC36319R	22.25 x 26.5 x 15.75	15	6.75	\$451	
	565 x 673 x 400	6.8	0.19		

- For a thermally fused laminate top (LP), specify model GC36319R-LP.
- For a high pressure laminate top (HP), specify model GC36319R-HP. Add \$42.
- For a solid surface top (CO), specify model GC36319R-CO. Add \$869 for Grade 1. Add \$1159 for Grade 2.

Coordinating edge and solid wood frame. Must be connected to a guest chair. Includes one set of U-channel connectors and hardware. 1 per carton. Power and data can be added on the surface of the table (CNT). Add \$232.

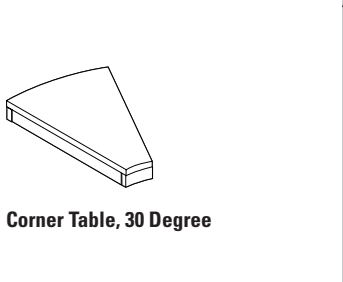

Corner Table, 30 Degree

GC36320	15.75 x 22.5 x 3	16	1.5	\$340	
	400 x 572 x 76	7.25	0.04		

- For a thermally fused laminate top (LP), specify model GC36320-LP.
- For a high pressure laminate top (HP), specify model GC36320-HP. Add \$42.
- For a solid surface top (CO), specify model GC36320-CO. Add \$690 for Grade 1. Add \$840 for Grade 2.

Coordinating edge and solid wood frame. Must be connected between two guest chairs. Includes two sets of U-channel connectors and hardware. 1 per carton. Power and data can be added on the surface of the table (CNT). Add \$232.

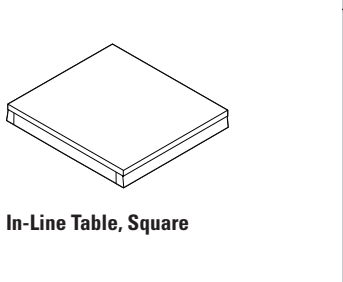

In-Line Table, Square

GC36321	23.5 x 21 x 3	16	1.9	\$368	
	597 x 533 x 76	7.3	0.05		

- For a thermally fused laminate top (LP), specify model GC36321-LP.
- For a high pressure laminate top (HP), specify model GC36321-HP. Add \$42.
- For a solid surface top (CO), specify model GC36321-CO. Add \$822 for Grade 1. Add \$1032 for Grade 2.

Coordinating edge and solid wood frame. Must be connected between two guest chairs. Includes two sets of U-channel connectors and hardware. 1 per carton. Power and data can be added on the surface of the table (CNT). Add \$232.

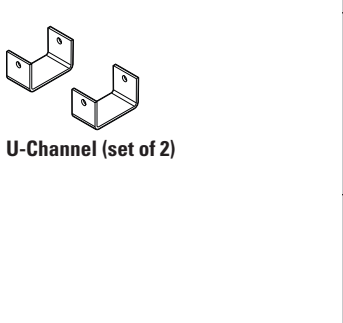

U-Channel (set of 2)

GC36322	1.5 x 2.87 x 1.62	0.5	0.1	\$40	
	38 x 73 x 41	0.2	-		

Includes hardware. 4 sets per carton.

COAST



model GC4172



Clean out space around seat cushions for easy housekeeping

STANDARD FEATURES

- The smooth low range glide adds relaxing motion while you sink back and coast in this ultra-comfortable chair.
- Adjustable non-marking glides are standard.
- For added comfort, seats are standard with high density Ultracell foam.
- Clean out space is provided between the seat and back cushions for easy housekeeping.
- Arms on the glider are fixed with a grip allowing the user to easily enter and exit from the chair. Combined with a smooth low-range motion mechanism, this eliminates the need for a locking mechanism.
- Standard with Black urethane fully extended arms.
- Left and right position reference is determined from the seated position.
- Seamless front upholstery method on the seat cushion prevents eventual breakdown of seams causing liquid penetration into the foam.
- For healthcare textiles and finish options, visit the website at globalfurnituregroup.com.
- Can be upholstered in standard Global textiles if Healthcare compliance is not required.
- Shipped fully assembled.

OPTIONAL FEATURES

- For moisture barrier on seat, please specify **(MB)**. Add \$81.
- To add sealed seams to your product, please specify **(SS)**. Add \$153.
- For adjustable non-slip glides, please specify **(NS)**. Add \$22.
- Tablet arm with spill collector on the edge is available, offered in Black Phenolic material. From seated position, specify **(LT)** for left hand tablet or **(RT)** for right hand tablet. Add \$572. For left and right tablets, please specify **(TB)**. Add \$1143.

SUGGESTED APPLICATIONS

- Patient rooms
- Resident rooms
- Lounge/Waiting

Please add option codes in the following order:

- **Model number**
GC4172 Glider/motion chair
- **Textile**
Specify fabric code.
- **Armcap finish**
(SS) Black urethane armcap
(LA) Latte urethane armcap
(KL) Kalua urethane armcap
(MC) Mocha urethane armcap
(SH) Shadow urethane armcap
(TO) Toast urethane armcap
(AB) Absolute wood armcap
(CJ) Charcoal Java wood armcap
(AC) Cherry wood armcap
(EP) Empire Mahogany wood armcap
(EM) English Oak wood armcap
(EC) Espresso Cafe wood armcap
(HG) Gray wood armcap
(HA) Harvest Oak wood armcap
(AH) Honey wood armcap
(JO) Jet Onyx wood armcap
(LH) Light Honey wood armcap
(AV) Maple wood armcap
(MW) Medium Walnut wood armcap
(NT) Natural Walnut wood armcap
(AT) Night wood armcap
(BI) Noce Biondo wood armcap
(GI) Noce Grigio wood armcap
(EI) Noce Leggero wood armcap
(MI) Noce Medio wood armcap
(SB) Sandy Beach wood armcap
(SK) Shaker Cherry wood armcap
(SM) Silver Oak wood armcap
(TF) Tiger Fruitwood wood armcap
(TM) Tiger Mahogany wood armcap
(TL) Tiger Walnut wood armcap
(WR) WC Cream wood armcap
(WH) White wood armcap
(WC) Winter Cherry wood armcap
- **Glides**
(ST) Adjustable non-marking glides
(NS) Adjustable non-slip glides
- **Moisture barrier**
(MB) Seat only
- **Sealed seams**
(SS) All sealed seams

EXAMPLE COAST ORDER CODE:

GC4172	-LX21	-SS	-ST	-	-
Model #	Textile	Armcaps	Glides	Moisture barrier	Sealed seams

DESCRIPTION	MODEL# / FEATURES	STANDARD TEXTILE GRADES																																
		COM	2	3	4	5	6	7	8	9	10	11	12																					
 <p>Glider/Motion Chair COM: 5.5 YD 5.03 M Unit weight: 100 LB 45.5 KG Carton weight: 115 LB 52.16 KG Carton volume: 29.5 FT³ 0.83 MT³</p>	GC4172	2107	2283	2432	2602	2883	3141	3400	3625	3906	4170	4527	5033																					
	<p>Active weight 350 lbs.</p> <p>Specify armcap: wood or urethane.</p>	<table border="1"> <thead> <tr> <th colspan="3">OVERALL DIMENSIONS</th> <th colspan="3">SEAT DIMENSIONS</th> <th colspan="2">BACK DIMENSIONS</th> </tr> <tr> <th>W</th> <th>D</th> <th>H</th> <th>W</th> <th>D</th> <th>H</th> <th>W</th> <th>H</th> </tr> </thead> <tbody> <tr> <td>IN 30</td> <td>31.5</td> <td>43.5</td> <td>21.5</td> <td>19.5</td> <td>18</td> <td>22</td> <td>28</td> </tr> <tr> <td>MM 762</td> <td>800</td> <td>1105</td> <td>546</td> <td>495</td> <td>457</td> <td>559</td> <td>711</td> </tr> </tbody> </table>	OVERALL DIMENSIONS			SEAT DIMENSIONS			BACK DIMENSIONS		W	D	H	W	D	H	W	H	IN 30	31.5	43.5	21.5	19.5	18	22	28	MM 762	800	1105	546	495	457	559	711
OVERALL DIMENSIONS			SEAT DIMENSIONS			BACK DIMENSIONS																												
W	D	H	W	D	H	W	H																											
IN 30	31.5	43.5	21.5	19.5	18	22	28																											
MM 762	800	1105	546	495	457	559	711																											

COLLINGWOOD



model GC36510



STANDARD FEATURES

- Collingwood offers a cozy, streamlined design with classic curves.
- Features a clean out around the seat cushion for easy housekeeping.
- The seat underside is sealed with a non-porous material to support housekeeping and infection control protocols.
- Seat cushion is mechanically removable, if required.
- Legs are available in wood or urethane, in a variety of colors.
- For added comfort, seat cushions are standard with high density Ultracell foam.
- Opaque non-marking glides are standard.
- For healthcare textiles, visit the website at globalfurnituregroup.com.
- Can be upholstered in standard Global textiles if healthcare compliance is not required.
- Shipped fully assembled.

SUGGESTED APPLICATIONS

- Dining/Cafeteria
- Guest seating
- Lobbies
- Lounge/Waiting
- Patient rooms
- Resident rooms

OPTIONAL FEATURES

Please add option codes in the following order:

- **Model number**
GC36510 Low Back Lounge Chair
GC36511 High Back Lounge Chair
- **Sealed back/arms seams (NS)** No sealed back seams.
(SS) Sealed back seams. Upcharges vary, see model.
- **Back/arms textile**
Specify textile code.
- **Sealed seat seams (NS)** No sealed seat seams.
(SS) Sealed seat seams. Add \$27.
- **Seat textile**
Specify textile code.
- **Wood leg finish**
(AAM) Absolute **(MWM)** Medium Walnut
(BKM) Black **(NLW)** Natural Walnut
(CJM) Charcoal Java **(NSM)** Night
(ACM) Cherry **(NBM)** Noce Biondo
(EMM) Empire Mahogany **(NGM)** Noce Grigio
(EOM) English Oak **(NEM)** Noce Leggero
(ECM) Espresso Cafe **(NMM)** Noce Medio
(TFM) Fruitwood **(SBM)** Sandy Beach
(HGM) Gray **(SKM)** Shaker Cherry
(HOM) Harvest Oak **(SOM)** Silver Oak
(AHM) Honey **(TWM)** Walnut
(JOM) Jet Onyx **(WTM)** WC Cream
(LHM) Light Honey **(WHM)** White
(TMM) Mahogany **(WCM)** Winter Cherry
(AVM) Maple
- **Urethane leg finish**
Add \$150.
(BLK) Black **(J52)** Mocha
(KAL) Kalua **(SHW)** Shadow
(LAB) Latte **(TOA)** Toast
- **Glides**
(NM) Non-marking glides. No upcharge
(RG) Rubber, non-slip glides. Add \$21.
(SG) Steel cushion glides. Add \$17.
(FG) Felt glides. Add \$21.
- **Moisture barrier (seat only)**
(NB) No moisture barrier. No upcharge.
(MB) Moisture barrier. Add \$77.

EXAMPLE COLLINGWOOD ORDER CODE:

GC36510	NS	CE90	NS	CE90	AAM	NM	NB
Model #	Sealed back/arms seams	Back/arms textile	Sealed seat seams	Seat textile	Base	Glides	Moisture barrier

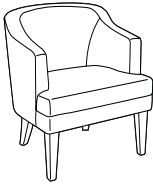
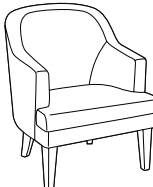
DESCRIPTION	MODEL# / FEATURES	STANDARD TEXTILE GRADES																																														
		COM	2	3	4	5	6	7	8	9	10	11	12																																			
 <p>Low Back Lounge Chair COM: 4.5 YD 4.11 M Unit weight: 42 LB 19.1 KG Carton weight: 55 LB 24.95 KG Carton volume: 19.25 FT³ 0.54 MT³</p>	GC36510	1591	1735	1857	1997	2225	2437	2649	2833	3063	3279	3571	3985																																			
	<p>Active weight 350 lbs. Replaceable seat cushion. Add \$54 for sealed back seams (SS)</p> <p>RTA 00 1 per carton</p>																																															
	<table border="1"> <thead> <tr> <th colspan="3">OVERALL DIMENSIONS</th> <th colspan="3">SEAT DIMENSIONS</th> <th colspan="3">BACK DIMENSIONS</th> </tr> <tr> <th>W</th> <th>D</th> <th>H</th> <th>W</th> <th>D</th> <th>H</th> <th>W</th> <th colspan="2">H</th> </tr> </thead> <tbody> <tr> <td>IN 28</td> <td>27.25</td> <td>31</td> <td>21</td> <td>19</td> <td>18</td> <td>21.5</td> <td colspan="2">12.5</td> </tr> <tr> <td>MM 711</td> <td>692</td> <td>787</td> <td>533</td> <td>483</td> <td>457</td> <td>546</td> <td colspan="2">318</td> </tr> </tbody> </table>	OVERALL DIMENSIONS			SEAT DIMENSIONS			BACK DIMENSIONS			W	D	H	W	D	H	W	H		IN 28	27.25	31	21	19	18	21.5	12.5		MM 711	692	787	533	483	457	546	318												
OVERALL DIMENSIONS			SEAT DIMENSIONS			BACK DIMENSIONS																																										
W	D	H	W	D	H	W	H																																									
IN 28	27.25	31	21	19	18	21.5	12.5																																									
MM 711	692	787	533	483	457	546	318																																									
 <p>High Back Lounge Chair COM: 5 YD 4.57 M Unit weight: 43 LB 19.5 KG Carton weight: 56 LB 25.4 KG Carton volume: 22.5 FT³ 0.63 MT³</p>	GC36511	1632	1792	1927	2083	2337	2572	2807	3012	3267	3507	3832	4292																																			
	<p>Active weight 350 lbs. Replaceable seat cushion. Add \$62 for sealed back seams (SS)</p> <p>RTA 00 1 per carton</p>																																															
	<table border="1"> <thead> <tr> <th colspan="3">OVERALL DIMENSIONS</th> <th colspan="3">SEAT DIMENSIONS</th> <th colspan="3">BACK DIMENSIONS</th> </tr> <tr> <th>W</th> <th>D</th> <th>H</th> <th>W</th> <th>D</th> <th>H</th> <th>W</th> <th colspan="2">H</th> </tr> </thead> <tbody> <tr> <td>IN 28</td> <td>28.5</td> <td>35.5</td> <td>21</td> <td>19</td> <td>18</td> <td>21.5</td> <td colspan="2">17</td> </tr> <tr> <td>MM 711</td> <td>724</td> <td>902</td> <td>533</td> <td>483</td> <td>457</td> <td>546</td> <td colspan="2">432</td> </tr> </tbody> </table>	OVERALL DIMENSIONS			SEAT DIMENSIONS			BACK DIMENSIONS			W	D	H	W	D	H	W	H		IN 28	28.5	35.5	21	19	18	21.5	17		MM 711	724	902	533	483	457	546	432												
OVERALL DIMENSIONS			SEAT DIMENSIONS			BACK DIMENSIONS																																										
W	D	H	W	D	H	W	H																																									
IN 28	28.5	35.5	21	19	18	21.5	17																																									
MM 711	724	902	533	483	457	546	432																																									

DESMOND



model GC4162

STANDARD FEATURES





- Clean lines and a contoured picture frame style back coordinate with any decor.
- Arms incorporate a firm grip extension to assist users in the entry and exit from the chair.
- Additional support rails on the legs ensure strength and durability.
- For added comfort, seats are standard with high density Ultracell foam.
- Opaque non-marking glides are standard.
- For healthcare textiles and wood finish options, visit the website at globalfurnituregroup.com. Available in European beechwood species only (refer to finishes that end with an "M").
- Models ending in FC have front casters.
- Shipped fully assembled.

OPTIONAL FEATURES

- For non-slip glides, please specify **(NS)**. Add \$22. For models with front casters, add \$9.
- For moisture barrier on seat, please specify **(MB)**. Add \$81.

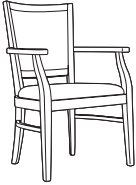
SUGGESTED APPLICATIONS

- Dining/Cafeteria
- Guest seating
- Lobbies
- Lounge/Waiting
- Office/Meeting
- Patient rooms
- Resident rooms

DESCRIPTION	MODEL# / FEATURES	STANDARD TEXTILE GRADES															
 <p>Armchair COM: 1.25 YD 1.14 M Unit weight: 19 LB 8.6 KG Carton weight: 24 LB 10.89 KG Carton volume: 14.5 FT³ 0.41 MT³</p>	COM	2	3	4	5	6	7	8	9	10	11	12					
	GC4162	1137	1177	1211	1250	1313	1372	1431	1482	1546	1606	1687	1802				
	OVERALL DIMENSIONS			SEAT DIMENSIONS			BACK DIMENSIONS										
	IN	24	22.5	36	22.5	18	17.5	17.5	18.5	MM	610	572	914	572	457	445	445
	<p>RTA 00 1 per carton</p>																
 <p>Armchair Front Casters COM: 1.25 YD 1.14 M Unit weight: 19 LB 8.6 KG Carton weight: 24 LB 10.89 KG Carton volume: 14.5 FT³ 0.41 MT³</p>	COM	2	3	4	5	6	7	8	9	10	11	12					
	GC4162FC	1218	1258	1292	1331	1394	1453	1512	1563	1627	1687	1768	1883				
	OVERALL DIMENSIONS			SEAT DIMENSIONS			BACK DIMENSIONS										
	IN	24	22.5	36	22.5	18	17.5	17.5	18.5	MM	610	572	914	572	457	445	445
	<p>RTA 00 1 per carton</p>																
 <p>Side Chair COM: 1.25 YD 1.14 M Unit weight: 17 LB 7.7 KG Carton weight: 22 LB 9.98 KG Carton volume: 14.5 FT³ 0.41 MT³</p>	COM	2	3	4	5	6	7	8	9	10	11	12					
	GC4165	1070	1110	1144	1183	1246	1305	1364	1415	1479	1539	1620	1735				
	OVERALL DIMENSIONS			SEAT DIMENSIONS			BACK DIMENSIONS										
	IN	22.5	22.5	36	22.5	18	17.5	17.5	18.5	MM	572	572	914	572	457	445	445
	<p>RTA 00 1 per carton</p>																
 <p>Side Chair Front Casters COM: 1.25 YD 1.14 M Unit weight: 17 LB 7.7 KG Carton weight: 22 LB 9.98 KG Carton volume: 14.5 FT³ 0.41 MT³</p>	COM	2	3	4	5	6	7	8	9	10	11	12					
	GC4165FC	1149	1189	1223	1262	1325	1384	1443	1494	1558	1618	1699	1814				
	OVERALL DIMENSIONS			SEAT DIMENSIONS			BACK DIMENSIONS										
	IN	22.5	22.5	36	22.5	18	17.5	17.5	18.5	MM	572	572	914	572	457	445	445
	<p>RTA 00 1 per carton</p>																

DESMOND HT



model GC4290

EXAMPLE DESMOND HT ORDER CODE:

GC4290	-LX21	-TBL	-PT	-BK	-MB
Model #	Textile	Frame	Armcaps	Glides	Moisture barrier

STANDARD FEATURES

- Desmond HT is a metal framed chair with residential design while ensuring maximum strength and durability within very challenging applications.
- Available with four-legged metal welded frame with or without arms; with rear casters that allow the caregiver to tip and move chair without lifting; with lift mechanism and rear casters to assist the caregiver in turning the chair and moving the occupant to and from a table; or a bariatric model.
- Models with rear casters also allow the caregiver to turn the chair with occupant seated for better access to wheelchair or walker.
- The welded metal frame, welded cross rails on lower frame, metal-to-metal fasteners on seat pan, back insert and urethane armcaps enhance strength and durability, ensuring its performance in the most rigorous environments.
- Urethane armcaps are comfortable, durable, cleanable and replaceable. Designed to offer proper support while seated and the egress grip allows the occupant to use with confidence when getting in or out of the chair.
- For added comfort and long term performance the seat cushion is standard with high density Ultracell foam.
- The underside of the seat pan is moisture resistant, and the cushions have no exposed seams to support improved housekeeping and infection prevention practices.
- For healthcare textiles and finish options, visit the website at globalfurnituregroup.com.
- Can be upholstered in standard Global textiles if Healthcare compliance is not required.
- Shipped fully assembled.

OPTIONAL FEATURES



- To add additional weight to your product, contact Customer Service for more information.
- For moisture barrier on seat, please specify **(MB)**. Add \$81. For bariatric model, add \$122.



Please add option codes in the following order:

- **Model number**
GC4290 Metal armchair
GC4291 Metal armchair w/two rear swivel casters
GC4292 Metal armchair w/two rear swivel casters and lift mechanism
GC4293 Metal bariatric armchair
GC4294 Metal side chair, armless
- **Textile**
Specify fabric code.
- **Frame finish**
(TBL) Black
(TIV) Cloud
(TDW) Designer White
(TFO) Fog
(TFR) Frost
(TKA) Kalua
(TLA) Latte
(TMO) Mocha
(TNE) Nevada
(TSN) Sand
(TSH) Shadow
(TOA) Toast
(TTU) Tungsten
- **Armcap finish**
(SS) Black
(KL) Kalua
(LA) Latte
(MC) Mocha
(SH) Shadow
(TO) Toast
- **Glides**
(BK) Black plastic glides
- **Moisture barrier**
(MB) Seat only

SUGGESTED APPLICATIONS

- Bariatric seating (model GC4293)
- Dining/Cafeteria
- Guest seating
- Lobbies
- Lounge/Waiting
- Office/Meeting
- Patient rooms
- Resident room

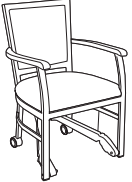
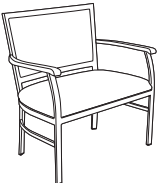
DESCRIPTION	MODEL# / FEATURES	STANDARD TEXTILE GRADES											
		COM	2	3	4	5	6	7	8	9	10	11	12
 <p>Metal Armchair COM: 1.25 YD 1.14 M Unit weight: 34 LB 15.5 KG Carton weight: 41 LB 18.6 KG Carton volume: 13.75 FT³ 0.38 MT³</p>	GC4290	1262	1302	1336	1375	1438	1497	1556	1607	1671	1731	1812	1927
	Active weight 500 lbs.												
		OVERALL DIMENSIONS			SEAT DIMENSIONS			BACK DIMENSIONS					
		IN	24.5	23.5	35.75	23	19	18.5	18	17.5			
	MM	622	597	908	584	483	470	457	445				
	RTA 00	1 per carton											
 <p>Metal Armchair w/Two Rear Swivel Casters COM: 1.25 YD 1.14 M Unit weight: 34 LB 15.5 KG Carton weight: 41 LB 18.6 KG Carton volume: 13.75 FT³ 0.38 MT³</p>	GC4291	1349	1389	1423	1462	1525	1584	1643	1694	1758	1818	1899	2014
	Active weight 500 lbs.												
		OVERALL DIMENSIONS			SEAT DIMENSIONS			BACK DIMENSIONS					
		IN	24.5	23.5	35.75	23	19	18.5	18	17.5			
	MM	622	597	908	584	483	470	457	445				
	RTA 00	1 per carton											

DESCRIPTION	MODEL# / FEATURES	STANDARD TEXTILE GRADES											
		COM	2	3	4	5	6	7	8	9	10	11	12
 <p>Metal Armchair w/Two Rear Swivel Casters & Lift Mec. COM: 1.25 YD 1.14 M Unit weight: 37 LB 16.8 KG Carton weight: 44 LB 19.96 KG Carton volume: 13.75 FT³ 0.38 MT³</p>	GC4292 Active weight 500 lbs.	1739	1779	1813	1852	1915	1974	2033	2084	2148	2208	2289	2404
		OVERALL DIMENSIONS			SEAT DIMENSIONS			BACK DIMENSIONS					
		W	D	H	W	D	H	W	H				
		IN 24.5 MM 622	23.5 597	35.75 908	23 584	19 483	18.5 470	18 457	17.5 445				
			RTA 00	1 per carton									
 <p>Metal Bariatric Armchair COM: 2.25 YD 2.06 M Unit weight: 40 LB 18.2 KG Carton weight: 48 LB 21.77 KG Carton volume: 20 FT³ 0.56 MT³</p>	GC4293 Active weight 750 lbs.	1686	1758	1819	1889	2003	2109	2215	2307	2422	2530	2676	2883
		OVERALL DIMENSIONS			SEAT DIMENSIONS			BACK DIMENSIONS					
		W	D	H	W	D	H	W	H				
		IN 35.5 MM 902	23.5 597	35.75 908	34 864	19 483	18.5 470	29 737	17.5 445				
			RTA 00	1 per carton									
 <p>Metal Armless Side Chair COM: 1.25 YD 1.14 M Unit weight: 29 LB 13.2 KG Carton weight: 36 LB 16.33 KG Carton volume: 13.75 FT³ 0.38 MT³</p>	GC4294 Active weight 500 lbs.	1158	1198	1232	1271	1334	1393	1452	1503	1567	1627	1708	1823
		OVERALL DIMENSIONS			SEAT DIMENSIONS			BACK DIMENSIONS					
		W	D	H	W	D	H	W	H				
		IN 23 MM 584	23.5 597	35.75 908	23 584	19 483	18.5 470	18 457	17.5 445				
			RTA 00	1 per carton									

DREME



model GC35042



Drawer box surface

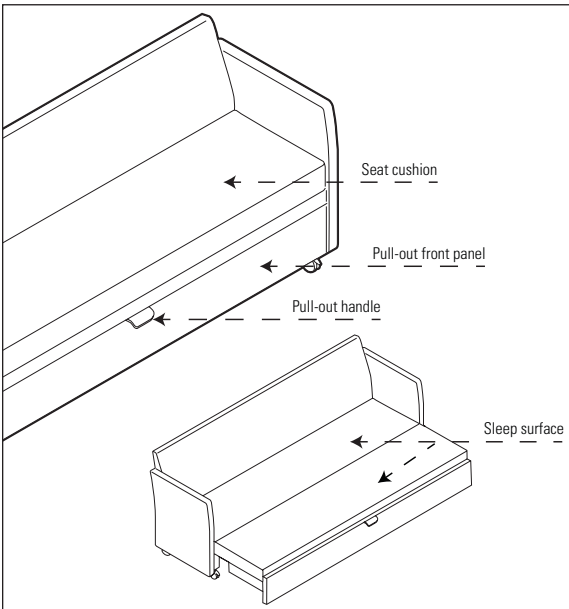

STANDARD FEATURES

- Dreme has a compact, comfortable design that offers a place to sit or easily converts into a generous sleep surface. The various configurations include a bench with or without back and with or without arms. All models are listed.
- The seat deck is a clean through metal platform for superior strength.
- The seat/sleep cushion is attached to the unit with straps that are held in place by metal-to-metal fasteners for unparalleled strength and durability. This allows sheets to be tucked in place.
- There is a clean out space to the floor at the back of the seat cushion in support of housekeeping and infection control practices.
- The seat cushion folds open to create a 36" deep sleep surface area. Foam is standard high density Ultracell, for enhanced comfort and long-term performance.
- Below the seat deck is a closed drawer box that pulls out, increasing the sleep area.
- The sleep surface cushion and drawer box covering are upholstered in Bantam Vinyl to ensure moisture barrier protection. These surfaces are 9:1 (water to bleach) cleanable. Please select **(BM)** color. See Morbern Bantam textile card for color samples.
- All other surfaces can be specified in your textile of choice.
- The drawer section of the unit has a Chrome handle to assist adjusting the unit from a bench to a sleep surface.
- The lower portion of the unit is supported by four heavy duty supporting non-locking casters when in sleep position and is standard without storage.
- Straps can be unfastened for field replacement of the cushion, if required for any reason.
- Dreme requires zero wall clearance to open into sleep position.
- Standard configuration for all models: two metal legs in front position, two non-locking swivel casters in back position (to assist with moving the unit). Optional front, locking, swivel casters **(BC)** are available. Add \$54.
- A tablet arm is available on units with arms only. The tablet surfaces attach to the outside of the arm (will add 4" to the length of the overall length per tablet). The tablet swivels up and can be moved over the arm and swiveled into place for use by the occupant. The oblong oval shaped tablet is a phenolic surface, strong, non-porous and extremely durable. It offers a no-spill edge and is standard in soft Black. Tablet designation is based on seated position. See models with tablet option for ordering.
- Interior sleep surface: 79"L x 37"W
- All textiles are railroaded across all Dreme components.
- For healthcare textiles, visit the website at globalfurnituregroup.com.
- Can be upholstered in standard Global textiles if Healthcare compliance is not required.

OPTIONAL FEATURES

- The pull-out is available with a storage compartment option below the sleep surface. The storage compartment is divided into two sides and is finished in Storm Grey **(SOG)** laminate. The storage compartment must be ordered at time of original order and cannot be retrofitted, specify **(SR)**. Add \$327.
- Storage compartment lids have a pneumatic lift support, allowing the lid to stay open when accessing the interior storage area.
- An optional seamless White drawer liner is available for the storage compartment, as a set of two. Liners can be removed for ease of maintenance, specify **(SL)**. Add \$655.
- Pull-out front panel is available in upholstered or laminate finish with or without power units. Specify the following:
(FL) laminate panel no power
(LP) laminate panel with power. Add \$160
(FU) upholstered panel
(UP) upholstered panel with power. Add \$160
 Select from all standard laminate finishes.
- Power module is available on the front panel, center front position. The unit includes one power and two USB-A, 10 watt charging ports and an 8 ft. long power cord. When the pull-out is in open position the remaining power cord length is 6 ft. The power module is Black with Black face plate and must be specified at time of order.
- **Leg finish/caster option:**
(TBL) Black
(TLA) Latte
(TKA) Kalua
(TMO) Mocha
(TSH) Shadow
(TOA) Toast
(TTU) Tungsten
(BC) Front, locking, swivel casters. Add \$54 (Casters are Black with Taupe center)
- **Sleep Surface Finish:**
(B21) BM21 Apple
(B25) BM25 Cosmic
(B23) BM23 Dove
(B26) BM26 Firelight
(B22) BM22 Ghost
(B27) BM27 Ginger
(B24) BM24 Iron
(B20) BM20 Rabbit
(B28) BM28 Tropical
- For moisture barrier on seat and sleeping surface, please specify **(MB)**. Upcharges vary by model.
- To add sealed seams to your product, please specify **(SS)**. Upcharges vary by model.

SUGGESTED APPLICATIONS

- Lounge rooms
- Patient rooms
- Resident rooms
- Treatment/Exam rooms

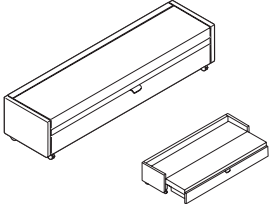
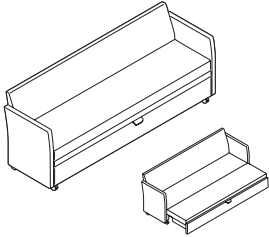
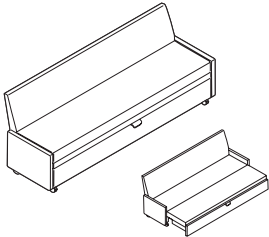
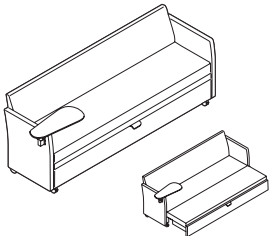
DESCRIPTION	MODEL# / FEATURES	STANDARD TEXTILE GRADES																															
		COM	2	3	4	5	6	7	8	9	10	11	12																				
 <p>Armless Sleeper COM: 9.5 YD 8.69 M Unit weight: 143 LB 65 KG Carton weight: 158 LB 71.67 KG Carton volume: 22.75 FT³ 0.64 MT³</p>	GC35041NA	4185	4489	4746	5040	5525	5971	6418	6807	7292	7748	8365	9239																				
	<p>Active weight 450 lbs.</p> <p>Add \$310 for (MB) Add \$299 for (SS)</p>	<table border="1"> <thead> <tr> <th colspan="3">OVERALL DIMENSIONS</th> <th colspan="3">SEAT DIMENSIONS</th> <th colspan="2">BACK DIMENSIONS</th> </tr> <tr> <th>W</th> <th>D</th> <th>H</th> <th>W</th> <th>D</th> <th>H</th> <th>W</th> <th>H</th> </tr> </thead> <tbody> <tr> <td>IN 82</td> <td>23</td> <td>18.5</td> <td>78</td> <td>-</td> <td>18.5</td> <td>-</td> <td>-</td> </tr> <tr> <td>MM 2083</td> <td>584</td> <td>470</td> <td>1981</td> <td>-</td> <td>470</td> <td>-</td> <td>-</td> </tr> </tbody> </table>	OVERALL DIMENSIONS			SEAT DIMENSIONS			BACK DIMENSIONS		W	D	H	W	D	H	W	H	IN 82	23	18.5	78	-	18.5	-	-	MM 2083	584	470	1981	-	470	-
OVERALL DIMENSIONS			SEAT DIMENSIONS			BACK DIMENSIONS																											
W	D	H	W	D	H	W	H																										
IN 82	23	18.5	78	-	18.5	-	-																										
MM 2083	584	470	1981	-	470	-	-																										
 <p>Sleeper w/Back and Arms COM: 11.75 YD 10.74 M Unit weight: 195 LB 88.6 KG Carton weight: 210 LB 95.25 KG Carton volume: 46.25 FT³ 1.3 MT³</p>	GC35042	4732	5108	5426	5790	6389	6941	7494	7975	8575	9139	9902	10983																				
	<p>Active weight 450 lbs.</p> <p>Add \$310 for (MB) Add \$371 for (SS)</p>	<table border="1"> <thead> <tr> <th colspan="3">OVERALL DIMENSIONS</th> <th colspan="3">SEAT DIMENSIONS</th> <th colspan="2">BACK DIMENSIONS</th> </tr> <tr> <th>W</th> <th>D</th> <th>H</th> <th>W</th> <th>D</th> <th>H</th> <th>W</th> <th>H</th> </tr> </thead> <tbody> <tr> <td>IN 82</td> <td>25</td> <td>32.5</td> <td>78</td> <td>18</td> <td>18.5</td> <td>78</td> <td>14</td> </tr> <tr> <td>MM 2083</td> <td>635</td> <td>826</td> <td>1981</td> <td>457</td> <td>470</td> <td>1981</td> <td>356</td> </tr> </tbody> </table>	OVERALL DIMENSIONS			SEAT DIMENSIONS			BACK DIMENSIONS		W	D	H	W	D	H	W	H	IN 82	25	32.5	78	18	18.5	78	14	MM 2083	635	826	1981	457	470	1981
OVERALL DIMENSIONS			SEAT DIMENSIONS			BACK DIMENSIONS																											
W	D	H	W	D	H	W	H																										
IN 82	25	32.5	78	18	18.5	78	14																										
MM 2083	635	826	1981	457	470	1981	356																										
 <p>Armless Sleeper w/Back COM: 10.5 YD 9.6 M Unit weight: 175 LB 79.5 KG Carton weight: 190 LB 86.18 KG Carton volume: 46.25 FT³ 1.3 MT³</p>	GC35042NA	4628	4964	5248	5573	6109	6602	7096	7526	8062	8566	9248	10214																				
	<p>Active weight 450 lbs.</p> <p>Add \$310 for (MB) Add \$299 for (SS)</p>	<table border="1"> <thead> <tr> <th colspan="3">OVERALL DIMENSIONS</th> <th colspan="3">SEAT DIMENSIONS</th> <th colspan="2">BACK DIMENSIONS</th> </tr> <tr> <th>W</th> <th>D</th> <th>H</th> <th>W</th> <th>D</th> <th>H</th> <th>W</th> <th>H</th> </tr> </thead> <tbody> <tr> <td>IN 82</td> <td>25</td> <td>32.5</td> <td>78</td> <td>18</td> <td>18.5</td> <td>78</td> <td>14</td> </tr> <tr> <td>MM 2083</td> <td>635</td> <td>826</td> <td>1981</td> <td>457</td> <td>470</td> <td>1981</td> <td>356</td> </tr> </tbody> </table>	OVERALL DIMENSIONS			SEAT DIMENSIONS			BACK DIMENSIONS		W	D	H	W	D	H	W	H	IN 82	25	32.5	78	18	18.5	78	14	MM 2083	635	826	1981	457	470	1981
OVERALL DIMENSIONS			SEAT DIMENSIONS			BACK DIMENSIONS																											
W	D	H	W	D	H	W	H																										
IN 82	25	32.5	78	18	18.5	78	14																										
MM 2083	635	826	1981	457	470	1981	356																										
 <p>Sleeper w/Back, Arms, Right Tablet COM: 11.75 YD 10.74 M Unit weight: 200 LB 90.9 KG Carton weight: 215 LB 97.52 KG Carton volume: 48.5 FT³ 1.37 MT³</p>	GC35042T	4981	5357	5675	6039	6638	7190	7743	8224	8824	9388	10151	11232																				
	<p>Active weight 450 lbs.</p> <p>Specify (LT) for left tablet. Specify (TB) for tablet on both arms. Add \$238.</p> <p>Add \$310 for (MB) Add \$371 for (SS)</p>	<table border="1"> <thead> <tr> <th colspan="3">OVERALL DIMENSIONS</th> <th colspan="3">SEAT DIMENSIONS</th> <th colspan="2">BACK DIMENSIONS</th> </tr> <tr> <th>W</th> <th>D</th> <th>H</th> <th>W</th> <th>D</th> <th>H</th> <th>W</th> <th>H</th> </tr> </thead> <tbody> <tr> <td>IN 86</td> <td>25</td> <td>32.5</td> <td>78</td> <td>18</td> <td>18.5</td> <td>78</td> <td>14</td> </tr> <tr> <td>MM 2184</td> <td>635</td> <td>826</td> <td>1981</td> <td>457</td> <td>470</td> <td>1981</td> <td>356</td> </tr> </tbody> </table>	OVERALL DIMENSIONS			SEAT DIMENSIONS			BACK DIMENSIONS		W	D	H	W	D	H	W	H	IN 86	25	32.5	78	18	18.5	78	14	MM 2184	635	826	1981	457	470	1981
OVERALL DIMENSIONS			SEAT DIMENSIONS			BACK DIMENSIONS																											
W	D	H	W	D	H	W	H																										
IN 86	25	32.5	78	18	18.5	78	14																										
MM 2184	635	826	1981	457	470	1981	356																										

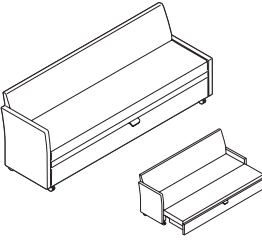
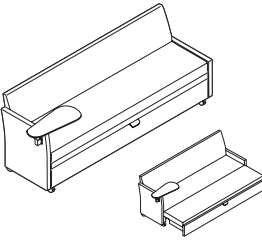
DESCRIPTION	MODEL# / FEATURES	STANDARD TEXTILE GRADES											
		COM	2	3	4	5	6	7	8	9	10	11	12
 <p>Sleeper w/Back, Right Arm COM: 11.25 YD 10.29 M Unit weight: 185 LB 84.1 KG Carton weight: 200 LB 90.72 KG Carton volume: 46.25 FT³ 1.3 MT³</p>	GC35043 Active weight 450 lbs. Add \$310! for (MB) Add \$335 for (SS)	4748	5108	5412	5761	6335	6863	7392	7853	8427	8967	9698	10733
		OVERALL DIMENSIONS W D H			SEAT DIMENSIONS W D H			BACK DIMENSIONS W H					
		IN 82	25	32.5		78	18	18.5		78	14		
		MM 2083	635	826		1981	457	470		1981	356		
						RTA 00	1 per carton						
 <p>Sleeper w/Back, Right Arm w/Tablet COM: 11.25 YD 10.29 M Unit weight: 190 LB 86.4 KG Carton weight: 205 LB 92.99 KG Carton volume: 47.5 FT³ 1.34 MT³</p>	GC35043T Specify (LT) for left tablet/arm. Active weight 450 lbs. Add \$310 for (MB) Add \$335 for (SS)	4997	5357	5661	6010	6584	7112	7641	8102	8676	9216	9947	10982
		OVERALL DIMENSIONS W D H			SEAT DIMENSIONS W D H			BACK DIMENSIONS W H					
		IN 86	25	32.5		78	18	18.5		78	14		
		MM 2184	635	826		1981	457	470		1981	356		
						RTA 00	1 per carton						

ERIN



model GC36530



model GC36533



back textile

seat textile

STANDARD FEATURES

- Erin offers a streamlined silhouette brimming with mid-century modern style.
- A rounded arch gently curves around and under the seat to give extra support to user's upper back and sides, while creating an open clean out space at the back of the cushion.
- Tapered legs add style and elegance.
- Legs are available in wood or metal paint/plated finishes (noted).
- The seat underside is sealed with a non-porous material to support housekeeping and infection control protocols.
- Additional improved cleaning options include sealed seams (back and/or seat) and moisture barrier (seat). Upcharges apply.
- Assembled with tamper-resistant fasteners for greater security.
- For added comfort, seat cushions are standard with high density Ultracell foam.
- Glides are self-leveling. Choose from standard non-marking glides, rubber non-slip glides or felt glides (upcharges apply).
- For healthcare textiles, visit the website at globalfurnituregroup.com.
- Can be upholstered in standard Global textiles if Healthcare 24/7 application compliance is not required.
- Shipped fully assembled.

SUGGESTED APPLICATIONS

- Dining/Cafeteria
- Guest seating
- Lobbies
- Lounge/Waiting
- Patient rooms
- Resident rooms

OPTIONAL FEATURES

Please add option codes in the following order:

- **Model number**
GC36530 Guest armless chair, wood legs
GC36531 Guest armless chair, metal legs
GC3632 Guest armchair, wood legs
GC3632 Guest armchair, metal legs
- **Sealed back seams**
(NS) No sealed back seams
(SS) Sealed back seams. Upcharges vary, see model. Add \$43.
- **Back textile**
Specify textile code.
- **Sealed seat seams**
(NS) No sealed seat seams
(SS) Sealed seat seams. Add \$17.
- **Seat textile**
Specify textile code.
- **Wood leg finish** (models GC36530 and GC36532)
(AAM) Absolute **(MWM)** Medium Walnut
(BKM) Black **(NLW)** Natural Walnut
(CJM) Charcoal Java **(ASM)** Night
(ACM) Cherry **(NBM)** Noce Biondo
(EMM) Empire Mahogany **(NGM)** Noce Grigio
(EOM) English Oak **(NEM)** Noce Leggero
(ECM) Espresso Cafe **(NMM)** Noce Medio
(TFM) Fruitwood **(SBM)** Sandy Beach
(HGM) Gray **(SKM)** Shaker Cherry
(HOM) Harvest Oak **(SOM)** Silver Oak
(AHM) Honey **(TWM)** Walnut
(JOM) Jet Onyx **(WTM)** WC Cream
(LHM) Light Honey **(WHM)** White
(TMM) Mahogany **(WCM)** Winter Cherry
(AVM) Maple
- **Metal leg finish** (models GC36531 and GC36533)
(CHM) Chrome **(TTU)** Tungsten
(TBL) Black **(TKA)** Kalua
(TLA) Latte **(TMO)** Mocha
(TSH) Shadow **(TOA)** Toast
- **Glides**
(NM) Non-marking glides. No upcharge
(RG) Rubber, non-slip glides. Add \$43.
(FG) Felt glides. Add \$43.
- **Moisture barrier**
(NB) No moisture barrier. No upcharge.
(MB) Moisture barrier (seat only). Add \$81.

EXAMPLE ERIN ORDER CODE:

GC36530	NS	CE90	NS	CE90	AAM	NM	NB
Model #	Sealed back seams	Back textile	Sealed seat seams	Seat textile	Leg finish	Glides	Moisture barrier

DESCRIPTION	MODEL# / FEATURES	STANDARD TEXTILE GRADES																																										
		COM	2	3	4	5	6	7	8	9	10	11	12																															
 Armless Guest Chair, Wood Legs COM: 2.75 YD 2.51 M Unit weight: 23.5 LB 10.7 KG Carton weight: 32.5 LB 14.74 KG Carton volume: 13.25 FT³ 0.37 MT³	GC36530	1410	1498	1572	1658	1798	1927	2056	2169	2309	2441	2620	2873																															
	Active weight 350 lbs.	<table border="1"> <thead> <tr> <th colspan="3">OVERALL DIMENSIONS</th> <th colspan="3">SEAT DIMENSIONS</th> <th colspan="2">BACK DIMENSIONS</th> </tr> <tr> <th>W</th> <th>D</th> <th>H</th> <th>W</th> <th>D</th> <th>H</th> <th>W</th> <th>H</th> </tr> </thead> <tbody> <tr> <td>IN 24</td> <td>22.25</td> <td>34</td> <td>19</td> <td>18</td> <td>19</td> <td>15</td> <td>15.5</td> </tr> <tr> <td>MM 610</td> <td>565</td> <td>864</td> <td>483</td> <td>457</td> <td>483</td> <td>381</td> <td>394</td> </tr> </tbody> </table>												OVERALL DIMENSIONS			SEAT DIMENSIONS			BACK DIMENSIONS		W	D	H	W	D	H	W	H	IN 24	22.25	34	19	18	19	15	15.5	MM 610	565	864	483	457	483	381
OVERALL DIMENSIONS			SEAT DIMENSIONS			BACK DIMENSIONS																																						
W	D	H	W	D	H	W	H																																					
IN 24	22.25	34	19	18	19	15	15.5																																					
MM 610	565	864	483	457	483	381	394																																					
	RTA 00	1 per carton																																										

DESCRIPTION MODEL# / FEATURES STANDARD TEXTILE GRADES



Armless Guest Chair, Metal Legs
 COM: 2.75 YD | 2.51 M
 Unit weight: 25.5 LB | 11.6 KG
 Carton weight: 34.5 LB | 15.65 KG
 Carton volume: 13.25 FT³ | 0.37 MT³

MODEL#	2	3	4	5	6	7	8	9	10	11	12	
GC36531	1335	1423	1497	1583	1723	1852	1981	2094	2234	2366	2545	2798

OVERALL DIMENSIONS			SEAT DIMENSIONS			BACK DIMENSIONS	
W	D	H	W	D	H	W	H

Active weight 350 lbs.

IN	24	22.25	34	19	18	19	15	15.5
MM	610	565	864	483	457	483	381	394

RTA 00 1 per carton



Guest Armchair, Wood Legs
 COM: 2.75 YD | 2.51 M
 Unit weight: 24 LB | 10.9 KG
 Carton weight: 33 LB | 14.97 KG
 Carton volume: 13.25 FT³ | 0.37 MT³

MODEL#	2	3	4	5	6	7	8	9	10	11	12	
GC36532	1410	1498	1572	1658	1798	1927	2056	2169	2309	2441	2620	2873

OVERALL DIMENSIONS			SEAT DIMENSIONS			BACK DIMENSIONS	
W	D	H	W	D	H	W	H

Active weight 350 lbs.

IN	24	22	34.25	19	18.5	18.5	17	15.75
MM	610	559	870	483	470	470	432	400

RTA 00 1 per carton



Guest Armchair, Metal Legs
 COM: 2.75 YD | 2.51 M
 Unit weight: 26 LB | 11.8 KG
 Carton weight: 35 LB | 15.88 KG
 Carton volume: 13.25 FT³ | 0.37 MT³

MODEL#	2	3	4	5	6	7	8	9	10	11	12	
GC36533	1335	1423	1497	1583	1723	1852	1981	2094	2234	2366	2545	2798

OVERALL DIMENSIONS			SEAT DIMENSIONS			BACK DIMENSIONS	
W	D	H	W	D	H	W	H

Active weight 350 lbs.

IN	24	22	34.25	19	18.5	18.5	17	15.75
MM	610	559	870	483	470	470	432	400

RTA 00 1 per carton

FROLICK & SPLASH



model GC3001

model GC3011

Three different back constructions



Separate panel piece closes the lower back to conceal the support bracket. Offered on select **Frolick** models.



Single piece back with a pullover style upholstery cover and exposed support brackets fastened on the outer back. Offered on select **Frolick** models.



Two-piece back covering the back support brackets when fastened in place. Offered on **Splash** models.

STANDARD FEATURES

- Frolick & Splash are multi-purpose stacking chairs that share generous widths between the arms, great comfort and a frame built for greater strength and stability. Each series offers a different back design with special features to best address the application and infection prevention practices.
- Four-legged standard size models stack 5 high on floor and 8 high on GC3010 dolly.
- Four-legged bariatric models stack 2 high only on floor. No dolly available.
- Sled base models do not stack.
- Standard size models offer 19" seat width with 21.5" clearance between the armrests. Bariatric size models (Frolick) offer 31.5" seat width with 33.5" clearance between the armrests.
- For a smaller scale bariatric chair, refer to GC Comet #GC2180 which offers 18.5" seat depth with 28" clearance between armrests.
- Heavy duty round, tubular gusseted frames available. Please specify finish.
- Active weight capacity is up to 300 lbs. for standard models; 500 lbs. for bariatric models.
- Protective Platinum color seat shroud is standard on all models (except bariatric models GC3003 and GC3023).
- To respond to higher expectations for housekeeping and infection control practices, select models with a one-piece back. Description of back is noted with each model.
- Wall saver rear legs eliminate accidental damage to walls.
- Armrests are fiberglass reinforced nylon and have a flat profile. Fully extended to front of seat edge to assist in entry and exit from the chair.
- Armrests are standard in Black.
- For added comfort, seats are standard with high density Ultracell foam.
- For ganging brackets, see model 2180 on page 123.
- Black frames are standard with Black glides and front leg caps on armless models. All other frame colors are standard with Platinum glides and front leg caps on armless models.
- For healthcare textile and finish options, visit the website at globalfurnituregroup.com.
- Can be upholstered in standard Global textiles if Healthcare compliance is not required.

OPTIONAL FEATURES

- A selection of glide options is available. Glides must be chosen to best suit flooring type and site conditions. For more information, please refer to the glide section (page 274).
- For hard surface floors, please specify opaque non-marking glides (**NM**). No upcharge.
- Glides with felt pads (**FG**) are available for vinyl sheet, cork or laminate flooring, please specify. Add \$43.
- Glides with rubber pads (**RG**) are available for vinyl, hardwood, laminate, stone or ceramic flooring, please specify. Add \$43.
- Armrests available in Shadow (**SHW**) and Toast (**TOA**). Please specify. Add \$25.
- To add sealed seams to your product contact Customer Service. Pricing is based on the model number, available on the website Build It tool.
- For moisture barrier on seat, please specify (**MB**). Add \$81. Bariatric models: Add \$122.
- For improved housekeeping and infection control practices sealed underside (**SU**) on the seat shroud can be removed and the underside of the seat can be finished with vinyl and sealed to prevent penetration of liquids. The back seam that closes upholstery on underside of the back will also be sealed.
- **Frame finish**
Paint finishes. No upcharge.
(**TBL**) Black (**TIN**) Ink
(**TBZ**) Buzz Blue (**TKA**) Kalua
(**TCC**) Cactus (**TLA**) Latte
(**TCR**) Carrot (**TMO**) Mocha
(**TIV**) Cloud (**TNE**) Nevada
(**TDW**) Designer White (**TSN**) Sand
(**TDJ**) Dijon (**TSR**) Scarlet
(**TEG**) Eggplant (**TSH**) Shadow
(**TFO**) Fog (**TOA**) Toast
(**TFR**) Frost (**TTU**) Tungsten
Plated finish. See models for upcharges.
(**CHM**) Chrome

SUGGESTED APPLICATIONS

- Bariatric seating (Frolick)
- Dining/Cafeteria
- Guest seating
- Lobbies
- Lounge/Waiting
- Office/Meeting
- Patient rooms
- Resident rooms
- Stacking
- Treatment/Exam rooms

DESCRIPTION	MODEL# / FEATURES	STANDARD TEXTILE GRADES																																				
		COM	2	3	4	5	6	7	8	9	10	11	12																									
 Frolick Stacking Armchair, Four-Legged COM: 1.25 YD 1.14 M Unit weight: 22 LB 10 KG Carton weight: 25.67 LB 11.64 KG Carton volume: 24 FT³ 0.67 MT³	GC3001 2-piece rectangular back	491	531	565	604	668	726	785	836	900	960	1041	1156																									
	Active weight 300 lbs. Stacks 5 high on floor. Chrome (CHM) frame finish, add \$147	<table border="1"> <thead> <tr> <th rowspan="2"></th> <th colspan="3">OVERALL DIMENSIONS</th> <th colspan="3">SEAT DIMENSIONS</th> <th colspan="2">BACK DIMENSIONS</th> </tr> <tr> <th>W</th> <th>D</th> <th>H</th> <th>W</th> <th>D</th> <th>H</th> <th>W</th> <th>H</th> </tr> </thead> <tbody> <tr> <td>IN</td> <td>25</td> <td>24.5</td> <td>36</td> <td>19</td> <td>18</td> <td>18.5</td> <td>19.5</td> <td>17</td> </tr> <tr> <td>MM</td> <td>635</td> <td>622</td> <td>914</td> <td>483</td> <td>457</td> <td>470</td> <td>495</td> <td>432</td> </tr> </tbody> </table>		OVERALL DIMENSIONS			SEAT DIMENSIONS			BACK DIMENSIONS		W	D	H	W	D	H	W	H	IN	25	24.5	36	19	18	18.5	19.5	17	MM	635	622	914	483	457	470	495	432	RTA 00
	OVERALL DIMENSIONS			SEAT DIMENSIONS			BACK DIMENSIONS																															
	W	D	H	W	D	H	W	H																														
IN	25	24.5	36	19	18	18.5	19.5	17																														
MM	635	622	914	483	457	470	495	432																														

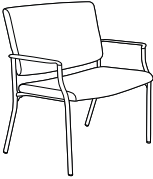

DESCRIPTION	MODEL# / FEATURES	STANDARD TEXTILE GRADES											
		COM	2	3	4	5	6	7	8	9	10	11	12
 <p>Frolick Stacking Armless Chair, Four-Legged COM: 1.25 YD 1.14 M Unit weight: 20 LB 9.1 KG Carton weight: 23.67 LB 10.74 KG Carton volume: 24 FT³ 0.67 MT³</p>	<p>GC3002 2-piece rectangular back</p>	452	492	526	565	629	687	746	797	861	921	1002	1117
		OVERALL DIMENSIONS			SEAT DIMENSIONS			BACK DIMENSIONS					
		W	D	H	W	D	H	W	H				
		IN 21 MM 533	24.5 622	36 914	19 483	18 457	18.5 470	19.5 495	17 432				
<p>Active weight 300 lbs. Stacks 5 high on floor. Chrome (CHM) frame finish, add \$132</p>		RTA 00	3 per carton (pricing and specifications are for one chair)										

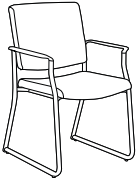
DESCRIPTION	MODEL# / FEATURES	STANDARD TEXTILE GRADES											
		COM	2	3	4	5	6	7	8	9	10	11	12
 <p>Frolick Bariatric Armchair, Four-Legged COM: 2.25 YD 2.06 M Unit weight: 35 LB 15.9 KG Carton weight: 46 LB 20.87 KG Carton volume: 28.25 FT³ 0.79 MT³</p>	<p>GC3003 2-piece rectangular back</p>	1133	1205	1266	1336	1450	1556	1662	1754	1869	1977	2123	2330
		OVERALL DIMENSIONS			SEAT DIMENSIONS			BACK DIMENSIONS					
		W	D	H	W	D	H	W	H				
		IN 37 MM 940	24.5 622	36.5 927	31.5 800	18 457	18.5 470	32 813	18.5 470				
<p>Active weight 500 lbs. Stacks 2 high. Chrome (CHM) frame finish, add \$206</p>		RTA 00	1 per carton										

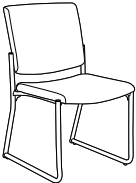
DESCRIPTION	MODEL# / FEATURES	STANDARD TEXTILE GRADES											
		COM	2	3	4	5	6	7	8	9	10	11	12
 <p>Frolick Armchair, Sled Base COM: 1.25 YD 1.14 M Unit weight: 26 LB 11.8 KG Carton weight: 36 LB 16.33 KG Carton volume: 15.5 FT³ 0.43 MT³</p>	<p>GC3021 2-piece rectangular back</p>	554	594	628	667	731	789	848	899	963	1023	1104	1219
		OVERALL DIMENSIONS			SEAT DIMENSIONS			BACK DIMENSIONS					
		W	D	H	W	D	H	W	H				
		IN 25 MM 635	24.5 622	36 914	18 457	17 432	18.5 470	18.75 476	18 457				
<p>Active weight 300 lbs. Does not stack. Chrome (CHM) frame finish, add \$176</p>		RTA 00	1 per carton										

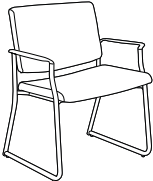
DESCRIPTION	MODEL# / FEATURES	STANDARD TEXTILE GRADES											
		COM	2	3	4	5	6	7	8	9	10	11	12
 <p>Frolick Armless Chair, Sled Base COM: 1.25 YD 1.14 M Unit weight: 25 LB 11.4 KG Carton weight: 35 LB 15.88 KG Carton volume: 15.5 FT³ 0.43 MT³</p>	<p>GC3022 2-piece rectangular back</p>	511	551	585	624	688	746	805	856	920	980	1061	1176
		OVERALL DIMENSIONS			SEAT DIMENSIONS			BACK DIMENSIONS					
		W	D	H	W	D	H	W	H				
		IN 21 MM 533	24.5 622	36 914	19 483	18 457	18.5 470	19.5 495	17 432				
<p>Active weight 300 lbs. Does not stack. Chrome (CHM) frame finish, add \$158</p>		RTA 00	1 per carton										

DESCRIPTION	MODEL# / FEATURES	STANDARD TEXTILE GRADES											
		COM	2	3	4	5	6	7	8	9	10	11	12
 <p>Frolick Bariatric Armchair, Sled Base COM: 2.25 YD 2.06 M Unit weight: 40 LB 18.2 KG Carton weight: 51 LB 23.13 KG Carton volume: 28.25 FT³ 0.79 MT³</p>	<p>GC3023 2-piece rectangular back</p>	1190	1262	1323	1393	1507	1613	1719	1811	1926	2034	2180	2387
		OVERALL DIMENSIONS			SEAT DIMENSIONS			BACK DIMENSIONS					
		W	D	H	W	D	H	W	H				
		IN 37 MM 940	24.5 622	36.5 927	31.5 800	18 457	18.5 470	32 813	18.5 470				
<p>Active weight 500 lbs. Does not stack. Chrome (CHM) frame finish, add \$247</p>		RTA 00	1 per carton										

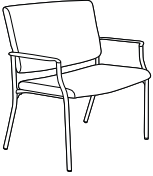
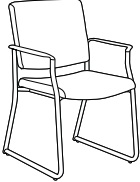
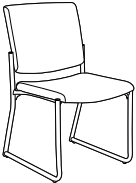
DESCRIPTION	MODEL# / FEATURES	STANDARD TEXTILE GRADES											
		COM	2	3	4	5	6	7	8	9	10	11	12
 <p>Frolick Stacking Armchair, Four-Legged COM: 1.25 YD 1.14 M Unit weight: 22 LB 10 KG Carton weight: 25.67 LB 11.64 KG Carton volume: 24 FT³ 0.67 MT³</p>	<p>GC3031 1-piece rectangular back</p> <p>Active weight 300 lbs.</p> <p>Stacks 5 high on floor. Chrome (CHM) frame finish, add \$147</p>	491	531	565	604	668	726	785	836	900	960	1041	1156
		OVERALL DIMENSIONS			SEAT DIMENSIONS			BACK DIMENSIONS					
		W	D	H	W	D	H	W	H				
		IN 25 MM 635	24.5 622	36 914	19 483	18 457	18.5 470	19.5 495	17 432				
		RTA 00	3 per carton (pricing and specifications are for one chair)										
 <p>Frolick Stacking Armless Chair, Four-Legged COM: 1.25 YD 1.14 M Unit weight: 19 LB 8.6 KG Carton weight: 22.67 LB 10.28 KG Carton volume: 24 FT³ 0.67 MT³</p>	<p>GC3032 1-piece rectangular back</p> <p>Active weight 300 lbs.</p> <p>Stacks 5 high on floor. Chrome (CHM) frame finish, add \$132</p>	452	492	526	565	629	687	746	797	861	921	1002	1117
		OVERALL DIMENSIONS			SEAT DIMENSIONS			BACK DIMENSIONS					
		W	D	H	W	D	H	W	H				
		IN 21 MM 533	24.5 622	36 914	19 483	18 457	18.5 470	19.5 495	17 432				
		RTA 00	3 per carton (pricing and specifications are for one chair)										
 <p>Frolick Bariatric Stacking Armchair, Four-Legged COM: 2.25 YD 2.06 M Unit weight: 35 LB 15.9 KG Carton weight: 46 LB 20.87 KG Carton volume: 28.25 FT³ 0.79 MT³</p>	<p>GC3033 1-piece rectangular back</p> <p>Active weight 500 lbs.</p> <p>Stacks 2 high. Chrome (CHM) frame finish, add \$206</p>	1133	1205	1266	1336	1450	1556	1662	1754	1869	1977	2123	2330
		OVERALL DIMENSIONS			SEAT DIMENSIONS			BACK DIMENSIONS					
		W	D	H	W	D	H	W	H				
		IN 37 MM 940	24.5 622	36.5 927	31.5 800	18 457	18.5 470	32 813	18.5 470				
		RTA 00	1 per carton										
 <p>Frolick Armchair, Sled Base COM: 1.25 YD 1.14 M Unit weight: 26 LB 11.8 KG Carton weight: 36 LB 16.33 KG Carton volume: 15.5 FT³ 0.43 MT³</p>	<p>GC3034 1-piece rectangular back</p> <p>Active weight 300 lbs.</p> <p>Does not stack. Chrome (CHM) frame finish, add \$176</p>	554	594	628	667	731	789	848	899	963	1023	1104	1219
		OVERALL DIMENSIONS			SEAT DIMENSIONS			BACK DIMENSIONS					
		W	D	H	W	D	H	W	H				
		IN 25 MM 635	24.5 622	36 914	18 457	17 432	18.5 470	18.75 476	18 457				
		RTA 00	1 per carton										
 <p>Frolick Armless Chair, Sled Base COM: 1.25 YD 1.14 M Unit weight: 25 LB 11.4 KG Carton weight: 35 LB 15.88 KG Carton volume: 15.5 FT³ 0.43 MT³</p>	<p>GC3035 1-piece rectangular back</p> <p>Active weight 300 lbs.</p> <p>Does not stack. Chrome (CHM) frame finish, add \$158</p>	511	551	585	624	688	746	805	856	920	980	1061	1176
		OVERALL DIMENSIONS			SEAT DIMENSIONS			BACK DIMENSIONS					
		W	D	H	W	D	H	W	H				
		IN 21 MM 533	24.5 622	36 914	19 483	18 457	18.5 470	19.5 495	17 432				
		RTA 00	1 per carton										

DESCRIPTION MODEL# / FEATURES STANDARD TEXTILE GRADES

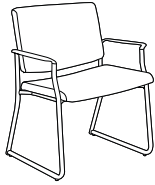

Frolick Bariatric Armchair, Sled Base
 COM: 2.25 YD | 2.06 M
 Unit weight: 40 LB | 18.2 KG
 Carton weight: 51 LB | 23.13 KG
 Carton volume: 28.25 FT³ | 0.79 MT³

COM	2	3	4	5	6	7	8	9	10	11	12	
GC3036	1190	1262	1323	1393	1507	1613	1719	1811	1926	2034	2180	2387

1-piece rectangular back

Active weight 500 lbs.

Does not stack.
 Chrome (CHM) frame finish, add \$247

OVERALL DIMENSIONS			SEAT DIMENSIONS			BACK DIMENSIONS	
W	D	H	W	D	H	W	H
IN 37	24.5	36.5	31.5	18	18.5	32	18.5
MM 940	622	927	800	457	470	813	470

RTA 00 1 per carton



Splash Stacking Armchair, Four-Legged
 COM: 1.25 YD | 1.14 M
 Unit weight: 23 LB | 10.5 KG
 Carton weight: 26.67 LB | 12.1 KG
 Carton volume: 24 FT³ | 0.67 MT³

COM	2	3	4	5	6	7	8	9	10	11	12	
GC3011	491	531	565	604	668	726	785	836	900	960	1041	1156

2-piece fan back

Active weight 300 lbs.

Stacks 5 high on floor.
 Chrome (CHM) frame finish, add \$147

OVERALL DIMENSIONS			SEAT DIMENSIONS			BACK DIMENSIONS	
W	D	H	W	D	H	W	H
IN 25	24.25	35.5	19.5	18.5	18.5	20	17.5
MM 635	616	902	495	470	470	508	445

RTA 00 3 per carton (pricing and specifications are for one chair)

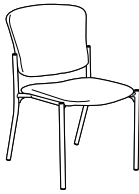

Splash Stacking Armless Chair, Four-Legged
 COM: 1.25 YD | 1.14 M
 Unit weight: 21 LB | 9.5 KG
 Carton weight: 24.67 LB | 11.19 KG
 Carton volume: 24 FT³ | 0.67 MT³

COM	2	3	4	5	6	7	8	9	10	11	12	
GC3012	452	492	526	565	629	687	746	797	861	921	1002	1117

2-piece fan back

Active weight 300 lbs.

Stacks 5 high on floor.
 Chrome (CHM) frame finish, add \$132

OVERALL DIMENSIONS			SEAT DIMENSIONS			BACK DIMENSIONS	
W	D	H	W	D	H	W	H
IN 21	24.25	35.5	19.5	18.5	18.5	20	17.5
MM 533	616	902	495	470	470	508	445

RTA 00 3 per carton (pricing and specifications are for one chair)

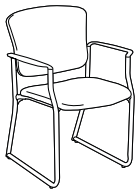

Splash Armchair, Sled Base
 COM: 1.25 YD | 1.14 M
 Unit weight: 28 LB | 12.7 KG
 Carton weight: 38 LB | 17.24 KG
 Carton volume: 20.75 FT³ | 0.58 MT³

COM	2	3	4	5	6	7	8	9	10	11	12	
GC3013	554	594	628	667	731	789	848	899	963	1023	1104	1219

2-piece fan back

Active weight 300 lbs.

Does not stack.
 Chrome (CHM) frame finish, add \$176

OVERALL DIMENSIONS			SEAT DIMENSIONS			BACK DIMENSIONS	
W	D	H	W	D	H	W	H
IN 25	24.25	35.5	19.5	18.5	18.5	20	17.5
MM 635	616	902	495	470	470	508	445

RTA 00 1 per carton

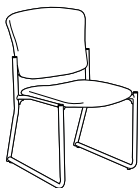

Splash Side Armless Chair, Sled Base
 COM: 1.25 YD | 1.14 M
 Unit weight: 26 LB | 11.8 KG
 Carton weight: 36 LB | 16.33 KG
 Carton volume: 15.5 FT³ | 0.43 MT³

COM	2	3	4	5	6	7	8	9	10	11	12	
GC3014	511	551	585	624	688	746	805	856	920	980	1061	1176



2-piece fan back

Active weight 300 lbs.

Does not stack.
 Chrome (CHM) frame finish, add \$158

OVERALL DIMENSIONS			SEAT DIMENSIONS			BACK DIMENSIONS	
W	D	H	W	D	H	W	H
IN 21	24.25	35.5	19.5	18.5	18.5	20	17.5
MM 533	616	902	495	470	470	508	445

RTA 00 1 per carton

DESCRIPTION	MODEL# / FEATURES	STANDARD TEXTILE GRADES								
		List price								
	GC3010	293								
	Standard size, four-legged models (only) stack 8 high.	OVERALL DIMENSIONS			SEAT DIMENSIONS			BACK DIMENSIONS		
		W	D	H	W	D	H	W	D	H
Dolly for Frolick or Splash COM: - YD - M Unit weight: 13 LB 5.9 KG Carton weight: 16 LB 7.26 KG Carton volume: 3.8 FT ³ 0.1 MT ³		IN 23.25	24.75	12.25	-	-	-	-	-	-
		MM 591	629	311	-	-	-	-	-	-
		RTA 1		1 per carton						

GC BEACH



model GC4077



model GC4078

STANDARD FEATURES



- Elegant wood seating with a choice of an upholstered or vertical wood slat back.
- Frame construction is beech hardwood.
- Legs are equipped with White non-marking polypropylene glides. Suitable for both carpet and hard surface flooring.
- All cushions are fixed and non-removable.
- Cushions are made with highly resilient foam and seats are equipped with a synthetic rubberized webbing suspension system for extra comfort.
- Seat cushion underside is finished with Black polyurethane.
- Does not stack.
- Can be upholstered in standard Global textiles if healthcare compliance is not required.

OPTIONAL FEATURES

- Wood frame available in Absolute (AAM), Black (BKM), Cherry (ACM), English Oak (EOM), Espresso Cafe (ECM), Fruitwood (TFM), Gray (HGM), Honey (AHM), Mahogany (TMM), Maple (AVM), Medium Walnut (MWM), Natural Walnut (NLW), Night (ASM), Noce Biondo (NBM), Noce Grigio (NGM), Noce Leggero (NEM), Noce Medio (NMM), Sandy Beach (SBM), Shaker Cherry (SKM), Silver Oak (SOM), Walnut (TWM), WC Cream (WTM), White (WHM) and Winter Cherry (WCM). Please specify.
- For moisture barrier on seat, please specify **(MB)**. Add \$81 per seat.

SUGGESTED APPLICATIONS

- Dining/Cafeteria
- Guest seating
- Lobbies
- Lounge/Waiting
- Office/Meeting
- Patient rooms
- Resident rooms

DESCRIPTION	MODEL# / FEATURES	STANDARD TEXTILE GRADES											
		COM	2	3	4	5	6	7	8	9	10	11	12
 <p>Armchair w/Upholstered Back COM: 1 YD 0.91 M Unit weight: 15 LB 6.8 KG Carton weight: 20 LB 9.07 KG Carton volume: 13.25 FT³ 0.37 MT³</p>	GC4077	781	813	840	871	922	969	1016	1057	1108	1156	1221	1313
		OVERALL DIMENSIONS			SEAT DIMENSIONS			BACK DIMENSIONS					
		W	D	H	W	D	H	W	H				
		IN 22	22.25	33.5	19.5	18.5	18.75	19.5	15.5				
		MM 559	565	851	495	470	476	495	394				
		RTA 00		1 per carton									
 <p>Armchair w/Vertical Wood Slat Back COM: 1 YD 0.91 M Unit weight: 15 LB 6.8 KG Carton weight: 20 LB 9.07 KG Carton volume: 13.25 FT³ 0.37 MT³</p>	GC4078	781	813	840	871	922	969	1016	1057	1108	1156	1221	1313
		OVERALL DIMENSIONS			SEAT DIMENSIONS			BACK DIMENSIONS					
		W	D	H	W	D	H	W	H				
		IN 22	22.25	33.5	19.5	19	18.75	19.5	15.5				
		MM 559	565	851	495	483	476	495	394				
		RTA 00		1 per carton									

GC BELONG



model GC4231

model GC4231HB

STANDARD FEATURES

- The GC Belong series was developed for active and transient environments with rigorous demands.
- Elliptical metal tube frame. Available in Black (TBL), Cloud (TIV), Designer White (TDW), Fog (TFO), Frost (TFR), Kalua (TKA), Latte (TLA), Mocha (TMO), Nevada (TNE), Sand (TSN), Shadow (TSH), Toast (TOA) and Tungsten (TTU). Please specify.
- Urethane armcaps are available in Black (BLK), Kalua (KAL), Latte (LAB), Mocha (J52), Shadow (SHW) and Toast (TOA). Please specify. Wood armcaps are also available in all healthcare wood finishes. Please specify. For upcharge refer to individual models.
- The frame can be weighted and made with tamperproof fasteners for greater security in more challenging mental health spaces or correctional facilities. Request a special quote.
- The seat and back are removable and field replaceable.
- For added comfort, seats are standard with high density Ultracell foam.
- All seat frames feature a wall saver design to prevent back contact with wall. **Note:** In order to allow full flex of the back on models GC4242, GC4242HB, GC4243 and GC4243HB, a 10.5" wall clearance is required.
- Ottomans and benches do not have wall saver legs.
- Seat height on standard models and benches is 18".
- Seat height on GC4231-24 and GC4241-24 is 24".
- Standard with Black glides.
- Select models are offered with **rear tip and move wheels**. To activate wheels, tilt the chair back so the wheels are in contact with the floor. This feature makes it easy to relocate the chair while unoccupied.
- Clean out space is provided between the seat and back cushions for easy housekeeping.

- Left and right position reference is determined from the seated position.
- Flex back models feature a torsion control mechanism which allows the back to move 14° in a soothing rocking motion.
- For healthcare textiles and wood finish options, visit the website at globalfurnituregroup.com.
- Can be upholstered in standard Global textiles if healthcare compliance is not required.

OPTIONAL FEATURES

- For hard surface floors, please specify opaque non-marking glides (**NM**). No upcharge.
- For moisture barrier on seat, please specify (**MB**). Add \$81 per seat. For bariatric models, add \$122 per seat.
- For improved housekeeping and infection control practices, please add (**SU**) to model number. The underside of the seat will be finished with vinyl and sealed to prevent penetration of liquids. For standard models: Add \$35. For bariatric models: Add \$47. Upcharges may vary.

SUGGESTED APPLICATIONS

- Bariatric seating
- Guest seating
- Lobbies
- Lounge/Waiting
- Patient rooms
- Resident rooms
- Treatment/Exam rooms

For freestanding GC Belong tables, see page 42

GC BELONG BENCHES & BRIDGES

- Units with links can only gang with a bridge. They cannot gang directly with another link unit. (Link units have side brackets.)
- Available in one, two or three seat models.
- A bridge unit suspends between two other units using their links. A bridge is not freestanding. (A bridge does not have legs.)
- Benches have no front or back facing distinction, so models with links can be reversed.
- All bridge models can be ganged to seat units with link.

GC BELONG MODULAR TABLES

- Table heights are 16".
- 1" thick tops are available in thermally fused laminate (LP) and high pressure laminate (HP). Please select the appropriate model number for the finish you prefer.
- 2mm edging color coordinated with laminate finish is standard for all tops. Finish must be specified at the time of order.
- Refer to the following lists when selecting a finish color. Must specify both a top color and leg finish at time of order.

Thermally Fused Laminate (LP)

Absolute Acajou (ACJ)
Asian Night (ASN)
Avant Cherry (AWC)
Avant Honey (AWH)
Brushed Cobalt (BRC)
Clear Maple (CMB)
Dark Espresso (DES)
Designer White (DWT)
Fashionista (FAS)
First Class (FCL)
Quartered Mahogany (QTM)
Noce Biondo (NBL)
Noce Grigio (NGL)
Noce Leggero (NEL)
Noce Medio (NML)
Sheer Beauty (SBY)
Walnut Heights (WHE)
White Chocolate (WHC)
Winter Cherry (WCR)













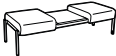



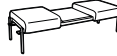







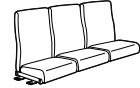



High Pressure Laminate (HP)

Absolute Acajou (ACJ)
Asian Night (ASN)
Avant Cherry (W357)
Avant Honey (W356)
Brushed Cobalt (BRC)
Clear Maple (CMB)
Dark Espresso (W142)
Designer White (DWT)
Fashionista (FAS)
First Class (FCL)
Quartered Mahogany (QTM)
Noce Biondo (NBL)
Noce Grigio (NGL)
Noce Leggero (NEL)
Noce Medio (NML)
Sheer Beauty (SBY)
Walnut Heights (WHE)
White Chocolate (WHC)
Winter Cherry (WCR)













	one seater armless	one seater two arms	two seater two arms	two seater three arms	three seater two arms	three seater four arms	two seater one table, two arms
LOW BACK							
Freestanding units	GC4230 	GC4231 	GC4232 	GC4234 	GC4233 	GC4235 	GC4236
Ganging units with link on left side	GC4230L 	GC4231L 	GC4232L 	GC4234L 	GC4233L 	GC4235L 	GC4236L
Ganging units with link on right side	GC4230R 	GC4231R 	GC4232R 	GC4234R 	GC4233R 	GC4235R 	GC4236R
Ganging units with links on both sides	GC4230B 	GC4231B 	GC4232B 	GC4234B 	GC4233B 	GC4235B 	GC4236B
HIGH BACK							
Freestanding units	GC4230HB 	GC4231HB 	GC4232HB 	GC4234HB 	GC4233HB 	GC4235HB 	GC4236HB
Ganging units with link on left side	GC4230HBL 	GC4231HBL 	GC4232HBL 	GC4234HBL 	GC4233HBL 	GC4235HBL 	GC4236HBL
Ganging units with link on right side	GC4230HBR 	GC4231HBR 	GC4232HBR 	GC4234HBR 	GC4233HBR 	GC4235HBR 	GC4236HBR
Ganging units with links on both sides	GC4230HBB 	GC4231HBB 	GC4232HBB 	GC4234HBB 	GC4233HBB 	GC4235HBB 	GC4236HBB

SPECIALTY							
Freestanding units with casters	GC4240 	GC4240HB 	Ganging bariatric units with link on left side		GC4241L 	GC4241HBL 	
Freestanding Bariatric units	GC4241 	GC4241HB 	Ganging bariatric units with link on right side		GC4241R 	GC4241HBR 	GC4244HB
Freestanding flex back units	GC4242 	GC4242HB 	Ganging bariatric units with link on both sides		GC4241B 	GC4241HBB 	GC4245HB
Freestanding flex back units with casters	GC4243 	GC4243HB 	Hip height chair with wedged cushion 24" seat height		GC4231-24 	GC4241-24 (bariatric) 	

BENCHES & BRIDGES

	GC4251	GC4252	GC4253	GC4256				
Freestanding units								
	GC4251L	GC4252L	GC4253L	GC4256L				
Ganging units with reversible hook/link								
	GC4251B	GC4252B	GC4253B	GC4256B				
Ganging units with hooks on both sides								
	GC4259							
Ottoman								
	GC4261HB	GC4262HB	GC4264HB	GC4263HB	GC4265HB	GC4266HB	GC4269HB (bariatric)	
HB add on bridge, no legs								
	GC4261	GC4262	GC4264	GC4263	GC4265	GC4266	GC4269 (bariatric)	
LB add on bridge, no legs								
	GC4271	GC4272	GC4273	GC4276				
Bench add on bridge, no legs								

TABLES

	GC4281-LP GC4281-HP	GC4282-LP GC4282-HP	GC4283-LP GC4283-HP	GC4284-LP GC4284-HP	GC4288-LP GC4288-HP
Freestanding					
	GC4285-LP GC4285-HP	GC4286-LP GC4286-HP	GC4287-LP GC4287-HP		
					
	GC4274-LP GC4274-HP	GC4275-LP GC4275-HP	GC4277-LP GC4277-HP	GC4278-LP GC4278-HP	
Bridges					

- A bridge unit suspends between two other units with legs and is supported by their linking brackets.
- A bridge unit is **not** freestanding and cannot be made freestanding.
- Units with legs and links can only gang with a bridge. They **cannot** gang directly with another link unit with legs.
- Bridges **cannot** gang directly with another bridge.

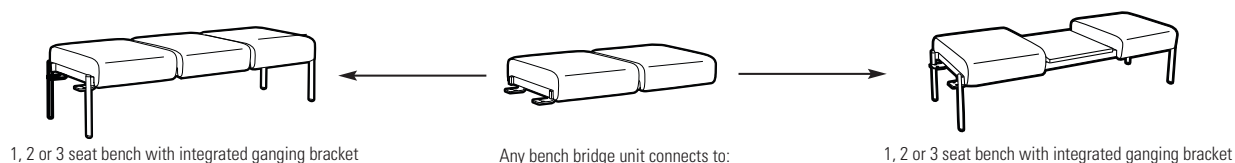
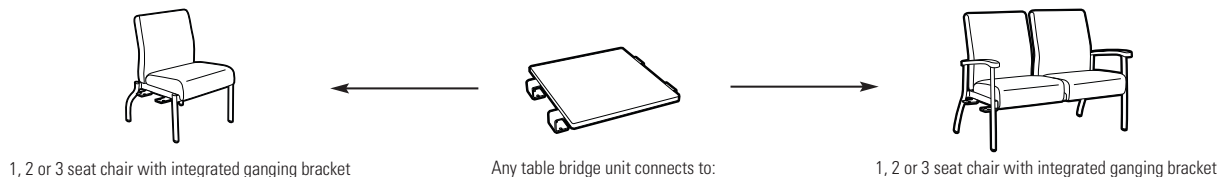
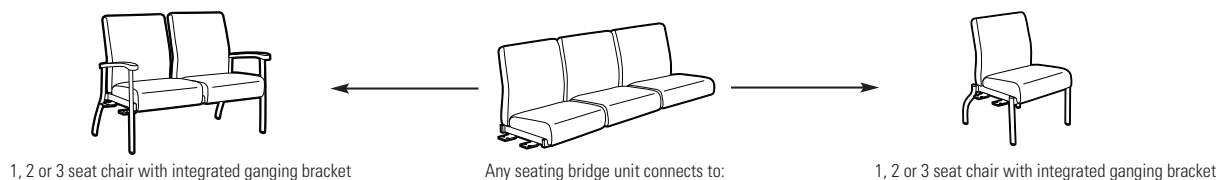

PACKAGE 1

Description
Low Back Three Seat Chair

Qty	Model #	W x D x H	Yardage	Unit Weight	Carton Volume
4	GC4235	74.5 x 26 x 37.5	5	130	65.25



PACKAGE 2

Description
Low Back Three Seat Chair
Low Back Armchair, Left
Low Back Armchair, Right
End Corner Table Bridge

Qty	Model #	W x D x H	Yardage	Unit Weight	Carton Volume
1	GC4233B	72.75 x 26 x 37.5	5	122	65.25
1	GC4231L	26.5 x 28 x 37.5	1.75	41	20.25
1	GC4231R	26.5 x 28 x 37.5	1.75	41	20.25
2	GC4277-HP	35 x 35 x 16	-	40	6



PACKAGE 3

Description
Low Back Armless Chair
Low Back Armless Chair, Right
Low Back Armless Chair, Left
End Corner Table Bridge

Qty	Model #	W x D x H	Yardage	Unit Weight	Carton Volume
2	GC4230B	26.75 x 28 x 37.5	1.75	33	20.25
1	GC4230R	25.75 x 28 x 37.5	1.75	33	20.25
1	GC4230L	25.75 x 28 x 37.5	1.75	33	20.25
3	GC4277-HP	35 x 35 x 16	-	40	6



PACKAGE 4

Description
Low Back Three Seat Chair
Bariatric Low Back Armchair, Left
Low Back Armchair, Left
Low Back Armchair, Right
End Corner Table Bridge
Rectangular Coffee Table
Square Table Top

Qty	Model #	W x D x H	Yardage	Unit Weight	Carton Volume
1	GC4235R	74.5 x 26 x 37.5	5	131	65.25
1	GC4241L	37.5 x 28 x 37.5	3	57	30.5
1	GC4231L	26.5 x 28 x 37.5	1.75	41	20.25
1	GC4231R	26.5 x 28 x 37.5	1.75	41	20.25
1	GC4277-HP	35 x 35 x 16	-	40	6
1	GC4283-HP	22 x 54 x 16	-	30	6
1	GC4275-HP	23 x 23 x 1	-	14	3.4



DESCRIPTION MODEL# / FEATURES STANDARD TEXTILE GRADES



LB Chair Armless
 COM: 1.75 YD | 1.6 M
 Unit weight: 33 LB | 15 KG
 Carton weight: 45.5 LB | 20.64 KG
 Carton volume: 20.25 FT³ | 0.57 MT³

COM	2	3	4	5	6	7	8	9	10	11	12	
GC4230	877	933	980	1035	1124	1206	1288	1360	1449	1533	1647	1808

OVERALL DIMENSIONS			SEAT DIMENSIONS			BACK DIMENSIONS	
W	D	H	W	D	H	W	H

Active weight 500 lbs.	IN 24.75	28	37.5	22	18	18	21.5	19.5
	MM 629	711	953	559	457	457	546	495

RTA 00 1 per carton



LB Chair Armless - Left
 COM: 1.75 YD | 1.6 M
 Unit weight: 33 LB | 15 KG
 Carton weight: 45.5 LB | 20.64 KG
 Carton volume: 20.25 FT³ | 0.57 MT³

COM	2	3	4	5	6	7	8	9	10	11	12	
GC4230L	908	964	1011	1066	1155	1237	1319	1391	1480	1564	1678	1839

OVERALL DIMENSIONS			SEAT DIMENSIONS			BACK DIMENSIONS	
W	D	H	W	D	H	W	H

Ganging.	IN 25.75	28	37.5	22	18	18	21.5	19.5
Active weight 500 lbs.	MM 533	711	953	559	457	457	546	495

RTA 00 1 per carton



LB Chair Armless - Right
 COM: 1.75 YD | 1.6 M
 Unit weight: 33 LB | 15 KG
 Carton weight: 45.5 LB | 20.64 KG
 Carton volume: 20.25 FT³ | 0.57 MT³

COM	2	3	4	5	6	7	8	9	10	11	12	
GC4230R	908	964	1011	1066	1155	1237	1319	1391	1480	1564	1678	1839

OVERALL DIMENSIONS			SEAT DIMENSIONS			BACK DIMENSIONS	
W	D	H	W	D	H	W	H

Ganging.	IN 25.75	28	37.5	22	18	18	21.5	19.5
Active weight 500 lbs.	MM 654	711	953	559	457	457	546	495

RTA 00 1 per carton



LB Chair Armless - Left & Right
 COM: 1.75 YD | 1.6 M
 Unit weight: 33 LB | 15 KG
 Carton weight: 45.5 LB | 20.64 KG
 Carton volume: 20.25 FT³ | 0.57 MT³

COM	2	3	4	5	6	7	8	9	10	11	12	
GC4230B	938	994	1041	1096	1185	1267	1349	1421	1510	1594	1708	1869

OVERALL DIMENSIONS			SEAT DIMENSIONS			BACK DIMENSIONS	
W	D	H	W	D	H	W	H

Ganging.	IN 26.75	28	37.5	22	18	18	21.5	19.5
Active weight 500 lbs.	MM 679	711	953	559	457	457	546	495

RTA 00 1 per carton

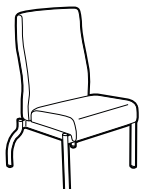





HB Chair Armless
 COM: 2 YD | 1.83 M
 Unit weight: 37 LB | 16.8 KG
 Carton weight: 49.5 LB | 22.45 KG
 Carton volume: 20.25 FT³ | 0.57 MT³

COM	2	3	4	5	6	7	8	9	10	11	12	
GC4230HB	923	987	1041	1103	1205	1299	1393	1475	1577	1673	1803	1987

OVERALL DIMENSIONS			SEAT DIMENSIONS			BACK DIMENSIONS	
W	D	H	W	D	H	W	H

Active weight 500 lbs.	IN 24.75	28	42.5	22	18	18	21.5	24.5
	MM 629	711	1080	559	457	457	546	622

RTA 00 1 per carton

DESCRIPTION	MODEL# / FEATURES	STANDARD TEXTILE GRADES											
		COM	2	3	4	5	6	7	8	9	10	11	12
 <p>HB Chair Armless - Left COM: 2 YD 1.83 M Unit weight: 37 LB 16.8 KG Carton weight: 49.5 LB 22.45 KG Carton volume: 20.25 FT³ 0.57 MT³</p>	GC4230HBL	952	1016	1070	1132	1234	1328	1422	1504	1606	1702	1832	2016
	Ganging.	OVERALL DIMENSIONS			SEAT DIMENSIONS			BACK DIMENSIONS					
		W	D	H	W	D	H	W	H				
	Active weight 500 lbs.	IN 25.75	28	42.5	22	18	18	21.5	24.5				
		MM 654	711	1080	559	457	457	546	622				
	RTA 00	1 per carton											
 <p>HB Chair Armless - Right COM: 2 YD 1.83 M Unit weight: 37 LB 16.8 KG Carton weight: 49.5 LB 22.45 KG Carton volume: 20.25 FT³ 0.57 MT³</p>	GC4230HBR	952	1016	1070	1132	1234	1328	1422	1504	1606	1702	1832	2016
	Ganging.	OVERALL DIMENSIONS			SEAT DIMENSIONS			BACK DIMENSIONS					
		W	D	H	W	D	H	W	H				
	Active weight 500 lbs.	IN 25.75	28	42.5	22	18	18	21.5	24.5				
		MM 654	711	1080	559	457	457	546	622				
	RTA 00	1 per carton											
 <p>HB Chair Armless - Left & Right COM: 2 YD 1.83 M Unit weight: 39 LB 17.7 KG Carton weight: 51.5 LB 23.36 KG Carton volume: 20.25 FT³ 0.57 MT³</p>	GC4230HBB	982	1046	1100	1162	1264	1358	1452	1534	1636	1732	1862	2046
	Ganging.	OVERALL DIMENSIONS			SEAT DIMENSIONS			BACK DIMENSIONS					
		W	D	H	W	D	H	W	H				
	Active weight 500 lbs.	IN 26.75	28	42.5	22	18	18	21.5	24.5				
		MM 679	711	1080	559	457	457	546	622				
	RTA 00	1 per carton											
 <p>LB Armchair COM: 1.75 YD 1.6 M Unit weight: 41 LB 18.6 KG Carton weight: 53.5 LB 24.27 KG Carton volume: 20.25 FT³ 0.57 MT³</p>	GC4231	1146	1202	1249	1304	1393	1475	1557	1629	1718	1802	1916	2077
	Ganging.	OVERALL DIMENSIONS			SEAT DIMENSIONS			BACK DIMENSIONS					
		W	D	H	W	D	H	W	H				
	Active weight 500 lbs.	IN 26.5	28	37.5	22	18	18	21.5	19.5				
	Wood armcap option: Add \$49.	MM 673	711	953	559	457	457	546	495				
	RTA 00	1 per carton											
 <p>LB Armchair - Left COM: 1.75 YD 1.6 M Unit weight: 41 LB 18.6 KG Carton weight: 53.5 LB 24.27 KG Carton volume: 20.25 FT³ 0.57 MT³</p>	GC4231L	1175	1231	1278	1333	1422	1504	1586	1658	1747	1831	1945	2106
	Ganging.	OVERALL DIMENSIONS			SEAT DIMENSIONS			BACK DIMENSIONS					
		W	D	H	W	D	H	W	H				
	Active weight 500 lbs.	IN 26.5	28	37.5	22	18	18	21.5	19.5				
	Wood armcap option: Add \$49.	MM 673	711	953	559	457	457	546	495				
	RTA 00	1 per carton											

DESCRIPTION MODEL# / FEATURES STANDARD TEXTILE GRADES

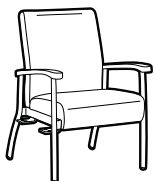

LB Armchair - Right
 COM: 1.75 YD | 1.6 M
 Unit weight: 41 LB | 18.6 KG
 Carton weight: 53.5 LB | 24.27 KG
 Carton volume: 20.25 FT³ | 0.57 MT³

MODEL#	COM	2	3	4	5	6	7	8	9	10	11	12
GC4231R	1175	1231	1278	1333	1422	1504	1586	1658	1747	1831	1945	2106

Ganging.

Active weight 500 lbs.

Wood armcap option:
 Add \$49.

OVERALL DIMENSIONS			SEAT DIMENSIONS			BACK DIMENSIONS	
W	D	H	W	D	H	W	H
IN 26.5	28	37.5	22	18	18	21.5	19.5
MM 673	711	953	559	457	457	546	495

RTA 00 1 per carton

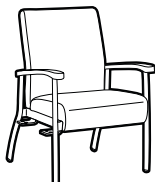

LB Armchair - Left & Right
 COM: 1.75 YD | 1.6 M
 Unit weight: 41 LB | 18.6 KG
 Carton weight: 53.5 LB | 24.27 KG
 Carton volume: 20.25 FT³ | 0.57 MT³

MODEL#	COM	2	3	4	5	6	7	8	9	10	11	12
GC4231B	1205	1261	1308	1363	1452	1534	1616	1688	1777	1861	1975	2136

Ganging.

Active weight 500 lbs.

Wood armcap option:
 Add \$49.

OVERALL DIMENSIONS			SEAT DIMENSIONS			BACK DIMENSIONS	
W	D	H	W	D	H	W	H
IN 26.5	28	37.5	22	18	18	21.5	19.5
MM 673	711	953	559	457	457	546	495

RTA 00 1 per carton

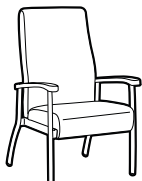

HB Armchair
 COM: 2 YD | 1.83 M
 Unit weight: 46 LB | 20.9 KG
 Carton weight: 58.5 LB | 26.54 KG
 Carton volume: 20.25 FT³ | 0.57 MT³

MODEL#	COM	2	3	4	5	6	7	8	9	10	11	12
GC4231HB	1189	1253	1307	1369	1471	1565	1659	1741	1843	1939	2069	2253

Active weight 500 lbs.

Wood armcap option:
 Add \$49.

OVERALL DIMENSIONS			SEAT DIMENSIONS			BACK DIMENSIONS	
W	D	H	W	D	H	W	H
IN 26.5	28	42.5	22	18	18	21.5	24.5
MM 673	711	1080	559	457	457	546	622

RTA 00 1 per carton

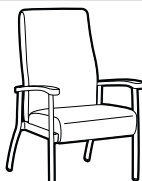

HB Armchair - Left
 COM: 2 YD | 1.83 M
 Unit weight: 46 LB | 20.9 KG
 Carton weight: 58.5 LB | 26.54 KG
 Carton volume: 20.25 FT³ | 0.57 MT³

MODEL#	COM	2	3	4	5	6	7	8	9	10	11	12
GC4231HBL	1222	1286	1340	1402	1504	1598	1692	1774	1876	1972	2102	2286

Ganging.

Active weight 500 lbs.

Wood armcap option:
 Add \$49.

OVERALL DIMENSIONS			SEAT DIMENSIONS			BACK DIMENSIONS	
W	D	H	W	D	H	W	H
IN 26.5	28	42.5	22	18	18	21.5	24.5
MM 673	711	1080	559	457	457	546	622

RTA 00 1 per carton



HB Armchair - Right
 COM: 2 YD | 1.83 M
 Unit weight: 46 LB | 20.9 KG
 Carton weight: 58.5 LB | 26.54 KG
 Carton volume: 20.25 FT³ | 0.57 MT³

MODEL#	COM	2	3	4	5	6	7	8	9	10	11	12
GC4231HBR	1222	1286	1340	1402	1504	1598	1692	1774	1876	1972	2102	2286



Ganging.

Active weight 500 lbs.

Wood armcap option:
 Add \$49.

OVERALL DIMENSIONS			SEAT DIMENSIONS			BACK DIMENSIONS	
W	D	H	W	D	H	W	H
IN 26.5	28	42.5	22	18	18	21.5	24.5
MM 673	711	1080	559	457	457	546	622

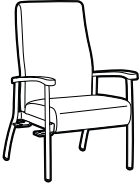
RTA 00 1 per carton

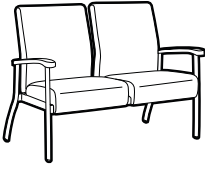
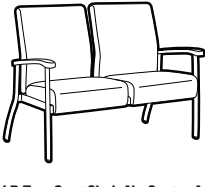
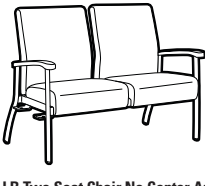
DESCRIPTION	MODEL# / FEATURES	STANDARD TEXTILE GRADES																
 <p>HB Armchair - Left & Right COM: 2 YD 1.83 M Unit weight: 48 LB 21.8 KG Carton weight: 60.5 LB 27.44 KG Carton volume: 20.25 FT³ 0.57 MT³</p>	GC4231HBB	COM	2	3	4	5	6	7	8	9	10	11	12					
		1254	1318	1372	1434	1536	1630	1724	1806	1908	2004	2134	2318					
	Ganging.	OVERALL DIMENSIONS			SEAT DIMENSIONS			BACK DIMENSIONS										
	Active weight 500 lbs.	IN	26.5	28	42.5	22	18	18	21.5	24.5	MM	673	711	1080	559	457	457	546
Wood armcap option: Add \$49.		RTA 00	1 per carton															
 <p>LB Armchair, Post Surgery COM: 1.75 YD 1.6 M Unit weight: 45 LB 20.5 KG Carton weight: 57.5 LB 26.08 KG Carton volume: 24.25 FT³ 0.68 MT³</p> <p>Designed to immobilize the pelvis and hip joints after surgery.</p>	GC4231-24	COM	2	3	4	5	6	7	8	9	10	11	12					
		1267	1323	1370	1425	1514	1596	1678	1750	1839	1923	2037	2198					
	Ganging.	OVERALL DIMENSIONS			SEAT DIMENSIONS			BACK DIMENSIONS										
	Active weight 500 lbs.	IN	26.5	28.75	43.5	22	18	24	21.5	19.5	MM	673	730	1105	559	457	610	546
Wood armcap option: Add \$49.		RTA 00	1 per carton															
 <p>LB Two Seat Chair No Center Arm COM: 3.5 YD 3.2 M Unit weight: 82 LB 37.3 KG Carton weight: 94 LB 42.64 KG Carton volume: 43 FT³ 1.21 MT³</p>	GC4232	COM	2	3	4	5	6	7	8	9	10	11	12					
		1946	2058	2153	2261	2440	2604	2769	2912	3091	3259	3486	3808					
	Ganging.	OVERALL DIMENSIONS			SEAT DIMENSIONS			BACK DIMENSIONS										
	Active weight 500 lbs/seat.	IN	49.75	26	37.5	44	18	18	44	19.5	MM	1264	660	953	1118	457	457	1118
Wood armcap option: Add \$49.		RTA 00	1 per carton															
 <p>LB Two Seat Chair No Center Arm - Left COM: 3.5 YD 3.2 M Unit weight: 83 LB 37.7 KG Carton weight: 95 LB 43.09 KG Carton volume: 43 FT³ 1.21 MT³</p>	GC4232L	COM	2	3	4	5	6	7	8	9	10	11	12					
		1977	2089	2184	2292	2471	2635	2800	2943	3122	3290	3517	3839					
	Ganging.	OVERALL DIMENSIONS			SEAT DIMENSIONS			BACK DIMENSIONS										
	Active weight 500 lbs/seat.	IN	49.75	26	37.5	44	18	18	44	19.5	MM	1264	660	953	1118	457	457	1118
Wood armcap option: Add \$49.		RTA 00	1 per carton															
 <p>LB Two Seat Chair No Center Arm - Right COM: 3.5 YD 3.2 M Unit weight: 83 LB 37.7 KG Carton weight: 95 LB 43.09 KG Carton volume: 43 FT³ 1.21 MT³</p>	GC4232R	COM	2	3	4	5	6	7	8	9	10	11	12					
		1977	2089	2184	2292	2471	2635	2800	2943	3122	3290	3517	3839					
	Ganging.	OVERALL DIMENSIONS			SEAT DIMENSIONS			BACK DIMENSIONS										
	Active weight 500 lbs/seat.	IN	49.75	26	37.5	44	18	18	44	19.5	MM	1264	660	953	1118	457	457	1118
Wood armcap option: Add \$49.		RTA 00	1 per carton															

DESCRIPTION MODEL# / FEATURES STANDARD TEXTILE GRADES

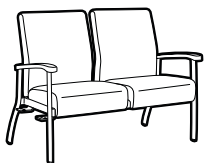

LB Two Seat Chair No Center Arm - Left & Right
 COM: 3.5 YD | 3.2 M
 Unit weight: 84 LB | 38.2 KG
 Carton weight: 96 LB | 43.54 KG
 Carton volume: 43 FT³ | 1.21 MT³

MODEL#	2	3	4	5	6	7	8	9	10	11	12	
GC4232B	2007	2119	2214	2322	2501	2665	2830	2973	3152	3320	3547	3869

Ganging.

Active weight 500 lbs.

Wood armcap option:
 Add \$49.

OVERALL DIMENSIONS			SEAT DIMENSIONS			BACK DIMENSIONS	
W	D	H	W	D	H	W	H
IN 49.75	26	37.5	44	18	18	44	19.5
MM 1264	660	953	1118	457	457	1118	495

RTA 00 1 per carton

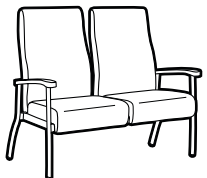

HB Two Seat Chair No Center Arm
 COM: 4 YD | 3.66 M
 Unit weight: 83 LB | 37.7 KG
 Carton weight: 95 LB | 43.09 KG
 Carton volume: 56.5 FT³ | 1.59 MT³

MODEL#	2	3	4	5	6	7	8	9	10	11	12	
GC4232HB	2036	2164	2272	2396	2600	2788	2976	3140	3344	3536	3796	4164

Active weight 500 lbs.

Wood armcap option:
 Add \$49.

OVERALL DIMENSIONS			SEAT DIMENSIONS			BACK DIMENSIONS	
W	D	H	W	D	H	W	H
IN 49.75	26	42.5	44	18	18	44	24.5
MM 1264	660	1080	1118	457	457	1118	622

RTA 00 1 per carton

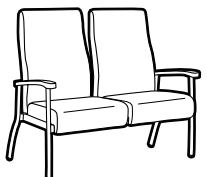

HB Two Seat Chair No Center Arm - Left
 COM: 4 YD | 3.66 M
 Unit weight: 84 LB | 38.2 KG
 Carton weight: 96 LB | 43.54 KG
 Carton volume: 56.5 FT³ | 1.59 MT³

MODEL#	2	3	4	5	6	7	8	9	10	11	12	
GC4232HBL	2068	2196	2304	2428	2632	2820	3008	3172	3376	3568	3828	4196

Ganging.

Active weight 500 lbs/seat.

Wood armcap option:
 Add \$49.

OVERALL DIMENSIONS			SEAT DIMENSIONS			BACK DIMENSIONS	
W	D	H	W	D	H	W	H
IN 49.75	26	42.5	44	18	18	44	24.5
MM 1264	660	1080	1118	457	457	1118	622

RTA 00 1 per carton

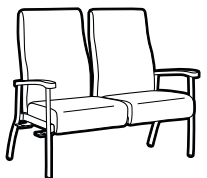

HB Two Seat Chair No Center Arm - Right
 COM: 4 YD | 3.66 M
 Unit weight: 84 LB | 38.2 KG
 Carton weight: 96 LB | 43.54 KG
 Carton volume: 56.5 FT³ | 1.59 MT³

MODEL#	2	3	4	5	6	7	8	9	10	11	12	
GC4232HBR	2068	2196	2304	2428	2632	2820	3008	3172	3376	3568	3828	4196

Ganging.

Active weight 500 lbs/seat.

Wood armcap option:
 Add \$49.

OVERALL DIMENSIONS			SEAT DIMENSIONS			BACK DIMENSIONS	
W	D	H	W	D	H	W	H
IN 49.75	26	42.5	44	18	18	44	24.5
MM 1264	660	1080	1118	457	457	1118	622

RTA 00 1 per carton

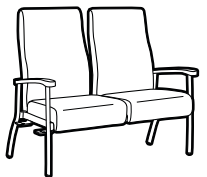

HB Two Seat Chair No Center Arm - Left & Right
 COM: 4 YD | 3.66 M
 Unit weight: 86 LB | 39.1 KG
 Carton weight: 98 LB | 44.45 KG
 Carton volume: 56.5 FT³ | 1.59 MT³

MODEL#	2	3	4	5	6	7	8	9	10	11	12	
GC4232HBB	2096	2224	2332	2456	2660	2848	3036	3200	3404	3596	3856	4224

Ganging.

Active weight 500 lbs/seat.

Wood armcap option:
 Add \$49.

OVERALL DIMENSIONS			SEAT DIMENSIONS			BACK DIMENSIONS	
W	D	H	W	D	H	W	H
IN 49.75	26	42.5	44	18	18	44	24.5
MM 1264	660	1080	1118	457	457	1118	622

RTA 00 1 per carton

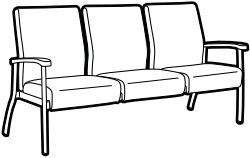
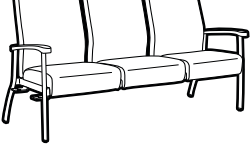
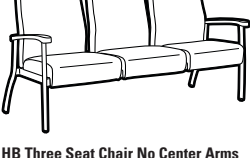
DESCRIPTION	MODEL# / FEATURES	STANDARD TEXTILE GRADES											
		COM	2	3	4	5	6	7	8	9	10	11	12
 <p>LB Three Seat Chair No Center Arms COM: 5 YD 4.57 M Unit weight: 120 LB 54.5 KG Carton weight: 132 LB 59.87 KG Carton volume: 65.25 FT³ 1.84 MT³</p>	GC4233	2753	2913	3048	3203	3458	3693	3928	4133	4388	4628	4953	5413
		OVERALL DIMENSIONS			SEAT DIMENSIONS			BACK DIMENSIONS					
		W	D	H	W	D	H	W	H				
		IN 72.75 MM 1848	26 660	37.5 953	70 1778	18 457	18 457	70 1778	19.5 495				
	Active weight 500 lbs/seat. Wood armcap option: Add \$49.	RTA 00		1 per carton									
 <p>LB Three Seat Chair No Center Arms - Left COM: 5 YD 4.57 M Unit weight: 122 LB 55.5 KG Carton weight: 134 LB 60.78 KG Carton volume: 65.25 FT³ 1.84 MT³</p>	GC4233L	2785	2945	3080	3235	3490	3725	3960	4165	4420	4660	4985	5445
	Ganging.	OVERALL DIMENSIONS			SEAT DIMENSIONS			BACK DIMENSIONS					
		W	D	H	W	D	H	W	H				
		IN 72.75 MM 1848	26 660	37.5 953	70 1778	18 457	18 457	70 1778	19.5 495				
	Active weight 500 lbs/seat. Wood armcap option: Add \$49.	RTA 00		1 per carton									
 <p>LB Three Seat Chair No Center Arms - Right COM: 5 YD 4.57 M Unit weight: 122 LB 55.5 KG Carton weight: 134 LB 60.78 KG Carton volume: 65.25 FT³ 1.84 MT³</p>	GC4233R	2785	2945	3080	3235	3490	3725	3960	4165	4420	4660	4985	5445
	Ganging.	OVERALL DIMENSIONS			SEAT DIMENSIONS			BACK DIMENSIONS					
		W	D	H	W	D	H	W	H				
		IN 72.75 MM 1848	26 660	37.5 953	70 1778	18 457	18 457	70 1778	19.5 495				
	Active weight 500 lbs/seat. Wood armcap option: Add \$49.	RTA 00		1 per carton									
 <p>LB Three Seat Chair No Center Arms - Left & Right COM: 5 YD 4.57 M Unit weight: 122 LB 55.5 KG Carton weight: 134 LB 60.78 KG Carton volume: 65.25 FT³ 1.84 MT³</p>	GC4233B	2816	2976	3111	3266	3521	3756	3991	4196	4451	4691	5016	5476
	Ganging.	OVERALL DIMENSIONS			SEAT DIMENSIONS			BACK DIMENSIONS					
		W	D	H	W	D	H	W	H				
		IN 72.75 MM 1848	26 660	37.5 953	70 1778	18 457	18 457	70 1778	19.5 495				
	Active weight 500 lbs/seat. Wood armcap option: Add \$49.	RTA 00		1 per carton									
 <p>HB Three Seat Chair No Center Arms COM: 5.75 YD 5.26 M Unit weight: 126 LB 57.3 KG Carton weight: 138 LB 62.6 KG Carton volume: 80.75 FT³ 2.28 MT³</p>	GC4233HB	2888	3072	3227	3406	3699	3969	4239	4475	4768	5044	5418	5947
		OVERALL DIMENSIONS			SEAT DIMENSIONS			BACK DIMENSIONS					
		W	D	H	W	D	H	W	H				
		IN 72.75 MM 1848	26 660	42.5 1080	70 1778	18 457	18 457	70 1778	24.5 622				
	Active weight 500 lbs/seat. Wood armcap option: Add \$49.	RTA 00		1 per carton									

DESCRIPTION MODEL# / FEATURES STANDARD TEXTILE GRADES

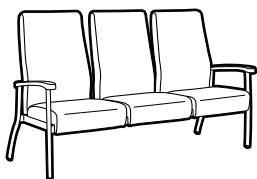

HB Three Seat Chair No Center Arms - Left
 COM: 5.75 YD | 5.26 M
 Unit weight: 128 LB | 58.2 KG
 Carton weight: 140 LB | 63.5 KG
 Carton volume: 80.75 FT³ | 2.28 MT³

MODEL# / FEATURES	COM	2	3	4	5	6	7	8	9	10	11	12
GC4233HBL	2920	3104	3259	3438	3731	4001	4271	4507	4800	5076	5450	5979

Ganging.

Active weight 500 lbs/seat.

Wood armcap option:
 Add \$49.

OVERALL DIMENSIONS			SEAT DIMENSIONS			BACK DIMENSIONS	
W	D	H	W	D	H	W	H
IN 72.75	26	42.5	70	18	18	70	24.5
MM 1848	660	1080	1778	457	457	1778	622

RTA 00 1 per carton

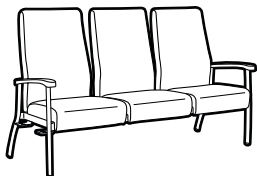

HB Three Seat Chair No Center Arms - Right
 COM: 5.75 YD | 5.26 M
 Unit weight: 128 LB | 58.2 KG
 Carton weight: 140 LB | 63.5 KG
 Carton volume: 80.75 FT³ | 2.28 MT³

MODEL# / FEATURES	COM	2	3	4	5	6	7	8	9	10	11	12
GC4233HBR	2920	3104	3259	3438	3731	4001	4271	4507	4800	5076	5450	5979

Ganging.

Active weight 500 lbs/seat.

Wood armcap option:
 Add \$49.

OVERALL DIMENSIONS			SEAT DIMENSIONS			BACK DIMENSIONS	
W	D	H	W	D	H	W	H
IN 72.75	26	42.5	70	18	18	70	24.5
MM 1848	660	1080	1778	457	457	1778	622

RTA 00 1 per carton

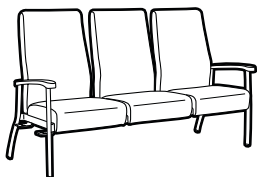

HB Three Seat Chair No Center Arms - Left & Right
 COM: 5.75 YD | 5.26 M
 Unit weight: 128 LB | 58.2 KG
 Carton weight: 140 LB | 63.5 KG
 Carton volume: 80.75 FT³ | 2.28 MT³

MODEL# / FEATURES	COM	2	3	4	5	6	7	8	9	10	11	12
GC4233HBB	2951	3135	3290	3469	3762	4032	4302	4538	4831	5107	5481	6010

Ganging.

Active weight 500 lbs/seat.

Wood armcap option:
 Add \$49.

OVERALL DIMENSIONS			SEAT DIMENSIONS			BACK DIMENSIONS	
W	D	H	W	D	H	W	H
IN 72.75	26	42.5	70	18	18	70	24.5
MM 1848	660	1080	1778	457	457	1778	622

RTA 00 1 per carton

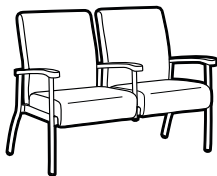

LB Two Seat Chair Half Center Arm
 COM: 3.5 YD | 3.2 M
 Unit weight: 88 LB | 40 KG
 Carton weight: 100 LB | 45.36 KG
 Carton volume: 43 FT³ | 1.21 MT³

MODEL# / FEATURES	COM	2	3	4	5	6	7	8	9	10	11	12
GC4234	2121	2233	2328	2436	2615	2779	2944	3087	3266	3434	3661	3983

Active weight 500 lbs/seat.

Wood armcap option:
 Add \$74.

OVERALL DIMENSIONS			SEAT DIMENSIONS			BACK DIMENSIONS	
W	D	H	W	D	H	W	H
IN 50.75	26	37.5	22	18	18	21.5	19.5
MM 1289	660	953	559	457	457	546	495

RTA 00 1 per carton

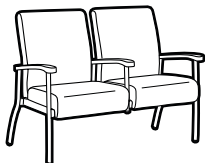

LB Two Seat Chair Half Center Arm - Left
 COM: 3.5 YD | 3.2 M
 Unit weight: 88 LB | 40.5 KG
 Carton weight: 101 LB | 45.81 KG
 Carton volume: 43 FT³ | 1.21 MT³

MODEL# / FEATURES	COM	2	3	4	5	6	7	8	9	10	11	12
GC4234L	2151	2263	2358	2466	2645	2809	2974	3117	3296	3464	3691	4013

Ganging.

Active weight 500 lbs/seat.

Wood armcap option:
 Add \$74.

OVERALL DIMENSIONS			SEAT DIMENSIONS			BACK DIMENSIONS	
W	D	H	W	D	H	W	H
IN 50.75	26	37.5	22	18	18	21.5	19.5
MM 1289	660	953	559	457	457	546	495

RTA 00 1 per carton

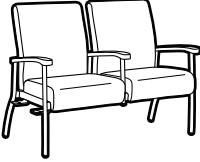
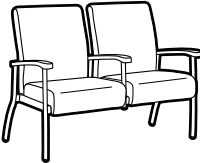
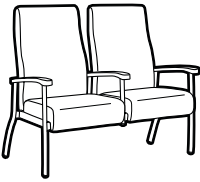
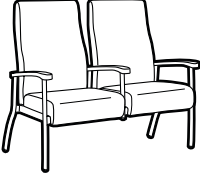
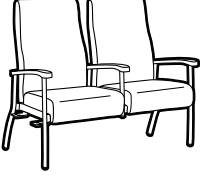
DESCRIPTION	MODEL# / FEATURES	STANDARD TEXTILE GRADES											
		COM	2	3	4	5	6	7	8	9	10	11	12
 <p>LB Two Seat Chair Half Center Arm - Right COM: 3.5 YD 3.2 M Unit weight: 89 LB 40.5 KG Carton weight: 101 LB 45.81 KG Carton volume: 43 FT³ 1.21 MT³</p>	GC4234R	2151	2263	2358	2466	2645	2809	2974	3117	3296	3464	3691	4013
	Ganging.	OVERALL DIMENSIONS			SEAT DIMENSIONS			BACK DIMENSIONS					
	Active weight 500 lbs/seat.	IN 50.75	26	37.5		22	18	18		21.5	19.5		
	Wood armcap option: Add \$74.	MM 1289	660	953		559	457	457		546	495		
		RTA 00	1 per carton										
 <p>LB Two Seat Chair Half Center Arm - Left & Right COM: 3.5 YD 3.2 M Unit weight: 90 LB 40.9 KG Carton weight: 102 LB 46.27 KG Carton volume: 43 FT³ 1.21 MT³</p>	GC4234B	2182	2294	2389	2497	2676	2840	3005	3148	3327	3495	3722	4044
	Ganging.	OVERALL DIMENSIONS			SEAT DIMENSIONS			BACK DIMENSIONS					
	Active weight 500 lbs/seat.	IN 50.75	26	37.5		22	18	18		21	19.5		
	Wood armcap option: Add \$74.	MM 1289	660	953		559	457	457		533	495		
		RTA 00	1 per carton										
 <p>HB Two Seat Chair Half Center Arm COM: 4 YD 3.66 M Unit weight: 92 LB 41.8 KG Carton weight: 104 LB 47.17 KG Carton volume: 56.5 FT³ 1.59 MT³</p>	GC4234HB	2214	2342	2450	2574	2778	2966	3154	3318	3522	3714	3974	4342
	Ganging.	OVERALL DIMENSIONS			SEAT DIMENSIONS			BACK DIMENSIONS					
	Active weight 500 lbs/seat.	IN 50.75	26	42.5		22	18	18		21.5	24.5		
	Wood armcap option: Add \$74.	MM 1289	660	1080		559	457	457		546	622		
		RTA 00	1 per carton										
 <p>HB Two Seat Chair Half Center Arm - Left COM: 4 YD 3.66 M Unit weight: 93 LB 42.3 KG Carton weight: 104 LB 47.17 KG Carton volume: 56.5 FT³ 1.59 MT³</p>	GC4234HBL	2244	2372	2480	2604	2808	2996	3184	3348	3552	3744	4004	4372
	Ganging.	OVERALL DIMENSIONS			SEAT DIMENSIONS			BACK DIMENSIONS					
	Active weight 500 lbs/seat.	IN 50.75	26	42.5		22	18	18		21.5	24.5		
	Wood armcap option: Add \$74.	MM 1289	660	1080		559	457	457		546	622		
		RTA 00	1 per carton										
 <p>HB Two Seat Chair Half Center Arm - Right COM: 4 YD 3.66 M Unit weight: 93 LB 42.3 KG Carton weight: 104 LB 47.17 KG Carton volume: 56.5 FT³ 1.59 MT³</p>	GC4234HBR	2244	2372	2480	2604	2808	2996	3184	3348	3552	3744	4004	4372
	Ganging.	OVERALL DIMENSIONS			SEAT DIMENSIONS			BACK DIMENSIONS					
	Active weight 500 lbs/seat.	IN 50.75	26	42.5		22	18	18		21.5	24.5		
	Wood armcap option: Add \$74.	MM 1289	660	1080		559	457	457		546	622		
		RTA 00	1 per carton										

DESCRIPTION MODEL# / FEATURES STANDARD TEXTILE GRADES

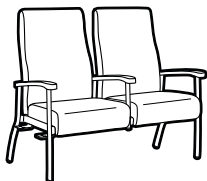

HB Two Seat Chair Half Center Arm - Left & Right
 COM: 1.25 YD | 3.66 M
 Unit weight: 96 LB | 43.6 KG
 Carton weight: 108 LB | 48.99 KG
 Carton volume: 56.5 FT³ | 1.59 MT³

COM	2	3	4	5	6	7	8	9	10	11	12	
GC4234HBB	2273	2401	2509	2633	2837	3025	3213	3377	3581	3773	4033	4401

Ganging.

Active weight 500 lbs/seat.

Wood armcap option:
 Add \$74.

OVERALL DIMENSIONS			SEAT DIMENSIONS			BACK DIMENSIONS	
W	D	H	W	D	H	W	H
IN 50.75	26	42.5	22	18	18	21	24.5
MM 1289	660	1080	559	457	457	533	622

RTA 00 1 per carton

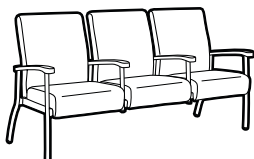

LB Three Seat Chair Half Center Arms
 COM: 5 YD | 4.57 M
 Unit weight: 130 LB | 59.1 KG
 Carton weight: 142 LB | 64.41 KG
 Carton volume: 65.25 FT³ | 1.84 MT³

COM	2	3	4	5	6	7	8	9	10	11	12	
GC4235	3105	3265	3400	3555	3810	4045	4280	4485	4740	4980	5305	5765

Active weight 500 lbs/seat.

Wood armcap option:
 Add \$99.

OVERALL DIMENSIONS			SEAT DIMENSIONS			BACK DIMENSIONS	
W	D	H	W	D	H	W	H
IN 74.5	26	37.5	22	18	18	21.5	19.5
MM 1892	660	953	559	457	457	546	495

RTA 00 1 per carton

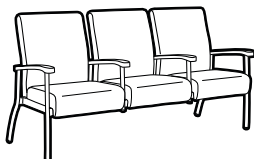

LB Three Seat Chair Half Center Arms - Left
 COM: 5 YD | 4.57 M
 Unit weight: 131 LB | 59.5 KG
 Carton weight: 143 LB | 64.86 KG
 Carton volume: 65.25 FT³ | 1.84 MT³

COM	2	3	4	5	6	7	8	9	10	11	12	
GC4235L	3133	3293	3428	3583	3838	4073	4308	4513	4768	5008	5333	5793

Ganging.

Active weight 500 lbs/seat.

Wood armcap option:
 Add \$99.

OVERALL DIMENSIONS			SEAT DIMENSIONS			BACK DIMENSIONS	
W	D	H	W	D	H	W	H
IN 74.5	26	37.5	22	18	18	21.5	19.5
MM 1892	660	953	559	457	457	546	495

RTA 00 1 per carton

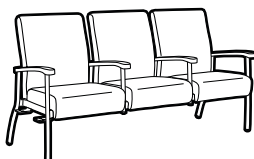

LB Three Seat Chair Half Center Arms - Right
 COM: 5 YD | 4.57 M
 Unit weight: 131 LB | 59.5 KG
 Carton weight: 143 LB | 64.86 KG
 Carton volume: 65.25 FT³ | 1.84 MT³

COM	2	3	4	5	6	7	8	9	10	11	12	
GC4235R	3133	3293	3428	3583	3838	4073	4308	4513	4768	5008	5333	5793

Ganging.

Active weight 500 lbs/seat.

Wood armcap option:
 Add \$99.

OVERALL DIMENSIONS			SEAT DIMENSIONS			BACK DIMENSIONS	
W	D	H	W	D	H	W	H
IN 74.5	26	37.5	22	18	18	21.5	19.5
MM 1892	660	953	559	457	457	546	495

RTA 00 1 per carton

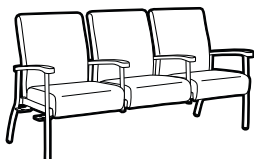

LB Three Seat Chair Half Center Arms - Left & Right
 COM: 5 YD | 4.57 M
 Unit weight: 132 LB | 60 KG
 Carton weight: 144 LB | 65.32 KG
 Carton volume: 65.25 FT³ | 1.84 MT³

COM	2	3	4	5	6	7	8	9	10	11	12	
GC4235B	3168	3328	3463	3618	3873	4108	4343	4548	4803	5043	5368	5828

Ganging.

Active weight 500 lbs/seat.



Wood armcap option:
 Add \$99.

OVERALL DIMENSIONS			SEAT DIMENSIONS			BACK DIMENSIONS	
W	D	H	W	D	H	W	H
IN 74.5	26	37.5	22	18	18	21.5	19.5
MM 1892	660	953	559	457	457	546	495

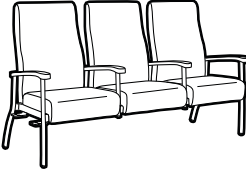
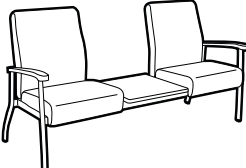
RTA 00 1 per carton

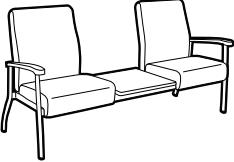
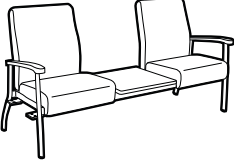
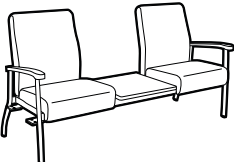
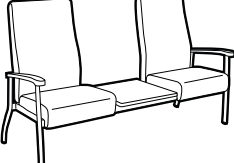
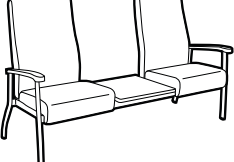
DESCRIPTION	MODEL# / FEATURES	STANDARD TEXTILE GRADES															
		COM	2	3	4	5	6	7	8	9	10	11	12				
 <p>HB Three Seat Chair Half Center Arms COM: 5.75 YD 5.26 M Unit weight: 136 LB 61.8 KG Carton weight: 148 LB 67.13 KG Carton volume: 80.75 FT³ 2.28 MT³</p>	GC4235HB	3241	3425	3580	3759	4052	4322	4592	4828	5121	5397	5771	6300				
	Active weight 500 lbs/seat.	OVERALL DIMENSIONS W D H			SEAT DIMENSIONS W D H			BACK DIMENSIONS W H									
	Wood armcap option: Add \$99.	IN 74.5	26	42.5	22	18	18	21.5	24.5	MM 1892	660	1080	559	457	457	546	622
		RTA 00	1 per carton														
 <p>HB Three Seat Chair Half Center Arms - Left COM: 5.75 YD 5.26 M Unit weight: 137 LB 62.3 KG Carton weight: 149 LB 67.59 KG Carton volume: 80.75 FT³ 2.28 MT³</p>	GC4235HBL	3272	3456	3611	3790	4083	4353	4623	4859	5152	5428	5802	6331				
	Ganging.	OVERALL DIMENSIONS W D H			SEAT DIMENSIONS W D H			BACK DIMENSIONS W H									
	Active weight 500 lbs/seat.	IN 74.5	26	42.5	22	18	18	21.5	24.5	MM 1892	660	1080	559	457	457	546	622
	Wood armcap option: Add \$99.	RTA 00	1 per carton														
 <p>HB Three Seat Chair Half Center Arms - Right COM: 5.75 YD 5.26 M Unit weight: 137 LB 62.3 KG Carton weight: 159 LB 72.12 KG Carton volume: 80.75 FT³ 2.28 MT³</p>	GC4235HBR	3272	3456	3611	3790	4083	4353	4623	4859	5152	5428	5802	6331				
	Ganging.	OVERALL DIMENSIONS W D H			SEAT DIMENSIONS W D H			BACK DIMENSIONS W H									
	Active weight 500 lbs/seat.	IN 74.5	26	42.5	22	18	18	21.5	24.5	MM 1892	660	1080	559	457	457	546	622
	Wood armcap option: Add \$99.	RTA 00	1 per carton														
 <p>HB Three Seat Chair Half Center Arms - Left & Right COM: 5.75 YD 5.26 M Unit weight: 138 LB 62.7 KG Carton weight: 160 LB 72.57 KG Carton volume: 80.75 FT³ 2.28 MT³</p>	GC4235HBB	3303	3487	3642	3821	4114	4384	4654	4890	5183	5459	5833	6362				
	Ganging.	OVERALL DIMENSIONS W D H			SEAT DIMENSIONS W D H			BACK DIMENSIONS W H									
	Active weight 500 lbs/seat.	IN 74.5	26	42.5	22	18	18	21.5	24.5	MM 1892	660	1080	559	457	457	546	622
	Wood armcap option: Add \$99.	RTA 00	1 per carton														
 <p>LB Two Seat Chair w/Center Table Top COM: 3.5 YD 3.2 M Unit weight: 94 LB 42.7 KG Carton weight: 106 LB 48.08 KG Carton volume: 65.25 FT³ 1.84 MT³</p>	GC4236	2527	2639	2734	2842	3021	3185	3350	3493	3672	3840	4067	4389				
	Active weight 500 lbs/seat.	OVERALL DIMENSIONS W D H			SEAT DIMENSIONS W D H			BACK DIMENSIONS W H									
	Wood armcap option: Add \$49.	IN 72.75	26	37.5	44	18	18	44	19.5	MM 1848	660	953	1118	457	457	1118	495
	Table top only offered in high pressure laminate.	RTA 00	1 per carton														

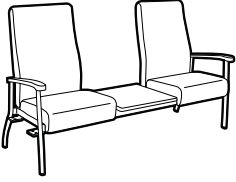
DESCRIPTION	MODEL# / FEATURES	STANDARD TEXTILE GRADES											
		COM	2	3	4	5	6	7	8	9	10	11	12
 <p>LB Two Seat Chair w/Center Table Top - Left COM: 3.5 YD 3.2 M Unit weight: 95 LB 43.2 KG Carton weight: 107 LB 48.53 KG Carton volume: 65.25 FT³ 1.84 MT³</p>	GC4236L	2556	2668	2763	2871	3050	3214	3379	3522	3701	3869	4096	4418
	Ganging.												
	Active weight 500 lbs/seat.	OVERALL DIMENSIONS			SEAT DIMENSIONS			BACK DIMENSIONS					
		W	D	H	W	D	H	W	H				
	Wood armcap option: Add \$49.	IN 72.75 MM 1848	26 660	37.5 953	44 1118	18 457	18 457	44 1118	19.5 495				
Table top only offered in high pressure laminate.	RTA 00	1 per carton											
 <p>LB Two Seat Chair w/Center Table Top - Right COM: 3.5 YD 3.2 M Unit weight: 95 LB 43.2 KG Carton weight: 107 LB 48.53 KG Carton volume: 65.25 FT³ 1.84 MT³</p>	GC4236R	2556	2668	2763	2871	3050	3214	3379	3522	3701	3869	4096	4418
	Ganging.												
	Active weight 500 lbs/seat.	OVERALL DIMENSIONS			SEAT DIMENSIONS			BACK DIMENSIONS					
		W	D	H	W	D	H	W	H				
	Wood armcap option: Add \$49.	IN 72.75 MM 1848	26 660	37.5 953	44 1118	18 457	18 457	44 1118	19.5 495				
Table top only offered in high pressure laminate.	RTA 00	1 per carton											
 <p>LB Two Seat Chair w/Center Table Top - Left & Right COM: 3.5 YD 3.2 M Unit weight: 96 LB 43.6 KG Carton weight: 108 LB 48.99 KG Carton volume: 65.25 FT³ 1.84 MT³</p>	GC4236B	2589	2701	2796	2904	3083	3247	3412	3555	3734	3902	4129	4451
	Ganging.												
	Active weight 500 lbs/seat.	OVERALL DIMENSIONS			SEAT DIMENSIONS			BACK DIMENSIONS					
		W	D	H	W	D	H	W	H				
	Wood armcap option: Add \$49.	IN 72.75 MM 1848	26 660	37.5 953	44 1118	18 457	18 457	44 1118	19.5 495				
Table top only offered in high pressure laminate.	RTA 00	1 per carton											
 <p>HB Two Seat Chair w/Center Table Top COM: 4 YD 3.66 M Unit weight: 98 LB 44.5 KG Carton weight: 110 LB 49.9 KG Carton volume: 80.75 FT³ 2.28 MT³</p>	GC4236HB	2617	2745	2853	2977	3181	3369	3557	3721	3925	4117	4377	4745
	Ganging.												
	Active weight 500 lbs/seat.	OVERALL DIMENSIONS			SEAT DIMENSIONS			BACK DIMENSIONS					
		W	D	H	W	D	H	W	H				
	Wood armcap option: Add \$49.	IN 72.75 MM 1848	26 660	42.5 1080	44 1118	18 457	18 457	44 1118	24.5 622				
Table top only offered in high pressure laminate.	RTA 00	1 per carton											
 <p>HB Two Seat Chair w/Center Table Top - Left COM: 4 YD 3.66 M Unit weight: 99 LB 45 KG Carton weight: 111 LB 50.35 KG Carton volume: 80.75 FT³ 2.28 MT³</p>	GC4236HBL	2647	2775	2883	3007	3211	3399	3587	3751	3955	4147	4407	4775
	Ganging.												
	Active weight 500 lbs/seat.	OVERALL DIMENSIONS			SEAT DIMENSIONS			BACK DIMENSIONS					
		W	D	H	W	D	H	W	H				
	Wood armcap option: Add \$49.	IN 72.75 MM 1848	26 660	42.5 1080	44 1118	18 457	18 457	44 1118	24.5 622				
Table top only offered in high pressure laminate.	RTA 00	1 per carton											

DESCRIPTION	MODEL# / FEATURES	STANDARD TEXTILE GRADES											
 <p>HB Two Seat Chair w/Center Table Top - Right COM: 4 YD 3.66 M Unit weight: 99 LB 45 KG Carton weight: 111 LB 50.35 KG Carton volume: 80.75 FT³ 2.28 MT³</p>	GC4236HBR	COM	2	3	4	5	6	7	8	9	10	11	12
		2647	2775	2883	3007	3211	3399	805	3751	3955	4147	4407	4775
	Ganging.	OVERALL DIMENSIONS			SEAT DIMENSIONS			BACK DIMENSIONS					
	Active weight 500 lbs/seat.	W	D	H	W	D	H	W	H				
Wood armcap option: Add \$49.	IN 72.75	26	42.5	44	18	18	44	24.5					
Table top only offered in high pressure laminate.	MM 1848	660	1080	1118	457	457	1118	622					
	RTA 00	1 per carton											
 <p>HB Two Seat Chair w/Center Table Top - Left & Right COM: 4 YD 3.66 M Unit weight: 102 LB 46.4 KG Carton weight: 114 LB 51.71 KG Carton volume: 80.75 FT³ 2.28 MT³</p>	GC4236HBB	COM	2	3	4	5	6	7	8	9	10	11	12
		2679	2807	2915	3039	3243	3431	3619	3783	3987	4179	4439	4807
	Ganging.	OVERALL DIMENSIONS			SEAT DIMENSIONS			BACK DIMENSIONS					
	Active weight 500 lbs/seat.	W	D	H	W	D	H	W	H				
Wood armcap option: Add \$49.	IN 72.75	26	42.5	44	18	18	44	24.5					
Table top only offered in high pressure laminate.	MM 1848	660	1080	1118	457	457	1118	622					
	RTA 00	1 per carton											
 <p>LB Armchair w/Rear Casters COM: 1.75 YD 1.6 M Unit weight: 41 LB 18.6 KG Carton weight: 49 LB 22.23 KG Carton volume: 20.25 FT³ 0.57 MT³</p>	GC4240	COM	2	3	4	5	6	7	8	9	10	11	12
		1237	1293	1340	1395	1484	1566	1648	1720	1809	1893	2007	2168
	Active weight 500 lbs.	OVERALL DIMENSIONS			SEAT DIMENSIONS			BACK DIMENSIONS					
	Wood armcap option: Add \$49.	IN 26.75	27.5	37.5	22	18	18	21.5	19.5				
	MM 679	699	953	559	457	457	546	495					
	RTA 00	1 per carton											
 <p>HB Armchair w/Rear Casters COM: 2 YD 1.83 M Unit weight: 46 LB 20.9 KG Carton weight: 54 LB 24.49 KG Carton volume: 22.25 FT³ 0.63 MT³</p>	GC4240HB	COM	2	3	4	5	6	7	8	9	10	11	12
		1282	1346	1400	1462	1564	1658	1752	1834	1936	2032	2162	2346
	Active weight 500 lbs.	OVERALL DIMENSIONS			SEAT DIMENSIONS			BACK DIMENSIONS					
	Wood armcap option: Add \$49.	IN 26.75	27.5	42.5	22	18	18	21.5	24.5				
	MM 679	699	1080	559	457	457	546	622					
	RTA 00	1 per carton											
 <p>Bariatric LB Armchair COM: 3 YD 2.74 M Unit weight: 56 LB 25.5 KG Carton weight: 70 LB 31.75 KG Carton volume: 30.5 FT³ 0.86 MT³</p>	GC4241	COM	2	3	4	5	6	7	8	9	10	11	12
		1524	1620	1701	1794	1947	2088	2229	2352	2505	2649	2844	3120
	Active weight 750 lbs.	OVERALL DIMENSIONS			SEAT DIMENSIONS			BACK DIMENSIONS					
	Wood armcap option: Add \$49.	IN 37.5	28	37.5	32.5	18	18	32.5	19.5				
Armless bariatric models are not available.	MM 953	711	953	826	457	457	826	495					
	RTA 00	1 per carton											

DESCRIPTION MODEL# / FEATURES STANDARD TEXTILE GRADES

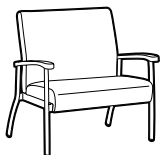

Bariatric LB Armchair - Left
 COM: 3 YD | 2.74 M
 Unit weight: 57 LB | 25.9 KG
 Carton weight: 71 LB | 32.21 KG
 Carton volume: 30.5 FT³ | 0.86 MT³

MODEL#	2	3	4	5	6	7	8	9	10	11	12																																					
GC4241L	1555	1651	1732	1825	1978	2119	2260	2383	2536	2680	2875	3151																																				
Ganging.																																																
Active weight 750 lbs.																																																
Wood armcap option: Add \$49.																																																
Armless bariatric models are <u>not</u> available.																																																
<table border="1"> <thead> <tr> <th colspan="3">OVERALL DIMENSIONS</th> <th colspan="3">SEAT DIMENSIONS</th> <th colspan="3">BACK DIMENSIONS</th> </tr> <tr> <th>W</th> <th>D</th> <th>H</th> <th>W</th> <th>D</th> <th>H</th> <th>W</th> <th colspan="2">H</th> </tr> </thead> <tbody> <tr> <td>IN 37.5</td> <td>28</td> <td>37.5</td> <td>32.5</td> <td>18</td> <td>18</td> <td>32.5</td> <td colspan="2">19.5</td> </tr> <tr> <td>MM 953</td> <td>711</td> <td>953</td> <td>826</td> <td>457</td> <td>457</td> <td>826</td> <td colspan="2">495</td> </tr> </tbody> </table>													OVERALL DIMENSIONS			SEAT DIMENSIONS			BACK DIMENSIONS			W	D	H	W	D	H	W	H		IN 37.5	28	37.5	32.5	18	18	32.5	19.5		MM 953	711	953	826	457	457	826	495	
OVERALL DIMENSIONS			SEAT DIMENSIONS			BACK DIMENSIONS																																										
W	D	H	W	D	H	W	H																																									
IN 37.5	28	37.5	32.5	18	18	32.5	19.5																																									
MM 953	711	953	826	457	457	826	495																																									
<table border="1"> <tbody> <tr> <td>RTA 00</td> <td colspan="11">1 per carton</td> </tr> </tbody> </table>													RTA 00	1 per carton																																		
RTA 00	1 per carton																																															



Bariatric LB Armchair - Right
 COM: 3 YD | 2.74 M
 Unit weight: 57 LB | 25.9 KG
 Carton weight: 71 LB | 32.21 KG
 Carton volume: 30.5 FT³ | 0.86 MT³

MODEL#	2	3	4	5	6	7	8	9	10	11	12																																					
GC4241R	1555	1651	1732	1825	1978	2119	2260	2383	2536	2680	2875	3151																																				
Ganging.																																																
Active weight 750 lbs.																																																
Wood armcap option: Add \$49.																																																
Armless bariatric models are <u>not</u> available.																																																
<table border="1"> <thead> <tr> <th colspan="3">OVERALL DIMENSIONS</th> <th colspan="3">SEAT DIMENSIONS</th> <th colspan="3">BACK DIMENSIONS</th> </tr> <tr> <th>W</th> <th>D</th> <th>H</th> <th>W</th> <th>D</th> <th>H</th> <th>W</th> <th colspan="2">H</th> </tr> </thead> <tbody> <tr> <td>IN 37.5</td> <td>28</td> <td>37.5</td> <td>32.5</td> <td>18</td> <td>18</td> <td>32.5</td> <td colspan="2">19.5</td> </tr> <tr> <td>MM 953</td> <td>711</td> <td>953</td> <td>826</td> <td>457</td> <td>457</td> <td>826</td> <td colspan="2">495</td> </tr> </tbody> </table>													OVERALL DIMENSIONS			SEAT DIMENSIONS			BACK DIMENSIONS			W	D	H	W	D	H	W	H		IN 37.5	28	37.5	32.5	18	18	32.5	19.5		MM 953	711	953	826	457	457	826	495	
OVERALL DIMENSIONS			SEAT DIMENSIONS			BACK DIMENSIONS																																										
W	D	H	W	D	H	W	H																																									
IN 37.5	28	37.5	32.5	18	18	32.5	19.5																																									
MM 953	711	953	826	457	457	826	495																																									
<table border="1"> <tbody> <tr> <td>RTA 00</td> <td colspan="11">1 per carton</td> </tr> </tbody> </table>													RTA 00	1 per carton																																		
RTA 00	1 per carton																																															



Bariatric LB Armchair - Left & Right
 COM: 3 YD | 2.74 M
 Unit weight: 57 LB | 25.9 KG
 Carton weight: 71 LB | 32.21 KG
 Carton volume: 30.5 FT³ | 0.86 MT³

MODEL#	2	3	4	5	6	7	8	9	10	11	12																																					
GC4241B	1588	1684	1765	1858	2011	2152	2293	2416	2569	2713	2908	3184																																				
Ganging.																																																
Active weight 750 lbs.																																																
Wood armcap option: Add \$49.																																																
Armless bariatric models are <u>not</u> available.																																																
<table border="1"> <thead> <tr> <th colspan="3">OVERALL DIMENSIONS</th> <th colspan="3">SEAT DIMENSIONS</th> <th colspan="3">BACK DIMENSIONS</th> </tr> <tr> <th>W</th> <th>D</th> <th>H</th> <th>W</th> <th>D</th> <th>H</th> <th>W</th> <th colspan="2">H</th> </tr> </thead> <tbody> <tr> <td>IN 37.5</td> <td>28</td> <td>37.5</td> <td>32.5</td> <td>18</td> <td>18</td> <td>32.5</td> <td colspan="2">19.5</td> </tr> <tr> <td>MM 953</td> <td>711</td> <td>953</td> <td>826</td> <td>457</td> <td>457</td> <td>826</td> <td colspan="2">495</td> </tr> </tbody> </table>													OVERALL DIMENSIONS			SEAT DIMENSIONS			BACK DIMENSIONS			W	D	H	W	D	H	W	H		IN 37.5	28	37.5	32.5	18	18	32.5	19.5		MM 953	711	953	826	457	457	826	495	
OVERALL DIMENSIONS			SEAT DIMENSIONS			BACK DIMENSIONS																																										
W	D	H	W	D	H	W	H																																									
IN 37.5	28	37.5	32.5	18	18	32.5	19.5																																									
MM 953	711	953	826	457	457	826	495																																									
<table border="1"> <tbody> <tr> <td>RTA 00</td> <td colspan="11">1 per carton</td> </tr> </tbody> </table>													RTA 00	1 per carton																																		
RTA 00	1 per carton																																															





Bariatric HB Armchair
 COM: 3.25 YD | 2.97 M
 Unit weight: 59 LB | 26.8 KG
 Carton weight: 73 LB | 33.11 KG
 Carton volume: 30.5 FT³ | 0.86 MT³

MODEL#	2	3	4	5	6	7	8	9	10	11	12																																					
GC4241HB	1600	1704	1792	1893	2058	2211	2364	2497	2663	2819	3030	3329																																				
Active weight 750 lbs.																																																
Wood armcap option: Add \$49.																																																
Armless bariatric models are <u>not</u> available.																																																
<table border="1"> <thead> <tr> <th colspan="3">OVERALL DIMENSIONS</th> <th colspan="3">SEAT DIMENSIONS</th> <th colspan="3">BACK DIMENSIONS</th> </tr> <tr> <th>W</th> <th>D</th> <th>H</th> <th>W</th> <th>D</th> <th>H</th> <th>W</th> <th colspan="2">H</th> </tr> </thead> <tbody> <tr> <td>IN 37.5</td> <td>28</td> <td>43</td> <td>32.5</td> <td>18</td> <td>18</td> <td>32.5</td> <td colspan="2">24.5</td> </tr> <tr> <td>MM 953</td> <td>711</td> <td>1092</td> <td>826</td> <td>457</td> <td>457</td> <td>826</td> <td colspan="2">622</td> </tr> </tbody> </table>													OVERALL DIMENSIONS			SEAT DIMENSIONS			BACK DIMENSIONS			W	D	H	W	D	H	W	H		IN 37.5	28	43	32.5	18	18	32.5	24.5		MM 953	711	1092	826	457	457	826	622	
OVERALL DIMENSIONS			SEAT DIMENSIONS			BACK DIMENSIONS																																										
W	D	H	W	D	H	W	H																																									
IN 37.5	28	43	32.5	18	18	32.5	24.5																																									
MM 953	711	1092	826	457	457	826	622																																									
<table border="1"> <tbody> <tr> <td>RTA 00</td> <td colspan="11">1 per carton</td> </tr> </tbody> </table>													RTA 00	1 per carton																																		
RTA 00	1 per carton																																															

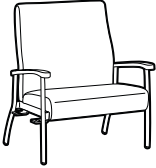
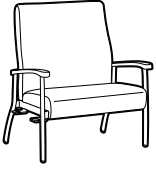

Bariatric HB Armchair - Left
 COM: 3.25 YD | 2.97 M
 Unit weight: 60 LB | 27.3 KG
 Carton weight: 73 LB | 33.11 KG
 Carton volume: 15.5 FT³ | 0.86 MT³

MODEL#	2	3	4	5	6	7	8	9	10	11	12																																					
GC4241HBL	1632	1736	1824	1925	2090	2243	2396	2529	2695	2851	3062	3361																																				
Ganging.																																																
Active weight 750 lbs.																																																
Wood armcap option: Add \$49.																																																
Armless bariatric models are <u>not</u> available.																																																
<table border="1"> <thead> <tr> <th colspan="3">OVERALL DIMENSIONS</th> <th colspan="3">SEAT DIMENSIONS</th> <th colspan="3">BACK DIMENSIONS</th> </tr> <tr> <th>W</th> <th>D</th> <th>H</th> <th>W</th> <th>D</th> <th>H</th> <th>W</th> <th colspan="2">H</th> </tr> </thead> <tbody> <tr> <td>IN 37.5</td> <td>28</td> <td>43</td> <td>32.5</td> <td>18</td> <td>18</td> <td>32.5</td> <td colspan="2">24.5</td> </tr> <tr> <td>MM 953</td> <td>711</td> <td>1092</td> <td>826</td> <td>457</td> <td>457</td> <td>826</td> <td colspan="2">622</td> </tr> </tbody> </table>													OVERALL DIMENSIONS			SEAT DIMENSIONS			BACK DIMENSIONS			W	D	H	W	D	H	W	H		IN 37.5	28	43	32.5	18	18	32.5	24.5		MM 953	711	1092	826	457	457	826	622	
OVERALL DIMENSIONS			SEAT DIMENSIONS			BACK DIMENSIONS																																										
W	D	H	W	D	H	W	H																																									
IN 37.5	28	43	32.5	18	18	32.5	24.5																																									
MM 953	711	1092	826	457	457	826	622																																									
<table border="1"> <tbody> <tr> <td>RTA 00</td> <td colspan="11">1 per carton</td> </tr> </tbody> </table>													RTA 00	1 per carton																																		
RTA 00	1 per carton																																															

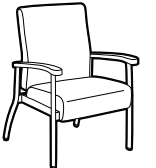
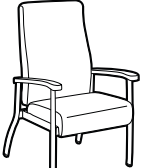
DESCRIPTION	MODEL# / FEATURES	STANDARD TEXTILE GRADES											
		COM	2	3	4	5	6	7	8	9	10	11	12
 <p>Bariatric HB Armchair - Right COM: 3.25 YD 2.97 M Unit weight: 60 LB 27.3 KG Carton weight: 74 LB 33.57 KG Carton volume: 30.5 FT³ 0.86 MT³</p>	GC4241HBR	1632	1736	1824	1925	2090	2243	2396	2529	2695	2851	3062	3361
	Ganging.												
	Active weight 750 lbs.	OVERALL DIMENSIONS			SEAT DIMENSIONS			BACK DIMENSIONS					
	Wood armcap option: Add \$49.	IN	37.5	28	43	32.5	18	18	32.5	24.5			
	Armless bariatric models are <u>not</u> available.	MM	953	711	1092	826	457	457	826	622			
	RTA 00	1 per carton											
 <p>Bariatric HB Armchair - Left & Right COM: 3.25 YD 2.97 M Unit weight: 60 LB 27.3 KG Carton weight: 74 LB 33.57 KG Carton volume: 30.5 FT³ 0.86 MT³</p>	GC4241HBB	1664	1768	1856	1957	2122	2275	2428	2561	2727	2883	3094	3393
	Ganging.												
	Active weight 750 lbs.	OVERALL DIMENSIONS			SEAT DIMENSIONS			BACK DIMENSIONS					
	Wood armcap option: Add \$49.	IN	37.5	28	43	32.5	18	18	32.5	24.5			
	Armless bariatric models are <u>not</u> available.	MM	953	711	1092	826	457	457	826	622			
	RTA 00	1 per carton											
 <p>Designed to immobilize the pelvis and hip joints after surgery.</p> <p>Bariatric LB Armchair Post Surgery COM: 3 YD 2.74 M Unit weight: 64 LB 29.1 KG Carton weight: 76 LB 34.47 KG Carton volume: 33.5 FT³ 0.94 MT³</p>	GC4241-24 24" seat height	1672	1768	1849	1942	2095	2236	2377	2500	2653	2797	2992	3268
	Active weight 750 lbs.	OVERALL DIMENSIONS			SEAT DIMENSIONS			BACK DIMENSIONS					
	Wood armcap option: Add \$49.	IN	37.5	28.75	43.5	32.5	18	24	32.5	19.5			
	Armless bariatric models are <u>not</u> available.	MM	953	730	1105	826	457	610	826	495			
		RTA 00	1 per carton										
 <p>LB Armchair Flex Back COM: 1.75 YD 1.6 M Unit weight: 41 LB 18.6 KG Carton weight: 53 LB 24.04 KG Carton volume: 20.25 FT³ 0.57 MT³</p>	GC4242	1482	1538	1585	1640	1729	1811	1893	1965	2054	2138	2252	2413
	Active weight 500 lbs.	OVERALL DIMENSIONS			SEAT DIMENSIONS			BACK DIMENSIONS					
	Wood armcap option: Add \$49.	IN	26.5	28	37.5	22	18	18	21.5	19.5			
		MM	673	711	953	559	457	457	546	495			
		RTA 00	1 per carton										
 <p>HB Armchair Flex Back COM: 2 YD 1.83 M Unit weight: 48 LB 21.8 KG Carton weight: 61 LB 27.67 KG Carton volume: 22.25 FT³ 0.63 MT³</p>	GC4242HB	1527	1591	1645	1707	1809	1903	1997	2079	2181	2277	2407	2591
	Active weight 500 lbs.	OVERALL DIMENSIONS			SEAT DIMENSIONS			BACK DIMENSIONS					
	Wood armcap option: Add \$49.	IN	26.5	28	43	22	18	18	21.5	24.5			
		MM	673	711	1092	559	457	457	546	622			
		RTA 00	1 per carton										

DESCRIPTION MODEL# / FEATURES STANDARD TEXTILE GRADES



LB Armchair Flex Back w/Rear Casters
 COM: 1.75 YD | 1.6 M
 Unit weight: 41 LB | 18.6 KG
 Carton weight: 49 LB | 22.23 KG
 Carton volume: 20.25 FT³ | 0.57 MT³

COM	2	3	4	5	6	7	8	9	10	11	12	
GC4243	1571	1627	1674	1729	1818	1900	1982	2054	2143	2227	2341	2502

OVERALL DIMENSIONS			SEAT DIMENSIONS			BACK DIMENSIONS	
W	D	H	W	D	H	W	H

Active weight 500 lbs.	IN 26.75	27.5	37.5	22	18	18	21.5	19.5
Wood armcap option: Add \$49.	MM 679	699	953	559	457	457	546	495
	RTA 00							1 per carton

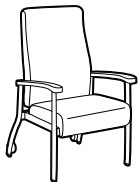

HB Armchair Flex Back w/Rear Casters
 COM: 2 YD | 1.83 M
 Unit weight: 43 LB | 19.5 KG
 Carton weight: 51 LB | 23.13 KG
 Carton volume: 22.25 FT³ | 0.63 MT³

COM	2	3	4	5	6	7	8	9	10	11	12	
GC4243HB	1620	1684	1738	1800	1902	1996	2090	2172	2274	2370	2500	2684

OVERALL DIMENSIONS			SEAT DIMENSIONS			BACK DIMENSIONS	
W	D	H	W	D	H	W	H

Active weight 500 lbs.	IN 26.75	27.5	42.5	22	18	18	21.5	24.5
Wood armcap option: Add \$49.	MM 679	699	1080	559	457	457	546	622
	RTA 00							1 per carton



HB Armchair Split Back
 COM: 2.25 YD | 2.06 M
 Unit weight: 46 LB | 20.9 KG
 Carton weight: 54 LB | 24.49 KG
 Carton volume: 20.25 FT³ | 0.57 MT³

COM	2	3	4	5	6	7	8	9	10	11	12	
GC4244HB	1412	1484	1545	1615	1729	1835	1941	2033	2148	2256	2402	2609

OVERALL DIMENSIONS			SEAT DIMENSIONS			BACK DIMENSIONS	
W	D	H	W	D	H	W	H

Active weight 500 lbs.	IN 26.75	26	42.5	22	18	18	21.5	24.5
Fold down headrest allows caregiver to assist occupant.	MM 679	660	1080	559	457	457	546	622
Wood armcap option: Add \$49.	RTA 00							1 per carton



HB Armchair Split Back w/Rear Casters
 COM: 2.25 YD | 2.06 M
 Unit weight: 46 LB | 20.9 KG
 Carton weight: 54 LB | 24.49 KG
 Carton volume: 20.25 FT³ | 0.57 MT³

COM	2	3	4	5	6	7	8	9	10	11	12	
GC4245HB	1503	1575	1636	1706	1820	1926	2032	2124	2239	2347	2493	2700

OVERALL DIMENSIONS			SEAT DIMENSIONS			BACK DIMENSIONS	
W	D	H	W	D	H	W	H

Active weight 500 lbs.	IN 26.75	26	42.5	22	18	18	21.5	24.5
Fold down headrest allows caregiver to assist occupant.	MM 679	660	1080	559	457	457	546	622
Wood armcap option: Add \$49.	RTA 00							1 per carton











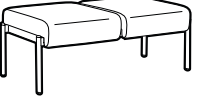

Single Seat Bench
 COM: 1.5 YD | 1.37 M
 Unit weight: 25 LB | 11.4 KG
 Carton weight: 30 LB | 13.61 KG
 Carton volume: 13 FT³ | 0.36 MT³

COM	2	3	4	5	6	7	8	9	10	11	12	
GC4251	740	788	829	875	952	1022	1093	1154	1231	1303	1400	1538

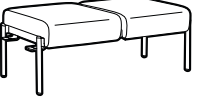
OVERALL DIMENSIONS			SEAT DIMENSIONS			BACK DIMENSIONS	
W	D	H	W	D	H	W	H

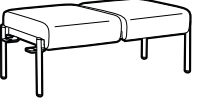
Active weight 500 lbs.	IN 24.75	26.5	18	-	-	-	-	-
	MM 629	673	457	-	-	-	-	-
	RTA 00							1 per carton

DESCRIPTION	MODEL# / FEATURES	STANDARD TEXTILE GRADES													
		COM	2	3	4	5	6	7	8	9	10	11	12		
 <p>Single Seat Bench - Reversible (One Side) COM: 1.5 YD 1.37 M Unit weight: 26 LB 11.8 KG Carton weight: 31 LB 14.06 KG Carton volume: 13 FT³ 0.36 MT³</p>	GC4251L	769	817	858	904	981	1051	1122	1183	1260	1332	1429	1567		
	Ganging.	OVERALL DIMENSIONS			SEAT DIMENSIONS			BACK DIMENSIONS							
	Active weight 500 lbs.	IN 25.75	26.5	18	-	-	-	-	-	-	-	-	-		
		MM 654	673	457	-	-	-	-	-	-	-	-	-		
		RTA 00		1 per carton											
 <p>Single Seat Bench - Left & Right COM: 1.5 YD 1.37 M Unit weight: 27 LB 12.3 KG Carton weight: 32 LB 14.51 KG Carton volume: 13 FT³ 0.36 MT³</p>	GC4251B	801	849	890	936	1013	1083	1154	1215	1292	1364	1461	1599		
	Ganging.	OVERALL DIMENSIONS			SEAT DIMENSIONS			BACK DIMENSIONS							
	Active weight 500 lbs.	IN 26.75	26.5	18	-	-	-	-	-	-	-	-	-		
		MM 679	673	457	-	-	-	-	-	-	-	-	-		
		RTA 00		1 per carton											
 <p>Two Seat Bench COM: 2.25 YD 2.06 M Unit weight: 45 LB 20.5 KG Carton weight: 53 LB 24.04 KG Carton volume: 23 FT³ 0.65 MT³</p>	GC4252	1328	1400	1461	1531	1645	1751	1857	1949	2064	2172	2318	2525		
		OVERALL DIMENSIONS			SEAT DIMENSIONS			BACK DIMENSIONS							
	Active weight 500 lbs/seat.	IN 47.75	26.5	18	-	-	-	-	-	-	-	-	-		
		MM 1213	673	457	-	-	-	-	-	-	-	-	-		
		RTA 00		1 per carton											
 <p>Two Seat Bench - Reversible (One Side) COM: 2.25 YD 2.06 M Unit weight: 46 LB 20.9 KG Carton weight: 54 LB 24.49 KG Carton volume: 23 FT³ 0.65 MT³</p>	GC4252L	1358	1430	1491	1561	1675	1781	1887	1979	2094	2202	2348	2555		
	Ganging.	OVERALL DIMENSIONS			SEAT DIMENSIONS			BACK DIMENSIONS							
	Active weight 500 lbs/seat.	IN 48.75	26.5	18	-	-	-	-	-	-	-	-	-		
		MM 1238	673	457	-	-	-	-	-	-	-	-	-		
		RTA 00		1 per carton											
 <p>Two Seat Bench - Left & Right COM: 2.25 YD 2.06 M Unit weight: 47 LB 21.4 KG Carton weight: 55 LB 24.95 KG Carton volume: 23 FT³ 0.65 MT³</p>	GC4252B	1388	1460	1521	1591	1705	1811	1917	2009	2124	2232	2378	2585		
	Ganging.	OVERALL DIMENSIONS			SEAT DIMENSIONS			BACK DIMENSIONS							
	Active weight 500 lbs/seat.	IN 49.75	26.5	18	-	-	-	-	-	-	-	-	-		
		MM 1264	673	457	-	-	-	-	-	-	-	-	-		
		RTA 00		1 per carton											

DESCRIPTION MODEL# / FEATURES STANDARD TEXTILE GRADES

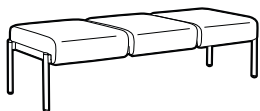

Three Seat Bench
 COM: 3 YD | 2.74 M
 Unit weight: 65 LB | 29.5 KG
 Carton weight: 73 LB | 33.11 KG
 Carton volume: 33.25 FT³ | 0.94 MT³

MODEL#	STANDARD TEXTILE GRADES											
	COM	2	3	4	5	6	7	8	9	10	11	12
GC4253	1954	2050	2131	2224	2377	2518	2659	2782	2935	3079	3274	3550
Active weight 500 lbs/seat.	OVERALL DIMENSIONS			SEAT DIMENSIONS			BACK DIMENSIONS					
	W	D	H	W	D	H	W	H				
	IN 70.75	26.5	18	-	-	-	-	-	-	-	-	-
	MM 1797	673	457	-	-	-	-	-	-	-	-	-
	RTA 00	1 per carton										

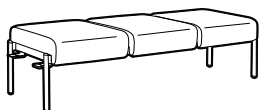

Three Seat Bench - Reversible (One Side)
 COM: 3 YD | 2.74 M
 Unit weight: 66 LB | 30 KG
 Carton weight: 74 LB | 33.57 KG
 Carton volume: 33.25 FT³ | 0.94 MT³

MODEL#	STANDARD TEXTILE GRADES											
	COM	2	3	4	5	6	7	8	9	10	11	12
GC4253L	1983	2079	2160	2253	2406	2547	2688	2811	2964	3108	3303	3579
Ganging.	OVERALL DIMENSIONS			SEAT DIMENSIONS			BACK DIMENSIONS					
	W	D	H	W	D	H	W	H				
	IN 71.75	26.5	18	-	-	-	-	-	-	-	-	-
	MM 1822	673	457	-	-	-	-	-	-	-	-	-
	RTA 00	1 per carton										

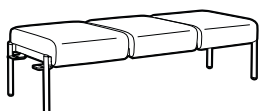

Three Seat Bench - Left & Right
 COM: 3 YD | 2.74 M
 Unit weight: 67 LB | 30.5 KG
 Carton weight: 75 LB | 34.02 KG
 Carton volume: 33.25 FT³ | 0.94 MT³

MODEL#	STANDARD TEXTILE GRADES											
	COM	2	3	4	5	6	7	8	9	10	11	12
GC4253B	2013	2109	2190	2283	2436	2577	2718	2841	2994	3138	3333	3609
Ganging.	OVERALL DIMENSIONS			SEAT DIMENSIONS			BACK DIMENSIONS					
	W	D	H	W	D	H	W	H				
	IN 72.75	26.5	18	-	-	-	-	-	-	-	-	-
	MM 1848	673	457	-	-	-	-	-	-	-	-	-
	RTA 00	1 per carton										

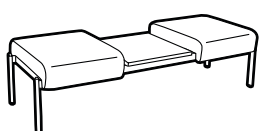





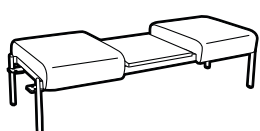



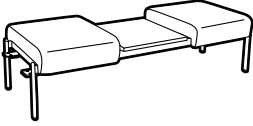

Two Seat Bench w/Center Table Top
 COM: 2.25 YD | 2.06 M
 Unit weight: 60 LB | 27.3 KG
 Carton weight: 68 LB | 30.84 KG
 Carton volume: 33.25 FT³ | 0.94 MT³

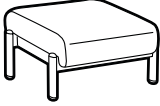

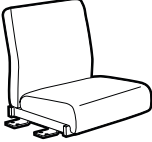

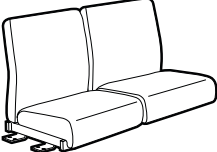

MODEL#	STANDARD TEXTILE GRADES											
	COM	2	3	4	5	6	7	8	9	10	11	12
GC4256	1908	1980	2041	2111	2225	2331	2437	2529	2644	2752	2898	3105
Active weight 500 lbs/seat.	OVERALL DIMENSIONS			SEAT DIMENSIONS			BACK DIMENSIONS					
	W	D	H	W	D	H	W	H				
	IN 70.75	26.5	18	-	-	-	-	-	-	-	-	-
	MM 1797	673	457	-	-	-	-	-	-	-	-	-
Table top only offered in high pressure laminate.	RTA 00		1 per carton									



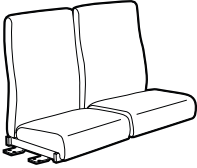

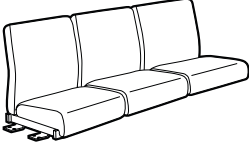

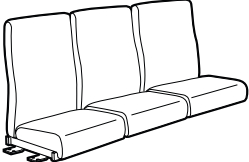

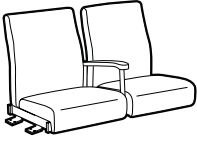
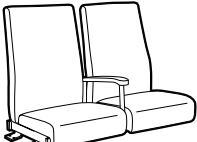

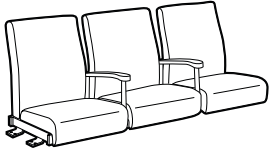

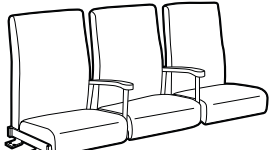
Two Seat Bench w/Center Table Top - Reversible (One Side)
 COM: 2.25 YD | 2.06 M
 Unit weight: 64 LB | 29.1 KG
 Carton weight: 72 LB | 32.66 KG
 Carton volume: 33.25 FT³ | 0.94 MT³

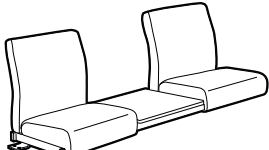
MODEL#	STANDARD TEXTILE GRADES											
	COM	2	3	4	5	6	7	8	9	10	11	12
GC4256L	1941	2013	2074	2144	2258	2364	2470	2562	2677	2785	2931	3138
Ganging.	OVERALL DIMENSIONS			SEAT DIMENSIONS			BACK DIMENSIONS					
	W	D	H	W	D	H	W	H				
	IN 71.75	26.5	18	-	-	-	-	-	-	-	-	-
	MM 1822	673	457	-	-	-	-	-	-	-	-	-
Table top only offered in high pressure laminate.	RTA 00		1 per carton									

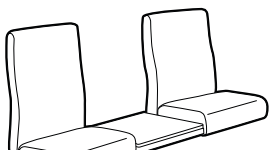
DESCRIPTION	MODEL# / FEATURES	STANDARD TEXTILE GRADES												
		COM	2	3	4	5	6	7	8	9	10	11	12	
 <p>Two Seat Bench w/Center Table Top - Left & Right COM: 2.25 YD 2.06 M Unit weight: 62 LB 28.2 KG Carton weight: 70 LB 31.75 KG Carton volume: 33.25 FT³ 0.94 MT³</p>	GC4256B	1969	2041	2102	2172	2286	2392	2498	2590	2705	2813	2959	3166	
	Ganging.	OVERALL DIMENSIONS			SEAT DIMENSIONS			BACK DIMENSIONS						
	Active weight 500 lbs/seat.	IN 72.75	26.5	18	-	-	-	-	-	-	-	-	-	-
	Table top only offered in high pressure laminate.	MM 1848	673	457	-	-	-	-	-	-	-	-	-	-
		RTA 00		1 per carton										
 <p>Ottoman Angled Cushion Top COM: 1 YD 0.91 M Unit weight: 14 LB 6.4 KG Carton weight: 16 LB 7.26 KG Carton volume: 3.6 FT³ 0.1 MT³</p>	GC4259	426	458	485	516	567	614	661	702	753	801	866	958	
	Active weight 500 lbs.	IN 17.75	19	10.5	-	-	-	-	-	-	-	-	-	
		MM 451	483	267	-	-	-	-	-	-	-	-	-	
		RTA 00		1 per carton										
 <p>LB Single Seat Armless Bridge - Left & Right COM: 1.75 YD 1.6 M Unit weight: 31 LB 14.1 KG Carton weight: 36 LB 16.33 KG Carton volume: 13 FT³ 0.36 MT³</p>	GC4261	855	911	958	1013	1102	1184	1266	1338	1427	1511	1625	1786	
	Ganging/linking.	OVERALL DIMENSIONS			SEAT DIMENSIONS			BACK DIMENSIONS						
	Active weight 500 lbs.	IN 26.75	24	25.5	22	18	-	21.5	19.5	-	-	-	-	
	Not freestanding. Suspends between 2 units via linking brackets.	MM 679	610	648	559	457	-	546	495	-	-	-	-	
		RTA 00		1 per carton										
 <p>HB Single Seat Armless Bridge - Left & Right COM: 2 YD 1.83 M Unit weight: 36 LB 16.4 KG Carton weight: 41 LB 18.6 KG Carton volume: 14.5 FT³ 0.41 MT³</p>	GC4261HB	900	964	1018	1080	1182	1276	1370	1452	1554	1650	1780	1964	
	Ganging/linking.	OVERALL DIMENSIONS			SEAT DIMENSIONS			BACK DIMENSIONS						
	Active weight 500 lbs.	IN 26.75	24	30.5	22	18	-	21.5	24.5	-	-	-	-	
	Not freestanding. Suspends between 2 units via linking brackets.	MM 679	610	775	559	457	-	546	622	-	-	-	-	
		RTA 00		1 per carton										
 <p>LB Two Seat Armless Bridge - Left & Right COM: 3.5 YD 3.2 M Unit weight: 60 LB 27.3 KG Carton weight: 66 LB 29.94 KG Carton volume: 23 FT³ 0.65 MT³</p>	GC4262	1656	1768	1863	1971	2150	2314	2479	2622	2801	2969	3196	3518	
	Ganging/linking.	OVERALL DIMENSIONS			SEAT DIMENSIONS			BACK DIMENSIONS						
	Active weight 500 lbs/seat.	IN 49.75	24	25.5	44	18	-	44	19.5	-	-	-	-	
	Not freestanding. Suspends between 2 units via linking brackets.	MM 1264	610	648	1118	457	-	1118	495	-	-	-	-	
		RTA 00		1 per carton										

DESCRIPTION	MODEL# / FEATURES	STANDARD TEXTILE GRADES											
		COM	2	3	4	5	6	7	8	9	10	11	12
 <p>HB Two Seat Armless Bridge - Left & Right COM: 4 YD 3.66 M Unit weight: 64 LB 29.1 KG Carton weight: 72 LB 32.66 KG Carton volume: 24 FT³ 0.67 MT³</p>	GC4262HB	1745	1873	1981	2105	2309	2497	2685	2849	3053	3245	3505	3873
	Ganging/linking.	OVERALL DIMENSIONS			SEAT DIMENSIONS			BACK DIMENSIONS					
		W	D	H	W	D	H	W	H				
	Active weight 500 lbs/seat.	IN 49.75 MM 1264	24 610	30.5 775	44 1118	18 457	- -	44 1118	24.5 622				
Not freestanding. Suspends between 2 units via linking brackets.	RTA 00		1 per carton										
 <p>LB Three Seat Armless Bridge - Left & Right COM: 5 YD 4.57 M Unit weight: 68 LB 30.9 KG Carton weight: 74 LB 33.57 KG Carton volume: 38.75 FT³ 1.09 MT³</p>	GC4263	2464	2624	2759	2914	3169	3404	3639	3844	4099	4339	4664	5124
	Ganging/linking.	OVERALL DIMENSIONS			SEAT DIMENSIONS			BACK DIMENSIONS					
		W	D	H	W	D	H	W	H				
	Active weight 500 lbs/seat.	IN 72.75 MM 1848	24 610	25.5 648	70 1778	18 457	- -	70 1778	19.5 495				
Not freestanding. Suspends between 2 units via linking brackets.	RTA 00		1 per carton										
 <p>HB Three Seat Armless Bridge - Left & Right COM: 5.75 YD 5.26 M Unit weight: 74 LB 33.6 KG Carton weight: 80 LB 36.29 KG Carton volume: 38.75 FT³ 1.09 MT³</p>	GC4263HB	2601	2785	2940	3119	3412	3682	3952	4188	4481	4757	5131	5660
	Ganging/linking.	OVERALL DIMENSIONS			SEAT DIMENSIONS			BACK DIMENSIONS					
		W	D	H	W	D	H	W	H				
	Active weight 500 lbs/seat.	IN 72.75 MM 1848	24 610	30.5 775	70 1778	18 457	- -	70 1778	24.5 622				
Not freestanding. Suspends between 2 units via linking brackets.	RTA 00		1 per carton										
 <p>LB Two Seat Bridge Half Center Arm - Left & Right COM: 3.5 YD 3.2 M Unit weight: 52 LB 23.6 KG Carton weight: 58 LB 26.31 KG Carton volume: 27.25 FT³ 0.77 MT³</p>	GC4264	1831	1943	2038	2146	2325	2489	2654	2797	2976	3144	3371	3693
	Ganging/linking.	OVERALL DIMENSIONS			SEAT DIMENSIONS			BACK DIMENSIONS					
		W	D	H	W	D	H	W	H				
	Active weight 500 lbs/seat.	IN 50.75 MM 1289	24 610	25.5 648	22 559	18 457	- -	21.5 546	19.5 4951				
Wood armcap option: Add \$25.	RTA 00	1 per carton											
 <p>HB Two Seat Bridge Half Center Arm - Left & Right COM: 4 YD 3.66 M Unit weight: 62 LB 28.2 KG Carton weight: 68 LB 30.84 KG Carton volume: 27.25 FT³ 0.77 MT³</p>	GC4264HB	1922	2050	2158	2282	2486	2674	2862	3026	3230	3422	3682	4050
	Ganging/linking.	OVERALL DIMENSIONS			SEAT DIMENSIONS			BACK DIMENSIONS					
		W	D	H	W	D	H	W	H				
	Active weight 500 lbs/seat.	IN 50.75 MM 1289	24 610	30.5 775	22 559	18 457	- -	21.5 546	24.5 622				
Wood armcap option: Add \$25.	RTA 00	1 per carton											

DESCRIPTION	MODEL# / FEATURES	STANDARD TEXTILE GRADES											
		COM	2	3	4	5	6	7	8	9	10	11	12
 <p>LB Three Seat Bridge Half Center Arms - Left & Right COM: 5 YD 4.57 M Unit weight: 72 LB 32.7 KG Carton weight: 78 LB 35.38 KG Carton volume: 38.75 FT³ 1.09 MT³</p>	GC4265	2816	2976	3111	3266	3521	3756	3991	4196	4451	4691	5016	5476
	Ganging/linking.												
	Active weight 500 lbs/seat.	OVERALL DIMENSIONS			SEAT DIMENSIONS			BACK DIMENSIONS					
			W	D	H	W	D	H	W	H			
	Not freestanding. Suspends between 2 units via linking brackets.	IN 74.25	24	25.5	22	18	-	21.5	19.5				
	MM 1886	610	648	559	457	-	546	495					
	Wood armcap option: Add \$49.	RTA 00		1 per carton									
 <p>HB Three Seat Bridge Half Center Arms - Left & Right COM: 5.75 YD 5.26 M Unit weight: 80 LB 36.4 KG Carton weight: 86 LB 39.01 KG Carton volume: 38.75 FT³ 1.09 MT³</p>	GC4265HB	2951	3135	3290	3469	3762	4032	4302	4538	4831	5107	5481	6010
	Ganging/linking.												
	Active weight 500 lbs/seat.	OVERALL DIMENSIONS			SEAT DIMENSIONS			BACK DIMENSIONS					
			W	D	H	W	D	H	W	H			
	Not freestanding. Suspends between 2 units via linking brackets.	IN 74.25	24	30.5	22	18	-	21.5	24.5				
	MM 1886	610	775	559	457	-	546	622					
	Wood armcap option: Add \$49.	RTA 00		1 per carton									
 <p>LB Two Seat Armless Bridge Center Table Top - Left & Right COM: 3.5 YD 3.2 M Unit weight: 54 LB 24.5 KG Carton weight: 60 LB 27.22 KG Carton volume: 38.75 FT³ 1.09 MT³</p>	GC4266	2235	2347	2442	2550	2729	2893	3058	3201	3380	3548	3775	4097
	Ganging/linking.												
	Active weight 500 lbs/seat.	OVERALL DIMENSIONS			SEAT DIMENSIONS			BACK DIMENSIONS					
			W	D	H	W	D	H	W	H			
	Not freestanding. Suspends between 2 units via linking brackets.	IN 72.75	24	25.5	22	18	-	21.5	19.5				
	MM 1848	610	648	559	457	-	546	495					
	Table top only offered in high pressure laminate.	RTA 00		1 per carton									
 <p>HB Two Seat Armless Bridge Center Table Top - Left & Right COM: 4 YD 3.66 M Unit weight: 60 LB 27.3 KG Carton weight: 66 LB 29.94 KG Carton volume: 38.75 FT³ 1.09 MT³</p>	GC4266HB	2327	2455	2563	2687	2891	3079	3267	3431	3635	3827	4087	4455
	Ganging/linking.												
	Active weight 500 lbs/seat.	OVERALL DIMENSIONS			SEAT DIMENSIONS			BACK DIMENSIONS					
			W	D	H	W	D	H	W	H			
	Not freestanding. Suspends between 2 units via linking brackets.	IN 72.75	24	30.5	22	18	-	21.5	24.5				
	MM 1848	610	775	559	457	-	546	622					
	Table top only offered in high pressure laminate.	RTA 00		1 per carton									
 <p>Bariatric LB Armless Bridge - Left & Right COM: 3 YD 2.74 M Unit weight: 38 LB 17.3 KG Carton weight: 44 LB 19.96 KG Carton volume: 26.5 FT³ 0.75 MT³</p>	GC4269	1235	1331	1412	1505	1658	1799	1940	2063	2216	2360	2555	2831
	Ganging/linking.												
	Active weight 750 lbs.	OVERALL DIMENSIONS			SEAT DIMENSIONS			BACK DIMENSIONS					
			W	D	H	W	D	H	W	H			
	Not freestanding. Suspends between 2 units via linking brackets.	IN 37.5	24	25.5	32.5	18	-	32.5	19.5				
	MM 953	610	648	826	457	-	826	495					
		RTA 00		1 per carton									

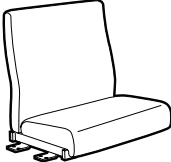
DESCRIPTION	MODEL# / FEATURES	STANDARD TEXTILE GRADES																															
		COM	2	3	4	5	6	7	8	9	10	11	12																				
 <p>Bariatric HB Armless Bridge - Left & Right COM: 3.25 YD 2.97 M Unit weight: 44 LB 20 KG Carton weight: 50 LB 22.68 KG Carton volume: 26.5 FT³ 0.75 MT³</p>	GC4269HB	1310	1414	1502	1603	1768	1921	2074	2207	2373	2529	2740	3039																				
	Ganging/linking. Active weight 750 lbs. Not freestanding. Suspends between 2 units via linking brackets.	<table border="1"> <thead> <tr> <th colspan="3">OVERALL DIMENSIONS</th> <th colspan="3">SEAT DIMENSIONS</th> <th colspan="2">BACK DIMENSIONS</th> </tr> <tr> <th>W</th> <th>D</th> <th>H</th> <th>W</th> <th>D</th> <th>H</th> <th>W</th> <th>H</th> </tr> </thead> <tbody> <tr> <td>IN 37.5</td> <td>24</td> <td>30.5</td> <td>32.5</td> <td>18</td> <td>-</td> <td>32.5</td> <td>24.5</td> </tr> <tr> <td>MM 953</td> <td>610</td> <td>775</td> <td>826</td> <td>457</td> <td>-</td> <td>826</td> <td>622</td> </tr> </tbody> </table>	OVERALL DIMENSIONS			SEAT DIMENSIONS			BACK DIMENSIONS		W	D	H	W	D	H	W	H	IN 37.5	24	30.5	32.5	18	-	32.5	24.5	MM 953	610	775	826	457	-	826
OVERALL DIMENSIONS			SEAT DIMENSIONS			BACK DIMENSIONS																											
W	D	H	W	D	H	W	H																										
IN 37.5	24	30.5	32.5	18	-	32.5	24.5																										
MM 953	610	775	826	457	-	826	622																										

DESCRIPTION	MODEL# / FEATURES	STANDARD TEXTILE GRADES																															
		COM	2	3	4	5	6	7	8	9	10	11	12																				
 <p>Single Seat Bench Bridge - Left & Right COM: 1.5 YD 1.37 M Unit weight: 20 LB 9.1 KG Carton weight: 24 LB 10.89 KG Carton volume: 2.9 FT³ 0.08 MT³</p>	GC4271	718	766	807	853	930	1000	1071	1132	1209	1281	1378	1516																				
	Ganging/linking. Active weight 500 lbs. Not freestanding. Suspends between 2 units via linking brackets.	<table border="1"> <thead> <tr> <th colspan="3">OVERALL DIMENSIONS</th> <th colspan="3">SEAT DIMENSIONS</th> <th colspan="2">BACK DIMENSIONS</th> </tr> <tr> <th>W</th> <th>D</th> <th>H</th> <th>W</th> <th>D</th> <th>H</th> <th>W</th> <th>H</th> </tr> </thead> <tbody> <tr> <td>IN 24.75</td> <td>26.5</td> <td>6</td> <td>-</td> <td>-</td> <td>-</td> <td>-</td> <td>-</td> </tr> <tr> <td>MM 629</td> <td>673</td> <td>152</td> <td>-</td> <td>-</td> <td>-</td> <td>-</td> <td>-</td> </tr> </tbody> </table>	OVERALL DIMENSIONS			SEAT DIMENSIONS			BACK DIMENSIONS		W	D	H	W	D	H	W	H	IN 24.75	26.5	6	-	-	-	-	-	MM 629	673	152	-	-	-	-
OVERALL DIMENSIONS			SEAT DIMENSIONS			BACK DIMENSIONS																											
W	D	H	W	D	H	W	H																										
IN 24.75	26.5	6	-	-	-	-	-																										
MM 629	673	152	-	-	-	-	-																										

DESCRIPTION	MODEL# / FEATURES	STANDARD TEXTILE GRADES																															
		COM	2	3	4	5	6	7	8	9	10	11	12																				
 <p>Two Seat Bench Bridge - Left & Right COM: 2.25 YD 2.06 M Unit weight: 58 LB 26.4 KG Carton weight: 64 LB 29.03 KG Carton volume: 9.25 FT³ 0.26 MT³</p>	GC4272	1304	1376	1437	1507	1621	1727	1833	1925	2040	2148	2294	2501																				
	Ganging/linking. Active weight 500 lbs/seat. Not freestanding. Suspends between 2 units via linking brackets.	<table border="1"> <thead> <tr> <th colspan="3">OVERALL DIMENSIONS</th> <th colspan="3">SEAT DIMENSIONS</th> <th colspan="2">BACK DIMENSIONS</th> </tr> <tr> <th>W</th> <th>D</th> <th>H</th> <th>W</th> <th>D</th> <th>H</th> <th>W</th> <th>H</th> </tr> </thead> <tbody> <tr> <td>IN 49.75</td> <td>26.5</td> <td>6</td> <td>-</td> <td>-</td> <td>-</td> <td>-</td> <td>-</td> </tr> <tr> <td>MM 1264</td> <td>673</td> <td>152</td> <td>-</td> <td>-</td> <td>-</td> <td>-</td> <td>-</td> </tr> </tbody> </table>	OVERALL DIMENSIONS			SEAT DIMENSIONS			BACK DIMENSIONS		W	D	H	W	D	H	W	H	IN 49.75	26.5	6	-	-	-	-	-	MM 1264	673	152	-	-	-	-
OVERALL DIMENSIONS			SEAT DIMENSIONS			BACK DIMENSIONS																											
W	D	H	W	D	H	W	H																										
IN 49.75	26.5	6	-	-	-	-	-																										
MM 1264	673	152	-	-	-	-	-																										

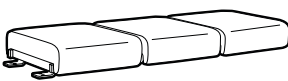
DESCRIPTION	MODEL# / FEATURES	STANDARD TEXTILE GRADES																															
		COM	2	3	4	5	6	7	8	9	10	11	12																				
 <p>Three Seat Bench Bridge - Left & Right COM: 3 YD 2.74 M Unit weight: 62 LB 28.2 KG Carton weight: 68 LB 30.84 KG Carton volume: 9.25 FT³ 0.26 MT³</p>	GC4273	1929	2025	2106	2199	2352	2493	2634	2757	2910	3054	3249	3525																				
	Ganging/linking. Active weight 500 lbs/seat. Not freestanding. Suspends between 2 units via linking brackets.	<table border="1"> <thead> <tr> <th colspan="3">OVERALL DIMENSIONS</th> <th colspan="3">SEAT DIMENSIONS</th> <th colspan="2">BACK DIMENSIONS</th> </tr> <tr> <th>W</th> <th>D</th> <th>H</th> <th>W</th> <th>D</th> <th>H</th> <th>W</th> <th>H</th> </tr> </thead> <tbody> <tr> <td>IN 72.75</td> <td>26.5</td> <td>6</td> <td>-</td> <td>-</td> <td>-</td> <td>-</td> <td>-</td> </tr> <tr> <td>MM 1848</td> <td>673</td> <td>152</td> <td>-</td> <td>-</td> <td>-</td> <td>-</td> <td>-</td> </tr> </tbody> </table>	OVERALL DIMENSIONS			SEAT DIMENSIONS			BACK DIMENSIONS		W	D	H	W	D	H	W	H	IN 72.75	26.5	6	-	-	-	-	-	MM 1848	673	152	-	-	-	-
OVERALL DIMENSIONS			SEAT DIMENSIONS			BACK DIMENSIONS																											
W	D	H	W	D	H	W	H																										
IN 72.75	26.5	6	-	-	-	-	-																										
MM 1848	673	152	-	-	-	-	-																										

DESCRIPTION	MODEL# / FEATURES	STANDARD TEXTILE GRADES																															
		COM	2	3	4	5	6	7	8	9	10	11	12																				
 <p>Two Seat Bench Bridge Center Table Top - Left & Right COM: 2.25 YD 2.06 M Unit weight: 28 LB 12.7 KG Carton weight: 32 LB 14.51 KG Carton volume: 9.25 FT³ 0.26 MT³</p>	GC4276	1886	1958	2019	2089	2203	2309	2415	2507	2622	2730	2876	3083																				
	Ganging/linking. Active weight 500 lbs/seat. Not freestanding. Suspends between 2 units via linking brackets.	<table border="1"> <thead> <tr> <th colspan="3">OVERALL DIMENSIONS</th> <th colspan="3">SEAT DIMENSIONS</th> <th colspan="2">BACK DIMENSIONS</th> </tr> <tr> <th>W</th> <th>D</th> <th>H</th> <th>W</th> <th>D</th> <th>H</th> <th>W</th> <th>H</th> </tr> </thead> <tbody> <tr> <td>IN 72.75</td> <td>26</td> <td>6</td> <td>-</td> <td>-</td> <td>-</td> <td>-</td> <td>-</td> </tr> <tr> <td>MM 1848</td> <td>660</td> <td>152</td> <td>-</td> <td>-</td> <td>-</td> <td>-</td> <td>-</td> </tr> </tbody> </table>	OVERALL DIMENSIONS			SEAT DIMENSIONS			BACK DIMENSIONS		W	D	H	W	D	H	W	H	IN 72.75	26	6	-	-	-	-	-	MM 1848	660	152	-	-	-	-
OVERALL DIMENSIONS			SEAT DIMENSIONS			BACK DIMENSIONS																											
W	D	H	W	D	H	W	H																										
IN 72.75	26	6	-	-	-	-	-																										
MM 1848	660	152	-	-	-	-	-																										

TABLE BRIDGES	MODEL #	DIMENSIONS ^{IN} _{MM}	WEIGHT ^{LB} _{KG}	VOLUME ^{FT³} _{MT³}	LIST PRICE
---------------	---------	---	---------------------------------------	---	------------



End Table Bridge, Not Freestanding

	W x D x H			
GC4274-LP	23 x 23 x 16 584 x 584 x 406	20 9.1	3.4 0.09	\$523
GC4274-HP	23 x 23 x 16 584 x 584 x 406	20 9.1	3.4 0.09	\$553

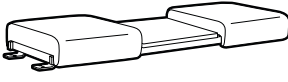
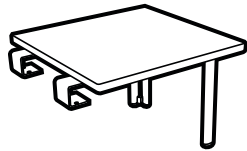
- For a thermally fused laminate top (LP), specify model GC4274-LP.
- For a high pressure laminate top (HP), specify model GC4274-HP.

1 end suspends to a seating unit via linking brackets. Coordinating 2mm edge. Oval steel tube legs. Reversible. 1 per carton.

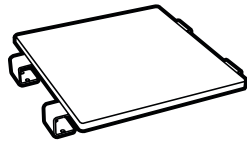

Square Table Top, Not Freestanding

GC4275-LP	23 x 23 x 1 584 x 584 x 25	14 6.4	3.4 0.09	\$347
GC4275-HP	23 x 23 x 1 584 x 584 x 25	14 6.4	3.4 0.09	\$375

- For a thermally fused laminate top (LP), specify model GC4275-LP.
- For a high pressure laminate top (HP), specify model GC4275-HP.

Suspends between two seating units via linking brackets. Coordinating 2mm edge. No legs. Reversible. 1 per carton.

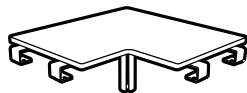

End Corner Table Bridge, Not Freestanding

GC4277-LP	35 x 35 x 16 889 x 889 x 406	40 18.2	6 0.16	\$543
GC4277-HP	35 x 35 x 16 889 x 889 x 406	40 18.2	6 0.16	\$611

- For a thermally fused laminate top (LP), specify model GC4277-LP.
- For a high pressure laminate top (HP), specify model GC4277-HP.

Suspends between two seating units via linking brackets. Coordinating 2mm edge. Oval steel tube legs. Can be used for right or left corner. 1 per carton.



End Corner Curve Table Bridge, Not Freestanding

GC4278-LP	35 x 35 x 16 889 x 889 x 406	40 18.2	6 0.16	\$543
GC4278-HP	35 x 35 x 16 889 x 889 x 406	40 18.2	6 0.16	\$611

- For a thermally fused laminate top (LP), specify model GC4278-LP.
- For a high pressure laminate top (HP), specify model GC4278-HP.

Suspends between two seating units via linking brackets. Coordinating 2mm edge. Oval steel tube legs. Can be used for right or left corner. 1 per carton.

GC CITI



model GC7875LTL (TBL)

Leg options



5" tubular metal leg (shown in Tungsten finish)



5" tapered, softened edge, wood leg (shown in Maple finish)

STANDARD FEATURES

- Fully upholstered contemporary design, complements timeless decor. Proportions are compact, 31" deep, works well in public spaces, lounges and lobbies.
- The steel leg brings a lightness of scale, while satisfying the need for accessibility.
- GC Citi seat and table legs are 5" high tubular metal, standard in a Tungsten finish.
- The seat is fastened into place and removable over an open frame structure eliminating all barriers and traps below the surface.
- The seat cushion is fully encased by the upholstery with a nylon zippered opening for access if replacement is required. This method of upholstery when using Crypton or vinyl textiles prevents the interior construction from contact with spills and body fluids that could affect the products long-term performance.
- All models have removable cushions. Cushions feature removable covers.
- The interior wood frame has an interlocking construction providing superior strength and long-term durability.
- Arm height on all models is 25".
- Casters are not available on this series.
- Citi table tops are available in either tempered glass or laminate. See the Global Seating list price book for details.
- Tablets are made from thermally fused laminate.
- Tablet arms measure 12"D x 16.5"W. Available right hand seated (RT), left hand seated (LT) or both right and left hand (LRT).
- For added comfort, seats are standard with high density Ultracell foam.
- Laminate tables and tablets are offered in the following finishes: Absolute Acajou (ACJ), Asian Night (ASN), Avant Cherry (AWC), Avant Honey (AWH), Black (BLK), Brushed Cobalt (BRC), Clear Maple (CMB), Dark Espresso (DES), Designer White (DWT), Fashionista (FAS), First Class (FCL), Quartered Mahogany (QTM), Noce Biondo (NBL), Noce Grigio (NGL), Noce Leggero (NEL), Noce Medio (NML), Sheer Beauty (SBY), Walnut Heights (WHE), White Chocolate (WHC) and Winter Cherry (WCR). Please specify.
- For healthcare textiles and wood finish options, visit the website at globalfurnituregroup.com.
- Can be upholstered in standard Global textiles if healthcare compliance is not required.
- Shipped fully assembled.

OPTIONAL FEATURES

- For two and three seat units with tablet arms, after the 6 digit model number:
 - Add (LTL) for left hand laminate tablet or (RTL) for right hand laminate tablet. Add \$412.
- To add sealed seams to your product contact Customer Service. Upcharges vary.
- For moisture barrier on seat, please specify (MB). Add \$122 per seat.
- Leg options:
 - (MTL) Cylindrical metal legs
Paint finishes. No upcharge.
 - (TBL) Black
(TTU) Tungsten
Plated finish. Add \$68.
 - (CHM) Chrome
 - (WDL) Non-cylindrical wood legs
Wood finishes. Add \$300.
 - (AAM) Absolute
(BKM) Black
(CJM) Charcoal Java
(ACM) Cherry
(EMM) Empire Mahogany
(EOM) English Oak
(ECM) Espresso Cafe
(TFM) Fruitwood
(HGM) Gray
(HOM) Harvest Oak
(AHM) Honey
(JOM) Jet Onyx
(LHM) Light Honey
(TMM) Mahogany
(AVM) Maple
 - (MWM) Medium Walnut
(NLW) Natural Walnut
(ASM) Night
(NBM) Noce Biondo
(NGM) Noce Grigio
(NEM) Noce Leggero
(NMM) Noce Medio
(SBM) Sandy Beach
(SKM) Shaker Cherry
(SOM) Silver Oak
(TWM) Walnut
(WTM) WC Cream
(WHM) White
(WCM) Winter Cherry



SUGGESTED APPLICATIONS

- Guest seating
- Lobbies
- Lounge/Waiting
- Resident rooms

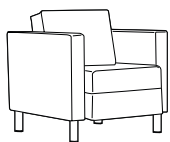
For matching tables, see Citi series in the Global Seating list price book.

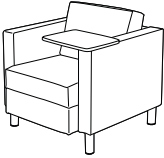
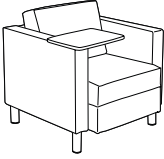
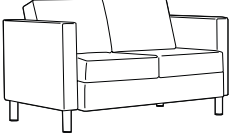
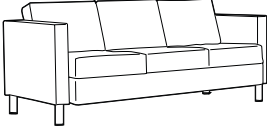
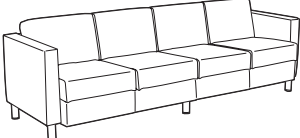
DESCRIPTION	MODEL# / FEATURES	STANDARD TEXTILE GRADES											
		COM	2	3	4	5	6	7	8	9	10	11	12
 <p>Lounge Chair COM: 4.75 YD 4.34 M Unit weight: 57 LB 25.9 KG Carton weight: 67 LB 30.39 KG Carton volume: 21 FT³ 0.59 MT³</p>	GC7875	1303	1455	1583	1731	1973	2196	2419	2614	2856	3084	3393	3830
	Active weight 300 lbs.												
		OVERALL DIMENSIONS			SEAT DIMENSIONS			BACK DIMENSIONS					
		W	D	H	W	D	H	W	D	H			
		IN 30	31	30	22	19.5	17.5	22	12.5				
		MM 762	787	762	559	495	445	559	318				
		RTA 00		1 per carton									

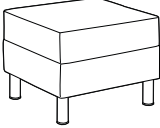
DESCRIPTION	MODEL# / FEATURES	STANDARD TEXTILE GRADES											
		COM	2	3	4	5	6	7	8	9	10	11	12
 <p>Lounge Chair w/Laminate Tablet - Left COM: 4.75 YD 4.34 M Unit weight: 65 LB 29.5 KG Carton weight: 78 LB 35.38 KG Carton volume: 22.5 FT³ 0.63 MT³</p>	GC7875LTL	1715	1867	1995	2143	2385	2608	2831	3026	3268	3496	3805	4242
		OVERALL DIMENSIONS			SEAT DIMENSIONS			BACK DIMENSIONS					
		W	D	H	W	D	H	W	H				
		IN 31.5 MM 800	33.5 851	30 762	22 559	19.5 495	17.5 445	22 559	12.5 318				
		RTA 2	1 per carton										
 <p>Lounge Chair w/Laminate Tablet - Right COM: 4.75 YD 4.34 M Unit weight: 65 LB 29.5 KG Carton weight: 75 LB 34.02 KG Carton volume: 22.5 FT³ 0.63 MT³</p>	GC7875RTL	1715	1867	1995	2143	2385	2608	2831	3026	3268	3496	3805	4242
		OVERALL DIMENSIONS			SEAT DIMENSIONS			BACK DIMENSIONS					
		W	D	H	W	D	H	W	H				
		IN 31.5 MM 800	33.5 851	30 762	22 559	19.5 495	17.5 445	22 559	12.5 318				
		RTA 00	1 per carton										
 <p>Two Seat Sofa COM: 7 YD 6.4 M Unit weight: 113 LB 51.4 KG Carton weight: 125 LB 56.7 KG Carton volume: 36 FT³ 1.01 MT³</p>	GC7876	1854	2078	2267	2485	2841	3170	3499	3786	4143	4479	4934	5578
		OVERALL DIMENSIONS			SEAT DIMENSIONS			BACK DIMENSIONS					
		W	D	H	W	D	H	W	H				
		IN 51.25 MM 1302	31 787	30 762	43.25 1099	19.5 495	17.5 445	43.25 1099	12.5 318				
		RTA 00	1 per carton										
 <p>Three Seat Sofa COM: 9 YD 8.23 M Unit weight: 149 LB 67.7 KG Carton weight: 163 LB 73.94 KG Carton volume: 50.25 FT³ 1.42 MT³</p>	GC7877	2417	2705	2948	3228	3686	4109	4532	4901	5360	5792	6377	7205
		OVERALL DIMENSIONS			SEAT DIMENSIONS			BACK DIMENSIONS					
		W	D	H	W	D	H	W	H				
		IN 72.5 MM 1842	31 787	30 762	64.5 1638	19.5 495	17.5 445	64.5 1638	12.5 318				
		RTA 00	1 per carton										
 <p>Four Seat Sofa COM: 11.5 YD 10.52 M Unit weight: 188 LB 85.5 KG Carton weight: 204 LB 92.53 KG Carton volume: 69 FT³ 1.95 MT³</p>	GC7878	3015	3383	3694	4050	4637	5177	5718	6189	6776	7328	8075	9133
		OVERALL DIMENSIONS			SEAT DIMENSIONS			BACK DIMENSIONS					
		W	D	H	W	D	H	W	H				
		IN 93.5 MM 2375	31 787	30 762	85.5 2172	19.5 495	17.5 445	85.5 2172	12.5 318				
		RTA 00	1 per carton										

DESCRIPTION	MODEL# / FEATURES	STANDARD TEXTILE GRADES											
		COM	2	3	4	5	6	7	8	9	10	11	12
 <p>Ottoman COM: 1.75 YD 1.6 M Unit weight: 23 LB 10.5 KG Carton weight: 27 LB 12.25 KG Carton volume: 7.5 FT³ 0.21 MT³</p>	GC7879	677	733	780	835	924	1006	1088	1160	1249	1333	1447	1608
	Active weight 300 lbs.	OVERALL DIMENSIONS W D H			SEAT DIMENSIONS W D H			BACK DIMENSIONS W H					
		IN 22	22	17	-	-	17	-	-				
		MM 559	559	432	-	-	432	-	-				
						1 per carton							

GC COMET



Black plastic arms



Wall saver leg

model GC2180 (TUN)

STANDARD FEATURES

- The rounded steel frame and durable seat cushion will ensure years of use.
- Black plastic arms are standard.
- Round tubular steel frame.
- Active weight capacity is up to 300 lbs. for standard models; 500 lbs. for bariatric models.
- For added comfort, seats are standard with high density Ultracell foam.
- Standard glide is a plastic dome shape on back legs, flat glide on front legs.
- Ganging hardware is available for standard models.
- Standard models stack 5 high on floor, 8 high on dolly.
- Bariatric models stack 2 high on floor. No dolly available.
- For healthcare textiles and finish options, visit the website at globalfurnituregroup.com.
- Can be upholstered in standard Global textiles if Healthcare compliance is not required.
- Shipped fully assembled.



OPTIONAL FEATURES

- Plastic arms available in Shadow (SHW) and Toast (TOA). Please specify. Add \$25.
- A selection of glide options is available. Glides must be chosen to best suit flooring type and site conditions. For more information, please refer to the glide section (page 274).
- For thick carpeted floors, request four dome/ball glides for ease of movement. No upcharge.
- Steel cushioned glides (B) are available on four-legged models. Add \$17.

- Glides with felt pads (FG) are available for vinyl sheet, cork or laminate flooring, please specify. Add \$43.
- Glides with rubber pads (RG) are available for vinyl, hardwood, laminate, stone or ceramic flooring, please specify. Add \$43.
- For improved housekeeping and infection control practices, please add (SU) to model number. The underside of the seat will be finished with vinyl and sealed to prevent penetration of liquids. For standard models: Add \$41. For bariatric models: Add \$59.
- For moisture barrier on seat, please specify (MB). Add \$81. Bariatric models: Add \$122.
- **Frame finish**
Paint finishes. No upcharge.
(TBL) Black (TIN) Ink
(TBZ) Buzz Blue (TKA) Kalua
(TCC) Cactus (TLA) Latte
(TCR) Carrot (TMO) Mocha
(TIV) Cloud (TNE) Nevada
(TDW) Designer White (TSN) Sand
(TDJ) Dijon (TSR) Scarlet
(TEG) Eggplant (TSH) Shadow
(TFO) Fog (TOA) Toast
(TFR) Frost (TTU) Tungsten
Plated finish. Add \$26.
(CHM) Chrome

SUGGESTED APPLICATIONS

- Bariatric seating
- Dining/Cafeteria
- Guest seating
- Lobbies
- Lounge/Waiting
- Office/Meeting
- Patient rooms
- Resident rooms
- Stacking
- Treatment/Exam

DESCRIPTION	MODEL# / FEATURES	STANDARD TEXTILE GRADES											
		COM	2	3	4	5	6	7	8	9	10	11	12
 <p>Medium Back Stacking Armchair COM: 1 YD 0.91 M Unit weight: 14 LB 6.4 KG Carton weight: 16.67 LB 7.56 KG Carton volume: 13.75 FT³ 0.38 MT³</p>	GC2173	377	409	436	467	518	565	612	653	704	752	817	909
		OVERALL DIMENSIONS			SEAT DIMENSIONS			BACK DIMENSIONS					
		W	D	H	W	D	H	W	H				
		IN	23	24.5	32	18	17	18.5	17.5	13.5			
	MM	584	622	813	457	432	470	445	343				
		<div style="border: 1px solid black; padding: 2px; display: inline-block;">RTA 00</div> 3 per carton (pricing and specifications are for one chair)											
 <p>High Back Stacking Armchair COM: 1.25 YD 1.14 M Unit weight: 15 LB 6.8 KG Carton weight: 18 LB 8.16 KG Carton volume: 17.75 FT³ 0.5 MT³</p>	GC2173HB	430	470	504	543	606	665	724	775	839	899	980	1095
		OVERALL DIMENSIONS			SEAT DIMENSIONS			BACK DIMENSIONS					
		W	D	H	W	D	H	W	H				
		IN	23	24.5	36.5	18	17.5	18	17.5	18			
	MM	584	622	927	457	445	457	445	457				
		<div style="border: 1px solid black; padding: 2px; display: inline-block;">RTA 00</div> 3 per carton (pricing and specifications are for one chair)											

DESCRIPTION MODEL# / FEATURES STANDARD TEXTILE GRADES



Medium Back Stacking Chair, Armless

COM: 1 YD | 0.91 M
 Unit weight: 13 LB | 5.9 KG
 Carton weight: 15.67 LB | 7.11 KG
 Carton volume: 14.25 FT³ | 0.4 MT³

Active weight 300 lbs.

Stacks 5 high on floor.
 Stacks 8 high on dolly.

COM	2	3	4	5	6	7	8	9	10	11	12
301	333	360	391	442	489	536	577	628	676	741	833

OVERALL DIMENSIONS			SEAT DIMENSIONS			BACK DIMENSIONS	
W	D	H	W	D	H	W	H

IN	20	24.5	32	18	17	18.5	17.5	13.5
MM	508	622	813	457	432	470	445	343

RTA 00 3 per carton (pricing and specifications are for one chair)



High Back Stacking Chair, Armless

COM: 1.25 YD | 1.14 M
 Unit weight: 14 LB | 6.4 KG
 Carton weight: 17 LB | 7.71 KG
 Carton volume: 17.75 FT³ | 0.5 MT³

Active weight 300 lbs.

Stacks 2 high on floor.
 Stacks 8 high on dolly.

COM	2	3	4	5	6	7	8	9	10	11	12
396	436	470	509	572	631	690	741	805	865	946	1061

OVERALL DIMENSIONS			SEAT DIMENSIONS			BACK DIMENSIONS	
W	D	H	W	D	H	W	H

IN	20	24.5	36.5	18	17.5	18	17.5	18
MM	508	622	927	457	445	457	445	457

RTA 00 3 per carton (pricing and specifications are for one chair)



Bariatric Stacking Armchair

COM: 1.75 YD | 1.6 M
 Unit weight: 35 LB | 15.9 KG
 Carton weight: 46 LB | 20.87 KG
 Carton volume: 26.75 FT³ | 0.75 MT³

Active weight 500 lbs.

Stacks 2 high on floor.
 (no dolly available)

COM	2	3	4	5	6	7	8	9	10	11	12
1135	1191	1238	1293	1382	1464	1546	1618	1707	1791	1905	2066

OVERALL DIMENSIONS			SEAT DIMENSIONS			BACK DIMENSIONS	
W	D	H	W	D	H	W	H

IN	31.5	27	38	26.5	18.5	18	26.5	20
MM	800	686	965	673	470	457	673	508

RTA 00 1 per carton



Square Medium Back Stacking Armchair

COM: 1 YD | 0.91 M
 Unit weight: 14 LB | 6.4 KG
 Carton weight: 17.33 LB | 7.86 KG
 Carton volume: 15.5 FT³ | 0.43 MT³

Active weight 300 lbs.

Stacks 5 high on floor.
 Stacks 8 high on dolly.

COM	2	3	4	5	6	7	8	9	10	11	12
377	409	436	467	518	565	612	653	704	752	817	909

OVERALL DIMENSIONS			SEAT DIMENSIONS			BACK DIMENSIONS	
W	D	H	W	D	H	W	H

IN	23	22.5	32	18	17.5	18	17.5	13.5
MM	584	572	813	457	445	457	445	343

RTA 00 3 per carton (pricing and specifications are for one chair)



Square High Back Stacking Armchair

COM: 1 YD | 0.91 M
 Unit weight: 15 LB | 6.8 KG
 Carton weight: 18.33 LB | 8.31 KG
 Carton volume: 15.5 FT³ | 0.43 MT³

Active weight 300 lbs.







Stacks 5 high on floor.
 Stacks 8 high on dolly.

COM	2	3	4	5	6	7	8	9	10	11	12
438	470	497	528	579	626	673	714	765	813	878	970

OVERALL DIMENSIONS			SEAT DIMENSIONS			BACK DIMENSIONS	
W	D	H	W	D	H	W	H

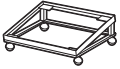
IN	23	22.5	35.5	18	17.5	18	17.5	17
MM	584	572	902	457	445	457	445	432

RTA 00 3 per carton (pricing and specifications are for one chair)

DESCRIPTION	MODEL# / FEATURES	STANDARD TEXTILE GRADES											
		COM	2	3	4	5	6	7	8	9	10	11	12
 <p>Square Medium Stacking Side Chair COM: 1 YD 0.91 M Unit weight: 13 LB 5.9 KG Carton weight: 16.33 LB 7.41 KG Carton volume: 15.5 FT³ 0.43 MT³</p>	GC2184	301	333	360	391	442	489	536	577	628	676	741	833
		OVERALL DIMENSIONS			SEAT DIMENSIONS			BACK DIMENSIONS					
		W	D	H	W	D	H	W	H				
		IN 20	22.5	32	18	17.5	18	17.5	13.5				
	MM 508	572	813	457	445	457	445	343					
		RTA 00 3 per carton (pricing and specifications are for one chair)											
 <p>Fan Back Stacking Armchair COM: 1.25 YD 1.14 M Unit weight: 19 LB 8.6 KG Carton weight: 24 LB 10.89 KG Carton volume: 15.5 FT³ 0.43 MT³</p>	GC2194	516	556	590	629	692	751	810	861	925	985	1066	1181
		OVERALL DIMENSIONS			SEAT DIMENSIONS			BACK DIMENSIONS					
		W	D	H	W	D	H	W	H				
		IN 23	24.5	35	18	16	18	18.5	16				
	MM 584	622	889	457	406	457	470	406					
		RTA 00 2 per carton (pricing and specifications are for one chair)											
 <p>Fan Back Stacking Side Chair COM: 1.25 YD 1.14 M Unit weight: 16 LB 7.3 KG Carton weight: 21 LB 9.53 KG Carton volume: 15.5 FT³ 0.43 MT³</p>	GC2195	445	485	519	558	621	680	739	790	854	914	995	1110
		OVERALL DIMENSIONS			SEAT DIMENSIONS			BACK DIMENSIONS					
		W	D	H	W	D	H	W	H				
		IN 20	24.5	35	18	16	18	18.5	16				
	MM 508	622	889	457	406	457	470	406					
		RTA 00 2 per carton (pricing and specifications are for one chair)											
 <p>Dolly COM: N/A Unit weight: 13 LB 5.9 KG Carton weight: 16 LB 7.26 KG Carton volume: 3.8 FT³ 0.1 MT³</p>	2125WS	List price											
		290											
		OVERALL DIMENSIONS			SEAT DIMENSIONS			BACK DIMENSIONS					
		W	D	H	W	D	H	W	H				
	IN 23.25	24.75	12.25	-	-	-	-	-					
	MM 591	629	311	-	-	-	-	-					
		RTA 00  1 per carton											
 <p>Snap On Ganging Brackets - Set of 2 COM: N/A Unit weight: 0.09 LB 0.04 KG Carton weight: 0.2 LB 0.09 KG Carton volume: 1 FT³ 0.02 MT³</p>	2180	List price											
		15											
		OVERALL DIMENSIONS			SEAT DIMENSIONS			BACK DIMENSIONS					
		W	D	H	W	D	H	W	H				
	IN 0.87	7.75	1.5	-	-	-	-	-					
	MM 22	197	38	-	-	-	-	-					
		RTA 00  1 per carton (pricing is for the set, specifications are for one bracket)											

GC ISLANDS



model GC4075



model GC4076

STANDARD FEATURES



- GC Islands offers wood guest seating with contemporary styling.
- Two back styles: Upholstered back pad or horizontal wood slat back.
- Legs are equipped with White non-marking polypropylene glides. Suitable for both carpet and hard surface flooring.
- All cushions are fixed and non-removable.
- Cushions are made with highly resilient foam and seats are equipped with a synthetic rubberized webbing suspension system for extra comfort.
- Seat cushion underside is finished with a Black impermeable surface material.
- Does not stack.
- Can be upholstered in standard Global textiles if healthcare compliance is not required.

OPTIONAL FEATURES

- Wood frame available in Absolute (AAM), Black (BKM), Cherry (ACM), English Oak (EOM), Espresso Cafe (ECM), Fruitwood (TFM), Gray (HGM), Honey (AHM), Mahogany (TMM), Maple (AVM), Medium Walnut (MWM), Natural Walnut (NLW), Night (ASM), Noce Biondo (NBM), Noce Grigio (NGM), Noce Leggero (NEM), Noce Medio (NMM), Sandy Beach (SGM), Shaker Cherry (SKM), Silver Oak (SOM), Walnut (TWM), WC Cream (WTM), White (WHM) and Winter Cherry (WCM).
- For moisture barrier on seat, please specify **(MB)**. Add \$81 per seat.
- Upholstered back sealed seam available, please specify **(S2)**. Add \$27.

SUGGESTED APPLICATIONS

- Dining/Cafeteria
- Guest seating
- Lobbies
- Lounge/Waiting
- Office/Meeting
- Patient rooms
- Resident rooms

DESCRIPTION	MODEL# / FEATURES	STANDARD TEXTILE GRADES											
		COM	2	3	4	5	6	7	8	9	10	11	12
 <p>Armchair - Upholstered Back COM: 1.5 YD 1.37 M Unit weight: 19 LB 8.6 KG Carton weight: 25 LB 11.34 KG Carton volume: 13.25 FT³ 0.37 MT³</p>	GC4075	856	904	945	991	1068	1138	1209	1270	1347	1419	1516	1654
	Active weight 300 lbs.												
	Does not stack.												
		RTA 00	1 per carton										
 <p>Armchair - Horizontal Wood Slat Back COM: 1 YD 0.91 M Unit weight: 19 LB 8.6 KG Carton weight: 25 LB 11.34 KG Carton volume: 13.25 FT³ 0.37 MT³</p>	GC4076	923	955	982	1013	1064	1111	1158	1199	1250	1298	1363	1455
	Active weight 300 lbs.												
	Does not stack.												
		RTA 00	1 per carton										

GC PRAIRIE



model GC3481



model GC3482

STANDARD FEATURES









- Features barrel shaped arms that provide an attractive and enticing appearance.
- GC Prairie is fully upholstered.
- Tapered wood skirt and legs.
- Removable cushions and covers.
- Elasticized seat suspension system for extra comfort built into cushions.
- Seamless front upholstery on the seat cushion prevents eventual breakdown of seams causing liquid penetration into the foam.
- For added comfort, seats are standard with high density Ultracell foam.
- For healthcare textiles and wood finish options, visit the website at globalfurnituregroup.com. Available in Maple wood species only (refer to finishes ending in "M").
- Can be upholstered in standard Global textiles if Healthcare compliance is not required.
- Shipped fully assembled.

OPTIONAL FEATURES

- For non-slip glides, please specify **(NS)**. Add \$22.
- Tapered wood legs are available in Absolute (AAM), Charcoal Java (CJM), Cherry (ACM), Empire Mahogany (EMM), English Oak (EOM), Espresso Cafe (ECM), Fruitwood (TFM), Gray (HGM), Harvest Oak (HOM), Honey (AHM), Jet Onyx (JOM), Light Honey (LHM), Mahogany (TMM), Maple (AVM), Medium Walnut (MWM), Natural Walnut (NLW), Night (ASM), Noce Biondo (NBM), Noce Grigio (NGM), Noce Leggero (NEM), Noce Medio (NMM), Sandy Beach (SBM), Silver Oak (SOM), Walnut (TWM), WC Cream (WTM), White (WHM) and Winter Cherry (WCM). Please specify. Genuine Maple faced veneers and solids are used.
- To add sealed seams to your product contact Customer Service. Upcharges vary.
- For moisture barrier on seat, please specify **(MB)**. See upcharges below.

SUGGESTED APPLICATIONS

- Lobbies
- Lounge/Waiting
- Resident rooms

DESCRIPTION	MODEL# / FEATURES	STANDARD TEXTILE GRADES																																								
		COM	2	3	4	5	6	7	8	9	10	11	12																													
 Lounge Chair COM: 4.5 YD 4.11 M Unit weight: 70 LB 31.8 KG Carton weight: 80 LB 36.29 KG Carton volume: 19.25 FT³ 0.54 MT³	GC3481	1516	1660	1782	1921	2151	2362	2574	2758	2988	3204	3496	3910																													
	<table border="1"> <thead> <tr> <th colspan="3">OVERALL DIMENSIONS</th> <th colspan="3">SEAT DIMENSIONS</th> <th colspan="2">BACK DIMENSIONS</th> </tr> <tr> <th>W</th> <th>D</th> <th>H</th> <th>W</th> <th>D</th> <th>H</th> <th>W</th> <th>H</th> </tr> </thead> <tbody> <tr> <td>IN 32</td> <td>29</td> <td>30.5</td> <td>21</td> <td>19</td> <td>16</td> <td>21</td> <td>14.5</td> </tr> <tr> <td>MM 813</td> <td>737</td> <td>775</td> <td>533</td> <td>483</td> <td>406</td> <td>533</td> <td>368</td> </tr> </tbody> </table>	OVERALL DIMENSIONS			SEAT DIMENSIONS			BACK DIMENSIONS		W	D	H	W	D	H	W	H	IN 32	29	30.5	21	19	16	21	14.5	MM 813	737	775	533	483	406	533	368	Active weight 300 lbs.	IN 32	29	30.5	21	19	16	21	14.5
	OVERALL DIMENSIONS			SEAT DIMENSIONS			BACK DIMENSIONS																																			
	W	D	H	W	D	H	W	H																																		
IN 32	29	30.5	21	19	16	21	14.5																																			
MM 813	737	775	533	483	406	533	368																																			
Add \$122 for (MB) .   1 per carton																																										
 Two Seat Sofa COM: 6.75 YD 6.17 M Unit weight: 96 LB 43.6 KG Carton weight: 106 LB 48.08 KG Carton volume: 41.25 FT³ 1.16 MT³	GC3482	2068	2284	2466	2676	3020	3337	3654	3931	4275	4599	5038	5659																													
	<table border="1"> <thead> <tr> <th colspan="3">OVERALL DIMENSIONS</th> <th colspan="3">SEAT DIMENSIONS</th> <th colspan="2">BACK DIMENSIONS</th> </tr> <tr> <th>W</th> <th>D</th> <th>H</th> <th>W</th> <th>D</th> <th>H</th> <th>W</th> <th>H</th> </tr> </thead> <tbody> <tr> <td>IN 52.5</td> <td>29</td> <td>30.5</td> <td>42</td> <td>19</td> <td>16</td> <td>42</td> <td>14.5</td> </tr> <tr> <td>MM 1334</td> <td>737</td> <td>775</td> <td>1067</td> <td>483</td> <td>406</td> <td>1067</td> <td>368</td> </tr> </tbody> </table>	OVERALL DIMENSIONS			SEAT DIMENSIONS			BACK DIMENSIONS		W	D	H	W	D	H	W	H	IN 52.5	29	30.5	42	19	16	42	14.5	MM 1334	737	775	1067	483	406	1067	368	Active weight 300 lbs/seat.	IN 52.5	29	30.5	42	19	16	42	14.5
	OVERALL DIMENSIONS			SEAT DIMENSIONS			BACK DIMENSIONS																																			
	W	D	H	W	D	H	W	H																																		
IN 52.5	29	30.5	42	19	16	42	14.5																																			
MM 1334	737	775	1067	483	406	1067	368																																			
Add \$245 for (MB) .   1 per carton																																										
 Three Seat Sofa COM: 10.75 YD 9.83 M Unit weight: 135 LB 61.4 KG Carton weight: 150 LB 68.04 KG Carton volume: 55.5 FT³ 1.57 MT³	GC3483	2610	2954	3244	3578	4126	4631	5136	5577	6125	6641	7340	8329																													
	<table border="1"> <thead> <tr> <th colspan="3">OVERALL DIMENSIONS</th> <th colspan="3">SEAT DIMENSIONS</th> <th colspan="2">BACK DIMENSIONS</th> </tr> <tr> <th>W</th> <th>D</th> <th>H</th> <th>W</th> <th>D</th> <th>H</th> <th>W</th> <th>H</th> </tr> </thead> <tbody> <tr> <td>IN 73.5</td> <td>29</td> <td>30.5</td> <td>63.5</td> <td>19</td> <td>16</td> <td>63.5</td> <td>14.5</td> </tr> <tr> <td>MM 1867</td> <td>737</td> <td>775</td> <td>1613</td> <td>483</td> <td>406</td> <td>1613</td> <td>368</td> </tr> </tbody> </table>	OVERALL DIMENSIONS			SEAT DIMENSIONS			BACK DIMENSIONS		W	D	H	W	D	H	W	H	IN 73.5	29	30.5	63.5	19	16	63.5	14.5	MM 1867	737	775	1613	483	406	1613	368	Active weight 300 lbs/seat.	IN 73.5	29	30.5	63.5	19	16	63.5	14.5
	OVERALL DIMENSIONS			SEAT DIMENSIONS			BACK DIMENSIONS																																			
	W	D	H	W	D	H	W	H																																		
IN 73.5	29	30.5	63.5	19	16	63.5	14.5																																			
MM 1867	737	775	1613	483	406	1613	368																																			
Add \$366 for (MB) .   1 per carton																																										

GC SIDERO



model GC6900

model GC6900HB



model GC6924

model GC6926

SEAT WIDTH	STACKING CAPABILITIES
19.5"	Four-legged armchairs and side chairs can stack up to 5 high on the floor or 8 high on dolly #2125WS. Sled base armchairs and side chairs do not stack.
24"	Four-legged armchairs and side chairs can stack up to 5 high on the floor, no dolly is available. Sled base armchairs and side chairs do not stack.
30" bariatric	Four-legged armchairs can stack up to 2 high on the floor, no dolly is available. Sled base models do not stack.

STANDARD FEATURES

- GC Sidero is a collection of contemporary multi-purpose stacking chairs with a sculpted look, featuring wide, curved arms, and a round tubular wall saver steel frame.
- Available in arm and armless models (except on bariatric models) with three seat widths, two back heights, and a four-legged and sled base frame.
- Offers options that allow the chair to meet rigorous infection prevention control requirements.
- Compound curved back provides comfort and support in multiple seated positions.
- Rugged steel frame made from round welded steel tubing with a 7/8" steel dia.
- Frames feature a wall saver design to prevent back contact with wall.
- Standard glide is durable Black polypropylene.
- For added comfort, seats are standard with high density Ultracell foam.
- Three seat widths: 19.5" (standard size), 24" (mid size) and 30" (bariatric).
- Two different back constructions are offered:
 - Concealed back attachment: two-piece back covering the back support brackets when fastened in place.
 - Single piece back with a pullover style upholstery cover and exposed support bracket fastened on the outer back.
- Low back and high back models are available:
 - Low back version is available on all three seat widths: 15.5" (394mm) high.
 - High back version on 19" and 24" seat widths: 21" (533mm) high.
 - High back version on bariatric 30" seat width: 21.75" (552mm) high.
- Fiberglass nylon reinforced arms have a generous width and extend to the front of the seat. They offer additional support and help to stabilize users as they sit or exit the chair. Available in Black only.
- Select GC Sidero models are equipped with a polypropylene seat shroud that helps avoid frame imprints on upholstered seats when chairs are stacked. Protective seat shroud is standard on all 19.5" seat width models.
- 30" bariatric and 24" seat width models do not have a seat shroud and are standard with a vinyl covered seat underside.
- For healthcare textiles and finish options, visit the website at globalfurnituregroup.com.
- Can be upholstered in standard Global textiles if Healthcare compliance is not required.

OPTIONAL FEATURES

- A selection of glide options is available. Glides must be chosen to best suit flooring type and site conditions. For more information, please refer to the glide section (page 274).
- For hard surface floors, please specify opaque non-marking glides (NM). No upcharge.
- To respond to higher expectations for housekeeping and infection control practices, single piece back underside and all seat pan undersides can be completely sealed and seat shroud (if standard on the model) would be removed.
 - For standard models with single piece back, please specify (BSS). Add \$51.
 - For standard models with concealed attachment back, please specify (SU). Add \$32.
 - For 24" width models with single piece back, please specify (BSS). Add \$58.
 - For 24" width models with concealed attachment back, please specify (SU). Add \$41.
 - For bariatric models with single piece back, please specify (BSS). Add \$73.
 - For bariatric models with concealed attachment back, please specify (SU). Add \$59.
- Steel cushioned glides (B) are available on four-legged models. Add \$17.
- Glides with felt pads (FG) are available for vinyl sheet, cork or laminate flooring, please specify. Add \$43.
- Glides with rubber pads (RG) are available for vinyl, hardwood, laminate, stone or ceramic flooring, please specify. Add \$43.
- For moisture barrier on seat, please specify (MB). See below for upcharges:
 - 19.5" seat width units: Add \$81.
 - 24" seat width units: Add \$81.
 - 30" seat width bariatric units: Add \$122.
- Frame finish**
Paint finishes. No upcharge.





(TBL) Black	(TMO) Mocha
(TIV) Cloud	(TNE) Nevada
(TDW) Designer White	(TSN) Sand
(TFO) Fog	(TSH) Shadow
(TFR) Frost	(TOA) Toast
(TKA) Kalua	(TTU) Tungsten
(TLA) Latte	





 Plated finish. Add \$26.
(CHM) Chrome

SUGGESTED APPLICATIONS

- Bariatric seating (some models)
- Dining/Cafeteria
- Guest seating
- Lobbies
- Lounge/Waiting
- Office/Meeting
- Patient rooms
- Resident rooms
- Stacking
- Treatment/Exam rooms

DESCRIPTION	MODEL# / FEATURES	STANDARD TEXTILE GRADES																																							
		COM	2	3	4	5	6	7	8	9	10	11	12																												
 <p>LB Concealed Attachment Armchair, Four-Legged COM: 1.25 YD 1.14 M Unit weight: 23 LB 10.5 KG Carton weight: 31.5 LB 14.29 KG Carton volume: 15.5 FT³ 0.43 MT³</p>	<p>Active weight 300 lbs.</p>	GC6900	491	531	565	604	667	726	785	836	900	960	1041	1156																											
		<table border="1"> <thead> <tr> <th colspan="3">OVERALL DIMENSIONS</th> <th colspan="3">SEAT DIMENSIONS</th> <th colspan="3">BACK DIMENSIONS</th> </tr> <tr> <th>W</th> <th>D</th> <th>H</th> <th>W</th> <th>D</th> <th>H</th> <th>W</th> <th>H</th> <th>H</th> </tr> </thead> <tbody> <tr> <td>IN 25.5</td> <td>24</td> <td>33</td> <td>19.5</td> <td>18</td> <td>17.5</td> <td>19</td> <td>15.5</td> <td>15.5</td> </tr> <tr> <td>MM 648</td> <td>610</td> <td>838</td> <td>495</td> <td>457</td> <td>445</td> <td>483</td> <td>394</td> <td>394</td> </tr> </tbody> </table>			OVERALL DIMENSIONS			SEAT DIMENSIONS			BACK DIMENSIONS			W	D	H	W	D	H	W	H	H	IN 25.5	24	33	19.5	18	17.5	19	15.5	15.5	MM 648	610	838	495	457	445	483	394	394	<p>RTA 00 1 per carton</p>
OVERALL DIMENSIONS			SEAT DIMENSIONS			BACK DIMENSIONS																																			
W	D	H	W	D	H	W	H	H																																	
IN 25.5	24	33	19.5	18	17.5	19	15.5	15.5																																	
MM 648	610	838	495	457	445	483	394	394																																	

DESCRIPTION	MODEL# / FEATURES	STANDARD TEXTILE GRADES											
 <p>HB Concealed Attachment Armchair, Four-Legged COM: 1.75 YD 1.6 M Unit weight: 25 LB 11.4 KG Carton weight: 34 LB 15.42 KG Carton volume: 17.75 FT³ 0.5 MT³</p>	COM	2	3	4	5	6	7	8	9	10	11	12	
	GC6900HB	596	652	699	754	843	925	1007	1079	1168	1252	1366	1527
	OVERALL DIMENSIONS			SEAT DIMENSIONS			BACK DIMENSIONS						
		W	D	H	W	D	H	W	H				
	IN 25.5 MM 648	24 610	38.5 978	19.5 495	18 457	17.5 445	19 483	21 533					
	RTA 00		1 per carton										
 <p>LB Concealed Attachment Side Chair, Four-Legged COM: 1.25 YD 1.14 M Unit weight: 20 LB 9.1 KG Carton weight: 28 LB 12.7 KG Carton volume: 13.75 FT³ 0.38 MT³</p>	COM	2	3	4	5	6	7	8	9	10	11	12	
	GC6901	462	502	536	575	638	697	756	807	871	931	1012	1127
	OVERALL DIMENSIONS			SEAT DIMENSIONS			BACK DIMENSIONS						
		W	D	H	W	D	H	W	H				
	IN 21 MM 533	24 610	33 838	19.5 495	18 457	17.5 445	19 483	15.5 394					
	RTA 00		1 per carton										
 <p>HB Concealed Attachment Side Chair, Four-Legged COM: 1.75 YD 1.6 M Unit weight: 22 LB 10 KG Carton weight: 31 LB 14.06 KG Carton volume: 17.75 FT³ 0.5 MT³</p>	COM	2	3	4	5	6	7	8	9	10	11	12	
	GC6901HB	566	622	669	724	813	895	977	1049	1138	1222	1336	1497
	OVERALL DIMENSIONS			SEAT DIMENSIONS			BACK DIMENSIONS						
		W	D	H	W	D	H	W	H				
	IN 21 MM 533	24 610	38.5 978	19.5 495	18 457	17.5 445	19 483	21 533					
	RTA 00		1 per carton										
 <p>LB Concealed Attachment Armchair, Sled Base COM: 1.25 YD 1.14 M Unit weight: 26 LB 11.8 KG Carton weight: 34.5 LB 15.65 KG Carton volume: 15.5 FT³ 0.43 MT³</p>	COM	2	3	4	5	6	7	8	9	10	11	12	
	GC6902	593	633	667	706	769	828	887	938	1002	1062	1143	1258
	OVERALL DIMENSIONS			SEAT DIMENSIONS			BACK DIMENSIONS						
		W	D	H	W	D	H	W	H				
	IN 25.5 MM 648	24 610	33 838	19.5 495	18 457	17.5 445	19 483	15.5 394					
	RTA 00		1 per carton										
 <p>HB Concealed Attachment Armchair, Sled Base COM: 1.75 YD 1.6 M Unit weight: 28 LB 12.7 KG Carton weight: 37 LB 16.78 KG Carton volume: 17.75 FT³ 0.5 MT³</p>	COM	2	3	4	5	6	7	8	9	10	11	12	
	GC6902HB	695	751	798	853	942	1024	1106	1178	1267	1351	1465	1626
	OVERALL DIMENSIONS			SEAT DIMENSIONS			BACK DIMENSIONS						
		W	D	H	W	D	H	W	H				
	IN 25.5 MM 648	24 610	38.5 978	19.5 495	18 457	17.5 445	19 483	21 533					
	RTA 00		1 per carton										

DESCRIPTION	MODEL# / FEATURES	STANDARD TEXTILE GRADES												
		COM	2	3	4	5	6	7	8	9	10	11	12	
 <p>LB Concealed Attachment Std Side Chair, Sled Base COM: 1.25 YD 1.14 M Unit weight: 24 LB 10.9 KG Carton weight: 32 LB 14.51 KG Carton volume: 13.75 FT³ 0.38 MT³</p>	GC6903 Active weight 300 lbs.	561	601	635	674	737	796	855	906	970	1030	1111	1226	
		OVERALL DIMENSIONS W D H			SEAT DIMENSIONS W D H			BACK DIMENSIONS W H						
		IN 21	24	33	19.5	18	17.5	19	15.5					
		MM 533	610	838	495	457	445	483	394					
		RTA 00		1 per carton										
 <p>HB Concealed Attachment Std Side Chair, Sled Base COM: 1.75 YD 1.6 M Unit weight: 26 LB 11.8 KG Carton weight: 35 LB 15.88 KG Carton volume: 17.75 FT³ 0.5 MT³</p>	GC6903HB Active weight 300 lbs.	663	719	766	821	910	992	1074	1146	1235	1319	1433	1594	
		OVERALL DIMENSIONS W D H			SEAT DIMENSIONS W D H			BACK DIMENSIONS W H						
		IN 21	24	38.5	19.5	18	17.5	19	21					
		MM 533	610	978	495	457	445	483	533					
		RTA 00		1 per carton										
 <p>Low Single Piece Back Std Side Chair, Four-Legged COM: 1.25 YD 1.14 M Unit weight: 20 LB 9.1 KG Carton weight: 28 LB 12.7 KG Carton volume: 13.75 FT³ 0.38 MT³</p>	GC6912 Active weight 300 lbs.	462	502	536	575	638	697	756	807	871	931	1012	1127	
		OVERALL DIMENSIONS W D H			SEAT DIMENSIONS W D H			BACK DIMENSIONS W H						
		IN 21	24	33	19.5	18	17.5	19	15.5					
		MM 533	610	838	495	457	445	483	394					
		RTA 00		1 per carton										
 <p>High Single Piece Back Std Side Chair, Four-Legged COM: 1.75 YD 1.6 M Unit weight: 22 LB 10 KG Carton weight: 31 LB 14.06 KG Carton volume: 17.75 FT³ 0.5 MT³</p>	GC6912HB Active weight 300 lbs.	566	622	669	724	813	895	977	1049	1138	1222	1336	1497	
		OVERALL DIMENSIONS W D H			SEAT DIMENSIONS W D H			BACK DIMENSIONS W H						
		IN 21	24	38.5	19.5	18	17.5	19	21					
		MM 533	610	978	495	457	445	483	533					
		RTA 00		1 per carton										
 <p>Low Single Piece Back Std Armchair, Four-Legged COM: 1.25 YD 1.14 M Unit weight: 23 LB 10.5 KG Carton weight: 31.5 LB 14.29 KG Carton volume: 15.5 FT³ 0.43 MT³</p>	GC6913 Active weight 300 lbs.	491	531	565	604	667	726	785	836	900	960	1041	1156	
		OVERALL DIMENSIONS W D H			SEAT DIMENSIONS W D H			BACK DIMENSIONS W H						
		IN 25.5	24	33	19.5	18	17.5	19	15.5					
		MM 648	610	838	495	457	445	483	394					
		RTA 00		1 per carton										

DESCRIPTION	MODEL# / FEATURES	STANDARD TEXTILE GRADES											
 <p>High Single Piece Back Std Armchair, Four-Legged COM: 1.75 YD 1.6 M Unit weight: 25 LB 11.4 KG Carton weight: 34 LB 15.42 KG Carton volume: 17.75 FT³ 0.5 MT³</p>	COM	2	3	4	5	6	7	8	9	10	11	12	
	GC6913HB	596	652	699	754	843	925	1007	1079	1168	1252	1366	1527
	OVERALL DIMENSIONS			SEAT DIMENSIONS			BACK DIMENSIONS						
		W	D	H	W	D	H	W	H				
<p>Active weight 300 lbs.</p> <p>IN 25.5 24 38.5 19.5 18 17.5 19 21 MM 648 610 978 495 457 445 483 533</p> <p>RTA 00 1 per carton</p>	COM	2	3	4	5	6	7	8	9	10	11	12	
	GC6914	593	633	667	706	769	828	887	938	1002	1062	1143	1258
	OVERALL DIMENSIONS			SEAT DIMENSIONS			BACK DIMENSIONS						
		W	D	H	W	D	H	W	H				
<p>Active weight 300 lbs.</p> <p>IN 25.5 24 33 19.5 18 17.5 19 15.5 MM 648 610 838 495 457 445 483 394</p> <p>RTA 00 1 per carton</p>	COM	2	3	4	5	6	7	8	9	10	11	12	
	GC6914HB	695	751	798	853	942	1024	1106	1178	1267	1351	1465	1626
	OVERALL DIMENSIONS			SEAT DIMENSIONS			BACK DIMENSIONS						
		W	D	H	W	D	H	W	H				
<p>Active weight 300 lbs.</p> <p>IN 25.5 24 38.5 19.5 18 17.5 19 21 MM 648 610 978 495 457 445 483 533</p> <p>RTA 00 1 per carton</p>	COM	2	3	4	5	6	7	8	9	10	11	12	
	GC6915	561	601	635	674	737	796	855	906	970	1030	1111	1226
	OVERALL DIMENSIONS			SEAT DIMENSIONS			BACK DIMENSIONS						
		W	D	H	W	D	H	W	H				
<p>Active weight 300 lbs.</p> <p>IN 21 24 33 19.5 18 17.5 19 15.5 MM 533 610 838 495 457 445 483 394</p> <p>RTA 00 1 per carton</p>	COM	2	3	4	5	6	7	8	9	10	11	12	
	GC6915HB	663	719	766	821	910	992	1074	1146	1235	1319	1433	1594
	OVERALL DIMENSIONS			SEAT DIMENSIONS			BACK DIMENSIONS						
		W	D	H	W	D	H	W	H				
<p>Active weight 300 lbs.</p> <p>IN 21 24 38.5 19.5 18 17.5 19 21 MM 533 610 978 495 457 445 483 533</p> <p>RTA 00 1 per carton</p>	COM	2	3	4	5	6	7	8	9	10	11	12	
	GC6915HB	663	719	766	821	910	992	1074	1146	1235	1319	1433	1594
	OVERALL DIMENSIONS			SEAT DIMENSIONS			BACK DIMENSIONS						
		W	D	H	W	D	H	W	H				

DESCRIPTION MODEL# / FEATURES STANDARD TEXTILE GRADES



GC6916	COM	2	3	4	5	6	7	8	9	10	11	12
---------------	-----	---	---	---	---	---	---	---	---	----	----	----

789	845	892	947	1036	1118	1200	1272	1361	1445	1559	1720
-----	-----	-----	-----	------	------	------	------	------	------	------	------

OVERALL DIMENSIONS			SEAT DIMENSIONS			BACK DIMENSIONS	
W	D	H	W	D	H	W	H

IN	30.5	24	33	24	18	17.5	24	15.5
MM	775	610	838	610	457	445	610	394

RTA 00 1 per carton

Low Single Piece Back Mid Size Armchair, Four-Legged
 COM: 1.75 YD | 1.6 M
 Unit weight: 26 LB | 11.8 KG
 Carton weight: 36 LB | 16.33 KG
 Carton volume: 23 FT³ | 0.65 MT³

Active weight 500 lbs.



GC6916HB	COM	2	3	4	5	6	7	8	9	10	11	12
-----------------	-----	---	---	---	---	---	---	---	---	----	----	----

878	942	996	1058	1160	1254	1348	1430	1532	1628	1758	1942
-----	-----	-----	------	------	------	------	------	------	------	------	------

OVERALL DIMENSIONS			SEAT DIMENSIONS			BACK DIMENSIONS	
W	D	H	W	D	H	W	H

IN	30.5	24	38.5	24	18	17.5	24	21
MM	775	610	978	610	457	445	610	533

RTA 00 1 per carton

High Single Piece Back Mid Size Armchair, Four-Legged
 COM: 2 YD | 1.83 M
 Unit weight: 29 LB | 13.2 KG
 Carton weight: 40 LB | 18.14 KG
 Carton volume: 26.75 FT³ | 0.75 MT³

Active weight 500 lbs.



GC6917	COM	2	3	4	5	6	7	8	9	10	11	12
---------------	-----	---	---	---	---	---	---	---	---	----	----	----

757	813	860	915	1004	1086	1168	1240	1329	1413	1527	1688
-----	-----	-----	-----	------	------	------	------	------	------	------	------

OVERALL DIMENSIONS			SEAT DIMENSIONS			BACK DIMENSIONS	
W	D	H	W	D	H	W	H

IN	26	24	33	24	18	17.5	24	15.5
MM	660	610	838	610	457	445	610	394

RTA 00 1 per carton

Low Single Piece Back Mid Size Side Chair, Four-Legged
 COM: 1.75 YD | 1.6 M
 Unit weight: 22 LB | 10 KG
 Carton weight: 30 LB | 13.61 KG
 Carton volume: 14.5 FT³ | 0.41 MT³

Active weight 500 lbs.

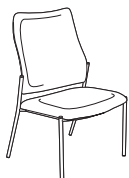

GC6917HB	COM	2	3	4	5	6	7	8	9	10	11	12
-----------------	-----	---	---	---	---	---	---	---	---	----	----	----

848	912	966	1028	1130	1224	1318	1400	1502	1598	1728	1912
-----	-----	-----	------	------	------	------	------	------	------	------	------

OVERALL DIMENSIONS			SEAT DIMENSIONS			BACK DIMENSIONS	
W	D	H	W	D	H	W	H

IN	26	24	38.5	24	18	17.5	24	21
MM	660	610	978	610	457	445	610	533

RTA 00 1 per carton

High Single Piece Back Mid Size Sidechair, Four-Legged
 COM: 2 YD | 1.83 M
 Unit weight: 25 LB | 11.4 KG
 Carton weight: 33 LB | 14.97 KG
 Carton volume: 17.75 FT³ | 0.5 MT³

Active weight 500 lbs.



GC6918	COM	2	3	4	5	6	7	8	9	10	11	12
---------------	-----	---	---	---	---	---	---	---	---	----	----	----

899	955	1002	1057	1146	1228	1310	1382	1471	1555	1669	1830
-----	-----	------	------	------	------	------	------	------	------	------	------





OVERALL DIMENSIONS			SEAT DIMENSIONS			BACK DIMENSIONS	
W	D	H	W	D	H	W	H





IN	30.5	24	33	24	18	17.5	24	15.5
MM	775	610	838	610	457	445	610	394





RTA 00 1 per carton

Low Single Piece Back Mid Size Armchair, Sled Base
 COM: 1.75 YD | 1.6 M
 Unit weight: 28 LB | 12.7 KG
 Carton weight: 38 LB | 17.24 KG
 Carton volume: 23 FT³ | 0.65 MT³

Active weight 500 lbs.

DESCRIPTION	MODEL# / FEATURES	STANDARD TEXTILE GRADES											
		COM	2	3	4	5	6	7	8	9	10	11	12
 <p>High Single Piece Back Mid Size Armchair, Sled Base COM: 2 YD 1.83 M Unit weight: 31 LB 14.1 KG Carton weight: 39 LB 17.69 KG Carton volume: 18.25 FT³ 0.51 MT³</p>	<p>Active weight 500 lbs.</p>	988	1052	1106	1168	1270	1364	1458	1540	1642	1738	1868	2052
		OVERALL DIMENSIONS			SEAT DIMENSIONS			BACK DIMENSIONS					
		W	D	H	W	D	H	W	H				
		IN 30.5 MM 775	24 610	38.5 978	24 610	18 457	17.5 445	24 610	21 533				
		RTA 00	1 per carton										
 <p>Low Single Piece Back Mid Size Sidechair, Sled Base COM: 1.75 YD 1.6 M Unit weight: 26 LB 11.8 KG Carton weight: 34 LB 15.42 KG Carton volume: 14.5 FT³ 0.41 MT³</p>	<p>Active weight 500 lbs.</p>	866	922	969	1024	1113	1195	1277	1349	1438	1522	1636	1797
		OVERALL DIMENSIONS			SEAT DIMENSIONS			BACK DIMENSIONS					
		W	D	H	W	D	H	W	H				
		IN 26 MM 660	24 610	33 838	24 610	18 457	17.5 445	24 610	15.5 394				
		RTA 00	1 per carton										
 <p>High Single Piece Back Mid Size Sidechair, Sled Base COM: 2 YD 1.83 M Unit weight: 28 LB 12.7 KG Carton weight: 37 LB 16.78 KG Carton volume: 17.75 FT³ 0.5 MT³</p>	<p>Active weight 500 lbs.</p>	957	1021	1075	1137	1239	1333	1427	1509	1611	1707	1837	2021
		OVERALL DIMENSIONS			SEAT DIMENSIONS			BACK DIMENSIONS					
		W	D	H	W	D	H	W	H				
		IN 26 MM 660	24 610	38.5 978	24 610	18 457	17.5 445	24 610	21 533				
		RTA 00	1 per carton										
 <p>Bariatric Low Single Piece Back Armchair, Four-Legged COM: 2.5 YD 2.29 M Unit weight: 36 LB 16.4 KG Carton weight: 46 LB 20.87 KG Carton volume: 20.5 FT³ 0.58 MT³</p>	<p>Active weight 500 lbs.</p>	1081	1161	1229	1306	1434	1551	1669	1771	1899	2019	2181	2411
		OVERALL DIMENSIONS			SEAT DIMENSIONS			BACK DIMENSIONS					
		W	D	H	W	D	H	W	H				
		IN 36.5 MM 927	26 660	33 838	30 762	18 457	17.5 445	30 762	15.5 394				
		RTA 00	1 per carton										
 <p>Bariatric High Single Piece Back Armchair, Four-Legged COM: 2.75 YD 2.51 M Unit weight: 37 LB 16.8 KG Carton weight: 47 LB 21.32 KG Carton volume: 22.5 FT³ 0.63 MT³</p>	<p>Active weight 500 lbs.</p>	1110	1198	1272	1358	1498	1627	1756	1869	2009	2141	2320	2573
		OVERALL DIMENSIONS			SEAT DIMENSIONS			BACK DIMENSIONS					
		W	D	H	W	D	H	W	H				
		IN 36.5 MM 927	26 660	38.5 978	30 762	18 457	17.5 445	30 762	21 533				
		RTA 00	1 per carton										

DESCRIPTION	MODEL# / FEATURES	STANDARD TEXTILE GRADES											
		COM	2	3	4	5	6	7	8	9	10	11	12
 Bariatric Low Single Piece Back Armchair, Sled Base COM: 2.5 YD 2.29 M Unit weight: 38 LB 17.3 KG Carton weight: 48 LB 21.77 KG Carton volume: 20.5 FT³ 0.58 MT³	Active weight 500 lbs. RTA 00 1 per carton	1188	1268	1336	1413	1541	1658	1776	1878	2006	2126	2288	2518
		OVERALL DIMENSIONS			SEAT DIMENSIONS			BACK DIMENSIONS					
		W	D	H	W	D	H	W	H				
		IN 36.5 MM 927	26 660	33 838	30 762	18 457	17.5 445	30 762	15.5 394				
 Bariatric High Single Piece Back Armchair, Sled Base COM: 2.75 YD 2.51 M Unit weight: 39 LB 17.7 KG Carton weight: 51 LB 23.13 KG Carton volume: 22.5 FT³ 0.63 MT³	Active weight 500 lbs. RTA 00 1 per carton	1218	1306	1380	1466	1606	1735	1864	1977	2117	2249	2428	2681
		OVERALL DIMENSIONS			SEAT DIMENSIONS			BACK DIMENSIONS					
		W	D	H	W	D	H	W	H				
		IN 36.5 MM 927	26 660	38.5 978	30 762	18 457	17.5 445	30 762	21 533				
 Bariatric LB Concealed Attachment Armchair, Sled Base COM: 2.5 YD 2.29 M Unit weight: 38 LB 17.3 KG Carton weight: 48 LB 21.77 KG Carton volume: 20.5 FT³ 0.58 MT³	Active weight 500 lbs. RTA 00 1 per carton	1188	1268	1336	1413	1541	1658	1776	1878	2006	2126	2288	2518
		OVERALL DIMENSIONS			SEAT DIMENSIONS			BACK DIMENSIONS					
		W	D	H	W	D	H	W	H				
		IN 36.5 MM 927	26 660	33 838	30 762	18 457	17.5 445	30 762	15.5 394				
 Bariatric HB Concealed Attachment Armchair, Sled Base COM: 2.5 YD 2.29 M Unit weight: 38 LB 17.3 KG Carton weight: 48 LB 21.77 KG Carton volume: 20.5 FT³ 0.58 MT³	Active weight 500 lbs. RTA 00 1 per carton	1210	1306	1387	1480	1633	1774	1915	2038	2191	2335	2530	2806
		OVERALL DIMENSIONS			SEAT DIMENSIONS			BACK DIMENSIONS					
		W	D	H	W	D	H	W	H				
		IN 36.5 MM 927	26 660	38.5 978	30 762	18 457	17.5 445	30 762	21 533				
 Bariatric LB Concealed Attachment Armchair, Four-Legged COM: 2.5 YD 2.29 M Unit weight: 36 LB 16.4 KG Carton weight: 46 LB 20.87 KG Carton volume: 20.5 FT³ 0.58 MT³	Active weight 500 lbs. RTA 00 1 per carton	1127	1207	1275	1352	1490	1597	1715	1817	1945	2065	2227	2457
		OVERALL DIMENSIONS			SEAT DIMENSIONS			BACK DIMENSIONS					
		W	D	H	W	D	H	W	H				
		IN 36.5 MM 927	26 660	33 838	30 762	18 457	17.5 445	30 762	15.5 394				

DESCRIPTION	MODEL# / FEATURES	STANDARD TEXTILE GRADES											
		COM	2	3	4	5	6	7	8	9	10	11	12
 <p>Bariatric HB Concealed Attachment Armchair, Four-Legged COM: 3 YD 2.74 M Unit weight: 37 LB 16.8 KG Carton weight: 47 LB 21.32 KG Carton volume: 22.5 FT³ 0.63 MT³</p>	GC6923HB	1148	1244	1325	1418	1571	1712	1853	1976	2129	2273	2468	2744
		OVERALL DIMENSIONS			SEAT DIMENSIONS			BACK DIMENSIONS					
		W	D	H	W	D	H	W	H				
		IN 36.5 MM 927	26 660	38.5 978	30 762	18 457	17.5 445	30 762	21 533				
		RTA 00	1 per carton										
 <p>LB Concealed Attachment Mid Size Armchair, Four-Legged COM: 2.5 YD 2.29 M Unit weight: 26 LB 11.8 KG Carton weight: 36 LB 16.33 KG Carton volume: 23 FT³ 0.63 MT³</p>	GC6924	765	845	913	990	1118	1235	1353	1455	1583	1703	1865	2095
		OVERALL DIMENSIONS			SEAT DIMENSIONS			BACK DIMENSIONS					
		W	D	H	W	D	H	W	H				
		IN 30.5 MM 775	24 610	33 838	24 610	18 457	17.5 445	24 610	15.5 394				
		RTA 00	1 per carton										
 <p>HB Concealed Attachment Mid Size Armchair, Four-Legged COM: 2.5 YD 2.51 M Unit weight: 29 LB 13.2 KG Carton weight: 41 LB 18.6 KG Carton volume: 26.75 FT³ 0.75 MT³</p>	GC6924HB	854	942	1016	1102	1242	1371	1500	1613	1753	1885	2064	2317
		OVERALL DIMENSIONS			SEAT DIMENSIONS			BACK DIMENSIONS					
		W	D	H	W	D	H	W	H				
		IN 30.5 MM 775	24 610	38.5 978	24 610	18 457	17.5 445	24 610	21 533				
		RTA 00	1 per carton										
 <p>LB Concealed Attachment Mid Size Sidechair, Four-Legged COM: 2.5 YD 2.29 M Unit weight: 22 LB 10 KG Carton weight: 30 LB 13.61 KG Carton volume: 14.5 FT³ 0.41 MT³</p>	GC6925	733	813	881	958	1086	1203	1321	1423	1551	1671	1833	2063
		OVERALL DIMENSIONS			SEAT DIMENSIONS			BACK DIMENSIONS					
		W	D	H	W	D	H	W	H				
		IN 26 MM 660	24 610	33 838	24 610	18 457	17.5 445	24 610	15.5 394				
		RTA 00	1 per carton										
 <p>HB Concealed Attachment Mid Size Sidechair, Four-Legged COM: 2.5 YD 2.51 M Unit weight: 25 LB 11.4 KG Carton weight: 35.5 LB 16.1 KG Carton volume: 24 FT³ 0.67 MT³</p>	GC6925HB	824	912	986	1072	1212	1341	1470	1583	1723	1855	2034	2287
		OVERALL DIMENSIONS			SEAT DIMENSIONS			BACK DIMENSIONS					
		W	D	H	W	D	H	W	H				
		IN 26 MM 660	24 610	38.5 978	24 610	18 457	17.5 445	24 610	21 533				
		RTA 00	1 per carton										

DESCRIPTION MODEL# / FEATURES STANDARD TEXTILE GRADES



GC6926	COM	2	3	4	5	6	7	8	9	10	11	12
---------------	-----	---	---	---	---	---	---	---	---	----	----	----

875	955	1023	1100	1228	1345	1463	1565	1693	1813	1975	2205
-----	-----	------	------	------	------	------	------	------	------	------	------

OVERALL DIMENSIONS			SEAT DIMENSIONS			BACK DIMENSIONS	
W	D	H	W	D	H	W	H

LB Concealed Attachment Mid Size Armchair, Sled Base
 COM: 2.5 YD | 2.29 M
 Unit weight: 28 LB | 12.7 KG
 Carton weight: 36 LB | 16.33 KG
 Carton volume: 16 FT³ | 0.45 MT³

Active weight 500 lbs.

IN	30.5	24	33	24	18	17.5	24	15.5
MM	775	610	838	610	457	445	610	394

RTA 00 1 per carton



GC6926HB	COM	2	3	4	5	6	7	8	9	10	11	12
-----------------	-----	---	---	---	---	---	---	---	---	----	----	----

964	1052	1126	1212	1352	1481	1610	1723	1863	1995	2174	2427
-----	------	------	------	------	------	------	------	------	------	------	------

OVERALL DIMENSIONS			SEAT DIMENSIONS			BACK DIMENSIONS	
W	D	H	W	D	H	W	H

HB Concealed Attachment Mid Size Armchair, Sled Base
 COM: 2.75 YD | 2.51 M
 Unit weight: 31 LB | 14.1 KG
 Carton weight: 42 LB | 19.05 KG
 Carton volume: 26.75 FT³ | 0.75 MT³

Active weight 500 lbs.

IN	30.5	24	38.5	24	18	17.5	24	21
MM	775	610	978	610	457	445	610	533

RTA 00 1 per carton



GC6927	COM	2	3	4	5	6	7	8	9	10	11	12
---------------	-----	---	---	---	---	---	---	---	---	----	----	----

842	922	990	1067	1195	1312	1430	1532	1660	1780	1942	2172
-----	-----	-----	------	------	------	------	------	------	------	------	------

OVERALL DIMENSIONS			SEAT DIMENSIONS			BACK DIMENSIONS	
W	D	H	W	D	H	W	H

LB Concealed Attachment Mid Size Sidechair, Sled Base
 COM: 2.5 YD | 2.29 M
 Unit weight: 26 LB | 11.8 KG
 Carton weight: 34 LB | 15.42 KG
 Carton volume: 14.5 FT³ | 0.41 MT³

Active weight 500 lbs.

IN	26	24	33	24	18	17.5	24	15.5
MM	660	610	838	610	457	445	610	394

RTA 00 1 per carton



GC6927HB	COM	2	3	4	5	6	7	8	9	10	11	12
-----------------	-----	---	---	---	---	---	---	---	---	----	----	----

933	1021	1095	1181	1321	1450	1579	1692	1832	1964	2143	2396
-----	------	------	------	------	------	------	------	------	------	------	------



OVERALL DIMENSIONS			SEAT DIMENSIONS			BACK DIMENSIONS	
W	D	H	W	D	H	W	H



HB Concealed Attachment Mid Size Sidechair, Sled Base
 COM: 2.75 YD | 2.51 M
 Unit weight: 28 LB | 12.7 KG
 Carton weight: 37 LB | 16.78 KG
 Carton volume: 17.75 FT³ | 0.5 MT³

Active weight 500 lbs.

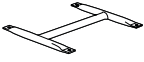
IN	26	24	38.5	24	18	17.5	24	21
MM	660	610	978	610	457	445	610	533

RTA 00 1 per carton

DESCRIPTION	MODEL# / FEATURES	STANDARD TEXTILE GRADES							
		List price							
	GC6928	84							
 <p>Metal Ganging Connector for Armchairs COM: N/A Unit weight: 2 LB 0.9 KG Carton weight: 4 LB 1.81 KG Carton volume: 0.4 FT³ 0.01 MT³</p>		OVERALL DIMENSIONS			SEAT DIMENSIONS			BACK DIMENSIONS	
		W	D		H	W	D	H	WH
	IN	12	13.75	1	-	-	-	-	-
	MM	305	349	25	-	-	-	-	-
		RTA 00							

		List price							
	GC6929	84							
 <p>Metal Ganging Connector for Armless Chairs COM: N/A Unit weight: 1.5 LB 0.7 KG Carton weight: 3.5 LB 1.59 KG Carton volume: 0.4 FT³ 0.01 MT³</p>		OVERALL DIMENSIONS			SEAT DIMENSIONS			BACK DIMENSIONS	
		W	D	H	W	D	H	W	H
	IN	7.87	13.75	1	-	-	-	-	-
	MM	200	349	25	-	-	-	-	-
		RTA 00							

GC SIRENA



model GC3380



model GC3380CTRL

STANDARD FEATURES

- A modern take on a classic design, GC Sirena remains relevant, charming and diverse offering simple, clean, flexible lines that will complement and create a sense of warmth in any room. The soft curves and comfortable fit make it the right solution for relaxation or meetings.
- Models are available with complementary round bun shaped foot design or swivel casters in Black only.
- For tablet models, please specify left hand or right hand tablet at time of order (determined from the seated position). See models below.
- Tablets rotate and are non-removable. Overall tablet size is 17"W by 14"D.
- Laminate tablet surfaces are 1.5" thick.
- **(C1M)** dual wheel carpet casters are standard on select models.
- The interior wood frame is an interlocking construction providing superior strength and long-term durability.
- Clean out space is provided around the seat pan for easy housekeeping and infection prevention practices.
- Seat cushion can be removed if replacement is required.
- For added comfort, seats are standard with high density Ultracell foam.
- For textile options, visit the Healthcare vertical section on globalfurnituregroup.com.
- Can be upholstered in standard Global textiles if Healthcare compliance is not required.

OPTIONAL FEATURES

- Laminate tablets are offered in the following laminate finishes: Absolute Acajou (ACJ), Asian Night (ASN), Avant Cherry (AWC), Avant Honey (AWH), Black (BLK), Blizzard (BZD) Brushed Cobalt (BRC), Clear Maple (CMB), Custom Grey (CGY), Dark Espresso (DES), Designer White (DWT), Fashionista (FAS), First Class (FCL), Quartered Mahogany (QTM), Noce Biondo (NBL), Noce Grigio (NGL), Noce Leggero (NEL), Noce Medio (NML), Sheer Beauty (SBY), Stonedust (SDT) Walnut Heights (WHE), White Chocolate (WHC) and Winter Cherry (WCR). Please specify.
- For less demanding areas, models are available with a tapered cylindrical 3 ¾ high wood leg to create a 19" seat height for models GC3380 and GC3380-CW. Add \$366.
- To add sealed seams to your product contact Customer Service. Upcharges vary.
- For moisture barrier on seat, please specify **(MB)**. Add \$122.

SUGGESTED APPLICATIONS

- Dining/Cafeteria
- Guest seating
- Lobbies
- Lounge/Waiting
- Office/Meeting
- Patient rooms
- Resident rooms

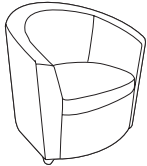
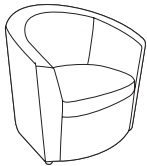
DESCRIPTION	MODEL# / FEATURES	STANDARD TEXTILE GRADES											
		COM	2	3	4	5	6	7	8	9	10	11	12
 <p>Club Chair w/Seat Clean Out COM: 4.25 YD 3.89 M Unit weight: 45 LB 20.5 KG Carton weight: 52 LB 23.59 KG Carton volume: 19.25 FT³ 0.54 MT³</p>	GC3380	1152	1288	1403	1535	1751	1951	2151	2325	2542	2746	3022	3413
		OVERALL DIMENSIONS			SEAT DIMENSIONS			BACK DIMENSIONS					
		W	D	H	W	D	H	W	H				
		IN	30.5	29.5	28.5	20	20	17.5	19	11.5			
	MM	775	749	724	508	508	445	483	292				
	RTA 00	1 per carton											
 <p>Club Chair on Casters w/Seat Clean Out COM: 4.25 YD 3.89 M Unit weight: 47 LB 21.4 KG Carton weight: 52 LB 23.59 KG Carton volume: 19.25 FT³ 0.54 MT³</p>	GC3380C	1242	1378	1493	1625	1841	2041	2241	2415	2632	2836	3112	3503
		OVERALL DIMENSIONS			SEAT DIMENSIONS			BACK DIMENSIONS					
		W	D	H	W	D	H	W	H				
		IN	30.5	29.5	29.5	20	20	18	19	12.5			
	MM	775	749	749	508	508	457	483	318				
	RTA 00	1 per carton											

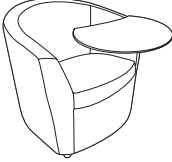
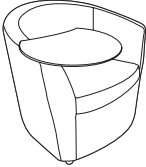
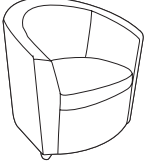
DESCRIPTION	MODEL# / FEATURES	STANDARD TEXTILE GRADES																																											
		COM	2	3	4	5	6	7	8	9	10	11	12																																
 <p>Club Chair on Casters w/Seat Clean Out and LP Tablet - Left COM: 4.25 YD 3.89 M Unit weight: 57 LB 25.9 KG Carton weight: 62 LB 28.12 KG Carton volume: 19.25 FT³ 0.54 MT³</p>	<p>Active weight 300 lbs.</p>	GC3380CLTL	1652	1788	1903	2035	2251	2451	2651	2825	3042	3246	3522	3913																															
		<table border="1"> <thead> <tr> <th colspan="3">OVERALL DIMENSIONS</th> <th colspan="3">SEAT DIMENSIONS</th> <th colspan="2">BACK DIMENSIONS</th> </tr> <tr> <th>W</th> <th>D</th> <th>H</th> <th>W</th> <th>D</th> <th>H</th> <th>W</th> <th>H</th> </tr> </thead> <tbody> <tr> <td>IN 32</td> <td>29.5</td> <td>29.5</td> <td>20</td> <td>20</td> <td>18</td> <td>19</td> <td>12.5</td> </tr> <tr> <td>MM 813</td> <td>749</td> <td>749</td> <td>508</td> <td>508</td> <td>457</td> <td>483</td> <td>318</td> </tr> </tbody> </table>			OVERALL DIMENSIONS			SEAT DIMENSIONS			BACK DIMENSIONS		W	D	H	W	D	H	W	H	IN 32	29.5	29.5	20	20	18	19	12.5	MM 813	749	749	508	508	457	483	318	<p>RTA 00 1 per carton</p>								
		OVERALL DIMENSIONS			SEAT DIMENSIONS			BACK DIMENSIONS																																					
		W	D	H	W	D	H	W	H																																				
		IN 32	29.5	29.5	20	20	18	19	12.5																																				
MM 813	749	749	508	508	457	483	318																																						
<table border="1"> <thead> <tr> <th>COM</th> <th>2</th> <th>3</th> <th>4</th> <th>5</th> <th>6</th> <th>7</th> <th>8</th> <th>9</th> <th>10</th> <th>11</th> <th>12</th> </tr> </thead> <tbody> <tr> <td>1652</td> <td>1788</td> <td>1903</td> <td>2035</td> <td>2251</td> <td>2451</td> <td>2651</td> <td>2825</td> <td>3042</td> <td>3246</td> <td>3522</td> <td>3913</td> </tr> </tbody> </table>														COM	2	3	4	5	6	7	8	9	10	11	12	1652	1788	1903	2035	2251	2451	2651	2825	3042	3246	3522	3913								
COM	2	3	4	5	6	7	8	9	10	11	12																																		
1652	1788	1903	2035	2251	2451	2651	2825	3042	3246	3522	3913																																		
<table border="1"> <thead> <tr> <th colspan="3">OVERALL DIMENSIONS</th> <th colspan="3">SEAT DIMENSIONS</th> <th colspan="2">BACK DIMENSIONS</th> </tr> <tr> <th>W</th> <th>D</th> <th>H</th> <th>W</th> <th>D</th> <th>H</th> <th>W</th> <th>H</th> </tr> </thead> <tbody> <tr> <td>IN 32</td> <td>29.5</td> <td>29.5</td> <td>20</td> <td>20</td> <td>18</td> <td>19</td> <td>12.5</td> </tr> <tr> <td>MM 813</td> <td>749</td> <td>749</td> <td>508</td> <td>508</td> <td>457</td> <td>483</td> <td>318</td> </tr> </tbody> </table>														OVERALL DIMENSIONS			SEAT DIMENSIONS			BACK DIMENSIONS		W	D	H	W	D	H	W	H	IN 32	29.5	29.5	20	20	18	19	12.5	MM 813	749	749	508	508	457	483	318
OVERALL DIMENSIONS			SEAT DIMENSIONS			BACK DIMENSIONS																																							
W	D	H	W	D	H	W	H																																						
IN 32	29.5	29.5	20	20	18	19	12.5																																						
MM 813	749	749	508	508	457	483	318																																						
<p>RTA 00 1 per carton</p>																																													
 <p>Club Chair on Casters w/Seat Clean Out and LP Tablet - Right COM: 4.25 YD 3.89 M Unit weight: 57 LB 25.9 KG Carton weight: 62 LB 28.12 KG Carton volume: 19.25 FT³ 0.54 MT³</p>	<p>Active weight 300 lbs.</p>	GC3380CRTL	1652	1788	1903	2035	2251	2451	2651	2825	3042	3246	3522	3913																															
		<table border="1"> <thead> <tr> <th colspan="3">OVERALL DIMENSIONS</th> <th colspan="3">SEAT DIMENSIONS</th> <th colspan="2">BACK DIMENSIONS</th> </tr> <tr> <th>W</th> <th>D</th> <th>H</th> <th>W</th> <th>D</th> <th>H</th> <th>W</th> <th>H</th> </tr> </thead> <tbody> <tr> <td>IN 32</td> <td>29.5</td> <td>29.5</td> <td>20</td> <td>20</td> <td>18</td> <td>19</td> <td>12.5</td> </tr> <tr> <td>MM 813</td> <td>749</td> <td>749</td> <td>508</td> <td>508</td> <td>457</td> <td>483</td> <td>318</td> </tr> </tbody> </table>			OVERALL DIMENSIONS			SEAT DIMENSIONS			BACK DIMENSIONS		W	D	H	W	D	H	W	H	IN 32	29.5	29.5	20	20	18	19	12.5	MM 813	749	749	508	508	457	483	318	<p>RTA 00 1 per carton</p>								
		OVERALL DIMENSIONS			SEAT DIMENSIONS			BACK DIMENSIONS																																					
		W	D	H	W	D	H	W	H																																				
		IN 32	29.5	29.5	20	20	18	19	12.5																																				
MM 813	749	749	508	508	457	483	318																																						
<table border="1"> <thead> <tr> <th>COM</th> <th>2</th> <th>3</th> <th>4</th> <th>5</th> <th>6</th> <th>7</th> <th>8</th> <th>9</th> <th>10</th> <th>11</th> <th>12</th> </tr> </thead> <tbody> <tr> <td>1652</td> <td>1788</td> <td>1903</td> <td>2035</td> <td>2251</td> <td>2451</td> <td>2651</td> <td>2825</td> <td>3042</td> <td>3246</td> <td>3522</td> <td>3913</td> </tr> </tbody> </table>														COM	2	3	4	5	6	7	8	9	10	11	12	1652	1788	1903	2035	2251	2451	2651	2825	3042	3246	3522	3913								
COM	2	3	4	5	6	7	8	9	10	11	12																																		
1652	1788	1903	2035	2251	2451	2651	2825	3042	3246	3522	3913																																		
<table border="1"> <thead> <tr> <th colspan="3">OVERALL DIMENSIONS</th> <th colspan="3">SEAT DIMENSIONS</th> <th colspan="2">BACK DIMENSIONS</th> </tr> <tr> <th>W</th> <th>D</th> <th>H</th> <th>W</th> <th>D</th> <th>H</th> <th>W</th> <th>H</th> </tr> </thead> <tbody> <tr> <td>IN 32</td> <td>29.5</td> <td>29.5</td> <td>20</td> <td>20</td> <td>18</td> <td>19</td> <td>12.5</td> </tr> <tr> <td>MM 813</td> <td>749</td> <td>749</td> <td>508</td> <td>508</td> <td>457</td> <td>483</td> <td>318</td> </tr> </tbody> </table>														OVERALL DIMENSIONS			SEAT DIMENSIONS			BACK DIMENSIONS		W	D	H	W	D	H	W	H	IN 32	29.5	29.5	20	20	18	19	12.5	MM 813	749	749	508	508	457	483	318
OVERALL DIMENSIONS			SEAT DIMENSIONS			BACK DIMENSIONS																																							
W	D	H	W	D	H	W	H																																						
IN 32	29.5	29.5	20	20	18	19	12.5																																						
MM 813	749	749	508	508	457	483	318																																						
<p>RTA 00 1 per carton</p>																																													
 <p>Weighted Club Chair w/Seat Clean Out COM: 4.25 YD 3.89 M Unit weight: 98 LB 44.5 KG Carton weight: 108 LB 48.99 KG Carton volume: 19.25 FT³ 0.54 MT³</p>	<p>Active weight 300 lbs.</p>	GC3380-CW	1419	1555	1670	1802	2018	2218	2418	2592	2809	3013	3289	3680																															
		<table border="1"> <thead> <tr> <th colspan="3">OVERALL DIMENSIONS</th> <th colspan="3">SEAT DIMENSIONS</th> <th colspan="2">BACK DIMENSIONS</th> </tr> <tr> <th>W</th> <th>D</th> <th>H</th> <th>W</th> <th>D</th> <th>H</th> <th>W</th> <th>H</th> </tr> </thead> <tbody> <tr> <td>IN 30.5</td> <td>29.5</td> <td>28.5</td> <td>20</td> <td>20</td> <td>17.5</td> <td>19</td> <td>11.5</td> </tr> <tr> <td>MM 775</td> <td>749</td> <td>724</td> <td>508</td> <td>508</td> <td>445</td> <td>483</td> <td>292</td> </tr> </tbody> </table>			OVERALL DIMENSIONS			SEAT DIMENSIONS			BACK DIMENSIONS		W	D	H	W	D	H	W	H	IN 30.5	29.5	28.5	20	20	17.5	19	11.5	MM 775	749	724	508	508	445	483	292	<p>RTA 00 1 per carton</p>								
		OVERALL DIMENSIONS			SEAT DIMENSIONS			BACK DIMENSIONS																																					
		W	D	H	W	D	H	W	H																																				
		IN 30.5	29.5	28.5	20	20	17.5	19	11.5																																				
MM 775	749	724	508	508	445	483	292																																						
<table border="1"> <thead> <tr> <th>COM</th> <th>2</th> <th>3</th> <th>4</th> <th>5</th> <th>6</th> <th>7</th> <th>8</th> <th>9</th> <th>10</th> <th>11</th> <th>12</th> </tr> </thead> <tbody> <tr> <td>1419</td> <td>1555</td> <td>1670</td> <td>1802</td> <td>2018</td> <td>2218</td> <td>2418</td> <td>2592</td> <td>2809</td> <td>3013</td> <td>3289</td> <td>3680</td> </tr> </tbody> </table>														COM	2	3	4	5	6	7	8	9	10	11	12	1419	1555	1670	1802	2018	2218	2418	2592	2809	3013	3289	3680								
COM	2	3	4	5	6	7	8	9	10	11	12																																		
1419	1555	1670	1802	2018	2218	2418	2592	2809	3013	3289	3680																																		
<table border="1"> <thead> <tr> <th colspan="3">OVERALL DIMENSIONS</th> <th colspan="3">SEAT DIMENSIONS</th> <th colspan="2">BACK DIMENSIONS</th> </tr> <tr> <th>W</th> <th>D</th> <th>H</th> <th>W</th> <th>D</th> <th>H</th> <th>W</th> <th>H</th> </tr> </thead> <tbody> <tr> <td>IN 30.5</td> <td>29.5</td> <td>28.5</td> <td>20</td> <td>20</td> <td>17.5</td> <td>19</td> <td>11.5</td> </tr> <tr> <td>MM 775</td> <td>749</td> <td>724</td> <td>508</td> <td>508</td> <td>445</td> <td>483</td> <td>292</td> </tr> </tbody> </table>														OVERALL DIMENSIONS			SEAT DIMENSIONS			BACK DIMENSIONS		W	D	H	W	D	H	W	H	IN 30.5	29.5	28.5	20	20	17.5	19	11.5	MM 775	749	724	508	508	445	483	292
OVERALL DIMENSIONS			SEAT DIMENSIONS			BACK DIMENSIONS																																							
W	D	H	W	D	H	W	H																																						
IN 30.5	29.5	28.5	20	20	17.5	19	11.5																																						
MM 775	749	724	508	508	445	483	292																																						
<p>RTA 00 1 per carton</p>																																													

GC SONIC



model GC6508WS



model GC6525WS

STANDARD FEATURES

- GC Sonic offers a large variety of solutions for patient rooms, public and reception areas and activity rooms, either as stand-alone or as a beam seating solution.
- The versatility continues with plastic or upholstered seat/back options. For convenience and additional space, the four-legged models stack.
- Four-legged/freestanding models are standard with a straight leg or with a “WS” wall saver frame in Chrome and durable polypropylene glides.
- “WS” models have a wall saver frame design; rear legs hit the baseboard first leaving clearance between the back of the chair and the wall, saving both the chair and the wall from damage.
- Four-legged/freestanding models are stackable up to 5 high on floor and 10 high on dolly 6517WS.
- Upholstered chairs have a polypropylene seat shroud to prevent imprints on the upholstery on the seat below when they are stacked.
- Units available with or without arms. Arms available in Black finish.
- For healthcare textiles, visit the website at globalfurnituregroup.com.
- Can be upholstered in standard Global textiles if Healthcare compliance is not required.
- Shipped fully assembled.

SUGGESTED APPLICATIONS

- Dining/Cafeteria
- Guest seating
- Lobbies
- Lounge/Waiting
- Office/Meeting
- Patient rooms
- Resident rooms
- Stacking
- Treatment/Exam rooms

OPTIONAL FEATURES

- Polypropylene seats and backs are available in 14 designer colors: Buzz Blue (B2B), Cactus (CCT), Carrot (CRO), Cloud (IVC), Dijon (DJN), Eggplant (EGP), Fog (FOG), Frost (FRO), Ink (INK), Latte (LAB), Night (BLK), Sand (SND), Scarlet (SAR) and Shadow (SHW). Please specify.
- A selection of glide options is available. Glides must be chosen to best suit flooring type and site conditions. For more information, please refer to the glide section (page 274).
- For hard surface floors, please specify opaque non-marking glides (NM). No upcharge.
- Steel cushioned glides (B) are available on four-legged chairs. Add \$17.
- Glides with felt pads (FG) are available for vinyl sheet, cork or laminate flooring, please specify. Add \$43.
- Glides with rubber pads (RG) are available for vinyl, hardwood, laminate, stone or ceramic flooring, please specify. Add \$43.
- For highly resilient, high density Ultracell foam seat, please specify (UC). Add \$15.
- For moisture barrier on seat, please specify (MB). Add \$81.
- **Frame finish**
Paint finishes. No upcharge.
(TBL) Black (TIN) Ink
(TBZ) Buzz Blue (TKA) Kalua
(TCC) Cactus (TLA) Latte
(TCR) Carrot (TMO) Mocha
(TIV) Cloud (TNE) Nevada
(TDW) Designer White (TSN) Sand
(TDJ) Dijon (TSR) Scarlet
(TEG) Eggplant (TSH) Shadow
(TFO) Fog (TOA) Toast
(TFR) Frost (TTU) Tungsten
Plated finish. No upcharge.
(CHM) Chrome

DESCRIPTION MODEL# / FEATURES STANDARD TEXTILE GRADES



GC6508



GC6508WS

Armless Chair
COM: N/A
Unit weight: 7.5 LB | 3.4 KG
Carton weight: 11.5 LB | 5.22 KG
Carton volume: 13.75 FT³ | 0.38 MT³

List price	
GC6508	213
GC6508WS	241

Active weight 300 lbs.
Polypropylene seat & back.

	OVERALL DIMENSIONS			SEAT DIMENSIONS			BACK DIMENSIONS	
	W	D	H	W	D	H	W	H
IN	21.5	22	33	17	16	18	17	15
MM	546	559	838	432	406	457	432	381

RTA 00 2 per carton (pricing and specifications are for one chair)



GC6509



GC6509WS











Armless Chair
COM: 0.75 YD | 0.69 M
Unit weight: 10 LB | 4.5 KG
Carton weight: 12.5 LB | 5.67 KG
Carton volume: 11.75 FT³ | 0.33 MT³

COM	2	3	4	5	6	7	8	9	10	11	12	
GC6509	272	296	316	340	378	413	448	479	517	553	602	671
GC6509WS	301	325	345	369	407	442	477	508	546	582	631	700

Active weight 300 lbs.
Upholstered seat/poly back.

	OVERALL DIMENSIONS			SEAT DIMENSIONS			BACK DIMENSIONS	
	W	D	H	W	D	H	W	H
IN	21.5	22	33	17	16	18.5	17	14.5
MM	546	559	838	432	406	470	432	368

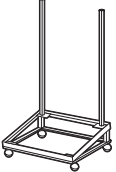
RTA 00 2 per carton (pricing and specifications are for one chair)

DESCRIPTION	MODEL# / FEATURES	STANDARD TEXTILE GRADES											
		COM	2	3	4	5	6	7	8	9	10	11	12
 GC6511 Armless Chair COM: 0.75 YD 0.69 M Unit weight: 11 LB 5 KG Carton weight: 13.5 LB 6.12 KG Carton volume: 11.75 FT³ 0.33 MT³	 GC6511WS Wall saver	309	333	353	377	415	450	485	516	554	590	639	708
		338	362	382	406	444	479	514	545	583	619	668	737
		OVERALL DIMENSIONS			SEAT DIMENSIONS			BACK DIMENSIONS					
		W	D	H	W	D	H	W	H				
		IN 21.5	22	33.5	17	15.5	18.5	17	15				
		MM 546	559	851	432	394	470	432	381				
		RTA 00		2 per carton (pricing and specifications are for one chair)									
		List price											
		GC6511 271 GC6511WS 297											
 GC6513 Armchair COM: N/A Unit weight: 9.5 LB 4.3 KG Carton weight: 12 LB 5.44 KG Carton volume: 11.75 FT³ 0.33 MT³	 GC6513WS Wall saver	271											
		297											
		OVERALL DIMENSIONS			SEAT DIMENSIONS			BACK DIMENSIONS					
		W	D	H	W	D	H	W	H				
		IN 23	22	33	17	16	18	17	15				
		MM 584	559	838	432	406	457	432	381				
		RTA 00		2 per carton (pricing and specifications are for one chair)									
		List price											
		GC6513 271 GC6513WS 297											
 GC6514 Armchair COM: 0.75 YD 0.69 M Unit weight: 12 LB 5.5 KG Carton weight: 14.5 LB 6.58 KG Carton volume: 11.75 FT³ 0.33 MT³	 GC6514WS Wall saver	331	355	375	399	437	472	507	538	576	612	661	730
		358	382	402	426	464	499	534	565	603	639	688	757
		OVERALL DIMENSIONS			SEAT DIMENSIONS			BACK DIMENSIONS					
		W	D	H	W	D	H	W	H				
		IN 23	22	33	17	16	18.5	17	14.5				
		MM 584	559	838	432	406	470	432	368				
		RTA 00		2 per carton (pricing and specifications are for one chair)									
		List price											
		GC6514 331 GC6514WS 358											
 GC6515 Armchair COM: 0.75 YD 0.69 M Unit weight: 13 LB 5.9 KG Carton weight: 15.5 LB 7.03 KG Carton volume: 11.75 FT³ 0.33 MT³	 GC6515WS Wall saver	368	392	412	436	474	509	544	575	613	649	698	767
		381	405	425	449	487	522	557	588	626	662	711	780
		OVERALL DIMENSIONS			SEAT DIMENSIONS			BACK DIMENSIONS					
		W	D	H	W	D	H	W	H				
		IN 23	22	33.5	17	15.5	18.5	17	15				
		MM 584	559	851	432	394	470	432	381				
		RTA 00		2 per carton (pricing and specifications are for one chair)									
		List price											
		GC6515 368 GC6515WS 381											
 GC6517WS Dolly COM: N/A Unit weight: 17 LB 7.7 KG Carton weight: 20 LB 9.07 KG Carton volume: 4 FT³ 0.11 MT³	GC6517WS Accommodates 10 chairs.	383											
		OVERALL DIMENSIONS			SEAT DIMENSIONS			BACK DIMENSIONS					
		W	D	H	W	D	H	W	H				
		IN 23.25	24.75	12.25	-	-	-	-	-				
		MM 591	629	311	-	-	-	-	-				
		RTA 1				2 cartons							

DESCRIPTION MODEL# / FEATURES STANDARD TEXTILE GRADES



GC6518



GC6518WS

Armless Chair, Sled Base

COM: N/A
 Unit weight: 9 LB | 4.1 KG
 Carton weight: 11.5 LB | 5.22 KG
 Carton volume: 11.75 FT³ | 0.33 MT³

Active weight 300 lbs.
 Polypropylene seat & back.

List price

GC6518 271
 GC6518WS 297

OVERALL DIMENSIONS SEAT DIMENSIONS BACK DIMENSIONS

	W	D	H	W	D	H	W	H
IN	21.5	22	33	17	16	18	17	15
MM	546	559	838	432	406	457	432	381

RTA 00 2 per carton (pricing and specifications are for one chair)



GC6519



GC6519WS

Armless Chair, Sled Base

COM: 0.75 YD | 0.69 M
 Unit weight: 11.5 LB | 5.2 KG
 Carton weight: 14 LB | 6.35 KG
 Carton volume: 11.75 FT³ | 0.33 MT³

Active weight 300 lbs.
 Upholstered seat/poly back.

COM	2	3	4	5	6	7	8	9	10	11	12	
GC6519	331	355	375	399	437	472	507	538	576	612	661	730
GC6519WS	358	382	402	426	464	499	534	565	603	639	688	757

RTA 00 2 per carton (pricing and specifications are for one chair)

OVERALL DIMENSIONS SEAT DIMENSIONS BACK DIMENSIONS

	W	D	H	W	D	H	W	H
IN	21.5	22	33	17	16	18.5	17	14.5
MM	546	559	838	432	406	470	432	368



GC6521



GC6521WS

Armless Chair, Sled Base

COM: 0.75 YD | 0.69 M
 Unit weight: 12.5 LB | 5.7 KG
 Carton weight: 15 LB | 6.8 KG
 Carton volume: 11.75 FT³ | 0.33 MT³

Active weight 300 lbs.
 Upholstered seat & back.

COM	2	3	4	5	6	7	8	9	10	11	12	
GC6521	368	392	412	436	474	509	544	575	613	649	698	767
GC6521WS	393	417	437	461	499	534	569	600	638	674	723	792

RTA 00 2 per carton (pricing and specifications are for one chair)

OVERALL DIMENSIONS SEAT DIMENSIONS BACK DIMENSIONS

	W	D	H	W	D	H	W	H
IN	21.5	22	33.5	17	16	18.5	17	15
MM	546	559	851	432	406	470	432	381



GC6523



GC6523WS

Armchair, Sled Base

COM: N/A
 Unit weight: 11 LB | 5 KG
 Carton weight: 15 LB | 6.8 KG
 Carton volume: 13.75 FT³ | 0.38 MT³

Active weight 300 lbs.
 Polypropylene seat & back.

List price

GC6523 327
 GC6523WS 354

OVERALL DIMENSIONS SEAT DIMENSIONS BACK DIMENSIONS

	W	D	H	W	D	H	W	H
IN	23	22	33	17	16	18	17	15
MM	584	559	838	432	406	457	432	381

RTA 00 2 per carton (pricing and specifications are for one chair)



GC6524



GC6524WS

Armchair, Sled Base

COM: 0.75 YD | 0.69 M
 Unit weight: 13.5 LB | 6.1 KG
 Carton weight: 16 LB | 7.26 KG
 Carton volume: 11.75 FT³ | 0.33 MT³







Active weight 300 lbs.
 Upholstered seat/poly back.

COM	2	3	4	5	6	7	8	9	10	11	12	
GC6524	386	410	430	454	492	527	562	593	631	667	716	785
GC6524WS	413	437	457	481	519	554	589	620	658	694	743	812

RTA 00  2 per carton (pricing and specifications are for one chair)

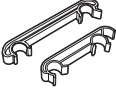
OVERALL DIMENSIONS SEAT DIMENSIONS BACK DIMENSIONS

	W	D	H	W	D	H	W	H
IN	23	22	33	17	16	18.5	17	14.5
MM	584	559	838	432	406	470	432	368

DESCRIPTION	MODEL# / FEATURES	STANDARD TEXTILE GRADES											
		COM	2	3	4	5	6	7	8	9	10	11	12
 GC6525  GC6525WS	GC6525 GC6525WS Wall saver	422	446	466	490	528	563	598	629	667	703	752	821
	449	473	493	517	555	590	625	656	694	730	779	848	
		OVERALL DIMENSIONS			SEAT DIMENSIONS			BACK DIMENSIONS					
		W	D	H	W	D	H	W	H				
Armchair, Sled Base COM: 0.75 YD 0.69 M Unit weight: 14.5 LB 6.6 KG Carton weight: 17 LB 7.71 KG Carton volume: 11.75 FT³ 0.33 MT³	Active weight 300 lbs.	IN 23	22	33.5	17	16	18.5	17	15				
	Upholstered seat & back.	MM 584	559	851	432	406	470	432	381				
		RTA 00	2 per carton (pricing and specifications are for one chair)										
		List price											
		GC6522	15										
 Ganging Brackets - Set of 2 COM: N/A Unit weight: 0.07 LB 0.03 KG Carton weight: 0.16 LB 0.07 KG Carton volume: 1 FT³ 0.02 MT³	For four-legged models only.	IN 0.87	7.75	1.5	-	-	-	-	-				
		MM 22	197	38	-	-	-	-	-				
		RTA 00		Pricing is for the set, specifications are for one bracket									
		List price											
		GC6526	15										
 Ganging Brackets - Set of 2 COM: N/A Unit weight: 0.25 LB 0.1 KG Carton weight: 0.28 LB 0.13 KG Carton volume: 0.5 FT³ 0.01 MT³	For sled base models only.	IN 0.75	5.75	1.25	-	-	-	-	-				
		MM 19	146	32	-	-	-	-	-				
		RTA 00		Pricing is for the set, specifications are for one bracket									

GC VITROLA



model GC8271LB

model GC8271HB



EXAMPLE GC VITROLA ORDER CODE:

GC8271HB	-NS	-WA50	-NS	-WA50
Model #	Sealed back/arms seams	Back/arms textile	Sealed seat seams	Seat textile
-WOD	-AAM	-RS	-NB	-NM
Leg type	Leg finish	Fastener type	Moisture barrier	Glide

STANDARD FEATURES

- Classic soft seating upholstery design with swooping arms.
- Available in two back heights.
- Clean out space is provided between the seat and back cushions for easy housekeeping.
- The seat underside is sealed with a non-porous material to support housekeeping and infection control protocols.
- Seat cushion is mechanically removable for replacement.
- For added comfort, seats are standard with high density Ultracell foam.
- Tapered legs are available in Maple wood in a variety of finishes.
- White non-marking nylon glides are standard.
- Textiles with a minimum of 100,000 double rubs must be specified to meet Global 24/7 warranty coverage.
- For healthcare textiles and finish options, visit the website at globalfurnituregroup.com.
- Can be upholstered in standard Global textiles if Healthcare 24/7 application compliance is not required. Global's Limited Lifetime warranty applies.
- Shipped fully assembled.
- Active weight capacity is up to 350 lbs.

OPTIONAL FEATURES



- A selection of glide options is available, see Glide types. Glides must be chosen to best suit flooring type and site conditions.
- Sealed seams are available on chair's back and arms and/or seat (upcharges apply).
- Moisture barrier may be added to seat cushions only (upcharge applies).

SUGGESTED APPLICATIONS

- Lobbies
- Lounge/Waiting
- Patient rooms
- Resident rooms

Please add option codes in the following order:

- **Model number**
GC8271LB Lounge chair
GC8271HB High back lounge chair
- **Back and arm seams**
(NS) No sealed seams.
(S2) Sealed back and arm seams. Add \$93. For high back, add \$109.
- **Back and arm textile**
Specify back and arm textile.
- **Seat seams**
(NS) No sealed seams.
(SE) Sealed seat seams. Add \$18.
- **Seat textile**
Specify seat textile.
- **Leg type**
(WOD) Wood
- **Leg finish**
(AAM) Absolute
(BKM) Black
(ACM) Cherry
(CJM) Charcoal Java
(EMM) Empire Mahogany
(EOM) English Oak
(ECM) Espresso Cafe
(TFM) Fruitwood
(HGM) Gray
(HOM) Harvest Oak
(AHM) Honey
(JOM) Jet Onyx
(LHM) Light Honey
(TMM) Mahogany
(AVM) Maple
(MWM) Medium Walnut
(ASM) Night
(NBM) Noce Biondo
(NGM) Noce Grigio
(NEM) Noce Leggero
(NMM) Noce Medio
(SBM) Sandy Beach
(SKM) Shaker Cherry
(SOM) Silver Oak
(TWM) Walnut
(WTM) WC Cream
(WHM) White
(WCM) Winter Cherry
- **Fastener type**
(RS) Standard fasteners.
(TP) Tamperproof fasteners. Add \$70.
- **Moisture barrier** (seat only, not available with sealed seams option)
(NB) No moisture barrier.
(MB) Moisture barrier. Add \$81.
- **Glides**
(NM) Non-marking glides for most surfaces.
(SG) Steel cushioned glides for carpeted surfaces. Add \$17.
(RG) Rubber non-slip glides for most hard floor surfaces. Add \$22.
(FG) Felt glides for most hard floor surfaces. Add \$22.

DESCRIPTION	MODEL# / FEATURES	STANDARD TEXTILE GRADES											
		COM	2	3	4	5	6	7	8	9	10	11	12
 <p>Lounge Chair COM: 5.75 YD 5.26 M Unit weight: 59.5 LB 27 KG Carton weight: 74.5 LB 33.79 KG Carton volume: 20.25 FT³ 0.57 MT³</p>	GC8271LB	1946	2130	2286	2464	2757	3027	3298	3533	3827	4103	4476	5005
		OVERALL DIMENSIONS			SEAT DIMENSIONS			BACK DIMENSIONS					
		W	D	H	W	D	H	W	H				
		IN	28.25	32.25	34.25	21.5	19.25	18.5	22.5	15.75			
	MM	718	819	870	546	489	470	572	400				
	RTA 00	1 per carton											
 <p>High Back Lounge Chair COM: 6.25 YD 5.72 M Unit weight: 67.5 LB 30.7 KG Carton weight: 83.5 LB 37.87 KG Carton volume: 28.25 FT³ 0.79 MT³</p>	GC8271HB	2099	2299	2468	2662	2980	3274	3568	3824	4143	4443	4849	5424
		OVERALL DIMENSIONS			SEAT DIMENSIONS			BACK DIMENSIONS					
		W	D	H	W	D	H	W	H				
		IN	28.25	33.75	42	21.5	19.25	18.5	22.5	23.5			
	MM	718	857	1067	546	489	470	572	597				
	RTA 00	1 per carton											

GC WIND



model GC3361HB

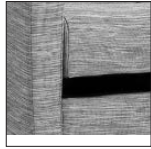

Removable Seat Cushion



Tubular Steel Leg



model GC3363HB

STANDARD FEATURES

- An attractive, sleek and modern lounge series with tubular legs.
- Seat cushions are easily removable for cleaning and the open frame is great for housekeeping access. Cushion covers are removable.
- For added comfort, seats are standard with high density Ultracell foam.
- Standard glide is Black plastic.
- For healthcare textiles and finish options, visit the website at globalfurnituregroup.com.
- Can be upholstered in standard Global textiles if Healthcare compliance is not required.
- Shipped fully assembled.

SUGGESTED APPLICATIONS

- Lobbies
- Lounge/Waiting
- Office/Meeting
- Patient rooms
- Resident rooms

OPTIONAL FEATURES

- For hard surface floors, please specify opaque non-marking glides (**NM**). No upcharge.
- To add sealed seams to your product contact Customer Service. Upcharges vary.
- For moisture barrier on seat, please specify (**MB**). See below for upcharges:
Lounge chair: Add \$122.
Two seat sofa: Add \$245.
Three seat sofa: Add \$366.
- **Frame finish**
Paint finishes. No upcharge.
(**TBL**) Black (**TIN**) Ink
(**TBZ**) Buzz Blue (**TKA**) Kalua
(**TCC**) Cactus (**TLA**) Latte
(**TCR**) Carrot (**TMO**) Mocha
(**TIV**) Cloud (**TNE**) Nevada
(**TDW**) Designer White (**TSN**) Sand
(**TDJ**) Dijon (**TSR**) Scarlet
(**TEG**) Eggplant (**TSH**) Shadow
(**TFO**) Fog (**TOA**) Toast
(**TFR**) Frost (**TTU**) Tungsten
Plated finish. See below for upcharges.
(**CHM**) Chrome (**SBR**) Satin Brass
(**BCH**) Brushed Chrome (**ACO**) Antique Copper
- Upcharges apply for plated finishes:
(**CHM**) Chrome. No upcharge.
(**BCH**) Brushed Chrome. Add \$49 for lounge chair. Add \$84 for two seat sofa. Add \$174 for three seat sofa.
(**SBR**) Satin Brass. Add \$132 for lounge chair. Add \$204 for two seat sofa. Add \$399 for three seat sofa.
(**ACO**) Antique Copper. Add \$132 for lounge chair. Add \$204 for two seat sofa. Add \$399 for three seat sofa.

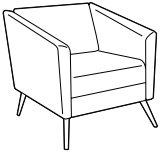
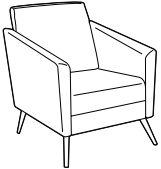
DESCRIPTION	MODEL# / FEATURES	STANDARD TEXTILE GRADES											
		COM	2	3	4	5	6	7	8	9	10	11	12
 <p>Lounge Chair COM: 4.25 YD 3.89 M Unit weight: 55 LB 25 KG Carton weight: 62 LB 28.12 KG Carton volume: 16.5 FT³ 0.46 MT³</p>	GC3361	1781	1917	2032	2164	2380	2580	2780	2954	3171	3375	3651	4042
	Active weight 300 lbs. Removable seat cushion.	OVERALL DIMENSIONS			SEAT DIMENSIONS			BACK DIMENSIONS					
		W	D	H	W	D	H	W	H				
		IN 27.5 MM 699	29 737	28.5 724	19.5 495	19 483	17 432	19 483	12 305				
	RTA 00	1 per carton											
 <p>High Back Lounge Chair COM: 4.75 YD 4.34 M Unit weight: 62 LB 28.2 KG Carton weight: 69 LB 31.3 KG Carton volume: 23 FT³ 0.65 MT³</p>	GC3361HB	2040	2192	2320	2468	2710	2933	3156	3351	3593	3821	4130	4567
	Active weight 300 lbs. Removable seat cushions.	OVERALL DIMENSIONS			SEAT DIMENSIONS			BACK DIMENSIONS					
		W	D	H	W	D	H	W	H				
		IN 27.5 MM 699	29 737	36 914	19.5 495	19 483	17 432	19 483	19.5 495				
	RTA 00	1 per carton											

DESCRIPTION	MODEL# / FEATURES	STANDARD TEXTILE GRADES											
		COM	2	3	4	5	6	7	8	9	10	11	12

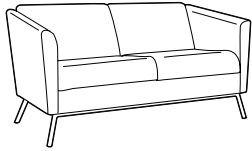

GC3362	2332	2564	2760	2985	3354	3695	4036	4333	4703	5051	5522	6189
---------------	------	------	------	------	------	------	------	------	------	------	------	------

Active weight 300 lbs/seat.
Removable seat cushions.

	OVERALL DIMENSIONS			SEAT DIMENSIONS			BACK DIMENSIONS	
	W	D	H	W	D	H	W	H
IN	54.5	29	28.5	46.5	19	17	46.5	12
MM	1384	737	724	1181	483	432	1181	305

RTA 00 1 per carton

Two Seat Sofa
COM: 7.25 YD | 6.63 M
Unit weight: 95 LB | 43.2 KG
Carton weight: 102 LB | 46.27 KG
Carton volume: 30 FT³ | 0.84 MT³

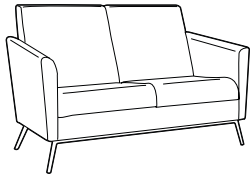

GC3362HB	2834	3090	3306	3554	3962	4338	4714	5042	5450	5834	6354	7090
-----------------	------	------	------	------	------	------	------	------	------	------	------	------

Active weight 300 lbs/seat.
Removable seat cushions.

	OVERALL DIMENSIONS			SEAT DIMENSIONS			BACK DIMENSIONS	
	W	D	H	W	D	H	W	H
IN	54.5	29	36	46.5	19	17	46.5	19.5
MM	1384	737	914	1181	483	432	1181	495

RTA 00 1 per carton

High Back Two Seat Sofa
COM: 8 YD | 7.32 M
Unit weight: 100 LB | 45.5 KG
Carton weight: 107 LB | 48.53 KG
Carton volume: 44.75 FT³ | 1.26 MT³

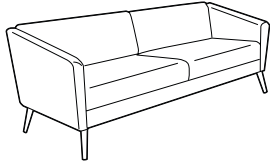

GC3363	2872	3208	3492	3817	4353	4846	5340	5770	6306	6810	7492	8458
---------------	------	------	------	------	------	------	------	------	------	------	------	------

Active weight 300 lbs/seat.
Removable seat cushions.

	OVERALL DIMENSIONS			SEAT DIMENSIONS			BACK DIMENSIONS	
	W	D	H	W	D	H	W	H
IN	78	29	28.5	70.5	19	17	70.5	12
MM	1981	737	724	1791	483	432	1791	305

RTA 00 1 per carton

Three Seat Sofa
COM: 10.5 YD | 9.6 M
Unit weight: 125 LB | 56.8 KG
Carton weight: 135 LB | 61.23 KG
Carton volume: 42.5 FT³ | 1.2 MT³

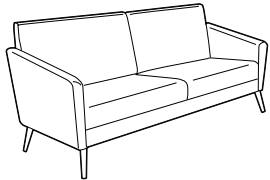

GC3363HB	3597	3989	4320	4700	5324	5900	6476	6978	7603	8191	8987	10114
-----------------	------	------	------	------	------	------	------	------	------	------	------	-------

Active weight 300 lbs/seat.
Removable seat cushions.

	OVERALL DIMENSIONS			SEAT DIMENSIONS			BACK DIMENSIONS	
	W	D	H	W	D	H	W	H
IN	78	29	36	70.5	19	17	70.5	19.5
MM	1981	737	914	1791	483	432	1791	495

RTA 00 1 per carton

High Back Three Seat Sofa
COM: 12.25 YD | 11.2 M
Unit weight: 130 LB | 59.1 KG
Carton weight: 140 LB | 63.5 KG
Carton volume: 62.25 FT³ | 1.76 MT³

HEATHER



model GC3770

STANDARD FEATURES



- Contemporary slim line design is compact and stylish for a variety of different environments.
- Seat cushions are easily removable for cleaning and the open frame below the cushion eliminates traps.
- Wood legs are available in a variety of finishes. Available in Maple wood species only (refer to finishes ending in "M").
- Matching tapered leg tables are also available, see Tables section.
- For added comfort, seats are standard with high density Ultracell foam.
- Opaque non-marking glides are standard.
- For healthcare textiles and wood finish options, visit the website at globalfurnituregroup.com.
- This product can be upholstered in standard Global textiles only if Healthcare compliance is not required.
- Shipped fully assembled.

OPTIONAL FEATURES

- For non-slip glides, please specify **(NS)**. Add \$22.
- For steel cushion glide, please specify **(GI)**. Add \$5.
- To add sealed seams to your product contact Customer Service. Upcharges vary.
- For moisture barrier on seat, please specify **(MB)**. Add \$81.

SUGGESTED APPLICATIONS

- Dining/Cafeteria
- Guest seating
- Lobbies
- Lounge/Waiting
- Patient rooms
- Resident rooms

DESCRIPTION	MODEL# / FEATURES	STANDARD TEXTILE GRADES												
		COM	2	3	4	5	6	7	8	9	10	11	12	
 <p>High Back Lounge Chair COM: 3.25 YD 2.97 M Unit weight: 35 LB 15.9 KG Carton weight: 40 LB 18.14 KG Carton volume: 17 FT³ 0.48 MT³</p>	GC3770	1327	1431	1519	1620	1785	1938	2091	2224	2390	2546	2757	3056	
		OVERALL DIMENSIONS			SEAT DIMENSIONS			BACK DIMENSIONS						
		W	D	H	W	D	H	W	H					
	Active weight 300 lbs. Removable seat cushion.	IN 24 MM 610	24.5 622	36.5 927	18.5 470	17 432	18 457	19.5 495	18.5 470					
		RTA 00		1 per carton										
 <p>Low Back Lounge Chair COM: 3 YD 2.74 M Unit weight: 32 LB 14.5 KG Carton weight: 36 LB 16.33 KG Carton volume: 13.25 FT³ 0.37 MT³</p>	GC3771	1241	1337	1418	1511	1664	1805	1946	2069	2222	2366	2561	2837	
		OVERALL DIMENSIONS			SEAT DIMENSIONS			BACK DIMENSIONS						
		W	D	H	W	D	H	W	H					
	Active weight 300 lbs. Removable seat cushion.	IN 24 MM 610	24.5 622	31.5 800	18.5 470	17 432	18 457	19.5 495	13.5 343					
		RTA 00		1 per carton										

JANNA



model GC7609

STANDARD FEATURES







- Very often tight spaces create a challenge when additional seating is required for guests. Janna's unique folding frame is the perfect solution for temporary seating, especially where space is at a premium.
- Molded wood veneer frame.
- Concealed folding mechanism uses metal-to-metal construction details with lock tight fasteners.
- For added comfort, seats are standard with high density Ultracell foam.
- Non-marking nylon glides are standard.
- For healthcare textiles and wood finish options, visit the website at globalfurnituregroup.com. Available in Maple wood species only.
- Can be upholstered in standard Global textiles if Healthcare compliance is not required.
- Shipped fully assembled.

OPTIONAL FEATURES

- White cushioned glides (B) are available. Add \$5.
- For wall mounting bracket, please specify (WH). Add \$38.
- For moisture barrier on seat, please specify (MB). Add \$81.

SUGGESTED APPLICATIONS

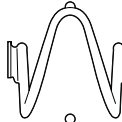
- Dining/Cafeteria
- Guest seating
- Lounge/Waiting
- Office/Meeting
- Patient rooms
- Resident rooms
- Treatment/Exam

DESCRIPTION	MODEL# / FEATURES	STANDARD TEXTILE GRADES												
		COM	2	3	4	5	6	7	8	9	10	11	12	
 <p>Folding Chair Upholstered Seat and Back COM: 1 YD 0.91 M Unit weight: 17 LB 7.7 KG Carton weight: 19 LB 8.62 KG Carton volume: 7 FT³ 0.19 MT³</p>	GC7609	602	634	661	692	743	790	837	878	929	977	1042	1134	
	Active weight 300 lbs.	OVERALL DIMENSIONS			SEAT DIMENSIONS			BACK DIMENSIONS						
		IN	19	22.5	32.5	16	17.5	18.5	16	13.5				
		MM	483	572	826	406	445	470	406	343				
		RTA 00		2 per carton (pricing and specifications are for one chair)										
 <p>Folding Chair Wood Back Upholstered Seat COM: 1 YD 0.91 M Unit weight: 17 LB 7.7 KG Carton weight: 19 LB 8.62 KG Carton volume: 7 FT³ 0.19 MT³</p>	GC7611	568	600	627	658	709	756	803	844	895	943	1008	1100	
	Active weight 300 lbs.	OVERALL DIMENSIONS			SEAT DIMENSIONS			BACK DIMENSIONS						
		IN	19	22.5	32.5	16	17.5	18.5	16	13.5				
		MM	483	572	826	406	445	470	406	343				
		RTA 00		2 per carton (pricing and specifications are for one chair)										
 <p>Wall Mounting Bracket COM: N/A Unit weight: 0.5 LB 0.2 KG Carton weight: 1.5 LB 0.68 KG Carton volume: 0.1 FT³ 0.003 MT³</p>	GC7607	List price 48												
	For Janna series only.	OVERALL DIMENSIONS			SEAT DIMENSIONS			BACK DIMENSIONS						
	Allows for hanging of one chair on a wall or a door.	IN	3	1.5	3.5	-	-	-	-	-				
	If ordering after the original purchase, specify GC7607.	MM	76	38	89	-	-	-	-	-				
		RTA 00		Two (one pair) per package in Chrome finish. One bracket connects to the underside of the chair seat. The other bracket connects to the wall or door.										

NOURISH



model GC3683



model GC3685



Headrest adjustment handle



Tip and Move (T&M) wheels, height adjustable legs



Transfer arm

STANDARD FEATURES

- Nourish is an innovative state of the art patient chair, developed in consultation with leading healthcare professionals. It curves around the body, providing additional comfort during periods of recovery.
- All chair models have left and right, easy to operate transfer arms. Transfer arms allow for ease of movement in and out of the chair and provide easy caregiver access to assist the user.
- Models with fixed legs have a standard seat height of 18.5".
- Models with adjustable legs have adjustment pins to conveniently adapt seat heights from 17" to 20". The 20" seat height models (-20) have a seat height adjustment range of 20"-23". Front and back legs can be adjusted separately, allowing modification of seat pitch, forward or backward.
- Models with rear casters allow for 'tip and move' so that the chair can be conveniently relocated while unoccupied. The optional push bar aids staff in moving the chair (see upcharge). Push bar matches frame finish.
- Select models have a unique Schukra depth adjustable headrest solution integrated inside the back near the user's neck area. The depth is controlled by a handle on the lower outer back cushion.
- Schukra depth adjustable lumbar support for additional comfort is standard on select models.
- For added comfort, seats are standard with high density Ultracell foam.
- Metal frame is available in several paint finishes.
- The arm structure finish is Tungsten, with a urethane armcap, available in five finishes.
- Active weight capacity for standard single seat is 350 lbs. and 750 lbs. for bariatric seating.
- For healthcare textile and finish options, visit our website at globalfurnituregroup.com.
- Can be upholstered in standard Global textiles if Healthcare compliance is not required.

Please add option codes in the following order

- **Model number**
Specify model number.
- **Back seams and textile**
(NS) No sealed seams.
(S2) Sealed back seams. Add \$55.
For bariatric model, add \$89.
Back textile
Specify textile code.
- **Seat seams and textile**
(NS) No sealed seat seams.
(SE) Sealed seat seams. Add \$20.
For bariatric model, add \$23.
Seat textile
Specify textile code.
- **Sealed seat underside**
(ST) No sealed seat underside.
(SU) Sealed seat underside. Add \$39.
For bariatric model, add \$47.
- **Frame finish**
(TBL) Black
(TIV) Cloud
(TDW) Designer White
(TFO) Fog
(TFR) Frost
(TKA) Kalua
(TLA) Latte
(TMO) Mocha
(TNE) Nevada
(TSN) Sand
(TSH) Shadow
(TOA) Toast
(TTU) Tungsten
- **Back push bar** (matches frame finish)
(NBR) No push bar.
(PBR) Back push bar. Add \$81.
- **Armcap finish**
(BLK) Black
(KAL) Kalua
(LAB) Latte
(J52) Mocha
(SHW) Shadow
(TOA) Toast
- **Moisture barrier** (seat only, not available with sealed seams option)
(NB) No moisture barrier.
(MB) Moisture barrier. Add \$81.
For bariatric model, add \$124.

SUGGESTED APPLICATIONS

- Bariatric seating (model GC3685)
- Lounge/Waiting
- Patient rooms
- Resident rooms
- Treatment/Exam rooms

EXAMPLE NOURISH ORDER CODE:

GC3681	NS	FU75	NS	FU75	ST	TMO	NBR	J52	NB
Model #	Back seams	Back textile	Seat seams	Seat textile	Seat underside	Frame finish	Push bar	Armcap finish	Moisture barrier



DESCRIPTION	MODEL# / FEATURES	STANDARD TEXTILE GRADES												
		COM	2	3	4	5	6	7	8	9	10	11	12	
 <p>High Back Patient Chair COM: 2 YD 1.83 M Unit weight: 42 LB 19.1 KG Carton weight: 52 LB 23.59 KG Carton volume: 33.5 FT³ 0.94 MT³</p>	GC3681 Adjustable 17"-20" seat height	1916	1980	2034	2096	2198	2292	2386	2468	2570	2666	2796	2980	
	GC3681-20 Adjustable 20"-23" seat height	1962	2026	2080	2142	2244	2338	2432	2514	2616	2712	2842	3026	
	GC3681XH Fixed 18.5" seat height	1871	1935	1989	2052	2153	2247	2341	2423	2525	2621	2751	2935	
		OVERALL DIMENSIONS			SEAT DIMENSIONS			BACK DIMENSIONS						
		W	D	H	W	D	H	W	H					
Active weight 350 lbs.		IN 28.5	29	45.5	20	18.5	17	20	29					
Optional push bar, add \$81.		MM 724	737	1156	508	470	432	508	737					
		RTA 00		1 per carton (specifications are for model GC3681)										

DESCRIPTION	MODEL# / FEATURES	STANDARD TEXTILE GRADES																																								
		COM	2	3	4	5	6	7	8	9	10	11	12																													
 <p>High Back Patient Chair w/Schukra Lumbar COM: 2 YD 1.83 M Unit weight: 42 LB 19.1 KG Carton weight: 52 LB 23.59 KG Carton volume: 33.5 FT³ 0.94 MT³</p>	GC3682 Adjustable 17"-20" seat height	2040	2104	2158	2220	2322	2416	2510	2592	2694	2790	2920	3104																													
	GC3682-20 Adjustable 20"-23" seat height	2088	2152	2206	2268	2370	2464	2558	2640	2742	2838	2968	3152																													
	GC3682XH Fixed 18.5" seat height	1995	2059	2113	2176	2277	2371	2465	2547	2649	2745	2875	3059																													
	<table border="1"> <thead> <tr> <th colspan="3">OVERALL DIMENSIONS</th> <th colspan="3">SEAT DIMENSIONS</th> <th colspan="2">BACK DIMENSIONS</th> </tr> <tr> <th>W</th> <th>D</th> <th>H</th> <th>W</th> <th>D</th> <th>H</th> <th>W</th> <th>H</th> </tr> </thead> <tbody> <tr> <td>IN 28.5</td> <td>29</td> <td>45.5</td> <td>20</td> <td>18.5</td> <td>17</td> <td>20</td> <td>29</td> </tr> <tr> <td>MM 724</td> <td>737</td> <td>1156</td> <td>508</td> <td>470</td> <td>432</td> <td>508</td> <td>737</td> </tr> </tbody> </table> <p>Active weight 350 lbs. Optional push bar: Add \$81.</p> <p>RTA 00 1 per carton (specifications are for model GC3682)</p>	OVERALL DIMENSIONS			SEAT DIMENSIONS			BACK DIMENSIONS		W	D	H	W	D	H	W	H	IN 28.5	29	45.5	20	18.5	17	20	29	MM 724	737	1156	508	470	432	508	737									
OVERALL DIMENSIONS			SEAT DIMENSIONS			BACK DIMENSIONS																																				
W	D	H	W	D	H	W	H																																			
IN 28.5	29	45.5	20	18.5	17	20	29																																			
MM 724	737	1156	508	470	432	508	737																																			

DESCRIPTION	MODEL# / FEATURES	STANDARD TEXTILE GRADES																																								
		COM	2	3	4	5	6	7	8	9	10	11	12																													
 <p>High Back Patient Chair w/Schukra Headrest COM: 2 YD 1.83 M Unit weight: 42 LB 19.1 KG Carton weight: 52 LB 23.59 KG Carton volume: 33.5 FT³ 0.94 MT³</p>	GC3683 Adjustable 17"-20" seat height	2040	2104	2158	2220	2322	2416	2510	2592	2694	2790	2920	3104																													
	GC3683-20 Adjustable 20"-23" seat height	2088	2152	2206	2268	2370	2464	2558	2640	2742	2838	2968	3152																													
	GC3683XH Fixed 18.5" seat height	1995	2059	2113	2176	2277	2371	2465	2547	2649	2745	2875	3059																													
	<table border="1"> <thead> <tr> <th colspan="3">OVERALL DIMENSIONS</th> <th colspan="3">SEAT DIMENSIONS</th> <th colspan="2">BACK DIMENSIONS</th> </tr> <tr> <th>W</th> <th>D</th> <th>H</th> <th>W</th> <th>D</th> <th>H</th> <th>W</th> <th>H</th> </tr> </thead> <tbody> <tr> <td>IN 28.5</td> <td>29</td> <td>45.5</td> <td>20</td> <td>18.5</td> <td>17</td> <td>20</td> <td>29</td> </tr> <tr> <td>MM 724</td> <td>737</td> <td>1156</td> <td>508</td> <td>470</td> <td>432</td> <td>508</td> <td>737</td> </tr> </tbody> </table> <p>Active weight 350 lbs. Optional push bar, add \$81.</p> <p>RTA 00 1 per carton (specifications are for model GC3683)</p>	OVERALL DIMENSIONS			SEAT DIMENSIONS			BACK DIMENSIONS		W	D	H	W	D	H	W	H	IN 28.5	29	45.5	20	18.5	17	20	29	MM 724	737	1156	508	470	432	508	737									
OVERALL DIMENSIONS			SEAT DIMENSIONS			BACK DIMENSIONS																																				
W	D	H	W	D	H	W	H																																			
IN 28.5	29	45.5	20	18.5	17	20	29																																			
MM 724	737	1156	508	470	432	508	737																																			

DESCRIPTION	MODEL# / FEATURES	STANDARD TEXTILE GRADES																																								
		COM	2	3	4	5	6	7	8	9	10	11	12																													
 <p>High Back Patient Chair w/Schukra Lumbar & Headrest COM: 2 YD 1.83 M Unit weight: 42 LB 19.1 KG Carton weight: 52 LB 23.59 KG Carton volume: 33.5 FT³ 0.94 MT³</p>	GC3684 Adjustable 17"-20" seat height	2162	2226	2280	2342	2444	2538	2632	2714	2816	2912	3042	3226																													
	GC3684-20 Adjustable 20"-23" seat height	2209	2273	2327	2389	2491	2585	2679	2761	2863	2959	3089	3273																													
	GC3684XH Fixed 18.5" seat height	2117	2181	2235	2298	2399	2493	2587	2669	2771	2867	2997	3181																													
	<table border="1"> <thead> <tr> <th colspan="3">OVERALL DIMENSIONS</th> <th colspan="3">SEAT DIMENSIONS</th> <th colspan="2">BACK DIMENSIONS</th> </tr> <tr> <th>W</th> <th>D</th> <th>H</th> <th>W</th> <th>D</th> <th>H</th> <th>W</th> <th>H</th> </tr> </thead> <tbody> <tr> <td>IN 28.5</td> <td>29</td> <td>45.5</td> <td>20</td> <td>18.5</td> <td>17</td> <td>20</td> <td>29</td> </tr> <tr> <td>MM 724</td> <td>737</td> <td>1156</td> <td>508</td> <td>470</td> <td>432</td> <td>508</td> <td>737</td> </tr> </tbody> </table> <p>Active weight 350 lbs. Optional push bar, add \$81.</p> <p>RTA 00 1 per carton (specifications are for model GC3684)</p>	OVERALL DIMENSIONS			SEAT DIMENSIONS			BACK DIMENSIONS		W	D	H	W	D	H	W	H	IN 28.5	29	45.5	20	18.5	17	20	29	MM 724	737	1156	508	470	432	508	737									
OVERALL DIMENSIONS			SEAT DIMENSIONS			BACK DIMENSIONS																																				
W	D	H	W	D	H	W	H																																			
IN 28.5	29	45.5	20	18.5	17	20	29																																			
MM 724	737	1156	508	470	432	508	737																																			

DESCRIPTION	MODEL# / FEATURES	STANDARD TEXTILE GRADES																																									
		COM	2	3	4	5	6	7	8	9	10	11	12																														
 <p>Bariatric High Back Patient Chair (no height adjustment) COM: 3.25 YD 2.97 M Unit weight: 60 LB 27.3 KG Carton weight: 70 LB 31.75 KG Carton volume: 45 FT³ 1.27 MT³</p>	GC3685 Fixed 18.5" seat height	2372	2476	2564	2665	2830	2983	3136	3269	3435	3591	3802	4101																														
	<table border="1"> <thead> <tr> <th colspan="3">OVERALL DIMENSIONS</th> <th colspan="3">SEAT DIMENSIONS</th> <th colspan="2">BACK DIMENSIONS</th> </tr> <tr> <th>W</th> <th>D</th> <th>H</th> <th>W</th> <th>D</th> <th>H</th> <th>W</th> <th>H</th> </tr> </thead> <tbody> <tr> <td>IN 40</td> <td>29</td> <td>47</td> <td>35</td> <td>18.5</td> <td>18.5</td> <td>35</td> <td>29</td> </tr> <tr> <td>MM 1016</td> <td>737</td> <td>1194</td> <td>889</td> <td>470</td> <td>470</td> <td>889</td> <td>737</td> </tr> </tbody> </table> <p>Active weight 750 lbs. Optional push bar, add \$81.</p> <p>RTA 00 1 per carton</p>	OVERALL DIMENSIONS			SEAT DIMENSIONS			BACK DIMENSIONS		W	D	H	W	D	H	W	H	IN 40	29	47	35	18.5	18.5	35	29	MM 1016	737	1194	889	470	470	889	737										
	OVERALL DIMENSIONS			SEAT DIMENSIONS			BACK DIMENSIONS																																				
	W	D	H	W	D	H	W	H																																			
IN 40	29	47	35	18.5	18.5	35	29																																				
MM 1016	737	1194	889	470	470	889	737																																				

DESCRIPTION	MODEL# / FEATURES	STANDARD TEXTILE GRADES											
		COM	2	3	4	5	6	7	8	9	10	11	12
 <p>Footstool COM: 1 YD 0.91 M Unit weight: 15 LB 6.8 KG Carton weight: 18 LB 8.16 KG Carton volume: 3.6 FT³ 0.1 MT³</p>	GC3686	463	495	522	553	604	651	698	739	790	838	903	995
		OVERALL DIMENSIONS			SEAT DIMENSIONS			BACK DIMENSIONS					
		W	D	H	W	D	H	W	H				
	<p>Active weight 350 lbs.</p> <p>Can be stored beneath any Nourish chair when not in use.</p>	IN 17 MM 432	17.5 445	12.5 318	-	-	-	-	-				
	RTA 00		1 per carton										
 <p>High Back Patient Chair w/Four Manual Locking Casters (no height adjustment) COM: 2 YD 1.83 M Unit weight: 42 LB 19.1 KG Carton weight: 52 LB 23.59 KG Carton volume: 33.5 FT³ 0.94 MT³</p>	GC3698	2447	2511	2565	2627	2729	2823	2917	2999	3101	3197	3327	3511
		OVERALL DIMENSIONS			SEAT DIMENSIONS			BACK DIMENSIONS					
		W	D	H	W	D	H	W	H				
	<p>Active weight 500 lbs.</p> <p>Optional push bar, add \$81.</p>	IN 28.5 MM 724	29 737	45.5 1156	20 508	18.5 470	17 432	20 508	29 737				
	RTA 00	1 per carton											

OAKVILLE



model GC36500



STANDARD FEATURES

- Oakville offers a modern take on wingback seating for social settings, resident rooms and lounge areas.
- Features a clean out space at the back of the seat cushion for easy housekeeping.
- The seat underside is sealed with a non-porous material to support housekeeping and infection control protocols.
- For added comfort, seat cushions are standard with high density Ultracell foam.
- Legs are available in wood or urethane, in a variety of colors.
- Choose from standard non-marking glides, steel cushioned glides, rubber non-slip glides or felt glides (upcharges apply).
- Assembled with tamper-resistant fasteners for greater security.
- For healthcare textiles, visit the website at globalfurnituregroup.com.
- The Lifetime Warranty (for healthcare and 24/7 environments) applies for all Oakville models when performance textiles are selected.
- Can be upholstered in standard Global textiles if Healthcare compliance is not required.

SUGGESTED APPLICATIONS

- Guest seating
- Lobbies
- Lounge/Waiting
- Patient rooms
- Resident rooms

OPTIONAL FEATURES

Please add option codes in the following order:

- **Model number**
GC36500 High Back Lounge Chair
- **Sealed back/arms seams**
(NS) No sealed back seams.
(SS) Sealed back seams. Add \$148.
- **Back/arms textile**
Specify textile code.
- **Sealed seat seams**
(NS) No sealed seat seams.
(SS) Sealed seat seams. Add \$27.
- **Seat textile**
Specify textile code.
- **Wood leg finish**
(AAM) Absolute
(BKM) Black
(CJM) Charcoal Java
(ACM) Cherry
(EMM) Empire Mahogany
(EOM) English Oak
(ECM) Espresso Cafe
(TFM) Fruitwood
(HGM) Grey
(HOM) Harvest Oak
(AHM) Honey
(JOM) Jet Onyx
(LHM) Light Honey
(TMM) Mahogany
(AVM) Maple
(MWM) Medium Walnut
(NLW) Natural Walnut
(ASM) Night
(NBM) Noce Biondo
(NGM) Noce Grigio
(NEM) Noce Leggero
(NMM) Noce Medio
(SBM) Sandy Beach
(SKM) Shaker Cherry
(SOM) Silver Oak
(TWM) Walnut
(WTM) WC Cream
(WHM) White
(WCM) Winter Cherry
- **Urethane leg finish**
Add \$63.
(BLK) Black
(KAL) Kalua
(LAB) Latte
(J52) Mocha
(SHW) Shadow
(TOA) Toast
- **Glides**
(NM) Non-marking glides. No upcharge
(RG) Rubber, non-slip glides. Add \$22.
(SG) Steel cushion glides. Add \$17.
(FG) Felt glides. Add \$22.
- **Moisture barrier** (seat only)
(NB) No moisture barrier. No upcharge.
(MB) Moisture barrier. Add \$81.

EXAMPLE OAKVILLE ORDER CODE:

GC36500	NS	CE90	NS	CE90	BLK	NM	NB
Model #	Sealed back/arms seams	Back/arms textile	Sealed seat seams	Seat textile	Leg finish	Glides	Moisture barrier

DESCRIPTION	MODEL# / FEATURES	STANDARD TEXTILE GRADES											
		COM	2	3	4	5	6	7	8	9	10	11	12
 High Back Lounge Chair COM: 5.5 YD 5.03 M Unit weight: 59.5 LB 27 KG Carton weight: 75.5 LB 34.25 KG Carton volume: 19.25 FT³ 0.54 MT³	GC36500	2280	2456	2605	2776	3055	3314	3573	3798	4079	4343	4700	5206
	Active weight 350 lbs.	OVERALL DIMENSIONS W D H			SEAT DIMENSIONS W D H			BACK DIMENSIONS W H					
		IN 30	30	41.25	20.5	21	18.5	21.75	23.75				
		MM 762	762	1048	521	533	470	552	603				
		RTA 00		1 per carton									



GC3616W Dining armchair with open arms

Primacare™ set a benchmark for healthcare seating. All the features, all the looks and quite possibly the most extensive offering of its kind for both acute care and long-term care applications.

Under the skin of every Primacare chair is a heart of solid steel waiting to meet the rigorous demands of any environment.

The Primacare series includes more than 40 models that extend from patient rooms to waiting areas, dining rooms to treatment centers including bariatric hip chair solutions.

FEATURES



Open arms



Closed arms - fully upholstered side panels



Arm grip extension - to assist getting in and out of the chair safely

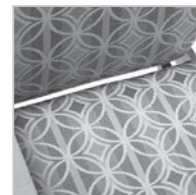

Separate seat and back - provides clean out for housekeeping staff



Fold down headrest - to provide access for caregiver assistance



Removable upholstery - for ease of cleaning and replacement

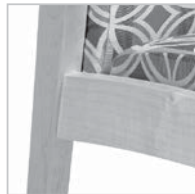

Solid wood frame - in hardwood for long life and a warm look



Metal-to-metal connector - provides unparalleled strength and durability

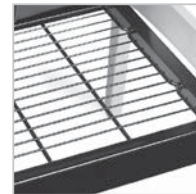

Metal mesh pan - superior comfort and hygiene for patient incontinence



Wall saver legs - offer first contact to protect walls and chair backs on most models

AVAILABLE TEXTILES AND FINISHES

Please see the healthcare Textile and Finishes section at globalfurnituregroup.com for all details including wood finishes.

SUGGESTED APPLICATIONS

- Bariatric seating (some models)
- Dining/Cafeteria
- Guest seating
- Lobbies
- Lounge/Waiting
- Patient rooms
- Resident rooms
- Treatment/Exam rooms

DINING - available with wood or metal frames



GUEST - available with wood or metal frames



PATIENT - available with wood or metal frames



HIP CHAIRS - available with wood or metal frames



LOUNGE - available with wood or metal legs



FULLY UPHOLSTERED LOUNGE - available with wood or urethane legs

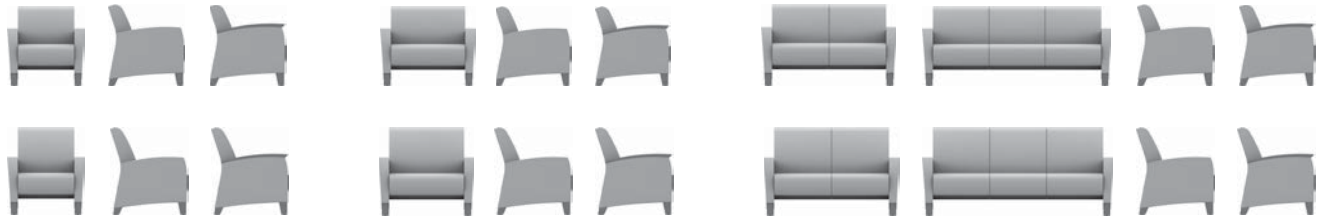

WINGBACK ARMCHAIR - available with wood or urethane armcaps and legs



RECLINERS - available with wood or urethane armcaps



SLEEPERS - available with wood or urethane armcaps



BENCHES - available with wood or metal legs



(urethane or wood legs only)

MODULAR GUEST/PATIENT - see page 193.

MODULAR LOUNGE - see page 208.

PRIMACARE DINING



model GC3616CA (HT)



model GC3616W (Wood)

STANDARD FEATURES

- Primacare is a family of products offering the most significant return on investment approach in the industry since every component can be repaired or replaced on site.
- **High traffic (HT) models:** Metal frame with die cast zinc connectors and metal-to-metal fasteners. Available in the following finishes: Black (TBL), Cloud (TIV), Designer White (TDW), Fog (TFO), Frost (TFR), Kalua (TKA), Latte (TLA), Mocha (TMO), Nevada (TNE), Sand (TSN), Shadow (TSH), Toast (TOA) and Tungsten (TTU).
- **Wood models:** Solid hardwood frame with die cast zinc connectors and metal-to-metal fastening. Available in the following finishes: Absolute (AAM), Charcoal Java (CJM), Cherry (ACM), Empire Mahogany (EMM), English Oak (EOM), Espresso Cafe (ECM), Fruitwood (TFM), Gray (HGM), Harvest Oak (HOM), Honey (AHM), Jet Onyx (JOM), Light Honey (LHM), Mahogany (TMM), Maple (AVM), Medium Walnut (MWM), Natural Walnut (NLW), Night (ASM), Noce Biondo (NBM), Noce Grigio (NGM), Noce Leggero (NEM), Noce Medio (NMM), Sandy Beach (SBM), Shaker Cherry (SKM), Silver Oak (SOM), Walnut (TWM), White (WHM), WC Cream (WTM) and Winter Cherry (WCM).
- Armcaps are securely fastened with metal-to-metal connectors which allow for field replacement if required.
- Easy grip forward extending armcap on models with arms.
- Replaceable seat covers and replaceable and/or removable seat cushions are standard.

- Seat cushion has a seamless waterfall front and clean out between and around the seat and back cushions.
- Models are standard with metal mesh seat deck. For mental health applications, the metal mesh seat deck can be covered with a solid moisture resistant surface, held in place with tamperproof fasteners. Contact your Global sales rep for a special quotation.
- All seat frames feature a wall saver design to prevent back contact with wall.
- **GC3616WCA** and **GC3616CA** have upholstered panel arm inserts closing the arm. (Closed arm panels are designed to be replaceable. Request a special quote to have them secured with tamperproof fasteners.)
- For healthcare textile options, visit the website at globalfurnituregroup.com.
- Can be upholstered in standard Global textiles if healthcare compliance is not required.
- Shipped fully assembled.



OPTIONAL FEATURES



- **High traffic (HT) models:** Wood armcaps are available. See far left column "Wood models" for finishes. Please specify. No upcharge.
- **High traffic (HT) and wood models:** Urethane armcaps are available in the following finishes: Black (BLK), Kalua (KAL), Latte (LAB), Mocha (J52), Shadow (SHW) and Toast (TOA). Please specify. No upcharge.
- For moisture barrier on seat, please specify **(MB)**. Add \$81 per seat.
- To add sealed seams to your product contact Customer Service. Upcharges vary.
- For Primacare tables, see page 59.

SUGGESTED APPLICATIONS

- Dining/Cafeteria
- Guest seating
- Lobbies
- Lounge/Waiting
- Patient rooms
- Resident rooms

HIGH TRAFFIC (HT) MODELS ARE LISTED FIRST, FOLLOWED BY WOOD MODELS.

DESCRIPTION	MODEL# / FEATURES	STANDARD TEXTILE GRADES												
		COM	2	3	4	5	6	7	8	9	10	11	12	
 <p>Dining Chair, Open Arms (HT) COM: 1.5 YD 1.37 M Unit weight: 50 LB 22.7 KG Carton weight: 58 LB 26.31 KG Carton volume: 13.25 FT³ 0.37 MT³</p>	<p>GC3616 Metal</p>	1433	1481	1522	1568	1645	1715	1786	1847	1924	1996	2093	2231	
		OVERALL DIMENSIONS			SEAT DIMENSIONS			BACK DIMENSIONS						
			W	D	H	W	D	H	W	H				
		IN	23	23	34.5	19	17.5	18	19	16.5				
MM	584	584	876	483	445	457	483	419						
	RTA 00	1 per carton												
 <p>Dining Chair, Closed Arms (HT) COM: 2 YD 1.83 M Unit weight: 58 LB 26.4 KG Carton weight: 66 LB 29.94 KG Carton volume: 13.25 FT³ 0.37 MT³</p>	<p>GC3616CA Metal</p>	1649	1713	1767	1829	1931	2025	2119	2201	2303	2399	2529	2713	
		OVERALL DIMENSIONS			SEAT DIMENSIONS			BACK DIMENSIONS						
			W	D	H	W	D	H	W	H				
		IN	23	23	34.5	19	17.5	18	19	16.5				
MM	584	584	876	483	445	457	483	419						
	RTA 00	1 per carton												
 <p>Dining Chair, Closed Arms, Laminate Panels (HT) COM: 1.5 YD 1.37 M Unit weight: 58 LB 26.4 KG Carton weight: 66 LB 29.94 KG Carton volume: 13.25 FT³ 0.37 MT³</p>	<p>GC3616CAL Metal</p>	1950	1998	2039	2085	2162	2232	2303	2364	2441	2513	2610	2748	
		OVERALL DIMENSIONS			SEAT DIMENSIONS			BACK DIMENSIONS						
			W	D	H	W	D	H	W	H				
		IN	23	23	34.5	19	17.5	18	19	16.5				
MM	584	584	876	483	445	457	483	419						
	RTA 00	1 per carton												

DESCRIPTION	MODEL# / FEATURES	STANDARD TEXTILE GRADES											
		COM	2	3	4	5	6	7	8	9	10	11	12
 <p>Dining Chair, Open Arms, Rear Swivel Casters (HT) COM: 1.5 YD 1.37 M Unit weight: 50 LB 22.7 KG Carton weight: 58 LB 26.31 KG Carton volume: 13.25 FT³ 0.37 MT³</p>	GC3616RC Metal	1522	1570	1611	1657	1734	1804	1875	1936	2013	2085	2182	2320
		OVERALL DIMENSIONS			SEAT DIMENSIONS			BACK DIMENSIONS					
		W	D	H	W	D	H	W	H				
		IN 23 MM 584	23 584	34.5 876	19 483	17.5 445	18 457	19 483	16.5 419				
			RTA 00		1 per carton								
 <p>Dining Chair, Closed Arms, Rear Swivel Casters (HT) COM: 2 YD 1.83 M Unit weight: 58 LB 26.4 KG Carton weight: 66 LB 29.94 KG Carton volume: 13.25 FT³ 0.37 MT³</p>	GC3616CARC Metal	1737	1801	1855	1917	2019	2113	2207	2289	2391	2487	2617	2801
		OVERALL DIMENSIONS			SEAT DIMENSIONS			BACK DIMENSIONS					
		W	D	H	W	D	H	W	H				
		IN 23 MM 584	23 584	34.5 876	19 483	17.5 445	18 457	19 483	16.5 419				
			RTA 00		1 per carton								
 <p>Allows caregiver to gently move a seated person to and from a table.</p> <p>Dining Chair, Open Arms, Rear Swivel Casters & Lift Mec. (HT) COM: 1.5 YD 1.37 M Unit weight: 51 LB 23.2 KG Carton weight: 59 LB 26.76 KG Carton volume: 13.25 FT³ 0.37 MT³</p>	GC3616RCEZ Metal	1983	2031	2072	2118	2195	2265	2336	2397	2474	2546	2643	2781
		OVERALL DIMENSIONS			SEAT DIMENSIONS			BACK DIMENSIONS					
		W	D	H	W	D	H	W	H				
		IN 23 MM 584	23 584	34.5 876	19 483	17.5 445	18 457	19 483	16.5 419				
			RTA 00		1 per carton								
 <p>Dining Chair Open Arms (Wood) COM: 1.5 YD 1.37 M Unit weight: 40 LB 18.2 KG Carton weight: 50 LB 22.68 KG Carton volume: 13.25 FT³ 0.37 MT³</p>	GC3616W Wood	1122	1170	1211	1257	1334	1404	1475	1536	1613	1685	1782	1920
		OVERALL DIMENSIONS			SEAT DIMENSIONS			BACK DIMENSIONS					
		W	D	H	W	D	H	W	H				
		IN 23 MM 584	23 584	34.5 876	19 483	17.5 445	18 457	19 483	16.5 419				
			RTA 00		1 per carton								
 <p>Dining Chair Closed Arms (Wood) COM: 2 YD 1.83 M Unit weight: 48 LB 21.8 KG Carton weight: 58 LB 26.31 KG Carton volume: 13.25 FT³ 0.37 MT³</p>	GC3616WCA Wood	1289	1353	1407	1469	1571	1665	1759	1841	1943	2039	2169	2353
		OVERALL DIMENSIONS			SEAT DIMENSIONS			BACK DIMENSIONS					
		W	D	H	W	D	H	W	H				
		IN 23 MM 584	23 584	34.5 876	19 483	17.5 445	18 457	19 483	16.5 419				
			RTA 00		1 per carton								

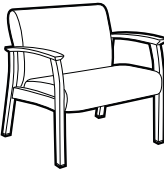
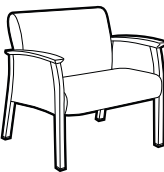
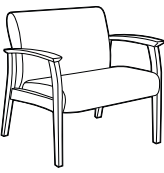
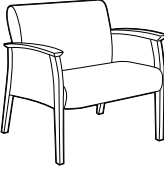
DESCRIPTION	MODEL# / FEATURES	STANDARD TEXTILE GRADES											
		COM	2	3	4	5	6	7	8	9	10	11	12
 <p>Dining Chair Open Arms, Front Casters (Wood) COM: 1.5 YD 1.37 M Unit weight: 40 LB 18.2 KG Carton weight: 50 LB 22.68 KG Carton volume: 13.25 FT³ 0.37 MT³</p>	GC3616WFC Wood	1203	1251	1292	1338	1415	1485	1556	1617	1694	1766	1863	2001
	Active weight 350 lbs.												
	Optional urethane armcaps. Please specify. No upcharge.												
	RTA 00	1 per carton											
		OVERALL DIMENSIONS			SEAT DIMENSIONS			BACK DIMENSIONS					
		W	D	H	W	D	H	W	H				
		IN 23	23	34.5	19	17.5	18	19	16.5				
		MM 584	584	876	483	445	457	483	419				
 <p>Bariatric LB Single Seat Armchair Open Arms (HT) COM: 2.5 YD 2.29 M Unit weight: 66 LB 30 KG Carton weight: 78 LB 35.38 KG Carton volume: 26.5 FT³ 0.75 MT³</p>	GC3637 Metal	2009	2089	2157	2234	2362	2479	2597	2699	2827	2947	3109	3339
	Active weight 500 lbs.												
	Optional wood armcaps. Please specify. No upcharge.												
	RTA 00	1 per carton											
		OVERALL DIMENSIONS			SEAT DIMENSIONS			BACK DIMENSIONS					
		W	D	H	W	D	H	W	H				
		IN 35	27	33	30	17.5	18	30	15				
		MM 889	686	838	762	445	457	762	381				
 <p>Bariatric LB Single Seat Armchair Closed Arms (HT) COM: 3.5 YD 3.2 M Unit weight: 76 LB 34.5 KG Carton weight: 88 LB 39.92 KG Carton volume: 26.5 FT³ 0.75 MT³</p>	GC3637CA Metal	2257	2369	2464	2572	2751	2915	3080	3223	3402	3570	3797	4119
	Active weight 500 lbs.												
	Optional wood armcaps. Please specify. No upcharge.												
	RTA 00	1 per carton											
		OVERALL DIMENSIONS			SEAT DIMENSIONS			BACK DIMENSIONS					
		W	D	H	W	D	H	W	H				
		IN 35	27	33	30	17.5	18	30	15				
		MM 889	686	838	762	445	457	762	381				
 <p>Bariatric LB Single Seat Armchair, Open Arms (Wood) COM: 2.5 YD 2.29 M Unit weight: 54 LB 24.5 KG Carton weight: 66 LB 29.94 KG Carton volume: 26.5 FT³ 0.75 MT³</p>	GC3637W Wood	1570	1650	1718	1795	1923	2040	2158	2260	2388	2508	2670	2900
	Active weight 500 lbs.												
	Optional urethane armcaps. Please specify. No upcharge.												
	RTA 00	1 per carton											
		OVERALL DIMENSIONS			SEAT DIMENSIONS			BACK DIMENSIONS					
		W	D	H	W	D	H	W	H				
		IN 35	27	33	30	17.5	18	30	15				
		MM 889	686	838	762	445	457	762	381				
 <p>Bariatric LB Single Seat Armchair, Closed Arms (Wood) COM: 3.5 YD 3.2 M Unit weight: 64 LB 29.1 KG Carton weight: 76 LB 34.47 KG Carton volume: 26.5 FT³ 0.75 MT³</p>	GC3637WCA Wood	1760	1872	1967	2075	2254	2418	2583	2726	2905	3073	3300	3622
	Active weight 500 lbs.												
	Optional urethane armcaps. Please specify. No upcharge.												
	RTA 00	1 per carton											
		OVERALL DIMENSIONS			SEAT DIMENSIONS			BACK DIMENSIONS					
		W	D	H	W	D	H	W	H				
		IN 35	27	33	30	17.5	18	30	15				
		MM 889	686	838	762	445	457	762	381				

PRIMACARE GUEST



model GC3620CA (HT)



model GC3625W (Wood)

STANDARD FEATURES

- Primacare is a family of products offering the most significant return on investment approach in the industry since every component can be repaired or replaced on site.
- High traffic (HT) models:** Metal frame with die cast zinc connectors and metal-to-metal fasteners. Available in the following finishes: Black (TBL), Cloud (TIV), Designer White (TDW), Fog (TFO), Frost (TFR), Kalua (TKA), Latte (TLA), Mocha (TMO), Nevada (TNE), Sand (TSN), Shadow (TSH), Toast (TOA) and Tungsten (TTU).
- Wood models:** Solid hardwood frame with die cast zinc connectors and metal-to-metal fastening. Available in the following finishes: Absolute (AAM), Charcoal Java (CJM), Cherry (ACM), Empire Mahogany (EMM), English Oak (EOM), Espresso Cafe (ECM), Fruitwood (TFM), Gray (HGM), Harvest Oak (HOM), Honey (AHM), Jet Onyx (JOM), Light Honey (LHM), Mahogany (TMM), Maple (AVM), Medium Walnut (MWM), Natural Walnut (NLW), Night (ASM), Noce Biondo (NBM), Noce Grigio (NGM), Noce Leggero (NEM), Noce Medio (NMM), Sandy Beach (SBM), Shaker Cherry (SKM), Silver Oak (SOM), Walnut (TWM), White (WHM), WC Cream (WTM) and Winter Cherry (WCM).
- Armchairs are securely fastened with metal-to-metal connectors which allow for field replacement if required.
- Easy grip forward extending armcap on models with arms.
- Replaceable seat covers and replaceable and/or removable seat cushions are standard.
- Seat cushion has a seamless waterfall front and clean out between and around the seat and back cushions.
- Models are standard with metal mesh seat deck. For mental health applications, the metal mesh seat deck can be covered with a solid moisture resistant surface, held in place with tamperproof fasteners. Contact your sales rep for a special quotation.
- All seat frames feature a wall saver design to prevent back contact with wall.
- Models ending in **CA / ARC**, have upholstered panel arm inserts closing the arm. (Closed arm panels are designed to be replaceable. Request a special quote to have them secured with tamperproof fasteners.)
- For healthcare textile options, visit the website at globalfurnituregroup.com.
- Can be upholstered in standard Global textiles if healthcare compliance is not required.
- Shipped fully assembled.



OPTIONAL FEATURES

- High traffic (HT) models:** Wood armchairs are available. See far left column "Wood models" for finishes. Please specify. No upcharge.
- High traffic (HT) and wood models:** Urethane armchairs are available in the following finishes: Black (BLK), Kalua (KAL), Latte (LAB), Mocha (J52), Shadow (SHW) and Toast (TOA). Please specify. No upcharge.
- For moisture barrier on seat, please specify **(MB)**. Add \$81 per seat.
- To add sealed seams to your product contact Customer Service. Upcharges vary.
- For Primacare tables, see page 59.

SUGGESTED APPLICATIONS

- Bariatric seating
- Guest seating
- Lobbies
- Lounge/Waiting
- Patient rooms
- Resident rooms

HIGH TRAFFIC (HT) MODELS ARE LISTED FIRST, FOLLOWED BY WOOD MODELS.

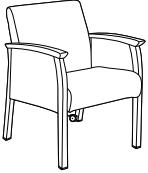
DESCRIPTION	MODEL# / FEATURES	STANDARD TEXTILE GRADES											
		COM	2	3	4	5	6	7	8	9	10	11	12
 <p>LB Armchair Open Arms (HT) COM: 1.75 YD 1.6 M Unit weight: 54 LB 24.5 KG Carton weight: 62 LB 28.12 KG Carton volume: 17.5 FT³ 0.49 MT³</p>	GC3620 Metal	1558	1614	1661	1716	1805	1887	1969	2041	2130	2214	2328	2489
	GC3620F Metal flex back	1930	1986	2033	2088	2177	2259	2341	2413	2502	2586	2700	2861
	OVERALL DIMENSIONS W D H		SEAT DIMENSIONS W D H			BACK DIMENSIONS W H							
	Active weight 500 lbs. Optional wood armchairs. Please specify. No upcharge.	IN 25 27 33 MM 635 686 838	20.5 17.5 18 521 445 457	20.5 15 521 381	RTA 00 1 per carton								
 <p>LB Armchair Closed Arms (HT) COM: 2.75 YD 2.51 M Unit weight: 64 LB 29.1 KG Carton weight: 72 LB 32.66 KG Carton volume: 17.5 FT³ 0.49 MT³</p>	GC3620CA Metal	1810	1898	1972	2058	2198	2327	2456	2569	2709	2841	3020	3273
	GC3620FCA Metal flex back	2178	2266	2340	2426	2566	2695	2824	2937	3077	3209	3388	3641
	OVERALL DIMENSIONS W D H		SEAT DIMENSIONS W D H			BACK DIMENSIONS W H							
	Active weight 500 lbs. Optional wood armchairs. Please specify. No upcharge.	IN 25 27 33 MM 635 686 838	20.5 17.5 18 521 445 457	20.5 15 521 381	RTA 00 1 per carton								
 <p>LB Armchair Closed Arms, Rear Tip and Move Wheels (HT) COM: 2.75 YD 2.51 M Unit weight: 64 LB 29.1 KG Carton weight: 72 LB 32.66 KG Carton volume: 23 FT³ 0.65 MT³</p>	GC3620CARC Metal	1909	1997	2071	2157	2297	2426	2555	2668	2808	2940	3119	3372
	OVERALL DIMENSIONS W D H		SEAT DIMENSIONS W D H			BACK DIMENSIONS W H							
	Active weight 500 lbs. Optional wood armchairs. Please specify. No upcharge.	IN 25 29.5 33 MM 635 749 838	20.5 17.5 18 521 445 457	20.5 15 521 381	RTA 00 1 per carton								

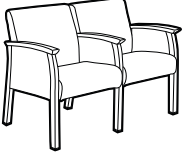
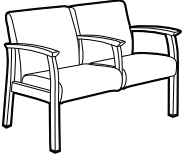
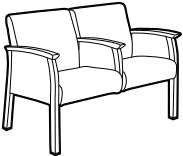
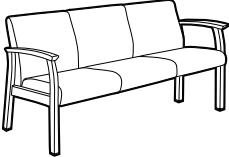
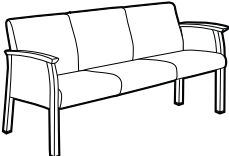
DESCRIPTION	MODEL# / FEATURES	STANDARD TEXTILE GRADES											
		COM	2	3	4	5	6	7	8	9	10	11	12
 <p>LB Two Seat Chair Full Center Arm, Closed Arms (HT) COM: 4.5 YD 4.11 M Unit weight: 106 LB 48.2 KG Carton weight: 118 LB 53.52 KG Carton volume: 43 FT³ 1.21 MT³</p>	<p>GC3622CA Metal</p>	3248	3392	3514	3653	3883	4094	4306	4490	4720	4936	5228	5642
		OVERALL DIMENSIONS			SEAT DIMENSIONS			BACK DIMENSIONS					
		W	D	H	W	D	H	W	H				
		IN 46 MM 1168	27 686	33 838	20.5 521	17.5 445	18 457	20.5 521	15 381				
			RTA 00	1 per carton									
 <p>LB Two Seat Chair Half Center Arm, Open Arms (HT) COM: 3.25 YD 2.97 M Unit weight: 82 LB 37.3 KG Carton weight: 94 LB 42.64 KG Carton volume: 43 FT³ 1.21 MT³</p>	<p>GC3623 Metal</p>	2731	2835	2923	3024	3189	3342	3495	3628	3794	3950	4161	4460
		OVERALL DIMENSIONS			SEAT DIMENSIONS			BACK DIMENSIONS					
		W	D	H	W	D	H	W	H				
		IN 46 MM 1168	27 686	33 838	20.5 521	17.5 445	18 457	20.5 521	15 381				
			RTA 00	1 per carton									
 <p>LB Two Seat Chair Half Center Arm, Closed Arms (HT) COM: 4.5 YD 4.11 M Unit weight: 94 LB 42.7 KG Carton weight: 106 LB 48.08 KG Carton volume: 43 FT³ 1.21 MT³</p>	<p>GC3623CA Metal</p>	3193	3337	3459	3598	3828	4039	4251	4435	4665	4881	5173	5587
		OVERALL DIMENSIONS			SEAT DIMENSIONS			BACK DIMENSIONS					
		W	D	H	W	D	H	W	H				
		IN 46 MM 1168	27 686	33 838	20.5 521	17.5 445	18 457	20.5 483	15 381				
			RTA 00	1 per carton									
 <p>LB Three Seat Chair No Center Arms, Open Arms (HT) COM: 4.25 YD 3.89 M Unit weight: 114 LB 51.8 KG Carton weight: 137 LB 62.14 KG Carton volume: 65.25 FT³ 1.84 MT³</p>	<p>GC3624 Metal</p>	3230	3366	3481	3613	3829	4029	4229	4403	4620	4824	5100	5491
		OVERALL DIMENSIONS			SEAT DIMENSIONS			BACK DIMENSIONS					
		W	D	H	W	D	H	W	H				
		IN 65 MM 1651	27 686	33 838	60 1524	17.5 445	18 457	60 1524	15 381				
			RTA 00	1 per carton									
 <p>LB Three Seat Chair No Center Arms, Closed Arms (HT) COM: 5.25 YD 4.8 M Unit weight: 124 LB 56.4 KG Carton weight: 147 LB 66.68 KG Carton volume: 65.25 FT³ 1.84 MT³</p>	<p>GC3624CA Metal</p>	3477	3645	3787	3950	4217	4464	4711	4926	5194	5446	5787	6270
		OVERALL DIMENSIONS			SEAT DIMENSIONS			BACK DIMENSIONS					
		W	D	H	W	D	H	W	H				
		IN 65 MM 1651	27 686	33 838	60 1524	17.5 445	18 457	60 1524	15 381				
			RTA 00	1 per carton									

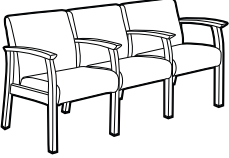
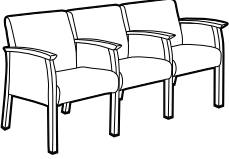
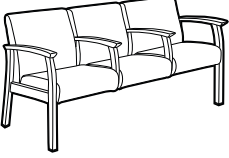
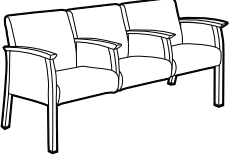
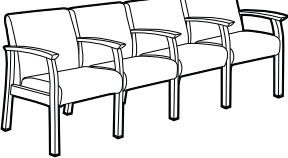
DESCRIPTION	MODEL# / FEATURES	STANDARD TEXTILE GRADES											
		COM	2	3	4	5	6	7	8	9	10	11	12
 <p>LB Three Seat Chair Full Center Arms, Open Arms (HT) COM: 4.75 YD 4.34 M Unit weight: 137 LB 62.3 KG Carton weight: 162 LB 73.48 KG Carton volume: 65.25 FT³ 1.84 MT³</p>	<p>GC3625 Metal</p>	4201	4353	4481	4629	4871	5094	5317	5512	5754	5982	6291	6728
		OVERALL DIMENSIONS			SEAT DIMENSIONS			BACK DIMENSIONS					
		W D H			W D H			W H					
		IN 69	27	33	20.5	17.5	18	20.5	15				
MM 1753	686	838	521	445	457	521	381						
Active weight 500 lbs/seat.	Optional wood armcaps. Please specify. No upcharge.	<p>RTA 00 1 per carton</p>											
 <p>LB Three Seat Chair Full Center Arms, Closed Arms (HT) COM: 6.25 YD 5.72 M Unit weight: 147 LB 66.8 KG Carton weight: 172 LB 78.02 KG Carton volume: 65.25 FT³ 1.84 MT³</p>	<p>GC3625CA Metal</p>	4713	4913	5082	5276	5594	5888	6182	6438	6757	7057	7463	8038
		OVERALL DIMENSIONS			SEAT DIMENSIONS			BACK DIMENSIONS					
		W D H			W D H			W H					
		IN 69	27	33	20.5	17.5	18	20.5	15				
MM 1753	686	838	521	445	457	521	381						
Active weight 500 lbs/seat.	Optional wood armcaps. Please specify. No upcharge.	<p>RTA 00 1 per carton</p>											
 <p>LB Three Seat Chair Half Center Arms, Open Arms (HT) COM: 4.75 YD 4.34 M Unit weight: 124 LB 56.4 KG Carton weight: 147 LB 66.68 KG Carton volume: 65.25 FT³ 1.84 MT³</p>	<p>GC3626 Metal</p>	3872	4024	4152	4300	4542	4765	4988	5183	5425	5653	5962	6399
		OVERALL DIMENSIONS			SEAT DIMENSIONS			BACK DIMENSIONS					
		W D H			W D H			W H					
		IN 69	27	33	20.5	17.5	18	20.5	15				
MM 1753	686	838	521	445	457	521	381						
Active weight 500 lbs/seat.	Optional wood armcaps. Please specify. No upcharge.	<p>RTA 00 1 per carton</p>											
 <p>LB Three Seat Chair Half Center Arms, Closed Arms (HT) COM: 6.25 YD 5.72 M Unit weight: 134 LB 60.9 KG Carton weight: 157 LB 71.21 KG Carton volume: 65.25 FT³ 1.84 MT³</p>	<p>GC3626CA Metal</p>	4386	4586	4755	4949	5267	5561	5855	6111	6430	6730	7136	7711
		OVERALL DIMENSIONS			SEAT DIMENSIONS			BACK DIMENSIONS					
		W D H			W D H			W H					
		IN 69	27	33	20.5	17.5	18	20.5	15				
MM 1753	686	838	521	445	457	521	381						
Active weight 500 lbs/seat.	Optional wood armcaps. Please specify. No upcharge.	<p>RTA 00 1 per carton</p>											
 <p>LB Four Seat Chair Full Center Arms, Open Arms (HT) COM: 6 YD 5.49 M Unit weight: 172 LB 78.2 KG Carton weight: 197 LB 89.36 KG Carton volume: 43 FT³ 1.21 MT³</p>	<p>GC3628 Metal</p>	5546	5738	5900	6086	6392	6674	6956	7202	7508	7796	8186	8738
		OVERALL DIMENSIONS			SEAT DIMENSIONS			BACK DIMENSIONS					
		W D H			W D H			W H					
		IN 93	27	33	20.5	17.5	18	20.5	15				
MM 2362	686	838	521	445	457	521	381						
Active weight 500 lbs/seat.	Optional wood armcaps. Please specify. No upcharge.	<p>RTA 2 2 cartons</p>											

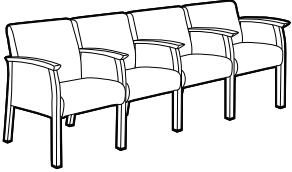
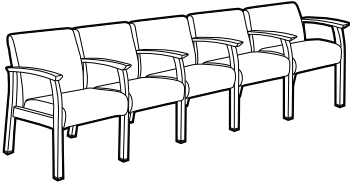
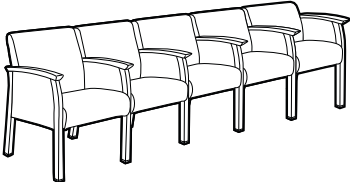
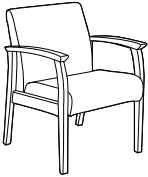
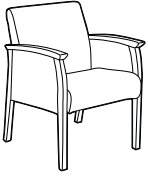
DESCRIPTION	MODEL# / FEATURES	STANDARD TEXTILE GRADES											
		COM	2	3	4	5	6	7	8	9	10	11	12
 <p>LB Four Seat Chair Full Center Arms, Closed Arms (HT) COM: 8 YD 7.32 M Unit weight: 182 LB 82.7 KG Carton weight: 207 LB 93.89 KG Carton volume: 43 FT³ 1.21 MT³</p>	<p>GC3628CA Metal</p>	6182	6438	6654	6902	7310	7686	8062	8390	8798	9182	9702	10438
		OVERALL DIMENSIONS			SEAT DIMENSIONS			BACK DIMENSIONS					
		W	D	H	W	D	H	W	H				
		IN 93	27	33	20.5	17.5	18	20.5	15				
	MM 2362	686	838	521	445	457	521	381					
		RTA 2	2 cartons										
 <p>LB Five Seat Chair Full Center Arms, Open Arms (HT) COM: 7.5 YD 6.86 M Unit weight: 224 LB 101.8 KG Carton weight: 249 LB 112.94 KG Carton volume: 43 FT³ 1.21 MT³</p>	<p>GC3630 Metal</p>	6879	7119	7322	7554	7937	8289	8642	8949	9332	9692	10179	10869
		OVERALL DIMENSIONS			SEAT DIMENSIONS			BACK DIMENSIONS					
		W	D	H	W	D	H	W	H				
		IN 115	27	33	20.5	17.5	18	20.5	15				
	MM 2921	686	838	521	445	457	521	381					
		RTA 2	2 cartons										
 <p>LB Five Seat Chair Full Center Arms, Closed Arms (HT) COM: 10 YD 9.14 M Unit weight: 236 LB 107.3 KG Carton weight: 261 LB 118.39 KG Carton volume: 43 FT³ 1.21 MT³</p>	<p>GC3630CA Metal</p>	7640	7960	8230	8540	9050	9520	9990	10400	10910	11390	12040	12960
		OVERALL DIMENSIONS			SEAT DIMENSIONS			BACK DIMENSIONS					
		W	D	H	W	D	H	W	H				
		IN 115	27	33	20.5	17.5	18	20.5	15				
	MM 2921	686	838	521	445	457	521	381					
		RTA 2	2 cartons										
 <p>LB Single Seat Armchair Open Arms (Wood) COM: 1.75 YD 1.6 M Unit weight: 42 LB 19.1 KG Carton weight: 50 LB 22.68 KG Carton volume: 17.5 FT³ 0.49 MT³</p>	<p>GC3620W Wood GC3620WF Wood flex back</p>	1222	1278	1325	1380	1469	1551	1633	1705	1794	1878	1992	2153
		OVERALL DIMENSIONS			SEAT DIMENSIONS			BACK DIMENSIONS					
		W	D	H	W	D	H	W	H				
		IN 25	27	33	20.5	17.5	18	20.5	15				
	MM 635	686	838	521	445	457	521	381					
		RTA 00	1 per carton										
 <p>LB Single Seat Armchair Closed Arms (Wood) COM: 2.75 YD 2.51 M Unit weight: 52 LB 23.6 KG Carton weight: 60 LB 27.22 KG Carton volume: 17.5 FT³ 0.49 MT³</p>	<p>GC3620WCA Wood GC3620WFCA Wood flex back</p>	1411	1499	1573	1659	1799	1928	2057	2170	2310	2442	2621	2874
		OVERALL DIMENSIONS			SEAT DIMENSIONS			BACK DIMENSIONS					
		W	D	H	W	D	H	W	H				
		IN 25	27	33	20.5	17.5	18	20.5	15				
	MM 635	686	838	521	445	457	521	381					
		RTA 00	1 per carton										

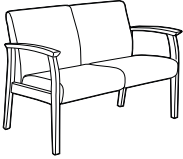
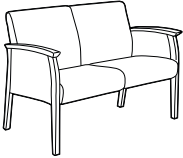
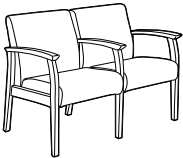
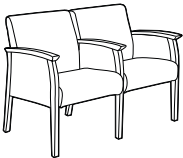
DESCRIPTION	MODEL# / FEATURES	STANDARD TEXTILE GRADES															
		COM	2	3	4	5	6	7	8	9	10	11	12				
 <p>LB Single Seat Chair, Armless (Wood) COM: 1.75 YD 1.6 M Unit weight: 40 LB 18.2 KG Carton weight: 48 LB 21.77 KG Carton volume: 17.5 FT³ 0.49 MT³</p>	GC3620WNA Wood	1094	1150	1197	1252	1341	1423	1505	1577	1666	1750	1864	2025				
		OVERALL DIMENSIONS W D H			SEAT DIMENSIONS W D H			BACK DIMENSIONS W H									
	Active weight 350 lbs.	IN 23.5	27	33	20.5	17.5	18	20.5	15	MM 597	686	838	521	445	457	521	381
		RTA 00	1 per carton														
 <p>LB Two Seat Chair No Center Arm, Open Arms (Wood) COM: 3.25 YD 2.97 M Unit weight: 68 LB 30.9 KG Carton weight: 80 LB 36.29 KG Carton volume: 43 FT³ 1.21 MT³</p>	GC3621W Wood	1854	1958	2046	2147	2312	2465	2618	2751	2917	3073	3284	3583				
		OVERALL DIMENSIONS W D H			SEAT DIMENSIONS W D H			BACK DIMENSIONS W H									
	Active weight 350 lbs/seat. Optional urethane armcaps. Please specify. No upcharge.	IN 45	27	33	40	17.5	18	40	15	MM 1143	686	838	1016	445	457	1016	381
		RTA 00	1 per carton														
 <p>LB Two Seat Chair No Center Arm, Closed Arms (Wood) COM: 3.75 YD 3.43 M Unit weight: 78 LB 35.5 KG Carton weight: 90 LB 40.82 KG Carton volume: 43 FT³ 1.21 MT³</p>	GC3621WCA Wood	2060	2180	2281	2398	2589	2765	2941	3095	3286	3466	3710	4055				
		OVERALL DIMENSIONS W D H			SEAT DIMENSIONS W D H			BACK DIMENSIONS W H									
	Active weight 350 lbs/seat. Optional urethane armcaps. Please specify. No upcharge.	IN 45	27	33	40	17.5	18	40	15	MM 1143	686	838	1016	445	457	1016	381
		RTA 00	1 per carton														
 <p>LB Two Seat Chair Full Center Arm, Open Arms (Wood) COM: 3.25 YD 2.97 M Unit weight: 74 LB 33.6 KG Carton weight: 86 LB 39.01 KG Carton volume: 43 FT³ 1.21 MT³</p>	GC3622W Wood	2243	2347	2435	2536	2701	2854	3007	3140	3306	3462	3673	3972				
		OVERALL DIMENSIONS W D H			SEAT DIMENSIONS W D H			BACK DIMENSIONS W H									
	Active weight 350 lbs/seat. Optional urethane armcaps. Please specify. No upcharge.	IN 46	27	33	20.5	17.5	18	20.5	15	MM 1168	686	838	521	445	457	521	381
		RTA 00	1 per carton														
 <p>LB Two Seat Chair Full Center Arm, Closed Arms (Wood) COM: 4.5 YD 4.11 M Unit weight: 94 LB 42.7 KG Carton weight: 106 LB 48.08 KG Carton volume: 43 FT³ 1.21 MT³</p>	GC3622WCA Wood	2538	2682	2804	2943	3173	3384	3596	3780	4010	4226	4518	4932				
		OVERALL DIMENSIONS W D H			SEAT DIMENSIONS W D H			BACK DIMENSIONS W H									
	Active weight 350 lbs/seat. Optional urethane armcaps. Please specify. No upcharge.	IN 46	27	33	20.5	17.5	18	20.5	15	MM 1168	686	838	521	445	457	521	381
		RTA 00	1 per carton														

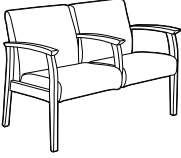
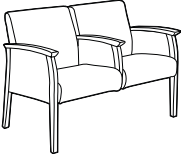
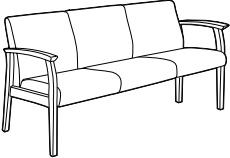
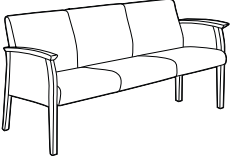
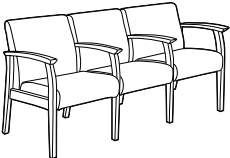
DESCRIPTION	MODEL# / FEATURES	STANDARD TEXTILE GRADES											
		COM	2	3	4	5	6	7	8	9	10	11	12
 <p>LB Two Seat Chair Half Center Arm, Open Arms (Wood) COM: 3.25 YD 2.97 M Unit weight: 70 LB 31.8 KG Carton weight: 82 LB 37.19 KG Carton volume: 43 FT³ 1.21 MT³</p>	GC3623W Wood	2137	2241	2329	2430	2595	2748	2901	3034	3200	3356	3567	3866
		OVERALL DIMENSIONS			SEAT DIMENSIONS			BACK DIMENSIONS					
		W	D	H	W	D	H	W	H				
		IN 46 MM 1168	27 686	33 838	20.5 521	17.5 445	18 457	20.5 521	15 381				
			RTA 00	1 per carton									
 <p>LB Two Seat Chair Half Center Arm, Closed Arms (Wood) COM: 4.5 YD 4.11 M Unit weight: 80 LB 36.4 KG Carton weight: 92 LB 41.73 KG Carton volume: 43 FT³ 1.21 MT³</p>	GC3623WCA Wood	2430	2574	2696	2835	3065	3276	3488	3672	3902	4118	4410	4824
		OVERALL DIMENSIONS			SEAT DIMENSIONS			BACK DIMENSIONS					
		W	D	H	W	D	H	W	H				
		IN 46 MM 1168	27 686	36.5 927	20.5 521	17.5 445	18 457	20.5 521	18 457				
			RTA 00	1 per carton									
 <p>LB Three Seat Chair No Center Arm, Open Arms (Wood) COM: 4.25 YD 3.89 M Unit weight: 102 LB 46.4 KG Carton weight: 125 LB 56.7 KG Carton volume: 65.25 FT³ 1.84 MT³</p>	GC3624W Wood	2524	2660	2775	2907	3123	3323	3523	3697	3914	4118	4394	4785
		OVERALL DIMENSIONS			SEAT DIMENSIONS			BACK DIMENSIONS					
		W	D	H	W	D	H	W	H				
		IN 65 MM 1651	27 686	33 838	60 1524	17.5 445	18 457	60 1524	15 381				
			RTA 00	1 per carton									
 <p>LB Three Seat Chair No Center Arm, Closed Arms (Wood) COM: 5.25 YD 4.8 M Unit weight: 112 LB 50.9 KG Carton weight: 135 LB 61.23 KG Carton volume: 65.25 FT³ 1.84 MT³</p>	GC3624WCA Wood	2714	2882	3024	3187	3454	3701	3948	4163	4431	4683	5024	5507
		OVERALL DIMENSIONS			SEAT DIMENSIONS			BACK DIMENSIONS					
		W	D	H	W	D	H	W	H				
		IN 65 MM 1651	27 686	33 838	60 1524	17.5 445	18 457	60 1524	15 381				
			RTA 00	1 per carton									
 <p>LB Three Seat Chair Full Center Arm, Open Arms (Wood) COM: 4.75 YD 4.34 M Unit weight: 125 LB 56.8 KG Carton weight: 150 LB 68.04 KG Carton volume: 65.25 FT³ 1.84 MT³</p>	GC3625W Wood	3290	3442	3570	3718	3960	4183	4406	4601	4843	5071	5380	5817
		OVERALL DIMENSIONS			SEAT DIMENSIONS			BACK DIMENSIONS					
		W	D	H	W	D	H	W	H				
		IN 69 MM 1753	27 686	33 876	20.5 521	17.5 445	18 457	20.5 521	15 381				
			RTA 00	1 per carton									

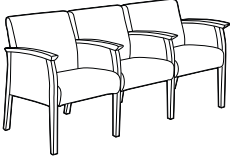
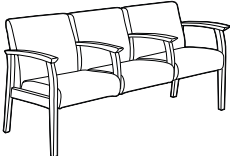
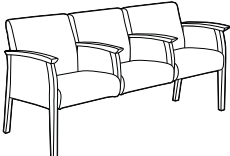
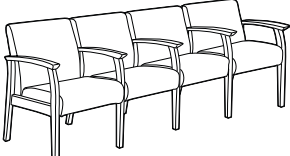
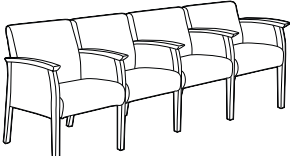
DESCRIPTION	MODEL# / FEATURES	STANDARD TEXTILE GRADES											
		COM	2	3	4	5	6	7	8	9	10	11	12
 <p>LB Three Seat Chair Full Center Arms, Closed Arms (Wood) COM: 6.25 YD 5.72 M Unit weight: 135 LB 61.4 KG Carton weight: 160 LB 72.57 KG Carton volume: 65.25 FT³ 1.84 MT³</p>	<p>GC3625WCA Wood</p>	3685	3885	4054	4248	4566	4860	5154	5410	5729	6029	6435	7010
		OVERALL DIMENSIONS			SEAT DIMENSIONS			BACK DIMENSIONS					
		W D H			W D H			W H					
		IN 69	27	33	20.5	17.5	18	20.5	15				
MM 1753	686	838	521	445	457	521	381						
Active weight 350 lbs/seat.		1 per carton											
Optional urethane armcaps. Please specify. No upcharge.		RTA 00											
 <p>LB Three Seat Chair Half Center Arms, Open Arms (Wood) COM: 4.75 YD 4.34 M Unit weight: 112 LB 50.9 KG Carton weight: 135 LB 61.23 KG Carton volume: 65.25 FT³ 1.84 MT³</p>	<p>GC3626W Wood</p>	3028	3180	3308	3456	3698	3921	4144	4339	4581	4809	5118	5555
		OVERALL DIMENSIONS			SEAT DIMENSIONS			BACK DIMENSIONS					
		W D H			W D H			W H					
		IN 69	27	33	20.5	17.5	18	20.5	15				
MM 1753	686	838	521	445	457	521	381						
Active weight 350 lbs/seat.		1 per carton											
Optional urethane armcaps. Please specify. No upcharge.		RTA 00											
 <p>LB Three Seat Chair Half Center Arms, Closed Arms (Wood) COM: 6.25 YD 5.72 M Unit weight: 122 LB 55.5 KG Carton weight: 145 LB 65.77 KG Carton volume: 65.25 FT³ 1.84 MT³</p>	<p>GC3626WCA Wood</p>	3423	3623	3792	3986	4304	4598	4892	5148	5467	5767	6173	6748
		OVERALL DIMENSIONS			SEAT DIMENSIONS			BACK DIMENSIONS					
		W D H			W D H			W H					
		IN 69	27	33	20.5	17.5	18	20.5	15				
MM 1753	686	838	521	445	457	521	381						
Active weight 350 lbs/seat.		1 per carton											
Optional urethane armcaps. Please specify. No upcharge.		RTA 00											
 <p>LB Four Seat Chair Full Center Arms, Open Arms (Wood) COM: 8 YD 5.49 M Unit weight: 160 LB 72.7 KG Carton weight: 185 LB 83.91 KG Carton volume: 43 FT³ 1.21 MT³</p>	<p>GC3628W Wood</p>	4342	4534	4696	4882	5188	5470	5752	5998	6304	6592	6982	7534
		OVERALL DIMENSIONS			SEAT DIMENSIONS			BACK DIMENSIONS					
		W D H			W D H			W H					
		IN 93	27	33	20.5	17.5	18	20.5	15				
MM 2362	686	838	521	445	457	521	381						
Active weight 350 lbs/seat.		2 cartons											
Optional urethane armcaps. Please specify. No upcharge.		RTA 4											
 <p>LB Four Seat Chair Full Center Arms, Closed Arms (Wood) COM: 8 YD 7.32 M Unit weight: 170 LB 77.3 KG Carton weight: 195 LB 88.45 KG Carton volume: 43 FT³ 1.21 MT³</p>	<p>GC3628WCA Wood</p>	4833	5089	5305	5553	5961	6337	6713	7041	7449	7833	8353	9089
		OVERALL DIMENSIONS			SEAT DIMENSIONS			BACK DIMENSIONS					
		W D H			W D H			W H					
		IN 93	27	33	20.5	17.5	18	20.5	15				
MM 2362	686	838	521	445	457	521	381						
Active weight 350 lbs/seat.		2 cartons											
Optional urethane armcaps. Please specify. No upcharge.		RTA 4											

PRIMACARE PATIENT



model GC3631 (HT)



model GC3632WCA (Wood)

STANDARD FEATURES

- Primacare is a family of products offering the most significant return on investment approach in the industry since every component can be repaired or replaced on site.
- **High traffic (HT) models:** Metal frame with die cast zinc connectors and metal-to-metal fasteners. Available in the following finishes: Black (TBL), Cloud (TIV), Designer White (TDW), Fog (TFO), Frost (TFR), Kalua (TKA), Latte (TLA), Mocha (TMO), Nevada (TNE), Sand (TSN), Shadow (TSH), Toast (TOA) and Tungsten (TTU).
- **Wood models:** Solid hardwood frame with die cast zinc connectors and metal-to-metal fastening. Available in the following finishes: Absolute (AAM), Charcoal Java (CJM), Cherry (ACM), Empire Mahogany (EMM), English Oak (EOM), Espresso Cafe (ECM), Fruitwood (TFM), Gray (HGM), Harvest Oak (HOM), Honey (AHM), Jet Onyx (JOM), Light Honey (LHM), Mahogany (TMM), Maple (AVM), Medium Walnut (MWM), Natural Walnut (NLW), Night (ASM), Noce Biondo (NBM), Noce Grigio (NGM), Noce Leggero (NEM), Noce Medio (NMM), Sandy Beach (SBM), Shaker Cherry (SKM), Silver Oak (SOM), Walnut (TWM), White (WHM), WC Cream (WTM) and Winter Cherry (WCM).
- Armcaps are securely fastened with metal-to-metal connectors which allow for field replacement if required.
- Easy grip forward extending armcap on models with arms.
- Replaceable seat covers and replaceable and/or removable seat cushions are standard.
- Seat cushion has a seamless waterfall front and clean out between and around the seat and back cushions.
- Models are standard with metal mesh seat deck. For mental health applications, the metal mesh seat deck can be covered with a solid moisture resistant surface, held in place with tamperproof fasteners. Contact your sales rep for a special quotation.
- All seat frames feature a wall saver design to prevent back contact with wall.
- Models ending in **CA / ARC**, have upholstered panel arm inserts closing the arm. (Closed arm panels are designed to be replaceable. Request a special quote to have them secured with tamperproof fasteners.)
- For healthcare textile options, visit the website at globalfurnituregroup.com.
- Can be upholstered in standard Global textiles if healthcare compliance is not required.
- Shipped fully assembled.



OPTIONAL FEATURES





- **High traffic (HT) models:** Wood armcaps are available. See far left column "Wood models" for finishes. Please specify. No upcharge.
- **High traffic (HT) and wood models:** Urethane armcaps are available in the following finishes: Black (BLK), Kalua (KAL), Latte (LAB), Mocha (J52), Shadow (SHW) and Toast (TOA). Please specify. No upcharge.
- For moisture barrier on seat, please specify **(MB)**. Add \$81 per seat. For bariatric models, add \$122 per seat.
- To add sealed seams to your product contact Customer Service. Upcharges vary.
- For Primacare tables, see page 59.





SUGGESTED APPLICATIONS

- Bariatric seating
- Guest seating
- Lobbies
- Lounge/Waiting
- Patient rooms
- Resident rooms
- Treatment/Exam rooms

HIGH TRAFFIC (HT) MODELS ARE LISTED FIRST, FOLLOWED BY WOOD MODELS.

DESCRIPTION	MODEL# / FEATURES	STANDARD TEXTILE GRADES																								
 <p>MB Armchair Open Arms (HT) COM: 1.75 YD 1.6 M Unit weight: 56 LB 25.5 KG Carton weight: 64 LB 29.03 KG Carton volume: 17.5 FT³ 0.49 MT³</p>	COM	2	3	4	5	6	7	8	9	10	11	12														
	GC3631 Metal	1597	1653	1700	1755	1844	1926	2008	2080	2169	2253	2367	2528													
	GC3631F Metal flex back	1968	2024	2071	2126	2215	2297	2379	2451	2540	2624	2738	2899													
	<p>OVERALL DIMENSIONS</p> <table border="1"> <tr> <th>W</th> <th>D</th> <th>H</th> <th colspan="3">SEAT DIMENSIONS</th> <th colspan="2">BACK DIMENSIONS</th> </tr> <tr> <td>IN 25</td> <td>27</td> <td>36.5</td> <td>20.5</td> <td>17.5</td> <td>18</td> <td>20.5</td> <td>18</td> </tr> <tr> <td>MM 635</td> <td>686</td> <td>927</td> <td>521</td> <td>445</td> <td>457</td> <td>521</td> <td>457</td> </tr> </table>		W	D	H	SEAT DIMENSIONS			BACK DIMENSIONS		IN 25	27	36.5	20.5	17.5	18	20.5	18	MM 635	686	927	521	445	457	521	457
W	D	H	SEAT DIMENSIONS			BACK DIMENSIONS																				
IN 25	27	36.5	20.5	17.5	18	20.5	18																			
MM 635	686	927	521	445	457	521	457																			
<p>Active weight 500 lbs.</p> <p>Optional wood armcaps. Please specify. No upcharge.</p> <p>RTA 00 1 per carton</p>																										
 <p>MB Armchair Closed Arms (HT) COM: 2.75 YD 2.51 M Unit weight: 68 LB 30.9 KG Carton weight: 76 LB 34.47 KG Carton volume: 17.5 FT³ 0.49 MT³</p>	COM	2	3	4	5	6	7	8	9	10	11	12														
	GC3631CA Metal	1858	1946	2020	2106	2246	2375	2504	2617	2757	2889	3068	3321													
	GC3631FCA Metal flex back	2226	2314	2388	2474	2614	2743	2872	2985	3125	3257	3436	3689													
	<p>OVERALL DIMENSIONS</p> <table border="1"> <tr> <th>W</th> <th>D</th> <th>H</th> <th colspan="3">SEAT DIMENSIONS</th> <th colspan="2">BACK DIMENSIONS</th> </tr> <tr> <td>IN 25</td> <td>27</td> <td>36.5</td> <td>20.5</td> <td>17.5</td> <td>18</td> <td>20.5</td> <td>18</td> </tr> <tr> <td>MM 635</td> <td>686</td> <td>927</td> <td>521</td> <td>445</td> <td>457</td> <td>521</td> <td>457</td> </tr> </table>		W	D	H	SEAT DIMENSIONS			BACK DIMENSIONS		IN 25	27	36.5	20.5	17.5	18	20.5	18	MM 635	686	927	521	445	457	521	457
W	D	H	SEAT DIMENSIONS			BACK DIMENSIONS																				
IN 25	27	36.5	20.5	17.5	18	20.5	18																			
MM 635	686	927	521	445	457	521	457																			
<p>Active weight 500 lbs.</p> <p>Optional wood armcaps. Please specify. No upcharge.</p> <p>RTA 00 1 per carton</p>																										
 <p>MB Armchair Open Arms, Rear Tip and Move Wheels (HT) COM: 1.75 YD 1.6 M Unit weight: 56 LB 25.5 KG Carton weight: 64 LB 29.03 KG Carton volume: 23 FT³ 0.65 MT³</p>	COM	2	3	4	5	6	7	8	9	10	11	12														
	GC3631RC Metal	1697	1753	1800	1855	1944	2026	2108	2180	2269	2353	2467	2628													
	<p>OVERALL DIMENSIONS</p> <table border="1"> <tr> <th>W</th> <th>D</th> <th>H</th> <th colspan="3">SEAT DIMENSIONS</th> <th colspan="2">BACK DIMENSIONS</th> </tr> <tr> <td>IN 25</td> <td>29.5</td> <td>36.5</td> <td>20.5</td> <td>17.5</td> <td>18</td> <td>20.5</td> <td>18</td> </tr> <tr> <td>MM 635</td> <td>749</td> <td>927</td> <td>521</td> <td>445</td> <td>457</td> <td>521</td> <td>457</td> </tr> </table>		W	D	H	SEAT DIMENSIONS			BACK DIMENSIONS		IN 25	29.5	36.5	20.5	17.5	18	20.5	18	MM 635	749	927	521	445	457	521	457
	W	D	H	SEAT DIMENSIONS			BACK DIMENSIONS																			
IN 25	29.5	36.5	20.5	17.5	18	20.5	18																			
MM 635	749	927	521	445	457	521	457																			
<p>Active weight 500 lbs.</p> <p>Optional wood armcaps. Please specify. No upcharge.</p> <p>RTA 00 1 per carton</p>																										

DESCRIPTION	MODEL# / FEATURES	STANDARD TEXTILE GRADES												
		COM	2	3	4	5	6	7	8	9	10	11	12	
 <p>MB Armchair Closed Arms, Rear Tip and Move Wheels (HT) COM: 2.75 YD 2.51 M Unit weight: 68 LB 30.9 KG Carton weight: 76 LB 34.47 KG Carton volume: 23 FT³ 0.65 MT³</p>	GC3631CARC Metal	1956	2044	2118	2204	2344	2473	2602	2715	2855	2987	3166	3419	
	Active weight 500 lbs.													
	Optional wood armcaps. Please specify. No upcharge.													
		RTA 00	1 per carton											
		OVERALL DIMENSIONS			SEAT DIMENSIONS			BACK DIMENSIONS						
		W	D	H	W	D	H	W	H					
		IN 25	29.5	36.5	20.5	17.5	18	20.5	18					
		MM 635	749	927	521	445	457	521	457					
 <p>MB Chair, Armless (HT) COM: 1.75 YD 1.6 M Unit weight: 46 LB 20.9 KG Carton weight: 54 LB 24.49 KG Carton volume: 20 FT³ 0.56 MT³</p>	GC3631NA Metal	1299	1355	1402	1457	1546	1628	1710	1782	1871	1955	2069	2230	
	Active weight 500 lbs.													
		RTA 00	1 per carton											
			OVERALL DIMENSIONS			SEAT DIMENSIONS			BACK DIMENSIONS					
		W	D	H	W	D	H	W	H					
		IN 22.5	27	36.5	20.5	17.5	18	20.5	18					
		MM 572	686	927	521	445	457	521	457					
 <p>HB Armchair Open Arms, Split Back (HT) COM: 2.25 YD 2.06 M Unit weight: 62 LB 28.2 KG Carton weight: 72 LB 32.66 KG Carton volume: 27.5 FT³ 0.77 MT³</p>	GC3632 Metal	1884	1956	2017	2087	2201	2307	2413	2505	2620	2728	2874	3081	
	Active weight 500 lbs.	GC3632F Metal flex back	2253	2325	2386	2456	2570	2676	2782	2874	2989	3097	3243	3450
		Fold down headrest allows caregiver to assist occupant.												
	Optional wood armcaps. Please specify. No upcharge.	RTA 00	1 per carton											
		OVERALL DIMENSIONS			SEAT DIMENSIONS			BACK DIMENSIONS						
		W	D	H	W	D	H	W	H					
		IN 25	27	48.5	20.5	17.5	18	20.5	30					
		MM 635	686	1232	521	445	457	521	762					
 <p>HB Armchair Closed Arms, Split Back (HT) COM: 3 YD 2.74 M Unit weight: 74 LB 33.6 KG Carton weight: 84 LB 38.1 KG Carton volume: 27.5 FT³ 0.77 MT³</p>	GC3632CA Metal	2149	2245	2326	2419	2572	2713	2854	2977	3130	3274	3469	3745	
	Active weight 500 lbs.	GC3632FCA Metal flex back	2520	2616	2697	2790	2943	3084	3225	3348	3501	3645	3840	4116
		Fold down headrest allows caregiver to assist occupant.												
	Optional wood armcaps. Please specify. No upcharge.	RTA 00	1 per carton											
		OVERALL DIMENSIONS			SEAT DIMENSIONS			BACK DIMENSIONS						
		W	D	H	W	D	H	W	H					
		IN 25	27	48.5	20.5	17.5	18	20.5	30					
		MM 635	686	1232	521	445	457	521	762					
 <p>HB Armchair Open Arms, Split Back, Rear Tip and Move Wheels (HT) COM: 2.25 YD 2.06 M Unit weight: 62 LB 28.2 KG Carton weight: 72 LB 32.66 KG Carton volume: 27.5 FT³ 0.77 MT³</p>	GC3632RC Metal	1985	2057	2118	2188	2302	2408	2514	2606	2721	2829	2975	3182	
	Active weight 500 lbs.													
		Fold down headrest allows caregiver to assist occupant.												
	Optional wood armcaps. Please specify. No upcharge.	RTA 00	1 per carton											
		OVERALL DIMENSIONS			SEAT DIMENSIONS			BACK DIMENSIONS						
		W	D	H	W	D	H	W	H					
		IN 25	29.5	48.5	20.5	17.5	18	20.5	30					
		MM 635	749	1232	521	445	457	521	762					

DESCRIPTION		MODEL# / FEATURES	STANDARD TEXTILE GRADES																																		
 <p>HB Armchair Closed Arms, Split Back, Rear Tip and Move Wheels (HT) COM: 3 YD 2.74 M Unit weight: 74 LB 33.6 KG Carton weight: 84 LB 38.1 KG Carton volume: 27.5 FT³ 0.77 MT³</p>	<p>Active weight 500 lbs.</p> <p>Fold down headrest allows caregiver to assist occupant.</p> <p>Optional wood armcaps. Please specify. No upcharge.</p>	COM	2	3	4	5	6	7	8	9	10	11	12																								
		GC3632CARC	2251	2347	2428	2521	2674	2815	2956	3079	3232	3376	3571	3847																							
		<table border="1"> <thead> <tr> <th colspan="3">OVERALL DIMENSIONS</th> <th colspan="3">SEAT DIMENSIONS</th> <th colspan="2">BACK DIMENSIONS</th> </tr> <tr> <th>W</th> <th>D</th> <th>H</th> <th>W</th> <th>D</th> <th>H</th> <th>W</th> <th>H</th> </tr> </thead> <tbody> <tr> <td>IN 25</td> <td>29.5</td> <td>48.5</td> <td>20.5</td> <td>17.5</td> <td>18</td> <td>20.5</td> <td>30</td> </tr> <tr> <td>MM 635</td> <td>749</td> <td>1232</td> <td>521</td> <td>445</td> <td>457</td> <td>521</td> <td>762</td> </tr> </tbody> </table>			OVERALL DIMENSIONS			SEAT DIMENSIONS			BACK DIMENSIONS		W	D	H	W	D	H	W	H	IN 25	29.5	48.5	20.5	17.5	18	20.5	30	MM 635	749	1232	521	445	457	521	762	<p>RTA 00 1 per carton</p>
OVERALL DIMENSIONS			SEAT DIMENSIONS			BACK DIMENSIONS																															
W	D	H	W	D	H	W	H																														
IN 25	29.5	48.5	20.5	17.5	18	20.5	30																														
MM 635	749	1232	521	445	457	521	762																														
 <p>HB Chair, Split Back, Armless (HT) COM: 2.25 YD 2.06 M Unit weight: 52 LB 23.6 KG Carton weight: 62 LB 28.12 KG Carton volume: 27.5 FT³ 0.77 MT³</p>	<p>Active weight 500 lbs.</p> <p>Fold down headrest allows caregiver to assist occupant.</p>	COM	2	3	4	5	6	7	8	9	10	11	12																								
		GC3632NA	1532	1604	1665	1735	1849	1955	2061	2153	2268	2376	2522	2729																							
		<table border="1"> <thead> <tr> <th colspan="3">OVERALL DIMENSIONS</th> <th colspan="3">SEAT DIMENSIONS</th> <th colspan="2">BACK DIMENSIONS</th> </tr> <tr> <th>W</th> <th>D</th> <th>H</th> <th>W</th> <th>D</th> <th>H</th> <th>W</th> <th>H</th> </tr> </thead> <tbody> <tr> <td>IN 22</td> <td>27</td> <td>48.5</td> <td>20.5</td> <td>17.5</td> <td>18</td> <td>20.5</td> <td>30</td> </tr> <tr> <td>MM 559</td> <td>686</td> <td>1232</td> <td>521</td> <td>445</td> <td>457</td> <td>521</td> <td>762</td> </tr> </tbody> </table>			OVERALL DIMENSIONS			SEAT DIMENSIONS			BACK DIMENSIONS		W	D	H	W	D	H	W	H	IN 22	27	48.5	20.5	17.5	18	20.5	30	MM 559	686	1232	521	445	457	521	762	<p>RTA 00 1 per carton</p>
OVERALL DIMENSIONS			SEAT DIMENSIONS			BACK DIMENSIONS																															
W	D	H	W	D	H	W	H																														
IN 22	27	48.5	20.5	17.5	18	20.5	30																														
MM 559	686	1232	521	445	457	521	762																														
 <p>Designed to immobilize the pelvis and hip joints after surgery.</p> <p>LB Hip Armchair Open Arms - Post Surgery (HT) COM: 1.5 YD 1.37 M Unit weight: 57 LB 25.9 KG Carton weight: 67 LB 30.39 KG Carton volume: 20 FT³ 0.56 MT³</p>	<p>Active weight 500 lbs.</p> <p>Optional wood armcaps. Please specify. No upcharge.</p>	COM	2	3	4	5	6	7	8	9	10	11	12																								
		GC3636	1840	1888	1929	1975	2052	2122	2193	2254	2331	2403	2500	2638																							
		<table border="1"> <thead> <tr> <th colspan="3">OVERALL DIMENSIONS</th> <th colspan="3">SEAT DIMENSIONS</th> <th colspan="2">BACK DIMENSIONS</th> </tr> <tr> <th>W</th> <th>D</th> <th>H</th> <th>W</th> <th>D</th> <th>H</th> <th>W</th> <th>H</th> </tr> </thead> <tbody> <tr> <td>IN 23</td> <td>26</td> <td>40.5</td> <td>19</td> <td>17.5</td> <td>25.5</td> <td>19</td> <td>15.5</td> </tr> <tr> <td>MM 584</td> <td>660</td> <td>1029</td> <td>483</td> <td>445</td> <td>648</td> <td>483</td> <td>394</td> </tr> </tbody> </table>			OVERALL DIMENSIONS			SEAT DIMENSIONS			BACK DIMENSIONS		W	D	H	W	D	H	W	H	IN 23	26	40.5	19	17.5	25.5	19	15.5	MM 584	660	1029	483	445	648	483	394	<p>RTA 00 1 per carton</p>
OVERALL DIMENSIONS			SEAT DIMENSIONS			BACK DIMENSIONS																															
W	D	H	W	D	H	W	H																														
IN 23	26	40.5	19	17.5	25.5	19	15.5																														
MM 584	660	1029	483	445	648	483	394																														
 <p>Bariatric MB Armchair Open Arms (HT) COM: 2.75 YD 2.51 M Unit weight: 82 LB 37.3 KG Carton weight: 94 LB 42.64 KG Carton volume: 30.5 FT³ 0.86 MT³</p>	<p>Active weight 500 lbs.</p> <p>Optional wood armcaps. Please specify. No upcharge.</p>	COM	2	3	4	5	6	7	8	9	10	11	12																								
		GC3638	2064	2152	2226	2312	2452	2581	2710	2823	2963	3095	3274	3527																							
		<table border="1"> <thead> <tr> <th colspan="3">OVERALL DIMENSIONS</th> <th colspan="3">SEAT DIMENSIONS</th> <th colspan="2">BACK DIMENSIONS</th> </tr> <tr> <th>W</th> <th>D</th> <th>H</th> <th>W</th> <th>D</th> <th>H</th> <th>W</th> <th>H</th> </tr> </thead> <tbody> <tr> <td>IN 35</td> <td>27</td> <td>36.5</td> <td>30</td> <td>17.5</td> <td>18</td> <td>30</td> <td>18</td> </tr> <tr> <td>MM 889</td> <td>686</td> <td>927</td> <td>762</td> <td>445</td> <td>457</td> <td>762</td> <td>457</td> </tr> </tbody> </table>			OVERALL DIMENSIONS			SEAT DIMENSIONS			BACK DIMENSIONS		W	D	H	W	D	H	W	H	IN 35	27	36.5	30	17.5	18	30	18	MM 889	686	927	762	445	457	762	457	<p>RTA 00 1 per carton</p>
OVERALL DIMENSIONS			SEAT DIMENSIONS			BACK DIMENSIONS																															
W	D	H	W	D	H	W	H																														
IN 35	27	36.5	30	17.5	18	30	18																														
MM 889	686	927	762	445	457	762	457																														
 <p>Bariatric MB Armchair Closed Arms (HT) COM: 3.75 YD 3.43 M Unit weight: 92 LB 41.8 KG Carton weight: 104 LB 47.17 KG Carton volume: 30.5 FT³ 0.86 MT³</p>	<p>Active weight 500 lbs.</p> <p>Optional wood armcaps. Please specify. No upcharge.</p>	COM	2	3	4	5	6	7	8	9	10	11	12																								
		GC3638CA	2320	2440	2541	2658	2849	3025	3201	3355	3546	3726	3970	4315																							
		<table border="1"> <thead> <tr> <th colspan="3">OVERALL DIMENSIONS</th> <th colspan="3">SEAT DIMENSIONS</th> <th colspan="2">BACK DIMENSIONS</th> </tr> <tr> <th>W</th> <th>D</th> <th>H</th> <th>W</th> <th>D</th> <th>H</th> <th>W</th> <th>H</th> </tr> </thead> <tbody> <tr> <td>IN 35</td> <td>27</td> <td>36.5</td> <td>30</td> <td>17.5</td> <td>18</td> <td>30</td> <td>18</td> </tr> <tr> <td>MM 889</td> <td>686</td> <td>927</td> <td>762</td> <td>445</td> <td>457</td> <td>762</td> <td>457</td> </tr> </tbody> </table>			OVERALL DIMENSIONS			SEAT DIMENSIONS			BACK DIMENSIONS		W	D	H	W	D	H	W	H	IN 35	27	36.5	30	17.5	18	30	18	MM 889	686	927	762	445	457	762	457	<p>RTA 00 1 per carton</p>
OVERALL DIMENSIONS			SEAT DIMENSIONS			BACK DIMENSIONS																															
W	D	H	W	D	H	W	H																														
IN 35	27	36.5	30	17.5	18	30	18																														
MM 889	686	927	762	445	457	762	457																														

DESCRIPTION MODEL# / FEATURES STANDARD TEXTILE GRADES



Bariatric HB Armchair Open Arms, Split Back (HT)

COM: 3.75 YD | 3.43 M
Unit weight: 67 LB | 30.5 KG
Carton weight: 77 LB | 34.93 KG
Carton volume: 33 FT³ | 0.93 MT³

Active weight 500 lbs.

Fold down headrest allows caregiver to assist occupant.

Optional wood armcaps. Please specify. No upcharge.

COM	2	3	4	5	6	7	8	9	10	11	12
2422	2542	2643	2760	2951	3127	3303	3457	3648	3828	4072	4417

OVERALL DIMENSIONS			SEAT DIMENSIONS			BACK DIMENSIONS	
W	D	H	W	D	H	W	H

IN	35	27	48.5	30	17.5	18	30	30
MM	889	686	1232	762	445	457	762	762

RTA 00 1 per carton



Bariatric HB Armchair Closed Arms, Split Back (HT)

COM: 4.75 YD | 4.34 M
Unit weight: 96 LB | 43.6 KG
Carton weight: 108 LB | 48.99 KG
Carton volume: 33 FT³ | 0.93 MT³

Active weight 500 lbs.

Fold down headrest allows caregiver to assist occupant.

Optional wood armcaps. Please specify. No upcharge.

COM	2	3	4	5	6	7	8	9	10	11	12
2681	2833	2961	3109	3351	3574	3797	3992	4234	4462	4771	5208

OVERALL DIMENSIONS			SEAT DIMENSIONS			BACK DIMENSIONS	
W	D	H	W	D	H	W	H

IN	35	27	48.5	30	17.5	18	30	30
MM	889	686	1232	762	445	457	762	762

RTA 00 1 per carton



HB Armchair Open Arms (HT)

COM: 2.5 YD | 2.29 M
Unit weight: 62 LB | 28.2 KG
Carton weight: 72 LB | 32.66 KG
Carton volume: 27.5 FT³ | 0.77 MT³

Active weight 500 lbs.

Optional wood armcaps. Please specify. No upcharge.

COM	2	3	4	5	6	7	8	9	10	11	12	
1651	1731	1799	1876	2004	2121	2239	2341	2469	2589	2751	2981	
GC3655F	2021	2101	2169	2246	2374	2491	2609	2711	2839	2959	3121	3351

OVERALL DIMENSIONS			SEAT DIMENSIONS			BACK DIMENSIONS	
W	D	H	W	D	H	W	H

IN	25	27	48.5	20.5	17.5	18	20.5	30
MM	635	686	1232	521	445	457	521	762

RTA 00 1 per carton



HB Armchair Closed Arms (HT)

COM: 3.25 YD | 2.97 M
Unit weight: 74 LB | 33.6 KG
Carton weight: 84 LB | 38.1 KG
Carton volume: 27.5 FT³ | 0.77 MT³

Active weight 500 lbs.

Optional wood armcaps. Please specify. No upcharge.

COM	2	3	4	5	6	7	8	9	10	11	12	
1919	2023	2111	2212	2377	2530	2683	2816	2982	3138	3349	3648	
GC3655FCA	2287	2391	2479	2580	2745	2898	3051	3184	3350	3506	3717	4016

OVERALL DIMENSIONS			SEAT DIMENSIONS			BACK DIMENSIONS	
W	D	H	W	D	H	W	H

IN	25	27	48.5	20.5	17.5	18	20.5	30
MM	635	686	1232	521	445	457	521	762

RTA 00 1 per carton

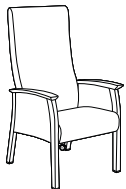

HB Armchair Closed Arms, Rear Tip and Move Wheels (HT)

COM: 3.25 YD | 2.97 M
Unit weight: 74 LB | 33.6 KG
Carton weight: 84 LB | 38.1 KG
Carton volume: 27.5 FT³ | 0.77 MT³

Active weight 500 lbs.





Optional wood armcaps. Please specify. No upcharge.

COM	2	3	4	5	6	7	8	9	10	11	12
2020	2124	2212	2313	2478	2631	2784	2917	3083	3239	3450	3749

OVERALL DIMENSIONS			SEAT DIMENSIONS			BACK DIMENSIONS	
W	D	H	W	D	H	W	H

IN	25	29.5	48.5	20.5	17.5	18	20.5	30
MM	635	749	1232	521	445	457	521	762

RTA 00 1 per carton

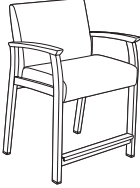
DESCRIPTION	MODEL# / FEATURES	STANDARD TEXTILE GRADES											
 <p>HB Armchair Open Arms, Rear Tip and Move Wheels (HT) COM: 2.5 YD 2.29 M Unit weight: 62 LB 28.2 KG Carton weight: 72 LB 32.66 KG Carton volume: 27.5 FT³ 0.77 MT³</p>	GC3655RC Metal	COM	2	3	4	5	6	7	8	9	10	11	12
		1750	1830	1898	1975	2103	2220	2338	2440	2568	2688	2850	3080
		OVERALL DIMENSIONS			SEAT DIMENSIONS			BACK DIMENSIONS					
		W	D	H	W	D	H	W	H				
IN	25	29.5	48.5	20.5	17.5	18	20.5	30					
MM	635	749	1232	521	445	457	521	762					
Active weight 500 lbs.		Optional wood armcaps. Please specify. No upcharge.											
		RTA 00	1 per carton										
 <p>HB Chair, Armless (HT) COM: 2.5 YD 2.29 M Unit weight: 52 LB 23.6 KG Carton weight: 62 LB 28.12 KG Carton volume: 27.5 FT³ 0.77 MT³</p>	GC3655NA Metal	COM	2	3	4	5	6	7	8	9	10	11	12
		1340	1420	1488	1565	1693	1810	1928	2030	2158	2278	2440	2670
		OVERALL DIMENSIONS			SEAT DIMENSIONS			BACK DIMENSIONS					
		W	D	H	W	D	H	W	H				
IN	22	27	48.5	20.5	17.5	18	20.5	30					
MM	559	686	1232	521	445	457	521	762					
Active weight 500 lbs.		Optional wood armcaps. Please specify. No upcharge.											
		RTA 00	1 per carton										
 <p>Bariatric HB Armchair Open Arms (HT) COM: 3.5 YD 3.2 M Unit weight: 67 LB 30.5 KG Carton weight: 79 LB 35.83 KG Carton volume: 33 FT³ 0.93 MT³</p>	GC3656 Metal	COM	2	3	4	5	6	7	8	9	10	11	12
		2155	2267	2362	2470	2649	2813	2978	3121	3300	3468	3695	4017
		OVERALL DIMENSIONS			SEAT DIMENSIONS			BACK DIMENSIONS					
		W	D	H	W	D	H	W	H				
IN	35	27	48.5	30	17.5	18	30	30					
MM	889	686	1232	762	445	457	762	762					
Active weight 500 lbs.		Optional wood armcaps. Please specify. No upcharge.											
		RTA 00	1 per carton										
 <p>Bariatric HB Armchair Closed Arms (HT) COM: 4.5 YD 4.11 M Unit weight: 96 LB 43.6 KG Carton weight: 108 LB 48.99 KG Carton volume: 33 FT³ 0.93 MT³</p>	GC3656CA Metal	COM	2	3	4	5	6	7	8	9	10	11	12
		2411	2555	2677	2816	3046	3257	3469	3653	3883	4099	4391	4805
		OVERALL DIMENSIONS			SEAT DIMENSIONS			BACK DIMENSIONS					
		W	D	H	W	D	H	W	H				
IN	35	27	48.5	30	17.5	18	30	30					
MM	889	686	1232	762	445	457	762	762					
Active weight 500 lbs.		Optional wood armcaps. Please specify. No upcharge.											
		RTA 00	1 per carton										
 <p>Wide Hip Armchair Open Arms - Post Surgery (HT) COM: 1.5 YD 1.37 M Unit weight: 68 LB 30.9 KG Carton weight: 78 LB 35.38 KG Carton volume: 20 FT³ 0.56 MT³</p>	GC3657 Metal	COM	2	3	4	5	6	7	8	9	10	11	12
		2239	2287	2328	2374	2451	2521	2592	2653	2730	2802	2899	3037
		OVERALL DIMENSIONS			SEAT DIMENSIONS			BACK DIMENSIONS					
		W	D	H	W	D	H	W	H				
IN	28	25	41	24	17.5	26	24	15.5					
MM	711	635	1041	610	445	660	610	394					
Active weight 500 lbs.		Optional wood armcaps. Please specify. No upcharge.											
		RTA 00	1 per carton										

Designed to immobilize the pelvis and hip joints after surgery.



DESCRIPTION	MODEL# / FEATURES	STANDARD TEXTILE GRADES											
		COM	2	3	4	5	6	7	8	9	10	11	12
	GC3631W Wood	1250	1306	1353	1408	1497	1579	1661	1733	1822	1906	2020	2181
	GC3631WF Wood flex back	1590	1646	1693	1748	1837	1919	2001	2073	2162	2246	2360	2521
MB Armchair, Open Arms (Wood) COM: 1.75 YD 1.6 M Unit weight: 44 LB 20 KG Carton weight: 52 LB 23.59 KG Carton volume: 20 FT³ 0.56 MT³	Active weight 350 lbs. Optional urethane armcaps. Please specify. No upcharge.	OVERALL DIMENSIONS			SEAT DIMENSIONS			BACK DIMENSIONS					
		W	D	H	W	D	H	W	H				
		IN 25	27	36.5	20.5	17.5	18	20.5	18				
		MM 635	686	927	521	445	457	521	457				
		RTA 00	1 per carton										





DESCRIPTION	MODEL# / FEATURES	STANDARD TEXTILE GRADES											
		COM	2	3	4	5	6	7	8	9	10	11	12
	GC3631WCA Wood	1450	1538	1612	1698	1838	1967	2096	2209	2349	2481	2660	2913
	GC3631WFCA Wood flex back	1785	1873	1947	2033	2173	2302	2431	2544	2684	2816	2995	3248
MB Armchair, Closed Arms (Wood) COM: 2.75 YD 2.51 M Unit weight: 54 LB 24.5 KG Carton weight: 62 LB 28.12 KG Carton volume: 17.5 FT³ 0.49 MT³	Active weight 350 lbs. Optional urethane armcaps. Please specify. No upcharge.	OVERALL DIMENSIONS			SEAT DIMENSIONS			BACK DIMENSIONS					
		W	D	H	W	D	H	W	H				
		IN 25	27	36.5	20.5	17.5	18	20.5	18				
		MM 635	686	927	521	445	457	521	457				
		RTA 00	1 per carton										



DESCRIPTION	MODEL# / FEATURES	STANDARD TEXTILE GRADES											
		COM	2	3	4	5	6	7	8	9	10	11	12
	GC3631WNA Wood	1120	1176	1223	1278	1367	1449	1531	1603	1692	1776	1890	2051
MB Chair, Armless (Wood) COM: 1.75 YD 1.6 M Unit weight: 34 LB 15.5 KG Carton weight: 42 LB 19.05 KG Carton volume: 20 FT³ 0.56 MT³	Active weight 350 lbs.	OVERALL DIMENSIONS			SEAT DIMENSIONS			BACK DIMENSIONS					
		W	D	H	W	D	H	W	H				
		IN 22.5	27	36.5	20.5	17.5	18	20.5	18				
		MM 572	686	927	521	445	457	521	457				
		RTA 00	1 per carton										

DESCRIPTION	MODEL# / FEATURES	STANDARD TEXTILE GRADES											
		COM	2	3	4	5	6	7	8	9	10	11	12
	GC3632W Wood	1472	1544	1605	1675	1789	1895	2001	2093	2208	2316	2462	2669
	GC3632WF Wood flex back	1811	1883	1944	2014	2128	2234	2340	2432	2547	2655	2801	3008
HB Armchair Open Arms, Split Back (Wood) COM: 2.25 YD 2.06 M Unit weight: 50 LB 22.7 KG Carton weight: 60 LB 27.22 KG Carton volume: 27.5 FT³ 0.77 MT³	Active weight 350 lbs. Fold down headrest allows caregiver to assist occupant. Optional urethane armcaps. Please specify. No upcharge.	OVERALL DIMENSIONS			SEAT DIMENSIONS			BACK DIMENSIONS					
		W	D	H	W	D	H	W	H				
		IN 25	27	48.5	20.5	17.5	18	20.5	30				
		MM 635	686	1232	521	445	457	521	762				
		RTA 00	1 per carton										

DESCRIPTION	MODEL# / FEATURES	STANDARD TEXTILE GRADES											
		COM	2	3	4	5	6	7	8	9	10	11	12
	GC3632WCA Wood	1679	1775	1856	1949	2102	2243	2384	2507	2660	2804	2999	3275
	GC3632WFCA Wood flex back	2015	2111	2192	2285	2438	2579	2720	2843	2996	3140	3335	3611
High Back Armchair Closed Arms, Split Back (Wood) COM: 3 YD 2.74 M Unit weight: 58 LB 26.4 KG Carton weight: 68 LB 30.84 KG Carton volume: 27.5 FT³ 0.77 MT³	Active weight 350 lbs. Fold down headrest allows caregiver to assist occupant. Optional urethane armcaps. Please specify. No upcharge.	OVERALL DIMENSIONS			SEAT DIMENSIONS			BACK DIMENSIONS					
		W	D	H	W	D	H	W	H				
		IN 25	27	48.5	20.5	17.5	18	20.5	30				
		MM 635	686	1232	521	445	457	521	762				
		RTA 00	1 per carton										

DESCRIPTION	MODEL# / FEATURES	STANDARD TEXTILE GRADES													
 <p>HB Chair, Split Back, Armless (Wood) COM: 2.25 YD 2.06 M Unit weight: 40 LB 18.2 KG Carton weight: 50 LB 22.68 KG Carton volume: 27.5 FT³ 0.77 MT³</p>	<p>GC3632WNA Wood</p>	COM	2	3	4	5	6	7	8	9	10	11	12		
		1318	1390	1451	1521	1635	1741	1847	1939	2054	2162	2308	2515		
		OVERALL DIMENSIONS			SEAT DIMENSIONS			BACK DIMENSIONS							
		W	D	H	W	D	H	W	H						
<p>Active weight 350 lbs.</p> <p>Fold down headrest allows caregiver to assist occupant.</p>	<p>RTA 00</p> <p>1 per carton</p>	IN	22	27	48.5	20.5	17.5	18	20.5	30					
		MM	559	686	1232	521	445	457	521	762					
		 <p>LB Hip Armchair Open Arms - Post Surgery (Wood) COM: 1.5 YD 1.37 M Unit weight: 47 LB 21.4 KG Carton weight: 57 LB 25.85 KG Carton volume: 20 FT³ 0.56 MT³</p> <p>Designed to immobilize the pelvis and hip joints after surgery.</p>	<p>GC3636W Wood</p>	COM	2	3	4	5	6	7	8	9	10	11	12
				1441	1489	1530	1576	1653	1723	1794	1855	1932	2004	2101	2239
OVERALL DIMENSIONS				SEAT DIMENSIONS			BACK DIMENSIONS								
W	D			H	W	D	H	W	H						
<p>Active weight 350 lbs.</p> <p>Optional urethane armcaps. Please specify. No upcharge.</p>	<p>RTA 00</p> <p>1 per carton</p>	IN	23	26	40.5	19	17.5	25.5	19	15.5					
		MM	584	660	1029	483	445	648	483	394					
		 <p>LB Hip Armchair Closed Arms - Post Surgery (Wood) COM: 2 YD 1.83 M Unit weight: 52 LB 23.6 KG Carton weight: 62 LB 28.12 KG Carton volume: 20 FT³ 0.56 MT³</p> <p>Designed to immobilize the pelvis and hip joints after surgery.</p>	<p>GC3636WCA Wood</p>	COM	2	3	4	5	6	7	8	9	10	11	12
				1648	1712	1766	1828	1930	2024	2118	2200	2302	2398	2528	2712
OVERALL DIMENSIONS				SEAT DIMENSIONS			BACK DIMENSIONS								
W	D			H	W	D	H	W	H						
<p>Active weight 350 lbs.</p> <p>Optional urethane armcaps. Please specify. No upcharge.</p>	<p>RTA 00</p> <p>1 per carton</p>	IN	23	26	40.5	19	17.5	25.5	19	15.5					
		MM	584	660	1029	483	445	648	483	394					
		 <p>Bariatric MB Armchair, Open Arms (Wood) COM: 2.75 YD 2.51 M Unit weight: 70 LB 31.8 KG Carton weight: 82 LB 37.19 KG Carton volume: 30.5 FT³ 0.86 MT³</p>	<p>GC3638W Wood</p>	COM	2	3	4	5	6	7	8	9	10	11	12
				1612	1700	1774	1860	2000	2129	2258	2371	2511	2643	2822	3075
OVERALL DIMENSIONS				SEAT DIMENSIONS			BACK DIMENSIONS								
W	D			H	W	D	H	W	H						
<p>Active weight 500 lbs.</p> <p>Optional urethane armcaps. Please specify. No upcharge.</p>	<p>RTA 00</p> <p>1 per carton</p>	IN	35	27	36.5	30	17.5	18	30	18					
		MM	889	686	927	762	445	457	762	457					
		 <p>Bariatric MB Armchair, Closed Arms (Wood) COM: 3.75 YD 3.43 M Unit weight: 80 LB 36.4 KG Carton weight: 92 LB 41.73 KG Carton volume: 30.5 FT³ 0.86 MT³</p>	<p>GC3638WCA Wood</p>	COM	2	3	4	5	6	7	8	9	10	11	12
				1811	1931	2032	2149	2340	2516	2692	2846	3037	3217	3461	3806
OVERALL DIMENSIONS				SEAT DIMENSIONS			BACK DIMENSIONS								
W	D			H	W	D	H	W	H						
<p>Active weight 500 lbs.</p> <p>Optional urethane armcaps. Please specify. No upcharge.</p>	<p>RTA 00</p> <p>1 per carton</p>	IN	35	27	36.5	30	17.5	18	30	18					
		MM	889	686	927	762	445	457	762	457					

DESCRIPTION	MODEL# / FEATURES	STANDARD TEXTILE GRADES												
		COM	2	3	4	5	6	7	8	9	10	11	12	
 <p>Bariatric HB Armchair, Split Back, Open Arms (Wood) COM: 3.75 YD 3.43 M Unit weight: 55 LB 25 KG Carton weight: 65 LB 29.48 KG Carton volume: 33 FT³ 0.93 MT³</p>	GC3639W Wood	1890	2010	2111	2228	2419	2595	2771	2925	3116	3296	3540	3885	
	Active weight 500 lbs.	OVERALL DIMENSIONS			SEAT DIMENSIONS			BACK DIMENSIONS						
		W	D	H	W	D	H	W	H					
	Fold down headrest allows caregiver to assist occupant.	IN 35	27	48.5	30	17.5	18	30	30					
	Optional urethane armcaps. Please specify. No upcharge.	MM 889	686	1232	762	445	457	762	762					
	RTA 00	1 per carton												
 <p>Bariatric HB Armchair, Split Back, Closed Arms (Wood) COM: 4.75 YD 4.34 M Unit weight: 65 LB 29.5 KG Carton weight: 75 LB 34.02 KG Carton volume: 33 FT³ 0.93 MT³</p>	GC3639WCA Wood	2088	2240	2368	2516	2758	2981	3204	3399	3641	3869	4178	4615	
	Active weight 500 lbs.	OVERALL DIMENSIONS			SEAT DIMENSIONS			BACK DIMENSIONS						
		W	D	H	W	D	H	W	H					
	Fold down headrest allows caregiver to assist occupant.	IN 35	27	48.5	30	17.5	18	30	30					
	Optional urethane armcaps. Please specify. No upcharge.	MM 889	686	1232	762	445	457	762	762					
	RTA 00	1 per carton												
 <p>HB Chair, Open Arms (Wood) COM: 2.5 YD 2.29 M Unit weight: 50 LB 22.7 KG Carton weight: 60 LB 27.22 KG Carton volume: 27.5 FT³ 0.77 MT³</p>	GC3655W Wood	1290	1370	1438	1515	1643	1760	1878	1980	2108	2228	2390	2620	
	Active weight 350 lbs.	GC3655WF Wood flex back	1624	1704	1772	1849	1977	2094	2212	2314	2442	2562	2724	2954
		OVERALL DIMENSIONS			SEAT DIMENSIONS			BACK DIMENSIONS						
		W	D	H	W	D	H	W	H					
		IN 25	27	48.5	20.5	17.5	18	20.5	30					
	MM 635	686	1232	521	445	457	521	762						
	RTA 00	1 per carton												
 <p>HB Chair, Armless (Wood) COM: 2.5 YD 2.29 M Unit weight: 40 LB 18.2 KG Carton weight: 50 LB 22.68 KG Carton volume: 27.5 FT³ 0.77 MT³</p>	GC3655WNA Wood	1151	1231	1299	1376	1504	1621	1739	1841	1969	2089	2251	2481	
	Active weight 350 lbs.	OVERALL DIMENSIONS			SEAT DIMENSIONS			BACK DIMENSIONS						
		W	D	H	W	D	H	W	H					
		IN 22	27	48.5	20.5	17.5	18	20.5	30					
		MM 559	686	1232	521	445	457	521	762					
	RTA 00	1 per carton												
 <p>HB Armchair, Closed Arms (Wood) COM: 3.25 YD 2.97 M Unit weight: 58 LB 26.4 KG Carton weight: 68 LB 30.84 KG Carton volume: 27.5 FT³ 0.77 MT³</p>	GC3655WCA Wood	1493	1597	1685	1786	1951	2104	2257	2390	2556	2712	2923	3222	
	Active weight 350 lbs.	GC3655WFCA Wood flex back	1831	1935	2023	2124	2289	2442	2595	2728	2894	3050	3261	3560
		OVERALL DIMENSIONS			SEAT DIMENSIONS			BACK DIMENSIONS						
		W	D	H	W	D	H	W	H					
		IN 25	27	48.5	20.5	17.5	18	20.5	30					
	MM 635	686	1232	521	445	457	521	762						
	RTA 00	1 per carton												

DESCRIPTION	MODEL# / FEATURES	STANDARD TEXTILE GRADES											
		COM	2	3	4	5	6	7	8	9	10	11	12
 <p>Bariatric HB Armchair, Open Arms (Wood) COM: 3.5 YD 3.2 M Unit weight: 55 LB 25 KG Carton weight: 65 LB 29.48 KG Carton volume: 30.75 FT³ 0.87 MT³</p>	GC3656W Wood	1682	1794	1889	1997	2176	2340	2505	2648	2827	2995	3222	3544
		OVERALL DIMENSIONS W D H			SEAT DIMENSIONS W D H			BACK DIMENSIONS W H					
	Active weight 500 lbs.	IN 35	27	48.5	30	17.5	18	30	30				
	Optional urethane armcaps. Please specify. No upcharge.	MM 889	686	1232	762	445	457	762	762				
		RTA 00		1 per carton									
 <p>Bariatric HB Armchair, Closed Arms (Wood) COM: 4.5 YD 4.11 M Unit weight: 65 LB 29.5 KG Carton weight: 75 LB 34.02 KG Carton volume: 33 FT³ 0.93 MT³</p>	GC3656WCA Wood	1878	2022	2144	2283	2513	2724	2936	3120	3350	3566	3858	4272
		OVERALL DIMENSIONS W D H			SEAT DIMENSIONS W D H			BACK DIMENSIONS W H					
	Active weight 500 lbs.	IN 35	27	48.5	30	17.5	18	30	30				
	Optional urethane armcaps. Please specify. No upcharge.	MM 889	686	1232	762	445	457	762	762				
		RTA 00		1 per carton									
 <p>Wide Hip Armchair Open Arms - Post Surgery (Wood) COM: 1.5 YD 1.37 M Unit weight: 58 LB 26.4 KG Carton weight: 64 LB 29.03 KG Carton volume: 20 FT³ 0.56 MT³</p> <p>Designed to immobilize the pelvis and hip joints after surgery.</p>	GC3657W Wood	1784	1832	1873	1919	1996	2066	2137	2198	2275	2347	2444	2582
		OVERALL DIMENSIONS W D H			SEAT DIMENSIONS W D H			BACK DIMENSIONS W H					
	Active weight 350 lbs.	IN 28	25	41	24	17.5	26	24	15.5				
	Optional urethane armcaps. Please specify. No upcharge.	MM 711	635	1041	610	445	660	610	394				
		RTA 00		1 per carton									

PRIMACARE LOUNGE



model GC3641 (HT)



model GC3641W (Wood)

STANDARD FEATURES

- Primacare is a family of products offering the most significant return on investment approach in the industry since every component can be repaired or replaced on site.
- **High traffic (HT) models:** Metal frame with die cast zinc connectors and metal-to-metal fasteners. Available in the following finishes: Black (TBL), Cloud (TIV), Designer White (TDW), Fog (TFO), Frost (TFR), Kalua (TKA), Latte (TLA), Mocha (TMO), Nevada (TNE), Sand (TSN), Shadow (TSH), Toast (TOA) and Tungsten (TTU).
- **Wood models:** Solid hardwood frame and armcaps with die cast zinc connectors and metal-to-metal fastening. Available in the following finishes: Absolute (AAM), Charcoal Java (CJM), Cherry (ACM), Empire Mahogany (EMM), English Oak (EOM), Espresso Cafe (ECM), Fruitwood (TFM), Gray (HGM), Harvest Oak (HOM), Honey (AHM), Jet Onyx (JOM), Light Honey (LHM), Mahogany (TMM), Maple (AVM), Medium Walnut (MWM), Natural Walnut (NLW), Night (ASM), Noce Biondo (NBM), Noce Grigio (NGM), Noce Leggero (NEM), Noce Medio (NMM), Sandy Beach (SBM), Shaker Cherry (SKM), Silver Oak (SOM), Walnut (TWM), White (WHM), WC Cream (WTM) and Winter Cherry (WCM).
- Armcaps are securely fastened with metal-to-metal connectors which allow for field replacement if required.
- Easy grip forward extending armcap on models with arms.
- Replaceable seat covers and replaceable and/or removable seat cushions are standard.

- Seat cushion has a seamless waterfall front and clean out between and around the seat and back cushions.
- Models are standard with metal mesh seat deck. For mental health applications, the metal mesh seat deck can be covered with a solid moisture resistant surface, held in place with tamperproof fasteners. Contact your sales rep for a special quotation.
- All seat frames feature a wall saver design to prevent back contact with wall.
- Models ending in **CA** have upholstered panel arm inserts closing the arm. (Closed arm panels are designed to be replaceable. Request a special quote to have them secured with tamperproof fasteners.)
- For healthcare textile options, visit the website at globalfurnituregroup.com.
- Can be upholstered in standard Global textiles if healthcare compliance is not required.
- Shipped fully assembled.

HIGH TRAFFIC (HT) MODELS ARE LISTED FIRST, FOLLOWED BY WOOD MODELS.

OPTIONAL FEATURES

- **High traffic (HT) models:** Wood armcaps are available. See far left column "Wood models" for finishes. Please specify. No upcharge.
- **High traffic (HT) and wood models:** Urethane armcaps are available in the following finishes: Black (BLK), Kalua (KAL), Latte (LAB), Mocha (J52), Shadow (SHW) and Toast (TOA). Please specify. No upcharge.
- For moisture barrier on seat, please specify **(MB)**. Add \$122 per seat.
- To add sealed seams to your product contact Customer Service. Upcharges vary.
- For Primacare tables, see page 59.

SUGGESTED APPLICATIONS

- Bariatric seating
- Guest seating
- Lobbies
- Lounge/Waiting
- Patient rooms
- Resident rooms

DESCRIPTION MODEL# / FEATURES STANDARD TEXTILE GRADES

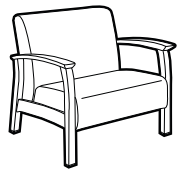

Bariatric Lounge Chair Open Arms (HT)
 COM: 3.25 YD | 2.97 M
 Unit weight: 97 LB | 44.1 KG
 Carton weight: 109 LB | 49.44 KG
 Carton volume: 49.5 FT³ | 1.4 MT³

COM	2	3	4	5	6	7	8	9	10	11	12	
GC3640 Metal	2865	2969	3057	3158	3223	3476	3629	3762	3928	4084	4295	4594

OVERALL DIMENSIONS			SEAT DIMENSIONS			BACK DIMENSIONS	
W	D	H	W	D	H	W	H

Active weight 500 lbs.	IN 40	32	33	36	20	17.25	36	16
Optional wood armcaps. Please specify. No upcharge.	MM 1016	813	838	914	508	438	914	406
	RTA 00	1 per carton						

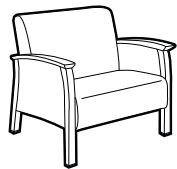

Bariatric Lounge Chair Closed Arms (HT)
 COM: 5.75 YD | 5.26 M
 Unit weight: 107 LB | 48.6 KG
 Carton weight: 119 LB | 53.98 KG
 Carton volume: 49.5 FT³ | 1.4 MT³

COM	2	3	4	5	6	7	8	9	10	11	12	
GC3640CA Metal	3162	3346	3501	3680	3973	4243	4513	4749	5042	5318	5692	6221

OVERALL DIMENSIONS			SEAT DIMENSIONS			BACK DIMENSIONS	
W	D	H	W	D	H	W	H

Active weight 500 lbs.	IN 40	32	33	36	20	17.25	36	16
Optional wood armcaps. Please specify. No upcharge.	MM 1016	813	838	914	508	438	914	406
	RTA 00	1 per carton						

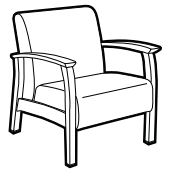

Lounge Chair Open Arms (HT)
 COM: 2.5 YD | 2.29 M
 Unit weight: 66 LB | 30 KG
 Carton weight: 78 LB | 35.38 KG
 Carton volume: 29.5 FT³ | 0.83 MT³

COM	2	3	4	5	6	7	8	9	10	11	12	
GC3641 Metal	2204	2284	2352	2429	2557	2674	2792	2894	3022	3142	3304	3534

OVERALL DIMENSIONS			SEAT DIMENSIONS			BACK DIMENSIONS	
W	D	H	W	D	H	W	H

Active weight 500 lbs.	IN 29	32	33	23	20	17.25	22.5	16
Optional wood armcaps. Please specify. No upcharge.	MM 737	813	838	584	508	438	572	406
	RTA 00	1 per carton						

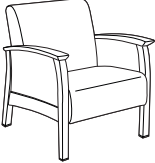
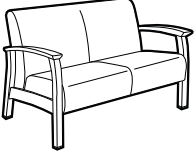
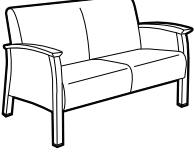
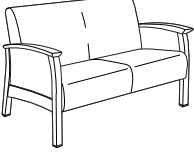
DESCRIPTION	MODEL# / FEATURES	STANDARD TEXTILE GRADES												
		COM	2	3	4	5	6	7	8	9	10	11	12	
 <p>Lounge Chair Closed Arms (HT) COM: 3.75 YD 3.43 M Unit weight: 79 LB 35.9 KG Carton weight: 91 LB 41.28 KG Carton volume: 29.5 FT³ 0.83 MT³</p>	GC3641CA Metal	2541	2661	2762	2879	3070	3246	3422	3576	3767	3947	4191	4536	
		OVERALL DIMENSIONS			SEAT DIMENSIONS			BACK DIMENSIONS						
		W	D	H	W	D	H	W	H					
	Active weight 500 lbs. Optional wood armcaps. Please specify. No upcharge.	IN 29 MM 737	32 813	33 838	23 584	20 508	17.25 438	22.5 572	16 406					
		RTA 00	1 per carton											
 <p>Lounge Chair Closed Arms, Laminate Panels (HT) COM: 2.5 YD 2.29 M Unit weight: 79 LB 35.9 KG Carton weight: 91 LB 41.28 KG Carton volume: 29.5 FT³ 0.83 MT³</p>	GC3641CAL Metal	2867	2947	3015	3092	3220	3337	3455	3557	3685	3805	3967	4197	
		OVERALL DIMENSIONS			SEAT DIMENSIONS			BACK DIMENSIONS						
		W	D	H	W	D	H	W	H					
	Active weight 500 lbs. Optional wood armcaps. Please specify. No upcharge.	IN 29 MM 737	32 813	33 838	23 584	20 508	17.25 438	22.5 572	16 406					
		RTA 00	1 per carton											
 <p>Two Seat Sofa Open Arms (HT) COM: 4 YD 3.66 M Unit weight: 107 LB 48.6 KG Carton weight: 122 LB 55.34 KG Carton volume: 49.5 FT³ 1.4 MT³</p>	GC3642 Metal	3172	3300	3408	3532	3736	3924	4112	4276	4480	4672	4932	5300	
		OVERALL DIMENSIONS			SEAT DIMENSIONS			BACK DIMENSIONS						
		W	D	H	W	D	H	W	H					
	Active weight 500 lbs/seat. Optional wood armcaps. Please specify. No upcharge.	IN 52 MM 1321	32 813	33 838	48 1219	20 508	17.25 438	48 1219	16 406					
		RTA 00	1 per carton											
 <p>Two Seat Sofa Closed Arms (HT) COM: 5.5 YD 5.03 M Unit weight: 117 LB 53.2 KG Carton weight: 132 LB 59.87 KG Carton volume: 49.5 FT³ 1.4 MT³</p>	GC3642CA Metal	3500	3676	3825	3995	4276	4534	4793	5018	5299	5563	5920	6426	
		OVERALL DIMENSIONS			SEAT DIMENSIONS			BACK DIMENSIONS						
		W	D	H	W	D	H	W	H					
	Active weight 500 lbs/seat. Optional wood armcaps. Please specify. No upcharge.	IN 52 MM 1321	32 813	33 838	48 1219	20 508	17.25 438	48 1219	16 406					
		RTA 00	1 per carton											
 <p>Two Seat Sofa Closed Arms, Laminate Panels (HT) COM: 4 YD 3.66 M Unit weight: 117 LB 53.2 KG Carton weight: 132 LB 59.87 KG Carton volume: 49.5 FT³ 1.4 MT³</p>	GC3642CAL Metal	3836	3964	4072	4196	4400	4588	4776	4940	5144	5336	5596	5964	
		OVERALL DIMENSIONS			SEAT DIMENSIONS			BACK DIMENSIONS						
		W	D	H	W	D	H	W	H					
	Active weight 500 lbs/seat. Optional wood armcaps. Please specify. No upcharge.	IN 52 MM 1321	32 813	33 838	48 1219	20 508	17.25 438	48 1219	16 406					
		RTA 00	1 per carton											

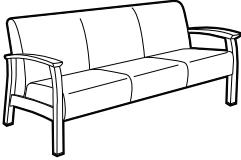
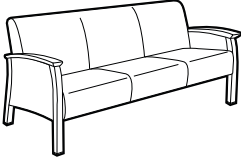
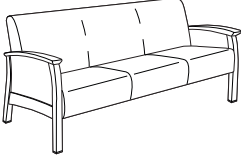
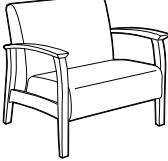
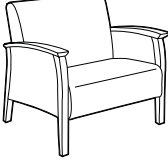
DESCRIPTION	MODEL# / FEATURES	STANDARD TEXTILE GRADES											
		COM	2	3	4	5	6	7	8	9	10	11	12
 <p>Three Seat Sofa Open Arms (HT) COM: 6.25 YD 5.72 M Unit weight: 148 LB 67.3 KG Carton weight: 173 LB 78.47 KG Carton volume: 69.5 FT³ 1.96 MT³</p>	GC3643 Metal	4112	4312	4481	4675	4993	5287	5581	5837	6156	6456	6862	7437
	Active weight 500 lbs/seat.	IN 75	32	33		71	20	17.25		71	16		
	Optional wood armcaps. Please specify. No upcharge.	MM 1905	813	838		1803	508	438		1803	406		
		RTA 00											
 <p>Three Seat Sofa Closed Arms (HT) COM: 7.5 YD 6.86 M Unit weight: 158 LB 71.8 KG Carton weight: 183 LB 83.01 KG Carton volume: 69.5 FT³ 1.96 MT³</p>	GC3643CA Metal	4453	4693	4896	5128	5511	5863	6216	6523	6906	7266	7753	8443
	Active weight 500 lbs/seat.	IN 75	32	33		71	20	17.25		71	16		
	Optional wood armcaps. Please specify. No upcharge.	MM 1905	813	838		1803	508	438		1803	406		
		RTA 00											
 <p>Three Seat Sofa Closed Arms, Laminate Panels (HT) COM: 6.25 YD 5.72 M Unit weight: 158 LB 71.8 KG Carton weight: 183 LB 83.01 KG Carton volume: 69.5 FT³ 1.96 MT³</p>	GC3643CAL Metal	4778	4978	5147	5341	5659	5953	6247	6503	6822	7122	7528	8103
	Active weight 500 lbs/seat.	IN 75	32	33		71	20	17.25		71	16		
	Optional wood armcaps. Please specify. No upcharge.	MM 1905	813	838		1803	508	438		1803	406		
		RTA 00											
 <p>Bariatric Lounge Chair, Open Arms (Wood) COM: 3.25 YD 2.97 M Unit weight: 85 LB 38.6 KG Carton weight: 97 LB 44 KG Carton volume: 49.5 FT³ 1.4 MT³</p>	GC3640W Wood	2242	2346	2434	2535	2700	2853	3006	3139	3305	3461	3672	3971
	Active weight 500 lbs.	IN 40	32	33		36	20	17.25		36	16		
	Optional urethane armcaps. Please specify. No upcharge.	MM 1016	813	838		914	508	438		914	406		
		RTA 00											
 <p>Bariatric Lounge Chair, Closed Arms (Wood) COM: 5.75 YD 5.26 M Unit weight: 95 LB 43.2 KG Carton weight: 107 LB 48.53 KG Carton volume: 49.5 FT³ 1.4 MT³</p>	GC3640WCA Wood	2460	2644	2799	2978	3271	3541	3811	4047	4340	4616	4990	5519
	Active weight 500 lbs.	IN 40	32	33		36	20	17.25		36	16		
	Optional urethane armcaps. Please specify. No upcharge.	MM 1016	813	838		914	508	438		914	406		
		RTA 00											

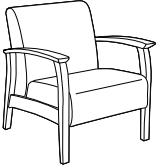
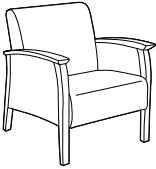
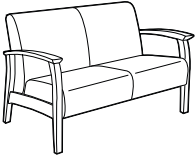
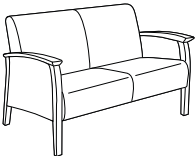
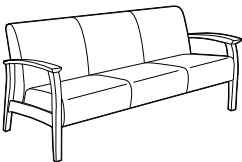
DESCRIPTION	MODEL# / FEATURES	STANDARD TEXTILE GRADES											
 <p>Lounge Chair, Open Arms (Wood) COM: 2.5 YD 2.29 M Unit weight: 54 LB 24.5 KG Carton weight: 66 LB 29.94 KG Carton volume: 29.5 FT³ 0.83 MT³</p>	<p>GC3641W Wood</p>	COM	2	3	4	5	6	7	8	9	10	11	12
		1725	1805	1873	1950	2078	2195	2313	2415	2543	2663	2825	3055
		OVERALL DIMENSIONS			SEAT DIMENSIONS			BACK DIMENSIONS					
		W	D	H	W	D	H	W	H				
IN	29	32	33	23	20	17.25	22.5	16					
MM	737	813	838	584	508	438	572	406					
Active weight 350 lbs.	Optional urethane armcaps. Please specify. No upcharge.	RTA 00		1 per carton									
 <p>Lounge Chair, Closed Arms (Wood) COM: 3.75 YD 3.43 M Unit weight: 67 LB 30.5 KG Carton weight: 79 LB 35.83 KG Carton volume: 29.5 FT³ 0.83 MT³</p>	<p>GC3641WCA Wood</p>	COM	2	3	4	5	6	7	8	9	10	11	12
		1983	2103	2204	2321	2512	2688	2864	3018	3209	3389	3633	3978
		OVERALL DIMENSIONS			SEAT DIMENSIONS			BACK DIMENSIONS					
		W	D	H	W	D	H	W	H				
IN	29	32	33	23	20	17.25	22.5	16					
MM	737	813	838	584	508	438	572	406					
Active weight 350 lbs.	Optional urethane armcaps. Please specify. No upcharge.	RTA 00		1 per carton									
 <p>Two Seat Sofa, Open Arms (Wood) COM: 4 YD 3.66 M Unit weight: 95 LB 43.2 KG Carton weight: 110 LB 49.9 KG Carton volume: 49.5 FT³ 1.4 MT³</p>	<p>GC3642W Wood</p>	COM	2	3	4	5	6	7	8	9	10	11	12
		2480	2608	2716	2840	3044	3232	3420	3584	3788	3980	4240	4608
		OVERALL DIMENSIONS			SEAT DIMENSIONS			BACK DIMENSIONS					
		W	D	H	W	D	H	W	H				
IN	52	32	33	48	20	17.25	48	16					
MM	1321	813	838	1219	508	438	1219	406					
Active weight 350 lbs/seat.	Optional urethane armcaps. Please specify. No upcharge.	RTA 00		1 per carton									
 <p>Two Seat Sofa, Closed Arms (Wood) COM: 5.5 YD 5.03 M Unit weight: 105 LB 47.7 KG Carton weight: 120 LB 54.43 KG Carton volume: 49.5 FT³ 1.4 MT³</p>	<p>GC3642WCA Wood</p>	COM	2	3	4	5	6	7	8	9	10	11	12
		2729	2905	3054	3224	3505	3763	4022	4247	4528	4792	5149	5655
		OVERALL DIMENSIONS			SEAT DIMENSIONS			BACK DIMENSIONS					
		W	D	H	W	D	H	W	H				
IN	52	32	33	48	20	17.25	48	16					
MM	1321	813	838	1219	508	438	1219	406					
Active weight 350 lbs/seat.	Optional urethane armcaps. Please specify. No upcharge.	RTA 00		1 per carton									
 <p>Three Seat Sofa, Open Arms (Wood) COM: 6.25 YD 5.72 M Unit weight: 136 LB 61.8 KG Carton weight: 161 LB 73.03 KG Carton volume: 69.5 FT³ 1.96 MT³</p>	<p>GC3643W Wood</p>	COM	2	3	4	5	6	7	8	9	10	11	12
		3212	3412	3581	3775	4093	4387	4681	4937	5256	5556	5962	6537
		OVERALL DIMENSIONS			SEAT DIMENSIONS			BACK DIMENSIONS					
		W	D	H	W	D	H	W	H				
IN	75	32	33	71	20	17.25	71	16					
MM	1905	813	838	1803	508	438	1803	406					
Active weight 350 lbs/seat.	Optional urethane armcaps. Please specify. No upcharge.	RTA 00		1 per carton									

DESCRIPTION

MODEL# / FEATURES

STANDARD TEXTILE GRADES

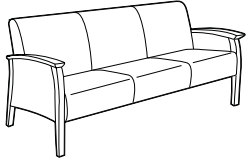

GC3643WCA
Wood

COM	2	3	4	5	6	7	8	9	10	11	12
3469	3709	3912	4144	4527	4879	5232	5539	5922	6282	6769	7459

OVERALL DIMENSIONS
W D H

SEAT DIMENSIONS
W D H

BACK DIMENSIONS
W H

Active weight 350 lbs/seat.

IN	75	32	33	71	20	17.25	71	16
MM	1905	813	838	1803	508	438	1803	406

Optional urethane armcaps.
Please specify. No upcharge.

RTA 00 1 per carton

Three Seat Sofa, Closed Arms (Wood)
COM: 7.5 YD | 6.86 M
Unit weight: 146 LB | 66.4 KG
Carton weight: 171 LB | 77.56 KG
Carton volume: 69.5 FT³ | 1.96 MT³

PRIMACARE FULLY UPHOLSTERED LOUNGE



model GC3676HB



model GC3677

STANDARD FEATURES

- Primacare is a family of products offering the most significant return on investment approach in the industry since every component can be repaired or replaced on site.
- Standard with fully upholstered arms.
- The seat frame features a beautifully angled back creating a wall saver design to prevent damage to walls.
- The structural frame is constructed of solid hardwood with metal mesh seat deck, die cast zinc connectors and metal-to-metal fastening, providing an exceptionally strong and durable solution.
- The arm panels, legs, seat, back and cushion covers are field replaceable.
- Seat cushion has a seamless waterfall front and clean out between and around the seat and back cushions.
- For mental health applications, the metal mesh seat deck can be covered with a solid moisture resistant surface, held in place with tamperproof fasteners. Contact your sales rep for a special quotation.
- For healthcare textile options, visit the website at globalfurnituregroup.com.
- Can be upholstered in standard Global textiles if healthcare compliance is not required.
- Left and right position reference is determined from the seated position.
- Shipped fully assembled.

OPTIONAL FEATURES

- Optional urethane (urethane) legs and armcaps available in the following finishes: Black (BLK), Kalua (KAL), Latte (LAB), Mocha (J52), Shadow (SHW) and Toast (TOA). See features column for upcharges.
- Optional wood legs and armcaps available in the following finishes: Absolute (AAM), Charcoal Java (CJM), Cherry (ACM), Empire Mahogany (EMM), English Oak (EOM), Espresso Cafe (ECM), Fruitwood (TFM), Gray (HGM), Harvest Oak (HOM), Honey (AHM), Jet Onyx (JOM), Light Honey (LHM), Mahogany (TMM), Maple (AVM), Medium Walnut (MWM), Neutral Walnut (NLW), Night (ASM), Noce Biondo (NBM), Noce Grigio (NGM), Noce Leggero (NEM), Noce Medio (NMM), Sandy Beach (SBM), Silver Oak (SOM), Walnut (TWM), White (WHM), WC Cream (WTM) and Winter Cherry (WCM). See features column for upcharges.
- Armcaps are securely fastened with metal-to-metal connectors which allow for field replacement if required. Armcaps cannot be retrofitted in the field on units with no existing armcaps.
- For moisture barrier on seat, please specify **(MB)**. Add \$122 per seat.
- To add sealed seams to your product contact Customer Service. Upcharges vary.
- For Primacare tables, see page 59.

SUGGESTED APPLICATIONS

- Bariatric setting
- Lobbies
- Guest seating
- Lounge/Waiting

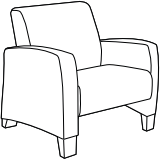
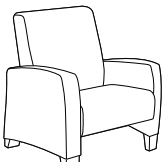
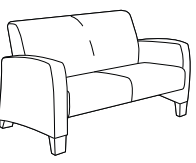
DESCRIPTION	MODEL# / FEATURES	STANDARD TEXTILE GRADES												
		COM	2	3	4	5	6	7	8	9	10	11	12	
 <p>Lounge Chair Fully Uph Arms, Urethane Legs COM: 6.25 YD 5.72 M Unit weight: 83 LB 37.7 KG Carton weight: 95 LB 43.09 KG Carton volume: 29.5 FT³ 0.83 MT³</p>	GC3676	1966	2166	2335	2529	2847	3141	3435	3691	4010	4310	4716	5291	
	Active weight 350 lbs.	OVERALL DIMENSIONS			SEAT DIMENSIONS			BACK DIMENSIONS						
	Optional wood legs. No upcharge.	IN	32.5	29	33	23	20	17.25	23	16				
	Optional urethane or wood armcaps. Add \$284.	MM	826	737	838	584	508	438	584	406				
		RTA 00	1 per carton											
 <p>HB Lounge Chair Fully Uph Arms, Urethane Legs COM: 6.5 YD 5.94 M Unit weight: 102 LB 46.4 KG Carton weight: 114 LB 51.71 KG Carton volume: 29.5 FT³ 0.83 MT³</p>	GC3676HB	2111	2319	2495	2696	3028	3333	3639	3905	4237	4549	4971	5569	
	Active weight 350 lbs.	OVERALL DIMENSIONS			SEAT DIMENSIONS			BACK DIMENSIONS						
	Optional wood legs. No upcharge.	IN	32.5	29	36	23	20	17.25	23	19				
	Optional urethane or wood armcaps. Add \$284.	MM	826	737	914	584	508	438	584	483				
		RTA 00	1 per carton											
 <p>Two Seat Sofa Fully Uph Arms, Urethane Legs COM: 7.5 YD 6.86 M Unit weight: 120 LB 54.5 KG Carton weight: 135 LB 61.23 KG Carton volume: 56.25 FT³ 1.59 MT³</p>	GC3677	2733	2973	3176	3408	3791	4143	4496	4803	5186	5546	6033	6723	
	Active weight 350 lbs/seat.	OVERALL DIMENSIONS			SEAT DIMENSIONS			BACK DIMENSIONS						
	Optional wood legs. No upcharge.	IN	55.5	29	33	45.5	20	17.25	45.5	16				
	Optional urethane or wood armcaps. Add \$284.	MM	1410	737	838	1156	508	438	1156	406				
		RTA 00	1 per carton											

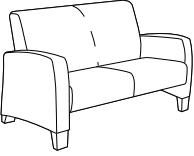
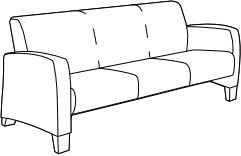
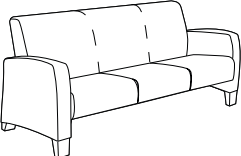
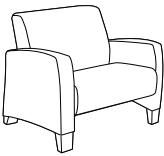
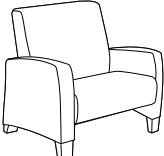
DESCRIPTION	MODEL# / FEATURES	STANDARD TEXTILE GRADES											
		COM	2	3	4	5	6	7	8	9	10	11	12
 <p>HB Two Seat Sofa Fully Uph Arms, Urethane Legs COM: 7.75 YD 7.09 M Unit weight: 127 LB 57.7 KG Carton weight: 142 LB 64.41 KG Carton volume: 56.25 FT³ 1.59 MT³</p>	GC3677HB	3032	3280	3489	3730	4125	4489	4853	5171	5566	5938	6442	7155
	Active weight 350 lbs/seat.	OVERALL DIMENSIONS			SEAT DIMENSIONS			BACK DIMENSIONS					
	Optional wood legs. No upcharge.	W	D	H	W	D	H	W	H				
	Optional urethane or wood armcaps. Add \$284.	IN 55.5	29	36	45.5	20	17.25	45.5	19				
		MM 1410	737	914	1156	508	438	1156	483				
	RTA 00	1 per carton											
 <p>Three Seat Sofa Fully Uph Arms, Urethane Legs COM: 9 YD 8.23 M Unit weight: 156 LB 70.9 KG Carton weight: 181 LB 82.1 KG Carton volume: 69.5 FT³ 1.96 MT³</p>	GC3678	3645	3933	4176	4455	4914	5337	5760	6129	6588	7020	7605	8433
	Active weight 350 lbs/seat.	OVERALL DIMENSIONS			SEAT DIMENSIONS			BACK DIMENSIONS					
	Optional wood legs. No upcharge.	W	D	H	W	D	H	W	H				
	Optional urethane or wood armcaps. Add \$284.	IN 78.5	29	33	68.5	20	17.25	68.5	16				
		MM 1994	737	838	1740	508	438	1740	406				
	RTA 00	1 per carton											
 <p>HB Three Seat Sofa Fully Uph Arms, Urethane Legs COM: 9.25 YD 8.46 M Unit weight: 163 LB 74.1 KG Carton weight: 188 LB 85.28 KG Carton volume: 69.5 FT³ 1.96 MT³</p>	GC3678HB	4097	4393	4643	4930	5401	5836	6271	6650	7122	7566	8167	9018
	Active weight 350 lbs/seat.	OVERALL DIMENSIONS			SEAT DIMENSIONS			BACK DIMENSIONS					
	Optional wood legs. No upcharge.	W	D	H	W	D	H	W	H				
	Optional urethane or wood armcaps. Add \$284.	IN 78.5	29	36	68.5	20	17.25	68.5	19				
		MM 1994	737	914	1740	508	438	1740	483				
	RTA 00	1 per carton											
 <p>Bariatric Lounge Chair Fully Uph Arms, Urethane Legs COM: 6.5 YD 5.94 M Unit weight: 95 LB 43.2 KG Carton weight: 107 LB 48.53 KG Carton volume: 37.75 FT³ 1.06 MT³</p>	GC3679	2303	2511	2687	2888	3220	3525	3831	4097	4429	4741	5163	5761
	Active weight 500 lbs.	OVERALL DIMENSIONS			SEAT DIMENSIONS			BACK DIMENSIONS					
	Optional wood legs. No upcharge.	W	D	H	W	D	H	W	H				
	Optional urethane or wood armcaps. Add \$284.	IN 42	29	33	32	20	17.25	32	16				
		MM 1067	737	838	813	508	438	813	406				
	RTA 00	1 per carton											
 <p>HB Bariatric Lounge Chair Fully Uph Arms, Urethane Legs COM: 6.75 YD 6.17 M Unit weight: 109 LB 49.5 KG Carton weight: 121 LB 54.88 KG Carton volume: 37.75 FT³ 1.06 MT³</p>	GC3679HB	2497	2713	2895	3105	3449	3766	4083	4360	4704	5028	5467	6088
	Active weight 500 lbs.	OVERALL DIMENSIONS			SEAT DIMENSIONS			BACK DIMENSIONS					
	Optional wood legs. No upcharge.	W	D	H	W	D	H	W	H				
	Optional urethane or wood armcaps. Add \$284.	IN 42	29	36	32	20	17.25	32	19				
		MM 1067	737	914	813	508	438	813	483				
	RTA 00	1 per carton											

PRIMACARE WINGBACK



model GC3691HB



model GC3692HB

STANDARD FEATURES



- Primacare is a family of products offering the most significant return on investment approach in the industry since every component can be repaired or replaced on site.
- Standard with Black urethane (urethane) legs and armcaps.
- Armcaps are securely fastened with metal-to-metal connectors which allow for field replacement if required.
- Easy grip forward extending armcap on models with arms.
- For added comfort, seat and back are standard with high density Ultracell foam.
- Replaceable seat covers and replaceable and/or removable seat cushions are standard.
- Seat cushion has a seamless waterfall front and clean out between and around the seat and back cushions.
- Models are standard with metal mesh seat deck. For mental health applications, the metal mesh seat deck can be covered with a solid moisture resistant surface, held in place with tamperproof fasteners. Contact your sales rep for a special quotation.
- For healthcare textile options, visit the website at globalfurnituregroup.com.
- Can be upholstered in standard Global textiles if healthcare compliance is not required.

OPTIONAL FEATURES

- Optional urethane (urethane) legs and armcaps available in the following finishes: Kalua (KAL), Latte (LAB), Mocha (J52), Shadow (SHW) and Toast (TOA). No upcharge.
- For optional wood legs and armcaps, refer to the Seating wood finishes in the Textiles and Finishes section.
For wood armcaps: Add \$65.
For wood legs: Add \$155.
- For moisture barrier on seat, please specify **(MB)**.
For one seater: Add \$122.
For two seater: Add \$242.
For bariatric models: Add \$162.
- To add sealed seams to your product contact Customer Service. Upcharges vary.
- For Primacare tables, see page 59.

SUGGESTED APPLICATIONS

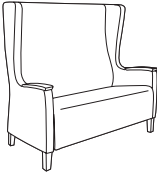
- Bariatric seating
- Lobbies
- Lounge/Waiting
- Guest seating
- Patient rooms
- Resident rooms

DESCRIPTION	MODEL# / FEATURES	STANDARD TEXTILE GRADES												
		COM	2	3	4	5	6	7	8	9	10	11	12	
 <p>Single Seater Wingback Armchair COM: 6.25 YD 5.72 M Unit weight: 77 LB 35 KG Carton weight: 94 LB 42.64 KG Carton volume: 29 FT³ 0.82 MT³</p>	GC3691HB	2727	2927	3096	3290	3609	3902	4196	4452	4771	5071	5477	6052	
	Active weight 350 lbs.	IN		30.5	28.5	45.5	22.5	18	19	19	26			
		MM		775	724	1156	572	457	483	483	660			
		RTA 00	1 per carton											
			OVERALL DIMENSIONS		SEAT DIMENSIONS			BACK DIMENSIONS						
		W	D	H	W	D	H	W	H					
 <p>Two Seater Wingback Armchair COM: 9.5 YD 8.69 M Unit weight: 133 LB 60.5 KG Carton weight: 163 LB 73.94 KG Carton volume: 52.5 FT³ 1.48 MT³</p>	GC3692HB	3742	4046	4303	4597	5082	5528	5975	6364	6849	7305	7922	8796	
	Active weight 350 lbs/seat.	IN		57.5	28.5	45.5	50	18	19	45	26			
		MM		1461	724	1156	1270	457	483	1143	660			
		RTA 00	1 per carton											
			OVERALL DIMENSIONS		SEAT DIMENSIONS			BACK DIMENSIONS						
		W	D	H	W	D	H	W	H					
 <p>Bariatric Single Seater Wingback Armchair COM: 8.25 YD 7.54 M Unit weight: 109 LB 49.5 KG Carton weight: 130 LB 58.97 KG Carton volume: 35.5 FT³ 1 MT³</p>	GC3694HB	3054	3318	3541	3797	4218	4605	4993	5331	5752	6148	6684	7443	
	Active weight 600 lbs.	IN		38	28.5	45.5	31	18	19	26.5	26			
		MM		965	724	1156	787	457	483	673	660			
		RTA 00	1 per carton											
			OVERALL DIMENSIONS		SEAT DIMENSIONS			BACK DIMENSIONS						
		W	D	H	W	D	H	W	H					

DESCRIPTION	MODEL# / FEATURES	STANDARD TEXTILE GRADES											
-------------	-------------------	-------------------------	--	--	--	--	--	--	--	--	--	--	--

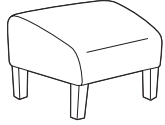

Standard Size Ottoman
 COM: 1.25 YD | 1.14 M
 Unit weight: 12 LB | 5.5 KG
 Carton weight: 17 LB | 7.71 KG
 Carton volume: 4.7 FT³ | 0.13 MT³

MODEL# / FEATURES	COM	2	3	4	5	6	7	8	9	10	11	12
GC3695	675	715	749	788	851	910	969	1020	1084	1144	1225	1340

OVERALL DIMENSIONS			SEAT DIMENSIONS			BACK DIMENSIONS	
W	D	H	W	D	H	W	H

Active weight 350 lbs.	IN 23	18	15.75	-	-	-	-	-
	MM 584	457	400	-	-	-	-	-

Add \$81 for (MB).
RTA 00 1 per carton

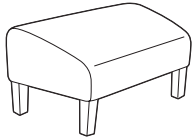

Bariatric Ottoman
 COM: 1.75 YD | 1.6 M
 Unit weight: 15 LB | 6.8 KG
 Carton weight: 20 LB | 9.07 KG
 Carton volume: 9 FT³ | 0.25 MT³

MODEL# / FEATURES	COM	2	3	4	5	6	7	8	9	10	11	12
GC3696	848	904	951	1006	1095	1177	1259	1331	1420	1504	1618	1779

OVERALL DIMENSIONS			SEAT DIMENSIONS			BACK DIMENSIONS	
W	D	H	W	D	H	W	H

Active weight 500 lbs.	IN 31.25	18	15.75	-	-	-	-	-
	MM 794	457	400	-	-	-	-	-

Add \$122 for (MB).
RTA 00 1 per carton

PRIMACARE RECLINERS



model GC3608



model GC3609

STANDARD FEATURES

- Primacare is a family of products offering the most significant return on investment approach in the industry since every component can be repaired or replaced on site.
- Solid hardwood frame with die cast zinc connectors and metal-to-metal fastening. Available in the following finishes: Absolute (AAM), Charcoal Java (CJM), Cherry (ACM), Empire Mahogany (EMM), English Oak (EOM), Espresso Cafe (ECM), Fruitwood (TFM), Gray (HGM), Harvest Oak (HOM), Honey (AHM), Jet Onyx (JOM), Light Honey (LHM), Mahogany (TMM), Maple (AVM), Medium Walnut (MWM), Natural Walnut (NLW), Night (ASM), Noce Biondo (NBM), Noce Grigio (NGM), Noce Leggero (NEM), Noce Medio (NMM), Sandy Beach (SBM), Shaker Cherry (SKM), Silver Oak (SOM), Walnut (TWM), White (WHM), WC Cream (WTM) and Winter Cherry (WCM).
- Armcaps are securely fastened with metal-to-metal connectors which allow for field replacement if required.
- Easy grip forward extending armcap on models with arms.
- For healthcare textile options, visit the website at globalfurnituregroup.com.
- Can be upholstered in standard Global textiles if healthcare compliance is not required.
- Shipped easy to assemble.

OPTIONAL FEATURES



- Urethane armcaps are available in the following finishes: Black (BLK), Kalua (KAL), Latte (LAB), Mocha (J52), Shadow (SHW) and Toast (TOA). Please specify. No upcharge.
- Urethane armcaps are not available on models GC3606 and GC3609.
- For moisture barrier on seat, please specify (MB). Add \$122 per seat.
- To add sealed seams to your product contact Customer Service. Upcharges vary.
- For Primacare tables, see page 59.

GC3608 AND GC3609 ONLY

- To add a Reverse Recline mechanism, please specify (RR). No upcharge.
- Tablet arm with spill collector on the edge is available, offered in Black Phenolic material. From seated position, specify (LT) for left hand tablet or (RT) for right hand tablet. Add \$572. For left and right tablets, please specify (TB). Add \$1143.
- A Foley bag hook can be positioned on the left (LT) or right (RT). Add \$23. For left and right Foley bag hooks, please specify (LR). Add \$45.
- An IV pole that can be positioned on the left or right side is available. Specify (IV). Add \$247.
- An oxygen tank holder is available, please specify (OX). Add \$142.
- Footrest in Grey thermally fused laminate with a Black edge is available. Specify (FT). Add \$199.

SUGGESTED APPLICATIONS

- Guest seating
- Lobbies
- Lounge/Waiting
- Patient rooms
- Resident rooms
- Treatment/Exam rooms

DESCRIPTION	MODEL# / FEATURES	STANDARD TEXTILE GRADES											
		COM	2	3	4	5	6	7	8	9	10	11	12
 <p>Recliner Solid Wood Armcaps, Full Span COM: 6.5 YD 5.94 M Unit weight: 98 LB 44.5 KG Carton weight: 110 LB 49.9 KG Carton volume: 22.75 FT³ 0.64 MT³</p>	GC3605	2394	2602	2778	2979	3311	3616	3922	4188	4520	4832	5254	5852
	Active weight 350 lbs.												
	Head mat & replaceable seat cushion.												
	Optional urethane armcaps. Please specify. No upcharge.												
	Not available with casters.	RTA 2	1 per carton										
 <p>Recliner Partial (Front Only) Solid Wood Armcaps COM: 6.5 YD 5.94 M Unit weight: 98 LB 44.5 KG Carton weight: 110 LB 49.9 KG Carton volume: 22.75 FT³ 0.64 MT³</p>	GC3606	2237	2445	2621	2822	3154	3459	3765	4031	4363	4675	5097	5695
	Active weight 350 lbs.												
	Head mat & replaceable seat cushion.												
	Not available with casters.	RTA 2	1 per carton										

DESCRIPTION MODEL# / FEATURES STANDARD TEXTILE GRADES

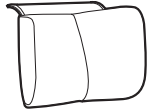

Headrest For Primacare Recliners Only

COM: 1.25 YD | 1.14 M
 Unit weight: 1.5 LB | 0.7 KG
 Carton weight: 3 LB | 1.36 KG
 Carton volume: 1 FT³ | 0.02 MT³

MODEL#	2	3	4	5	6	7	8	9	10	11	12	
GC3607	114	154	188	227	290	349	408	459	523	583	664	779

OVERALL DIMENSIONS			SEAT DIMENSIONS			BACK DIMENSIONS	
W	D	H	W	D	H	W	H

IN	14	4	9.5	-	-	-	-	-
MM	356	102	241	-	-	-	-	-

RTA 00  1 per carton



Motion Recliner Solid Wood Armcaps, Full Span

COM: 6.5 YD | 5.94 M
 Unit weight: 110 LB | 50 KG
 Carton weight: 120 LB | 54.43 KG
 Carton volume: 27.75 FT³ | 0.78 MT³

MODEL#	2	3	4	5	6	7	8	9	10	11	12	
GC3608	2989	3197	3373	3574	3906	4211	4517	4783	5115	5427	5849	6447

Active weight 400 lbs.

Optional urethane armcaps. Please specify. No upcharge.

Optional 4 manual locking casters w/push bar. Please specify **(MRC)**. No upcharge.

OVERALL DIMENSIONS			SEAT DIMENSIONS			BACK DIMENSIONS	
W	D	H	W	D	H	W	H

IN	30	39	46.5	23.5	20	19	22.5	29
MM	762	991	1181	597	508	483	572	737

RTA 2 1 per carton



Motion Recliner Partial (Front Only) Solid Wood Armcaps

COM: 6.5 YD | 5.94 M
 Unit weight: 110 LB | 50 KG
 Carton weight: 120 LB | 54.43 KG
 Carton volume: 27.75 FT³ | 0.78 MT³

MODEL#	2	3	4	5	6	7	8	9	10	11	12	
GC3609	2566	2774	2950	3151	3483	3788	4094	4360	4692	5004	5426	6024

Active weight 400 lbs.

Optional 4 manual locking casters w/push bar. Please specify **(MRC)**. No upcharge.

OVERALL DIMENSIONS			SEAT DIMENSIONS			BACK DIMENSIONS	
W	D	H	W	D	H	W	H

IN	30	39	46.5	23.5	20	19	22.5	29
MM	762	991	1181	597	508	483	572	737

RTA 2 1 per carton

PRIMACARE SLEEPERS



model GC3611



model GC3611 (pulled out)

STANDARD FEATURES



- Primacare is a family of products offering the most significant return on investment approach in the industry since every component can be repaired or replaced on site.
- Solid hardwood frame with die cast zinc connectors and metal-to-metal fastening. Available in the following finishes: Absolute (AAM), Charcoal Java (CJM), Cherry (ACM), Empire Mahogany (EMM), English Oak (EOM), Espresso Cafe (ECM), Fruitwood (TFM), Gray (HGM), Harvest Oak (HOM), Honey (AHM), Jet Onyx (JOM), Light Honey (LHM), Mahogany (TMM), Maple (AVM), Medium Walnut (MWM), Natural Walnut (NLW), Night (ASM), Noce Biondo (NBM), Noce Grigio (NGM), Noce Leggero (NEM), Noce Medio (NMM), Sandy Beach (SBM), Shaker Cherry (SKM), Silver Oak (SOM), Walnut (TWM), White (WHM), WC Cream (WTM) and Winter Cherry (WCM).
- Armcaps are securely fastened with metal-to-metal connectors which allow for field replacement if required.
- Easy grip forward extending armcap on models with arms.
- For healthcare textile options, visit the website at globalfurnituregroup.com.
- Can be upholstered in standard Global textiles if healthcare compliance is not required.
- Shipped fully assembled.

OPTIONAL FEATURES

- Urethane armcaps are available in the following finishes: Black (BLK), Kalua (KAL), Latte (LAB), Mocha (J52), Shadow (SHW) and Toast (TOA). Please specify. No upcharge.
- Tablet arm with spill collector on the edge is available, offered in Black Phenolic material. From a seated position, specify **(LT)** for left hand tablet or **(RT)** for right hand tablet. Add \$572. For left and right tablets, please specify **(TB)**. Add \$1143.
- For moisture barrier on seat, please specify **(MB)**. For single sleeper: Add \$122. For double sleeper: Add \$245.
- To add sealed seams to your product contact Customer Service. Upcharges vary.
- For Primacare tables, see page 59.

SUGGESTED APPLICATIONS

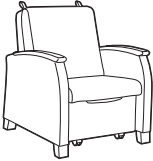
- Guest seating
- Lounge/Waiting
- Patient rooms
- Resident rooms
- Treatment/Exam rooms

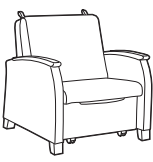
DESCRIPTION	MODEL# / FEATURES	STANDARD TEXTILE GRADES											
		COM	2	3	4	5	6	7	8	9	10	11	12
 <p>Single Sleeper Chair, Wood Legs COM: 7.5 YD 6.86 M Unit weight: 108 LB 49.1 KG Carton weight: 116 LB 52.62 KG Carton volume: 32.25 FT³ 0.91 MT³</p>	GC3610	3696	3936	4139	4371	4754	5106	5459	5766	6149	6509	6996	7686
	Active weight 350 lbs.												
	Sleep surface 24.5"W x 77"L												
	Optional urethane armcaps. Please specify. No upcharge.												
		RTA 00	1 per carton										
 <p>Single Sleeper Chair, Casters COM: 7.5 YD 6.86 M Unit weight: 108 LB 49.1 KG Carton weight: 116 LB 52.62 KG Carton volume: 32.25 FT³ 0.91 MT³</p>	GC3610C	3696	3936	4139	4371	4754	5106	5459	5766	6149	6509	6996	7686
	Active weight 350 lbs.												
	Sleep surface 24.5"W x 77"L												
	Optional urethane armcaps. Please specify. No upcharge.												
		RTA 00	1 per carton										
 <p>Single Sleeper Chair, Wide, Wood Legs COM: 9 YD 8.23 M Unit weight: 128 LB 58.2 KG Carton weight: 140 LB 63.5 KG Carton volume: 36.75 FT³ 1.04 MT³</p>	GC3611	3960	4248	4491	4770	5229	5652	6075	6444	6903	7335	7920	8748
	Active weight 350 lbs.												
	Sleep surface 30"W x 77"L												
	Optional urethane armcaps. Please specify. No upcharge.												
		RTA 00	1 per carton										

DESCRIPTION	MODEL# / FEATURES	STANDARD TEXTILE GRADES											
		COM	2	3	4	5	6	7	8	9	10	11	12



Single Sleeper Chair, Wide, Casters
 COM: 9 YD | 8.23 M
 Unit weight: 128 LB | 58.2 KG
 Carton weight: 140 LB | 63.5 KG
 Carton volume: 36.75 FT³ | 1.04 MT³

Active weight 350 lbs.

Sleep surface 30"W x 77"L.

Optional urethane armcaps.
 Please specify. No upcharge.

COM	2	3	4	5	6	7	8	9	10	11	12
3960	4248	4491	4770	5229	5652	6075	6444	6903	7335	7920	8748

OVERALL DIMENSIONS			SEAT DIMENSIONS			BACK DIMENSIONS	
W	D	H	W	D	H	W	H

IN	37	37.5	38	30	20	18	30	21
MM	940	953	965	762	508	457	762	533

RTA 00 1 per carton

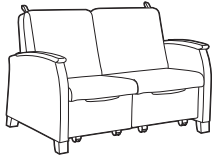

Double Sleeper Chair, Wood Legs
 COM: 11.75 YD | 10.74 M
 Unit weight: 205 LB | 93.2 KG
 Carton weight: 215 LB | 97.52 KG
 Carton volume: 60 FT³ | 1.69 MT³

Active weight 350 lbs/seat.

Each sleep surface is
 24.5"W x 77"L.

Optional urethane armcaps.
 Please specify. No upcharge.

COM	2	3	4	5	6	7	8	9	10	11	12
5526	5902	6219	6584	7183	7735	8287	8769	9368	9932	10696	11777

OVERALL DIMENSIONS			SEAT DIMENSIONS			BACK DIMENSIONS	
W	D	H	W	D	H	W	H

IN	56	36	38	48	19.5	18	48	21
MM	1422	914	965	1219	495	457	1219	533

RTA 00 1 per carton

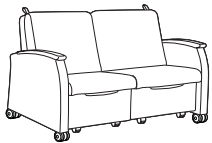

Double Sleeper Chair, Casters
 COM: 11.75 YD | 10.74 M
 Unit weight: 205 LB | 93.2 KG
 Carton weight: 215 LB | 97.52 KG
 Carton volume: 60 FT³ | 1.69 MT³

Active weight 350 lbs/seat.

Each sleep surface is
 24.5"W x 77"L.





Optional urethane armcaps.
 Please specify. No upcharge.

COM	2	3	4	5	6	7	8	9	10	11	12
5526	5902	6219	6584	7183	7735	8287	8769	9368	9932	10696	11777

OVERALL DIMENSIONS			SEAT DIMENSIONS			BACK DIMENSIONS	
W	D	H	W	D	H	W	H

IN	56	36	38	48	19.5	18	48	21
MM	1422	914	965	1219	495	457	1219	533

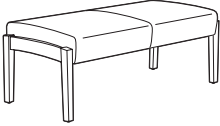
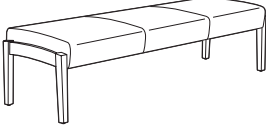
RTA 00 1 per carton

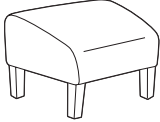
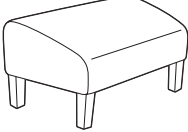
DESCRIPTION	MODEL# / FEATURES	STANDARD TEXTILE GRADES												
		COM	2	3	4	5	6	7	8	9	10	11	12	
 <p>Single Seat Bench (Wood) COM: 1.25 YD 1.14 M Unit weight: 20 LB 9.1 KG Carton weight: 26 LB 11.79 KG Carton volume: 9.75 FT³ 0.27 MT³</p>	GC3651W Wood	1130	1170	1204	1243	1306	1365	1424	1475	1539	1599	1680	1795	
	Active weight 350 lbs.	IN 26.5 MM 673	22.5 572	19 483	-	-	19 483	-	-					
		RTA 00		1 per carton										
			OVERALL DIMENSIONS			SEAT DIMENSIONS			BACK DIMENSIONS					
			W	D	H	W	D	H	W	H				
 <p>Two Seat Bench (Wood) COM: 2 YD 1.83 M Unit weight: 36 LB 16.4 KG Carton weight: 41 LB 18.6 KG Carton volume: 20.25 FT³ 0.57 MT³</p>	GC3652W Wood	1790	1854	1908	1970	2072	2166	2260	2342	2444	2540	2670	2854	
	Active weight 350 lbs/seat.	IN 49.5 MM 1257	22.5 572	19 483	-	-	19 483	-	-					
		RTA 00	1 per carton											
			OVERALL DIMENSIONS			SEAT DIMENSIONS			BACK DIMENSIONS					
			W	D	H	W	D	H	W	H				
 <p>Three Seat Bench (Wood) COM: 2.75 YD 2.51 M Unit weight: 55 LB 25 KG Carton weight: 61 LB 27.67 KG Carton volume: 28.75 FT³ 0.81 MT³</p>	GC3653W Wood	2449	2537	2611	2697	2837	2966	3095	3208	3348	3480	3659	3912	
	Active weight 350 lbs/seat.	IN 72.5 MM 1842	22.5 572	19 483	-	-	19 483	-	-					
		RTA 00		1 per carton										
			OVERALL DIMENSIONS			SEAT DIMENSIONS			BACK DIMENSIONS					
			W	D	H	W	D	H	W	H				
 <p>Standard Size Ottoman COM: 1.25 YD 1.14 M Unit weight: 12 LB 5.5 KG Carton weight: 17 LB 7.71 KG Carton volume: 4.7 FT³ 0.13 MT³</p>	GC3695	675	715	749	788	851	910	969	1020	1084	1144	1225	1340	
	Active weight 350 lbs.	IN 23 MM 584	18 457	15.75 400	-	-	-	-	-					
	Standard leg is Black urethane.	Optional urethane colors or wood legs. No upcharge.												
		RTA 00	1 per carton											
			OVERALL DIMENSIONS			SEAT DIMENSIONS			BACK DIMENSIONS					
		W	D	H	W	D	H	W	H					
 <p>Bariatric Ottoman COM: 1.75 YD 1.6 M Unit weight: 15 LB 6.8 KG Carton weight: 20 LB 9.07 KG Carton volume: 9 FT³ 0.25 MT³</p>	GC3696	848	904	951	1006	1095	1177	1259	1331	1420	1504	1618	1779	
	Active weight 500 lbs.	IN 31.25 MM 794	18 457	15.75 400	-	-	-	-	-					
	Standard leg is Black urethane.	Optional urethane colors or wood legs. No upcharge.												
		RTA 00	1 per carton											
			OVERALL DIMENSIONS			SEAT DIMENSIONS			BACK DIMENSIONS					
		W	D	H	W	D	H	W	H					

PRIMACARE MODULAR



STANDARD FEATURES

- Modular seating tops: Linking applications are available for medium and high back patient top units, low back guest top units and lounge top units.
- All modular seating top units are complete with frame and cushions. Leg/arm frames are ordered separately according to the desired specification.
- Frame design features a wall saver leg to prevent damage to walls. Frame construction ensures metal-to-metal fastening.
- For leg/arm frames and modular tables with power/USB module, refer to models ending in "M". Module includes two power outlets, four USB charging ports and a 6 foot long power cord. Available in Black or White (must be specified at time of order).
- Replaceable and/or removable seat and back cushions with replaceable cushion covers are standard.
- Seat cushion has a seamless waterfall front and clean out between and around the seat and back cushions.
- All **(CA)** models have closed upholstered arm panel inserts at each arm position.
- For added comfort, seats are standard with high density Ultracell foam.
- Active weight capacity up to 500 lbs/seat when using metal frame, fully upholstered frame or on bariatric models; up to 350 lbs/seat when using wood frame.
- For healthcare textile options, visit the website at globalfurnituregroup.com.
- Can be upholstered in standard Global textiles if healthcare compliance is not required.
- Left and right position reference is determined from the seated position.
- Metal leg/arm frames are available in the following finishes: Black (TBL), Cloud (TIV), Designer White (TDW), Fog (TFO), Frost (TFR), Kalua (TKA), Latte (TLA), Mocha (TMO), Nevada (TNE), Sand (TSN), Shadow (TSH), Toast (TOA) and Tungsten (TTU). Please specify.
- Wood leg/arm frames and armcaps are available in the following finishes: Absolute (AAM), Charcoal Java (CJM), Cherry (ACM), Empire Mahogany (EMM), English Oak (EOM), Espresso Cafe (ECM), Fruitwood (TFM), Gray (HGM), Harvest Oak (HOM), Honey (AHM), Jet Onyx (JOM), Light Honey (LHM), Mahogany (TMM), Maple (AVM), Medium Walnut (MWM), Natural Walnut (NLW), Night (ASM), Noce Biondo (NBM), Noce Grigio (NGM), Noce Leggero (NEM), Noce Medio (NMM), Sandy Beach (SBM), Shaker Cherry (SKM), Silver Oak (SOM), Walnut (TWM), White (WHM), WC Cream (WTM) and Winter Cherry (WCM). See features column for upcharges.
- Armcaps are securely fastened with metal-to-metal connectors which allows for field replacement if required. Armcaps cannot be retrofitted in the field on units with no existing armcaps.
- For moisture barrier on seat, please specify **(MB)**. Add \$81 per seat. For bariatric/lounge models, add \$122 per seat.
- To add sealed seams to your product contact Customer Service. Upcharges vary.

For Primacare freestanding tables, see page 59.
For Primacare Modular tables, see page 203.
For Primacare Modular lounge tables, see page 217.

SUGGESTED APPLICATIONS

- Bariatric seating
- Guest seating
- Lobbies
- Lounge/Waiting

OPTIONAL FEATURES

- Urethane armcaps are available in the following finishes: Black (BLK), Kalua (KAL), Latte (LAB), Mocha (J52), Shadow (SHW) and Toast (TOA).

MODULAR TABLES

Modular tables are offered with wood or metal legs. 1" thick table tops are available in thermally fused laminate (LP) and high pressure laminate (HP). Please select the appropriate model number for the finish you prefer.

Note: Modular tables are shipped KD (knock down) as per the published cube and weight. For freestanding Primacare tables, see page 59

Thermally fused laminate (LP):

Absolute Acajou (ACJ)	Quartered Mahogany (QTM)
Asian Night (ASN)	Noce Biondo (NBL)
Avant Cherry (AWC)	Noce Grigio (NGL)
Avant Honey (AWH)	Noce Leggero (NEL)
Brushed Cobalt (BRC)	Noce Medio (NML)
Clear Maple (CMB)	Sheer Beauty (SBY)
Dark Espresso (DES)	Walnut Heights (WHE)
Designer White (DWT)	White Chocolate (WHC)
Fashionista (FAS)	Winter Cherry (WCR)
First Class (FCL)	

High pressure laminate (HP):

Absolute Acajou (ACJ)	Quartered Mahogany (QTM)
Asian Night (ASN)	Noce Biondo (NBL)
Avant Cherry (W357)	Noce Grigio (NGL)
Avant Honey (W356)	Noce Leggero (NEL)
Brushed Cobalt (BRC)	Noce Medio (NML)
Clear Maple (CMB)	Sheer Beauty (SBY)
Dark Espresso (W142)	Walnut Heights (WHE)
Designer White (DWT)	White Chocolate (WHC)
Fashionista (FAS)	Winter Cherry (WCR)
First Class (FCL)	

Metal leg and frame finishes:

Available in Black (TBL), Cloud (TIV), Designer White (TDW), Fog (TFO), Frost (TFR), Kalua (TKA), Latte (TLA), Mocha (TMO), Nevada (TNE), Sand (TSN), Shadow (TSH), Toast (TOA) and Tungsten (TTU). Please specify.

SHIPPING INFORMATION:

Product components and parts will be shipped knocked down (**KD**). Weight and volume are indicated with each item KD. They will not be shipped assembled.

Assembled with drawing:

Product orders that are part of a linked application may require a combination of complete units and components for build up to achieve the limitless configurations that are possible. CAD drawing must be submitted with order when requesting units ship assembled.

Global will provide assembled units under the following conditions:

1. Detailed drawing clearly indicating:
 - The layout and location of each model number being ordered (see sample following).
 - If multiple textiles are used - textile color codes must be clearly identified on drawing.
2. Global will carton assemble orders to a maximum of 3 regular seat positions, which is the largest carton available.
3. Global reserves the right to determine the best method of assembly based on the information provided with the order.

PACKAGE 1 - Primacare HT

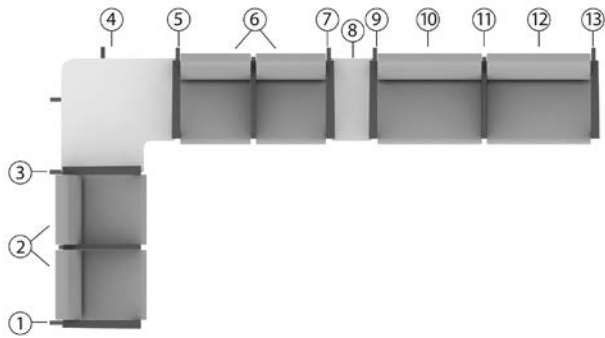

Always call out components as if seated in the chairs.

Item	Description	Qty	Model #	W x D x H	Yardage	Unit Weight	Carton Volume
1	Right End Frame with Right Armcap	1	GC3620RA	2.5 x 27 x 26.5	-	6	1.4
2, 6	Guest Low Back Two Seat Top w/Half Center Arm	2	GC3623TOP	42 x 25 x 19	3.25	58	43
3, 7	Seat to Table Center Linking Frame w/Left Armcap	2	GC3622TLA	2.5 x 27 x 26.5	-	6	1.4
4	Right Corner Table	1	GC3671R-HP	33 x 33 x 17	-	40	6
5, 9	Seat to Table Center Linking Frame w/Right Armcap	2	GC3622TRA	2.5 x 27 x 26.5	-	6	1.4
8	Narrow Center Table	1	GC3673-HP	12 x 23.87 x 5.5	-	14	2.1
10, 12	Guest Low Back Bariatric Top	2	GC3637TOP	30 x 25 x 19	2.5	43	26.5
11	Seat to Seat Center Linking Frame w/Narrow Armcap	1	GC3622LA	2.5 x 27 x 26.5	-	6	1.4
13	Left End Frame with Left Armcap	1	GC3620LA	2.5 x 27 x 26.5	-	6	1.4

PACKAGE 2 - Primacare HT

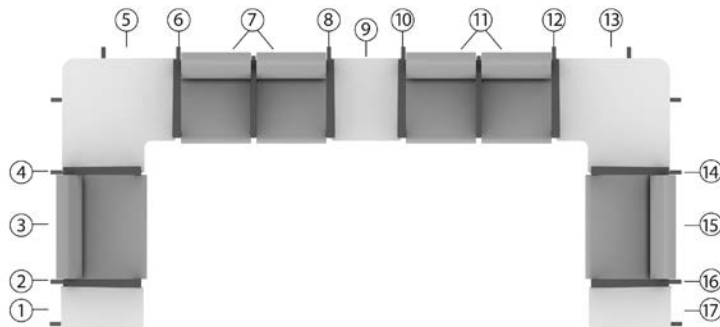

Always call out components as if seated in the chairs.

Item	Description	Qty	Model #	W x D x H	Yardage	Unit Weight	Carton Volume
1	Narrow Right End Table	1	GC3675R-HP	12 x 23.87 x 17	-	14	2.1
2, 6, 10, 14	Seat to Table Center Linking Frame w/Right Armcap	4	GC3622TRA	2.5 x 27 x 26.5	-	6	1.4
3, 15	Guest Low Back Bariatric Top	2	GC3637TOP	30 x 25 x 19	2.5	43	26.5
4, 8, 12, 16	Seat to Table Center Linking Frame w/Left Armcap	4	GC3622TLA	2.5 x 27 x 26.5	-	6	1.4
5	Right Corner Table	1	GC3671R-HP	33 x 33 x 17	-	40	6
7, 11	Guest Low Back Two Seat Top w/Half Center Arm	2	GC3623TOP	42 x 25 x 19	3.25	58	43
9	Regular Center Table	1	GC3672-HP	20.25 x 23.87 x 5.5	-	15	3.4
13	Left Corner Table	1	GC3671L-HP	33 x 33 x 17	-	46	6
17	Narrow Left End Table	1	GC3675L-HP	12 x 23.87 x 17	-	14	2.1

PACKAGE 3 - Primacare Wood

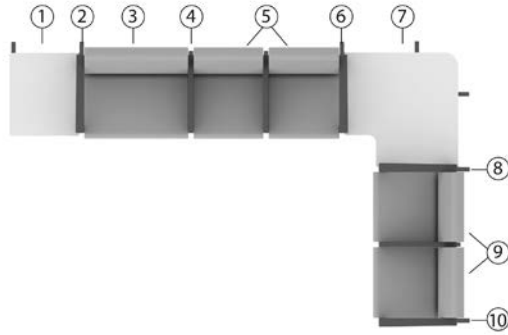

Always call out components as if seated in the chairs.

Item	Description	Qty	Model #	W x D x H	Yardage	Unit Weight	Carton Volume
1	Right End Run Table	1	GC3674WR-HP	20.25 x 23.87 x 17	-	15	3.4
2, 8	Seat to Table Center Linking Frame w/Right Armcap	2	GC3622WTRA	2.5 x 27 x 26.5	-	4	1.4
3	Guest Low Back Bariatric Top	1	GC3637TOP	30 x 25 x 19	2.5	43	26.5
4	Seat to Seat Center Linking Frame w/Narrow Armcap	1	GC3622WLA	2.5 x 27 x 26.5	-	4	1.4
5, 9	Guest Low Back Two Seat Top w/Half Center Arm	2	GC3623WTOP	42 x 25 x 19	3.25	60	43
6	Seat to Table Center Linking Frame w/Left Armcap	1	GC3622WTLA	2.5 x 27 x 26.5	-	4	1.4
7	Left Corner Table	1	GC3671WL-HP	33 x 33 x 17	-	46	6
10	Left End Frame w/Left Armcap	1	GC3620WLA	2 x 23 x 26	-	5	1.4

MODULAR TOP UNITS	SINGLE SEAT BARIATRIC		SINGLE SEAT BARIATRIC		TWO SEATER, NO CENTER ARM	TWO SEATER, CENTER ARM		THREE SEATER, NO CENTER ARMS	THREE SEATER, TWO ARMS	
	medium back	high back	medium back	high back	medium back	medium back	high back	medium back	medium back	high back
Guest seating	GC3620TOP	GC3637TOP	GC3655TOP	GC3656TOP	GC3621TOP	GC3623TOP GC3623WTOP	GC3623HB-TOP GC3623WHB-TOP	GC3624TOP	GC3626TOP GC3626WTOP	GC3626HB-TOP GC3626WHB-TOP
Patient seating	GC3631TOP	GC3638TOP	GC3655TOP	GC3656TOP		GC3623CATOP GC3623WCATOP	GC3623HBCA-TOP GC3623WHBCA-TOP		GC3626CATOP GC3626WCATOP	GC3626HBCA-TOP GC3626WHBCA-TOP

LEG / ARM FRAMES	Wood frame: Must select armcap Metal frame: Standard with Black urethane armcap (see notes for wood and urethane finish options)									
	LEFT, OPEN		RIGHT, OPEN		LEFT, CLOSED		RIGHT, CLOSED		LEFT, CLOSED LAMINATE PANEL	RIGHT, CLOSED LAMINATE PANEL
Metal (HT) End	GC3620LA	GC3620LAM	GC3620RA	GC3620RAM	GC3620LA	GC3620LCAM	GC3620RCA	GC3620RCAM	GC3620LCAL	GC3620RCAL
Wood End	GC3620WLA	GC3620WLAM	GC3620WRA	GC3620WRAM	GC3620WLA	GC3620WLCAM	GC3620WRCA	GC3620WRCAM		
Metal (HT) Center	GC3622LA				GC3622LCA				GC3622LCAL	
Wood Center	GC3622WLA				GC3622WLCA					
Metal (HT) Center table linking	GC3622TLA		GC3622TRA		GC3622TLCA		GC3622TRCA		GC3622TLCAL	GC3622TRCAL
Wood Center table linking	GC3622WTLA		GC3622WTRA		GC3622WTLCA		GC3622WTRCA			

For frame with power/USB module*, refer to models ending in "M"

End Frame: Armless

	LEFT	RIGHT
Metal End	GC3620LNA	GC3620RNA
Wood End	GC3620WLNA	GC3620WRNA

Central Linking Frame: Armless

	CENTER
Metal	GC3622LNA
Wood	GC3622WLNA

(Center = link both sides)

*Power module includes two power outlets, four USB charging ports and a 6 foot long power cord. Available in Black or White (must be specified at time of order). Power module is mounted on the frame below seat support rail.

MODULAR TABLES

Tables include legs to support table top (except for center tables). All tables have a metal frame.

	LEFT		RIGHT	
Corner (laminate top with metal legs)	GC3671L-HP	GC3671LM-HP	GC3671R-HP	GC3671RM-HP
	GC3671L-LP	GC3671LM-LP	GC3671R-LP	GC3671RM-LP
Corner (laminate top with wood legs)	GC3671WL-HP	GC3671WLM-HP	GC3671WR-HP	GC3671WRM-HP
	GC3671WL-LP	GC3671WLM-LP	GC3671WR-LP	GC3671WRM-LP
Center (laminate top, connects to metal or wood frame)	GC3672-HP	GC3672M-HP		
	GC3672-LP	GC3672M-LP		
Narrow Center (laminate top, connects to metal or wood frame)	GC3673-HP	GC3673M-HP		
	GC3673-LP	GC3673M-LP		
End (laminate top with metal legs)	GC3674L-HP	GC3674LM-HP	GC3674R-HP	GC3674RM-HP
	GC3674L-LP	GC3674LM-LP	GC3674R-LP	GC3674RM-LP
End (laminate top with wood legs)	GC3674WL-HP	GC3674WLM-HP	GC3674WR-HP	GC3674WRM-HP
	GC3674WL-LP	GC3674WLM-LP	GC3674WR-LP	GC3674WRM-LP
Narrow End (laminate top with metal legs)	GC3675L-HP	GC3675LM-HP	GC3675R-HP	GC3675RM-HP
	GC3675L-LP	GC3675LM-LP	GC3675R-LP	GC3675RM-LP
Narrow End (laminate top with wood legs)	GC3675WL-HP	GC3675WLM-HP	GC3675WR-HP	GC3675WRM-HP
	GC3675WL-LP	GC3675WLM-LP	GC3675WR-LP	GC3675WRM-LP

For table with power/USB module*, refer to models ending in "M"

*Power module includes two power outlets, four USB charging ports and a 6 foot long power cord. Available in Black or White (must be specified at time of order). Power module is mounted **on surface** on narrow tables; mounted **in surface** on larger tables (as shown above).

DESCRIPTION MODEL# / FEATURES STANDARD TEXTILE GRADES



LB Guest Single Seat Top
 COM: 1.75 YD | 1.6 M
 Unit weight: 30 LB | 13.6 KG
 Carton weight: 36 LB | 16.33 KG
 Carton volume: 10 FT³ | 0.28 MT³

COM	2	3	4	5	6	7	8	9	10	11	12
704	760	807	862	951	1033	1115	1187	1276	1360	1474	1635

Active weight: see notes.

Single frame guest top unit with 1 low back and 1 seat cushion.

Must be connected to a full arm/leg frame.

OVERALL DIMENSIONS			SEAT DIMENSIONS			BACK DIMENSIONS	
W	D	H	W	D	H	W	H
IN 20.5	25	19	20.5	17.5	-	20.5	15
MM 521	635	483	521	445	-	521	381

RTA 00 1 per carton

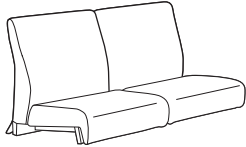

LB Guest Two Seat Top No Center Arm
 COM: 3.25 YD | 2.97 M
 Unit weight: 62 LB | 28.2 KG
 Carton weight: 72 LB | 32.66 KG
 Carton volume: 43 FT³ | 1.21 MT³

COM	2	3	4	5	6	7	8	9	10	11	12
1490	1594	1682	1783	1948	2101	2254	2387	2553	2709	2920	3219

Active weight: see notes.

Double frame guest top unit with 2 low back and 2 seat cushions.

Must be connected to a full arm/leg frame.

OVERALL DIMENSIONS			SEAT DIMENSIONS			BACK DIMENSIONS	
W	D	H	W	D	H	W	H
IN 40	25	19	40	17.5	-	40	15
MM 1016	635	483	1016	445	-	1016	381

RTA 00 1 per carton

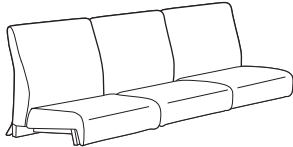

LB Guest Three Seat Top No Center Arm
 COM: 4.25 YD | 3.89 M
 Unit weight: 72 LB | 32.7 KG
 Carton weight: 82 LB | 37.19 KG
 Carton volume: 65.25 FT³ | 1.84 MT³

COM	2	3	4	5	6	7	8	9	10	11	12
2325	2461	2576	2708	2924	3124	3324	3498	3715	3919	4195	4586

Active weight: see notes.

Triple frame guest top unit with 3 low back and 3 seat cushions.

Must be connected to a full arm/leg frame.

OVERALL DIMENSIONS			SEAT DIMENSIONS			BACK DIMENSIONS	
W	D	H	W	D	H	W	H
IN 60	25	19	60	17.5	-	60	15
MM 1524	635	483	1524	445	-	1524	381

RTA 00 1 per carton

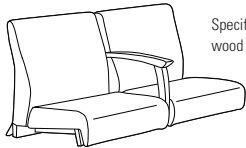

Specify armcap: wood or urethane.

LB Guest Two Seat Top Open Center Arm
 COM: 3.25 YD | 2.97 M
 Unit weight: metal: 58 LB | 26.4 KG | wood: 60 LB | 27.3 KG
 Carton weight: metal: 68 LB | 30.84 KG | wood: 68 LB | 30.84 KG
 Carton volume: 43 FT³ | 1.21 MT³

COM	2	3	4	5	6	7	8	9	10	11	12
2034	2138	2226	2327	2492	2645	2798	2931	3097	3253	3464	3763
1687	1791	1879	1980	2145	2298	2451	2584	2750	2906	3117	3416

Active weight: see notes.

Double low back frame guest top, 2 back and 2 seat cushions.

Must be connected to a full arm/leg frame.

OVERALL DIMENSIONS			SEAT DIMENSIONS			BACK DIMENSIONS	
W	D	H	W	D	H	W	H
IN 42	25	19	20.5	17.5	-	20.5	15
MM 1067	635	483	521	445	-	521	381

RTA 00 1 per carton

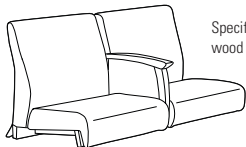

Specify armcap: wood or urethane.

LB Guest Two Seat Top Closed Center Arm, Metal
 COM: 3.5 YD | 3.2 M
 Unit weight: metal: 66 LB | 30 KG | wood: 66 LB | 30 KG
 Carton weight: metal: 74 LB | 33.57 KG | wood: 74 LB | 33.57 KG
 Carton volume: 43 FT³ | 1.21 MT³

COM	2	3	4	5	6	7	8	9	10	11	12
2263	2375	2470	2578	2757	2921	3086	3229	3408	3576	3803	4125
1795	1907	2002	2110	2289	2453	2618	2761	2940	3108	3335	3657





Active weight: see notes.

Double low back frame guest top, 2 back and 2 seat cushions.

Must be connected to a full arm/leg frame.

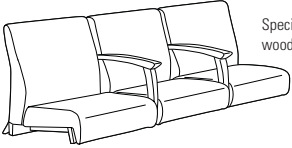
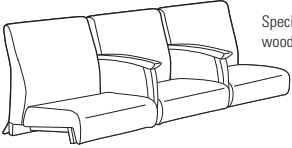
OVERALL DIMENSIONS			SEAT DIMENSIONS			BACK DIMENSIONS	
W	D	H	W	D	H	W	H
IN 42	25	19	20.5	17.5	-	20.5	15
MM 1067	635	483	521	445	-	521	381

RTA 00 1 per carton

DESCRIPTION	MODEL# / FEATURES	STANDARD TEXTILE GRADES											
		COM	2	3	4	5	6	7	8	9	10	11	12
 <p>Specify armcap: wood or urethane.</p> <p>LB Guest Three Seat Top Open Center Arm COM: 4.75 YD 4.34 M Unit weight: metal: 67 LB 30.5 KG wood: 67 LB 30.5 KG Carton weight: metal: 77 LB 34.93 KG wood: 77 LB 34.93 KG Carton volume: 65.25 FT³ 1.84 MT³</p>	GC3626TOP (metal)	3259	3411	3539	3687	3929	4152	4375	4570	4812	5040	5349	5786
	GC3626WTOP (wood)	2641	2793	2921	3069	3311	3534	3757	3952	4194	4422	4731	5168
<p>Due to the size and weight, this top requires at least 3 installers.</p> <p>Active weight: see notes.</p> <p>Triple low back frame guest top, 3 back and 3 seat cushions.</p>		OVERALL DIMENSIONS W D H			SEAT DIMENSIONS W D H			BACK DIMENSIONS W H					
		IN	64	25	19	20.5	17.5	-	20.5	15			
		MM	1626	635	483	521	445	-	521	381			
<p>Must be connected to a full arm/leg frame.</p>		RTA 00	1 per carton										
 <p>Specify armcap: wood or urethane.</p> <p>LB Guest Three Seat Top Closed Center Arms, Metal COM: 5.5 YD 5.03 M Unit weight: metal: 73 LB 33.2 KG wood: 77 LB 35 KG Carton weight: metal: 83 LB 37.65 KG wood: 87 LB 39.46 KG Carton volume: 65.25 FT³ 1.84 MT³</p>	GC3626CATOP (metal)	3535	3711	3860	4030	4311	4569	4828	5053	5334	5598	5955	6461
	GC3626WCATOP (wood)	2853	3029	3178	3348	3629	3887	4146	4371	4652	4916	5273	5779
<p>Due to the size and weight, this top requires at least 3 installers.</p> <p>Active weight: see notes.</p> <p>Triple low back frame guest top, 3 back and 3 seat cushions.</p>		OVERALL DIMENSIONS W D H			SEAT DIMENSIONS W D H			BACK DIMENSIONS W H					
		IN	64	25	19	20.5	17.5	-	20.5	15			
		MM	1626	635	483	521	445	-	521	381			
<p>Must be connected to a full arm/leg frame.</p>		RTA 00	1 per carton										
 <p>MB Patient Top COM: 1.75 YD 1.6 M Unit weight: 36 LB 16.4 KG Carton weight: 42 LB 19.05 KG Carton volume: 10 FT³ 0.28 MT³</p>	GC3631TOP	740	796	843	898	987	1069	1151	1223	1312	1396	1510	1671
	<p>Active weight: see notes.</p> <p>Single mid back frame patient top, 1 back and 1 seat cushion.</p>		OVERALL DIMENSIONS W D H			SEAT DIMENSIONS W D H			BACK DIMENSIONS W H				
		IN	20.5	25	22	20.5	17.5	-	20.5	18			
		MM	521	635	559	521	445	-	521	457			
<p>Must be connected to a full arm/leg frame.</p>		RTA 00	1 per carton										
 <p>LB Bariatric Guest Top COM: 2.5 YD 2.29 M Unit weight: 43 LB 19.5 KG Carton weight: 53 LB 24.04 KG Carton volume: 26.5 FT³ 0.75 MT³</p>	GC3637TOP	1137	1217	1285	1362	1490	1607	1725	1827	1955	2075	2237	2467
	<p>Active weight: see notes.</p> <p>Single low back frame bariatric guest top, 1 back and 1 seat cushion.</p>		OVERALL DIMENSIONS W D H			SEAT DIMENSIONS W D H			BACK DIMENSIONS W H				
		IN	30	25	19	30	17.5	-	30	15			
		MM	762	635	483	762	445	-	762	381			
<p>Must be connected to a full arm/leg frame.</p>		RTA 00	1 per carton										
 <p>MB Bariatric Patient Top COM: 2.75 YD 2.51 M Unit weight: 52 LB 23.6 KG Carton weight: 62 LB 28.12 KG Carton volume: 30.5 FT³ 0.86 MT³</p>	GC3638TOP	1192	1280	1354	1440	1580	1709	1838	1951	2091	2223	2402	2655
	<p>Active weight: see notes.</p> <p>Single mid back frame bariatric patient top, 1 back and 1 seat cushion.</p>		OVERALL DIMENSIONS W D H			SEAT DIMENSIONS W D H			BACK DIMENSIONS W H				
		IN	30	25	22	30	17.5	-	30	18			
		MM	762	635	559	762	445	-	762	457			
<p>Must be connected to a full arm/leg frame.</p>		RTA 00	1 per carton										

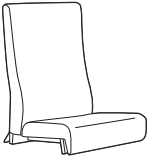
DESCRIPTION	MODEL# / FEATURES	STANDARD TEXTILE GRADES											
		COM	2	3	4	5	6	7	8	9	10	11	12
 <p>HB Patient Top COM: 2.5 YD 2.29 M Unit weight: metal: 42 LB 19.1 KG Carton weight: metal: 52 LB 23.59 KG Carton volume: 13.25 FT³ 0.37 MT³</p>	GC3655TOP	879	959	1027	1104	1232	1349	1467	1569	1697	1817	1979	2209
	Active weight: see notes.	OVERALL DIMENSIONS			SEAT DIMENSIONS			BACK DIMENSIONS					
		W	D	H	W	D	H	W	H				
	Single high back frame patient top, 1 back and 1 seat cushion.	IN 20.5 MM 521	25 635	34 864	20.5 521	17.5 445	- -	20.5 521	30 762				
Must be connected to a full arm/leg frame.	RTA 00	1 per carton											

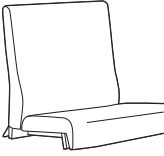
DESCRIPTION	MODEL# / FEATURES	STANDARD TEXTILE GRADES											
		COM	2	3	4	5	6	7	8	9	10	11	12
 <p>HB Bariatric Patient Top COM: 3.5 YD 3.2 M Unit weight: 52 LB 23.6 KG Carton weight: 62 LB 28.12 KG Carton volume: 33 FT³ 0.93 MT³</p>	GC3656TOP	1419	1531	1626	1734	1913	2077	2242	2385	2564	2732	2959	3281
	Active weight: see notes.	OVERALL DIMENSIONS			SEAT DIMENSIONS			BACK DIMENSIONS					
		W	D	H	W	D	H	W	H				
	Single high back frame bariatric patient top, 1 back and 1 seat cushion.	IN 30 MM 762	25 635	34 864	30 762	17.5 445	- -	30 762	30 762				
Must be connected to a full arm/leg frame.	RTA 00	1 per carton											

DESCRIPTION	MODEL# / FEATURES	STANDARD TEXTILE GRADES											
		COM	2	3	4	5	6	7	8	9	10	11	12
 <p>Specify armcap: wood or urethane.</p> <p>HB Guest Two Seat Top Open Center Arm COM: 4.5 YD 4.11 M Unit weight: metal: 70 LB 31.8 KG wood: 70 LB 31.8 KG Carton weight: metal: 80 LB 36.29 KG wood: 80 LB 36.29 KG Carton volume: 43 FT³ 1.21 MT³</p>	GC3623HB-TOP (metal)	2151	2295	2417	2556	2786	2997	3209	3393	3623	3839	4131	4545
	GC3623WHB-TOP (wood)	1788	1932	2054	2193	2423	2634	2846	3030	3260	3476	3768	4182
	Active weight: see notes.	OVERALL DIMENSIONS			SEAT DIMENSIONS			BACK DIMENSIONS					
	Double high back frame guest top, 2 back and 2 seat cushions.	IN 42 MM 1067	27 686	32 813	20.5 521	17.5 445	- -	20.5 521	28 711				
Must be connected to a full arm/leg frame.	RTA 00	1 per carton											

DESCRIPTION	MODEL# / FEATURES	STANDARD TEXTILE GRADES											
		COM	2	3	4	5	6	7	8	9	10	11	12
 <p>Specify armcap: wood or urethane.</p> <p>HB Guest Two Seat Top Closed Center Arm, Metal COM: 4.5 YD 4.11 M Unit weight: metal: 138 LB 62.7 KG wood: 138 LB 62.7 KG Carton weight: metal: 150 LB 68.04 KG wood: 150 LB 68.04 KG Carton volume: 43 FT³ 1.21 MT³</p>	GC3623HB-CA-TOP (metal)	2387	2531	2653	2792	3022	3233	3445	3629	3859	4075	4367	4781
	GC3623WHB-CA-TOP (wood)	1905	2049	2171	2310	2540	2751	2963	3147	3377	3593	3885	4299
	Active weight: see notes.	OVERALL DIMENSIONS			SEAT DIMENSIONS			BACK DIMENSIONS					
	Double high back frame guest top, 2 back and 2 seat cushions.	IN 42 MM 1067	27 686	32 813	20.5 521	17.5 445	- -	20.5 521	28 711				
Must be connected to a full arm/leg frame.	RTA 00	1 per carton											

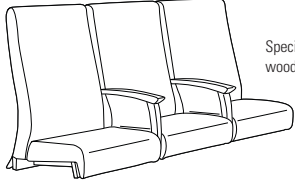
DESCRIPTION	MODEL# / FEATURES	STANDARD TEXTILE GRADES											
		COM	2	3	4	5	6	7	8	9	10	11	12
 <p>Specify armcap: wood or urethane.</p> <p>HB Guest Three Seat Top Open Center Arm COM: 6.25 YD 5.72 M Unit weight: metal: 77 LB 35 KG wood: 77 LB 35 KG Carton weight: metal: 92 LB 41.73 KG wood: 92 LB 41.73 KG Carton volume: 65.25 FT³ 1.84 MT³</p>	GC3626HB-TOP (metal)	3444	3644	3813	4007	4325	4619	4913	5169	5488	5788	6194	6769
	GC3626WHB-TOP (wood)	2805	3005	3174	3368	3686	3980	4274	4530	4849	5149	5555	6130
	Due to the size and weight, this top requires at least 3 installers.	OVERALL DIMENSIONS			SEAT DIMENSIONS			BACK DIMENSIONS					
	Triple high back frame guest top, 3 back and 3 seat cushions.	IN 64 MM 1626	27 686	32 813	20.5 521	17.5 445	- -	20.5 521	28 711				
Must be connected to a full arm/leg frame.	RTA 00	1 per carton											

DESCRIPTION MODEL# / FEATURES STANDARD TEXTILE GRADES

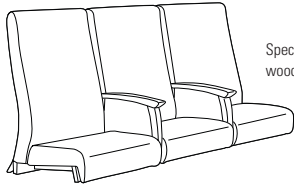

Specify armcap:
wood or urethane.

HB Guest Three Seat Top Closed Center Arms, Metal

COM: 7 YD | 6.4 M
Unit weight: metal: 160 LB | 72.7 KG | wood: 160 LB | 72.7 KG
Carton weight: metal: 175 LB | 79.38 KG | wood: 175 LB | 79.38 KG
Carton volume: 80.75 FT³ | 2.28 MT³

	COM	2	3	4	5	6	7	8	9	10	11	12
GC3626HBCA-TOP (metal)	3724	3948	4137	4354	4711	5040	5369	5656	6013	6349	6804	7448
GC3626WHBCA-TOP (wood)	3017	3241	3430	3647	4004	4333	4662	4949	5306	5642	6097	6741

Due to the size and weight, this top requires at least 3 installers.

Active weight: see notes.

Triple high back frame
guest top, 3 back and 3
seat cushions.

	OVERALL DIMENSIONS			SEAT DIMENSIONS			BACK DIMENSIONS	
	W	D	H	W	D	H	W	H
IN	64	27	32	20.5	17.5	-	20.5	28
MM	1626	686	813	521	445	-	521	711

Must be connected to a full arm/leg frame.

RTA 00 1 per carton

List price

GC3620LNA (metal)	353
GC3620WLN (wood)	223

	OVERALL DIMENSIONS			SEAT DIMENSIONS			BACK DIMENSIONS	
	W	D	H	W	D	H	W	H

For use in **left** side finished position of guest and/or patient seating units.

IN	1.25	24.25	16	-	-	-	-	-
MM	32	616	406	-	-	-	-	-

Does not allow linking to other units or tables.

RTA 00  1 per carton

List price

GC3620RNA (metal)	353
GC3620WRNA (wood)	223

	OVERALL DIMENSIONS			SEAT DIMENSIONS			BACK DIMENSIONS	
	W	D	H	W	D	H	W	H

For use in **right** side finished position of guest and/or patient seating units.

IN	1.25	24.25	16	-	-	-	-	-
MM	32	616	406	-	-	-	-	-

Does not allow linking to other units or tables.

RTA 00  1 per carton

List price

GC3620LA (metal)	448
GC3620LAM (w/power)	1467
GC3620WLA (wood)	306
GC3620WLAM (w/power)	1232

• Models GC3620LAM and GC3620WLAM have **power/USB** module (not shown).

Specify armcap:
wood or urethane.

	OVERALL DIMENSIONS			SEAT DIMENSIONS			BACK DIMENSIONS	
	W	D	H	W	D	H	W	H

For use in **left** side finished position of guest and/or patient seating units.

IN	2.5	27	26.5	-	-	-	-	-
MM	64	686	673	-	-	-	-	-

Does not allow linking to other units or tables.

RTA 00  1 per carton

List price

GC3620RA (metal)	448
GC3620RAM (w/power)	1467
GC3620WRA (wood)	306
GC3620WRAM (w/power)	1232

• Models GC3620RAM and GC3620WRAM have **power/USB** module (not shown).

Specify armcap:
wood or urethane.

	OVERALL DIMENSIONS			SEAT DIMENSIONS			BACK DIMENSIONS	
	W	D	H	W	D	H	W	H

For use in **right** side finished position of guest and/or patient seating units.

IN	2.5	27	26.5	-	-	-	-	-
MM	64	686	673	-	-	-	-	-

Does not allow linking to other units or tables.

RTA 00  1 per carton

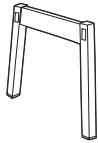

Left End Frame, Armless

COM: N/A
Unit weight: metal: 4 LB | 1.8 KG | wood: 3 LB | 1.4 KG
Carton weight: metal: 5 LB | 2.27 KG | wood: 4 LB | 1.81 KG
Carton volume: 1.2 FT³ | 0.03 MT³

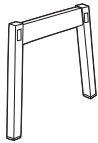

Right End Frame, Armless

COM: N/A
Unit weight: metal: 4 LB | 1.8 KG | wood: 3 LB | 1.4 KG
Carton weight: metal: 5 LB | 2.27 KG | wood: 4 LB | 1.81 KG
Carton volume: 1.2 FT³ | 0.03 MT³

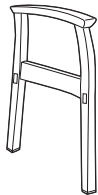

Left End Frame, Open Arm

COM: N/A
Unit weight: metal: 6 LB | 2.7 KG | wood: 5 LB | 2.3 KG
Carton weight: metal: 10 LB | 4.54 KG | wood: 10 LB | 4.54 KG
Carton volume: 1.4 FT³ | 0.03 MT³



Right End Frame, Open Arm

COM: N/A
Unit weight: metal: 6 LB | 2.7 KG | wood: 5 LB | 2.3 KG
Carton weight: metal: 10 LB | 4.54 KG | wood: 10 LB | 4.54 KG
Carton volume: 1.4 FT³ | 0.03 MT³

DESCRIPTION MODEL# / FEATURES STANDARD TEXTILE GRADES

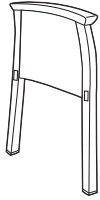

Left End Frame, Closed Arm

COM: 0.65 YD | 0.59 M
 Unit weight: metal: 10 LB | 4.5 KG | wood: 10 LB | 4.5 KG
 Carton weight: metal: 15 LB | 6.8 KG | wood: 15 LB | 6.8 KG
 Carton volume: 1.4 FT³ | 0.03 MT³

	COM	2	3	4	5	6	7	8	9	10	11	12
GC3620LCA (metal)	579	600	618	638	671	701	732	759	792	823	865	925
GC3620LCAM (w/power)	1597	1618	1636	1656	1689	1719	1750	1777	1810	1841	1883	1943
GC3620WLCA (wood)	399	420	438	458	491	521	552	579	612	643	685	745
GC3620WLCAM (w/power)	1329	1350	1368	1388	1421	1451	1482	1509	1542	1573	1615	1675

• Models GC3620LCAM and GC3620WLCAM have **power/USB** module (not shown).

Specify armcap:
wood or urethane.

	OVERALL DIMENSIONS			SEAT DIMENSIONS			BACK DIMENSIONS	
	W	D	H	W	D	H	W	H
IN	2.5	27	26.5	-	-	-	-	-
MM	64	686	673	-	-	-	-	-

For use in **left** side finished position of guest and/or patient seating units.

Does not allow linking to other units or tables.

RTA 00  1 per carton

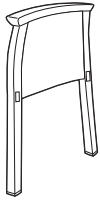

Right End Frame, Closed Arm

COM: 0.65 YD | 0.59 M
 Unit weight: metal: 10 LB | 4.5 KG | wood: 10 LB | 4.5 KG
 Carton weight: metal: 15 LB | 6.8 KG | wood: 15 LB | 6.8 KG
 Carton volume: 1.4 FT³ | 0.03 MT³

	COM	2	3	4	5	6	7	8	9	10	11	12
GC3620RCA (metal)	579	600	618	638	671	701	732	759	792	823	865	925
GC3620RCAM (w/power)	1597	1618	1636	1656	1689	1719	1750	1777	1810	1841	1883	1943
GC3620WRCA (wood)	399	420	438	458	491	521	552	579	612	643	685	745
GC3620WRCAM (w/power)	1329	1350	1368	1388	1421	1451	1482	1509	1542	1573	1615	1675

• Models GC3620RCAM and GC3620WRCAM have **power/USB** module (not shown).

Specify armcap:
wood or urethane.

	OVERALL DIMENSIONS			SEAT DIMENSIONS			BACK DIMENSIONS	
	W	D	H	W	D	H	W	H
IN	2.5	27	26.5	-	-	-	-	-
MM	64	686	673	-	-	-	-	-

For use in **right** side finished position of guest and/or patient seating units.

Does not allow linking to other units or tables.

RTA 00  1 per carton

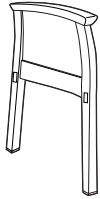

Left End Frame, Closed Arm, Laminate Panel

COM: N/A
 Unit weight: 15 LB | 6.8 KG
 Carton weight: 18 LB | 8.16 KG
 Carton volume: 1.4 FT³ | 0.03 MT³

List price

GC3620LCAL (metal) 740

Specify armcap:
wood or urethane.

	OVERALL DIMENSIONS			SEAT DIMENSIONS			BACK DIMENSIONS	
	W	D	H	W	D	H	W	H
IN	2.5	27	26.5	-	-	-	-	-
MM	64	686	673	-	-	-	-	-

For use in **left** side finished position of guest and/or patient seating units.

Does not allow linking to other units or tables.

RTA 00  1 per carton

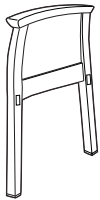

Right End Frame, Closed Arm, Laminate Panel

COM: N/A
 Unit weight: 15 LB | 6.8 KG
 Carton weight: 18 LB | 8.16 KG
 Carton volume: 1.4 FT³ | 0.03 MT³

List price

GC3620RCAL (metal) 740

Specify armcap:
wood or urethane.

	OVERALL DIMENSIONS			SEAT DIMENSIONS			BACK DIMENSIONS	
	W	D	H	W	D	H	W	H
IN	2.5	27	26.5	-	-	-	-	-
MM	64	686	673	-	-	-	-	-

For use in **right** side finished position of guest and/or patient seating units.

Does not allow linking to other units or tables.

RTA 00  1 per carton

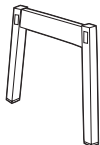

Seat to Seat Central Linking Frame, Armless

COM: N/A
 Unit weight: metal: 4 LB | 1.8 KG | wood: 3 LB | 1.4 KG
 Carton weight: metal: 5 LB | 2.27 KG | wood: 4 LB | 1.81 KG
 Carton volume: 1.2 FT³ | 0.03 MT³

List price



GC3622LNA (metal) 353







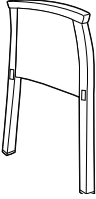
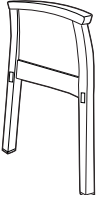
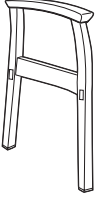

GC3622WLNA (wood) 223

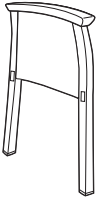
For **linking** guest and/or patient top seating units together only.

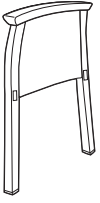
	OVERALL DIMENSIONS			SEAT DIMENSIONS			BACK DIMENSIONS	
	W	D	H	W	D	H	W	H
IN	1.25	24.25	16	-	-	-	-	-
MM	32	616	406	-	-	-	-	-

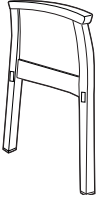
RTA 00  1 per carton

DESCRIPTION	MODEL# / FEATURES	STANDARD TEXTILE GRADES										
	List price											
	GC3622LA (metal)	448										
	GC3622WLA (wood)	306										
Center Frame, Open Arm COM: N/A Unit weight: metal: 6 LB 2.7 KG wood: 4 LB 1.8 KG Carton weight: metal: 10 LB 4.54 KG wood: 8 LB 3.63 KG Carton volume: 1.4 FT³ 0.03 MT³	Specify armcap: wood or urethane.	OVERALL DIMENSIONS			SEAT DIMENSIONS			BACK DIMENSIONS				
		W	D	H	W	D	H	W	H			
	For linking guest and/or patient top seating units together only.	IN 2.5	27	26.5	-	-	-	-	-			
		MM 64	686	673	-	-	-	-	-			
		RTA 00		courier		1 per carton						
	COM											
	GC3622LCA (metal)	2	3	4	5	6	7	8	9	10	11	12
	GC3622WLCA (wood)	399	420	438	458	491	521	552	579	612	643	685
Center Frame, Closed Arm COM: 0.65 YD 0.59 M Unit weight: metal: 10 LB 4.5 KG wood: 6 LB 2.7 KG Carton weight: metal: 15 LB 6.8 KG wood: 10 LB 4.54 KG Carton volume: 1.4 FT³ 0.03 MT³	Specify armcap: wood or urethane.	OVERALL DIMENSIONS			SEAT DIMENSIONS			BACK DIMENSIONS				
		W	D	H	W	D	H	W	H			
	For linking guest and/or patient top seating units together only.	IN 2.5	27	26.5	-	-	-	-	-			
		MM 64	686	673	-	-	-	-	-			
		RTA 00		courier		1 per carton						
	List price											
	GC3622LCAL (metal)	740										
Center Frame, Closed Arm, Laminate Panel COM: N/A Unit weight: 15 LB 6.8 KG Carton weight: 18 LB 8.16 KG Carton volume: 1.4 FT³ 0.03 MT³	Specify armcap: wood or urethane.	OVERALL DIMENSIONS			SEAT DIMENSIONS			BACK DIMENSIONS				
		W	D	H	W	D	H	W	H			
	For linking guest and/or patient top seating units together only.	IN 2.5	27	26.5	-	-	-	-	-			
		MM 64	686	673	-	-	-	-	-			
		RTA 00		courier		1 per carton						
	List price											
	GC3622TLA (metal)	481										
	GC3622WTLA (wood)	333										
Center Frame, Open Arm COM: N/A Unit weight: metal: 6 LB 2.7 KG wood: 4 LB 1.8 KG Carton weight: metal: 10 LB 4.54 KG wood: 8 LB 3.63 KG Carton volume: 1.4 FT³ 0.03 MT³	Specify armcap: wood or urethane.	OVERALL DIMENSIONS			SEAT DIMENSIONS			BACK DIMENSIONS				
		W	D	H	W	D	H	W	H			
	For linking guest and/or patient top seating units table on the left side of the frame.	IN 2.5	27	26.5	-	-	-	-	-			
		MM 64	686	673	-	-	-	-	-			
		RTA 00		courier		1 per carton						
	List price											
	GC3622TRA (metal)	481										
	GC3622WTRA (wood)	333										
Center Frame, Open Arm COM: N/A Unit weight: metal: 6 LB 2.7 KG wood: 4 LB 1.8 KG Carton weight: metal: 10 LB 4.54 KG wood: 8 LB 3.63 KG Carton volume: 1.4 FT³ 0.03 MT³	Specify armcap: wood or urethane.	OVERALL DIMENSIONS			SEAT DIMENSIONS			BACK DIMENSIONS				
		W	D	H	W	D	H	W	H			
	For linking guest and/or patient top seating units table on the right side of the frame.	IN 2.5	27	26.5	-	-	-	-	-			
		MM 64	686	673	-	-	-	-	-			
		RTA 00		courier		1 per carton						

DESCRIPTION	MODEL# / FEATURES	STANDARD TEXTILE GRADES											
		COM	2	3	4	5	6	7	8	9	10	11	12
 <p>Center Frame, Closed Arm COM: 0.65 YD 0.59 M Unit weight: metal: 10 LB 4.5 KG wood: 6 LB 2.7 KG Carton weight: metal: 15 LB 6.8 KG wood: 10 LB 4.54 KG Carton volume: 1.4 FT³ 0.03 MT³</p>	GC3622TLCA (metal)	610	631	649	669	702	732	763	790	823	854	896	956
	GC3622WTLCA (wood)	430	451	469	489	522	552	583	610	643	674	716	776
Specify armcap: wood or urethane.		OVERALL DIMENSIONS			SEAT DIMENSIONS			BACK DIMENSIONS					
		W	D	H	W	D	H	W	H				
For linking guest and/or patient top seating units table on the left side of the frame.		IN 2.5	27	26.5	-	-	-	-	-				
		MM 64	686	673	-	-	-	-	-				
		RTA 00		1 per carton									
 <p>Center Frame, Closed Arm COM: 0.65 YD 0.59 M Unit weight: metal: 10 LB 4.5 KG wood: 6 LB 2.7 KG Carton weight: metal: 15 LB 6.8 KG wood: 10 LB 4.54 KG Carton volume: 1.4 FT³ 0.03 MT³</p>	GC3622TRCA (metal)	610	631	649	669	702	732	763	790	823	854	896	956
	GC3622WTRCA (wood)	430	451	469	489	522	552	583	610	643	674	716	776
Specify armcap: wood or urethane.		OVERALL DIMENSIONS			SEAT DIMENSIONS			BACK DIMENSIONS					
		W	D	H	W	D	H	W	H				
For linking guest and/or patient top seating units table on the right side of the frame.		IN 2.5	27	26.5	-	-	-	-	-				
		MM 64	686	673	-	-	-	-	-				
		RTA 00		1 per carton									
		List price											
 <p>Center Frame, Closed Arm, Laminate Panel COM: N/A Unit weight: 15 LB 6.8 KG Carton weight: 18 LB 8.16 KG Carton volume: 1.4 FT³ 0.03 MT³</p>	GC3622TLCAL (metal)	774											
	Specify armcap: wood or urethane.		OVERALL DIMENSIONS			SEAT DIMENSIONS			BACK DIMENSIONS				
		W	D	H	W	D	H	W	H				
For linking guest and/or patient top seating units table on the left side of the frame.		IN 2.5	27	26.5	-	-	-	-	-				
		MM 64	686	673	-	-	-	-	-				
		RTA 00		1 per carton									
		List price											
 <p>Center Frame, Closed Arm, Laminate Panel COM: N/A Unit weight: 15 LB 6.8 KG Carton weight: 18 LB 8.16 KG Carton volume: 1.4 FT³ 0.03 MT³</p>	GC3622TRCAL (metal)	774											
	Specify armcap: wood or urethane.		OVERALL DIMENSIONS			SEAT DIMENSIONS			BACK DIMENSIONS				
		W	D	H	W	D	H	W	H				
For linking guest and/or patient top seating units table on the right side of the frame.		IN 2.5	27	26.5	-	-	-	-	-				
		MM 64	686	673	-	-	-	-	-				
		RTA 00		1 per carton									

Modular tables:

Tops are 1" thick.

Wooden leg tables:

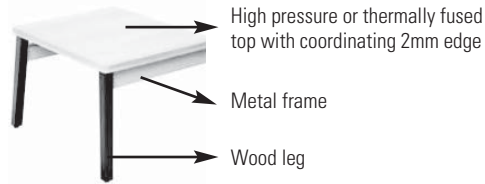

Metal leg tables:

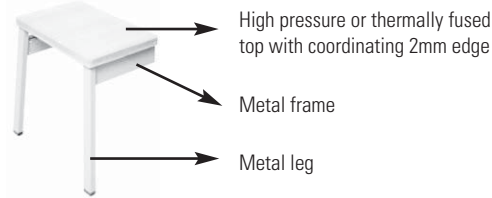

Table top finishes:

Thermally Fused Laminate (LP)

- Absolute Acajou (ACJ)
- Asian Night (ASN)
- Avant Cherry (AWC)
- Avant Honey (AWH)
- Black (BLK)
- Brushed Cobalt (BRC)
- Clear Maple (CMB)
- Dark Espresso (DES)
- Designer White (DWT)
- Fashionista (FAS)
- First Class (FCL)
- Quartered Mahogany (QTM)
- Noce Biondo (NBL)
- Noce Grigio (NGL)
- Noce Leggero (NEL)
- Noce Medio (NML)
- Sheer Beauty (SBY)
- Storm (SOG)
- Walnut Heights (WHE)
- White Chocolate (WHC)
- Winter Cherry (WCR)

High Pressure Laminate (HP)

- Absolute Acajou (ACJ)
- Asian Night (ASN)
- Avant Cherry (W357)
- Avant Honey (W356)
- Black (BLK)
- Brushed Cobalt (BRC)
- Clear Maple (CMB)
- Dark Espresso (W142)
- Designer White (DWT)
- Fashionista (FAS)
- First Class (FCL)
- Quartered Mahogany (QTM)
- Noce Biondo (NBL)
- Noce Grigio (NGL)
- Noce Leggero (NEL)
- Noce Medio (NML)
- Sheer Beauty (SBY)
- Storm (SOG)
- Walnut Heights (WHE)
- White Chocolate (WHC)
- Winter Cherry (WCR)

Wooden leg finishes (top, base, legs & apron):

- | | |
|--------------------------------|-------------------------------|
| Absolute (AAM) | Natural Walnut (NLW) |
| Charcoal Java on Maple (CJM) | Night (ASM) |
| Cherry on Maple (ACM) | Noce Biondo (NBM) |
| Empire Mahogany on Maple (EMM) | Noce Grigio (NGM) |
| English Oak on Maple (EOM) | Noce Leggero (NEM) |
| Medium Walnut on Maple (MWM) | Noce Medio (NMM) |
| Espresso Cafe on Maple (ECM) | Shaker Cherry on Maple (SKM) |
| Fruitwood on Maple (TFM) | Tiger Mahogany on Maple (TMM) |
| Gray (HGM) | Tiger Walnut on Maple (TWM) |
| Harvest Oak on Maple (HOM) | Winter Cherry on Maple (WCM) |
| Honey on Maple (AHM) | Sandy Beach on Maple (SBM) |
| Jet Onyx on Maple (JOM) | WC Cream (WTM) |
| Light Honey on Maple (LHM) | Silver Oak on Maple (SOM) |
| Maple on Maple (AVM) | White on Maple (WHM) |

Metal leg finishes:

Black (TBL), Cloud (TIV), Designer White (TDW), Fog (TFO), Frost (TFR), Kalua (TKA), Latte (TLA), Mocha (TMO), Nevada (TNE), Sand (TSN), Shadow (TSH), Toast (TOA) and Tungsten (TTU). Please specify.

Metal frame finishes:

Black (TBL), Cloud (TIV), Designer White (TDW), Fog (TFO), Frost (TFR), Kalua (TKA), Latte (TLA), Mocha (TMO), Nevada (TNE), Sand (TSN), Shadow (TSH), Toast (TOA) and Tungsten (TTU). Please specify.

Power/USB modules:

For modular tables with power/USB module, refer to models ending in "M". Power module includes two power outlets, four USB charging ports and a 6 foot long power cord. Available in Black or White (must be specified at time of order). Power module is mounted **on surface** on narrow tables; mounted **in surface** on larger tables.



On surface power module on narrow tables

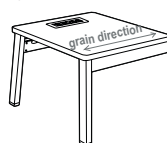

In surface power module on larger tables

MODULAR TABLES	MODEL #	DIMENSIONS ^{IN} _{MM}	WEIGHT ^{LB} _{KG}	VOLUME ^{FT³} _{MT³}	LIST PRICE
----------------	---------	---	---------------------------------------	---	------------

W x D x H

GC3671WL-LP	33 x 33 x 17 838 x 838 x 432	46 20.9	6 0.16	\$969
GC3671WLM-LP With power				\$1843
GC3671WL-HP	33 x 33 x 17 838 x 838 x 432	46 20.9	6 0.16	\$1040
GC3671WLM-HP With power				\$1910

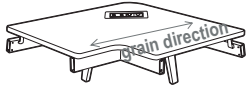

Left Corner Table, For Wood Frame

- For a thermally fused laminate top (LP), specify model GC3671WL-LP.
- For a high pressure laminate top (HP), specify model GC3671WL-HP.
- Models GC3671WLM-LP and GC3671WLM-HP have a **power/USB** module mounted in surface.

Coordinating 2mm edge. Must be connected to full arm and leg with **wood** frames (GC3622WTLA/WTRA, GC3622WTLCA/WTRCA). This table allows for kneespace when specifying chairs in a corner position. 1 per carton.

- Includes 2 rear wood legs.

GC3671L-LP	33 x 33 x 17 838 x 838 x 432	45 20.5	6 0.16	\$1142
GC3671LM-LP With power				\$2098
GC3671L-HP	33 x 33 x 17 838 x 838 x 432	46 20.9	6 0.16	\$1213
GC3671LM-HP With power				\$2175

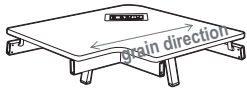

Left Corner Table, For Metal Frame

- For a thermally fused laminate top (LP), specify model GC3671L-LP.
- For a high pressure laminate top (HP), specify model GC3671L-HP.
- Models GC3671LM-LP and GC3671LM-HP have a **power/USB** module mounted in surface.

Coordinating 2mm edge. Must be connected to full arm and leg with **metal** frames (GC3622TLA/TRA, GC3622TLCA/TRCA). This table allows for kneespace when specifying chairs in a corner position. 1 per carton.

- Includes 2 rear metal legs.

GC3671WR-LP	33 x 33 x 17 838 x 838 x 432	46 20.9	6 0.16	\$969
GC3671WRM-LP With power				\$1843
GC3671WR-HP	33 x 33 x 17 838 x 838 x 432	46 20.9	6 0.16	\$1040
GC3671WRM-HP With power				\$1910



Right Corner Table, For Wood Frame

- For a thermally fused laminate top (LP), specify model GC3671WR-LP.
- For a high pressure laminate top (HP), specify model GC3671WR-HP.
- Models GC3671WRM-LP and GC3671WRM-HP have a **power/USB** module mounted in surface.

Coordinating 2mm edge. Must be connected to full arm and leg with **wood** frames (GC3622WTLA/WTRA, GC3622WTLCA/WTRCA). This table allows for kneespace when specifying chairs in a corner position. 1 per carton.

- Includes 2 rear wood legs.

MODULAR TABLES	MODEL #	DIMENSIONS ^{IN} _{MM}	WEIGHT ^{LB} _{KG}	VOLUME ^{FT³} _{MT³}	LIST PRICE
----------------	---------	---	---------------------------------------	---	------------



Right Corner Table, For Metal Frame

	W x D x H			
GC3671R-LP	33 x 33 x 17 838 x 838 x 432	46 20.9	6 0.16	\$1142
GC3671RM-LP With power				\$2098
GC3671R-HP	33 x 33 x 17 838 x 838 x 432	40 18.2	6 0.16	\$1213
GC3671RM-HP With power				\$2175

- For a thermally fused laminate top (LP), specify model GC3671R-LP.
- For a high pressure laminate top (HP), specify model GC3671R-HP.

- Models GC3671RM-LP and GC3671RM-HP have a **power/USB** module mounted in surface.

Coordinating 2mm edge. Must be connected to full arm and leg with **metal** frames (GC3622TLA/TRA, GC3622TLCA/TRCA). This table allows for kneespace when specifying chairs in a corner position. 1 per carton.

- Includes 2 rear metal legs (not shown).



Center Table

GC3672-LP	20.25 x 23.87 x 5.5 514 x 606 x 140	15 6.8	3.4 0.09	\$651
GC3672M-LP With power				\$1607
GC3672-HP	20.25 x 23.87 x 5.5 514 x 606 x 140	15 6.8	3.4 0.09	\$686
GC3672M-HP With power				\$1645

- For a thermally fused laminate top (LP), specify model GC3672-LP.
- For a high pressure laminate top (HP), specify model GC3672-HP.

- Models GC3672M-LP and GC3672M-HP have a **power/USB** module mounted in surface.

Coordinating 2mm edge. Regular center table for **wood** or **metal** (HT) frame. Must be connected to full arm and leg with **metal** or **wood** frames (GC3622TLA/TRA, GC3622TLCA/TRCA, GC3622WTLA/WTRA, GC3622WTLCA/WTRCA). 1 per carton.

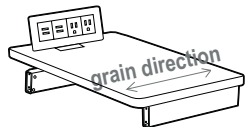

Narrow Center Table

GC3673-LP	12 x 23.87 x 5.5 305 x 606 x 140	14 6.4	2.1 0.05	\$633
GC3673M-LP With power				\$1592
GC3673-HP	12 x 23.87 x 5.5 305 x 606 x 140	14 6.4	2.1 0.05	\$667
GC3673M-HP With power				\$1628

- For a thermally fused laminate top (LP), specify model GC3673-LP.
- For a high pressure laminate top (HP), specify model GC3673-HP.

- Models GC3673M-LP and GC3673M-HP have a **power/USB** module mounted on surface.

Coordinating 2mm edge. Narrow center table for **wood** or **metal** (HT) frame. Must be connected to full arm and leg with **metal** or **wood** frames (GC3622TLA/TRA, GC3622TLCA/TRCA, GC3622WTLA/WTRA, GC3622WTLCA/WTRCA). 1 per carton.

MODULAR TABLES **MODEL #** **DIMENSIONS** ^{IN}/_{MM} **WEIGHT** ^{LB}/_{KG} **VOLUME** ^{FT³}/_{MT³} **LIST PRICE**

W x D x H

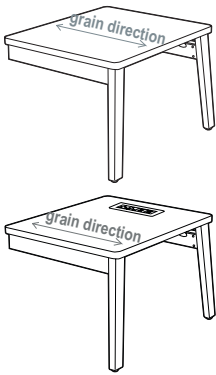

Left End Table, For Wood Frame

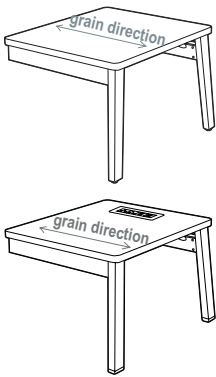

Left End Table, For Metal Frame

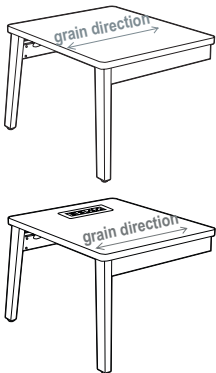

Right End Table, For Wood Frame

GC3674WL-LP	20.25 x 23.87 x 17 514 x 606 x 432	14 6.4	3.4 0.09	\$817
GC3674WLM-LP With power				\$1690
GC3674WL-HP	20.25 x 23.87 x 17 514 x 606 x 432	15 6.8	3.4 0.09	\$850
GC3674WLM-HP With power				\$1722

- For a thermally fused laminate top (LP), specify model GC3674WL-LP.
- For a high pressure laminate top (HP), specify model GC3674WL-HP.
- Models GC3674WLM-LP and GC3674WLM-HP have a **power/USB** module mounted in surface.

Coordinating 2mm edge. Must be connected to full arm and leg with **wood** frames (GC3622WTLA or GC3622WTLCA). 1 per carton.

GC3674L-LP	20.25 x 23.87 x 17 514 x 606 x 432	14 6.4	3.4 0.09	\$972
GC3674LM-LP With power				\$1931
GC3674L-HP	20.25 x 23.87 x 17 514 x 606 x 432	15 6.8	3.4 0.09	\$1009
GC3674LM-HP With power				\$1967

- For a thermally fused laminate top (LP), specify model GC3674L-LP.
- For a high pressure laminate top (HP), specify model GC3674L-HP.
- Models GC3674LM-LP and GC3674LM-HP have a **power/USB** module mounted in surface.

Coordinating 2mm edge. Must be connected to full arm and leg with **metal** frames (GC3622TLA or GC3622TLCA). 1 per carton.

GC3674WR-LP	20.25 x 23.87 x 17 514 x 606 x 432	14 6.4	3.4 0.09	\$817
GC3674WRM-LP With power				\$1690
GC3674WR-HP	20.25 x 23.87 x 17 514 x 606 x 432	15 6.8	3.4 0.09	\$850
GC3674WRM-HP With power				\$1722

- For a thermally fused laminate top (LP), specify model GC3674WR-LP.
- For a high pressure laminate top (HP), specify model GC3674WR-HP.
- Models GC3674WRM-LP and GC3674WRM-HP have a **power/USB** module mounted in surface.

Coordinating 2mm edge. Must be connected to full arm and leg with **wood** frames (GC3622WTRA or GC3622WTRCA). 1 per carton.

SEATING

PRIMACARE™ MODULAR - GUEST/PATIENT P

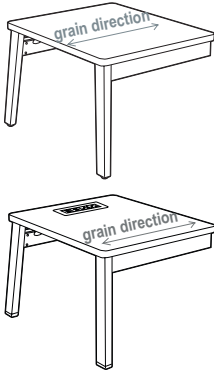
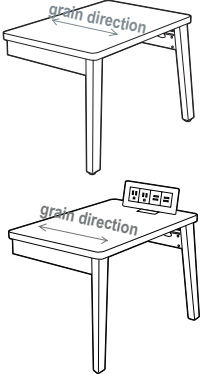
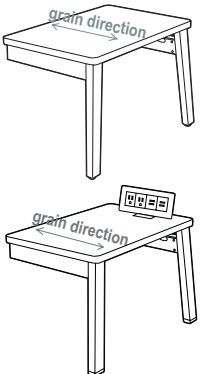
MODULAR TABLES	MODEL #	DIMENSIONS ^{IN} _{MM}	WEIGHT ^{LB} _{KG}	VOLUME ^{FT³} _{MT³}	LIST PRICE
 <p>Right End Table, For Metal Frame</p>	GC3674R-LP	20.25 x 23.87 x 17 514 x 606 x 432	14 6.4	3.4 0.09	\$972
	GC3674RM-LP With power				\$1931
	GC3674R-HP	20.25 x 23.87 x 17 514 x 606 x 432	15 6.8	3.4 0.09	\$1009
	GC3674RM-HP With power				\$1967
 <p>Narrow Left End Table, For Wood Frame</p>	GC3675WL-LP	12 x 23.87 x 17 305 x 606 x 432	14 6.4	2.1 0.05	\$802
	GC3675WLM-LP With power				\$1673
	GC3675WL-HP	12 x 23.87 x 17 305 x 606 x 432	14 6.4	2.1 0.05	\$835
	GC3675WLM-HP With power				\$1705
 <p>Narrow Left End Table, For Metal Frame</p>	GC3675L-LP	12 x 23.87 x 17 305 x 606 x 432	14 6.4	2.1 0.05	\$954
	GC3675LM-LP With power				\$1914
	GC3675L-HP	12 x 23.87 x 17 305 x 606 x 432	14 6.4	2.1 0.05	\$991
	GC3675LM-HP With power				\$1948

- For a thermally fused laminate top (LP), specify model GC3674R-LP.
- For a high pressure laminate top (HP), specify model GC3674R-HP.

- Models GC3674RM-LP and GC3674RM-HP have a **power/USB** module mounted in surface.

Coordinating 2mm edge. Must be connected to full arm and leg with **metal** frames (GC3622TRA or GC3622TRCA). 1 per carton.

- For a thermally fused laminate top (LP), specify model GC3675WL-LP.
- For a high pressure laminate top (HP), specify model GC3675WL-HP.

- Models GC3675WLM-LP and GC3675WLM-HP have a **power/USB** module mounted on surface.

Coordinating 2mm edge. Must be connected to full arm and leg with **wood** frames (GC3622WTLA or GC3622WTLCA). 1 per carton.

- For a thermally fused laminate top (LP), specify model GC3675L-LP.
- For a high pressure laminate top (HP), specify model GC3675L-HP.

- Models GC3675LM-LP and GC3675LM-HP have a **power/USB** module mounted on surface.

Coordinating 2mm edge. Must be connected to full arm and leg with **metal** frames (GC3622TLA or GC3622TLCA). 1 per carton.

MODULAR TABLES **MODEL #** **DIMENSIONS** ^{IN}/_{MM} **WEIGHT** ^{LB}/_{KG} **VOLUME** ^{FT³}/_{MT³} **LIST PRICE**

W x D x H

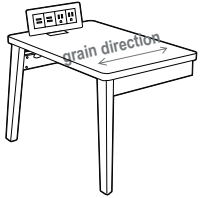
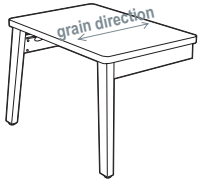

**Narrow Right End Table,
For Wood Frame**

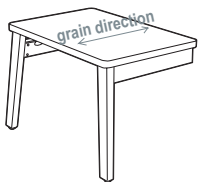

**Narrow Right End Table,
For Metal Frame**

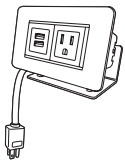

On Surface Power/Data Module

GC3675WR-LP	12 x 23.87 x 17 305 x 606 x 432	14 6.4	2.1 0.05	\$802
GC3675WRM-LP With power				\$1673
GC3675WR-HP	12 x 23.87 x 17 305 x 606 x 432	14 6.4	2.1 0.05	\$835
GC3675WRM-HP With power				\$1705

- For a thermally fused laminate top (LP), specify model GC3675WR-LP.
- For a high pressure laminate top (HP), specify model GC3675WR-HP.

- Models GC3675WRM-LP and GC3675WRM-HP have a **power/USB** module mounted on surface.

Coordinating 2mm edge. Must be connected to full arm and leg with **wood** frames (GC3622WTRA or GC3622WTRCA).
1 per carton.

GC3675R-LP	12 x 23.87 x 17 305 x 606 x 432	14 6.4	2.1 0.05	\$954
GC3675RM-LP With power				\$1914
GC3675R-HP	12 x 23.87 x 17 305 x 606 x 432	14 6.4	2.1 0.05	\$991
GC3675RM-HP With power				\$1948

- For a thermally fused laminate top (LP), specify model GC3675R-LP.
- For a high pressure laminate top (HP), specify model GC3675R-HP.

- Models GC3675RM-LP and GC3675RM-HP have a **power/USB** module mounted on surface.









Coordinating 2mm edge. Must be connected to full arm and leg with **metal** frames (GC3622TRA or GC3622TRCA).
1 per carton.

GC36410	- x - x - - x - x -	2 0.9	1 0.02	\$568
---------	------------------------	----------	-----------	--------------

Surface top mount power/data module with one power outlet and two USB charging ports. 6 foot cord. White.
Can be mounted on all freestanding and modular tables.

MODULAR TOP UNITS















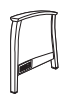

















FOR MODULAR LOUNGE AND FULLY UPHOLSTERED LOUNGE

	SINGLE SEAT	BARIATRIC	TWO SEATER	THREE SEATER
Lounge Seating	GC3641TOP 	GC3640TOP 	GC3642TOP 	GC3643TOP 
High Back Lounge Seating	GC3676HBTOP 	GC3679HBTOP 	GC3677HBTOP 	GC3678HBTOP 

LEG / ARM FRAMES

FOR MODULAR LOUNGE

Metal frame: Standard with Black urethane armcap (see notes for wood and urethane finish options) | Wood frame: Must select



	LEFT, OPEN	RIGHT, OPEN	LEFT, CLOSED	RIGHT, CLOSED	LEFT, CLOSED LAMINATE PANEL	RIGHT, CLOSED LAMINATE PANEL				
Metal (HT) End	GC3641LA 	GC3641LAM 	GC3641RA 	GC3641RAM 	GC3641LCA 	GC3641LCAM 	GC3641RCA 	GC3641RCAM 	GC3641LCAL 	GC3641RCAL 
Wood End	GC3641WLA 	GC3641WLAM 	GC3641WRA 	GC3641WRAM 	GC3641WLCA 	GC3641WLCAM 	GC3641WRCA 	GC3641WRCAM 		
Metal (HT) Center	GC36406LA 			GC36406LCA 					GC36406LCAL 	
Wood, Center	GC36406WLA 			GC36406WLCA 						
Metal (HT) Center table linking	GC36406TLA 	GC3622TRA 	GC36406TLCA 	GC36406TRCA 	GC36406TLCAL 	GC36406TRCAL 				
Wood Center table linking	GC36406WTLA 	GC3622WTRA 	GC36406WTLCA 	GC36406WTRCA 						

For frame with power/USB module*, add "M" after model number

LEG / ARM FRAMES

FOR FULLY UPHOLSTERED MODULAR LOUNGE

Standard with Black urethane legs (see notes for wood and urethane finish options)
Optional armcap in wood or urethane (cannot be retrofitted in the field if the frame is ordered without armcap)

Fully Upholstered End	LEFT GC3676LA 	RIGHT GC3676RA 
Fully Upholstered Center	GC3676CFA 	

(Center = link both sides)

*Power module includes two power outlets, four USB charging ports and a 6 foot long power cord.
Available in Black or White (must be specified at time of order). Power module is mounted on the frame below seat support rail.

MODULAR TABLES FOR MODULAR LOUNGE AND FULLY UPHOLSTERED LOUNGE

Tables include legs to support table top (except for center tables). All tables have a metal frame.

LEFT

RIGHT

Corner
(laminated top with metal legs)

GC36403L-HP
GC36403L-LP

GC36403LM-HP
GC36403LM-LP

GC36403R-HP
GC36403R-LP

GC36403RM-HP
GC36403RM-LP



Corner
(laminated top with wood legs)

GC36403WL-HP
GC36403WL-LP

GC36403WLM-HP
GC36403WLM-LP

GC36403WR-HP
GC36403WR-LP

GC36403WRM-HP
GC36403WRM-LP

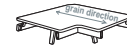

Center
(laminated top, connects to metal or wood frame)

GC36401-HP
GC36401-LP

GC36401M-HP
GC36401M-LP



Narrow Center
(laminated top, connects to metal or wood frame)

GC36402-HP
GC36402-LP

GC36402M-HP
GC36402M-LP



For table with power/USB module*, refer to models ending in "M"

End
(laminated top with metal legs)

GC36404L-HP
GC36404L-LP

GC36404LM-HP
GC36404LM-LP

GC36404R-HP
GC36404R-LP

GC36404RM-HP
GC36404RM-LP

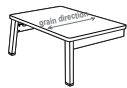

End
(laminated top with wood legs)

GC36404WL-HP
GC36404WL-LP

GC36404WLM-HP
GC36404WLM-LP

GC36404WR-HP
GC36404WR-LP

GC36404WRM-HP
GC36404WRM-LP



Narrow End
(laminated top with metal legs)

GC36405L-HP
GC36405L-LP

GC36405LM-HP
GC36405LM-LP

GC36405R-HP
GC36405R-LP

GC36405RM-HP
GC36405RM-LP

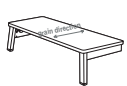
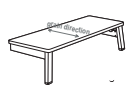

Narrow End
(laminated top with wood legs)

GC36405WL-HP
GC36405WL-LP

GC36405WLM-HP
GC36405WLM-LP

GC36405WR-HP
GC36405WR-LP

GC36405WRM-HP
GC36405WRM-LP

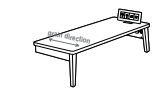
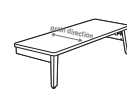

* Power module includes two power outlets, four USB charging ports and a 6 foot long power cord. Available in Black or White (must be specified at time of order). Power module is mounted **on surface** on narrow tables; mounted **in surface** on larger tables (as shown above).

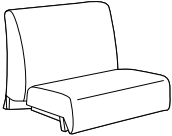
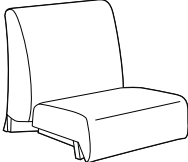
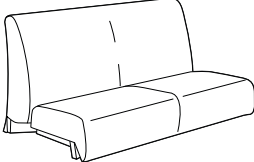
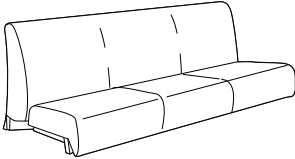
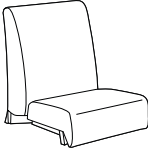
DESCRIPTION	MODEL# / FEATURES	STANDARD TEXTILE GRADES											
		COM	2	3	4	5	6	7	8	9	10	11	12
 <p>Lounge Bariatric Top COM: 3.25 YD 2.97 M Unit weight: 85 LB 38.6 KG Carton weight: 97 LB 44 KG Carton volume: 49.5 FT³ 1.4 MT³</p>	GC3640TOP	1654	1758	1846	1947	2112	2265	2418	2551	2717	2873	3084	3383
	Active weight: 500 lbs.	OVERALL DIMENSIONS			SEAT DIMENSIONS			BACK DIMENSIONS					
		W	D	H	W	D	H	W	H				
	Single frame lounge top unit with 1 back and 1 seat cushion.	IN 36	32	25	36	20	-	36	16				
	MM 914	813	635	914	508	-	914	406					
Must be connected to a full arm/leg frame.	RTA 00	1 per carton											
 <p>Lounge Single Seater Top COM: 2.5 YD 2.29 M Unit weight: 54 LB 24.5 KG Carton weight: 66 LB 29.9 KG Carton volume: 29.5 FT³ 0.83 MT³</p>	GC3641TOP	1099	1179	1247	1324	1452	1569	1687	1789	1917	2037	2199	2429
	Active weight: see notes.	OVERALL DIMENSIONS			SEAT DIMENSIONS			BACK DIMENSIONS					
		W	D	H	W	D	H	W	H				
	Single frame lounge top unit with 1 back and 1 seat cushion.	IN 25	32	25	23	20	-	22.5	16				
	MM 635	813	635	584	508	-	572	406					
Must be connected to a full arm/leg frame.	RTA 00	1 per carton											
 <p>Lounge Two Seater Top COM: 4 YD 3.66 M Unit weight: 95 LB 43.2 KG Carton weight: 110 LB 49.9 KG Carton volume: 49.5 FT³ 1.4 MT³</p>	GC3642TOP	1933	2061	2169	2293	2497	2685	2873	3037	3241	3433	3693	4061
	Active weight: see notes.	OVERALL DIMENSIONS			SEAT DIMENSIONS			BACK DIMENSIONS					
		W	D	H	W	D	H	W	H				
	Double frame lounge top unit with 2 back and 2 seat cushions.	IN 48	32	25	48	20	-	48	16				
	MM 1219	813	635	1219	508	-	1219	406					
Must be connected to a full arm/leg frame.	RTA 00	1 per carton											
 <p>Lounge Three Seater Top COM: 6.25 YD 5.72 M Unit weight: 136 LB 61.8 KG Carton weight: 161 LB 73.03 KG Carton volume: 69.5 FT³ 1.96 MT³</p>	GC3643TOP	2785	2985	3154	3348	3666	3960	4254	4510	4829	5129	5535	6110
	Due to the size and weight, this top requires at least 3 installers.												
	Active weight: see notes.	OVERALL DIMENSIONS			SEAT DIMENSIONS			BACK DIMENSIONS					
		W	D	H	W	D	H	W	H				
Triple frame lounge top guest top, 3 back and 3 seat cushions.	IN 71	32	25	71	20	-	71	16					
	MM 1803	813	635	1803	508	-	1803	406					
Must be connected to a full arm/leg frame.	RTA 00	1 per carton											
 <p>HB Lounge Single Seater Top COM: 6.5 YD 5.94 M Unit weight: metal: 72 LB 32.7 KG Carton weight: metal: 92 LB 41.73 KG Carton volume: 29.5 FT³ 0.83 MT³</p>	GC3676HB-TOP	1244	1452	1628	1829	2161	2466	2772	3038	3370	3682	4104	4702
	Active weight: see notes.	OVERALL DIMENSIONS			SEAT DIMENSIONS			BACK DIMENSIONS					
		W	D	H	W	D	H	W	H				
	Single high back frame lounge top, 1 back and 1 seat cushion.	IN 23	29	36	23	20	-	23	19				
	MM 584	737	914	584	508	-	584	483					
Must be connected to a full arm/leg frame.	RTA 00	1 per carton											

DESCRIPTION MODEL# / FEATURES STANDARD TEXTILE GRADES

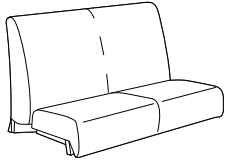

HB Lounge Two Seater Top
 COM: 7.75 YD | 7.09 M
 Unit weight: 97 LB | 44.1 KG
 Carton weight: 117 LB | 53.07 KG
 Carton volume: 56.25 FT³ | 1.59 MT³

GC3677HB-TOP

COM	2	3	4	5	6	7	8	9	10	11	12
2329	2577	2786	3027	3422	3786	4150	4468	4863	5235	5739	6452

Active weight: see notes.

Double high back frame lounge top, 1 back and 1 seat cushion.

Must be connected to a full arm/leg frame.

	OVERALL DIMENSIONS			SEAT DIMENSIONS			BACK DIMENSIONS				
	W	D	H	W	D	H	W	H			
IN	45.5	29	36	45.5	20	-	45.5	19			
MM	1156	737	914	1156	508	-	1156	483			
RTA 00		1 per carton									

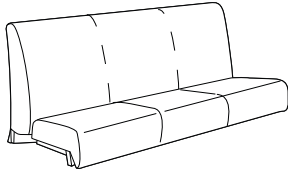

HB Lounge Three Seater Top
 COM: 9.25 YD | 8.46 M
 Unit weight: 133 LB | 60.5 KG
 Carton weight: 158 LB | 71.67 KG
 Carton volume: 69.5 FT³ | 1.96 MT³

GC3678HB-TOP

COM	2	3	4	5	6	7	8	9	10	11	12
3450	3746	3996	4283	4754	5189	5624	6003	6475	6919	7520	8371

Active weight: see notes.

Triple high back frame lounge top, 1 back and 1 seat cushion.

Must be connected to a full arm/leg frame.

	OVERALL DIMENSIONS			SEAT DIMENSIONS			BACK DIMENSIONS				
	W	D	H	W	D	H	W	H			
IN	68.5	29	36	68.5	20	-	71	19			
MM	1740	737	914	1740	508	-	1803	483			
RTA 00		1 per carton									

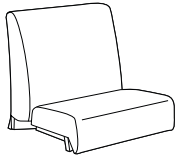

HB Lounge Bariatric Top
 COM: 6.75 YD | 6.17 M
 Unit weight: 80 LB | 36.4 KG
 Carton weight: 96 LB | 43.54 KG
 Carton volume: 37.75 FT³ | 1.06 MT³

GC3679HB-TOP



COM	2	3	4	5	6	7	8	9	10	11	12
1922	2138	2320	2530	2874	3191	3508	3785	4129	4453	4892	5513



Active weight: see notes.

Single high back frame bariatric lounge top, 1 back and 1 seat cushion.

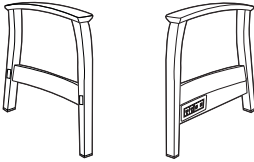

Must be connected to a full arm/leg frame.

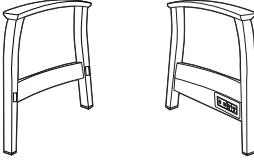

	OVERALL DIMENSIONS			SEAT DIMENSIONS			BACK DIMENSIONS				
	W	D	H	W	D	H	W	H			
IN	32	29	36	32	20	-	32	19			
MM	813	737	914	813	508	-	813	483			
RTA 00		1 per carton									

DESCRIPTION	MODEL# / FEATURES	STANDARD TEXTILE GRADES																																			
	List price																																				
	GC3641LA (metal) 545 GC3641LAM (w/power) 1568 GC3641WLA (wood) 375 GC3641WLAM (w/power) 1304																																				
Lounge Left End Frame, Open Arm COM: N/A Unit weight: metal: 7 LB 3.2 KG wood: 7 LB 3.2 KG Carton weight: metal: 9.67 LB 4.39 KG wood: 11 LB 4.99 KG Carton volume: 2.1 FT³ 0.05 MT³	Specify armcap: wood or urethane.	<table border="1"> <thead> <tr> <th rowspan="2"></th> <th colspan="3">OVERALL DIMENSIONS</th> <th colspan="3">SEAT DIMENSIONS</th> <th colspan="2">BACK DIMENSIONS</th> </tr> <tr> <th>W</th> <th>D</th> <th>H</th> <th>W</th> <th>D</th> <th>H</th> <th>W</th> <th>H</th> </tr> </thead> <tbody> <tr> <td>For use in left side finished position of lounge seating units.</td> <td>IN 3.5</td> <td>29</td> <td>25.25</td> <td>-</td> <td>-</td> <td>-</td> <td>-</td> <td>-</td> </tr> <tr> <td></td> <td>MM 89</td> <td>737</td> <td>641</td> <td>-</td> <td>-</td> <td>-</td> <td>-</td> <td>-</td> </tr> </tbody> </table>		OVERALL DIMENSIONS			SEAT DIMENSIONS			BACK DIMENSIONS		W	D	H	W	D	H	W	H	For use in left side finished position of lounge seating units.	IN 3.5	29	25.25	-	-	-	-	-		MM 89	737	641	-	-	-	-	-
	OVERALL DIMENSIONS			SEAT DIMENSIONS			BACK DIMENSIONS																														
	W	D	H	W	D	H	W	H																													
For use in left side finished position of lounge seating units.	IN 3.5	29	25.25	-	-	-	-	-																													
	MM 89	737	641	-	-	-	-	-																													
	Does not allow linking to other units or tables.	RTA 1  1 per carton																																			

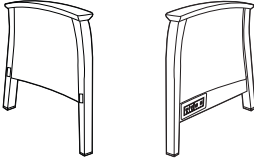
	List price																																				
	GC3641RA (metal) 545 GC3641RAM (w/power) 1568 GC3641WRA (wood) 375 GC3641WRAM (w/power) 1304																																				
Lounge Right End Frame, Open Arm COM: N/A Unit weight: metal: 7 LB 3.2 KG wood: 7 LB 3.2 KG Carton weight: metal: 9.67 LB 4.39 KG wood: 11 LB 4.99 KG Carton volume: 2.1 FT³ 0.05 MT³	Specify armcap: wood or urethane.	<table border="1"> <thead> <tr> <th rowspan="2"></th> <th colspan="3">OVERALL DIMENSIONS</th> <th colspan="3">SEAT DIMENSIONS</th> <th colspan="2">BACK DIMENSIONS</th> </tr> <tr> <th>W</th> <th>D</th> <th>H</th> <th>W</th> <th>D</th> <th>H</th> <th>W</th> <th>H</th> </tr> </thead> <tbody> <tr> <td>For use in right side finished position of lounge seating units.</td> <td>IN 3.5</td> <td>29</td> <td>25.25</td> <td>-</td> <td>-</td> <td>-</td> <td>-</td> <td>-</td> </tr> <tr> <td></td> <td>MM 89</td> <td>737</td> <td>641</td> <td>-</td> <td>-</td> <td>-</td> <td>-</td> <td>-</td> </tr> </tbody> </table>		OVERALL DIMENSIONS			SEAT DIMENSIONS			BACK DIMENSIONS		W	D	H	W	D	H	W	H	For use in right side finished position of lounge seating units.	IN 3.5	29	25.25	-	-	-	-	-		MM 89	737	641	-	-	-	-	-
	OVERALL DIMENSIONS			SEAT DIMENSIONS			BACK DIMENSIONS																														
	W	D	H	W	D	H	W	H																													
For use in right side finished position of lounge seating units.	IN 3.5	29	25.25	-	-	-	-	-																													
	MM 89	737	641	-	-	-	-	-																													
	Does not allow linking to other units or tables.	RTA 1  1 per carton																																			

	COM	2	3	4	5	6	7	8	9	10	11	12
GC3641LCA (metal)	722	746	766	790	828	863	898	929	967	1003	1052	1121
GC3641LCAM (w/power)	1742	1766	1786	1810	1848	1883	1918	1949	1987	2023	2072	2141
GC3641WLCA (wood)	504	536	563	594	645	692	739	780	831	879	944	1036
GC3641WLCAM (w/power)	1430	1462	1489	1520	1571	1618	1665	1706	1757	1805	1870	1962

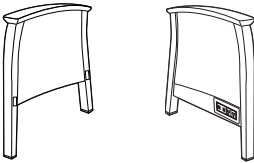
	List price																																				
	GC3641LCA (metal) 722 GC3641LCAM (w/power) 1742 GC3641WLCA (wood) 504 GC3641WLCAM (w/power) 1430																																				
Lounge Left End Frame, Closed Arm COM: 0.75 YD 0.69 M Unit weight: metal: 7 LB 3.2 KG wood: 7 LB 3.2 KG Carton weight: metal: 16.3 LB 7.39 KG wood: 11 LB 4.99 KG Carton volume: 2.1 FT³ 0.05 MT³	Specify armcap: wood or urethane.	<table border="1"> <thead> <tr> <th rowspan="2"></th> <th colspan="3">OVERALL DIMENSIONS</th> <th colspan="3">SEAT DIMENSIONS</th> <th colspan="2">BACK DIMENSIONS</th> </tr> <tr> <th>W</th> <th>D</th> <th>H</th> <th>W</th> <th>D</th> <th>H</th> <th>W</th> <th>H</th> </tr> </thead> <tbody> <tr> <td>For use in left side finished position of lounge seating units.</td> <td>IN 3.5</td> <td>29</td> <td>25.25</td> <td>-</td> <td>-</td> <td>-</td> <td>-</td> <td>-</td> </tr> <tr> <td></td> <td>MM 89</td> <td>737</td> <td>641</td> <td>-</td> <td>-</td> <td>-</td> <td>-</td> <td>-</td> </tr> </tbody> </table>		OVERALL DIMENSIONS			SEAT DIMENSIONS			BACK DIMENSIONS		W	D	H	W	D	H	W	H	For use in left side finished position of lounge seating units.	IN 3.5	29	25.25	-	-	-	-	-		MM 89	737	641	-	-	-	-	-
	OVERALL DIMENSIONS			SEAT DIMENSIONS			BACK DIMENSIONS																														
	W	D	H	W	D	H	W	H																													
For use in left side finished position of lounge seating units.	IN 3.5	29	25.25	-	-	-	-	-																													
	MM 89	737	641	-	-	-	-	-																													
	Does not allow linking to other units or tables.	RTA 1  1 per carton																																			

	List price																																				
	GC3641RCA (metal) 722 GC3641RCAM (w/power) 1742 GC3641WRCA (wood) 504 GC3641WRCAM (w/power) 1430																																				
Lounge Right End Frame, Closed Arm COM: 0.75 YD 0.69 M Unit weight: metal: 7 LB 3.2 KG wood: 7 LB 3.2 KG Carton weight: metal: 16.3 LB 7.39 KG wood: 11 LB 4.99 KG Carton volume: 2.1 FT³ 0.05 MT³	Specify armcap: wood or urethane.	<table border="1"> <thead> <tr> <th rowspan="2"></th> <th colspan="3">OVERALL DIMENSIONS</th> <th colspan="3">SEAT DIMENSIONS</th> <th colspan="2">BACK DIMENSIONS</th> </tr> <tr> <th>W</th> <th>D</th> <th>H</th> <th>W</th> <th>D</th> <th>H</th> <th>W</th> <th>H</th> </tr> </thead> <tbody> <tr> <td>For use in right side finished position of lounge seating units.</td> <td>IN 3.5</td> <td>29</td> <td>25.25</td> <td>-</td> <td>-</td> <td>-</td> <td>-</td> <td>-</td> </tr> <tr> <td></td> <td>MM 89</td> <td>737</td> <td>641</td> <td>-</td> <td>-</td> <td>-</td> <td>-</td> <td>-</td> </tr> </tbody> </table>		OVERALL DIMENSIONS			SEAT DIMENSIONS			BACK DIMENSIONS		W	D	H	W	D	H	W	H	For use in right side finished position of lounge seating units.	IN 3.5	29	25.25	-	-	-	-	-		MM 89	737	641	-	-	-	-	-
	OVERALL DIMENSIONS			SEAT DIMENSIONS			BACK DIMENSIONS																														
	W	D	H	W	D	H	W	H																													
For use in right side finished position of lounge seating units.	IN 3.5	29	25.25	-	-	-	-	-																													
	MM 89	737	641	-	-	-	-	-																													
	Does not allow linking to other units or tables.	RTA 1  1 per carton																																			

DESCRIPTION MODEL# / FEATURES STANDARD TEXTILE GRADES

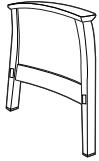

Lounge Left End Frame, Closed Arm, Laminate Panel
 COM: N/A
 Unit weight: 15 LB | 6.8 KG
 Carton weight: 18 LB | 8.16 KG
 Carton volume: 2.1 FT³ | 0.05 MT³

List price
GC3641LCAL (metal) 886

Specify armcap:
 wood or urethane.

For use in **left** side finished position of lounge seating units.
Does not allow linking to other units or tables.

OVERALL DIMENSIONS			SEAT DIMENSIONS			BACK DIMENSIONS	
W	D	H	W	D	H	W	H
IN 3.5	29	25.25	-	-	-	-	-
MM 89	737	641	-	-	-	-	-

RTA 1 1 per carton

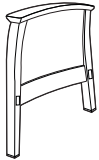

Lounge Right End Frame, Closed Arm, Laminate Panel
 COM: N/A
 Unit weight: 15 LB | 6.8 KG
 Carton weight: 18 LB | 8.16 KG
 Carton volume: 2.1 FT³ | 0.05 MT³

List price
GC3641RCAL (metal) 886

Specify armcap:
 wood or urethane.

For use in **right** side finished position of lounge seating units.
Does not allow linking to other units or tables.

OVERALL DIMENSIONS			SEAT DIMENSIONS			BACK DIMENSIONS	
W	D	H	W	D	H	W	H
IN 3.5	29	25.25	-	-	-	-	-
MM 89	737	641	-	-	-	-	-

RTA 1 1 per carton

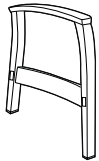

Lounge Center Frame, Open Arm
 COM: N/A
 Unit weight: metal: 7 LB | 3.2 KG | wood: 7 LB | 3.2 KG
 Carton weight: metal: 11 LB | 4.99 KG | wood: 11 LB | 4.99 KG
 Carton volume: 2.1 FT³ | 0.05 MT³

List price
GC36406LA (metal) 545
GC36406WLA (wood) 375

Specify armcap:
 wood or urethane.

For **linking** lounge top seating units together only.

OVERALL DIMENSIONS			SEAT DIMENSIONS			BACK DIMENSIONS	
W	D	H	W	D	H	W	H
IN 3.5	29	25.25	-	-	-	-	-
MM 89	737	641	-	-	-	-	-

RTA 1 1 per carton

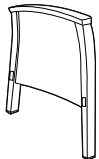

Lounge Center Frame, Closed Arm
 COM: 0.75 YD | 0.69 M
 Unit weight: metal: 7 LB | 3.2 KG | wood: 7 LB | 3.2 KG
 Carton weight: metal: 8.87 LB | 4.02 KG | wood: 11 LB | 4.99 KG
 Carton volume: 2.1 FT³ | 0.05 MT³

COM	2	3	4	5	6	7	8	9	10	11	12	
GC36406LCA (metal)	722	746	766	790	828	863	898	929	967	1003	1052	1121
GC36406WLCA (wood)	504	536	563	594	645	692	739	780	831	879	944	1036

Specify armcap:
 wood or urethane.

For **linking** lounge top seating units together only.

OVERALL DIMENSIONS			SEAT DIMENSIONS			BACK DIMENSIONS	
W	D	H	W	D	H	W	H
IN 3.5	29	25.25	-	-	-	-	-
MM 89	737	641	-	-	-	-	-

RTA 1 1 per carton

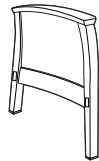

Lounge Center Frame, Closed Arm, Laminate Panel
 COM: N/A
 Unit weight: 15 LB | 6.8 KG
 Carton weight: 18 LB | 8.16 KG
 Carton volume: 2.1 FT³ | 0.05 MT³

List price
GC36406LCAL (metal) 886

Specify armcap:
 wood or urethane.

For **linking** lounge top seating units together only.

OVERALL DIMENSIONS			SEAT DIMENSIONS			BACK DIMENSIONS	
W	D	H	W	D	H	W	H
IN 3.5	29	25.25	-	-	-	-	-
MM 89	737	641	-	-	-	-	-

RTA 1 1 per carton

DESCRIPTION MODEL# / FEATURES STANDARD TEXTILE GRADES

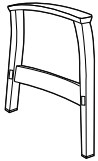

Lounge Center Frame, Open Arm

COM: N/A
 Unit weight: metal: 7 LB | 3.2 KG | wood: 7 LB | 3.2 KG
 Carton weight: metal: 11 LB | 4.99 KG | wood: 11 LB | 4.99 KG
 Carton volume: 2.1 FT³ | 0.05 MT³

List price											
GC36406TLA (metal)	545	OVERALL DIMENSIONS			SEAT DIMENSIONS			BACK DIMENSIONS			
GC36406WTLA (wood)	375	W	D	H	W	D	H	W	H		
Specify armcap: wood or urethane.		IN	3.5	29	25.25	-	-	-	-	-	-
For linking lounge top seating units to modular table on the left side of the frame.		MM	89	737	641	-	-	-	-	-	-
		RTA 1				1 per carton					

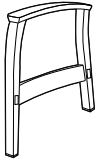

Lounge Center Frame, Open Arm

COM: N/A
 Unit weight: metal: 7 LB | 3.2 KG | wood: 7 LB | 3.2 KG
 Carton weight: metal: 2.24 LB | 1.02 KG | wood: 11 LB | 4.99 KG
 Carton volume: 2.1 FT³ | 0.05 MT³

List price											
GC36406TRA (metal)	545	OVERALL DIMENSIONS			SEAT DIMENSIONS			BACK DIMENSIONS			
GC36406WTRA (wood)	375	W	D	H	W	D	H	W	H		
Specify armcap: wood or urethane.		IN	3.5	29	25.25	-	-	-	-	-	-
For linking lounge top seating units to modular table on the right side of the frame.		MM	89	737	641	-	-	-	-	-	-
		RTA 1				1 per carton					

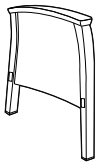

Lounge Center Frame, Closed Arm

COM: 0.75 YD | 0.69 M
 Unit weight: metal: 7 LB | 3.2 KG | wood: 7 LB | 3.2 KG
 Carton weight: metal: 8.87 LB | 4.02 KG | wood: 11 LB | 4.99 KG
 Carton volume: 2.1 FT³ | 0.05 MT³

COM	2	3	4	5	6	7	8	9	10	11	12	
GC36406TLCA (metal)	722	746	766	790	828	863	898	929	967	1003	1052	1121
GC36406WTLCA (wood)	504	536	563	594	645	692	739	780	831	879	944	1036

Specify armcap: wood or urethane.		OVERALL DIMENSIONS			SEAT DIMENSIONS			BACK DIMENSIONS			
		W	D	H	W	D	H	W	H		
IN	3.5	29	25.25	-	-	-	-	-	-		
MM	89	737	641	-	-	-	-	-	-		
		RTA 1				1 per carton					

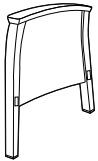

Lounge Center Frame, Closed Arm

COM: 0.75 YD | 0.69 M
 Unit weight: metal: 7 LB | 3.2 KG | wood: 7 LB | 3.2 KG
 Carton weight: metal: 11 LB | 4.99 KG | wood: 11 LB | 4.99 KG
 Carton volume: 2.1 FT³ | 0.05 MT³

COM	2	3	4	5	6	7	8	9	10	11	12	
GC36406TRCA (metal)	722	746	766	790	828	863	898	929	967	1003	1052	1121
GC36406WTRCA (wood)	504	536	563	594	645	692	739	780	831	879	944	1036

Specify armcap: wood or urethane.		OVERALL DIMENSIONS			SEAT DIMENSIONS			BACK DIMENSIONS			
		W	D	H	W	D	H	W	H		
IN	3.5	29	25.25	-	-	-	-	-	-		
MM	89	737	641	-	-	-	-	-	-		
		RTA 1				1 per carton					

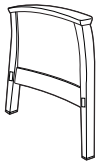

Lounge Center Frame, Closed Arm, Laminate Panel

COM: N/A
 Unit weight: 15 LB | 6.8 KG
 Carton weight: 18 LB | 8.16 KG
 Carton volume: 2.1 FT³ | 0.05 MT³

List price											
GC36406TLCAL (metal)	886	OVERALL DIMENSIONS			SEAT DIMENSIONS			BACK DIMENSIONS			
		W	D	H	W	D	H	W	H		
Specify armcap: wood or urethane.		IN	3.5	29	25.25	-	-	-	-	-	-
For linking lounge top seating units to modular table on the left side of the frame.		MM	89	737	641	-	-	-	-	-	-
		RTA 1				1 per carton					



Lounge Center Frame, Closed Arm, Laminate Panel

COM: N/A
 Unit weight: 15 LB | 6.8 KG
 Carton weight: 18 LB | 8.16 KG
 Carton volume: 2.1 FT³ | 0.05 MT³

List price											
GC36406TRCAL (metal)	886	OVERALL DIMENSIONS			SEAT DIMENSIONS			BACK DIMENSIONS			
		W	D	H	W	D	H	W	H		
Specify armcap: wood or urethane.		IN	3.5	29	25.25	-	-	-	-	-	-
For linking lounge top seating units to modular table on the right side of the frame.		MM	89	737	641	-	-	-	-	-	-
		RTA 1				1 per carton					

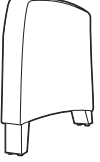
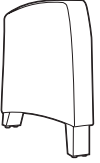
DESCRIPTION	MODEL# / FEATURES		STANDARD TEXTILE GRADES																																													
	COM	2	3	4	5	6	7	8	9	10	11	12																																				
 <p>Center Frame, Fully Upholstered Arm COM: 1.75 YD 1.6 M Unit weight: metal: 15 LB 6.8 KG Carton weight: metal: 35 LB 15.88 KG Carton volume: 6 FT³ 0.16 MT³</p>	GC3676CFA	440	496	543	598	687	769	851	923	1012	1096	1210	1371																																			
	Specify leg finish: wood or urethane.																																															
	Optional wood or urethane armcap. Please specify. Add \$142.																																															
	<table border="1"> <thead> <tr> <th colspan="3">OVERALL DIMENSIONS</th> <th colspan="3">SEAT DIMENSIONS</th> <th colspan="3">BACK DIMENSIONS</th> </tr> <tr> <th>W</th> <th>D</th> <th>H</th> <th>W</th> <th>D</th> <th>H</th> <th>W</th> <th>H</th> <th></th> </tr> </thead> <tbody> <tr> <td>IN 5</td> <td>29</td> <td>25.25</td> <td>-</td> <td>-</td> <td>-</td> <td>-</td> <td>-</td> <td>-</td> </tr> <tr> <td>MM 127</td> <td>737</td> <td>641</td> <td>-</td> <td>-</td> <td>-</td> <td>-</td> <td>-</td> <td>-</td> </tr> </tbody> </table> <p>For linking lounge top seating units together or to modular table.</p> <p>RTA 00 1 per carton</p>													OVERALL DIMENSIONS			SEAT DIMENSIONS			BACK DIMENSIONS			W	D	H	W	D	H	W	H		IN 5	29	25.25	-	-	-	-	-	-	MM 127	737	641	-	-	-	-	-
OVERALL DIMENSIONS			SEAT DIMENSIONS			BACK DIMENSIONS																																										
W	D	H	W	D	H	W	H																																									
IN 5	29	25.25	-	-	-	-	-	-																																								
MM 127	737	641	-	-	-	-	-	-																																								
 <p>Left End Frame, Fully Upholstered Arm COM: 1.75 YD 1.6 M Unit weight: metal: 15 LB 6.8 KG Carton weight: metal: 20 LB 9.07 KG Carton volume: 6 FT³ 0.16 MT³</p>	GC3676LA	440	496	543	598	687	769	851	923	1012	1096	1210	1371																																			
	Specify leg finish: wood or urethane.																																															
	Optional wood or urethane armcap. Please specify. Add \$142.																																															
	<table border="1"> <thead> <tr> <th colspan="3">OVERALL DIMENSIONS</th> <th colspan="3">SEAT DIMENSIONS</th> <th colspan="3">BACK DIMENSIONS</th> </tr> <tr> <th>W</th> <th>D</th> <th>H</th> <th>W</th> <th>D</th> <th>H</th> <th>W</th> <th>H</th> <th></th> </tr> </thead> <tbody> <tr> <td>IN 5</td> <td>29</td> <td>25.25</td> <td>-</td> <td>-</td> <td>-</td> <td>-</td> <td>-</td> <td>-</td> </tr> <tr> <td>MM 127</td> <td>737</td> <td>641</td> <td>-</td> <td>-</td> <td>-</td> <td>-</td> <td>-</td> <td>-</td> </tr> </tbody> </table> <p>For use in left side finished position of lounge seating units. Does not allow linking to other units or tables.</p> <p>RTA 00 1 per carton</p>													OVERALL DIMENSIONS			SEAT DIMENSIONS			BACK DIMENSIONS			W	D	H	W	D	H	W	H		IN 5	29	25.25	-	-	-	-	-	-	MM 127	737	641	-	-	-	-	-
OVERALL DIMENSIONS			SEAT DIMENSIONS			BACK DIMENSIONS																																										
W	D	H	W	D	H	W	H																																									
IN 5	29	25.25	-	-	-	-	-	-																																								
MM 127	737	641	-	-	-	-	-	-																																								
 <p>Right End Frame, Fully Upholstered Arm COM: 1.75 YD 1.6 M Unit weight: metal: 15 LB 6.8 KG Carton weight: metal: 20 LB 9.07 KG Carton volume: 6 FT³ 0.16 MT³</p>	GC3676RA	440	496	543	598	687	769	851	923	1012	1096	1210	1371																																			
	Specify leg finish: wood or urethane.																																															
	Optional wood or urethane armcap. Please specify. Add \$142.																																															
	<table border="1"> <thead> <tr> <th colspan="3">OVERALL DIMENSIONS</th> <th colspan="3">SEAT DIMENSIONS</th> <th colspan="3">BACK DIMENSIONS</th> </tr> <tr> <th>W</th> <th>D</th> <th>H</th> <th>W</th> <th>D</th> <th>H</th> <th>W</th> <th>H</th> <th></th> </tr> </thead> <tbody> <tr> <td>IN 5</td> <td>29</td> <td>25.25</td> <td>-</td> <td>-</td> <td>-</td> <td>-</td> <td>-</td> <td>-</td> </tr> <tr> <td>MM 127</td> <td>737</td> <td>641</td> <td>-</td> <td>-</td> <td>-</td> <td>-</td> <td>-</td> <td>-</td> </tr> </tbody> </table> <p>For use in right side finished position of lounge seating units. Does not allow linking to other units or tables.</p> <p>RTA 00 1 per carton</p>													OVERALL DIMENSIONS			SEAT DIMENSIONS			BACK DIMENSIONS			W	D	H	W	D	H	W	H		IN 5	29	25.25	-	-	-	-	-	-	MM 127	737	641	-	-	-	-	-
OVERALL DIMENSIONS			SEAT DIMENSIONS			BACK DIMENSIONS																																										
W	D	H	W	D	H	W	H																																									
IN 5	29	25.25	-	-	-	-	-	-																																								
MM 127	737	641	-	-	-	-	-	-																																								

Modular tables for use with modular lounge and fully upholstered lounge units:

Tops are 1" thick.

Wooden leg tables:

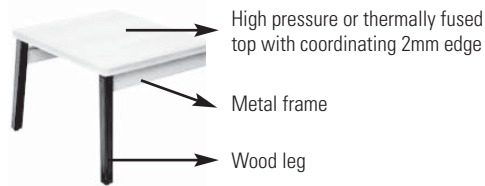

Metal leg tables:

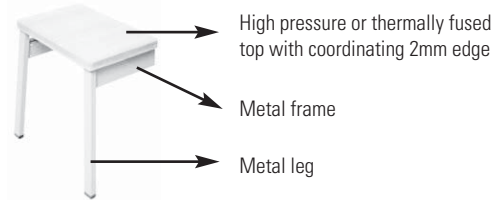

Table top finishes:

Thermally Fused Laminate (LP)

- Absolute Acajou (ACJ)
- Asian Night (ASN)
- Avant Cherry (AWC)
- Avant Honey (AWH)
- Black (BLK)
- Brushed Cobalt (BRC)
- Clear Maple (CMB)
- Dark Espresso (DES)
- Designer White (DWT)
- Fashionista (FAS)
- First Class (FCL)
- Quartered Mahogany (QTM)
- Noce Biondo (NBL)
- Noce Grigio (NGL)
- Noce Leggero (NEL)
- Noce Medio (NML)
- Sheer Beauty (SBY)
- Storm (SOG)
- Walnut Heights (WHE)
- White Chocolate (WHC)
- Winter Cherry (WCR)

High Pressure Laminate (HP)

- Absolute Acajou (ACJ)
- Asian Night (ASN)
- Avant Cherry (W357)
- Avant Honey (W356)
- Black (BLK)
- Brushed Cobalt (BRC)
- Clear Maple (CMB)
- Dark Espresso (W142)
- Designer White (DWT)
- Fashionista (FAS)
- First Class (FCL)
- Quartered Mahogany (QTM)
- Noce Biondo (NBL)
- Noce Grigio (NGL)
- Noce Leggero (NEL)
- Noce Medio (NML)
- Sheer Beauty (SBY)
- Storm (SOG)
- Walnut Heights (WHE)
- White Chocolate (WHC)
- Winter Cherry (WCR)

Wooden leg finishes (top, base, legs & apron):

- | | |
|--------------------------------|-------------------------------|
| Absolute (AAM) | Natural Walnut (NLW) |
| Charcoal Java on Maple (CJM) | Night (ASM) |
| Cherry on Maple (ACM) | Noce Biondo (NBM) |
| Empire Mahogany on Maple (EMM) | Noce Grigio (NGM) |
| English Oak on Maple (EOM) | Noce Leggero (NEM) |
| Medium Walnut on Maple (MWM) | Noce Medio (NMM) |
| Espresso Cafe on Maple (ECM) | Shaker Cherry on Maple (SKM) |
| Fruitwood on Maple (TFM) | Tiger Mahogany on Maple (TMM) |
| Gray (HGM) | Tiger Walnut on Maple (TWM) |
| Harvest Oak on Maple (HOM) | Winter Cherry on Maple (WCM) |
| Honey on Maple (AHM) | Sandy Beach on Maple (SBM) |
| Jet Onyx on Maple (JOM) | WC Cream (WTM) |
| Light Honey on Maple (LHM) | Silver Oak on Maple (SOM) |
| Maple on Maple (AVM) | White on Maple (WHM) |

Metal leg finishes:

Black (TBL), Cloud (TIV), Designer White (TDW), Fog (TFO), Frost (TFR), Kalua (TKA), Latte (TLA), Mocha (TMO), Nevada (TNE), Sand (TSN), Shadow (TSH), Toast (TOA) and Tungsten (TTU). Please specify.

Metal frame finishes:

Black (TBL), Cloud (TIV), Designer White (TDW), Fog (TFO), Frost (TFR), Kalua (TKA), Latte (TLA), Mocha (TMO), Nevada (TNE), Sand (TSN), Shadow (TSH), Toast (TOA) and Tungsten (TTU). Please specify.

Power/USB modules:

For modular tables with power/USB module, refer to models ending in "M". Module includes two power outlets, four USB charging ports and a 6 foot long power cord. Available in Black or White (must be specified at time of order). Power module is mounted **on surface** on narrow tables; mounted **in surface** on larger tables.

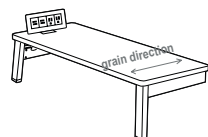

On surface power module on narrow tables

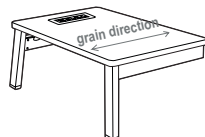

In surface power module on larger tables

MODULAR TABLES	MODEL #	DIMENSIONS ^{IN} ^{MM}	WEIGHT ^{LB} ^{KG}	VOLUME ^{FT³} ^{MT³}	LIST PRICE
----------------	---------	---	---------------------------------------	---	------------



Center Table

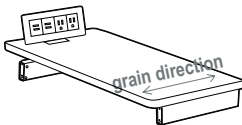

Narrow Center Table

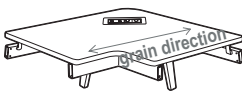

Left Corner Table, Wood Legs

GC36401-LP	20.25 x 28 x 13 514 x 711 x 330	18 8.2	3.5 0.09	\$785
GC36401M-LP With power				\$1744
GC36401-HP	20.25 x 28 x 13 514 x 711 x 330	18 8.2	3.5 0.09	\$821
GC36401M-HP With power				\$1780

- For a thermally fused laminate top (LP), specify model GC36401-LP.
- For a high pressure laminate top (HP), specify model GC36401-HP.
- Models GC36401M-LP and GC36401M-HP have a **power/USB** module mounted in surface.

Coordinating 2mm edge. Regular center table for **wood or metal lounge** frame. Must be connected to full arm and leg with **lounge** frames (GC36406TLA/TRA, GC36406TLCA/TRCA, GC36406WTLA/TRA, GC36406WTLCA/TRCA). 1 per carton.

GC36402-LP	12 x 28 x 13 305 x 711 x 330	15 6.8	2.1 0.05	\$757
GC36402M-LP With power				\$1717
GC36402-HP	12 x 28 x 13 305 x 711 x 330	15 6.8	2.1 0.05	\$791
GC36402M-HP With power				\$1750

- For a thermally fused laminate top (LP), specify model GC36402-LP.
- For a high pressure laminate top (HP), specify model GC36402-HP.
- Models GC36402M-LP and GC36402M-HP have a **power/USB** module mounted in surface.



Coordinating 2mm edge. Narrow center table for **wood or metal lounge** frame. Must be connected to full arm and leg with **lounge** frames (GC36406TLA/TRA, GC36406TLCA/TRCA, GC36406WTLA/TRA, GC36406WTLCA/TRCA). 1 per carton.

GC36403WL-LP	37.12 x 37.12 x 13 943 x 943 x 330	41 18.6	6 0.16	\$1220
GC36403WLM-LP With power				\$2091
GC36403WL-HP	37.12 x 37.12 x 13 943 x 943 x 330	41 18.6	6 0.16	\$1294
GC36403WLM-HP With power				\$2164

- For a thermally fused laminate top (LP), specify model GC36403WL-LP.
- For a high pressure laminate top (HP), specify model GC36403WL-HP.
- Models GC36403WLM-LP and GC36403WLM-HP have a **power/USB** module mounted in surface.

Coordinating 2mm edge. Must be connected to full arm and leg with **wood lounge** frames (GC36406WTLA/TRA, GC36406WTLCA/TRCA). This table allows for kneespace when specifying chairs in a corner position. 1 per carton.

- Includes 2 rear wood legs (not shown).

MODULAR TABLES	MODEL #	DIMENSIONS ^{IN} _{MM}	WEIGHT ^{LB} _{KG}	VOLUME ^{FT³} _{MT³}	LIST PRICE
 <p>Left Corner Table, Metal Legs</p>	GC36403L-LP	37.12 x 37.12 x 13 943 x 943 x 330	41 18.6	6 0.16	\$1405
	GC36403LM-LP With power				\$2362
	GC36403L-HP	37.12 x 37.12 x 13 943 x 943 x 330	41 18.6	6 0.16	\$1485
	GC36403LM-HP With power				\$2444
 <p>Right Corner Table, Wood Legs</p>	GC36403WR-LP	37.12 x 37.12 x 13 943 x 943 x 330	41 18.6	6 0.16	\$1220
	GC36403WRM-LP With power				\$2091
	GC36403WR-HP	37.12 x 37.12 x 13 943 x 943 x 330	41 18.6	6 0.16	\$1294
	GC36403WRM-HP With power				\$2164
 <p>Right Corner Table, Metal Legs</p>	GC36403R-LP	37.12 x 37.12 x 13 943 x 943 x 330	41 18.6	6 0.16	\$1405
	GC36403RM-LP With power				\$2362
	GC36403R-HP	37.12 x 37.12 x 13 943 x 943 x 330	41 18.6	6 0.16	\$1485
	GC36403RM-HP With power				\$2444

W x D x H

- For a thermally fused laminate top (LP), specify model GC36403L-LP.
- For a high pressure laminate top (HP), specify model GC36403L-HP.
- Models GC36403LM-LP and GC36403LM-HP have a **power/USB** module mounted in surface.

Coordinating 2mm edge. Must be connected to full arm and leg with **metal lounge** frames (GC36406TLA/TRA, GC36406TLCA/TRCA). This table allows for kneespace when specifying chairs in a corner position. 1 per carton.

- Includes 2 rear metal legs (not shown).

- For a thermally fused laminate top (LP), specify model GC36403WR-LP.
- For a high pressure laminate top (HP), specify model GC36403WR-HP.
- Models GC36403WRM-LP and GC36403WRM-HP have a **power/USB** module mounted in surface.

Coordinating 2mm edge. Must be connected to full arm and leg with **wood lounge** frames (GC36406WTLA/TRA, GC36406WTLCA/TRCA). This table allows for kneespace when specifying chairs in a corner position. 1 per carton.

- Includes 2 rear wood legs (not shown).

- For a thermally fused laminate top (LP), specify model GC36403R-LP.
- For a high pressure laminate top (HP), specify model GC36403R-HP.
- Models GC36403RM-LP and GC36403RM-HP have a **power/USB** module mounted in surface.

Coordinating 2mm edge. Must be connected to full arm and leg with **metal lounge** frames (GC36406TLA/TRA, GC36406TLCA/TRCA). This table allows for kneespace when specifying chairs in a corner position. 1 per carton.

- Includes 2 rear metal legs (not shown).

MODULAR TABLES **MODEL #** **DIMENSIONS** ^{IN}/_{MM} **WEIGHT** ^{LB}/_{KG} **VOLUME** ^{FT³}/_{MT³} **LIST PRICE**

W x D x H

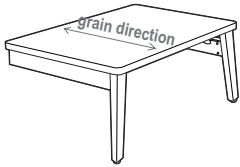

Left End Table, Wood Legs

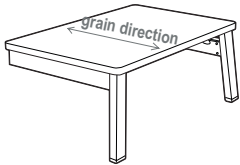
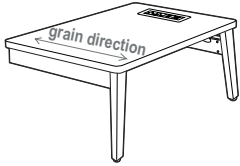

Left End Table, Metal Legs

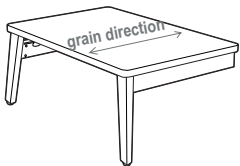
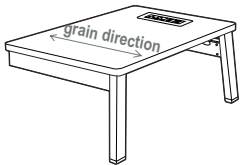

Right End Table, Wood Legs

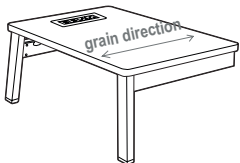

GC36404WL-LP	20.25 x 28 x 13 514 x 711 x 330	18 8.2	3.5 0.09	\$933
GC36404WLM-LP With power				\$1803
GC36404WL-HP	20.25 x 28 x 13 514 x 711 x 330	18 8.2	3.5 0.09	\$966
GC36404WLM-HP With power				\$1837

- For a thermally fused laminate top (LP), specify model GC36404WL-LP.
- For a high pressure laminate top (HP), specify model GC36404WL-HP.

- Models GC36404WLM-LP and GC36404WLM-HP have a **power/USB** module mounted in surface.

Coordinating 2mm edge. Must be connected to full arm and leg with **wood lounge** frames (GC36406WTLA or GC36406WTLCA). 1 per carton.

GC36404L-LP	20.25 x 28 x 13 514 x 711 x 330	18 8.2	3.5 0.09	\$1088
GC36404LM-LP With power				\$2045
GC36404L-HP	20.25 x 28 x 13 514 x 711 x 330	18 8.2	3.5 0.09	\$1124
GC36404LM-HP With power				\$2085

- For a thermally fused laminate top (LP), specify model GC36404L-LP.
- For a high pressure laminate top (HP), specify model GC36404L-HP.

- Models GC36404LM-LP and GC36404LM-HP have a **power/USB** module mounted in surface.

Coordinating 2mm edge. Must be connected to full arm and leg with **metal lounge** frames (GC36406TLA or GC36406TLCA). 1 per carton.

GC36404WR-LP	20.25 x 28 x 13 514 x 711 x 330	18 8.2	3.5 0.09	\$933
GC36404WRM-LP With power				\$1803
GC36404WR-HP	20.25 x 28 x 13 514 x 711 x 330	18 8.2	3.5 0.09	\$966
GC36404WRM-HP With power				\$1837

- For a thermally fused laminate top (LP), specify model GC36404WR-LP.
- For a high pressure laminate top (HP), specify model GC36404WR-HP.

- Models GC36404WRM-LP and GC36404WRM-HP have a **power/USB** module mounted in surface.

Coordinating 2mm edge. Must be connected to full arm and leg with **wood lounge** frames (GC36406WTRA or GC36406WTRCA). 1 per carton.

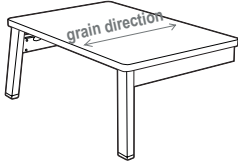
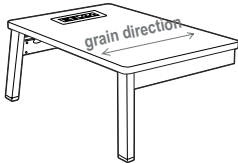
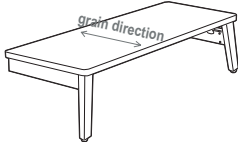
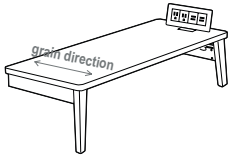
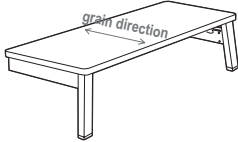
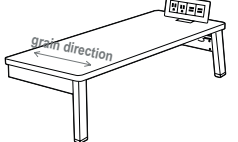
MODULAR TABLES	MODEL #	DIMENSIONS W x D x H	IN MM	WEIGHT	LB KG	VOLUME FT ³ MT ³	LIST PRICE
	GC36404R-LP	20.25 x 28 x 13		18		3.5	\$1088
	GC36404RM-LP With power	514 x 711 x 330		8.2		0.09	\$2045
	GC36404R-HP	20.25 x 28 x 13		18		3.5	\$1124
	GC36404RM-HP With power	514 x 711 x 330		8.2		0.09	\$2085
<ul style="list-style-type: none"> For a thermally fused laminate top (LP), specify model GC36404R-LP. For a high pressure laminate top (HP), specify model GC36404R-HP. Models GC36404RM-LP and GC36404RM-HP have a power/USB module mounted on surface. <p>Coordinating 2mm edge. Must be connected to full arm and leg with metal lounge frames (GC36406TRA or GC36406TRCA). 1 per carton.</p>							
	GC36405WL-LP	12 x 28 x 13		15		2.1	\$911
	GC36405WLM-LP With power	305 x 711 x 330		6.8		0.05	\$1783
	GC36405WL-HP	12 x 28 x 13		15		2.1	\$938
	GC36405WLM-HP With power	305 x 711 x 330		6.8		0.05	\$1811
<ul style="list-style-type: none"> For a thermally fused laminate top (LP), specify model GC36405WL-LP. For a high pressure laminate top (HP), specify model GC36405WL-HP. Models GC36405WLM-LP and GC36405WLM-HP have a power/USB module mounted on surface. <p>Coordinating 2mm edge. Must be connected to full arm and leg with wood lounge frames (GC36406WTLA or GC36406WTLCA). 1 per carton.</p>							
	GC36405L-LP	12 x 28 x 13		15		2.1	\$1064
	GC36405LM-LP With power	305 x 711 x 330		6.8		0.05	\$2024
	GC36405L-HP	12 x 28 x 13		15		2.1	\$1096
	GC36405LM-HP With power	305 x 711 x 330		6.8		0.05	\$2056
<ul style="list-style-type: none"> For a thermally fused laminate top (LP), specify model GC36405L-LP. For a high pressure laminate top (HP), specify model GC36405L-HP. Models GC36405LM-LP and GC36405LM-HP have a power/USB module mounted on surface. <p>Coordinating 2mm edge. Must be connected to full arm and leg with metal lounge frames (GC36406TLA or GC36406TLCA). 1 per carton.</p>							

MODULAR TABLES **MODEL #** **DIMENSIONS ^{MM}** **WEIGHT ^{KG}** **VOLUME ^{MT³}** **LIST PRICE**

W x D x H

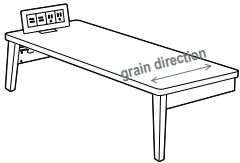
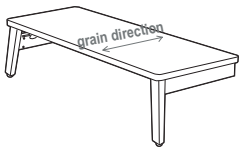

Narrow Right End Table, Wood Legs

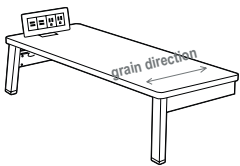
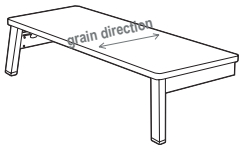

Narrow Right End Table, Metal Legs

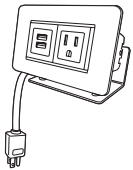

Power/Data Module for tables

GC36405WR-LP	12 x 28 x 13 305 x 711 x 330	15 6.8	2.1 0.05	\$911
GC36405WRM-LP With power				\$1783
GC36405WR-HP	12 x 28 x 13 305 x 711 x 330	15 6.8	2.1 0.05	\$938
GC36405WRM-HP With power				\$1811

- For a thermally fused laminate top (LP), specify model GC36405WR-LP.
- For a high pressure laminate top (HP), specify model GC36405WR-HP.
- Models GC36405WRM-LP and GC36405WRM-HP have a **power/USB** module mounted on surface.

Coordinating 2mm edge. Must be connected to full arm and leg with **wood lounge** frames (GC36406WTRA or GC36406WTRCA). 1 per carton.

GC36405R-LP	12 x 28 x 13 305 x 711 x 330	15 6.8	2.1 0.05	\$1064
GC36405RM-LP With power				\$2024
GC36405R-HP	12 x 28 x 13 305 x 711 x 330	15 6.8	2.1 0.05	\$1096
GC36405RM-HP With power				\$2056

- For a thermally fused laminate top (LP), specify model GC36405R-LP.
- For a high pressure laminate top (HP), specify model GC36405R-HP.
- Models GC36405RM-LP and GC36405RM-HP have a **power/USB** module mounted on surface.

Coordinating 2mm edge. Must be connected to full arm and leg with **metal lounge** frames (GC36406TRA or GC36406TRCA). 1 per carton.

GC36410	- x - x - - x - x -	2 0.9	1 0.02	\$568
---------	------------------------	----------	-----------	--------------

Surface top mount power/data module with one power outlet, two USB charging ports. 6 foot cord. White. Can be mounted to all freestanding and modular tables.



Meet River+™, the next generation of our highly popular lounge series. Now with industry-leading support for workplace, education and healthcare, River+ performs at three times the BIFMA standard for true 24/7 applications in demanding environments. All models have been active weight tested to 600 lbs. including bariatric use. Multiple back and seat heights, 120-degree configurations and modular Aluminum arms are just a few of the many options that will make it yours.

To see the full River+ series, please refer to the Seating price list at globalfurnituregroup.com/ca/resources/pricelists.

Features and Benefits

- A modular series that is composed of straight, curved and corner sections.
- Units can be linked together to create a wide variety of layouts. Ganging hardware is standard and is factory installed. Ganging hardware swivels out of the way when not in use.
- The tapered legs are made of welded steel, with each leg bolted directly to the unit frame. Standard leg height is 6.5" with an optional 8" height. The leg height makes it easy to clean under the product.
- Seat to back connector components join back and seat; maintaining offset for clean out.
- All River+ seating models meet or exceed the applicable ANSI/BIFMA standards and are backed by Global's Heavy Duty warranty.
- Back shelf available on corner, two and three seater units in many low pressure laminate finishes. Shelf supports are Aluminum with accessory hook in three finishes.
- Upholstery options: fabric, vinyl or leather (leather recommended only for use on seat).
- For improved housekeeping and infection control practices, the underside of the seat can be finished with PVC (vinyl) and sealed to prevent penetration of liquids.
- Sealed seams option and steel bottom tamperproof protection is also available.
- For environmental certifications, please visit globalfurnituregroup.com.

SENATOR



Optional metal leg

model GC3392 (tapered wood legs)

STANDARD FEATURES

- The flared back design and creative curves enhance any healthcare environment without sacrificing comfort.
- Waterfall seamless front upholstered design with removable seat cushions for easy cleaning and protecting against bacteria.
- For added comfort, seats are standard with high density Ultracell foam.
- Standard with wood legs.
- For healthcare textiles and wood finish options, visit the website at globalfurnituregroup.com. Available in European beechwood species only (refer to finishes ending in "M").
- Can be upholstered in standard Global textiles if healthcare compliance is not required.
- Shipped fully assembled.

OPTIONAL FEATURES

- Optional metal legs are available in Black (TBL), Kalua (TKA), Latte (TLA), Mocha (TMO), Shadow (TSH), Toast (TOA) and Tungsten (TTU). Please specify. No upcharge.
- For hard surface floors, please specify opaque non-marking glides (**GL**). No upcharge.
- For steel cushion glide, please specify (**GI**). Add \$5.
- For non-slip glides, please specify (**NS**). Add \$22.
- For moisture barrier on seat, please specify (**MB**). See upcharges below.
- To add sealed seams to your product contact Customer Service. Upcharges vary.

SUGGESTED APPLICATIONS

- Lobbies
- Lounge/Waiting
- Patient rooms
- Resident rooms

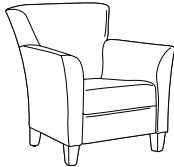
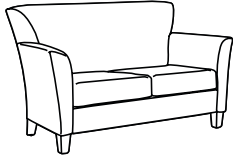
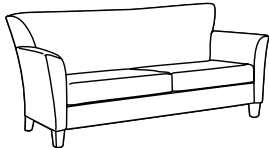
DESCRIPTION	MODEL# / FEATURES	STANDARD TEXTILE GRADES											
		COM	2	3	4	5	6	7	8	9	10	11	12
 <p>Armchair COM: 5.25 YD 4.8 M Unit weight: 56 LB 25.5 KG Carton weight: 72 LB 32.66 KG Carton volume: 29.25 FT³ 0.82 MT³</p>	GC3391	2065	2233	2375	2538	2805	3052	3299	3514	3782	4034	4375	4858
	Active weight 300 lbs.	IN 34	32.25	36		19.5	19	17.5		28	18.5		
	Removable seat cushion.	MM 864	819	914		495	483	445		711	470		
Add \$122 for (MB).		RTA 00		1 per carton									
 <p>Two Seat Sofa COM: 8.25 YD 7.54 M Unit weight: 90 LB 40.9 KG Carton weight: 116 LB 52.62 KG Carton volume: 55.5 FT³ 1.57 MT³</p>	GC3392	2845	3109	3332	3588	4008	4396	4784	5122	5543	5939	6475	7234
	Active weight 300 lbs/seat.	IN 61	32.25	36		46	19	17.5		56	18.5		
	Removable seat cushions.	MM 1549	819	914		1168	483	445		1422	470		
Add \$245 for (MB).		RTA 00		1 per carton									
 <p>Three Seat Sofa COM: 9.5 YD 8.69 M Unit weight: 110 LB 50 KG Carton weight: 141 LB 63.96 KG Carton volume: 67 FT³ 1.89 MT³</p>	GC3393	3681	3985	4242	4536	5021	5467	5914	6303	6788	7244	7861	8735
	Active weight 300 lbs/seat.	IN 76	32.25	36		61	19	17.5		71	18.5		
	Removable seat cushions.	MM 1930	819	914		1549	483	445		1803	470		
Add \$366 for (MB).		RTA 00		1 per carton									

SLEEP-EEZ



model GC3614

Sleep surface dimensions:

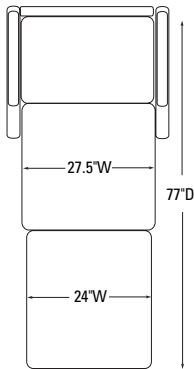

EXAMPLE SLEEP-EEZ ORDER CODE:

GC3614	-LX21	-PT	-	-SS
Model #	Textile	Armcaps	Moisture Barrier	Sealed seams

STANDARD FEATURES

- Sleep-Eez provides incredible comfort, requires zero wall clearance and can be easily opened and close by one person.
- It can be adjusted to create three functional positions: a chair, a chaise lounge and a sleep surface.
- The heavy duty steel mechanism will provide long-term performance.
- Commercial grade casters are standard. Front casters are non-swivel manual locking. Back casters are non-locking and swivel for better steering when moving the chair.
- Clean out space is provided between the seat and back cushions for housekeeping and infection prevention control.
- Sleep-Eez's construction allows for on-site replacement of all components, eliminating down time and enhancing the product's life.
- Standard with Black urethane (urethane) fully extended arms with a grip for ease of entry and exit from chair.
- For healthcare textile options, visit the website at globalfurnituregroup.com.
- Can be upholstered in standard Global textiles if healthcare compliance is not required.
- Shipped fully assembled.
- Measurements:
Chaise lounge: 35"W x 64"D x 35"H
Sleep surface: 24"W x 77"D

OPTIONAL FEATURES

- For moisture barrier on seat, please specify **(MB)**. Add \$122.
- To add sealed seams to your product, please specify **(SS)**. Add \$189.

SUGGESTED APPLICATIONS

- Lobbies
- Lounge/Waiting
- Office/Meeting
- Patient rooms
- Resident rooms
- Treatment/Exam rooms

Please add option codes in the following order:

- **Model number**
GC3614 Single sleeper chair
- **Textile**
Specify fabric code
- **Armcap finish**
(SS) Black urethane armcap
(LA) Latte urethane armcap
(KL) Kalua urethane armcap
(MC) Mocha urethane armcap
(SH) Shadow urethane armcap
(TO) Toast urethane armcap
(AB) Absolute wood armcap
(CJ) Charcoal Java wood armcap
(AC) Cherry wood armcap
(EP) Empire Mahogany wood armcap
(EM) English Oak wood armcap
(EC) Espresso Cafe wood armcap
(HG) Gray wood armcap
(HA) Harvest Oak wood armcap
(AH) Honey wood armcap
(JO) Jet Onyx wood armcap
(LH) Light Honey wood armcap
(AV) Maple wood armcap
(MW) Medium Walnut wood armcap
(NW) Natural Walnut wood armcap
(AT) Night wood armcap
(BI) Noce Biondo wood armcap
(GI) Noce Grigio wood armcap
(EI) Noce Leggero wood armcap
(MI) Noce Medio wood armcap
(SB) Sandy Beach wood armcap
(SM) Silver Oak wood armcap
(TF) Tiger Fruitwood wood armcap
(TM) Tiger Mahogany wood armcap
(TL) Tiger Walnut wood armcap
(WR) WC Cream wood armcap
(WH) White wood armcap
(WC) Winter Cherry wood armcap
- **Moisture Barrier**
(MB) Seat only
- **Sealed seams**
(SS) All sealed seams

DESCRIPTION	MODEL# / FEATURES	STANDARD TEXTILE GRADES											
		COM	2	3	4	5	6	7	8	9	10	11	12
 Single Sleeper Chair COM: 8.5 YD 7.77 M Unit weight: 146 LB 66.4 KG Carton weight: 160 LB 72.57 KG Carton volume: 38 FT³ 1.07 MT³	GC3614	3171	3443	3673	3936	4370	4769	5169	5517	5951	6359	6911	7693
	Active weight 350 lbs.	OVERALL DIMENSIONS W D H		SEAT DIMENSIONS W D H			BACK DIMENSIONS W H						
		IN 35	37	35	27.5	21	17.5	27.5	18.5				
		MM 889	940	889	699	533	445	699	470				
		RTA 00	1 per carton										

STRAND



model GC3707HB



model GC3702

STANDARD FEATURES

- Strand is the perfect synthesis of versatility, comfort, durability and value pricing. Strand offers a pleasing look in a diverse range of solutions from single patient room chairs to waiting areas and public spaces.
- All models are standard in oval metal tube frame.
- Frame available in Black (TBL), Cloud (TIV), Designer White (TDW), Fog (TFO), Frost (TFR), Kalua (TKA), Latte (TLA), Mocha (TMO), Nevada (TNE), Sand (TSN), Shadow (TSH), Toast (TOA) and Tungsten (TTU). Please specify.
- The frame can be weighted and made with tamperproof fasteners for greater security in more challenging mental health spaces or correctional facilities. Request a special quote.
- Armcaps are standard in Black urethane (urethane).
- Left and right position reference is determined from the seated position.
- The seat and back are removable and field replaceable.
- For added comfort, seats are standard with high density Ultracell foam.
- All seat frames feature a wall saver design to prevent back contact with wall. Footstool and benches do not have wall saver legs.
- Standard seat height on all models is 18".
- Clean out space is provided between the seat and back cushions for easy housekeeping.
- Standard with Black plastic glides.
- Select models are offered with rear tip and move wheels. To activate wheels, tilt the chair back so the casters are in contact with the floor. This feature makes it easy to relocate the chair while unoccupied.
- Flex back models allow the back to move in a soothing rocking motion.
- Active weight capacity for standard single seat is 350 lbs. and 750 lbs. for bariatric seating.
- For healthcare textiles and wood finish options, visit the website at globalfurnituregroup.com.
- Can be upholstered in standard Global textiles if healthcare compliance is not required.



OPTIONAL FEATURES





- The seat cushion is slightly inclined to enhance comfort. An optional flat seat cushion is available. Please specify **(FS)**.
For one seater: Add \$33.
For two seater: Add \$70
For three seater: Add \$102.
For bariatric models: Add \$55.
- Wood armcaps are available in all Seating wood finishes (see features column for upcharges).
- Non-marking White glides are available. Please specify **(WH)**. No upcharge.
- For moisture barrier on seat, please specify **(MB)**.
For one seater: Add \$81.
For two seater: Add \$165.
For three seater: Add \$245.
For bariatric models: Add \$122.
- For improved housekeeping and infection control practices, please add **(SU)** to model number. The underside of the seat will be finished with vinyl and sealed to prevent penetration of liquids.
For one seater: Add \$39.
For two seater: Add \$79.
For three seater: Add \$117.
For bariatric models: Add \$59.

SUGGESTED APPLICATIONS

- Bariatric seating (some models)
- Guest seating
- Lobbies
- Lounge/Waiting
- Patient rooms
- Resident rooms
- Treatment/Exam rooms

For complementary tables, please refer to the GC Belong **freestanding** tables, page 42. (Not for use with GC Belong table bridges.)

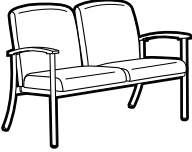
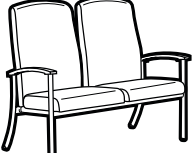
DESCRIPTION	MODEL# / FEATURES	STANDARD TEXTILE GRADES											
		COM	2	3	4	5	6	7	8	9	10	11	12
 <p>Low Back Single Seat Armless Chair COM: 1.75 YD 1.6 M Unit weight: 35 LB 15.9 KG Carton weight: 43 LB 19.5 KG Carton volume: 17.5 FT³ 0.49 MT³</p>	GC3700	800	856	903	958	1047	1129	1211	1283	1372	1456	1570	1731
	Active weight 350 lbs.	OVERALL DIMENSIONS			SEAT DIMENSIONS			BACK DIMENSIONS					
		IN	24.5	27.5	34.5	22	18.5	18	21.5	17			
		MM	622	699	876	559	470	457	546	432			
	RTA 00	1 per carton											
 <p>Low Back Single Seat Armchair COM: 1.75 YD 1.6 M Unit weight: 40 LB 18.2 KG Carton weight: 48 LB 21.77 KG Carton volume: 17.5 FT³ 0.49 MT³</p>	GC3701	954	1010	1057	1112	1201	1283	1365	1437	1526	1610	1724	1885
	Active weight 350 lbs.	OVERALL DIMENSIONS			SEAT DIMENSIONS			BACK DIMENSIONS					
		IN	25.5	27.5	34.5	22	18.5	18	21.5	17			
		MM	648	699	876	559	470	457	546	432			
Wood armcap option: Add \$85.	RTA 00	1 per carton											

DESCRIPTION	MODEL# / FEATURES	STANDARD TEXTILE GRADES											
		COM	2	3	4	5	6	7	8	9	10	11	12
 <p>Designed to immobilize the pelvis and hip joints after surgery.</p> <p>Low Back Hip Armchair Post Surgery COM: 1.75 YD 1.6 M Unit weight: 45 LB 20.5 KG Carton weight: 53 LB 24.04 KG Carton volume: 17.5 FT³ 0.49 MT³</p>	GC3701-24 24" seat height	1145	1201	1248	1303	1392	1474	1556	1628	1717	1801	1915	2076
	Active weight 350 lbs.	IN 25.5 MM 648	27.5 699	40.5 1029	22 559	18.5 470	24 610	21.5 546	17 432				
	Wood armcap option: Add \$85.	RTA 00 1 per carton											
			OVERALL DIMENSIONS W D H			SEAT DIMENSIONS W D H			BACK DIMENSIONS W H				
 <p>High Back Single Seat Armchair COM: 2 YD 1.83 M Unit weight: 45 LB 20.5 KG Carton weight: 53 LB 24.04 KG Carton volume: 20 FT³ 0.56 MT³</p>	GC3701HB	1004	1068	1122	1184	1286	1380	1474	1556	1658	1754	1884	2068
	Active weight 350 lbs.	IN 25.5 MM 648	27.5 699	42.5 1080	22 559	18 457	18 457	21.5 546	25 635				
	Wood armcap option: Add \$85.	RTA 00 1 per carton											
			OVERALL DIMENSIONS W D H			SEAT DIMENSIONS W D H			BACK DIMENSIONS W H				
 <p>Low Back Two Seat Chair No Center Arm COM: 3.25 YD 2.97 M Unit weight: 60 LB 27.3 KG Carton weight: 68 LB 30.84 KG Carton volume: 43 FT³ 1.21 MT³</p>	GC3702	1515	1619	1707	1808	1973	2126	2279	2412	2578	2734	2945	3244
	Active weight 350 lbs/seat.	IN 49.75 MM 1264	27.5 699	34.5 876	44 1118	18.5 470	18 457	43 1092	17 432				
	Wood armcap option: Add \$85.	RTA 00 1 per carton											
			OVERALL DIMENSIONS W D H			SEAT DIMENSIONS W D H			BACK DIMENSIONS W H				
 <p>High Back Two Seat Chair No Center Arm COM: 3.75 YD 3.43 M Unit weight: 67 LB 30.5 KG Carton weight: 75 LB 34.02 KG Carton volume: 56.5 FT³ 1.59 MT³</p>	GC3702HB	1616	1736	1837	1954	2145	2321	2497	2651	2842	3022	3266	3611
	Active weight 350 lbs/seat.	IN 49.75 MM 1264	27.5 699	42.5 1080	44 1118	18.5 470	18 457	43 1092	25 635				
	Wood armcap option: Add \$85.	RTA 00 1 per carton											
			OVERALL DIMENSIONS W D H			SEAT DIMENSIONS W D H			BACK DIMENSIONS W H				
 <p>Low Back Three Seat Chair No Center Arms COM: 4.5 YD 4.11 M Unit weight: 80 LB 36.4 KG Carton weight: 90 LB 40.82 KG Carton volume: 65.25 FT³ 1.84 MT³</p>	GC3703	2086	2230	2352	2491	2721	2932	3144	3328	3558	3774	4066	4480
	Active weight 350 lbs/seat.	IN 71.25 MM 1810	27.5 699	34.5 876	66 1676	18.5 470	18 457	64.5 1638	17 432				
	Wood armcap option: Add \$85.	RTA 00 1 per carton											
			OVERALL DIMENSIONS W D H			SEAT DIMENSIONS W D H			BACK DIMENSIONS W H				

DESCRIPTION MODEL# / FEATURES STANDARD TEXTILE GRADES

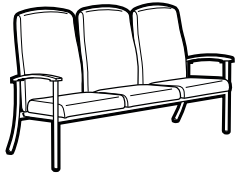

High Back Three Seat Chair No Center Arms
 COM: 5.25 YD | 4.8 M
 Unit weight: 86 LB | 39.1 KG
 Carton weight: 96 LB | 43.54 KG
 Carton volume: 80.75 FT³ | 2.28 MT³

COM	2	3	4	5	6	7	8	9	10	11	12	
GC3703HB	2236	2404	2546	2709	2976	3223	3470	3685	3953	4205	4546	5029

OVERALL DIMENSIONS			SEAT DIMENSIONS			BACK DIMENSIONS	
W	D	H	W	D	H	W	H

Active weight 350 lbs/seat.
 Wood armcap option:
 Add \$85.

IN	71.25	27.5	42.5	66	18.5	18	64.5	25
MM	1810	699	1080	1676	470	457	1638	635
RTA 00			1 per carton					

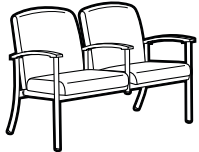

Low Back Two Seat Chair Half Center Arm
 COM: 3.25 YD | 2.97 M
 Unit weight: 65 LB | 29.5 KG
 Carton weight: 73 LB | 33.11 KG
 Carton volume: 43 FT³ | 1.21 MT³

COM	2	3	4	5	6	7	8	9	10	11	12	
GC3704	1675	1779	1867	1968	2133	2286	2439	2572	2738	2894	3105	3404

OVERALL DIMENSIONS			SEAT DIMENSIONS			BACK DIMENSIONS	
W	D	H	W	D	H	W	H

Active weight 350 lbs/seat.
 Wood armcap option:
 Add \$130.

IN	49.75	27.5	34.5	22	18.5	18	21.5	17
MM	1264	699	876	559	470	457	546	432
RTA 00			1 per carton					

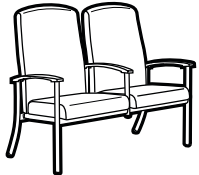

High Back Two Seat Chair Half Center Arm
 COM: 3.75 YD | 3.43 M
 Unit weight: 71 LB | 32.3 KG
 Carton weight: 79 LB | 35.83 KG
 Carton volume: 56.5 FT³ | 1.59 MT³

COM	2	3	4	5	6	7	8	9	10	11	12	
GC3704HB	1776	1896	1997	2114	2305	2481	2657	2811	3002	3182	3426	3771

OVERALL DIMENSIONS			SEAT DIMENSIONS			BACK DIMENSIONS	
W	D	H	W	D	H	W	H

Active weight 350 lbs/seat.
 Wood armcap option:
 Add \$130.

IN	49.75	27.5	42.5	44	18.5	18	43	25
MM	1264	699	1080	1118	470	457	1092	635
RTA 00			1 per carton					

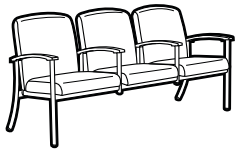

Low Back Three Seat Chair Half Center Arms
 COM: 4.5 YD | 4.11 M
 Unit weight: 90 LB | 40.9 KG
 Carton weight: 100 LB | 45.36 KG
 Carton volume: 65.25 FT³ | 1.84 MT³

COM	2	3	4	5	6	7	8	9	10	11	12	
GC3705	2406	2550	2672	2811	3041	3252	3464	3648	3878	4094	4386	4800

OVERALL DIMENSIONS			SEAT DIMENSIONS			BACK DIMENSIONS	
W	D	H	W	D	H	W	H

Active weight 350 lbs/seat.
 Wood armcap option:
 Add \$174.

IN	71.25	27.5	34.5	22	18.5	18	21.5	17
MM	1810	699	876	559	470	457	546	432
RTA 00			1 per carton					

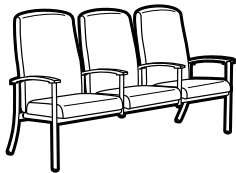





High Back Three Seat Chair Half Center Arms
 COM: 5.25 YD | 4.8 M
 Unit weight: 90 LB | 40.9 KG
 Carton weight: 100 LB | 45.36 KG
 Carton volume: 80.75 FT³ | 2.28 MT³

COM	2	3	4	5	6	7	8	9	10	11	12	
GC3705HB	2559	2727	2869	3032	3299	3546	3793	4008	4276	4528	4869	5352

OVERALL DIMENSIONS			SEAT DIMENSIONS			BACK DIMENSIONS	
W	D	H	W	D	H	W	H

Active weight 350 lbs/seat.
 Wood armcap option:
 Add \$174.

IN	71.25	27.5	42.5	66	18.5	18	64.5	25
MM	1810	699	1080	1676	470	457	1638	635
RTA 00			1 per carton					

DESCRIPTION	MODEL# / FEATURES	STANDARD TEXTILE GRADES											
		COM	2	3	4	5	6	7	8	9	10	11	12
 <p>LB Armchair, Rear Tip and Move Wheels COM: 1.75 YD 1.6 M Unit weight: 40 LB 18.2 KG Carton weight: 48 LB 21.77 KG Carton volume: 17.5 FT³ 0.49 MT³</p>	GC3707	1044	1100	1147	1202	1291	1373	1455	1527	1616	1700	1814	1975
		OVERALL DIMENSIONS			SEAT DIMENSIONS			BACK DIMENSIONS					
		W	D	H	W	D	H	W	H				
		IN 25.5 MM 648	27.5 699	34.5 876	22 559	18.5 470	18 457	21.5 546	17 432				
	Active weight 350 lbs.												
	Wood armcap option: Add \$85.												
	RTA 00	1 per carton											
 <p>HB Armchair, Rear Tip and Move Wheels COM: 2 YD 1.83 M Unit weight: 43 LB 19.5 KG Carton weight: 50 LB 22.68 KG Carton volume: 20 FT³ 0.56 MT³</p>	GC3707HB	1094	1158	1212	1274	1376	1470	1564	1646	1748	1844	1974	2158
		OVERALL DIMENSIONS			SEAT DIMENSIONS			BACK DIMENSIONS					
		W	D	H	W	D	H	W	H				
		IN 25.5 MM 648	27.5 699	42.5 1080	22 559	18 457	18 457	21 533	25 635				
	Active weight 350 lbs.												
	Wood armcap option: Add \$85.												
	RTA 00	1 per carton											
 <p>Bariatric Low Back Armchair COM: 2.75 YD 2.51 M Unit weight: 49 LB 22.3 KG Carton weight: 60 LB 27.22 KG Carton volume: 26.5 FT³ 0.75 MT³</p>	GC3711	1224	1312	1386	1472	1612	1741	1870	1983	2123	2255	2434	2687
		OVERALL DIMENSIONS			SEAT DIMENSIONS			BACK DIMENSIONS					
		W	D	H	W	D	H	W	H				
		IN 36 MM 914	27.5 699	34.5 876	32.5 826	18 457	18 457	31 787	17 432				
	Active weight 750 lbs.												
	Wood armcap option: Add \$85.												
	RTA 00	1 per carton											
 <p>Bariatric Low Back Hip Armchair Post Surgery COM: 2.75 YD 2.51 M Unit weight: 52 LB 23.6 KG Carton weight: 63 LB 28.58 KG Carton volume: 30.5 FT³ 0.86 MT³</p> <p>Designed to immobilize the pelvis and hip joints after surgery.</p>	GC3711-24 24" seat height	1439	1527	1601	1687	1827	1956	2085	2198	2338	2470	2649	2902
		OVERALL DIMENSIONS			SEAT DIMENSIONS			BACK DIMENSIONS					
		W	D	H	W	D	H	W	H				
		IN 36 MM 914	27.5 699	40.5 1029	32.5 826	18 457	24 610	31 787	17 432				
	Active weight 750 lbs.												
	Wood armcap option: Add \$85.												
	RTA 00	1 per carton											
 <p>Bariatric High Back Armchair COM: 3.25 YD 2.97 M Unit weight: 55 LB 25 KG Carton weight: 66 LB 29.94 KG Carton volume: 30.5 FT³ 0.86 MT³</p>	GC3711HB	1294	1398	1486	1587	1752	1905	2058	2191	2357	2513	2724	3023
		OVERALL DIMENSIONS			SEAT DIMENSIONS			BACK DIMENSIONS					
		W	D	H	W	D	H	W	H				
		IN 36 MM 914	27.5 699	42.5 1080	32.5 826	18 457	18 457	31 787	25 635				
	Active weight 750 lbs.												
	Wood armcap option: Add \$85.												
	RTA 00	1 per carton											

DESCRIPTION MODEL# / FEATURES STANDARD TEXTILE GRADES



Bariatric LB Armchair, Rear Tip and Move Wheels
 COM: 2.75 YD | 2.51 M
 Unit weight: 49 LB | 22.3 KG
 Carton weight: 60 LB | 27.22 KG
 Carton volume: 26.5 FT³ | 0.75 MT³

Active weight 750 lbs.
 Wood armcap option:
 Add \$85.

COM	2	3	4	5	6	7	8	9	10	11	12	
GC3712	1317	1405	1479	1565	1705	1834	1963	2076	2216	2348	2527	2780

OVERALL DIMENSIONS			SEAT DIMENSIONS			BACK DIMENSIONS	
W	D	H	W	D	H	W	H

IN	36	27.5	34.5	32.5	18	18	31	17
MM	914	699	876	826	457	457	787	432

RTA 00 1 per carton



Bariatric HB Armchair, Rear Tip and Move Wheels
 COM: 3.25 YD | 2.97 M
 Unit weight: 56 LB | 25.5 KG
 Carton weight: 66 LB | 29.94 KG
 Carton volume: 30.5 FT³ | 0.86 MT³

Active weight 750 lbs.
 Wood armcap option:
 Add \$85.

COM	2	3	4	5	6	7	8	9	10	11	12	
GC3712HB	1383	1487	1575	1676	1841	1994	2147	2280	2446	2602	2813	3112

OVERALL DIMENSIONS			SEAT DIMENSIONS			BACK DIMENSIONS	
W	D	H	W	D	H	W	H

IN	36	27.5	42.5	31	18	18	30	25
MM	914	699	1080	787	457	457	762	635

RTA 00 1 per carton



Low Back Single Seat Armchair Flex Back
 COM: 1.75 YD | 1.6 M
 Unit weight: 41 LB | 18.6 KG
 Carton weight: 49 LB | 22.23 KG
 Carton volume: 17.5 FT³ | 0.49 MT³

Active weight 350 lbs.
 Wood armcap option:
 Add \$85.

COM	2	3	4	5	6	7	8	9	10	11	12	
GC3715	1160	1216	1263	1318	1407	1489	1571	1643	1732	1816	1930	2091

OVERALL DIMENSIONS			SEAT DIMENSIONS			BACK DIMENSIONS	
W	D	H	W	D	H	W	H

IN	25.5	27.5	34.5	22	18	18	21	17
MM	648	699	876	559	457	457	533	432

RTA 00 1 per carton



High Back Single Seat Armchair Flex Back
 COM: 2 YD | 1.83 M
 Unit weight: 43 LB | 19.5 KG
 Carton weight: 50 LB | 22.68 KG
 Carton volume: 20 FT³ | 0.56 MT³

Active weight 350 lbs.
 Wood armcap option:
 Add \$85.

COM	2	3	4	5	6	7	8	9	10	11	12	
GC3715HB	1212	1276	1330	1392	1494	1588	1682	1764	1866	1962	2092	2276

OVERALL DIMENSIONS			SEAT DIMENSIONS			BACK DIMENSIONS	
W	D	H	W	D	H	W	H

IN	25.5	27.5	42.5	22	18	18	21	25
MM	648	699	1080	559	457	457	533	635

RTA 00 1 per carton

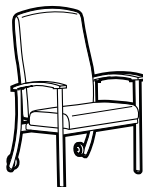

HB Armchair Flex Back, Rear Tip and Move Wheels
 COM: 2 YD | 1.83 M
 Unit weight: 43 LB | 19.5 KG
 Carton weight: 50 LB | 22.68 KG
 Carton volume: 20 FT³ | 0.56 MT³



Active weight 350 lbs.
 Wood armcap option:
 Add \$85.

COM	2	3	4	5	6	7	8	9	10	11	12	
GC3716HB	1302	1366	1420	1482	1584	1678	1772	1854	1956	2052	2182	2366

OVERALL DIMENSIONS			SEAT DIMENSIONS			BACK DIMENSIONS	
W	D	H	W	D	H	W	H

IN	25.5	27.5	42.5	22	18	18	21	25
MM	648	699	1080	559	457	457	533	635

RTA 00 1 per carton

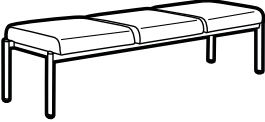
DESCRIPTION	MODEL# / FEATURES	STANDARD TEXTILE GRADES											
		COM	2	3	4	5	6	7	8	9	10	11	12
 <p>High Back Single Seat Armchair Split Back COM: 2 YD 1.83 M Unit weight: 45 LB 20.5 KG Carton weight: 53 LB 24.04 KG Carton volume: 20 FT³ 0.56 MT³</p>	GC3717HB	1232	1296	1350	1412	1514	1608	1702	1784	1886	1982	2112	2296
	Active weight 350 lbs.	OVERALL DIMENSIONS			SEAT DIMENSIONS			BACK DIMENSIONS					
	Fold down headrest.	W	D	H	W	D	H	W	H				
	Wood armcap option: Add \$85.	IN	MM										
 <p>Footstool Angled Top COM: 1 YD 0.91 M Unit weight: 13 LB 5.9 KG Carton weight: 16 LB 7.26 KG Carton volume: 3.5 FT³ 0.09 MT³</p>	GC3708	601	633	660	691	742	789	836	877	928	976	1041	1133
	Active weight 350 lbs.	OVERALL DIMENSIONS			SEAT DIMENSIONS			BACK DIMENSIONS					
	Stores beneath any standard seating unit.	W	D	H	W	D	H	W	H				
	Add \$81 for (MB).	IN	MM										
 <p>Two Seat Bench COM: 1.75 YD 1.6 M Unit weight: 40 LB 18.2 KG Carton weight: 48 LB 21.77 KG Carton volume: 23 FT³ 0.65 MT³</p>	GC3722	1028	1084	1131	1186	1275	1357	1439	1511	1600	1684	1798	1959
	Active weight 350 lbs/seat.	OVERALL DIMENSIONS			SEAT DIMENSIONS			BACK DIMENSIONS					
	Add \$165 for (MB). Add \$70 for (FS).	W	D	H	W	D	H	W	H				
		IN	MM										
 <p>Three Seat Bench COM: 2 YD 1.83 M Unit weight: 60 LB 27.3 KG Carton weight: 68 LB 30.84 KG Carton volume: 33.25 FT³ 0.94 MT³</p>	GC3723	1383	1447	1501	1563	1665	1759	1853	1935	2037	2133	2263	2447
	Active weight 350 lbs/seat.	OVERALL DIMENSIONS			SEAT DIMENSIONS			BACK DIMENSIONS					
	Add \$245 for (MB). Add \$102 for (FS).	W	D	H	W	D	H	W	H				
		IN	MM										

WILLOW



model W5AUUG



Wipeable shroud edge does not collect debris



No visible brackets or upholstery staples



Waterfall arm (WFA)



Forward grip assist arm (GAA)

		Willow chairs stacking capability	
		on floor	on dolly
Four-leg arm and armless chairs with glides only	Poly back/seat models	up to 6 high	up to 10 high
	Upholstered models	up to 4 high	up to 8 high
	Bariatric models	up to 4 high	up to 8 high
Bar and counter stools	Stools with arms	does not stack	N/A
	Armless stools	up to 4 high	N/A

Plastic component finish matching chart		
Chair type	Seat shroud	Arms + back shrouds
Poly back/seat	matches seat/back	matches seat/back
Upholstered back/seat	specify	specify
Poly back/upholstered seat	specify	specify
Upholstered back/poly seat	matches seat	specify

EXAMPLE WILLOW ORDER CODE:

W5AUU	NS	PU75	NS	PU75	WFA	BLK
Model #	Back seams	Back textile	Seat	Seat textile	Arm style	Arm + back shroud finish

BLK	CHM	ST	BLK	NB
Seat shroud finish	Frame finish	Glide type	Glide finish	Moisture barrier

Willow linking tables



For linking tables, see page 242.

STANDARD FEATURES

- Willow's durable design and open, welcoming form will ensure years of use. Freestanding chairs are available with four legs or sled base, in standard or bariatric width. Additional models include hip, counter and bar height stools. Corner, in-line and end linking tables are also available to complement the line.
- Chairs can be ganged with ganging brackets or with in-line and corner tables.
- Plastic seats and backs, reinforced nylon arms, back shrouds and seat shrouds are all available in 17 colors. See finish chart for matching color components.
- Ganging brackets are available in 13 paint finishes (see page 242).
- Tubular steel frame is available in 20 paint finishes and 4 plated finishes with an upcharge.
- Frame design features a wall saver leg to prevent contact with walls.
- Active weight capacity:
 - four-leg seating with casters: 300 lbs.
 - standard size seating with glides is 400 lbs.
 - bariatric models: 600 lbs.
- Plastic seat shrouds are standard on all models.
- Bariatric models are only available with upholstered seat and back.
- All models are standard with colored nylon glides (ST) in two finishes (Black or Sand).
- Upholstered seats have no seams for ease of cleaning.
- Four-leg models with glides are stackable. See chart. Stacking of models with caster is not recommended due to possible damage to plastic and upholstery.
- Armless stools are stackable. See chart.
- Four-leg and stool models are available with various glide options. Glides must be chosen to best suit flooring type and site conditions. For more information, please refer to glide selection chart (page 274).
- Tables used with Willow armchairs require 28" clearance under the surface top; counter height stools require 34.25" clearance; bar height stools require 40.25" clearance.
- Sled base models have nylon colored glides, non-marking natural glides for use on most floor surfaces, or with no glides for use on carpeted floors.
- For healthcare textile options, visit the website at globalfurnituregroup.com.
- Can be upholstered in standard Global textiles if healthcare compliance is not required.
- Shipped fully assembled.

OPTIONAL FEATURES

- Additional weight (CW) of 24 lbs. is available. Weighted four-leg chairs and armless stools are not stackable. Not available for models with casters.
- Power/USB units are available for use with in-line, corner and end tables. Tables are predrilled for field installation of undermount power. Clamp mount units are available. Order power units separately for field installation.
- Sealed seams may be specified on upholstered back models. Seats have no seams.
- Moisture barrier may be specified on seats.
- Sled base models offer a floor mount (FM) option. See upcharges. Mounting hardware not included

Please add option codes in the following order:

- Model number**
- Back/seat/seat shroud finish** (for plastic back and seat models)
 - Back finish** (for plastic back and upholstered seat models)

(BZB) Buzz Blue	(KAL) Kalua
(CCT) Cactus	(LAB) Latte
(CRO) Carrot	(J52) Mocha
(IVC) Cloud	(BLK) Night
(DJN) Dijon	(SND) Sand
(EGP) Eggplant	(SAR) Scarlet
(FOG) Fog	(SHW) Shadow
(FRO) Frost	(TOA) Toast
(INK) Ink	
- Back seams and textile** (upholstered back models)
 - (NS) No sealed seams.
 - (S2) Sealed seams. Add \$14. For bariatric models, add \$20. Specify back textile.
- Seat textile** (for upholstered seat models)
 - (NS) No sealed seams
 - Specify seat textile.
- Arm style** (models with arms only)
 - (WFA) Waterfall arm.
 - (GAA) Grip assist arm. Add \$30.
- Arm and back shroud finish**

(BZB) Buzz Blue	(KAL) Kalua
(CCT) Cactus	(LAB) Latte
(CRO) Carrot	(J52) Mocha
(IVC) Cloud	(BLK) Night
(DJN) Dijon	(SND) Sand
(EGP) Eggplant	(SAR) Scarlet
(FOG) Fog	(SHW) Shadow
(FRO) Frost	(TOA) Toast
(INK) Ink	
- Seat and seat shroud finish** (for upholstered back and plastic seat models)

(BZB) Buzz Blue	(KAL) Kalua
(CCT) Cactus	(LAB) Latte
(CRO) Carrot	(J52) Mocha
(IVC) Cloud	(BLK) Night
(DJN) Dijon	(SND) Sand
(EGP) Eggplant	(SAR) Scarlet
(FOG) Fog	(SHW) Shadow
(FRO) Frost	(TOA) Toast
(INK) Ink	
- Leg type** (for sled base models)
 - (NF) No floor mount.
 - (FM) Floor mounted. Add \$10.
- Frame finish**
 - Paint finishes. No upcharge.

(TBL) Black	(TIN) Ink
(TBZ) Buzz Blue	(TKA) Kalua
(TCC) Cactus	(TLA) Latte
(TCR) Carrot	(TMO) Mocha
(TIV) Cloud	(TNE) Nevada
(TDW) Designer White	(TSN) Sand
(TDJ) Dijon	(TSR) Scarlet
(TEG) Eggplant	(TSH) Shadow
(TFO) Fog	(TOA) Toast
(TFR) Frost	(TTU) Tungsten
 - Plated finish. See models for upcharges.

(CHM) Chrome	(SBR) Satin Brass
(BCH) Brushed Chrome	(ACO) Antique Copper
- Glide type** (for four-leg glide models)
 - (ST) Colored nylon glides for most surfaces.
 - (NM) Natural non-marking nylon glides for most surfaces.
 - (SG) Steel cushioned glides for carpeted surfaces. Add \$19.
 - (FG) Felt glides for most hard floor surfaces. Add \$19.
 - (RG) Rubber non-slip glides for most hard floor surfaces. Add \$19.
- Glide type** (for sled base models)
 - (ST) Colored nylon glides for most surfaces
 - (NM) Natural non-marking nylon glides for most surfaces.
 - (XG) No glides for carpeted surfaces.
- Glide finish** (for all ST glides)

(BLK) Black	(SND) Sand
-------------	------------
- Caster type** (for four-leg caster models)
 - (DC) 2" casters for carpeted surfaces.
 - (RC) 2" casters for most hard floor surfaces. Add \$17.
- Moisture barrier** (on seat)
 - (NB) No moisture barrier.
 - (MB) Moisture barrier. Add \$81. For bariatric models, add \$122.
- Additional weight**
 - (NC) No additional weight.
 - (CW) Additional weight of 24 lbs. Add \$700.

	GLIDES							
	Standard colored (ST) + non-marking (NM) glides - standard height		Steel cushion (SG) glides - 0.313" higher than standard		Felt pad (FG) glides - 0.375" higher than standard		Rubber non-slip (RG) glides - 0.563" higher than standard	
	SEAT HEIGHT (in)	ARM HEIGHT (in)	SEAT HEIGHT (in)	ARM HEIGHT (in)	SEAT HEIGHT (in)	ARM HEIGHT (in)	SEAT HEIGHT (in)	ARM HEIGHT (in)
ARMCHAIRS								
Plastic seat, standard arms	17	26.75	17.31	27.06	17.38	27.13	17.56	27.31
Plastic seat, grip assist arms	17	27	17.31	27.31	17.38	27.38	17.56	27.56
Upholstered seat, standard arms	18.25	26.75	18.56	27.06	18.63	27.13	18.81	27.31
Upholstered seat, grip assist arms	18.25	27	18.56	27.31	18.63	27.38	18.81	27.56
COUNTER STOOLS WITH ARMS								
Plastic seat, standard arms	23.25	33	23.56	33.31	23.63	33.38	23.81	33.56
Plastic seat, grip assist arms	23.25	33.25	23.56	33.56	23.63	33.63	23.81	33.81
Upholstered seat, standard arms	24.25	33	24.56	33.31	24.63	33.38	24.81	33.56
Upholstered seat, grip assist arms	24.25	33.25	24.56	33.56	24.63	33.63	24.81	33.81
BAR STOOLS WITH ARMS								
Plastic seat, standard arms	29.25	39	29.56	39.31	29.63	39.38	29.81	39.56
Plastic seat, grip assist arms	29.25	39.25	29.56	39.56	29.63	39.63	29.81	39.81
Upholstered seat, standard arms	30.25	39	30.56	39.31	30.63	39.38	30.81	39.56
Upholstered seat, grip assist arms	30.25	39.25	30.56	39.56	30.63	39.63	30.81	39.81

DESCRIPTION MODEL# / FEATURES STANDARD TEXTILE GRADES



Stacks 6 high on floor

List price
W5APPG 486
 w/glides



Caster model does not stack

W5APPC 626
 w/casters

	OVERALL DIMENSIONS			SEAT DIMENSIONS			BACK DIMENSIONS	
	W	D	H	W	D	H	W	H
Add \$30 for grip assist arms (GAA)								
Frame plated finish options:	IN 24.25	23.5	32	17.75	17.5	17	16	16
Add \$33 for Chrome (CHM)	MM 616	597	813	451	445	432	406	406
Add \$119 for Brushed Chrome (BCH)								
Add \$176 for Antique Copper (ACO)								
Add \$176 for Satin Brass (SBR)								
	RTA 00 4 per carton (pricing for one chair, specifications for one chair with glides)							

Armchair, Poly Back and Seat
 COM: N/A
 Unit weight: 17.5 LB | 8 KG
 Carton weight: 20.88 LB | 9.47 KG
 Carton volume: 22.25 FT³ | 0.63 MT³



Stacks 4 high on floor

	1	2	3	4	5	6	7	8	9	10	11	12
W5AUPG w/glides	540	556	570	585	611	634	658	678	704	728	760	806



Caster model does not stack

W5AUPC w/casters	680	696	710	725	751	774	798	818	844	868	900	946
-------------------------	-----	-----	-----	-----	-----	-----	-----	-----	-----	-----	-----	-----

	OVERALL DIMENSIONS			SEAT DIMENSIONS			BACK DIMENSIONS	
	W	D	H	W	D	H	W	H
Add \$30 for grip assist arms (GAA)								
Frame plated finish options:	IN 24.25	23.5	32	17.75	17.5	17	16	16
Add \$33 for Chrome (CHM)	MM 616	597	819	451	425	432	419	406
Add \$119 for Brushed Chrome (BCH)								
Add \$176 for Antique Copper (ACO)								
Add \$176 for Satin Brass (SBR)								
	RTA 00 4 per carton (pricing for one chair, specifications for one chair with glides)							

Armchair, Uph Back and Poly Seat
 COM: 0.5 YD | 0.46 M
 Unit weight: 18 LB | 8.2 KG
 Carton weight: 21.38 LB | 9.7 KG
 Carton volume: 22.25 FT³ | 0.63 MT³



Stacks 4 high on floor

W5APUG w/glides	545	569	589	613	651	686	721	752	790	826	875	944
------------------------	-----	-----	-----	-----	-----	-----	-----	-----	-----	-----	-----	-----



Caster model does not stack

W5APUC w/casters	685	709	729	753	791	826	861	892	930	966	1015	1084
-------------------------	-----	-----	-----	-----	-----	-----	-----	-----	-----	-----	------	------

	OVERALL DIMENSIONS			SEAT DIMENSIONS			BACK DIMENSIONS	
	W	D	H	W	D	H	W	H
Add \$30 for grip assist arms (GAA)								
Frame plated finish options:	IN 24.25	23.5	32	18.25	17.75	18.25	16	15.25
Add \$33 for Chrome (CHM)	MM 616	597	813	464	451	464	406	387
Add \$119 for Brushed Chrome (BCH)								
Add \$176 for Antique Copper (ACO)								
Add \$176 for Satin Brass (SBR)								
	RTA 00 4 per carton (pricing for one chair, specifications for one chair with glides)							

Armchair, Poly Back and Uph Seat
 COM: 0.75 YD | 0.69 M
 Unit weight: 18 LB | 8.2 KG
 Carton weight: 21.38 LB | 9.7 KG
 Carton volume: 22.25 FT³ | 0.63 MT³



Stacks 4 high on floor

W5AUUG w/glides	599	639	673	712	776	834	893	944	1008	1068	1149	1264
------------------------	-----	-----	-----	-----	-----	-----	-----	-----	------	------	------	------











Caster model does not stack

W5AUUC w/casters	739	779	813	852	916	974	1033	1084	1148	1208	1289	1404
-------------------------	-----	-----	-----	-----	-----	-----	------	------	------	------	------	------

	OVERALL DIMENSIONS			SEAT DIMENSIONS			BACK DIMENSIONS	
	W	D	H	W	D	H	W	H
Add \$30 for grip assist arms (GAA)								
Frame plated finish options:	IN 24.25	23.5	32.25	18.25	17	18.25	16.5	15.25
Add \$33 for Chrome (CHM)	MM 616	597	819	464	432	464	419	387
Add \$119 for Brushed Chrome (BCH)								
Add \$176 for Antique Copper (ACO)								
Add \$176 for Satin Brass (SBR)								
	RTA 00 4 per carton (pricing for one chair, specifications for one chair with glides)							

Armchair, Uph Back and Seat
 COM: 1.25 YD | 1.14 M
 Unit weight: 18.5 LB | 8.4 KG
 Carton weight: 21.88 LB | 9.92 KG
 Carton volume: 22.25 FT³ | 0.63 MT³

DESCRIPTION	MODEL# / FEATURES	STANDARD TEXTILE GRADES													
 <p>Stacks 6 high on floor</p>	<p>W5NPPG w/glides</p> <p>List price 471</p>														
	<p>W5NPPC w/casters</p> <p>611</p>														
 <p>Caster model does not stack</p>	<p>OVERALL DIMENSIONS</p> <p>W D H</p>	<p>SEAT DIMENSIONS</p> <p>W D H</p>			<p>BACK DIMENSIONS</p> <p>W H</p>										
	<p>Frame plated finish options: Add \$33 for Chrome (CHM) Add \$119 for Brushed Chrome (BCH) Add \$176 for Antique Copper (ACO) Add \$176 for Satin Brass (SBR)</p>	<p>IN 20.75 23.5 32 MM 527 597 813</p>	<p>17.75 17.5 17 451 445 432</p>	<p>16 16 406 406</p>	<p>RTA 00 4 per carton (pricing for one chair, specifications for one chair with glides)</p>										
 <p>Stacks 4 high on floor</p>	<p>W5NUPG w/glides</p>	1	2	3	4	5	6	7	8	9	10	11	12		
	<p>W5NUPC w/casters</p>	525	541	555	570	596	619	643	663	689	713	745	791		
 <p>Caster model does not stack</p>	<p>OVERALL DIMENSIONS</p> <p>W D H</p>	<p>SEAT DIMENSIONS</p> <p>W D H</p>			<p>BACK DIMENSIONS</p> <p>W H</p>										
	<p>Frame plated finish options: Add \$33 for Chrome (CHM) Add \$119 for Brushed Chrome (BCH) Add \$176 for Antique Copper (ACO) Add \$176 for Satin Brass (SBR)</p>	<p>IN 20.75 23.5 32.25 MM 527 597 819</p>	<p>17.75 16.75 17 451 425 432</p>	<p>16.5 16 419 406</p>	<p>RTA 00 4 per carton (pricing for one chair, specifications for one chair with glides)</p>										
 <p>Stacks 4 high on floor</p>	<p>W5NPUG w/glides</p>	1	2	3	4	5	6	7	8	9	10	11	12		
	<p>W5NPUC w/casters</p>	530	554	574	598	636	671	706	737	775	811	860	929		
 <p>Caster model does not stack</p>	<p>OVERALL DIMENSIONS</p> <p>W D H</p>	<p>SEAT DIMENSIONS</p> <p>W D H</p>			<p>BACK DIMENSIONS</p> <p>W H</p>										
	<p>Frame plated finish options: Add \$33 for Chrome (CHM) Add \$119 for Brushed Chrome (BCH) Add \$176 for Antique Copper (ACO) Add \$176 for Satin Brass (SBR)</p>	<p>IN 20.75 23.5 32 MM 527 597 813</p>	<p>18.25 17.75 18.25 464 451 464</p>	<p>16 15.25 406 387</p>	<p>RTA 00 4 per carton (pricing for one chair, specifications for one chair with glides)</p>										
 <p>Stacks 4 high on floor</p>	<p>W5NUUG w/glides</p>	1	2	3	4	5	6	7	8	9	10	11	12		
	<p>W5NUUC w/casters</p>	584	624	658	697	761	819	878	929	993	1053	1134	1249		
 <p>Caster model does not stack</p>	<p>OVERALL DIMENSIONS</p> <p>W D H</p>	<p>SEAT DIMENSIONS</p> <p>W D H</p>			<p>BACK DIMENSIONS</p> <p>W H</p>										
	<p>Frame plated finish options: Add \$33 for Chrome (CHM) Add \$119 for Brushed Chrome (BCH) Add \$176 for Antique Copper (ACO) Add \$176 for Satin Brass (SBR)</p>	<p>IN 20.75 23.5 32.25 MM 527 597 819</p>	<p>18.25 17 18.25 464 432 464</p>	<p>16.5 15.25 419 387</p>	<p>RTA 00 4 per carton (pricing for one chair, specifications for one chair with glides)</p>										

DESCRIPTION MODEL# / FEATURES STANDARD TEXTILE GRADES



Does not stack

Armchair, Sled Base, Poly Back and Seat
 COM: N/A
 Unit weight: 22 LB | 10 KG
 Carton weight: 29.5 LB | 13.38 KG
 Carton volume: 13.25 FT³ | 0.37 MT³

List price												
W6APP	575											
Add \$30 for grip assist arms (GAA)	OVERALL DIMENSIONS			SEAT DIMENSIONS			BACK DIMENSIONS					
	W	D	H	W	D	H	W	H				
Frame plated finish options:	IN	24.25	23.75	32	17.75	17.75	17.75	16	16			
Add \$42 for Chrome (CHM)	MM	616	603	813	451	451	451	406	406			
Add \$145 for Brushed Chrome (BCH)												
Add \$213 for Antique Copper (ACO)												
Add \$213 for Satin Brass (SBR)	RTA 00	1 per carton										



Does not stack

Armchair, Sled Base, Uph Back and Poly Seat
 COM: 0.5 YD | 0.46 M
 Unit weight: 22.5 LB | 10.2 KG
 Carton weight: 30 LB | 13.61 KG
 Carton volume: 13.25 FT³ | 0.37 MT³

W6AUP	629	645	659	674	700	723	747	767	793	817	849	895
Add \$30 for grip assist arms (GAA)	OVERALL DIMENSIONS			SEAT DIMENSIONS			BACK DIMENSIONS					
	W	D	H	W	D	H	W	H				
Frame plated finish options:	IN	24.25	23.75	32.25	17.75	17.75	17.75	16.5	16			
Add \$42 for Chrome (CHM)	MM	616	603	819	451	451	451	419	406			
Add \$145 for Brushed Chrome (BCH)												
Add \$213 for Antique Copper (ACO)												
Add \$213 for Satin Brass (SBR)	RTA 00	1 per carton										



Does not stack

Armchair, Sled Base, Poly Back and Uph Seat
 COM: 0.75 YD | 0.69 M
 Unit weight: 22.5 LB | 10.2 KG
 Carton weight: 30 LB | 13.61 KG
 Carton volume: 13.25 FT³ | 0.37 MT³

W6APU	634	658	678	702	740	775	810	841	879	915	964	1033
Add \$30 for grip assist arms (GAA)	OVERALL DIMENSIONS			SEAT DIMENSIONS			BACK DIMENSIONS					
	W	D	H	W	D	H	W	H				
Frame plated finish options:	IN	24.25	23.75	32	18.25	17.75	18.25	16	15.25			
Add \$42 for Chrome (CHM)	MM	616	603	813	464	451	464	406	387			
Add \$145 for Brushed Chrome (BCH)												
Add \$213 for Antique Copper (ACO)												
Add \$213 for Satin Brass (SBR)	RTA 00	1 per carton										



Does not stack

Armchair, Sled Base, Uph Back and Seat
 COM: 1.25 YD | 1.14 M
 Unit weight: 23 LB | 10.5 KG
 Carton weight: 30.5 LB | 13.83 KG
 Carton volume: 13.25 FT³ | 0.37 MT³

W6AAU	685	725	759	798	862	920	979	1030	1094	1154	1235	1350
Add \$30 for grip assist arms (GAA)	OVERALL DIMENSIONS			SEAT DIMENSIONS			BACK DIMENSIONS					
	W	D	H	W	D	H	W	H				
Frame plated finish options:	IN	24.25	23.75	32.25	18.25	16.5	18.25	16.5	15.25			
Add \$42 for Chrome (CHM)	MM	616	603	819	464	419	464	419	387			
Add \$145 for Brushed Chrome (BCH)												
Add \$213 for Antique Copper (ACO)												
Add \$213 for Satin Brass (SBR)	RTA 00	1 per carton										



Does not stack

Armless Chair, Sled Base, Poly Back and Seat
 COM: N/A
 Unit weight: 19.5 LB | 8.9 KG
 Carton weight: 26.5 LB | 12.02 KG
 Carton volume: 11.75 FT³ | 0.33 MT³



List price												
W6NPP	560											
	OVERALL DIMENSIONS			SEAT DIMENSIONS			BACK DIMENSIONS					
	W	D	H	W	D	H	W	H				
Frame plated finish options:	IN	20.75	23.5	32	17.75	17.75	17.75	16	16			
Add \$42 for Chrome (CHM)	MM	527	597	813	451	451	451	406	406			
Add \$145 for Brushed Chrome (BCH)												
Add \$213 for Antique Copper (ACO)												
Add \$213 for Satin Brass (SBR)	RTA 00	1 per carton										



Does not stack

Armless Chair, Sled Base, Uph Back and Poly Seat
 COM: 0.5 YD | 0.46 M
 Unit weight: 20 LB | 9.1 KG
 Carton weight: 27 LB | 12.25 KG
 Carton volume: 11.75 FT³ | 0.33 MT³

W6NUP	614	630	644	659	685	708	732	752	778	802	834	880
	OVERALL DIMENSIONS			SEAT DIMENSIONS			BACK DIMENSIONS					
	W	D	H	W	D	H	W	H				
Frame plated finish options:	IN	20.75	23.5	32.25	17.75	17.75	17.75	16.5	16			
Add \$42 for Chrome (CHM)	MM	527	597	819	451	451	451	419	406			
Add \$145 for Brushed Chrome (BCH)												
Add \$213 for Antique Copper (ACO)												
Add \$213 for Satin Brass (SBR)	RTA 00	1 per carton										

DESCRIPTION	MODEL# / FEATURES	STANDARD TEXTILE GRADES											
		1	2	3	4	5	6	7	8	9	10	11	12
 <p>Does not stack</p> <p>Armless Chair, Sled Base, Poly Back and Uph Seat COM: 0.75 YD 0.69 M Unit weight: 20 LB 9.1 KG Carton weight: 27 LB 12.25 KG Carton volume: 11.75 FT³ 0.33 MT³</p>	W6NPU	619	643	663	687	725	760	795	826	864	900	949	1018
		OVERALL DIMENSIONS			SEAT DIMENSIONS			BACK DIMENSIONS					
		W	D	H	W	D	H	W	H				
	Frame plated finish options:	IN 20.75	23.5	32	18.25	17.75	18.25	16	15.25				
	Add \$42 for Chrome (CHM)	MM 527	597	813	464	451	464	406	387				
	Add \$145 for Brushed Chrome (BCH)												
	Add \$213 for Antique Copper (ACO)												
	Add \$213 for Satin Brass (SBR)	RTA 00	1 per carton										
 <p>Does not stack</p> <p>Armless Chair, Sled Base, Uph Back and Seat COM: 1.25 YD 1.14 M Unit weight: 20.5 LB 9.3 KG Carton weight: 27.5 LB 12.47 KG Carton volume: 11.75 FT³ 0.33 MT³</p>	W6NUU	670	710	744	783	847	905	964	1015	1079	1139	1220	1335
		OVERALL DIMENSIONS			SEAT DIMENSIONS			BACK DIMENSIONS					
		W	D	H	W	D	H	W	H				
	Frame plated finish options:	IN 20.75	23.5	32.25	18.25	16.5	18.25	16.5	15.25				
	Add \$42 for Chrome (CHM)	MM 527	597	819	464	419	464	419	387				
	Add \$145 for Brushed Chrome (BCH)												
	Add \$213 for Antique Copper (ACO)												
	Add \$213 for Satin Brass (SBR)	RTA 00	1 per carton										
 <p>Stacks 4 high on floor</p> <p>Bariatric Armchair, Uph Back and Seat COM: 1.75 YD 1.6 M Unit weight: 30 LB 13.6 KG Carton weight: 41 LB 18.6 KG Carton volume: 20.5 FT³ 0.58 MT³</p>	W530AUU	889	945	992	1047	1136	1218	1300	1372	1461	1545	1659	1820
		OVERALL DIMENSIONS			SEAT DIMENSIONS			BACK DIMENSIONS					
		W	D	H	W	D	H	W	H				
	Frame plated finish options:	IN 35.25	23.5	32.25	29	17	18.25	26.75	15.25				
	Add \$57 for Chrome (CHM)	MM 895	597	819	737	432	464	679	387				
	Add \$185 for Brushed Chrome (BCH)												
	Add \$271 for Antique Copper (ACO)												
	Add \$271 for Satin Brass (SBR)	RTA 00	1 per carton										
	Add \$30 for grip assist arms (GAA)												
 <p>Stacks 4 high on floor</p> <p>Bariatric Armless Chair, Uph Back and Seat COM: 1.75 YD 1.6 M Unit weight: 27.5 LB 12.5 KG Carton weight: 37.5 LB 17.01 KG Carton volume: 16.75 FT³ 0.47 MT³</p>	W530NUU	874	930	977	1032	1121	1203	1285	1357	1446	1530	1644	1805
		OVERALL DIMENSIONS			SEAT DIMENSIONS			BACK DIMENSIONS					
		W	D	H	W	D	H	W	H				
	Frame plated finish options:	IN 31.75	23.5	32.25	29	17	18.25	26.75	15.25				
	Add \$57 for Chrome (CHM)	MM 806	597	819	737	432	464	679	387				
	Add \$185 for Brushed Chrome (BCH)												
	Add \$271 for Antique Copper (ACO)												
	Add \$271 for Satin Brass (SBR)	RTA 00	1 per carton										
 <p>Does not stack</p> <p>Bariatric Armchair, Sled Base, Uph Back and Seat COM: 1.75 YD 1.6 M Unit weight: 34 LB 15.5 KG Carton weight: 45 LB 20.41 KG Carton volume: 20.5 FT³ 0.58 MT³</p>	W630AUU	978	1034	1081	1136	1225	1307	1389	1461	1550	1634	1748	1909
		OVERALL DIMENSIONS			SEAT DIMENSIONS			BACK DIMENSIONS					
		W	D	H	W	D	H	W	H				
	Frame plated finish options:	IN 35.25	23.5	32.25	29	17	18.25	26.75	15.25				
	Add \$57 for Chrome (CHM)	MM 895	597	819	737	432	464	679	387				
	Add \$185 for Brushed Chrome (BCH)												
	Add \$271 for Antique Copper (ACO)												
	Add \$271 for Satin Brass (SBR)	RTA 00	1 per carton										
	Add \$30 for grip assist arms (GAA)												
 <p>Does not stack</p> <p>Bariatric Armless Chair, Sled Base, Uph Back and Seat COM: 1.75 YD 1.6 M Unit weight: 31.5 LB 14.3 KG Carton weight: 41.5 LB 18.82 KG Carton volume: 16.75 FT³ 0.47 MT³</p>	W630NUU	960	1016	1063	1118	1207	1289	1371	1443	1532	1616	1730	1891
		OVERALL DIMENSIONS			SEAT DIMENSIONS			BACK DIMENSIONS					
		W	D	H	W	D	H	W	H				
	Frame plated finish options:	IN 31.75	23.5	32.25	29	17	18.25	26.75	15.25				
	Add \$57 for Chrome (CHM)	MM 806	597	819	737	432	464	679	387				
	Add \$185 for Brushed Chrome (BCH)												
	Add \$271 for Antique Copper (ACO)												
	Add \$271 for Satin Brass (SBR)	RTA 00	1 per carton										

DESCRIPTION MODEL# / FEATURES STANDARD TEXTILE GRADES



Does not stack

Counter Stool w/Arms, Poly Back and Seat
 COM: N/A
 Unit weight: 23 LB | 10.5 KG
 Carton weight: 32.5 LB | 14.74 KG
 Carton volume: 15 FT³ | 0.42 MT³

List price												
W5CSAPP	631											
Add \$30 for grip assist arms (GAA)	OVERALL DIMENSIONS			SEAT DIMENSIONS			BACK DIMENSIONS					
	W	D	H	W	D	H	W	H				
Frame plated finish options:	IN	24.25	23.5	38.25	17.75	17.15	23.25	16	16			
Add \$60 for Chrome (CHM)	MM	616	597	972	451	436	591	406	406			
Add \$197 for Brushed Chrome (BCH)												
Add \$288 for Antique Copper (ACO)												
Add \$288 for Satin Brass (SBR)	RTA 00	1 per carton										



Does not stack

Counter Stool w/Arms, Uph Back and Poly Seat
 COM: 0.5 YD | 0.46 M
 Unit weight: 23.5 LB | 10.7 KG
 Carton weight: 33 LB | 14.97 KG
 Carton volume: 15 FT³ | 0.42 MT³

	1	2	3	4	5	6	7	8	9	10	11	12
W5CSAUP	685	701	715	730	756	779	803	823	849	873	905	951
Add \$30 for grip assist arms (GAA)	OVERALL DIMENSIONS			SEAT DIMENSIONS			BACK DIMENSIONS					
	W	D	H	W	D	H	W	H				
Frame plated finish options:	IN	24.25	23.5	38.25	17.75	16.5	23.25	16.5	16			
Add \$60 for Chrome (CHM)	MM	616	597	972	451	419	591	419	406			
Add \$197 for Brushed Chrome (BCH)												
Add \$288 for Antique Copper (ACO)												
Add \$288 for Satin Brass (SBR)	RTA 00	1 per carton										



Does not stack

Counter Stool w/Arms, Poly Back and Uph Seat
 COM: 0.75 YD | 0.69 M
 Unit weight: 23.5 LB | 10.7 KG
 Carton weight: 33 LB | 14.97 KG
 Carton volume: 15 FT³ | 0.42 MT³

	1	2	3	4	5	6	7	8	9	10	11	12
W5CSAPU	690	714	734	758	796	831	866	897	935	971	1020	1089
Add \$30 for grip assist arms (GAA)	OVERALL DIMENSIONS			SEAT DIMENSIONS			BACK DIMENSIONS					
	W	D	H	W	D	H	W	H				
Frame plated finish options:	IN	24.25	23.5	38.25	18.25	17.75	24.25	16	15.25			
Add \$60 for Chrome (CHM)	MM	616	597	972	464	451	616	406	387			
Add \$197 for Brushed Chrome (BCH)												
Add \$288 for Antique Copper (ACO)												
Add \$288 for Satin Brass (SBR)	RTA 00	1 per carton										



Does not stack

Counter Stool w/Arms, Uph Back and Seat
 COM: 1.25 YD | 1.14 M
 Unit weight: 24 LB | 10.9 KG
 Carton weight: 33.5 LB | 15.2 KG
 Carton volume: 15 FT³ | 0.42 MT³

	1	2	3	4	5	6	7	8	9	10	11	12
W5CSAUU	744	784	818	857	921	979	1038	1089	1153	1213	1294	1409
Add \$30 for grip assist arms (GAA)	OVERALL DIMENSIONS			SEAT DIMENSIONS			BACK DIMENSIONS					
	W	D	H	W	D	H	W	H				
Frame plated finish options:	IN	24.25	23.5	38.25	18.25	17	24.25	16.5	15.25			
Add \$60 for Chrome (CHM)	MM	616	597	972	464	432	616	419	387			
Add \$197 for Brushed Chrome (BCH)												
Add \$288 for Antique Copper (ACO)												
Add \$288 for Satin Brass (SBR)	RTA 00	1 per carton										



Stacks 4 on the floor

Armless Counter Stool, Poly Back and Seat
 COM: N/A
 Unit weight: 20.5 LB | 9.3 KG
 Carton weight: 29.5 LB | 13.38 KG
 Carton volume: 13.75 FT³ | 0.38 MT³







	1	2	3	4	5	6	7	8	9	10	11	12
W5CSNPP	616											
	OVERALL DIMENSIONS			SEAT DIMENSIONS			BACK DIMENSIONS					
	W	D	H	W	D	H	W	H				
Frame plated finish options:	IN	21.75	23.5	38.25	17.75	17.15	23.25	16	16			
Add \$60 for Chrome (CHM)	MM	552	597	972	451	436	591	406	406			
Add \$197 for Brushed Chrome (BCH)												
Add \$288 for Antique Copper (ACO)												
Add \$288 for Satin Brass (SBR)	RTA 00	1 per carton										



Stacks 4 on the floor

Armless Counter Stool, Uph Back and Poly Seat
 COM: 0.5 YD | 0.46 M
 Unit weight: 21 LB | 9.5 KG
 Carton weight: 30 LB | 13.61 KG
 Carton volume: 13.75 FT³ | 0.38 MT³

	1	2	3	4	5	6	7	8	9	10	11	12
W5CSNUP	670	686	700	715	741	764	788	808	834	858	890	936
	OVERALL DIMENSIONS			SEAT DIMENSIONS			BACK DIMENSIONS					
	W	D	H	W	D	H	W	H				
Frame plated finish options:	IN	21.75	23.5	38.25	17.75	16.5	23.25	16.5	16			
Add \$60 for Chrome (CHM)	MM	552	597	972	451	419	591	419	406			
Add \$197 for Brushed Chrome (BCH)												
Add \$288 for Antique Copper (ACO)												
Add \$288 for Satin Brass (SBR)	RTA 00	1 per carton										

DESCRIPTION	MODEL# / FEATURES	STANDARD TEXTILE GRADES											
		1	2	3	4	5	6	7	8	9	10	11	12
 <p>Stacks 4 on the floor</p> <p>Armless Counter Stool, Poly Back and Uph Seat COM: 0.75 YD 0.69 M Unit weight: 21 LB 9.5 KG Carton weight: 30 LB 13.61 KG Carton volume: 13.75 FT³ 0.38 MT³</p>	W5CSNPU	675	699	719	743	781	816	851	882	920	956	1005	1074
		OVERALL DIMENSIONS			SEAT DIMENSIONS			BACK DIMENSIONS					
		W	D	H	W	D	H	W	H				
		IN 21.75	23.5	38.25	18.25	17.75	24.25	16	15.25				
	MM 552	597	972	464	451	616	406	387					
	Frame plated finish options: Add \$60 for Chrome (CHM) Add \$197 for Brushed Chrome (BCH) Add \$288 for Antique Copper (ACO) Add \$288 for Satin Brass (SBR)	RTA 00	1 per carton										
 <p>Stacks 4 on the floor</p> <p>Armless Counter Stool, Uph Back and Seat COM: 1.25 YD 1.14 M Unit weight: 21.5 LB 9.8 KG Carton weight: 30.5 LB 13.83 KG Carton volume: 13.75 FT³ 0.38 MT³</p>	W5CSNUU	729	769	803	842	906	964	1023	1074	1138	1198	1279	1394
		OVERALL DIMENSIONS			SEAT DIMENSIONS			BACK DIMENSIONS					
		W	D	H	W	D	H	W	H				
		IN 21.75	23.5	38.25	18.25	17	24.25	16.5	15.25				
	MM 552	597	972	464	432	616	419	387					
	Frame plated finish options: Add \$60 for Chrome (CHM) Add \$197 for Brushed Chrome (BCH) Add \$288 for Antique Copper (ACO) Add \$288 for Satin Brass (SBR)	RTA 00	1 per carton										
 <p>Does not stack</p> <p>Bar Stool w/Arms, Poly Back and Seat COM: N/A Unit weight: 24.5 LB 11.1 KG Carton weight: 34.5 LB 15.65 KG Carton volume: 17 FT³ 0.48 MT³</p>	W5BSAPP	List price 636											
		OVERALL DIMENSIONS			SEAT DIMENSIONS			BACK DIMENSIONS					
		W	D	H	W	D	H	W	H				
		IN 24.25	23.5	44	17.75	17.5	29.25	16	16				
	MM 616	597	1118	451	445	743	406	406					
	Frame plated finish options: Add \$60 for Chrome (CHM) Add \$197 for Brushed Chrome (BCH) Add \$288 for Antique Copper (ACO) Add \$288 for Satin Brass (SBR)	RTA 00	1 per carton										
	Add \$30 for grip assist arms (GAA)												
 <p>Does not stack</p> <p>Bar Stool w/Arms, Uph Back and Poly Seat COM: 0.5 YD 0.46 M Unit weight: 25 LB 11.4 KG Carton weight: 35 LB 15.88 KG Carton volume: 17 FT³ 0.48 MT³</p>	W5BSAUP	690	706	720	735	761	784	808	828	854	878	910	956
		OVERALL DIMENSIONS			SEAT DIMENSIONS			BACK DIMENSIONS					
		W	D	H	W	D	H	W	H				
		IN 24.25	23.5	44.5	17.75	16.5	29.25	16.5	16				
	MM 616	597	1130	451	419	743	419	406					
	Frame plated finish options: Add \$60 for Chrome (CHM) Add \$197 for Brushed Chrome (BCH) Add \$288 for Antique Copper (ACO) Add \$288 for Satin Brass (SBR)	RTA 00	1 per carton										
	Add \$30 for grip assist arms (GAA)												
 <p>Does not stack</p> <p>Bar Stool w/Arms, Poly Back and Uph Seat COM: 0.75 YD 0.69 M Unit weight: 25 LB 11.4 KG Carton weight: 35 LB 15.88 KG Carton volume: 17 FT³ 0.48 MT³</p>	W5BSAPU	695	711	725	740	766	789	813	833	859	883	915	961
		OVERALL DIMENSIONS			SEAT DIMENSIONS			BACK DIMENSIONS					
		W	D	H	W	D	H	W	H				
		IN 24.25	23.5	44	18.25	17.5	30.25	16	15.25				
	MM 616	597	1118	464	445	768	406	387					
	Frame plated finish options: Add \$60 for Chrome (CHM) Add \$197 for Brushed Chrome (BCH) Add \$288 for Antique Copper (ACO) Add \$288 for Satin Brass (SBR)	RTA 00	1 per carton										
	Add \$30 for grip assist arms (GAA)												
 <p>Does not stack</p> <p>Bar Stool w/Arms, Uph Back and Seat COM: 1.25 YD 1.14 M Unit weight: 25.5 LB 11.6 KG Carton weight: 35.5 LB 16.1 KG Carton volume: 17 FT³ 0.48 MT³</p>	W5BSAUU	749	789	823	862	926	984	1043	1094	1158	1218	1299	1414
		OVERALL DIMENSIONS			SEAT DIMENSIONS			BACK DIMENSIONS					
		W	D	H	W	D	H	W	H				
		IN 24.25	23.5	44.5	18.25	16.75	30.25	16.5	15.25				
	MM 616	597	1130	464	425	768	419	387					
	Frame plated finish options: Add \$60 for Chrome (CHM) Add \$197 for Brushed Chrome (BCH) Add \$288 for Antique Copper (ACO) Add \$288 for Satin Brass (SBR)	RTA 00	1 per carton										
	Add \$30 for grip assist arms (GAA)												

DESCRIPTION MODEL# / FEATURES STANDARD TEXTILE GRADES



Stacks 4 on the floor

Armless Bar Stool, Poly Back and Seat
 COM: N/A
 Unit weight: 22 LB | 10 KG
 Carton weight: 31.5 LB | 14.29 KG
 Carton volume: 15.75 FT³ | 0.44 MT³

List price											
W5BSNPP											
621											
OVERALL DIMENSIONS			SEAT DIMENSIONS			BACK DIMENSIONS					
W	D	H	W	D	H	W	H				
IN 20.75	23.5	44	17.75	17.5	29.25	16	16				
MM 527	597	1118	451	445	743	406	406				
Frame plated finish options:											
Add \$60 for Chrome (CHM)											
Add \$197 for Brushed Chrome (BCH)											
Add \$288 for Antique Copper (ACO)											
Add \$288 for Satin Brass (SBR)											
RTA 00 1 per carton											



Stacks 4 on the floor

Armless Bar Stool, Uph Back and Poly Seat
 COM: 0.5 YD | 0.46 M
 Unit weight: 22.5 LB | 10.2 KG
 Carton weight: 32 LB | 14.51 KG
 Carton volume: 15.75 FT³ | 0.44 MT³

1 2 3 4 5 6 7 8 9 10 11 12											
W5BSNUP											
675 691 705 720 746 769 793 813 839 863 895 941											
OVERALL DIMENSIONS			SEAT DIMENSIONS			BACK DIMENSIONS					
W	D	H	W	D	H	W	H				
IN 20.75	23.5	44.5	17.75	16.5	29.25	16.5	16				
MM 527	597	1130	451	419	743	419	406				
Frame plated finish options:											
Add \$60 for Chrome (CHM)											
Add \$197 for Brushed Chrome (BCH)											
Add \$288 for Antique Copper (ACO)											
Add \$288 for Satin Brass (SBR)											
RTA 00 1 per carton											



Stacks 4 on the floor

Armless Bar Stool, Poly Back and Uph Seat
 COM: 0.75 YD | 0.69 M
 Unit weight: 22.5 LB | 10.2 KG
 Carton weight: 32 LB | 14.51 KG
 Carton volume: 15.75 FT³ | 0.44 MT³

1 2 3 4 5 6 7 8 9 10 11 12											
W5BSNPU											
680 704 724 748 786 821 856 887 925 961 1010 1079											
OVERALL DIMENSIONS			SEAT DIMENSIONS			BACK DIMENSIONS					
W	D	H	W	D	H	W	H				
IN 20.75	23.5	44	18.25	17.5	30.25	16	15.25				
MM 527	597	1118	464	445	768	406	387				
Frame plated finish options:											
Add \$60 for Chrome (CHM)											
Add \$197 for Brushed Chrome (BCH)											
Add \$288 for Antique Copper (ACO)											
Add \$288 for Satin Brass (SBR)											
RTA 00 1 per carton											



Stacks 4 on the floor

Armless Bar Stool, Uph Back and Seat
 COM: 1.25 YD | 1.14 M
 Unit weight: 23 LB | 10.5 KG
 Carton weight: 32.5 LB | 14.74 KG
 Carton volume: 15.75 FT³ | 0.44 MT³

1 2 3 4 5 6 7 8 9 10 11 12											
W5BSNUU											
734 774 808 847 911 969 1028 1079 1143 1203 1284 1399											
OVERALL DIMENSIONS			SEAT DIMENSIONS			BACK DIMENSIONS					
W	D	H	W	D	H	W	H				
IN 20.75	23.5	44.5	18.25	16.75	30.25	16.5	15.25				
MM 527	597	1130	464	425	768	419	387				
Frame plated finish options:											
Add \$60 for Chrome (CHM)											
Add \$197 for Brushed Chrome (BCH)											
Add \$288 for Antique Copper (ACO)											
Add \$288 for Satin Brass (SBR)											
RTA 00 1 per carton											



Does not stack

Hip Chair, Poly Back and Seat
 COM: N/A
 Unit weight: 25 LB | 11.4 KG
 Carton weight: 35.5 LB | 16.1 KG
 Carton volume: 17.75 FT³ | 0.5 MT³









List price											
W524APP											
671											
OVERALL DIMENSIONS			SEAT DIMENSIONS			BACK DIMENSIONS					
W	D	H	W	D	H	W	H				
IN 24.25	24.25	38	17.75	17.5	22.25	16	16				
MM 616	616	965	451	445	565	406	406				
Add \$30 for grip assist arms (GAA)											
Frame plated finish options:											
Add \$57 for Chrome (CHM)											
Add \$185 for Brushed Chrome (BCH)											
Add \$271 for Antique Copper (ACO)											
Add \$271 for Satin Brass (SBR)											
RTA 00 1 per carton											



Does not stack

Hip Chair, Uph Back and Poly Seat
 COM: 0.5 YD | 0.46 M
 Unit weight: 25.5 LB | 11.6 KG
 Carton weight: 36 LB | 16.33 KG
 Carton volume: 17.75 FT³ | 0.5 MT³

1 2 3 4 5 6 7 8 9 10 11 12											
W524AUP											
725 741 755 770 796 819 843 863 889 913 945 991											
OVERALL DIMENSIONS			SEAT DIMENSIONS			BACK DIMENSIONS					
W	D	H	W	D	H	W	H				
IN 24.25	24.25	38.25	17.75	16.5	22.25	16.5	16.25				
MM 616	616	972	451	419	565	419	413				
Add \$30 for grip assist arms (GAA)											
Frame plated finish options:											
Add \$57 for Chrome (CHM)											
Add \$185 for Brushed Chrome (BCH)											
Add \$271 for Antique Copper (ACO)											
Add \$271 for Satin Brass (SBR)											
RTA 00 1 per carton											

DESCRIPTION	MODEL# / FEATURES	STANDARD TEXTILE GRADES											
		1	2	3	4	5	6	7	8	9	10	11	12
 <p>Does not stack</p> <p>Hip Chair, Poly Back and Uph Seat COM: 0.75 YD 0.69 M Unit weight: 25.5 LB 11.6 KG Carton weight: 36 LB 16.33 KG Carton volume: 17.75 FT³ 0.5 MT³</p>	W524APU	730	754	774	798	836	871	906	937	975	1011	1060	1129
	Add \$30 for grip assist arms (GAA)	OVERALL DIMENSIONS			SEAT DIMENSIONS			BACK DIMENSIONS					
		W	D	H	W	D	H	W	H				
	Frame plated finish options: Add \$57 for Chrome (CHM) Add \$185 for Brushed Chrome (BCH) Add \$271 for Antique Copper (ACO) Add \$271 for Satin Brass (SBR)	IN 24.25 MM 616	24.25 616	38 965	18.25 464	17.5 445	23.25 591	16 406	15.25 387				
	RTA 00	1 per carton											
 <p>Does not stack</p> <p>Hip Chair, Uph Back and Seat COM: 1.25 YD 1.14 M Unit weight: 26 LB 11.8 KG Carton weight: 36.5 LB 16.56 KG Carton volume: 17.75 FT³ 0.5 MT³</p>	W524AUU	784	824	858	897	961	1019	1078	1129	1193	1253	1334	1449
	Add \$30 for grip assist arms (GAA)	OVERALL DIMENSIONS			SEAT DIMENSIONS			BACK DIMENSIONS					
		W	D	H	W	D	H	W	H				
	Frame plated finish options: Add \$57 for Chrome (CHM) Add \$185 for Brushed Chrome (BCH) Add \$271 for Antique Copper (ACO) Add \$271 for Satin Brass (SBR)	IN 24.25 MM 616	24.25 616	38.25 972	18.25 464	16.5 419	23.25 591	16.5 419	15.25 387				
	RTA 00	1 per carton											
 <p>Does not stack</p> <p>Bariatric Hip Chair, Uph Back and Seat COM: 1.75 YD 1.6 M Unit weight: 38 LB 17.3 KG Carton weight: 50 LB 22.68 KG Carton volume: 23.75 FT³ 0.67 MT³</p>	W324AUU	1074	1130	1177	1232	1321	1403	1485	1557	1646	1730	1844	2005
	Casters not available.	OVERALL DIMENSIONS			SEAT DIMENSIONS			BACK DIMENSIONS					
	Add \$30 for grip assist arms (GAA)	W	D	H	W	D	H	W	H				
	Frame plated finish options: Add \$57 for Chrome (CHM) Add \$185 for Brushed Chrome (BCH) Add \$271 for Antique Copper (ACO) Add \$271 for Satin Brass (SBR)	IN 35.25 MM 895	24.25 616	38.5 978	29 737	17.5 445	23.25 591	26.75 679	15.25 387				
	RTA 00	1 per carton											
		List price											
	WDOL	435											
 <p>Dolly for Four-Leg Chairs COM: N/A Unit weight: 13 LB 5.9 KG Carton weight: 16 LB 7.26 KG Carton volume: 3.5 FT³ 0.09 MT³</p>	OVERALL DIMENSIONS			SEAT DIMENSIONS			BACK DIMENSIONS						
	Accommodates 10 standard four-leg chairs	W	D	H	W	D	H	W	H				
		IN 22 MM 559	23.75 603	9.25 235	-	-	-	-	-				
		RTA 00		1 per carton									
		List price											
	WDOL30	610											
 <p>Dolly for Bariatric Four-Leg Chairs COM: N/A Unit weight: 15 LB 6.8 KG Carton weight: 19 LB 8.62 KG Carton volume: 5 FT³ 0.14 MT³</p>	OVERALL DIMENSIONS			SEAT DIMENSIONS			BACK DIMENSIONS						
	Accommodates 4 bariatric four-leg chairs	W	D	H	W	D	H	W	H				
		IN 32.12 MM 816	23.75 603	9.25 235	-	-	-	-	-				
		RTA 00		1 per carton									
		List price											
	WPGBRK	92											
 <p>Ganging Bracket COM: N/A Unit weight: 4 LB 1.81 KG Carton weight: 2 LB 0.91 KG Carton volume: 2 FT³ 0.05 MT³</p>	OVERALL DIMENSIONS			SEAT DIMENSIONS			BACK DIMENSIONS						
	Does not accept power units. For use between 2 seated height arm or armless chairs where table top is not desired. Not usable with stool models.	W	D	H	W	D	H	W	H				
		IN 15 MM 381	9 229	1.25 32	-	-	-	-	-				
		RTA 00		1 per carton									

WILLOW LINKING TABLES



model WPT12G
120 degree corner linking table

model WPTTEGL
end linking table - left



Willow seating



For Willow seating, see page 232.

EXAMPLE WILLOW TABLE ORDER CODE:

WPT90G	HPL	ACJ	CHM	ST	SND
Model #	Surface type	Top finish	Leg finish	Glide type	Glide finish









STANDARD FEATURES

- Linking tables can be used together in any combination with Willow four-leg or sled base chairs to create a wide variety of layouts.
- Connecting hardware is included.
- Legs and ganging brackets are available in 20 paint finishes or 4 plated finishes with an upcharge.
- Tables are available in thermally fused or high pressure laminate, and feature a flat edge with edge band.
- Various table glide options are available. Glides must be chosen to best suit flooring type and site conditions. For more information, please refer to glide selection chart (page 274).
- All tables (except 9" in-line linking table) are predrilled for center front field installation of undermount power. Specify separately.
- Undermount power unit (model SU2P10U) includes 1 AC and 2 USB-A charging ports with a 10' power cord and 3-prong plug. Specify Jet Black or White. Power units are not designed for daisy-chaining.
- Clamp mount (model SU2P10C) power includes 1 AC and 2 USB-A charging ports with a 10' power cord. Specify Jet Black or White. These units can be mounted on the back edge of all linking tables. Specify separately for field installation. Power units are not designed for daisy-chaining.

Please add option codes in the following order:

- **Model number**
- **Surface type**
(TFL) Thermally fused laminate
(HPL) High pressure laminate
- **Top finish**
(ACJ) Absolute Acajou (NBL) Noce Biondo
(ASN) Asian Night (NGL) Noce Grigio
(AWC) Avant Cherry (NEL) Noce Leggero
(AWH) Avant Honey (NML) Noce Medio
(BLK) Black (OTM) Quartered Mahogany
(BRC) Brushed Cobalt (SBY) Sheer Beauty
(CMB) Clear Maple (SOG) Storm Grey
(DES) Dark Espresso (WHE) Walnut Heights
(DWT) Designer White (WHC) White Chocolate
(FAS) Fashionista (WCR) Winter Cherry
(FCL) First Class
- **Leg finish**
Paint finishes. No upcharge.
(TBL) Black (TIN) Ink
(TBZ) Buzz Blue (TKA) Kalua
(TCC) Cactus (TLA) Latte
(TCR) Carrot (TMO) Mocha
(TIV) Cloud (TNE) Nevada
(TDW) Designer White (TSN) Sand
(TDJ) Dijon (TSR) Scarlet
(TEG) Eggplant (TSH) Shadow
(TFO) Fog (TOA) Toast
(TFR) Frost (TTU) Tungsten
- Plated finish. See models for upcharges.
(CHM) Chrome (SBR) Satin Brass
(BCH) Brushed Chrome (ACO) Antique Copper
- **Bracket finish** (for linking tables)
Paint finishes. No upcharge.
(TBL) Black (TMO) Mocha
(TIV) Cloud (TNE) Nevada
(TDW) Designer White (TSN) Sand
(TFO) Fog (TSH) Shadow
(TFR) Frost (TOA) Toast
(TKA) Kalua (TTU) Tungsten
(TLA) Latte
- **Glide type** (for models with legs)
(ST) Colored nylon glides for most surfaces
(NM) Natural, non-marking nylon glides for most surfaces.
(SG) Steel cushioned glides for carpeted surfaces. Add \$10.
(FG) Felt glides for most hard floor surfaces. Add \$10.
(RG) Rubber non-slip glides for most hard floor surfaces. Add \$10.
- **Glide finish** (for all ST glides)
(BLK) Black
(SND) Sand

DESCRIPTION	MODEL# / FEATURES	STANDARD TEXTILE GRADES					
		List price			HPL add		
	WPT90G	475	116				
 90 Degree Corner Linking Table COM: N/A Unit weight: 20 LB 9.1 KG Carton weight: 24 LB 10.89 KG Carton volume: 2.6 FT³ 0.07 MT³	Must be connected to a 4-leg or sled base chair. Includes 1 set of U-channel connectors and hardware. Shipped KD for assembly on site.	IN 26.12	26.12	17.62	-	-	-
		MM 664	664	448	-	-	-
		RTA 2	courier	1 per carton			

DESCRIPTION	MODEL# / FEATURES	STANDARD TEXTILE GRADES							
		List price		HPL add					
 <p>120 Degree Corner Linking Table COM: N/A Unit weight: 13.5 LB 6.1 KG Carton weight: 16.5 LB 7.48 KG Carton volume: 1.5 FT³ 0.04 MT³</p>	WPT12G	406	74						
		Must be connected to a 4-leg or sled base chair. Includes 1 set of U-channel connectors and hardware.		Shipped KD for assembly on site.		RTA 2  1 per carton			
 <p>16" In-line Linking Table COM: N/A Unit weight: 10 LB 4.5 KG Carton weight: 12 LB 5.44 KG Carton volume: 0.9 FT³ 0.02 MT³</p>	WPT16G	265	47						
		Must be connected to a 4-leg or sled base chair. Includes 1 set of U-channel connectors and hardware.		Shipped KD for assembly on site.		RTA 00  1 per carton			
 <p>9" In-line Linking Table COM: N/A Unit weight: 7 LB 3.2 KG Carton weight: 8.5 LB 3.86 KG Carton volume: 0.7 FT³ 0.01 MT³</p>	WPT09G	207	33						
		Must be connected to a 4-leg or sled base chair. Includes 1 set of U-channel connectors and hardware.		Shipped KD for assembly on site.		RTA 00  1 per carton			
 <p>End Linking Table COM: N/A Unit weight: 10.5 LB 4.8 KG Carton weight: 13 LB 5.9 KG Carton volume: 1 FT³ 0.02 MT³</p>	WPTEGL Left	411	45						
	WPTEGR Right	411	45						
		Specify direction per seated use.		Shipped KD for assembly on site.		RTA 2  1 per carton			

DESCRIPTION MODEL# / FEATURES STANDARD TEXTILE GRADES

List price

SU2P10C 517



Power Unit, Clamp Attachment
 COM: N/A
 Unit weight: 3 LB | 1.36 KG
 Carton weight: 3 LB | 1.36 KG
 Carton volume: 0.5 FT³ | 0.01 MT³

Includes 1 AC and 2 USB-A ports.
 Tamper resistant with 10' cord.

	OVERALL DIMENSIONS			SEAT DIMENSIONS			BACK DIMENSIONS	
	W	D	H	W	D	H	W	H
IN	1.69	4.05	2.77	-	-	-	-	-
MM	43	103	70	-	-	-	-	-

RTA 00  1 per carton

List price

SU2P10U 517



Power Unit, Undermount Attachment
 COM: N/A
 Unit weight: 3 LB | 1.36 KG
 Carton weight: 3 LB | 1.36 KG
 Carton volume: 0.5 FT³ | 0.01 MT³

Includes 1 AC and 2 USB-A ports.
 Tamper resistant with 10' cord.

	OVERALL DIMENSIONS			SEAT DIMENSIONS			BACK DIMENSIONS	
	W	D	H	W	D	H	W	H
IN	1.69	4.05	2.77	-	-	-	-	-
MM	43	103	70	-	-	-	-	-

RTA 00  1 per carton

WINGBACK



model GC3787C

STANDARD FEATURES

- Traditional styling, easy to exit and features removable and replaceable seats.
- For added comfort, seats are standard with high density Ultracell foam.
- Standard glide is plastic.
- Wood legs are available in a variety of finishes. Available in Maple wood only species.
- For healthcare textiles and wood finish options, visit the website at globalfurnituregroup.com.
- Can be upholstered in standard Global textiles if Healthcare compliance is not required.
- Shipped fully assembled.

OPTIONAL FEATURES

- For non-slip glides, please specify **(NS)**. Add \$22.
- For hard surface floors, please specify opaque non-marking glides **(NM)**. No upcharge.
- To add sealed seams to your product contact Customer Service. Upcharges vary.
- For moisture barrier on seat, please specify **(MB)**. Add \$122.

SUGGESTED APPLICATIONS

- Guest seating
- Lobbies
- Lounge/Waiting
- Patient rooms
- Resident rooms

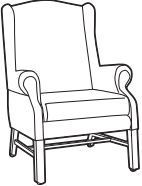
DESCRIPTION	MODEL# / FEATURES	STANDARD TEXTILE GRADES																																
		COM	2	3	4	5	6	7	8	9	10	11	12																					
 <p>High Back Armchair - Chippendale Legs COM: 4.75 YD 4.34 M Unit weight: 42 LB 19.1 KG Carton weight: 50 LB 22.68 KG Carton volume: 22.25 FT³ 0.63 MT³</p>	GC3787C	1743	1895	2023	2171	2413	2636	2859	3054	3296	3524	3833	4270																					
	<p>Active weight 300 lbs.</p> <p>Removable seat cushion.</p>	<table border="1"> <thead> <tr> <th colspan="3">OVERALL DIMENSIONS</th> <th colspan="3">SEAT DIMENSIONS</th> <th colspan="2">BACK DIMENSIONS</th> </tr> <tr> <th>W</th> <th>D</th> <th>H</th> <th>W</th> <th>D</th> <th>H</th> <th>W</th> <th>H</th> </tr> </thead> <tbody> <tr> <td>IN 29</td> <td>30</td> <td>39</td> <td>19.5</td> <td>18</td> <td>17.5</td> <td>19.5</td> <td>22</td> </tr> <tr> <td>MM 737</td> <td>762</td> <td>991</td> <td>495</td> <td>457</td> <td>445</td> <td>495</td> <td>559</td> </tr> </tbody> </table>	OVERALL DIMENSIONS			SEAT DIMENSIONS			BACK DIMENSIONS		W	D	H	W	D	H	W	H	IN 29	30	39	19.5	18	17.5	19.5	22	MM 737	762	991	495	457	445	495	559
OVERALL DIMENSIONS			SEAT DIMENSIONS			BACK DIMENSIONS																												
W	D	H	W	D	H	W	H																											
IN 29	30	39	19.5	18	17.5	19.5	22																											
MM 737	762	991	495	457	445	495	559																											

seating

Work + Task

Doctor Buddy.....	249	GC Tritek	256
Ergonomic features	247	GC Tritek TS.....	258
Foot activated stools	251	GC Vion	260
Gala II.....	252	Harmony.....	262
Gala II TS.....	254	Mechanism adjustments	248

EACH HEALTHCARE CHAIR IS BUILT WITH FEATURES THAT ARE ERGONOMICALLY DESIGNED TO PROMOTE GOOD POSTURE AND PROVIDE MAXIMUM COMFORT. WHILE FULLY SUPPORTING YOUR BODY, THESE FEATURES SHOULD ALSO ALLOW YOU TO ADJUST YOUR CHAIR TO FIT YOU.



A TENSION ADJUSTMENT

Increase or decrease to match body weight. Allows you to rock comfortably, without heavy pushing, reducing muscle fatigue.



B CHAIR TILT LOCK

Lock the tilt movement in position(s) to accommodate your working posture. Allows you to lock your chair in a comfortable and supportive position. (Can be either single position, multiple position or infinite position.)



C SEAT HEIGHT

Raise or lower to allow your feet to rest flat on the floor. Avoids pressure under your thighs, easing blood flow.



D BACK/LUMBAR HEIGHT ADJUSTMENT

Raise or lower to position lumbar support in your lumbar area. Reduces likelihood of back pain.



E SEAT DEPTH

Change the depth of the seat to accommodate the length of your thighs. Keeps your back in contact with the backrest while avoiding pressure behind your knees. Can be sliding (MD) or manual.



F SEAT ANGLE ADJUSTMENT

Allows chair to tilt forward changing the angle of your thighs in relation to the floor. Helps reduce disc pressure during forward leaning tasks.



G BACK ANGLE ADJUSTMENT

Adjust to change the angle of your torso in relation to your thighs. Helps reduce disc pressure and relaxes your back muscles.



H ARM HEIGHT

Raise or lower to support your forearms. Reduces muscular effort in neck and shoulders, minimizing risk of pain.



J KNEE-TILT MOVEMENT

Chair tilts from a pivot point at the front of the seat, keeping your feet on the floor as you rock. Maintains stability.



L SYNCHRO-TILT MOVEMENT

Backrest reclines at a faster rate than the seat, increasing the angle between your torso and thighs. Enhances comfort and encourages dynamic body movement.



M WATERFALL SEAT EDGE

Reduces pressure at the back of your knees, contributing to good blood flow.



N CONTOURED CUSHION

Supports the body effectively, allowing you to sit longer without discomfort.



P VIBRATING SEAT & BACK

Soothing effect contributes to your relaxation during work breaks.



Q WIDTH ADJUSTABLE ARMS

Allows outward movement of armrests to match shoulder breadth. Ensures armrests properly support forearms, reducing muscular efforts in neck and shoulders.

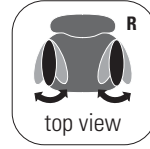

R ARM ROTATION

Rotate armcaps to support your forearms in various positions. Reduces muscular effort in neck and shoulders minimizing risk of pain.



S CENTRE TILT

Chair tilts from a pivot point under the centre of the seat allowing you to rock. When your feet are well supported, blood flow is enhanced.



U SOFT DESCENT PNEUMATIC LIFT

Gently and gradually lowering the seat helps you easily select proper seat height without causing a jerking motion.



V LUMBAR DEPTH ADJUSTMENT

Increase or decrease curvature of the back to match the profile of your lower back. Enhances comfort and support in the lower lumbar area.

MAXIMIZING YOUR ERGONOMIC SEATING

- Always select a chair that is designed for the type of work you perform and make certain the chair is comfortable for the length of time spent using it.
- Ensure that the seat and back cushions are contoured to fit your body, which will help eliminate pressure points.
- An ergonomically designed chair should allow changing positions easily.
- As you work, reposition yourself throughout the day to reduce strain and stress on specific muscle groups. If you change job functions, adjust your chair to fit the new task.
- Proper ergonomic seating should help eliminate many of the work related injuries that result from poor posture and poorly designed chairs.

TASK



ADJUSTMENTS

- (2) Pneumatic seat height
- (8) Manual seat depth
- Back/lumbar height **
- Swivel

POSTURE TASK



ADJUSTMENTS

- (2) Pneumatic seat height
- (3) Back angle
- (6) Back/lumbar height **
- Swivel

TILTER



ADJUSTMENTS

- (1) Tilt tension
- (2) Pneumatic seat height
- (9) Multiple position tilt lock *
- Centre tilt action
- Swivel

MULTI-TILTER

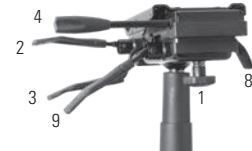

ADJUSTMENTS

- (1) Tilt tension
- (2) Pneumatic seat height
- (3) Back angle adjustment
- (4) Seat angle
- (8) Sliding seat depth adjustment (MD)
- (9) Infinite position tilt lock
- Back/lumbar height **
- Centre tilt action
- Swivel

SYNCHRO-TILTER



ADJUSTMENTS

- (1) Tilt tension
- (2) Pneumatic seat height
- (3) Back angle adjustment *
- (8) Sliding seat depth adjustment (MD)
- (9) Multiple position tilt lock/ Synchro tilt action
- Anti kick back *
- Back/lumbar height **
- Swivel

OPERATOR



ADJUSTMENTS

- (2) Pneumatic seat height
- (3) Back angle *(free float/lock)
- (4) Seat angle *(free float/lock)
- Back/lumbar height **
- With single lever operator mechanism, seat and back angle are controlled using lever 4 *
- Swivel

NOTES

- * Select models only.
- ** Ratchet back height adjustment on select models.
- Mechanisms shown are generic depictions and may differ from one chair to another.

DOCTOR BUDDY



model GC1105

model GC1111

STANDARD FEATURES









- Doctor Buddy is the perfect stool to provide comfort when performing office tasks or as an examination or feeding stool when caring for others.
- For the right comfort and support when performing tasks select Doctor Buddy with or without a back.
- Seat and back can be upholstered in vinyl or fabric. Seat is standard with high density Ultracell foam cushion.
- Models available with backrests: GC1111, GC1112, GC1113 & GC1114.
- Moisture resistant protection on the underside of seat pan.
- GC1104, GC1109, GC1111 & GC1113: 16" seat diameter.
- GC1105, GC1110, GC1112 & GC1114: 13.5" seat diameter.
- Black 5-prong injection molded base is standard.
- (C65) casters are standard.
- For healthcare textiles, visit the website at globalfurnituregroup.com.
- Can be upholstered in standard Global textiles only if Healthcare compliance is not required.











OPTIONAL FEATURES

- For improved housekeeping and infection control practices, please add (SU) to model number. The underside of the seat will be finished with vinyl and sealed to prevent penetration of liquids. Add \$39.
- **Casters/Glides**
 (C65) Dual wheel carpet casters. No upcharge.
 (C65R) Dual wheel hard floor casters. Add \$21.
 (C7) Set of 5 large Black slipper glides (for all surfaces). Can replace any Global casters. Glide is the same height as casters. No upcharge.
- To add sealed seams for seat and/or back, specify (SS). Upcharges vary, see model.
- Height adjustable footrest, please specify (R2). Add \$52.

SUGGESTED APPLICATIONS

- Dining/Cafeteria
- Office/Meeting
- Patient rooms
- Resident rooms
- Treatment/Exam rooms

DESCRIPTION	MODEL# / FEATURES	STANDARD TEXTILE GRADES											
		COM	2	3	4	5	6	7	8	9	10	11	12
 <p>16" Dia. Swivel Stool 5" Pneumatic, 22" Base COM: 0.75 YD 0.69 M Unit weight: 12 LB 5.5 KG Carton weight: 15 LB 6.8 KG Carton volume: 2.9 FT³ 0.08 MT³</p>	GC1104	386	410	430	454	492	527	562	593	631	667	716	785
	Active weight 300 lbs.												
	Add \$15 for (SS)												
	Ergonomic features: C	  1 per carton											
		OVERALL DIMENSIONS			SEAT DIMENSIONS			BACK DIMENSIONS					
		W	D	H	W	D	H	W	H				
		IN 16	16	18.5	16	-	16.5-21.5	-	-				
		MM 406	406	470	406	-	419-546	-	-				
 <p>14" Dia. Swivel Stool 5" Pneumatic, 20" Base COM: 0.75 YD 0.69 M Unit weight: 11 LB 5 KG Carton weight: 14 LB 6.35 KG Carton volume: 2.5 FT³ 0.07 MT³</p>	GC1105	327	351	371	395	433	468	503	534	572	608	657	726
	Active weight 300 lbs.												
	Add \$15 for (SS)												
	Ergonomic features: C	  1 per carton											
		OVERALL DIMENSIONS			SEAT DIMENSIONS			BACK DIMENSIONS					
		W	D	H	W	D	H	W	H				
		IN 13.5	13.5	18.5	13.5	-	16.5-21.5	-	-				
		MM 343	343	470	343	-	419-546	-	-				
 <p>16" Dia. Swivel Stool 10" Pneumatic, 22" Base COM: 0.75 YD 0.69 M Unit weight: 15 LB 6.8 KG Carton weight: 18 LB 8.16 KG Carton volume: 2.9 FT³ 0.08 MT³</p>	GC1109	471	495	515	539	577	612	647	678	716	752	801	870
	Active weight 300 lbs.												
	Add \$15 for (SS)												
	Ergonomic features: C	  1 per carton											
		OVERALL DIMENSIONS			SEAT DIMENSIONS			BACK DIMENSIONS					
		W	D	H	W	D	H	W	H				
		IN 16	16	27.5	16	-	22.5-32.5	-	-				
		MM 406	406	699	406	-	572-826	-	-				

DESCRIPTION	MODEL# / FEATURES	STANDARD TEXTILE GRADES												
		COM	2	3	4	5	6	7	8	9	10	11	12	
 <p>14" Dia. Swivel Stool 10" Pneumatic, 22" Base COM: 0.75 YD 0.69 M Unit weight: 14 LB 6.4 KG Carton weight: 17 LB 7.71 KG Carton volume: 2.9 FT³ 0.08 MT³</p>	GC1110	395	419	439	463	501	536	571	602	640	676	725	794	
		OVERALL DIMENSIONS W D H			SEAT DIMENSIONS W D H			BACK DIMENSIONS W H						
	Active weight 300 lbs.	IN	13.5	13.5	27.5	13.5	-	22.5-32.5	-	-	-	-	-	-
	Add \$15 for (SS)	MM	343	343	699	343	-	572-826	-	-	-	-	-	-
Ergonomic features: C		RTA 1		1 per carton										
 <p>16" Dia. Swivel Stool with back 5" Pneumatic, 24" Base COM: 1 YD 0.91 M Unit weight: 24 LB 10.9 KG Carton weight: 32.5 LB 14.74 KG Carton volume: 15.5 FT³ 0.43 MT³</p>	GC1111	535	567	594	625	676	723	770	811	862	910	975	1067	
		OVERALL DIMENSIONS W D H			SEAT DIMENSIONS W D H			BACK DIMENSIONS W H						
	Active weight 300 lbs.	IN	16.5	20.5	29.75	16.5	15.5-17.5	16-21	14	11.25	-	-	-	-
	Add \$27 for (SS)	MM	419	521	756	419	394-445	406-533	356	286	-	-	-	-
Ergonomic features: C		RTA 1		1 per carton										
 <p>14" Dia. Swivel Stool with back 5" Pneumatic, 24" Base COM: 0.75 YD 0.69 M Unit weight: 21 LB 9.5 KG Carton weight: 29 LB 13.15 KG Carton volume: 11.25 FT³ 0.31 MT³</p>	GC1112	476	500	520	544	582	617	652	683	721	757	806	875	
		OVERALL DIMENSIONS W D H			SEAT DIMENSIONS W D H			BACK DIMENSIONS W H						
	Active weight 300 lbs.	IN	13.5	17	29.75	13.5	12-14	16-21	14	11.25	-	-	-	-
	Add \$24 for (SS)	MM	343	432	756	343	305-356	406-533	356	286	-	-	-	-
Ergonomic features: C		RTA 1		1 per carton										
 <p>16" Dia. Swivel Stool with back 10" Pneumatic, 24" Base COM: 1 YD 0.91 M Unit weight: 25 LB 11.4 KG Carton weight: 33.5 LB 15.2 KG Carton volume: 15.5 FT³ 0.43 MT³</p>	GC1113	620	652	679	710	761	808	855	896	947	995	1060	1152	
		OVERALL DIMENSIONS W D H			SEAT DIMENSIONS W D H			BACK DIMENSIONS W H						
	Active weight 300 lbs.	IN	16.5	20.5	38.75	16.5	15.5-17.5	22.5-32.5	14	11.25	-	-	-	-
	Add \$27 for (SS)	MM	419	521	984	419	394-445	572-826	356	286	-	-	-	-
Ergonomic features: C		RTA 1		1 per carton										
 <p>14" Dia. Swivel Stool with back 10" Pneumatic, 24" Base COM: 0.75 YD 0.69 M Unit weight: 22 LB 10 KG Carton weight: 31 LB 14.06 KG Carton volume: 13.25 FT³ 0.37 MT³</p>	GC1114	544	568	588	612	650	685	720	751	789	825	874	943	
		OVERALL DIMENSIONS W D H			SEAT DIMENSIONS W D H			BACK DIMENSIONS W H						
	Active weight 300 lbs.	IN	13.5	17	38.75	13.5	12-14	22.5-32.5	14	11.25	-	-	-	-
	Add \$24 for (SS)	MM	343	432	984	343	305-356	572-826	356	286	-	-	-	-
Ergonomic features: C		RTA 1		1 per carton										

GALA II



model GC13011



model GC13015

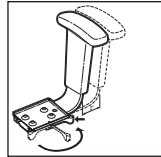

Vari-Width (WA) width adjustable arm extensions are standard when chair is ordered with adjustable arms.



model GC13021

MECHANISM OPTIONS:

Task mechanism (-6)

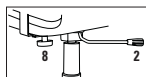

ADJUSTMENTS
(2) Pneumatic seat height
(8) Manual seat depth

Ergonomic features:
C, E, H, M, N, Q, R, U

Synchro-tilter mechanism (-0)

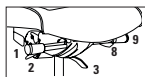

ADJUSTMENTS
(1) Tilt tension
(2) Pneumatic seat height
(3) Back angle
Back/lumbar height
(8) Sliding seat depth
(9) Multi position tilt lock
Synchro tilt action
Anti kick back

Ergonomic features:
A, B, C, D, E, G, H, L, M, N, Q, R, U

Multi-tilter mechanism (-3)



ADJUSTMENTS
(1) Tilt tension
(2) Pneumatic seat height
(3) Back angle
(4) Seat angle
(6) Back/lumbar height
(8) Sliding seat depth
(9) Infinite position tilt lock
Center tilt action

Ergonomic features:
A, B, C, D, E, F, G, H, M, N, Q, R, S, U

Posture task mechanism (-7)

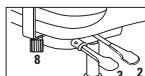

ADJUSTMENTS
(2) Pneumatic seat height
(3) Back angle
Back/lumbar height
(8) Manual seat depth
20" diameter Chrome footrest

Ergonomic features:
C, D, G, H, M, N, Q, R, U, V

STANDARD FEATURES

- Gala II is designed to provide exceptional support and comfort throughout the work day.
- Available in three back heights and three seat sizes to fit a person's body type and movements while at work.
- Models with adjustable headrest available.
- Choice of four mechanisms: Task, synchro-tilter, multi-tilter and posture task. Stool models are available with posture task mechanism only.
- Vertical back height ratchet adjustment of 5.25" is standard on all models (except task chairs).
- Back support upright is 3" wide for extra strength.
- One-piece curved back features a pull over style upholstery cover for easy housekeeping and infection prevention practices.
- Standard with Global's high quality Soft Descent™ pneumatic lift which slowly and gently lowers the seat height of the chair making it easy to obtain the exact seat height you desire.
- Models with arms are standard with height adjustable arms (**3B**) with self-skinned urethane (SSU) armcaps.
- Vari-Width (**WA**) width adjustable arm extensions are standard. Allows the arms to move away from the seat by 2" on each side to allow space if desired for broader hip widths.
- Waterfall seamless seat front design with high density Ultracell foam for superior comfort and longevity.
- Underside of seat pan is completely sealed.
- Side activated sliding seat depth adjustment (**MD**) is standard on synchro-tilter and multi-tilter.
- 5-prong, injection molded, fiberglass reinforced nylon Black base with dual wheel carpet casters (**C65**).
- For healthcare textiles and finish options, visit the website at globalfurnituregroup.com.
- Can be upholstered in standard Global textiles only if Healthcare compliance is not required.
- To meet higher standards for housekeeping and infection control, Gala II has a seamless seat and one stitch pull over back upholstery, while still offering soft curves to the design. Note: Vinyl and woven treated textiles are thicker in nature and will experience wrinkles on some curves or corners as a result.

OPTIONAL FEATURES

- For moisture barrier on seat, please specify (**MB**). Add \$81.
- Back sealed seam available, please specify (**S2**). Upcharges vary.
- Optional Schukra™ depth adjustable lumbar support for personalized back support and comfort, please specify (**SK**). Add \$119.
- For additional arms/caster options, please refer to the Arm and Caster section (269). Optional casters may be priced higher than the standard casters for your chair and the difference will be charged. Lower priced optional casters will not be credited.





Please add option codes in the following order:

- **Model number**
GC13011 High back with arms
GC13011NA High back, armless
GC13012 Medium back with arms
GC13012NA Medium back, armless
GC13013 Low back with arms
GC13013NA Low back, armless
GC13015 Medium back stool with arms
GC13015NA Medium back stool, armless
GC13021 High Back w/Adj. Headrest with arms
GC13021NA High Back w/Adj. Headrest, armless
GC13022 Medium Back w/Adj. Headrest with arms
GC13022NA Medium Back w/Adj. Headrest, armless
- **Textile**
Specify textile code.
- **Mechanism**
(6) Task mechanism. No upcharge.
(0) Synchro-tilter mechanism. Add \$168.
(3) Multi-tilter mechanism. Add \$168.
(7) Posture task mechanism. Add \$99.
NOTE: Stool models are only available with Posture Task Mechanism, no upcharge.
- **Seat size**
(P) Petite
(S) Standard
(G) Generous
- **Arms**
(3B) Height adjustable arms. No upcharge. For additional arm options, please refer to Arm Selections section on page 271.
- **Base**
(BK) Black nylon spider base.
(AL) Polished aluminum base. Add \$131.
- **Casters**
(C65) Dual wheel carpet casters.
(C65R) Dual wheel hard floor casters. Add \$21.

EXAMPLE GALA II SELECT ORDER CODE:

GC13011	-WA53	-0	-S	-3B	-AL	-C65
Model number	Textile	Mechanism	Seat size	Arms	Base	Casters

DESCRIPTION	MODEL# / FEATURES	STANDARD TEXTILE GRADES											
		COM	2	3	4	5	6	7	8	9	10	11	12
	GC13011 With arms	734	803	861	928	1037	1138	1240	1328	1438	1541	1680	1878
	GC13011NA Armless	630	699	757	824	933	1034	1136	1224	1334	1437	1576	1774
		OVERALL DIMENSIONS			SEAT DIMENSIONS			BACK DIMENSIONS					
		W	D	H	W	D	H	W		H			
	Active weight 300 lbs.	IN 24.5	23.5	43	20.5	17-18	16.5-21.5	20		24.5			
	See series notes for mechanism options.	MM 622	597	1092	521	432-457	419-546	508		622			
		RTA 2		1 per carton									

DESCRIPTION	MODEL# / FEATURES	STANDARD TEXTILE GRADES											
		COM	2	3	4	5	6	7	8	9	10	11	12
 <p>Medium Back COM: 1.9 YD 1.74 M Unit weight: 43 LB 19.5 KG Carton weight: 53 LB 24.04 KG Carton volume: 10.5 FT³ 0.29 MT³</p>	GC13012 With arms	704	765	816	875	972	1061	1151	1229	1326	1417	1540	1715
	GC13012NA Armless	598	659	710	769	866	955	1045	1123	1220	1311	1434	1609
		OVERALL DIMENSIONS			SEAT DIMENSIONS			BACK DIMENSIONS					
		W	D	H	W	D	H	W	H				
		IN 24.5 MM 622	23.5 597	39 991	20.5 521	17-18 432-457	16.5-21.5 419-546	20 508	20.5 521				
	Active weight 300 lbs.	See series notes for mechanism options.		RTA 2	1 per carton								
 <p>Low Back COM: 1.8 YD 1.65 M Unit weight: 41 LB 18.6 KG Carton weight: 51 LB 23.13 KG Carton volume: 10.5 FT³ 0.29 MT³</p>	GC13013 With arms	688	746	794	850	942	1026	1112	1186	1278	1364	1480	1646
	GC13013NA Armless	586	644	692	748	840	924	1010	1084	1176	1262	1378	1544
		OVERALL DIMENSIONS			SEAT DIMENSIONS			BACK DIMENSIONS					
		W	D	H	W	D	H	W	H				
		IN 24.5 MM 622	23.5 597	35 889	20.5 521	17-18 432-457	16.5-21.5 419-546	20 508	16.5 419				
	Active weight 300 lbs.	See series notes for mechanism options.		RTA 2	1 per carton								
 <p>Medium Back Posture Task Stool COM: 1.8 YD 1.65 M Unit weight: 53 LB 24.1 KG Carton weight: 63 LB 28.58 KG Carton volume: 10.5 FT³ 0.29 MT³</p>	GC13015 With arms	913	971	1019	1075	1167	1251	1337	1411	1503	1589	1705	1871
	GC13015NA Armless	809	867	915	971	1063	1147	1233	1307	1399	1485	1601	1767
		OVERALL DIMENSIONS			SEAT DIMENSIONS			BACK DIMENSIONS					
		W	D	H	W	D	H	W	H				
		IN 24.5 MM 622	23.5 597	51 1295	20.5 521	17 432	24-34 610-864	20 508	20 508				
	Active weight 300 lbs.	See series notes for mechanism options.		RTA 2	1 per carton								
 <p>High Back with Adjustable Headrest COM: 2.4 YD 2.19 M Unit weight: 49 LB 22.3 KG Carton weight: 61 LB 27.67 KG Carton volume: 10.5 FT³ 0.29 MT³</p>	GC13021 With arms	976	1053	1118	1192	1315	1427	1541	1639	1762	1877	2032	2253
	GC13021NA Armless	872	949	1014	1088	1211	1323	1437	1535	1658	1773	1928	2149
		OVERALL DIMENSIONS			SEAT DIMENSIONS			BACK DIMENSIONS					
		W	D	H	W	D	H	W	H				
		IN 24.5 MM 622	23.5 597	50 1270	20.5 521	17-18 432-457	16.5-21.5 419-546	20 508	31.5 800				
	Active weight 300 lbs.	See series notes for mechanism options.		RTA 2	1 per carton								
 <p>Medium Back with Adjustable Headrest COM: 2.15 YD 1.97 M Unit weight: 47 LB 21.4 KG Carton weight: 59 LB 26.76 KG Carton volume: 10.5 FT³ 0.29 MT³</p>	GC13022 With arms	946	1015	1073	1140	1249	1350	1452	1540	1650	1753	1892	2090
	GC13022NA Armless	840	909	967	1034	1143	1244	1346	1434	1544	1647	1786	1984
		OVERALL DIMENSIONS			SEAT DIMENSIONS			BACK DIMENSIONS					
		W	D	H	W	D	H	W	H				
		IN 24.5 MM 622	23.5 597	46 1168	20.5 521	17 432	16.5-21.5 419-546	20 508	27.5 699				
	Active weight 300 lbs.	See series notes for mechanism options.		RTA 2	1 per carton								

GALA II TS



model GCTS13011



model GCTS13015

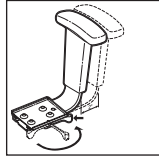

Vari-Width (WA) width adjustable arm extensions are standard when chair is ordered with adjustable arms.



model GCTS13021

MECHANISMS:

Synchro-tilter mechanism (-0)

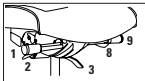

- ADJUSTMENTS**
- (1) Tilt tension
 - (2) Pneumatic seat height
 - (3) Back angle
 - Back/lumbar height
 - (8) Sliding seat depth
 - (9) Multi position tilt lock
 - Synchro tilt action
 - Anti kick back

Ergonomic features:
A, B, C, D, E, G, H, L, M, N, Q, R, U

Task mechanism (-6)

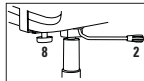

- ADJUSTMENTS**
- (2) Pneumatic seat height
 - (8) Manual seat depth

Ergonomic features:
C, E, H, M, N, Q, R, U

STANDARD FEATURES

- Gala II TS is designed for 24/7 applications to provide exceptional support and comfort throughout the work day.
- Available in three back heights and three seat sizes to fit a person's body type and movements while at work.
- Models with adjustable headrest available.
- Heavy duty synchro-tilter mechanism with side activated sliding seat depth adjustment (MD) and separate back angle adjustment for individual comfort are standard. Stool models are available with task mechanism only.
- Vertical back height ratchet adjustment of 5.25" is standard on all models (except task chairs).
- Back support upright is 3" wide for extra strength.
- One-piece curved back features a pull over style upholstery cover for easy housekeeping and infection prevention practices.
- Standard with Global's high quality Soft Descent™ pneumatic lift which slowly and gently lowers the seat height of the chair making it easy to obtain the exact seat height you desire.
- Models with arms are standard with height adjustable arms (3B) with self-skinned urethane (SSU) armcaps.
- Vari-Width (WA) width adjustable arm extensions are standard. Allows the arms to move away from the seat by 2" on each side to allow space if desired for broader hip widths.
- Waterfall seamless seat front design with high density Ultracell foam for superior comfort and longevity.
- Underside of seat pan is completely sealed.
- 5-prong, injection molded, fiberglass reinforced nylon Black base with dual wheel carpet casters (C10).
- For healthcare textiles and finish options, visit the website at globalfurnituregroup.com.
- Can be upholstered in standard Global textiles only if Healthcare compliance is not required.
- To meet higher standards for housekeeping and infection control, Gala II has a seamless seat and one stitch pull over back upholstery, while still offering soft curves to the design. Note: Vinyl and woven treated textiles are thicker in nature and will experience wrinkles on some curves or corners as a result.

OPTIONAL FEATURES

- For moisture barrier on seat, please specify (MB). Add \$81.
- Back sealed seam available, please specify (S2). Upcharges vary.
- Optional Schukra™ depth adjustable lumbar support for personalized back support and comfort, please specify (SK). Add \$119.
- For additional arms/caster options, please refer to the Arm and Caster section (269). Optional casters may be priced higher than the standard casters for your chair and the difference will be charged. Lower priced optional casters will not be credited.

Please add option codes in the following order:

- **Model number**
GCTS13011 High back with arms
GCTS13011NA High back, armless
GCTS13012 Medium back with arms
GCTS13012NA Medium back, armless
GCTS13013 Low back with arms
GCTS13013NA Low back, armless
GCTS13015 Medium back stool with arms
GCTS13015NA Medium back stool, armless
GCTS13021 High Back w/Adj. Headrest with arms
GCTS13021NA High Back w/Adj. Headrest, armless
GCTS13022 Medium Back w/Adj. Headrest with arms
GCTS13022NA Medium Back w/Adj. Headrest, armless
- **Textile**
Specify textile code.
- **Mechanism**
(0) Synchro-tilter mechanism. No upcharge.
(6) Task mechanism (models GCTS13015 and GCTS13015NA only). No upcharge.
- **Seat size**
(P) Petite
(S) Standard
(G) Generous
- **Arms**
(3B) Height adjustable arms. No upcharge.
For additional arm options, please refer to Arm Selections section on page 271.
- **Base**
(BK) Black nylon spider base.
(AL) Polished aluminum base. Add \$131.
- **Casters**
(C10) Dual wheel carpet casters.
(C10R) Dual wheel hard floor casters. Add \$20.

EXAMPLE GALA II TS ORDER CODE:

GCTS13011	-WA53	-0	-S	-3B	-B7	-C10R
Model number	Textile	Mechanism	Seat size	Arms	Base	Casters

DESCRIPTION



High Back Heavy Duty
 COM: 2.15 YD | 1.97 M
 Unit weight: 59 LB | 26.8 KG
 Carton weight: 69 LB | 31.3 KG
 Carton volume: 10.5 FT³ | 0.29 MT³

MODEL# / FEATURES

GCTS13011
With arms
GCTS13011NA
Armless

Active weight 350 lbs.





See series notes for mechanism options.

STANDARD TEXTILE GRADES

COM	2	3	4	5	6	7	8	9	10	11	12
1064	1133	1191	1258	1367	1468	1570	1658	1768	1871	2010	2208
960	1029	1087	1154	1263	1364	1466	1554	1664	1767	1906	2104

OVERALL DIMENSIONS			SEAT DIMENSIONS			BACK DIMENSIONS	
W	D	H	W	D	H	W	H
IN 24.5	23.5	43.5	20.5	17-18	17-21	20	24.5
MM 622	597	1105	521	432-457	432-533	508	622

RTA 2 1 per carton

DESCRIPTION	MODEL# / FEATURES	STANDARD TEXTILE GRADES											
		COM	2	3	4	5	6	7	8	9	10	11	12
 <p>Medium Back Heavy Duty COM: 1.9 YD 1.74 M Unit weight: 58 LB 26.4 KG Carton weight: 68 LB 30.84 KG Carton volume: 10.5 FT³ 0.29 MT³</p>	GCTS13012 With arms	1033	1094	1145	1204	1301	1390	1480	1558	1655	1746	1869	2044
	GCTS13012NA Armless	930	991	1042	1101	1198	1287	1377	1455	1552	1643	1766	1941
		OVERALL DIMENSIONS			SEAT DIMENSIONS			BACK DIMENSIONS					
		W	D	H	W	D	H	W	H				
		IN 24.5 MM 622	23.5 597	39.5 1003	20.5 521	17-18 432-457	17-21 432-533	20 508	20.5 521				
	Active weight 350 lbs.	See series notes for mechanism options.		RTA 2	1 per carton								
 <p>Low Back Heavy Duty COM: 1.8 YD 1.65 M Unit weight: 56 LB 25.5 KG Carton weight: 66 LB 29.94 KG Carton volume: 10.5 FT³ 0.29 MT³</p>	GCTS13013 With arms	1019	1077	1125	1181	1273	1357	1443	1517	1609	1695	1811	1977
	GCTS13013NA Armless	915	973	1021	1077	1169	1253	1339	1413	1505	1591	1707	1873
		OVERALL DIMENSIONS			SEAT DIMENSIONS			BACK DIMENSIONS					
		W	D	H	W	D	H	W	H				
		IN 24.5 MM 622	23.5 597	35.5 902	20.5 521	17-18 432-457	17-21 432-533	20 508	16.5 419				
	Active weight 350 lbs.	See series notes for mechanism options.		RTA 2	1 per carton								
 <p>Medium Back Heavy Duty Task Stool COM: 1.8 YD 1.65 M Unit weight: 47 LB 21.4 KG Carton weight: 57 LB 25.85 KG Carton volume: 10.5 FT³ 0.29 MT³</p>	GCTS13015 With arms	1242	1300	1348	1404	1496	1580	1666	1740	1832	1918	2034	2200
	GCTS13015NA Armless	1138	1196	1244	1300	1392	1476	1562	1636	1728	1814	1930	2096
		OVERALL DIMENSIONS			SEAT DIMENSIONS			BACK DIMENSIONS					
		W	D	H	W	D	H	W	H				
		IN 24.5 MM 622	23.5 597	48.5 1232	20.5 521	17 432	23.5-33.5 597-851	20 508	20.5 521				
	Active weight 350 lbs.	See series notes for mechanism options.		RTA 2	1 per carton								
 <p>High Back Heavy Duty with Adjustable Headrest COM: 2.4 YD 2.19 M Unit weight: 63 LB 28.6 KG Carton weight: 75 LB 34.02 KG Carton volume: 10.5 FT³ 0.29 MT³</p>	GCTS13021 With arms	1306	1383	1448	1522	1645	1757	1871	1969	2092	2207	2362	2583
	GCTS13021NA Armless	1202	1279	1344	1418	1541	1653	1767	1865	1988	2103	2258	2479
		OVERALL DIMENSIONS			SEAT DIMENSIONS			BACK DIMENSIONS					
		W	D	H	W	D	H	W	H				
		IN 24.5 MM 622	23.5 597	50.5 1283	20.5 521	17-18 432-457	17-21 432-533	20 508	31.5 800				
	Active weight 350 lbs.	See series notes for mechanism options.		RTA 2	1 per carton								
 <p>Medium Back Heavy Duty with Adjustable Headrest COM: 2.15 YD 1.97 M Unit weight: 62 LB 28.2 KG Carton weight: 74 LB 33.57 KG Carton volume: 10.5 FT³ 0.29 MT³</p>	GCTS13022 With arms	1275	1344	1402	1469	1578	1679	1781	1869	1979	2082	2221	2419
	GCTS13022NA Armless	1172	1241	1299	1366	1475	1576	1678	1766	1876	1979	2118	2316
		OVERALL DIMENSIONS			SEAT DIMENSIONS			BACK DIMENSIONS					
		W	D	H	W	D	H	W	H				
		IN 24.5 MM 622	23.5 597	46.5 1181	20.5 521	17 432	17-21 432-533	20 508	27.5 699				
	Active weight 350 lbs.	See series notes for mechanism options.		RTA 2	1 per carton								

GC TRITEK



model GC7472NA

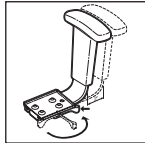

Vari-Width (WA) width adjustable arm extensions are standard when chair is ordered with adjustable arms.

MECHANISM OPTIONS:

Task mechanism (-6)

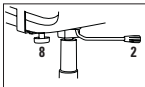

ADJUSTMENTS
(2) Pneumatic seat height
(8) Manual seat depth

Ergonomic features:
C, E, H, M, N, Q, R, U

Synchro-tilter mechanism (-0)

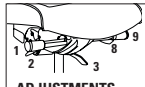

ADJUSTMENTS
(1) Tilt tension
(2) Pneumatic seat height
(3) Back angle
Back/lumbar height
(8) Sliding seat depth
(9) Multi position tilt lock
Synchro tilt action
Anti kick back

Ergonomic features:
A, B, C, D, E, G, H, L, M, N, Q, R, U

Multi-tilter mechanism (-3)



ADJUSTMENTS
(1) Tilt tension
(2) Pneumatic seat height
(3) Back angle
(4) Seat angle
(6) Back/lumbar height
(8) Sliding seat depth
(9) Infinite position tilt lock
Center tilt action

Ergonomic features:
A, B, C, D, E, F, G, H, M, N, Q, R, S, U

Posture task mechanism (-7)

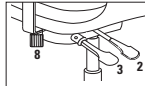

ADJUSTMENTS
(2) Pneumatic seat height
(3) Back angle
Back/lumbar height
(8) Manual seat depth
20" diameter Chrome footrest

Ergonomic features:
C, D, G, H, M, N, Q, R, U, V

STANDARD FEATURES

- GC Tritek is designed to meet every body shape and task, providing exceptional support and comfort throughout the work day.
- Available in three back heights and three seat sizes to fit a person's body type and movements while at work.
- Choice of four mechanisms: Task, synchro-tilter, multi-tilter and posture task. Stool models are available with posture task mechanism only.
- Side activated sliding seat depth adjustment (**MD**) and separate back angle adjustment is standard on synchro-tilter and multi-tilter.
- Durable Black polypropylene back shroud with unique upper back shape enables free lateral movement.
- Schukra™ depth adjustable lumbar support for personalized back support and comfort is standard on all models.
- Dual density foam spine pad embedded in the back of the chair forms to the user's shape.
- Vertical back height ratchet adjustment of 5.25".
- Back support upright is 3" wide for extra strength and durability.
- Standard with Global's high quality Soft Descent™ pneumatic lift which slowly and gently lowers the seat height of the chair making it easy to obtain the exact seat height you desire. 4" cylinder is standard on synchro-tilter models. 5" cylinder is standard on multi-tilter, task and posture task models.
- Models with arms are standard with height and width adjustable arms (**G6**) with sliding armcaps. Armcaps also articulate inwards and outwards to aim toward the keyboard or mouse area.
- Vari-Width (**WA**) width adjustable arm extensions are standard. Allows the arms to move away from the seat by 2" on each side to allow space if desired for broader hip widths.
- Waterfall seamless seat front design with high density Ultracell foam for superior comfort and longevity.
- Underside of seat pan is completely sealed.
- 5-prong, injection molded, fiberglass reinforced nylon Black base with dual wheel carpet casters (**C65**).
- Can be upholstered in standard Global textiles only if Healthcare compliance is not required.
- To meet higher standards for housekeeping and infection control, GC Tritek has a seamless seat and one stitch pullover back upholstery, while still offering soft curves to the design. Note: Vinyl and woven treated textiles are thicker in nature and will experience wrinkles on some curves or corners as a result.

OPTIONAL FEATURES

- For moisture barrier on seat, please specify (**MB**). Add \$81.
- To add sealed seams to your product, contact Customer Service. Upcharges vary.
- For additional arms/caster options, please refer to the Arm and Caster section (269). Optional casters may be priced higher than the standard casters for your chair and the difference will be charged. Lower priced optional casters will not be credited.



Please add option codes in the following order:

- Model number**
GC7471 Medium back with arms
GC7471NA Medium back, armless
GC7472 High back with arms
GC7472NA High back, armless
GC7473 Extended high back with arms
GC7473NA Extended high back, armless
GC7476 Medium back stool with arms
GC7476NA Medium back stool, armless
- Textile**
Specify textile code.
- Mechanism**
(6) Task mechanism. No upcharge.
(0) Synchro-tilter mechanism. Add \$168.
(3) Multi-tilter mechanism. Add \$168.
(7) Posture task mechanism. Add \$99 (no upcharge on stool models).
- Seat size**
(P) Petite
(S) Standard
(G) Generous
- Arms**
(G6) Height and width adjustable arms. No upcharge. For additional arm options, please refer to Arm Selections section on page 271.
- Base**
(BK) Black nylon B7B base.
(B7) Polished aluminum base. Add \$131.
- Casters/Glides**
(C65) Dual wheel carpet casters.
(C65R) Dual wheel hard floor casters. Add \$21.
(C7) Set of 5 large Black slipper glides (for all surfaces). Can replace any Global casters. Glide is the same height as casters. No upcharge.

EXAMPLE GC TRITEK ORDER CODE:

GC7471	-WA53	-0	-S	-G6	-B7	-C65R
Model number	Textile	Mechanism	Seat size	Arms	Base	Casters/Glides

DESCRIPTION	MODEL# / FEATURES	STANDARD TEXTILE GRADES											
		COM	2	3	4	5	6	7	8	9	10	11	12
 GC7471 With arms GC7471NA Armless		1108	1164	1211	1266	1355	1437	1519	1591	1680	1764	1878	2039
		1002	1058	1105	1160	1249	1331	1413	1485	1574	1658	1772	1933
		OVERALL DIMENSIONS			SEAT DIMENSIONS			BACK DIMENSIONS					
		W	D	H	W	D	H	W	H				
Medium Back COM: 1.75 YD 1.6 M Unit weight: 40 LB 18.2 KG Carton weight: 47 LB 21.32 KG Carton volume: 13 FT³ 0.36 MT³	Active weight 300 lbs.	IN 25.5	23	39	20.5	17-18	16.5-21.5	18.5	19				
		MM 648	584	991	521	432-457	419-546	470	483				
	See series notes for mechanism options.	RTA 2		1 per carton									

DESCRIPTION	MODEL# / FEATURES	STANDARD TEXTILE GRADES											
		COM	2	3	4	5	6	7	8	9	10	11	12
 <p>High Back COM: 1.9 YD 1.74 M Unit weight: 41 LB 18.6 KG Carton weight: 48 LB 21.77 KG Carton volume: 13 FT³ 0.36 MT³</p>	GC7472 With arms	1141	1202	1253	1312	1409	1498	1588	1666	1763	1854	1977	2152
	GC7472NA Armless	1038	1099	1150	1209	1306	1395	1485	1563	1660	1751	1874	2049
		OVERALL DIMENSIONS			SEAT DIMENSIONS			BACK DIMENSIONS					
		W	D	H	W	D	H	W	H				
		IN 25.5 MM 648	23 584	42 1067	20.5 521	17-18 432-457	16.5-21.5 419-546	18.5 470	22 559				
	Active weight 300 lbs.	See series notes for mechanism options.		RTA 2	1 per carton								
 <p>Extended High Back COM: 2 YD 1.83 M Unit weight: 43 LB 19.5 KG Carton weight: 50 LB 22.68 KG Carton volume: 13 FT³ 0.36 MT³</p>	GC7473 With arms	1175	1239	1293	1355	1457	1551	1645	1727	1829	1925	2055	2239
	GC7473NA Armless	1070	1134	1188	1250	1352	1446	1540	1622	1724	1820	1950	2134
		OVERALL DIMENSIONS			SEAT DIMENSIONS			BACK DIMENSIONS					
		W	D	H	W	D	H	W	H				
		IN 25.5 MM 648	23 584	47 1194	20.5 521	17-18 432-457	16.5-21.5 419-546	18.5 470	27 686				
	Active weight 300 lbs.	See series notes for mechanism options.		RTA 2	1 per carton								
 <p>Medium Back Posture Task Stool COM: 1.75 YD 1.6 M Unit weight: 50 LB 22.7 KG Carton weight: 57 LB 25.85 KG Carton volume: 13 FT³ 0.36 MT³</p>	GC7476 With arms	1313	1369	1416	1471	1560	1642	1724	1796	1885	1969	2083	2244
	GC7476NA Armless	1210	1266	1313	1368	1457	1539	1621	1693	1782	1866	1980	2141
		OVERALL DIMENSIONS			SEAT DIMENSIONS			BACK DIMENSIONS					
		W	D	H	W	D	H	W	H				
		IN 25.5 MM 648	23 584	49 1245	20.5 521	17 432	23.5-33.5 597-851	18.5 470	17.5 445				
	Active weight 300 lbs.	See series notes for mechanism options.		RTA 2	1 per carton								

GC TRITEK TS



model GCTS7473

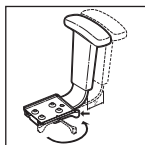

Vari-Width (WA) width adjustable arm extensions are standard when chair is ordered with adjustable arms.

MECHANISMS:

Synchro-tilter mechanism (-0)

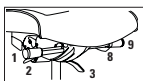

ADJUSTMENTS

- (1) Tilt tension
- (2) Pneumatic seat height
- (3) Back angle
- Back/lumbar height
- (8) Sliding seat depth
- (9) Multi position tilt lock
- Synchro tilt action
- Anti kick back

Ergonomic features:

A, B, C, D, E, G, H, L, M, N, Q, R, U

Task mechanism (-6)

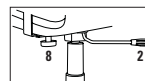

ADJUSTMENTS

- (2) Pneumatic seat height
- (8) Manual seat depth

Ergonomic features:

C, E, H, M, N, Q, R, U

STANDARD FEATURES

- GC Tritek TS is designed for 24/7 applications to meet every body shape and task, providing exceptional support and comfort throughout the work day.
- Available in three back heights and three seat sizes to fit a person's body type and movements while at work.
- Heavy duty synchro-tilter mechanism with side activated sliding seat depth adjustment (**MD**) and separate back angle adjustment for individual comfort are standard. Stool models are available with task mechanism only.
- Durable Black polypropylene back shroud with unique upper back shape enables free lateral movement.
- Schukra™ depth adjustable lumbar support for personalized back support and comfort is standard on all models.
- Dual density foam spine pad embedded in the back of the chair forms to the user's shape.
- Vertical back height ratchet adjustment of 5.25".
- Back support upright is 3" wide for extra strength and durability.
- Standard with heavy duty 4" pneumatic gas lift.
- Models with arms are standard with height and width adjustable arms (**G6**) with sliding armcaps. Armcaps are low rise and also articulate inwards and outwards to aim toward the keyboard or mouse area.
- Vari-Width (**WA**) width adjustable arm extensions are standard. Allows the arms to move away from the seat by 2" on each side to allow space if desired for broader hip widths.
- Waterfall seamless seat front design with high density Ultracell foam for superior comfort and longevity.
- Underside of seat pan is completely sealed.
- 5-prong, injection molded, fiberglass reinforced nylon Black base with dual wheel carpet casters (**C10**).
- Can be upholstered in standard Global textiles only if Healthcare compliance is not required.
- To meet higher standards for housekeeping and infection control, GC Tritek TS has a seamless seat and one stitch pullover back upholstery, while still offering soft curves to the design. Note: that vinyl and woven treated textiles are thicker in nature and will experience wrinkles on some curves or corners as a result.

OPTIONAL FEATURES

- For moisture barrier on seat, please specify (**MB**). Add \$81.
- To add sealed seams to your product, contact Customer Service. Upcharges vary.
- For additional caster options, please refer to the Arm and Caster section (269). Optional casters may be priced higher than the standard casters for your chair and the difference will be charged. Lower priced optional casters will not be credited.



Please add option codes in the following order:

- **Model number**
GCTS7471 Medium back with arms
GCTS7471NA Medium back, armless
GCTS7472 High back with arms
GCTS7472NA High back, armless
GCTS7473 Extended high back with arms
GCTS7473NA Extended high back, armless
GCTS7477 Medium back stool with arms
GCTS7477NA Medium back stool, armless
- **Textile**
Specify textile code.
- **Mechanism**
(0) Synchro-tilter mechanism. No upcharge.
(6) Task mechanism (models GCTS7477 and GCTS7477NA only). No upcharge.
- **Seat size**
(P) Petite
(S) Standard
(G) Generous
- **Arms**
(G6) Height and width adjustable arms. No upcharge. For additional arm options, please refer to Arm Selections section on page 271.
- **Base**
(BK) Black nylon B7B base.
(B7) Polished aluminum base. Add \$131.
- **Casters/Glides**
(C10) Dual wheel carpet casters.
(C10R) Dual wheel hard floor casters. Add \$20.
(C7) Set of 5 large Black slipper glides (for all surfaces). Can replace any Global casters. Allows chair to remain at chair height. No upcharge.

EXAMPLE GC TRITEK TS ORDER CODE:

GCTS7471	-WA53	-0	-S	-G6	-B7	-C10R
Model number	Textile	Mechanism	Seat size	Arms	Base	Casters/Glides

DESCRIPTION	MODEL# / FEATURES	STANDARD TEXTILE GRADES											
		COM	2	3	4	5	6	7	8	9	10	11	12
 Medium Back Heavy Duty COM: 1.75 YD 1.6 M Unit weight: 54 LB 24.5 KG Carton weight: 61 LB 27.67 KG Carton volume: 13 FT³ 0.36 MT³	GCTS7471 With arms	1437	1493	1540	1595	1684	1766	1848	1920	2009	2093	2207	2368
	GCTS7471NA Armless	1334	1390	1437	1492	1581	1663	1745	1817	1906	1990	2104	2265
		OVERALL DIMENSIONS			SEAT DIMENSIONS			BACK DIMENSIONS					
		W	D	H	W	D	H	W	H				
	Active weight 350 lbs.	IN 25.5	24.5	38	20.5	17-20	17-21	18.5	18				
	See series notes for mechanism options.	MM 648	622	965	521	432-508	432-533	470	457				
		RTA 2		1 per carton									

DESCRIPTION	MODEL# / FEATURES	STANDARD TEXTILE GRADES												
		COM	2	3	4	5	6	7	8	9	10	11	12	
 <p>High Back Heavy Duty COM: 1.9 YD 1.74 M Unit weight: 58 LB 26.4 KG Carton weight: 65 LB 29.48 KG Carton volume: 13 FT³ 0.36 MT³</p>	GCTS7472 With arms	1471	1532	1583	1642	1739	1828	1918	1996	2093	2184	2307	2482	
	GCTS7472NA Armless	1366	1427	1478	1537	1634	1723	1813	1891	1988	2079	2202	2377	
			OVERALL DIMENSIONS			SEAT DIMENSIONS			BACK DIMENSIONS					
			W	D	H	W	D	H	W	H				
	Active weight 350 lbs.		IN 25.5	24.5	41	20.5	17-20	17-21	18.5	21				
			MM 648	622	1041	521	432-508	432-533	470	533				
	See series notes for mechanism options.		RTA 2		1 per carton									
	 <p>Extended High Back Heavy Duty COM: 2 YD 1.83 M Unit weight: 60 LB 27.3 KG Carton weight: 67 LB 30.39 KG Carton volume: 13 FT³ 0.36 MT³</p>	GCTS7473 With arms	1504	1568	1622	1684	1786	1880	1974	2056	2158	2254	2384	2568
		GCTS7473NA Armless	1400	1464	1518	1580	1682	1776	1870	1952	2054	2150	2280	2464
				OVERALL DIMENSIONS			SEAT DIMENSIONS			BACK DIMENSIONS				
		W	D	H	W	D	H	W	H					
Active weight 350 lbs.		IN 25.5	24.5	46	20.5	17-20	17-21	18.5	26					
		MM 648	622	1168	521	432-508	432-533	470	660					
See series notes for mechanism options.		RTA 2		1 per carton										
 <p>Medium Back Heavy Duty Task Stool COM: 1.75 YD 1.6 M Unit weight: 45 LB 20.5 KG Carton weight: 52 LB 23.59 KG Carton volume: 13 FT³ 0.36 MT³</p>		GCTS7477 With arms	1375	1431	1478	1533	1622	1704	1786	1858	1947	2031	2145	2306
		GCTS7477NA Armless	1271	1327	1374	1429	1518	1600	1682	1754	1843	1927	2041	2202
				OVERALL DIMENSIONS			SEAT DIMENSIONS			BACK DIMENSIONS				
			W	D	H	W	D	H	W	H				
	Active weight 350 lbs.		IN 25.5	23	49	20.5	17-18	23.5-33.5	18.5	19				
			MM 648	584	1245	521	432-457	597-851	470	483				
	See series notes for mechanism options.		RTA 2		1 per carton									

GC VION



model GC6322-4 (BLK-C)

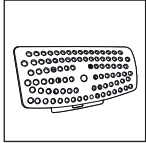

Optional Lumbar Pad (LS)
See right for details.

MECHANISMS:

Synchro-tilter mechanism (-0)

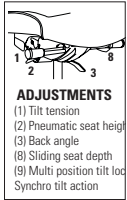

Ergonomic features:

A, B, C, E, G, H, L, M, N, Q, U

Tilter (-4)

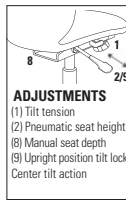

Ergonomic features:

A, B, C, E, H, M, N, Q, S, U

EXAMPLE GC VION ORDER CODE:

GC6322	-BAU	-A5	-ST	-ST	-HX01
Model number	Finish	Mesh	Seat size	Seat Foam	Seat Upholstery
-AF	-EE	-NB	-NS	-5L	
Arms	Casters	Moisture Barrier	Sealed Seams	Pneumatic Lift	

STANDARD FEATURES

- Vion is a comprehensive seating series offering a family of models to address multiple applications: task, management and conference.
- Series offers mid and high back models with either a mesh or upholstered back.
- Mechanism options available: synchro tilter (-0) and tilter (-4).
- All models are standard with height and width adjustable arms that feature a front to back sliding armcap.
- Standard with Global's high quality Soft Descent™ pneumatic lift which slowly and gently lowers the seat height of the chair making it easy to obtain the exact seat height you desire.
- Side activated sliding seat depth adjustment (MD) is standard on multi-tilter, synchro-tilter with back angle adjustment and weight sensing synchro tilter control mechanisms.
- Standard with 5-prong, injection molded, fiberglass reinforced nylon Governor base (B7) with dual wheel carpet casters (C1).
- Mesh back models are available in 10 standard Vion colors: Aqua (MS75), Black (MS69), Black Cherry (MS76), Blue (MS72), Dust (MS77), Ivory (MS78), Natural (MS74), Paprika (MS79), Rope (MS73) and Stone (MS71).
- Underside of the seat is upholstered in a coated textile. The joining of the textiles on the underside of the seat pan is sealed on all models.
- Upholstered back models feature Black textile (Jenny JN02) on the back side as standard.
- Upholstery options: fabric, vinyl or leather.

OPTIONAL FEATURES

- Vion back frames, arms and bases are available in 3 colours: Black, Shadow and Fog. See Vion finishes chart for options and upcharges. Armcaps are always black.
- Mesh back models are also available in 10 Dimension Mesh colours: Black (DBK), Berry (DBE), Chalk (DCL), Charcoal (DCH), Citrus (DCT), Cobalt (DCO), Fog (DST), Pool Blue (DPB), Sand (DSD) and Shadow (DGM). Add \$25.
- Optional lumbar pad (LS) can be added at time of order, please specify. Add \$17. Lumbar pad can also be ordered after sale as a kit, specify model GC6339 at \$32 list price. The Lumbar pad is adjustable up to 3".
- Seat available in memory foam, please specify (MF). Add \$106.
- Petite seat models (2" shorter and 2" narrower than the standard size seat) are available. Please specify by adding (P) to the model code. No upcharge.
- For hard surface flooring casters, please specify (C9R). Add \$21.
- For additional arm/caster options, please refer to the Arm and Caster section (269). Optional casters may be priced higher than the standard casters for your chair and the difference will be charged. Lower priced optional casters will not be credited.

VION FINISHES - TASK SEATING				
Back Frame	Base	SPECIFY CODE	Arm Options	SPECIFY CODE
Black	Black	BLK	Adjustable "T" arm (Black)	AS
Black	Polished Aluminum	BAU Add \$131	Adjustable "T" arm, fixed armcap (Black)	AF
			Adjustable "T" arm (Black, Chrome accent)	AC
Shadow	Shadow	SHW Add \$131	Adj. "T" arm, fixed armcap (Black, Chrome accent)	AD
			Adjustable "T" arm (Shadow)	SHA
Shadow	Polished Aluminum	SAU Add \$131	Adjustable "T" arm, fixed armcap (Shadow)	SHF
			Adjustable "T" arm (Shadow, Chrome accent)	SHR
Fog	Fog	FOG Add \$131	Adj. "T" arm, fixed armcap (Shadow, Chrome accent)	SHD
			Adjustable "T" arm (Fog)	FA
Fog	Polished Aluminum	FAU Add \$131	Adjustable "T" arm, fixed armcap (Fog)	FF
			Adjustable "T" arm (Fog, Chrome accent)	FC
			Adj. "T" arm, fixed armcap (Fog, Chrome accent)	CF
			Fixed "C" arm (Black)	C
Fog	Polished Aluminum	FAU Add \$131	Fixed "C" arm (shadow)	SHC
			Fixed "C" arm (Fog)	CC
			Fixed "C" arm (Polished aluminum)	CA - Add \$111

* All arms have Black SSU armcaps.

DESCRIPTION



mesh back

MB Synchro-Tilter w/Back Angle Adj.

COM: 1 YD | 0.91 M
 Unit weight: 46 LB | 20.9 KG
 Carton weight: 58 LB | 26.31 KG
 Carton volume: 10.5 FT³ | 0.29 MT³

MODEL# / FEATURES

GC6322-0

Active weight 300 lbs.

See series notes for mechanism options.

STANDARD TEXTILE GRADES

COM	2	3	4	5	6	7	8	9	10	11	12
1048	1080	1107	1138	1189	1236	1283	1324	1375	1423	1488	1580

OVERALL DIMENSIONS

W	D	H
IN 25.5	24	39.5
MM 648	610	1003





SEAT DIMENSIONS

W	D	H
17-20	17.5-22.5	
508	445-572	

BACK DIMENSIONS

W	H
18.5	21
470	533

RTA 2 1 per carton

DESCRIPTION	MODEL# / FEATURES	STANDARD TEXTILE GRADES											
		COM	2	3	4	5	6	7	8	9	10	11	12
 <p>mesh back</p> <p>MB Tilter COM: 1 YD 0.91 M Unit weight: 40 LB 18.2 KG Carton weight: 52 LB 23.59 KG Carton volume: 10.5 FT³ 0.29 MT³</p>	GC6322-4	1013	1045	1072	1103	1154	1201	1248	1289	1340	1388	1453	1545
	Active weight 300 lbs.	IN 25.5 MM 648	24 610	37.5 953		20 508	17.5-19 445-483	16-21 406-533		18.5 470	21 533		
	See series notes for mechanism options.	<div style="display: flex; align-items: center;"> <div style="border: 1px solid black; padding: 2px; margin-right: 10px;">RTA 2</div> 1 per carton </div>											
		OVERALL DIMENSIONS W D H			SEAT DIMENSIONS W D H			BACK DIMENSIONS W H					
 <p>upholstered back, standard seat</p> <p>HB Synchro-Tilter w/Back Angle Adj. COM: 1.25 YD 1.14 M Unit weight: 49 LB 22.3 KG Carton weight: 61 LB 27.67 KG Carton volume: 10.5 FT³ 0.29 MT³</p>	GC6331-0	1097	1137	1171	1210	1273	1332	1391	1442	1506	1566	1647	1762
	Active weight 300 lbs.	IN 25.5 MM 648	24 610	41.5 1054		20 508	17-20 432-508	17.5-22.5 445-572		18.5 470	23 584		
	See series notes for mechanism options.	<div style="display: flex; align-items: center;"> <div style="border: 1px solid black; padding: 2px; margin-right: 10px;">RTA 2</div> 1 per carton </div>											
		OVERALL DIMENSIONS W D H			SEAT DIMENSIONS W D H			BACK DIMENSIONS W H					
 <p>upholstered back, standard seat</p> <p>HB Tilter COM: 1.25 YD 1.14 M Unit weight: 43 LB 19.5 KG Carton weight: 55 LB 24.95 KG Carton volume: 10.5 FT³ 0.29 MT³</p>	GC6331-4	1070	1110	1144	1183	1246	1305	1364	1415	1479	1539	1620	1735
	Active weight 300 lbs.	IN 25.5 MM 648	24 610	39.25 997		20 508	17.5-19 445-483	16-21 406-533		18.5 470	23 584		
	See series notes for mechanism options.	<div style="display: flex; align-items: center;"> <div style="border: 1px solid black; padding: 2px; margin-right: 10px;">RTA 2</div> 1 per carton </div>											
		OVERALL DIMENSIONS W D H			SEAT DIMENSIONS W D H			BACK DIMENSIONS W H					
 <p>Lumbar Pad Kit for Vion COM: N/A Unit weight: 0.5 LB 0.2 KG Carton weight: 1.5 LB 0.68 KG Carton volume: 0.5 FT³ 0.01 MT³</p>	GC6339	32											
		OVERALL DIMENSIONS W D H			SEAT DIMENSIONS W D H			BACK DIMENSIONS W H					
		IN 10.25 MM 260	3.5 89	5.25 133		- -	- -	- -		- -	- -		
		<div style="display: flex; align-items: center;"> <div style="border: 1px solid black; padding: 2px; margin-right: 10px;">RTA 00</div> 1 per carton </div>											

HARMONY



model GCTS35032-3

model GC35022-5

STANDARD FEATURES

- Harmony is the sized right solution for everyone with many applications.
- Compound curved back and seat comfortably match body shape.
- For added comfort, seats are standard with high density Ultracell foam.
- Standard with soft, durable, depth adjustable, sliding self-skinned urethane (SSU) armcaps that are warm to the touch. Armcaps articulate inwards and outwards 15°.
- Vari-Width (WA) width adjustable arm extensions are standard. Allows the arms to move away from the seat by 2" on each side to allow space if desired for broader hip widths.
- All models except bariatric multi-tilter: Height adjustable low rise (G6) arms are standard.
- Bariatric multi-tilters: Solid steel loop arm is standard. The arm is vinyl dipped to be warm to the touch and impact absorbent.
- Standard with Global's high quality Soft Descent™ pneumatic lift which slowly and gently lowers the seat height of the chair making it easy to obtain the exact seat height you desire (except HD 24HR multi-shift models and bariatric multi-tilters).
- Side activated sliding seat depth adjustment (MD) is standard on multi-tilters (non bariatric).
- Schukra™ depth adjustable lumbar support for personalized back support and comfort is standard on select models.
- Vertical back height ratchet adjustment of 5.25" is standard on all models (except bariatric multi-tilters, task chairs and operator stools).
- Back support upright is 3" wide for extra strength.
- All models except bariatric multi-tilter: 5-prong, injection molded, fiberglass reinforced nylon Black base with (C65) dual wheel carpet casters. Heavy duty 24HR multi-tilters: (C10) dual wheel carpet casters are standard.

- Bariatric multi-tilters: 6-prong Black steel base with (C98) large diameter 3" dual wheel carpet casters are standard.
- Can be upholstered in standard Global textiles only if Healthcare compliance is not required.
- For healthcare textiles and finish options, visit the website at globalfurnituregroup.com.
- Petite, standard and generous seats have the same list prices.

OPTIONAL FEATURES

- For improved housekeeping and infection control practices, please add (SU) to model number. The underside of the seat will be finished with vinyl and sealed to prevent penetration of liquids. Add \$39.
- Side activated sliding seat depth adjustment (MD) is optional on knee-tilters. Add \$32.
- Multi-tilters: For hard surface flooring casters, please specify (C65R). Add \$21.
- Heavy duty 24HR multi-tilters: For hard surface flooring casters, please specify (C10R). Add \$20.
- Bariatric multi-tilters: Standard arms and casters are made specifically for these models to provide maximum strength and durability. Therefore, no other casters or arms can be used.
- For moisture barrier on seat, please specify (MB). Add \$81. Bariatric models: Add \$122
- To add sealed seams to your product contact Customer Service. Upcharges vary.
- For additional arm/caster options, please refer the Arm and Caster section (page 269). Optional casters may be priced higher than the standard casters for your chair and the difference will be charged. Lower priced optional casters will not be credited.

SUGGESTED APPLICATIONS

- Office/Meeting
- Treatment/Exam rooms

Dimensional Information: Multi-tilters (including 24HR) (non bariatric)

	Armrest Clearance	Standard Arm Height	Seat Depth	Seat Height
Petite seat low rise 4" gas cylinder	17" - 23"	8" - 11"	17" - 19.5"	16" - 20"
Standard seat 4" Soft Descent™ gas cylinder	18" - 24"	8" - 11"	18" - 20.5"	18" - 22"
Generous seat 4" Soft Descent™ gas cylinder	18.5" - 24.5"	8" - 11"	19" - 21.5"	18" - 22"

Dimensional Information: Knee-tilters

	Armrest Clearance	Standard Arm Height	Seat Depth	Seat Height
Standard seat 4" Soft Descent™ gas cylinder	18" - 24"	8" - 11"	18" - 20.5" with optional (MD) mec	17.5" - 21.5"
Generous seat 4" Soft Descent™ gas cylinder	18" - 24.5"	8" - 11"	19" - 21.5" with optional (MD) mec	17.5" - 21.5"

DESCRIPTION MODEL# / FEATURES STANDARD TEXTILE GRADES



Low Back Multi-Tilter
COM: 1.75 YD | 1.6 M
Unit weight: 52 LB | 23.6 KG
Carton weight: 61 LB | 27.67 KG
Carton volume: 9.25 FT³ | 0.26 MT³

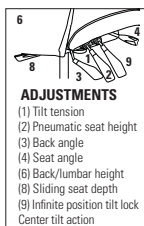





	COM	2	3	4	5	6	7	8	9	10	11	12
GC35012-3 Standard seat	900	956	1003	1058	1147	1229	1311	1383	1472	1556	1670	1831
GC35011-3 Petite seat												
IN W19.5 D17-20 H16-20 MM W495 D432-508 H406-508												

	OVERALL DIMENSIONS			SEAT DIMENSIONS			BACK DIMENSIONS	
	W	D	H	W	D	H	W	H
Active weight 300 lbs.	IN 26 MM 660	24 610	37.5 953	20.5 521	18-21 457-533	17.5-22.5 445-572	18.5 470	16.5-21.75 419-552

Ergonomic features:
A, B, C, D, E, F, G, H, M, N, Q, R, S, U

RTA 2 courier 1 per carton

DESCRIPTION	MODEL# / FEATURES	STANDARD TEXTILE GRADES											
		COM	2	3	4	5	6	7	8	9	10	11	12
 <p>Side Chair Sled Base COM: 1.75 YD 1.6 M Unit weight: 30 LB 13.6 KG Carton weight: 35 LB 15.88 KG Carton volume: 13 FT³ 0.36 MT³</p>	GC35018	569	625	672	727	816	898	980	1052	1141	1225	1339	1500
	Active weight 300 lbs.	OVERALL DIMENSIONS W D H			SEAT DIMENSIONS W D H			BACK DIMENSIONS W H					
	Ergonomic features: M, N	IN 21	24	41.25	21	18	18	19.5	22.25				
		MM 533	610	1048	533	457	457	495	565				
 <p>Armchair Sled Base COM: 1.75 YD 1.6 M Unit weight: 35 LB 15.9 KG Carton weight: 40 LB 18.14 KG Carton volume: 13 FT³ 0.36 MT³</p>	GC35019	718	774	821	876	965	1047	1129	1201	1290	1374	1488	1649
	Active weight 300 lbs.	OVERALL DIMENSIONS W D H			SEAT DIMENSIONS W D H			BACK DIMENSIONS W H					
	Ergonomic features: M, N	IN 26	24	41.25	21	18	18	19.5	22.25				
		MM 660	610	1048	533	457	457	495	565				
 <div data-bbox="414 788 553 1010" style="border: 1px solid black; padding: 5px;"> <p>ADJUSTMENTS</p> <p>(1) Tilt tension (2) Pneumatic seat height (3) Back angle (4) Seat angle (6) Back/lumbar height (8) Sliding seat depth (9) Infinite position tilt lock</p> </div> <p>MB Multi-Tilter COM: 1.75 YD 1.6 M Unit weight: 53 LB 24.1 KG Carton weight: 62 LB 28.12 KG Carton volume: 9.25 FT³ 0.26 MT³</p>	GC35022-3 Standard seat	944	1000	1047	1102	1191	1273	1355	1427	1516	1600	1714	1875
	GC35023-3 Generous seat	IN W21.5 D19-22 H17.5-22.5 MM W546 D483-559 H445-572											
	Active weight 300 lbs.	OVERALL DIMENSIONS W D H			SEAT DIMENSIONS W D H			BACK DIMENSIONS W H					
	Ergonomic features: A, B, C, D, E, F, G, H, M, N, Q, R, S, U	IN 26	24	42.5	20.5	18-21	17.5-22.5	19	19.5-24.75				
	MM 660	610	1080	521	457-533	445-572	483	495-629					
 <div data-bbox="414 1100 553 1322" style="border: 1px solid black; padding: 5px;"> <p>ADJUSTMENTS</p> <p>(1) Tilt tension (2) Pneumatic seat height (6) Back/lumbar height (8) Manual seat depth (9) Upright position tilt lock Center tilt action</p> </div> <p>MB Tilter Standard Seat COM: 1.75 YD 1.6 M Unit weight: 44 LB 20 KG Carton weight: 53 LB 24.04 KG Carton volume: 9.25 FT³ 0.26 MT³</p>	GC35022-4	890	946	993	1048	1137	1219	1301	1373	1462	1546	1660	1821
	Active weight 300 lbs.	OVERALL DIMENSIONS W D H			SEAT DIMENSIONS W D H			BACK DIMENSIONS W H					
	Ergonomic features: A, B, C, D, E, F, G, H, M, N, Q, R, S, U	IN 26	24	42	20.5	18-19	17-22	19	19.5-24.75				
		MM 660	610	1067	521	457-483	432-559	483	495-629				
 <div data-bbox="414 1413 553 1634" style="border: 1px solid black; padding: 5px;"> <p>ADJUSTMENTS</p> <p>(2) Pneumatic seat height (3) Back angle (4) Seat angle (6) Back/lumbar height Free floating seat & back</p> </div> <p>MB Operator Standard Seat COM: 1.75 YD 1.6 M Unit weight: 46 LB 20.9 KG Carton weight: 55 LB 24.95 KG Carton volume: 9.25 FT³ 0.26 MT³</p>	GC35022-5	904	960	1007	1062	1151	1233	1315	1387	1476	1560	1674	1835
	Active weight 300 lbs.	OVERALL DIMENSIONS W D H			SEAT DIMENSIONS W D H			BACK DIMENSIONS W H					
	Ergonomic features: C, D, F, G, H, M, N, Q, R, S, U	IN 26	24	40.5	20.5	18	17-22	19	19.5-24.75				
		MM 660	610	1029	521	457	432-559	483	495-629				

DESCRIPTION MODEL# / FEATURES STANDARD TEXTILE GRADES

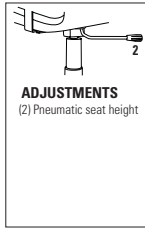

MB Task Standard Seat
COM: 1.75 YD | 1.6 M
Unit weight: 38 LB | 17.3 KG
Carton weight: 47 LB | 21.32 KG
Carton volume: 9.25 FT³ | 0.26 MT³

COM	2	3	4	5	6	7	8	9	10	11	12	
GC35022-6	683	739	786	841	930	1012	1094	1166	1255	1339	1453	1614
OVERALL DIMENSIONS			SEAT DIMENSIONS			BACK DIMENSIONS						
W D H			W D H			W H						
IN 26 24 42.5			20.5 17.5-18.5 17-22			19 20.5						
MM 660 610 1080			521 445-470 432-559			483 521						
Active weight 300 lbs.												
Ergonomic features: C, E, H, M, N, Q, R, U												
RTA 2 courier 1 per carton												

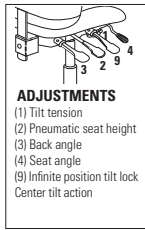

MB Bariatric Multi-Tilter
COM: 3 YD | 2.74 M
Unit weight: 90 LB | 40.9 KG
Carton weight: 114 LB | 51.71 KG
Carton volume: 29.5 FT³ | 0.83 MT³

COM	2	3	4	5	6	7	8	9	10	11	12	
GC35024-3	2059	2155	2236	2329	2482	2623	2764	2887	3040	3184	3379	3655
OVERALL DIMENSIONS			SEAT DIMENSIONS			BACK DIMENSIONS						
W D H			W D H			W H						
IN 29 26.5 42.5			25.5 20 16.5-20.5			22 24						
MM 737 673 1080			648 508 419-521			559 610						
Active weight 500 lbs.												
Ergonomic features: A, B, C, F, G, M, N, Q, S												
RTA 00 1 per carton												

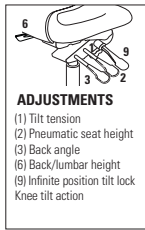

HB Knee-Tilter
COM: 2 YD | 1.83 M
Unit weight: 52 LB | 23.6 KG
Carton weight: 61 LB | 27.67 KG
Carton volume: 9.25 FT³ | 0.26 MT³

COM	2	3	4	5	6	7	8	9	10	11	12	
GC35032-2 Standard seat	1124	1188	1242	1304	1406	1500	1594	1676	1778	1874	2004	2188
GC35033-2 Generous seat												
IN W21.5 D19-21.5 H17.5-22.5 MM W546 D483-546 H445-572												
OVERALL DIMENSIONS			SEAT DIMENSIONS			BACK DIMENSIONS						
W D H			W D H			W H						
IN 26 24 44.5			20.5 18-20.5 17.5-22.5			19 22.5-27.75						
MM 660 610 1130			521 457-521 445-572			483 572-705						
Active weight 300 lbs.												
Ergonomic features: A, B, C, D, G, H, J, M, N, Q, R, U												
RTA 2 courier 1 per carton												

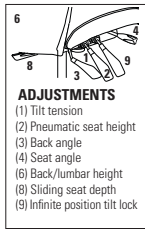





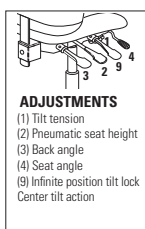

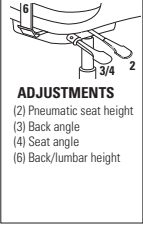

HB Multi-Tilter
COM: 2 YD | 1.83 M
Unit weight: 55 LB | 25 KG
Carton weight: 64 LB | 29.03 KG
Carton volume: 9.25 FT³ | 0.26 MT³

COM	2	3	4	5	6	7	8	9	10	11	12	
GC35032-3 Standard seat	982	1046	1100	1162	1264	1358	1452	1534	1636	1732	1862	2046
GC35033-3 Generous seat												
IN W21.5 D19-22 H17.5-22.5 MM W546 D483-559 H445-572												
OVERALL DIMENSIONS			SEAT DIMENSIONS			BACK DIMENSIONS						
W D H			W D H			W H						
IN 26 24 45			20.5 18-21 17.5-22.5			19 22.5-27.75						
MM 660 610 1143			521 457-533 445-572			483 572-705						
Active weight 300 lbs.												
Ergonomic features: A, B, C, D, E, F, G, H, M, N, Q, R, S, U												
RTA 2 courier 1 per carton												

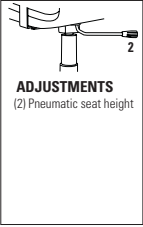

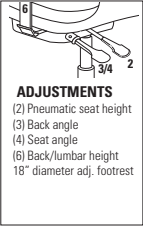
HB Bariatric Multi-Tilter
COM: 3.25 YD | 2.97 M
Unit weight: 92 LB | 41.8 KG
Carton weight: 118 LB | 53.52 KG
Carton volume: 33.5 FT³ | 0.94 MT³

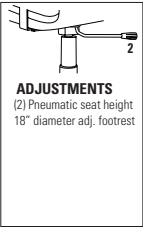
COM	2	3	4	5	6	7	8	9	10	11	12	
GC35034-3	2156	2260	2348	2449	2614	2767	2920	3053	3219	3375	3586	3885
OVERALL DIMENSIONS			SEAT DIMENSIONS			BACK DIMENSIONS						
W D H			W D H			W H						
IN 29 27.5 50.5			25.5 20 16.5-20.5			22 30						
MM 737 699 1283			648 508 419-521			559 762						
Active weight 500 lbs.												
Ergonomic features: A, B, C, F, G, M, N, Q, S												
RTA 00 1 per carton												

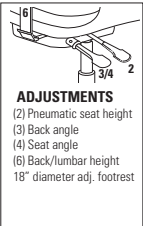
DESCRIPTION	MODEL# / FEATURES	STANDARD TEXTILE GRADES												
		COM	2	3	4	5	6	7	8	9	10	11	12	
 <p>MB Operator Standard Seat Armless COM: 1.75 YD 1.6 M Unit weight: 40 LB 18.2 KG Carton weight: 49 LB 22.23 KG Carton volume: 9.25 FT³ 0.26 MT³</p>	 <p>ADJUSTMENTS (2) Pneumatic seat height (3) Back angle (4) Seat angle (6) Back/lumbar height</p>	GC35122-5	787	843	890	945	1034	1116	1198	1270	1359	1443	1557	1718
		Active weight 300 lbs.	OVERALL DIMENSIONS			SEAT DIMENSIONS			BACK DIMENSIONS					
			W	D	H	W	D	H	W	H				
			IN 20.5 MM 521	24 610	40.5 1029	20.5 521	18 457	17-22 432-559	19 483	19.5-24.75 495-629				
	Ergonomic features: C, D, F, G, M, N, S, U	RTA 2	courier	1 per carton										
 <p>MB Task Standard Seat Armless COM: 1.75 YD 1.6 M Unit weight: 32 LB 14.5 KG Carton weight: 41 LB 18.6 KG Carton volume: 9.25 FT³ 0.26 MT³</p>	 <p>ADJUSTMENTS (2) Pneumatic seat height</p>	GC35122-6	564	620	667	722	811	893	975	1047	1136	1220	1334	1495
		Active weight 300 lbs.	OVERALL DIMENSIONS			SEAT DIMENSIONS			BACK DIMENSIONS					
			W	D	H	W	D	H	W	H				
			IN 20.5 MM 521	24 610	42.5 1080	20.5 521	17.5-18.5 445-470	17-22 432-559	19 483	20.5 521				
	Ergonomic features: C, E, M, N, U	RTA 2	courier	1 per carton										
 <p>Low Back Operator Stool - Small Seat COM: 1.75 YD 1.6 M Unit weight: 46 LB 20.9 KG Carton weight: 55 LB 24.95 KG Carton volume: 9.25 FT³ 0.26 MT³</p>	 <p>ADJUSTMENTS (2) Pneumatic seat height (3) Back angle (4) Seat angle (6) Back/lumbar height 18" diameter adj. footrest</p>	GC35211-5	1135	1191	1238	1293	1382	1464	1546	1618	1707	1791	1905	2066
		Active weight 300 lbs.	OVERALL DIMENSIONS			SEAT DIMENSIONS			BACK DIMENSIONS					
			W	D	H	W	D	H	W	H				
			IN 25 MM 635	23 584	47 1194	19.5 495	17.5 445	24-34 610-864	18.5 470	16.5-21.75 419-552				
	Ergonomic features: C, D, F, G, H, M, N, Q, R, S, U	RTA 2	courier	1 per carton										
 <p>Low Back Task Stool - Small Seat COM: 1.75 YD 1.6 M Unit weight: 42 LB 19.1 KG Carton weight: 51 LB 23.13 KG Carton volume: 9.25 FT³ 0.26 MT³</p>	 <p>ADJUSTMENTS (2) Pneumatic seat height 18" diameter adj. footrest</p>	GC35211-6	911	967	1014	1069	1158	1240	1322	1394	1483	1567	1681	1842
		Active weight 300 lbs.	OVERALL DIMENSIONS			SEAT DIMENSIONS			BACK DIMENSIONS					
			W	D	H	W	D	H	W	H				
			IN 25 MM 635	23 584	48 1219	19.5 495	17.5-18.5 445-470	24-34 610-864	18.5 470	17.5 445				
	Ergonomic features: C, E, H, M, N, Q, R, U	RTA 2	courier	1 per carton										
 <p>LB Operator Stool Armless - Small Seat COM: 1.75 YD 1.6 M Unit weight: 40 LB 18.2 KG Carton weight: 49 LB 22.23 KG Carton volume: 9.25 FT³ 0.26 MT³</p>	 <p>ADJUSTMENTS (2) Pneumatic seat height (3) Back angle (4) Seat angle (6) Back/lumbar height 18" diameter adj. footrest</p>	GC35311-5	1016	1072	1119	1174	1263	1345	1427	1499	1588	1672	1786	1947
		Active weight 300 lbs.	OVERALL DIMENSIONS			SEAT DIMENSIONS			BACK DIMENSIONS					
			W	D	H	W	D	H	W	H				
			IN 19.5 MM 495	23 584	47 1194	19.5 495	17.5 445	24-34 610-864	18.5 470	16.5-21.75 419-552				
	Ergonomic features: C, E, M, N, U	RTA 2	courier	1 per carton										

DESCRIPTION MODEL# / FEATURES STANDARD TEXTILE GRADES



LB Task Stool Armless - Petite Seat
 COM: 1.75 YD | 1.6 M
 Unit weight: 36 LB | 16.4 KG
 Carton weight: 45 LB | 20.41 KG
 Carton volume: 9.25 FT³ | 0.26 MT³

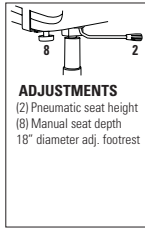

ADJUSTMENTS
 (2) Pneumatic seat height
 (8) Manual seat depth
 18" diameter adj. footrest

COM	2	3	4	5	6	7	8	9	10	11	12	
GC35311-6	792	848	895	950	1039	1121	1203	1275	1364	1448	1562	1723
OVERALL DIMENSIONS			SEAT DIMENSIONS			BACK DIMENSIONS						
W D H			W D H			W H						
IN 19.5 23 48			19.5 17.5-18.5 24-34			18.5 17.5						
MM 495 584 1219			495 445-470 610-864			470 445						
Active weight 300 lbs.												
Ergonomic features: RTA 2 1 per carton												



LB Multi-Tilt w/Schukra
 COM: 1.75 YD | 1.6 M
 Unit weight: 52 LB | 23.6 KG
 Carton weight: 61 LB | 27.67 KG
 Carton volume: 9.25 FT³ | 0.26 MT³

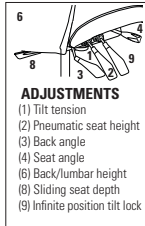

ADJUSTMENTS
 (1) Tilt tension
 (2) Pneumatic seat height
 (3) Back angle
 (4) Seat angle
 (6) Back/lumbar height
 (8) Sliding seat depth
 (9) Infinite position tilt lock

COM	2	3	4	5	6	7	8	9	10	11	12	
GC36012-3 Standard seat	1023	1079	1126	1181	1270	1352	1434	1506	1595	1679	1793	1954
GC36011-3 Petite seat												
IN W19.5 D17-20 H16-20 MM W495 D432-508 H406-508												
OVERALL DIMENSIONS			SEAT DIMENSIONS			BACK DIMENSIONS						
W D H			W D H			W H						
IN 26 24 37.5			20.5 18-21 17.5-22.5			18.5 16.5-21.75						
MM 660 610 953			521 457-533 445-572			470 419-552						
Active weight 300 lbs.												
Ergonomic features: A, B, C, D, E, F, G, H, M, N, Q, R, S, U, V RTA 2 1 per carton												



MB Multi-Tilter w/Schukra
 COM: 1.75 YD | 1.6 M
 Unit weight: 53 LB | 24.1 KG
 Carton weight: 62 LB | 28.12 KG
 Carton volume: 9.25 FT³ | 0.26 MT³

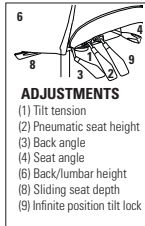

ADJUSTMENTS
 (1) Tilt tension
 (2) Pneumatic seat height
 (3) Back angle
 (4) Seat angle
 (6) Back/lumbar height
 (8) Sliding seat depth
 (9) Infinite position tilt lock

COM	2	3	4	5	6	7	8	9	10	11	12	
GC36022-3 Standard seat	1067	1123	1170	1225	1314	1396	1478	1550	1639	1723	1837	1998
GC36023-3 Generous seat												
IN W21.5 D19-22 H17.5-22.5 MM W546 D483-559 H445-572												
OVERALL DIMENSIONS			SEAT DIMENSIONS			BACK DIMENSIONS						
W D H			W D H			W H						
IN 26 24 42.5			20.5 18-21 17.5-22.5			19 19.5-24.75						
MM 660 610 1080			521 457-533 445-572			483 495-629						
Active weight 300 lbs.												
Ergonomic features: A, B, C, D, E, F, G, H, M, N, Q, R, S, U, V RTA 2 1 per carton												



HB Knee-Tilter w/Schukra
 COM: 2 YD | 1.83 M
 Unit weight: 55 LB | 25 KG
 Carton weight: 64 LB | 29.03 KG
 Carton volume: 9.25 FT³ | 0.26 MT³

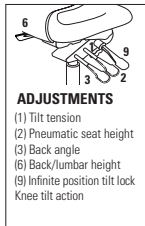

ADJUSTMENTS
 (1) Tilt tension
 (2) Pneumatic seat height
 (3) Back angle
 (6) Back/lumbar height
 (9) Infinite position tilt lock
 Knee tilt action

COM	2	3	4	5	6	7	8	9	10	11	12	
GC36032-2 Standard seat	1244	1308	1362	1424	1526	1620	1714	1796	1898	1994	2124	2308
GC36033-2 Generous seat												
IN W21.5 D19-21.5 H17.5-22.5 MM W546 D483-546 H445-572												
OVERALL DIMENSIONS			SEAT DIMENSIONS			BACK DIMENSIONS						
W D H			W D H			W H						
IN 26 24 45			20.5 18-20.5 17.5-22.5			19 22.5-27.75						
MM 660 610 1143			521 457-521 445-572			483 572-705						
Active weight 300 lbs.												
Ergonomic features: A, B, C, D, G, H, J, M, N, Q, R, U, V RTA 2 1 per carton												





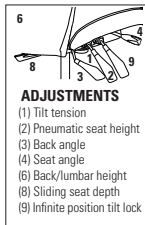





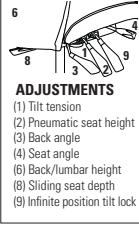

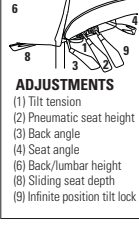
HB Multi-Tilter w/Schukra
 COM: 2 YD | 1.83 M
 Unit weight: 55 LB | 25 KG
 Carton weight: 64 LB | 29.03 KG
 Carton volume: 9.25 FT³ | 0.26 MT³

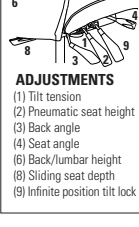

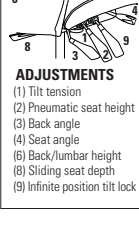
ADJUSTMENTS
 (1) Tilt tension
 (2) Pneumatic seat height
 (3) Back angle
 (4) Seat angle
 (6) Back/lumbar height
 (8) Sliding seat depth
 (9) Infinite position tilt lock

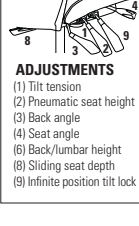
COM	2	3	4	5	6	7	8	9	10	11	12	
GC36032-3 Standard seat	1102	1166	1220	1282	1384	1478	1572	1654	1756	1852	1982	2166
GC36033-3 Generous seat												
IN W21.5 D19-22 H17.5-22.5 MM W546 D483-559 H445-572												
OVERALL DIMENSIONS			SEAT DIMENSIONS			BACK DIMENSIONS						
W D H			W D H			W H						
IN 26 24 45			20.5 18-21 17.5-22.5			19 22.5-27.75						
MM 660 610 1143			521 457-533 445-572			483 572-705						
Active weight 300 lbs.												
Ergonomic features: A, B, C, D, E, F, G, H, M, N, Q, R, S, U, V RTA 2 1 per carton												

DESCRIPTION	MODEL# / FEATURES	STANDARD TEXTILE GRADES												
		COM	2	3	4	5	6	7	8	9	10	11	12	
 <p>LB 24HR Multi-Tilter HD COM: 1.75 YD 1.6 M Unit weight: 54 LB 24.5 KG Carton weight: 63 LB 28.58 KG Carton volume: 9.25 FT³ 0.26 MT³</p>	 <p>ADJUSTMENTS (1) Tilt tension (2) Pneumatic seat height (3) Back angle (4) Seat angle (5) Back/lumbar height (6) Sliding seat depth (9) Infinite position tilt lock</p>	GCTS35012-3 Standard seat GCTS35011-3 Petite seat IN W19.5 D17-19.5 H16-20 MM W495 D432-495 H406-508	1110	1166	1213	1268	1357	1439	1521	1593	1682	1766	1880	2041
		OVERALL DIMENSIONS W D H			SEAT DIMENSIONS W D H			BACK DIMENSIONS W H						
		Active weight 350 lbs.	IN 26 MM 660	24 610	37.5 953	20.5 521	18-20.5 457-521	18-22 457-559	18.5 470	16.5-21.75 419-552				
		Ergonomic features: A, B, C, D, E, F, G, H, M, N, Q, R, S	RTA 2		1 per carton									
 <p>MB 24HR Multi-Tilter HD COM: 1.75 YD 1.6 M Unit weight: 55 LB 25 KG Carton weight: 64 LB 29.03 KG Carton volume: 9.25 FT³ 0.26 MT³</p>	 <p>ADJUSTMENTS (1) Tilt tension (2) Pneumatic seat height (3) Back angle (4) Seat angle (5) Back/lumbar height (6) Sliding seat depth (9) Infinite position tilt lock</p>	GCTS35022-3 Standard seat GCTS35023-3 Generous seat IN W21.5 D19-21.5 H18-22 MM W546 D483-546 H457-559	1153	1209	1256	1311	1400	1482	1564	1636	1725	1809	1923	2084
		OVERALL DIMENSIONS W D H			SEAT DIMENSIONS W D H			BACK DIMENSIONS W H						
		Active weight 350 lbs.	IN 26 MM 660	24 610	42.5 1080	20.5 521	18-20.5 457-521	18-22 457-559	19 483	19.5-24.75 495-629				
		Ergonomic features: A, B, C, D, E, F, G, H, M, N, Q, R, S	RTA 2		1 per carton									
 <p>HB 24HR Multi-Tilter HD COM: 2 YD 1.83 M Unit weight: 57 LB 25.9 KG Carton weight: 66 LB 29.94 KG Carton volume: 9.25 FT³ 0.26 MT³</p>	 <p>ADJUSTMENTS (1) Tilt tension (2) Pneumatic seat height (3) Back angle (4) Seat angle (5) Back/lumbar height (6) Sliding seat depth (9) Infinite position tilt lock</p>	GCTS35032-3 Standard seat GCTS35033-3 Generous seat IN W21.5 D19-21.5 H18-22 MM W546 D483-546 H457-559	1188	1252	1306	1368	1470	1564	1658	1740	1842	1938	2068	2252
		OVERALL DIMENSIONS W D H			SEAT DIMENSIONS W D H			BACK DIMENSIONS W H						
		Active weight 350 lbs.	IN 26 MM 660	24 610	45 1143	20.5 521	18-20.5 457-521	18-22 457-559	19 483	22.5-27.75 572-705				
		Ergonomic features: A, B, C, D, E, F, G, H, M, N, Q, R, S	RTA 2		1 per carton									
 <p>LB 24HR Multi-Tilter HD w/Schukra COM: 1.75 YD 1.6 M Unit weight: 54 LB 24.5 KG Carton weight: 63 LB 28.58 KG Carton volume: 9.25 FT³ 0.26 MT³</p>	 <p>ADJUSTMENTS (1) Tilt tension (2) Pneumatic seat height (3) Back angle (4) Seat angle (5) Back/lumbar height (6) Sliding seat depth (9) Infinite position tilt lock</p>	GCTS36012-3 Standard seat GCTS36011-3 Petite seat IN W19.5 D17-19.5 H16-20 MM W495 D432-495 H406-508	1230	1286	1333	1388	1477	1559	1641	1713	1802	1886	2000	2161
		OVERALL DIMENSIONS W D H			SEAT DIMENSIONS W D H			BACK DIMENSIONS W H						
		Active weight 350 lbs.	IN 26 MM 660	24 610	37.5 953	20.5 521	18-20.5 457-521	18-22 457-559	18.5 470	16.5-21.75 419-552				
		Ergonomic features: A, B, C, D, E, F, G, H, M, N, Q, R, S, V	RTA 2		1 per carton									
 <p>MB 24HR Multi-Tilter HD w/ Schukra COM: 1.75 YD 1.6 M Unit weight: 55 LB 25 KG Carton weight: 64 LB 29.03 KG Carton volume: 9.25 FT³ 0.26 MT³</p>	 <p>ADJUSTMENTS (1) Tilt tension (2) Pneumatic seat height (3) Back angle (4) Seat angle (5) Back/lumbar height (6) Sliding seat depth (9) Infinite position tilt lock</p>	GCTS36022-3 Standard seat GCTS36023-3 Generous seat IN W21.5 D19-21.5 H18-22 MM W546 D483-546 H457-559	1276	1332	1379	1434	1523	1605	1687	1759	1848	1932	2046	2207
		OVERALL DIMENSIONS W D H			SEAT DIMENSIONS W D H			BACK DIMENSIONS W H						
		Active weight 350 lbs.	IN 26 MM 660	24 610	42.5 1080	20.5 521	18-20.5 457-521	18-22 457-559	19 483	19.5-24.75 495-629				
		Ergonomic features: A, B, C, D, E, F, G, H, M, N, Q, R, S, V	RTA 2		1 per carton									

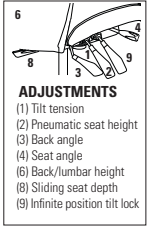
DESCRIPTION	MODEL# / FEATURES	STANDARD TEXTILE GRADES																																
		COM	2	3	4	5	6	7	8	9	10	11	12																					
 <p>HB 24HR Multi-Titer HD w/Schukra COM: 2 YD 1.83 M Unit weight: 57 LB 25.9 KG Carton weight: 66 LB 29.94 KG Carton volume: 9.25 FT³ 0.26 MT³</p>	 <p>ADJUSTMENTS (1) Tilt tension (2) Pneumatic seat height (3) Back angle (4) Seat angle (6) Back/lumbar height (8) Sliding seat depth (9) Infinite position tilt lock</p>	GCTS36032-3 Standard seat GCTS36033-3 Generous seat in W21.5 D19-21.5 H18-22 mm W546 D483-546 H457-559	1312	1376	1430	1492	1594	1688	1782	1864	1966	2062	2192	2376																				
		Active weight 350 lbs. Ergonomic features: A, B, C, D, E, F, G, H, M, N, O, R, S, V	<table border="1"> <thead> <tr> <th colspan="3">OVERALL DIMENSIONS</th> <th colspan="3">SEAT DIMENSIONS</th> <th colspan="2">BACK DIMENSIONS</th> </tr> <tr> <th>W</th> <th>D</th> <th>H</th> <th>W</th> <th>D</th> <th>H</th> <th>W</th> <th>H</th> </tr> </thead> <tbody> <tr> <td>in 26</td> <td>24</td> <td>45</td> <td>20.5</td> <td>18-20.5</td> <td>18-22</td> <td>19</td> <td>22.5-27.75</td> </tr> <tr> <td>mm 660</td> <td>610</td> <td>1143</td> <td>521</td> <td>457-521</td> <td>457-559</td> <td>483</td> <td>572-705</td> </tr> </tbody> </table>	OVERALL DIMENSIONS			SEAT DIMENSIONS			BACK DIMENSIONS		W	D	H	W	D	H	W	H	in 26	24	45	20.5	18-20.5	18-22	19	22.5-27.75	mm 660	610	1143	521	457-521	457-559	483
OVERALL DIMENSIONS			SEAT DIMENSIONS			BACK DIMENSIONS																												
W	D	H	W	D	H	W	H																											
in 26	24	45	20.5	18-20.5	18-22	19	22.5-27.75																											
mm 660	610	1143	521	457-521	457-559	483	572-705																											

arm + caster selections

HOW TO SELECT ARMRESTS

GLOBAL HAS A WIDE SELECTION OF ARMRESTS TO SUIT ALMOST EVERY WORK TASK. ARMRESTS ARE AN IMPORTANT FEATURE OF A CHAIR – THEY REDUCE STRESS AND TENSION ON THE SPINE, NECK AND SHOULDER MUSCLES BY SUPPORTING THE WEIGHT OF YOUR ARMS. THIS MAKES YOU MORE COMFORTABLE AND ULTIMATELY MORE PRODUCTIVE. HEIGHT, WIDTH AND ANGLE ADJUSTABLE ARMRESTS ENABLE YOU TO POSITION YOUR ARMS AT A COMFORTABLE WORKING POSITION, BASED ON THE TASK AT HAND.

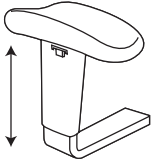

COMFORT TIPS

- Wrists should be in a straight or neutral position - avoid bending your wrists.
- When mousing, use whole arm movements instead of flexing your wrist.
- Rest your palm on the mouse pad for support.

HEIGHT ADJUSTABLE ARMS

- A full range of arms is available with armcaps in self-skinned urethane (SSU).
- Use the features available on Global's adjustable arms to accommodate your ergonomic requirements.

THE VARI-WIDTH ARM FEATURES MAXIMUM COMFORT WHILE ENABLING YOU TO MAINTAIN TOP PRODUCTIVITY LEVELS.

VARI-WIDTH

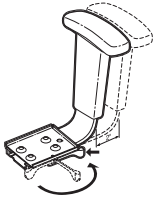

Easy to use levers enable you to adjust the distance between armrests quickly and simply. An ergonomic feature, Vari-Width maximizes shoulder support as it accommodates the specific width requirements of each user.

- Metal adapter plates provide width adjustability. One adapter plate is attached under each side of the seat. Arms are inserted into the adapter plates.
- Arms extend outward up to 2" on each side. A lever locks each arm in any position.
- Vari-Width is available only with Global's height adjustable arms. The arm chart (on the following pages) specifies all arm options available for the Vari-Width series. Vari-Width is standard on many chairs; they can also be retroactively installed on chairs.

ROTATING ARMCAPS

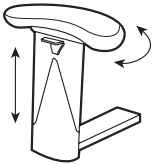

Rotating armcaps articulate inward and/or outward. This positions the arm to support mousing or keyboarding activities. Rotating armcaps can also be used to narrow the space between the arms for slender people seeking arm support while keyboarding.

SLIDING ARMCAPS

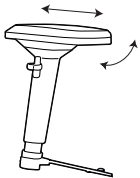

Select arms have sliding armcaps. They can slide over top of the seat to narrow the space between the arms for smaller users. Sliding armcaps also slide forward for arm support for larger users or slide to the rear allowing slender users to sit closer to their worksurface.

ARMS	GALA II	GC TRITEK (GENEROUS SEAT)	GC TRITEK (STANDARD SEAT)	GC TRITEK (PETITE SEAT)	GC VION (STANDARD SEAT)	GC VION (PETITE SEAT)	HARMONY (GENEROUS SEAT)	HARMONY (MEDIUM SEAT)	HARMONY (SMALL SEAT)
STD	3B	G6	G6	G6	AS	AS	G6	G6	G6
AS	\$31	\$0	\$0	NA	STD	STD	\$0	\$0	NA
GL	\$28	\$0	\$0	\$0	\$0	\$0	\$0	\$0	\$0
G1	\$31	\$0	\$0	\$0	\$0	\$0	\$0	\$0	\$0
G2	\$31	\$0	\$0	\$0	\$0	\$0	\$0	\$0	\$0
G3	\$31	\$0	\$0	\$0	\$0	\$0	\$0	\$0	\$0
G4	\$31	\$0	\$0	\$0	\$0	\$0	\$0	\$0	\$0
G5	\$31	\$0	\$0	\$0	\$0	\$0	\$0	\$0	\$0
G6	\$31	STD	STD	STD	\$0	\$0	STD	STD	STD
G7	\$31	\$0	\$0	\$0	\$0	\$0	\$0	\$0	\$0
G8	\$31	\$0	\$0	\$0	\$0	\$0	\$0	\$0	\$0
SC	\$0	\$0	\$0	NA	\$0	\$0	NR	NR	NA
TD	\$0	\$0	\$0	NA	\$0	\$0	\$0	\$0	NA
T6	\$97	\$67	\$67	\$67	\$68	\$68	NA	NA	NA
WA	STD	STD	STD	STD	NA	NA	STD	STD	STD
ZT	\$49	\$22	\$22	NA	\$22	\$22	\$21	\$21	NA
3B	STD	\$0	\$0	NA	\$0	\$0	\$0	\$0	NA
3M	\$0	\$0	\$0	NA	\$0	\$0	\$0	\$0	NA
3N	\$0	\$0	\$0	NA	\$0	\$0	\$0	\$0	NA
3P	\$0	\$0	\$0	NA	\$0	\$0	\$0	\$0	NA
3R	\$0	\$0	\$0	NA	\$0	\$0	\$0	\$0	NA

NOTE: ARMCHAIRS HAVE FIXED ARMS WHICH ARE NOT INTERCHANGEABLE WITH ADJUSTABLE ARMS LISTED ABOVE.

* INDICATES THAT ARMS CANNOT BE USED WITH (WA) ARM WIDTH ADAPTER.

\$0 = AVAILABLE AT NO ADDITIONAL CHARGE







NA = NOT AVAILABLE

NR = OPTION NOT RECOMMENDED

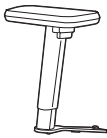
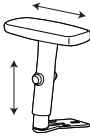
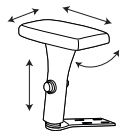
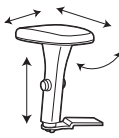
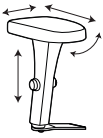
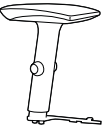
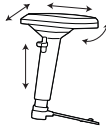
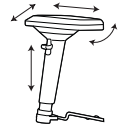
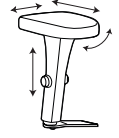
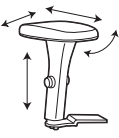
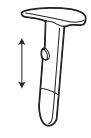

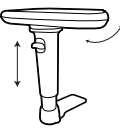
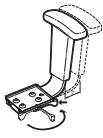

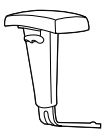
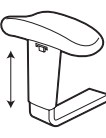
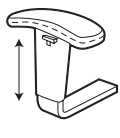
ARM SELECTIONS

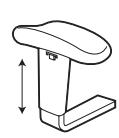
OPTIONAL ARMS

Purchased separately from the chair. Cost listed below arm descriptions. Refer to chart for series compatibility.

 <p>AS Height adjustable T-arm. Self-skinned urethane (SSU) armcap slides forward & backward. For non-sliding armcap, specify (AF). \$189</p>	 <p>GL Height adjustable T-arm. Self-skinned urethane (SSU) armcap slides forward & backward. \$189</p>	 <p>G1 Height and width adjustable T-arm. Rectilinear self-skinned urethane (SSU) armcap slides forward & backward, side-to-side, rotates inward. \$189</p>	 <p>G2 Special low rise version of G3 arm, positions 1" lower but retains all G3 functions. \$189</p>	 <p>G3 Height and width adjustable T-arm. Curved self-skinned urethane (SSU) armcap slides forward & backward, side-to-side, rotates inward. \$189</p>
 <p>G4 Height adjustable T-arm. Self-skinned urethane (SSU) armcap slides forward & backward. \$189</p>	 <p>G5 Lockable, height and width adjustable T-arm. Self-skinned urethane (SSU) armcap slides forward & backward, side-to-side, rotates inward & outward. \$189</p>	 <p>G6 Special low rise version of G5 arm, positions 1" lower but retains all G5 functions. \$189</p>	 <p>G7 Special wide version of G3 arm, retains all G3 functions. \$189</p>	 <p>G8 Special low rise version of G7 arm, positions 1" lower but retains all G7 functions. \$189</p>
 <p>SC Height adjustable forward swept arm. Oval soft touch self-skinned urethane (SSU) armcap. \$158</p>	 <p>TD Height adjustable T-arm. Teardrop shaped, soft touch self-skinned urethane (SSU) armcap. \$158</p>	 <p>T6 Height adjustable T-arm. Self-skinned urethane (SSU) armcap slides forward & backward, rotates 360°. 4" adjustment, highest position sits higher than standard arms. \$260</p>	 <p>WA Vari-Width metal adapter plate. Permits arms to extend outward up to 2" each side. Lever locks arm in position. \$84</p>	 <p>ZT Swing away/folding, height adjustable T-arm. Teardrop shaped, soft touch self-skinned urethane (SSU) armcap. \$210</p>
 <p>3B Height adjustable T-arm. Soft touch self-skinned urethane (SSU) armcap. \$158</p>	 <p>3M Height adjustable T-arm. Concave oval, soft touch self-skinned urethane (SSU) armcap. \$158</p>	 <p>3N Height adjustable T-arm. Luxcurve soft touch self-skinned urethane (SSU) armcap. \$119</p>	 <p>3P Height adjustable T-arm. Waterfall edge, soft touch self-skinned urethane (SSU) armcap. \$158</p>	 <p>3R Height adjustable T-arm. Concave oval, hard durometer self-skinned urethane (SSU) armcap. For abusive environments. \$158</p>



CASTER SELECTIONS

	MODEL #	DESCRIPTION	COLOR	FLOORING	QUANTITY	LIST PRICE
	C1SET	Universal carpet caster 2" dual wheel caster, hooded, no collar. Available on all bases.	Black	carpet	set of 5	\$75
	C7SET	Slipper glide Allows base to remain at caster height. Available on all bases.	Black	any surface	set of 5	\$75
	C9RSET	Universal hard floor caster 2.5" dual wheel caster, hooded, no collar. Available on all bases.	Black Grey urethane treads	vinyl, marble, hardwood	set of 5	\$96
	C10SET	Integrated carpet caster 2" dual wheel caster, hooded, large collar. Available on Harmony only.	Black	carpet	set of 5	\$84
	C10RSET	Integrated hard floor caster 2" dual wheel caster, hooded, large collar Available on Harmony only.	Black Grey urethane treads	vinyl, marble, hardwood	set of 5	\$104
	C14RSET	Automatically locking caster 2" dual wheel caster, steel hood, no collar. Brake activated while seated. Available on all bases.	Black	any surface	set of 5	\$314
	C65SET	Integrated carpet caster 2" dual wheel caster, hooded, standard collar.	Black	carpet	set of 5	\$75
	C65RSET	Integrated hard floor caster 2" dual wheel caster, hooded, standard collar.	Black Grey urethane treads	vinyl, marble, hardwood	set of 5	\$96
	C66RSET	Dual wheel roll resistant caster 2" dual wheel caster, steel hood, standard collar. Roll resistance activated when not in use.	Black	any surface	set of 5	\$141
	C82SET	Large carpet caster 2.5" dual wheel caster, no hood no collar Available on all bases.	Black	carpet	set of 5	\$75

CASTER NOTES:

- The casters shown above are sold in sets for replacement purposes. This price list can also be used to calculate the upcharge to change casters at time of order. Optional casters may be priced higher than the standard casters for your chair and the difference will be charged. Lower priced casters will not be credited.
- All casters are not appropriate for all flooring surfaces. Please contact your Global representative or Customer Service for special situations that can be verified with the caster manufacturer. Alternative casters, if needed, may require an upcharge.

FROLICK, GC COMET, GC SIDERO, GC SONIC AND SPLASH - GLIDE SELECTIONS

GLIDES	SURFACE	CARPET	VINYL SHEET	LVT	VCT	RUBBER	CORK	HARDWOOD	LAMINATE	CERAMIC TILE, STONE	MARBLE, GRANITE	CONCRETE
 <p>FELT PAD ON POLYCARBONATE GLIDE (FG)</p>		NR	●	●	NR	NR	●	NR	●	NR	NR	NR
 <p>RUBBER NO SLIP PAD ON POLYCARBONATE GLIDE (RG)</p>		NR	●	●	●	NR	NR	●	●	●	●	NR





NOTE: The above is only a guideline based on clean and properly finished floors. Glides that are not recommended for use will not be covered by Global's lifetime warranty. Site conditions can dramatically affect how appropriate a glide is for any application. Regular inspection of glides is critical to preventing floor damage. See descriptions below.

● = BEST FOR APPLICATION

NR = NOT RECOMMENDED FOR USE

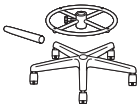
FELT PAD ON POLYCARBONATE GLIDE (FG): The felt bottomed glide moves silently and smoothly on hard surface flooring. Helps to prevent floor damage.

RUBBER NO SLIP PAD ON POLYCARBONATE GLIDE (RG): The rubber bottomed glide is slip-resistant. It grips flooring, reduces movement, scratching and eliminates noise.

MODEL #	MODEL NAME	LIST PRICE
 2241	Drafting conversion kit Includes extension hub for chair's existing pneumatic cylinder, raises seat height by 8 inches. Height adjustable Chrome footrest (18" diameter). Injection molded base in Black only (26.5" diameter). To ensure stability, this kit is recommended for use with task chairs only.	\$252
 2243	Drafting conversion kit Includes 10" pneumatic cylinder. Approximate seat height of 24" to 34". Height adjustable Chrome footrest (18" diameter). Provides footrest travel of 8" to 16" above the floor. Injection molded base in Black only (26.5" diameter). To ensure stability, this kit is recommended for use with task chairs only.	\$286
	3" pneumatic lift Pneumatic lift cylinder with 3 inch travel. Contact Customer Service for availability and details as model number and cover can vary for applications. Sits approximately 1.5" lower than a 4 inch lift at the lowest seat height. Note: replacement cost as shown. If ordered on new chair at time of order a 3 inch lift can be specified at no extra cost.	\$41
	4" pneumatic lift Pneumatic lift cylinder with 4 inch travel. Contact Customer Service for availability and details as model number and cover can vary for applications. Sits approximately 1.5" higher than a 3 inch lift at the lowest seat height. Note: replacement cost as shown. If ordered on new chair at time of order a 4 inch lift can be specified at no extra cost.	\$41
	5" pneumatic lift Pneumatic lift cylinder with 5 inch travel. Contact Customer Service for availability and details as model number and cover can vary for applications. Sits approximately 1.27" higher than a standard 4 inch lift at the lowest seat height. Note: replacement cost as shown. If ordered on new chair at time of order a 5 inch lift can be specified at no extra cost.	\$41

ottomans + throw pillows

OTTOMANS



model GC3342

STANDARD FEATURES



- Designed to coordinate with healthcare seating.
- Standard glide is plastic.
- Wood legs are available in a variety of finishes. Available in Maple wood species only. Refer to the Seating wood finishes in the Textiles and Finishes section.
- This product can be upholstered in standard Global textiles only if Healthcare compliance is not required.
- For a complete list of healthcare textiles and wood seating finishes, visit the website at globalfurnituregroup.com.
- Shipped fully assembled.

OPTIONAL FEATURES

- For improved housekeeping and infection control practices, please add **(SU)** to model number. The underside of the seat will be finished with vinyl and sealed to prevent penetration of liquids. Add \$78.
- For hard surface floors, please specify opaque non-marking glides **(NM)**. No upcharge.
- For non-slip glides, please specify **(NS)**. Add \$22.
- To add sealed seams to your product contact Customer Service. Upcharges vary.
- For moisture barrier, please specify **(MB)**. GC3342: Add \$165. GC3346 and GC7536: Add \$81.
- Optional metal legs are available on GC3342 and GC3346. Offered in Black (TBL), Kalua (TKA), Latte (TLA), Mocha (TMO), Shadow (TSH), Toast (TOA) and Tungsten (TTU). Please specify. No upcharge.

SUGGESTED APPLICATIONS

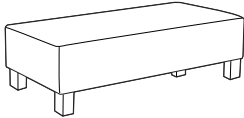
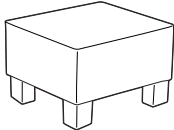
- Guest seating
- Patient rooms
- Lobbies
- Resident rooms
- Lounge/Waiting
- Treatment/Exam

DESCRIPTION	MODEL# / FEATURES	STANDARD TEXTILE GRADES																															
		COM	2	3	4	5	6	7	8	9	10	11	12																				
 <p>Large Ottoman Block Legs COM: 2.5 YD 2.29 M Unit weight: 38 LB 17.3 KG Carton weight: 44 LB 19.96 KG Carton volume: 13.25 FT³ 0.37 MT³</p>	GC3342	787	867	935	1012	1140	1257	1375	1477	1605	1725	1887	2117																				
	<p>Standard with wood legs.</p> <p>Metal legs are available. No upcharge.</p> <p>RTA 00 1 per carton</p>	<table border="1"> <thead> <tr> <th colspan="3">OVERALL DIMENSIONS</th> <th colspan="3">SEAT DIMENSIONS</th> <th colspan="2">BACK DIMENSIONS</th> </tr> <tr> <th>W</th> <th>D</th> <th>H</th> <th>W</th> <th>D</th> <th>H</th> <th>W</th> <th>H</th> </tr> </thead> <tbody> <tr> <td>IN 24</td> <td>48</td> <td>15</td> <td>-</td> <td>-</td> <td>15</td> <td>-</td> <td>-</td> </tr> <tr> <td>MM 610</td> <td>1219</td> <td>381</td> <td>-</td> <td>-</td> <td>381</td> <td>-</td> <td>-</td> </tr> </tbody> </table>	OVERALL DIMENSIONS			SEAT DIMENSIONS			BACK DIMENSIONS		W	D	H	W	D	H	W	H	IN 24	48	15	-	-	15	-	-	MM 610	1219	381	-	-	381	-
OVERALL DIMENSIONS			SEAT DIMENSIONS			BACK DIMENSIONS																											
W	D	H	W	D	H	W	H																										
IN 24	48	15	-	-	15	-	-																										
MM 610	1219	381	-	-	381	-	-																										
 <p>Ottoman Block Legs COM: 1.25 YD 1.14 M Unit weight: 17 LB 7.7 KG Carton weight: 20 LB 9.07 KG Carton volume: 7.5 FT³ 0.21 MT³</p>	GC3346	458	498	532	571	634	693	752	803	867	927	1008	1123																				
	<p>Standard with wood legs.</p> <p>Metal legs are available. No upcharge.</p> <p>RTA 00  1 per carton</p>	<table border="1"> <thead> <tr> <th colspan="3">OVERALL DIMENSIONS</th> <th colspan="3">SEAT DIMENSIONS</th> <th colspan="2">BACK DIMENSIONS</th> </tr> <tr> <th>W</th> <th>D</th> <th>H</th> <th>W</th> <th>D</th> <th>H</th> <th>W</th> <th>H</th> </tr> </thead> <tbody> <tr> <td>IN 17.5</td> <td>19.5</td> <td>15</td> <td>-</td> <td>-</td> <td>15</td> <td>-</td> <td>-</td> </tr> <tr> <td>MM 445</td> <td>495</td> <td>381</td> <td>-</td> <td>-</td> <td>381</td> <td>-</td> <td>-</td> </tr> </tbody> </table>	OVERALL DIMENSIONS			SEAT DIMENSIONS			BACK DIMENSIONS		W	D	H	W	D	H	W	H	IN 17.5	19.5	15	-	-	15	-	-	MM 445	495	381	-	-	381	-
OVERALL DIMENSIONS			SEAT DIMENSIONS			BACK DIMENSIONS																											
W	D	H	W	D	H	W	H																										
IN 17.5	19.5	15	-	-	15	-	-																										
MM 445	495	381	-	-	381	-	-																										

THROW PILLOWS





model GCTP1515

STANDARD FEATURES

- Throw pillows complement decor by adding a personal touch.
- Colors and patterns enhance and add to the overall design.
- Velcro closure allows for covers to be changed.
- This product can be upholstered in standard Global textiles only if Healthcare compliance is not required.
- For a complete list of healthcare textiles, visit the website at globalfurnituregroup.com.

SUGGESTED APPLICATIONS

- Lobbies
- Lounge/Waiting
- Resident rooms

DESCRIPTION	MODEL# / FEATURES	STANDARD TEXTILE GRADES											
		COM	2	3	4	5	6	7	8	9	10	11	12
 <p>15" x 15" Square Throw Pillow COM: 0.75 YD 0.69 M Unit weight: 0.5 LB 0.2 KG Carton weight: 1 LB 0.45 KG Carton volume: 1.3 FT³ 0.03 MT³</p>	GCTP1515	81	105	125	149	187	222	257	288	326	362	411	480
		OVERALL DIMENSIONS			SEAT DIMENSIONS			BACK DIMENSIONS					
		W	D	H	W	D	H	W	H				
		IN 15 MM 381	15 381	6 152	-	-	-	-	-				
		RTA 00	1 per carton										
 <p>20" x 20" Square Throw Pillow COM: 0.75 YD 0.69 M Unit weight: 0.5 LB 0.2 KG Carton weight: 1.5 LB 0.68 KG Carton volume: 1.3 FT³ 0.03 MT³</p>	GCTP2020	89	113	133	157	195	230	265	296	334	370	419	488
		OVERALL DIMENSIONS			SEAT DIMENSIONS			BACK DIMENSIONS					
		W	D	H	W	D	H	W	H				
		IN 20 MM 508	20 508	6 152	-	-	-	-	-				
		RTA 00		1 per carton									

textiles + finishes

Textiles and finishes for Healthcare settings often have higher expectations for performance. It is important to note care and cleaning are not the same as disinfecting with chemical solutions. For information regarding the use of disinfectants on finishes, please contact your Global sales representative. Please advise them of the finish in question and the details of the disinfectant in question.

The following information refers to care and cleaning, not the use of disinfectant substances. The information provided is general in nature based on regular maintenance under normal conditions. By request, the supplier of a specific textile can provide more specific information on care and cleaning and the use of disinfectant chemicals on specific textiles.

Care and Cleaning

Textiles

Fabrics: To extend the life of your seating upholstered in fabric, regularly dust the chair to prevent airborne particles from penetrating the fabric surface.

For light soiling, use a damp cloth and blot the spot with very light pressure, taking care never to soak the fabric. Dry with a clean cloth by blotting - never rub fabric. More intense stains can be treated the same way, but with a mild detergent. Always test fabric first in an unseen area before using any cleaning method.

Leather: For regular cleaning, simply use a soft damp cloth, taking care not to soak the leather. For more thorough treatment, soak a soft cloth in a mild soap solution and wipe surface in a light circular motion. Repeat with clean water. Allow to dry and polish with a soft dry cloth. Do not use detergents, aerosol sprays or other polishes.

Hard Surfaces

Laminate & painted metal finishes: Wipe the surface with a clean soft damp cloth; if needed, a mild soap solution (i.e. Ivory dishwashing liquid) can be used. To prevent streaks, dry the surface with a clean soft cloth moving in a circular motion.

Textiles

- **Water-based cleaner (W):** Spot clean, using the foam only from a water-based cleaning agent, such as a mild detergent or non-solvent upholstery shampoo product. Apply foam with a soft brush in a circular motion. Vacuum when dry. Pretest small area before proceeding.
- **Solvent cleaner (S):** Spot clean, using a mild water-free solvent or dry cleaning product. Clean only in a well-ventilated room and avoid any product containing carbon tetrachloride or other toxic materials. Pretest a small area before proceeding.
- **Water/solvent cleaner (WS):** Spot clean with a mild solvent, an upholstery shampoo, or the foam from a mild detergent. When using a solvent or dry cleaning product, follow instructions carefully and clean only in a well-ventilated room. Avoid any product that contains carbon tetrachloride or other toxic materials. With either method, pretest a small area before proceeding.
- **Vacuum only (X):** Clean this fabric only by vacuuming or light brushing to prevent accumulation of dust and grime. Water-based foam cleaning agents of any kind may cause excessive shrinking, staining, or distortion of the surface pile and therefore, should not be used.
- These recommendations and codes were developed by fabric specialists. However, because of the various ways fabric can be stained or damaged, there is no guarantee that the results will be completely successful. Use suggested methods on your own responsibility. To help prevent overall soil, frequent vacuuming or light brushing to remove dust and grime is recommended. Use professional furniture cleaning service when overall soiled condition has been reached.

TEXTILES

For a complete listing of healthcare carded textiles, please refer to our website at globalfurnituregroup.com.

SEATING FINISHES

METAL

Black (TBL)	Buzz Blue (TBZ)	Cactus (TCC)	Carrot (TCR)	Cloud (TIV)	Designer White (TDW)
Dijon (TDJ)	Eggplant (TEG)	Fog (TFO)	Frost (TFR)	Ink (TIN)	Kalua (TKA)
Latte (TLA)	Mocha (TMO)	Nevada (TNE)	Sand (TSN)	Scarlet (TSR)	Shadow (TSH)
Toast (TOA)	Tungsten (TTU)	Antique Copper (ACO)	Brushed Chrome (BCH)	Chrome (CHM)	Satin Brass (SBR)

WOOD

Absolute (AAM)	Cherry (ACM)	Charcoal Java (CJM)	Empire Mahogany (EMM)	English Oak (EOM)	Espresso Cafe (ECM)
Fruitwood (TFM)	Gray (HGM)	Harvest Oak (HOM)	Honey (AHM)	Jet Onyx (JOM)	Light Honey (LHM)
Mahogany (TMM)	Maple (AVM)	Medium Walnut (MWM)	Night (ASM)	Noce Biondo (NBM)	Noce Grigio (NGM)
Noce Leggero (NEM)	Noce Medio (NMM)	Sandy Beach (SBM)	Shaker Cherry (SKM)	Silver Oak (SOM)	Walnut (TWM)
WC Cream (WTM)	White (WHM)	Winter Cherry (WCM)			

Finishes ending in "M" use Maple wood. Finishes ending in "O" use Oak wood.

PLASTIC (GC SONIC, WILLOW*)

Buzz Blue (BZB)	Cactus (CCT)	Carrot (CRO)	Cloud (IVC)	Dijon (DJN)	Eggplant (EGP)
Fog (FOG)	Frost (FRO)	Ink (INK)	Kalua (KAL)*	Latte (LAB)	Mocha (J52)*
Night (BLK)	Sand (SND)	Scarlet (SAR)	Shadow (SHW)	Toast (TOA)*	

*Available on Willow series only.

URETHANE ARMCAPS

Black (BLK)	Kalua (KAL)	Latte (LAB)	Mocha (J52)	Shadow (SHW)	Toast (TOA)
-------------	-------------	-------------	-------------	--------------	-------------

POLYPROPYLENE ARMCAPS

Black (BLK)	Shadow (SHW)	Toast (TOA)
-------------	--------------	-------------

TABLE FINISHES

THERMALLY FUSED LAMINATES (ENABLE, FLORAL, GC BELONG, OCCASIONAL, PRIMACARE, TABLET & WILLOW)

Absolute Acajou (ACJ)	Asian Night (ASN)	Avant Cherry (AWC)	Avant Honey (AWH)	Black (BLK)	Blizzard (BZD)*
Brushed Cobalt (BRC)	Clear Maple (CMB)	Custom Grey (CGY)*	Dark Espresso (DES)	Designer White (DWT)	Fashionista (FAS)
First Class (FCL)	Noce Biondo (NBL)	Noce Grigio (NGL)	Noce Leggero (NEL)	Noce Medio (NML)	Quartered Mahogany (QTM)
Sheer Beauty (SBY)	Stonedust (SDT)*	Storm Grey (SOG)	Walnut Heights (WHE)	White Chocolate (WHC)	Winter Cherry (WCR)

*Available on Enable, Floral, GC Belong, Occasional, Primacare, Tablet series only.

HIGH PRESSURE LAMINATES (ENABLE, FLORAL, GC BELONG, OCCASIONAL, PRIMACARE, TABLET & WILLOW)

Absolute Acajou (ACJ)	Asian Night (ASN)	Avant Cherry (W357)	Avant Honey (W356)	Black (BLK)	Blizzard (BZD)*
Brushed Cobalt (BRC)	Clear Maple (CMB)	Custom Grey (CGY)*	Dark Espresso (W142)	Designer White (DWT)	Fashionista (FAS)
First Class (FCL)	Noce Biondo (NBL)	Noce Grigio (NGL)	Noce Leggero (NEL)	Noce Medio (NML)	Quartered Mahogany (QTM)
Sheer Beauty (SBY)	Stonedust (SDT)*	Storm Grey (SOG)	Walnut Heights (WHE)	White Chocolate (WHC)	Winter Cherry (WCR)

*Available on Enable, Floral, GC Belong, Occasional, Primacare, Tablet series only.

WOOD OCCASIONAL TABLES

Absolute (AAM)	Charcoal Java (CJM)	Cherry (ACM)	Empire Mahogany (EMM)	English Oak (EOM)	Espresso Cafe (ECM)
Fruitwood (TFM)	Gray (HGM)	Harvest Oak (HOM)	Honey (AHM)	Jet Onyx (JOM)	Light Honey (LHM)
Mahogany (TMM)	Maple (AVM)	Medium Walnut (MWM)	Night (ASM)	Noce Biondo (NBM)	Noce Grigio (NGM)
Noce Leggero (NEM)	Noce Medio (NMM)	Sandy Beach (SBM)	Shaker Cherry (SKM)	Silver Oak (SOM)	Walnut (TWM)
WC Cream (WTM)	White (WHM)	Winter Cherry (WCM)			

Please refer to the Tables section for availability and coordinating wood base & leg finishes.

METAL TABLE LEGS

Please refer to the specific table series for finish listings.

OVERBED TABLE FINISHES

HIGH PRESSURE LAMINATE TOPS

Candlelight (TCL)	Chocolate Pear (TCP)	Hard Rock Maple (THM)	Medium Cherry (TMC)	Medium Oak (TMO)
-------------------	----------------------	-----------------------	---------------------	------------------

THERMOFOIL TOPS

Candlelight (TCL)	Chocolate Pear (TCP)	Hard Rock Maple (THM)	Medium Cherry (TMC)	Medium Oak (TMO)
-------------------	----------------------	-----------------------	---------------------	------------------

STEEL BASES

Almond (AL)	Graphite Grey (GG)	Nevada (NV)
-------------	--------------------	-------------

TEXTILES AND FINISHES

PERSONAL ROOM FURNITURE FINISHES

ALDON - METAL LEGS

Black (BLK)	Blizzard (BZD)	Charcoal (CHR)	Kalua (TKA)	Latte (TLA)	Mocha (TMO)
Nevada (NEV)	Sierra (SCA)	Silver (SIL)	Taupe (TPE)	Toast (TOA)	Tungsten (TUN)

ALDON - LAMINATES

Absolute Acajou (ACJ)	Asian Night (ASN)	Avant Cherry (AWC)	Avant Honey (AWH)	Black (BLK)	Blizzard (BZD)
Blizzard Matrix (BMX)	Brushed Cobalt (BRC)	Clear Maple (CMB)	Custom Grey (CGY)	Dark Espresso (DES)	Designer White (DWT)
Fashionista (FAS)	First Class (FCL)	Hayden Linen (HLN)	Quartered Mahogany (QTM)	Noce Biondo (NBL)	Noce Grigio (NGL)
Noce Leggero (NEL)	Noce Medio (NML)	Sheer beauty (SBY)	Stonedust (SDT)	Stone Linen (SLN)	Storm Grey (SOG)
String (STG)	Studio White Matrix (SWX)	Walnut Heights (WHE)	White Chocolate (WHC)	Winter Cherry (WCR)	

ALDON - THERMOFOIL (FRONT & TOP)

Absolute Acajou (ACJ)	Clear Maple (CMB)	Custom Grey (CGY)	Dark Espresso (DES)	Designer White (DWT)	Fashionista (FAS)
First Class (FCL)	Sheer beauty (SBY)	Storm Grey (SOG)	White Chocolate (WHC)		

ALDON - SOLID SURFACES (TOPS ONLY)

Grade 1	Grade 2				
Designer White (SWH)	Beige Tempest (SBT)	Hot Stone (SHS)	Northern Melange (SNM)	Black Onyx Mirage (SBX)	
	Frosty White Mirage (SFW)	Milk Glass Spectra (SMG)			

SONOMA - LAMINATES

Absolute Acajou (ACJ)	Asian Night (ASN)	Avant Cherry (AWC)	Avant Honey (AWH)	Black (BLK)	Blizzard (BZD)
Blizzard Matrix (BMX)	Brushed Cobalt (BRC)	Clear Maple (CMB)	Custom Grey (CGY)	Dark Espresso (DES)	Designer White (DWT)
Fashionista (FAS)	First Class (FCL)	Hayden Linen (HLN)	Quartered Mahogany (QTM)	Noce Biondo (NBL)	Noce Grigio (NGL)
Noce Leggero (NEL)	Noce Medio (NML)	Sheer Beauty (SBY)	Stonedust (SDT)	Stone Linen (SLN)	Storm Grey (SOG)
String (STG)	Studio White Matrix (SWX)	Walnut Heights (WHE)	White Chocolate (WHC)	Winter Cherry (WCR)	

SONOMA - THERMOFOIL (FRONT & TOP)

Absolute Acajou (ACJ)	Clear Maple (CMB)	Custom Grey (CGY)	Dark Espresso (DES)	Designer White (DWT)	Fashionista (FAS)
First Class (FCL)	Sheer beauty (SBY)	Storm Grey (SOG)	White Chocolate (WHC)		

SONOMA - SOLID SURFACES (TOPS ONLY)

Grade 1	Grade 2				
Designer White (SWH)	Beige Tempest (SBT)	Hot Stone (SHS)	Northern Melange (SNM)	Black Onyx Mirage (SBX)	
	Frosty White Mirage (SFW)	Milk Glass Spectra (SMG)			

SONOMA - ALUMINUM EXTRUSIONS

Black (BLK)	Blizzard (BZD)	Charcoal (CHR)	Kalua (TKA)	Latte (TLA)	Mocha (TMO)
Nevada (NEV)	Sierra (SCA)	Silver (SIL)	Taupe (TPE)	Toast (TOA)	Tungsten (TUN)

For a complete listing of healthcare textiles and finishes, please refer to our website at globalfurnituregroup.com.

TEXTILES AND FINISHES

Carded Textiles

Grade 1	Bantam
Grade 2	Arc, Aristo, GC Linen, Release, Verve, Vitality
Grade 3	Canter EPU, Nomad
Grade 4	Abbey, Beeline EPU, California, Montana
Grade 5	Cinema, Cosmopolitan, Cover Cloth, Endurance EPU, Eon EPU, Groove EPU, Keynote, Lavish, Solitaire, Whit EPU
Grade 6	Faux Felt, Flock, Isabella
Grade 7	Affinity, Channel, Kit, Linnen, Luster, Moon Beam2, Oath, Palatine 2, Synergy
Grade 8	Rainwater, Silica, Silica Etch, Silica Leather, Silicone Element, Ultraleather Pro, Ultraleather Reef Pro, Viewpoint
Grade 9	Silica Andy, Silica Stride
Grade 10	Silica Cusp, Silica Hiatus
Grade 11	Lumi, Silica Deflect, Silica Reach
Grade 12	No standard Global textiles - provided for grading GPM (Global purchased material, customer specified) textiles
Grade 13	Sail

TWO GRADES COMBINATION CHART - GLOBAL

FIRST TEXTILE SELECTED

	1	2	3	4	5	6	7	8	9	10	11	12	13	14	15	16	17	18	19	20
1	1																			
2	2	2																		
3	3	3	3																	
4	3	4	4	4																
5	4	4	5	5	5															
6	5	5	5	6	6	6														
7	5	6	6	6	7	7	7													
8	6	6	7	7	7	8	8	8												
9	7	7	7	8	8	8	9	9	9											
10	8	8	8	8	9	9	9	10	10	10										
11	9	9	9	9	10	10	10	11	11	11										
12	10	10	10	10	10	10	11	11	11	12	12	12								
13	11	11	11	11	11	11	12	12	12	12	13	13	13							
14	11	12	12	12	12	12	12	13	13	13	13	14	14	14						
15	12	12	13	13	13	13	13	13	14	14	14	14	15	15	15					
16	13	13	13	14	14	14	14	14	14	14	14	15	15	15	16	16	16			
17	14	14	14	14	14	15	15	15	15	15	15	16	16	16	16	17	17	17		
18	15	15	15	15	15	16	16	16	16	16	16	17	17	17	17	18	18	18		
19	16	16	16	16	16	16	16	17	17	17	17	17	17	17	18	18	18	19	19	
20	17	17	17	17	17	17	17	18	18	18	18	18	18	18	19	19	19	20	20	20

Combining two textile grades on Global seating will result in the revised grade shown above.

- Assumptions: Two or more chairs are being ordered, there are no textile pattern repeats larger than 15" and the textile is at least 54" wide.
- A picture or sketch of where the two textiles are to be applied must be provided at time of order.
- This chart cannot be used for combining more than two textiles, a special quotation will be required for combining three or more textiles.

ALTERNATIVE TEXTILE OPTIONS

GPM - Global Purchased Material (customer specified)

For a greater selection of upholstery options, please visit the following websites. Global will be happy to provide as a GPM.

Supplier's name	Website	Phone number to call for memo samples
CF Stinson	www.cfstinson.com	800.841.6279
Maharam Textiles	www.maharam.com	800.645.3943
Mayer Fabrics	www.mayerfabrics.com	800.428.4415
Momentum Textiles	www.themomgroup.com	877.670.5002
Morbern	www.morbern.com	416.746.4484

To access any of the selected suppliers' textiles for use on healthcare products as a GPM, please contact your Global sales representative or Customer Service.

NOTE: Please contact Global Customer Service for inquiries regarding grading as a GPM from the above mentioned suppliers.

HOW TO ORDER COM OR GPM TEXTILES

BELOW YOU WILL FIND GENERAL INFORMATION ON PLACING COM (CUSTOMER'S OWN MATERIAL) OR GPM (GLOBAL PURCHASES CUSTOMER'S MATERIAL) ORDERS. PLEASE FOLLOW THESE STEPS TO ENSURE YOUR ORDER IS PROCESSED QUICKLY.

1. You can access the Customer's Own Material (COM) order form from the Dealer Centre or directly at <https://www.globalfurnituregroupapps.com/COMForm>.
2. Fill out the "COM/GPM AUTHORIZATION FORM" with all appropriate information:
 - Enter the dealership name, address, contact name, phone number and email address.
 - Enter fabric name/color and mill/manufacturer name (mandatory fields).
 - Enter the chair model and quantity of chairs for the fabric to be used on. You must also select the fabric direction for the seat and the back by clicking on the chair image and then selecting the direction. If you make a mistake with the direction you can click on the "here" text under the image.
3. Once you have entered all the information on the form, click "Submit" at the bottom of the screen. You will receive a copy of the form by email and a reference number for your records. The Fabric Department at Global will also get a copy.
4. Once the Fabric Department reviews the form, you may be asked to provide a sample of the fabric for approval. This will apply for any fabrics that have not been approved in the past.

Please mail the sample to:

Fabric Coordinator
596 Supertest Road
Toronto, Ontario
M3J 2M6

5. The Fabric Department will review your application and they will either approve or deny it. Once the request is approved, you will receive an email containing the approval with the fabric code and the amount of fabric yards to send in. There is also a label with a barcode for the sender to attach to the fabric coming in.

All Canadian and international customers, send to:
Global Upholstery Co. Inc.
596 Supertest Road
Toronto, Ontario
M3J 2M6

Global reserves the right to reject a textile if it is found unacceptable for any reason.

COM / GPM(special) AUTHORIZATION REQUEST/TRACKING FORM

CUSTOMER INFORMATION (To be filled by the Dealer) *Use one form per fabric*
Note: Incomplete information may delay or prevent approval

Dealer/Company Name: _____ Email: _____
 Address: _____ City: _____ Postal Code: _____
 Contact Name: _____ Phone: _____
 P.O.#: _____ Contract #: _____ Date: _____
 Design Specifier of Record (often requested by Mill for Sales Commission): _____

FABRIC INFORMATION

1. Fabric Name (series/style/etc.): _____
 Fabric color name and description (including specifically designed): _____
 2. Mill/Manufacturer name: _____ Mill phone#: _____
 Website address (if available): _____
 3. Specified fabric's country of origin (if available): _____
 4. Fabric Specification (data sheet (if available please upload and disregard step 5) Attached?)
 Yes, skip Step #5. No, complete Step #5.
 5. Fabric content (% Cotton, % Polyester, etc.): _____
 Fabric Width: _____ Pattern Repeat: Warp: _____ Fill: _____
 Railroaded? Yes No FR Chemical? Yes No

FABRIC APPLICATION INFORMATION

Chair Model	Qty.	Multi Fabric	Special instructions for CS and buyer	Special Instructions (e.g. remove side of disassemble/without pattern, avoid seam, moisture barrier etc.)
		Yes <input type="radio"/> (Drawing attached) No <input checked="" type="radio"/>		Sealed seams: Yes <input type="radio"/> No <input checked="" type="radio"/> Off Direction/tilt read the pattern: Yes <input type="radio"/> No <input checked="" type="radio"/> Moisture barrier: Yes <input type="radio"/> No <input checked="" type="radio"/> Inside out: Yes <input type="radio"/> No <input checked="" type="radio"/> Other options: Yes <input type="radio"/> No <input checked="" type="radio"/>

FABRIC DIRECTION

New fabric request
 Attach fabric sample (12" x width of fabric roll) in correct direction and side

Previously approved fabric
 Previous Global Approval/order # _____
 Attach tactile sample (8" x 8" swatch) in correct direction and side

CANADIAN AND INTERNATIONAL CUSTOMER
 Mail to Fabric Coordinator, 596 Supertest Road, Toronto, Ontario, M3J 2M6

USA CUSTOMER
 Mail to Customer Service Rep., 17 W. Steen Rd # 3136, Marlton, NJ 08053, USA

*Please click on the image above to select the direction for the fabrics for the seat and back.



GLOBAL UPHOLSTERY AUTHORIZATION (To be filled by Global Upholstery)

Global Approval # _____ Fabric yard (required for the order) _____ Fabric code _____

Signature: _____ Print Name: _____ Date: _____
 Comment: _____

COM ** Customer's Own Material
 Once approval is done, send the specified fabric amount for order to 596 Supertest Road, Toronto, Ontario, M3J 2M6

PS: 1. Global Upholstery cannot be responsible for fabric received without the Approval/ Acknowledgment # 2. Global requires MD# and Country of Origin for fabric supplied by customer from Mill to complete the order and for future references.

Global is focused on providing furniture products for use in healthcare environments. This illustrated price list book has been designed to facilitate fast reference and easy use. Products are categorized into "personal room furniture", "tables" or "seating" and are listed numerically within their categories. The line drawings match actual photographs (where possible) to aid in instant recognition of the total range within a series.

Sales of healthcare products are made only on Global's standard Terms and Conditions of sale which are contained in this price list book. The "Purchaser" in these Terms, Conditions and General Information shall refer to Dealers and those who originally purchase directly from Global for use or re-sale. These standard Terms and Conditions may be modified or supplemented only by a separately written document signed by Global's authorized personnel at its head office in Toronto, Ontario, Canada. Any term or condition contained in any purchase order or other form used by the Purchaser to order goods (including standard, printed language) which is different from, in addition to, or in any way inconsistent with Global's standard Terms and Conditions shall be of no force or effect whatsoever.

All illustrations, specifications and prices in this price list book are based on the latest product information available at time of publication. Global reserves the right to make changes at any time and without prior notice to prices, colors, materials, specifications and models offered.

Description

Each product shown or described in this price list book is standard healthcare product. Available options are noted at the beginning of each series. Available options may require additional delivery time and cost, and may affect the warranty given. Sizes and weights shown are approximate and are subject to slight changes from time to time.

Prices and Payment

The prices shown in this price list book as well as those quoted by Global, are in Canadian dollars for orders shipped to destinations in Canada.

If shipping date requested is more than 90 days from date of order, Global shall reserve the right to use published price lists effective at time of shipment.

Orders are invoiced at time of shipment. Terms of payment are net 30 days from date of invoice unless otherwise stated. The Purchaser agrees that Global shall reserve the right to enforce a charge amounting to 1.5% per month (18% per year) on invoices outstanding more than 30 days.

If the Purchaser's most recent annual net volume is less than \$5,000, Global may suggest payment be made in advance.

All orders are subject to the Purchaser complying with Global's prevailing credit policy.

Any products sold by Global shall remain the property of Global until fully paid.

Prices are suggested price lists only and are subject to change without notice. Global will, however, attempt to keep the Purchasers up-to-date on all developments including price changes.

Taxes

All prices shown in this price list book are exclusive of sales, use, excise, HST and other applicable taxes and duties which may be the Purchaser's responsibility as per the invoice issued by Global. If the Purchaser claims an exemption from such taxes, it shall be the Purchaser's responsibility to furnish Global with an appropriate exemption certificate at time of order.

Ordering Information

Global requires that all orders be submitted in writing and will be acknowledged on Global's acknowledgment forms governing the transaction.

The details appearing on this acknowledgment will describe the items to be shipped and the approximate shipping date. It is the Purchaser's responsibility to determine that the information in the acknowledgment is correct. In the event of an error, the Purchaser must notify their Global Customer Service representative immediately by telephone followed by written confirmation. Shipping dates are assigned to orders based on the items having the longest manufacturing lead time (unless instructed to partial ship).

At time of order, please provide the following information:

1. Account number (if possible)
2. PO number
3. "Bill to" and/or "Ship to" and name and address
4. Complete model number and selected options including textiles/finishes
5. Special instructions and tag information
6. Shipping instructions, please indicate:
 - a. pick up
 - b. Global trailer program
 - c. common carrier, provide name of carrier, your account number
7. Special quote (SQ) # or MTM # (if applicable)
8. Customer's Own Material (COM), Global Purchased Material (GPM), Customer's Own Leather (COL), see below.
9. For specials and custom quoted product, please indicate the custom quote # on your PO. If changes are made to the quote a new quote must be issued prior to submitting the order. It is the Purchaser's responsibility to determine that the information on the quote is correct. Global will not be responsible for wrong product due to errors in the quote.

The above points will be checked by Global for accuracy. Global will process orders using the codes provided by the Purchaser. Price discrepancy is the responsibility of the Purchaser. The Purchaser must notify Global prior to invoicing.

The Purchaser is responsible for providing correct information at time of order. If no option(s) are selected the system will default to standard feature(s). Orders with missing/incorrect information (finish, etc.) will be put on hold until all information is complete. Orders will be scheduled for manufacturing upon receipt of complete information.

Changes and Cancellations

After the date of Global's acknowledgment of the Purchaser's order, the order may not be changed or canceled by the Purchaser without the written consent of Global. Orders for products upholstered in "special order textiles" (GPM) cannot be canceled once material has been purchased. Special order items, COM and textile-covered items already in production are not subject to change or cancellation under any circumstances. Textile-covered items are considered to be in production once the textile is scheduled for cutting. Other standard items already in production are subject to a minimum 35% cancellation charge.

Errors and Omissions

All quotations, acknowledgments and invoices are subject to corrections for any errors and omissions.

Castors

The price list book specifies the caster which comes standard with each chair model. Most chairs are equipped with C1 or C65 casters which are best used on carpeted surfaces. If it is intended to use the product on hard surfaces such as ceramics, concrete, linoleum or hardwood, it is recommended to use different casters. It is the responsibility of the customer to determine the standard caster for a particular product and whether such caster is appropriate for the given application. The Arm and Caster section illustrates the caster options offered by Global and their suggested uses.

FINISHES

Seating Finishes - Painted

Where painted frames are not a standard color, a special quote is required.

Seating Finishes - Wood Stained

A one time setup fee of \$250 net will be applied per order for custom wood staining/color matching requests. This payment will be valid for 5 years from the date it is set up. After 5 years, the \$250 setup fee will apply again. Restrictions may apply. The customer must provide a 3" x 3" color chip/sample. For application of customer's own wood stain, there will be an upcharge of 10% list price, per unit (in addition to the option upcharge, when applicable). For orders with custom stain unit quantities of 30 or more, the upcharge may be reduced or eliminated. A [Special Product Request](#) must be submitted for a quotation.

Custom Wood Staining

Custom wood staining procedure for wood seating is as follows. Customer provides a sample of the desired wood finish. That sample is sent to Specials Department. Several finished samples will be sent back. The customer/end user will sign off on the samples (keeping one for their records) and return the rest of the samples. Global will not necessarily match the wood species but rather will generate a color that will coordinate with the sample when it is applied to the wood species used in the seating frame.

File Finishes

There is no upcharge on any standard file finish. Any non-standard file finish must be approved by Global prior to acceptance of order and may be subject to an upcharge. An upcharge of 10% will apply to Metallic, Mica and any non-standard White finishes regardless of the number of units ordered.

Wood Veneer Finishes

Because the distinctive characteristics and the nature of wood products cause variations, exact matches are not always possible. Global will not be held responsible if the finishes cannot be matched.

Customer's Own Material (COM)

Use of COM must be approved by Global prior to acceptance of order. Please submit the Authorization Request Form. Photocopy and use this form as often as necessary. The customer must provide a 12" x 12" textile sample and advise how the textile is to be applied and quantity of textile being sent. **Textile yardage requirement will be advised by the factory, and additional yardage may be required if pattern requires matching.** Upon approval from Global, send textile to the COM Department at: 596 Supertest Road, Toronto ON, M3J 2M5. Send to the address provided on shipping document upon approval from Global. If COM is difficult to apply or if product is required to be modified, extra charges will apply. Global reserves the right to cancel an order at any time if COM is inadequate for any reason. COM must be shipped freight and duties paid if applicable to our factory. Such shipment must be fully identified with the Purchaser's order number, and the item for which the material is intended. Performance of COM when applied to product is the sole responsibility of the Purchaser. Global's standard product warranty shall not apply to COM.

(COM continued)

COM price is the lowest published price/grade for the series. The published yardage requirement for COM orders is approximate and shown beside each item in the price list book. The yardage shown there is based on the textile requirements for cutting and sewing a single chair in a plain patterned textile. For textiles with a pattern repeat or for COM orders involving 10 or more chairs, please consult with Customer Service for recalculation of the yardage requirements as this may significantly change the textile requirement.

Textile Grading

All products are priced according to their standard textile grade. Lower grade textiles may be available but at the same price as standard textile grade. Please refer to globalfurnituregroup.com for graded textiles.

Combining two grades of textiles may result in a revised grade. Please refer to "Two Grades Combination Chart" in the Textiles and Finishes section. For more than two textiles a special quotation is required.

Global Purchased Material, Customer Specified (GPM)

Global may purchase material specified by the customer. Use of GPM must be approved by Global prior to acceptance of order. If it is difficult to apply or if product is required to be modified, extra charges will apply. Global reserves the right to cancel an order at any time if GPM is inadequate for any reason. Performance of GPM when applied to product is the sole responsibility of the textile vendor. Global's standard warranty will not apply to GPM materials.

Customer's Own Leather (COL)

Not all seating can be upholstered in leather. Please consult series notes for availability. COL price is the lowest published grade for the series (leather or fabric).

Upholstery Coverings

Slight variations in color may occur between dye lots. Although Global attempts to minimize these variances, they do occur and must be accepted as normal and will not be considered defects.

Leather is a Natural Product

Natural variations occur in the color, grain and texture of leather. As a result, a degree of variation should be expected. As leather is used it develops a patina. Its color changes slightly, it will get marked and it will stretch and pull, these are the hallmarks of genuine leather and are not considered defects.

Yardage

Required yardage (yd) is based on unmatched materials with widths of 54" for seating, 63" for panels.

Arms

A wide selection of arms are available for some series, refer to the Arm Chart.

Weight

For seating products, unit weight and carton weight are provided. For Desking + Tables or Metal Filing + Storage products, carton weight is provided.

Delays

Global's order acknowledgment will state a shipping date which is Global's best estimate at the time the order is acknowledged. However, Global shall not incur any obligation or liability to the Purchaser for failure to ship by specified date unless Global has agreed to an unequivocal shipping date in a separately signed written document executed by its authorized personnel at its head office. In addition, Global will not be liable for any loss or damage resulting from any delay or failure in shipment or other failure to perform all or any part of the agreement between the parties with respect to the goods shown on the face of the order acknowledgment where such delay, failure, loss or damage is the proximate result of any act of any governmental authority or political subdivision thereof, revolution, riot, civil disorder or disturbance, delay or default in transportation, strike disputes among or between labor unions or other labor disputes, delay or inability in obtaining materials and facilities, fire, flood, act of God or any cause not within the reasonable control of Global.

Free on Board (FOB)

FOB point is Global's Factory, Toronto, Ontario, Canada.

Courier Type Shipments

courier



This symbol is used to indicate that the adjacent product can be sent by courier type shipments, such as Federal Express, Purolator, CanPar and UPS.

Shipping

The Purchaser must select, at time of order, one of two methods of freight payment. Global will make no end-user shipments unless special arrangements have been made.

1. FOB point of shipment, freight collect - pick up and common carrier.
2. FOB point of shipment, freight prepaid and invoiced to the Purchaser - Global Trailer Program.

All deliveries are dock to dock.

Service

Service requests are normally the responsibility of Global's authorized Dealers. Where this cannot be accomplished on a local level, service problems should be referred to Global's Customer Service Department.

Global/Express (Canada)

Tel: (905) 660-5101 or 1-800-567-8901

Fax: (905) 660-4759 or 1-800-375-5134

Global International

Tel: (416) 661-3660

Fax: (416) 661-661-0983 or 1-877-585-5579

Returns

No returns of goods will be accepted without written consent and shipping instruction from Global. A minimum re-stocking charge of 35% is made on all authorized returns for credit or refund, provided goods are received by Global in the condition in which they left the factory. This may increase depending on the type of product. Global's Return Goods Authorization (RGA) numbers must appear prominently on all authorized returns. Global will not be responsible for return freight costs. No credit will be given if goods cannot be reused as new. Special order items, non-stock items and COM products are in no event subject to return. All returns must be approved and authorized in writing by Global Customer Service. Global reserves the right to refuse delivery of any unauthorized returns.

Claims

All goods are sold FOB plant or Global Distribution Center. Global is not responsible for damage which occurs in transit (or in storage). The carrier signs for all goods received in apparently good order. It is the Purchaser's responsibility to examine goods upon receipt and to file any claims with the carrier for losses or damage to the product occurring during transit, including concealed damage.

Any claims made against Global for apparent defects, errors or shortages must be made by the Purchaser, in writing, within 15 working days after any delivery. Failure by the Purchaser to make any claim against Global within 15 days shall constitute acceptance of the goods and a waiver of any apparent defects, errors or shortages.

Suspension

In the event that the Purchaser defaults in the payment of any sum due to Global, or in the event the Purchaser's financial condition becomes unsatisfactory to Global, Global shall have the right to defer or discontinue shipment of any goods until such time as the default is cured or the Purchaser provides assurance of payment to Global.

Copyright

All catalogs, photographs, drawings, price list books and other printed materials are protected by copyright. All rights reserved.

Trademarks

All trademarks are owned by Global Furniture Group other than OBUSFORME™ which is owned by OBUSFORME LTD CO., a division of Homematics Inc., MOR-CARE which is owned by MORBERN INC, Perma-Mesh which is the property of J.B. Research Inc. SCHUKRA™ which is owned by SCHUKRA MANUFACTURING INC. OBUSFORME® and the distinctive backrest design are registered trademarks of OBUSFORME LTD CO.

Designs and Patents

Many of the products produced by Global are protected by design registrations, design patents and/or patents. Design and specifications are subject to change, discontinuance or additions without notice.

For a full listing of issued trademarks, please visit globalfurnituregroup.com.

Cubic Measure

The stated volume is an approximate cubic foot measure that may be used to calculate freight costs. The figure shown is the total shipping volume of a unit (e.g. if a part is sent in 2 cartons the volume indicated reflects both cartons together) and is subject to change without notice. It is most economical to purchase the specified number per carton.

Combined Shipments

Global will make every effort to combine shipments and orders on written request. However, Global cannot be held responsible where such requests are not complied with.

Offer of Sale

Possession of this price list book or any other literature shall not imply the company's willingness to sell to the holder and shall not be construed as a direct offer of sale.

If a conflict arises between: (i) prices found in software support packages furnished to the customer by Global or by any other source on behalf of Global; and (ii) Global's current pricing found on Global's website, then the most current shall prevail.

Testing Qualifications

Many Global products pass or exceed the most stringent industry testing standards.

Disclaimer

Metric dimensions are provided for reference only. In the event that there is a discrepancy between imperial measurements and metric measurements, imperial measurements shall prevail. Prices shown are current manufacturer's suggested price lists at time of printing. Updated pricing is available on Global's website. All applicable taxes are extra. Descriptions, specifications and prices are subject to change without notice. Errors and omissions are subject to correction.

For periodic updates, please check the price list book PDF at globalfurnituregroup.com. Global warrants that all commercial products are free from defects in material and workmanship, for the life of the product, to the original Purchaser.

Fire Rating

The state of California recently repealed CAL TB133, but requests for it may still occur until local fire codes are updated and/or a national standard is declared. Global will no longer test products to meet CAL TB133.

The industry is supporting the adoption of CAL TB117-2013 as the accepted fire standard and will be what Global can support. CAL TB117 outlines performance standards and methods for testing the smolder resistance of cover textiles, barrier materials, filing materials and decking materials used in upholstered furniture. This is done by a "cigarette test".

CAL TB117-2013 does not require a fire blocker or any additional components to achieve the rating. All Global foams and textiles (carded & GPM) meet CAL TB117-2013 requirements without any harmful chemicals. Global can provide third party CAL TB117-2013 certifications upon request for any textile or foam by model.

Often the Fire Marshal will request 'NFPA 261', however, this is not a test required by our industry or provided by Global. CAL TB117-2013 is the equivalent and can be accepted at the discretion of the Fire Marshal.

**WARNING - SEATING PRODUCTS
TO PREVENT PRODUCT FAILURE AND POSSIBLE INJURY:**

Ensure that the appropriate selection is made for the intended use of the chair including user's weight. Some chairs are not recommended for users above a certain weight. Frequently inspect the chair for visible cracks and tighten all screws, bolts and adjustable knobs. If the chair is damaged or unstable, immediately remove it from service.

Any information or suggestions concerning applications, specifications or compliances with codes and standards is provided solely for your convenient reference and without any representation as to accuracy or suitability. Global disclaims any legal responsibility. The user must verify and test the suitability of any information or products for his specific application. Global reserves the right to change the Terms and Conditions in the price list book without notice.

This price list book is effective as of January 1, 2023.

Global warrants that all commercial products are free from defects in material and workmanship, for the life of the product, to the original Purchaser.

Global will repair or replace, at Global's option, as the sole remedy for any defect covered by the warranty. The warranty applies to products manufactured after March 22, 2016.

Global makes no warranty that any of its products are suitable for any particular purpose and makes no other warranties, express or implied, other than those set out here. As codes and standards vary from one jurisdiction to another, references to compliance are solely for convenience and without any representation as to accuracy or suitability. Users must verify the suitability of such information or product for their specific application. In no event shall Global be liable in either tort or contract for any loss or direct, special, incidental, consequential, or exemplary damages.

General Healthcare Seating

Global's healthcare warranty for general seating covers all chair components including pneumatic cylinders, bases, casters, glides, frames, arms, plastic seats, backs and other structural components.

The warranty applies to single shift, standard usage, defined as a standard eight (8) hour day, forty (40) hour week as noted with each model number.

Exceptions to the warranty for general seating are as follows:

- Foam, upholstery, textiles (as sampled on Global branded and textile program cards), mesh material and electrical devices, are warranted for five (5) years
- Control mechanisms are warranted for twelve (12) years
- Heavy Duty Seating is not defined as General Healthcare Seating (see below for warranty exceptions)

Heavy Duty / Bariatric Seating

Global offers products designed for multiple shift applications (24 hours a day / 7 days a week) and larger individuals weighing up to 350 and/or 500 lbs or 750 lbs (depending on series and/or model). Global warrants these products for twelve (12) years to the original Purchaser. All components (including control mechanisms, pneumatic cylinders, bases, casters, glides, frames, arms, plastic seats/backs, etc.) are covered for 24/7 applications under the warranty. The exceptions are foam, upholstery and textiles, which are covered for five (5) years. Fabric or upholstery material on these products must exceed 100,000 double rubs for the textile portion of the warranty to apply. Please refer to globalfurnituregroup.com for an up to date list of series and/or applicable models.

Files, Desks, Modular Furniture, Tables & Accessories

Global warrants all components of metal storage and filing, laminate and wood veneer desks, laminate and wood veneer tables and metal leg components for the lifetime of the product to the original Purchaser.

Seating Warranty Summary

Seating Type	Components Warranty For Original Purchaser	Use Time For Warranty Coverage	Exceptions
General healthcare seating	lifetime	8 hours/5 days per week	foam/upholstery/textiles/mesh/electrical devices - 5 years control mechanisms - 12 years
Heavy duty / bariatric seating	12 years	24 hours/7 days per week	foam/upholstery/textiles - 5 years

Files, Desks, Modular Furniture, Tables & Accessories Warranty Summary

Product Type	Components Warranty For Original Purchaser	Exceptions
Metal storage and filing	lifetime	none
Laminate/wood veneer desks and modular furniture	lifetime	tackboard textiles, electrical devices, task lights - 5 years
Boardroom, conference and training tables	lifetime	electrical devices - 5 years moving parts - 5 years
Overbed tables	2 years	none

Global's healthcare warranty does not apply (for any product category) to the following:

- Nominal or normal amount of wear and tear that can occur over time
- Failures which result from negligence, abuse, accident or misuse
- Failure to apply, install or maintain products according to Global's written instructions and warnings
- Modifications, attachments or repair methods not approved by Global
- Damage caused by a carrier in transit, or delivery/installation contractors
- The matching of colors, grains or textures (wood, leather, etc.) of natural materials
- Products exposed to extreme hot or cold temperatures or excessively dry or humid environments
- Color fastness or the matching of color of textiles, dye lots of textile can vary
- Damage by markings or staining; damage by sharp objects or imprinting from instruments
- Damage to textiles or laminate and wood surfaces/edges from exposure to sunlight (including UV rays)
- Products used for rental purposes
- Purchased parts are warranted for one (1) year
- Failure to follow specific cleaning and disinfecting instructions by the textile supplier

Warranty does not cover the costs of transportation or labor. Repair or replacement will be at Global's discretion.

Textiles and Finishes

Global warrants Global branded textiles and Global carded textile programs inclusive of fabrics, vinyls and leather products for five (5) years. Global does not warrant COM (Customer's Own Material) or GPM (Global Purchased Material) that are customer specified materials, or graded-in and purchased by Global for a customer. For GPM or COM products, please contact the textile supplier for performance information and warranty details. Please refer to our website at globalfurnituregroup.com for a link to the supplier's recommendation for cleaning and disinfecting procedures. Improper usage of disinfecting/cleaning products may void the warranty.

Global textiles and finishes are updated periodically to meet the demand and trends of the market. As a result, some textiles and finishes may be discontinued by Global or the manufacturer. In the event that a textile or finish is discontinued, Global will make every reasonable effort to provide an alternative product(s) of comparable function.

2125WS.....	123	GC3483.....	125	GC3620LCA.....	200	GC3626HBCA-TOP.....	199	GC3641WLA.....	213	GC3674R-HP.....	207
2180.....	123	GC3554.....	53	GC3620LCAL.....	200	GC3626HB-TOP.....	198	GC3641WLAM.....	213	GC3674R-LP.....	207
	A	GC3554F.....	53	GC3620LCAM.....	200	GC3626TOP.....	197	GC3641WLCA.....	213	GC3674RM-HP.....	207
AL00975COREK.....	19	GC3554V.....	53	GC3620LNA.....	199	GC3626W.....	164	GC3641WLCAM.....	213	GC3674RM-LP.....	207
AL00975KEY.....	19	GC3554VF.....	53	GC3620NA.....	158	GC3626WCA.....	164	GC3641WRA.....	213	GC3674WL-HP.....	206
	C	GC3555.....	53	GC3620RA.....	199	GC3626WHBCA-TOP.....	199	GC3641WRAM.....	213	GC3674WL-LP.....	206
C1SET.....	273	GC3555F.....	53	GC3620RAM.....	199	GC3626WHB-TOP.....	198	GC3641WRCA.....	213	GC3674WLM-HP.....	206
C7SET.....	273	GC3555V.....	53	GC3620RC.....	158	GC3626WTOP.....	197	GC3641WRCAM.....	213	GC3674WLM-LP.....	206
C9RSET.....	273	GC3555VF.....	53	GC3620RCA.....	200	GC3628.....	160	GC3642.....	177	GC3674WR-HP.....	206
C10RSET.....	273	GC3556.....	54	GC3620RCAL.....	200	GC3628CA.....	161	GC3642CA.....	177	GC3674WR-LP.....	206
C10SET.....	273	GC3556V.....	54	GC3620RCAM.....	200	GC3628W.....	164	GC3642CAL.....	177	GC3674WRM-HP.....	206
C14RSET.....	273	GC3557L.....	54	GC3620RNA.....	199	GC3628WCA.....	164	GC3642TOP.....	211	GC3674WRM-LP.....	206
C65RSET.....	273	GC3557LF.....	54	GC3620TOP.....	196	GC3630.....	161	GC3642W.....	179	GC3675L-HP.....	207
C65SET.....	273	GC3557LV.....	54	GC3620W.....	161	GC3630CA.....	161	GC3642WCA.....	179	GC3675L-LP.....	207
C66RSET.....	273	GC3557LVF.....	54	GC3620WCA.....	161	GC3630W.....	165	GC3643.....	178	GC3675LM-HP.....	207
C82SET.....	273	GC3557R.....	54	GC3620WF.....	161	GC3630WCA.....	165	GC3643CA.....	178	GC3675LM-LP.....	207
	G	GC3557RF.....	54	GC3620WFCA.....	161	GC3631.....	167	GC3643CAL.....	178	GC3675R-HP.....	208
GC3.....	63	GC3557RV.....	54	GC3620WLA.....	199	GC3631CA.....	167	GC3643TOP.....	211	GC3675R-LP.....	208
GC3-36L.....	62	GC3557RVF.....	54	GC3620WLAM.....	199	GC3631CARC.....	168	GC3643W.....	179	GC3675RM-HP.....	208
GC3-36LH.....	62	GC3558L.....	55	GC3620WLCA.....	200	GC3631F.....	167	GC3643WCA.....	180	GC3675RM-LP.....	208
GC3-42L.....	62	GC3558LF.....	55	GC3620WLCAM.....	200	GC3631FCA.....	167	GC3651.....	189	GC3675WL-HP.....	207
GC3-42LH.....	62	GC3558LV.....	55	GC3620WLNA.....	199	GC3631NA.....	168	GC3651W.....	190	GC3675WL-LP.....	207
GC3-DAHN.....	39	GC3558LVF.....	55	GC3620WNA.....	162	GC3631RC.....	167	GC3652.....	189	GC3675WLM-HP.....	207
GC3-DALN.....	39	GC3558R.....	55	GC3620WNR.....	199	GC3631TOP.....	197	GC3652W.....	190	GC3675WLM-LP.....	207
GC3-NUG.....	39, 63	GC3558RF.....	55	GC3620WRAM.....	199	GC3631W.....	172	GC3653.....	189	GC3675WR-HP.....	208
GC3-NUGH.....	39, 63	GC3558RV.....	55	GC3620WRCA.....	200	GC3631WCA.....	172	GC3653W.....	190	GC3675WR-LP.....	208
GC1104.....	249	GC3558RVF.....	55	GC3620WRCAM.....	200	GC3631WF.....	172	GC3655.....	170	GC3675WRM-HP.....	208
GC1105.....	249	GC3559L.....	55	GC3620WRNA.....	199	GC3631WFCA.....	172	GC3655CA.....	170	GC3675WRM-LP.....	208
GC1109.....	249	GC3559LV.....	55	GC3621.....	158	GC3631WNA.....	172	GC3655CARC.....	170	GC3676.....	181
GC1110.....	250	GC3560.....	56	GC3621CA.....	158	GC3632.....	168	GC3655F.....	170	GC3676CFA.....	216
GC2173.....	121	GC3560F.....	56	GC3621TOP.....	196	GC3632CA.....	168	GC3655FCA.....	170	GC3676HB.....	181
GC2173HB.....	121	GC3560V.....	56	GC3621W.....	162	GC3632CARC.....	169	GC3655NA.....	171	GC3676HB-TOP.....	211
GC2174.....	122	GC3560VF.....	56	GC3621WCA.....	162	GC3632F.....	168	GC3655RC.....	171	GC3676LA.....	216
GC2174HB.....	122	GC3561.....	56	GC3622.....	158	GC3632FCA.....	168	GC3655TOP.....	198	GC3676RA.....	216
GC2180.....	122	GC3561F.....	56	GC3622CA.....	159	GC3632NA.....	169	GC3655W.....	174	GC3677.....	181
GC2183.....	122	GC3561V.....	56	GC3622LA.....	201	GC3632RC.....	168	GC3655WCA.....	174	GC3677HB.....	182
GC2183HB.....	122	GC3561VF.....	56	GC3622LCA.....	201	GC3632W.....	172	GC3655WF.....	174	GC3677HB-TOP.....	212
GC2184.....	123	GC3562.....	56	GC3622LCAL.....	201	GC3632WCA.....	172	GC3655WFCA.....	174	GC3678.....	182
GC2194.....	123	GC3562V.....	56	GC3622LNA.....	200	GC3632WF.....	172	GC3655WNA.....	174	GC3678HB.....	182
GC2195.....	123	GC3563L.....	57	GC3622TLA.....	201	GC3632WFCA.....	172	GC3656.....	171	GC3678HB-TOP.....	212
GC3001.....	85	GC3563LV.....	57	GC3622TLCA.....	202	GC3632WNA.....	173	GC3656CA.....	171	GC3679.....	182
GC3002.....	76, 83, 84, 86	GC3563R.....	57	GC3622TLCAL.....	202	GC3636.....	169	GC3656TOP.....	198	GC3679HB.....	182
GC3003.....	86	GC3563RV.....	57	GC3622TRA.....	201	GC3636W.....	173	GC3656W.....	175	GC3679HB-TOP.....	212
GC3010.....	89	GC3564L.....	57	GC3622TRCA.....	202	GC3636WCA.....	173	GC3656WCA.....	175	GC3681.....	147, 150
GC3011.....	88	GC3564LV.....	57	GC3622TRCAL.....	202	GC3637.....	156, 165	GC3657.....	171	GC3681-20.....	147
GC3012.....	88	GC3564R.....	57	GC3622W.....	162	GC3637CA.....	156, 165	GC3657W.....	175	GC3681XH.....	147
GC3013.....	88	GC3564RV.....	57	GC3622WCA.....	162	GC3637TOP.....	197	GC3661-HP.....	60	GC3682.....	148
GC3014.....	88	GC3565L.....	57	GC3622WLA.....	201	GC3637W.....	156, 165	GC3661-LP.....	60	GC3682-20.....	148
GC3021.....	86	GC3565LV.....	57	GC3622WLCA.....	201	GC3637WCA.....	156, 166	GC3662-HP.....	60	GC3682XH.....	148
GC3022.....	86	GC3566.....	58	GC3622WLNA.....	200	GC3638.....	169	GC3662-LP.....	60	GC3683.....	148
GC3023.....	86	GC3567.....	58	GC3622WTLA.....	201	GC3638CA.....	169	GC3663-HP.....	60	GC3683-20.....	148
GC3023-S.....	86	GC3605.....	185	GC3622WTLCA.....	202	GC3638TOP.....	197	GC3663-LP.....	60	GC3683XH.....	148
GC3031.....	87	GC3606.....	185	GC3622WTRCA.....	202	GC3638W.....	173	GC3664-HP.....	59	GC3684.....	148
GC3031-S.....	87	GC3607.....	186	GC3622WTRCAL.....	202	GC3638WCA.....	173	GC3664-LP.....	59	GC3684-20.....	148
GC3032.....	87	GC3608.....	186	GC3623.....	159	GC3639.....	170	GC3665-HP.....	59	GC3684XH.....	148
GC3033.....	87	GC3609.....	186	GC3623CA.....	159	GC3639CA.....	170	GC3665-LP.....	59	GC3685.....	148
GC3033-S.....	87	GC3610.....	187	GC3623CATOP.....	196	GC3639W.....	174	GC3671L.....	204	GC3686.....	149
GC3034.....	87	GC3610C.....	187	GC3623HBCA-TOP.....	198	GC3639WCA.....	174	GC3671LM-HP.....	204	GC3686.....	149
GC3035.....	87	GC3611.....	187	GC3623HB-TOP.....	198	GC3640.....	176	GC3671LM-LP.....	204	GC3691HB.....	183
GC3036.....	88	GC3611C.....	188	GC3623TOP.....	196	GC3640CA.....	176	GC3671R.....	205	GC3692.....	183
GC3036-S.....	88	GC3612.....	188	GC3623W.....	163	GC3640TOP.....	211	GC3671RM-HP.....	205	GC3692HB.....	183
GC3342.....	277	GC3612C.....	188	GC3623WCA.....	163	GC3640W.....	178	GC3671RM-LP.....	205	GC3694.....	183
GC3346.....	277	GC3614.....	225	GC3623WCATOP.....	196	GC3640WCA.....	178	GC3671WL.....	204	GC3694HB.....	183
GC3361.....	143	GC3616.....	154	GC3623WHBCA-TOP.....	198	GC3641.....	176	GC3671WLM-HP.....	204	GC3695.....	184, 190
GC3361HB.....	143	GC3616CA.....	154	GC3623WHB-TOP.....	198	GC3641CA.....	177	GC3671WLM-LP.....	204	GC3696.....	184, 190
GC3362.....	144	GC3616CAL.....	154	GC3623WTOP.....	196	GC3641CAL.....	177	GC3671WR.....	204	GC3698.....	149
GC3362HB.....	144	GC3616CARC.....	155	GC3624.....	159	GC3641LA.....	213	GC3671WRM-LP.....	204	GC3700.....	226
GC3363.....	144	GC3616RC.....	155	GC3624CA.....	159	GC3641LAM.....	213	GC3672-HP.....	205	GC3701.....	226, 227
GC3363HB.....	144	GC3616RCEZ.....	155	GC3624TOP.....	196	GC3641LCA.....	213	GC3672-LP.....	205	GC3701HB.....	227
GC3380.....	136	GC3616W.....	155	GC3624W.....	163	GC3641LCAL.....	214	GC3672M-HP.....	205	GC3702.....	227
GC3380C.....	136	GC3616WCA.....	155	GC3624WCA.....	163	GC3641LCAM.....	213	GC3672M-LP.....	205	GC3702HB.....	227
GC3380CLTL.....	137	GC3616WFC.....	156	GC3625.....	160	GC3641RA.....	213	GC3673-HP.....	205	GC3703.....	227
GC3380CRTL.....	137	GC3620.....	157	GC3625CA.....	160	GC3641RAM.....	213	GC3673-LP.....	205	GC3703HB.....	228
GC3380-CW.....	137	GC3620CA.....	157	GC3625W.....	163	GC3641RCA.....	213	GC3673M-HP.....	205	GC3704.....	228
GC3391.....	224	GC3620CARC.....	157	GC3625WCA.....	164	GC3641RCAL.....	214	GC3673M-LP.....	205	GC3704HB.....	228
GC3392.....	224	GC3620F.....	157	GC3626.....	160	GC3641RCAM.....	213	GC3674L-HP.....	206	GC3705.....	228
GC3393.....	224	GC3620FCA.....	157	GC3626CA.....	160	GC3641TOP.....	211	GC3674L-LP.....	206	GC3705HB.....	228
GC3481.....	125	GC3620LA.....	199	GC3626CATOP.....	197	GC3641W.....	179	GC3674LM-HP.....	206	GC3707.....	229
GC3482.....	125	GC3620LAM.....	199	GC3626CAWTOP.....	197	GC3641WCA.....	179	GC3674LM-LP.....	206	GC3707HB.....	229

INDEX

GC3708.....	231	GC3772-HC.....	50	GC4235B.....	104	GC4285-HP.....	43	GC6925HB.....	133	GC36032-3.....	266
GC3711.....	229	GC3772-HP.....	50	GC4235HB.....	105	GC4285-LP.....	43	GC6926.....	134	GC36033-2.....	266
GC3711HB.....	229	GC3772-HT.....	50	GC4235HBB.....	105	GC4286-HP.....	43	GC6926HB.....	134	GC36033-3.....	266
GC3712.....	230	GC3772-LC.....	50	GC4235HBL.....	105	GC4286-LP.....	43	GC6927.....	134	GC36301.....	71
GC3712HB.....	230	GC3772-LP.....	50	GC4235HBR.....	105	GC4287-HP.....	43	GC6927HB.....	134	GC36302.....	71
GC3715.....	230	GC3772-LT.....	50	GC4235L.....	104	GC4287-LP.....	43	GC6928.....	135	GC36303.....	71
GC3715HB.....	230	GC3772-WC.....	50	GC4235R.....	104	GC4288-HP.....	43	GC6929.....	135	GC36304.....	71
GC3716HB.....	230	GC3772-WP.....	50	GC4236.....	105	GC4288-LP.....	43	GC7471.....	256	GC36305.....	71
GC3717HB.....	231	GC3772-WT.....	50	GC4236B.....	106	GC4290.....	78	GC7471NA.....	256	GC36306.....	72
GC3722.....	231	GC3773-HC.....	50	GC4236HB.....	106	GC4291.....	78	GC7472.....	257	GC36307.....	72
GC3723.....	231	GC3773-HP.....	51	GC4236HBB.....	107	GC4292.....	79	GC7472NA.....	257	GC36308.....	72
GC3751.....	69	GC3773-HT.....	51	GC4236HBL.....	106	GC4293.....	79	GC7473.....	257	GC36309.....	72
GC3752.....	69	GC3773-LC.....	50	GC4236HBR.....	107	GC4294.....	79	GC7473NA.....	257	GC36310.....	72
GC3753.....	69	GC3773-LP.....	51	GC4236L.....	106	GC6322-0.....	260	GC7476.....	257	GC36311.....	73
GC3760-HC.....	44	GC3773-LT.....	51	GC4236R.....	106	GC6322-4.....	261	GC7476NA.....	257	GC36312.....	73
GC3760-HP.....	45	GC3773-WC.....	50	GC4240.....	107	GC6331-0.....	261	GC7607.....	146	GC36313.....	73
GC3760-HT.....	45	GC3773-WP.....	51	GC4240HB.....	107	GC6331-4.....	261	GC7609.....	146	GC36314.....	37
GC3760-LC.....	44	GC3773-WT.....	51	GC4241.....	107	GC6339.....	261	GC7611.....	146	GC36315.....	37
GC3760-LP.....	45	GC3774-HC.....	51	GC4241-24.....	109	GC6508.....	138	GC7680.....	67	GC36316.....	37
GC3760-LT.....	45	GC3774-HP.....	51	GC4241B.....	108	GC6508WS.....	138	GC7681.....	67	GC36317.....	38
GC3760-WC.....	44	GC3774-HT.....	52	GC4241HB.....	108	GC6509.....	138	GC7692.....	67	GC36318.....	74
GC3760-WP.....	45	GC3774-LC.....	51	GC4241HBB.....	109	GC6509WS.....	138	GC7693.....	68	GC36319L.....	74
GC3760-WT.....	45	GC3774-LP.....	51	GC4241HBL.....	108	GC6511.....	139	GC7694.....	68	GC36319R.....	74
GC3761-HC.....	45	GC3774-LT.....	52	GC4241HBR.....	109	GC6511WS.....	139	GC7696.....	68	GC36320.....	74
GC3761-HP.....	45	GC3774-WC.....	51	GC4241L.....	108	GC6513.....	139	GC7875.....	118	GC36321.....	74
GC3761-HT.....	46	GC3774-WP.....	51	GC4241R.....	108	GC6513WS.....	139	GC7875LTL.....	119	GC36322.....	74
GC3761-LC.....	45	GC3774-WT.....	52	GC4242.....	109	GC6514.....	139	GC7875RTL.....	119	GC36324.....	37
GC3761-LP.....	45	GC3787C.....	245	GC4242HB.....	109	GC6514WS.....	139	GC7876.....	119	GC36325.....	37
GC3761-LT.....	46	GC4075.....	124	GC4243.....	110	GC6515.....	139	GC7877.....	119	GC36326.....	37
GC3761-WC.....	45	GC4076.....	124	GC4243HB.....	110	GC6515WS.....	139	GC7878.....	119	GC36401-HP.....	218
GC3761-WP.....	45	GC4077.....	90	GC4244HB.....	110	GC6517WS.....	139	GC7879.....	120	GC36401-LP.....	218
GC3761-WT.....	46	GC4078.....	90	GC4245HB.....	110	GC6518.....	140	GC8271HB.....	142	GC36401M-HP.....	218
GC3762-HC.....	46	GC4162.....	77	GC4251.....	110	GC6518WS.....	140	GC8271LB.....	142	GC36401M-LP.....	218
GC3762-HP.....	46	GC4162FC.....	77	GC4251B.....	111	GC6519.....	140	GC9604FG.....	251	GC36402-HP.....	218
GC3762-HT.....	46	GC4165.....	77	GC4251L.....	111	GC6519WS.....	140	GC9668FG.....	251	GC36402-LP.....	218
GC3762-LC.....	46	GC4165FC.....	77	GC4252.....	111	GC6521.....	140	GC13011.....	252	GC36402M-HP.....	218
GC3762-LP.....	46	GC4172.....	75	GC4252B.....	111	GC6521WS.....	140	GC13011NA.....	252	GC36402M-LP.....	218
GC3762-LT.....	46	GC4230.....	96	GC4252L.....	111	GC6522.....	141	GC13012.....	253	GC36403L-HP.....	219
GC3762-WC.....	46	GC4230B.....	96	GC4253.....	112	GC6523.....	140	GC13012NA.....	253	GC36403L-LP.....	219
GC3762-WP.....	46	GC4230HB.....	96	GC4253B.....	112	GC6523WS.....	140	GC13013.....	253, 255	GC36403LM-HP.....	219
GC3762-WT.....	46	GC4230HBB.....	97	GC4253L.....	112	GC6524.....	140	GC13013NA.....	253, 255	GC36403LM-LP.....	219
GC3763-HC.....	47	GC4230HBL.....	97	GC4256.....	112	GC6524WS.....	140	GC13015.....	253, 255	GC36403R-HP.....	219
GC3763-HP.....	47	GC4230HBR.....	97	GC4256B.....	113	GC6525.....	141	GC13015NA.....	253, 255	GC36403R-LP.....	219
GC3763-HT.....	47	GC4230L.....	96	GC4256L.....	112	GC6525WS.....	141	GC13021.....	253	GC36403RM-HP.....	219
GC3763-LC.....	47	GC4230R.....	96	GC4259.....	113	GC6526.....	141	GC13021NA.....	253	GC36403RM-LP.....	219
GC3763-LP.....	47	GC4231.....	97	GC4261.....	113	GC6900.....	126	GC13022.....	253	GC36403WL-HP.....	218
GC3763-LT.....	47	GC4231-24.....	99	GC4261HB.....	113	GC6900HB.....	127	GC13022NA.....	253	GC36403WL-LP.....	218
GC3763-WC.....	47	GC4231B.....	98	GC4262.....	113	GC6901.....	127	GC35011-3.....	262	GC36403WLM-HP.....	218
GC3763-WP.....	47	GC4231HBB.....	98	GC4262HB.....	114	GC6901HB.....	127	GC35012-3.....	262	GC36403WLM-LP.....	218
GC3763-WT.....	47	GC4231HBL.....	98	GC4263.....	114	GC6902.....	127	GC35018.....	263	GC36403WR-HP.....	219
GC3764-HC.....	48	GC4231HBR.....	98	GC4264.....	114	GC6902HB.....	127	GC35019.....	263	GC36403WR-LP.....	219
GC3764-HP.....	48	GC4231L.....	97	GC4264HB.....	114	GC6903.....	128	GC35022-3.....	263	GC36403WRM-HP.....	219
GC3764-HT.....	48	GC4231R.....	98	GC4265.....	115	GC6903HB.....	128	GC35022-4.....	263	GC36403WRM-LP.....	219
GC3764-LC.....	47	GC4232.....	99	GC4265HB.....	115	GC6912.....	128	GC35022-5.....	263	GC36404L-HP.....	220
GC3764-LP.....	48	GC4232B.....	100	GC4266.....	115	GC6912HB.....	128	GC35022-6.....	264	GC36404L-LP.....	220
GC3764-LT.....	48	GC4232B.....	100	GC4266HB.....	115	GC6913.....	128	GC35023-3.....	263	GC36404LM-HP.....	220
GC3764-WC.....	47	GC4232HB.....	100	GC4269.....	115	GC6913HB.....	129	GC35024-3.....	264	GC36404LM-LP.....	220
GC3764-WP.....	48	GC4232HBB.....	100	GC4269HB.....	116	GC6914.....	129	GC35032-2.....	264	GC36404R-HP.....	221
GC3764-WT.....	48	GC4232HBL.....	100	GC4271.....	116	GC6914HB.....	129	GC35032-3.....	264	GC36404R-LP.....	221
GC3765-HC.....	48	GC4232HBR.....	100	GC4272.....	116	GC6915.....	129	GC35033-2.....	264	GC36404RM-HP.....	221
GC3765-HP.....	48	GC4232L.....	99	GC4273.....	116	GC6915HB.....	129	GC35033-3.....	264	GC36404RM-LP.....	221
GC3765-HT.....	49	GC4232R.....	99	GC4274-HP.....	117	GC6916.....	130	GC35034.....	264	GC36404WL-HP.....	220
GC3765-LC.....	48	GC4233.....	101	GC4274-LP.....	117	GC6916HB.....	130	GC35041NA.....	81	GC36404WL-LP.....	220
GC3765-LP.....	48	GC4233B.....	101	GC4275-HP.....	117	GC6917.....	130	GC35042.....	81	GC36404WLM-HP.....	220
GC3765-LT.....	49	GC4233HB.....	101	GC4275-LP.....	117	GC6917HB.....	130	GC35042NA.....	81	GC36404WLM-LP.....	220
GC3765-WC.....	48	GC4233HBB.....	102	GC4276.....	116	GC6918.....	130	GC35042T.....	81	GC36404WR-HP.....	220
GC3765-WP.....	48	GC4233HBL.....	102	GC4277-HP.....	117	GC6918HB.....	131	GC35043.....	82	GC36404WR-LP.....	220
GC3765-WT.....	49	GC4233HBR.....	102	GC4277-LP.....	117	GC6919.....	131	GC35043T.....	82	GC36404WRM-HP.....	220
GC3766-HC.....	49	GC4233L.....	101	GC4278-HP.....	117	GC6919HB.....	131	GC35122-5.....	265	GC36404WRM-LP.....	220
GC3766-HP.....	49	GC4233R.....	101	GC4278-LP.....	117	GC6920.....	131	GC35122-6.....	265	GC36405L-HP.....	221
GC3766-HT.....	49	GC4234.....	102	GC4281-HP.....	42	GC6920HB.....	131	GC35211-5.....	265	GC36405L-LP.....	221
GC3766-LC.....	49	GC4234B.....	103	GC4281-LP.....	42	GC6921.....	132	GC35211-6.....	265	GC36405LM-HP.....	221
GC3766-LP.....	49	GC4234HB.....	103	GC4282-HP.....	42	GC6922.....	132	GC35311-5.....	265	GC36405LM-LP.....	221
GC3766-LT.....	49	GC4234HBB.....	104	GC4282-LP.....	42	GC6922HB.....	132	GC35311-6.....	266	GC36405R-HP.....	222
GC3766-WC.....	49	GC4234HBL.....	103	GC4283-HP.....	42	GC6923.....	132	GC36011-3.....	266	GC36405R-LP.....	222
GC3766-WP.....	49	GC4234HBR.....	103	GC4283-LP.....	42	GC6923HB.....	132, 133	GC36012-3.....	266	GC36405RM-HP.....	222
GC3766-WT.....	49	GC4234L.....	102	GC4284-HP.....	43	GC6924.....	133	GC36022-3.....	266	GC36405RM-LP.....	222
GC3770.....	145	GC4234R.....	103	GC4284-LP.....	43	GC6924HB.....	133	GC36023-3.....	266	GC36405WL-HP.....	221
GC3771.....	145	GC4235.....	104			GC6925.....	133	GC36032-2.....	266	GC36405WL-LP.....	221

GC36405WLM-HP.....	221	GCEXB06CRNC1.....	12	GCSNBTO2TH.....	25	GCSNDR04.....	30	W5BSNUP.....	240
GC36405WLM-LP.....	221	GCEXB06CRNC2.....	12	GCSNBTO2THSC.....	25	GCSNDR06.....	30	W5BSNUU.....	240
GC36405WR-HP.....	222	GCEXB06CRNCO.....	12	GCSNBTO3.....	26	GCSNFB01.....	34	W5CSAPP.....	238
GC36405WR-LP.....	222	GCEXB06CRNTH.....	12	GCSNBTO3C.....	26	GCSNFB04.....	34	W5CSAPU.....	238
GC36405WRM-HP.....	222	GCEXB06CRNTHSC.....	12	GCSNBTO3C1.....	26	GCSNHA01.....	33	W5CSAUP.....	238
GC36405WRM-LP.....	222	GCEXB06LLN.....	13	GCSNBTO3CC.....	26	GCSNHA02.....	33	W5CSAUU.....	238
GC36406LA.....	214	GCEXB06LLNC1.....	13	GCSNBTO3CC1.....	26	GCSNHA03.....	33	W5CSNPP.....	238
GC36406LCA.....	214	GCEXB06LLNC2.....	13	GCSNBTO3CC2.....	26	GCSNHB01.....	34	W5CSNPU.....	239
GC36406LCA.....	214	GCEXB06LLNCO.....	13	GCSNBTO3CTH.....	26	GCSNHB04.....	34	W5CSNUU.....	238
GC36406TLA.....	215	GCEXB06LLNTH.....	13	GCSNBTO3CTHSC.....	26	GCSNHFO1.....	34	W5CSNUU.....	239
GC36406TLCA.....	215	GCEXB06LLNTHSC.....	13	GCSNBTO3TH.....	26	GCSNHFO4.....	34	W5NPPC.....	235
GC36406TLCAL.....	215	GCEXB06LRN.....	13	GCSNBTO3THSC.....	26	GCSNLP01.....	34	W5NPPG.....	235
GC36406TRA.....	215	GCEXB06LRNC1.....	13	GCSNBTO4.....	27	GCSNWC01.....	31	W5NPUC.....	235
GC36406TRCA.....	215	GCEXB06LRNC2.....	13	GCSNBTO4C.....	27	GCSNWC02.....	31	W5NPUG.....	235
GC36406TRCAL.....	215	GCEXB06LRNCO.....	13	GCSNBTO4C1.....	27	GCSNWD01.....	31	W5NUPC.....	235
GC36406WLA.....	214	GCEXB06LRNTH.....	13	GCSNBTO4CC.....	27	GCSNWD02.....	32	W5NUPG.....	235
GC36406WLCA.....	214	GCEXB06LRNTHSC.....	13	GCSNBTO4CC1.....	27	GCSNWD03.....	32	W5NUUC.....	235
GC36406WTLA.....	215	GCEXB06PLN.....	14	GCSNBTO4CC2.....	27	GCSNWM01.....	34	W5NUUG.....	235
GC36406WTLCA.....	215	GCEXB06PLNC1.....	14	GCSNBTO4CTH.....	27	GCSNWN01L.....	32	W6APP.....	236
GC36406WTRA.....	215	GCEXB06PLNC2.....	14	GCSNBTO4CTHSC.....	27	GCSNWN01R.....	32	W6APU.....	236, 237
GC36406WTRCA.....	215	GCEXB06PLNCO.....	14	GCSNBTO4TH.....	27	GCTP1515.....	278	W6APU.....	236
GC36410.....	208, 222	GCEXB06PLNTH.....	14	GCSNBTO4THSC.....	27	GCTP2020.....	278	W6AAU.....	236, 237
GC36500.....	150	GCEXB06PLNTHSC.....	14	GCSNBTO6CL.....	28	GCTS7471.....	258	W6NPP.....	236
GC36510.....	76	GCEXB06PRN.....	14	GCSNBTO6CLC1.....	28	GCTS7471NA.....	258	W6NPU.....	237
GC36511.....	76	GCEXB06PRNC1.....	14	GCSNBTO6CLC2.....	28	GCTS7472.....	259	W6NUP.....	236
GC36530.....	83	GCEXB06PRNC2.....	14	GCSNBTO6CLTH.....	28	GCTS7472NA.....	259	W6NUU.....	237
GC36531.....	84	GCEXB06PRNCO.....	14	GCSNBTO6CLTHSC.....	28	GCTS7473.....	259	W324AAU.....	241
GC36532.....	84	GCEXB06PRNTH.....	14	GCSNBTO6CR.....	29	GCTS7473NA.....	259	W524APP.....	240
GC36533.....	84	GCEXB06PRNTHSC.....	14	GCSNBTO6CRC1.....	29	GCTS7477.....	259	W524APU.....	241
GCA7400.....	33	GCEXDD01LN.....	15	GCSNBTO6CRC2.....	29	GCTS7477NA.....	259	W524AUP.....	240
GCEN3642H.....	40	GCEXDD01PN.....	15	GCSNBTO6CRTH.....	29	GCTS13011.....	254	W524AAU.....	241
GCEN3642L.....	40	GCEXDR02LN.....	15	GCSNBTO6CRTHSC.....	29	GCTS13011NA.....	254	W530AAU.....	237
GCEN4242H.....	40	GCEXDR02PN.....	15	GCSNBTO6L.....	28	GCTS13012.....	255	W530AAU.....	237
GCEN4242L.....	40	GCEXDR07LN.....	15	GCSNBTO6L4C.....	28	GCTS13012NA.....	255	W630AAU.....	237
GCEN4848H.....	40	GCEXDR07PN.....	15	GCSNBTO6L4CC1.....	28	GCTS13013.....	255	W630AAU.....	237
GCEN4848L.....	40	GCEXLLP01.....	16	GCSNBTO6L4CC2.....	28	GCTS13013NA.....	255	WDOL.....	241
GCEXB01CN.....	10	GCEXWD03LN.....	16	GCSNBTO6L4CTH.....	28	GCTS13015.....	255	WDOL30.....	241
GCEXB01CNC1.....	10	GCEXWD03PN.....	16	GCSNBTO6L4CTHSC.....	28	GCTS13015NA.....	255	WL2EK.....	32
GCEXB01CNC2.....	10	GCEXWD04LN.....	16	GCSNBTO6LC1.....	28	GCTS13021.....	255	WPGBRK.....	241
GCEXB01CNC0.....	10	GCEXWD04PN.....	17	GCSNBTO6LC2.....	28	GCTS13021NA.....	255	WPT09G.....	243
GCEXB01CNTH.....	10	GCEXWD05LN.....	17	GCSNBTO6LTH.....	28	GCTS13022.....	255	WPT12G.....	243
GCEXB01CNTHSC.....	10	GCEXWD05PN.....	17	GCSNBTO6LTHSC.....	28	GCTS13022NA.....	255	WPT16G.....	243
GCEXB01LN.....	10	GCEXWN02LLN.....	18	GCSNBTO6R.....	29	GCTS35011-3.....	267	WPT90G.....	242
GCEXB01LNC1.....	10	GCEXWN02LRN.....	18	GCSNBTO6R4C.....	29	GCTS35012-3.....	267	WPTEGL.....	243
GCEXB01LNC2.....	10	GCEXWN02PLN.....	18	GCSNBTO6R4CC1.....	29	GCTS35022-3.....	267	WPTEGR.....	243
GCEXB01LNC0.....	10	GCEXWN02PRN.....	19	GCSNBTO6R4CC2.....	29	GCTS35023-3.....	267		
GCEXB01LNTH.....	10	GCF-42H.....	41	GCSNBTO6R4CTH.....	29	GCTS35032-3.....	267		
GCEXB01LNTHSC.....	10	GCF-42L.....	41	GCSNBTO6R4CTHSC.....	29	GCTS35033-3.....	267		
GCEXB01PN.....	10	GCF-48H.....	41	GCSNBTO6RC1.....	29	GCTS36011-3.....	267		
GCEXB01PNC1.....	10	GCF-48L.....	41	GCSNBTO6RC2.....	29	GCTS36012-3.....	267		
GCEXB01PNC2.....	10	GCSNBC02.....	33	GCSNBTO6RTH.....	29	GCTS36022-3.....	267		
GCEXB01PNC0.....	10	GCSNBTO1.....	23	GCSNBTO6RTHSC.....	29	GCTS36023-3.....	267		
GCEXB01PNTH.....	10	GCSNBTO1C.....	23	GCSNBTO14C.....	23	GCTS36032-3.....	268		
GCEXB01PNTHSC.....	10	GCSNBTO1C1.....	23	GCSNBTO14CC1.....	23	GCTS36033-3.....	268		
GCEXB04CN.....	11	GCSNBTO1C2.....	23	GCSNBTO14CC2.....	23	L			
GCEXB04CNC1.....	11	GCSNBTO1CC1.....	23	GCSNBTO14CS.....	24	LCL291.....	40, 63		
GCEXB04CNC2.....	11	GCSNBTO1CC2.....	23	GCSNBTO14CSC1.....	24	LCL294.....	40, 63		
GCEXB04CNC0.....	11	GCSNBTO1CS.....	24	GCSNBTO14CSC2.....	24	LLL291.....	40, 63		
GCEXB04CNTH.....	11	GCSNBTO1CSC1.....	24	GCSNBTO14CSTH.....	24	LLL294.....	40, 63		
GCEXB04CNTHSC.....	11	GCSNBTO1CSC2.....	24	GCSNBTO14CSTHSC.....	24	S			
GCEXB04LN.....	11	GCSNBTO1CSTH.....	23	GCSNBTO14CTH.....	23	SU2P10C.....	244		
GCEXB04LNC1.....	11	GCSNBTO1CSTHSC.....	24	GCSNBTO14CTHSC.....	23	SU2P10U.....	244		
GCEXB04LNC2.....	11	GCSNBTO1CTH.....	23	GCSNBTO24C.....	25	V			
GCEXB04LNC0.....	11	GCSNBTO1CTHSC.....	23	GCSNBTO24CC1.....	25	V00465FLOCK3/4.....	32		
GCEXB04LNTH.....	11	GCSNBTO1S.....	24	GCSNBTO24CC2.....	25	W			
GCEXB04LNTHSC.....	11	GCSNBTO1SC1.....	24	GCSNBTO24CTH.....	25	W5APP.....	234		
GCEXB04PN.....	11	GCSNBTO1SC2.....	24	GCSNBTO24CTHSC.....	25	W5APPG.....	234		
GCEXB04PNC1.....	11	GCSNBTO1STH.....	24	GCSNBTO34C.....	26	W5APUC.....	234		
GCEXB04PNC2.....	11	GCSNBTO1STHSC.....	24	GCSNBTO34CC1.....	26	W5APUG.....	234		
GCEXB04PNC0.....	11	GCSNBTO1TH.....	23	GCSNBTO34CC2.....	26	W5AUPC.....	234		
GCEXB04PNTH.....	11	GCSNBTO1THSC.....	23	GCSNBTO34CTH.....	26	W5AUPG.....	234		
GCEXB04PNTHSC.....	11	GCSNBTO2.....	25	GCSNBTO34CTHSC.....	26	W5AUUC.....	234		
GCEXB06CLN.....	12	GCSNBTO2C.....	25	GCSNBTO44C.....	27	W5AUUG.....	234		
GCEXB06CLNC1.....	12	GCSNBTO2C1.....	25	GCSNBTO44CC1.....	27	W5BSAPP.....	239		
GCEXB06CLNC2.....	12	GCSNBTO2C2.....	25	GCSNBTO44CC2.....	27	W5BSAPU.....	239		
GCEXB06CLNCO.....	12	GCSNBTO2CC1.....	25	GCSNBTO44CTH.....	27	W5BSAUP.....	239		
GCEXB06CLNTH.....	12	GCSNBTO2CC2.....	25	GCSNBTO44CTHSC.....	27	W5BSAUU.....	239		
GCEXB06CLNTHSC.....	12	GCSNBTO2CTH.....	25	GCSNDD01.....	30	W5BSNPP.....	240		
GCEXB06CRN.....	12	GCSNBTO2CTHSC.....	25	GCSNDR02.....	30	W5BSNPU.....	240		

Global offices in Canada

Head Office

560 Supertest Road
Toronto, Ontario
M3J 2M6
T (416) 650-6500

Toronto Sales Office

1350 Flint Road
Toronto, Ontario
M3J 2J7
T (416) 661-3660

Showrooms

Calgary

237 8 Avenue SE, Suite 302
Calgary, Alberta
T2G 5C3
T (403) 250-7770

The Blueprint Montreal

1010 Sainte-Catherine Street W, Mezz 2
Montreal, Quebec
H3B 1E7
T (514) 866-4331

Ottawa

251 Laurier Avenue West, Suite 400
Ottawa, Ontario
K1P 5J6
T (613) 234-2881
Please call ahead to book an appointment.

Edmonton

10158 103 Street NW, Suite 201
Edmonton, Alberta
T5J 0X6
T (780) 444-8922

Toronto

1350 Flint Road
Toronto, Ontario
M3J 2J7
T (416) 661-3660

Vancouver

675 West Hastings Street, Suite 1000
Vancouver, British Columbia
V6B 1N2
T (604) 432-1701

Halifax

1061 Marginal Road, Suite 120
Halifax, Nova Scotia
B3H 4P7
T (902) 422-7434

The Blueprint Toronto

(MetroCentre)
200 Wellington Street West, Suite 1602
Toronto, Ontario
M5V 3C7

Winnipeg

111 Lombard Avenue, Suite 220
Winnipeg, Manitoba
R3B 0T4
T (204) 925-3350

