

Foundations Price List











Effective June 2024 Canada















General Information A

Where to order / How to use this guide **A.7**
 How to order a product **A.7**
 Example - How to specify **A.7**
 Construction **A.8**
 Engineered Wood Veneer **A.8**
 Descor Conversion Varnish Specifications **A.8**
 General Installation and Hardware **A.8**
 Care and Maintenance Guide **A.9**
 Descor Limited Lifetime Warranty **A.9**
 Terms and Conditions of Sale **A.10**
 Casegoods Series Details **A.11**
 Conference Series Details **A.14**
 Finishes and Options **A.17**
 Edges/Handle Available **A.17**
 Casegoods Finish Options **A.18**
 Conference Finish Options **A.24**
 Tackboard Fabrics **A.28**
 Key Alike Form **A.29**
 Casegoods Configurations **A.30**
 Conference Configurations **A.33**



Casegoods Desks B

-  **FD-BB • Double Pedestal Desk with Box/File Pedestal flush on Left and Right B.2**
-  **FD-BBOS • Double Pedestal Desk with Box/File Pedestal offset on Left and Right B.2**
-  **FSL-B • Single Pedestal Desk with Box/File Pedestal flush on Left B.2**
-  **FSL-BOS • Single Pedestal Desk with Box/File Pedestal offset on Left B.2**
-  **FSR-B • Single Pedestal Desk with Box/File Pedestal flush on Right B.2**
-  **FSR-BOS • Single Pedestal Desk with Box/File Pedestal offset on Right B.2**
-  **FT • Desk Shell B.2**
-  **FGTT • Rectangular Transaction Counter with Decorative Panel B.3**
-  **FCMP-W • Hanging Wood Modesty Panel B.3**
-  **FCMP-G • Hanging Glass Modesty Panel B.3**

Casegoods Single Pedestal Credenzas C

-  **FCCL-B • Single Pedestal Credenza with Box/File Pedestal flush on Left C.1**
-  **FCCL-BOS • Single Pedestal Credenza with Box/File Pedestal offset on Left C.1**
-  **FCCR-B • Single Pedestal Credenza with Box/File Pedestal flush on Right C.1**
-  **FCCR-BOS • Single Pedestal Credenza with Box/File Pedestal offset on Right C.2**
-  **FCC35L-H • Single Pedestal Credenza with 35" Lat. Box/File flush on Left C.2**
-  **FCC35L-HOS • Single Pedestal Credenza with 35" Lat. Box/File offset on Left C.2**
-  **FCC35R-H • Single Pedestal Credenza with 35" Lat. Box/File flush on Right C.2**
-  **FCC35R-HOS • Single Pedestal Credenza with 35" Lat. Box/File offset on Right C.2**
-  **FCC40L-H • Single Pedestal Credenza with 40" Lat. Box/File flush on Left C.2**
-  **FCC40L-HOS • Single Pedestal Credenza with 40" Lat. Box/File offset on Left C.2**
-  **FCC40R-H • Single Pedestal Credenza with 40" Lat. Box/File flush on Right C.2**
-  **FCC40R-HOS • Single Pedestal Credenza with 40" Lat. File Box/File offset on Right C.3**







Casegoods Full Storage Credenzas D

-  **FCC-HO • Credenza with Lat. Box/File on Left and Open Storage on Right D.1**
-  **FCC-OH • Credenza with Open Storage on Left and Lat. Box/File on Right D.1**
-  **FCC-HH • Credenza with Lat. Box/File on Left and Right D.1**







-  **FCC-XX • Credenza with 4 Doors and Adj. Shelves D.1**

-  **FCC-X • Credenza with 2 Doors and Adj. Shelves D.1**

Casegoods Modular Storage E

-  **F-BL • Box/File Pedestal handed Left E.1**
-  **F-BR • Box/File Pedestal handed Right E.1**
-  **F-HL • Lat. Box/File Pedestal handed Left E.1**
-  **F-HR • Lat. Box/File Pedestal handed Right E.1**
-  **FLEG • Frame Leg E.1**
-  **FCON • Top Connecting Bracket E.1**
-  **F-T • Modular Top E.2**

Casegoods Freestanding Storage F

-  **FN-L • Left Freestanding 2H Lat. File Pedestal F.1**
-  **FN-R • Right Freestanding 2H Lat. File Pedestal F.1**
-  **FN-3L • Left Freestanding 3H Lat. File Pedestal F.1**
-  **FN-3R • Right Freestanding 3H Lat. File Pedestal F.1**
-  **FBENKK • Bench with two File Drawers and Cushion F.1**
-  **FBENK • Bench with one File Drawer and Cushion F.1**



F-BMCU • Mobile Box/Box Pedestal with cushion
F.2



FW9584-2R • 95" wide x 84" high Work Wall
J.1



FW12570-2L • 125" wide x 70" high Work Wall
J.3

Casegoods Returns **G**



FERL-CG • Left Executive Return
G.1



FW11084-1L • 110" wide x 84" high Work Wall
J.1



FW12570-2R • 125" wide x 70" high Work Wall
J.4



FERR-CG • Right Executive Return
G.1



FW11084-1R • 110" wide x 84" high Work Wall
J.1



FW14070-1L • 140" wide x 70" high Work Wall
J.4



FERL-BCG • Left Executive Return with Box/File Pedestal
G.1



FW11084-2L • 110" wide x 84" high Work Wall
J.2



FW14070-1R • 140" wide x 70" high Work Wall
J.4



FERL-BOSCG • Left Executive Return with Box/File Pedestal offset
G.2



FW11084-2R • 110" wide x 84" high Work Wall
J.2



FW15570-1L • 155" wide x 70" high Work Wall
J.4



FERR-BCG • Right Executive Return with Box/File Pedestal flush
G.2



FW12584-1L • 125" wide x 84" high Work Wall
J.2



FW15570-1R • 155" wide x 70" high Work Wall
J.4



FERR-BOSCG • Right Executive Return with Box/File Pedestal offset
G.2



FW12584-1R • 125" wide x 84" high Work Wall
J.2



FW9556-1 • 95" wide x 56" high Work Wall
J.4

Casegoods Bridges **H**



FBT-CG • Bridge Top
H.1



FW14084-1L • 140" wide x 84" high Work Wall
J.2



FW9556-2 • 95" wide x 56" high Work Wall
J.4



FW14084-1R • 140" wide x 84" high Work Wall
J.2



FW11056-1L • 110" wide x 56" high Work Wall
J.4



FW9570-1L • 95" wide x 70" high Work Wall
J.2



FW11056-1R • 110" wide x 56" high Work Wall
J.5

Casegoods Wall Mount Storage **I**



FSF • Wall Mount Storage with Doors
I.1



FW9570-1R • 95" wide x 70" high Work Wall
J.3



FW11056-2L • 110" wide x 56" high Work Wall
J.5



FW11070-1L • 110" wide x 70" high Work Wall
J.3



FW11056-2R • 110" wide x 56" high Work Wall
J.5



FTS • Wall Mount Tackboard
I.1



FW11070-1R • 110" wide x 70" high Work Wall
J.3



FW11056-3L • 110" wide x 56" high Work Wall
J.5

Casegoods Work Walls **J**



FW9584-1L • 95" wide x 84" high Work Wall
J.1



FW11070-2L • 110" wide x 70" high Work Wall
J.3



FW11056-3R • 110" wide x 56" high Work Wall
J.5



FW11070-2R • 110" wide x 70" high Work Wall
J.3



FW11056-4L • 110" wide x 56" high Work Wall
J.5



FW9584-1R • 95" wide x 84" high Work Wall
J.1



FW12570-1L • 125" wide x 70" high Work Wall
J.3



FW11056-4R • 110" wide x 56" high Work Wall
J.5



FW9584-2L • 95" wide x 84" high Work Wall
J.1





FW12570-1R • 125" wide x 70" high Work Wall
J.3





FW9584-20 • 95" wide x 84" high Work Wall
J.5

 FW9584-21 • 95" wide x 84" high Work Wall J.6

 FW9584-22 • 95" wide x 84" high Work Wall J.6

 FW11084-20L • 110" wide x 84" high Work Wall J.6

 FW11084-20R • 110" wide x 84" high Work Wall J.6

 FW12584-20 • 125" wide x 84" high Work Wall J.6

 FW12584-21 • 125" wide x 84" high Work Wall J.6

 FW9570-20 • 95" wide x 70" high Work Wall J.6

 FW11070-20 • 110" wide x 70" high Work Wall J.7

 FW12570-20 • 125" wide x 70" high Work Wall J.7

 FW12570-21L • 125" wide x 70" high Work Wall J.7

 FW12570-21R • 125" wide x 70" high Work Wall J.7

 FW14070-20 • 140" wide x 70" high Work Wall J.7

 FW14070-21L • 140" wide x 70" high Work Wall J.7

 FW14070-21R • 140" wide x 70" high Work Wall J.7

 FW15570-20 • 155" wide x 70" high Work Wall J.8

 FW10784L • 107" wide x 84" high Work Wall J.8

 FW927002R • 92" wide x 70" high Open Knee Space Work Wall J.8

 FW95840WR • 95" wide x 84" high Open Knee Space Work Wall J.8

 FW110840W2R • 110" wide x 84" high Open Knee Space Work Wall J.8

 FW125840IL • 125" wide x 84" high Open Knee Space Work Wall J.8

 FW9026-1 • 90" wide x 26" high Work Wall Credenza J.8

 FW9026-2 • 90" wide x 26" high Work Wall Credenza J.8

 FW9026-3 • 90" wide x 26" high Work Wall Credenza J.9

 FW9026-4 • 90" wide x 26" high Work Wall Credenza J.9

Conference Room Furniture K

 FC-xx • Full Storage Credenza with two sets of Storage Cabinets K.1

 FCD-A • Full Storage Credenza with BBB on Left, Storage Cabinet and BBB on Right K.1

 FBP • Decorative Credenza Back Panel K.1

 FC-GGTWH • Full Storage Credenza with two sets of Storage Cabinets and Display Wall K.1

 FCD-ATWH • Full Storage Credenza with BBB, Storage Cabinet, BBB and Display Wall K.1

 FFTWA-WH • Full Storage Credenza with BB, Storage Cabinet, BB and Display Wall K.2

 FVMED • TV Mount for Flat Screen Monitors up to 50" K.2

 FVLRG • TV Mount for Flat Screen Monitors over 50" K.2

 FLEC-36 • Lectern K.2

 FLEC-24 • Lectern K.2

 FLEC-24M • Mobile Lectern K.2

 FSM • Mobile Server K.2

 FTGM • Mobile Tech Cart K.3

Conference Tables

 FRE • Rectangular Shaped Conference Table, one piece top L.1

 FRE • Rectangular Shaped Conference Table, two piece top L.1

 FRE • Rectangular Shaped Conference Table, two piece top L.1

 FREST • Rectangular Shaped Sectional Conference Table L.1

 FREST • Rectangular Shaped Sectional Conference Table L.1

 FRESTCT • Rectangular Shaped Sectional Conference Table L.1

 FRESTCT • Rectangular Shaped Sectional Conference Table L.2



















































 FREBE • Rectangular Shaped Conference Table with Bow Ends, one piece top L.2

 FREBE • Rectangular Shaped Conference Table with Bow Ends, two piece top L.2

 FREBE • Rectangular Shaped Conference Table with Bow Ends, two piece top L.2

 FREST • Rectangular Shaped Sectional Conference Table with Bow Ends L.2

 FREST • Rectangular Shaped Sectional Conference Table with Bow Ends L.2

	FREBESTCT • Rectangular Shaped Sectional Conference Table with Bow Ends L.2		FRA • Racetrack Conference Table, two piece top L.5		BTC002 • Vault Conference Power Grommet M.1
	FREBESTCT • Rectangular Shaped Sectional Conference Table with Bow Ends L.3		FRA • Racetrack Conference Table, two piece top L.5		BTC003 • Vault Desk Power Grommet M.1
	FBO • Boat Shaped Conference Table, one piece top L.3		FRAST • Racetrack Sectional Conference Table L.5		DSRTMCS401 • Recessed Power Block, 401 M.1
	FBO • Boat Shaped Conference Table, two piece top L.3		FRAST • Racetrack Sectional Conference Table L.5		DSRTMCS421 • Recessed Power Block, 421 M.1
	FBO • Boat Shaped Conference Table, two piece top L.3		FRASTCT • Racetrack Sectional Conference Table L.5		DSRTMCS602 • Recessed Power Block, 602 M.1
	FBOST • Boat Shaped Sectional Conference Table L.3		FRASTCT • Racetrack Sectional Conference Table L.6		DSRTMCS622 • Recessed Power Block, 622 M.1
	FBOST • Boat Shaped Sectional Conference Table L.3		FWE • Wedge Shaped Conference Table, one piece top L.6		DSRTMCS642 • Recessed Power Block, 642 M.2
	FBOSTCT • Boat Shaped Sectional Conference Table L.3		FWE • Wedge Shaped Conference Table, two piece top L.6		ABLBB • Telcom Plate M.2
	FBOSTCT • Boat Shaped Sectional Conference Table L.4		FWE • Wedge Shaped Conference Table, two piece top L.6		ABLBBBB • Telcom Plate M.2
	FBOBE • Boat Shaped Conference Table, one piece top L.4		FWEST • Wedge Shaped Sectional Conference Table L.6		ABLAB437 • Telcom Plate M.2
	FBOBE • Boat Shaped Conference Table, two piece top L.4		FWEST • Wedge Shaped Sectional Conference Table L.6		ABLC17L37 • Telcom Plate M.2
	FBOBE • Boat Shaped Conference Table, two piece top L.4		FWESTCT • Wedge Shaped Sectional Conference Table L.6		ABLC17AB • Telcom Plate M.2
	FBOBEST • Boat Shaped Sectional Conference Table L.4		FWESTCT • Wedge Shaped Sectional Conference Table L.6		ABLC9C9 • Telcom Plate M.2
	FBOBEST • Boat Shaped Sectional Conference Table L.4		FRE • Square Table L.7		LED • LED Light M.2
	FBOBESTCT • Boat Shaped Sectional Conference Table L.4		FRO • Round Table L.7		VVACSBLK • Wire Management Snake M.3
	FBOBESTCT • Boat Shaped Sectional Conference Table L.5	Accessories M			LIG • LED Snake Light with dimmer M.3
	FRA • Racetrack Conference Table, one piece top L.5		BTC001 • Vault Conference Power Grommet M.1		MIC • Microphone M.3



LO • Lock Assembly
M.3



LOB • Lock Drum with Key
M.3



LOCK • Lock Key
M.3



GM1 • Round Grommet - Plastic
M.3



GM5 • Rectangular Grommet - Metal
M.3



QC • Quick Connector
M.4

WHERE TO ORDER / HOW TO USE THIS GUIDE

AREA	PHONE	FAX
Ontario (Except Ottawa)	905-470-0010	905-470-6262
Calgary, AB (Global Alberta - Calgary)	403-250-7770	403-250-7773
Edmonton, AB (Global Alberta - Edmonton)	780-444-8922	780-443-3913
Halifax, NS (Halifax)	902-422-7434	902-423-9924
Quebec, QC (Quebec)	418-653-6111	418-653-6151
Montreal, QC (Montreal)	514-866-4331	514-866-8567
Ottawa, ON (Ottawa)	613-234-2881	613-234-5350
Burnaby, BC (Global West)	604-432-1701	604-432-7475
Winnipeg, MB (Winnipeg - Saskatchewan)	204-925-3350	204-925-3356

Price and Product Guide Section: Features the actual product pricing and specification instructions. This section is divided into Casegoods, Workwalls, Conference Room Furniture, Conference Tables and Accessories.

General Information: Includes subdivision sections of casegoods construction, varnish specification, veneers and wood solids, finishing process, general installation and hardware, maintenance, terms and conditions of sale, warranty and where to order.

ISO 9001:2015 Registered: The Descor Factory is ISO 9001:2015 registered for manufacturing procedures and practices of quality and quality control processes.

ISO 14001:2015 Registered: The Descor Factory is ISO 14001:2015 registered for environmental procedures and practices.

ANSI/BIFMA Certified: Descor casegoods have passed ANSI/BIFMA standards for product construction and durability.

FSC ®: Forest Stewardship Council ®. Option available on all wood veneer products by special request.

BIFMA e3: Furniture sustainability level 3

Greenguard: All Descor Products are Greenguard certified

Price List Effective: June 2024

HOW TO ORDER A PRODUCT

Creating a correct and complete product number ensures clean orders and accurate information for the factory. Clean orders expedite order entry and factory order scheduling, thereby, saving days, sometimes weeks off potentially extended lead-times.

From product to product, there are different options available that affect the length, options and sequence of the order-string.

To view current wood, plastic laminate finish and fabric samples, please visit www.globalcontract.com.

To order actual wood, plastic laminate finish and fabric samples and cards, place request with the Global Marketing Department via fax at 416-667-0338 or via e-mail at literaturecdn@globalfurnituregroup.com.

Wood finish and LP Laminate samples are individual 3"x 5" chips and can be obtained through the above by request.

EXAMPLE - HOW TO SPECIFY

CODES: The price list uses a numbering system with meaningful alphanumeric characters to create a simple-to-understand product number. This makes specifying the product easy and accurate.

SPECIFICATION EXAMPLE OF A DESK UNIT

PRODUCT CODE: FSL7230B
 F = Foundations
 S = Single
 L = Pedestal on Left
 7230 = Size: Width x Depth
 B = Pedestal Style

FINISH: Choose Finish

NOTE: Arrow indicates direction of grain.

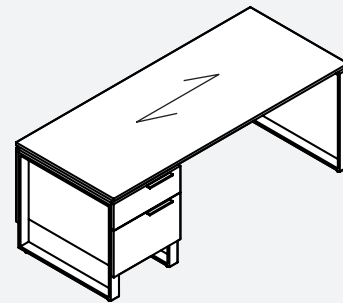

CONSTRUCTION

Finish: Conversion varnish (similar to catalyzed lacquer, but tougher), 25° sheen. Descor does not buff or rub its finishes.

360° Finishing: All Descor wood casegood products are veneered and finished on the back sides (except modular under-surface storage - tops and backs are unfinished).

Engineered Veneer: Is standard on Casegoods.

Pedestals and Credenzas: Are suspended 7 ½" off the floor by an open framed aluminum leg. Locks are always located on the side panel. Handle placement is offset from the centre towards the lock. Overall height is always 26 ½".

Drawer Suspensions: Pedestal drawer suspensions are metal ball bearing type.

Both box and file drawers are full extension.

Hanging file rails: Are pre-installed on file drawer perimeters. The back rail in a lateral file drawer is designed for both legal and letter size filing.

Drawer Construction: Drawer sides and bottoms are wrapped black vinyl. Veneered drawer interiors are available as an option (see finishes and options section).

Drawer Fronts: The drawer front is an applied element to a four sided drawer. Drawer fronts are veneered on all surfaces. Drawer fronts can be removed or replaced in the field.

Leveling Glides: Levelers have a 1" range of adjustment.

ENGINEERED WOOD VENEER

Engineered veneer is real wood that through a manufacturing process of slicing, dying, gluing and re-slicing achieves consistent wood grain and colour structure.

Veneer is purchased by the block and sliced into a rift cut slip matched pattern to a thickness of 0.6mm (1/42")

Descor lays up rift cut veneers in a slip match method.

For other natural or engineered veneers, species, cuts and patterns, please contact Customer Service.

DESCOR CONVERSION VARNISH SPECIFICATIONS

Descor uses conversion varnish: It is among the most durable finishes used in the contract furniture industry (more durable than catalyzed lacquer).

Conversion varnish is a synthetic, catalyzed cured (chemically active) finish, containing UV inhibitors to slow the oxidizing (colour changing) effects of ultra-violet rays on wood.

Descor produces low 25° sheen. Low sheens are the most practical for commercial use as it doesn't show most scratches and are more easily touched-up than higher sheens.

Cures with heat, developed two ways:

- Chemically (catalyst reaction within the varnish itself)
- Line oven (approximately 140° F) accelerates finish curing and increases molecular density for a harder finish

Conversion varnish has a component called "solids", produced by a combination of resins when the solvent evaporates. These solids float to the varnish surface, which is where they cure. These solids are the durable aspect of the finish. Descor uses an "off-the-gun" technique with conversion varnish. This means the "solids" (the durable aspect of the finish) remain intact on the surface of the finish.

Descors standard finish on oak and walnut is open pore, on cherry and maple is semi-closed pore. If a full fill finish is required for walnut, cherry and maple tops, add the suffix "2" to the finish code and add 5% to the base pricing for each product.

Custom finish is available at an upcharge (see finishes and options section).

GENERAL INSTALLATION AND HARDWARE

Uncartoning

Always uncarton wood office furniture with care. Never use a knife or sharp object of any kind to open cartons. Tear cartoning tape off by hand. Protective corner blocks, foam-wrap, and a bottom skid are included in the carton during shipping for protection.

Hardware: All necessary hardware to assemble the furniture is included in the shipment. Actual wall-attachment fasteners for wall cabinets and tackboards are not included due to variable site conditions.

Hanging file rails: Pre-installed on file drawer perimeters and accommodates both legal and letter size filing.

Connecting Brackets: Are used to attach Bridges and Returns to Desks and are shipped pre-attached to the bottom of the Bridge or Return. Additional screws are shipped in a plastic bag.

Installation: Wall-mounted cabinets and tackboards are shipped with pre-attached horizontal wall rails at the back of each unit. The wall-side components must be detached from the unit and fastened to the wall accordingly. Wall fasteners are not included due to the variable site conditions. Securing the wall rail to a vertical structural member is the required manner of installation. The cabinet or tackboard is then lowered on to the wall rail. It is important to level the wall rail before installation. Wall cabinets are equipped with levelers at the bottom of the back panels for proper cabinet alignment. Units with doors are equipped with adjustable European door hinges to assist in door alignment. It is required to use a #8 wood screw through the back of the cabinet and the wall-mounted rail, to further secure the wall attachment. Tackboards have vertical grooves in the back for tasklight wiring.

Transaction Counter and Decorative Panels: Are shipped knock down.

To assemble it follow the assembly instruction sheet included. To secure the transaction counter to the desk, double sided tape is applied to the bottom of the end panels. Included screws must be used to attach the decorative panel to the desk.

Modular storage units: Have pre-drilled holes through the tops for securing to the bottom of the work surfaces. Screws and lock keys are included in a plastic bag fastened inside the pedestal. Pedestals may be installed flush or offset. Disassemble the Modular Unit first before relocating the entire unit to avoid damage or bodily injuries.

Work Walls: Incorporate storage units, credenzas and niches of different sizes, attached to the base with connecting bolts. Upper units are installed with plastic dowels. Small connectors are supplied to secure the units thru the side panels. Complete assembly instruction is included with the wall unit. All necessary connectors and dowels are shipped in a plastic bag.

Credenza Backpanels and Display Walls: Optional credenza backpanels and display walls are attached to the units with supplied quick connectors. To assemble the display wall follow the assembly instructions included. All connectors and confirmat screws are shipped in a plastic bag.

Tables: All table components are shipped in multiple boxes. Screws and table connectors are packed in a separate box identified with the label "Hardware Enclosed". Assembly instructions for specific tables are included.

You may visit www.globalcontract.com to find the assembly instructions under Resources - Installation Manuals - Foundations

Caution: Using screws other than those supplied by Descor could result in damage to finished tops. Descor will not honor claims due to installation of incorrect hardware.

Upon completing installation, wipe furniture with a damp cloth, followed by a dry soft cloth.

Leveling wood office furniture properly is the most important procedure to ensure proper functioning and alignment of drawers, locks and doors.

CARE AND MAINTENANCE GUIDE

Wood Casegoods Care: Descor furniture is constructed to strict specifications to ensure years of satisfied use. As with all wood products, certain care requirements and periodic maintenance are necessary in order to maintain the original new appearance and function.

Finish Protection: All clear wood finishes are susceptible to scratches from rough and abrasive objects, such as staples, paper clips, ceramic coffee mugs, flower pots, picture frames, etc. Computer equipment with rubber feet can also cause discoloration and softening of the finish due to petroleum distillates in the rubber.

Glass tops are the ultimate protection against scratch mishaps.

The most practical protection is the use of desk-pads or blotters, paper management bins, coasters, common sense caution with rough items, and adding pressure sensitive felt to the feet or bottoms of any potentially destructive item on the Desk.

Finish Care: Wax or polish should never be used on the catalyzed finish; they will give a greasy, cloudy or uneven appearance to the product. Descor's conversion varnish finish is best cleaned by wiping the surfaces with a damp cloth, followed by a soft dry cloth in the direction of the grain. If the surfaces are very dirty, use of a glass cleaning type of product is recommended.

Never use a silicon based product to dust or polish catalyzed finishes. Over time, silicon may disrupt the actual molecular composition of the finish and cause it to soften and become cloudy.

Additional Tips:

- Remove any spilled liquid immediately with a blotting, rather than a wiping motion.
- Do not drag or push objects or stacks of papers across any finely finished surface.
- Avoid exposing surfaces to extreme heat, cold or humidity.
- The surface finish may be burn resistant, however, the wood underneath the finish is not and can be charred by a burning cigarette or heat producing unit.
- Exposure to strong sunlight should be avoided. The surface finish is fade-proof, however, in spite of UV inhibitors in the finish, the wood underneath may change colour (patina) where extended exposure to sunlight exists. Natural or light finished species are especially susceptible to UV colour change.
- Building maintenance and maintenance service management should be notified of the proper care instructions and procedures for your furniture to avoid damage and allow optimum appearance for years to come.
- Special care should be taken to protect wood furniture when other trades such as painters, electricians and telecommunications workers are present performing work.
- Drawer suspensions are lubricated prior to shipment. Periodic lubrication may be applied to the ball bearing housing with a high quality lubricant found in most hardware stores.
- Drawer alignment is achieved with proper leveling of desks and credenzas.
- Check leveling glides for adjustment if the furniture is moved.
- Modular furniture items, such as Desk Shells and Modular Pedestals **must be disassembled** prior to moving or relocating to avoid damage to the furniture.
- Hutch and wall cabinet doors may require field adjustment, from time to time, due to shifting weight load factors inside the cabinet.
- Touch-up of wood furniture should only be attempted by a qualified refinisher/touch-up technician. Contact your furniture dealer if this need should arise.

DESCOR LIMITED LIFETIME WARRANTY

Descor will, at no cost to the original purchaser and for as long as the original purchaser owns a Descor product repair or replace with a comparable product, at Descor's option, any part or product sold after January 01, 2001, which fails as a result of a defect in its design, materials or workmanship. For all purposes of this warranty, the term "purchaser" is defined as the entity or individual acquiring a new Descor product as the initial purchase thereof either from Descor or an authorized Descor dealer.

Exceptions to this warranty include:

- Descor warrants wood casegoods products to be free from defects in materials and workmanship for a period of 10 years, of single shift service, from the date of delivery.
- Lighting products and grommets are warranted for one year from date of delivery.
- Custom electrical solutions may carry varying warranty coverage.
- Descor fabrics and wood veneers are warranted for 5 years from the date of delivery.
- Electrical components are warranted for 1 years from the date of delivery.
- Moving parts, which include, glides, slides, casters, user adjustable worksurface mechanism are warranted for 5 years from date of delivery.
- Descor warrants its products based on a single shift (40 hours/week). Usage beyond a single shift (40 hours/week) will result in a reduction in the warranty, in proportion to the increased usage.
- Pneumatic cylinders for any product, unless otherwise stated, are warranted for 10 years of single shift (40 hours/week) usage from date of delivery.

This warranty does not include:

- Customers Own Material or finishes applied to Descor products (which include graded in fabrics, which are treated as Customers Own Material).
- Wood Veneer being a natural material will have shade differences between veneer leaves. This will be more apparent between flitches. Fading on wood veneers can be caused by exposure to UV rays / sunlight.
- Wood colour, grain and stain acceptance, which may occur due to the natural elements of wood.
- Ballasts and light bulbs.
- Products which have been modified or which have not been installed or used according to Descor's application and installation guidelines or warnings.
- Products that must be replaced due to normal wear and tear, negligence, abuse, accidents or shipping damage.
- Products used for rental purposes.

In no event shall Descor be liable in either tort or contract for any loss or direct, special, incidental, consequential, or exemplary damages.

This warranty is the customer's sole remedy for product defect. Descor makes no warranties, including the express or implied warranties of merchantability and fitness purpose, other than the express warranties contain herein.

TERMS AND CONDITIONS OF SALE

Prices: Prices are subject to change without notice. All shipments are F.O.B. the plant unless otherwise indicated. All taxes are extra.

Terms: Merchandise shall be invoiced when shipped and payment is due 30 days after invoice date.

Orders: All orders are subject to acceptance by Descor head office and to the Terms of Sale which appear in current price lists.

Orders: All orders are subject to acceptance by Descor head office and to the Terms of Sale which appear in current price lists.

Returns: Merchandise may not be returned without prior written consent. Upon approval, a minimum restocking charge of 35% shall be deducted from the credit note, in addition to any expense incurred should reconditioning be necessary. Return shipping must be prepaid.

Cancellations: All orders are considered firm and not subject to cancellation without our documented approval. Cancellation charges may be required based on expenses incurred during order processing.

Carriers: All shipments shall normally be made through the Buyer's specified carrier. Otherwise Descor shall use its best judgment in selecting a carrier. Prepay and Add Service Charge to cover cost of processing prepaid freight bills, a charge of \$32.00 per shipment will be made. This amount will be included in the "Freight Charges" invoiced by Descor.

Liability: Every effort is employed to effect secure packing for shipment. Descor's liability ends when the carrier issues a clear receipt, acknowledging automatically that the shipment has been received in good condition.

Claims: It is required that all merchandise be carefully examined by recipient before issuance of clear receipt to carrier. Should the shipment arrive unsound or incomplete, have carrier make proper notation on the delivery receipt and original freight bill as to discrepancy before accepting shipment. Any claim for damage or shortage must be filed by you with the delivering carrier. Descor will not accept return of merchandise damaged in transit.

Changes and Cancellations: Descor reserves the right to institute changes with regard to materials, equipment, specification and designs, as well as to discontinue models at any time without prior notice.

After the date of Descor's acknowledgement of a Purchaser's order, the order may not be changed or cancelled by Purchaser without the written consent of Descor. Special order items already in production are not subject to change or cancellation under any circumstances. Other standard items already in production are subject to a minimum 35% restocking charge, based on list price.

A higher percentage may apply, depending on the stage of production.

Finishes: Descor veneers and solid woods are carefully selected for colour, tone and grain. Since the distinctive characteristics and nature of wood cause variations, exact matches are not always possible.

Shipping Weight: All shipping weights and cubic sizes as indicated are approximate.

Dimensions: Are approximate. Please contact Descor for specific dimensions required.

FOUNDATIONS CASEGOODS SERIES DETAILS

Optional Grommet Locations for Desks, Credenzas and Returns

Standard Grommet for Foundations Tops is GM5K (Tungsten).
Grommets and locations must be specified.

For Tops up to 24" Deep

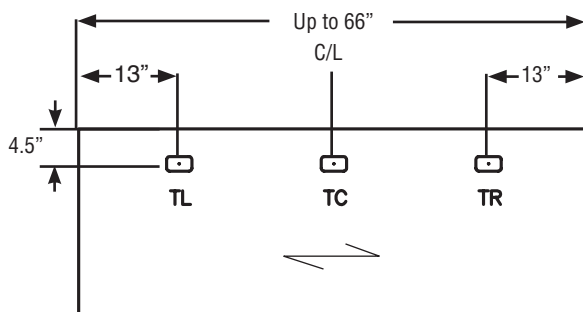
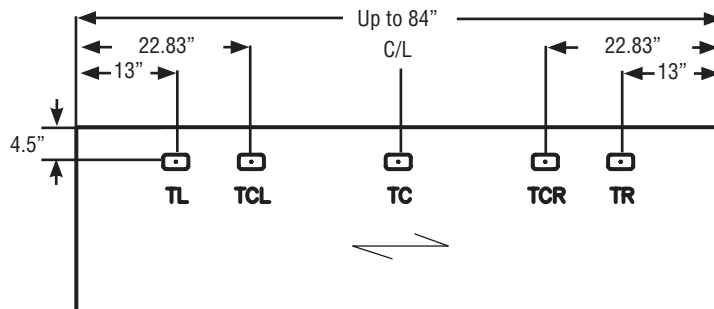

For Tops from 30" to 36" Deep

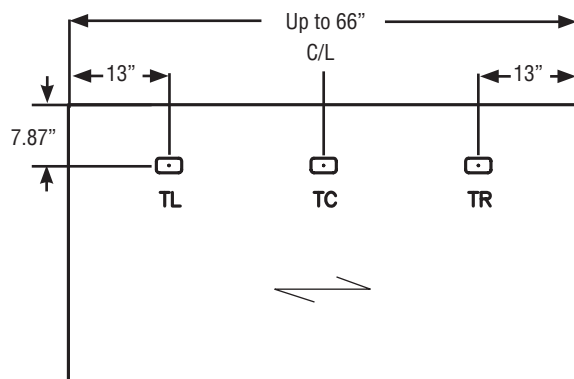
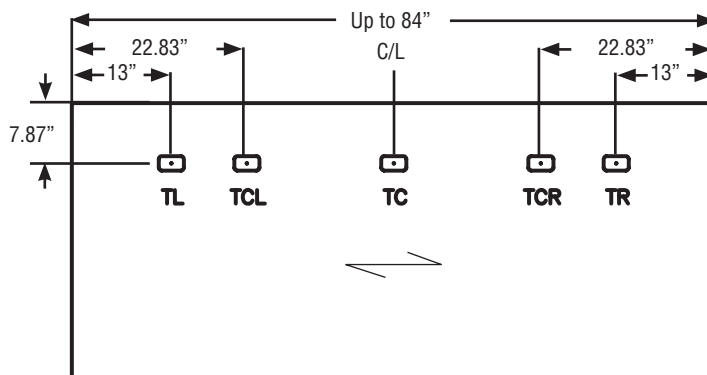

NOTE: Arrow indicates direction of grain.

TL - Top Left
TR - Top Right

TCL - Top Centre Left
TCR - Top Centre Right

TC - Top Centre

Optional Grommet Locations on Work Walls

Grommets and Grommet Locations must be specified.

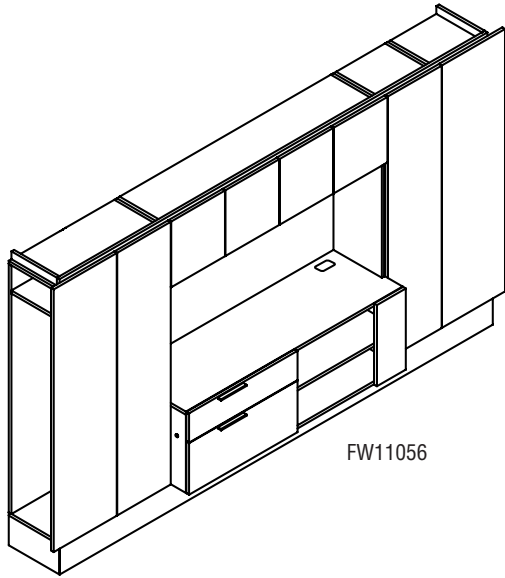

FW11056

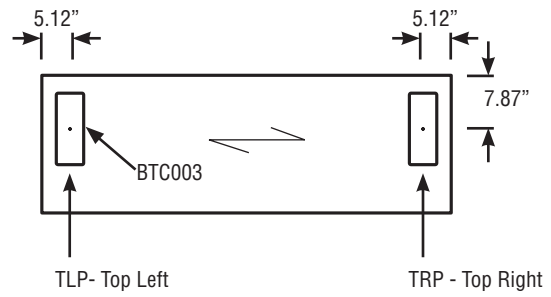
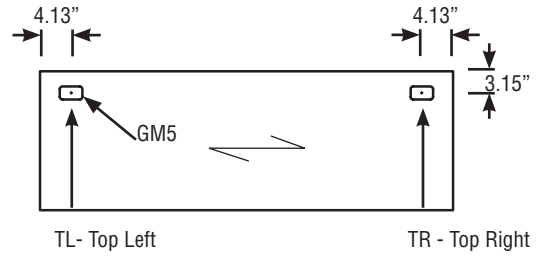

Standard Grommet Locations on Work Walls

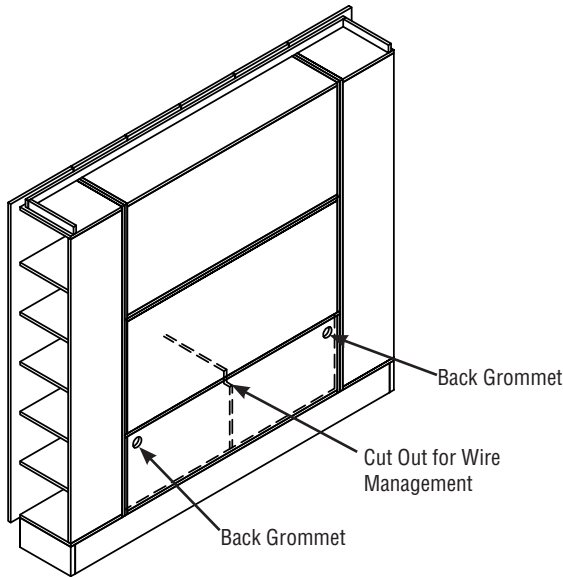

FW9570-IR Back View

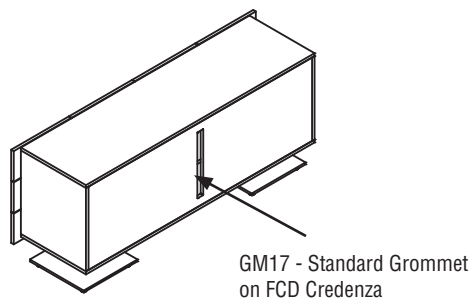
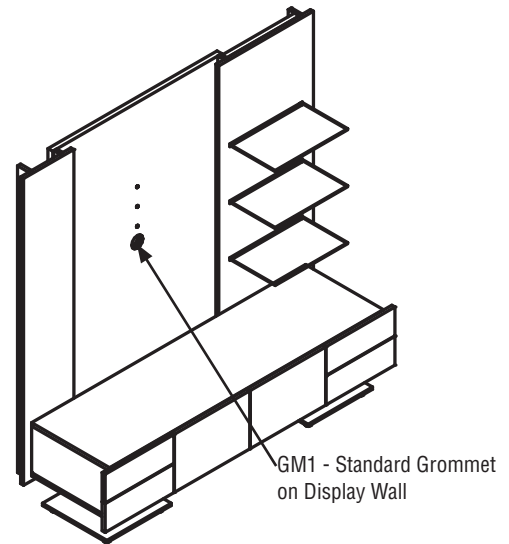

GM17 - Standard Grommet on FCD Credenza

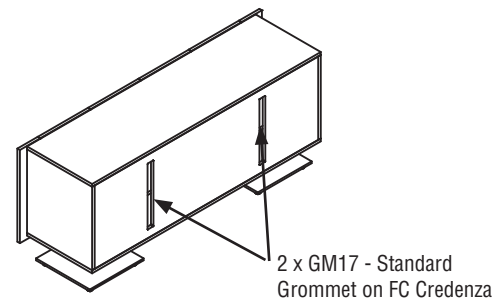

2 x GM17 - Standard Grommet on FC Credenza

Work Wall Display Niches

Available widths 15", 30", 45", 60" wide.
 Available heights 14", 28", 42" high.
 Maximum niche dimension 60" wide is 42" high.
 Maximum niche dimension 75" wide is 28" high.

When a niche is placed on 20" cantilevered storage there is no bottom

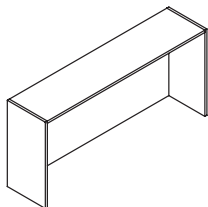

When a niche is placed between storage components it always has a bottom

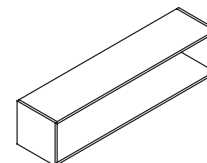

Work Wall Lighting

LED lights for niches must be specified at time of manufacture. When more than one LED light is required in a work wall configuration, a single remote switch is included. Up to four LED lights can work off a single transformer.

Four sided niche with routed upper panel for LED light.

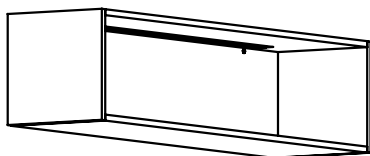

Niche is routed on inside top panel & back is drilled for wire pass through.

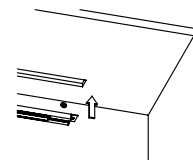

Open bottom niche with routed upper panel for LED light.

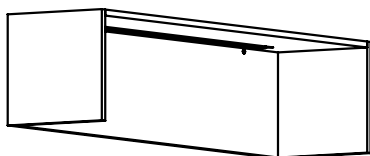

LED lights available in 12", 24", 36" and 48" widths.

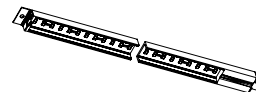

FOUNDATIONS CONFERENCE SERIES DETAILS

Optional Grommet Locations for Conference Table Tops

Grommets and Grommet Locations must be specified.

For tables that are 48" wide and 96", 120", 144" or 168" long

TCL - Top Centre Left

TCR - Top Left

TC - Top Centre

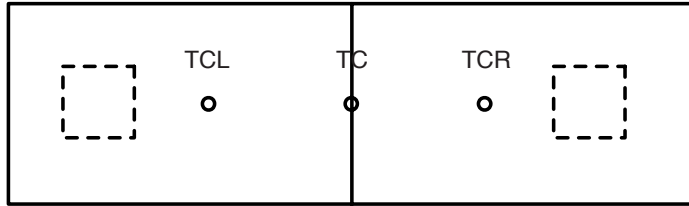

For tables that are 48" wide and 192" or 216" long

and

tables that are 60" wide and 168", 192", 216" or 240" long

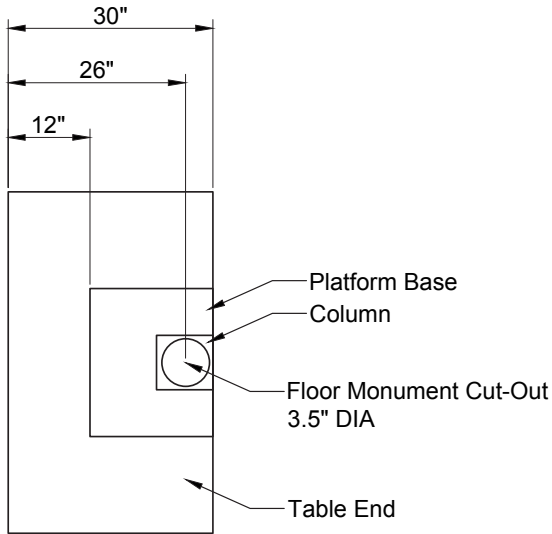
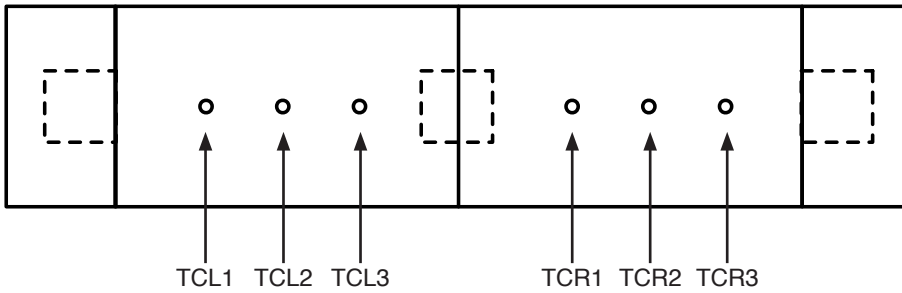

Conference Table Top and Base Guide

Conference Table, two piece Top with 3 Bases

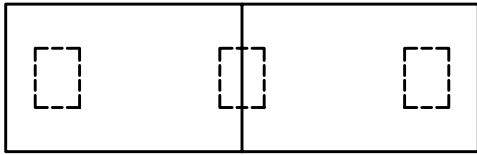

Sectional Conference Table with 3 Bases

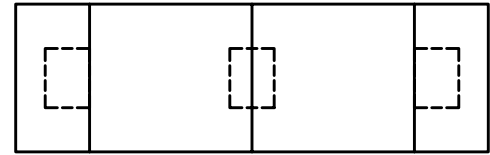

Conference Table, two piece Top with 2 Bases

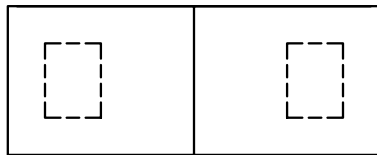

Sectional Conference Table with 2 Bases



Conference Table, one piece Top with 2 Bases

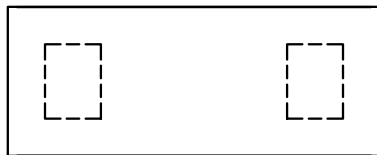

Square Table Top with Mono Base

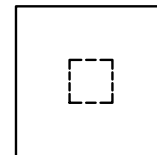

Sectional Conference Table with Technology Trough and 3 Bases

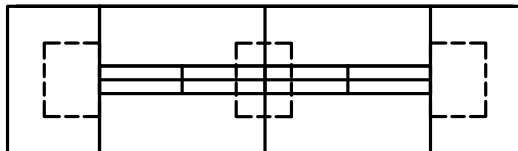

Round Table Top with Mono Base

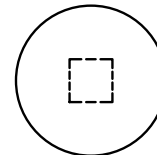

Sectional Conference Table with Technology Trough and 2 Bases



Sectional Conference Table with Technology Trough and 2 Bases

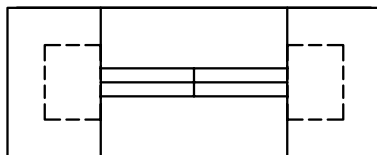

Note: Different Table Shapes are available (Section "L").

Technology Trough Details

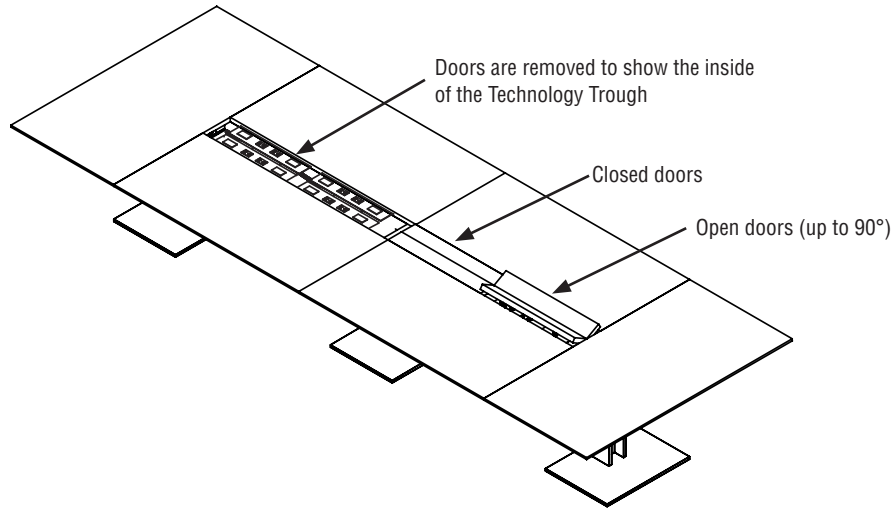

Side View

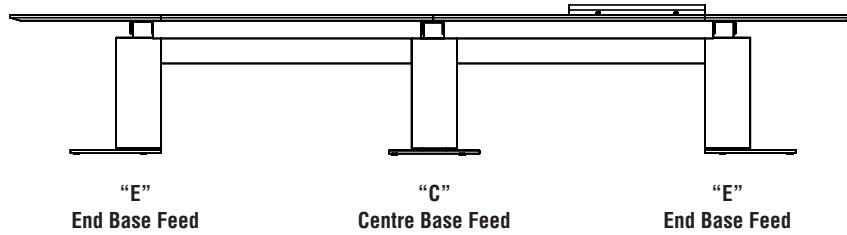

End View

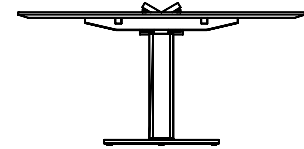

Power kits are included. For telcom plates please refer to page M.3. Two power receptacles and two telcom knockouts per door are standard. Telcom plates will be shipped separately. If no telcom plate is specified, blank coverplate will be included.

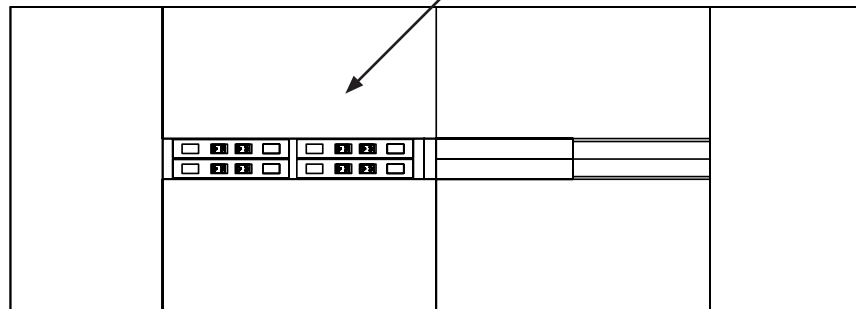
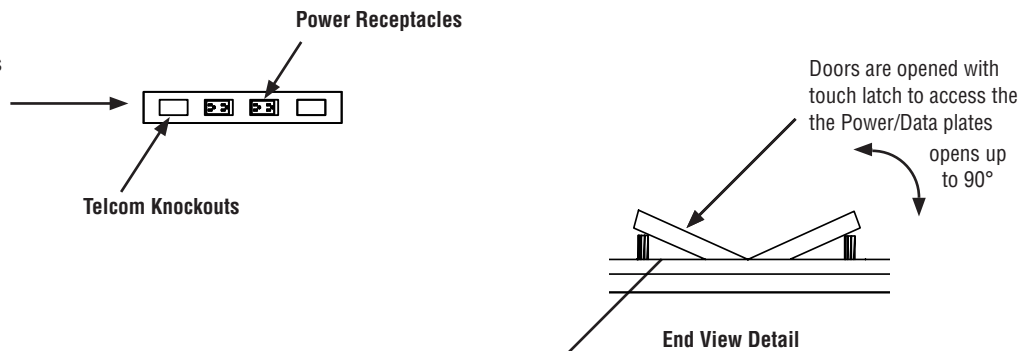

FINISHES

Descor Products are Greenguard certified

Standard Foundations Finish Options

- Up to three colours are available for Foundation Casegoods. Please refer to pages A.18 and following.

Foundation Engineered Veneer (Horizontal Grain Standard)

Finish Code	Colour	Veneer Type	Veneer Cut
NTF	Natural	Maple Reconstituted	Rift
TLF	Twilight	Maple Reconstituted	Rift
CIF	Chai	White Oak Reconstituted	Rift
FGF	Fig	White Oak Reconstituted	Rift
RVF	Riviera	White Oak Reconstituted	Rift
STF	Sumatra	White Oak Reconstituted	Rift
WHF	Wheat	White Oak Reconstituted	Rift
MTF	Metro	White Oak Reconstituted	Rift
MSF	Mesa	White Oak Reconstituted	Rift
CHF	Cashmere	White Oak Reconstituted	Rift
SNF	Sienna	White Oak Reconstituted	Rift
WIF	Winter	White Oak Reconstituted	Rift

Finish for Metal Legs (Casegoods)

Finish Code	Colour
SGR	Silver Glimmer

Finish for Metal Legs (Conference)

Finish Code	Colour
BLKT	Black Textured
TUNT	Tungsten Textured
DWTT	Designer White Textured

Solid Colours on MDF

DESCOR FINISH		CODE
Black	(solid colour)	BLM
Chantilly	(solid colour)	CHM
Cloud	(solid colour)	CLM
Dove	(solid colour)	DVM
Oyster	(solid colour)	OSM
Tungsten	(solid colour)	TNM
White	(solid colour)	WHM

- For Decorative Modesty Panels and Plinth used on VGTCUS, VGRCUS, VGLCUS, VGCKCUS and LEC-CURV at no upcharge
- For Doors, Drawer Fronts and Decorative Panels (two tone finish) upcharge 15%

Group 1 and 2 Finishes are available with Vertical Grain only. Add suffix "VG" to the end of the product code.

Group 1 Finishes (Standard Finishes)

Finish Code	Colour	Veneer Type	Veneer Cut
BTW	Biscotti	White Oak	Rift
JAW	Java	White Oak	Rift
MCW	Moch	White Oak	Rift
CRW	Coral	White Oak	Rift
EVW	Evening Oak	White Oak	Rift
MTW	Milestone	White Oak	Rift
CAW	Cocoa Walnut	Walnut	Flat
DWW	Dark Walnut	Walnut	Flat
EWW	Empress Walnut	Walnut	Flat
LTW	Latte Walnut	Walnut	Flat
MHW	Mahogany on Walnut	Walnut	Flat
WLW	Walnut	Walnut	Flat
NLW	Natural Walnut	Walnut	Flat
ULW	Umber Walnut	Walnut	Flat
ACW	Amber Cherry	Cherry	Flat
DCW	Dark Cherry	Cherry	Flat
RCW	Red Cherry	Cherry	Flat
WCW	Windsor Cherry	Cherry	Flat
AMW	Almond Cherry	Cherry	Flat
VNW	Vintage Cherry	Cherry	Flat
HAW	Hazelnut	Maple	Flat
MPW	Maple	Maple	Flat
SMW	Sugar Maple	Maple	Flat
WMW	White Maple	Maple	Flat
OYW	Oyster Maple	Maple	Flat
SHW	Sahara Maple	Maple	Flat

Group 2 Finishes (Add 25% to the list price)

Finish Code	Colour	Veneer Type	Veneer Cut
BRW	Butternut	Anigre	Figured

Finish Options

- Custom staining service is available. Cost to match finish is:
 - Orders for \$0 to \$50,000 list, add a \$528 flat fee and 15% to the base pricing for each product.
 - Orders for \$50,000 to \$200,000 list, add 15% to the base pricing for each product.
 - Order for over \$200,000 will not have an upcharge.
- Plastic laminate inlay is available. Surcharges may apply.
- Custom veneers available. Please contact Customer Service for selection & pricing.
- Full fill for walnut, cherry, anigre and maple tops, available at 5% upcharge. Add suffix "2" to the end of the finish code.

EDGES AND HANDLES AVAILABLE

Edge Detail
Foundations Casegoods

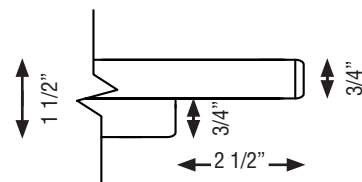

Edge Detail
Foundations Conference Tables



Foundations Handle



PL83 Anodized Aluminum, 7.2"

FOUNDATIONS CASEGOODS • FINISH OPTIONS

Double and Single Pedestal Desks

For desks two finishes can be specified.

The first finish in the product string, indicated as #1.

The second finish in the product string indicated as #2.

If only one finish is indicated, the entire unit will be monotone.

Note:

Horizontal grain direction is standard on all engineered finishes.

If natural veneer is required, the grain direction will be vertical.

Arrow indicates direction of grain.

User Side

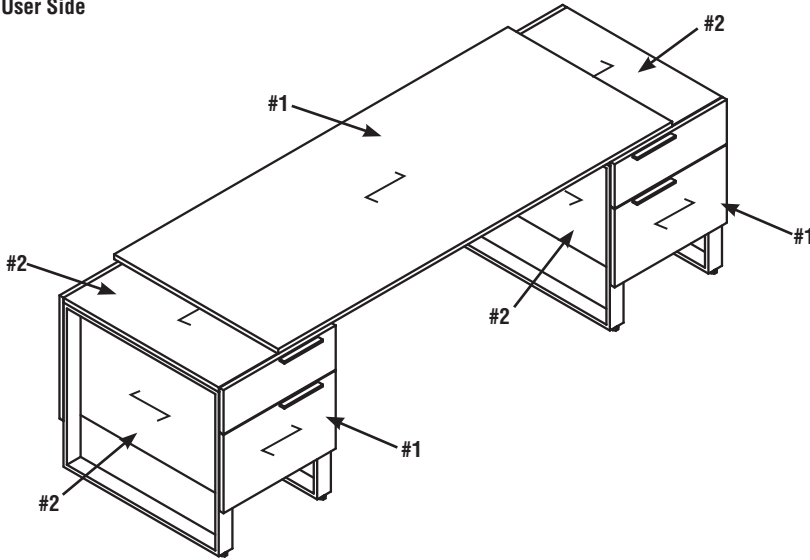

Back View

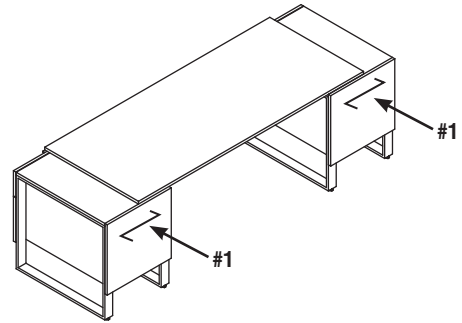

Transaction Counter and Decorative Panel

For Transaction Counter and Decorative Panel only one finish can be specified.

User Side

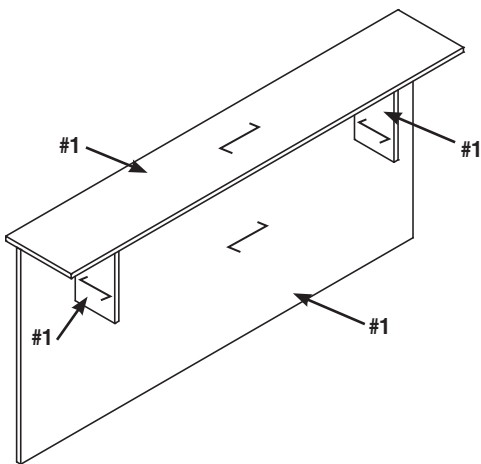

Back View

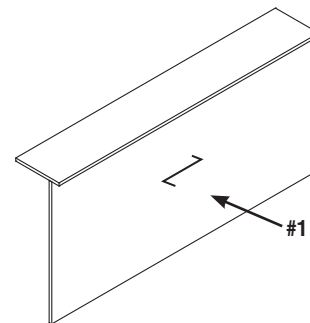

Modular Pedestals

For Modular Pedestals two finishes can be specified. The first finish in the product string, indicated as #1. The second finish in the product string indicated as #2. If only one finish is indicated, the entire unit will be monotone.

Note:

Horizontal grain direction is standard on all engineered finishes. If natural veneer is required, the grain direction will be vertical. Arrow indicates direction of grain.

User Side

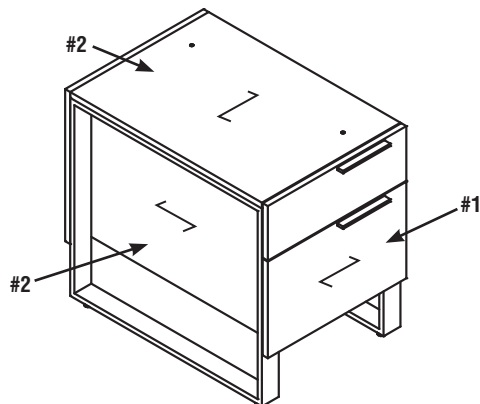

Back View

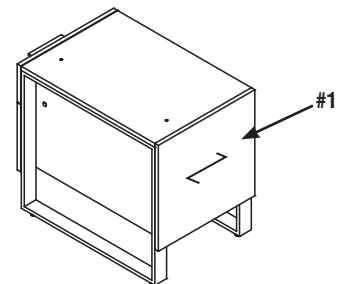

Lateral Files

For Lateral Files two finishes can be specified. The first finish in the product string, indicated as #1. The second finish in the product string indicated as #2. If only one finish is indicated, the entire unit will be monotone.

User Side

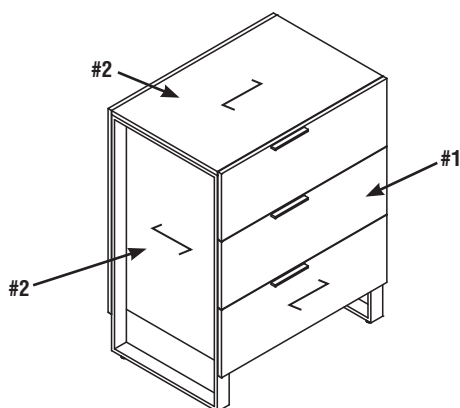

Back View

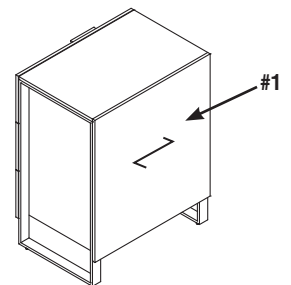

Mobile pedestals

For Mobile Pedestals two finishes can be specified.
 The first finish in the product string, indicated as **#1**.
 The second finish in the product string indicated as **#2**.
 If only one finish is indicated, the entire unit will be monotone.

Note:

Horizontal grain direction is standard on all engineered finishes.
 If natural veneer is required, the grain direction will be vertical.
 Arrow indicates direction of grain.

User Side

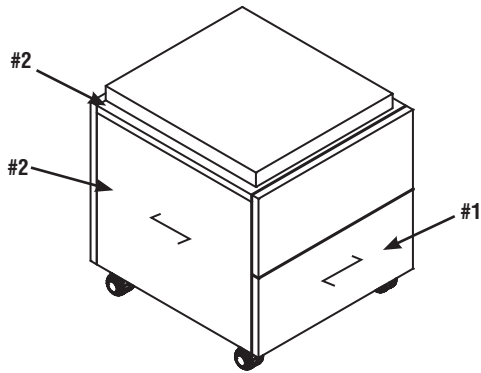

Back View

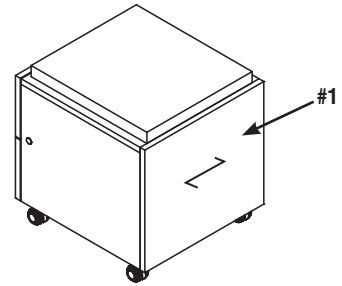

Benches

For Benches two finishes can be specified.
 The first finish in the product string, indicated as **#1**.
 The second finish in the product string indicated as **#2**.
 If only one finish is indicated, the entire unit will be monotone.

User Side

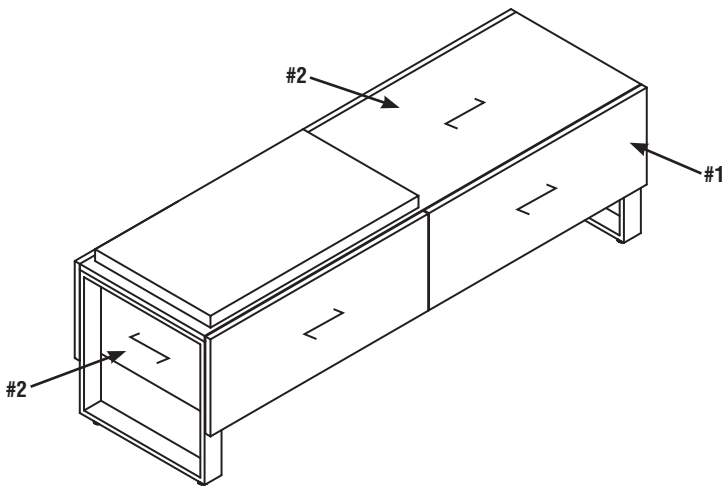

Back View

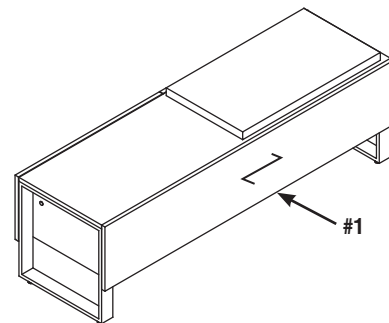

Credenzas

For Credenzas two finishes can be specified.
 The first finish in the product string, indicated as #1.
 The second finish in the product string indicated as #2.
 If only one finish is indicated, the entire unit will be monotone.

Note:

Horizontal grain direction is standard on all engineered finishes.
 If natural veneer is required, the grain direction will be vertical.
 Arrow indicates direction of grain.

User Side

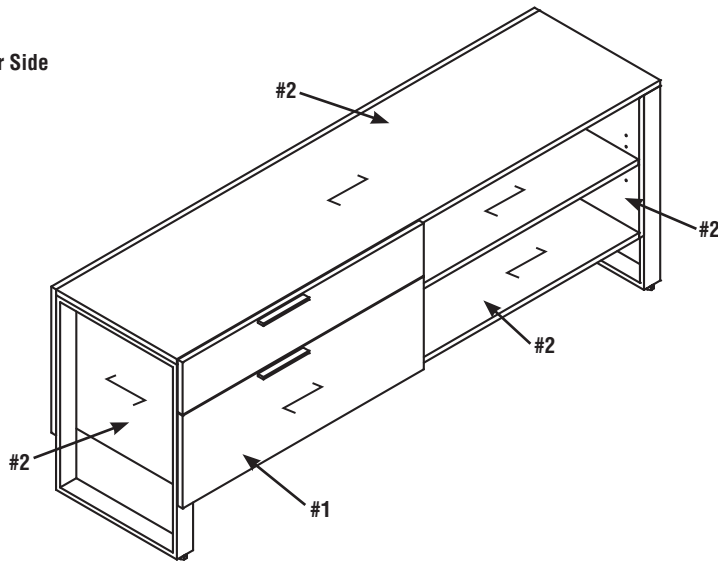

Back View

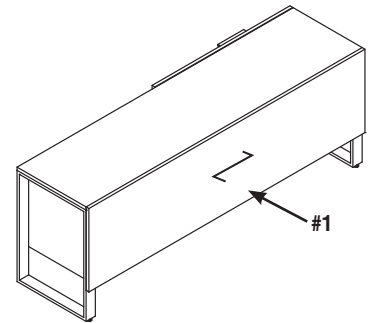

Modular Tops

For Modular Tops only one finish can be specified.

Isometric View

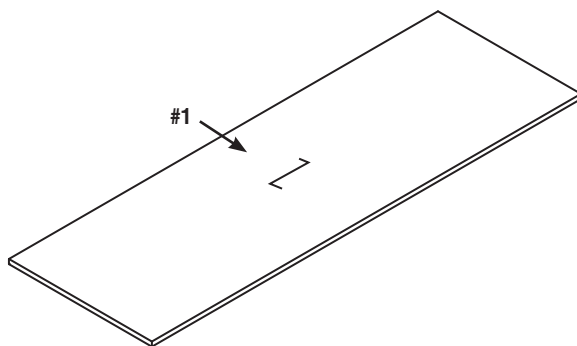

End View



Wall Mounted Overheads

For Wall Mounted Overheads two finishes can be specified. The first finish in the product string, indicated as **#1**. The second finish in the product string indicated as **#2**. If only one finish is indicated, the entire unit will be monotone.

Note:

Horizontal grain direction is standard on all engineered finishes. If natural veneer is required, the grain direction will be vertical. Arrow indicates direction of grain.

User Side

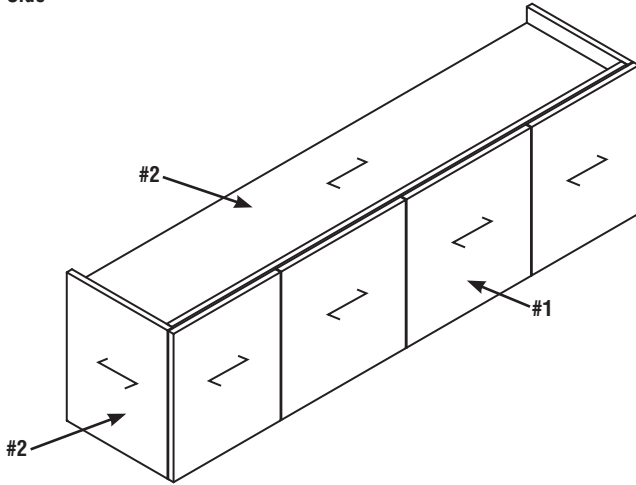

Back View

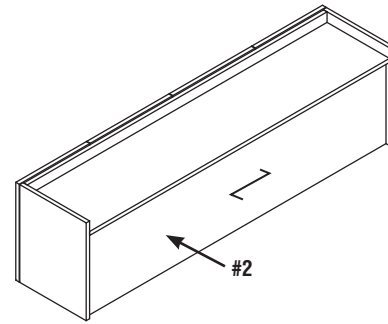

Work Wall Credenzas

For Work Wall Credenzas two finishes can be specified. The first finish in the product string, indicated as **#1**. The second finish in the product string indicated as **#2**. If only one finish is indicated, the entire unit will be monotone.

User Side

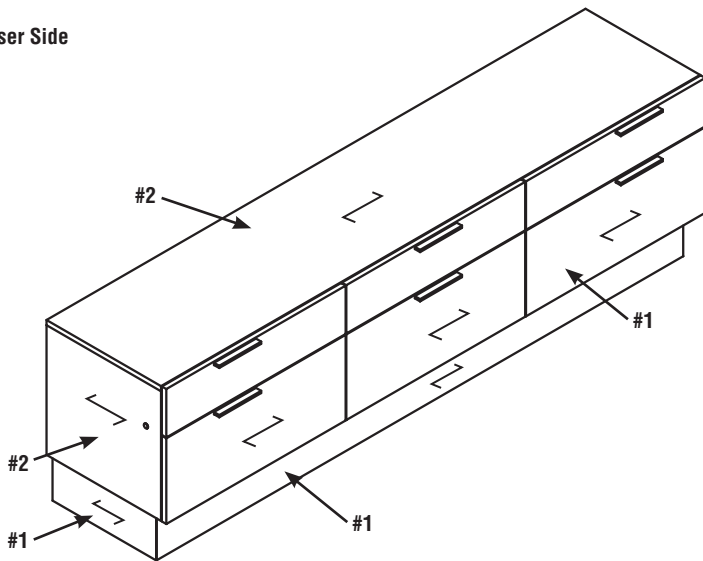

Back View

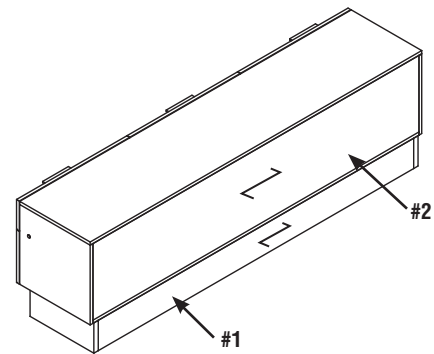

Work Walls

For Work Walls three finishes can be specified.
 The first finish in the product string, indicated as #1.
 The second finish in the product string indicated as #2.
 The third finish in the product string indicated as #3.
 If only one finish is indicated, the entire unit will be monotone.

Note:

Horizontal grain direction is standard on all engineered finishes.
 If natural veneer is required, the grain direction will be vertical.
 Arrow indicates direction of grain.

Front View

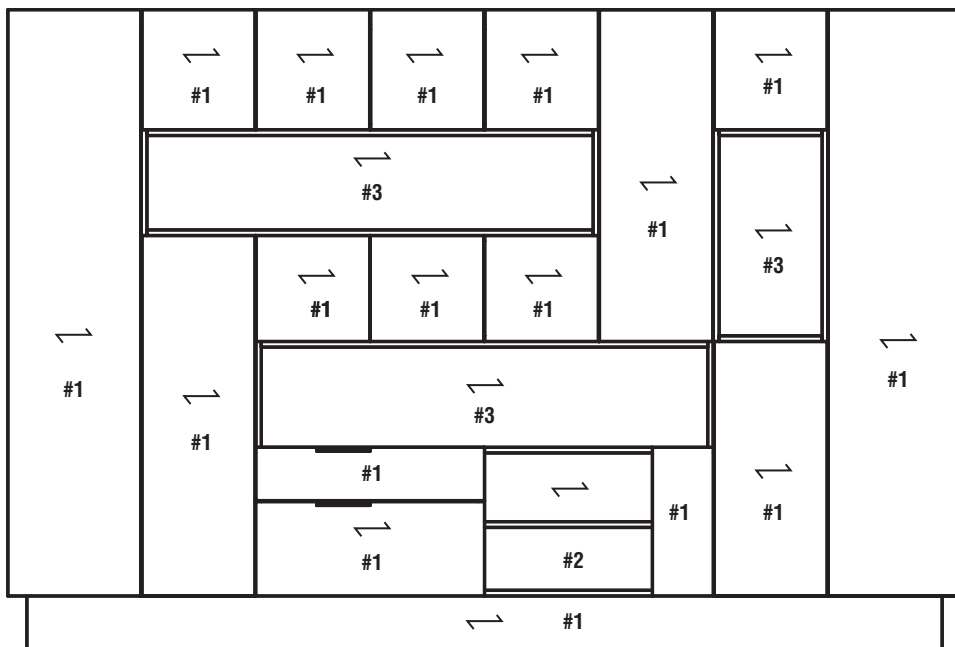

Side View



Isometric View

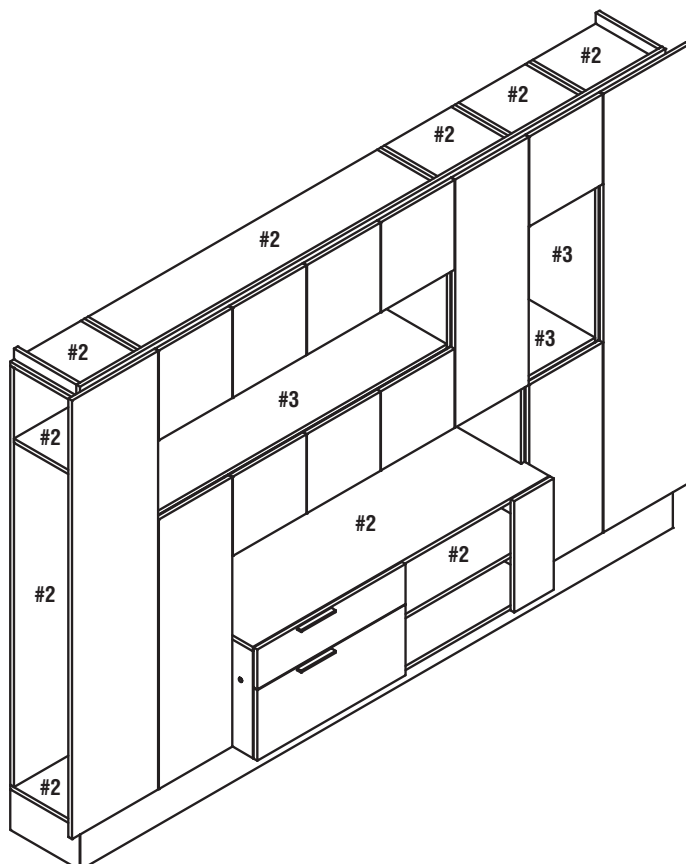

FOUNDATIONS CONFERENCE • FINISH OPTIONS

Sectional Top with two bases

For Sectional Tops two finishes can be specified.

The first finish in the product string, indicated as #1.

The second finish in the product string indicated as #2.

If only one finish is indicated, the entire Table will be monotone.

Top View

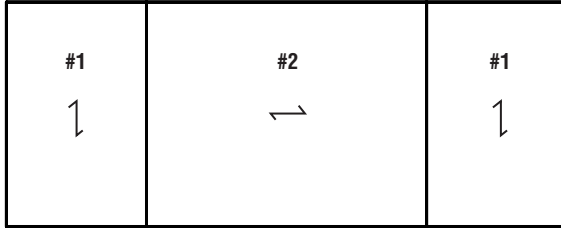

Side View

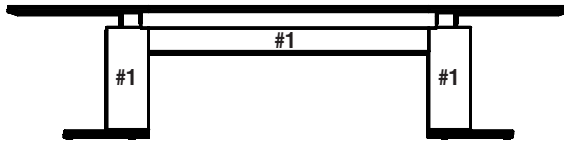

End View

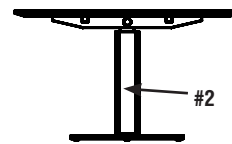

Sectional Top with Technology Trough and bases

For Sectional Tops with Technology Troughs three finishes can be specified.

The first finish in the product string, indicated as #1.

The second finish in the product string indicated as #2.

The third finish in the product string indicated as #3.

If only one finish is indicated, the entire Table will be monotone.

Top View

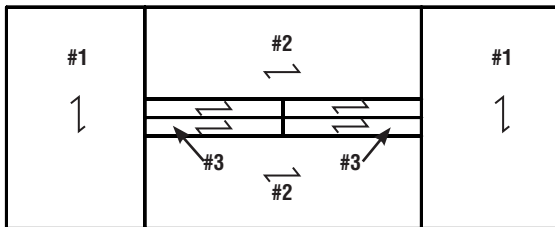

Side View

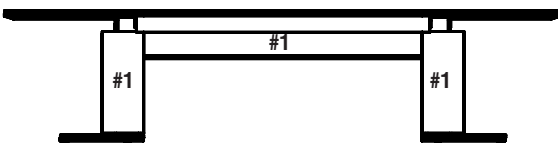

End View

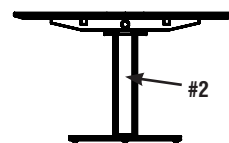

Full Storage Credenza with two sets of Storage Cabinets and Display Wall

For Storage Credenzas two finishes can be specified.
 The first finish in the product string, indicated as #1.
 The second finish in the product string indicated as #2.
 If only one finish is indicated, the entire unit will be monotone.

Note:

Horizontal grain direction is standard on all engineered finishes.
 If natural veneer is required, the grain direction will be vertical.
 Arrow indicates direction of grain.

Front View

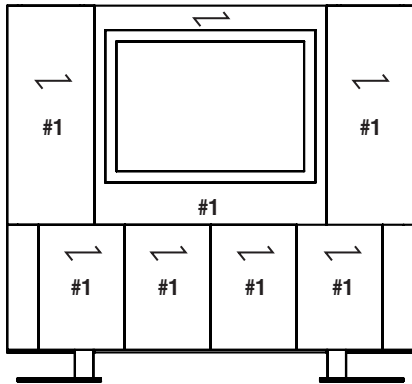

Side View

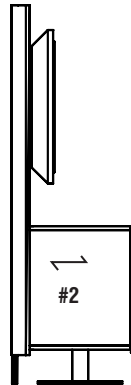

Top View

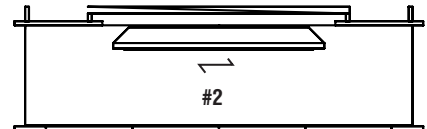

Full Storage Credenza with BBB, Storage Cabinet, BBB and Display Wall

For Storage Credenzas two finishes can be specified.
 The first finish in the product string, indicated as #1.
 The second finish in the product string indicated as #2.
 If only one finish is indicated, the entire unit will be monotone.

Front View

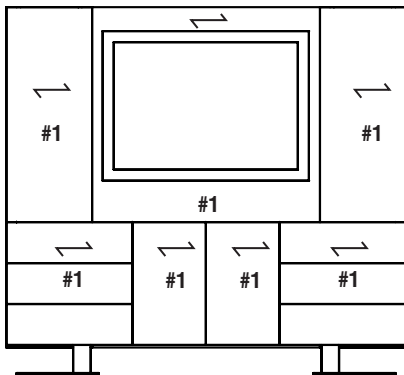

Side View



Top View

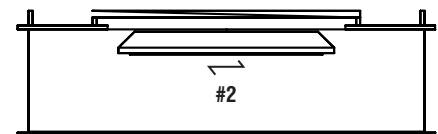

Full Storage Credenza with BB, Storage Cabinet, BB and Display Wall
 For Storage Credenzas two finishes can be specified.
 The first finish in the product string, indicated as **#1**.
 The second finish in the product string indicated as **#2**.
 If only one finish is indicated, the entire unit will be monotone.

Note:
 Horizontal grain direction is standard on all engineered finishes.
 If natural veneer is required, the grain direction will be vertical.
 Arrow indicates direction of grain.

Front View

Side View

Top View

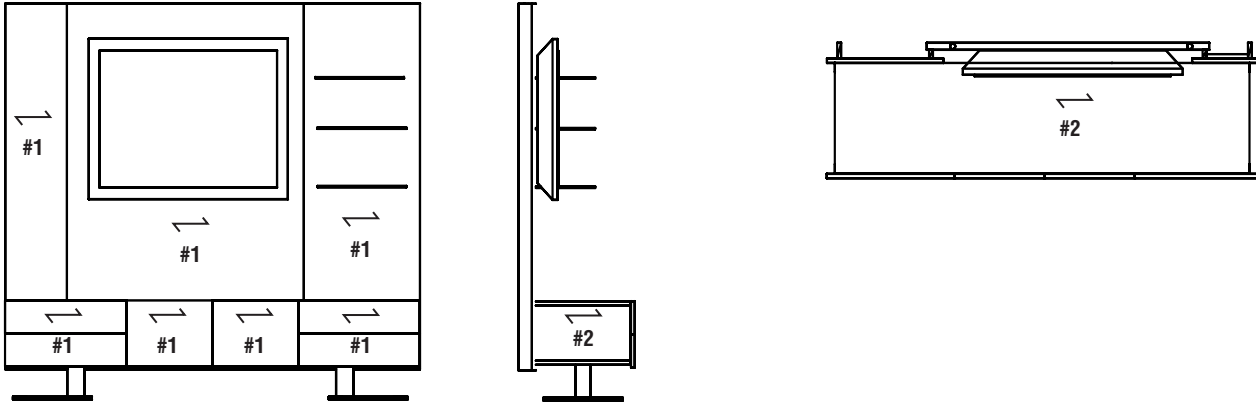

Lecturn

For Lecturn two finishes can be specified.
 The first finish in the product string, indicated as **#1**.
 The second finish in the product string indicated as **#2**.
 If only one finish is indicated, the entire unit will be monotone.

FLEC-36 Lecturn

Front View

Side View

Top View

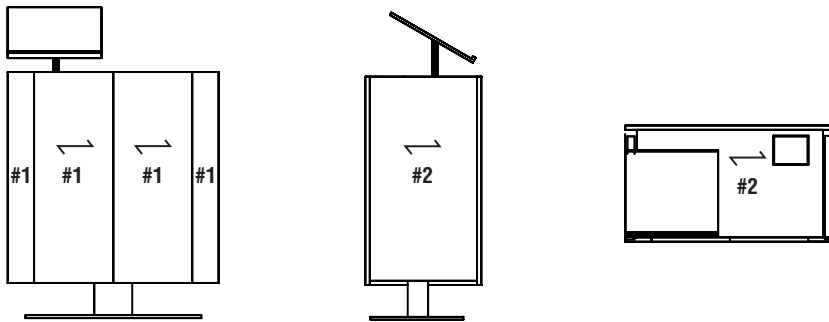

FLEC-24 Lecturn

Front View

Side View

Top View

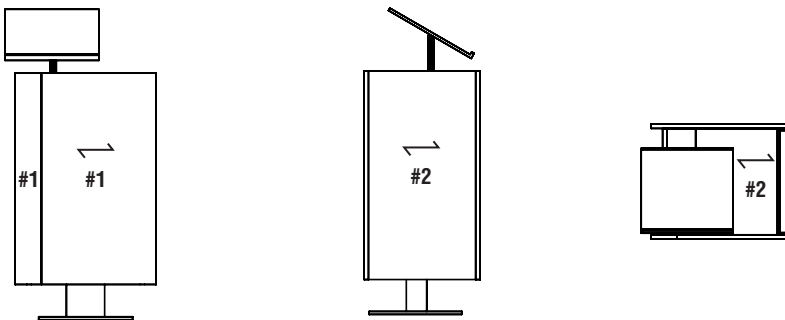

Mobile Units

For Sectional Tops two finishes can be specified.
 The first finish in the product string, indicated as #1.
 The second finish in the product string indicated as #2.
 If only one finish is indicated, the entire unit will be monotone.

Note:

Horizontal grain direction is standard on all engineered finishes.
 If natural veneer is required, the grain direction will be vertical.
 Arrow indicates direction of grain.

Mobile Lecturn

Front View

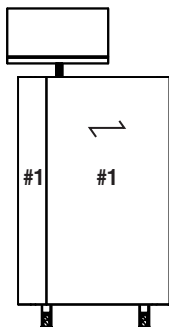

Side View

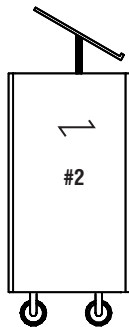

Top View

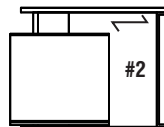

Mobile Tech Cart

Front View

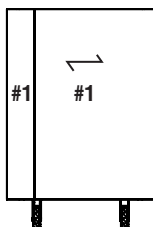

Side View

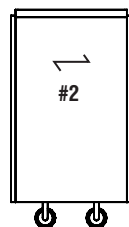

Top View

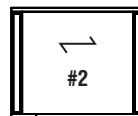

Mobile Server

Front View

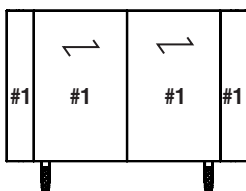

Side View

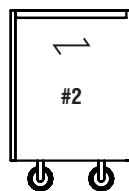

Top View

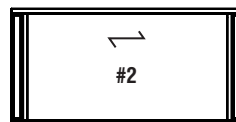

TACKBOARD FABRICS - GRADE 1

Tackboards are standard in Global Contract Grade 1 panel fabrics, please refer to the following website for the current offering

<http://www.globalcontract.com>

To find the **Panel Fabrics** choose the **Resources** tab and click on **Fabrics and Finishes**. Here you will find the different panel fabric collections to choose from, which include the different fabric patterns.

For Example:

The collection Anchorage has 23 different Fabric Patterns

Anchorage	
Birch	AN40
Green Apple	AN41
Lapis	AN42
Straw	AN43
Wolf	AN44
Goose	AN45
Angora	AN46
Cumin	AN47
Asteroid	AN48
Geranium	AN49
Thistle	AN50
Graphite	AN51
Slate	AN52
Quarry Blue	AN53
Onyx	AN54
Pumpkin	AN55
Red Delicious	AN56
Sunshine	AN57
Magenta	AN58
Waterfall	AN59
Green Olive	AN60
Vanilla	AN61
Cobalt	AN62

Casegoods F-01

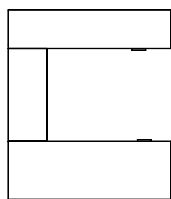
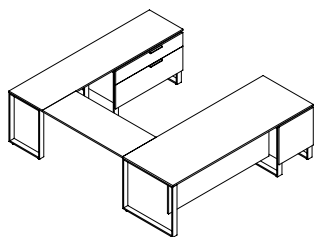

QUANTITY	CODE	DESCRIPTION	PRICE
1	FSL7830B	Single Pedestal Desk with Box/File Pedestal flush on Left	5885
1	FCMP54W	Hanging Wood Modesty Panel	1190
1	FBT4820CG	Bridge Top	1427
1	FCC40R7820H	Single Pedestal Credenza with 40" Lat.Box/File flush on Right	6189
TOTAL			\$14,691

Casegoods F-02

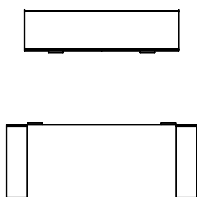
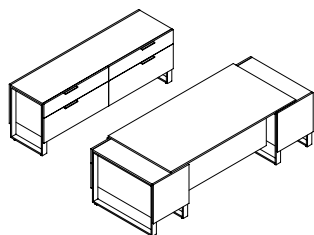

QUANTITY	CODE	DESCRIPTION	PRICE
1	FD7236BBOS	Double Pedestal Desk with Box/File Pedestal offset on Left and Right	8777
1	FCMP50W	Hanging Wood Modesty Panel	1179
1	FCC7420HH	Credenza with Lat. Box/File on Left and right	6153
TOTAL			\$16,108

Casegoods F-03

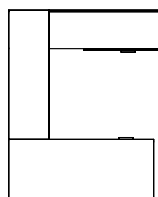
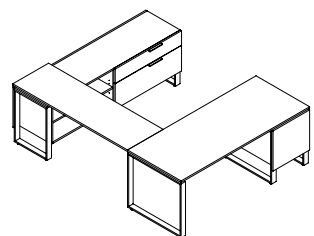

QUANTITY	CODE	DESCRIPTION	PRICE
1	FSL7230B	Single Pedestal Desk with Box/File Pedestal flush on Left	5685
1	F6420TCG	Modular Top, Cross Grain	1305
1	FCC74200H	Credenza with Open Storage on Left and Lat.Box/File flush on Right	5422
1	FCON20	Connection Bracket for Top	161
TOTAL			\$12,572

Casegoods F-04

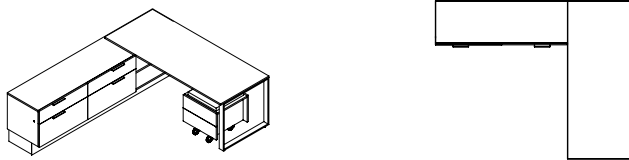

QUANTITY	CODE	DESCRIPTION	PRICE
1	FW9026-2	90" wide x 26" high Work Wall	7604
1	F7230T	Modular Top	1801
1	FLEG30	Frame Leg	840
1	F20BMCU	Mobile Box Box Pedestal with cushion	2232
TOTAL			\$12,476

Casegoods F-05

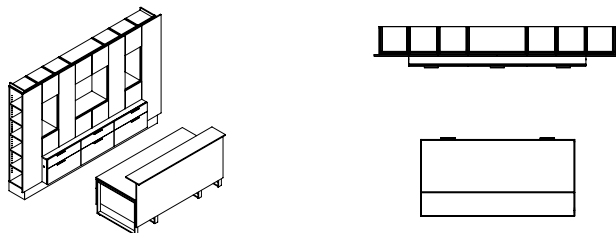

QUANTITY	CODE	DESCRIPTION	PRICE
1	FW12584-20LT	125" wide x 84" high Work Wall with LED Light	28365
1	FD7836BB	Double Pedestal Desk with Box/File Pedestal flush on Left and Right	8714
1	F GTT7812	Rectangular Transaction Counter with Decorative Panel	2727
TOTAL			\$39,806

Casegoods F-06

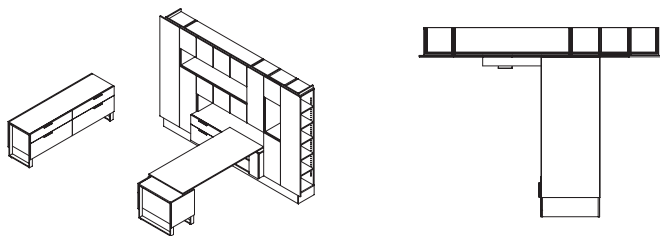

QUANTITY	CODE	DESCRIPTION	PRICE
1	FW12584-1RLT	125" wide x 84" high Work Wall with LED Light	25620
1	F7230T	Modular Top	1801
1	F2030BR	Box/File Pedestal handed Right (installed offset)	3242
1	FCC7420HH	Credenza with Lat. Box/File on Left and Right	6153
TOTAL			\$36,816

Casegoods F-07

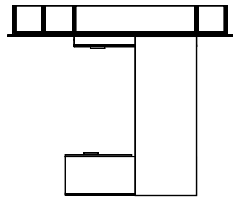
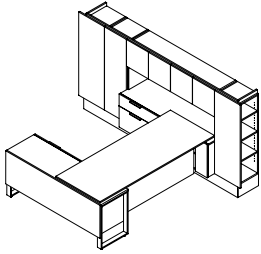

QUANTITY	CODE	DESCRIPTION	PRICE
1	FW11056-1RTBLT	110" wide x 56" high Work Wall with Tackboard and LED Light	15891
1	F7830T	Modular Top with sub top	1967
1	FCMP48W	Hanging Wood Modesty Panel	1175
1	FCC64200H	Credenza with Open Storage on Left and Lat. Box/File on Right	4770
TOTAL			\$23,802

Casegoods F-08

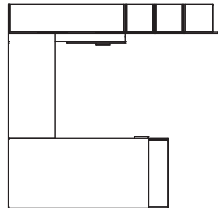
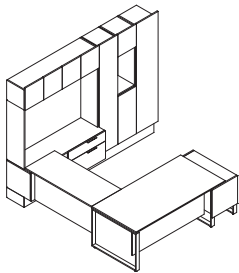

QUANTITY	CODE	DESCRIPTION	PRICE
1	FW10784L	107" wide x 84" high Work Wall	18622
1	FBT6024CG/S	Special Bridge Top	2046
1	FCMP50W	Hanging Wood Modesty Panel	1179
1	FSL7236BOS	Single Pedestal Desk with Box/File Pedestal offset on Left	6335
1	FCMP60W/S	Special Hanging Wood Modesty Panel	1211
TOTAL			\$29,394

Casegoods F-09

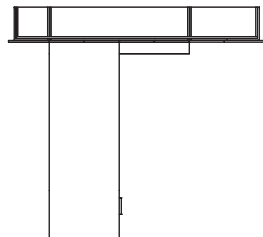
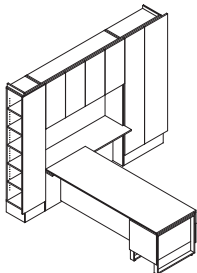

QUANTITY	CODE	DESCRIPTION	PRICE
1	FW110840W2R	110" wide x 84" high Open Knee Space Work Wall	14186
1	FQRL9030B	Special Executive Return	7536
TOTAL			\$21,724

Conference F-01

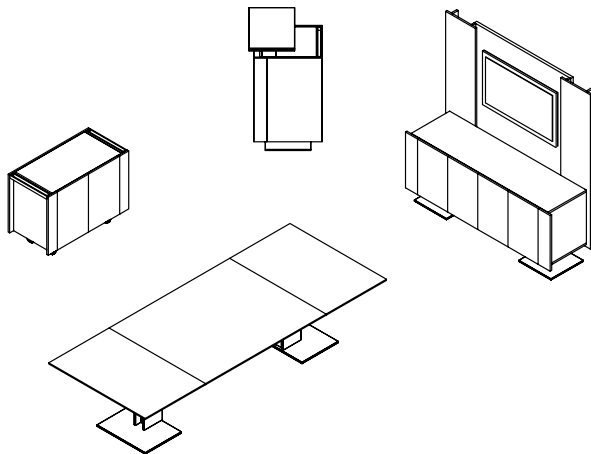

QUANTITY	CODE	DESCRIPTION	PRICE
1	FREST12048	Rectangular Shaped Sectional Conference Table	8754
1	FC7224GGTWH66	Full Storage Credenza with two sets of Storage Cabinets and Display Wall	7976
1	FLEC24	Lectern	4871
1	FSM4020	Mobile Server	3930
		TOTAL	\$25,530

Conference F-02

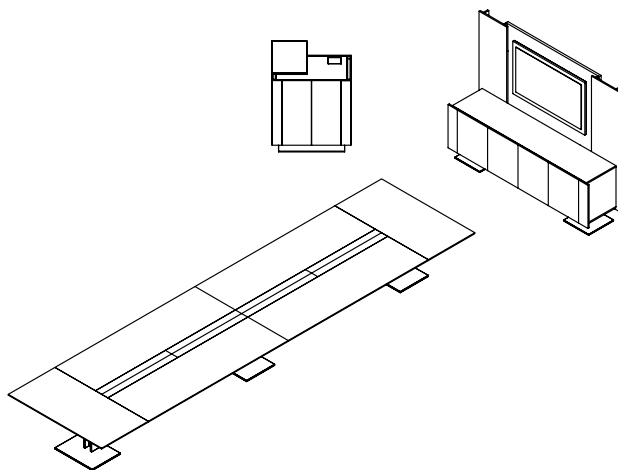

QUANTITY	CODE	DESCRIPTION	PRICE
1	FRESTCT24060	Rectangular Shaped Sectional Conference Table with 8 doors	23214
1	FC9024GGT WH72	Full Storage Credenza with two sets of Storage Cabinets and Display Wall	9560
	FLEC36	Lectern	5903
		TOTAL	\$38,677

Conference F-03

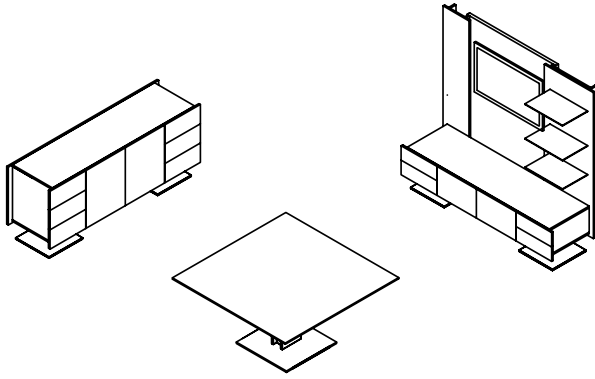

QUANTITY	CODE	DESCRIPTION	PRICE
1	FRE5454	Square Table	4628
1	FFTWA72WH66	Full Storage Credenza with BB, Storage Cabinet, BB and Display Wall	8491
1	FCD7220A	Full Storage Credenza with BBB on Left, Storage Cabinet and BBB on Right	5717
1	FBP7220	Credenza Back Panel	807
TOTAL			\$19,644

Conference F-04

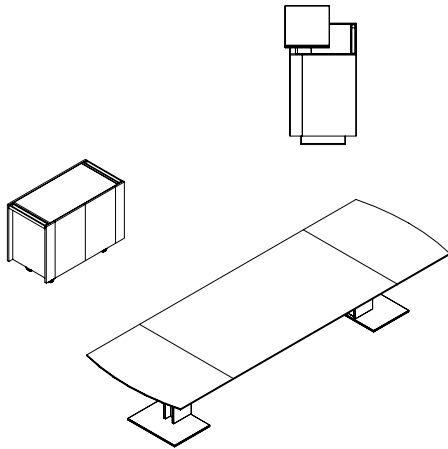

QUANTITY	CODE	DESCRIPTION	PRICE
1	FREBEST14448	Rectangular Shaped Sectional Conference Table with Bow Ends	10061
1	FSM4020	Mobile Server	3930
1	FLEC24	Lectern	4871
TOTAL			\$18,862

Conference F-05

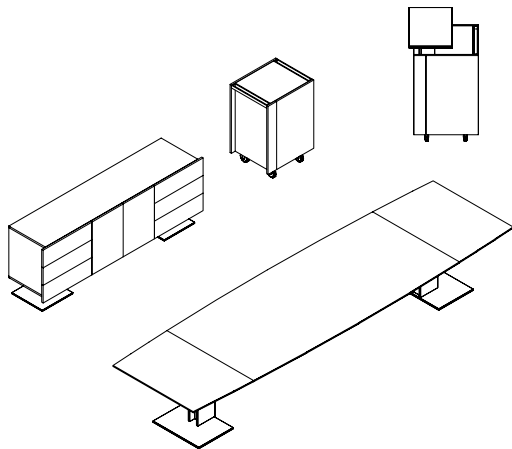

QUANTITY	CODE	DESCRIPTION	PRICE
1	FBOST16848	Boat Shaped Sectional Conference Table	11474
1	FCD8420A	Full Storage Credenza with BBB on Left, Storage Cabinet and BBB on Right	6292
1	FLEC24M	Mobile Lectern	3609
1	FTCM2020H36	Mobile Tech Cart	2455
TOTAL			\$23,830

Conference F-06

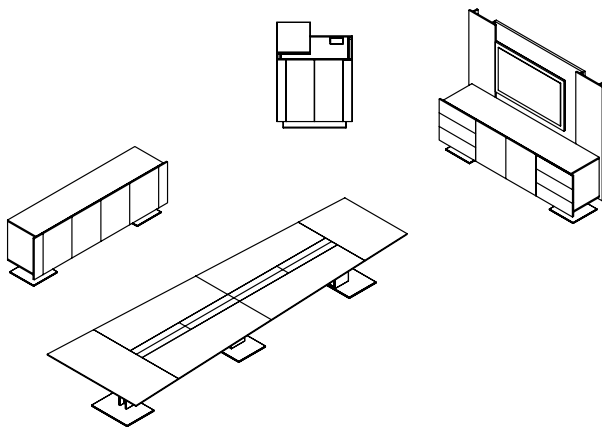

QUANTITY	CODE	DESCRIPTION	PRICE
1	FWESTCT1926048	Wedge Shaped Sectional Conference Table with 8 doors	20649
1	FCD9024ATWH72	Full Storage Credenza with BBB, Storage Cabinet, BBB and Display Wall	9706
1	FLEC36	Lectern	5903
1	FC9020GG	Full Storage Credenza with two sets of Storage Cabinets	6167
TOTAL			\$42,425

CASEGOODS DESKS • TECHNICAL INFORMATION

- Horizontal grain direction is standard on all engineered finishes. If natural veneer is required, the grain direction will be vertical - Add suffix "VG" to the end of the product code
- Tops are constructed with two 3/4" thick panels laminated together to create a total thickness of 1 1/2".
- All Pedestals are suspended 7.5" off the floor by an open framed Leg and can be installed flush or offset.
- Pedestals are handed:
 - Left pedestals have the handle offset from the centre to the right and the lock is placed on the right gable.
 - Right pedestals have the handle offset from the centre to the left and the lock is placed on the left gable.
- If a Modesty Panel is required please refer to page B.3 to choose from Modesty Panel Options (Wood or Glass).
- Grommets can be specified for Desk Tops. Please refer to page A.11

NOTE: Arrow indicates direction of grain.

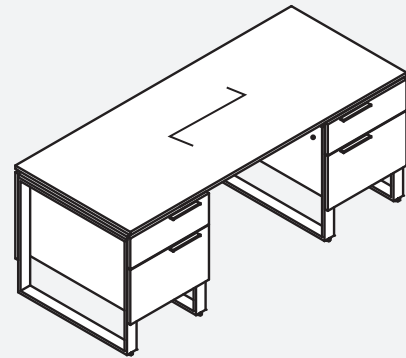

Double Pedestal Desk with Box/File installed flush.

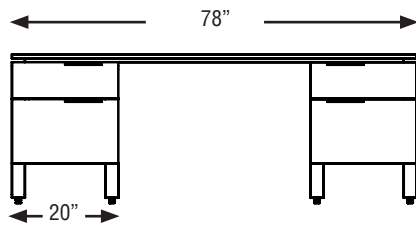

Double Pedestal Desk with Box/File installed offset. Add 20" to the overall width of the top.

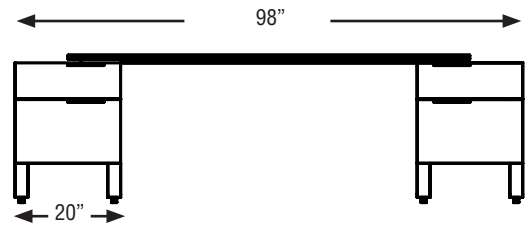

Single Pedestal Desk with Box/File installed flush.

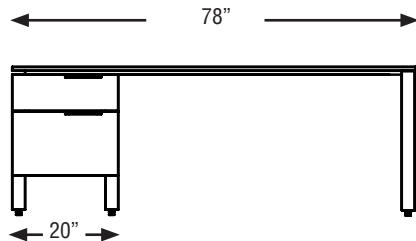

Single Pedestal Desk with Box/File installed offset. Add 10" to the overall width of the top.

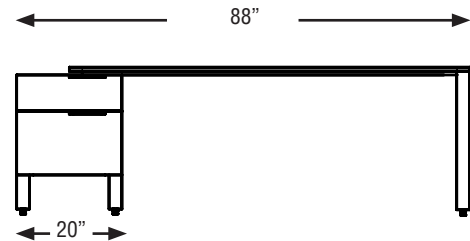

By adding a Transaction Counter Top with Decorative Front Panel (See Page B.3 Product code FGTT) to a Desk, the Desk can be used as a Reception.

User View

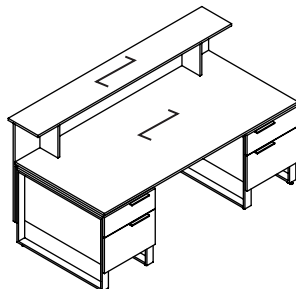

Guest View

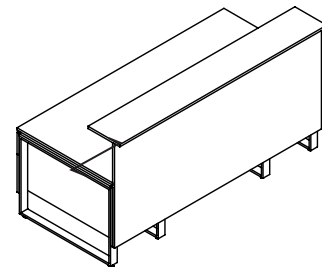

FD-BB • Double Pedestal Desk with Box/File Pedestal flush on Left and Right

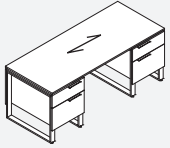

PRODUCT CODE	PRICE	SIZE (INCHES)			WEIGHT LBS	VOL FT3	<ul style="list-style-type: none"> • If Modesty Panel is required, refer to Page B.3 for pricing and choose the size indicated below. - FCMP42W or FCMP42G - FCMP36W or FCMP36G - FCMP30W or FCMP30G - FCMP42W or FCMP42G - FCMP36W or FCMP36G - FCMP30W or FCMP30G
		H	W	D			
FD8436BB	8890	28	84	36	201	15	
FD7836BB	8717	28	78	36	192	15	
FD7236BB	8498	28	72	36	177	15	
FD8430BB	8446	28	84	30	184	15	
FD7830BB	8308	28	78	30	176	15	
FD7230BB	8111	28	72	30	163	14	

FD-BBOS • Double Pedestal Desk with Box/File Pedestal offset on Left and Right

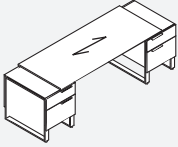

PRODUCT CODE	PRICE	SIZE (INCHES)			WEIGHT LBS	VOL FT3	<ul style="list-style-type: none"> • If Modesty Panel is required, refer to Page B.3 for pricing and choose the size indicated below. - FCMP62W or FCMP62G - FCMP56W or FCMP56G - FCMP50W or FCMP50G - FCMP62W or FCMP62G - FCMP56W or FCMP56G - FCMP50W or FCMP50G
		H	W	D			
FD8436BBOS	9169	28	104	36	201	15	
FD7836BBOS	8996	28	98	36	192	15	
FD7236BBOS	8780	28	92	36	177	15	
FD8430BBOS	8728	28	104	30	184	15	
FD7830BBOS	8588	28	98	30	176	15	
FD7230BBOS	8390	28	92	30	163	14	

FSL-B • Single Pedestal Desk with Box/File Pedestal flush on Left

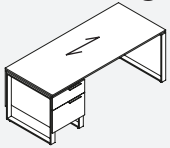

PRODUCT CODE	PRICE	SIZE (INCHES)			WEIGHT LBS	VOL FT3	<ul style="list-style-type: none"> • If Modesty Panel is required, refer to Page B.3 for pricing and choose the size indicated below. - FCMP60W or FCMP60G - FCMP54W or FCMP54G - FCMP48W or FCMP48G - FCMP60W or FCMP60G - FCMP54W or FCMP54G - FCMP48W or FCMP48G
		H	W	D			
FSL8436B	6467	28	84	36	201	15	
FSL7836B	6294	28	78	36	192	15	
FSL7236B	6056	28	72	36	177	15	
FSL8430B	6024	28	84	30	184	15	
FSL7830B	5885	28	78	30	176	15	
FSL7230B	5689	28	72	30	163	14	

FSL-BOS • Single Pedestal Desk with Box/File Pedestal offset on Left

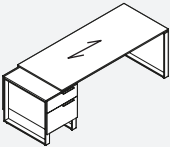

PRODUCT CODE	PRICE	SIZE (INCHES)			WEIGHT LBS	VOL FT3	<ul style="list-style-type: none"> • If Modesty Panel is required, refer to Page B.3 for pricing and choose the size indicated below. - FCMP70W or FCMP70G - FCMP64W or FCMP64G - FCMP58W or FCMP58G - FCMP70W or FCMP70G - FCMP64W or FCMP64G - FCMP58W or FCMP58G
		H	W	D			
FSL8436BOS	6747	28	94	36	201	15	
FSL7836BOS	6574	28	88	36	192	15	
FSL7236BOS	6339	28	82	36	177	15	
FSL8430BOS	6306	28	94	30	184	15	
FSL7830BOS	6166	28	88	30	176	15	
FSL7230BOS	5968	28	82	30	163	14	

FSR-B • Single Pedestal Desk with Box/File Pedestal flush on Right

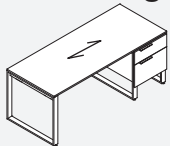

PRODUCT CODE	PRICE	SIZE (INCHES)			WEIGHT LBS	VOL FT3	<ul style="list-style-type: none"> • If Modesty Panel is required, refer to Page B.3 for pricing and choose the size indicated below. - FCMP60W or FCMP60G - FCMP54W or FCMP54G - FCMP48W or FCMP48G - FCMP60W or FCMP60G - FCMP54W or FCMP54G - FCMP48W or FCMP48G
		H	W	D			
FSR8436B	6467	28	84	36	201	15	
FSR7836B	6294	28	78	36	192	15	
FSR7236B	6056	28	72	36	177	15	
FSR8430B	6024	28	84	30	184	15	
FSR7830B	5885	28	78	30	176	15	
FSR7230B	5689	28	72	30	163	14	

FSR-BOS • Single Pedestal Desk with Box/File Pedestal offset on Right

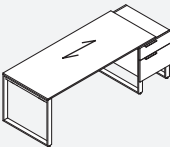

PRODUCT CODE	PRICE	SIZE (INCHES)			WEIGHT LBS	VOL FT3	<ul style="list-style-type: none"> • If Modesty Panel is required, refer to Page B.3 for pricing and choose the size indicated below. - FCMP70W or FCMP70G - FCMP64W or FCMP64G - FCMP58W or FCMP58G - FCMP70W or FCMP70G - FCMP64W or FCMP64G - FCMP58W or FCMP58G
		H	W	D			
FSR8436BOS	6747	28	94	36	201	15	
FSR7836BOS	6574	28	88	36	192	15	
FSR7236BOS	6339	28	82	36	177	15	
FSR8430BOS	6306	28	94	30	184	15	
FSR7830BOS	6166	28	88	30	176	15	
FSR7230BOS	5968	28	82	30	163	14	

FT • Desk Shell

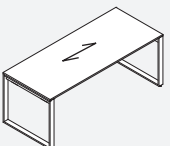

PRODUCT CODE	PRICE	SIZE (INCHES)			WEIGHT LBS	VOL FT3	<ul style="list-style-type: none"> • If Modesty Panel is required, refer to Page B.3 for pricing and choose the size indicated below. - FCMP66W or FCMP66G - FCMP60W or FCMP60G - FCMP54W or FCMP54G - FCMP66W or FCMP66G - FCMP60W or FCMP60G - FCMP54W or FCMP54G
		H	W	D			
FT7236	4264	28	72	36	94	7	
FT6636	4070	28	66	36	79	7	
FT6036	3891	28	60	36	73	7	
FT7230	3748	28	72	30	79	6	
FT6630	3600	28	66	30	74	6	
FT6030	3453	28	60	30	68	6	

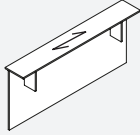
FGTT • Rectangular Transaction Counter with Decorative Panel

PRODUCT CODE	PRICE	SIZE (INCHES)			WEIGHT LBS	VOL FT3
		H	W	D		
FGTT8412	2846	42	84	12	73	21
FGTT7812	2728	42	78	12	68	19
FGTT7212	2548	42	72	12	63	18

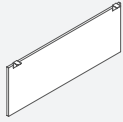
FCMP-W • Hanging Wood Modesty Panel

PRODUCT CODE	PRICE	SIZE (INCHES)			WEIGHT LBS	VOL FT3
		H	W	D		
FCMP70W	1275	18	70	0.75	25	1
FCMP64W	1234	18	64	0.75	23	1
FCMP62W	1220	18	62	0.75	22	1
FCMP60W	1216	18	60	0.75	22	1
FCMP58W	1206	18	58	0.75	21	1
FCMP56W	1197	18	56	0.75	20	1
FCMP54W	1194	18	54	0.75	20	1
FCMP50W	1181	18	50	0.75	18	1
FCMP48W	1175	18	48	0.75	18	1
FCMP42W	1096	18	42	0.75	16	1
FCMP36W	943	18	36	0.75	14	1
FCMP30W	788	18	30	0.75	12	1

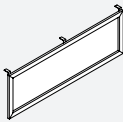
FCMP-G • Hanging Glass Modesty Panel

PRODUCT CODE	PRICE	SIZE (INCHES)			WEIGHT LBS	VOL FT3
		H	W	D		
FCMP70G	2052	18	70	0.75	20	1
FCMP64G	1939	18	64	0.75	18	1
FCMP62G	1831	18	62	0.75	17	1
FCMP60G	1770	18	60	0.75	16	1
FCMP58G	1726	18	58	0.75	15	1
FCMP56G	1711	18	56	0.75	15	1
FCMP54G	1652	18	54	0.75	14	1
FCMP50G	1606	18	50	0.75	13	1
FCMP48G	1577	18	48	0.75	13	1
FCMP42G	1564	18	42	0.75	12	1
FCMP36G	1548	18	36	0.75	11	1
FCMP30G	1533	18	30	0.75	10	1

- Aluminum Framed Glass Modesty Panel with frosted glass is standard

- For white back painted glass, please contact Customer Service for pricing

CASEGOODS SINGLE PEDESTAL CREDENZAS • TECHNICAL INFORMATION

- Horizontal grain direction is standard on all engineered finishes. If natural veneer is required, the grain direction will be vertical - Add suffix "VG" to the end of the product code
- Tops are constructed with two ¾" thick panels laminated together to create a total thickness of 1 ½".
- All Pedestals are suspended 7.5" off the floor by an open framed Leg and can be installed flush or offset.
- Pedestals are handed:
 - Left Pedestals have the handle offset from the centre to the right and the lock is placed on the left gable.
 - Right Pedestals have the handle offset from the centre to the left and the lock is placed on the right gable.
- Grommets can be specified on Credenza Tops. Please refer to page A.12

NOTE: Arrow indicates direction of grain.

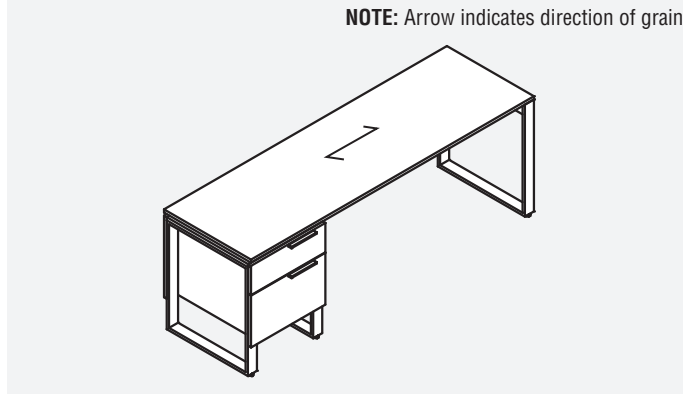

Single Pedestal Credenza with 35" Lat. Box/File installed flush

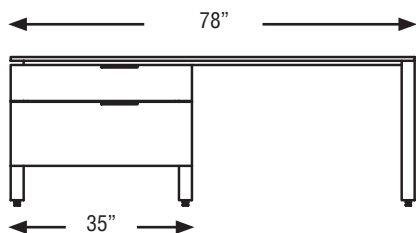

Single Pedestal Credenza with 35" Lat. Box/File installed offset Adds 10" to overall width

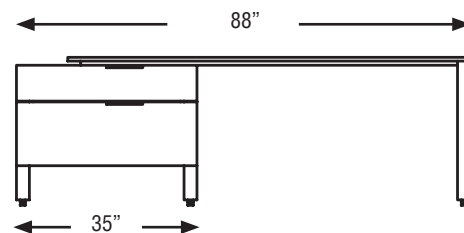

Single Pedestal Credenza with 40" Lat. Box/File installed flush.

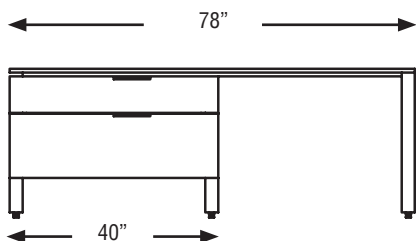

Double Pedestal Credenza with 40" Lat. Box/File installed offset. Adds 10" to overall width

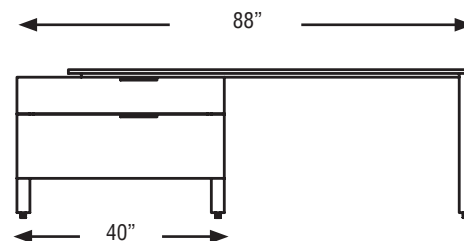

FCCL-B • Single Pedestal Credenza with Box/File Pedestal flush on Left

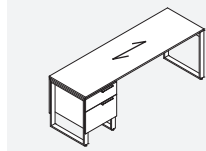

PRODUCT CODE	PRICE	SIZE (INCHES)			WEIGHT LBS	VOL FT3
		H	W	D		
FCCL7824B	5838	28	78	24	160	12
FCCL7224B	5650	28	72	24	151	12
FCCL7820B	5483	28	78	20	153	11
FCCL7220B	5309	28	72	20	144	11

FCCL-BOS • Single Pedestal Credenza with Box/File Pedestal offset on Left

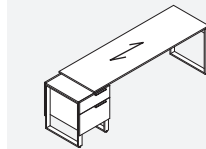

PRODUCT CODE	PRICE	SIZE (INCHES)			WEIGHT LBS	VOL FT3
		H	W	D		
FCCL7824BOS	5877	28	88	24	160	12
FCCL7224BOS	5689	28	82	24	151	12
FCCL7820BOS	5519	28	88	20	153	11
FCCL7220BOS	5346	28	82	20	144	11

FCCR-B • Single Pedestal Credenza with Box/File Pedestal flush on Right

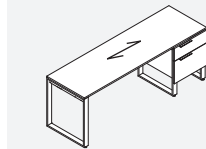

PRODUCT CODE	PRICE	SIZE (INCHES)			WEIGHT LBS	VOL FT3
		H	W	D		
FCCR7824B	5838	28	78	24	160	12
FCCR7224B	5650	28	72	24	151	12
FCCR7820B	5483	28	78	20	153	11
FCCR7220B	5309	28	72	20	144	11

FCCR-BOS • Single Pedestal Credenza with Box/File Pedestal offset on Right

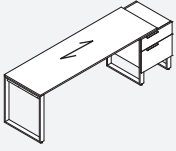

PRODUCT CODE	PRICE	SIZE (INCHES)			WEIGHT LBS	VOL FT3
		H	W	D		
FCCR7824BOS	5877	28	88	24	160	12
FCCR7224BOS	5689	28	82	24	151	12
FCCR7820BOS	5519	28	88	20	153	11
FCCR7220BOS	5346	28	82	20	144	11

FCC35L-H • Single Pedestal Credenza with 35" Lat. Box/File flush on Left

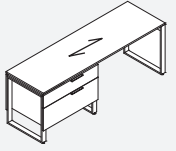

PRODUCT CODE	PRICE	SIZE (INCHES)			WEIGHT LBS	VOL FT3
		H	W	D		
FCC35L7824H	6297	28	78	24	188	18
FCC35L7224H	6109	28	72	24	179	18
FCC35L7820H	5910	28	78	20	179	15
FCC35L7220H	5735	28	72	20	170	15

FCC35L-HOS • Single Pedestal Credenza with 35" Lat. Box/File offset on Left

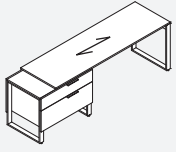

PRODUCT CODE	PRICE	SIZE (INCHES)			WEIGHT LBS	VOL FT3
		H	W	D		
FCC35L7824HOS	6550	28	88	24	188	18
FCC35L7224HOS	6363	28	82	24	179	18
FCC35L7820HOS	6162	28	88	20	179	15
FCC35L7220HOS	5988	28	82	20	170	15

FCC35R-H • Single Pedestal Credenza with 35" Lat. Box/File flush on Right

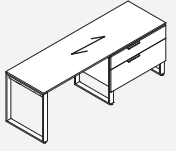

PRODUCT CODE	PRICE	SIZE (INCHES)			WEIGHT LBS	VOL FT3
		H	W	D		
FCC35R7824H	6297	28	78	24	188	18
FCC35R7224H	6109	28	72	24	179	18
FCC35R7820H	5910	28	78	20	179	15
FCC35R7220H	5735	28	72	20	170	15

FCC35R-HOS • Single Pedestal Credenza with 35" Lat. Box/File offset on Right

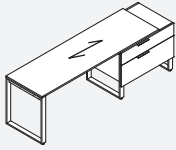

PRODUCT CODE	PRICE	SIZE (INCHES)			WEIGHT LBS	VOL FT3
		H	W	D		
FCC35R7824HOS	6550	28	88	24	188	18
FCC35R7224HOS	6363	28	82	24	179	18
FCC35R7820HOS	6162	28	88	20	179	15
FCC35R7220HOS	5988	28	82	20	170	15

FCC40L-H • Single Pedestal Credenza with 40" Lat. Box/File flush on Left

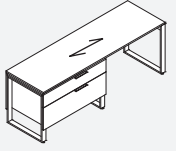

PRODUCT CODE	PRICE	SIZE (INCHES)			WEIGHT LBS	VOL FT3
		H	W	D		
FCC40L7824H	6516	28	78	24	198	20
FCC40L7224H	6328	28	72	24	189	20
FCC40L7820H	6190	28	78	20	188	17
FCC40L7220H	6017	28	72	20	179	17

FCC40L-HOS • Single Pedestal Credenza with 40" Lat. Box/File offset on Left

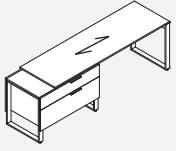

PRODUCT CODE	PRICE	SIZE (INCHES)			WEIGHT LBS	VOL FT3
		H	W	D		
FCC40L7824HOS	6770	28	88	24	198	20
FCC40L7224HOS	6582	28	82	24	189	20
FCC40L7820HOS	6443	28	88	20	188	17
FCC40L7220HOS	6267	28	82	20	179	17

FCC40R-H • Single Pedestal Credenza with 40" Lat. Box/File flush on Right

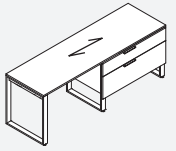

PRODUCT CODE	PRICE	SIZE (INCHES)			WEIGHT LBS	VOL FT3
		H	W	D		
FCC40R7824H	6516	28	78	24	198	20
FCC40R7224H	6328	28	72	24	189	20
FCC40R7820H	6190	28	78	20	188	17
FCC40R7220H	6017	28	72	20	179	17

FCC40R-HOS • Single Pedestal Credenza with 40" Lat. File Box/File offset on Right

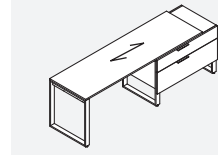

PRODUCT CODE	PRICE	SIZE (INCHES)			WEIGHT LBS	VOL FT ³
		H	W	D		
FCC40R7824HOS	6770	28	88	24	198	20
FCC40R7224HOS	6582	28	82	24	189	20
FCC40R7820HOS	6443	28	88	20	188	17
FCC40R7220HOS	6267	28	82	20	179	17

CASEGOODS FULL STORAGE CREDENZAS • TECHNICAL INFORMATION

- Horizontal grain direction is standard on all engineered finishes. If natural veneer is required, the grain direction will be vertical - Add suffix "VG" to the end of the product code
- Tops are ¾" thick with flat edge.
- All Pedestals are suspended 7.5" off the floor by an open framed Leg and can be installed flush or offset.
- Handles are standard on all drawer fronts.
- Doors will open with touch latch.
- Units placed on the Left have handles offset from centre to the left and the lock is placed on left side panel.
- Units placed on the Right have handles offset from centre to the right and the lock is placed on right side panel.

NOTE: Arrow indicates direction

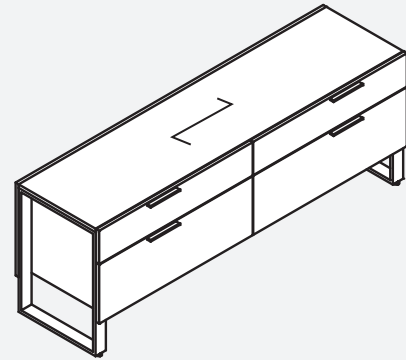
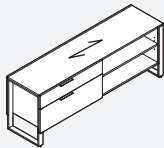
**FCC-HO • Credenza with Lat. Box/File on Left and Open Storage on Right**

PRODUCT CODE	PRICE	SIZE (INCHES)			WEIGHT LBS	VOL FT3
		H	W	D		
FCC7424HO	5692	26.75	74.5	24	203	29
FCC6424HO	5018	26.75	64.5	24	186	25
FCC7420HO	5422	26.75	74.5	20	187	24
FCC6420HO	4771	26.75	64.5	20	171	21

- Handle and Lock on Left

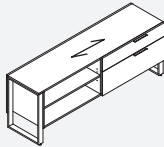
FCC-OH • Credenza with Open Storage on Left and Lat. Box/File on Right

PRODUCT CODE	PRICE	SIZE (INCHES)			WEIGHT LBS	VOL FT3
		H	W	D		
FCC7424OH	5692	26.75	74.5	24	203	29
FCC6424OH	5018	26.75	64.5	24	186	25
FCC7420OH	5422	26.75	74.5	20	187	24
FCC6420OH	4771	26.75	64.5	20	171	21

- Handle and Lock on Right

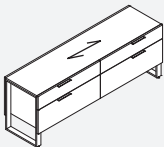
FCC-HH • Credenza with Lat. Box/File on Left and Right

PRODUCT CODE	PRICE	SIZE (INCHES)			WEIGHT LBS	VOL FT3
		H	W	D		
FCC7424HH	6460	26.75	74.5	24	265	29
FCC6424HH	5661	26.75	64.5	24	238	25
FCC7420HH	6153	26.75	74.5	20	251	24
FCC6420HH	5393	26.75	64.5	20	226	21

- Handle and Lock on Left and Right

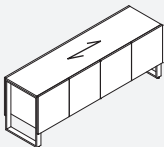
FCC-XX • Credenza with 4 Doors and Adj. Shelves

PRODUCT CODE	PRICE	SIZE (INCHES)			WEIGHT LBS	VOL FT3
		H	W	D		
FCC7424GG	5652	26.75	74.5	24	171	29
FCC6424MM	5124	26.75	64.5	24	152	25
FCC7420GG	5195	26.75	74.5	20	153	24
FCC6420MM	4711	26.75	64.5	20	136	21

FCC-X • Credenza with 2 Doors and Adj. Shelves

PRODUCT CODE	PRICE	SIZE (INCHES)			WEIGHT LBS	VOL FT3
		H	W	D		
FCC3624G	3534	26.75	36	24	86	15
FCC3024M	2946	26.75	30	24	76	13
FCC3620G	3159	26.75	36	20	77	12
FCC3020M	2634	26.75	30	20	68	11

CASEGOODS MODULAR STORAGE • TECHNICAL INFORMATION

- Horizontal grain direction is standard on all engineered finishes. If natural veneer is required, the grain direction will be vertical - Add suffix "VG" to the end of the product code
- All Pedestals are suspended 7.5" off the floor by an open framed Leg and can be installed flush or offset.
- Pedestals are handed:
 - Left Pedestals have the handle offset from the centre to the right and the lock is placed on the right gable.
 - Right Pedestals have the handle offset from the centre to the left and the lock is placed on the left gable.
- All Modular Pedestals have pre drilled holes on the top for easy connection to a work surface.
- You may customize a Desks or Credenzas by using Modular Storage.

NOTE: Arrow indicates direction of grain.

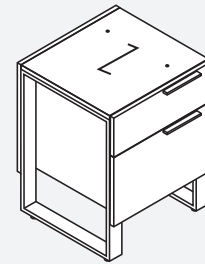

F-BL • Box/File Pedestal handed Left

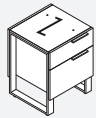

PRODUCT CODE	PRICE	SIZE (INCHES)			WEIGHT LBS	VOL FT ³
		H	W	D		
F2036BL	3404	26.75	20.5	36	103	12
F2030BL	3242	26.75	20.5	30	90	10
F2024BL	3055	26.75	20.5	24	83	8
F2020BL	2908	26.75	20.5	20	78	7

- Used on Desks and Credenzas

F-BR • Box/File Pedestal handed Right

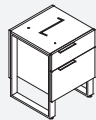

PRODUCT CODE	PRICE	SIZE (INCHES)			WEIGHT LBS	VOL FT ³
		H	W	D		
F2036BR	3404	26.75	20.5	36	103	12
F2030BR	3242	26.75	20.5	30	90	10
F2024BR	3055	26.75	20.5	24	83	8
F2020BR	2908	26.75	20.5	20	78	7

- Used on Desks and Credenzas

F-HL • Lat. Box/File Pedestal handed Left

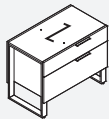

PRODUCT CODE	PRICE	SIZE (INCHES)			WEIGHT LBS	VOL FT ³
		H	W	D		
F4024HL	4002	26.75	40	24	121	16
F3524HL	3782	26.75	35	24	111	14
F4020HL	3879	26.75	40	20	113	13
F3520HL	3600	26.75	35	20	104	11

- Used on Credenzas

F-HR • Lat. Box/File Pedestal handed Right

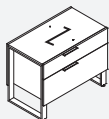

PRODUCT CODE	PRICE	SIZE (INCHES)			WEIGHT LBS	VOL FT ³
		H	W	D		
F4024HR	4002	26.75	40	24	121	16
F3524HR	3782	26.75	35	24	111	14
F4020HR	3879	26.75	40	20	113	13
F3520HR	3600	26.75	35	20	104	11

- Used on Credenzas

FLEG • Frame Leg

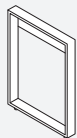

PRODUCT CODE	PRICE	SIZE (INCHES)			WEIGHT LBS	VOL FT ³
		H	W	D		
FLEG36	919	27.5	36	2.5	6	3
FLEG30	842	27.5	30	2.5	6	3
FLEG24	777	27.5	24	2.5	5	2
FLEG20	713	27.5	20	2.5	5	2

FCON • Top Connecting Bracket

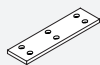

PRODUCT CODE	PRICE	SIZE (INCHES)			WEIGHT LBS	VOL FT ³
		H	W	D		
FCON36	195	0.75	10	31	4	1
FCON30	180	0.75	10	25	4	1
FCON24	175	0.75	10	19	3	1
FCON20	160	0.75	10	15	3	1

F-T • Modular Top

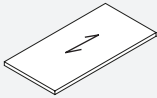

PRODUCT CODE	PRICE	SIZE (INCHES)			WEIGHT LBS	VOL FT3
		H	W	D		
F8436T	2522	1.5	84	36	95	3
F7836T	2349	1.5	78	36	88	3
F7236T	2166	1.5	72	36	82	3
F8430T	2112	1.5	84	30	80	3
F7830T	1971	1.5	78	30	73	3
F7230T	1804	1.5	72	30	67	2
F6630T	1669	1.5	66	30	62	2
F6030T	1523	1.5	60	30	56	2
F5430T	1377	1.5	54	30	51	2
F8424T	1874	1.5	84	24	67	2
F7824T	1743	1.5	78	24	62	2
F7424T	1654	1.5	74	24	58	2
F7224T	1555	1.5	72	24	53	2
F6624T	1496	1.5	66	24	51	2
F6424T	1404	1.5	64	24	49	2
F6024T	1311	1.5	60	24	47	2
F5424T	1218	1.5	54	24	42	2
F4824T	1124	1.5	48	24	38	1
F4224T	984	1.5	42	24	34	1
F8420T	1729	1.5	84	20	64	2
F7820T	1603	1.5	78	20	60	2
F7420T	1523	1.5	74	20	56	2
F7220T	1428	1.5	72	20	51	2
F6620T	1384	1.5	66	20	49	2
F6420T	1306	1.5	64	20	47	2
F6020T	1213	1.5	60	20	45	2
F5420T	1120	1.5	54	20	40	1
F4820T	1031	1.5	48	20	36	1
F4220T	902	1.5	42	20	31	1

- 3/4" Top with flat edge
- 3/4" Sub top inset 2 1/2" all around
- For Cross Grain veneer pattern add "CG" to the end of the product code
- When connecting two tops together a connecting bracket must be specified. Use the width of the smallest top to determine the correct bracket size (E.g. for a 20" deep top order FCON20)
- If optional grommet is required refer to Page A.11 for grommet location

CASEGOODS FREESTANDING STORAGE • TECHNICAL INFORMATION

- Horizontal grain direction is standard on all engineered finishes. If natural veneer is required, the grain direction will be vertical - Add suffix "VG" to the end of the product code
- All Pedestals are suspended 7.5" off the floor by an open framed Leg and can be installed flush or offset.
- Left Pedestals have the handle offset from the centre to the right and the lock is placed on the right gable.
- Right Pedestals have the handle offset from the centre to the left and the lock is placed on the left gable.
- Bench drawers do not come with a handle. They open by pulling the bottom edge of the drawer.
- Cushions will be field installed. On double width benches the cushion can either be installed left or right.
- On Mobile Pedestals, the lock will be placed on the right gable.

NOTE: Arrow indicates direction of grain.

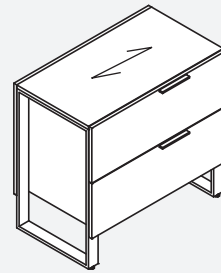
**FN-L • Left Freestanding 2H Lat. File Pedestal**

PRODUCT CODE	PRICE	SIZE (INCHES)			WEIGHT LBS	VOL FT3
		H	W	D		
FN3524L	4152	32	35	24	152	17
FN3520L	3953	32	35	20	144	15

FN-R • Right Freestanding 2H Lat. File Pedestal

PRODUCT CODE	PRICE	SIZE (INCHES)			WEIGHT LBS	VOL FT3
		H	W	D		
FN3524R	4152	32	35	24	152	17
FN3520R	3953	32	35	20	144	15

FN-3L • Left Freestanding 3H Lat. File Pedestal

PRODUCT CODE	PRICE	SIZE (INCHES)			WEIGHT LBS	VOL FT3
		H	W	D		
FN35243L	5286	44.5	35	24	220	22
FN35203L	5053	44.5	35	20	212	19

FN-3R • Right Freestanding 3H Lat. File Pedestal

PRODUCT CODE	PRICE	SIZE (INCHES)			WEIGHT LBS	VOL FT3
		H	W	D		
FN35243R	5286	44.5	35	24	220	22
FN35203R	5053	44.5	35	20	212	19

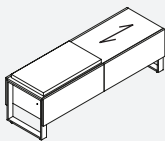
FBENKK • Bench with two File Drawers and Cushion

PRODUCT CODE	PRICE	SIZE (INCHES)			WEIGHT LBS	VOL FT3
		H	W	D		
FBENKK6420	4530	21	64.5	20	167	17

- Note: Seating Fabric Grade 2 is standard. Please visit: www.globalfurnituregroup.com Find your fabric selection under Resources - Fabrics & Finishes
- Lock on Left and Right

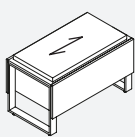
FBENK • Bench with one File Drawer and Cushion

PRODUCT CODE	PRICE	SIZE (INCHES)			WEIGHT LBS	VOL FT3
		H	W	D		
FBENK3520	3288	21	35	20	99	9

- Note: Seating Fabric Grade 2 is standard. Please visit: www.globalfurnituregroup.com Find your fabric selection under Resources - Fabrics & Finishes
- Lock on Right

F-BMCU • Mobile Box/Box Pedestal with cushion

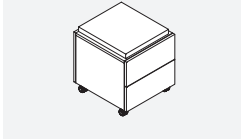

PRODUCT CODE	PRICE	SIZE (INCHES)			WEIGHT LBS	VOL FT3
		H	W	D		
F20BMCU	2233	20.5	20.5	20	87	5

- Note: Seating Fabric Grade 2 is standard. Please visit: www.globalfurnituregroup.com Find your fabric selection under Resources - Fabrics & Finishes
- Lock on Right
- Casters are locking

CASEGOODS RETURNS • TECHNICAL INFORMATION

- Horizontal grain direction is standard on all engineered finishes. If natural veneer is required, the grain direction will be vertical - Add suffix "VG" to the end of the product code
- Tops are constructed with two ¾" thick panels laminated together to create a total thickness of 1 ½".
- Returns can be connected to Wall Credenzas and Single Pedestal Desks
- All Pedestals are suspended 7.5" off the floor by an open framed Leg and can be installed flush or offset.
- Pedestals are handed:
 - Left Pedestals have the handle offset from the centre to the right and the lock is placed on the left gable.
 - Right Pedestals have the handle offset from the centre to the left and the lock is placed on the right gable.
- To Remove Cross Grain veneer pattern on Top, delete suffix "CG" from the Product Number Code (Available at no upcharge).
- One Connecting Bracket is included

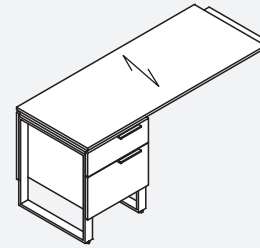
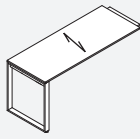
NOTE: Arrow indicates direction of grain.**FERL-CG • Left Executive Return**

PRODUCT CODE	PRICE	SIZE (INCHES)			WEIGHT LBS	VOL FT3
		H	W	D		
FERL6624CG	2799	28	66	24	59	4
FERL6024CG	2610	28	60	24	55	4
FERL5424CG	2464	28	54	24	50	4
FERL4824CG	2368	28	48	24	46	3
FERL4224CG	1949	28	42	24	42	3
FERL6620CG	2545	28	66	20	57	4
FERL6020CG	2373	28	60	20	53	4
FERL5420CG	2242	28	54	20	48	3
FERL4820CG	2154	28	48	20	44	3
FERL4220CG	1770	28	42	20	39	3

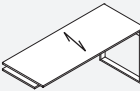
FERR-CG • Right Executive Return

PRODUCT CODE	PRICE	SIZE (INCHES)			WEIGHT LBS	VOL FT3
		H	W	D		
FERR6624CG	2799	28	66	24	59	4
FERR6024CG	2610	28	60	24	55	4
FERR5424CG	2464	28	54	24	50	4
FERR4824CG	2368	28	48	24	46	3
FERR4224CG	1949	28	42	24	42	3
FERR6620CG	2545	28	66	20	57	4
FERR6020CG	2373	28	60	20	53	4
FERR5420CG	2242	28	54	20	48	3
FERR4820CG	2154	28	48	20	44	3
FERR4220CG	1770	28	42	20	39	3

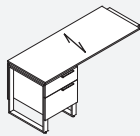
FERL-BCG • Left Executive Return with Box File Pedestal flush

PRODUCT CODE	PRICE	SIZE (INCHES)			WEIGHT LBS	VOL FT3
		H	W	D		
FERL6624BCG	4670	28	66	24	137	10
FERL6024BCG	4490	28	60	24	133	10
FERL5424BCG	4392	28	54	24	128	10
FERL4824BCG	4298	28	48	24	124	9
FERL4224BCG	4165	28	42	24	120	9
FERL6620BCG	4448	28	66	20	130	9
FERL6020BCG	4276	28	60	20	126	9
FERL5420BCG	4183	28	54	20	121	8
FERL4820BCG	4094	28	48	20	117	8
FERL4220BCG	3965	28	42	20	112	8

FERL-BOSCG • Left Executive Return with Box File Pedestal offset

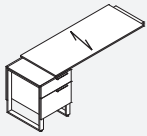

PRODUCT CODE	PRICE	SIZE (INCHES)			WEIGHT LBS	VOL FT3
		H	W	D		
FERL6624BOSCG	4670	28	76	24	137	10
FERL6024BOSCG	4490	28	70	24	133	10
FERL5424BOSCG	4392	28	64	24	128	10
FERL4824BOSCG	4298	28	58	24	124	9
FERL4224BOSCG	4165	28	52	24	120	9
FERL6620BOSCG	4701	28	76	20	130	9
FERL6020BOSCG	4276	28	70	20	126	9
FERL5420BOSCG	4183	28	64	20	121	8
FERL4820BOSCG	4094	28	58	20	117	8
FERL4220BOSCG	3965	28	52	20	112	8

FERR-BCG • Right Executive Return with Box File Pedestal flush

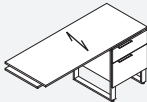

PRODUCT CODE	PRICE	SIZE (INCHES)			WEIGHT LBS	VOL FT3
		H	W	D		
FERR6624BCG	4670	28	66	24	137	10
FERR6024BCG	4490	28	60	24	133	10
FERR5424BCG	4392	28	54	24	128	10
FERR4824BCG	4298	28	48	24	124	9
FERR4224BCG	4165	28	42	24	120	9
FERR6620BCG	4448	28	66	20	130	9
FERR6020BCG	4276	28	60	20	126	9
FERR5420BCG	4183	28	54	20	121	8
FERR4820BCG	4094	28	48	20	117	8
FERR4220BCG	3965	28	42	20	112	8

FERR-BOSCG • Right Executive Return with Box File Pedestal offset

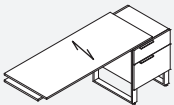

PRODUCT CODE	PRICE	SIZE (INCHES)			WEIGHT LBS	VOL FT3
		H	W	D		
FERR6624BOSCG	4670	28	76	24	137	10
FERR6024BOSCG	4490	28	70	24	133	10
FERR5424BOSCG	4392	28	64	24	128	10
FERR4824BOSCG	4298	28	58	24	124	9
FERR4224BOSCG	4165	28	52	24	120	9
FERR6620BOSCG	4701	28	76	20	130	9
FERR6020BOSCG	4276	28	70	20	126	9
FERR5420BOSCG	4183	28	64	20	121	8
FERR4820BOSCG	4094	28	58	20	117	8
FERR4220BOSCG	3965	28	52	20	112	8

CASEGOODS BRIDGES • TECHNICAL INFORMATION

- Horizontal grain direction is standard on all engineered finishes. If natural veneer is required, the grain direction will be vertical - Add suffix "VG" to the end of the product code
- Tops are constructed with two 3/4" thick panels laminated together to create a total thickness of 1 1/2".
- The standard grain direction on Bridge Tops is Cross Grain (CG).
- To remove Cross Grain veneer pattern on Top, delete suffix "CG" from the product number code (Available at no upcharge).
- GM5K (Tungsten) TC Location is standard.
- Two Connecting Brackets are included

NOTE: Arrow indicates direction of grain.

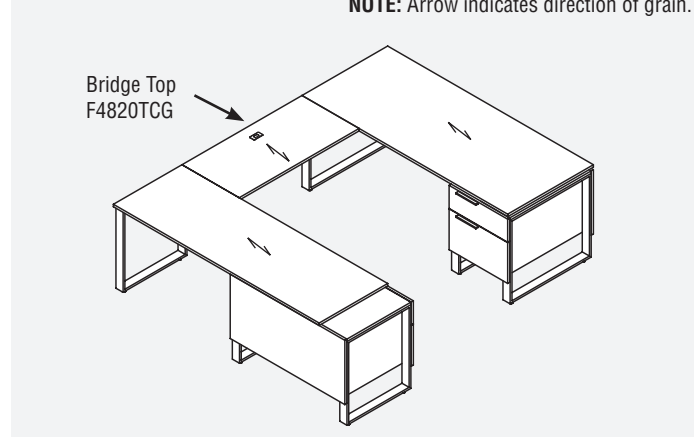

FBT-CG • Bridge Top

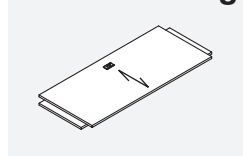

PRODUCT CODE	PRICE	SIZE (INCHES)			WEIGHT LBS	VOL FT3
		H	W	D		
FBT6624CG	2235	1.5	66	24	57	2
FBT6024CG	2049	1.5	60	24	53	2
FBT5424CG	1804	1.5	54	24	48	2
FBT4824CG	1576	1.5	48	24	44	1
FBT4224CG	1427	1.5	42	24	40	1
FBT6620CG	2033	1.5	66	20	55	2
FBT6020CG	1862	1.5	60	20	51	2
FBT5420CG	1628	1.5	54	20	46	1
FBT4820CG	1427	1.5	48	20	42	1
FBT4220CG	1298	1.5	42	20	37	1

FOUNDATIONS CASEGOODS • WALL MOUNT STORAGE

- Horizontal grain direction is standard on all engineered finishes. If natural veneer is required, the grain direction will be vertical - Add suffix "VG" to the end of the product code
- Wall Mount Overheads have a 2" deep valance on top and bottom and it can accommodate LED or T5 lighting in either location
- Tackboards are installed flush.
- Standard Heights for Tackboards are:
 - 19.2" (Overall Height above Worksurface = 36.5")
 - 26" (Overall Height above Worksurface = 42.5")

NOTE: Arrow indicates direction of grain.

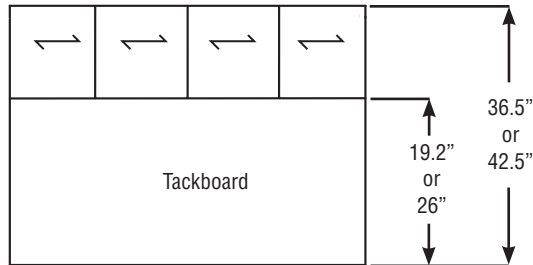
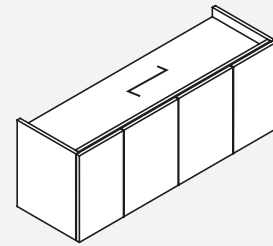

FSF • Wall Mount Storage with Doors

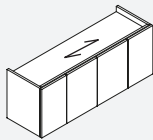

PRODUCT CODE	PRICE	SIZE (INCHES)			WEIGHT LBS	VOL FT3
		H	W	D		
FSF74	3031	18.5	74.5	15	103	13
FSF72	2909	18.5	72	15	101	12
FSF66	2735	18.5	66	15	94	11
FSF64	2677	18.5	64.5	15	92	11
FSF60	2565	18.5	60	15	87	10
FSF54	2445	18.5	54	15	80	9
FSF48	2221	18.5	48	15	74	8

FTS • Wall Mount Tackboard

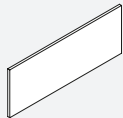

PRODUCT CODE	PRICE	SIZE (INCHES)			WEIGHT LBS	VOL FT3
		H	W	D		
FTS74H26	919	26	74.5	0.75	17	2
FTS72H26	849	26	72	0.75	16	1
FTS66H26	777	26	66	0.75	14	1
FTS64H26	756	26	64.5	0.75	13	1
FTS60H26	708	26	60	0.75	13	1
FTS54H26	635	26	54	0.75	13	1
FTS48H26	568	26	48	0.75	13	1
FTS74	707	19.2	74.5	0.75	13	1
FTS72	651	19.2	72	0.75	12	1
FTS66	597	19.2	66	0.75	11	1
FTS64	563	19.2	64.5	0.75	11	1
FTS60	544	19.2	60	0.75	10	1
FTS54	492	19.2	54	0.75	10	1
FTS48	439	19.2	48	0.75	10	1

CASEGOODS WORK WALLS • TECHNICAL INFORMATION

- Horizontal grain direction is standard on all engineered finishes. If natural veneer is required, the grain direction will be vertical - Add suffix "VG" to the end of the product code
- Tackboards and Tasklights must be specified.
- When the Tackboard option is specified, the price includes a Tackboard for each niche of the Work Wall.
- When the Task Light option is specified, the price includes LED Tasklight installed in the top of each niche. If more than one niche is needed in the configuration, remote on/off switch is included for simultaneous operation.
- All Storage Doors open with touch latch.
- Side Access to open storage or wardrobe - Front panels are fixed.
- Standard Heights are 26.5", 56", 70" and 84"
- Walls are available in 15" increments starting at 95" (I.E. 110", 125" 140", 155")
- Wall Credenzas are only available in 90" width.
- For available finish specification, see page A.17
- Cantilevered Storage units are side locking.
- For modifications to the wall configurations, size or finish, please contact Customer Service.

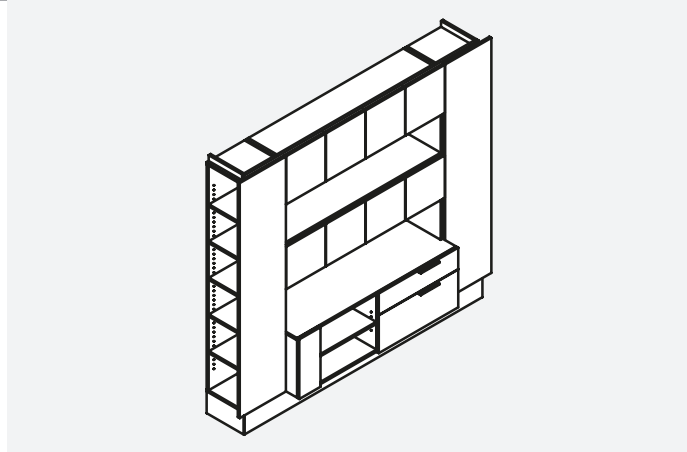

FW9584-1L • 95" wide x 84" high Work Wall

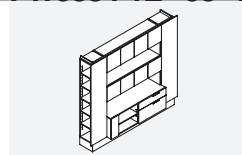

PRODUCT CODE	PRICE	SIZE / INCHES			WEIGHT VOL	
		H	W	D	LBS	FT ³
FW9584-1L	18622	84	95	20	634	79

95" wide - vertical storage with 5 adj. shelves, 60" wide wall credenza with adj. shelf and box/file, 60" wide niche, 60" wide single height storage, 60" wide niche, 60" wide single height storage, wardrobe with coat hook and hat shelf

- To add Tackboard to niche, add "TB" at the end of the product code and add \$1411 to the list price
- To add LED Light to niche, add "LT" at the end of the product code and add \$1485 to the list price

FW9584-1R • 95" wide x 84" high Work Wall

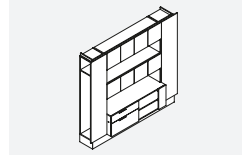

PRODUCT CODE	PRICE	SIZE / INCHES			WEIGHT VOL	
		H	W	D	LBS	FT ³
FW9584-1R	18622	84	95	20	634	79

95" wide - wardrobe with coat hook and hat shelf, 60" wide wall credenza with box/file and adj. shelf, 60" wide niche, 60" wide single height storage, 60" wide niche, 60" wide single height storage, vertical storage with 5 adj. shelves

- To add Tackboard to niche, add "TB" at the end of the product code and add \$1411 to the list price
- To add LED Light to niche, add "LT" at the end of the product code and add \$1485 to the list price

FW9584-2L • 95" wide x 84" high Work Wall

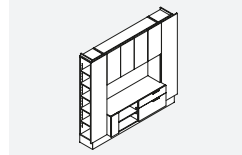

PRODUCT CODE	PRICE	SIZE / INCHES			WEIGHT VOL	
		H	W	D	LBS	FT ³
FW9584-2L	16762	84	95	20	568	77

95" wide - vertical storage with 5 adj. shelves, 60" wide wall credenza with adj. shelf and box/file, 60" wide double height niche, 60" wide double height storage, wardrobe with coat hook and hat shelf

- To add Tackboard to niche, add "TB" at the end of the product code and add \$875 to the list price
- To add LED Light to niche, add "LT" at the end of the product code and add \$599 to the list price

FW9584-2R • 95" wide x 84" high Work Wall

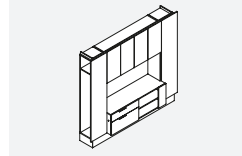

PRODUCT CODE	PRICE	SIZE / INCHES			WEIGHT VOL	
		H	W	D	LBS	FT ³
FW9584-2R	16762	84	95	20	568	77

95" wide - wardrobe with coat hook and hat shelf, 60" wide wall credenza with box/file and adj. shelf, 60" wide double height niche, 60" wide double height storage, vertical storage with 5 adj. shelves

- To add Tackboard to niche, add "TB" at the end of the product code and add \$875 to the list price
- To add LED Light to niche, add "LT" at the end of the product code and add \$599 to the list price

FW11084-1L • 110" wide x 84" high Work Wall

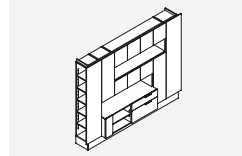

PRODUCT CODE	PRICE	SIZE / INCHES			WEIGHT VOL	
		H	W	D	LBS	FT ³
FW11084-1L	21415	84	110	20	741	91

110" wide - vertical storage with 5 adj. shelves, 60" wide wall credenza with adj. shelf and box/file, 60" wide niche, triple height storage, 45" wide single height storage, 60" wide niche, 60" wide single height storage, triple height storage, wardrobe with coat hook and hat shelf

- To add Tackboard to niche, add "TB" at the end of the product code and add \$1411 to the list price
- To add LED Light to niche, add "LT" at the end of the product code and add \$1485 to the list price

FW11084-1R • 110" wide x 84" high Work Wall

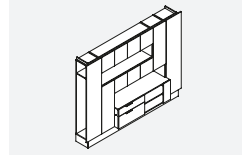

PRODUCT CODE	PRICE	SIZE / INCHES			WEIGHT VOL	
		H	W	D	LBS	FT ³
FW11084-1R	21415	84	110	20	741	91

110" wide - wardrobe with coat hook and hat shelf, triple height storage, 60" wide niche, 60" wide single height storage, 60" wide wall credenza with box/file and adj. shelf, 60" wide niche, 45" wide single height storage, triple height storage, vertical storage with 5 adj. shelves

- To add Tackboard to niche, add "TB" at the end of the product code and add \$1411 to the list price
- To add LED Light to niche, add "LT" at the end of the product code and add \$1485 to the list price

FW11084-2L • 110" wide x 84" high Work Wall

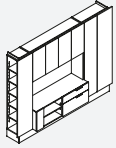

PRODUCT CODE	PRICE	SIZE / INCHES			WEIGHT VOL	
		H	W	D	LBS	FT ³
FW11084-2L	18622	84	110	20	628	88

110" wide - vertical storage with 5 adj. shelves, 60" wide wall credenza with adj. shelf and box/file, 60" wide double height niche, 60" wide double height storage, double depth wardrobe with coat rod and hat shelf

- To add Tackboard to niche, add "TB" at the end of the product code and add \$875 to the list price
- To add LED Light to niche, add "LT" at the end of the product code and add \$599 to the list price

FW11084-2R • 110" wide x 84" high Work Wall

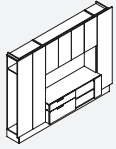

PRODUCT CODE	PRICE	SIZE / INCHES			WEIGHT VOL	
		H	W	D	LBS	FT ³
FW11084-2R	18622	84	110	20	628	88

110" wide - double depth wardrobe with coat rod and hat shelf, 60" wide wall credenza with box/file and adj. shelf, 60" wide double height niche, 60" wide double height storage, vertical storage with 5 adj. shelves

- To add Tackboard to niche, add "TB" at the end of the product code and add \$875 to the list price
- To add LED Light to niche, add "LT" at the end of the product code and add \$599 to the list price

FW12584-1L • 125" wide x 84" high Work Wall

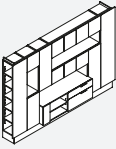

PRODUCT CODE	PRICE	SIZE / INCHES			WEIGHT VOL	
		H	W	D	LBS	FT ³
FW12584-1L	23897	84	125	20	858	103

125" wide - vertical storage with 5 adj. shelves, triple height storage, 15" wide double height niche, single height storage, 60" wide wall credenza with adj. shelf and box/file, 60" wide niche, triple height storage, 45" wide single height storage, 60" wide niche, 60" wide single height storage, triple height storage, wardrobe with coat hook and hat shelf

- To add Tackboard to niche, add "TB" at the end of the product code and add \$1720 to the list price
- To add LED Light to niche, add "LT" at the end of the product code and add \$1724 to the list price

FW12584-1R • 125" wide x 84" high Work Wall

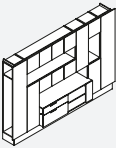

PRODUCT CODE	PRICE	SIZE / INCHES			WEIGHT VOL	
		H	W	D	LBS	FT ³
FW12584-1R	23897	84	125	20	858	103

125" wide - wardrobe with coat hook and hat shelf, triple height storage, 60" wide niche, 60" wide single height storage, 60" wide wall credenza with box/file and adj. shelf, 60" wide niche, 45" wide single height storage, triple height storage, triple height storage, 15" wide double height niche, single height storage, vertical storage with 5 adj. shelves

- To add Tackboard to niche, add "TB" at the end of the product code and add \$1720 to the list price
- To add LED Light to niche, add "LT" at the end of the product code and add \$1724 to the list price

FW14084-1L • 140" wide x 84" high Work Wall

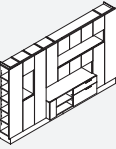

PRODUCT CODE	PRICE	SIZE / INCHES			WEIGHT VOL	
		H	W	D	LBS	FT ³
FW14084-1L	25915	84	140	20	936	118

140" wide - vertical storage with 5 adj. shelves, triple height storage, 15" wide double height niche, single height storage, vertical storage with 5 adj. shelves, 60" wide wall credenza with adj. shelf and box/file, 60" wide niche, triple height storage cabinet, 45" wide single height storage, 60" wide niche, 60" wide single height storage, double depth wardrobe with coat rod and 2 shelves

- To add Tackboard to niche, add "TB" at the end of the product code and add \$1720 to the list price
- To add LED Light to niche, add "LT" at the end of the product code and add \$1724 to the list price

FW14084-1R • 140" wide x 84" high Work Wall

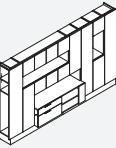

PRODUCT CODE	PRICE	SIZE / INCHES			WEIGHT VOL	
		H	W	D	LBS	FT ³
FW14084-1R	25915	84	140	20	936	118

140" wide - double depth wardrobe with coat rod and 2 shelves, 60" wide niche, 60" wide single height storage, 60" wide wall credenza with box/file and adj. shelf, 60" wide niche, 45" wide single height storage, triple height storage, vertical storage with 5 adj. shelves, triple height storage, 15" wide double height niche, single height storage, vertical storage with 5 adj. shelves

- To add Tackboard to niche, add "TB" at the end of the product code and add \$1720 to the list price
- To add LED Light to niche, add "LT" at the end of the product code and add \$1724 to the list price

FW9570-1L • 95" wide x 70" high Work Wall

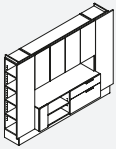

PRODUCT CODE	PRICE	SIZE / INCHES			WEIGHT VOL	
		H	W	D	LBS	FT ³
FW9570-1L	16139	70	95	20	523	66

95" wide - vertical storage with 4 adj. shelves, 60" wide wall credenza with adj. shelf and box/file, 60" wide niche, 60" wide double height storage, wardrobe with coat hook and hat shelf

- To add Tackboard to niche, add "TB" at the end of the product code and add \$707 to the list price
- To add LED Light to niche, add "LT" at the end of the product code and add \$599 to the list price

FW9570-1R • 95" wide x 70" high Work Wall

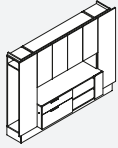

PRODUCT CODE	PRICE	SIZE / INCHES			WEIGHT VOL	
		H	W	D	LBS	FT ³
FW9570-1R	16139	70	95	20	523	66

95" wide - wardrobe with coat hook and hat shelf, 60" wide wall credenza with box/file and adj. shelf, 60" wide niche, 60" wide double height storage, vertical storage with 4 adj. shelves

- To add Tackboard to niche, add "TB" at the end of the product code and add \$707 to the list price
- To add LED Light to niche, add "LT" at the end of the product code and add \$599 to the list price

FW11070-1L • 110" wide x 70" high Work Wall

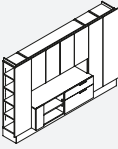

PRODUCT CODE	PRICE	SIZE / INCHES			WEIGHT VOL	
		H	W	D	LBS	FT ³
FW11070-1L	17692	70	110	20	618	76

110" wide - vertical storage with 4 adj. shelves, 60" wide wall credenza with adj. shelf and box/file, 60" wide niche, 60" wide double height storage, vertical storage with 4 adj. shelves, wardrobe with coat hook and hat shelf

- To add Tackboard to niche, add "TB" at the end of the product code and add \$707 to the list price
- To add LED Light to niche, add "LT" at the end of the product code and add \$599 to the list price

FW11070-1R • 110" wide x 70" high Work Wall

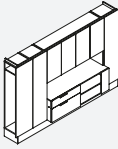

PRODUCT CODE	PRICE	SIZE / INCHES			WEIGHT VOL	
		H	W	D	LBS	FT ³
FW11070-1R	17692	70	110	20	618	76

110" wide - wardrobe with coat hook and hat shelf, vertical storage with 4 adj. shelves, 60" wide wall credenza with box/file and adj. shelf, 60" wide niche, 60" wide double height storage, vertical storage with 4 adj. shelves

- To add Tackboard to niche, add "TB" at the end of the product code and add \$707 to the list price
- To add LED Light to niche, add "LT" at the end of the product code and add \$599 to the list price

FW11070-2L • 110" wide x 70" high Work Wall

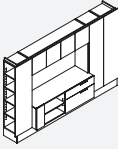

PRODUCT CODE	PRICE	SIZE / INCHES			WEIGHT VOL	
		H	W	D	LBS	FT ³
FW11070-2L	16450	70	110	20	586	76

110" wide - vertical storage with 4 adj. shelves, 60" wide wall credenza with adj. shelf and box/file, 60" wide double height niche, 60" wide single height storage, vertical storage with 4 adj. shelves, wardrobe with coat hook and hat shelf

- To add Tackboard to niche, add "TB" at the end of the product code and add \$875 to the list price
- To add LED Light to niche, add "LT" at the end of the product code and add \$599 to the list price

FW11070-2R • 110" wide x 70" high Work Wall

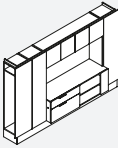

PRODUCT CODE	PRICE	SIZE / INCHES			WEIGHT VOL	
		H	W	D	LBS	FT ³
FW11070-2R	16450	70	110	20	586	76

110" wide - wardrobe with coat hook and hat shelf, vertical storage with 4 adj. shelves, 60" wide wall credenza with box/file and adj. shelf, 60" wide double height niche, 60" wide single height storage, vertical storage with 4 adj. shelves

- To add Tackboard to niche, add "TB" at the end of the product code and add \$875 to the list price
- To add LED Light to niche, add "LT" at the end of the product code and add \$599 to the list price

FW12570-1L • 125" wide x 70" high Work Wall

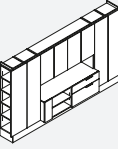

PRODUCT CODE	PRICE	SIZE / INCHES			WEIGHT VOL	
		H	W	D	LBS	FT ³
FW12570-1L	18622	70	125	20	713	85

125" wide - vertical storage with 4 adj. shelves, vertical storage with 4 adj. shelves, 60" wide wall credenza with adj. shelf and box/file, 60" wide niche, 60" wide double height storage, vertical storage with 4 adj. shelves, wardrobe with coat hook and hat shelf

- To add Tackboard to niche, add "TB" at the end of the product code and add \$707 to the list price
- To add LED Light to niche, add "LT" at the end of the product code and add \$599 to the list price

FW12570-1R • 125" wide x 70" high Work Wall

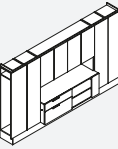

PRODUCT CODE	PRICE	SIZE / INCHES			WEIGHT VOL	
		H	W	D	LBS	FT ³
FW12570-1R	18622	70	125	20	713	85

125" wide - wardrobe with coat hook and hat shelf, vertical storage with 4 adj. shelves, 60" wide wall credenza with box/file and adj. shelf, 60" wide niche, 60" wide double height storage, vertical storage with 4 adj. shelves, vertical storage with 4 adj. shelves

- To add Tackboard to niche, add "TB" at the end of the product code and add \$707 to the list price
- To add LED Light to niche, add "LT" at the end of the product code and add \$599 to the list price

FW12570-2L • 125" wide x 70" high Work Wall

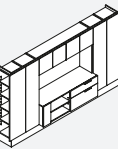

PRODUCT CODE	PRICE	SIZE / INCHES			WEIGHT VOL	
		H	W	D	LBS	FT ³
FW12570-2L	17379	70	125	20	681	85

125" wide - vertical storage with 4 adj. shelves, vertical storage with 4 adj. shelves, 60" wide wall credenza with adj. shelf and box/file, 60" wide double height niche, 60" wide single height storage, vertical storage with 4 adj. shelves, wardrobe with coat hook and hat shelf

- To add Tackboard to niche, add "TB" at the end of the product code and add \$875 to the list price
- To add LED Light to niche, add "LT" at the end of the product code and add \$599 to the list price

FW12570-2R • 125" wide x 70" high Work Wall

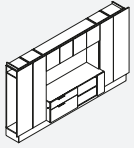

PRODUCT CODE	PRICE	SIZE / INCHES			WEIGHT VOL	
		H	W	D	LBS	FT ³
FW12570-2R	17379	70	125	20	681	85

125" wide - wardrobe with coat hook and hat shelf, vertical storage with 4 adj. shelves, 60" wide wall credenza with box/file and adj. shelf, 60" wide double height niche, 60" wide single height storage, vertical storage with 4 adj. shelves, vertical storage with 4 adj. shelves

- To add Tackboard to niche, add "TB" at the end of the product code and add \$875 to the list price
- To add LED Light to niche, add "LT" at the end of the product code and add \$599 to the list price

FW14070-1L • 140" wide x 70" high Work Wall

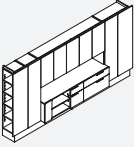

PRODUCT CODE	PRICE	SIZE / INCHES			WEIGHT VOL	
		H	W	D	LBS	FT ³
FW14070-1L	20019	70	140	20	750	95

140" wide - vertical storage with 4 adj. shelves, vertical storage with 4 adj. shelves, 75" wide wall credenza with adj. shelf narrow box/file and box/file, 75" wide single height niche, 75" wide double height storage, double depth wardrobe with coat rod and hat shelf

- To add Tackboard to niche, add "TB" at the end of the product code and add \$882 to the list price
- To add LED Light to niche, add "LT" at the end of the product code and add \$1352 to the list price

FW14070-1R • 140" wide x 70" high Work Wall

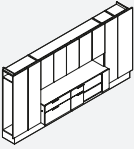

PRODUCT CODE	PRICE	SIZE / INCHES			WEIGHT VOL	
		H	W	D	LBS	FT ³
FW14070-1R	20019	70	140	20	750	95

140" wide - double depth wardrobe with coat rod and hat shelf, 75" wide wall credenza with box/file, narrow box/file and adj. shelf, 75" wide single height niche, 75" wide double height storage, vertical storage with 4 adj. shelves, vertical storage with 4 adj. shelves

- To add Tackboard to niche, add "TB" at the end of the product code and add \$882 to the list price
- To add LED Light to niche, add "LT" at the end of the product code and add \$1352 to the list price

FW15570-1L • 155" wide x 70" high Work Wall

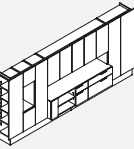

PRODUCT CODE	PRICE	SIZE / INCHES			WEIGHT VOL	
		H	W	D	LBS	FT ³
FW15570-1L	24051	70	155	20	849	107

155" wide - vertical storage with 4 adj. shelves, double height storage, 15" wide double height niche, single height storage, vertical storage with 4 adj. shelves, 75" wide wall credenza with adj. shelf, narrow box/file and box/file, 75" wide niche, 75" wide double height storage, double depth wardrobe with coat rod and hat shelf

- To add Tackboard to niche, add "TB" at the end of the product code and add \$1312 to the list price
- To add LED Light to niche, add "LT" at the end of the product code and add \$1591 to the list price

FW15570-1R • 155" wide x 70" high Work Wall

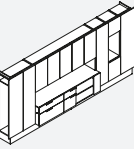

PRODUCT CODE	PRICE	SIZE / INCHES			WEIGHT VOL	
		H	W	D	LBS	FT ³
FW15570-1R	24051	70	155	20	849	107

155" wide - double depth wardrobe with coat rod and hat shelf, 75" wide wall credenza with box/file, narrow box/file and adj. shelf, 75" wide niche, 75" wide double height storage, vertical storage with 4 adj. shelves, double height storage, 15" wide double height niche, single height storage, vertical storage with 4 adj. shelves

- To add Tackboard to niche, add "TB" at the end of the product code and add \$1312 to the list price
- To add LED Light to niche, add "LT" at the end of the product code and add \$1591 to the list price

FW9556-1 • 95" wide x 56" high Work Wall

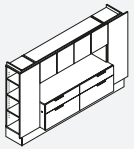

PRODUCT CODE	PRICE	SIZE / INCHES			WEIGHT VOL	
		H	W	D	LBS	FT ³
FW9556-1	14897	56	95	20	488	55

95" wide - vertical storage with 3 adj. shelves, 60" wide wall credenza with two box/files, 60" wide single height niche, 60" wide single height storage, vertical storage with 3 adj. shelves

- To add Tackboard to niche, add "TB" at the end of the product code and add \$707 to the list price
- To add LED Light to niche, add "LT" at the end of the product code and add \$599 to the list price

FW9556-2 • 95" wide x 56" high Work Wall

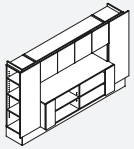

PRODUCT CODE	PRICE	SIZE / INCHES			WEIGHT VOL	
		H	W	D	LBS	FT ³
FW9556-2	13347	56	95	20	420	55

95" wide - vertical storage with 3 adj. shelves, 60" wide wall open credenza with 2 adj. shelves, 60" wide single height niche, 60" wide single height storage, vertical storage with 3 adj. shelves

- To add Tackboard to niche, add "TB" at the end of the product code and add \$707 to the list price
- To add LED Light to niche, add "LT" at the end of the product code and add \$599 to the list price

FW11056-1L • 110" wide x 56" high Work Wall

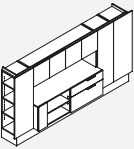

PRODUCT CODE	PRICE	SIZE / INCHES			WEIGHT VOL	
		H	W	D	LBS	FT ³
FW11056-1L	14588	56	110	20	533	63

95" wide - vertical storage with 3 adj. shelves, 60" wide wall credenza with adj. shelf and box/file, 60" wide niche, 60" wide single height storage, vertical storage with 3 adj. shelves, wardrobe with coat hook and hat shelf

- To add Tackboard to niche, add "TB" at the end of the product code and add \$707 to the list price
- To add LED Light to niche, add "LT" at the end of the product code and add \$599 to the list price

FW11056-1R • 110" wide x 56" high Work Wall

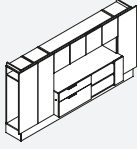

PRODUCT CODE	PRICE	SIZE / INCHES			WEIGHT VOL	
		H	W	D	LBS	FT ³
FW11056-1R	14588	56	110	20	533	63

95" wide - wardrobe with coat hook and hat shelf, vertical storage with 3 adj. shelves, 60" wide wall credenza with box/file and adj. shelf, 60" wide single height niche, 60" wide single height storage, vertical storage with 3 adj. shelves

- To add Tackboard to niche, add "TB" at the end of the product code and add \$707 to the list price
- To add LED Light to niche, add "LT" at the end of the product code and add \$599 to the list price

FW11056-2L • 110" wide x 56" high Work Wall

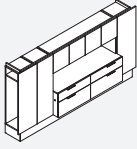

PRODUCT CODE	PRICE	SIZE / INCHES			WEIGHT VOL	
		H	W	D	LBS	FT ³
FW11056-2L	16139	56	110	20	549	62

110" wide - wardrobe with coat hook and hat shelf, vertical storage with 3 adj. shelves, 60" wide wall credenza with two box/files, 60" wide niche, 60" wide single height storage, vertical storage with 3 adj. shelves

- To add Tackboard to niche, add "TB" at the end of the product code and add \$707 to the list price
- To add LED Light to niche, add "LT" at the end of the product code and add \$599 to the list price

FW11056-2R • 110" wide x 56" high Work Wall

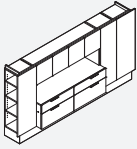

PRODUCT CODE	PRICE	SIZE / INCHES			WEIGHT VOL	
		H	W	D	LBS	FT ³
FW11056-2R	16139	56	110	20	549	62

110" wide - vertical storage with 3 adj. shelves, 60" wide wall credenza with two box/files, 60" wide niche, 60" wide single height storage, vertical storage with 3 adj. shelves, wardrobe with coat hook and hat shelf

- To add Tackboard to niche, add "TB" at the end of the product code and add \$707 to the list price
- To add LED Light to niche, add "LT" at the end of the product code and add \$599 to the list price

FW11056-3L • 110" wide x 56" high Work Wall

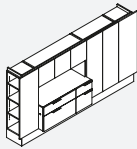

PRODUCT CODE	PRICE	SIZE / INCHES			WEIGHT VOL	
		H	W	D	LBS	FT ³
FW11056-3L	15983	56	110	20	538	62

110" wide - vertical storage with 3 adj. shelves, 45" wide wall credenza with box/file and narrow box/file, 45" wide niche, 45" wide single height storage, double width vertical storage with 3 adj. shelves, wardrobe with coat hook and hat shelf

- To add Tackboard to niche, add "TB" at the end of the product code and add \$707 to the list price
- To add LED Light to niche, add "LT" at the end of the product code and add \$486 to the list price

FW11056-3R • 110" wide x 56" high Work Wall

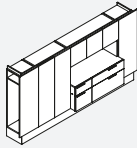

PRODUCT CODE	PRICE	SIZE / INCHES			WEIGHT VOL	
		H	W	D	LBS	FT ³
FW11056-3R	15983	56	110	20	538	62

110" wide - wardrobe with coat hook and hat shelf, double width vertical storage with 3 adj. shelves, 45" wide wall credenza with narrow box/file and box/file, 45" wide niche, 45" wide single height storage, vertical storage with 3 adj. shelves

- To add Tackboard to niche, add "TB" at the end of the product code and add \$707 to the list price
- To add LED Light to niche, add "LT" at the end of the product code and add \$486 to the list price

FW11056-4L • 110" wide x 56" high Work Wall

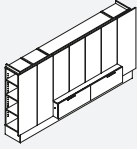

PRODUCT CODE	PRICE	SIZE / INCHES			WEIGHT VOL	
		H	W	D	LBS	FT ³
FW11056-4L	16064	56	110	20	530	61

110" wide - vertical storage with 3 adj. shelves, vertical storage with 3 adj. shelves, single high 60" wide wall credenza with two files, 60" wide triple height storage with 2 adj. shelves, wardrobe with coat hook and hat shelf

FW11056-4R • 110" wide x 56" high Work Wall

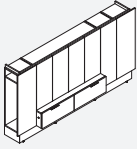

PRODUCT CODE	PRICE	SIZE / INCHES			WEIGHT VOL	
		H	W	D	LBS	FT ³
FW11056-4R	16064	56	110	20	530	61

110" wide - wardrobe with coat hook and hat shelf, single height 60" wide wall credenza with two files, 60" wide triple height storage with 2 adj. shelves, vertical storage with 3 adj. shelves, vertical storage with 3 adj. shelves

FW9584-20 • 95" wide x 84" high Work Wall

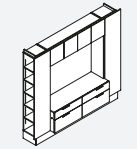

PRODUCT CODE	PRICE	SIZE / INCHES			WEIGHT VOL	
		H	W	D	LBS	FT ³
FW9584-20	18157	84	95	20	565	77

95" wide - vertical storage with 5 adj. shelves, 60" wide wall credenza with two box/files, 60" wide triple height niche, 60" wide single height storage, vertical storage with 5 adj. shelves

- To add Tackboard to niche, add "TB" at the end of the product code and add \$1312 to the list price
- To add LED Light to niche, add "LT" at the end of the product code and add \$599 to the list price

FW9584-21 • 95" wide x 84" high Work Wall

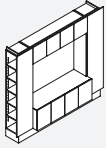

PRODUCT CODE	PRICE	SIZE / INCHES			WEIGHT VOL	
		H	W	D	LBS	FT ³
FW9584-21	16604	84	95	20	516	77

95" wide - vertical storage with 5 adj. shelves, 60" wide wall credenza with two cabinets with adj. shelves, 60" wide triple height niche, 60" wide single height storage, vertical storage with 5 adj. shelves

- To add Tackboard to niche, add "TB" at the end of the product code and add \$1312 to the list price
- To add LED Light to niche, add "LT" at the end of the product code and add \$599 to the list price

FW9584-22 • 95" wide x 84" high Work Wall

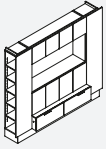

PRODUCT CODE	PRICE	SIZE / INCHES			WEIGHT VOL	
		H	W	D	LBS	FT ³
FW9584-22	17846	84	95	20	611	77

95" wide - vertical storage with 5 adj. shelves, 60" wide single height wall credenza with two files, 60" wide double height storage, 60" wide double height niche, 60" wide single height storage, vertical storage with 5 adj. shelves

- To add Tackboard to niche, add "TB" at the end of the product code and add \$875 to the list price
- To add LED Light to niche, add "LT" at the end of the product code and add \$599 to the list price

FW11084-20L • 110" wide x 84" high Work Wall

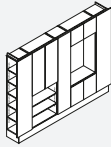

PRODUCT CODE	PRICE	SIZE / INCHES			WEIGHT VOL	
		H	W	D	LBS	FT ³
FW11084-20L	17692	84	110	15	659	87

110" wide - vertical storage with 5 adj. shelves, 30" wide triple height open bookcase, 30" wide triple height double width storage, vertical storage with 5 adj. shelves, 30" wide and double height storage, 30" wide triple height niche, 30" wide single height storage, vertical storage with 5 adj. shelves

- To add Tackboard to niche, add "TB" at the end of the product code and add \$657 to the list price
- To add LED Light to niche, add "LT" at the end of the product code and add \$368 to the list price

FW11084-20R • 110" wide x 84" high Work Wall

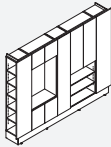

PRODUCT CODE	PRICE	SIZE / INCHES			WEIGHT VOL	
		H	W	D	LBS	FT ³
FW11084-20R	17692	84	110	15	659	87

110" wide - vertical storage with 5 adj. shelves, 30" wide double height storage, 30" wide triple height niche, 30" wide single height storage, vertical storage with 5 adj. shelves, 30" wide triple height open bookcase, 30" wide triple height double width storage, vertical storage with 5 adj. shelves

- To add Tackboard to niche, add "TB" at the end of the product code and add \$657 to the list price
- To add LED Light to niche, add "LT" at the end of the product code and add \$368 to the list price

FW12584-20 • 125" wide x 84" high Work Wall

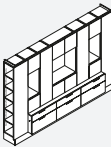

PRODUCT CODE	PRICE	SIZE / INCHES			WEIGHT VOL	
		H	W	D	LBS	FT ³
FW12584-20	27156	84	125	20	962	101

125" wide - vertical storage with 5 adj. shelves, 90" wide wall credenza with 3 box/files, single height storage, 15" wide double height niche, single height storage, four-fold height vertical storage with 3 adj. shelves, double width single height storage, 30" wide double height niche, double width single height storage, fourfold height vertical storage with 3 adj. shelves, single height storage, 15" wide double height niche, single height storage, vertical storage with 5 adj. shelves

- To add Tackboard to niche, add "TB" at the end of the product code and add \$1195 to the list price
- To add LED Light to niche, add "LT" at the end of the product code and add \$1210 to the list price

FW12584-21 • 125" wide x 84" high Work Wall

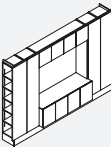

PRODUCT CODE	PRICE	SIZE / INCHES			WEIGHT VOL	
		H	W	D	LBS	FT ³
FW12584-21	20176	84	125	20	738	100

125" wide - vertical storage with 5 adj. shelves, vertical storage with 5 adj. shelves, 60" wide wall credenza with two cabinets and adj. shelf, 60" wide triple height niche, 60" wide single height storage, vertical storage with 5 adj. shelves, vertical storage with 5 adj. shelves

- To add Tackboard to niche, add "TB" at the end of the product code and add \$1312 to the list price
- To add LED Light to niche, add "LT" at the end of the product code and add \$599 to the list price

FW9570-20 • 95" wide x 70" high Work Wall

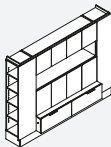

PRODUCT CODE	PRICE	SIZE / INCHES			WEIGHT VOL	
		H	W	D	LBS	FT ³
FW9570-20	16139	70	95	20	563	66

95" wide - vertical storage with 4 adj. shelves, 60" wide single height wall credenza with 2 files, 60" wide double height storage, 60" wide niche, 60" wide single height storage, vertical storage with 4 adj. shelves

- To add Tackboard to niche, add "TB" at the end of the product code and add \$707 to the list price
- To add LED Light to niche, add "LT" at the end of the product code and add \$599 to the list price

FW11070-20 • 110" wide x 70" high Work Wall

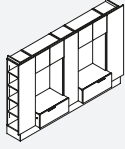

PRODUCT CODE	PRICE	SIZE / INCHES			WEIGHT VOL	
		H	W	D	LBS	FT ³
FW11070-20	17999	70	110	20	602	78

110" wide - vertical storage with 4 adj. shelves, 30" wide single height wall credenza with file, 30" wide triple height niche, 30" wide single height storage, vertical storage with 4 adj. shelves, 30" wide single height wall credenza with file, 30" wide triple height niche, 30" wide height storage, vertical storage with 4 adj. shelves

- To add Tackboard to niche, add "TB" at the end of the product code and add \$1312 to the list price
- To add LED Light to niche, add "LT" at the end of the product code and add \$950 to the list price

FW12570-20 • 125" wide x 70" high Work Wall

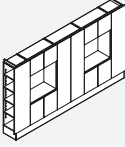

PRODUCT CODE	PRICE	SIZE / INCHES			WEIGHT VOL	
		H	W	D	LBS	FT ³
FW12570-20	18622	70	125	15	645	84

125" wide - vertical storage with 4 adj. shelves, 30" wide double height storage, 30" wide double height niche, 30" wide single height storage, double width vertical storage with 4 adj. shelves, 30" wide double height storage, 30" wide double height niche, 30" wide single height storage, vertical storage with 4 adj. shelves

- To add Tackboard to niche, add "TB" at the end of the product code and add \$875 to the list price
- To add LED Light to niche, add "LT" at the end of the product code and add \$950 to the list price

FW12570-21L • 125" wide x 70" high Work Wall

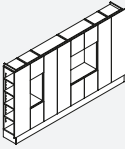

PRODUCT CODE	PRICE	SIZE / INCHES			WEIGHT VOL	
		H	W	D	LBS	FT ³
FW12570-21L	19863	70	125	15	685	84

125" wide - vertical storage with 4 adj. shelves, 15" wide double height storage, 15" wide double height niche, 15" wide single height storage, double width vertical storage with 4 adj. shelves, 30" wide double height storage, 30" wide double height niche, 30" wide single height storage, vertical storage with 4 adj. shelves, vertical storage with 4 adj. shelves

- To add Tackboard to niche, add "TB" at the end of the product code and add \$748 to the list price
- To add LED Light to niche, add "LT" at the end of the product code and add \$865 to the list price

FW12570-21R • 125" wide x 70" high Work Wall

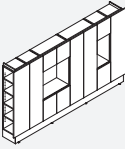

PRODUCT CODE	PRICE	SIZE / INCHES			WEIGHT VOL	
		H	W	D	LBS	FT ³
FW12570-21R	19863	70	125	15	685	84

125" wide - vertical storage with 4 adj. shelves, vertical storage with 4 adj. shelves, 30" wide double height storage, 30" wide double height niche, 30" wide single height storage, double width vertical storage with 4 adj. shelves, 15" wide double height storage, 15" wide double height niche, 15" wide single height storage, vertical storage with 4 adj. shelves

- To add Tackboard to niche, add "TB" at the end of the product code and add \$748 to the list price
- To add LED Light to niche, add "LT" at the end of the product code and add \$865 to the list price

FW14070-20 • 140" wide x 70" high Work Wall

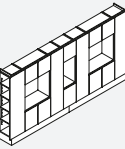

PRODUCT CODE	PRICE	SIZE / INCHES			WEIGHT VOL	
		H	W	D	LBS	FT ³
FW14070-20	21879	70	140	20	779	96

140" wide - vertical storage with 4 adj. shelves, 30" wide double height storage, 30" wide double height niche, 30" wide single height storage, vertical storage cabinet with 4 adj. shelves, 15" wide double height storage, 15" wide double height niche, 15" wide single height storage, vertical storage with 4 adj. shelves, 30" wide double height storage, 30" wide double height niche, 30" wide single height storage, vertical storage with 4 adj. shelves

- To add Tackboard to niche, add "TB" at the end of the product code and add \$1182 to the list price
- To add LED Light to niche, add "LT" at the end of the product code and add \$1198 to the list price

FW14070-21L • 140" wide x 70" high Work Wall

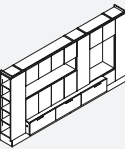

PRODUCT CODE	PRICE	SIZE / INCHES			WEIGHT VOL	
		H	W	D	LBS	FT ³
FW14070-21L	23121	70	140	20	832	96

140" wide - vertical storage with 4 adj. shelves, 60" wide double height storage, 60" wide niche, 60" wide single height storage, 15" wide triple height storage, 15" wide single height storage, 30" wide double height niche, 30" wide single height storage, 90" wide single height wall credenza, vertical storage with 4 adj. shelves

- To add Tackboard to niche, add "TB" at the end of the product code and add \$1361 to the list price
- To add LED Light to niche, add "LT" at the end of the product code and add \$1219 to the list price

FW14070-21R • 140" wide x 70" high Work Wall

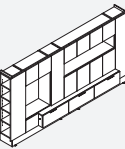

PRODUCT CODE	PRICE	SIZE / INCHES			WEIGHT VOL	
		H	W	D	LBS	FT ³
FW14070-21R	23121	70	140	20	832	96

140" wide - vertical storage with 4 adj. shelves, 15" wide single height storage, 30" wide double height niche, 30" wide single height storage, 90" wide single height wall credenza with three files, 15" wide triple height storage, 60" wide double height storage, 60" wide niche, 60" wide single height storage, vertical storage with 4 adj. shelves

- To add Tackboard to niche, add "TB" at the end of the product code and add \$1361 to the list price
- To add LED Light to niche, add "LT" at the end of the product code and add \$1219 to the list price

FW15570-20 • 155" wide x 70" high Work Wall

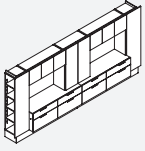

PRODUCT CODE	PRICE	SIZE / INCHES			WEIGHT VOL	
		H	W	D	LBS	FT ³
FW15570-20	25140	70	155	20	900	108

155" wide - vertical storage with 4 adj. shelves, 60" wide wall credenza with two box/files, 45" wide double height niche, 45" wide single height storage, 30" wide double width storage with 2 adj. shelves, 60" wide wall credenza with two box/files, 45" wide double height niche, 45" wide single height storage, vertical storage with 4 adj. shelves

- To add Tackboard to niche, add "TB" at the end of the product code and add \$1745 to the list price
- To add LED Light to niche, add "LT" at the end of the product code and add \$1254 to the list price

FW10784L • 107" wide x 84" high Work Wall

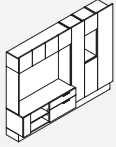

PRODUCT CODE	PRICE	SIZE / INCHES			WEIGHT VOL	
		H	W	D	LBS	FT ³
FW10784L	18622	84	107.5	20	620	80

107.5" wide - 60" wide wall credenza with adj. shelf and box/file, 60" wide triple height niche, 60" wide single height storage, vertical storage with 5 adj. shelves, triple height storage, 15" wide double height niche, single height storage, vertical storage with 5 adj. shelves

- To add Tackboard to niche, add "TB" at the end of the product code and add \$875 to the list price
- To add LED Light to niche, add "LT" at the end of the product code and add \$599 to the list price

FW927002R • 92" wide x 70" high Open Knee Space Work Wall

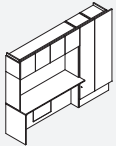

PRODUCT CODE	PRICE	SIZE / INCHES			WEIGHT VOL	
		H	W	D	LBS	FT ³
FW927002R	11706	70	92.5	20	533	63

92.5" wide - 60" wide work surface wall credenza, 60" wide double height niche, 60" wide single height storage, vertical storage with 4 adj. shelves, wardrobe with coat hook and hat shelf

- To add Tackboard to niche, add "TB" at the end of the product code and add \$875 to the list price
- To add LED Light to niche, add "LT" at the end of the product code and add \$599 to the list price

FW9584OWR • 95" wide x 84" high Open Knee Space Work Wall

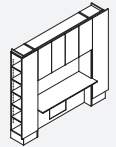

PRODUCT CODE	PRICE	SIZE / INCHES			WEIGHT VOL	
		H	W	D	LBS	FT ³
FW9584OWR	12268	84	95	20	523	33

95" wide - vertical storage with 5 adj. shelves, 60" wide work surface wall credenza, 60" wide double height niche, 60" wide double height storage, wardrobe with coat hook and hat shelf.

- To add Tackboard to niche, add "TB" at the end of the product code and add \$875 to the list price
- To add LED Light to niche, add "LT" at the end of the product code and add \$599 to the list price

FW11084OW2R • 110" wide x 84" high Open Knee Space Work Wall

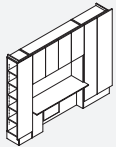

PRODUCT CODE	PRICE	SIZE / INCHES			WEIGHT VOL	
		H	W	D	LBS	FT ³
FW11084OW2R	14188	84	110	20	586	76

110" wide - vertical storage with 5 adj. shelves, 60" wide work surface wall credenza, 60" wide double height niche, 60" wide double height storage, double depth wardrobe with coat rod and hat shelf

- To add Tackboard to niche, add "TB" at the end of the product code and add \$875 to the list price
- To add LED Light to niche, add "LT" at the end of the product code and add \$599 to the list price

FW12584OIL • 125" wide x 84" high Open Knee Space Work Wall

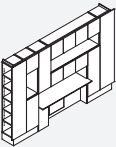

PRODUCT CODE	PRICE	SIZE / INCHES			WEIGHT VOL	
		H	W	D	LBS	FT ³
FW12584OIL	19465	84	125	20	832	96

125" wide - vertical storage with 5 adj. shelves, triple height storage, 15" wide triple height storage, 15" wide double height niche, single high storage, 60" wide work surface wall credenza, 60" wide single height niche, triple height storage, 45" wide single height storage, 60" wide single height niche, 60" wide single height storage, triple height storage, wardrobe with coat hook and hat shelf

- To add Tackboard to niche, add "TB" at the end of the product code and add \$1724 to the list price
- To add LED Light to niche, add "LT" at the end of the product code and add \$1210 to the list price

FW9026-1 • 90" wide x 26" high Work Wall Credenza

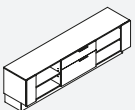

PRODUCT CODE	PRICE	SIZE / INCHES			WEIGHT VOL	
		H	W	D	LBS	FT ³
FW9026-1	7295	26	90	20	254	27

90" wide - wall credenza with adj. shelf, box/file and adj. shelf

FW9026-2 • 90" wide x 26" high Work Wall Credenza

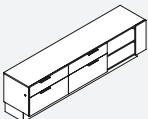

PRODUCT CODE	PRICE	SIZE / INCHES			WEIGHT VOL	
		H	W	D	LBS	FT ³
FW9026-2	7606	26	90	20	270	27

90" wide - wall credenza with box/file, box/file and adj. shelf

FW9026-3 • 90" wide x 26" high Work Wall Credenza

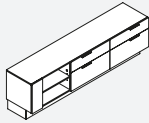

PRODUCT CODE	PRICE	SIZE / INCHES			WEIGHT VOL	
		H	W	D	LBS	FT ³
FW9026-3	7606	26	90	20	270	27

90" wide - wall credenza with adj. shelf, box/file and box/file

FW9026-4 • 90" wide x 26" high Work Wall Credenza

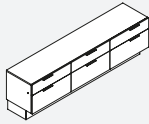

PRODUCT CODE	PRICE	SIZE / INCHES			WEIGHT VOL	
		H	W	D	LBS	FT ³
FW9026-4	8071	26	90	20	310	27

90" wide - wall credenza with three box/files

Note: Centre Pedestal does not have a lock.

CONFERENCE ROOM FURNITURE • TECHNICAL INFORMATION

- Horizontal grain direction is standard on all engineered finishes. If natural veneer is required, the grain direction will be vertical - Add suffix "VG" to the end of the product code
- Full Storage Credenza backs include GM17 vertical cut out (see page A12)
- Optional decorative credenza back panels (FBP) are available for full storage credenzas FC/FCD
- Doors open with touch latch
- To open the drawer, pull drawer front overhang - no handles available.
- Display Wall can be purchased with optional monitor mount installed.
- Mobile and stationary lecterns are available.
- For optional light and microphone see page M.4 in the accessories section.
- See page A.17 for metal colour finish.

NOTE: Arrow indicates direction of grain.

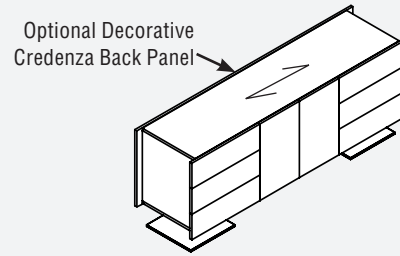

FC-xx • Full Storage Credenza with two sets of Storage Cabinets

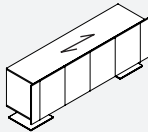

PRODUCT CODE	PRICE	SIZE (INCHES)			WEIGHT LBS	VOL FT3
		H	W	D		
FC9020GG	6170	29	90	20	241	36
FC8420GG	5924	29	84	20	232	33
FC7820GG	5502	29	78	20	223	31
FC7220GG	5350	29	72	20	213	29
FC6020MM	4969	29	60	20	194	26

FCD-A • Full Storage Credenza with BBB on Left, Storage Cabinet and BBB on Right

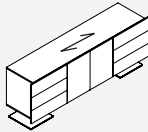

PRODUCT CODE	PRICE	SIZE (INCHES)			WEIGHT LBS	VOL FT3
		H	W	D		
FCD9020A	6537	29	90	20	249	36
FCD8420A	6294	29	84	20	240	33
FCD7820A	5843	29	78	20	230	31
FCD7220A	5718	29	72	20	221	29
FCD6020A	5339	29	60	20	202	26

FBP • Decorative Credenza Back Panel

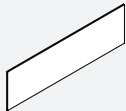

PRODUCT CODE	PRICE	SIZE (INCHES)			WEIGHT LBS	VOL FT3
		H	W	D		
FBP9020	1053	22	90	0.75	41	4
FBP8420	1001	22	84	0.75	38	4
FBP7820	929	22	78	0.75	36	3
FBP7220	810	22	72	0.75	33	3
FBP6020	687	22	60	0.75	27	3

FC-GGTWH • Full Storage Credenza with two sets of Storage Cabinets and Display Wall

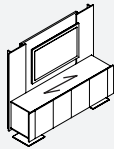

PRODUCT CODE	PRICE	SIZE (INCHES)			WEIGHT LBS	VOL FT3
		H	W	D		
FC9024GGTWH72	9561	72	90	24	463	47
FC8424GGTWH72	9108	72	84	24	444	44
FC7824GGTWH72	8459	72	78	24	424	41
FC7224GGTWH72	8203	72	72	24	403	38
FC9024GGTWH66	9231	66	90	24	425	47
FC8424GGTWH66	8866	66	84	24	406	44
FC7824GGTWH66	8232	66	78	24	286	41
FC7224GGTWH66	7979	66	72	24	365	38

Monitor Size Chart based on Display Wall Size:

Display Wall Width	Monitor Size
90"	54"
84"	50"
78"	46"
72"	42"

Note: Monitors and TV Mounts are not included
Display Wall includes GM1

FCD-ATWH • Full Storage Credenza with BBB, Storage Cabinet, BBB and Display Wall

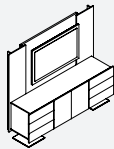

PRODUCT CODE	PRICE	SIZE (INCHES)			WEIGHT LBS	VOL FT3
		H	W	D		
FCD9024ATWH72	9710	72	90	24	481	48
FCD8424ATWH72	9256	72	84	24	460	45
FCD7824ATWH72	8607	72	78	24	439	42
FCD7224ATWH72	8353	72	72	24	418	39
FCD9024ATWH66	9378	66	90	24	444	48
FCD8424ATWH66	9016	66	84	24	422	45
FCD7824ATWH66	8381	66	78	24	402	42
FCD7224ATWH66	8127	66	72	24	381	39

Monitor Size Chart based on Display Wall Size:

Display Wall Width	Monitor Size
90"	54"
84"	50"
78"	46"
72"	42"

Note: Monitors and TV Mounts are not included
Display Wall includes GM1

FFTWA-WH • Full Storage Credenza with BB, Storage Cabinet, BB and Disolav Wall

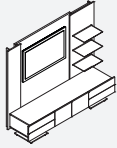

PRODUCT CODE	PRICE	SIZE (INCHES)			WEIGHT LBS	VOL FT3
		H	W	D		
FFTWA90WH72	10161	72	90	24	482	41
FFTWA84WH72	9816	72	84	24	462	38
FFTWA78WH72	9310	72	78	24	442	35
FFTWA72WH72	8752	72	72	24	421	32
FFTWA90WH66	9832	66	90	24	462	40
FFTWA84WH66	9485	66	84	24	443	37
FFTWA78WH66	8996	66	78	24	424	34
FFTWA72WH66	8492	66	72	24	404	31

Monitor Size Chart based on Display Wall Size:

Display Wall Width	Monitor Size
90"	54"
84"	48"
78"	42"
72"	36"

Note: Monitors and TV Mounts are not included

FVMED • TV Mount for Flat Screen Monitors up to 50"

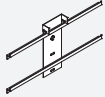

PRODUCT CODE	PRICE	SIZE (INCHES)			WEIGHT LBS	VOL FT3
		H	W	D		
FVMED	409	17	28	2	14	0.7

FVLRG • TV Mount for Flat Screen Monitors over 50"



PRODUCT CODE	PRICE	SIZE (INCHES)			WEIGHT LBS	VOL FT3
		H	W	D		
FVLRG	473	21	38	2	25	0.75

FLEC-36 • Lectern

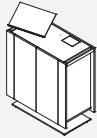

PRODUCT CODE	PRICE	SIZE (INCHES)			WEIGHT LBS	VOL FT3
		H	W	D		
FLEC36	5905	42	36	20	166	22

- With pop-up door to reveal concealed Power/Data monument (power duplex, 15 pin VGA, data and telephone connectors)
- Optional Light and/or Microphone to be specified
- Metal finish on base, book rest and handles must be specified
- Includes 1 adj. shelf

FLEC-24 • Lectern

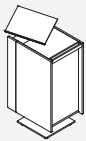

PRODUCT CODE	PRICE	SIZE (INCHES)			WEIGHT LBS	VOL FT3
		H	W	D		
FLEC24	4871	42	24	20	135	15

- With Laptop pull-out tray to reveal concealed Power/Data monument (power duplex, 15 pin VGA, data and telephone connectors)
- Optional Light or Microphone to be specified
- Metal finish on base, book rest and handles must be specified
- Includes 1 adj. shelf

FLEC-24M • Mobile Lectern

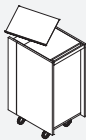

PRODUCT CODE	PRICE	SIZE (INCHES)			WEIGHT LBS	VOL FT3
		H	W	D		
FLEC24M	3611	42	24	20	135	15

- With Laptop pull-out tray
- Metal finish on base, book rest and handles must be specified
- Includes 1 adj. shelf
- With locking casters (Tungsten only)

FSM • Mobile Server

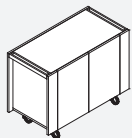

PRODUCT CODE	PRICE	SIZE (INCHES)			WEIGHT LBS	VOL FT3
		H	W	D		
FSM4020	3932	30	40	20	108	21

- With cutlery drawer and adj. shelf
- Metal finish on handles must be specified
- With locking casters (Tungsten only)

FTCM • Mobile Tech Cart

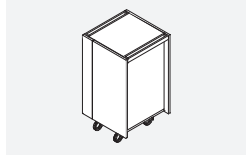

PRODUCT CODE	PRICE	SIZE (INCHES)			WEIGHT LBS	VOL FT3
		H	W	D		
FTCM2020H42	2865	42	20	20	67	13.5
FTCM2020H36	2458	36	20	20	54	10.5

- Metal finish on handles must be specified
- Includes 1 adj. shelf
- With locking casters (Tungsten only)

CONFERENCE TABLES • TECHNICAL INFORMATION

- Descor is offering a variety of Foundations Conference Tables.
- Table tops are 1 1/2" thick with a 2" undercut knife edge.
- All tops have a 1/8" (3mm) solid edge of walnut, cherry, maple and oak.
- For optional grommet location on tables without Technology Trough see page A.14
- See Technology Trough details on page A.16
- For Tables with 3 Bases and Technology Trough please add "C" (for Centre Base Feed) or "E" (for End Base Feed) to the end of the product code
Example FRESTCT19298C

Foundations Conference Table Edge

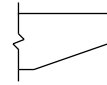

FRE • Rectangular Shaped Conference Table, one piece top

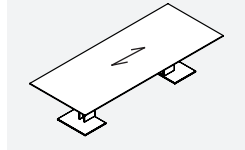

PRODUCT CODE	PRICE	SIZE (INCHES)			WEIGHT LBS	VOL FT3	• With 2 Bases
		H	W	D			
FRE12048	8360	29	120	48	450	54	
FRE9648	7573	29	96	48	390	49	

FRE • Rectangular Shaped Conference Table, two piece top

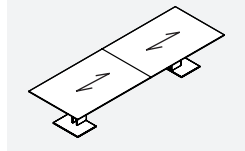

PRODUCT CODE	PRICE	SIZE (INCHES)			WEIGHT LBS	VOL FT3	• With 2 Bases
		H	W	D			
FRE16848	10212	29	168	48	571	65	
FRE14448	9248	29	144	48	511	60	
FRE12048-2	8472	29	120	48	450	56	

FRE • Rectangular Shaped Conference Table, two piece top

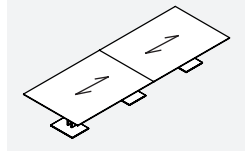

PRODUCT CODE	PRICE	SIZE (INCHES)			WEIGHT LBS	VOL FT3	• With 3 Bases
		H	W	D			
FRE24060	16302	29	240	60	965	109	
FRE21660	15388	29	216	60	893	104	
FRE19260	14443	29	192	60	821	99	
FRE16860	13510	29	168	60	748	93	
FRE21648	14122	29	216	48	872	87	
FRE19248	13284	29	192	48	774	82	

FREST • Rectangular Shaped Sectional Conference Table

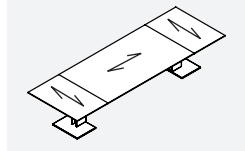

PRODUCT CODE	PRICE	SIZE (INCHES)			WEIGHT LBS	VOL FT3	• With 2 Bases
		H	W	D			
FREST16848	10410	29	168	48	571	65	
FREST14448	9585	29	144	48	511	60	
FREST12048	8754	29	120	48	450	54	

FREST • Rectangular Shaped Sectional Conference Table

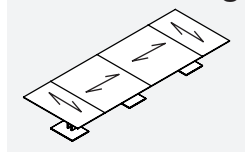

PRODUCT CODE	PRICE	SIZE (INCHES)			WEIGHT LBS	VOL FT3	• With 3 Bases
		H	W	D			
FREST24060	16654	29	240	60	965	109	
FREST21660	15723	29	216	60	893	104	
FREST19260	14673	29	192	60	821	99	
FREST16860	13667	29	168	60	748	93	
FREST21648	14508	29	216	48	872	87	• 168" Midsection in one piece
FREST19248	13612	29	192	48	744	82	

FRESTCT • Rectangular Shaped Sectional Conference Table

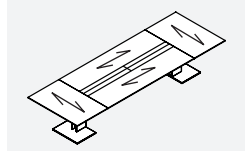

PRODUCT CODE	PRICE	SIZE (INCHES)			WEIGHT LBS	VOL FT3	• With 2 Bases / Power Kit included
		H	W	D			
FRESTCT16848	15883	29	168	48	659	69	• Technology Trough with 8 doors
FRESTCT14448	12723	29	144	48	584	63	• Technology Trough with 4 doors
FRESTCT12048	11797	29	120	48	508	57	• Technology Trough with 4 doors

FRESTCT • Rectangular Shaped Sectional Conference Table

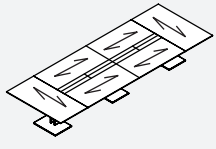

PRODUCT CODE	PRICE	SIZE (INCHES)			WEIGHT LBS	VOL FT3
		H	W	D		
FRESTCT24060	23216	29	240	60	1113	116
FRESTCT21660	21982	29	216	60	1021	109
FRESTCT19260	20651	29	192	60	920	103
FRESTCT16860	19272	29	168	60	836	96
FRESTCT21648	20828	29	216	48	1000	92
FRESTCT19248	19617	29	192	48	843	87

- With 3 Bases / Add C or E (Base Feed Location)
- Technology Trough with 8 doors
- 168" Midsection in one pieces

FREBE • Rectangular Shaped Conference Table with Bow Ends, one piece top

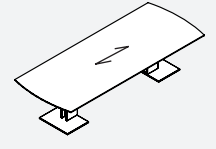

PRODUCT CODE	PRICE	SIZE (INCHES)			WEIGHT LBS	VOL FT3
		H	W	D		
FREBE12048	8780	29	120	48	450	54
FREBE9648	7950	29	96	48	390	49

- With 2 Bases

FREBE • Rectangular Shaped Conference Table with Bow Ends, two piece top

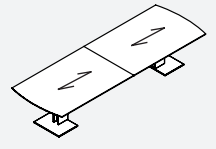

PRODUCT CODE	PRICE	SIZE (INCHES)			WEIGHT LBS	VOL FT3
		H	W	D		
FREBE16848	10722	29	168	48	571	65
FREBE14448	9711	29	148	48	511	60
FREBE12048-2	8895	29	120	48	450	55

- With 2 Bases

FREBE • Rectangular Shaped Conference Table with Bow Ends, two piece top

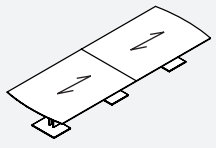

PRODUCT CODE	PRICE	SIZE (INCHES)			WEIGHT LBS	VOL FT3
		H	W	D		
FREBE24060	17118	29	240	60	965	109
FREBE21660	16156	29	216	60	893	104
FREBE19260	15164	29	192	60	821	99
FREBE16860	14186	29	168	60	748	93
FREBE21648	14826	29	216	48	872	87
FREBE19248	13947	29	192	48	744	82

- With 3 Bases

FREBEST • Rectangular Shaped Sectional Conference Table with Bow Ends

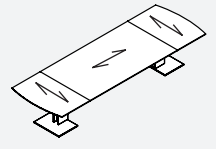

PRODUCT CODE	PRICE	SIZE (INCHES)			WEIGHT LBS	VOL FT3
		H	W	D		
FREBEST16848	10928	29	168	48	571	65
FREBEST14448	10063	29	144	48	511	60
FREBEST12048	9191	29	120	48	450	55

- With 2 Bases

FREBEST • Rectangular Shaped Sectional Conference Table with Bow Ends

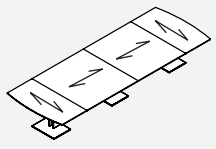

PRODUCT CODE	PRICE	SIZE (INCHES)			WEIGHT LBS	VOL FT3
		H	W	D		
FREBEST24060	17486	29	240	60	965	109
FREBEST21660	16506	29	216	60	893	104
FREBEST19260	15406	29	192	60	821	99
FREBEST16860	14352	29	168	60	748	93
FREBEST21648	15232	29	216	48	872	87
FREBEST19248	14293	29	192	48	744	82

- With 3 Bases

- 168" Midsection in one pieces

FREBESTCT • Rectangular Shaped Sectional Conference Table with Bow Ends

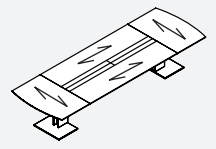

PRODUCT CODE	PRICE	SIZE (INCHES)			WEIGHT LBS	VOL FT3
		H	W	D		
FREBESTCT16848	16676	29	168	48	659	69
FREBESTCT14448	13360	29	144	48	584	63
FREBESTCT12048	12385	29	120	48	508	57

- With 2 Bases / Power Kit included

- Technology Trough with 8 doors
- Technology Trough with 4 doors
- Technology Trough with 4 doors

FREBESTCT • Rectangular Shaped Sectional Conference Table with Bow Ends

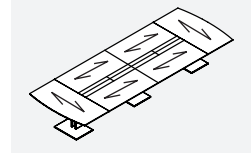

PRODUCT CODE	PRICE	SIZE (INCHES)			WEIGHT LBS	VOL FT3
		H	W	D		
FREBESTCT24060	24376	29	240	60	1113	116
FREBESTCT21660	23080	29	216	60	1021	109
FREBESTCT19260	21681	29	192	60	920	103
FREBESTCT16860	20237	29	168	60	836	96
FREBESTCT21648	21867	29	216	48	1000	92
FREBESTCT19248	20598	29	192	48	843	87

- With 3 Bases / Add C or E (Base Feed Location)
- Technology Trough with 8 doors
- 168" Midsection in one pieces

FBO • Boat Shaped Conference Table, one piece top

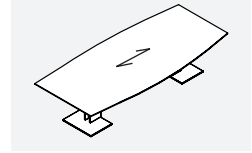

PRODUCT CODE	PRICE	SIZE (INCHES)			WEIGHT LBS	VOL FT3
		H	W	D		
FBO12048	9216	29	120	48	450	54
FBO9648	8346	29	96	48	390	49

- With 2 Bases

FBO • Boat Shaped Conference Table, two piece top

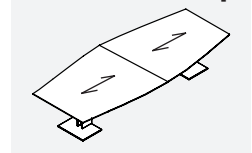

PRODUCT CODE	PRICE	SIZE (INCHES)			WEIGHT LBS	VOL FT3
		H	W	D		
FBO16848	11257	29	168	48	571	65
FBO14448	10195	29	144	48	511	60
FBO12048-2	9339	29	120	48	450	55

- With 2 Bases

FBO • Boat Shaped Conference Table, two piece top

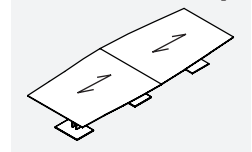

PRODUCT CODE	PRICE	SIZE (INCHES)			WEIGHT LBS	VOL FT3
		H	W	D		
FBO24060	17972	29	240	60	965	109
FBO21660	16962	29	216	60	893	104
FBO19260	15923	29	192	60	821	99
FBO16860	14892	29	168	60	748	93
FBO21648	15567	29	216	48	872	87
FBO19248	14643	29	192	48	744	82

- With 3 Bases

FBOST • Boat Shaped Sectional Conference Table

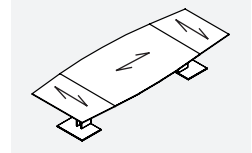

PRODUCT CODE	PRICE	SIZE (INCHES)			WEIGHT LBS	VOL FT3
		H	W	D		
FBOST16848	11473	29	168	48	571	65
FBOST14448	10566	29	144	48	511	60
FBOST12048	9650	29	120	48	450	56

- With 2 Bases

FBOST • Boat Shaped Sectional Conference Table

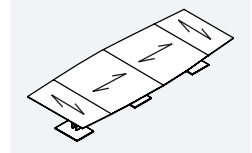

PRODUCT CODE	PRICE	SIZE (INCHES)			WEIGHT LBS	VOL FT3
		H	W	D		
FBOST24060	18361	29	240	60	965	109
FBOST21660	17331	29	216	60	893	104
FBOST19260	16175	29	192	60	821	99
FBOST16860	15067	29	168	60	748	93
FBOST21648	15992	29	216	48	872	87
FBOST19248	15006	29	192	48	744	82

- With 3 Bases

- 168" Midsection in one pieces

FBOSTCT • Boat Shaped Sectional Conference Table

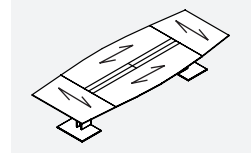

PRODUCT CODE	PRICE	SIZE (INCHES)			WEIGHT LBS	VOL FT3
		H	W	D		
FBOSTCT16848	17510	29	168	48	659	69
FBOSTCT14448	14025	29	144	48	584	63
FBOSTCT12048	13006	29	120	48	508	57

- With 2 Bases / Power Kit included

- Technology Trough with 8 doors
- Technology Trough with 4 doors
- Technology Trough with 4 doors

FBOSTCT • Boat Shaped Sectional Conference Table

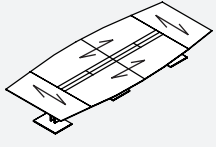

PRODUCT CODE	PRICE	SIZE (INCHES)			WEIGHT LBS	VOL FT3
		H	W	D		
FBOSTCT24060	25592	29	240	60	1113	116
FBOSTCT21660	24233	29	216	60	1021	109
FBOSTCT19260	22765	29	192	60	920	103
FBOSTCT16860	21247	29	168	60	836	96
FBOSTCT21648	22666	29	216	48	1000	92
FBOSTCT19248	21624	29	192	48	843	87

- With 3 Bases / Add C or E (Base Feed Location)
- Technology Trough with 8 doors
- 168" Midsection in one pieces

FBOBE • Boat Shaped Conference Table, one piece top

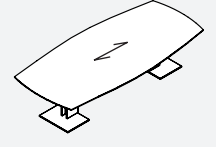

PRODUCT CODE	PRICE	SIZE (INCHES)			WEIGHT LBS	VOL FT3
		H	W	D		
FBOBE12048	9529	29	120	48	450	54
FBOBE9648	8616	29	96	48	390	49

- With 2 Bases

FBOBE • Boat Shaped Conference Table, two piece top

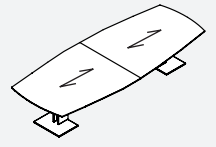

PRODUCT CODE	PRICE	SIZE (INCHES)			WEIGHT LBS	VOL FT3
		H	W	D		
FBOBE16848	11673	29	168	48	571	65
FBOBE14448	10555	29	144	48	511	60
FBOBE12048-2	9658	29	120	48	450	55

- With 2 Bases

FBOBE • Boat Shaped Conference Table, two piece top

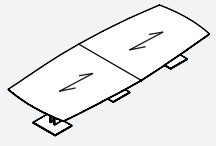

PRODUCT CODE	PRICE	SIZE (INCHES)			WEIGHT LBS	VOL FT3
		H	W	D		
FBOBE24060	18724	29	240	60	965	109
FBOBE21660	17661	29	216	60	893	104
FBOBE19260	16571	29	192	60	821	99
FBOBE16860	15490	29	168	60	748	93
FBOBE21648	16197	29	216	48	872	87
FBOBE19248	15226	29	192	48	744	82

- With 3 Bases

FBOBEST • Boat Shaped Sectional Conference Table

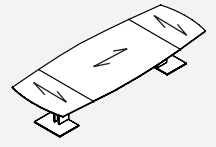

PRODUCT CODE	PRICE	SIZE (INCHES)			WEIGHT LBS	VOL FT3
		H	W	D		
FBOBEST16848	11900	29	168	48	571	65
FBOBEST14448	10947	29	144	48	511	60
FBOBEST12048	9979	29	120	48	450	56

- With 2 Bases

FBOBEST • Boat Shaped Sectional Conference Table

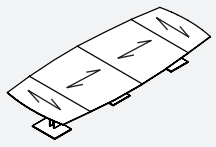

PRODUCT CODE	PRICE	SIZE (INCHES)			WEIGHT LBS	VOL FT3
		H	W	D		
FBOBEST24060	19129	29	240	60	965	109
FBOBEST21660	18049	29	216	60	893	104
FBOBEST19260	16681	29	192	60	821	99
FBOBEST16860	15671	29	168	60	748	93
FBOBEST21648	16643	29	216	48	872	87
FBOBEST19248	15607	29	192	48	744	82

- With 3 Bases

- 168" Midsection in one pieces

FBOBESTCT • Boat Shaped Sectional Conference Table

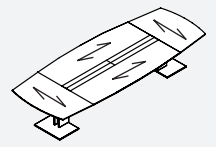

PRODUCT CODE	PRICE	SIZE (INCHES)			WEIGHT LBS	VOL FT3
		H	W	D		
FBOBESTCT16848	18237	29	168	48	659	69
FBOBESTCT14448	14577	29	144	48	584	63
FBOBESTCT12048	13506	29	120	48	508	57

- With 2 Bases / Power Kit included

- Technology Trough with 8 doors
- Technology Trough with 4 doors
- Technology Trough with 4 doors

FBOBESTCT • Boat Shaped Sectional Conference Table

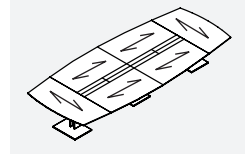

PRODUCT CODE	PRICE	SIZE (INCHES)			WEIGHT LBS	VOL FT3
		H	W	D		
FBOBESTCT24060	26724	29	240	60	1113	116
FBOBESTCT21660	25296	29	216	60	1021	109
FBOBESTCT19260	23755	29	192	60	920	103
FBOBESTCT16860	22169	29	168	60	836	96
FBOBESTCT21648	23650	29	216	48	1000	92
FBOBESTCT19248	22558	29	192	48	843	87

- With 3 Bases / Add C or E (Base Feed Location)
- Technology Trough with 8 doors
- 168" Midsection in one pieces

FRA • Racetrack Conference Table, one piece top

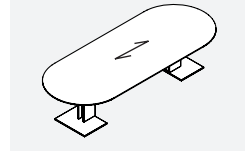

PRODUCT CODE	PRICE	SIZE (INCHES)			WEIGHT LBS	VOL FT3
		H	W	D		
FRA12048	9675	29	120	48	450	54
FRA9648	8763	29	96	48	390	49

- With 2 Bases

FRA • Racetrack Conference Table, two piece top

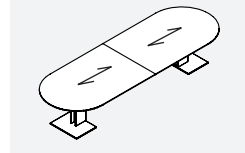

PRODUCT CODE	PRICE	SIZE (INCHES)			WEIGHT LBS	VOL FT3
		H	W	D		
FRA16848	11819	29	168	48	571	65
FRA14448	10705	29	144	48	511	60
FRA12048-2	9805	29	120	48	450	55

- With 2 Bases

FRA • Racetrack Conference Table, two piece top

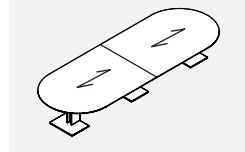

PRODUCT CODE	PRICE	SIZE (INCHES)			WEIGHT LBS	VOL FT3
		H	W	D		
FRA24060	18871	29	240	60	965	109
FRA21660	17812	29	216	60	893	104
FRA19260	16718	29	192	60	821	99
FRA16860	15637	29	168	60	748	93
FRA21648	16344	29	216	48	872	87
FRA19248	15375	29	192	48	744	82

- With 3 Bases

FRAST • Racetrack Sectional Conference Table

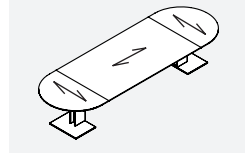

PRODUCT CODE	PRICE	SIZE (INCHES)			WEIGHT LBS	VOL FT3
		H	W	D		
FRAST16848	12048	29	168	48	571	65
FRAST14448	11093	29	144	48	511	60
FRAST12048	10127	29	120	48	450	55

- With 2 Bases

FRAST • Racetrack Sectional Conference Table

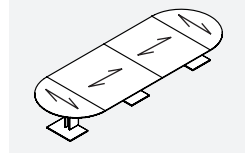

PRODUCT CODE	PRICE	SIZE (INCHES)			WEIGHT LBS	VOL FT3
		H	W	D		
FRAST24060	19276	29	240	60	965	109
FRAST21660	18197	29	216	60	893	104
FRAST19260	16829	29	192	60	821	99
FRAST16860	15821	29	168	60	748	93
FRAST21648	16792	29	216	48	872	87
FRAST19248	15754	29	192	48	744	82

- With 3 Bases

- 168" Midsection in one pieces

FRASTCT • Racetrack Sectional Conference Table

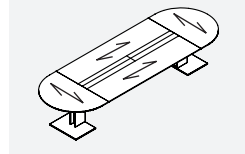

PRODUCT CODE	PRICE	SIZE (INCHES)			WEIGHT LBS	VOL FT3
		H	W	D		
FRASTCT16848	18384	29	168	48	659	69
FRASTCT14448	14726	29	144	48	584	63
FRASTCT12048	13655	29	120	48	508	57

- With 2 Bases / Power Kit included

- Technology Trough with 8 doors
- Technology Trough with 4 doors
- Technology Trough with 4 doors

FRASTCT • Racetrack Sectional Conference Table

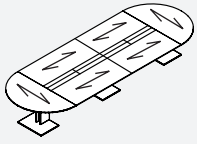

PRODUCT CODE	PRICE	SIZE (INCHES)			WEIGHT LBS	VOL FT3
		H	W	D		
FRASTCT24060	26871	29	240	60	1113	116
FRASTCT21660	25445	29	216	60	1021	109
FRASTCT19260	23902	29	192	60	920	103
FRASTCT16860	22310	29	168	60	836	96
FRASTCT21648	23798	29	216	48	1000	92
FRASTCT19248	22706	29	192	48	843	87

- With 3 Bases / Add C or E (Base Feed Location)
- Technology Trough with 8 doors
- 168" Midsection in one pieces

FWE • Wedge Shaped Conference Table, one piece top

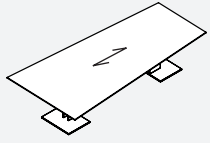

PRODUCT CODE	PRICE	SIZE (INCHES)			WEIGHT LBS	VOL FT3
		H	W	D		
FWE1206048	8509	29	120	60/48	511	60

- With 2 Bases

FWE • Wedge Shaped Conference Table, two piece top

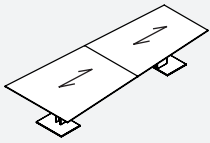

PRODUCT CODE	PRICE	SIZE (INCHES)			WEIGHT LBS	VOL FT3
		H	W	D		
FWE1446048	10360	29	144	60/48	571	65
FWE1206048-2	9396	29	120	60/48	511	60

- With 2 Bases

FWE • Wedge Shaped Conference Table, two piece top

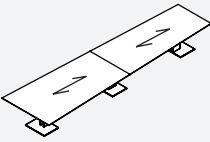

PRODUCT CODE	PRICE	SIZE (INCHES)			WEIGHT LBS	VOL FT3
		H	W	D		
FWE2406048	16450	29	240	60/48	1037	114
FWE2166048	15536	29	216	60/48	965	109
FWE1926048	14591	29	192	60/48	893	104
FWE1686048	13658	29	168	60/48	630	70

- With 3 Bases

FWEST • Wedge Shaped Sectional Conference Table

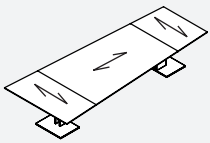

PRODUCT CODE	PRICE	SIZE (INCHES)			WEIGHT LBS	VOL FT3
		H	W	D		
FWEST1446048	10557	29	144	60/48	571	65
FWEST1206048	9732	29	120	60/48	511	60

- With 2 Bases

FWEST • Wedge Shaped Sectional Conference Table

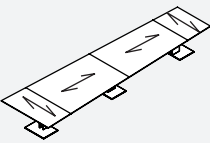

PRODUCT CODE	PRICE	SIZE (INCHES)			WEIGHT LBS	VOL FT3
		H	W	D		
FWEST2406048	16507	29	240	60/48	1037	114
FWEST2166048	15869	29	216	60/48	965	109
FWEST1926048	15406	29	192	60/48	893	104
FWEST1686048	13816	29	168	60/48	630	70

- With 3 Bases

- 168" Midsection in one pieces

FWESTCT • Wedge Shaped Sectional Conference Table

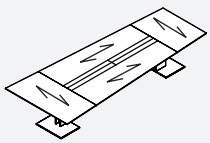

PRODUCT CODE	PRICE	SIZE (INCHES)			WEIGHT LBS	VOL FT3
		H	W	D		
FWESTCT1446048	16036	29	144	60/48	571	65
FWESTCT1206048	12873	29	120	60/48	511	60

- With 2 Bases / Power Kit included
- Technology Trough with 4 doors

FWESTCT • Wedge Shaped Sectional Conference Table

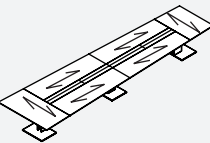

PRODUCT CODE	PRICE	SIZE (INCHES)			WEIGHT LBS	VOL FT3
		H	W	D		
FWESTCT2406048	23364	29	240	60/48	1037	114
FWESTCT2166048	22130	29	216	60/48	965	109
FWESTCT1926048	20651	29	192	60/48	893	104
FWESTCT1686048	19421	29	168	60/48	823	99

- With 3 Bases / Add C or E (Base Feed Location)
- Technology Trough with 8 doors

- 168" Midsection in one pieces

FRE • Square Table

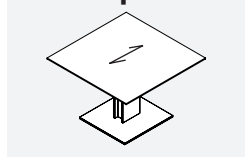

PRODUCT CODE	PRICE	SIZE (INCHES)			WEIGHT LBS	VOL FT3
		H	W	D		
FRE6060	4960	29	60	60	261	44
FRE5454	4629	29	54	54	233	42
FRE4848	4282	29	48	48	207	40
FRE4242	4021	29	42	42	185	39

- With Mono Base
- No Grommet option available

FRO • Round Table

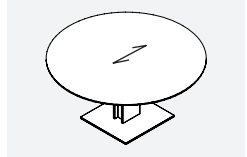

PRODUCT CODE	PRICE	SIZE (INCHES)			WEIGHT LBS	VOL FT3
		H	W	D		
FRO60	5209	29	60	60	261	44
FRO54	4862	29	54	54	233	42
FRO48	4497	29	48	48	207	40
FRO42	4223	29	42	42	185	39

- With Mono Base
- No Grommet option available

BTC001 • Vault Conference Power Grommet

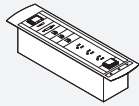

PRODUCT CODE	PRICE	SIZE / INCHES			WEIGHT VOL	
		H	W	D	LBS	FT ³
BTC001	1798	4	16	4.5	1	1

- incl. 3 Power, 3 Data and VGA
- Motorized touch control rotates top to reveal or conceal data/power connections
- 5' cord with 3 prong plug, anodized only

BTC002 • Vault Conference Power Grommet

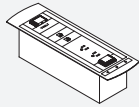

PRODUCT CODE	PRICE	SIZE / INCHES			WEIGHT VOL	
		H	W	D	LBS	FT ³
BTC002	1691	4	14	4.5		

- incl. 3 Power, 2 Data
- Motorized touch control rotates top to reveal or conceal data/power connections
- 5' cord with 3 prong plug, anodized only

BTC003 • Vault Desk Power Grommet

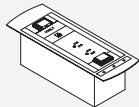

PRODUCT CODE	PRICE	SIZE / INCHES			WEIGHT VOL	
		H	W	D	LBS	FT ³
BTC003	1650	4	12	4.5		

- incl. 2 Power, 1 Data
- Motorized touch control rotates top to reveal or conceal data/power connections
- 5' cord with 3 prong plug, anodized only

DSRTMCS401 • Recessed Power Block



PRODUCT CODE	PRICE	SIZE / INCHES			WEIGHT VOL	
		H	W	D	LBS	FT ³
DSRTMCS401B	578	4.86	10.78	4.22	4.3	.51
DSRTMCS401T	578	4.86	10.78	4.22	4.3	.51
DSRTMCS401W	578	4.86	10.78	4.22	4.3	.51

NOTE: Cutout for each Recessed power block is available at an upcharge \$91.

- Single sided recessed power block with 1 regular duplex and 1 data knock-out on top, 1 power duplex on bottom. 10 ft power cord with straight plug.
- Telecom plates ordered separately.
- Available in Black - B, Tungsten - T or Designer White - W.

DSRTMCS421 • Recessed Power Block



PRODUCT CODE	PRICE	SIZE / INCHES			WEIGHT VOL	
		H	W	D	LBS	FT ³
DSRTMCS421B	759	4.86	10.78	4.22	4.5	.51
DSRTMCS421T	759	4.86	10.78	4.22	4.5	.51
DSRTMCS421W	759	4.86	10.78	4.22	4.5	.51

NOTE: Cutout for each Recessed power block is available at an upcharge \$91.

- Single sided recessed power block with 1 power & USB A+C duplex and 1 data knock-out on top, 1 power duplex on bottom. USB Type A port charges max 2.4 amps at 5V and Type C port charges max 3 amps at 5V. 10 ft power cord with straight plug.
- Telecom plates ordered separately.
- Available in Black - B, Tungsten - T or Designer White - W.

DSRTMCD602 • Recessed Power Block



PRODUCT CODE	PRICE	SIZE / INCHES			WEIGHT VOL	
		H	W	D	LBS	FT ³
DSRTMCD602B	660	4.86	10.78	6.22	5.9	.51
DSRTMCD602T	660	4.86	10.78	6.22	5.9	.51
DSRTMCD602W	660	4.86	10.78	6.22	5.9	.51

NOTE: Cutout for each Recessed power block is available at an upcharge \$91.

- Double sided recessed power block with 2 regular power duplexes and 2 data knock-outs on top, 1 power duplex on bottom. 10 ft power cord with straight plug.
- Telecom plates ordered separately.
- Available in Black - B, Tungsten - T or Designer White - W.

DSRTMCD622 • Recessed Power Block



PRODUCT CODE	PRICE	SIZE / INCHES			WEIGHT VOL	
		H	W	D	LBS	FT ³
DSRTMCD622B	831	4.86	10.78	6.22	6.1	.51
DSRTMCD622T	831	4.86	10.78	6.22	6.1	.51
DSRTMCD622W	831	4.86	10.78	6.22	6.1	.51

NOTE: Cutout for each Recessed power block is available at an upcharge \$91.

- Double sided recessed power block with 1 regular power duplex, 1 power & USB A+C duplex and 2 data knock-outs on top, 1 power duplex on bottom. USB Type A port charges max 2.4 amps at 5V and Type C port charges max 3 amps at 5V. 10 ft power cord with straight plug.
- Telecom plates ordered separately.
- Available in Black - B, Tungsten - T or Designer White - W.

DSRTMCD642 • Recessed Power Block

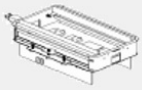

PRODUCT CODE	PRICE	SIZE / INCHES			WEIGHT VOL	
		H	W	D	LBS	FT ³
DSRTMCD642B	1001	4.86	10.78	6.22	6.3	.51
DSRTMCD642T	1001	4.86	10.78	6.22	6.3	.51
DSRTMCD642W	1001	4.86	10.78	6.22	6.3	.51

NOTE: Cutout for each Recessed power block is available at an upcharge \$91.

- Double sided recessed power block with 2 power & USB A+C duplexes and 2 data knock-outs on top, 1 power duplex on bottom. USB Type A port charges max 2.4 amps at 5V and Type C port charges max 3 amps at 5V. 10 ft power cord with straight plug
- Telecom plates ordered separately.
- Available in Black - B, Tungsten - T or Designer White - W.

ABLBB • Telcom Plate



PRODUCT CODE	PRICE	SIZE / INCHES			WEIGHT VOL	
		H	W	D	LBS	FT ³
ABLBB	286					

- Black telcom plate with two RJ45 cat 6 data

ABLBBBB • Telcom Plate



PRODUCT CODE	PRICE	SIZE / INCHES			WEIGHT VOL	
		H	W	D	LBS	FT ³
ABLBBBB	555					

- Black telcom plate with four RJ45 cat 6 data

ABLABC514 • Telcom Plate



PRODUCT CODE	PRICE	SIZE / INCHES			WEIGHT VOL	
		H	W	D	LBS	FT ³
ABLABC514	442					

- Black telcom plate with one RJ11 cat 3 phone, one RJ45 cat 6 data, one mini stereo and 15 pin HD VGA

ABLC51L • Telcom Plate

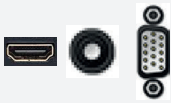

PRODUCT CODE	PRICE	SIZE / INCHES			WEIGHT VOL	
		H	W	D	LBS	FT ³
ABLC51L	631					

- Black telcom plate with one mini stereo, one 15 pin HD VGA and one HDMI

ABLABC45 • Telcom Plate

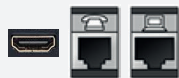

PRODUCT CODE	PRICE	SIZE / INCHES			WEIGHT VOL	
		H	W	D	LBS	FT ³
ABLABC45	494					

- Black telcom plate with one RJ11 cat 3 phone, one RJ45 cat 6 data and one HDMI

ABL102102 • Telcom Plate



PRODUCT CODE	PRICE	SIZE / INCHES			WEIGHT VOL	
		H	W	D	LBS	FT ³
ABL102102	260					

- Black telcom plate with two USB

LED • LED Light

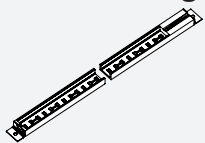

PRODUCT CODE	PRICE	SIZE / INCHES			WEIGHT VOL	
		H	W	D	LBS	FT ³
LED48	630	1	48	1	1	1
LED36	511	1	36	1	1	1
LED24	387	1	24	1	1	1
LED12	242	1	12	1	1	1

VVACSBLK • Wire Management Snake

PRODUCT CODE	PRICE	SIZE / INCHES			WEIGHT VOL	
		H	W	D	LBS	FT ³
VVACSBLK (Black)	238	39	2	2	3	0.5

LIG • LED Snake Light with dimmer

PRODUCT CODE	PRICE	SIZE / INCHES			WEIGHT VOL	
		H	W	D	LBS	FT ³
LIG400	300	13	6.5	2.5	1	1

MIC • Microphone

PRODUCT CODE	PRICE	SIZE / INCHES			WEIGHT VOL	
		H	W	D	LBS	FT ³
MIC400	785	24	2	2	1	1

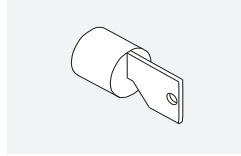
LO • Lock Assembly

PRODUCT CODE	PRICE	SIZE / INCHES			WEIGHT VOL	
		H	W	D	LBS	FT ³
LO (Black)	110					
LO/C (Tungsten)	110					

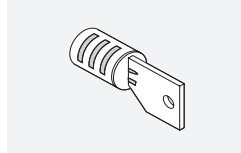
LOB • Lock Drum with Key

PRODUCT CODE	PRICE	SIZE / INCHES			WEIGHT VOL	
		H	W	D	LBS	FT ³
LOB (Black)	18					
LOB/C (Tungsten)	18					

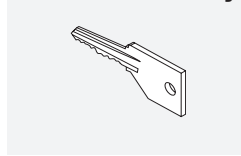
LOCK • Lock Key

PRODUCT CODE	PRICE	SIZE / INCHES			WEIGHT VOL	
		H	W	D	LBS	FT ³
LOCK	11					

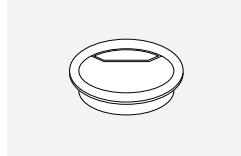
GM1 • Round Grommet - Plastic

PRODUCT CODE	PRICE	SIZE / INCHES			WEIGHT VOL	
		H	W	D	LBS	FT ³
GM1(Black)	48		2.4	2		
GM1(Tungsten)	48		24	2		

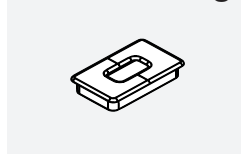
GM5 • Rectangular Grommet - Metal

PRODUCT CODE	PRICE	SIZE / INCHES			WEIGHT VOL	
		H	W	D	LBS	FT ³
GM5K (Black)	85		3.5	2		
GM5E (Tungsten)	85		3.5	2		

- GM5K is the standard Grommet for Foundations Tops

QC • Quick Connector

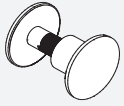

PRODUCT CODE	PRICE	SIZE / H W D	INCHES	WEIGHT LBS	VOL FT ³
QC50	11				
QC30	11				