

## Dufferin Price List

---

Effective June 2024 Canada



[globalfurnituregroup.com](http://globalfurnituregroup.com)

**D**  
DISTRIBUTION



## General Information













A

Where to Order / How to Order	<b>A.8</b>
Dufferin Series Details	<b>A.9</b>
Color Specification	<b>A.10</b>
Edge Details	<b>A.12</b>
Grommet Specification	<b>A.13</b>
Locks	<b>A.18</b>
Tackboards / Lighting	<b>A.19</b>
General Installation	<b>A.20</b>
Maintenance / Limited Lifetime Warranty	<b>A.21</b>
Finish and Finish Options	<b>A.23</b>
Edge, Handle and Fabric Options	<b>A.24</b>
Key Alike Form	<b>A.25</b>
Configurations	<b>A.26</b>

## Desks



B

 DMD-ED • Double Pedestal Bow Top Desk with FF on Left & BBF on Right B.1	 DMD-DE • Double Pedestal Bow Top Desk with BBF on Left & FF on Right B.1
 DD-ED • Double Pedestal Desk with FF on Left & BBF on Right B.2	 DD-DE • Double Pedestal Desk with BBF on Left & FF on Right B.2
 DMiD-ED • Double Pedestal Bow Top Desk, Breakfront Style with FF on Left & BBF on Right B.2	 DMiD-DE • Double Pedestal Bow Top Desk, Breakfront Style with BBF on Left & FF on Right B.2
 DiD-ED • Double Pedestal Desk, Breakfront Style with FF on Left & BBF on Right B.2	 DiD-DE • Double Pedestal Desk, Breakfront Style with BBF on Left & FF on Right B.3
 DMSR-D • Single Pedestal Bow Top Desk with BBF on Right B.3	 DMSL-D • Single Pedestal Bow Top Desk with BBF on Left B.3
 DSR-D • Single Pedestal Desk with BBF on Right B.3	

 DSL-D • Single Pedestal Desk with BBF on Left B.3	 DMiSR-D • Single Pedestal Bow Top Desk, Breakfront Style with BBF on Right B.4
 DMiSL-D • Single Pedestal Bow Top Desk, Breakfront Style with BBF on Left B.4	 DiSR-D • Single Pedestal Desk, Breakfront Style with BBF on Right B.4
 DiSL-D • Single Pedestal Desk, Breakfront Style with BBF on Left B.4	 DMIT • Desk Shell with Bow Top, Breakfront Style B.4
 DMT • Desk Shell with Bow Top & Recessed Modesty Panel B.5	 DT • Desk Shell with Recessed Modesty Panel B.5
 DDD • Connecting "D" Shaped Table Desk B.5	 DDDBE • Connecting Bow End Table Desk B.5
 DDDBS • Connecting Boat Shaped Table Desk B.5	 DTPR • Connecting "P" Shaped Table Desk B.6
 DTPL • Connecting "P" Shaped Table Desk B.6	

## Returns





C

 DERR-24E • Executive Return Right with FF Pedestal on Right C.1	 DERL-24E • Executive Return Left with FF Pedestal on Left C.2
--	--

 DERR-24D • Executive Return Right with BBF Pedestal on Right C.2	 DERL-24D • Executive Return Left with BBF Pedestal on Left C.2
 DERR-24 • Executive Return Right C.2	 DERL-24 • Executive Return Left C.2
 DERR-22E • Executive Return Right with FF Pedestal on Right C.3	 DERL-22E • Executive Return Left with FF Pedestal on Left C.3
 DERR-22D • Executive Return Right with BBF Pedestal on Right C.2	 DERL-22D • Executive Return Left with BBF Pedestal on Left C.3
 DERR-22 • Executive Return Right C.3	 DERL-22 • Executive Return Left C.4

## Piano Desks

D

 DTDPR • Right "D" Shaped Piano Table Desk D.1	 DTDPL • Left "D" Shaped Piano Table Desk D.1
 DTBPR • Right Boat Shaped Piano Table Desk D.2	 DTBPL • Left Boat Shaped Piano Table Desk D.2
 DTPPR • Right "P" Shaped Piano Table Desk D.2	

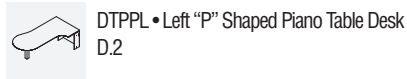

DTPPL • Left "P" Shaped Piano Table Desk  
D.2



DBTHPR • Right Delta Shaped Piano Table  
D.2



DBTHPL • Left Delta Shaped Piano Table  
D.2

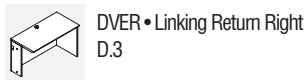

DVER • Linking Return Right  
D.3



DVEL • Linking Return Left  
D.3



DBTN • Bridge for Extended Piano Corner Units  
or Piano Shaped Desks  
D.3

**Bridges** **E**

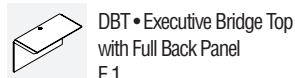

DBT • Executive Bridge Top  
with Full Back Panel  
E.1

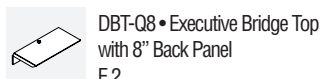

DBT-Q8 • Executive Bridge Top  
with 8" Back Panel  
E.2

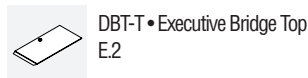

DBT-T • Executive Bridge Top  
E.2

**Credenzas** **F**



DC-XX • Full Storage Credenza with Storage  
Cabinet on Left & Lat. File on Right  
F.1



DC-XX • Full Storage Credenza with  
Lat. File on Left & Storage Cabinet on Right  
F.1

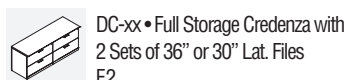

DC-xx • Full Storage Credenza with  
2 Sets of 36" or 30" Lat. Files  
F.2

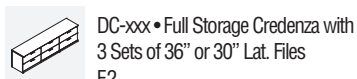

DC-xxx • Full Storage Credenza with  
3 Sets of 36" or 30" Lat. Files  
F.2



DC-xx • Full Storage Credenza with  
2 Sets of Storage Cabinets  
F.2



DC-xxx • Full Storage Credenza with  
3 Sets of Storage Cabinets  
F.2



DC-xxx • Full Storage Credenza with  
Lat. File, Storage Cabinet & Lat. File  
F.2



DCD-D • Full Storage Credenza with  
BBF, Storage Cabinet & BBF  
F.2



DCK-EE • Double Pedestal Credenza with  
FF on Left & FF on Right  
F.3

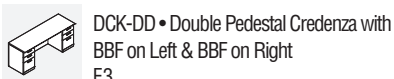

DCK-DD • Double Pedestal Credenza with  
BBF on Left & BBF on Right  
F.3

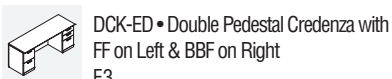

DCK-ED • Double Pedestal Credenza with  
FF on Left & BBF on Right  
F.3

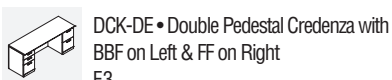

DCK-DE • Double Pedestal Credenza with  
BBF on Left & FF on Right  
F.3



DCR-E • Single Pedestal Credenza with  
FF on Right  
F.4



DCL-E • Single Pedestal Credenza with  
FF on Left  
F.4



DCR-D • Single Pedestal Credenza with  
BBF on Right  
F.4



DCL-D • Single Pedestal Credenza with  
BBF on Left  
F.4



DCR-F • Single Pedestal Credenza with  
36" Lat. File on Right  
F.5



DCL-F • Single Pedestal Credenza with  
36" Lat. File on Left  
F.5



DCR-Z • Single Pedestal Credenza with  
Combination Storage on Right  
F.5



DCL-Z • Single Pedestal Credenza with  
Combination Storage on Left  
F.5



DC • Credenza Shell with Full Back Panel &  
Middle Support  
F.6



DC • Credenza Shell with Full Back Panel  
F.6

**Corners & Components** **G**



DBT-NLR • Right Linking Bridge to join  
Corner Worksurface to Desk or Credenza  
G.1



DBT-NLL • Left Linking Bridge to join  
Corner Worksurface to Desk or Credenza  
G.2

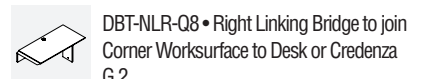

DBT-NLR-Q8 • Right Linking Bridge to join  
Corner Worksurface to Desk or Credenza  
G.2

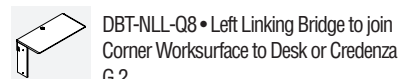

DBT-NLL-Q8 • Left Linking Bridge to join  
Corner Worksurface to Desk or Credenza  
G.2



DE • Corner Table to be used with Linking  
Returns & Linking Bridges  
G.2



DEK • Corner Table to be used with Linking  
Returns & Linking Bridges  
G.3



DEKS • Corner Table to be used with Linking  
Returns & Linking Bridges  
G.3



DEKR • Right Extended Corner Table with  
24" Return Connection  
G.3



DEKL • Left Extended Corner Table with  
24" Return Connection  
G.3



DEKR • Right Extended Corner Table with  
22" Return Connection  
G.3



DEKL • Left Extended Corner Table with  
22" Return Connection  
G.4



DVR • Right Linking Return to be used with  
Corner Unit  
G.4



DVL • Left Linking Return to be used with  
Corner Unit  
G.5



DV • Center Surface with Recessed End Panels  
G.5

## Modular Storage



DW-F/N • Modular Lateral File  
H.1



DWZR • Modular Combination Storage with  
1 Lat. File, 2 Boxes Top Left & 1 File Top Right  
H.1



DWZL • Modular Combination Storage with  
1 Lat. File, 1 File Top Left & 2 Boxes Top Right  
H.1



DWOB • Modular Open Storage with  
Adj. Shelf  
H.2



DW-G/M • Modular Storage Cabinet with  
Doors & Adj. Shelf  
H.2



DW-D • Modular BBF Pedestal  
H.2



DW-E • Modular FF Pedestal  
H.2



DW-Q • Modular Open Storage with  
Adj. Shelf  
H.2



DWi -R • Modular Storage Cabinet with  
Door & Adj. Shelf  
H.2



DWi -L • Modular Storage Cabinet with  
Door & Adj. Shelf  
H.2



DB • Modular Open Bookcase, 15" Deep  
H.3



D1 • Storage Cabinet with  
Doors & Adj. Shelves  
H.3



D1-R • Right Storage Cabinet with  
Door & Adj. Shelves  
H.3



D1-L • Left Storage Cabinet with  
Door & Adj. Shelves  
H.3



D2 • Wardrobe Cabinet with  
Doors, Coat Rack & Hat Shelf  
H.4



D2-R • Right Wardrobe Cabinet with Door,  
Coat Rack & Hat Shelf  
H.4



D2-L • Left Wardrobe Cabinet with Door,  
Coat Rack & Hat Shelf  
H.4



D7 • Open Bookcase with  
1 Fixed Shelf & 2 Adj. Shelves  
H.5



D12 • Open Storage Cabinet with  
Adj. Shelf above 2 Lat. File Drawers  
H.5



D13 • Storage Cabinet with Doors &  
Adj. Shelf above 2 Lat. File Drawers  
H.5



D15-R • Storage Cabinet with Doors &  
Adj. Shelf above Right Combination Storage  
H.5



D15-L • Storage Cabinet with Doors &  
Adj. Shelf above Left Combination Storage  
H.6



D17-R • Right Storage Cabinet with Door,  
Adj. Shelf above FF Drawers  
H.6



D17-L • Left Storage Cabinet with Door  
Adj. Shelf above FF Drawers  
H.6



D18-R • Right Storage Cabinet with Door,  
Adj. Shelf above BBF Drawers  
H.6



D18-L • Left Storage Cabinet with Door,  
Adj. Shelf above BBF Drawers  
H.6



D23 • Closed Storage Cabinet with Upper and  
Lower Split Doors & Adj. Shelves  
H.6



D25 • Cabinet with Doors, Storage with  
Adj. Shelves on Right & Wardrobe on Left  
H.7



D-17T • 17" Tops for Bookcases  
H.7



D-19T • 19" Tops for Modular Storage  
H.7



D-20T • Tops for Wood Front Metal Lateral Files  
H.7



D-22T • 22" Tops for Modular Storage  
H.8



D-24T • 24" Tops for Modular Storage  
H.9

## Hutches & Wall Mount



D-CL36 • Open Shelf Hutch  
I.1



D-CL19 • Pigeon Hole Hutch  
I.2



D-SH36 • 36" High Storage Hutch with Wood  
Doors  
I.2



D-SH36G • 36" High Storage Hutch with  
Glass Doors  
I.2



D-SH36GDG • 36" High Storage Hutch with  
Glass & Wood Doors  
I.2

















































D-SH36DGD • 36" High Storage Hutch with  
Glass & Wood Doors  
I.2









































D-SH42 • 42" High Storage Hutch with  
Wood Doors  
I.3









D-SH42G • 42" High Storage Hutch with  
Glass Doors  
I.3

 D-SH42GDG • 42" High Storage Hutch with Glass & Wood Doors I.3	 DSFP • Wall Mount Storage with Pigeon-Holes & Wood Doors I.6	 DOB • Freestanding Open Storage Cabinet with Adj. Shelf J.3
 D-SH42DGD • 42" High Storage Hutch with Glass & Wood Doors I.3	 DSFP-G • Wall Mount Storage with Pigeon-Holes & Glass Doors I.6	 DBx-3x15 • Open Bookcase with Adj. Shelves J.3
 D-SHP42 • 42" High Storage Hutch with Pigeon-Holes & Wood Doors I.3	 DSFF • Wall Mount Storage with Wood Flipper Doors I.6	 DMAG • Magazine Shelf for use with Open Bookcase J.3
 D-SHP42G • 42" High Storage Hutch with Pigeon-Holes & Glass Doors I.4	 DSFPP • Wall Mount Storage with Pigeon-Holes & Wood Flipper Doors I.7	 DBxS-1515 Square Open Bookcase with Adj. Shelves J.3
 D-SHP42GDG • 42" High Storage Hutch with Pigeon-Holes, Glass & Wood Doors I.4	 DSFO • Open Wall Mount Storage I.7	 DBxR-1515 • Quarter Round Open Bookcase with Adj. Shelves J.4
 D-SHP42DGD • 42" High Storage Hutch with Pigeon-Holes, Glass & Wood Doors I.4	 DSFOP • Open Wall Mount Storage with Pigeon-Holes I.7	 DB7R • Quarter Round Open Bookcase with Adj. Shelves J.4
 D-2SH54 • 54" High Storage Hutch with Wood Doors I.4	<b>Freestanding Storage</b> <b>J</b>	
 D-2SH54G • 54" High Storage Hutch with Glass Doors I.4	 DWDB/WWDB • Freestanding BBF Pedestal J.1	 D1 • Storage Cabinet with Doors & Adj. Shelves J.4
 D-2SH54GDG • 54" High Storage Hutch with Glass & Wood Doors I.5	 DWDM/WWDM • Freestanding Mobile BBF Pedestal J.1	 D2 • Wardrobe Cabinet with Doors, Coat Rack & Hat Shelf J.5
 D-2SH54DGD • 54" High Storage Hutch with Glass & Wood Doors I.5	 DWEM • Freestanding Mobile FF Pedestal J.2	 D6 • Storage Cupboard above Lat. File Cabinet with 4 Drawers J.5
 D-2SHP54 • 54" High Storage Hutch with Pigeon-Holes & Wood Doors I.5	 DF/N • Freestanding Lateral File J.2	 D7 • Open Bookcase with Adj. Shelves J.5
 D-2SHP54G • 54" High Storage Hutch with Pigeon-Hole & Glass Doors I.5	 DF-3/N-3 • Freestanding Lateral File with 3 Drawers J.2	 D12 • Open Cabinet with Adj. Shelves above 2 Lat. File Drawers J.6
 D-2SHP54GDG • 54" High Storage Hutch with Pigeon-Holes & Glass & Wood Doors I.5	 DF-4/N-4 • Freestanding Lateral File with 4 Drawers J.2	 D13 • Storage Cabinet with Doors & Adj. Shelves above 2 Lat. File Drawers J.6
 D-2SHP54DGD • 54" High Storage Hutch with Pigeon-Holes, Glass & Wood Doors I.5	 DZR • Right Combination Storage with 1 Lat. File, 2 Boxes Top Left & 1 File Top Right J.2	 D14 • Storage Cabinet with Doors & Adj. Shelf above 3 Lat. File Drawers J.6
 DSF • Wall Mount Storage with Wood Doors I.6	 DZL • Left Combination Storage with 1 Lat. File, 1 File Top Left & 2 Boxes Top Right J.2	 D15-R • Storage Cabinet with Doors & Adj. Shelves above Right Combination Storage J.7
 DSF-G • Wall Mount Storage with Glass Doors I.6	 DBD • Freestanding Storage Cabinet with Doors and Adj. Shelf J.3	 D15-L • Storage Cabinet with Doors & Adj. Shelves above Left Combination Storage J.7
		 D17-R • Right Storage Cabinet with Door, Adj. Shelves above FF Drawers J.7

 D17-L • Left Storage Cabinet with Door, Adj. Shelves above FF Drawers J.7	 SM • Metal Post Upgrade from SMO3 K.1	 TSPAS-H23 • Wall Mount Tackboard with Accessory Rail K.6
 D18-R • Right Storage Cabinet with Door, Adj. Shelves above BBF Drawers J.8	 F3 • Metal Flat Plate Base Upgrade from SMS4 K.1	 TSAS-H26 • Wall Mount Tackboard with Accessory Rail K.6
 D18-L • Left Storage Cabinet with Door, Adj. Shelves above BBF Drawers J.8	 TE • Wood Elliptical Base with PVC End Caps, Upgrade from SMS4 K.1	 BAFS01 • Metal Flip Sorter - Accessory Rail mounted K.6
 D22 • Open Storage with 2 Adj. Shelves above Storage Cabinet J.8	 TEL • Wood Elliptical Base with Aluminum End Caps, Upgrade from SMS4 K.1	 BASS01 • Metal Slant Sorter - Accessory Rail mounted K.6
 D25 • Cabinet with Doors, Storage with Adj. Shelves on Right & Wardrobe on Left J.9	 TEL-HPL • HPL Elliptical Base with Aluminum End Caps, Upgrade from SMS4 K.2	 BAB01 • Metal Binder Bin - Accessory Rail mounted K.7
 D26-R • Right Tower Unit with Wardrobe, 3 File Drawers, Open Storage & Adj. Shelf J.9	 TPML • Wood or Laminate Rectangular Pedestal Base, Upgrade from SMS4 K.2	 BAMB01 • Metal Media Bin - Accessory Rail mounted K.7
 D26-L • Left Tower Unit with Wardrobe, 3 File Drawers, Open Storage & Adj. Shelf J.9	 DTS • Tackboard for 36" High Non Pigeon-Hole Hutch K.2	 BALT01 • Metal Letter Tray - Accessory Rail mounted K.7
 D27-R • Right Tower Unit with Wardrobe, 3 File Drawers & Storage with Adj. Shelf J.10	 DTSP-H23 • Tackboard for 42" & 54" High Pigeon-Hole Hutch K.3	 BAUT01 • Metal Utility Tray - Accessory Rail mounted K.7
 D27-L • Left Tower Unit with Wardrobe, 3 File Drawers & Storage with Adj. Shelf J.10	 DTS-H26 • Tackboard for 42" & 54" High Non Pigeon-Hole Hutch K.3	 BAPP01 • Metal Paper Pocket - Accessory Rail mounted K.7
 D29-R • Right Tower Unit with Wardrobe, 2 File Drawers & Storage with Adj. Shelves J.10	 DTSAS • Tackboard with Accessory Rail for 36" High Non Pigeon-Hole Hutch K.3	 BATH01 • Telephone Holder - Accessory Rail mounted K.7
 D29-L • Left Tower Unit with Wardrobe, 2 File Drawers & Storage with Adj. Shelves J.10	 DTSPAS-H23 • Tackboard with Accessory Rail for 42" & 54" High Pigeon-Hole Hutch K.4	 DP-H16 • Paper Organizer, Legal & Letter Format K.7
 D30-R • Right Tower Unit with Wardrobe, 2 File Drawers, Open Storage & Adj. Shelves J.11	 DTSAS-H26 • Tackboard with Accessory Rail for 42" & 54" High Non Pigeon-Hole Hutch K.4	 LED • LED Light K.8
 D30-L • Left Tower Unit with Wordrobe, 2 File Drawers, Open Storage & Adj. Shelves J.11	 TS • Wall Mount Tackboard K.4	 GM1 • Round Grommet - Plastic K.8

## Accessories

K

 CMP-W • Wood Straight Modesty Panel hanging from Top K.1	 TSP-H23 • Wall Mount Tackboard K.5	 LO • Lock Assembly K.8
 CMP-G • Glass Straight Modesty Panel hanging from Top K.1	 TS-H26 • Wall Mount Tackboard K.5	
	 TSAS • Wall Mount Tackboard with Accessory Rail	



## WHERE TO ORDER / HOW TO USE THIS GUIDE

AREA	PHONE	FAX
Ontario (Except Ottawa)	905-470-0010	905-470-6262
Calgary, AB (Global Alberta - Calgary)	403-250-7770	403-250-7773
Edmonton, AB (Global Alberta - Edmonton)	780-444-8922	780-443-3913
Halifax, NS (Halifax)	902-422-7434	902-423-9924
Quebec, QC (Quebec)	418-653-6111	418-653-6151
Montreal, QC (Montreal)	514-866-4331	514-866-8567
Ottawa, ON (Ottawa)	613-234-2881	613-234-5350
Burnaby, BC (Global West)	604-432-1701	604-432-7475
Winnipeg, MB (Winnipeg - Saskatchewan)	204-925-3350	204-925-3356

**Price and Product Guide Section:** Features the actual product pricing and specification instructions. This section is divided into Desks, Returns, Bridges, Credenzas, Corners and Components, Modular Storage, Hutches, Wall Mounted Storage and Freestanding Storage.

**General Information:** Includes subdivision sections of casegoods construction, varnish specification, veneers and wood solids, finishing process, general installation and hardware, maintenance, terms and conditions of sale, warranty and where to order.

**ISO 9001:2015 Registered:** The Descor Factory is ISO 9001:2015 registered for manufacturing procedures and practices of quality and quality control processes.

**ISO 14001:2015 Registered:** The Descor Factory is ISO 14001:2015 registered for environmental procedures and practices.

**ANSI/BIFMA Certified:** Descor casegoods have passed ANSI/BIFMA standards for product construction and durability.

**FSC ®:** Forest Stewardship Council ®. Option available on all wood veneer products by special request.

**BIFMA e3:** Furniture sustainability level 3

**Greenguard:** All Descor Products are Greenguard certified

**Price List Effective : June 2024**

## HOW TO ORDER A PRODUCT

Creating a correct and complete product number ensures clean orders and accurate information for the factory. Clean orders expedite order entry and factory order scheduling, thereby, saving days, sometimes weeks off potentially extended lead-times.

From product to product, there are different options available that affect the length, options and sequence of the order-string.

To view current wood, plastic laminate finish and fabric samples, please visit [www.globalcontract.com](http://www.globalcontract.com).

To order actual wood, plastic laminate finish and fabric samples and cards, place request with the Global Marketing Department via fax at 416-667-0338 or via e-mail at [literaturecdn@globalfurnituregroup.com](mailto:literaturecdn@globalfurnituregroup.com).

Wood finish and laminate samples are individual chips and can be obtained through the above by request.

## EXAMPLE - HOW TO SPECIFY

**CODES:** The price list uses a numbering system with meaningful alphanumeric characters to create a simple-to-understand product number. This makes specifying the product easy and accurate.

### SPECIFICATION EXAMPLE OF A DESK UNIT

#### PRODUCT CODE:

DMID7242EDG

D = Dufferin Series

MID = Double Pedestal Desk, Breakfront Style with Bow Top

7242 = Size: Width x Depth

ED = Pedestal Configuration: FF on Left & BBF on Right

G = Aluminum Framed Glass Modesty option on Breakfront Style

#### CHOOSE FINISH OPTION (Page A.23):

##### Standard Finish:

Choose Laminate Finish & Veneer Finish

##### All Wood Finish:

Choose Veneer Finish

##### All Laminate Finish:

Choose Laminate Finish

#### HANDLE OPTION (Page A.24):

Choose a handle

#### Optional Grommet Locations (Page A.13):

TL - Top Left

TR - Top Right

TEL - Top End Left

TER - Top End Right

**NOTE:** Arrow indicates direction of grain.

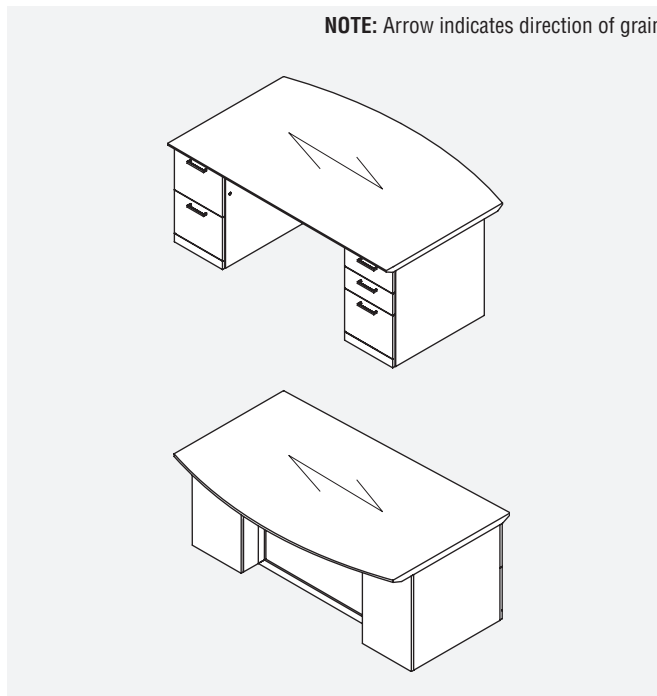



## DUFFERIN SERIES DETAILS

### Series Detailing:

Dufferin detailing is contemporary with a 2" overhang knife edge on user and guest sides, self-edge on ends and wall sides. User and guest side edges are 1/8" wide by 1/2" thick for an overall thickness of 1 3/16".

Dufferin is a "top over pedestal" detailed series. Top ends are flush with end-panels and storage.

**Grommets:** GM1 is the standard Dufferin grommet. Grommets are included standard with products where shown in the product line drawings. Otherwise, specify additional grommets where needed. See Grommet Specification details on Page A.13.

**Locking:** Locks are standard on all "below work surface level" drawer and door storage units with the exception of the pull-out tray units and single lateral file drawer combination tray/slot units. Combination storage unit comes with lock for file and lateral file drawer only, box drawers cannot lock. Lock colour will match the handle option. Locks are optional on all "above worksurface level" closed storage.

### For Optional Grommets and Locks:

GM1E (Black) / GM1K (Tungsten) \$48

LO (Black) / LOC (Tungsten) \$110

## CONSTRUCTION

**Finish:** Conversion varnish (similar to catalyzed lacquer, but tougher), 25° sheen. Descor does not buff or rub its finishes.

**360° Finishing:** All Descor casegood products are finished on the back sides (except modular under-surface storage - tops and backs are unfinished).

**Veneers and Solids:** Veneers and solids are Number One select, architectural grade "A" oak, walnut, cherry or maple. All Descor wood worksurface moulded edges are solid oak, walnut, cherry or maple.

**Laminate:** Low pressure laminate will be used on all chassis, fronts and doors. High pressure laminates will be used on all tops. Doors, fronts and user side of all tops (Dufferin edge) will be edgebanded with 1/8" PVC edge, all remaining parts/edges will have a standard 1/32" PVC edge.

**Pedestals:** Full-to-the-floor. Pedestals are fully assembled units that are either installed into desk and credenza shells, or available as modular units. Undersurface storage units include locks.

**Series Handles:** Handles must be specified.

**Drawer Suspensions:** Pedestal drawer suspensions are metal ball bearing type. Both box and file drawers are full extension.

**Hanging file rails:** Are pre-installed on file drawer perimeters. The back rail in a lateral file drawer is designed for both legal and letter size filing.

**Drawer Construction:** Drawer sides and bottoms are wrapped black vinyl. Veneered drawer interiors are available as an option (Contact Customer Service).

**Drawer Fronts:** The drawer front is an applied element to a four sided drawer. Drawer fronts are veneered on all surfaces. Drawer fronts can be removed or replaced in the field.

**Leveling Glides:** Levelers have a 1" range of adjustment.

## VENEERS AND WOOD SOLIDS

Descor provides high quality veneers and solids to our customers.

We procure wood globally but mainly in North America and Europe with a progressive approach towards sustainability. We ensure our vendors are protecting and maintaining the natural forests of origin. Descor lays-up its own flat cut (cathedral pattern) in book matched set and patterns. Rift cut veneers are laid-up in a slip match method.

For additional information on veneer species, cuts and patterns please contact your customer service representative.

## DESCOR CONVERSION VARNISH SPECIFICATIONS

Descor uses conversion varnish: It is among the most durable finishes used in the contract furniture industry (more durable than catalyzed lacquer).

Conversion varnish is a synthetic, catalyzed cured (chemically active) finish, containing UV inhibitors to slow the oxidizing (color changing) effects of ultra-violet rays on wood.

Descor produces low 25° sheen. Low sheens are the most practical for commercial use as it doesn't show most scratches and are more easily touched-up than higher sheens.

Cures with heat, developed two ways:

- Chemically (catalyst reaction within the varnish itself)
- Line oven (approximately 140° F) accelerates finish curing and increases molecular density for a harder finish

Conversion varnish has a component called "solids", produced by a combination of resins when the solvent evaporates. These solids float to the varnish surface, which is where they cure. These solids are the durable aspect of the finish.

Descor uses an "off-the-gun" technique with conversion varnish. This means the "solids" (the durable aspect of the finish) remain intact on the surface of the finish.

Descor's standard finish on oak and walnut is open pore, on cherry and maple is semi-closed pore. If a full fill finish is required for walnut, cherry and maple tops, add the suffix "2" to the finish code and add 5% to the base pricing for each product.

Custom finish is available at an upcharge (See Finishes and Options).

## COLOR SPECIFICATION



Standard Dufferin Products are finished in laminate with veneer finish accents but they are also available as an all wood finish or an all laminate finish.

Note:

- To choose All Wood Finish, add suffix "W" to the end of the product code.
- To choose All Laminate Option 1, add suffix "P1" to the end of the product code.
- To choose All Laminate Option 2, add suffix "P2" to the end of the product code.
- To choose All Laminate Option 3, add suffix "P3" to the end of the product code.

### Dufferin Standard Finish

#### Finish Specification

Profiled tops, panels on breakfront style units, doors, drawer fronts and all exposed shelves belong to the wood finish (indicated  ). The chassis belongs to the laminate finish (indicated  )

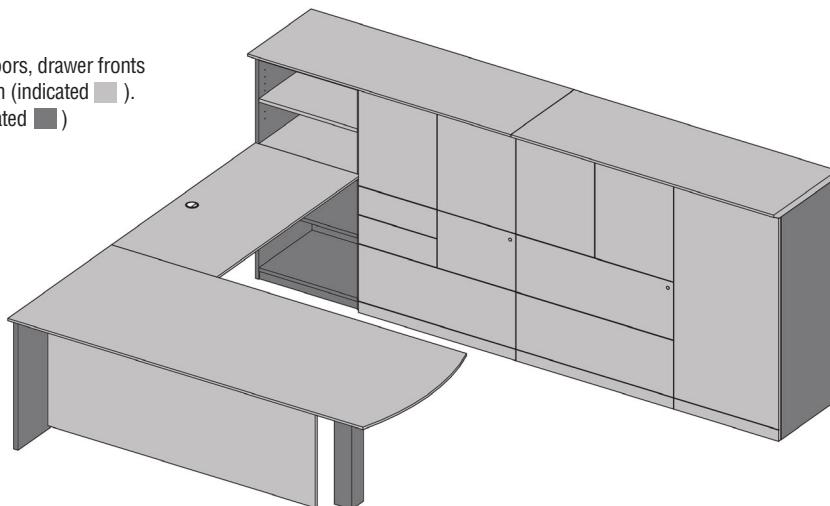

### Dufferin Wood (W)

#### Finish Specification

The wood only (indicated  )  
The unit will be monotone.

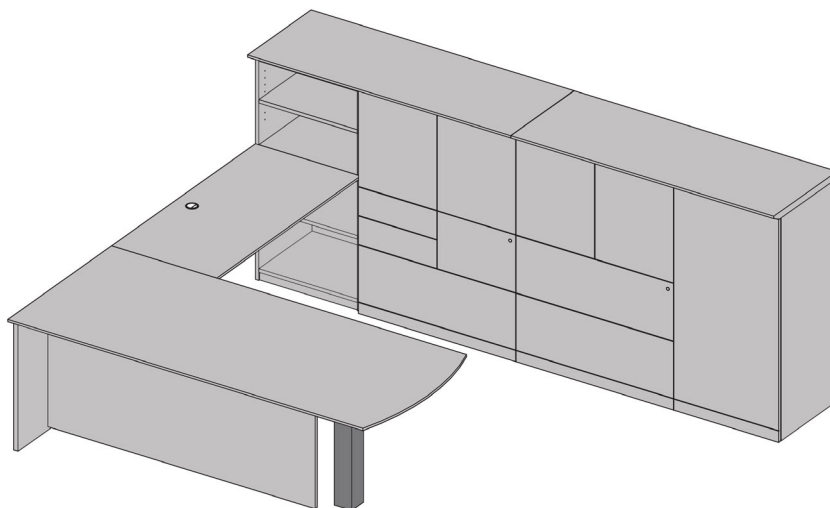

**Dufferin All Laminate Option P1**

**Finish Specification**

The laminate only (indicated ■)  
The unit will be monotone.

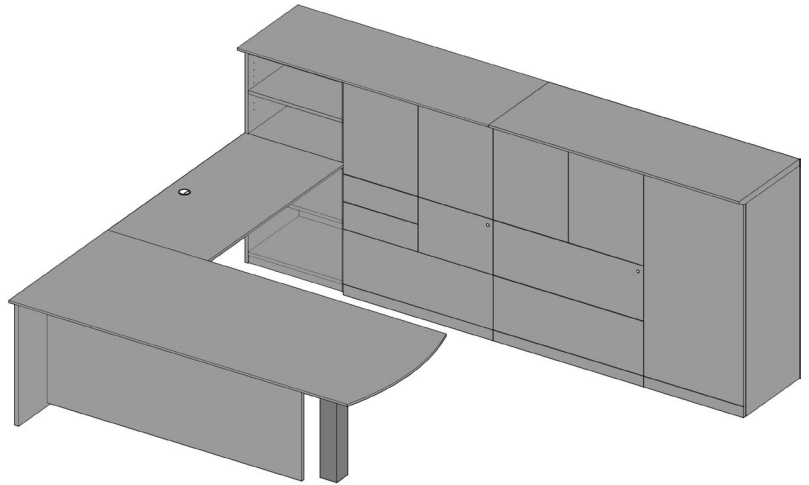

**Dufferin All Laminate Option P2**

**Finish Specification**

First Selection: The chassis belongs to the first laminate finish selection (indicated ■).  
Second Selection: Profiled tops, panels on breakfront style units, doors, drawer fronts and all exposed shelves belong to the second laminate finish selection (indicated ■).

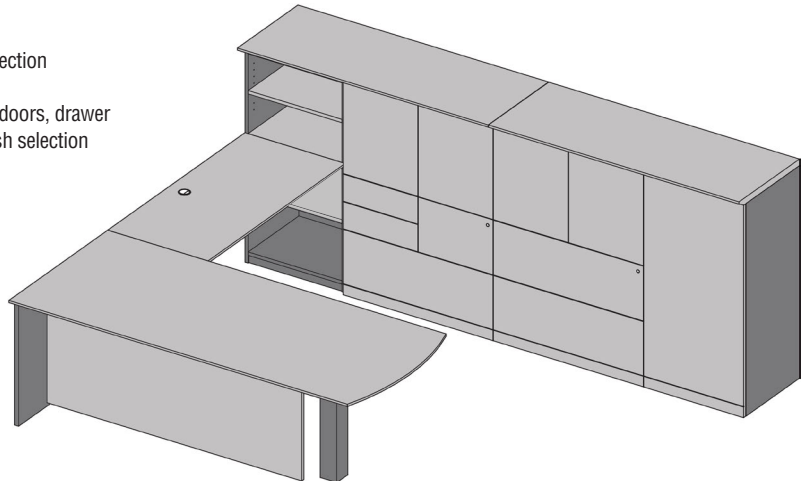

**Dufferin All Laminate Option P3**

**Finish Specification**

First Selection: The chassis belongs to the first laminate finish selection (indicated ■).  
Second Selection: Profiled tops and all exposed shelves belong to the second laminate finish selection (indicated ■).

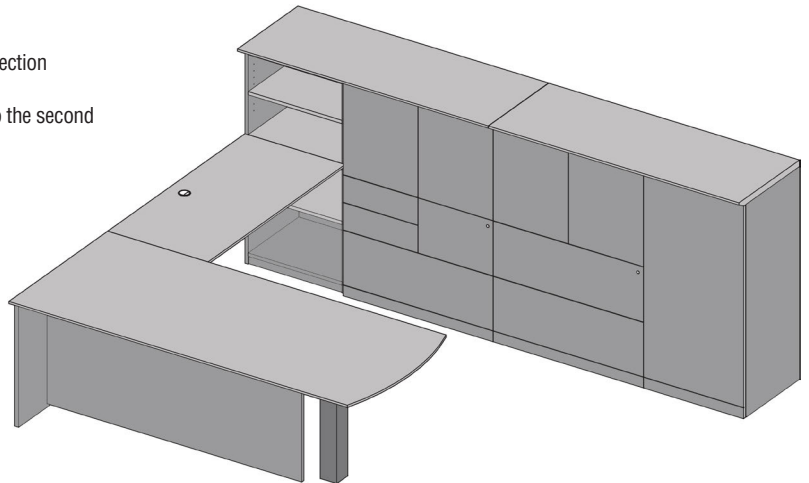

**DUFFERIN EDGE DETAILS**

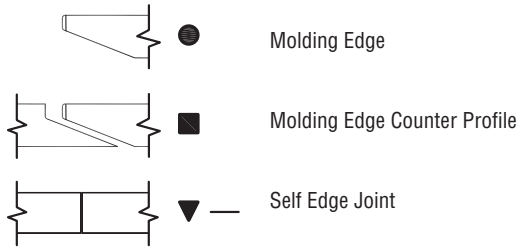

D - Desks and Credenzas  
 B - Executive Bridges  
 E - Executive Returns  
 C - Corner Components  
 L - Linking Bridges  
 P - Piano Desks

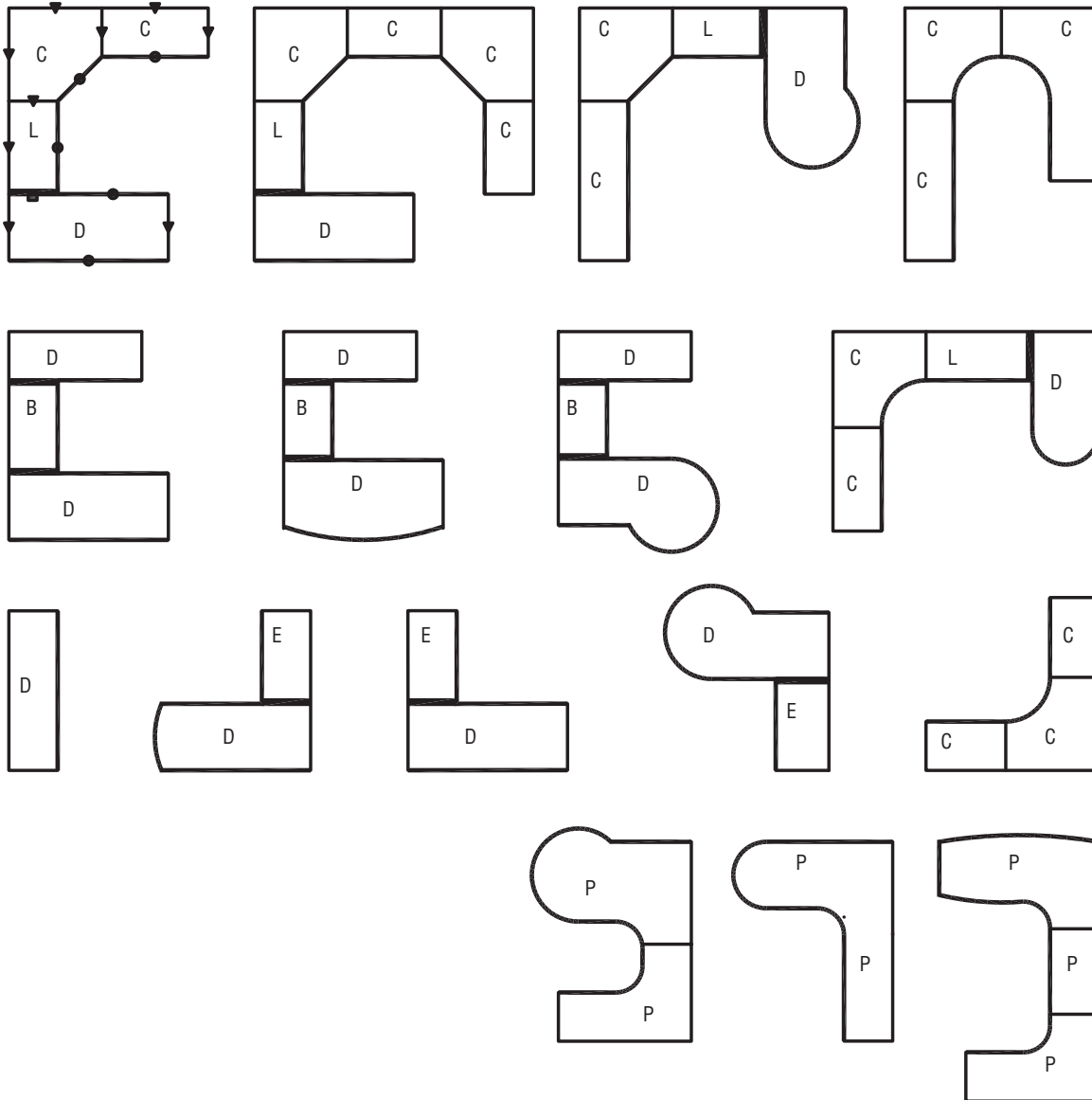

**Note:** Refer to Price List Pages for appropriate coding and pricing. Custom configurations are available by requesting a quote.

**GROMMET SPECIFICATION**

Includes standard and optional Grommet Locations

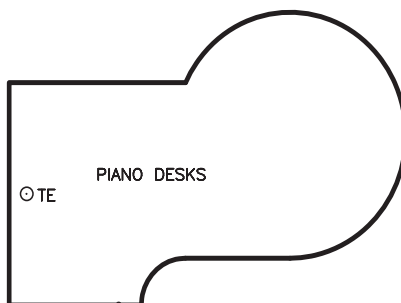
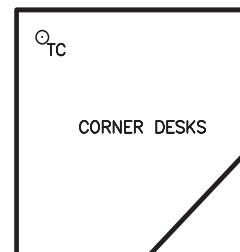
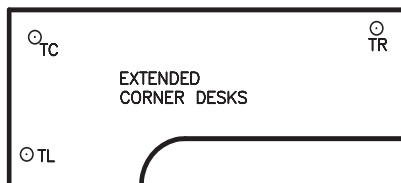
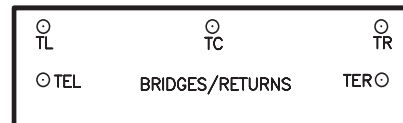
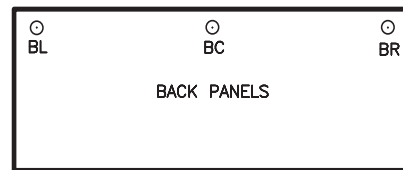
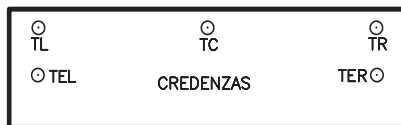
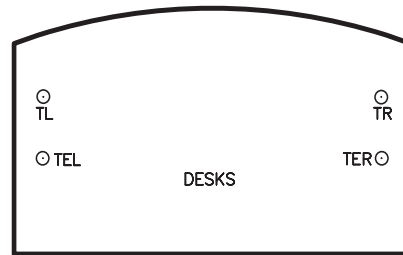

**Note:**

- For pricing on optional Grommets refer to Page K.8. Custom configurations are available by requesting a quote.
- For TEL & TER location please contact Customer Service.

**DUFFERIN DESKS AND CREDENZAS**

Can be ordered as a shell or with pedestals.  
 Hand of Rectangular Desk is determined by location of pedestal from user side.  
 Hand of "D" Top is determined by outward orientation of curved end from user projection.  
 Hand of "P" Top is determined by outward orientation of conference end from user projection.

Standard metal column support on "D" and "P" Tops is a SMS4.

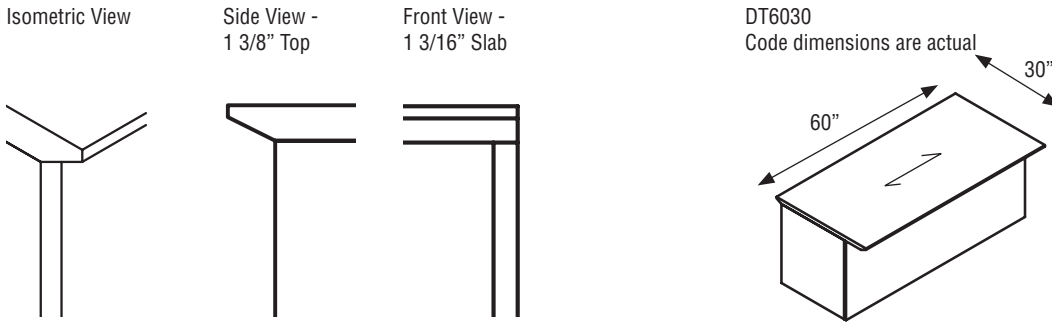

**MODESTY PANEL CLEARANCE**

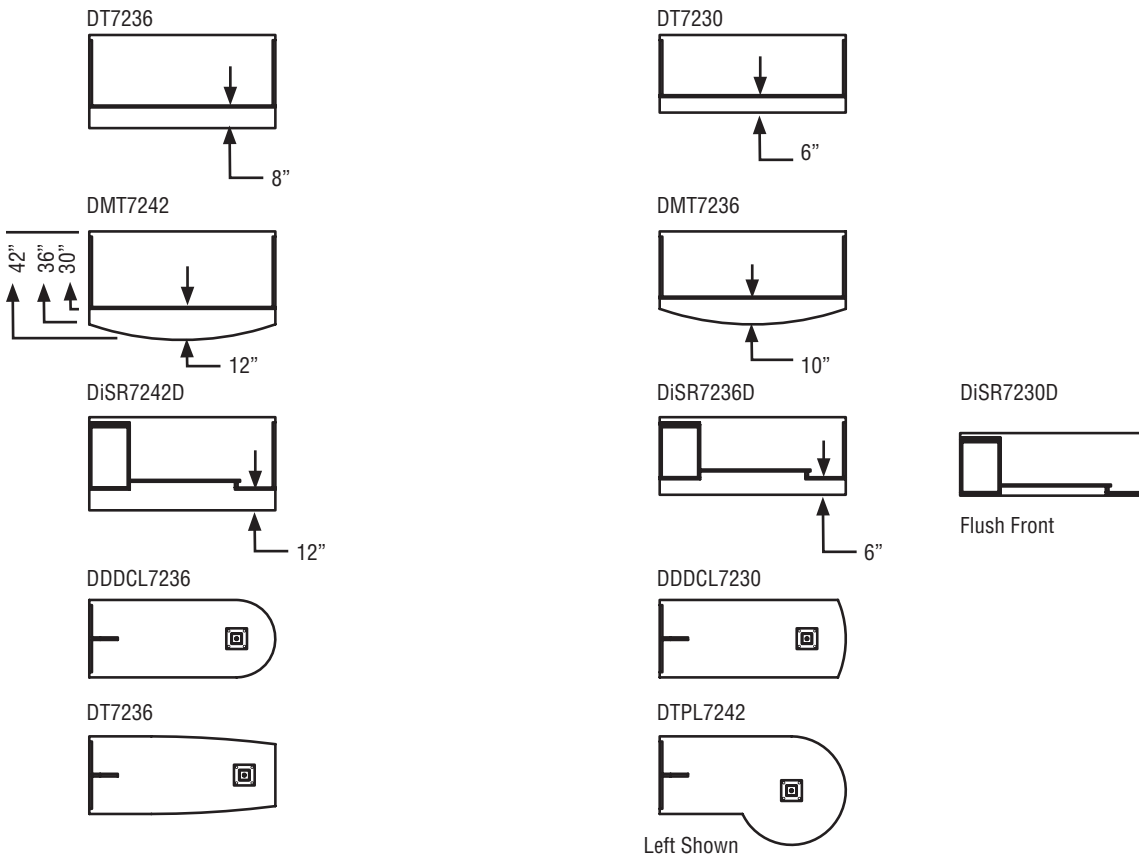

**MODESTY PANEL OPTIONS**

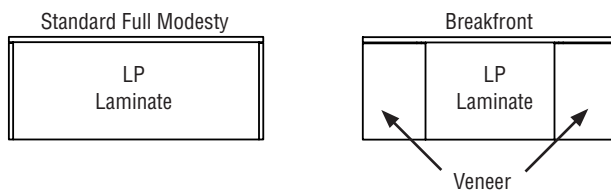

**DUFFERIN PIANO DESKS AND LINKING RETURNS**

- All Desks are shipped assembled.
- Units include standard Grommets shown and installed horizontal wire management.
- Unit is handed by Post Leg.
- Not for use with regular Corner Units.
- Standard metal column support on "D" and "P" Tops is SMS4.

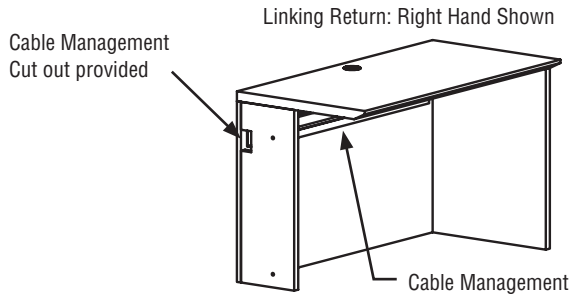

Supporting Slab Joining Structure

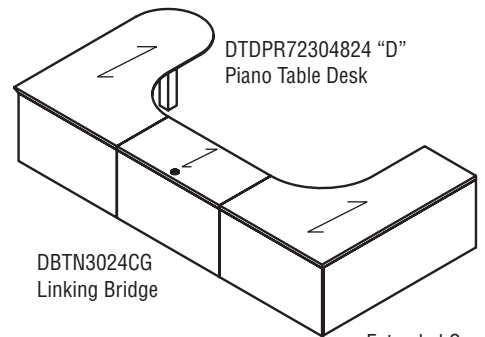
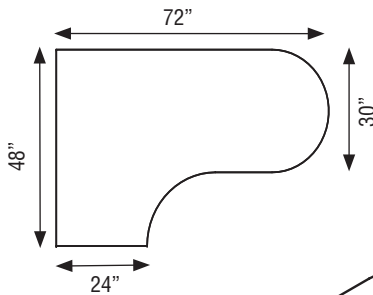
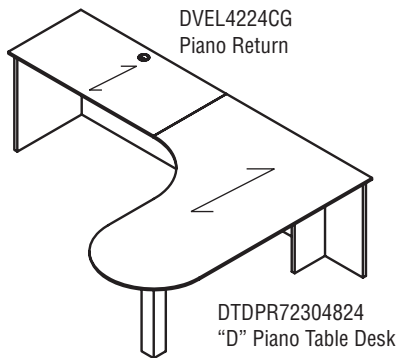
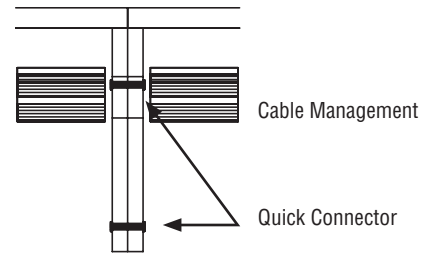

To remove Cross Grain veneer pattern on Top, delete suffix "CG" from the Product Number Code. (Available at no upcharge)

**DUFFERIN EXECUTIVE BRIDGES**

Executive Bridge is used to connect a Desk to a Credenza. Not to be used with Corner Components or Piano Desks. Three Back Panel options. Back panel flush with end panels of Desk and Credenza. Includes GM1 Grommet Top Center.

To remove Cross Grain veneer pattern on Top, delete suffix "CG" from the Product Number Code. (Available at no upcharge)

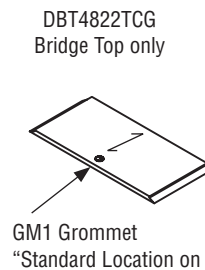
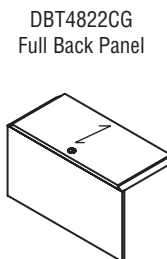
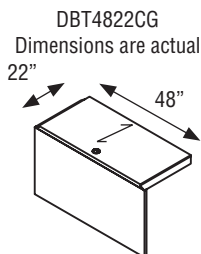
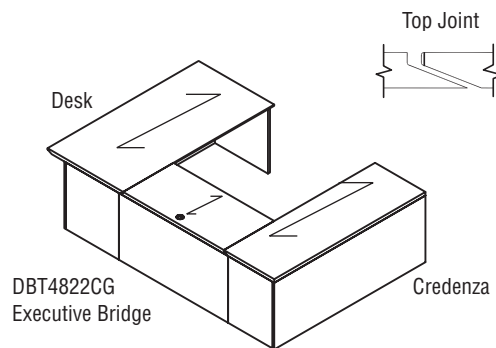

**DUFFERIN EXECUTIVE RETURNS**

Executive Return is used to attach to a Single Pedestal Desk, Single Pedestal Credenza, Desk Shell or Credenza Shell.

Can be specified as a Shell or with a Pedestal.

Back Panels are available as either full height or 8" from the underside of the worksurface.

Hand of Executive Return is determined by location of full end panel from user side.

Hand of Desk or Credenza is determined by location of pedestal from user side.

Executive Return attached to Desk or Credenza

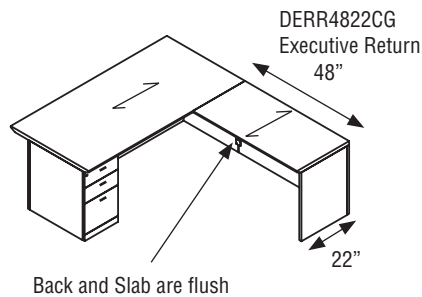
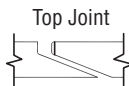
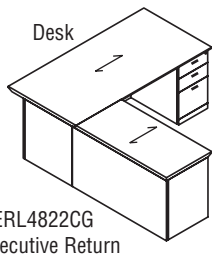

To remove Cross Grain veneer pattern on Top, delete suffix "CG" from the Product Number Code. (Available at no upcharge)

**DUFFERIN CORNER COMPONENTS**

Corner Table is used to connect to Linking Bridge and Linking Credenza.

Cable management tray included.

Back Panels are available as either full height or 8" from the underside of the worksurface.

Hand of Linking Credenza is determined by location of full end panel from user side.

Hand of Extended Corner is determined by location of long narrow end from user side.

To remove Cross Grain veneer pattern on Top, delete suffix "CG" from the Product Number Code. (Available at no upcharge)

Supporting Slab Joining Structure

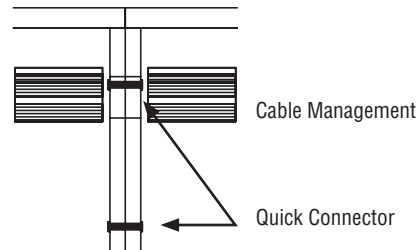

DEK424222 Corner Table

DEK424222 Corner Table

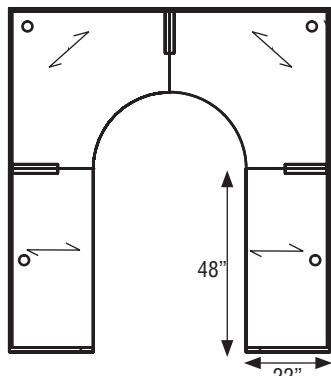

DVL4822CG Linking Return

DVL4822CG Linking Return

Linking Return Right Hand Shown

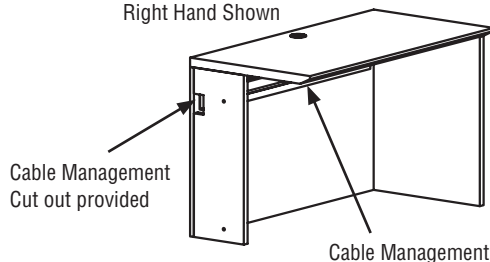

DE424222 Corner Table

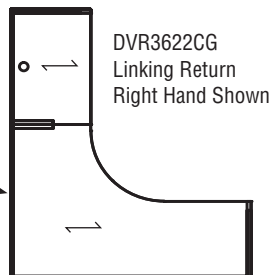
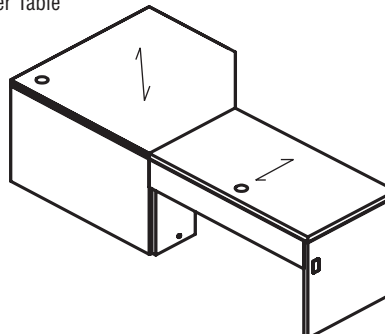

DEKL724822 Extended Corner Table



**DUFFERIN LINKING BRIDGES**

Linking Bridge is used to connect Corner Components to Single Pedestal Desk, Single Pedestal Credenza, Desk Shell or Credenza Shell. Back panels are available as either full height or 8" from the underside of the worksurface.

Includes GM1 Grommet Top Centre.

Hand of Linking Bridge is determined by location of half end panel from user side.

To remove Cross Grain veneer pattern on Top, delete suffix "CG" from the Product Number Code. (Available at no upcharge)

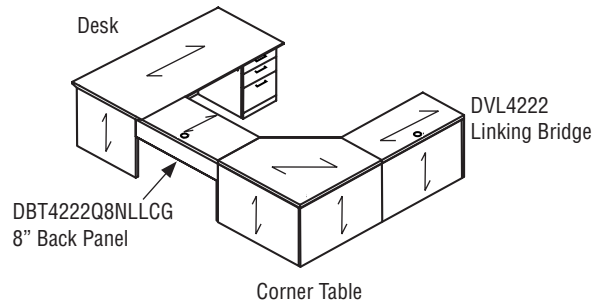
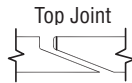

**Supporting Slab Joining Structure**

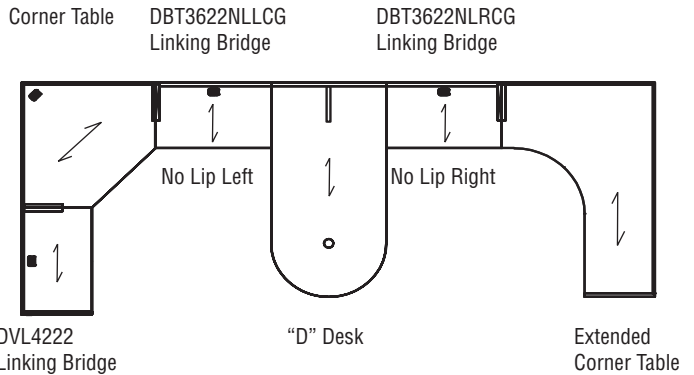
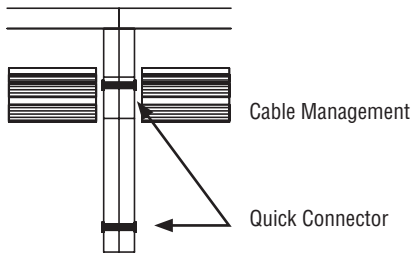

**DUFFERIN SIDE BY SIDE COMPONENTS**

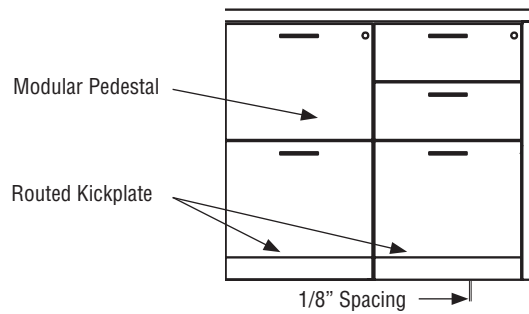
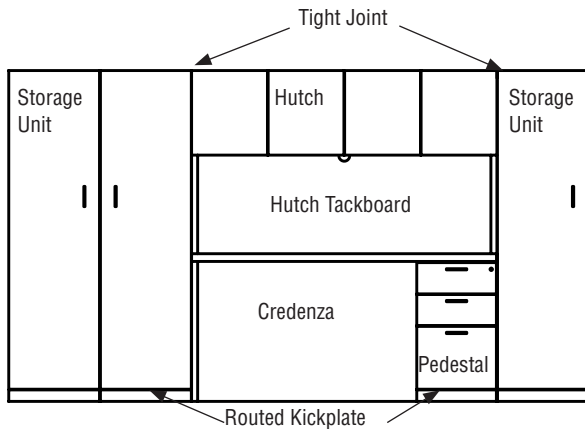

**DUFFERIN MODULAR PEDESTALS AND HANDLES**

Modular Pedestal for Dufferin.

Credenza Shell cannot be completely filled up with Modular Components to create a Full Storage Credenza.

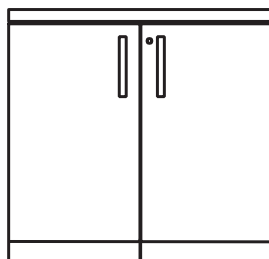

Pedestal Handle

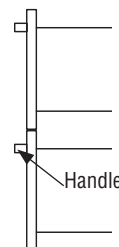

Handle

**DUFFERIN LOCKS**

**Locking**

Locks are Standard on all “below the work surface level” Drawer and Door Storage Units with the exception of the Pull-Out Tray Units and Single Lateral File Drawer Combination Tray/Slot Units

Locks are Optional on all “above the work surface level” Closed Storage Units. See Accessories Section Page K.8 for Lock Specification details.

**Standard Lock Positions**

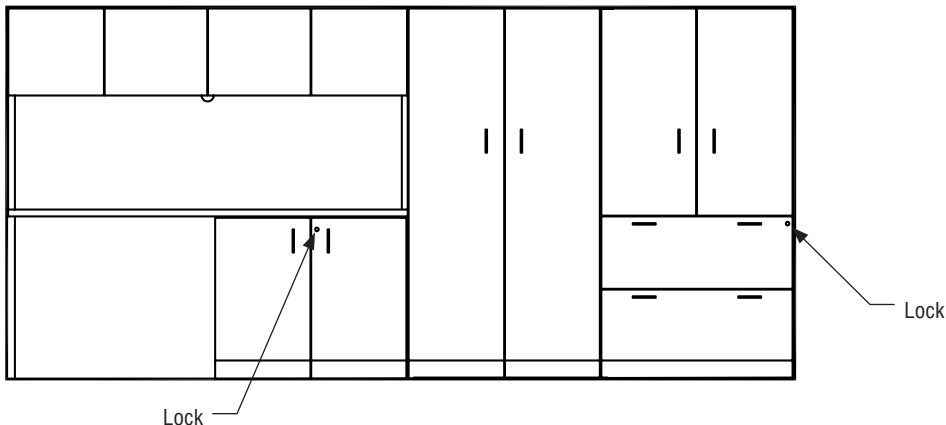

**DZR3622**

Combination Storage Unit:  
Lock for File and Lateral File Drawer only,  
Box Drawers do not lock.

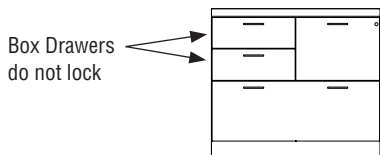

**DD7236DE**

Double Pedestal Desk/Credenza:  
Lock for D and E Pedestals are on the inside Gable.

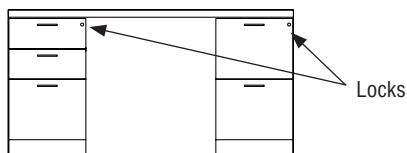

**DCF7222**

Full Storage Credenza: Locks are on the front.

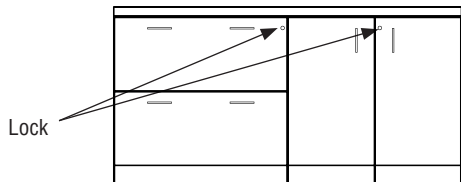

**DWD**

Modular Furniture:  
Lock is on the front.

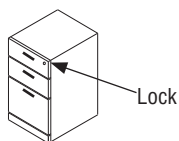

**DWF**

Modular Furniture:  
Lock is on the front.

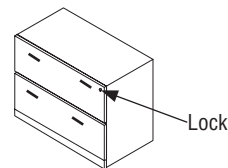

**HUTCH POSITIONING**

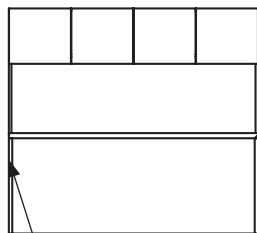

There must be an end panel under the hutch

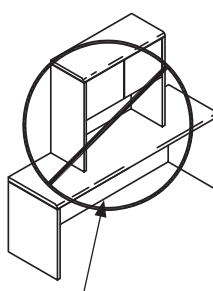
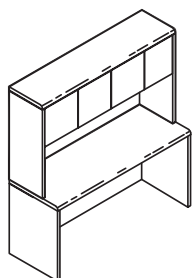

Missing Support NOT Recommended

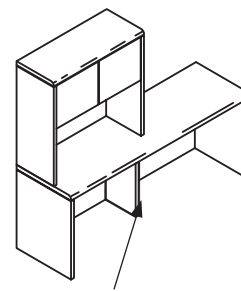

Add optional Support SLAB12 (as Special)

**DUFFERIN TACKBOARDS**

Tackboards for Storage Huches

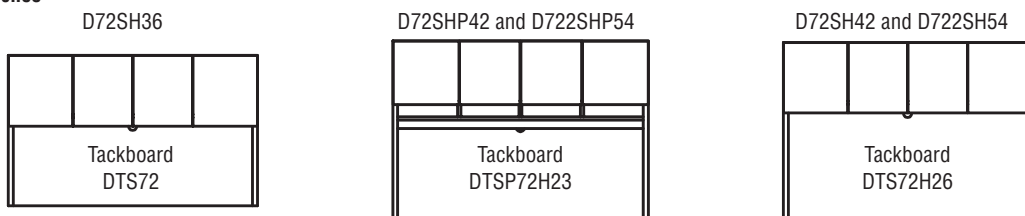

Tackboards with Accessory Rail

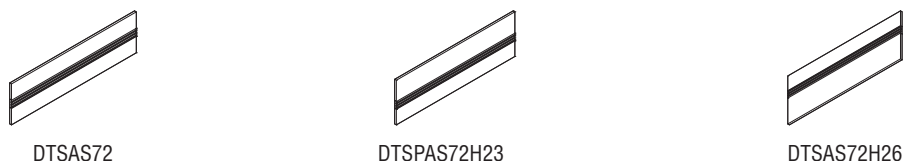

Tackboards for Wall Mount Overheads

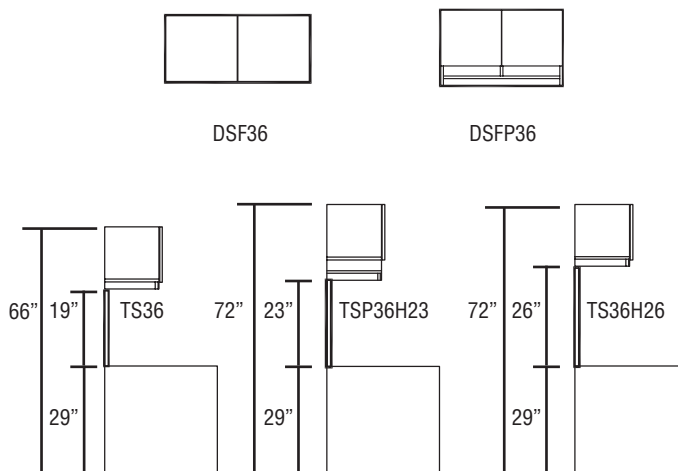

**DUFFERIN LIGHTING**

Lighting for Hutches and Wall Mount Overheads.

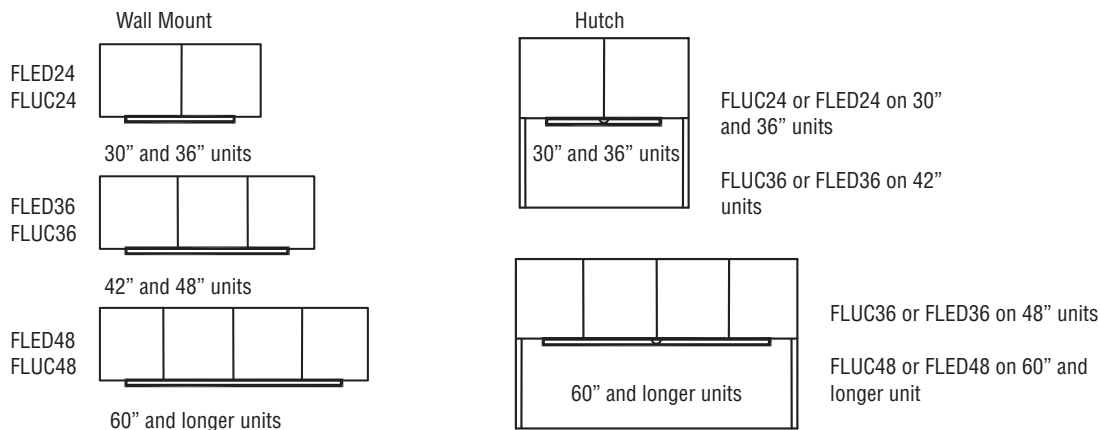

## GENERAL INSTALLATION AND HARDWARE

### Uncartoning

Always uncarton wood office furniture with care. Never use a knife or sharp object of any kind to open cartons. Tear cartoning tape off by hand. Protective corner blocks, foam-wrap, and a bottom skid are included in the carton during shipping for protection.

**Hardware:** All necessary hardware for attaching furniture is included in the shipment. Actual wall-attachment fasteners for wall cabinets, Tackboards and Visual Boards are not included due to variable site conditions.

**Hanging file rails:** Pre-installed on file drawer perimeters and accommodates both legal and letter size filing.

**Flat-plates:** Are used to attach Bridges and Returns to Desks and are shipped pre-attached to the bottom of the Bridge or Return. Mini-flat-plates for securing Bridge Back Panels to Desk or Credenza End-Panels, and quick connectors for securing modular Corner Units to adjacent pieces, are shipped along with screws in a plastic bag attached to the bottom of the Bridge or Return.

**Caution: Using screws other than those supplied by Descor could result in damage to finished tops. Descor will not honor claims due to installation of incorrect hardware.**

**Installation:** Wall-mounted cabinets, Tackboards and Visual Boards are pre-attached with horizontal wall rails to the back of each unit. The wall-side components must be detached from the unit and fastened to the wall accordingly. Wall fasteners are not included due to the variable site conditions. Securing the wall rail to a vertical structural member is the required manner of installation. The Cabinet or Visual Board is then lowered on to the wall rail. It is important to level the wall rail before installation. Wall cabinets are equipped with levelers at the bottom of the back panels for proper cabinet alignment. Units with doors are equipped with adjustable European door hinges to assist in door alignment. It is required to use a #8 wood screw through the back of the cabinet and the wall-mounted rail, to further secure the wall attachment. Tackboards have vertical grooves in the back for tasklight wiring.

**Hutches:** Descor utilizes a non-marring method of Hutch attachment. They are installed with double faced tape applied to the bottom of the end panels. The tape is shipped in a plastic bag found in the Hutch. Removal of the Hutch requires moderate pressure to be applied on the top of the unit towards the wall for at least a minute for the pressure sensitive tape to release. At the dealer or installer's discretion, additional support may be added by installing flat-plates along the outside back of the attached units. These flat-plates are not included in the shipment.

**Hutch tackboards:** Factory installed.

**Modular storage units:** Have pre-drilled holes through the unfinished tops for securing to the bottom of the work surfaces. Screws and lock keys are included in a plastic bag fastened inside the pedestal. Installer should leave a 1/8" reveal between the Modular Storage Unit and the End panel. Disassemble the Modular Unit first before relocating the entire unit to avoid damage or bodily injuries.

**5-sided corner tables:** Join Bridge and Credenza run-offs, using the supplied quick-connectors. Recessed end-panels in these units are pre-drilled to accept quick-connectors for easy alignment. Accurate leveling is critical for these units to align and connect properly. Flat-plates are pre-attached to the work surface to secure to the desk unit.

**Upon completing installation, wipe furniture with a damp cloth, followed by a dry soft cloth.**

**Leveling wood office furniture properly is the most important procedure to ensure proper functioning and alignment of drawers, locks and doors.**

## CARE AND MAINTENANCE GUIDE

**Wood Casegoods Care:** Descor furniture is constructed to strict specifications to ensure years of satisfied use. As with all wood products, certain care requirements and periodic maintenance are necessary in order to maintain the original new appearance and function.

**Laminate Chassis:** This sturdy and durable finished surface can be cleaned with a damp cloth. If the product is really dirty, a mild detergent solution may be used.

**Finish Protection:** All clear wood finishes are susceptible to scratches from rough and abrasive objects, such as staples, paper clips, ceramic coffee mugs, flower pots, picture frames, etc. Computer equipment with rubber feet can also cause discoloration and softening of the finish due to petroleum distillates in the rubber.

Glass tops are the ultimate protection against scratch mishaps.

The most practical protection is the use of desk-pads or blotters, paper management bins, coasters, common sense caution with rough items, and adding pressure sensitive felt to the feet or bottoms of any potentially destructive item on the Desk.

**Wood Finish Care:** Wax or polish should never be used on the catalyzed finish; they will give a greasy, cloudy or uneven appearance to the product. Descor's conversion varnish finish is best cleaned by wiping the surfaces with a damp cloth, followed by a soft dry cloth in the direction of the grain. If the surfaces are very dirty, use of a glass cleaning type of product is recommended.

**Laminate Finish Care:** The work surfaces are manufactured using primarily Nevamar® Brand laminates as the exposed surface. To properly clean these areas, it is best to use a clean, damp cloth. For stubborn stains, you are able to add a mild detergent to the water. Be certain not to use an ammonia-based solutions. It will react, causing permanent damage to the contacted areas.

**Never use a silicon based product to dust or polish catalyzed finishes. Over time, silicon may disrupt the actual molecular composition of the finish and cause it to soften and become cloudy.**

### Additional Tips:

- Remove any spilled liquid immediately with a blotting, rather than a wiping motion.
- Do not drag or push objects or stacks of papers across any finely finished surface.
- Avoid exposing surfaces to extreme heat, cold or humidity.
- The surface finish may be burn resistant, however, the wood underneath the finish is not and can be charred by a burning cigarette or heat producing unit.
- Exposure to strong sunlight should be avoided. The surface finish is fade-proof, however, in spite of UV inhibitors in the finish, the wood underneath may change color (patina) where extended exposure to sunlight exists. Natural or light finished species are especially susceptible to UV color change.
- Building maintenance and maintenance service management should be notified of the proper care instructions and procedures for your furniture to avoid damage and allow optimum appearance for years to come.
- Special care should be taken to protect wood furniture when other trades such as painters, electricians and telecommunications workers are present performing work.
- Drawer suspensions are lubricated prior to shipment. Periodic lubrication may be applied to the ball bearing housing with a high quality lubricant found in most hardware stores.
- Drawer alignment is achieved with proper leveling of desks and credenzas.
- Check leveling glides for adjustment if the furniture is moved.
- Modular furniture items, such as Desk Shells and Modular Pedestals **must be disassembled** prior to moving or relocating to avoid damage to the furniture.
- Hutch and wall cabinet doors may require field adjustment, from time to time, due to shifting weight load factors inside the cabinet.
- Touch-up of wood furniture should only be attempted by a qualified refinisher/touch-up technician. Contact your furniture dealer if this need should arise.

## DESCOR LIMITED LIFETIME WARRANTY

Descor will, at no cost to the original purchaser and for as long as the original purchaser owns a Descor product repair or replace with a comparable product, at Descor's option, any part or product sold after January 01, 2001, which fails as a result of a defect in its design, materials or workmanship. For all purposes of this warranty, the term "purchaser" is defined as the entity or individual acquiring a new Descor product as the initial purchase thereof either from Descor or an authorized Descor dealer.

### Exceptions to this warranty include:

- Descor warrants its products to be free from defects in materials and workmanship for a period of 10 years, of single shift service, from the date of delivery.
- Lighting products and grommets are warranted for one year from date of delivery.
- Custom electrical solutions may carry varying warranty coverage.
- Descor fabrics and wood veneers are warranted for 5 years from the date of delivery.
- Electrical components, are warranted for 10 years from the date of delivery.
- Moving parts, which include, glides, slides, casters, user adjustable worksurface mechanism are warranted for 5 years from date of delivery.
- Descor warrants its products based on a single shift (40 hour/week). Usage beyond a single shift (40 hour/week) will result in a reduction in the warranty, in proportion to the increased usage.

- Pneumatic cylinders for any product, unless otherwise stated, are warranted for 10 years of single shift (40 hour/week) usage, from date of delivery.

### This warranty does not include:

- Customers Own Material or finishes applied to Descor products (which include graded in fabrics, which are treated as Customers Own Material).
- Wood Veneer being a natural material will have shade differences between veneer leaves. This will be more apparent between flitches. Fading on wood veneers can be caused by exposure to UV rays / sunlight.
- Wood color, grain and stain acceptance, which may occur due to the natural elements of wood.
- Ballasts and light bulbs.
- Products which have been modified or which have not been installed or used according to Descor's application and installation guidelines or warnings.
- Products that must be replaced due to normal wear and tear, negligence, abuse, accidents or shipping damage.
- Products used for rental purposes.

In no event shall Descor be liable in either tort or contract for any loss or direct, special, incidental, consequential, or exemplary damages.

**This warranty is the customer's sole remedy for product defect. Descor makes no warranties, including the express or implied warranties of merchantability and fitness purpose, other than the express warranties contain herein.**

## TERMS AND CONDITIONS OF SALE

**Prices:** Prices are subject to change without notice. All shipments are F.O.B. the plant unless otherwise indicated. All taxes are extra.

**Terms:** Merchandise shall be invoiced when shipped and payment is due 30 days after invoice date.

**Orders:** All orders are subject to acceptance by Descor head office and to the Terms of Sale which appear in current price lists.

**Returns:** Merchandise may not be returned without prior written consent. Upon approval, a minimum restocking charge of 35% shall be deducted from the credit note, in addition to any expense incurred should reconditioning be necessary. Return shipping must be prepaid.

**Cancellations:** All orders are considered firm and not subject to cancellation without our documented approval. Cancellation charges may be required based on expenses incurred during order processing.

**Carriers:** All shipments shall normally be made through the Buyer's specified carrier. Otherwise Descor shall use its best judgment in selecting a carrier. Prepay and Add Service Charge to cover cost of processing prepaid freight bills, a charge of \$32.00 per shipment will be made. This amount will be included in the "Freight Charges" invoiced by Descor.

**Liability:** Every effort is employed to effect secure packing for shipment. Descor's liability ends when the carrier issues a clear receipt, acknowledging automatically that the shipment has been received in good condition.

**Claims:** It is required that all merchandise be carefully examined by recipient before issuance of clear receipt to carrier. Should the shipment arrive unsound or incomplete, have carrier make proper notation on the delivery receipt and original freight bill as to discrepancy before accepting shipment. Any claim for damage or shortage must be filed by you with the delivering carrier. Descor will not accept return of merchandise damaged in transit.

**Changes and Cancellations:** Descor reserves the right to institute changes with regard to materials, equipment, specification and designs, as well as to discontinue models at any time without prior notice. After the date of Descor's acknowledgement of a Purchaser's order, the order may not be changed or cancelled by Purchaser without the written consent of Descor. Special order items already in production are not subject to change or cancellation under any circumstances. Other standard items already in production are subject to a minimum 35% restocking charge, based on list price. A higher percentage may apply, depending on the stage of production.

**Finishes:** Descor veneers and solid woods are carefully selected for color, tone and grain. Since the distinctive characteristics and nature of wood cause variations, exact matches are not always possible.

**Shipping Weight:** All shipping weights and cubic sizes as indicated are approximate.

**Dimensions:** Are approximate. Please contact Descor for specific dimensions required.

**FINISHES**

Descor Collection Products are Greenguard certified

**Group 1 Finishes (Standard Finishes)**

Finish Code	Color	Veneer Type	Veneer Cut
BTW	Biscotti	White Oak	Rift
JAW	Java	White Oak	Rift
MCW	Moch	White Oak	Rift
CRW	Coral	White Oak	Rift
EVW	Evening Oak	White Oak	Rift
MTW	Milestone	White Oak	Rift
CAW	Cocoa Walnut	Walnut	Flat
DWW	Dark Walnut	Walnut	Flat
EWV	Empress Walnut	Walnut	Flat
LTW	Latte Walnut	Walnut	Flat
MHW	Mahogany on Walnut	Walnut	Flat
WLW	Walnut	Walnut	Flat
NLW	Natural Walnut	Walnut	Flat
ULW	Umber Walnut	Walnut	Flat
ACW	Amber Cherry	Cherry	Flat
DCW	Dark Cherry	Cherry	Flat
RCW	Red Cherry	Cherry	Flat
WCW	Windsor Cherry	Cherry	Flat
AMW	Almond Cherry	Cherry	Flat
VNW	Vintage Cherry	Cherry	Flat
HAW	Hazelnut	Maple	Flat
MPW	Maple	Maple	Flat
SMW	Sugar Maple	Maple	Flat
WMW	White Maple	Maple	Flat
OYW	Oyster Maple	Maple	Flat
SRW	Sahara Maple	Maple	Flat

**Group 2 Finishes (Add 25% upcharge)**

Finish Code	Color	Veneer Type	Veneer Cut
BRW	Butternut	Anigre	Figured

**Metal Finishes**

Finish Code	Color
E	Black
K	Tungsten (Silver)
DWT	Designer White

**Glass Finish (For Glass Doors and Modesty Panels)**

Frosted Glass Standard  
 White back painted glass Please contact Customer Service - Quote Required

**ALL LAMINATE FINISHES (LP) Chassis, Fronts, Doors and (HP) Top**

Top Code	Chassis, Fronts, Doors Code	Colour
ACJ	ACJ	Absolute Acajou*
ASN	ASN	Asian Night*
BLK	BLK	Black
BZD	BZD	Blizzard
CGY	CGY	Custom Grey
CMB	CMB	Clear Maple*
DES	DES	Dark Espresso*
DWT	DWT	Designer White
FAS	FAS	Fashionista*
FCL	FCL	First Class*
HGT	HGT	Hayden Grey
NBL	NBL	Noce Biondo*
NEL	NEL	Noce Leggero*
NGL	NGL	Noce Grigio*
NML	NML	Noce Medio*
SBY	SBY	Sheer Beauty*
SDT	SDT	Stonedust
SOG	SOG	Storm Grey (Charcoal)
STG	STG	String (Nevada)
WCR	WCR	Winter Cherry*
WHC	WHC	White Chocolate*
WHE	WHE	Walnut Heights*

Laminate Colour with \* is Wood Grain Laminate

**FINISH OPTIONS**

**Dufferin All Wood:**

Products are available as an all wood option. Add suffix "W" to the end of the product code (see page A.10).

**Special Finish Options**

Custom Veneers Please contact Customer Service for selection and  
 Laminate Inlays Please contact Customer Service - Surcharges may  
 FSC option available Please contact Customer Service - No upcharge

**Custom Staining (Please Contact Customer Service)**

up to \$50,000 Add \$528 Flat Fee and 15% and to the List Price  
 \$50,000 and \$200,000 Add 15% upcharge to the List Price  
 over \$200,000 No upcharge

**Dufferin All Laminate:**

Products are available as an all laminate option.  
 Low pressure laminate will be used on all chassis, fronts and doors.  
 High pressure laminate will be used on all tops.  
 Doors, fronts and user side of all tops (Dufferin edge) will be edgebanded with 3mm PVC edge, all remaining parts/edges will have a standard 0.5mm PVC edge.

Add suffix "P1", "P2" or "P3" to the end of the product code (see page A.10 and A.11)

Solid colour low pressure laminate and wood grain laminate can not be combined in one product.

**EDGE AVAILABLE**

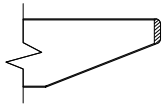

• COM Handles are available please contact Customer Service

**HANDLES AVAILABLE**



PL33  
Black Moon Pull, 4"



PL34  
Nickel Moon Pull, 4"



PL64  
Contemporary Nickel Pull, 5 3/8"



PL66  
Transitional Nickel Pull, 6 3/4"



PL92  
Silver Bar, 5 3/8"



PL93  
Black Bar, 5 3/8"



PL94  
Silver Rectangular Handle, 5 3/8"



PL95  
Black Rectangular Handle, 5 3/8"



PL96  
Silver Slimline Pull, 5 3/8"



PL97  
Black Slimline Pull, 5 3/8"

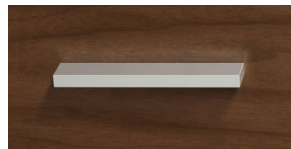

PL98  
Silver Princeton Bar, 5 3/8"



PL99  
Black Princeton Bar, 5 3/8"



PLS7  
Black Spaghetti Pull, 7 3/8"



PLS8  
Silver Spaghetti Pull, 7 3/8"

- Handle must be specified except for Hutches and Wall Mount Units
  - Black Handle = Black Lock & Grommet.
  - Silver, Nickel and Tungsten Handle = Tungsten Lock & Grommet.

**TACKBOARD FABRICS - GRADE 1**

Tackboards are standard in Global Furniture Group Grade 1 panel textiles, please refer to the following website for the current offering.  
<https://www.globalfurnituregroup.com/ca/workplace>  
 To find Panel Textiles choose the Resources tab and click on Textiles. Select Panel Textiles Grade 1 for standard offering.



# KEY ALIKE FORM

**DATE**

**ACK.NO. (PROVIDED BY DESCOR)**

**PAGE(S)**

of

**CUSTOMER PO#**

**SPECIAL INSTRUCTIONS**

**INITIATED BY**

**ADD ON**

**ORIGINAL PO#**

<b>KEY NO.</b> W401 to W500 Inclusive	<b>TAG AREA</b>	<b>QUANTITY</b>	<b>DESCOR USE ONLY</b>	
			Key Area Total	Checked Total
			Quantity	Print Initials

**NOTE:** If Key Alike Instructions are not Submitted to DESCOR INDUSTRIES with the Customer's Purchase Order, all components will be keyed randomly.

**D-01**

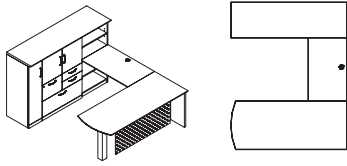

QTY	CODE	DESCRIPTION	STANDARD	WOOD	LAMINATE
1	D7D20W24H48	Open Bookcase with 1 Fixed Shelf & Adj. Shelves	1274	1527	1019
1	D15D20W36H48L	Storage Cabinet with Doors & Adj. Shelf above Left Combination Storage	3384	4062	2707
1	D2D20W12H48L	Left Wardrobe Cabinet with Door, Coat Rack & Hat Shelf	1637	1964	1311
1	DBT4224TSELCG/S	Left Linking Bridge Top - Self Edge on Left -Special	744	893	595
1	DDDBE7230	Connecting Bow End Table Desk	2851	3423	2283
1	CMP54W	Wood Straight Modesty Panel hanging from Top	1118	1118	893
1	D7222T	22" Top for Modular Storage	1277	1277	851
<b>TOTAL</b>			<b>\$12,287</b>	<b>\$14,263</b>	<b>\$9,660</b>

**D-02**

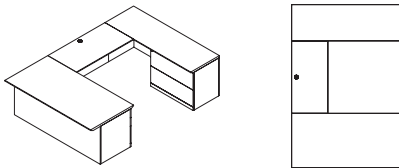

QTY	CODE	DESCRIPTION	STANDARD	WOOD	LAMINATE
1	DCR7222F	Single Pedestal Credenza with 36" Lat. File on Right	3762	4513	3010
1	DBT4820CG	Executive Bridge Top with Full Back Panel	1161	1394	930
1	DSL7236D	Single Pedestal Desk with BBF on Left	3433	4118	2746
<b>TOTAL</b>			<b>\$8,357</b>	<b>\$10,024</b>	<b>\$6,685</b>

**D-03**

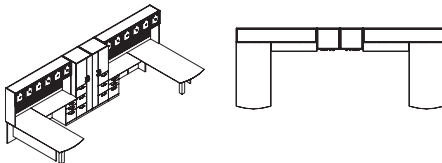

QTY	CODE	DESCRIPTION	STANDARD	WOOD	LAMINATE
2	DDDBE8436	Connecting Bow End Table Desk	7069	8480	5655
2	CMP66W	Wood Straight Modesty Panel hanging from Top	2311	2311	1850
1	DERR4822DCG	Executive Return Right with BBF Pedestal on Right	2428	2912	1942
1	DERL4822DCG	Executive Return Left with BBF Pedestal on Left	2428	2912	1942
1	D27D22W24H72L	Left Tower Unit with Wardrobe, 3 File Drawers & Storage with Adj. Shelves	5118	6139	4094
1	D27D22W24H72R	Right Tower Unit with Wardrobe, 3 File Drawers & Storage with Adj. Shelves	5118	6139	4094
2	D84SH42G	42" High Storage Hutch with Glass Doors	11161	13394	8928
2	DTSAS84H26	Tackboard with Rail for 42" & 54" High Non Pigeon-Hole Hutches	3359	3359	3359
<b>TOTAL</b>			<b>\$38,990</b>	<b>\$45,646</b>	<b>\$31,865</b>

**D-04**

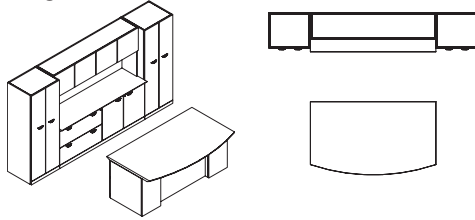

QTY	CODE	DESCRIPTION	STANDARD	WOOD	LAMINATE
1	DMiD7242DE	Double Pedestal Bow Top Desk, Breakfront Style with BBF Left & FF Right	5825	6989	4661
1	DC7222FG	Full Storage Credenza with Lat. File on Left & Storage Cabinet on Right	4076	4893	3263
1	D1D22W24H65	Storage Cabinet with Doors & Adj. Shelves	2522	3024	2017
1	D2D22W24H65	Wardrobe Cabinet with Doors, Coat Rack & Hat Shelf	2181	2618	1747
1	D72SH36	36" High Storage Hutch with Wood Doors	2971	3564	2376
1	DTS72	Tackboard for 36" High Non Pigeon-Hole Hutches	684	684	684
<b>TOTAL</b>			<b>\$18,258</b>	<b>\$21,770</b>	<b>\$14,744</b>

**D-05**

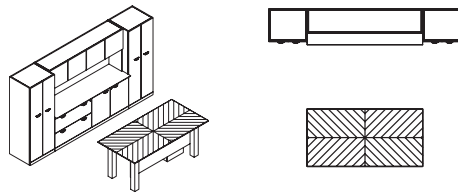

QTY	CODE	DESCRIPTION	STANDARD	WOOD	LAMINATE
1	RE7236(FD)	Rectangle Shaped Table Top	2522	2522	1682
1	CMP66W	Wood Straight Modesty Panel hanging from Top	1156	1156	926
4	SMS4	4" x 4" Metal Post Leg, Brushed Chrome	1537	1537	1537
1	DWDM	Freestanding Mobile BBF Pedestal	1685	2022	1349
1	DC7222FG	Full Storage Credenza with Lat. File on Left & Storage Cabinet on Right	4076	4893	3263
1	D1D22W24H65	Storage Cabinet with Doors & Adj. Shelves	2522	3024	2017
1	D2D22W24H65	Wardrobe Cabinet with Doors, Coat Rack & Hat Shelf	2181	2618	1747
1	D72SH36	36" High Storage Hutch with Wood Doors	2971	3564	2376
1	DTS72	Tackboard for 36" High Non Pigeon-Hole Hutches	684	684	684
<b>TOTAL</b>			<b>\$19,331</b>	<b>\$22,019</b>	<b>\$15,575</b>

**D-06**

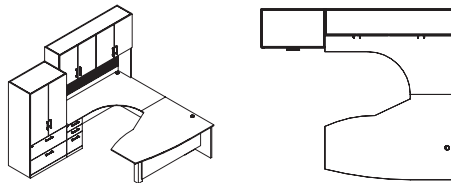

QTY	CODE	DESCRIPTION	STANDARD	WOOD	LAMINATE
1	DTBPR72364824	Right Boat Shaped Piano Table Desk	4015	4816	3212
1	ES22	Straight Front Upgrade	155	187	124
1	GM1TE	Round Grommet - Plastic Top End	48	48	48
1	CMP60W	Wood Straight Modesty Panel hanging from Top	1136	1136	909
1	DEKL724824D/S	Left Extended Corner Table with 22" Return Connection & BBF on Left - Special	3990	4787	3190
1	GM1TC	Round Grommet - Plastic Top Centre	48	48	48
1	D722SH54	54" High Storage Hutch with Wood Doors	4452	5341	3563
1	DTSAS72H26	Tackboard with Rail for 42" & 54" High Non Pigeon-Hole Hutches	1431	1431	1431
1	D13D22W36H72	Storage Cabinet with Doors & Adj. Shelves above 2 Lat. File Drawers	4529	5434	3622
<b>TOTAL</b>			<b>\$19,803</b>	<b>\$23,228</b>	<b>\$16,147</b>

**D-07**

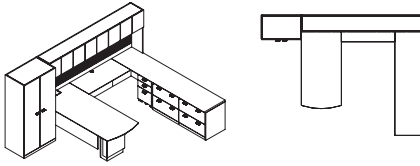

QTY	CODE	DESCRIPTION	STANDARD	WOOD	LAMINATE
1	DDDBE8436	Connecting Bow End Table Desk	3535	4241	2826
1	TPML18	Rectangular Pedestal Base Upgrade from SMS4	888	888	888
1	ESMR101	Data Power Box, Top End	868	868	868
1	CMP66W	Wood Straight Modesty Panel hanging from Top	1156	1156	926
1	DC10824/S	Credenza Shell with Full Back Panel - No Centre Support	3482	4177	2785
2	DWN	Modular Lateral File	3564	4277	2850
1	D108SH42	42" High Storage Hutch with Wood Doors	5194	6230	4156
1	DTSAS108H26	Tackboard with Rail for 42" & 54" High Non Pigeon-Hole Hutches	2191	2191	2191
1	D25D22W36H72	Cabinet with Doors, Storage with Adj. Shelves on Right & Wardrobe on Left	4105	4925	3286
1	DBT4822CG	Executive Bridge Top with Full Back Panel	1274	1527	1019
1	DWDM	Freestanding BBF Pedestal	1685	2022	1349
<b>TOTAL</b>			<b>\$27,938</b>	<b>\$32,500</b>	<b>\$23,142</b>

**D-08**

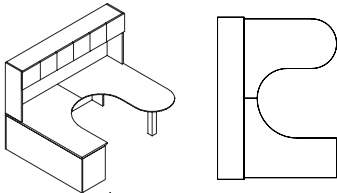

QTY	CODE	DESCRIPTION	STANDARD	WOOD	LAMINATE
1	DTDPR84304824	Right "D" Shaped Piano Table Desk	4073	4888	3259
1	D96SH42	42" High Storage Hutch with Wood Doors	4616	5537	3692
1	DEKL844824	Left Extended Corner Table with 24" Return Connection	4220	5064	3377
<b>TOTAL</b>			<b>\$12,909</b>	<b>\$15,489</b>	<b>\$10,327</b>

**D-09**

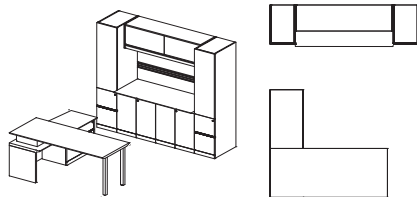

QTY	CODE	DESCRIPTION	STANDARD	WOOD	LAMINATE
1	DR7230/S	Connecting Rectangular Shaped Table Desk - Special	1746	2093	1396
1	DCR6620H23F/S	Credenza Shell with Full Back Panel 23" High - Special	3949	4741	3160
1	DSPBOX1620/S	Worksurface Spacer with Glass Shelf - Special	589	589	589
1	D17D22W16H72R	Right Storage Cabinet with Adj. Shelves above FF Drawers	3180	3816	2544
1	D17D22W16H72L	Left Storage Cabinet with Adj. Shelves above FF Drawers	3180	3816	2544
1	DC6022MM	Full Storage Credenza with 2 Sets of Storage Cabinets	3545	4255	2836
1	DSF60GSL	Wall Mount Storage with Sliding Glass Doors	2851	3423	2283
1	TSAS60H26	Wall Mount Tackboard with Accessory Rail	1211	1211	1211
<b>TOTAL</b>			<b>\$20,251</b>	<b>\$23,945</b>	<b>\$16,564</b>

**DESKS • TECHNICAL INFORMATION**

- All Desks are shipped assembled.
- Front locking standard.
- Desks come in Flush and Breakfront Style Modesty Panel configurations.
- Tops, panels on breakfront style units, door and drawer fronts and all exposed shelves are in wood. Chassis are in low pressure laminate.

- Handle must be specified:
  - Black and Brass Handle = Black Lock & Grommet.
  - Silver, Nickel and Tungsten Handle = Tungsten Lock & Grommet.
- To choose All Wood Finish, add suffix "W" to the end of the product code.
- To choose All Laminate Finish, add suffix "P1", "P2" or "P3" to the end of the product code (see page A.10 and A.11).

**DESKS • GUIDELINES FOR ORDERING PRODUCT**

**CODES:** The price list uses a numbering system with meaningful alphanumeric characters to create a simple-to-understand product number. This makes specifying the product easy and accurate.

**SPECIFICATION EXAMPLE OF A DESK UNIT**

**PRODUCT CODE:**

DMD8442ED  
 D = Dufferin Series  
 MD = Double Pedestal Bow Top Desk  
 8442 = Size: Width x Depth  
 ED = Pedestal Configuration: FF on Left & BBF on Right

**CHOOSE FINISH OPTION:**

**Standard Finish:**  
 Choose Laminate Finish & Veneer Finish

**All Wood Finish:**  
 Choose Veneer Finish

**All Laminate Finish:**  
 Choose Laminate Finish

**HANDLE OPTION:**  
 Choose a handle

**Optional Grommet Locations:**

- TL - Top Left
- TR - Top Right
- TEL - Top End Left
- TER - Top End Right

For Grommet Location see Page A.13

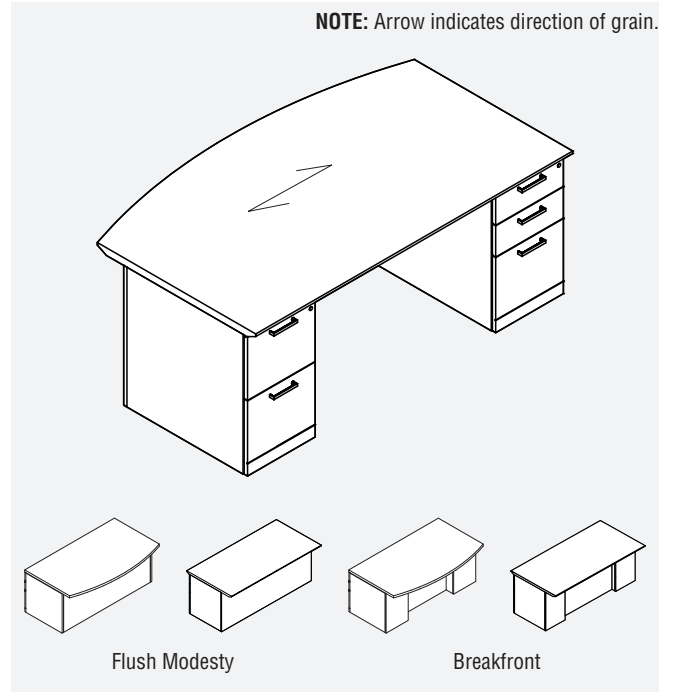

**DMD-ED • Double Pedestal Bow Top Desk with FF on Left & BBF on Right**

PRODUCT CODE	Finish options			SIZE (INCHES)			WEIGHT LBS	VOL FT3
	Standard	Wood	Laminate	H	W	D		
DMD8442ED	6180	7416	4944	29	84	42	314	59
DMD7842ED	5735	6882	4588	29	78	42	303	55
DMD7242ED	5295	6354	4236	29	72	42	292	51
DMD6636ED	5136	6163	4109	29	66	36	267	40

• Full height modesty panel

**DMD-DE • Double Pedestal Bow Top Desk with BBF on Left & FF on Right**

PRODUCT CODE	Finish options			SIZE (INCHES)			WEIGHT LBS	VOL FT3
	Standard	Wood	Laminate	H	W	D		
DMD8442DE	6180	7416	4944	29	84	42	314	59
DMD7842DE	5735	6882	4588	29	78	42	303	55
DMD7242DE	5295	6354	4236	29	72	42	292	51
DMD6636DE	5136	6163	4109	29	66	36	267	40

Full height modesty panel

**DD-ED • Double Pedestal Desk with FF on Left & BBF on Right**

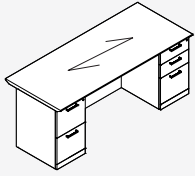

PRODUCT CODE	Finish options			SIZE (INCHES)			WEIGHT LBS	VOL FT3
	Standard	Wood	Laminate	H	W	D		
DD8442ED	5255	6306	4204	29	84	42	326	59
DD7842ED	4879	5855	3903	29	78	42	315	55
DD7236ED	4502	5402	3602	29	72	36	277	44
DD7230ED	4436	5323	3549	29	72	30	263	36
DD6636ED	4436	5323	3549	29	66	36	267	40
DD6630ED	4365	5238	3492	29	66	30	254	33
DD6030ED	4227	5072	3382	29	60	30	245	30

- Full height modesty panel

**DD-DE • Double Pedestal Desk with BBF on Left & FF on Right**

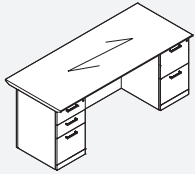

PRODUCT CODE	Finish options			SIZE (INCHES)			WEIGHT LBS	VOL FT3
	Standard	Wood	Laminate	H	W	D		
DD8442DE	5255	6306	4204	29	84	42	326	59
DD7842DE	4879	5855	3903	29	78	42	315	55
DD7236DE	4502	5402	3602	29	72	36	277	44
DD7230DE	4436	5323	3549	29	72	30	263	36
DD6636DE	4436	5323	3549	29	66	36	267	40
DD6630DE	4365	5238	3492	29	66	30	254	33
DD6030DE	4227	5072	3382	29	60	30	245	30

- Full height modesty panel

**DMiD-ED • Double Pedestal Bow Top Desk, Breakfront Style with FF on Left & BBF on Right**

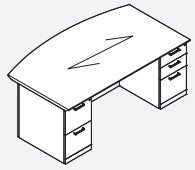

PRODUCT CODE	Finish options			SIZE (INCHES)			WEIGHT LBS	VOL FT3
	Standard	Wood	Laminate	H	W	D		
DMiD8442ED	6795	8154	5436	29	84	42	314	59
DMiD7842ED	6311	7573	5049	29	78	42	303	55
DMiD7242ED	5825	6990	4660	29	72	42	292	51
DMiD6636ED	5647	6776	4518	29	66	36	267	40

- Inset full height modesty panel
- For aluminum framed glass modesty option on breakfront style add "G" to the end of the product code (add \$1405 to the base price)

**DMiD-DE • Double Pedestal Bow Top Desk, Breakfront Style with BBF on Left & FF on Right**

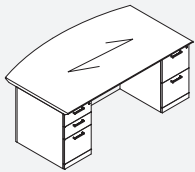

PRODUCT CODE	Finish options			SIZE (INCHES)			WEIGHT LBS	VOL FT3
	Standard	Wood	Laminate	H	W	D		
DMiD8442DE	6795	8154	5436	29	84	42	314	59
DMiD7842DE	6311	7573	5049	29	78	42	303	55
DMiD7242DE	5825	6990	4660	29	72	42	292	51
DMiD6636DE	5647	6776	4518	29	66	36	267	40

- Inset full height modesty panel
- For aluminum framed glass modesty option on breakfront style add "G" to the end of the product code (add \$1405 to the base price)

**DiD-ED • Double Pedestal Desk, Breakfront Style with FF on Left & BBF on Right**

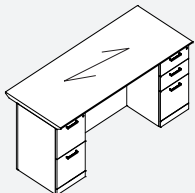

PRODUCT CODE	Finish options			SIZE (INCHES)			WEIGHT LBS	VOL FT3
	Standard	Wood	Laminate	H	W	D		
DiD8442ED	5779	6935	4623	29	84	42	326	59
DiD7842ED	5366	6439	4293	29	78	42	315	55
DiD7236ED	4954	5945	3963	29	72	36	277	44
DiD7230ED	4879	5855	3903	29	72	30	263	36
DiD6636ED	4879	5855	3903	29	66	36	267	40
DiD6630ED	4804	5765	3843	29	66	30	254	33
DiD6030ED	4648	5578	3718	29	60	30	254	30

- Inset full height modesty panel
- For aluminum framed glass modesty option on breakfront style add "G" to the end of the product code (add \$1405 to the base price)

**DiD-DE • Double Pedestal Desk, Breakfront Style with BBF on Left & FF on Right**

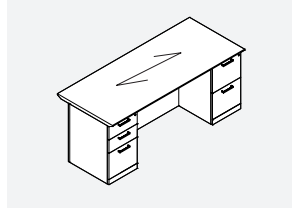

PRODUCT CODE	Finish options			SIZE (INCHES)			WEIGHT LBS	VOL FT3
	Standard	Wood	Laminate	H	W	D		
DID8442DE	5779	6935	4623	29	84	42	326	59
DID7842DE	5366	6439	4293	29	78	42	315	55
DID7236DE	4954	5945	3963	29	72	36	277	44
DID7230DE	4879	5855	3903	29	72	30	263	36
DID6636DE	4879	5855	3903	29	66	36	267	40
DID6630DE	4804	5765	3843	29	66	30	254	33
DID6030DE	4648	5578	3718	29	60	30	245	30

- Inset full height modesty panel
- For aluminum framed glass modesty option on breakfront style add "G" to the end of the product code (add \$1405 to the base price)

**DMSR-D • Single Pedestal Bow Top Desk with BBF on Right**



PRODUCT CODE	Finish options			SIZE (INCHES)			WEIGHT LBS	VOL FT3
	Standard	Wood	Laminate	H	W	D		
DMSR8442D	4896	5875	3917	29	84	42	270	59
DMSR7842D	4546	5455	3637	29	78	42	258	55
DMSR7242D	4200	5040	3360	29	72	42	247	51
DMSR6636D	4035	4842	3228	29	66	36	222	40

- Full height modesty panel

**DMSL-D • Single Pedestal Bow Top Desk with BBF on Left**

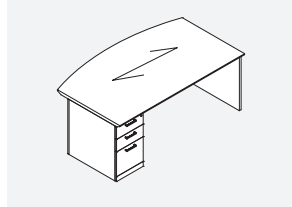

PRODUCT CODE	Finish options			SIZE (INCHES)			WEIGHT LBS	VOL FT3
	Standard	Wood	Laminate	H	W	D		
DMSL8442D	4896	5875	3917	29	84	42	270	59
DMSL7842D	4546	5455	3637	29	78	42	258	55
DMSL7242D	4200	5040	3360	29	72	42	247	51
DMSL6636D	4035	4842	3228	29	66	36	222	40

- Full height modesty panel

**DSR-D • Single Pedestal Desk with BBF on Right**



PRODUCT CODE	Finish options			SIZE (INCHES)			WEIGHT LBS	VOL FT3
	Standard	Wood	Laminate	H	W	D		
DSR8442D	4671	5605	3737	29	84	42	280	59
DSR7842D	4340	5208	3472	29	78	42	268	55
DSR7236D	3434	4121	2747	29	72	36	232	44
DSR7230D	3282	3938	2626	29	72	30	218	36
DSR6636D	3282	3938	2626	29	66	36	222	40
DSR6630D	3132	3758	2506	29	66	30	209	33
DSR6030D	2994	3593	2395	29	60	30	200	30

- Full height modesty panel

**DSL-D • Single Pedestal Desk with BBF on Left**

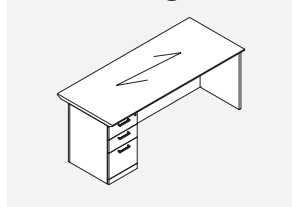

PRODUCT CODE	Finish options			SIZE (INCHES)			WEIGHT LBS	VOL FT3
	Standard	Wood	Laminate	H	W	D		
DSL8442D	4671	5605	3737	29	84	42	280	59
DSL7842D	4340	5208	3472	29	78	42	268	55
DSL7236D	3434	4121	2747	29	72	36	232	44
DSL7230D	3282	3938	2626	29	72	30	218	36
DSL6636D	3282	3938	2626	29	66	36	222	40
DSL6630D	3132	3758	2506	29	66	30	209	33
DSL6030D	2994	3593	2395	29	60	30	200	30

- Full height modesty panel

**DMiSR-D • Single Pedestal Bow Top Desk, Breakfront Style with BBF on Right**

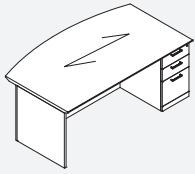

PRODUCT CODE	Finish options			SIZE (INCHES)			WEIGHT LBS	VOL FT3
	Standard	Wood	Laminate	H	W	D		
DMISR8442D	5386	6463	4309	29	84	42	270	59
DMISR7842D	5002	6002	4002	29	78	42	258	55
DMISR7242D	4617	5540	3694	29	72	42	247	51
DMISR6636D	4439	5327	3551	29	66	36	222	40

- Inset full height modesty panel
- For aluminum framed glass modesty option on breakfront style add "G" to the end of the product code (add \$1405 to the base price)

**DMiSL-D • Single Pedestal Bow Top Desk, Breakfront Style with BBF on Left**

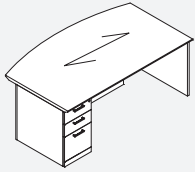

PRODUCT CODE	Finish options			SIZE (INCHES)			WEIGHT LBS	VOL FT3
	Standard	Wood	Laminate	H	W	D		
DMISL8442D	5386	6463	4309	29	84	42	270	59
DMISL7842D	5002	6002	4002	29	78	42	258	55
DMISL7242D	4617	5540	3694	29	72	42	247	51
DMISL6636D	4439	5327	3551	29	66	36	222	40

- Inset full height modesty panel
- For aluminum framed glass modesty option on breakfront style add "G" to the end of the product code (add \$1405 to the base price)

**DiSR-D • Single Pedestal Desk, Breakfront Style with BBF on Right**

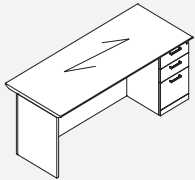

PRODUCT CODE	Finish options			SIZE (INCHES)			WEIGHT LBS	VOL FT3
	Standard	Wood	Laminate	H	W	D		
DISR8442D	5141	6169	4113	29	84	42	280	59
DISR7842D	4770	5724	3816	29	78	42	268	55
DISR7236D	4406	5287	3525	29	72	36	232	44
DISR7230D	3609	4331	2887	29	72	30	218	36
DISR6636D	3609	4331	2887	29	66	36	222	40
DISR6630D	3444	4133	2755	29	66	30	209	33
DISR6030D	3291	3949	2633	29	60	30	200	30

- Inset full height modesty panel
- For aluminum framed glass modesty option on breakfront style add "G" to the end of the product code (add \$1405 to the base price)

**DiSL-D • Single Pedestal Desk, Breakfront Style with BBF on Left**

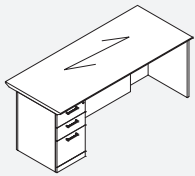

PRODUCT CODE	Finish options			SIZE (INCHES)			WEIGHT LBS	VOL FT3
	Standard	Wood	Laminate	H	W	D		
DISL8442D	5141	6169	4113	29	84	42	280	59
DISL7842D	4770	5724	3816	29	78	42	268	55
DISL7236D	4406	5287	3525	29	72	36	232	44
DISL7230D	3609	4331	2887	29	72	30	218	36
DISL6636D	3609	4331	2887	29	66	36	222	40
DISL6630D	3444	4133	2755	29	66	30	209	33
DISL6030D	3291	3949	2633	29	60	30	200	30

- Inset full height modesty panel
- For aluminum framed glass modesty option on breakfront style add "G" to the end of the product code (add \$1405 to the base price)

**DMiT • Desk Shell with Bow Top, Breakfront Style**

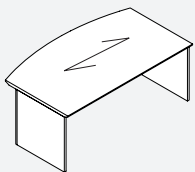

PRODUCT CODE	Finish options			SIZE (INCHES)			WEIGHT LBS	VOL FT3
	Standard	Wood	Laminate	H	W	D		
DMIT8442	4412	5294	3530	29	84	42	226	59
DMIT7842	4132	4958	3306	29	78	42	214	55
DMIT7242	3847	4616	3078	29	72	42	203	51
DMIT6636	3689	4427	2951	29	66	36	178	40

- Inset full height modesty panel
- For aluminum framed glass modesty option on breakfront style add "G" to the end of the product code (add \$1405 to the base price)



**DMT • Desk Shell with Bow Top & Recessed Modesty Panel**

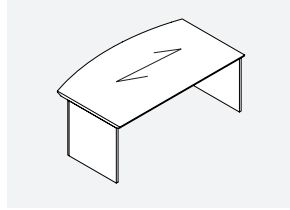

PRODUCT CODE	Finish options			SIZE (INCHES)			WEIGHT LBS	VOL FT3
	Standard	Wood	Laminate	H	W	D		
DMT8442	3960	4752	3168	29	84	42	226	59
DMT7842	3678	4414	2942	29	78	42	214	55
DMT7242	3396	4075	2717	29	72	42	203	51
DMT6636	3237	3884	2590	29	66	36	178	40

**DT • Desk Shell with Recessed Modesty Panel**

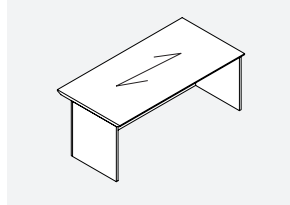

PRODUCT CODE	Finish options			SIZE (INCHES)			WEIGHT LBS	VOL FT3
	Standard	Wood	Laminate	H	W	D		
DT8442	3688	4426	2950	29	84	42	208	54
DT7842	3421	4105	2737	29	78	42	197	52
DT8436	3157	3788	2526	29	84	36	209	51
DT7836	2933	3520	2346	29	78	36	199	47
DT7236	2707	3248	2166	29	72	36	188	44
DT6636	2551	3061	2041	29	66	36	178	40
DT7230	2551	3061	2041	29	72	30	174	36
DT6630	2394	2873	1915	29	66	30	165	33
DT6030	2188	2626	1750	29	60	30	156	30

**DDD • Connecting “D” Shaped Table Desk**

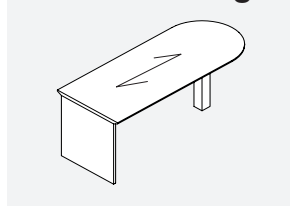

PRODUCT CODE	Finish options			SIZE (INCHES)			WEIGHT LBS	VOL FT3
	Standard	Wood	Laminate	H	W	D		
DDD8436	3535	4242	2828	29	84	36	182	51
DDD7236	3026	3631	2421	29	72	36	162	44
DDD7230	2853	3424	2282	29	72	30	144	36
DDD6636	2853	3424	2282	29	66	36	152	40
DDD6030	2813	3376	2250	29	60	30	127	30

- Full height end panel
- Please specify: Black or Tungsten for SMS4 (square metal leg).

**DDDDBE • Connecting Bow End Table Desk**

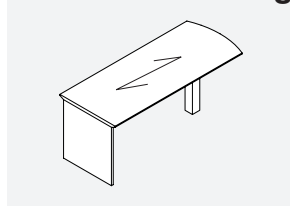

PRODUCT CODE	Finish options			SIZE (INCHES)			WEIGHT LBS	VOL FT3
	Standard	Wood	Laminate	H	W	D		
DDDDBE8436	3535	4242	2828	29	84	36	182	51
DDDDBE7236	3026	3631	2421	29	72	36	162	44
DDDDBE7230	2853	3424	2282	29	72	30	144	36
DDDDBE6636	2853	3424	2282	29	66	36	152	40
DDDDBE6030	2813	3376	2250	29	60	30	127	30

- Full height end panel
- Please specify: Black or Tungsten for SMS4 (square metal leg).

**DDDDBS • Connecting Boat Shaped Table Desk**

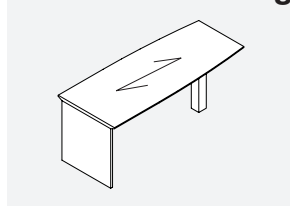

PRODUCT CODE	Finish options			SIZE (INCHES)			WEIGHT LBS	VOL FT3
	Standard	Wood	Laminate	H	W	D		
DDDDBS8442	4179	5015	3343	29	84	42	202	59
DDDDBS8436	3535	4242	2828	29	84	36	182	51
DDDDBS7236	3026	3631	2421	29	72	36	162	44
DDDDBS7230	2813	3376	2250	29	72	30	144	36
DDDDBS6636	2813	3376	2250	29	66	36	152	40
DDDDBS6030	2703	3244	2162	29	60	30	127	30

- Full height end panel
- Please specify: Black or Tungsten for SMS4 (square metal leg).

**DTPR • Right Connecting “P” Shaped Table Desk**

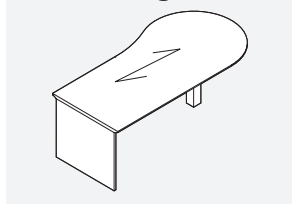

PRODUCT CODE	Finish options			SIZE (INCHES)			WEIGHT	VOL
	Standard	Wood	Laminate	H	W	D	LBS	FT3
DTPR9642	4412	5294	3530	29	96	42	220	68
DTPR8442	3859	4631	3087	29	84	42	198	59
DTPR7242	3521	4225	2817	29	72	42	171	51

- Full height end panel
- Please specify: Black or Tungsten for SMS4 (square metal leg).

**DTPL • Left Connecting “P” Shaped Table Desk**

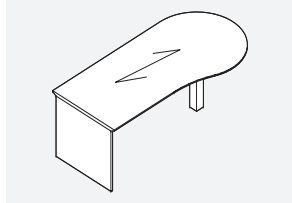

PRODUCT CODE	Finish options			SIZE (INCHES)			WEIGHT	VOL
	Standard	Wood	Laminate	H	W	D	LBS	FT3
DTPL9642	4412	5294	3530	29	96	42	220	68
DTPL8442	3859	4631	3087	29	84	42	198	59
DTPL7242	3521	4225	2817	29	72	42	171	51

- Full height end panel
- Please specify: Black or Tungsten for SMS4 (square metal leg).

**RETURNS • TECHNICAL INFORMATION**

- All Returns are shipped assembled.
- Front locking standard.
- All Returns have Cross Grain veneer pattern.
- To remove Cross Grain veneer pattern on Top, delete suffix “CG” from the product Number Code. (Available at no upcharge)
- Tops and drawer fronts are in wood. Chassis are in low pressure laminate.
- Handle must be specified:
  - Black and Brass Handle = Black Lock & Grommet.
  - Silver, Nickel and Tungsten Handle = Tungsten Lock & Grommet.
- To choose All Wood Finish, add suffix “W” to the end of the product code.
- To choose All Laminate Finish, add suffix “P1”, “P2” or “P3” to the end of the product code (see page A.10 and A.11).

**DESKS • GUIDELINES FOR ORDERING PRODUCT**

**CODES:** The price list uses a numbering system with meaningful alphanumeric characters to create a simple-to-understand product number. This makes specifying the product easy and accurate.

**SPECIFICATION EXAMPLE OF A DESK UNIT**

**PRODUCT CODE:**

DERR7224ECG  
 D = Dufferin Series  
 ERR = Executive Return Right  
 7224 = Size: Width x Depth  
 E = Pedestal Configuration: FF Pedestal  
 CG = Cross Grain

**CHOOSE FINISH OPTION:**

**Standard Finish:**  
 Choose Laminate Finish & Veneer Finish

**All Wood Finish:**

Choose Veneer Finish

**All Laminate Finish:**

Choose Laminate Finish

**HANDLE OPTION:**

Choose a handle

**Optional Grommet Locations:**

- TL - Top Left
- TR - Top Right
- TC - Top Center
- TEL - Top End Left
- TER - Top End Right

For Grommet Location see Page A.13

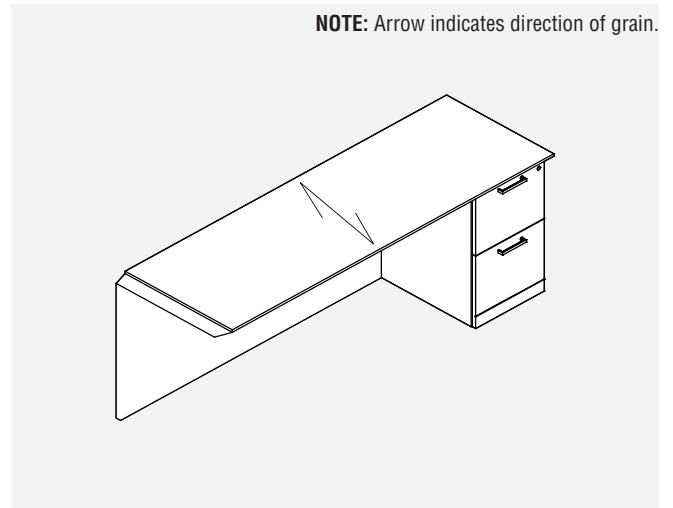

**DERR-E • Right Executive Return with FF Pedestal on Right**

PRODUCT CODE	FINISH OPTIONS			SIZE (INCHES)			WEIGHT LBS	VOL FT3
	STANDARD	WOOD	LAMINATE	H	W	D		
DERR7224ECG	3398	4078	2718	29	72	24	175	29
DERR6624ECG	3275	3930	2620	29	66	24	167	27
DERR6024ECG	2976	3571	2381	29	60	24	159	24
DERR5424ECG	2868	3442	2294	29	54	24	151	22
DERR4824ECG	2550	3060	2040	29	48	24	144	19
DERR4224ECG	2453	2944	1962	29	42	24	136	17

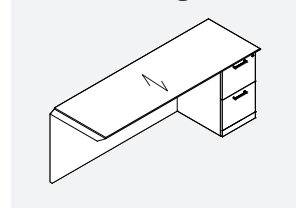

- Full height flush back panel

**DERL-E • Left Executive Return with FF Pedestal on Right**

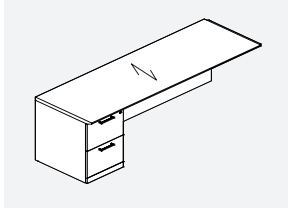

PRODUCT CODE	FINISH OPTIONS			SIZE (INCHES)			WEIGHT LBS	VOL FT3
	STANDARD	WOOD	LAMINATE	H	W	D		
DERL7224ECG	3398	4078	2718	29	72	24	175	29
DERL6624ECG	3275	3930	2620	29	66	24	167	27
DERL6024ECG	2976	3571	2381	29	60	24	159	24
DERL5424ECG	2868	3442	2294	29	54	24	151	22
DERL4824ECG	2550	3060	2040	29	48	24	144	19
DERL4224ECG	2453	2944	1962	29	42	24	136	17

• Full height flush back panel

**DERR-D • Right Executive Return with BBF Pedestal on Right**

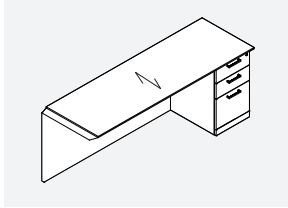

PRODUCT CODE	FINISH OPTIONS			SIZE (INCHES)			WEIGHT LBS	VOL FT3
	STANDARD	WOOD	LAMINATE	H	W	D		
DERR7224DCG	3398	4078	2718	29	72	24	174	29
DERR6624DCG	3275	3930	2620	29	66	24	166	27
DERR6024DCG	2976	3571	2381	29	60	24	158	24
DERR5424DCG	2868	3442	2294	29	54	24	151	22
DERR4824DCG	2550	3060	2040	29	48	24	143	19
DERR4224DCG	2453	2944	1962	29	42	24	135	17

• Full height flush back panel

**DERL-D • Left Executive Return with BBF Pedestal on Left**

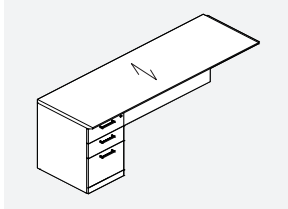

PRODUCT CODE	FINISH OPTIONS			SIZE (INCHES)			WEIGHT LBS	VOL FT3
	STANDARD	WOOD	LAMINATE	H	W	D		
DERL7224DCG	3398	4078	2718	29	72	24	174	29
DERL6624DCG	3275	3930	2620	29	66	24	166	27
DERL6024DCG	2976	3571	2381	29	60	24	158	24
DERL5424DCG	2868	3442	2294	29	54	24	151	22
DERL4824DCG	2550	3060	2040	29	48	24	143	19
DERL4224DCG	2453	2944	1962	29	42	24	135	17

• Full height flush back panel

**DERR • Right Executive Return**

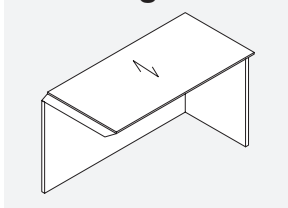

PRODUCT CODE	FINISH OPTIONS			SIZE (INCHES)			WEIGHT LBS	VOL FT3
	STANDARD	WOOD	LAMINATE	H	W	D		
DERR7224CG	2006	2407	1605	29	72	24	133	29
DERR6624CG	1839	2207	1471	29	66	24	125	27
DERR6024CG	1673	2008	1338	29	60	24	117	24
DERR5424CG	1504	1805	1203	29	54	24	110	22
DERR4824CG	1337	1604	1070	29	48	24	102	19
DERR4224CG	1170	1404	936	29	42	24	94	17

• Full height flush back panel

**DERL • Left Executive Return**

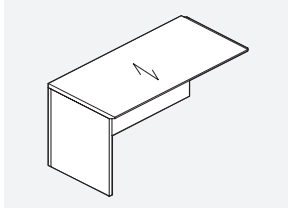

PRODUCT CODE	FINISH OPTIONS			SIZE (INCHES)			WEIGHT LBS	VOL FT3
	STANDARD	WOOD	LAMINATE	H	W	D		
DERL7224CG	2006	2407	1605	29	72	24	133	29
DERL6624CG	1839	2207	1471	29	66	24	125	27
DERL6024CG	1673	2008	1338	29	60	24	117	24
DERL5424CG	1504	1805	1203	29	54	24	110	22
DERL4824CG	1337	1604	1070	29	48	24	102	19
DERL4224CG	1170	1404	936	29	42	24	94	17

• Full height flush back panel

**DERR-E • Right Executive Return with FF Pedestal on Right**

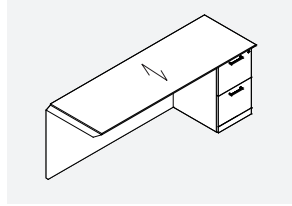

PRODUCT CODE	FINISH OPTIONS			SIZE (INCHES)			WEIGHT LBS	VOL FT3
	STANDARD	WOOD	LAMINATE	H	W	D		
DERR7222ECG	3234	3881	2587	29	72	22	167	27
DERR6622ECG	3115	3738	2492	29	66	22	160	24
DERR6022ECG	2834	3401	2267	29	60	22	153	22
DERR5422ECG	2730	3276	2184	29	54	22	145	20
DERR4822ECG	2428	2914	1942	29	48	22	138	18
DERR4222ECG	2336	2803	1869	29	42	22	131	16

• Full height flush back panel

**DERL-E • Left Executive Return with FF Pedestal on Left**

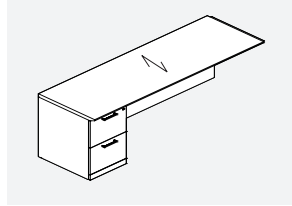

PRODUCT CODE	FINISH OPTIONS			SIZE (INCHES)			WEIGHT LBS	VOL FT3
	STANDARD	WOOD	LAMINATE	H	W	D		
DERL7222ECG	3234	3881	2587	29	72	22	167	27
DERL6622ECG	3115	3738	2492	29	66	22	160	24
DERL6022ECG	2834	3401	2267	29	60	22	153	22
DERL5422ECG	2730	3276	2184	29	54	22	145	20
DERL4822ECG	2428	2914	1942	29	48	22	138	18
DERL4222ECG	2336	2803	1869	29	42	22	131	16

• Full height flush back panel

**DERR-D • Right Executive Return with BBF Pedestal on Right**

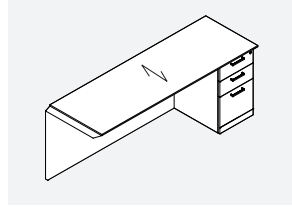

PRODUCT CODE	FINISH OPTIONS			SIZE (INCHES)			WEIGHT LBS	VOL FT3
	STANDARD	WOOD	LAMINATE	H	W	D		
DERR7222DCG	3234	3881	2587	29	72	22	167	27
DERR6622DCG	3115	3738	2492	29	66	22	159	24
DERR6022DCG	2834	3401	2267	29	60	22	152	22
DERR5422DCG	2730	3276	2184	29	54	22	145	20
DERR4822DCG	2428	2914	1942	29	48	22	137	18
DERR4222DCG	2336	2803	1869	29	42	22	130	16

• Full height flush back panel

**DERL-D • Left Executive Return with BBF Pedestal on Left**

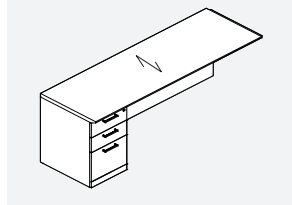

PRODUCT CODE	FINISH OPTIONS			SIZE (INCHES)			WEIGHT LBS	VOL FT3
	STANDARD	WOOD	LAMINATE	H	W	D		
DERL7222DCG	3234	3881	2587	29	72	22	167	27
DERL6622DCG	3115	3738	2492	29	66	22	159	24
DERL6022DCG	2834	3401	2267	29	60	22	152	22
DERL5422DCG	2730	3276	2184	29	54	22	145	20
DERL4822DCG	2428	2914	1942	29	48	22	137	18
DERL4222DCG	2336	2803	1869	29	42	22	130	16

• Full height flush back panel

**DERR • Right Executive Return**

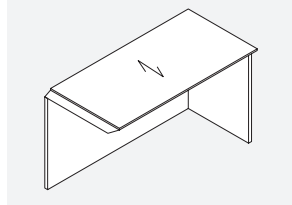

PRODUCT CODE	FINISH OPTIONS			SIZE (INCHES)			WEIGHT LBS	VOL FT3
	STANDARD	WOOD	LAMINATE	H	W	D		
DERR7222CG	1911	2293	1529	29	72	22	127	27
DERR6622CG	1751	2101	1401	29	66	22	119	24
DERR6022CG	1592	1910	1274	29	60	22	112	22
DERR5422CG	1431	1717	1145	29	54	22	104	20
DERR4822CG	1274	1529	1019	29	48	22	97	18
DERR4222CG	1115	1338	892	29	42	22	90	16

• Full height flush back panel

**DERL • Left Executive Return**

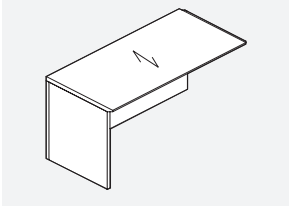

PRODUCT CODE	FINISH OPTIONS			SIZE (INCHES)			WEIGHT	VOL
	STANDARD	WOOD	LAMINATE	H	W	D	LBS	FT3
DERL7222CG	1911	2293	1529	29	72	22	127	27
DERL6622CG	1751	2101	1401	29	66	22	119	24
DERL6022CG	1592	1910	1274	29	60	22	112	22
DERL5422CG	1431	1717	1145	29	54	22	104	20
DERL4822CG	1274	1529	1019	29	48	22	97	18
DERL4222CG	1115	1338	892	29	42	22	90	16

- Full height flush back panel

**PIANO DESKS • TECHNICAL INFORMATION**

- All Desks are shipped assembled.
- Units include installed horizontal wire management.
- Unit is handed by Post Leg.
- Not for use with Regular Corner Units.
- All Standard Piano Desks have Tops in wood, Chassis are in low pressure laminate.
- To choose All Wood Finish, add suffix "W" to the end of the product code.
- To choose All Laminate Finish, add suffix "P1", "P2" or "P3" to the end of the product code (see page A.10 and A.11).

**PIANO DESKS • GUIDELINES FOR ORDERING PRODUCT**

**CODES:** The price list uses a numbering system with meaningful alphanumeric characters to create a simple-to-understand product number. This makes specifying the product easy and accurate.

**SPECIFICATION EXAMPLE OF A PIANO DESK UNIT**

**PRODUCT CODE:**

DTDPR72304824  
 D = Dufferin Series  
 TDP = Piano "D" Shaped Table Desk  
 R = Right Configuration  
 7230 = Size of Worksurface: Width x Depth  
 4824 = Size of End x Depth of Return Connection

**CHOOSE FINISH OPTION:**

**Standard Finish:**  
 Choose Laminate Finish & Veneer Finish

**All Wood Finish:**  
 Choose Veneer Finish

**All Laminate Finish:**  
 Choose Laminate Finish

**HANDLE OPTION:**  
 Choose a handle

**Optional Grommet Locations:**  
 TE - Top End

For Grommet Location see Page A.13

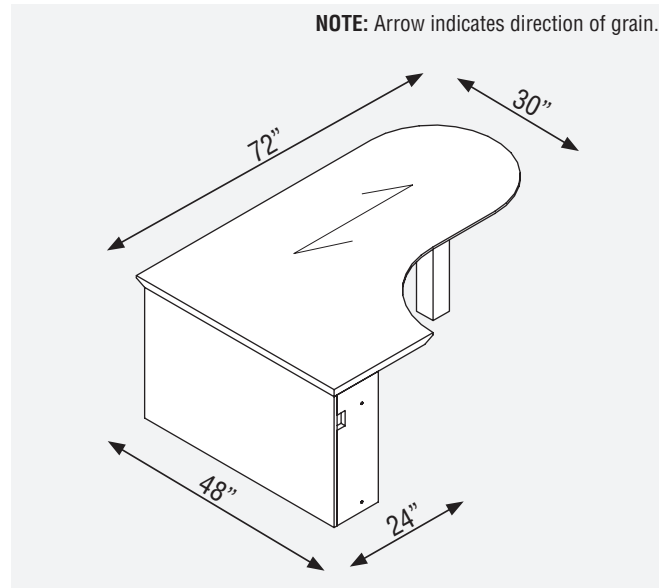

**DTDPR • Right "D" Shaped Piano Table Desk**

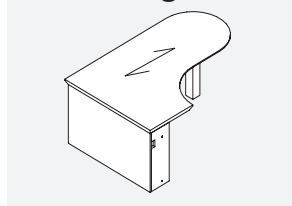

PRODUCT CODE	FINISH OPTIONS			SIZE (INCHES)			WEIGHT LBS	VOL FT3
	STANDARD	WOOD	LAMINATE	H	W	D		
DTDPR96304824	4579	5495	3663	29	96	48	217	77
DTDPR84304824	4073	4888	3258	29	84	48	198	68
DTDPR72304824	3571	4285	2857	29	72	48	178	58

- Square metal leg and full end panel, 30" deep work surface and 24" return connection

**DTDPL • Left "D" Shaped Piano Table Desk**

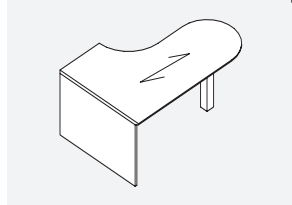

PRODUCT CODE	FINISH OPTIONS			SIZE (INCHES)			WEIGHT LBS	VOL FT3
	STANDARD	WOOD	LAMINATE	H	W	D		
DTDPL96304824	4579	5495	3663	29	96	48	217	77
DTDPL84304824	4073	4888	3258	29	84	48	198	68
DTDPL72304824	3571	4285	2857	29	72	48	178	58

- Square metal leg and full end panel, 30" deep work surface and 24" return connection

**DTBPR • Right Boat Shaped Piano Table Desk**

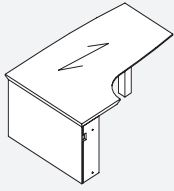

PRODUCT CODE	FINISH OPTIONS			SIZE (INCHES)			WEIGHT LBS	VOL FT3
	STANDARD	WOOD	LAMINATE	H	W	D		
DTBPR96364824	5155	6186	4124	29	96	48	217	87
DTBPR84364824	4582	5498	3666	29	84	48	198	76
DTBPR72364824	4015	4818	3212	29	72	48	178	65

• Square metal leg and full end panel, a 36" to 30" deep work surface and 24" return connection

**DTBPL • Left Boat Shaped Piano Table Desk**

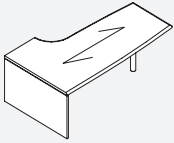

PRODUCT CODE	FINISH OPTIONS			SIZE (INCHES)			WEIGHT LBS	VOL FT3
	STANDARD	WOOD	LAMINATE	H	W	D		
DTBPL96364824	5155	6186	4124	29	96	48	217	87
DTBPL84364824	4582	5498	3666	29	84	48	198	76
DTBPL72364824	4015	4818	3212	29	72	48	178	65

• Square metal leg and full end panel, a 36" to 30" deep work surface and 24" return connection

**DTPPR • Right "P" Shaped Piano Table Desk**

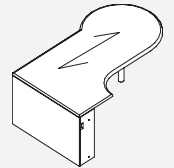

PRODUCT CODE	FINISH OPTIONS			SIZE (INCHES)			WEIGHT LBS	VOL FT3
	STANDARD	WOOD	LAMINATE	H	W	D		
DTPPR96424824	5226	6271	4181	29	96	54	241	97
DTPPR84424824	4673	5608	3738	29	84	54	219	85
DTPPR72424824	4334	5201	3467	29	72	54	197	73

• Square metal leg and full end panel, a 42" to 30" work surface and 24" return connection

**DTPPL • Left "P" Shaped Piano Table Desk**

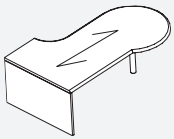

PRODUCT CODE	FINISH OPTIONS			SIZE (INCHES)			WEIGHT LBS	VOL FT3
	STANDARD	WOOD	LAMINATE	H	W	D		
DTPPL96424824	5226	6271	4181	29	96	54	241	97
DTPPL84424824	4673	5608	3738	29	84	54	219	85
DTPPL72424824	4334	5201	3467	29	72	54	197	73

• Square metal leg and full end panel, a 42" to 30" work surface and 24" return connection

**DBTHPR • Right Delta Shaped Piano Table Desk**

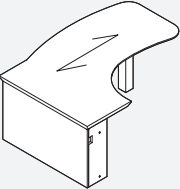

PRODUCT CODE	FINISH OPTIONS			SIZE (INCHES)			WEIGHT LBS	VOL FT3
	STANDARD	WOOD	LAMINATE	H	W	D		
DBTHPR96304824	5155	6186	4124	29	96	54	241	87
DBTHPR84304824	4580	5496	3664	29	84	54	219	76
DBTHPR72304824	4226	5071	3381	29	72	54	197	65

• Square metal leg and full end panel, 24" return connection

**DBTHPL • Left Delta Shaped Piano Table Desk**

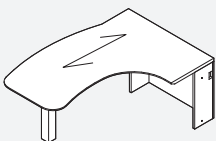

PRODUCT CODE	FINISH OPTIONS			SIZE (INCHES)			WEIGHT LBS	VOL FT3
	STANDARD	WOOD	LAMINATE	H	W	D		
DBTHPL96304824	5155	6186	4124	29	96	54	241	87
DBTHPL84304824	4580	5496	3664	29	84	54	219	76
DBTHPL72304824	4226	5071	3381	29	72	54	197	65

• Square metal leg and full end panel, 24" return connection

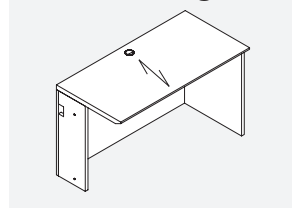

**DVER • Linking Return Right**

PRODUCT CODE	FINISH OPTIONS			SIZE (INCHES)			WEIGHT LBS	VOL FT3
	STANDARD	WOOD	LAMINATE	H	W	D		
DVER9624CG	3024	3629	2419	29	96	24	171	39
DVER9024CG	2835	3402	2268	29	90	24	163	36
DVER8424CG	2646	3175	2117	29	84	24	156	34
DVER7824CG	2457	2948	1966	29	78	24	148	31
DVER7224CG	2270	2724	1816	29	72	24	140	29
DVER6624CG	2129	2555	1703	29	66	24	132	27
DVER6024CG	1990	2388	1592	29	60	24	125	24
DVER5424CG	1879	2255	1503	29	54	24	117	22
DVER4824CG	1764	2117	1411	29	48	24	109	19
DVER4224CG	1488	1786	1190	29	42	24	101	17
DVER3624CG	1434	1721	1147	29	36	24	94	15
DVER3024CG	1426	1711	1141	29	30	24	86	12
DVER2424CG	1184	1421	947	29	24	24	78	10

- Used in conjunction with extended piano corner units or piano shaped desks

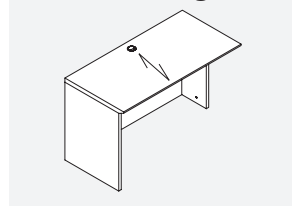
**DVEL • Linking Return Left**

PRODUCT CODE	FINISH OPTIONS			SIZE (INCHES)			WEIGHT LBS	VOL FT3
	STANDARD	WOOD	LAMINATE	H	W	D		
DVEL9624CG	3024	3629	2419	29	96	24	171	39
DVEL9024CG	2835	3402	2268	29	90	24	163	36
DVEL8424CG	2646	3175	2117	29	84	24	156	34
DVEL7824CG	2457	2948	1966	29	78	24	148	31
DVEL7224CG	2270	2724	1816	29	72	24	140	29
DVEL6624CG	2129	2555	1703	29	66	24	132	27
DVEL6024CG	1990	2388	1592	29	60	24	125	24
DVEL5424CG	1879	2255	1503	29	54	24	117	22
DVEL4824CG	1764	2117	1411	29	48	24	109	19
DVEL4224CG	1488	1786	1190	29	42	24	101	17
DVEL3624CG	1434	1721	1147	29	36	24	94	15
DVEL3024CG	1426	1711	1141	29	30	24	86	12
DVEL2424CG	1184	1421	947	29	24	24	78	10

- Used in conjunction with extended piano corner units or piano shaped desks

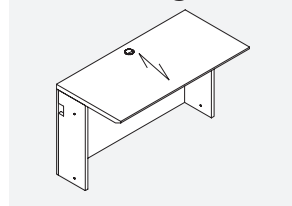
**DBTN • Bridge for Extended Piano Corner Unit or Piano Shaped Desk**

PRODUCT CODE	FINISH OPTIONS			SIZE (INCHES)			WEIGHT LBS	VOL FT3
	STANDARD	WOOD	LAMINATE	H	W	D		
DBTN4824CG	1712	2054	1370	29	48	24	99	19
DBTN4224CG	1434	1721	1147	29	42	24	91	17
DBTN3624CG	1378	1654	1102	29	36	24	83	15
DBTN3024CG	1354	1625	1083	29	30	24	76	12
DBTN2424CG	1136	1363	909	29	24	24	68	10
DBTN1824CG	853	1024	682	29	18	24	60	8
DBTN1224CG	571	685	457	29	12	24	52	5

- With full back panel and recessed end panels



## BRIDGES • TECHNICAL INFORMATION

- All Bridges are shipped knockdown.
- Not for use with Corner Units.
- To remove Cross Grain veneer pattern on Top, delete suffix "CG" from the product Number Code. (Available at no upcharge)
- All Bridges have Tops in wood, Chassis are in low pressure laminate.
- GM1 TC location is standard.
- To choose All Wood Finish, add suffix "W" to the end of the product code.
- To choose All Laminate Finish, add suffix "P1", "P2" or "P3" to the end of the product code (see page A.10 and A.11).

## BRIDGES • GUIDELINES FOR ORDERING PRODUCT

**CODES:** The price list uses a numbering system with meaningful alphanumeric characters to create a simple-to-understand product number. This makes specifying the product easy and accurate.

### SPECIFICATION EXAMPLE OF A BRIDGE UNIT

#### PRODUCT CODE:

DBT6024CG

D = Dufferin Series

BT = Bridge Top

6024 = Size: Width x Depth

CG = Cross Grain

#### CHOOSE FINISH OPTION:

##### Standard Finish:

Choose Laminate Finish & Veneer Finish

##### All Wood Finish:

Choose Veneer Finish

##### All Laminate Finish:

Choose Laminate Finish

#### Optional Grommet Locations (Additional):

TL - Top Left

TR - Top Right

TC - Top Center

TEL - Top End Left

TER - Top End Right

For Grommet Location see Page A.13

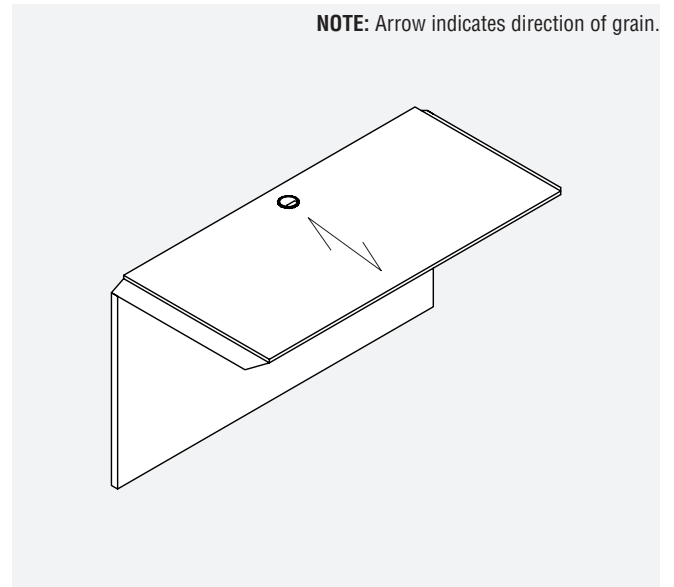

## DBT • Executive Bridge Top with Full Back Panel

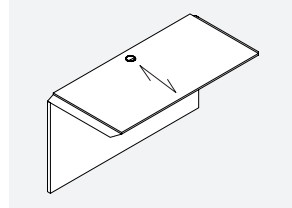

PRODUCT CODE	Finish options			SIZE (INCHES)			WEIGHT LBS	VOL FT3
	Standard	Wood	Laminate	H	W	D		
DBT6024CG	1773	2128	1418	29	60	24	115	10
DBT5424CG	1595	1914	1276	29	54	24	105	9
DBT4824CG	1419	1703	1135	29	48	24	96	8
DBT4224CG	1242	1490	994	29	42	24	87	7
DBT6022CG	1592	1910	1274	29	60	22	111	9
DBT5422CG	1434	1721	1147	29	54	22	102	8
DBT4822CG	1274	1529	1019	29	48	22	93	7
DBT4222CG	1118	1342	894	29	42	22	84	6
DBT6020CG	1453	1744	1162	29	60	20	107	8
DBT5420CG	1305	1566	1044	29	54	20	98	8
DBT4820CG	1162	1394	930	29	48	20	90	7
DBT4220CG	996	1195	797	29	42	20	81	6

## DBT-Q8 • Executive Bridge Top with 8" Back Panel

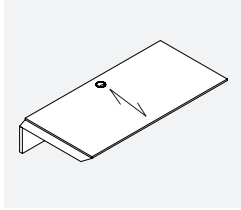

PRODUCT CODE	Finish options			SIZE (INCHES)			WEIGHT LBS	VOL FT3
	Standard	Wood	Laminate	H	W	D		
DBT6024Q8CG	1592	1910	1274	9	60	24	84	10
DBT5424Q8CG	1437	1724	1150	9	54	24	78	9
DBT4824Q8CG	1275	1530	1020	9	48	24	72	8
DBT4224Q8CG	1118	1342	894	9	42	24	66	7
DBT6022Q8CG	1434	1721	1147	9	60	22	80	9
DBT5422Q8CG	1291	1549	1033	9	54	22	74	8
DBT4822Q8CG	1145	1374	916	9	48	22	68	7
DBT4222Q8CG	1004	1205	803	9	42	22	63	6
DBT6020Q8CG	1305	1566	1044	9	60	20	76	8
DBT5420Q8CG	1177	1412	942	9	54	20	71	8
DBT4820Q8CG	1046	1255	837	9	48	20	65	7
DBT4220Q8CG	893	1072	714	9	42	20	60	6

## DBT-T • Executive Bridge Top

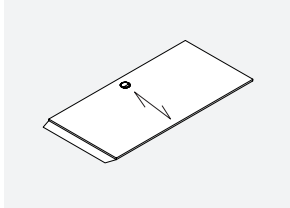

PRODUCT CODE	Finish options			SIZE (INCHES)			WEIGHT LBS	VOL FT3
	Standard	Wood	Laminate	H	W	D		
DBT5424TCG	957	1148	766	1	54	24	66	9
DBT4824TCG	851	1021	681	1	48	24	61	8
DBT4224TCG	744	893	595	1	42	24	56	7
DBT5422TCG	860	1032	688	1	54	22	62	8
DBT4822TCG	767	920	614	1	48	22	57	7
DBT4222TCG	671	805	537	1	42	22	53	6
DBT5420TCG	785	942	628	1	54	20	58	8
DBT4820TCG	697	836	558	1	48	20	54	7
DBT4220TCG	600	720	480	1	42	20	50	6

**CREDENZAS • TECHNICAL INFORMATION**

- All Credenzas are shipped assembled.
- All Storage Cabinets include one adjustable shelf per set of doors.
- “F” and “G” depict 36” and “M” and “N” depict 30”.
- “F” and “N” indicate lateral file drawers and “G” and “M” indicate storage cabinets with doors.
- Credenza Shells accept Modular Storage. Use Modular Storage for top support allowing no more than 72” unsupported.
- Credenza Shells with a width of 96” and more will have a 12” middle support gable.

- Credenza Shells can not be completely filled with Modular Storage. If a Full Credenza is required, see appropriate pages in this section.
- Tops, door and drawer fronts are in wood. Chassis are in low pressure laminate.
- Handle must be specified:
  - Black and Brass Handle = Black Lock & Grommet.
  - Silver, Nickel and Tungsten Handle = Tungsten Lock & Grommet.
- To choose All Wood Finish, add suffix “W” to the end of the product code.
- To choose All Laminate Finish, add suffix “P1”, “P2” or “P3” to the end of the product code (see page A.10 and A.11).

**CREDENZAS • GUIDELINES FOR ORDERING PRODUCT**

**CODES:** The price list uses a numbering system with meaningful alphanumeric characters to create a simple-to-understand product number. This makes specifying the product easy and accurate.

**SPECIFICATION EXAMPLE OF A CREDEZA UNIT**

**PRODUCT CODE:**

DC7222FG

D = Dufferin Series

C = Full Storage Credenza

7222 = Size: Width x Depth

F = 36” Lateral File Drawer

G = 36” Storage Cabinet w/doors

**CHOOSE FINISH OPTION:**

**Standard Finish:**

Choose Laminate Finish & Veneer Finish

**All Wood Finish:**

Choose Veneer Finish

**All Laminate Finish:**

Choose Laminate Finish

**HANDLE OPTION:**

Choose a handle

**Optional Grommet Locations:**

TL - Top Left

TR - Top Right

TC - Top Center

BL - Back Left

BR - Back Right

BC - Back Center

For Grommet Location see Page A.13

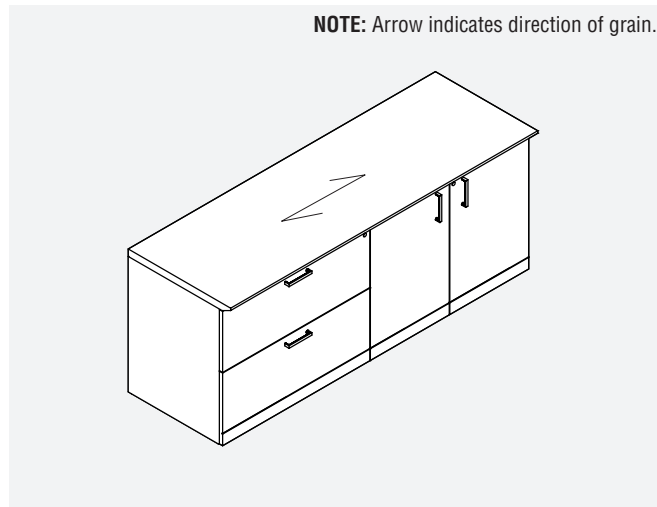

**DC-XX • Full Storage Credenza with Lat. File on Left & Storage Cabinet on Right**

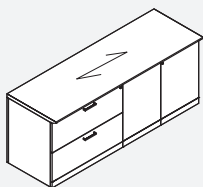

PRODUCT CODE	FINISH OPTIONS			SIZE (INCHES)			WEIGHT LBS	VOL FT3
	STANDARD	WOOD	LAMINATE	H	W	D		
DC7224FG	4445	5334	3556	29	72	24	261	29
DC6024NM	3705	4446	2964	29	60	24	232	24
DC7222FG	4077	4892	3262	29	72	22	249	27
DC6022NM	3397	4076	2718	29	60	22	222	22

**DC-XX • Full Storage Credenza with Lat. File on Right & Storage Cabinet on Left**

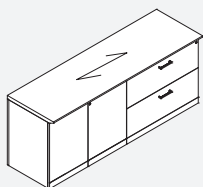

PRODUCT CODE	FINISH OPTIONS			SIZE (INCHES)			WEIGHT LBS	VOL FT3
	STANDARD	WOOD	LAMINATE	H	W	D		
DC7224GF	4445	5334	3556	29	72	24	261	29
DC6024MN	3705	4446	2964	29	60	24	232	24
DC7222GF	4077	4892	3262	29	72	22	249	27
DC6022MN	3397	4076	2718	29	60	22	222	22

**DC-XX • Full Storage Credenza with 2 Sets of 36" or 30" Lat. Files**

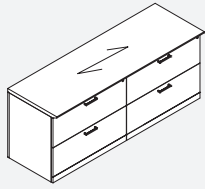

PRODUCT CODE	FINISH OPTIONS			SIZE (INCHES)			WEIGHT LBS	VOL FT3
	STANDARD	WOOD	LAMINATE	H	W	D		
DC7224FF	5685	6822	4548	29	72	24	278	29
DC6024NN	5194	6233	4155	29	60	24	252	24
DC7222FF	5212	6254	4170	29	72	22	268	27
DC6022NN	4778	5734	3822	29	60	22	243	22

**DC-XXX • Full Storage Credenza with 3 Sets of 36" or 30" Lat. Files**

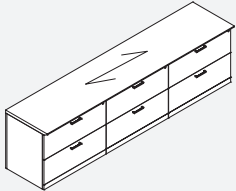

PRODUCT CODE	FINISH OPTIONS			SIZE (INCHES)			WEIGHT LBS	VOL FT3
	STANDARD	WOOD	LAMINATE	H	W	D		
DC10824FFF	9999	11999	7999	29	108	24	400	44
DC9024NNN	8336	10003	6669	29	90	24	361	36
DC10822FFF	9166	10999	7333	29	108	22	385	40
DC9022NNN	7643	9172	6114	29	90	22	348	33

**DC-XX • Full Storage Credenza with 2 Sets of Storage Cabinets**

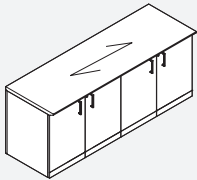

PRODUCT CODE	FINISH OPTIONS			SIZE (INCHES)			WEIGHT LBS	VOL FT3
	STANDARD	WOOD	LAMINATE	H	W	D		
DC7224GG	4217	5060	3374	29	72	24	243	29
DC6024MM	3868	4642	3094	29	60	24	212	24
DC7222GG	3867	4640	3094	29	72	22	231	27
DC6022MM	3546	4255	2837	29	60	22	201	22

**DC-XXX • Full Storage Credenza with 3 Sets of Storage Cabinets**

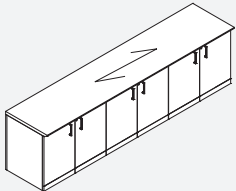

PRODUCT CODE	FINISH OPTIONS			SIZE (INCHES)			WEIGHT LBS	VOL FT3
	STANDARD	WOOD	LAMINATE	H	W	D		
DC10824GGG	7974	9569	6379	29	108	24	348	44
DC9024MMM	6647	7976	5318	29	90	24	301	36
DC10822GGG	7308	8770	5846	29	108	22	330	40
DC9022MMM	6092	7310	4874	29	90	22	285	33

**DC-XXX • Full Storage Credenza with Lat. File, Storage Cabinet & Lat. File**

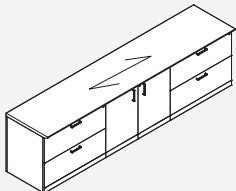

PRODUCT CODE	FINISH OPTIONS			SIZE (INCHES)			WEIGHT LBS	VOL FT3
	STANDARD	WOOD	LAMINATE	H	W	D		
DC10824FGF	9327	11192	7462	29	108	24	383	44
DC9024NMN	7769	9323	6215	29	90	24	341	36
DC10822FGF	8548	10258	6838	29	108	22	367	40
DC9022NMN	7125	8550	5700	29	90	22	327	33

**DCD-D • Full Storage Credenza with BBF, Storage Cabinet & BBF**

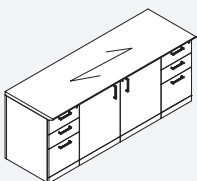

PRODUCT CODE	FINISH OPTIONS			SIZE (INCHES)			WEIGHT LBS	VOL FT3
	STANDARD	WOOD	LAMINATE	H	W	D		
DC7224DGD	5212	6254	4170	29	72	24	270	29
DC6024DMD	4778	5734	3822	29	60	24	244	24
DC7222DGD	5029	6035	4023	29	72	22	259	24
DC6022DMD	4609	5531	3687	29	60	22	234	20

**DCK-EE • Double Pedestal Credenza with FF on Left & FF on Right**

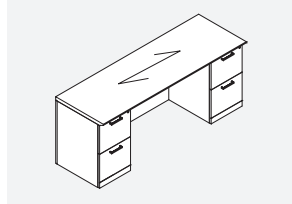

PRODUCT CODE	FINISH OPTIONS			SIZE (INCHES)			WEIGHT LBS	VOL FT3
	STANDARD	WOOD	LAMINATE	H	W	D		
DCK8424EE	5448	6538	4358	29	84	24	250	34
DCK7824EE	5059	6071	4047	29	78	24	242	31
DCK7224EE	4671	5605	3737	29	72	24	234	29
DCK6624EE	4602	5522	3682	29	66	24	226	27
DCK6024EE	4283	5140	3426	29	60	24	219	24
DCK8422EE	4994	5993	3995	29	84	22	239	34
DCK7822EE	4638	5566	3710	29	78	22	232	31
DCK7222EE	4285	5142	3428	29	72	22	224	29
DCK6622EE	4217	5060	3374	29	66	22	217	27
DCK6022EE	3926	4711	3141	29	60	22	210	24

- Full height back panel
- Knee space

**DCK-DD • Double Pedestal Credenza with BBF on Left & BBF on Right**

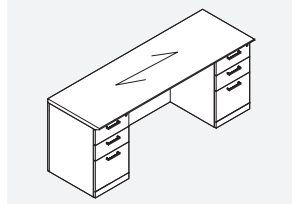

PRODUCT CODE	FINISH OPTIONS			SIZE (INCHES)			WEIGHT LBS	VOL FT3
	STANDARD	WOOD	LAMINATE	H	W	D		
DCK8424DD	5448	6538	4358	29	84	24	248	34
DCK7824DD	5059	6071	4047	29	78	24	240	31
DCK7224DD	4671	5605	3737	29	72	24	233	29
DCK6624DD	4602	5522	3682	29	66	24	225	27
DCK6024DD	4283	5140	3426	29	60	24	217	24
DCK8422DD	4994	5993	3995	29	84	22	238	34
DCK7822DD	4638	5566	3710	29	78	22	230	31
DCK7222DD	4285	5142	3428	29	72	22	223	29
DCK6622DD	4217	5060	3374	29	66	22	216	27
DCK6022DD	3926	4711	3141	29	60	22	208	24

- Full height back panel
- Knee space

**DCK-ED • Double Pedestal Credenza with FF on Left & BBF on Right**

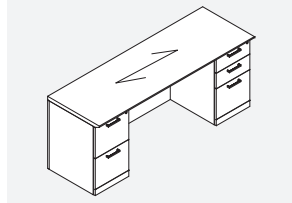

PRODUCT CODE	FINISH OPTIONS			SIZE (INCHES)			WEIGHT LBS	VOL FT3
	STANDARD	WOOD	LAMINATE	H	W	D		
DCK8424ED	5448	6538	4358	29	84	24	249	34
DCK7824ED	5059	6071	4047	29	78	24	241	31
DCK7224ED	4671	5605	3737	29	72	24	233	29
DCK6624ED	4602	5522	3682	29	66	24	226	27
DCK6024ED	4283	5140	3426	29	60	24	218	24
DCK8422ED	4994	5993	3995	29	84	22	238	34
DCK7822ED	4638	5566	3710	29	78	22	231	31
DCK7222ED	4285	5142	3428	29	72	22	224	29
DCK6622ED	4217	5060	3374	29	66	22	216	27
DCK6022ED	3926	4711	3141	29	60	22	209	24

- Full height back panel
- Knee space

**DCK-DE • Double Pedestal Credenza with BBF on Left & FF on Right**

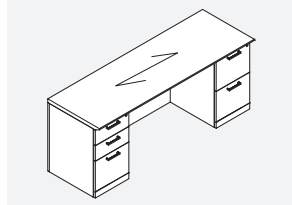

PRODUCT CODE	FINISH OPTIONS			SIZE (INCHES)			WEIGHT LBS	VOL FT3
	STANDARD	WOOD	LAMINATE	H	W	D		
DCK8424DE	5448	6538	4358	29	84	24	249	34
DCK7824DE	5059	6071	4047	29	78	24	241	31
DCK7224DE	4671	5605	3737	29	72	24	233	29
DCK6624DE	4602	5522	3682	29	66	24	226	27
DCK6024DE	4283	5140	3426	29	60	24	218	24
DCK8422DE	4994	5993	3995	29	84	22	238	34
DCK7822DE	4638	5566	3710	29	78	22	231	31
DCK7222DE	4285	5142	3428	29	72	22	224	29
DCK6622DE	4217	5060	3374	29	66	22	216	27
DCK6022DE	3926	4711	3141	29	60	22	209	24

- Full height back panel
- Knee space

**DCR-E • Single Pedestal Credenza with FF on Right**

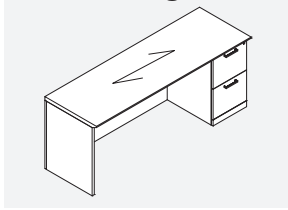

PRODUCT CODE	FINISH OPTIONS			SIZE (INCHES)			WEIGHT LBS	VOL FT3
	STANDARD	WOOD	LAMINATE	H	W	D		
DCR8424E	4118	4942	3294	29	84	24	208	34
DCR7824E	3825	4590	3060	29	78	24	200	31
DCR7224E	3528	4234	2822	29	72	24	192	29
DCR6624E	3399	4079	2719	29	66	24	185	27
DCR6024E	3090	3708	2472	29	60	24	177	24
DCR8422E	3776	4531	3021	29	84	22	198	34
DCR7822E	3507	4208	2806	29	78	22	191	31
DCR7222E	3234	3881	2587	29	72	22	184	29
DCR6622E	3115	3738	2492	29	66	22	176	27
DCR6022E	2834	3401	2267	29	60	22	169	24

**DCL-E • Single Pedestal Credenza with FF on Left**

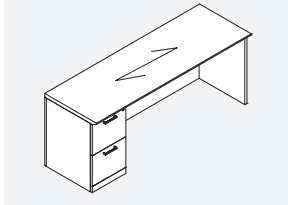

PRODUCT CODE	FINISH OPTIONS			SIZE (INCHES)			WEIGHT LBS	VOL FT3
	STANDARD	WOOD	LAMINATE	H	W	D		
DCL8424E	4118	4942	3294	29	84	24	208	34
DCL7824E	3825	4590	3060	29	78	24	200	31
DCL7224E	3528	4234	2822	29	72	24	192	29
DCL6624E	3399	4079	2719	29	66	24	185	27
DCL6024E	3090	3708	2472	29	60	24	177	24
DCL8422E	3776	4531	3021	29	84	22	198	34
DCL7822E	3507	4208	2806	29	78	22	191	31
DCL7222E	3234	3881	2587	29	72	22	184	29
DCL6622E	3115	3738	2492	29	66	22	176	27
DCL6022E	2834	3401	2267	29	60	22	169	24

**DCR-D • Single Pedestal Credenza with BBF on Right**

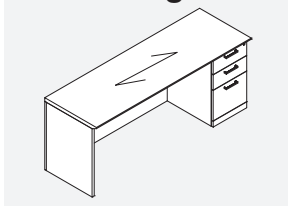

PRODUCT CODE	FINISH OPTIONS			SIZE (INCHES)			WEIGHT LBS	VOL FT3
	STANDARD	WOOD	LAMINATE	H	W	D		
DCR8424D	4118	4942	3294	29	84	24	207	34
DCR7824D	3825	4590	3060	29	78	24	199	31
DCR7224D	3528	4234	2822	29	72	24	192	29
DCR6624D	3399	4079	2719	29	66	24	184	27
DCR6024D	3090	3708	2472	29	60	24	176	24
DCR8422D	3776	4531	3021	29	84	22	198	34
DCR7822D	3507	4208	2806	29	78	22	190	31
DCR7222D	3234	3881	2587	29	72	22	183	29
DCR6622D	3115	3738	2492	29	66	22	175	27
DCR6022D	2834	3401	2267	29	60	22	168	24

**DCL-D • Single Pedestal Credenza with BBF on Left**

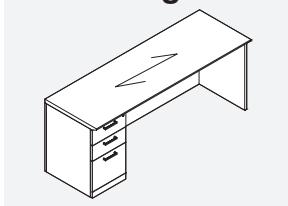

PRODUCT CODE	FINISH OPTIONS			SIZE (INCHES)			WEIGHT LBS	VOL FT3
	STANDARD	WOOD	LAMINATE	H	W	D		
DCL8424D	4118	4942	3294	29	84	24	207	34
DCL7824D	3825	4590	3060	29	78	24	199	31
DCL7224D	3528	4234	2822	29	72	24	192	29
DCL6624D	3399	4079	2719	29	66	24	184	27
DCL6024D	3090	3708	2472	29	60	24	176	24
DCL8422D	3776	4531	3021	29	84	22	198	34
DCL7822D	3507	4208	2806	29	78	22	190	31
DCL7222D	3234	3881	2587	29	72	22	183	29
DCL6622D	3115	3738	2492	29	66	22	175	27
DCL6022D	2834	3401	2267	29	60	22	168	24



**DCR-F • Single Pedestal Credenza with 36" Lat. File on Right**

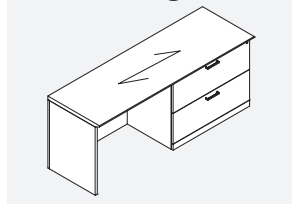

PRODUCT CODE	FINISH OPTIONS			SIZE (INCHES)			WEIGHT LBS	VOL FT3
	STANDARD	WOOD	LAMINATE	H	W	D		
DCR8424F	4788	5746	3830	29	84	24	236	34
DCR7824F	4443	5332	3554	29	78	24	228	31
DCR7224F	4106	4927	3285	29	72	24	220	29
DCR6624F	3952	4742	3162	29	66	24	212	27
DCR6024F	3586	4303	2869	29	60	24	205	24
DCR8422F	4387	5264	3510	29	84	22	225	31
DCR7822F	4074	4889	3259	29	78	22	218	29
DCR7222F	3762	4514	3010	29	72	22	211	27
DCR6622F	3623	4348	2898	29	66	22	203	24
DCR6022F	3288	3946	2630	29	60	22	196	22

**DCL-F • Single Pedestal Credenza with 36" Lat. File on Left**

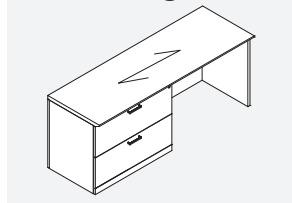

PRODUCT CODE	FINISH OPTIONS			SIZE (INCHES)			WEIGHT LBS	VOL FT3
	STANDARD	WOOD	LAMINATE	H	W	D		
DCL8424F	4788	5746	3830	29	84	24	236	34
DCL7824F	4443	5332	3554	29	78	24	228	31
DCL7224F	4106	4927	3285	29	72	24	220	29
DCL6624F	3952	4742	3162	29	66	24	212	27
DCL6024F	3586	4303	2869	29	60	24	205	24
DCL8422F	4387	5264	3510	29	84	22	225	31
DCL7822F	4074	4889	3259	29	78	22	218	29
DCL7222F	3762	4514	3010	29	72	22	211	27
DCL6622F	3623	4348	2898	29	66	22	203	24
DCL6022F	3288	3946	2630	29	60	22	196	22

**DCR-Z • Single Pedestal Credenza with Combination Storage on Right**

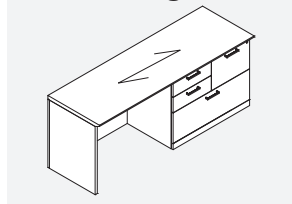

PRODUCT CODE	FINISH OPTIONS			SIZE (INCHES)			WEIGHT LBS	VOL FT3
	STANDARD	WOOD	LAMINATE	H	W	D		
DCR8424Z	5231	6277	4185	29	84	24	242	34
DCR7824Z	4854	5825	3883	29	78	24	234	31
DCR7224Z	4483	5380	3586	29	72	24	226	29
DCR6624Z	4311	5173	3449	29	66	24	218	27
DCR6024Z	3919	4703	3135	29	60	24	211	24
DCR8422Z	4791	5749	3833	29	84	22	231	31
DCR7822Z	4453	5344	3562	29	78	22	224	29
DCR7222Z	4109	4931	3287	29	72	22	217	27
DCR6622Z	3955	4746	3164	29	66	22	209	24
DCR6022Z	3596	4315	2877	29	60	22	202	22

• Modular combination storage with 1 lat. file, 2 boxes top left & 1 file top right

**DCL-Z • Single Pedestal Credenza with Combination Storage on Left**

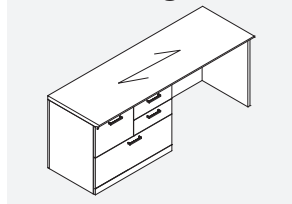

PRODUCT CODE	FINISH OPTIONS			SIZE (INCHES)			WEIGHT LBS	VOL FT3
	STANDARD	WOOD	LAMINATE	H	W	D		
DCL8424Z	5231	6277	4185	29	84	24	242	34
DCL7824Z	4854	5825	3883	29	78	24	234	31
DCL7224Z	4483	5380	3586	29	72	24	226	29
DCL6624Z	4311	5173	3449	29	66	24	218	27
DCL6024Z	3919	4703	3135	29	60	24	211	24
DCL8422Z	4791	5749	3833	29	84	22	231	31
DCL7822Z	4453	5344	3562	29	78	22	224	29
DCL7222Z	4109	4931	3287	29	72	22	217	27
DCL6622Z	3955	4746	3164	29	66	22	209	24
DCL6022Z	3596	4315	2877	29	60	22	202	22

• Modular combination storage with 1 lat. file, 1 file top left & 2 boxes top right

DC • Credenza Shell with Full Back Panel

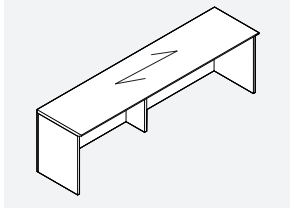

PRODUCT CODE	FINISH OPTIONS			SIZE (INCHES)			WEIGHT LBS	VOL FT <sup>3</sup>
	STANDARD	WOOD	LAMINATE	H	W	D		
DC10824	3482	4178	2786	29	108	24	197	44
DC10224	3288	3946	2630	29	102	24	189	41
DC9624	3097	3716	2478	29	96	24	182	39
DC10822	3193	3832	2554	29	108	22	187	40
DC10222	3013	3616	2410	29	102	22	180	38
DC9622	2837	3404	2270	29	96	22	172	35

• With middle support

DC • Credenza Shell with Full Back Panel

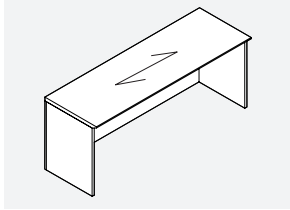

PRODUCT CODE	FINISH OPTIONS			SIZE (INCHES)			WEIGHT LBS	VOL FT <sup>3</sup>
	STANDARD	WOOD	LAMINATE	H	W	D		
DC9024	2903	3484	2322	29	90	24	174	36
DC8424	2710	3252	2168	29	84	24	166	34
DC7824	2515	3018	2012	29	78	24	158	31
DC7224	2324	2789	1859	29	72	24	151	29
DC6624	2241	2689	1793	29	66	24	143	27
DC6024	2032	2438	1626	29	60	24	135	24
DC5424	1924	2309	1539	29	54	24	127	22
DC4824	1819	2183	1455	29	48	24	120	19
DC4224	1540	1848	1232	29	42	24	112	17
DC9022	2660	3192	2128	29	90	22	165	33
DC8422	2485	2982	1988	29	84	22	157	31
DC7822	2305	2766	1844	29	78	22	150	29
DC7222	2129	2555	1703	29	72	22	143	27
DC6622	2050	2460	1640	29	66	22	135	24
DC6022	1863	2236	1490	29	60	22	128	22
DC5422	1764	2117	1411	29	54	22	121	20
DC4822	1669	2003	1335	29	48	22	113	18
DC4222	1412	1694	1130	29	42	22	106	16

**CORNERS AND COMPONENTS • TECHNICAL INFORMATION**

- All Corner Components have Tops in wood, Chassis are in low pressure laminate.
- Corners**
- All units are shipped assembled.
- Unit includes grommets shown and installed horizontal wire management.
- Linking Bridge**
- Handed by full end panel.
- Linking Return**

- Unit includes grommets shown and installed horizontal wire management.
- Handed by full end panel.
- Table**
- Unit includes grommets shown and installed horizontal wire management.
- To choose All Wood Finish, add suffix "W" to the end of the product code.
- To choose All Laminate Finish, add suffix "P1", "P2" or "P3" to the end of the product code (see page A.10 and A.11).

**CORNERS AND COMPONENTS • GUIDELINES FOR ORDERING PRODUCT**

**CODES:** The price list uses a numbering system with meaningful alphanumeric characters to create a simple-to-understand product number. This makes specifying the product easy and accurate.

**SPECIFICATION EXAMPLE OF A CORNER UNIT**

**PRODUCT CODE:**

DE484824  
 D = Dufferin Series  
 E = Corner Table with Straight Front  
 4848 = Size: Width x Depth  
 24 = Linking Bridge Depth Size

**CHOOSE FINISH OPTION:**

**Standard Finish:**  
 Choose Laminate Finish & Veneer Finish

**All Wood Finish:**

Choose Veneer Finish

**All Laminate Finish:**

Choose Laminate Finish

**HANDLE OPTION:**

Choose a handle

For Grommet Location see Page A.13

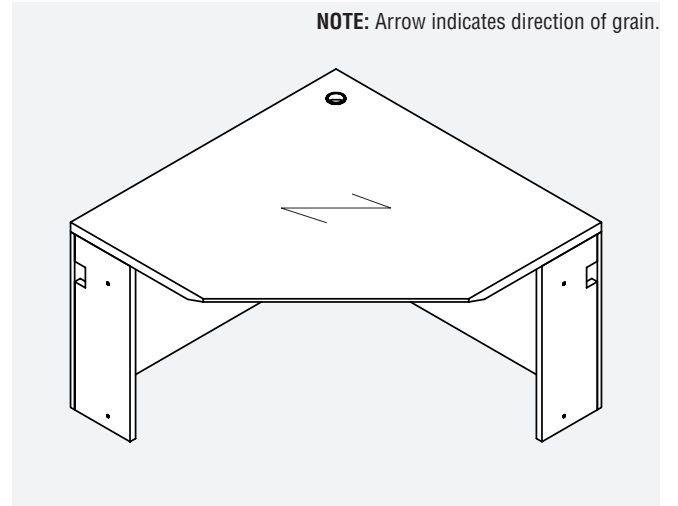

**DBT-NLR • Right Linking Bridge to join Corner Worksurface to Desk or Credenza**

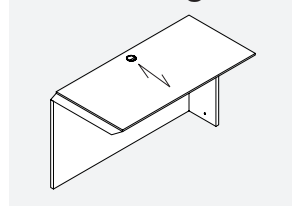

PRODUCT CODE	FINISH OPTIONS			SIZE (INCHES)			WEIGHT LBS	VOL FT <sup>3</sup>
	STANDARD	WOOD	LAMINATE	H	W	D		
DBT6024NLR CG	1756	2107	1405	29	60	24	120	24
DBT5424NLR CG	1581	1897	1265	29	54	24	110	22
DBT4824NLR CG	1403	1684	1122	29	48	24	101	19
DBT4224NLR CG	1140	1368	912	29	42	24	92	17
DBT3624NLR CG	1034	1241	827	29	36	24	82	15
DBT3024NLR CG	1009	1211	807	29	30	24	73	12
DBT6022NLR CG	1673	2008	1338	29	60	22	116	22
DBT5422NLR CG	1505	1806	1204	29	54	22	107	20
DBT4822NLR CG	1337	1604	1070	29	48	22	98	18
DBT4222NLR CG	1085	1302	868	29	42	22	89	16
DBT3622NLR CG	985	1182	788	29	36	22	80	13
DBT3022NLR CG	959	1151	767	29	30	22	71	11

- With full back panel

**DBT-NLL • Left Linking Bridge to join Corner Worksurface to Desk or Credenza**

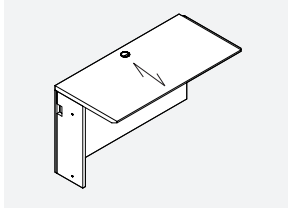

PRODUCT CODE	FINISH OPTIONS			SIZE (INCHES)			WEIGHT LBS	VOL FT <sup>3</sup>
	STANDARD	WOOD	LAMINATE	H	W	D		
DBT6024NLLCG	1756	2107	1405	29	60	24	120	24
DBT5424NLLCG	1581	1897	1265	29	54	24	110	22
DBT4824NLLCG	1403	1684	1122	29	48	24	101	19
DBT4224NLLCG	1140	1368	912	29	42	24	92	17
DBT3624NLLCG	1034	1241	827	29	36	24	82	15
DBT3024NLLCG	1009	1211	807	29	30	24	73	12
DBT6022NLLCG	1673	2008	1338	29	60	22	116	22
DBT5422NLLCG	1505	1806	1204	29	54	22	107	20
DBT4822NLLCG	1337	1604	1070	29	48	22	98	18
DBT4222NLLCG	1085	1302	868	29	42	22	89	16
DBT3622NLLCG	985	1182	788	29	36	22	80	13
DBT3022NLLCG	959	1151	767	29	30	22	71	11

• With full back panel

**DBT-NLR-Q8 • Right Linking Bridge to join Corner Worksurface to Desk or Credenza**

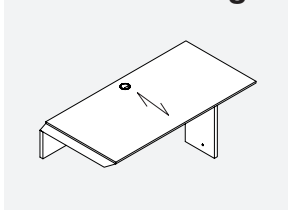

PRODUCT CODE	FINISH OPTIONS			SIZE (INCHES)			WEIGHT LBS	VOL FT <sup>3</sup>
	STANDARD	WOOD	LAMINATE	H	W	D		
DBT6024NLRQ8CG	1581	1897	1265	29	60	24	89	24
DBT5424NLRQ8CG	1426	1711	1141	29	54	24	83	22
DBT4824NLRQ8CG	1267	1520	1014	29	48	24	77	19
DBT4224NLRQ8CG	1024	1229	819	29	42	24	70	17
DBT3624NLRQ8CG	933	1120	746	29	36	24	64	15
DBT3024NLRQ8CG	910	1092	728	29	30	24	58	12
DBT6022NLRQ8CG	1505	1806	1204	29	60	22	85	22
DBT5422NLRQ8CG	1356	1627	1085	29	54	22	79	20
DBT4822NLRQ8CG	1207	1448	966	29	48	22	73	18
DBT4222NLRQ8CG	974	1169	779	29	42	22	68	16
DBT3622NLRQ8CG	888	1066	710	29	36	22	62	13
DBT3022NLRQ8CG	868	1042	694	29	30	22	56	11

• With 8" back panel

**DBT-NLL-Q8 • Left Linking Bridge to join Corner Worksurface to Desk or Credenza**

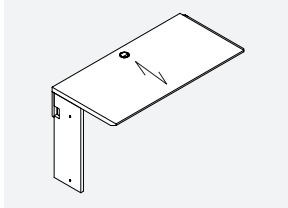

PRODUCT CODE	FINISH OPTIONS			SIZE (INCHES)			WEIGHT LBS	VOL FT <sup>3</sup>
	STANDARD	WOOD	LAMINATE	H	W	D		
DBT6024NLLQ8CG	1581	1897	1265	29	60	24	89	24
DBT5424NLLQ8CG	1426	1711	1141	29	54	24	83	22
DBT4824NLLQ8CG	1267	1520	1014	29	48	24	77	19
DBT4224NLLQ8CG	1024	1229	819	29	42	24	70	17
DBT3624NLLQ8CG	933	1120	746	29	36	24	64	15
DBT3024NLLQ8CG	910	1092	728	29	30	24	58	12
DBT6022NLLQ8CG	1505	1806	1204	29	60	22	85	22
DBT5422NLLQ8CG	1356	1627	1085	29	54	22	79	20
DBT4822NLLQ8CG	1207	1448	966	29	48	22	73	18
DBT4222NLLQ8CG	974	1169	779	29	42	22	68	16
DBT3622NLLQ8CG	888	1066	710	29	36	22	62	13
DBT3022NLLQ8CG	868	1042	694	29	30	22	56	11

• With 8" back panel

**DE • Corner Table to be used with Linking Returns & Linking Bridges**

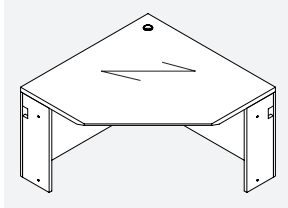

PRODUCT CODE	FINISH OPTIONS			SIZE (INCHES)			WEIGHT LBS	VOL FT <sup>3</sup>
	STANDARD	WOOD	LAMINATE	H	W	D		
DE484824	2527	3032	2022	29	48	48	175	39
DE424224	1938	2326	1550	29	42	42	148	30
DE363624	1839	2207	1471	29	36	36	124	22
DE484822	2527	3032	2022	29	48	48	175	39
DE424222	1938	2326	1550	29	42	42	148	30
DE363622	1839	2207	1471	29	36	36	124	22

**DEK • Corner Table to be used with Linking Returns & Linking Bridges**

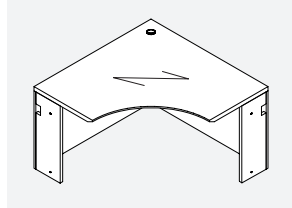

PRODUCT CODE	FINISH OPTIONS			SIZE (INCHES)			WEIGHT LBS	VOL FT3
	STANDARD	WOOD	LAMINATE	H	W	D		
DEK484824	2908	3490	2326	29	48	48	175	39
DEK424224	2223	2668	1778	29	42	42	148	30
DEK363624	2115	2538	1692	29	36	36	124	22
DEK484822	2908	3490	2326	29	48	48	175	39
DEK424222	2223	2668	1778	29	42	42	148	30
DEK363622	2115	2538	1692	29	36	36	124	22

**DEKS • Corner Table to be used with Linking Returns & Linking Bridges**

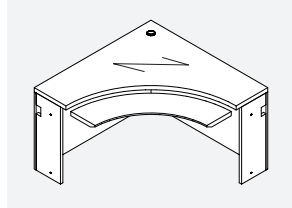

PRODUCT CODE	FINISH OPTIONS			SIZE (INCHES)			WEIGHT LBS	VOL FT3
	STANDARD	WOOD	LAMINATE	H	W	D		
DEKS484824	4829	5795	3863	29	48	48	175	39
DEKS424224	4046	4855	3237	29	42	42	148	30
DEKS363624	3917	4700	3134	29	36	36	124	22
DEKS484822	4829	5795	3863	29	48	48	175	39
DEKS424222	4046	4855	3237	29	42	42	148	30
DEKS363622	3917	4700	3134	29	36	36	124	22

- With 2 end panels and inner curve
- Adj. keyboard tray and an articulating arm

**DEKR • Right Extended Corner Table with 24" Return Connection**

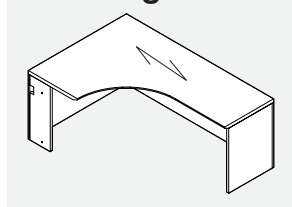

PRODUCT CODE	FINISH OPTIONS			SIZE (INCHES)			WEIGHT LBS	VOL FT3
	STANDARD	WOOD	LAMINATE	H	W	D		
DEKR489624	4521	5425	3617	29	96	48	300	77
DEKR489024	4270	5124	3416	29	90	48	285	73
DEKR488424	4221	5065	3377	29	84	48	271	68
DEKR487824	4200	5040	3360	29	78	48	257	63
DEKR487224	3990	4788	3192	29	72	48	243	58
DEKR486624	3721	4465	2977	29	66	48	229	52
DEKR486024	3451	4141	2761	29	60	48	215	48

**DEKL • Left Extended Corner Table with 24" Return Connection**

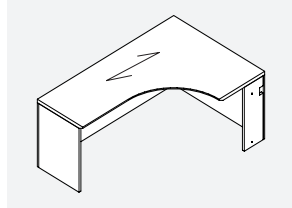

PRODUCT CODE	FINISH OPTIONS			SIZE (INCHES)			WEIGHT LBS	VOL FT3
	STANDARD	WOOD	LAMINATE	H	W	D		
DEKL964824	4521	5425	3617	29	96	48	300	77
DEKL904824	4270	5124	3416	29	90	48	285	73
DEKL844824	4221	5065	3377	29	84	48	271	68
DEKL784824	4200	5040	3360	29	78	48	257	63
DEKL724824	3990	4788	3192	29	72	48	243	58
DEKL664824	3721	4465	2977	29	66	48	229	52
DEKL604824	3451	4141	2761	29	60	48	215	48

**DEKR • Right Extended Corner Table with 22" Return Connection**

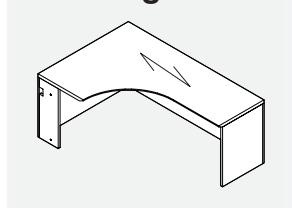

PRODUCT CODE	FINISH OPTIONS			SIZE (INCHES)			WEIGHT LBS	VOL FT3
	STANDARD	WOOD	LAMINATE	H	W	D		
DEKR489622	4521	5425	3617	29	96	48	299	77
DEKR489022	4270	5124	3416	29	90	48	285	73
DEKR488422	4221	5065	3377	29	84	48	270	68
DEKR487822	4200	5040	3360	29	78	48	256	63
DEKR487222	3990	4788	3192	29	72	48	242	58
DEKR486622	3721	4465	2977	29	66	48	228	52
DEKR486022	3451	4141	2761	29	60	48	214	48

**DEKL • Left Extended Corner Table with 22" Return Connection**

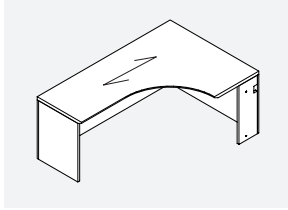

PRODUCT CODE	FINISH OPTIONS			SIZE (INCHES)			WEIGHT LBS	VOL FT3
	STANDARD	WOOD	LAMINATE	H	W	D		
DEKL964822	4521	5425	3617	29	96	48	299	77
DEKL904822	4270	5124	3416	29	90	48	285	73
DEKL844822	4221	5065	3377	29	84	48	270	68
DEKL784822	4200	5040	3360	29	78	48	256	63
DEKL724822	3990	4788	3192	29	72	48	242	58
DEKL664822	3721	4465	2977	29	66	48	228	52
DEKL604822	3451	4141	2761	29	60	48	214	48

**DVR • Right Linking Return to be used with Corner Unit**

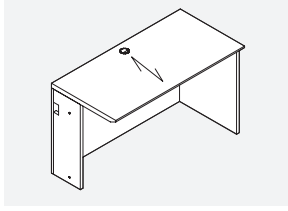

PRODUCT CODE	FINISH OPTIONS			SIZE (INCHES)			WEIGHT LBS	VOL FT3
	STANDARD	WOOD	LAMINATE	H	W	D		
DVR9624CG	2911	3493	2329	29	96	24	186	39
DVR9024CG	2730	3276	2184	29	90	24	177	36
DVR8424CG	2550	3060	2040	29	84	24	167	34
DVR7824CG	2365	2838	1892	29	78	24	158	31
DVR7224CG	2185	2622	1748	29	72	24	149	29
DVR6624CG	2049	2459	1639	29	66	24	140	27
DVR6024CG	1915	2298	1532	29	60	24	130	24
DVR5424CG	1807	2168	1446	29	54	24	121	22
DVR4824CG	1696	2035	1357	29	48	24	112	19
DVR4224CG	1431	1717	1145	29	42	24	102	17
DVR3624CG	1378	1654	1102	29	36	24	93	15
DVR3024CG	1356	1627	1085	29	30	24	84	12
DVR2424CG	1136	1363	909	29	24	24	75	10
DVR9622CG	2772	3326	2218	29	96	22	179	39
DVR9022CG	2603	3124	2082	29	90	22	171	36
DVR8422CG	2428	2914	1942	29	84	22	162	34
DVR7822CG	2250	2700	1800	29	78	22	153	31
DVR7222CG	2080	2496	1664	29	72	22	144	29
DVR6622CG	1953	2344	1562	29	66	22	135	27
DVR6022CG	1826	2191	1461	29	60	22	126	24
DVR5422CG	1723	2068	1378	29	54	22	117	22
DVR4822CG	1618	1942	1294	29	48	22	109	19
DVR4222CG	1363	1636	1090	29	42	22	100	17
DVR3622CG	1311	1573	1049	29	36	22	91	15
DVR3022CG	1291	1549	1033	29	30	22	82	12
DVR2422CG	1085	1302	868	29	24	22	73	10

**DVL • Left Linking Return to be used with Corner Unit**

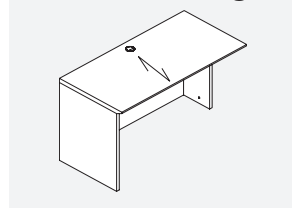

PRODUCT CODE	FINISH OPTIONS			SIZE (INCHES)			WEIGHT LBS	VOL FT <sup>3</sup>
	STANDARD	WOOD	LAMINATE	H	W	D		
DVL9624CG	2911	3493	2329	29	96	24	186	39
DVL9024CG	2730	3276	2184	29	90	24	177	36
DVL8424CG	2550	3060	2040	29	84	24	167	34
DVL7824CG	2365	2838	1892	29	78	24	158	31
DVL7224CG	2185	2622	1748	29	72	24	149	29
DVL6624CG	2049	2459	1639	29	66	24	140	27
DVL6024CG	1915	2298	1532	29	60	24	130	24
DVL5424CG	1807	2168	1446	29	54	24	121	22
DVL4824CG	1696	2035	1357	29	48	24	112	19
DVL4224CG	1431	1717	1145	29	42	24	102	17
DVL3624CG	1378	1654	1102	29	36	24	93	15
DVL3024CG	1356	1627	1085	29	30	24	84	12
DVL2424CG	1136	1363	909	29	24	24	75	10
DVL9622CG	2772	3326	2218	29	96	22	179	39
DVL9022CG	2603	3124	2082	29	90	22	171	36
DVL8422CG	2428	2914	1942	29	84	22	162	34
DVL7822CG	2250	2700	1800	29	78	22	153	31
DVL7222CG	2080	2496	1664	29	72	22	144	29
DVL6622CG	1953	2344	1562	29	66	22	135	27
DVL6022CG	1826	2191	1461	29	60	22	126	24
DVL5422CG	1723	2068	1378	29	54	22	117	22
DVL4822CG	1618	1942	1294	29	48	22	109	19
DVL4222CG	1363	1636	1090	29	42	22	100	17
DVL3622CG	1311	1573	1049	29	36	22	91	15
DVL3022CG	1291	1549	1033	29	30	22	82	12
DVL2422CG	1085	1302	868	29	24	22	73	10

**DV • Center Surface with Recessed End Panels**

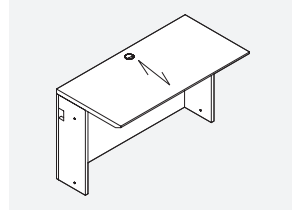

PRODUCT CODE	FINISH OPTIONS			SIZE (INCHES)			WEIGHT LBS	VOL FT <sup>3</sup>
	STANDARD	WOOD	LAMINATE	H	W	D		
DV9624CG	2845	3414	2276	29	96	24	180	39
DV9024CG	2666	3199	2133	29	90	24	171	36
DV8424CG	2489	2987	1991	29	84	24	161	34
DV7824CG	2309	2771	1847	29	78	24	152	31
DV7224CG	2132	2558	1706	29	72	24	143	29
DV6624CG	1999	2399	1599	29	66	24	134	27
DV6024CG	1865	2238	1492	29	60	24	124	24
DV5424CG	1756	2107	1405	29	54	24	115	22
DV4824CG	1648	1978	1318	29	48	24	106	19
DV4224CG	1519	1823	1215	29	42	24	97	17
DV3624CG	1378	1654	1102	29	36	24	87	15
DV3024CG	1304	1565	1043	29	30	24	78	12
DV2424CG	1093	1312	874	29	24	24	69	10
DV9622CG	2710	3252	2168	29	96	22	174	35
DV9022CG	2541	3049	2033	29	90	22	165	33
DV8422CG	2372	2846	1898	29	84	22	156	31
DV7822CG	2200	2640	1760	29	78	22	147	29
DV7222CG	2031	2437	1625	29	72	22	138	27
DV6622CG	1903	2284	1522	29	66	22	129	24
DV6022CG	1777	2132	1422	29	60	22	120	22
DV5422CG	1673	2008	1338	29	54	22	112	20
DV4822CG	1569	1883	1255	29	48	22	103	18
DV4222CG	1311	1573	1049	29	42	22	94	16
DV3622CG	1267	1520	1014	29	36	22	85	13
DV3022CG	1243	1492	994	29	30	22	76	11
DV2422CG	1041	1249	833	29	24	22	67	9





**MODULAR STORAGE • TECHNICAL INFORMATION**

- All storage components are shipped assembled.
- Components 28" high are intended for use with a Desk, Credenza or Return Shell
- Modular Cabinets and Bookcases 48" and 54" high do not have a profiled top. If a profiled top is required, please see Page H.8 to H.11 of this section.
- Tops, door and drawer fronts and all exposed shelves are in wood. Chassis are in low pressure laminate.
- Handle must be specified:
  - Black and Brass Handle = Black Lock & Grommet.
  - Silver, Nickel and Tungsten Handle = Tungsten Lock & Grommet.
- To choose All Wood Finish, add suffix "W" to the end of the product code.
- To choose All Laminate Finish, add suffix "P1", "P2" or "P3" to the end of the product code (see page A.10 and A.11).

**MODULAR STORAGE • GUIDELINES FOR ORDERING PRODUCT**

**CODES:** The price list uses a numbering system with meaningful alphanumeric characters to create a simple-to-understand product number. This makes specifying the product easy and accurate.

**SPECIFICATION EXAMPLE OF A LATERAL FILE UNIT**

**PRODUCT CODE:**

DWF  
 D = Dufferin Series  
 W = Modular/Freestanding Unit  
 F = 36" wide Lateral File

**CHOOSE FINISH OPTION:**

**Standard Finish:**  
 Choose Laminate Finish & Veneer Finish

**All Wood Finish:**

Choose Veneer Finish

**All Laminate Finish:**

Choose Laminate Finish

**HANDLE OPTION:**

Choose a handle

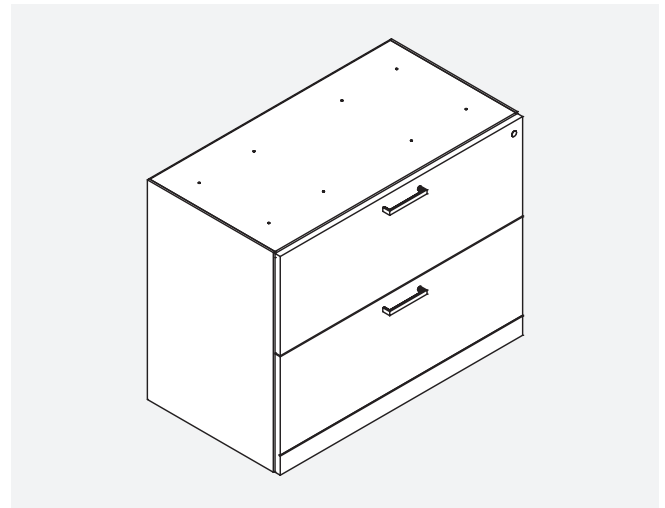

**DW-F/N • Modular Lateral File**

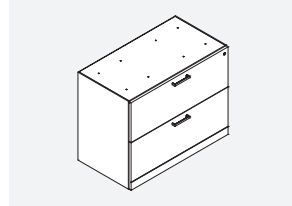

PRODUCT CODE	FINISH OPTIONS			SIZE (INCHES)			WEIGHT LBS	VOL FT3
	STANDARD	WOOD	LAMINATE	H	W	D		
DWF	2038	2446	1630	27.5	36	19	123	11
DWN	1782	2138	1426	27.5	30	19	102	9

**DWZR • Modular Combination Storage with 1 Lat. File, 2 Boxes Top Left & 1 File Top Right**

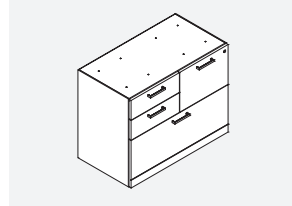

PRODUCT CODE	FINISH OPTIONS			SIZE (INCHES)			WEIGHT LBS	VOL FT3
	STANDARD	WOOD	LAMINATE	H	W	D		
DWZR	2363	2836	1890	27.5	36	19	145	11

**DWZL • Modular Combination Storage with 1 Lat. File, 1 File Top Left & 2 Boxes Top Right**

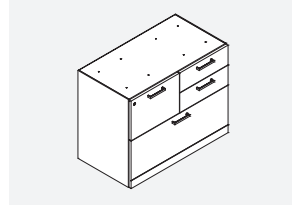

PRODUCT CODE	FINISH OPTIONS			SIZE (INCHES)			WEIGHT LBS	VOL FT3
	STANDARD	WOOD	LAMINATE	H	W	D		
DWZL	2363	2836	1890	27.5	36	19	145	11

**DWOB • Modular Open Storage with Adj. Shelf**

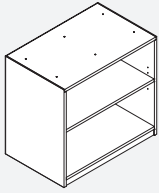

PRODUCT CODE	FINISH OPTIONS			SIZE (INCHES)			WEIGHT LBS	VOL FT3
	STANDARD	WOOD	LAMINATE	H	W	D		
DWOB36	1136	1363	909	27.5	36	19	91	11
DWOB30	1005	1206	804	27.5	30	19	82	9

• Storage with 1 adj. shelf

**DW-G/M • Modular Storage Cabinet with Doors and Adj. Shelf**

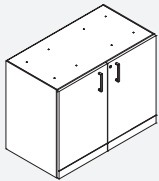

PRODUCT CODE	FINISH OPTIONS			SIZE (INCHES)			WEIGHT LBS	VOL FT3
	STANDARD	WOOD	LAMINATE	H	W	D		
DWG	1420	1704	1136	27.5	36	19	107	11
DWM	1254	1505	1003	27.5	30	19	96	9

• Storage with 1 adj. shelf

**DW-D • Modular BBF Pedestal**

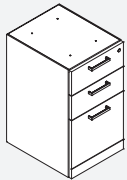

PRODUCT CODE	FINISH OPTIONS			SIZE (INCHES)			WEIGHT LBS	VOL FT3
	STANDARD	WOOD	LAMINATE	H	W	D		
DWWD (Letter Width)	1571	1885	1257	27.5	15.5	23	92	6
DWD (Letter Width)	1366	1639	1093	27.5	15.5	19	86	5
DWWLD (Legal Width)	1885	2262	1508	27.5	18.5	23	97	7
DWLD (Legal Width)	1643	1972	1314	27.5	18.5	19	91	6

**DW-E • Modular FF Pedestal**

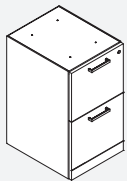

PRODUCT CODE	FINISH OPTIONS			SIZE (INCHES)			WEIGHT LBS	VOL FT3
	STANDARD	WOOD	LAMINATE	H	W	D		
DWWE (Letter Width)	1571	1885	1257	27.5	15.5	23	92	6
DWE (Letter Width)	1366	1639	1093	27.5	15.5	19	86	5
DWWLE (Legal Width)	1885	2262	1508	27.5	18.5	23	97	7
DWLE (Legal Width)	1643	1972	1314	27.5	18.5	19	91	6

**DW-Q • Modular Open Storage with Adj. Shelf**

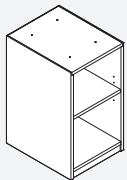

PRODUCT CODE	FINISH OPTIONS			SIZE (INCHES)			WEIGHT LBS	VOL FT3
	STANDARD	WOOD	LAMINATE	H	W	D		
DWWQ	1176	1411	941	27.5	15	22	60	6
DWQ	972	1166	778	27.5	15	18	55	5

• Storage with 1 adj. shelf

**DWiR • Modular Storage Cabinet with Door & Adj. Shelf**

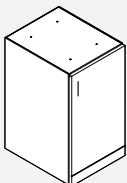

PRODUCT CODE	FINISH OPTIONS			SIZE (INCHES)			WEIGHT LBS	VOL FT3
	STANDARD	WOOD	LAMINATE	H	W	D		
DWWiR	1309	1571	1047	27.5	15.5	23	70	6
DWiR	1045	1254	836	27.5	15.5	19	64	5

• Storage with 1 adj. shelf

DWiL • Modular Storage Cabinet with Door & Adj. Shelf

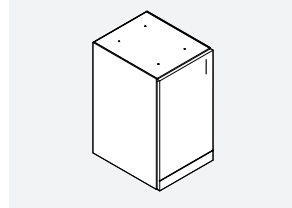

PRODUCT CODE	FINISH OPTIONS			SIZE (INCHES)			WEIGHT LBS	VOL FT3
	STANDARD	WOOD	LAMINATE	H	W	D		
DWWIL	1265	1518	1012	27.5	15.5	23	70	6
DWIL	1045	1254	836	27.5	15.5	19	64	5

• Storage with 1 adj. shelf

DB • Modular Open Bookcase with Adj. Shelf

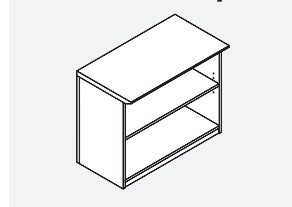

PRODUCT CODE	FINISH OPTIONS			SIZE (INCHES)			WEIGHT LBS	VOL FT3
	STANDARD	WOOD	LAMINATE	H	W	D		
DB23615	1205	1446	964	27.5	36	15	80	8
DB43615	1505	1806	1204	48	36	15	121	13
DB3615H54	1693	2032	1354	54	36	15	127	15

• Storage with 1 adj. shelf

D1 • Storage Cabinet with Doors & Adj. Shelves

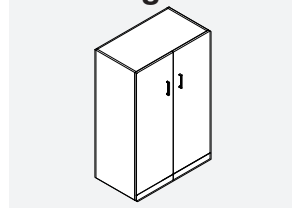

PRODUCT CODE	FINISH OPTIONS			SIZE (INCHES)			WEIGHT LBS	VOL FT3
	STANDARD	WOOD	LAMINATE	H	W	D		
D1D22W36H54	2652	3182	2122	54	36	22	194	22
D1D22W36H48	2452	2942	1962	48	36	22	182	25
D1D22W30H54	2638	3166	2110	54	30	22	172	19
D1D22W30H48	2394	2873	1915	48	30	22	161	21
D1D22W24H54	2638	3166	2110	54	24	22	150	15
D1D22W24H48	2345	2814	1876	48	24	22	140	17
D1D20W36H54	2506	3007	2005	54	36	20	184	20
D1D20W36H48	2229	2675	1783	48	36	20	173	23
D1D20W30H54	2450	2940	1960	54	30	20	163	17
D1D20W30H48	2179	2615	1743	48	30	20	153	19
D1D20W24H54	2400	2880	1920	54	24	20	142	13
D1D20W24H48	2132	2558	1706	48	24	20	133	15

• Storage with 3 adj. shelves

D1-R • Right Storage Cabinet with Door & Adj. Shelves

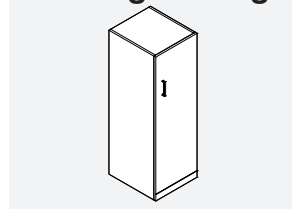

PRODUCT CODE	FINISH OPTIONS			SIZE (INCHES)			WEIGHT LBS	VOL FT3
	STANDARD	WOOD	LAMINATE	H	W	D		
D1D22W18H54R	2126	2551	1701	54	18	22	128	11
D1D22W18H48R	1891	2269	1513	48	18	22	120	12
D1D22W16H54R	1891	2269	1513	54	15.5	22	119	10
D1D22W16H48R	1681	2017	1345	48	15.5	22	111	11
D1D20W18H54R	1929	2315	1543	54	18	20	121	10
D1D20W18H48R	1718	2062	1374	48	18	20	113	11
D1D20W16H54R	1715	2058	1372	54	15.5	20	112	9
D1D20W16H48R	1528	1834	1222	48	15.5	20	105	10

• Storage with 3 adj. shelves

D1-L • Left Storage Cabinet with Door & Adj. Shelves

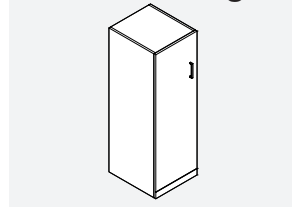

PRODUCT CODE	FINISH OPTIONS			SIZE (INCHES)			WEIGHT LBS	VOL FT3
	STANDARD	WOOD	LAMINATE	H	W	D		
D1D22W18H54L	2126	2551	1701	54	18	22	128	11
D1D22W18H48L	1891	2269	1513	48	18	22	120	12
D1D22W16H54L	1891	2269	1513	54	15.5	22	119	10
D1D22W16H48L	1681	2017	1345	48	15.5	22	111	11
D1D20W18H54L	1929	2315	1543	54	18	20	121	10
D1D20W18H48L	1718	2062	1374	48	18	20	113	11
D1D20W16H54L	1715	2058	1372	54	15.5	20	112	9
D1D20W16H48L	1528	1834	1222	48	15.5	20	105	10

• Storage with 3 adj. shelves

**D2 • Wardrobe Cabinet with Doors, Coat Rack & Hat Shelf**

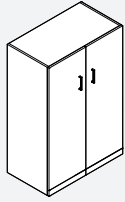

PRODUCT CODE	FINISH OPTIONS			SIZE (INCHES)			WEIGHT LBS	VOL FT3
	STANDARD	WOOD	LAMINATE	H	W	D		
D2D22W36H54	2386	2863	1909	54	36	22	167	25
D2D22W36H48	2187	2624	1750	48	36	22	155	22
D2D22W30H54	2375	2850	1900	54	30	22	152	21
D2D22W30H48	2131	2557	1705	48	30	22	142	19
D2D22W24H54	2375	2850	1900	54	24	22	132	17
D2D22W24H48	2081	2497	1665	48	24	22	123	15
D2D20W36H54	2242	2690	1794	54	36	20	160	23
D2D20W36H48	1962	2354	1570	48	36	20	149	20
D2D20W30H54	2242	2690	1794	54	30	20	145	19
D2D20W30H48	1915	2298	1532	48	30	20	135	17
D2D20W24H54	2132	2558	1706	54	24	20	126	15
D2D20W24H48	1869	2243	1495	48	24	20	117	13

**D2-R • Right Wardrobe Cabinet with Door, Coat Rack & Hat Shelf**

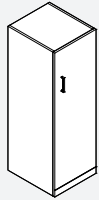

PRODUCT CODE	FINISH OPTIONS			SIZE (INCHES)			WEIGHT LBS	VOL FT3
	STANDARD	WOOD	LAMINATE	H	W	D		
D2D22W24H54R	2232	2678	1786	54	24	22	132	17
D2D22W24H48R	1983	2380	1586	48	24	22	123	15
D2D22W18H54R	2126	2551	1701	54	18	22	114	12
D2D22W18H48R	1891	2269	1513	48	18	22	106	11
D2D22W12H54R	2026	2431	1621	54	12	22	97	8
D2D22W12H48R	1800	2160	1440	48	12	22	90	7
D2D20W24H54R	2027	2432	1622	54	24	20	126	15
D2D20W24H48R	1805	2166	1444	48	24	20	117	13
D2D20W18H54R	1929	2315	1543	54	18	20	109	11
D2D20W18H48R	1718	2062	1374	48	18	20	101	10
D2D20W12H54R	1840	2208	1472	54	12	20	92	8
D2D20W12H48R	1638	1966	1310	48	12	20	86	7

**D2-L • Left Wardrobe Cabinet with Door, Coat Rack & Hat Shelf**

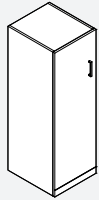

PRODUCT CODE	FINISH OPTIONS			SIZE (INCHES)			WEIGHT LBS	VOL FT3
	STANDARD	WOOD	LAMINATE	H	W	D		
D2D22W24H54L	2232	2678	1786	54	24	22	132	17
D2D22W24H48L	1983	2380	1586	48	24	22	123	15
D2D22W18H54L	2126	2551	1701	54	18	22	114	12
D2D22W18H48L	1891	2269	1513	48	18	22	106	11
D2D22W12H54L	2026	2431	1621	54	12	22	97	8
D2D22W12H48L	1800	2160	1440	48	12	22	90	7
D2D20W24H54L	2027	2432	1622	54	24	20	126	15
D2D20W24H48L	1805	2166	1444	48	24	20	117	13
D2D20W18H54L	1929	2315	1543	54	18	20	109	11
D2D20W18H48L	1718	2062	1374	48	18	20	101	10
D2D20W12H54L	1840	2208	1472	54	12	20	92	8
D2D20W12H48L	1638	1966	1310	48	12	20	86	7

**D7 • Open Bookcase with 1 Fixed Shelf and 2 Adj. Shelves**

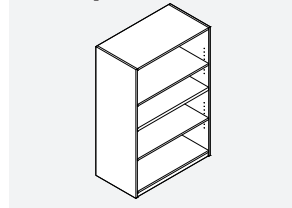

PRODUCT CODE	FINISH OPTIONS			SIZE (INCHES)			WEIGHT LBS	VOL FT <sup>3</sup>
	STANDARD	WOOD	LAMINATE	H	W	D		
D7D22W36H54	2659	3191	2127	54	36	22	161	25
D7D22W36H48	2364	2837	1891	48	36	22	153	22
D7D22W30H54	1970	2364	1576	54	30	22	144	21
D7D22W30H48	1751	2101	1401	48	30	22	137	19
D7D22W24H54	1577	1892	1262	54	24	22	128	17
D7D22W24H48	1400	1680	1120	48	24	22	121	15
D7D22W18H54	1183	1420	946	54	18	22	111	12
D7D22W18H48	1122	1346	898	48	18	22	105	11
D7D20W36H54	2418	2902	1934	54	36	20	151	23
D7D20W36H48	2149	2579	1719	48	36	20	144	20
D7D20W30H54	1791	2149	1433	54	30	20	136	19
D7D20W30H48	1592	1910	1274	48	30	20	129	17
D7D20W24H54	1439	1727	1151	54	24	20	120	15
D7D20W24H48	1274	1529	1019	48	24	20	114	13
D7D20W18H54	1111	1333	889	54	18	20	105	11
D7D20W18H48	1069	1283	855	48	18	20	99	10

- Storage with 1 fixed shelf and 2 adj. shelves

**D12 • Open Storage Cabinet with Adj. Shelf above 2 Lat. File Drawers**

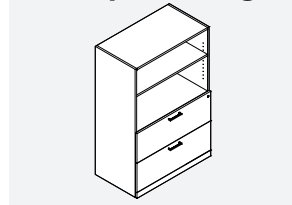

PRODUCT CODE	FINISH OPTIONS			SIZE (INCHES)			WEIGHT LBS	VOL FT <sup>3</sup>
	STANDARD	WOOD	LAMINATE	H	W	D		
D12D22W36H54	3369	4043	2695	54	36	22	167	24
D12D22W36H48	2995	3594	2396	48	36	22	159	23
D12D22W30H54	2918	3502	2334	54	30	22	154	20
D12D22W30H48	2594	3113	2075	48	30	22	146	19
D12D20W36H54	3230	3876	2584	54	36	20	160	19
D12D20W36H48	2871	3445	2297	48	36	20	152	23
D12D20W30H54	2797	3356	2238	54	30	20	147	19
D12D20W30H48	2485	2982	1988	48	30	20	140	21

- Storage with 1 adj. shelf

**D13 • Storage Cabinet with Doors & Adj. Shelf above 2 Lat. File Drawers**

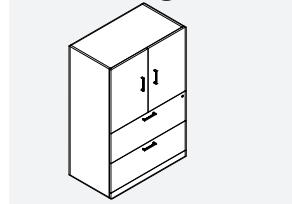

PRODUCT CODE	FINISH OPTIONS			SIZE (INCHES)			WEIGHT LBS	VOL FT <sup>3</sup>
	STANDARD	WOOD	LAMINATE	H	W	D		
D13D22W36H54	3587	4304	2870	54	36	22	183	24
D13D22W36H48	3189	3827	2551	48	36	22	171	23
D13D22W30H54	3247	3896	2598	54	30	22	167	20
D13D22W30H48	2886	3463	2309	48	30	22	157	19
D13D20W36H54	3439	4127	2751	54	36	20	176	19
D13D20W36H48	3055	3666	2444	48	36	20	164	23
D13D20W30H54	3113	3736	2490	48	30	20	161	19
D13D20W30H48	2768	3322	2214	54	30	20	150	21

- Storage with 1 adj. shelf

**D15-R • Storage Cabinet with Doors & Adj. Shelf above Right Combination Storage**

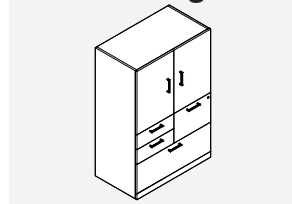

PRODUCT CODE	FINISH OPTIONS			SIZE (INCHES)			WEIGHT LBS	VOL FT <sup>3</sup>
	STANDARD	WOOD	LAMINATE	H	W	D		
D15D22W36H54R	3917	4700	3134	54	36	22	205	23
D15D22W36H48R	3519	4223	2815	48	36	22	193	23
D15D20W36H54R	3441	4129	2753	54	36	20	198	24
D15D20W36H48R	3386	4063	2709	48	36	20	186	24

- Storage with 1 adj. shelf
- Modular combination storage with 1 lat. file, 2 boxes top left & 1 file top right

**D15-L • Storage Cabinet with Doors & Adj. Shelf above Left Combination Storage**

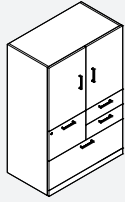

PRODUCT CODE	FINISH OPTIONS			SIZE (INCHES)			WEIGHT LBS	VOL FT3
	STANDARD	WOOD	LAMINATE	H	W	D		
D15D22W36H54L	3917	4700	3134	54	36	22	205	23
D15D22W36H48L	3519	4223	2815	48	36	22	193	23
D15D20W36H54L	3441	4129	2753	54	36	20	198	24
D15D20W36H48L	3386	4063	2709	48	36	20	186	24

- Storage with 1 adj. shelf
- Modular combination storage with 1 lat. file, 2 boxes top right & 1 file top left

**D17-R • Right Storage Cabinet with Door & Adj. Shelf above FF Drawers**

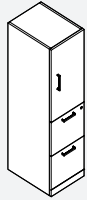

PRODUCT CODE	FINISH OPTIONS			SIZE (INCHES)			WEIGHT LBS	VOL FT3
	STANDARD	WOOD	LAMINATE	H	W	D		
D17D22W16H54R	2668	3202	2134	54	15.5	22	130	13
D17D22W16H48R	2372	2846	1898	48	15.5	22	122	13
D17D20W16H54R	2427	2912	1942	54	15.5	20	125	13
D17D20W16H48R	2157	2588	1726	48	15.5	20	118	13

- Storage with 1 adj. shelf

**D17-L • Left Storage Cabinet with Door & Adj. Shelf above FF Drawers**

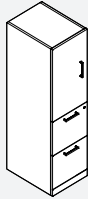

PRODUCT CODE	FINISH OPTIONS			SIZE (INCHES)			WEIGHT LBS	VOL FT3
	STANDARD	WOOD	LAMINATE	H	W	D		
D17D22W16H54L	2668	3202	2134	54	15.5	22	130	13
D17D22W16H48L	2372	2846	1898	48	15.5	22	122	13
D17D20W16H54L	2427	2912	1942	54	15.5	20	125	13
D17D20W16H48L	2157	2588	1726	48	15.5	20	118	13

- Storage with 1 adj. shelf

**D18-R • Right Storage Cabinet with Door & Adj. Shelf above BBF Drawers**



PRODUCT CODE	FINISH OPTIONS			SIZE (INCHES)			WEIGHT LBS	VOL FT3
	STANDARD	WOOD	LAMINATE	H	W	D		
D18D22W16H54R	2668	3202	2134	54	15.5	22	129	10
D18D22W16H48R	2372	2846	1898	48	15.5	22	122	9
D18D20W16H54R	2427	2912	1942	54	15.5	20	124	10
D18D20W16H48R	2157	2588	1726	48	15.5	20	117	9

- Storage with 1 adj. shelf

**D18-L • Left Storage Cabinet with Door & Adj. Shelf above BBF Drawers**

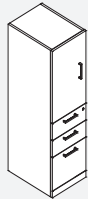

PRODUCT CODE	FINISH OPTIONS			SIZE (INCHES)			WEIGHT LBS	VOL FT3
	STANDARD	WOOD	LAMINATE	H	W	D		
D18D22W16H54L	2668	3202	2134	54	15.5	22	129	10
D18D22W16H48L	2372	2846	1898	48	15.5	22	122	9
D18D20W16H54L	2427	2912	1942	54	15.5	20	124	10
D18D20W16H48L	2157	2588	1726	48	15.5	20	117	9

- Storage with 1 adj. shelf

**D23 • Closed Storage Cabinet with Upper & Lower Split Doors & Adj. Shelves**

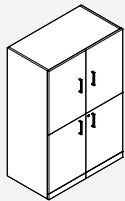

PRODUCT CODE	FINISH OPTIONS			SIZE (INCHES)			WEIGHT LBS	VOL FT3
	STANDARD	WOOD	LAMINATE	H	W	D		
D23D22W36H54	2911	3493	2329	54	36	22	194	24
D23D22W36H48	2589	3107	2071	48	36	22	182	23
D23D22W30H54	2855	3426	2284	54	30	22	172	20
D23D22W30H48	2538	3046	2030	48	30	22	161	19
D23D20W36H54	2646	3175	2117	54	36	20	184	24
D23D20W36H48	2354	2825	1883	48	36	20	173	23
D23D20W30H54	2594	3113	2075	54	30	20	163	20
D23D20W30H48	2306	2767	1845	48	30	20	153	19

- Storage with 1 fixed shelf and 2 adj. shelves

**D25 • Cabinet with Doors, Storage with Adj. Shelves on Right & Wardrobe on Left**

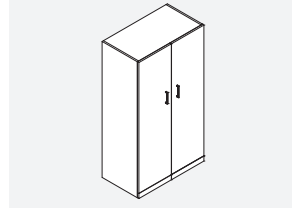

PRODUCT CODE	FINISH OPTIONS			SIZE (INCHES)			WEIGHT LBS	VOL FT3
	STANDARD	WOOD	LAMINATE	H	W	D		
D25D22W36H54	2932	3518	2346	54	36	22	174	24
D25D22W36H48	2605	3126	2084	48	36	22	162	23
D25D22W30H54	2875	3450	2300	54	30	22	155	20
D25D22W30H48	2555	3066	2044	48	30	22	145	19
D25D20W36H54	2808	3370	2246	54	36	20	166	24
D25D20W36H48	2497	2996	1998	48	36	20	155	23
D25D20W30H54	2754	3305	2203	54	30	20	148	20
D25D20W30H48	2450	2940	1960	48	30	20	138	19

- Storage with 3 adj. shelves
- Wardrobe with coat rack and fixed hat shelf

**D-17T • 17" Tops for Bookcases**

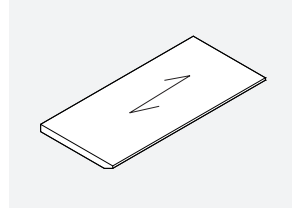

PRODUCT CODE	PRICE WOOD	SIZE (INCHES)			WEIGHT LBS	VOL FT3
		H	W	D		
D3617T	509	1	36	17	27	1
D3017T	425	1	30	17	23	1

**D-19T • 19" Tops for Modular Storage**

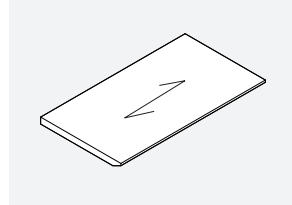

PRODUCT CODE	PRICE WOOD	SIZE (INCHES)			WEIGHT LBS	VOL FT3
		H	W	D		
D9619T	1546	1.5	96	18.5	82	1
D9019T	1452	1.5	90	18.5	78	1
D8419T	1355	1.5	84	18.5	74	1
D7819T	1289	1.5	78	18.5	70	1
D7219T	1161	1.5	72	18.5	67	1
D6619T	1063	1.5	66	18.5	63	1
D6019T	968	1.5	60	18.5	59	1
D4219T	747	1.5	42	18.5	48	1
D3619T	640	1.5	36	18.5	44	1
D3019T	530	1.5	30	18.5	41	1

**D-20T • 20" Tops for Metal Lateral Files with Wood Fronts**

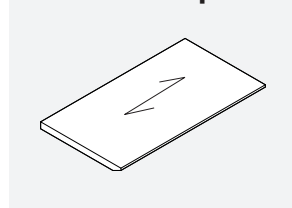

PRODUCT CODE	PRICE WOOD	SIZE (INCHES)			WEIGHT LBS	VOL FT3
		H	W	D		
D9620T	1546	1	96	20	86	1
D9020T	1452	1	90	20	82	1
D8420T	1355	1	84	20	78	1
D7820T	1258	1	78	20	74	1
D7220T	1161	1	72	20	70	1
D6620T	1063	1	66	20	66	1
D6020T	968	1	60	20	62	1
D4220T	747	1	42	20	50	1
D3620T	640	1	36	20	46	1
D3020T	530	1	30	20	42	1

D-22T • 22" Tops for Modular Storage

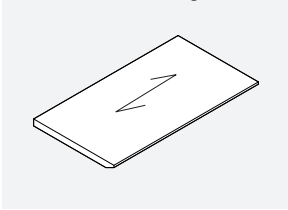

PRODUCT CODE	PRICE WOOD	SIZE (INCHES)			WEIGHT LBS	VOL FT3
		H	W	D		
D12022T	2126	1	120	22	111	2
D11822T	2090	1	118	22	109	2
D11622T	2055	1	116	22	108	2
D11422T	2020	1	114	22	106	2
D11222T	1983	1	112	22	105	2
D11022T	1949	1	110	22	103	2
D10822T	1913	1	108	22	102	2
D10622T	1876	1	106	22	100	2
D10422T	1841	1	104	22	99	2
D10222T	1808	1	102	22	97	2
D10022T	1774	1	100	22	96	2
D9822T	1735	1	98	22	94	2
D9622T	1702	1	96	22	93	2
D9422T	1668	1	94	22	91	2
D9222T	1631	1	92	22	90	2
D9022T	1595	1	90	22	89	2
D8822T	1560	1	88	22	87	2
D8622T	1524	1	86	22	86	2
D8422T	1489	1	84	22	84	2
D8222T	1454	1	82	22	83	2
D8022T	1418	1	80	22	81	2
D7822T	1384	1	78	22	80	2
D7622T	1349	1	76	22	78	2
D7422T	1311	1	74	22	77	2
D7222T	1277	1	72	22	75	2
D7022T	1242	1	70	22	74	2
D6822T	1207	1	68	22	72	2
D6622T	1173	1	66	22	71	2
D6422T	1135	1	64	22	69	1
D6222T	1097	1	62	22	68	1
D6022T	1062	1	60	22	66	1
D5822T	1030	1	58	22	65	1
D5622T	994	1	56	22	63	1
D5422T	956	1	54	22	62	1
D5222T	923	1	52	22	60	1
D5022T	889	1	50	22	59	1
D4822T	851	1	48	22	57	1
D4222T	822	1	42	22	53	1
D4022T	782	1	40	22	52	1
D3822T	744	1	38	22	50	1
D3622T	704	1	36	22	49	1
D3422T	660	1	34	22	47	1
D3222T	624	1	32	22	46	1
D3022T	584	1	30	22	44	1
D2422T	561	1	24	22	40	1
D1822T	400	1	18	22	35	1
D1622T	375	1	16	22	34	1
D1222T	279	1	12	22	31	1



**D-24T • 24" Tops for Modular Storage**

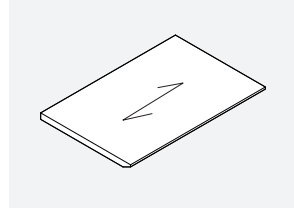

PRODUCT CODE	PRICE WOOD	SIZE (INCHES)			WEIGHT LBS	VOL FT3
		H	W	D		
D12024T	2319	1	120	24	119	2
D11824T	2279	1	118	24	117	2
D11624T	2248	1	116	24	115	2
D11424T	2220	1	114	24	114	2
D11224T	2165	1	112	24	112	2
D11024T	2129	1	110	24	111	2
D10824T	2088	1	108	24	109	2
D10624T	2047	1	106	24	107	2
D10424T	2011	1	104	24	106	2
D10224T	1975	1	102	24	104	2
D10024T	1935	1	100	24	103	2
D9824T	1893	1	98	24	101	2
D9624T	1856	1	96	24	99	2
D9424T	1816	1	94	24	98	2
D9224T	1779	1	92	24	96	2
D9024T	1739	1	90	24	95	2
D8824T	1703	1	88	24	93	2
D8624T	1661	1	86	24	91	2
D8424T	1624	1	84	24	90	2
D8224T	1586	1	82	24	88	2
D8024T	1546	1	80	24	86	2
D7824T	1524	1	78	24	85	2
D7624T	1471	1	76	24	83	2
D7424T	1432	1	74	24	82	2
D7224T	1392	1	72	24	80	2
D7024T	1354	1	70	24	78	2
D6824T	1313	1	68	24	77	2
D6624T	1277	1	66	24	75	2
D6424T	1239	1	64	24	74	1
D6224T	1200	1	62	24	74	1
D6024T	1159	1	60	24	70	1
D5824T	1121	1	58	24	69	1
D5624T	1084	1	56	24	67	1
D5424T	1045	1	54	24	66	1
D5224T	1007	1	52	24	64	1
D5024T	969	1	50	24	62	1
D4824T	927	1	48	24	61	1
D4224T	895	1	42	24	56	1
D4024T	853	1	40	24	54	1
D3824T	815	1	38	24	53	1
D3624T	767	1	36	24	51	1
D3424T	718	1	34	24	49	1
D3224T	680	1	32	24	48	1
D3024T	613	1	30	24	46	1
D2424T	584	1	24	24	41	1
D1824T	421	1	18	24	37	1
D1624T	409	1	16	24	35	1
D1224T	307	1	12	24	32	1



**HUTCHES & WALL MOUNT STORAGE • TECHNICAL INFORMATION**

- All Hutches and Wall Mount units have Doors in wood, Chassis are in low pressure laminate.

**Hutches**

- All Hutches are shipped assembled.
- Handles can be specified for hutches with wood doors
- Handles cannot be specified on Aluminum Framed Glass Doors.
- Frosted glass door is standard.

**Open Shelf Hutch**

- Includes 1 Adjustable Shelf.
- No Tackboard is available for use with this Hutch.

**Closed Pigeon Hole Storage Hutch**

- 42" unit has 21.5" of clearance.

**Closed Storage Hutch**

- 36" unit has 19.5" of clearance.
- 42" and 54" units have 25.5" of clearance.
- For Lock option see Page K.8

**Tasklight**

For proper size see section A.19

- If Handle is specified:
  - Black and Brass Handle = Black Lock & Grommet.
  - Silver, Nickel and Tungsten Handle = Tungsten Lock & Grommet.
- To choose All Wood Finish, add suffix "W" to the end of the product code.
- To choose All Laminate Finish, add suffix "P1", "P2" or "P3" to the end of the product code (see page A.10 and A.11).

**HUTCHES & WALL MOUNT STORAGE • GUIDELINES FOR ORDERING PRODUCT**

**CODES:** The price list uses a numbering system with meaningful alphanumeric characters to create a simple-to-understand product number. This makes specifying the product easy and accurate.

**SPECIFICATION EXAMPLE OF A HUTCH UNIT**

**PRODUCT CODE:**

D102SH42  
 D = Dufferin Series  
 102 = Size: Width  
 SH = Hutch with Wood Doors  
 42 = Size: Height

**CHOOSE FINISH OPTION:**

**Standard Finish:**  
 Choose Laminate Finish & Veneer Finish

**All Wood Finish:**  
 Choose Veneer Finish

**All Laminate Finish:**  
 Choose Laminate Finish

**HANDLE OPTION:**  
 Choose a handle

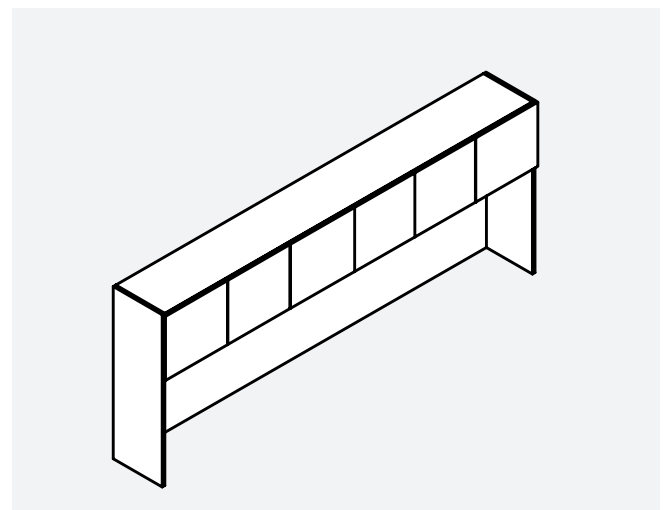

**D-CL36 • Open Shelf Hutch**

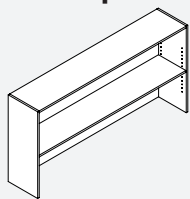

PRODUCT CODE	FINISH OPTIONS			SIZE (INCHES)			WEIGHT LBS	VOL FT <sup>3</sup>
	STANDARD	WOOD	LAMINATE	H	W	D		
D72CL36	1827	2192	1462	36	72	14	116	23
D66CL36	1694	2033	1355	36	66	14	110	21
D60CL36	1506	1807	1205	36	60	14	103	19
D48CL36	1431	1717	1145	36	48	14	91	15
D42CL36	1300	1560	1040	36	42	14	84	13
D36CL36	1217	1460	974	36	35	14	77	11
D30CL36	1013	1216	810	36	30	14	71	9

- With 1 adj. shelf

D-CL19 • Pigeon Hole Hutch

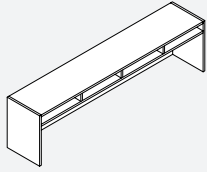

PRODUCT CODE	FINISH OPTIONS			SIZE (INCHES)			WEIGHT LBS	VOL FT3
	STANDARD	WOOD	LAMINATE	H	W	D		
D72CL19	1205	1446		19	72	14	88	12
D66CL19	1104	1325		19	66	14	83	11
D60CL19	1004	1205		19	60	14	78	9
D48CL19	802	962		19	48	14	69	8
D42CL19	703	844		19	42	14	64	7
D36CL19	603	724		19	35	14	59	6
D30CL19	502	602		19	30	14	55	5

D-SH36 • 36" High Storage Hutch with Wood Doors

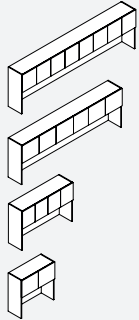

PRODUCT CODE	FINISH OPTIONS			SIZE (INCHES)			WEIGHT LBS	VOL FT3
	STANDARD	WOOD	LAMINATE	H	W	D		
D108SH36	4454	5345	3563	36	108	15	190	34
D102SH36	4203	5044	3362	36	102	15	181	32
D96SH36	3958	4750	3166	36	96	15	173	30
D90SH36	3709	4451	2967	36	90	15	165	28
D84SH36	3463	4156	2770	36	84	15	156	26
D78SH36	3216	3859	2573	36	78	15	148	24
D72SH36	2970	3564	2376	36	72	15	140	23
D66SH36	2858	3430	2286	36	66	15	132	21
D60SH36	2720	3264	2176	36	60	15	123	19
D36SH36	1856	2227	1485	36	35	15	89	11
D30SH36	1625	1950	1300	36	30	15	82	9

D-SH36G • 36" High Storage Hutch with Glass Doors

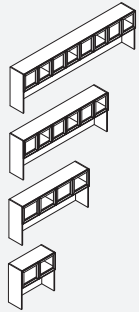

PRODUCT CODE	FINISH OPTIONS			SIZE (INCHES)			WEIGHT LBS	VOL FT3
	STANDARD	WOOD	LAMINATE	H	W	D		
D108SH36G	6479	7775		36	108	15	202	34
D102SH36G	5812	6974		36	102	15	193	32
D96SH36G	5544	6653		36	96	15	184	30
D90SH36G	5272	6326		36	90	15	175	28
D84SH36G	5003	6004		36	84	15	166	26
D78SH36G	4738	5686		36	78	15	157	24
D72SH36G	4058	4870		36	72	15	148	23
D66SH36G	3948	4738		36	66	15	139	21
D60SH36G	3748	4498		36	60	15	130	19
D36SH36G	2397	2876		36	35	15	93	11
D30SH36G	2134	2561		36	30	15	85	9

- Aluminum framed glass doors

D-SH36GDG • 36" High Storage Hutch with Glass & Wood Doors

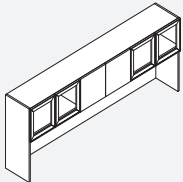

PRODUCT CODE	FINISH OPTIONS			SIZE (INCHES)			WEIGHT LBS	VOL FT3
	STANDARD	WOOD	LAMINATE	H	W	D		
D102SH36GDG	5228	6274	4182	36	102	15	189	32
D96SH36GDG	4979	5975	3983	36	96	15	180	30
D90SH36GDG	4732	5678	3786	36	90	15	171	28
D84SH36GDG	4275	5130	3420	36	84	15	163	26

- Doors at centre and aluminum framed glass doors at ends

D-SH36DGD • 36" High Storage Hutch with Glass & Wood Doors

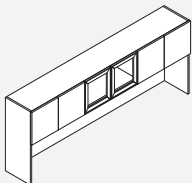

PRODUCT CODE	FINISH OPTIONS			SIZE (INCHES)			WEIGHT LBS	VOL FT3
	STANDARD	WOOD	LAMINATE	H	W	D		
D102SH36DGD	4715	5658	3772	36	102	15	185	32
D96SH36DGD	4340	5208	3472	36	96	15	177	30
D90SH36DGD	4220	5064	3376	36	90	15	168	28
D84SH36DGD	3974	4769	3179	36	84	15	160	26

- Aluminum framed glass doors at centre and doors at ends

**D-SH42 • 42" High Storage Hutch with Wood Doors**

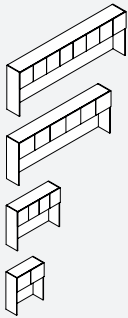

PRODUCT CODE	FINISH OPTIONS			SIZE (INCHES)			WEIGHT LBS	VOL FT <sup>3</sup>
	STANDARD	WOOD	LAMINATE	H	W	D		
D108SH42	5194	6233	4155	43	108	15	206	39
D102SH42	4904	5885	3923	43	102	15	197	37
D96SH42	4616	5539	3693	43	96	15	188	35
D90SH42	4326	5191	3461	43	90	15	179	33
D84SH42	4043	4852	3234	43	84	15	170	31
D78SH42	3751	4501	3001	43	78	15	161	38
D72SH42	3463	4156	2770	43	72	15	152	26
D66SH42	3335	4002	2668	43	66	15	143	24
D60SH42	3174	3809	2539	43	60	15	134	22
D36SH42	2166	2599	1733	43	35	15	96	13
D30SH42	1896	2275	1517	43	30	15	89	11

**D-SH42G • 42" High Storage Hutch with Glass Doors**

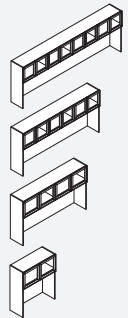

PRODUCT CODE	FINISH OPTIONS			SIZE (INCHES)			WEIGHT LBS	VOL FT <sup>3</sup>
	STANDARD	WOOD	LAMINATE	H	W	D		
D108SH42G	7217	8660		43	108	15	218	39
D102SH42G	6512	7814		43	102	15	208	37
D96SH42G	6203	7444		43	96	15	199	35
D90SH42G	5889	7067		43	90	15	189	33
D84SH42G	5583	6700		43	84	15	179	31
D78SH42G	5271	6325		43	78	15	170	38
D72SH42G	4550	5460		43	72	15	160	26
D66SH42G	4390	5268		43	66	15	150	24
D60SH42G	4234	5081		43	60	15	141	22
D36SH42G	2706	3247		43	35	15	100	13
D30SH42G	2405	2886		43	30	15	92	11

- Aluminum framed glass doors

**D-SH42GDG • 42" High Storage Hutch with Glass & Wood Doors**

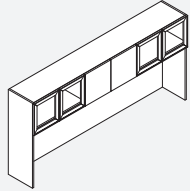

PRODUCT CODE	FINISH OPTIONS			SIZE (INCHES)			WEIGHT LBS	VOL FT <sup>3</sup>
	STANDARD	WOOD	LAMINATE	H	W	D		
D102SH42GDG	6795	8154	5436	43	102	15	205	37
D96SH42GDG	6394	7673	5115	43	96	15	195	35
D90SH42GDG	5994	7193	4795	43	90	15	186	33
D84SH42GDG	5594	6713	4475	43	84	15	176	31

- Doors at centre and aluminum framed glass doors at ends

**D-SH42DGD • 42" High Storage Hutch with Glass & Wood Doors**

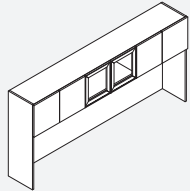

PRODUCT CODE	FINISH OPTIONS			SIZE (INCHES)			WEIGHT LBS	VOL FT <sup>3</sup>
	STANDARD	WOOD	LAMINATE	H	W	D		
D102SH42DGD	5685	6822	4548	43	102	15	201	37
D96SH42DGD	5127	6152	4102	43	96	15	191	35
D90SH42DGD	4838	5806	3870	43	90	15	182	33
D84SH42DGD	4550	5460	3640	43	84	15	173	31

- Aluminum framed glass doors at centre and doors at ends

**D-SHP42 • 42" High Storage Hutch with Pigeon-Holes & Wood Doors**

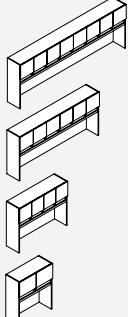

PRODUCT CODE	FINISH OPTIONS			SIZE (INCHES)			WEIGHT LBS	VOL FT <sup>3</sup>
	STANDARD	WOOD	LAMINATE	H	W	D		
D108SHP42	6232	7478	4986	43	108	15	201	39
D102SHP42	5886	7063	4709	43	102	15	193	37
D96SHP42	5537	6644	4430	43	96	15	184	35
D90SHP42	5194	6233	4155	43	90	15	175	33
D84SHP42	4848	5818	3878	43	84	15	166	31
D78SHP42	4500	5400	3600	43	78	15	158	38
D72SHP42	4151	4981	3321	43	72	15	149	26
D66SHP42	4001	4801	3201	43	66	15	140	24
D60SHP42	3799	4559	3039	43	60	15	131	22
D36SHP42	2598	3118	2078	43	35	15	95	13
D30SHP42	2274	2729	1819	43	30	15	88	11

**D-SHP42G • 42" High Storage Hutch with Pigeon-Holes & Glass Doors**

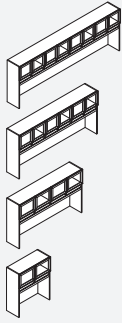

PRODUCT CODE	FINISH OPTIONS			SIZE (INCHES)			WEIGHT LBS	VOL FT <sup>3</sup>
	STANDARD	WOOD	LAMINATE	H	W	D		
D108SHP42G	8209	9851		43	108	15	218	39
D102SHP42G	7453	8944		43	102	15	208	37
D96SHP42G	7102	8522		43	96	15	199	35
D90SHP42G	6915	8298		43	90	15	189	33
D84SHP42G	6343	7612		43	84	15	179	31
D78SHP42G	5977	7172		43	78	15	170	38
D72SHP42G	5213	6256		43	72	15	160	26
D66SHP42G	5042	6050		43	66	15	150	24
D60SHP42G	4805	5766		43	60	15	141	22
D36SHP42G	3122	3746		43	35	15	100	13
D30SHP42G	2784	3341		43	30	15	92	11

- Aluminum framed glass doors

**D-SHP42GDG • 42" High Storage Hutch with Pigeon-Holes, Glass & Wood Doors**

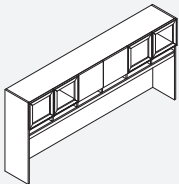

PRODUCT CODE	FINISH OPTIONS			SIZE (INCHES)			WEIGHT LBS	VOL FT <sup>3</sup>
	STANDARD	WOOD	LAMINATE	H	W	D		
D102SHP42GDG	6881	8257	5505	43	102	15	205	37
D96SHP42GDG	6534	7841	5227	43	96	15	195	35
D90SHP42GDG	6188	7426	4950	43	90	15	186	33
D84SHP42GDG	5565	6678	4452	43	84	15	176	31

- Doors at centre and aluminum framed glass doors at ends

**D-SHP42DGD • 42" High Storage Hutch with Pigeon-Holes Glass, & Wood Doors**

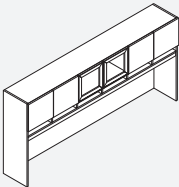

PRODUCT CODE	FINISH OPTIONS			SIZE (INCHES)			WEIGHT LBS	VOL FT <sup>3</sup>
	STANDARD	WOOD	LAMINATE	H	W	D		
D102SHP42DGD	6395	7674	5116	43	102	15	201	37
D96SHP42DGD	5752	6902	4602	43	96	15	191	35
D90SHP42DGD	5481	6577	4385	43	90	15	182	33
D84SHP42DGD	5345	6414	4276	43	84	15	173	31

- Aluminum framed glass doors at centre and doors at ends

**D-2SH54 • 54" High Storage Hutch with Wood Doors**

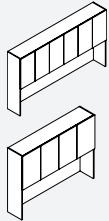

PRODUCT CODE	FINISH OPTIONS			SIZE (INCHES)			WEIGHT LBS	VOL FT <sup>3</sup>
	STANDARD	WOOD	LAMINATE	H	W	D		
D962SH54	5935	7122	4748	55	96	15	258	45
D902SH54	5565	6678	4452	55	90	15	245	42
D842SH54	5194	6233	4155	55	84	15	232	39
D782SH54	4822	5786	3858	55	78	15	219	37
D722SH54	4454	5345	3563	55	72	15	206	34
D662SH54	4286	5143	3429	55	66	15	193	31
D602SH54	4081	4897	3265	55	60	15	180	28

**D-2SH54G • 54" High Storage Hutch with Glass Doors**

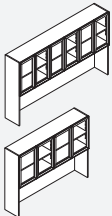

PRODUCT CODE	FINISH OPTIONS			SIZE (INCHES)			WEIGHT LBS	VOL FT <sup>3</sup>
	STANDARD	WOOD	LAMINATE	H	W	D		
D962SH54G	7919	9503		55	96	15	248	45
D902SH54G	7379	8855		55	90	15	236	42
D842SH54G	6830	8196		55	84	15	223	39
D782SH54G	6284	7541		55	78	15	211	37
D722SH54G	5741	6889		55	72	15	199	34
D662SH54G	5532	6638		55	66	15	186	31
D602SH54G	5289	6347		55	60	15	174	28

- Aluminum framed glass doors
- With 1 adj. shelf

**D-2SH54GDG • 54" High Storage Hutch with Glass & Wood Doors**

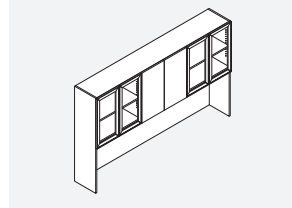

PRODUCT CODE	FINISH OPTIONS			SIZE (INCHES)			WEIGHT LBS	VOL FT <sup>3</sup>
	STANDARD	WOOD	LAMINATE	H	W	D		
D962SH54GDG	7145	8574	5716	55	96	15	45	45
D902SH54GDG	6773	8128	5418	55	90	15	42	42
D842SH54GDG	6403	7684	5122	55	84	15	39	39

- Doors at centre and aluminum framed glass doors at ends
- With 1 adj. shelf

**D-2SH54DGD • 54" High Storage Hutch with Glass & Wood Doors**

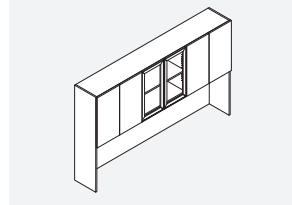

PRODUCT	FINISH OPTIONS			SIZE (INCHES)			WEIGHT LBS	VOL FT <sup>3</sup>
	STANDARD	WOOD	LAMINATE	H	W	D		
D962SH54DGD	6537	7844	5230	55	96	15	241	45
D902SH54DGD	6170	7404	4936	55	90	15	229	42
D842SH54DGD	5798	6958	4638	55	84	15	217	39

- Aluminum framed glass doors at centre and doors at ends
- With 1 adj. shelf

**D-2SHP54 • 54" High Storage Hutch with Pigeon-Holes & Wood Doors**

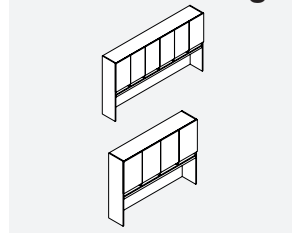

PRODUCT CODE	FINISH OPTIONS			SIZE (INCHES)			WEIGHT LBS	VOL FT <sup>3</sup>
	STANDARD	WOOD	LAMINATE	H	W	D		
D962SHP54	7125	8550	5700	55	96	15	254	45
D902SHP54	6679	8015	5343	55	90	15	242	42
D842SHP54	6230	7476	4984	55	84	15	229	39
D782SHP54	5786	6943	4629	55	78	15	216	37
D722SHP54	5344	6413	4275	55	72	15	203	34
D662SHP54	5143	6172	4114	55	66	15	190	31
D602SHP54	4901	5881	3921	55	60	15	178	28

- With 1 adj. shelf

**D-2SHP54G • 54" High Storage Hutch with Pigeon-Holes & Glass Doors**

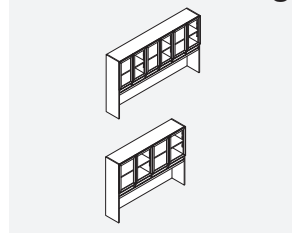

PRODUCT CODE	FINISH OPTIONS			SIZE (INCHES)			WEIGHT LBS	VOL FT <sup>3</sup>
	STANDARD	WOOD	LAMINATE	H	W	D		
D962SHP54G	9109	10931		55	96	15	248	45
D902SHP54G	8488	10186		55	90	15	236	42
D842SHP54G	7866	9439		55	84	15	223	39
D782SHP54G	7250	8700		55	78	15	211	37
D722SHP54G	6629	7955		55	72	15	199	34
D662SHP54G	6391	7669		55	66	15	186	31
D602SHP54G	6105	7326		55	60	15	174	28

- Aluminum framed glass doors
- With 1 adj. shelf

**D-2SHP54GDG • 54" High Storage Hutch with Pigeon-Holes, Glass & Wood Doors**

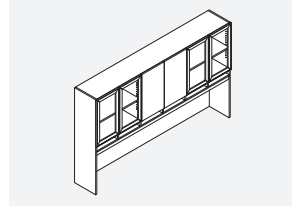

PRODUCT CODE	FINISH OPTIONS			SIZE (INCHES)			WEIGHT LBS	VOL FT <sup>3</sup>
	STANDARD	WOOD	LAMINATE	H	W	D		
D962SHP54GDG	8331	9997	6665	55	96	15	245	45
D902SHP54GDG	7887	9464	6310	55	90	15	232	42
D842SHP54GDG	7440	8928	5952	55	84	15	220	39

- Doors at centre and aluminum framed glass doors at ends
- With 1 adj. shelf

**D-2SHP54DGD • 54" High Storage Hutch with Pigeon-Holes, Glass & Wood Doors**

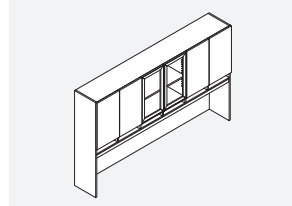

PRODUCT CODE	FINISH OPTIONS			SIZE (INCHES)			WEIGHT LBS	VOL FT <sup>3</sup>
	STANDARD	WOOD	LAMINATE	H	W	D		
D962SHP54DGD	7726	9271	6181	55	96	15	241	45
D902SHP54DGD	7281	8737	5825	55	90	15	229	42
D842SHP54DGD	6833	8200	5466	55	84	15	217	39

- Aluminum framed glass doors at centre and doors at ends
- With 1 adj. shelf

**DSF • Wall Mount Storage with Wood Doors**

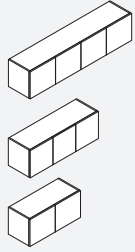

PRODUCT CODE	FINISH OPTIONS			SIZE (INCHES)			WEIGHT LBS	VOL FT3
	STANDARD	WOOD	LAMINATE	H	W	D		
DSF72	2122	2546	1698	16.5	72	15.5	105	10
DSF66	1947	2336	1558	16.5	66	15.5	99	9
DSF60	1766	2119	1413	16.5	60	15.5	93	8
DSF54	1590	1908	1272	16.5	54	15.5	86	7
DSF48	1415	1698	1132	16.5	48	15.5	80	7
DSF42	1299	1559	1039	16.5	42	15.5	74	6
DSF36	1274	1529	1019	16.5	36	15.5	68	5
DSF30	1251	1501	1001	16.5	30	15.5	62	4

**DSF-G • Wall Mount Storage with Glass Doors**

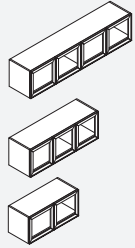

PRODUCT CODE	FINISH OPTIONS			SIZE (INCHES)			WEIGHT LBS	VOL FT3
	STANDARD	WOOD	LAMINATE	H	W	D		
DSF72G	3278	3934		16.5	72	15.5	135	10
DSF66G	3045	3654		16.5	66	15.5	126	9
DSF60G	2855	3426		16.5	60	15.5	117	8
DSF54G	2555	3066		16.5	54	15.5	109	7
DSF48G	2258	2710		16.5	48	15.5	100	7
DSF42G	2005	2406		16.5	42	15.5	91	6
DSF36G	1854	2225		16.5	36	15.5	83	5
DSF30G	1799	2159		16.5	30	15.5	74	4

• Aluminum framed glass doors

**DSFP • Wall Mount Storage with Pigeon-Holes & Wood Doors**

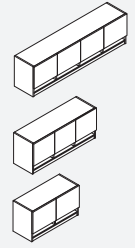

PRODUCT CODE	FINISH OPTIONS			SIZE (INCHES)			WEIGHT LBS	VOL FT3
	STANDARD	WOOD	LAMINATE	H	W	D		
DSFP72	2543	3052	2034	20	72	15.5	111	12
DSFP66	2331	2797	1865	20	66	15.5	104	11
DSFP60	2123	2548	1698	20	60	15.5	98	10
DSFP54	1909	2291	1527	20	54	15.5	91	9
DSFP48	1695	2034	1356	20	48	15.5	85	8
DSFP42	1613	1936	1290	20	42	15.5	78	7
DSFP36	1528	1834	1222	20	36	15.5	72	6
DSFP30	1504	1805	1203	20	30	15.5	65	5

**DSFP-G • Wall Mount Storage with Pigeon-Holes & Glass Doors**

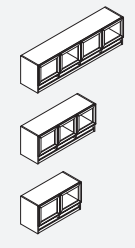

PRODUCT CODE	FINISH OPTIONS			SIZE (INCHES)			WEIGHT LBS	VOL FT3
	STANDARD	WOOD	LAMINATE	H	W	D		
DSFP72G	3608	4330		20	72	15.5	141	12
DSFP66G	3449	4139		20	66	15.5	132	11
DSFP60G	3177	3812		20	60	15.5	123	10
DSFP54G	2962	3554		20	54	15.5	114	9
DSFP48G	2515	3018		20	48	15.5	105	8
DSFP42G	2191	2629		20	42	15.5	96	7
DSFP36G	2091	2509		20	36	15.5	87	6
DSFP30G	2033	2440		20	30	15.5	78	5

• Aluminum framed glass doors

**DSFF • Wall Mount Storage with Wood Flipper Doors**

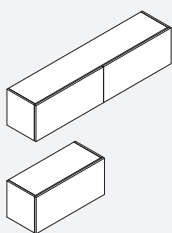

PRODUCT CODE	FINISH OPTIONS			SIZE (INCHES)			WEIGHT LBS	VOL FT3
	STANDARD	WOOD	LAMINATE	H	W	D		
DSFF72	2296	2755	1837	16.5	72	15.5	105	10
DSFF66	2105	2526	1684	16.5	66	15.5	99	9
DSFF60	1913	2296	1530	16.5	60	15.5	93	8
DSFF54	1724	2069	1379	16.5	54	15.5	86	7
DSFF48	1533	1840	1226	16.5	48	15.5	80	7
DSFF42	1420	1704	1136	16.5	42	15.5	74	6
DSFF36	1396	1675	1117	16.5	36	15.5	68	5
DSFF30	1373	1648	1098	16.5	30	15.5	62	4



**DSFFP • Wall Mount Storage with Pigeon-Holes & Wood Flipper Doors**

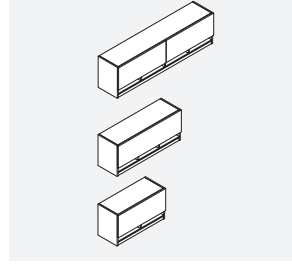

PRODUCT CODE	FINISH OPTIONS			SIZE (INCHES)			WEIGHT LBS	VOL FT <sup>3</sup>
	STANDARD	WOOD	LAMINATE	H	W	D		
DSFFP72	2756	3307	2205	20	72	15.5	12	12
DSFFP66	2527	3032	2022	20	66	15.5	11	11
DSFFP60	2298	2758	1838	20	60	15.5	10	10
DSFFP54	2067	2480	1654	20	54	15.5	9	9
DSFFP48	1839	2207	1471	20	48	15.5	8	8
DSFFP42	1705	2046	1364	20	42	15.5	7	7
DSFFP36	1673	2008	1338	20	36	15.5	6	6
DSFFP30	1647	1976	1318	20	30	15.5	5	5

**DSFO • Open Wall Mount Storage**

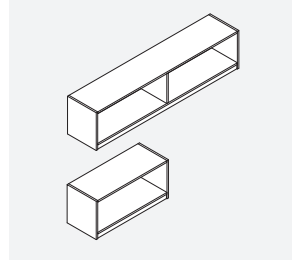

PRODUCT CODE	FINISH OPTIONS			SIZE (INCHES)			WEIGHT LBS	VOL FT <sup>3</sup>
	STANDARD	WOOD	LAMINATE	H	W	D		
DSFO72	2026	2431		16.5	72	14.5	85	10
DSFO66	1861	2233		16.5	66	14.5	80	9
DSFO60	1689	2027		16.5	60	14.5	76	8
DSFO54	1524	1829		16.5	54	14.5	71	7
DSFO48	1355	1626		16.5	48	14.5	67	7
DSFO42	1249	1499		16.5	42	14.5	62	6
DSFO36	1233	1480		16.5	36	14.5	58	5
DSFO30	1210	1452		16.5	30	14.5	53	4

**DSFOP • Open Wall Mount Storage with Pigeon-Holes**

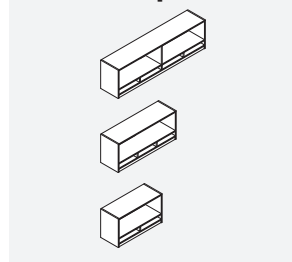

PRODUCT CODE	FINISH OPTIONS			SIZE (INCHES)			WEIGHT LBS	VOL FT <sup>3</sup>
	STANDARD	WOOD	LAMINATE	H	W	D		
DSFOP72	2432	2918		19.5	72	14.5	90	12
DSFOP66	2232	2678		19.5	66	14.5	85	11
DSFOP60	2027	2432		19.5	60	14.5	80	10
DSFOP54	1827	2192		19.5	54	14.5	75	9
DSFOP48	1621	1945		19.5	48	14.5	71	8
DSFOP42	1520	1824		19.5	42	14.5	66	7
DSFOP36	1477	1772		19.5	36	14.5	61	6
DSFOP30	1454	1745		19.5	30	14.5	56	5



**FREESTANDING STORAGE • TECHNICAL INFORMATION**

- All Freestanding Storage units have Fronts, Tops and all exposed Shelves in wood, Chassis are in low pressure laminate.

**Pedestals**

- All units are shipped assembled.
- Standard face locking.

**Combination Storage**

- All units are shipped assembled.
- No modifications accepted for this unit.
- Box drawers do not lock.
- Standard face locking.

**Storage Cabinets**

- Units include adjustable shelves.
- If Handle is specified:
  - Black and Brass Handle = Black Lock & Grommet.
  - Silver, Nickel and Tungsten Handle = Tungsten Lock & Grommet.
- To choose All Wood Finish, add suffix "W" to the end of the product code.
- To choose All Laminate Finish, add suffix "P1", "P2" or "P3" to the end of the product code (see page A.10 and A.11).

**FREESTANDING STORAGE • GUIDELINES FOR ORDERING PRODUCT**

**CODES:** The price list uses a numbering system with meaningful alphanumeric characters to create a simple-to-understand product number. This makes specifying the product easy and accurate.

**SPECIFICATION EXAMPLE OF A HUTCH UNIT**

**PRODUCT CODE:**

DWDM  
 D = Dufferin Series  
 W = Modular/Freestanding Unit  
 D = Box, Box, File  
 M = Mobile

**CHOOSE FINISH OPTION:**

**Standard Finish:**  
 Choose Laminate Finish & Veneer Finish

**All Wood Finish:**  
 Choose Veneer Finish

**All Laminate Finish:**  
 Choose Laminate Finish

**HANDLE OPTION:**  
 Choose a handle

**NOTE:** Arrow indicates direction of grain.

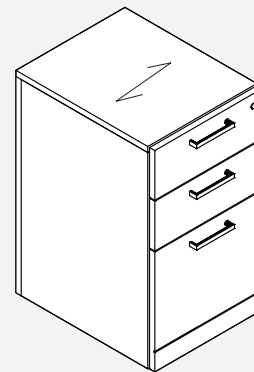

**DWDB/WWDB • Freestanding BBF Pedestal**

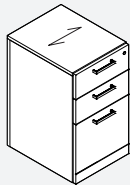

PRODUCT CODE	FINISH OPTIONS			SIZE (INCHES)			WEIGHT LBS	VOL FT3
	STANDARD	WOOD	LAMINATE	H	W	D		
DWDB	1570	1884	1256	27.5	15.5	20	87	5
DWWDB	1807	2168	1446	27.5	15.5	24	93	5

**DWDM/WWDM • Freestanding Mobile BBF Pedestal**



PRODUCT CODE	FINISH OPTIONS			SIZE (INCHES)			WEIGHT LBS	VOL FT3
	STANDARD	WOOD	LAMINATE	H	W	D		
DWDM	1685	2022	1348	27.5	15.5	20	70	5
DWWDM	1942	2330	1554	27.5	15.5	24	75	5

## DWEM/WWEM • Freestanding Lateral File

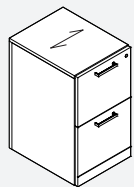

PRODUCT CODE	FINISH OPTIONS			SIZE (INCHES)			WEIGHT LBS	VOL FT <sup>3</sup>
	STANDARD	WOOD	LAMINATE	H	W	D		
DWEM	1791	2149	1433	27.5	15.5	20	88	5
DWWEM	2047	2456	1638	27.5	15.5	24	94	5

## DF/N • Freestanding Lateral File

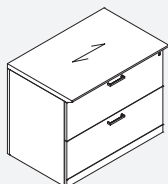

PRODUCT CODE	FINISH OPTIONS			SIZE (INCHES)			WEIGHT LBS	VOL FT <sup>3</sup>
	STANDARD	WOOD	LAMINATE	H	W	D		
DF3624	2915	3498	2332	29	36	24	156	15
DF3622	2532	3038	2026	29	36	22	150	13
DN3024	2417	2900	1934	29	30	24	141	12
DN3022	2213	2656	1770	29	30	22	136	11

## DF-3/N-3 • Freestanding Lateral File with 3 Drawers



PRODUCT CODE	FINISH OPTIONS			SIZE (INCHES)			WEIGHT LBS	VOL FT <sup>3</sup>
	STANDARD	WOOD	LAMINATE	H	W	D		
DF36243	3749	4499	2999	42	36	24	198	21
DF36223	3434	4121	2747	42	36	22	191	19
DN30243	3278	3934	2622	42	30	24	180	18
DN30223	3004	3605	2403	42	30	22	174	16

## DF-4/N-4 • Freestanding Lateral File with 4 Drawers



PRODUCT CODE	FINISH OPTIONS			SIZE (INCHES)			WEIGHT LBS	VOL FT <sup>3</sup>
	STANDARD	WOOD	LAMINATE	H	W	D		
DF36244	4569	5483	3655	54	36	24	238	27
DF36224	4186	5023	3349	54	36	22	231	25
DN30244	3993	4792	3194	54	30	24	217	23
DN30224	3664	4397	2931	54	30	22	210	21

## DZR • Right Combination Storage with 1 Lat. File, 2 Boxes Top Left &amp; 1 File Top Right

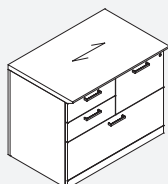

PRODUCT CODE	FINISH OPTIONS			SIZE (INCHES)			WEIGHT LBS	VOL FT <sup>3</sup>
	STANDARD	WOOD	LAMINATE	H	W	D		
DZR3624	2992	3590	2394	29	36	24	162	15
DZR3622	2745	3294	2196	29	36	22	156	13

## DZL • Left Combination Storage with 1 Lat. File, 1 File Top Left &amp; 2 Boxes Top Right

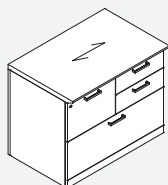

PRODUCT CODE	FINISH OPTIONS			SIZE (INCHES)			WEIGHT LBS	VOL FT <sup>3</sup>
	STANDARD	WOOD	LAMINATE	H	W	D		
DZL3624	2992	3590	2394	29	36	24	162	15
DZL3622	2745	3294	2196	29	36	22	156	13

**DBD • Freestanding Storage Cabinet with Doors and Adj. Shelf**

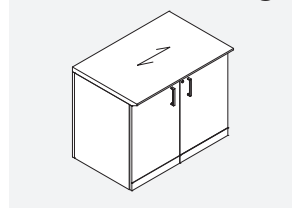

PRODUCT CODE	FINISH OPTIONS			SIZE (INCHES)			WEIGHT LBS	VOL FT <sup>3</sup>
	STANDARD	WOOD	LAMINATE	H	W	D		
DBD3624	1880	2256	1504	29	36	24	138	15
DBD3622	1723	2068	1378	29	36	22	132	13
DBD3024	1647	1976	1318	29	30	24	123	12
DBD3022	1507	1808	1206	29	30	22	117	11

- Storage with 1 adj. shelf

**DOB • Freestanding Open Storage Cabinet with Adj. Shelf**

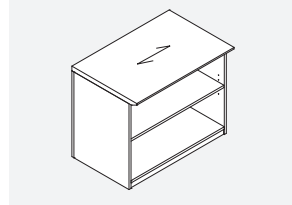

PRODUCT CODE	FINISH OPTIONS			SIZE (INCHES)			WEIGHT LBS	VOL FT <sup>3</sup>
	STANDARD	WOOD	LAMINATE	H	W	D		
DOB3624	1507	1808	1206	29	36	24	121	15
DOB3622	1384	1661	1107	29	36	22	114	13
DOB3024	1318	1582	1054	29	30	24	108	12
DOB3022	1207	1448	966	29	30	22	102	11

- Storage with 1 adj. shelf

**DBx-3x15 • Open Bookcase with Adj. Shelves**

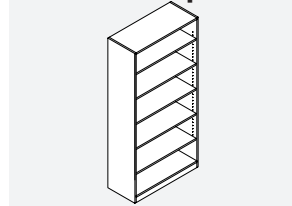

PRODUCT CODE	FINISH OPTIONS			SIZE (INCHES)			WEIGHT LBS	VOL FT <sup>3</sup>
	STANDARD	WOOD	LAMINATE	H	W	D		
DB73615	2270	2724	1816	78	36	15	181	24
DB63615	2096	2515	1677	72	36	15	165	23
DB53615	1927	2312	1542	65	36	15	148	21
DB73015	1987	2384	1590	78	30	15	161	20
DB63015	1834	2201	1467	72	30	15	147	19
DB53015	1687	2024	1350	65	30	15	133	21

- 78" has 6 adj. shelves
- 72" has 5 adj. shelves
- 65" has 4 adj. shelves

**DMAG • Magazine Shelf for use with Open Bookcase**

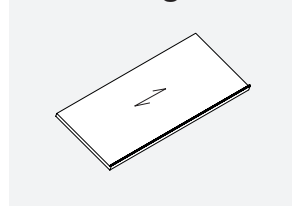

PRODUCT CODE	FINISH OPTIONS			SIZE (INCHES)			WEIGHT LBS	VOL FT <sup>3</sup>
	STANDARD	WOOD	LAMINATE	H	W	D		
DMAG3624		220		1	36	24	26	10
DMAG3622		205		1	36	22	24	10
DMAG3620		182		1	36	20	23	9
DMAG3615		157		1	36	15	20	8
DMAG3024		186		1	30	24	23	9
DMAG3022		173		1	30	22	22	9
DMAG3020		151		1	30	20	21	8
DMAG3015		131		1	30	15	19	8

- Shelf - can be specified for each shelf in an open bookcase

**DBxS-1515 • Square Open Bookcase with Adj. Shelves**

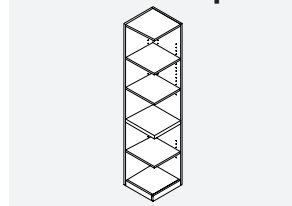

PRODUCT CODE	FINISH OPTIONS			SIZE (INCHES)			WEIGHT LBS	VOL FT <sup>3</sup>
	STANDARD	WOOD	LAMINATE	H	W	D		
DB7S1515	1788	2146	1430	78	16	16	119	10
DB6S1515	1650	1980	1320	72	16	16	110	9
DB5S1515	1520	1824	1216	65	16	16	100	9
DB4S1515	1251	1501	1001	48	16	16	82	6
DB2S1515	1024	1229	819	29	16	16	58	4

- 78" has 6 adj. shelves
- 72" has 5 adj. shelves
- 65" has 4 adj. shelves
- 48" has 3 adj. shelves
- 29" has 1 adj. shelf

## DBxR-1515 • Quarter Round Open Bookcase with Adj. Shelves



PRODUCT CODE	FINISH OPTIONS			SIZE (INCHES)			WEIGHT LBS	VOL FT <sup>3</sup>
	STANDARD	WOOD	LAMINATE	H	W	D		
DB7R1515	1788	2146	1430	78	16	16	119	10
DB6R1515	1650	1980	1320	72	16	16	110	9
DB5R1515	1520	1824	1216	65	16	16	100	9
DB4R1515	1251	1501	1001	48	16	16	82	6
DB2R1515	1024	1229	819	29	16	16	58	4

- 78" has 6 adj. shelves
- 72" has 5 adj. shelves
- 65" has 4 adj. shelves
- 48" has 3 adj. shelves
- 29" has 1 adj. shelf

## DB7R • Quarter Round Open Bookcase with Adj. Shelves

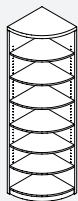

PRODUCT CODE	FINISH OPTIONS			SIZE (INCHES)			WEIGHT LBS	VOL FT <sup>3</sup>
	STANDARD	WOOD	LAMINATE	H	W	D		
DB7R2424H84	3355	4026	2684	84	24	24	201	28
DB7R2424H72	2875	3450	2300	72	24	24	177	28
DB7R2424H65	2637	3164	2110	65	24	24	159	22
DB7R2222H84	3076	3691	2461	84	22	22	180	20
DB7R2222H72	2637	3164	2110	72	22	22	159	20
DB7R2222H65	2300	2760	1840	65	22	22	143	18
DB7R2020H84	2928	3514	2342	84	20	20	160	19
DB7R2020H72	2511	3013	2009	72	20	20	142	17
DB7R2020H65	2300	2760	1840	65	20	20	128	15

- 84" has 6 adj. shelves
- 72" has 5 adj. shelves
- 65" has 4 adj. shelves

## D1 • Storage Cabinet with Doors &amp; Adj. Shelves

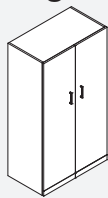

PRODUCT CODE	FINISH OPTIONS			SIZE (INCHES)			WEIGHT LBS	VOL FT <sup>3</sup>
	STANDARD	WOOD	LAMINATE	H	W	D		
D1D22W36H84	4267	5120	3414	84	36	22	279	42
D1D22W36H72	3660	4392	2928	72	36	22	242	33
D1D22W36H65	3354	4025	2683	65	36	22	228	30
D1D22W30H84	3736	4483	2989	84	30	22	246	35
D1D22W30H72	3201	3841	2561	72	30	22	214	28
D1D22W30H65	2936	3523	2349	65	30	22	202	25
D1D22W24H84	3199	3839	2559	84	24	22	214	28
D1D22W24H72	2743	3292	2194	72	24	22	186	24
D1D22W24H65	2519	3023	2015	65	24	22	176	22
D1D20W36H84	4067	4880	3254	84	36	20	265	35
D1D20W36H72	3484	4181	2787	72	36	20	230	30
D1D20W36H65	3196	3835	2557	65	36	20	217	28
D1D20W30H84	3390	4068	2712	84	30	20	234	29
D1D20W30H72	2905	3486	2324	72	30	20	203	25
D1D20W30H65	2662	3194	2130	65	30	20	192	23
D1D20W24H84	2715	3258	2172	84	24	20	203	23
D1D20W24H72	2325	2790	1860	72	24	20	177	20
D1D20W24H65	2130	2556	1704	65	24	20	166	18

- 84" has 5 adj. Shelves
- 72" has 4 adj. Shelves
- 65" has 4 adj. Shelves

**D2 • Wardrobe Cabinet with Doors, Coat Rack and Hat Shelf**

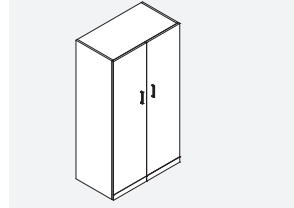

PRODUCT CODE	FINISH OPTIONS			SIZE (INCHES)			WEIGHT LBS	VOL FT <sup>3</sup>
	STANDARD	WOOD	LAMINATE	H	W	D		
D2D22W36H84	3705	4446	2964	84	36	22	225	42
D2D22W36H72	3175	3810	2540	72	36	22	202	33
D2D22W36H65	2911	3493	2329	65	36	22	188	30
D2D22W30H84	3243	3892	2594	84	30	22	202	42
D2D22W30H72	2779	3335	2223	72	30	22	181	33
D2D22W30H65	2548	3058	2038	65	30	22	169	30
D2D22W24H84	2778	3334	2222	84	24	22	178	28
D2D22W24H72	2382	2858	1906	72	24	22	160	24
D2D22W24H65	2182	2618	1746	65	24	22	149	22
D2D20W36H84	3527	4232	2822	84	36	20	216	35
D2D20W36H72	3023	3628	2418	72	36	20	194	30
D2D20W36H65	2771	3325	2217	65	36	20	180	28
D2D20W30H84	2938	3526	2350	84	30	20	193	29
D2D20W30H72	2519	3023	2015	72	30	20	173	25
D2D20W30H65	2312	2774	1850	65	30	20	161	23
D2D20W24H84	2351	2821	1881	84	24	20	170	23
D2D20W24H72	2016	2419	1613	72	24	20	153	20
D2D20W24H65	1849	2219	1479	65	24	20	142	18

**D6 • Storage Cupboard above Lat. File Cabinet with 4 Drawers**

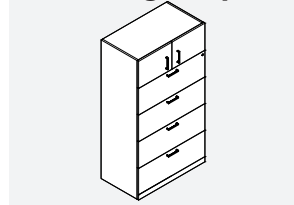

PRODUCT CODE	FINISH OPTIONS			SIZE (INCHES)			WEIGHT LBS	VOL FT <sup>3</sup>
	STANDARD	WOOD	LAMINATE	H	W	D		
D6D22W36H84	6244	7493	4995	84	36	22	289	42
D6D22W36H72	5353	6424	4282	72	36	22	252	33
D6D22W36H65	4904	5885	3923	65	36	22	239	30
D6D22W30H84	5462	6554	4370	84	30	22	247	35
D6D22W30H72	4727	5672	3782	72	30	22	215	28
D6D22W30H65	4303	5164	3442	65	30	22	203	25
D6D20W36H84	5944	7133	4755	84	36	20	280	35
D6D20W36H72	5093	6112	4074	72	36	20	245	30
D6D20W36H65	4670	5604	3736	65	36	20	232	28
D6D20W30H84	4953	5944	3962	84	30	20	239	29
D6D20W30H72	4247	5096	3398	72	30	20	209	25
D6D20W30H65	3896	4675	3117	65	30	20	197	23

• 84" has 1 adj. shelf

**D7 • Open Bookcase with Adj. Shelves**

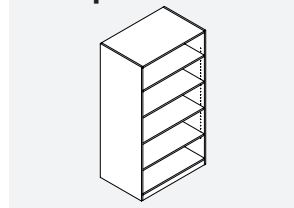

PRODUCT CODE	FINISH OPTIONS			SIZE (INCHES)			WEIGHT LBS	VOL FT <sup>3</sup>
	STANDARD	WOOD	LAMINATE	H	W	D		
D7D20W36H84	3254	3905	2603	84	36	20	214	35
D7D20W36H72	3010	3612	2408	72	36	20	186	30
D7D20W36H65	2791	3349	2233	65	36	20	177	28
D7D20W30H84	2715	3258	2172	84	30	20	191	29
D7D20W30H72	2325	2790	1860	72	30	20	167	25
D7D20W30H65	2132	2558	1706	65	30	20	159	23

- 84" has 6 adj. shelves
- 72" has 5 adj. shelves
- 65" has 4 adj. shelves

## D12 • Open Cabinet with Adj. Shelves above 2 Lat. File Drawers

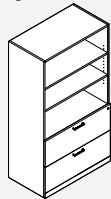

PRODUCT CODE	FINISH OPTIONS			SIZE (INCHES)			WEIGHT LBS	VOL FT <sup>3</sup>
	STANDARD	WOOD	LAMINATE	H	W	D		
D12D22W36H84	4637	5564	3710	84	36	22	250	36
D12D22W36H72	3974	4769	3179	72	36	22	220	33
D12D22W36H65	3643	4372	2914	65	36	22	211	30
D12D22W30H84	4059	4871	3247	84	30	22	226	31
D12D22W30H72	3480	4176	2784	72	30	22	200	28
D12D22W30H65	3188	3826	2550	65	30	22	191	25
D12D20W36H84	4462	5354	3570	84	36	20	238	33
D12D20W36H72	3785	4542	3028	72	36	20	211	30
D12D20W36H65	3468	4162	2774	65	36	20	202	28
D12D20W30H84	3865	4638	3092	84	30	20	215	28
D12D20W30H72	3313	3976	2650	72	30	20	191	25
D12D20W30H65	2894	3473	2315	65	30	20	183	23

- 84" has 3 adj. shelves
- 72" has 2 adj. shelves
- 65" has 2 adj. shelves

## D13 • Storage Cabinet with Doors &amp; Adj. Shelves above 2 Lat. File Drawers

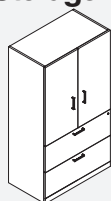

PRODUCT CODE	FINISH OPTIONS			SIZE (INCHES)			WEIGHT LBS	VOL FT <sup>3</sup>
	STANDARD	WOOD	LAMINATE	H	W	D		
D13D22W36H84	5281	6337	4225	84	36	22	284	36
D13D22W36H72	4528	5434	3622	72	36	22	247	33
D13D22W36H65	4150	4980	3320	65	36	22	234	30
D13D22W30H84	4622	5546	3698	84	30	22	254	31
D13D22W30H72	3962	4754	3170	72	30	22	222	28
D13D22W30H65	3632	4358	2906	65	30	22	210	25
D13D20W36H84	5029	6035	4023	84	36	20	272	35
D13D20W36H72	4312	5174	3450	72	36	20	238	30
D13D20W36H65	3955	4746	3164	65	36	20	224	28
D13D20W30H84	4593	5512	3674	84	30	20	244	29
D13D20W30H72	3598	4318	2878	72	30	20	214	25
D13D20W30H65	3293	3952	2634	65	30	20	202	23

- 84" has 3 adj. shelves
- 72" has 2 adj. shelves
- 65" has 2 adj. shelves

## D14 • Storage Cabinet with Doors &amp; Adj. Shelf above 3 Lat. File Drawers

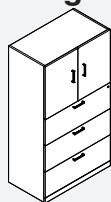

PRODUCT CODE	FINISH OPTIONS			SIZE (INCHES)			WEIGHT LBS	VOL FT <sup>3</sup>
	STANDARD	WOOD	LAMINATE	H	W	D		
D14D22W36H84	5704	6845	4563	84	36	22	287	42
D14D22W36H72	4871	5845	3897	72	36	22	250	33
D14D22W36H65	4465	5358	3572	65	36	22	236	30
D14D22W30H84	4971	5965	3977	84	30	22	258	35
D14D22W30H72	4261	5113	3409	72	30	22	226	28
D14D22W30H65	3905	4686	3124	65	30	22	214	25
D14D20W36H84	5411	6493	4329	84	36	20	276	35
D14D20W36H72	4638	5566	3710	72	36	20	241	30
D14D20W36H65	4250	5100	3400	65	36	20	228	28
D14D20W30H84	4511	5413	3609	84	30	20	249	29
D14D20W30H72	3867	4640	3094	72	30	20	219	25
D14D20W30H65	3544	4253	2835	65	30	20	207	23

- 84" has 2 adj. shelves
- 72" has 1 adj. shelf
- 65" has 1 adj. shelf



**D15-R • Storage Cabinet with Doors & Adj. Shelves above Right Lateral Combination Storage**

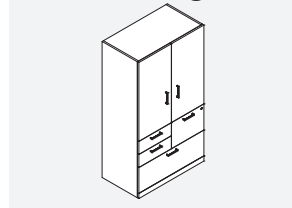

PRODUCT CODE	FINISH OPTIONS			SIZE (INCHES)			WEIGHT LBS	VOL FT <sup>3</sup>
	STANDARD	WOOD	LAMINATE	H	W	D		
D15D22W36H84R	5786	6943	4629	84	36	22	290	38
D15D22W36H72R	4962	5954	3970	72	36	22	253	33
D15D22W36H65R	4546	5455	3637	65	36	22	240	30
D15D20W36H84R	5085	6102	4068	84	36	20	278	35
D15D20W36H72R	4358	5230	3486	72	36	20	244	30
D15D20W36H65R	3994	4793	3195	65	36	20	231	28

- 84" has 3 adj. shelves
- 72" has 2 adj. shelves
- 65" has 2 adj. shelves

**D15-L • Storage Cabinet with Doors & Adj. Shelves above Left Lateral Combination Storage**

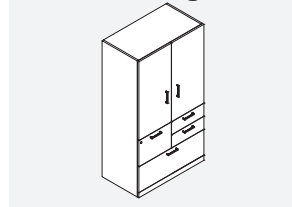

PRODUCT CODE	FINISH OPTIONS			SIZE (INCHES)			WEIGHT LBS	VOL FT <sup>3</sup>
	STANDARD	WOOD	LAMINATE	H	W	D		
D15D22W36H84L	5786	6943	4629	84	36	22	290	38
D15D22W36H72L	4962	5954	3970	72	36	22	253	33
D15D22W36H65L	4546	5455	3637	65	36	22	240	30
D15D20W36H84L	5085	6102	4068	84	36	20	278	35
D15D20W36H72L	4358	5230	3486	72	36	20	244	30
D15D20W36H65L	3994	4793	3195	65	36	20	231	28

- 84" has 3 adj. shelves
- 72" has 2 adj. shelves
- 65" has 2 adj. shelves

**D17-R • Right Storage Cabinet with Doors, Adj. Shelves above FF Drawers**

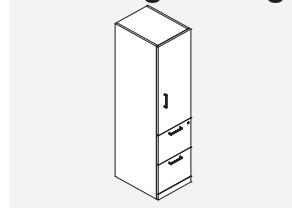

PRODUCT CODE	FINISH OPTIONS			SIZE (INCHES)			WEIGHT LBS	VOL FT <sup>3</sup>
	STANDARD	WOOD	LAMINATE	H	W	D		
D17D22W16H84R	3816	4579	3053	84	15.5	22	179	17
D17D22W16H72R	3180	3816	2544	72	15.5	22	158	15
D17D22W16H65R	2914	3497	2331	65	15.5	22	150	13
D17D20W16H84R	3467	4160	2774	84	15.5	20	171	15
D17D20W16H72R	2890	3468	2312	72	15.5	20	151	13
D17D20W16H65R	2650	3180	2120	65	15.5	20	143	12

- 84" has 3 adj. shelves
- 72" has 2 adj. shelves
- 65" has 2 adj. shelves

**D17-L • Left Storage Cabinet with Doors, Adj. Shelves above FF Drawers**

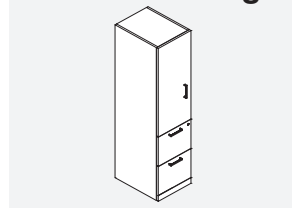

PRODUCT CODE	FINISH OPTIONS			SIZE (INCHES)			WEIGHT LBS	VOL FT <sup>3</sup>
	STANDARD	WOOD	LAMINATE	H	W	D		
D17D22W16H84L	3816	4579	3053	84	15.5	22	179	17
D17D22W16H72L	3180	3816	2544	72	15.5	22	158	15
D17D22W16H65L	2914	3497	2331	65	15.5	22	150	13
D17D20W16H84L	3467	4160	2774	84	15.5	20	171	15
D17D20W16H72L	2890	3468	2312	72	15.5	20	151	13
D17D20W16H65L	2650	3180	2120	65	15.5	20	143	12

- 84" has 3 adj. shelves
- 72" has 2 adj. shelves
- 65" has 2 adj. shelves

## D18-R • Right Storage Cabinet with Door, Adj. Shelves above BBF Drawers

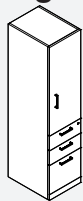

PRODUCT CODE	FINISH OPTIONS			SIZE (INCHES)			WEIGHT LBS	VOL FT <sup>3</sup>
	STANDARD	WOOD	LAMINATE	H	W	D		
D18D22W16H84R	3816	4579	3053	84	15.5	22	178	17
D18D22W16H72R	3180	3816	2544	72	15.5	22	158	15
D18D22W16H65R	2914	3497	2331	65	15.5	22	149	13
D18D20W16H84R	3467	4160	2774	84	15.5	20	170	15
D18D20W16H72R	2890	3468	2312	72	15.5	20	151	13
D18D20W16H65R	2650	3180	2120	65	15.5	20	142	12

- 84" has 3 adj. shelves
- 72" has 2 adj. shelves
- 65" has 2 adj. shelves

## D18-L • Left Storage Cabinet with Door, Adj. Shelves above BBF Drawers



PRODUCT CODE	FINISH OPTIONS			SIZE (INCHES)			WEIGHT LBS	VOL FT <sup>3</sup>
	STANDARD	WOOD	LAMINATE	H	W	D		
D18D22W16H84L	3816	4579	3053	84	15.5	22	178	17
D18D22W16H72L	3180	3816	2544	72	15.5	22	158	15
D18D22W16H65L	2914	3497	2331	65	15.5	22	149	13
D18D20W16H84L	3467	4160	2774	84	15.5	20	170	15
D18D20W16H72L	2890	3468	2312	72	15.5	20	151	13
D18D20W16H65L	2650	3180	2120	65	15.5	20	142	12

- 84" has 3 adj. shelves
- 72" has 2 adj. shelves
- 65" has 2 adj. shelves

## D22 • Open Storage with Adj. Shelves above Storage Cabinet

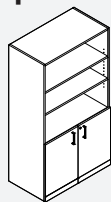

PRODUCT CODE	FINISH OPTIONS			SIZE (INCHES)			WEIGHT LBS	VOL FT <sup>3</sup>
	STANDARD	WOOD	LAMINATE	H	W	D		
D22D22W36H84	3895	4674	3116	84	36	22	231	42
D22D22W36H72	3336	4003	2669	72	36	22	202	33
D22D22W36H65	3055	3666	2444	65	36	22	192	30
D22D22W30H84	3403	4084	2722	84	30	22	207	35
D22D22W30H72	2543	3052	2034	72	30	22	181	28
D22D22W30H65	2673	3208	2138	65	30	22	172	25
D22D20W36H84	3705	4446	2964	84	36	20	218	33
D22D20W36H72	3175	3810	2540	72	36	20	191	30
D22D20W36H65	2911	3493	2329	65	36	20	182	28
D22D20W30H84	3090	3708	2472	84	30	20	195	28
D22D20W30H72	2650	3180	2120	72	30	20	171	25
D22D20W30H65	2427	2912	1942	65	30	20	163	23

- 84" has 4 adj. shelves and 1 LP adj. shelf
- 72" has 3 adj. shelves and 1 LP adj. shelf
- 65" has 3 adj. shelves and 1 LP adj. shelf

**D25 • Cabinet with Doors, Storage with Adj. Shelves on Right & Wardrobe on Left**

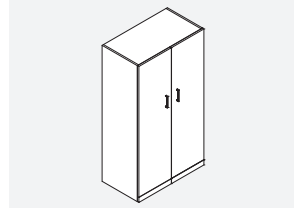

PRODUCT CODE	FINISH OPTIONS			SIZE (INCHES)			WEIGHT LBS	VOL FT <sup>3</sup>
	STANDARD	WOOD	LAMINATE	H	W	D		
D25D22W36H84	4789	5747	3831	84	36	22	245	42
D25D22W36H72	4106	4927	3285	72	36	22	215	33
D25D22W36H65	3763	4516	3010	65	36	22	202	30
D25D22W30H84	4188	5026	3350	84	30	22	219	35
D25D22W30H72	3588	4306	2870	72	30	22	192	28
D25D22W30H65	3291	3949	2633	65	30	22	180	25
D25D22W24H84	3588	4306	2870	84	24	22	192	28
D25D22W24H72	3078	3694	2462	72	24	22	169	24
D25D22W24H65	2820	3384	2256	65	24	22	158	22
D25D20W36H84	4556	5467	3645	84	36	20	234	35
D25D20W36H72	3906	4687	3125	72	36	20	206	30
D25D20W36H65	3583	4300	2866	65	36	20	193	28
D25D20W30H84	3799	4559	3039	84	30	20	208	29
D25D20W30H72	3256	3907	2605	72	30	20	183	25
D25D20W30H65	2984	3581	2387	65	30	20	171	23
D25D20W24H84	3043	3652	2434	84	24	20	182	23
D25D20W24H72	2608	3130	2086	72	24	20	161	20
D25D20W24H65	2391	2869	1913	65	24	20	150	18

- 84" has 5 adj. shelves
- 72" has 4 adj. shelves
- 65" has 4 adj. shelves
- Wardrobe with coat rack & hat shelf

**D26-R • Right Tower Unit with Wardrobe, 3 File Drawers, Open Storage & Adj Shelf**

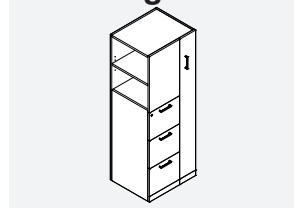

PRODUCT CODE	FINISH OPTIONS			SIZE (INCHES)			WEIGHT LBS	VOL FT <sup>3</sup>
	STANDARD	WOOD	LAMINATE	H	W	D		
D26D22W24H84R	5971	7165	4777	84	24	22	218	24
D26D22W24H72R	5116	6139	4093	72	24	22	194	22
D26D22W24H65R	4692	5630	3754	65	24	22	183	20
D26D20W24H84R	5685	6822	4548	84	24	20	209	22
D26D20W24H72R	4874	5849	3899	72	24	20	186	20
D26D20W24H65R	4468	5362	3574	65	24	20	176	18

- 84" has 2 adj. shelves on left
- 72" has 1 adj. shelf on left
- Wardrobe on right side with coat rack, three file drawers and open bookcase on side

**D26-L • Left Tower Unit with Wardrobe, 3 File Drawers, Open Storage & Adj Shelf**

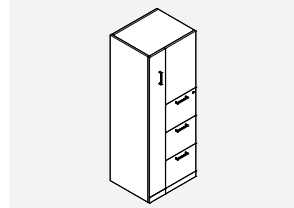

PRODUCT CODE	FINISH OPTIONS			SIZE (INCHES)			WEIGHT LBS	VOL FT <sup>3</sup>
	STANDARD	WOOD	LAMINATE	H	W	D		
D26D22W24H84L	5971	7165	4777	84	24	22	218	24
D26D22W24H72L	5116	6139	4093	72	24	22	194	22
D26D22W24H65L	4692	5630	3754	65	24	22	183	20
D26D20W24H84L	5685	6822	4548	84	24	20	209	22
D26D20W24H72L	4874	5849	3899	72	24	20	186	20
D26D20W24H65L	4468	5362	3574	65	24	20	176	18

- 84" has 2 adj. shelves on right
- 72" has 1 adj. shelf on right
- Wardrobe on left side with coat rack, three file drawers and open bookcase on side

## D27-R • Right Tower Unit with Wardrobe, 3 File Drawers &amp; Storage with Adj. Shelf

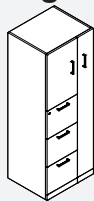

PRODUCT CODE	FINISH OPTIONS			SIZE (INCHES)			WEIGHT LBS	VOL FT <sup>3</sup>
	STANDARD	WOOD	LAMINATE	H	W	D		
D27D22W24H84R	5971	7165	4777	84	24	22	218	24
D27D22W24H72R	5116	6139	4093	72	24	22	194	22
D27D22W24H65R	4692	5630	3754	65	24	22	183	20
D27D20W24H84R	5685	6822	4548	84	24	20	209	22
D27D20W24H72R	4874	5849	3899	72	24	20	186	20
D27D20W24H65R	4468	5362	3574	65	24	20	176	18

- 84" has 2 adj. shelves on left
- 72" has 1 adj. shelf on left
- 65" has 1 adj. shelf on left
- Wardrobe with coat rack and hat shelf

## D27-L • Left Tower Unit with Wardrobe, 3 File Drawers &amp; Storage with Adj. Shelf



PRODUCT CODE	FINISH OPTIONS			SIZE (INCHES)			WEIGHT LBS	VOL FT <sup>3</sup>
	STANDARD	WOOD	LAMINATE	H	W	D		
D27D22W24H84L	5971	7165	4777	84	24	22	218	24
D27D22W24H72L	5116	6139	4093	72	24	22	194	22
D27D22W24H65L	4692	5630	3754	65	24	22	183	20
D27D20W24H84L	5685	6822	4548	84	24	20	209	22
D27D20W24H72L	4874	5849	3899	72	24	20	186	20
D27D20W24H65L	4468	5362	3574	65	24	20	176	18

- 84" has 2 adj. shelves on right
- 72" has 1 adj. shelf on right
- 65" has 1 adj. shelf on right
- Wardrobe with coat rack and hat shelf

## D29-R • Right Tower Unit with Wardrobe, 2 File Drawers &amp; Storage with Adj. Shelves

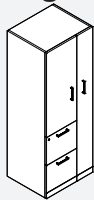

PRODUCT CODE	FINISH OPTIONS			SIZE (INCHES)			WEIGHT LBS	VOL FT <sup>3</sup>
	STANDARD	WOOD	LAMINATE	H	W	D		
D29D22W24H84R	5171	6205	4137	84	24	22	212	24
D29D22W24H72R	4362	5234	3490	72	24	22	188	22
D29D22W24H65R	3958	4750	3166	65	24	22	177	20
D29D20W24H84R	4902	5882	3922	84	24	20	203	22
D29D20W24H72R	4132	4958	3306	72	24	20	180	20
D29D20W24H65R	3748	4498	2998	65	24	20	170	18

- 84" has 2 adj. shelves on left
- 72" has 1 adj. shelf on left
- 65" has 1 adj. shelf on left
- Wardrobe on right side with coat rack, two file drawers, on the other side, a closed door bookcase with one adjustable shelf

## D29-L • Left Tower Unit with Wardrobe, 2 File Drawers &amp; Storage with Adj. Shelves



PRODUCT CODE	FINISH OPTIONS			SIZE (INCHES)			WEIGHT LBS	VOL FT <sup>3</sup>
	STANDARD	WOOD	LAMINATE	H	W	D		
D29D22W24H84L	5171	6205	4137	84	24	22	212	24
D29D22W24H72L	4362	5234	3490	72	24	22	188	22
D29D22W24H65L	3958	4750	3166	65	24	22	177	20
D29D20W24H84L	4902	5882	3922	84	24	20	203	22
D29D20W24H72L	4132	4958	3306	72	24	20	180	20
D29D20W24H65L	3748	4498	2998	65	24	20	170	18

- 84" has 2 adj. shelves on right
- 72" has 1 adj. shelf on right
- 65" has 1 adj. shelf on right
- Wardrobe on left side with coat rack, two file drawers, on the other side, a closed door bookcase with one adjustable shelf

**D30-R • Right Tower Unit with Wardrobe, 2 File Drawers, Open Storage & Adj. Shelves**

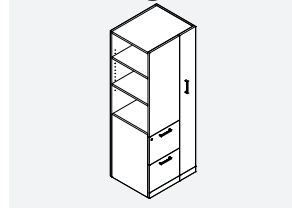

PRODUCT CODE	FINISH OPTIONS			SIZE (INCHES)			WEIGHT LBS	VOL FT <sup>3</sup>
	STANDARD	WOOD	LAMINATE	H	W	D		
D30D22W24H84R	5171	6205	4137	84	24	22	212	24
D30D22W24H72R	4362	5234	3490	72	24	22	188	22
D30D22W24H65R	3958	4750	3166	65	24	22	177	20
D30D20W24H84R	4902	5882	3922	84	24	20	203	22
D30D20W24H72R	4132	4958	3306	72	24	20	180	20
D30D20W24H65R	3748	4498	2998	65	24	20	170	18

- 84" has 2 adj. shelves on left
- 72" has 2 adj. shelves on left
- 65" has 1 adj. shelf on left
- Wardrobe on right side with coat rack, two file drawers and open bookcase on side

**D30-L • Left Tower Unit with Wardrobe, 2 File Drawers, Open Storage & Adj. Shelves**

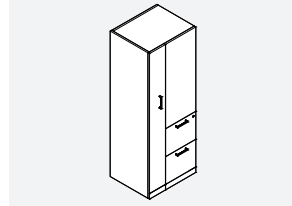

PRODUCT CODE	FINISH OPTIONS			SIZE (INCHES)			WEIGHT LBS	VOL FT <sup>3</sup>
	STANDARD	WOOD	LAMINATE	H	W	D		
D30D22W24H84L	5171	6205	4137	84	24	22	212	24
D30D22W24H72L	4362	5234	3490	72	24	22	188	22
D30D22W24H65L	3958	4750	3166	65	24	22	177	20
D30D20W24H84L	4902	5882	3922	84	24	20	203	22
D30D20W24H72L	4132	4958	3306	72	24	20	180	20
D30D20W24H65L	3748	4498	2998	65	24	20	170	18

- 84" has 2 adj. shelves on right
- 72" has 2 adj. shelves on right
- 65" has 1 adj. shelf on right
- Wardrobe on left side with coat rack, two file drawers and open bookcase on side



**CMP-W • Wood Straight Modesty Panel hanging from Top**

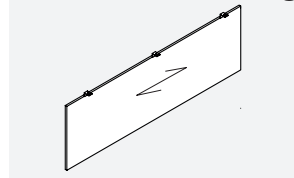

PRODUCT CODE	FINISH OPTION		SIZE (INCHES)			WEIGHT LBS	VOL FT <sup>3</sup>
	WOOD	LAMINATE	H	W	D		
CMP72W	1195	955	18	67		20	1
CMP66W	1156	924	18	61		18	1
CMP60W	1137	910	18	55		16	1
CMP54W	1118	893	18	49		14	1
CMP48W	1101	881	18	43		13	1

**CMP-G • Glass Straight Modesty Panel hanging from Top**

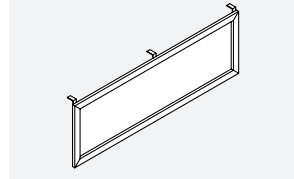

PRODUCT CODE	PRICE	SIZE (INCHES)			WEIGHT LBS	VOL FT <sup>3</sup>
		H	W	D		
CMP72G	2153	18	67		20	1
CMP66G	2034	18	61		18	1
CMP60G	1859	18	55		16	1
CMP54G	1733	18	49		14	1
CMP48G	1653	18	43		13	1

- Aluminum framed glass modesty panel with frosted glass is standard
- For white back painted glass, please contact Customer Service for pricing

**SM • Metal Post Upgrade from SM03**

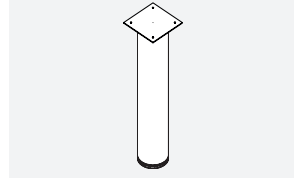

PRODUCT CODE	PRICE	SIZE (INCHES)			WEIGHT LBS	VOL FT <sup>3</sup>
		H	W	D		
SM06	304	28	6			
SM04	100	28	4			
SM03	0	28	3			

**F3 • Metal Flat Plate Base Upgrade from SMO3**

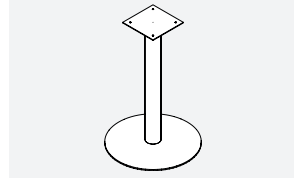

PRODUCT CODE	PRICE	SIZE (INCHES)			WEIGHT LBS	VOL FT <sup>3</sup>
		H	W	D		
F3P18	1038	28	18			

**TE • Wood Elliptical Base with PVC End Caps, Upgrade from SMO3**

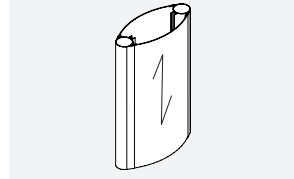

PRODUCT CODE	PRICE	SIZE (INCHES)			WEIGHT LBS	VOL FT <sup>3</sup>
		H	W	D		
TE18	837	28	18	5		

**TEL • Wood Elliptical Base with Aluminum End Caps, Upgrade from SMS4**

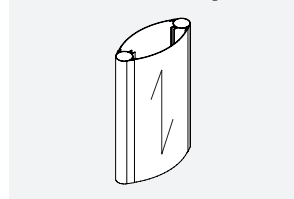

PRODUCT CODE	PRICE	SIZE (INCHES)			WEIGHT LBS	VOL FT <sup>3</sup>
		H	W	D		
TEL18	983	28	18	5	20	2

- Anodized Aluminum end caps

**TE-HPL • HPL Elliptical Base with PVC End Caps, Upgrade from SMS4**

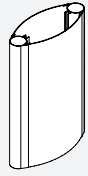

PRODUCT CODE	PRICE	SIZE (INCHES)			WEIGHT LBS	VOL FT3
		H	W	D		
TE18HPL	669	28	18	5	16	2

- Please specify: Black or Tungsten PVC end caps

**TEL-HPL • HPL Elliptical Base with Aluminum End Caps, Upgrade from SMS4**

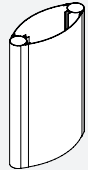

PRODUCT CODE	PRICE	SIZE (INCHES)			WEIGHT LBS	VOL FT3
		H	W	D		
TEL18HPL	788	28	18	5	20	2

- Anodized Aluminum end caps

**TPML • Laminate Rectangular Pedestal Base. Upgrade from SMS4**

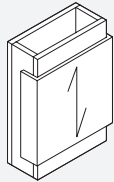

PRODUCT CODE	PRICE	SIZE (INCHES)			WEIGHT LBS	VOL FT3
		H	W	D		
TPML18	889	28	18	5	40	2

- With wood decorative panel

**DTS • Tackboard for 36" High Non Pigeon-Hole Hutches**

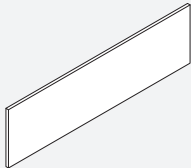

PRODUCT CODE	PRICE	SIZE (INCHES)			WEIGHT LBS	VOL FT3
		H	W	D		
DTS108	1026	20	106	1	23	2
DTS102	971	20	100	1	19	2
DTS96	911	20	94	1	15	1
DTS90	857	20	88	1	15	1
DTS84	802	20	82	1	14	1
DTS78	741	20	76	1	13	1
DTS72	684	20	70	1	12	1
DTS66	626	20	64	1	11	1
DTS60	572	20	58	1	10	1
DTS36	342	20	34	1	6	1
DTS30	284	20	28	1	4	1

- Factory Installed Hutch Tackboard

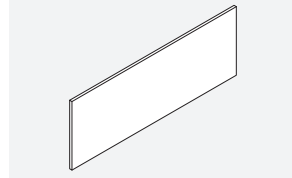

**DTSP-H23 • Tackboard for 42" & 54" High Pigeon-Hole Hutch**

PRODUCT CODE	PRICE	SIZE (INCHES)			WEIGHT LBS	VOL FT3
		H	W	D		
DTSP108H23	1159	23	106	1	30	2
DTSP102H23	1104	23	100	1	24	2
DTSP96H23	1032	23	94	1	20	2
DTSP90H23	968	23	88	1	20	2
DTSP84H23	901	23	82	1	18	2
DTSP78H23	838	23	76	1	17	2
DTSP72H23	777	23	70	1	16	1
DTSP66H23	711	23	64	1	14	1
DTSP60H23	648	23	58	1	13	1
DTSP36H23	386	23	34	1	8	1
DTSP30H23	321	23	28	1	5	1

- Factory Installed Hutch Tackboard

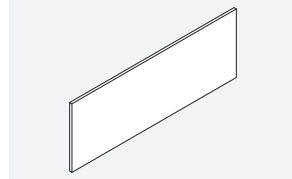
**DTS-H26 • Tackboard for 42" & 54" High Non Pigeon-Hole Hutch**

PRODUCT CODE	PRICE	SIZE (INCHES)			WEIGHT LBS	VOL FT3
		H	W	D		
DTS108H26	1337	26	106	1	30	2
DTS102H26	1261	26	100	1	24	2
DTS96H26	1187	26	94	1	20	2
DTS90H26	1115	26	88	1	20	2
DTS84H26	965	26	82	1	18	2
DTS78H26	816	26	76	1	17	2
DTS72H26	741	26	70	1	16	1
DTS66H26	663	26	64	1	14	1
DTS60H26	515	26	58	1	13	1
DTS36H26	447	26	34	1	8	1
DTS30H26	372	26	28	1	5	1

- Factory Installed Hutch Tackboard

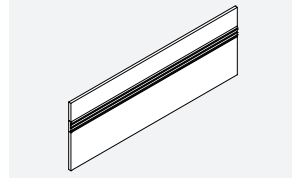
**DTSAS • Tackboard with Rail for 36" High Non Pigeon-Hole Hutch**

PRODUCT CODE	PRICE	SIZE (INCHES)			WEIGHT LBS	VOL FT3
		H	W	D		
DTSAS108	1816	20	106	1	23	2
DTSAS102	1641	20	100	1	19	2
DTSAS96	1617	20	94	1	15	1
DTSAS90	1517	20	88	1	15	1
DTSAS84	1416	20	82	1	14	1
DTSAS78	1312	20	76	1	13	1
DTSAS72	1211	20	70	1	12	1
DTSAS66	1112	20	64	1	11	1
DTSAS60	1011	20	58	1	10	1
DTSAS36	604	20	34	1	6	1
DTSAS30	502	20	28	1	4	1

- Factory Installed Hutch Tackboard
- Please specify the Metal Colour: Black (E), Tungsten (K) or Designer White (DWT)

**DTSPAS-H23 • Tackboard with Rail for 42” and 54” High Pigeon-Hole Hutches**

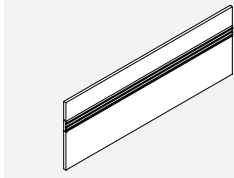

PRODUCT CODE	PRICE	SIZE (INCHES)			WEIGHT LBS	VOL FT3
		H	W	D		
DTSPAS108H23	1976	23	106	1	30	2
DTSPAS102H23	1876	23	100	1	24	2
DTSPAS96H23	1760	23	94	1	20	2
DTSPAS90H23	1649	23	88	1	20	2
DTSPAS84H23	1539	23	82	1	18	2
DTSPAS78H23	1429	23	76	1	17	2
DTSPAS72H23	1318	23	70	1	16	1
DTSPAS66H23	1209	23	64	1	14	1
DTSPAS60H23	1098	23	58	1	13	1
DTSPAS36H23	660	23	34	1	8	1
DTSPAS30H23	552	23	28	1	5	1

- Factory Installed Hutch Tackboard
- Please specify the Metal Colour: Black (E), Tungsten (K) or Designer White (DWT)

**DTSAS-H26 • Tackboard with Rail for 42” & 54” High Non Pigeon-Hole Hutches**

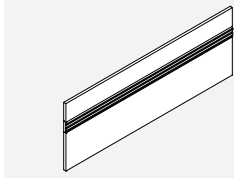

PRODUCT CODE	PRICE	SIZE (INCHES)			WEIGHT LBS	VOL FT3
		H	W	D		
DTSAS108H26	2190	26	106	1	23	2
DTSAS102H26	2063	26	100	1	19	2
DTSAS96H26	1942	26	94	1	15	1
DTSAS90H26	1827	26	88	1	15	1
DTSAS84H26	1682	26	82	1	14	1
DTSAS78H26	1577	26	76	1	13	1
DTSAS72H26	1431	26	70	1	12	1
DTSAS66H26	1337	26	64	1	11	1
DTSAS60H26	1214	26	58	1	10	1
DTSAS36H26	727	26	34	1	6	1
DTSAS30H26	611	26	28	1	4	1

- Factory Installed Hutch Tackboard
- Please specify the Metal Colour: Black (E), Tungsten (K) or Designer White (DWT)

**TS • Tackboard for 65” High Non Pigeon-Hole Wall Mount Cabinets**

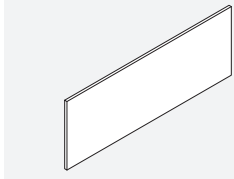

PRODUCT CODE	PRICE	SIZE (INCHES)			WEIGHT LBS	VOL FT3
		H	W	D		
TS108	1178	19.2	108	1	23	2
TS102	1115	19.2	102	1	19	2
TS96	1048	19.2	96	1	17	1
TS90	983	19.2	90	1	15	1
TS84	921	19.2	84	1	14	1
TS78	851	19.2	78	1	13	1
TS72	785	19.2	72	1	12	1
TS66	717	19.2	66	1	11	1
TS60	656	19.2	60	1	10	1
TS54	590	19.2	54	1	10	1
TS48	526	19.2	48	1	10	1
TS42	461	19.2	42	1	10	1
TS36	394	19.2	36	1	8	1
TS30	330	19.2	30	1	5	1

## TSP-H23 • Tackboard for 72" High Pigeon-Hole Wall Mount Cabinets

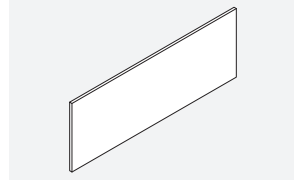

PRODUCT CODE	PRICE	SIZE (INCHES)			WEIGHT LBS	VOL FT <sup>3</sup>
		H	W	D		
TSP108H23	1331	22.3	108	1	30	2
TSP102H23	1267	22.3	102	1	24	2
TSP96H23	1184	22.3	96	1	22	2
TSP90H23	1111	22.3	90	1	20	1
TSP84H23	1035	22.3	84	1	18	1
TSP78H23	965	22.3	78	1	17	1
TSP72H23	892	22.3	72	1	16	1
TSP66H23	815	22.3	66	1	14	1
TSP60H23	765	22.3	60	1	13	1
TSP54H23	743	22.3	54	1	13	1
TSP48H23	590	22.3	48	1	13	1
TSP42H23	520	22.3	42	1	13	1
TSP36H23	444	22.3	36	1	8	1
TSP30H23	369	22.3	30	1	5	1

## TS-H26 • Tackboard for 72" High Non Pigeon-Hole Wall Mount Cabinets

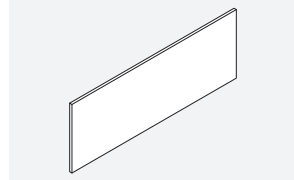

PRODUCT CODE	PRICE	SIZE (INCHES)			WEIGHT LBS	VOL FT <sup>3</sup>
		H	W	D		
TS108H26	1539	26	108	1	30	2
TS102H26	1447	26	102	1	24	2
TS96H26	1365	26	96	1	22	2
TS90H26	1280	26	90	1	20	2
TS84H26	1191	26	84	1	18	2
TS78H26	1107	26	78	1	17	2
TS72H26	1022	26	72	1	16	1
TS66H26	938	26	66	1	14	1
TS60H26	851	26	60	1	13	1
TS54H26	768	26	54	1	13	1
TS48H26	681	26	48	1	13	1
TS42H26	596	26	42	1	13	1
TS36H26	512	26	36	1	8	1
TS30H26	426	26	30	1	5	1

## TSAS • Tackboard with Rail for 65" High Non Pigeon-Hole Wall Mount Cabinets

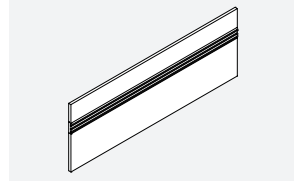

PRODUCT CODE	PRICE	SIZE (INCHES)			WEIGHT LBS	VOL FT <sup>3</sup>
		H	W	D		
TSAS108	2077	19.2	108	1	23	2
TSAS102	1968	19.2	102	1	19	2
TSAS96	1843	19.2	96	1	15	1
TSAS90	1735	19.2	90	1	15	1
TSAS84	1618	19.2	84	1	14	1
TSAS78	1502	19.2	78	1	13	1
TSAS72	1386	19.2	72	1	12	1
TSAS66	1272	19.2	66	1	11	1
TSAS60	1153	19.2	60	1	10	1
TSAS54	1042	19.2	54	1	10	1
TSAS48	927	19.2	48	1	10	1
TSAS42	809	19.2	42	1	10	1
TSAS36	690	19.2	36	1	6	0
TSAS30	535	19.2	30	1	4	0

• Please specify the Metal Colour: Black (E), Tungsten (K) or Designer White (DWT)

**TSPAS-H23 • Tackboard with Rail for 72" High Pigeon-Hole Wall Mount Cabinets**

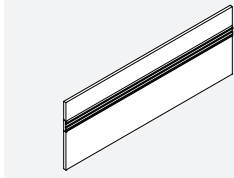

PRODUCT CODE	PRICE	SIZE (INCHES)			WEIGHT LBS	VOL FT3
		H	W	D		
TSPAS108H23	2256	22.3	108	1	30	2
TSPAS102H23	2145	22.3	102	1	24	2
TSPAS96H23	2011	22.3	96	1	20	2
TSPAS90H23	1884	22.3	90	1	20	2
TSPAS84H23	1758	22.3	84	1	18	2
TSPAS78H23	1635	22.3	78	1	17	2
TSPAS72H23	1507	22.3	72	1	16	1
TSPAS66H23	1384	22.3	66	1	14	1
TSPAS60H23	1254	22.3	60	1	13	1
TSPAS54H23	1112	22.3	54	1	13	1
TSPAS48H23	1004	22.3	48	1	13	1
TSPAS42H23	881	22.3	42	1	13	1
TSPAS36H23	757	22.3	36	1	6	1
TSPAS30H23	628	22.3	30	1	4	1

• Please specify the Metal Colour: Black (E), Tungsten (K) or Designer White (DWT)

**TSAS-H26 • Tackboard with Rail for 72" High Non Pigeon-Hole Wall Mount Cabinets**

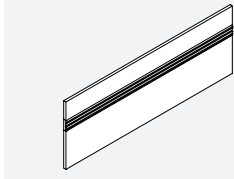

PRODUCT CODE	PRICE	SIZE (INCHES)			WEIGHT LBS	VOL FT3
		H	W	D		
TSAS108H26	2504	26	108	1	23	2
TSAS102H26	2357	26	102	1	19	2
TSAS96H26	2217	26	96	1	15	1
TSAS90H26	2088	26	90	1	15	1
TSAS84H26	1923	26	84	1	14	1
TSAS78H26	1801	26	78	1	13	1
TSAS72H26	1638	26	72	1	12	1
TSAS66H26	1531	26	66	1	11	1
TSAS60H26	1388	26	60	1	10	1
TSAS54H26	1249	26	54	1	10	1
TSAS48H26	1114	26	48	1	10	1
TSAS42H26	977	26	42	1	10	1
TSAS36H26	833	26	36	1	6	0
TSAS30H26	693	26	30	1	4	0

• Please specify the Metal Colour: Black (E), Tungsten (K) or Designer White (DWT)

**BAFS01 • Metal Flip Sorter - Accessory Rail mounted**

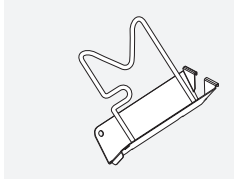

PRODUCT CODE	PRICE	SIZE (INCHES)			WEIGHT LBS	VOL FT3
		H	W	D		
BAFS01	41	9.25	275	9.25	0.6	0.14

• Please specify the Metal Color: Black (E), Tungsten (K) or Designer White (DWT)  
 • Rail mounted Metal Flip Sorter comes with nickel plated wire

**BASS01 • Metal Slant Sorter - Accessory Rail mounted**

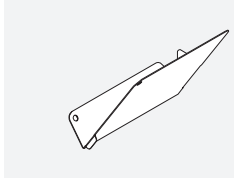

PRODUCT CODE	PRICE	SIZE (INCHES)			WEIGHT LBS	VOL FT3
		H	W	D		
BASS01R	36	9.5	5	10.25	1	0.28
BASS01L	36	9.5	5	10.25	1	0.28

• Please specify the Metal Color: Black (E), Tungsten (K) or Designer White (DWT)

**BABB01 • Metal Binder Bin - Accessory Rail mounted**

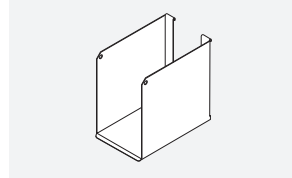

PRODUCT CODE	PRICE	SIZE (INCHES)			WEIGHT LBS	VOL FT <sup>3</sup>
		H	W	D		
BABB01	58	9	4	10.25	1.85	0.21

• Please specify the Metal Color: Black (E), Tungsten (K) or Designer White (DWT)

**BAMB01 • Metal Media Bin - Accessory Rail mounted**

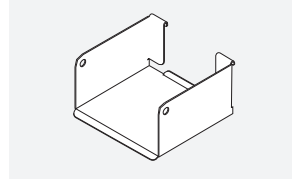

PRODUCT CODE	PRICE	SIZE (INCHES)			WEIGHT LBS	VOL FT <sup>3</sup>
		H	W	D		
BAMB01	43	3	5.75	5.25	0.8	0.05

• Please specify the Metal Color: Black (E), Tungsten (K) or Designer White (DWT)

**BALT01 • Metal Letter Tray - Accessory Rail mounted**

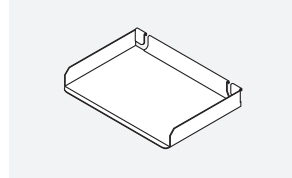

PRODUCT CODE	PRICE	SIZE (INCHES)			WEIGHT LBS	VOL FT <sup>3</sup>
		H	W	D		
BALT01	43	2	13.5	9.25	0.5	0.15
BALT01LGL	58					

• Please specify the Metal Color: Black (E), Tungsten (K) or Designer White (DWT)

**BAUT01 • Metal Utility Tray - Accessory Rail mounted**

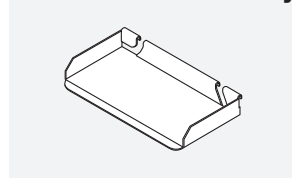

PRODUCT CODE	PRICE	SIZE (INCHES)			WEIGHT LBS	VOL FT <sup>3</sup>
		H	W	D		
BAUT01	33	1	8.5	3.75	0.5	0.02

• Please specify the Metal Color: Black (E), Tungsten (K) or Designer White (DWT)

**BAPP01 • Metal Paper Pocket - Accessory Rail mounted**

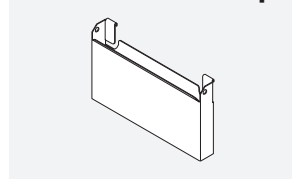

PRODUCT CODE	PRICE	SIZE (INCHES)			WEIGHT LBS	VOL FT <sup>3</sup>
		H	W	D		
BAPP01	72	9	16	2.75	2	0.25

• Please specify the Metal Color: Black (E), Tungsten (K) or Designer White (DWT)

**BATH01 • Telephone Holder - Accessory Rail mounted**

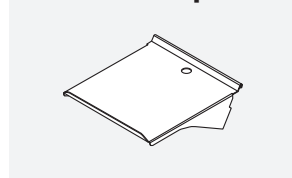

PRODUCT CODE	PRICE	SIZE (INCHES)			WEIGHT LBS	VOL FT <sup>3</sup>
		H	W	D		
BATH01	68	2	9	10	2	0.26

• Please specify the Metal Color: Black (E), Tungsten (K) or Designer White (DWT)

**DCPH16 • Paper Organizer, Legal & Letter Format**

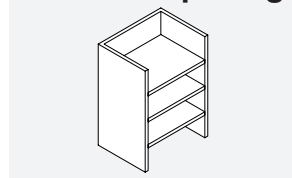

PRODUCT CODE	PRICE	SIZE (INCHES)			WEIGHT LBS	VOL FT <sup>3</sup>
		H	W	D		
DCPH161226	815	27	16	12	20	3
DCPH161223	689	23	16	12	18	3
DCPH161219	524	20	16	12	15	2
DCPH131226	660	27	13	12	16	2
DCPH131223	560	23	13	12	15	2
DCPH131219	422	20	13	12	12	2

• Please specify the Metal Color: Black (E), Tungsten (K) or Designer White (DWT)

**LED • LED Light**

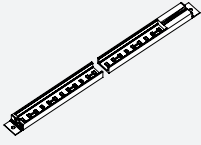

PRODUCT CODE	PRICE	SIZE (INCHES)			WEIGHT LBS	VOL FT3
		H	W	D		
LED48	628	1	48	1	1	1
LED36	509	1	36	1	1	1
LED24	384	1	24	1	1	1

**GM1 • Round Grommet - Plastic**



PRODUCT CODE	PRICE	SIZE (INCHES)			WEIGHT LBS	VOL FT3
		H	W	D		
GM1E (Black)	48		2.4	DIA		
GM1K (Tungsten)	48		2.4	DIA		

**LO • Lock Assembly**

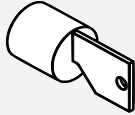

PRODUCT CODE	PRICE	SIZE (INCHES)			WEIGHT LBS	VOL FT3
		H	W	D		
LO (Black)	110		3.5	2		
LO/C (Tungsten)	110		3.5	2		