

Corby Price List

Effective June 2024 Canada















General Information

A

| | |
|------------------------------------|-------------|
| Where to Order / How to Order | A.8 |
| Series Details | A.9 |
| General Installation / Maintenance | A.16 |
| Limited Lifetime Warranty | A.17 |
| Finish Options | A.18 |
| Handle and Edge Options | A.18 |
| Key Alike Form | A.19 |

Tables

B

-  **AR • Peninsula Table**
B.1
-  **ART • Freestanding Work Table**
B.1
-  **ARTC • Freestanding Collaboration Table**
B.1
-  **ARC • Collaboration Media Table**
B.2
-  **ACSFO-GM • Wall Mount Media Storage**
B.2
-  **ACSFO • Wall Mount Open Storage**
B.2
-  **ASPBOX • Riser Box**
B.2
-  **FRC • Foot Rest Cover (Sets)**
B.2
-  **ACMP • 22" H Hanging wood modesty panel**
B.2
-  **CMP • 15" H Hanging wood modesty panel**
B.2
-  **ACT • 13" H Square Occasional Table**
B.3
-  **ACT • 17" H Square Occasional Table**
B.3
-  **ACT • 13" H Rectangular Occasional Table**
B.3



ACT • 17" H Rectangular Occasional Table
B.3



ACTRO-H13 • 13" H Round Occasional Table
B.4



ACTRO-H17 • 17" H Round Occasional Table
B.4



ARO-H29 • 29" H Round Table
B.4

Returns

C



AERL-24CG • Executive Return Left
C.1



AERL-24CG • Executive Return Right
C.1

Bridges

D



A-20T-COPL-CG • Executive Bridge Top Left, 20" Deep
D.1



A-20T-COPR-CG • Executive Bridge Top Right, 20" Deep
D.1



A-24T-COPL-CG • Executive Bridge Top Left, 24" Deep
D.1



A-24T-COPR-CG • Executive Bridge Top Right, 24" Deep
D.1



A-32T-COPL-CG • Executive Bridge Top Left, 32" Deep
D.2



A-32T-COPR-CG • Executive Bridge Top Right, 32" Deep
D.2

Pedestals

E



AP1LB • 20" H Freestanding Pedestal
E.1



AP2LB • 20" H Freestanding Pedestal
E.1



AP3LB • 20" H Freestanding Pedestal
E.1



AP4LB • 20" H Freestanding Pedestal
E.2



AP5LB • 20" H Freestanding Pedestal
E.2



AP1LB32 • 20" H Freestanding Pedestal
E.2



AP2LB32 • 20" H Freestanding Pedestal
E.2



AP3LB32 • 20" H Freestanding Pedestal
E.2



AP4LB32 • 20" H Freestanding Pedestal
E.2



AP5LB32 • 20" H Freestanding Pedestal
E.2



AP6LB • 28" H Freestanding Pedestal
E.3



AP7LB • 28" H Freestanding Pedestal
E.3



AP8LB • 28" H Freestanding Pedestal
E.3



AP9LB • 28" H Freestanding Pedestal
E.3



AP1HB • 28" H Freestanding Pedestal
E.3



AP2HB • 28" H Freestanding Pedestal
E.3



AP3HB • 28" H Freestanding Pedestal
E.3



AP4HB • 28" H Freestanding Pedestal
E.4



AP5HB • 28" H Freestanding Pedestal
E.4



AP1HB32 • 28”H Freestanding Pedestal E.4



AP2HB32 • 28”H Freestanding Pedestal E.4



AP3HB32 • 28”H Freestanding Pedestal E.4



AP4HB32 • 28”H Freestanding Pedestal E.4



AP5HB32 • 28”H Freestanding Pedestal E.4



AP6HB • 35”H Freestanding Pedestal E.5



AP7HB • 35”H Freestanding Pedestal E.5



AP8HB • 35”H Freestanding Pedestal E.5



AP9HB • 35”H Freestanding Pedestal E.5



AC5RLB • 20”H Freestanding Credenza, 64”W F.2



AC6LB • 20”H Freestanding Credenza, 64”W F.2



AC7LB • 20”H Freestanding Credenza, 64”W F.2



AC8LLB • 28”H Freestanding Credenza, 64”W F.3



AC8RLB • 28”H Freestanding Credenza, 64”W F.3



AC9LB • 28”H Freestanding Credenza, 64”W F.3



AC10LLB • 28”H Freestanding Credenza, 64”W F.3



AC10RLB • 28”H Freestanding Credenza, 64”W F.3



AC1LHB • 28”H Freestanding Credenza, 64”W F.3



AC1RHB • 28”H Freestanding Credenza, 64”W F.3



AC7HB • 35”H Freestanding Credenza, 64”W F.5



AC8LHB • 35”H Freestanding Credenza, 64”W F.5



AC8RHB • 35”H Freestanding Credenza, 64”W F.5



AC9HB • 35”H Freestanding Credenza, 64”W F.5



AC10LHB • 35”H Freestanding Credenza, 64”W F.5



AC10RHB • 35”H Freestanding Credenza, 64”W F.5



AC11LB • 20”H Freestanding Credenza, 96”W F.5



AC12LB • 20”H Freestanding Credenza, 96”W F.6



AC13LB • 20”H Freestanding Credenza, 96”W F.6



AC14LB • 20”H Freestanding Credenza, 96”W F.6

Credenzas **F**



AC1LLB • 20”H Freestanding Credenza, 64”W F.1



AC2HB • 28”H Freestanding Credenza, 64”W F.4



AC15LB • 20”H Freestanding Credenza, 96”W F.6



AC1RLB • 20”H Freestanding Credenza, 64”W F.1



AC3HB • 28”H Freestanding Credenza, 64”W F.4



AC16LB • 20”H Freestanding Credenza, 96”W F.6



AC2LB • 20”H Freestanding Credenza, 64”W F.1



AC4LHB • 28”H Freestanding Credenza, 64”W F.4



AC17LB • 20”H Freestanding Credenza, 96”W F.6



AC3LB • 20”H Freestanding Credenza, 64”W F.2



AC4RHB • 28”H Freestanding Credenza, 64”W F.4



AC18LB • 20”H Freestanding Credenza, 96”W F.6



AC4LLB • 20”H Freestanding Credenza, 64”W F.2



AC5LHB • 28”H Freestanding Credenza, 64”W F.4



AC19LB • 20”H Freestanding Credenza, 96”W F.7



AC4RLB • 20”H Freestanding Credenza, 64”W F.2



AC5RHB • 28”H Freestanding Credenza, 64”W F.4



AC20LB • 20”H Freestanding Credenza, 96”W F.7



AC5LLB • 20”H Freestanding Credenza, 64”W F.2



AC6HB • 28”H Freestanding Credenza, 64”W F.4



AC21LB • 20”H Freestanding Credenza, 96”W F.7

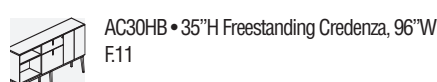
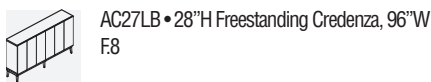

Stack-On Bookcases

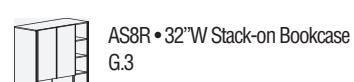
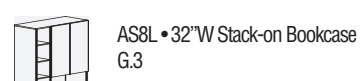
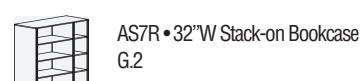
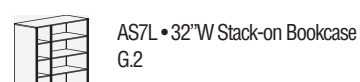
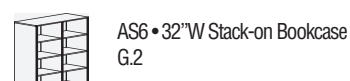
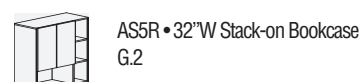
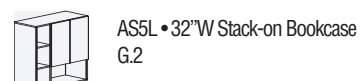
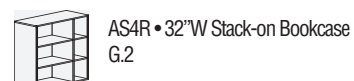
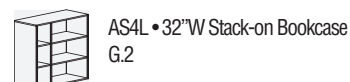
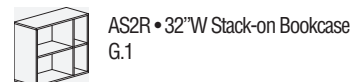
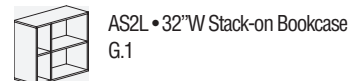
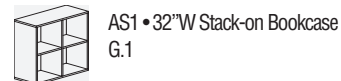



AS11 • 64"W Stack-on Bookcase
G.3



AS12 • 64"W Stack-on Bookcase
G.3



AS13 • 64"W Stack-on Bookcase
G.3



AS14 • 64"W Stack-on Bookcase
G.4



AS15 • 64"W Stack-on Bookcase
G.4



AS16 • 64"W Stack-on Bookcase
G.4



AS17 • 64"W Stack-on Bookcase
G.4



AS18 • 64"W Stack-on Bookcase
G.4



AS19 • 64"W Stack-on Bookcase
G.4



AS20 • 64"W Stack-on Bookcase
G.4



AS21 • 64"W Stack-on Bookcase
G.5



AB4RLB • 32" W Freestanding Bookcase
H.2



AB5LLB • 32" W Freestanding Bookcase
H.2



AB5RLB • 32" W Freestanding Bookcase
H.2



AB6LB • 32" W Freestanding Bookcase
H.2



AB7LLB • 32" W Freestanding Bookcase
H.2



AB7RLB • 32" W Freestanding Bookcase
H.2



AB8LLB • 32" W Freestanding Bookcase
H.3



AB8RLB • 32" W Freestanding Bookcase
H.3



AB1HB • 32" W Freestanding Bookcase
H.3



AB2LHB • 32" W Freestanding Bookcase
H.3



AB2RHB • 32" W Freestanding Bookcase
H.3



AB3HB • 32" W Freestanding Bookcase
H.3



AB4LHB • 32" W Freestanding Bookcase
H.3



AB4RHB • 32" W Freestanding Bookcase
H.4



AB5LHB • 32" W Freestanding Bookcase
H.4



AB5RHB • 32" W Freestanding Bookcase
H.4



AB6HB • 32" W Freestanding Bookcase
H.4



AB7LHB • 32" W Freestanding Bookcase
H.4



AB7RHB • 32" W Freestanding Bookcase
H.4



AB8LHB • 32" W Freestanding Bookcase
H.4



AB8RHB • 32" W Freestanding Bookcase
H.5



AB9LB • 64" W Freestanding Bookcase
H.5



AB10LB • 64" W Freestanding Bookcase
H.5



AB11LB • 64" W Freestanding Bookcase
H.5



AB12LB • 64" W Freestanding Bookcase
H.5



AB13LB • 64" W Freestanding Bookcase
H.5



AB14LB • 64" W Freestanding Bookcase
H.5



AB15LB • 64" W Freestanding Bookcase
H.6



AB16LB • 64" W Freestanding Bookcase
H.6



AB17LB • 64" W Freestanding Bookcase
H.6



AB18LB • 64" W Freestanding Bookcase
H.6



AB19LB • 64" W Freestanding Bookcase
H.6



AB20LB • 64" W Freestanding Bookcase
H.6



ATV1LB • 50" W Freestanding Media Cabinet
H.6

Freestanding Bookcases **H**



AB1LB • 32" W Freestanding Bookcase
H.1



AB2LLB • 32" W Freestanding Bookcase
H.1



AB2RLB • 32" W Freestanding Bookcase
H.1



AB3LB • 32" W Freestanding Bookcase
H.1



AB4LLB • 32" W Freestanding Bookcase
H.2



AB9HB • 64" W Freestanding Bookcase I.7

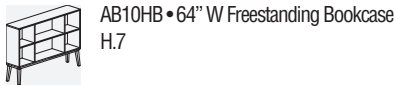

AB10HB • 64" W Freestanding Bookcase H.7

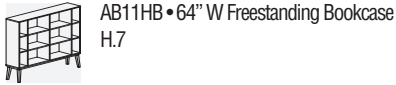

AB11HB • 64" W Freestanding Bookcase H.7

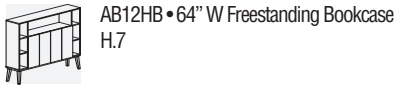

AB12HB • 64" W Freestanding Bookcase H.7

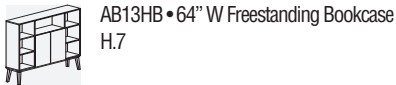

AB13HB • 64" W Freestanding Bookcase H.7

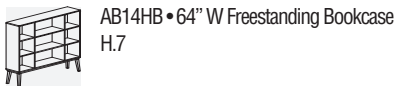

AB14HB • 64" W Freestanding Bookcase H.7

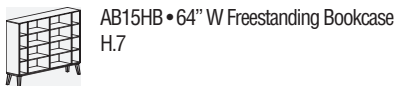

AB15HB • 64" W Freestanding Bookcase H.7

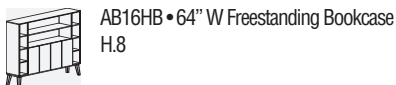

AB16HB • 64" W Freestanding Bookcase H.8

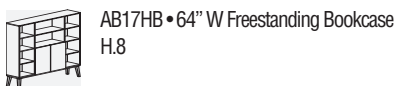

AB17HB • 64" W Freestanding Bookcase H.8

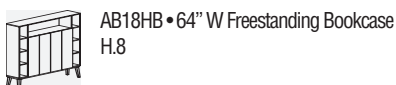

AB18HB • 64" W Freestanding Bookcase H.8

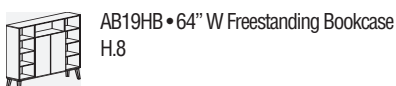

AB19HB • 64" W Freestanding Bookcase H.8

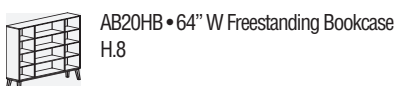

AB20HB • 64" W Freestanding Bookcase H.8

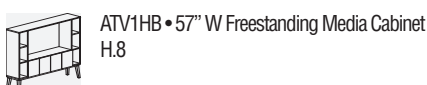

ATV1HB • 57" W Freestanding Media Cabinet H.8



AB25LB • 64" W Freestanding Divider Bookcase I.1



AB26LB • 64" W Freestanding Divider Bookcase I.2



AB27LB • 64" W Freestanding Divider Bookcase I.2



AB28LB • 64" W Freestanding Divider Bookcase I.2



AB29LB • 64" W Freestanding Divider Bookcase I.2



AB22HB • 64" W Freestanding Divider Bookcase I.2



AB23HB • 64" W Freestanding Divider Bookcase I.2



AB24HB • 64" W Freestanding Divider Bookcase I.2



AB25HB • 64" W Freestanding Divider Bookcase I.3



AB26HB • 64" W Freestanding Divider Bookcase I.3



AB27HB • 64" W Freestanding Divider Bookcase I.3



AB28HB • 64" W Freestanding Divider Bookcase I.3



AB29HB • 64" W Freestanding Divider Bookcase I.3

Freestanding Divider Bookcaes



AB22LB • 64" W Freestanding Divider Bookcase I.1



AB23LB • 64" W Freestanding Divider Bookcase I.1



AB24LB • 64" W Freestanding Divider Bookcase I.1

Conference Tables

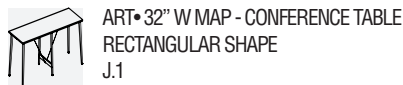

ART • 32" W MAP - CONFERENCE TABLE RECTANGULAR SHAPE J.1

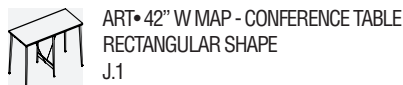

ART • 42" W MAP - CONFERENCE TABLE RECTANGULAR SHAPE J.1

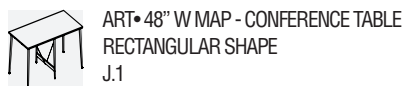

ART • 48" W MAP - CONFERENCE TABLE RECTANGULAR SHAPE J.1

Accessories

K



ASPBOX • Riser box K.1



ACMP • 22" H Hanging wood modesty panel K.1



ACMP • 15" H Hanging wood modesty panel K.1



ACU3214 • Cushion K.1



FVMED + GM1K • Flat screen monitor mount with round grommet K.1



GM5C • Rectangular grommet K.1



DSRTMCS401 • Recessed Power Block, 401 K.1



DSRTMCS421 • Recessed Power Block, 421 K.2



DSRTMCS602 • Recessed Power Block, 602 K.2



DSRTMCS602 • Recessed Power Block, 622 K.2



DSRTMCS642 • Recessed Power Block, 642 K.2



ABLBB • Telcom Plate K.2



ABLBBB • Telcom Plate K.2



ABLABC514 • Telcom Plate K.3



ABLC51L • Telcom Plate K.3



ABLABC45 • Telcom Plate K.3



ABL102102 • Telecom Plate
K.3



BTC003 • Vault Desk Power Grommet
K.3



BRTCS • Wire Management Snake
K.3



C2M • Wire Management Track
K.3



COBAR526 • L Bracket (Sets)
K.4



FRC • Foot Rest Cover (Sets)
K.4



LO/C • Lock Assembly - Tungsten
K.4



LOB/C • Lock Drum with Key - Tungsten
K.4



LOCK/C • Lock Key
K.4



PL89 • Handle
K.4



HOOK400 • Coat Hook
K.4

WHERE TO ORDER / HOW TO USE THIS GUIDE

| | PHONE | FAX |
|-------------------------------------|--------------|--------------|
| Descor Industries, Customer Service | 905-470-0010 | 905-470-6262 |

Price and Product Guide Section: Features the actual product pricing and specification instructions. This section is divided into Tables, Occasional Tables, Pedestals and Storage, Credenzas, Stack-on Bookcases and Storage Cabinets, Freestanding Bookcases and Storage Cabinets.

General Information: Includes subdivision sections of casegoods construction, varnish specification, veneers and wood solids, finishing process, general installation and hardware, maintenance, terms and conditions of sale, warranty and where to order.

ISO 9001: 2015 Registered: The Descor Factory is ISO 9001: 2015 registered for manufacturing procedures and practices of quality and quality control processes.

ISO 14001: 2015 Registered: The Descor Factory is ISO 14001: 2015 registered for environmental procedures and practices.

ANSI/BIFMA Certified: Descor casegoods have passed ANSI/BIFMA standards for product construction and durability.

FSC®: Forest Stewardship Council®. Option available on all wood veneer products by special request.

BIFMA e3: Furniture sustainability level 3.

Greenguard: All Descor Products are Greenguard certified.

Price List Effective: June 2024

HOW TO ORDER A PRODUCT

Creating a correct and complete product number ensures clean orders and accurate information for the factory. Clean orders expedite order entry and factory order scheduling, thereby, saving days, sometimes weeks off potentially extended lead-times.

It is important to indicate the correct option of finishes; wood and LP laminate (backs of Stack-on Units and Freestanding Bookcases)

For All wood finish; please add suffix "/W" at the end of the product code.
For All laminate finish; please add suffix "/P" at the end of the product code.

To view current wood, plastic laminate and fabric offering, please visit www.globalcontract.com.

To order actual wood, plastic laminate and fabric samples and cards, place request with the Global Marketing Department via fax at 416-667-0338 or via e-mail at: literaturecdn@globalfurnituregroup.com

Wood finish samples are individual 3"x 5" chips and can be obtained through the above by request.

EXAMPLE • HOW TO SPECIFY

CODES: The price list uses a product coding system that is specific to each of the units. The product description (next to the code) explains in detail construction of the unit.

SPECIFICATION EXAMPLE OF A 96" FREESTANDING CREDENZA:

PRODUCT CODE: AC17LB, all wood (AC17LB/W) and all laminate (AC17LB/P)

A = Corby Series

C = Credenza

17 = Product ID number (Freestanding Credenza 20H" x 96"W x 20"D)

LB = Low Base (4")

CHOOSE FINISH OPTION:

Standard Finish: Wood & Laminate back (e.g. AC17LB) - Please see page A.18

Laminate Finish: All Laminate (e.g. AC17LB/P) - Please see page A.18

Wood Finish: Wood & Wood back (e.g. AC17LB/W) - Please see page A.18

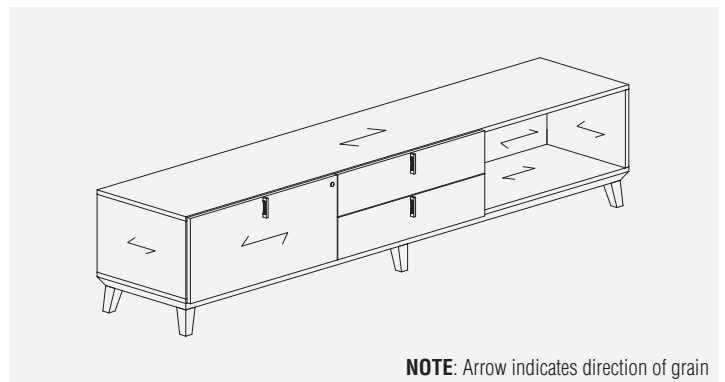

NOTE: Arrow indicates direction of grain

Series Detailing: Corby detailing is new century modern with knife edge on table tops. Solid walnut, cherry, oak and maple that band edge tops 1/8" wide by 3/4" thick for an overall thickness of 1^{3/8}".

Tapered, solid wood legs (walnut, cherry, oak and maple) are used to support the Peninsula, Work, Collaboration and Occasional Tables.

Pedestal, Credenza and Bookcase bottoms include 1^{3/8}" thick painted, bevelled profile and tapered solid wood legs (4"H or 11^{1/2}"H).

Grommets: GM5C (Chrome Finish) is optional on table tops, bridge tops and returns (see Grommet specification details on page A.4 and A.5).

CONSTRUCTION

Finish: Conversion varnish (similar to catalyzed lacquer, but tougher), 25° sheen. Descor does not buff or rub its finishes.

360° Finishing: All Descor wood casegood products are veneered and finished on the back side.

Veneers and Solids: Veneers and solids are Number One select, architectural grade "A" oak, walnut, cherry or maple. All Descor wood worksurface moulded edges are solid oak, walnut, cherry or maple.

Series Handles: All box and lateral drawers have one Vertical Handle PL89 (Chrome Finish) installed. Doors are equipped with touch latch mechanism with no handles (Optional handles available).

Pedestals, Storage Cabinets, Credenzas and Bookcases: All units are elevated 4" (xxLB = Low Base), or 11.5" (xxHB = High Base) off the floor by tapered solid wood legs.

Stack-on Bookcases and Storage Cabinets: Stack-on units are designed to be placed and installed on top of the Credenzas with Low and High Base.

Locking: Front locking is standard on the Pedestals with box/file and file drawers, Credenzas with box/lateral and lateral drawers. Optional locking on doors (Storage units) is available (see Accessories).

Drawer suspensions: Pedestal drawer suspensions are metal ball bearing type. Both box and file drawers are full extension.

Hanging file rails: Are pre-installed on file drawer perimeters. The back rail in a lateral file drawer is designed for both legal and letter size filing.

Drawer construction: Drawer sides and bottoms are maple veneer plywood with dowel construction.

Drawer fronts: The drawer front is an applied element to a four sided drawer. Drawer fronts are veneered on all surfaces. Drawer fronts can be removed or replaced in the field.

Levelling glides: Levellers have a 1" range of adjustment.

VENEERS AND SOLID WOODS

Descor provides high quality veneers and solids for our customers. Sourced from North America with a progressive approach to sustainability, ensures our vendors are protecting and maintaining the natural forests of origin.

Descor lays-up its own flat cut (cathedral pattern) in book matched set and patterns standard on cherry, maple and walnut veneer. Rift cut veneer are laid-up in a slip match method standard on oak veneer.

For additional information on veneer species, cuts and patterns, please contact your Customer Service representative.

DESCOR CONVERSION VARNISH SPECIFICATION

Descor uses conversion varnish: It is among the most durable finishes used in the contract furniture industry (more durable than catalyzed lacquer). Conversion varnish is a synthetic, catalyzed cured (chemically active) finish, containing UV inhibitors to slow the oxidizing (colour changing) effects of ultra-violet rays on wood.

Descor produces low 25° sheen. Low sheens are the most practical for commercial use as it doesn't show most scratches and are more easily touched-up than higher sheens.

Cures with heat, developed two ways:

- Chemically (catalyst reaction within the varnish itself)
- Line oven (approximately 140° F) accelerates finish curing and increases molecular density for a harder finish.

Conversion varnish has a component called "solids", produced by a combination of resins when the solvent evaporates. These solids float to the varnish surface, which is where they cure. These solids are the durable aspect of the finish.

Descor uses an "off-the-gun" technique with conversion varnish. This means the "solids" (the durable aspect of the finish) remain intact on the surface of the finish.

Descor's standard finish on oak and walnut is open pore, on cherry and maple is semi-closed pore. If a full fill finish is required for cherry and maple tops, add the suffix "2" to the finish code and add 5% to the base pricing for each product.

Custom finish is available at an up-charge (See finishes and options section).

GROMMET SPECIFICATION

OPTIONAL GM5C
GROMMET SPECIFICATION



Work and Collaboration Table
For 32" to 42" deep tops

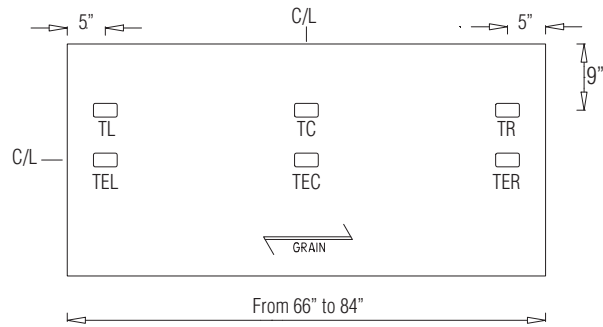

Peninsula Table
For 32" deep tops

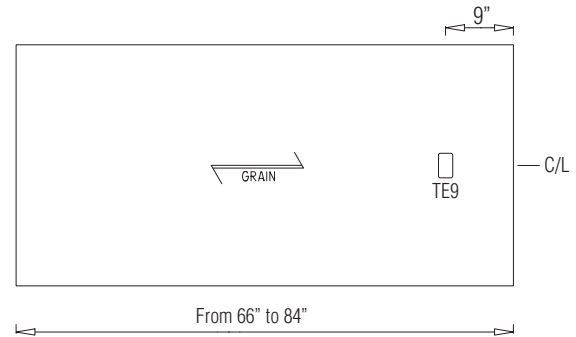

OPTIONAL POWER MANAGEMENT
GROMMET SPECIFICATION

BTC003
Work and Collaboration Tables
For 32" to 42" deep tops

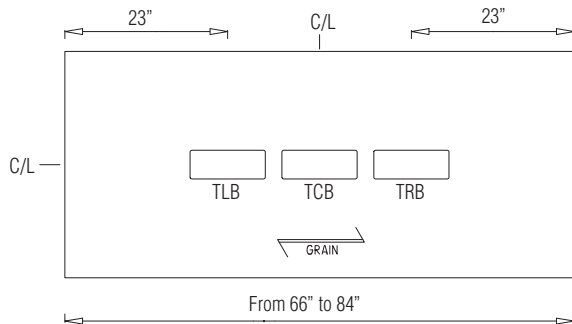
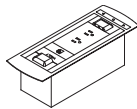

DSRTMCS401
Work and Collaboration Tables
For 32" to 42" deep tops

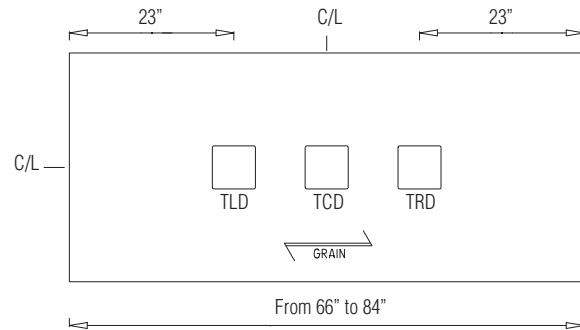

NOTE: For 66" & 72" wide tops, please select one location only.

NOTE: Cutout for each Recessed power block is available at an upcharge \$91.

GM1K
GROMMET SPECIFICATION



Freestanding Media Cabinet

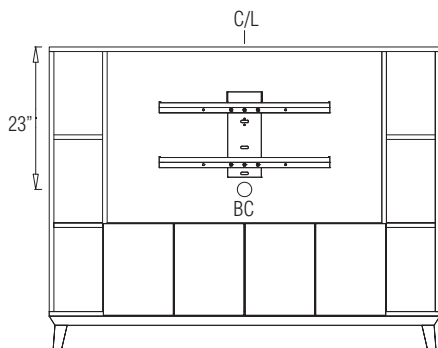

GROMMET SPECIFICATION

OPTIONAL GM5C
GROMMET SPECIFICATION



Executive Bridge Tops - AxxxxT/COPL/CG
From 20" to 32" deep tops

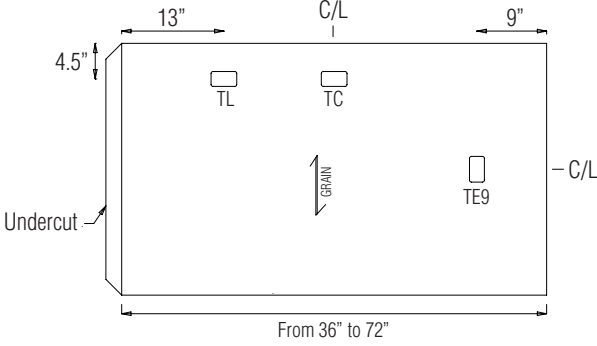

Executive Bridge Tops - AxxxxT/COPR/CG
From 20" to 32" deep tops

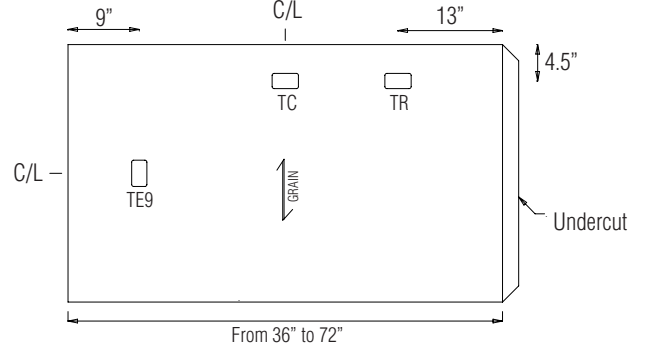

Executive Return Right - AERRxxxxCG
For 24" deep tops

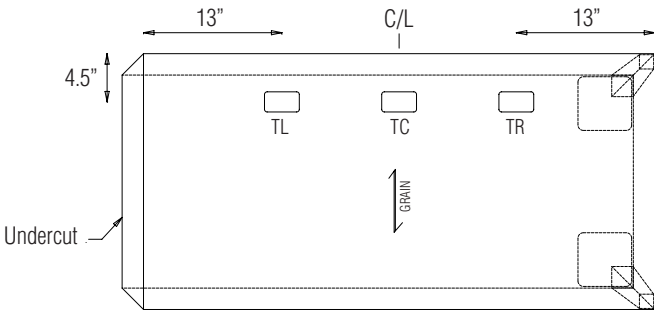

Executive Return Left - AERLxxxxCG
For 24" deep tops

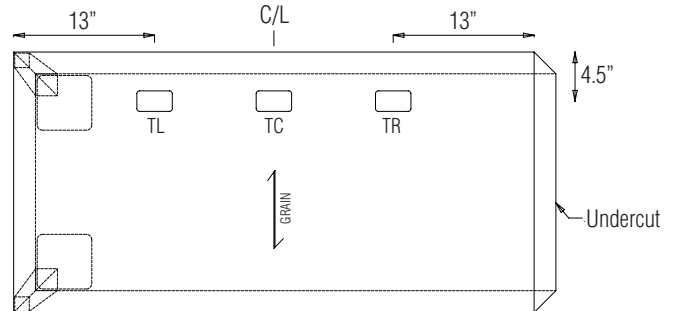

OPTIONAL WIRE MANAGEMENT CUTOUTS (C275)
CREDENZAS ONLY

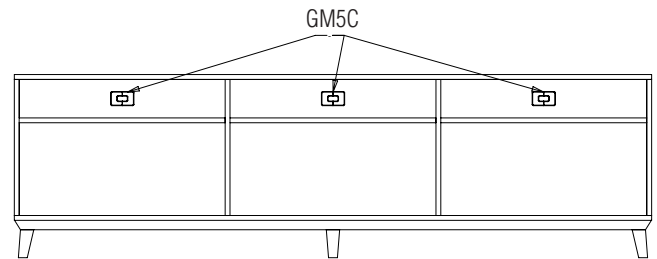
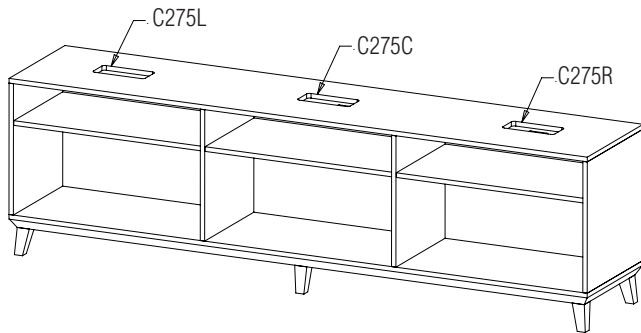

- Wire Management Cutouts available on request only for Credenzas
- To be used with Peninsula table and Executive Bridge Tops having GM5C grommet at TE9 location
- Each cutout is available at an upcharge of \$150. Add suffix "C275x" at the end of the product code. For Eg: AC32LB/C275L or AC32LB/C275C or AC32LB/C275R
- Available only on the open side of the Credenza
- Top panel will have 8" x 4" cutout
- Back panel will have GM5C grommet

MODESTY PANEL OPTIONS

- Wood Modesty Panels are available in 15" and 22" height.
- To be used on Work Tables and on the Peninsula Table with and without the Riser Box.
- Recommended position for installation is 6" inset.

PENINSULA TABLE WITH HIGH BASE PEDESTAL

MODESTY SIZES:

- ACMPW44H15 - 44" x 15" x 0.75"
- ACMPW50H15 - 50" x 15" x 0.75"
- ACMPW56H15 - 56" x 15" x 0.75"
- ACMPW62H15 - 62" x 15" x 0.75"

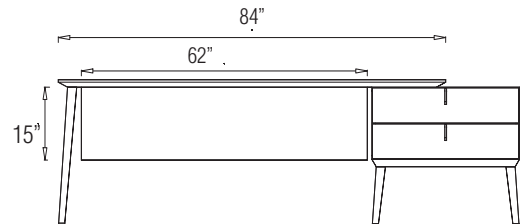
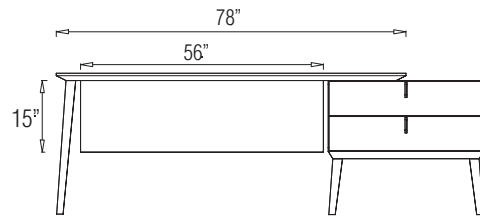
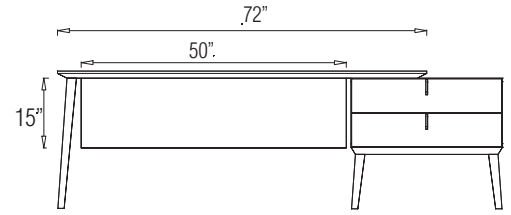
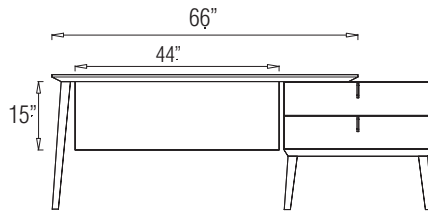

PENINSULA TABLE WITH LOW BASE PEDESTAL

MODESTY SIZES:

- ACMPW44H22 - 44" x 22" x 0.75"
- ACMPW50H22 - 50" x 22" x 0.75"
- ACMPW56H22 - 56" x 22" x 0.75"
- ACMPW62H22 - 62" x 22" x 0.75"

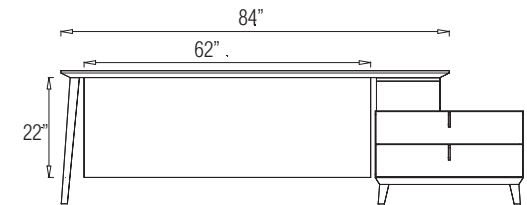
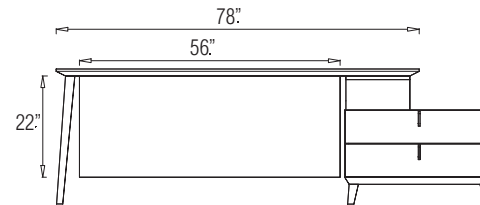
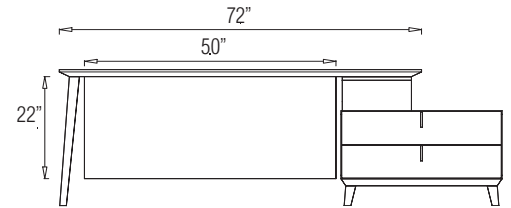
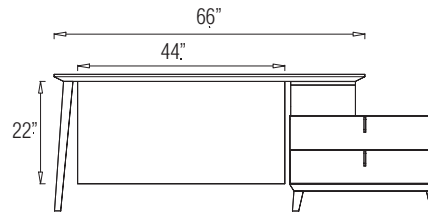

PENINSULA TABLE WITH HIGH BASE CREDENZA

MODESTY SIZES:

- ACMPW38H15 - 38" x 15" x 0.75"
- ACMPW44H15 - 44" x 15" x 0.75"
- ACMPW50H15 - 50" x 15" x 0.75"
- ACMPW56H15 - 56" x 15" x 0.75"

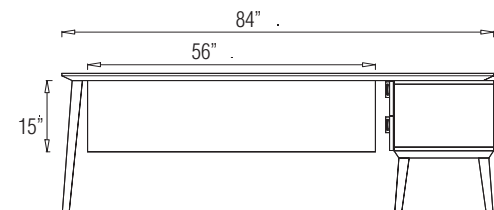
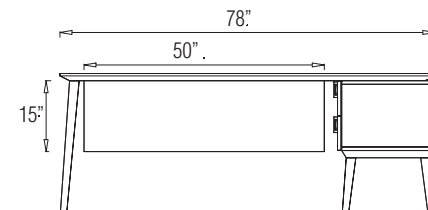
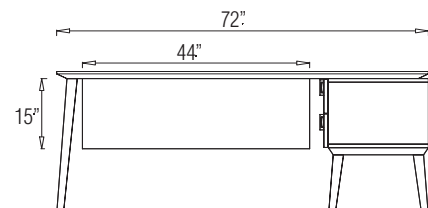
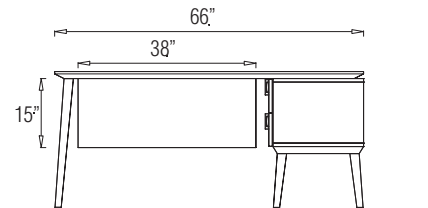

MODESTY PANEL OPTIONS

PENINSULA TABLE WITH LOW BASE CREDENZA

MODESTY SIZES:

ACMPW38H22 - 38" x 22" x 0.75"

ACMPW44H22 - 44" x 22" x 0.75"

ACMPW50H22 - 50" x 22" x 0.75"

ACMPW56H22 - 56" x 22" x 0.75"

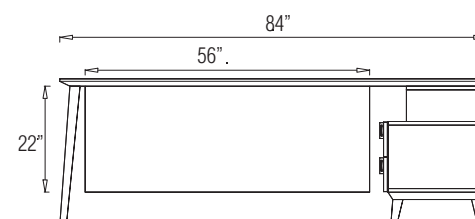
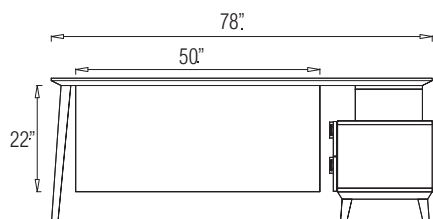
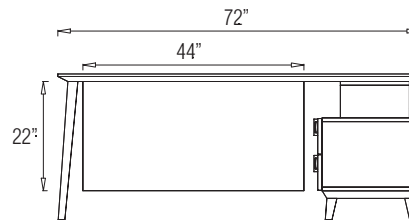
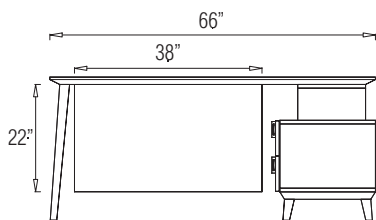

FREESTANDING WORK TABLES & COLLABORATION TABLES

MODESTY SIZES:

ACMPW56H15 - 56" x 15" x 0.75"

ACMPW62H15 - 62" x 15" x 0.75"

ACMPW68H15 - 68" x 15" x 0.75"

ACMPW74H15 - 74" x 15" x 0.75"

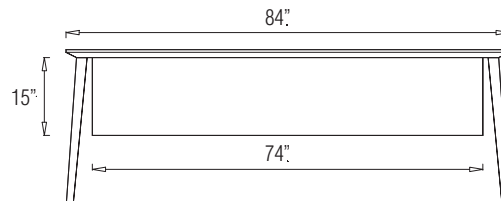
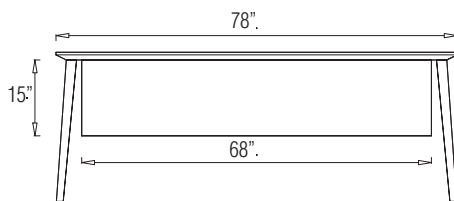
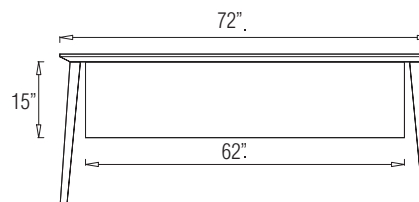
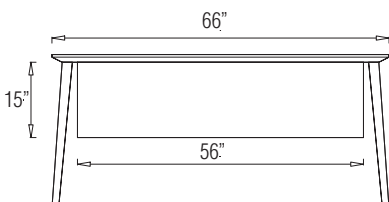

RISER BOX

- Riser Box is to be used as a spacer between the Peninsula Table and 20”H Pedestals and Credenzas.

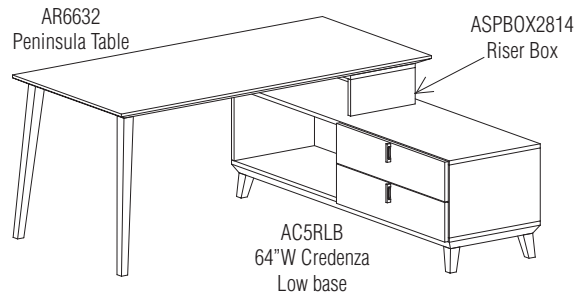
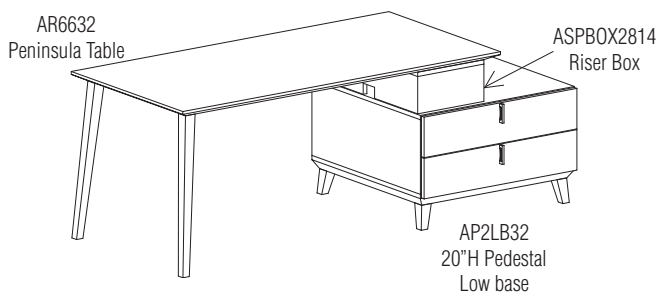

- On Peninsula Table, the Riser Box can be installed as below:

Riser Box opening is on the outside.

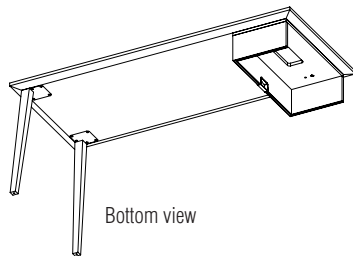

Riser Box opening is on the inside.

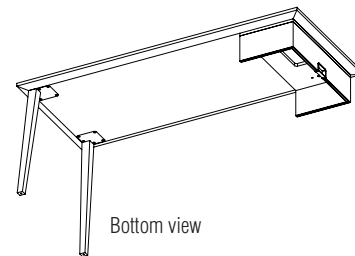

HEIGHT GRID • FLOOR UNITS

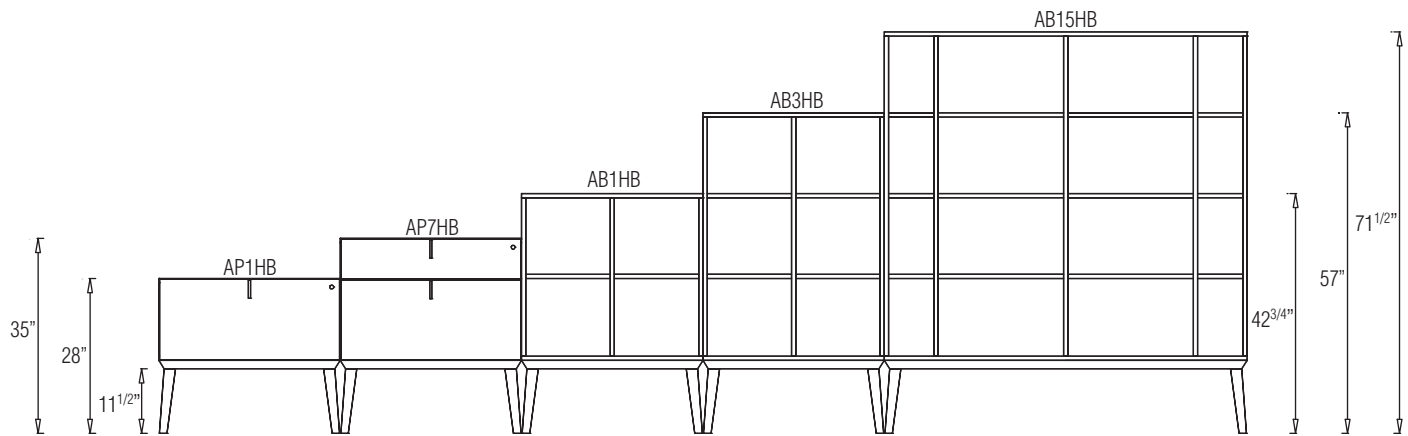
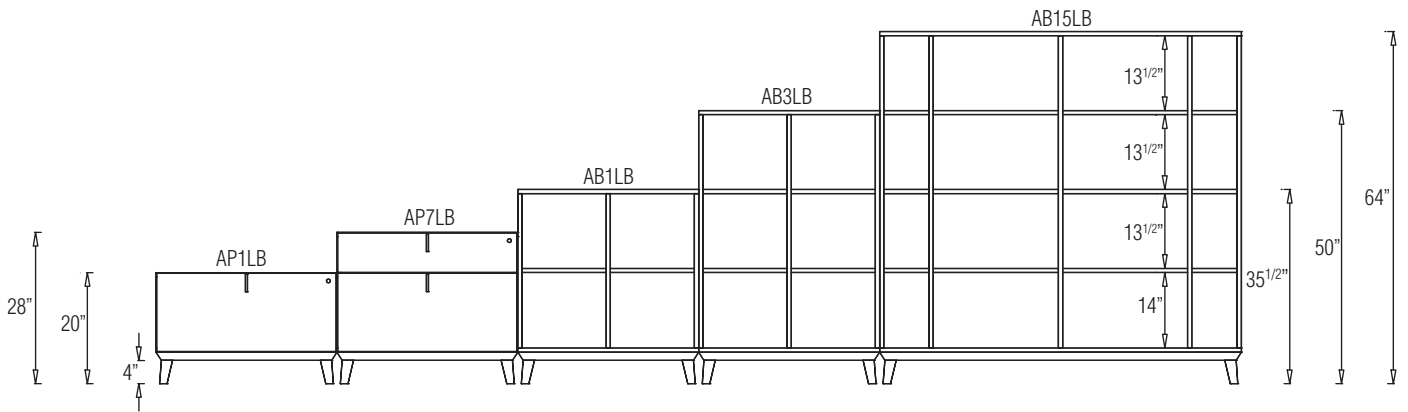

HEIGHT GRID • STACK-ON UNITS

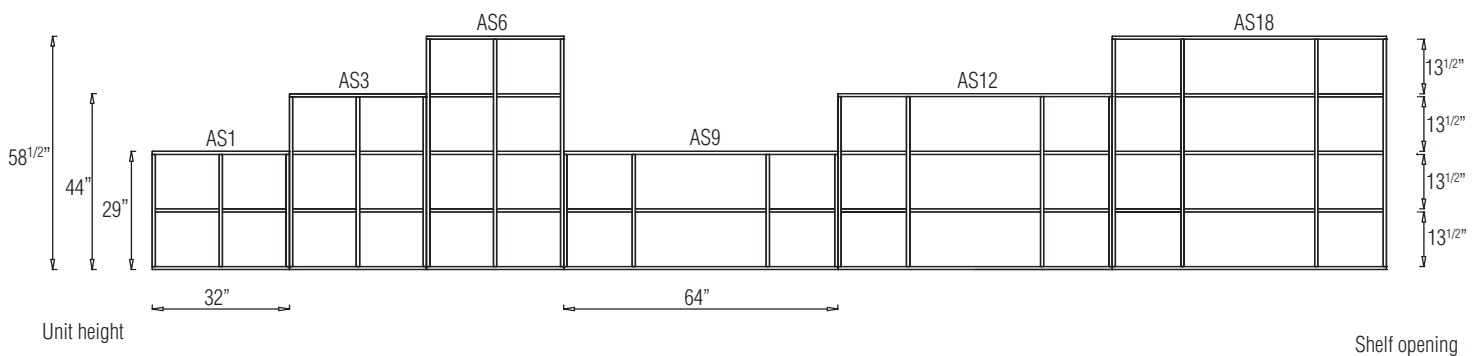

GENERAL INSTALLATION AND HARDWARE

UNCARTONING

Always uncarton wood office furniture with care. Never use a knife or sharp object of any kind to open cartons. Tear cartoning tape off by hand. Protective corner blocks, foam-wrap, and a bottom skid are included in the carton during shipping for protection.

Hardware: All necessary hardware for attaching furniture is included in the shipment.

Hanging file rails: Pre-installed on file drawer perimeters and accommodates both legal and letter size filing.

INSTALLATION

Stack-on: Descor utilizes a non-marring method of Stack-on unit attachment. They are installed with double faced tape applied to the bottom of the unit. The tape is shipped in a plastic bag found in the Stack-on unit. Removal of the Stack-on unit requires moderate pressure to be applied on the top of the unit towards the wall for at least a minute for the pressure sensitive tape to release. At the dealer or installer's discretion, additional support may be added by installing L brackets along the outside back of the attached units. These L brackets are not included in the shipment. Please see Accessories.

Riser Box: Descor utilizes both; mechanical and a non-marring method of Riser Box attachment. Riser Box is installed with double faced tape applied to the bottom of the unit and bolts that secure the unit to the underside of the Peninsula Table. The tape and bolts are shipped in a plastic bag found in the Riser Box.

Freestanding Pedestals: Have four pre-drilled pilot holes [two left (L) / two right (R)] on the inside top surface of the Pedestal top. In order to attach the Freestanding Pedestal 27.5"H (without the Riser Box) to the Peninsula Table the pedestal drawer/file must be removed. Depending on which side the Pedestal will be used, two pilot holes (L or R side) must be drilled through to allow for connection to the Peninsula Table. Assembly bolts are included in a plastic bag fastened inside the pedestal. Disassemble the Pedestals first before relocating the entire unit to avoid damage or bodily injuries.

Levelling wood office furniture properly is the most important procedure to ensure proper functioning and alignment of drawers, locks and doors. Upon completing installation, wipe furniture with a damp cloth, followed by a dry soft cloth.

CARE AND MAINTENANCE GUIDE

Wood Caseworks Care: Descor furniture is constructed to strict specifications to ensure years of satisfied use. As with all wood products, certain care requirements and periodic maintenance are necessary in order to maintain the original new appearance and function.

Finish Protection: All clear wood finishes are susceptible to scratches from rough and abrasive objects, such as staples, paper clips, ceramic coffee mugs, flower pots, picture frames, etc. Computer equipment with rubber feet can also cause discolouration and softening of the finish due to petroleum distillates in the rubber. Glass tops are the ultimate protection against scratch mishaps. The most practical protection is the use of desk-pads or blotters, paper management bins, coasters, common sense caution with rough items, and adding pressure sensitive felt to the feet or bottoms of any potentially destructive item on the Desk.

Finish Care: Wax or polish should never be used on the catalysed finish; they will give a greasy, cloudy or uneven appearance to the product. Descor's conversion varnish finish is best cleaned by wiping the surfaces with a damp cloth, followed by a soft dry cloth in the direction of the grain. If the surfaces are very dirty, use of a glass cleaning type of product is recommended.

Never use a silicon based product to dust or polish catalysed finishes. Over time, silicon may disrupt the actual molecular composition of the finish and cause it to soften and become cloudy.

Additional Tips:

- Remove any spilled liquid immediately with a blotting, rather than a wiping motion.
- Do not drag or push objects or stacks of papers across any finely finished surface.
- Avoid exposing surfaces to extreme heat, cold or humidity.
- The surface finish may be burn resistant, however, the wood underneath the finish is not and can be charred by a burning cigarette or heat producing unit.
- Exposure to strong sunlight should be avoided. The surface finish is fade-proof, however, in spite of UV inhibitors in the finish, the wood underneath may change colour (patina) where extended exposure to sunlight exists. Natural or light finished species are especially susceptible to UV colour change.
- Building maintenance and maintenance service management should be notified of the proper care instructions and procedures for your furniture to avoid damage and allow optimum appearance for years to come.
- Special care should be taken to protect wood furniture when other trades such as painters, electricians and telecommunications workers are present performing work.
- Drawer suspensions are lubricated prior to shipment. Periodic lubrication may be applied to the ball bearing housing with a high quality lubricant found in most hardware stores.
- Drawer alignment is achieved with proper levelling of desks and credenzas.
- Check levelling glides for adjustment if the furniture is moved.
- Modular furniture items, such as Peninsula Tables and Pedestals must be disassembled prior to moving or relocating to avoid damage to the furniture.
- Touch-up of wood furniture should only be attempted by a qualified re-finisher touch-up technician. Contact your furniture dealer if this need should arise.

DESCOR LIMITED LIFETIME WARRANTY

Descor will, at no cost to the original purchaser and for as long as the original purchaser owns a Descor product repair or replace with a comparable product, at Descor's option, any part or product sold after January 01, 2001, which fails as a result of a defect in its design, materials or workmanship. For all purposes of this warranty, the term "purchaser" is defined as the entity or individual acquiring a new Descor product as the initial purchase thereof either from Descor or an authorized Descor dealer.

Exceptions to this warranty include:

- Descor warrants wood casegoods products to be free from defects in materials and workmanship for a period of ten years, of single shift service, from the date of delivery.
- Lighting products and grommets are warranted for one year from date of delivery.
- Custom electrical solutions may carry varying warranty coverage.
- Descor fabrics and wood veneers are warranted for five years from the date of delivery.
- Electrical components are warranted for one year from the date of delivery.
- Moving parts, which include, glides, slides, casters, user adjustable worksurface mechanism are warranted for five years from date of delivery.
- Descor warrants its products based on a single shift (40 hours/week). Usage beyond a single shift (40 hours/week) will result in a reduction in the warranty, in proportion to the increased usage.
- Pneumatic cylinders for any product, unless otherwise stated, are warranted for ten years of single shift (40 hours/week) usage, from date of delivery.

This warranty does not include:

- Customers Own Material (COM) or finishes applied to Descor products (which include graded in fabrics that are treated as Customers Own Material).
- Wood Veneer being a natural material will have shade differences between veneer leaves. This will be more apparent between flitches. Fading on wood veneers can be caused by exposure to UV rays / sunlight.
- Wood colour, grain and stain acceptance, which may occur due to the natural elements of wood.
- Ballasts and light bulbs.
- Products which have been modified or which have not been installed or used according to Descor's application and installation guidelines or warnings.
- Products that must be replaced due to normal wear and tear, negligence, abuse, accidents or shipping damage.
- Products used for rental purposes.

In no event shall Descor be liable in either tort or contract for any loss or direct, special, incidental, consequential, or exemplary damages.

This warranty is the customer's sole remedy for product defect. Descor makes no warranties, including the express or implied warranties of merchantability and fitness purpose, other than the express warranties contain herein.

TERMS AND CONDITIONS OF SALE

Prices: Prices are subject to change without notice. All shipments are F.O.B. the plant unless otherwise indicated. All taxes are extra.

Terms: Merchandise shall be invoiced when shipped and payment is due 30 days after invoice date.

Orders: All orders are subject to acceptance by Descor head office and to the Terms of Sale which appear in current price lists.

Returns: Merchandise may not be returned without prior written consent. Upon approval, a minimum restocking charge of 35% shall be deducted from the credit note, in addition to any expense incurred should reconditioning be necessary. Return shipping must be prepaid.

Cancellations: All orders are considered firm and not subject to cancellation without our documented approval. Cancellation charges may be required based on expenses incurred during order processing.

Carriers: All shipments shall normally be made through the Buyer's specified carrier. Otherwise Descor shall use its best judgment in selecting a carrier. Prepay and Add Service Charge to cover cost of processing prepaid freight bills, a charge of \$30.00 per shipment will be made. This amount will be included in the "Freight Charges" invoiced by Descor.

Liability: Every effort is employed to effect secure packing for shipment. Descor's liability ends when the carrier issues a clear receipt, acknowledging automatically that the shipment has been received in good condition.

Claims: It is required that all merchandise be carefully examined by recipient before issuance of clear receipt to carrier. Should the shipment arrive unsound or incomplete, have carrier make proper notation on the delivery receipt and original freight bill as to discrepancy before accepting shipment. Any claim for damage or shortage must be filed by you with the delivering carrier. Descor will not accept return of merchandise damaged in transit.

Changes and Cancellations: Descor reserves the right to institute changes with regard to materials, equipment, specification and designs, as well as to discontinue models at any time without prior notice. After the date of Descor's acknowledgement of a Purchaser's order, the order may not be changed or cancelled by Purchaser without the written consent of Descor. Special order items already in production are not subject to change or cancellation under any circumstances. Other standard items already in production are subject to a minimum 35% restocking charge, based on list price. A higher percentage may apply, depending on the stage of production.

Finishes: Descor veneers and solid woods are carefully selected for color, tone and grain. Since the distinctive characteristics and nature of wood cause variations, exact matches are not always possible.

Shipping Weight: All shipping weights and cubic sizes as indicated are approximate.

Dimensions: are approximate. Please contact Descor for specific dimensions required.

FINISHES

Corby finishes can be specified three ways:

- 1- All veneer with solid hardwood legs choose from specification option # 1.
- 2- Veneer with laminate storage backs and solid hardwood legs.
 - A- Choose veneer finish option from specification option # 1.
 - B- Choose cabinet Back Solid Colour Option from specification option # 2.
- 3- All Laminate with painted hardwood legs and matching cabinet back.
 - A- Choose Laminate finish option from specification option # 3
 - B- Choose Solid hardwood legs colour from specification option # 2.
 (LP) Low pressure laminate will be used on all chassis, fronts and doors.
 (HP) High pressure laminate will be used on all tops.

Doors, fronts and user side of all tops will be edgebanded with 3mm PVC edge, all remaining parts/edges will have a standard 0.5mm PVC edge.

Specification option # 2

SOLID COLOUR ON HARDWOOD LEGS

| Finish Code | Colour | |
|-------------|-----------------------|--------------|
| BLK | Black | Solid Colour |
| BZD | Blizzard | Solid Colour |
| CGY | Custom Grey | Solid Colour |
| DWT | Designer White | Solid Colour |
| HGT | Hayden Grey | Solid Colour |
| MSM | Moss | Solid Colour |
| SEM | Sienna | Solid Colour |
| SPM | Spice | Solid Colour |
| SRM | Surf | Solid Colour |
| SDT | Stonedust | Solid Colour |
| SOG | Storm Grey (Charcoal) | Solid Colour |
| STG | String (Nevada) | Solid Colour |

**Specification option # 1
STANDARD FINISHES**

| Finish Code | Colour | Veneer Type | Veneer Cut |
|-------------|--------------------|-------------|------------|
| BTW | Biscotti | White Oak | Rift |
| JAW | Java | White Oak | Rift |
| MCW | Mocha | White Oak | Rift |
| CRW | Coral | White Oak | Rift |
| EVW | Evening Oak | White Oak | Rift |
| MTW | Milestone | White Oak | Rift |
| CAW | Cacao Walnut | Walnut | Flat |
| DWW | Dark Walnut | Walnut | Flat |
| EWV | Empress Walnut | Walnut | Flat |
| LTW | Latte Walnut | Walnut | Flat |
| MHW | Mahogany on Walnut | Walnut | Flat |
| WLW | Walnut | Walnut | Flat |
| NLW | Natural Walnut | Walnut | Flat |
| ULW | Umber Walnut | Walnut | Flat |
| ACW | Amber Cherry | Cherry | Flat |
| DCW | Dark Cherry | Cherry | Flat |
| RCW | Red Cherry | Cherry | Flat |
| WCW | Windsor Cherry | Cherry | Flat |
| AMW | Almond Cherry | Cherry | Flat |
| VNW | Vintage Cherry | Cherry | Flat |
| HAW | Hazelnut | Maple | Flat |
| MPW | Maple | Maple | Flat |
| SMW | Sugar Maple | Maple | Flat |
| WMW | White Maple | Maple | Flat |
| OYW | Oyster Maple | Maple | Flat |
| SHW | Sahara Maple | Maple | Flat |

Specification option # 3

ALL LAMINATE FINISHES (LP) Chassis, Fronts, Doors and (HP) Top

| Top Code | Chassis, Fronts, Doors Code | Colour |
|----------|-----------------------------|-----------------------|
| ACJ | ACJ | Absolute Acajou* |
| ASN | ASN | Asian Night* |
| BLK | BLK | Black |
| BZD | BZD | Blizzard |
| CGY | CGY | Custom Grey |
| CMB | CMB | Clear Maple* |
| DES | DES | Dark Espresso* |
| DWT | DWT | Designer White |
| FAS | FAS | Fashionista* |
| FCL | FCL | First Class* |
| HGT | HGT | Hayden Grey |
| NBL | NBL | Noce Biondo* |
| NEL | NEL | Noce Leggero* |
| NGL | NGL | Noce Grigio* |
| NML | NML | Noce Medio* |
| SBY | SBY | Sheer Beauty* |
| SDT | SDT | Stonedust |
| SOG | SOG | Storm Grey (Charcoal) |
| STG | STG | String (Nevada) |
| WCR | WCR | Winter Cherry* |
| WHC | WHC | White Chocolate* |
| WHE | WHE | Walnut Heights* |

Laminate Colour with * is Wood Grain Laminate

HANDLE

PL89 Chrome Finish



EDGE

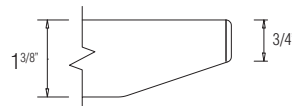

CUSHION FABRICS • GRADE 2

Cushions are standard in Global Upholstery Grade 2 - seating fabrics. Please refer to the following website for the current offering:

<https://www.globalfurnituregroup.com/ca/resources/textiles>

SUITE 1

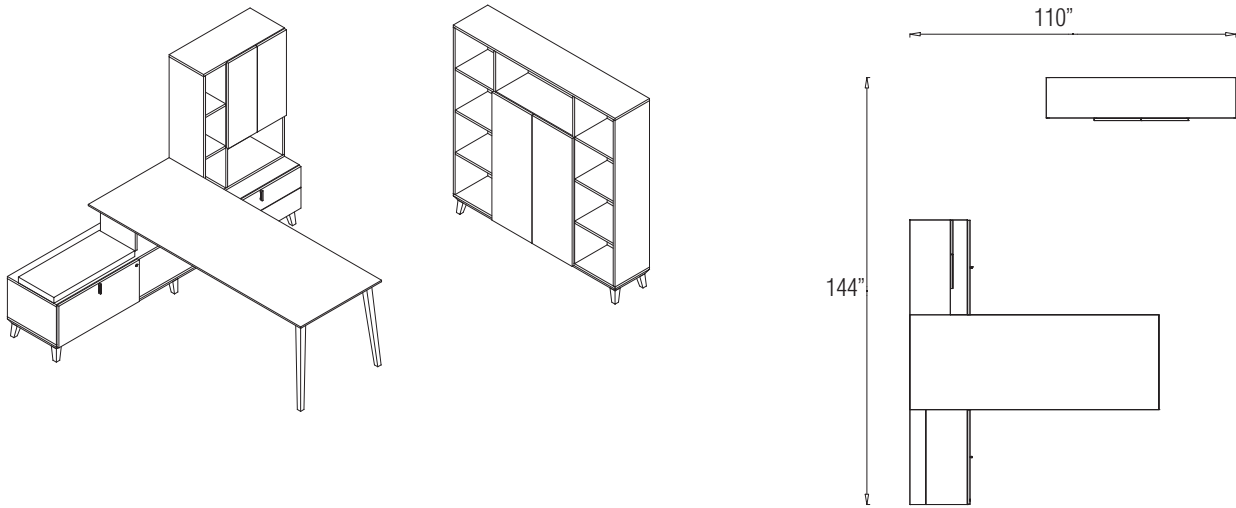

| QUANTITY | CODE | DESCRIPTION | STANDARD | LAMINATE | ALL WOOD |
|--------------|------------|---|-----------------|-----------------|-----------------|
| 1 | AC19LB | 20"H Freestanding Credenza, 96"W | 6131 | 4905 | 6131 |
| 1 | AS5L | Three High Stack-on Bookcase with asymmetrical openings | 2962 | 2370 | 3364 |
| 1 | AB19LB | 64"W Freestanding Four High Bookcase | 6881 | 5505 | 7284 |
| 1 | ASPBOX2814 | Riser Box for 20"H storage | 284 | 226 | 284 |
| 1 | AR8432 | Peninsula table with two legs | 2717 | 2176 | 2717 |
| 1 | ACU3214 | Cushion | 879 | 879 | 879 |
| TOTAL | | | \$19,846 | \$16,054 | \$20,650 |

SUITE 2

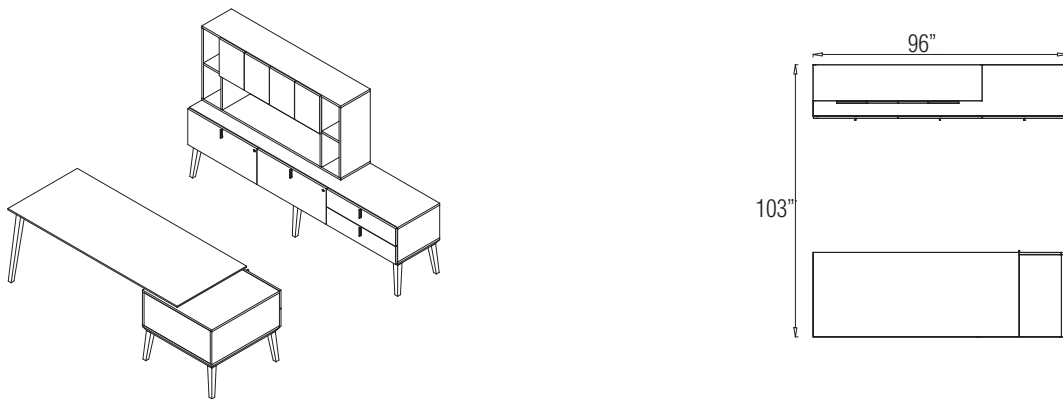

| QUANTITY | CODE | DESCRIPTION | STANDARD | LAMINATE | ALL WOOD |
|--------------|---------|---|-----------------|-----------------|-----------------|
| 1 | AP2HB32 | 28"H Freestanding Pedestal with two box drawers | 2584 | 2067 | 2584 |
| 1 | AC14HB | 28"H Freestanding Credenza, 96"W | 6694 | 5355 | 6694 |
| 1 | AS10 | Two high Stack-on Bookcase | 3760 | 3008 | 4162 |
| 1 | AR7832 | Peninsula table with two legs | 2584 | 2067 | 2584 |
| TOTAL | | | \$15,618 | \$12,495 | \$16,020 |

SUITE 3

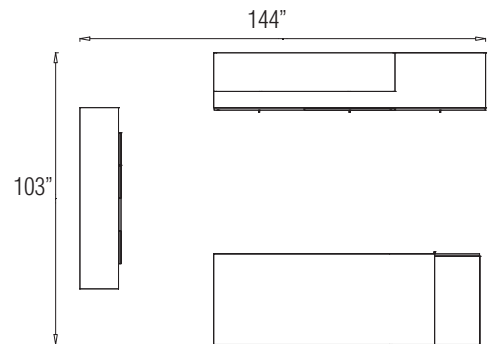
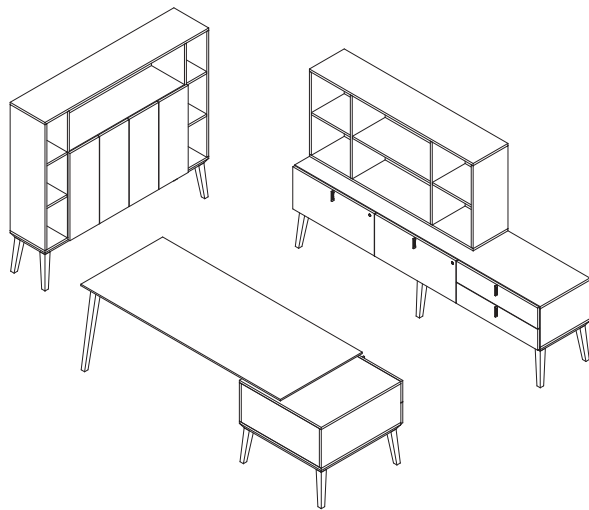

| QUANTITY | CODE | DESCRIPTION | STANDARD | LAMINATE | ALL WOOD |
|----------|---------|---|-----------------|-----------------|-----------------|
| 1 | AB12HB | 57"H Freestanding Three High Bookcase | 6504 | 5202 | 6905 |
| 1 | AR7832 | Peninsula table with two legs | 2584 | 2067 | 2584 |
| 1 | AP2HB32 | 28"H Freestanding Pedestal with two Box Drawers | 2584 | 2067 | 2584 |
| 1 | AS9 | Two-High Stack-on Bookcase | 3178 | 2544 | 3581 |
| 1 | AC14HB | 28"H Freestanding Credenza, 96"W | 6694 | 5355 | 6694 |
| | | TOTAL | \$21,535 | \$17,231 | \$22,339 |

SUITE 4

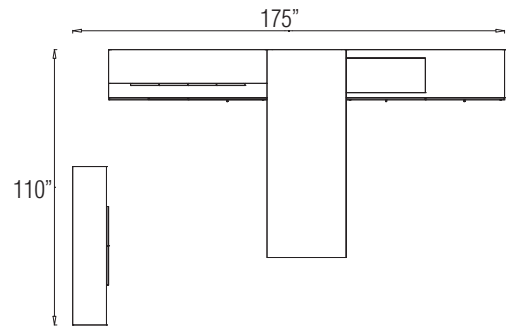
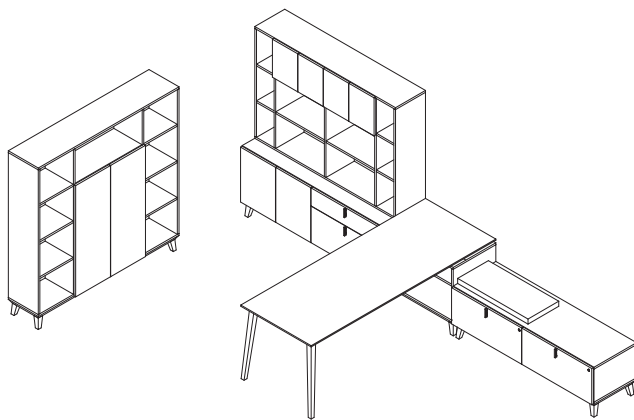

| QUANTITY | CODE | DESCRIPTION | STANDARD | LAMINATE | ALL WOOD |
|----------|---------|--------------------------------------|-----------------|-----------------|-----------------|
| 1 | AB19LB | 64"H Freestanding Four High Bookcase | 6881 | 5505 | 7284 |
| 1 | AR8432 | Peninsula table with two legs | 2717 | 2176 | 2717 |
| 1 | AC31LB | 28"H Freestanding Credenza, 96"W | 5906 | 4726 | 5906 |
| 1 | AS14 | Three High Stack-on Bookcase | 5354 | 4283 | 5756 |
| 1 | AC3LB | 20"H Freestanding Credenza, 64"W | 4312 | 3451 | 4312 |
| 1 | ACU3214 | Cushion | 879 | 879 | 879 |
| | | TOTAL | \$26,043 | \$21,012 | \$26,446 |

SUITE 5

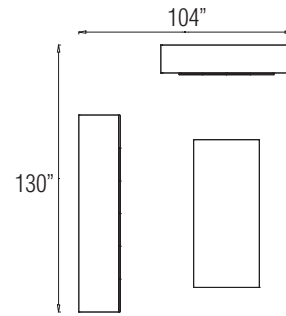
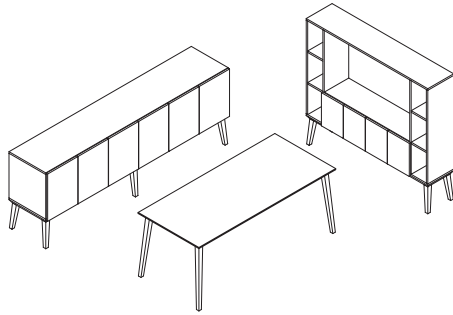

| QUANTITY | CODE | DESCRIPTION | STANDARD | LAMINATE | ALL WOOD |
|--------------|---------|--|-----------------|-----------------|-----------------|
| 1 | AC27HB | 35"H Freestanding Storage Credenza, 96"W | 6354 | 5084 | 6354 |
| 1 | ATV1HB | 57"H Freestanding Media Cabinet | 6165 | 4932 | 6567 |
| 1 | ART7232 | Freestanding work table with four legs | 3408 | 2728 | 3408 |
| TOTAL | | | \$15,924 | \$12,738 | \$16,326 |

SUITE 6

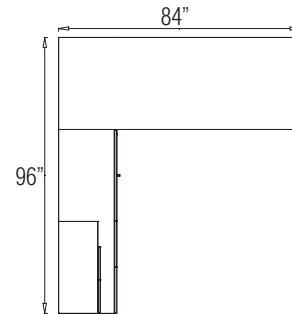
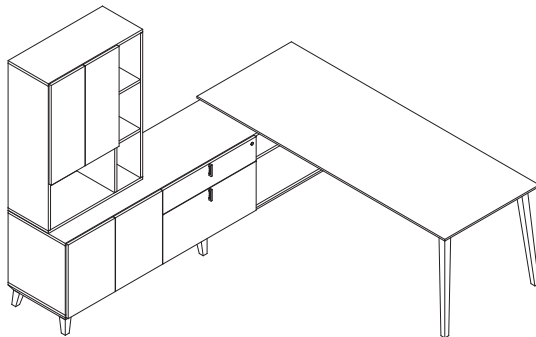

| QUANTITY | CODE | DESCRIPTION | STANDARD | LAMINATE | ALL WOOD |
|--------------|--------|---|-----------------|----------------|-----------------|
| 1 | AS5R | Three High Stack-on Bookcase with asymmetrical openings | 2962 | 2370 | 3364 |
| 1 | AC31LB | 28"H Freestanding Credenza, 96"W | 5906 | 4726 | 5906 |
| 1 | AR8432 | Peninsula table with two legs | 2717 | 2176 | 2717 |
| TOTAL | | | \$11,586 | \$9,269 | \$11,987 |

SUITE 7

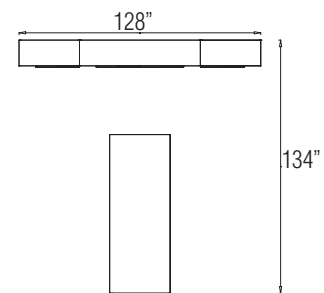
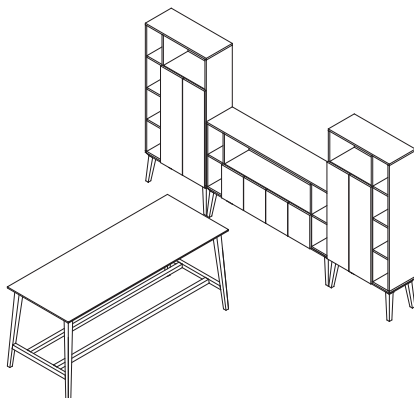

| QUANTITY | CODE | DESCRIPTION | STANDARD | LAMINATE | ALL WOOD |
|--------------|----------|---|-----------------|-----------------|-----------------|
| 1 | AB7LHB | 72"H Freestanding Four High Bookcase with asymmetrical openings | 4826 | 3861 | 5229 |
| 1 | AB9HB | 42"H Freestanding Two High Bookcase | 4569 | 3656 | 4971 |
| 1 | AB7RHB | 72"H Freestanding Four High Bookcase with asymmetrical openings | 4826 | 3861 | 5229 |
| 1 | ARTC8432 | Freestanding Collaboration Table with four legs and foot rests | 4609 | 3688 | 4609 |
| TOTAL | | | \$18,828 | \$15,062 | \$20,035 |

SUITE 8

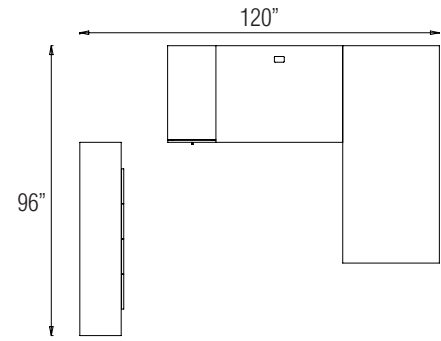
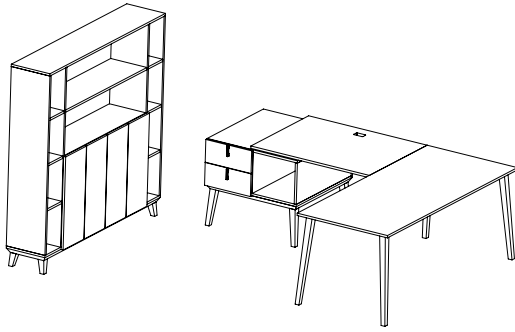

| QUANTITY | CODE | DESCRIPTION | STANDARD | LAMINATE | ALL WOOD |
|--------------|----------------|--|-----------------|-----------------|-----------------|
| 1 | AB16LB | 64"W Freestanding Bookcase | 7611 | 6089 | 8013 |
| 1 | ART7232 | Freestanding Work Table | 3408 | 2728 | 3408 |
| 1 | AP4HB32 | 28"H Freestanding Pedestal | 2447 | 1958 | 2447 |
| 1 | A4232T-COPR-CG | Executive Bridge Top, Undercut on right edge | 1082 | 865 | 1082 |
| TOTAL | | | \$14,546 | \$11,637 | \$14,947 |

SUITE 9

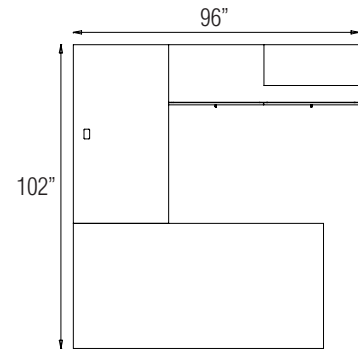
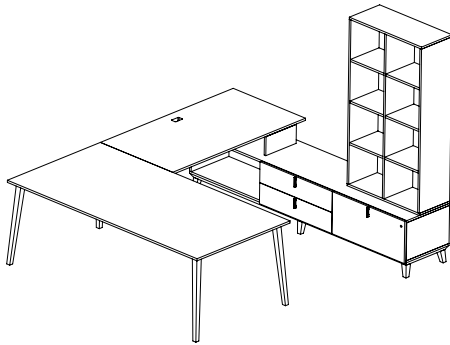

| QUANTITY | CODE | DESCRIPTION | STANDARD | LAMINATE | ALL WOOD |
|--------------|----------------|--|-----------------|-----------------|-----------------|
| 1 | ART8442 | Freestanding Work Table | 4218 | 3375 | 4218 |
| 1 | A6032T-COPL-CG | Executive Bridge Top, Undercut on Left | 1540 | 1234 | 1540 |
| 1 | ASPBOX2814 | Riserbox | 284 | 226 | 284 |
| 1 | AC16LB | 20"H Freestanding Credenza | 5988 | 4793 | 5988 |
| 1 | AS6 | 32"W Stackon Bookcase | 3316 | 2653 | 3718 |
| TOTAL | | | \$15,340 | \$12,274 | \$15,744 |

SUITE 10

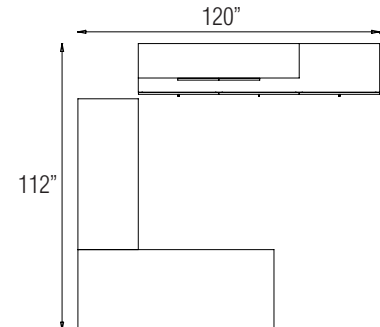
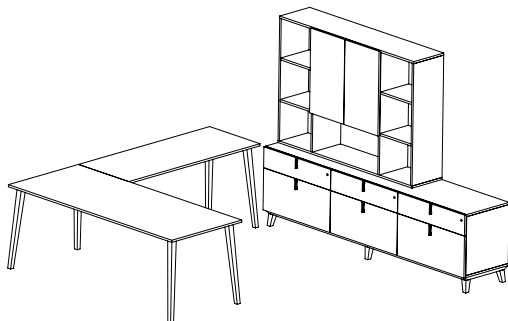

| QUANTITY | CODE | DESCRIPTION | STANDARD | LAMINATE | ALL WOOD |
|--------------|------------|----------------------------|-----------------|-----------------|-----------------|
| 1 | ART7832 | Freestanding Work Table | 3530 | 2824 | 3530 |
| 1 | AERR6024CG | Executive Return Right | 1939 | 1553 | 1939 |
| 1 | AC24LB | 96"W Freestanding Credenza | 7071 | 5657 | 7071 |
| 1 | AS17 | 64"W Stackon Bookcase | 5042 | 4034 | 5445 |
| TOTAL | | | \$17,578 | \$14,064 | \$17,981 |

SUITE 11

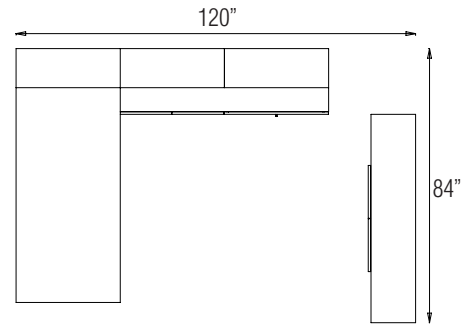
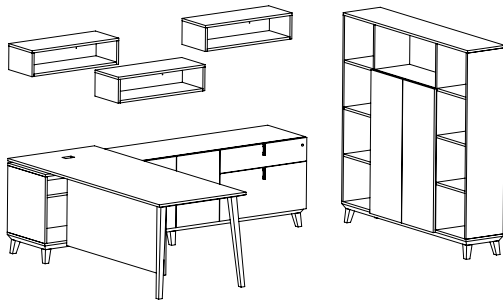

| QUANTITY | CODE | DESCRIPTION | STANDARD | LAMINATE | ALL WOOD |
|--------------|----------------|--|-----------------|-----------------|-----------------|
| 1 | AR7832/GM5CTE9 | Peninsula Table with GM5C grommet | 2669 | 2137 | 2669 |
| 1 | ACMPW50H22 | 22"H Modesty Panel | 677 | 542 | 677 |
| 1 | AC28LB/C275L | 96"W Freestanding Credenza with Wire Management Cutout on Left | 6118 | 4894 | 6118 |
| 1 | AB19LB | 64"W Freestanding Bookcase | 6881 | 5505 | 7284 |
| 3 | ACSF032D12H8 | Wall Mount Open Storage, Stand Alone Unit | 3416 | 2733 | 3416 |
| TOTAL | | | \$19,755 | \$15,802 | \$20,157 |

COLLABORATION MEDIA TABLE (ARC-32) AND WALL MOUNT MEDIA STORAGE (ACSF0-GM)

32" Wide, Wall Mount Media Storage

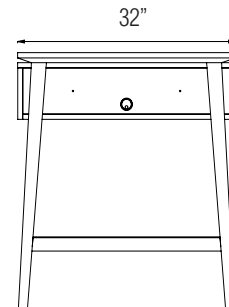
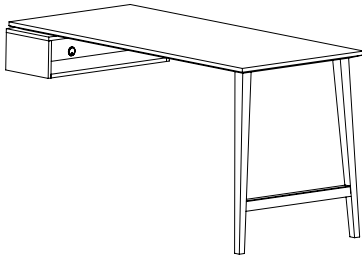

64" Wide, Wall Mount Media Storage

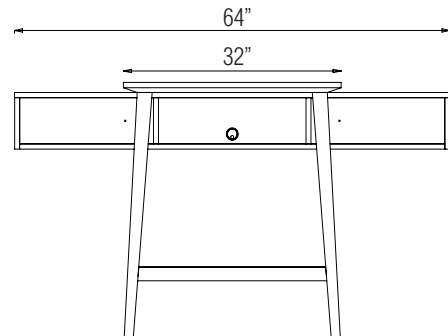
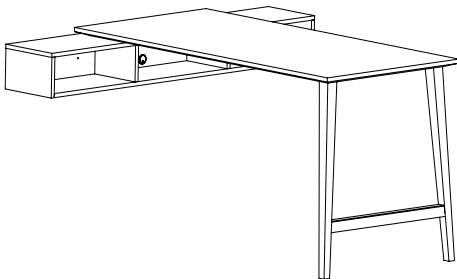

96" Wide, Wall Mount Media Storage

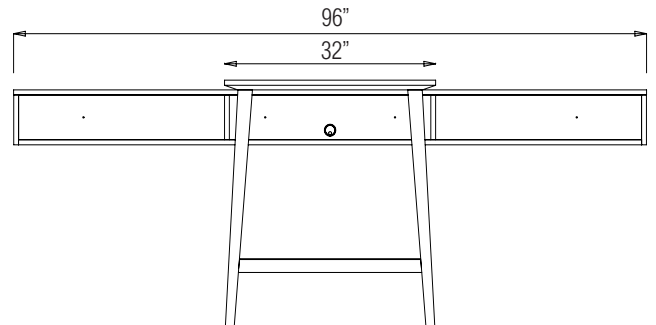
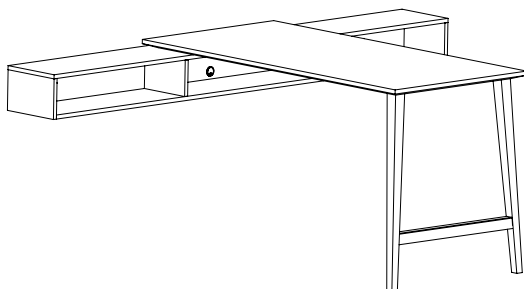

TABLES • TECHNICAL INFORMATION

- All tables are shipped Knock Down (KD). Please see assembly instructions included with the product.
- Available Modesty Panels are 15" and 22" height. Please see pages A.12 - A.13 for selection.
- Peninsula table has metal inserts installed for quick assembly to the Pedestal or Pedestal with Riser Box.

TABLES • GUIDELINES FOR ORDERING PRODUCT

CODES: The price list uses a product coding system that is specific to each of the units. The product description (next to the code) explains in detail construction of the unit.

SPECIFICATION EXAMPLE OF A FREESTANDING WORK TABLE

PRODUCT CODE: ART8432

A = Corby Series

RT = Rectangular Table

8432 = Width x Depth

CHOOSE FINISH OPTION:

Standard Finish: Veneer top and matching hardwood edge and legs. Please see page A.18

Laminate Finish: Please add "/P" to the end of the product code, includes HP laminate top, matching 3mm edge and painted hardwood legs. Please see page A.18

Optional Grommet Locations - please see page A.10

Optional Modesty Panel - please see pages A.5 - A.13

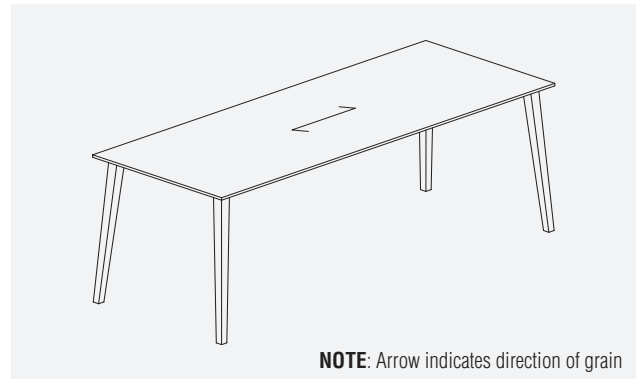

NOTE: Arrow indicates direction of grain

AR • Peninsula Table

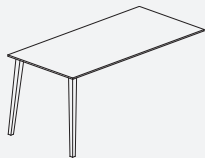

| PRODUCT | PRICE | | SIZE (INCHES) | | | WEIGHT | VOL |
|---------|----------|----------|---------------|----|----|--------|-----------------|
| | STANDARD | LAMINATE | H | W | D | LBS | FT ³ |
| AR6632 | 2338 | 1872 | 29 | 66 | 32 | 98 | 10 |
| AR7232 | 2461 | 1967 | 29 | 72 | 32 | 105 | 11 |
| AR7832 | 2582 | 2067 | 29 | 78 | 32 | 112 | 12 |
| AR8432 | 2717 | 2174 | 29 | 84 | 32 | 119 | 12 |

- Peninsula table with two legs
- Connects to 27.5" high storage

ART • Freestanding Work Table

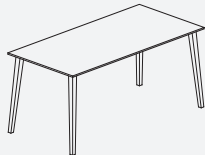

| PRODUCT | PRICE | | SIZE (INCHES) | | | WEIGHT | VOL |
|---------|----------|----------|---------------|----|----|--------|-----------------|
| | STANDARD | LAMINATE | H | W | D | LBS | FT ³ |
| ART6632 | 3285 | 2628 | 29 | 66 | 32 | 118 | 10 |
| ART7232 | 3407 | 2727 | 29 | 72 | 32 | 125 | 11 |
| ART7832 | 3528 | 2823 | 29 | 78 | 32 | 132 | 12 |
| ART8432 | 3663 | 2930 | 29 | 84 | 32 | 139 | 12 |
| ART6642 | 3717 | 2974 | 29 | 66 | 42 | 142 | 13 |
| ART7242 | 3881 | 3104 | 29 | 72 | 42 | 152 | 13 |
| ART7842 | 4043 | 3234 | 29 | 78 | 42 | 161 | 14 |
| ART8442 | 4216 | 3374 | 29 | 84 | 42 | 170 | 15 |

- Freestanding work table with four legs

ARTC • Freestanding Collaboration Table

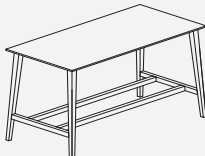

| PRODUCT | PRICE | | SIZE (INCHES) | | | WEIGHT | VOL |
|----------|----------|----------|---------------|----|----|--------|-----------------|
| | STANDARD | LAMINATE | H | W | D | LBS | FT ³ |
| ARTC6632 | 4228 | 3384 | 36 | 66 | 32 | 138 | 12 |
| ARTC7232 | 4353 | 3484 | 36 | 72 | 32 | 155 | 13 |
| ARTC7832 | 4475 | 3582 | 36 | 78 | 32 | 172 | 14 |
| ARTC8432 | 4608 | 3688 | 36 | 84 | 32 | 189 | 16 |
| ARTC6642 | 4663 | 3731 | 36 | 66 | 42 | 172 | 16 |
| ARTC7242 | 4826 | 3862 | 36 | 72 | 42 | 192 | 17 |
| ARTC7842 | 4986 | 3991 | 36 | 78 | 42 | 211 | 19 |
| ARTC8442 | 5162 | 4131 | 36 | 84 | 42 | 230 | 20 |

- Freestanding collaboration table with four legs and foot-rests
- For optional foot-rest cover, please see Accessories.
- Please note foot-rest and leg are same colour

ARC • Collaboration Media Table

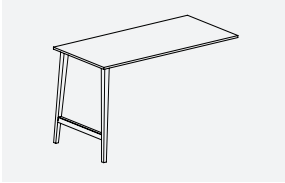

| PRODUCT | PRICE | | SIZE (INCHES) | | | WEIGHT VOL | |
|---------|----------|----------|---------------|----|----|------------|-----------------|
| | STANDARD | LAMINATE | H | W | D | LBS | FT ³ |
| ARC6632 | 2366 | 1894 | 36 | 66 | 32 | 100 | 10 |
| ARC7232 | 2484 | 1987 | 36 | 72 | 32 | 107 | 11 |
| ARC7832 | 2599 | 2081 | 36 | 78 | 32 | 114 | 12 |
| ARC8432 | 2728 | 2181 | 36 | 84 | 32 | 120 | 12 |

- Collaboration Media Table with 2 legs
- To be used with Wall Mount Media Storage (ACSFO- GM)

ACSFO-GM • Wall Mount Media Storage

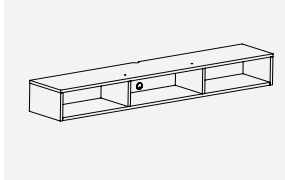

| PRODUCT | PRICE | | SIZE (INCHES) | | | WEIGHT VOL | |
|-----------------|----------|----------|---------------|----|----|------------|-----------------|
| | STANDARD | LAMINATE | H | W | D | LBS | FT ³ |
| ACSFO32D12H8-GM | 1209 | 968 | 8 | 32 | 12 | 35 | 2 |
| ACSFO64D12H8-GM | 1324 | 1060 | 8 | 64 | 12 | 50 | 4 |
| ACSFO96D12H8-GM | 1987 | 1590 | 8 | 96 | 12 | 78 | 6 |

- Wall Mount Media Storage
- To be used with Collaboration Media Table (ARC)
- GM38 grommet on the back panel is included
- For wire pass through, scoop cutouts on both top and bottom are included.
- Pre-drilled insert holes on top panel

ACSFO • Wall Mount Open Storage

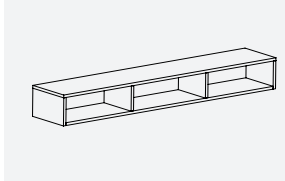

| PRODUCT | PRICE | | SIZE (INCHES) | | | WEIGHT VOL | |
|--------------|----------|----------|---------------|----|----|------------|-----------------|
| | STANDARD | LAMINATE | H | W | D | LBS | FT ³ |
| ACSFO32D12H8 | 1137 | 910 | 8 | 32 | 12 | 35 | 2 |
| ACSFO64D12H8 | 1254 | 1004 | 8 | 64 | 12 | 50 | 4 |
| ACSFO96D12H8 | 1915 | 1532 | 8 | 96 | 12 | 78 | 6 |

- Wall Mount Open Storage
- To be used as a stand alone unit

ASPBOX • Riser Box

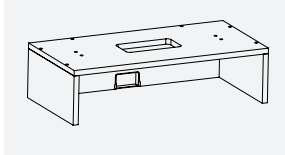

| PRODUCT | PRICE | | SIZE (INCHES) | | | WEIGHT VOL | |
|------------|----------|----------|---------------|----|----|------------|-----------------|
| | STANDARD | LAMINATE | H | W | D | LBS | FT ³ |
| ASPBOX2814 | 282 | 226 | 7.5 | 28 | 14 | 14 | 3 |
| ASPBOX2014 | 253 | 204 | 7.5 | 20 | 14 | 12 | 2 |

- 28"W Riser Box for 20"H storage to support Peninsula Table & 32" deep Bridge Top
- 20"W Riser Box for 20"H storage to support 24" deep Bridge Top
- For wire pass through, grommets cut-out on both top and back are included.

FRC • Foot Rest Cover (Sets)

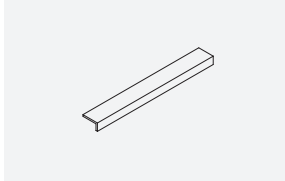

| PRODUCT | PRICE | | SIZE (INCHES) | | | WEIGHT VOL | |
|---------|----------|----------|---------------|---|---|------------|-----------------|
| | STANDARD | LAMINATE | H | W | D | LBS | FT ³ |
| FRC6632 | 384 | | | | | | |
| FRC7232 | 414 | | | | | | |
| FRC7832 | 444 | | | | | | |
| FRC8432 | 473 | | | | | | |
| FRC6642 | 444 | | | | | | |
| FRC7242 | 473 | | | | | | |
| FRC7842 | 503 | | | | | | |
| FRC8442 | 532 | | | | | | |

- Foot rest covers are factory installed (Only in Brushed Chrome Finish)
- For ARTC6632
- For ARTC7232
- For ARTC7832
- For ARTC8432
- For ARTC6642
- For ARTC7242
- For ARTC7842
- For ARTC8442

ACMP • 22"H Hanging wood modesty panel

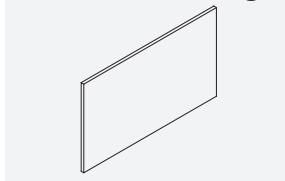

| PRODUCT | PRICE | | SIZE (INCHES) | | | WEIGHT VOL | |
|------------|----------|----------|---------------|----|------|------------|-----------------|
| | STANDARD | LAMINATE | H | W | D | LBS | FT ³ |
| ACMPW38H22 | 569 | 455 | 22 | 38 | 0.75 | 20 | 2 |
| ACMPW44H22 | 622 | 498 | 22 | 44 | 0.75 | 22 | 2 |
| ACMPW50H22 | 675 | 540 | 22 | 50 | 0.75 | 24 | 3 |
| ACMPW56H22 | 718 | 574 | 22 | 56 | 0.75 | 26 | 3 |
| ACMPW62H22 | 769 | 615 | 22 | 62 | 0.75 | 28 | 3 |

- 22" Hanging Wood Modesty Panel
- For selection of the hanging wood modesty panel, please see pages A.4 - A.5 for details.

ACMP • 15"H Hanging wood modesty panel

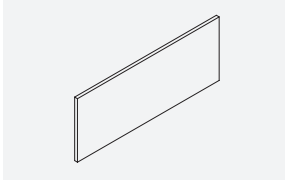

| PRODUCT | PRICE | | SIZE (INCHES) | | | WEIGHT VOL | |
|------------|----------|----------|---------------|----|------|------------|-----------------|
| | STANDARD | LAMINATE | H | W | D | LBS | FT ³ |
| ACMPW38H15 | 539 | 431 | 15 | 38 | 0.75 | 15 | 2 |
| ACMPW44H15 | 592 | 474 | 15 | 44 | 0.75 | 17 | 2 |
| ACMPW50H15 | 647 | 518 | 15 | 50 | 0.75 | 18 | 2 |
| ACMPW56H15 | 689 | 550 | 15 | 56 | 0.75 | 20 | 2 |
| ACMPW62H15 | 740 | 592 | 15 | 62 | 0.75 | 21 | 2 |
| ACMPW68H15 | 813 | 650 | 15 | 68 | 0.75 | 23 | 3 |
| ACMPW74H15 | 883 | 705 | 15 | 74 | 0.75 | 24 | 3 |

- 15" Hanging Wood Modesty Panel
- For selection of the hanging wood modesty panel, please see pages A.4 - A.5 for details.

OCCASIONAL TABLES • TECHNICAL INFORMATION

• All occasional tables are shipped Knock Down (KD). Please see assembly instructions.

OCCASIONAL TABLES • GUIDELINES FOR ORDERING PRODUCT

CODES: The price list uses a product coding system that is specific to each of the units. The product description (next to the code) explains in detail construction of the unit.

SPECIFICATION EXAMPLE OF AN OCCASIONAL TABLE

PRODUCT CODE:

ACT3620H17
 A = Corby Series
 CT = Occasional Table
 3620 = Width x Depth
 H17 = Height

CHOOSE FINISH OPTION:

Standard Finish: Veneer top and matching hardwood edge and legs. Please see page A.12
 Laminate Finish: Please add "/P" to the end of the product code, includes HP laminate top, matching 3mm edge and painted hardwood legs. Please see page A.12

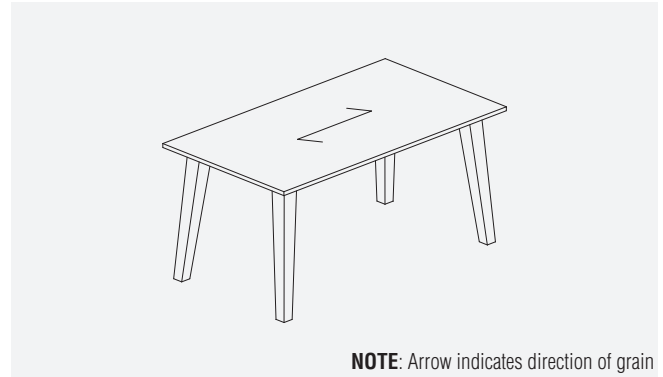

NOTE: Arrow indicates direction of grain

ACT • 13”H Square Occasional Table

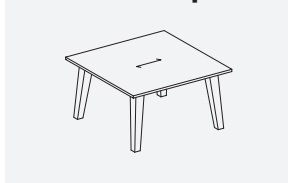

| PRODUCT | PRICE | | SIZE (INCHES) | | | WEIGHT | VOL |
|------------|----------|----------|---------------|----|----|--------|-----------------|
| | STANDARD | LAMINATE | H | W | D | LBS | FT ³ |
| ACT2424H13 | 1733 | 1387 | 13 | 24 | 24 | 47 | 5 |
| ACT3030H13 | 1947 | 1558 | 13 | 30 | 30 | 59 | 6 |
| ACT3636H13 | 2203 | 1763 | 13 | 36 | 36 | 73 | 8 |

ACT • 17”H Square Occasional Table

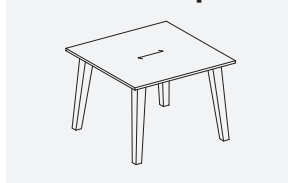

| PRODUCT | PRICE | | SIZE (INCHES) | | | WEIGHT | VOL |
|------------|----------|----------|---------------|----|----|--------|-----------------|
| | STANDARD | LAMINATE | H | W | D | LBS | FT ³ |
| ACT2424H17 | 2001 | 1601 | 17 | 24 | 24 | 52 | 6 |
| ACT3030H17 | 2218 | 1773 | 17 | 30 | 30 | 64 | 7 |
| ACT3636H17 | 2474 | 1980 | 17 | 36 | 36 | 78 | 9 |

ACT • 13”H Rectangular Occasional Table

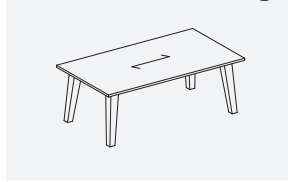

| PRODUCT | PRICE | | SIZE (INCHES) | | | WEIGHT | VOL |
|------------|----------|----------|---------------|----|----|--------|-----------------|
| | STANDARD | LAMINATE | H | W | D | LBS | FT ³ |
| ACT3620H13 | 1826 | 1462 | 13 | 36 | 20 | 52 | 6 |
| ACT4220H13 | 1892 | 1514 | 13 | 42 | 20 | 57 | 6 |
| ACT4820H13 | 1988 | 1591 | 13 | 48 | 20 | 61 | 7 |

ACT • 17”H Rectangular Occasional Table

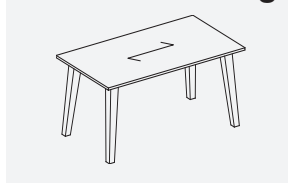

| PRODUCT | PRICE | | SIZE (INCHES) | | | WEIGHT | VOL |
|------------|----------|----------|---------------|----|----|--------|-----------------|
| | STANDARD | LAMINATE | H | W | D | LBS | FT ³ |
| ACT3620H17 | 2093 | 1675 | 17 | 36 | 20 | 57 | 7 |
| ACT4220H17 | 2162 | 1731 | 17 | 42 | 20 | 62 | 7 |
| ACT4820H17 | 2257 | 1805 | 17 | 48 | 20 | 66 | 8 |

ACTRO-H13 • 13”H Round Occasional Table



| PRODUCT | PRICE | | SIZE (INCHES) | | | WEIGHT | VOL |
|------------|----------|----------|---------------|----|----|--------|-----------------|
| | STANDARD | LAMINATE | H | W | D | LBS | FT ³ |
| ACTRO24H13 | 1929 | 1544 | 13 | 24 | 24 | 28 | 2 |
| ACTRO30H13 | 2276 | 1822 | 13 | 30 | 36 | 40 | 3 |
| ACTRO36H13 | 2382 | 1904 | 13 | 36 | 42 | 52 | 4 |

• Round Occasional Table with 13”H legs

ACTRO-H17 • 17”H Round Occasional Table



| PRODUCT | PRICE | | SIZE (INCHES) | | | WEIGHT | VOL |
|------------|----------|----------|---------------|----|----|--------|-----------------|
| | STANDARD | LAMINATE | H | W | D | LBS | FT ³ |
| ACTRO24H17 | 2187 | 1749 | 17 | 24 | 24 | 28 | 3 |
| ACTRO30H17 | 2391 | 1914 | 17 | 30 | 30 | 40 | 4 |
| ACTRO36H17 | 2638 | 2111 | 17 | 36 | 36 | 52 | 5 |

• Round Occasional Table with 17”H legs

ARO-H29 • 29”H Round Table



| PRODUCT | PRICE | | SIZE (INCHES) | | | WEIGHT | VOL |
|----------|----------|----------|---------------|----|----|--------|-----------------|
| | STANDARD | LAMINATE | H | W | D | LBS | FT ³ |
| ARO30H29 | 2682 | 2146 | 29 | 30 | 30 | 65 | 6 |
| ARO36H29 | 2895 | 2316 | 29 | 36 | 36 | 77 | 7 |
| ARO42H29 | 3071 | 2455 | 29 | 42 | 42 | 89 | 8 |

• Round Table with 29”H legs

RETURNS • TECHNICAL INFORMATION

- All Returns are shipped Knock Down (KD). Please see assembly instructions included with the product.
- All Returns have Cross Grain veneer pattern.
- To remove Cross Grain veneer pattern from the top, delete suffix "CG" from the product code. (Available at no upcharge)

RETURNS • GUIDELINES FOR ORDERING PRODUCT

CODES: The price list uses a product coding system that is specific to each of the units. The product description (next to the code) explains in detail construction of the unit.

SPECIFICATION EXAMPLE OF A RETURN

PRODUCT CODE: AERR3624CG

A = Corby Series
 ERR = Executive Return Right
 3624 = Width x Depth
 CG = Cross Grain

CHOOSE FINISH OPTION:

Standard Finish: Veneer top and matching hardwood edge and legs. Please see page A.18
 Laminate Finish: Please add "/P" to the end of the product code, includes HP laminate top, matching 3mm edge and painted hardwood legs. Please see page A.18

Optional Grommet Locations - Please see page A.10

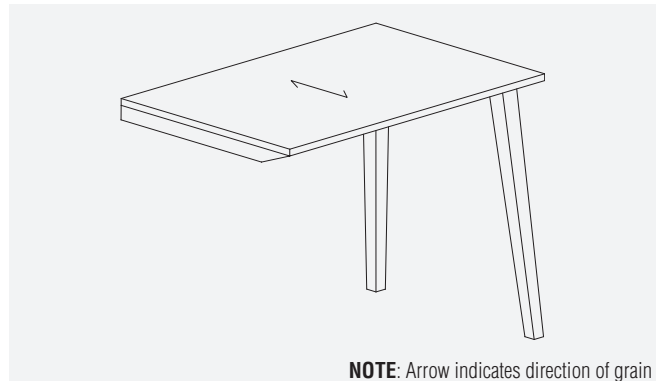

NOTE: Arrow indicates direction of grain

AERL-24CG • Executive Return Left

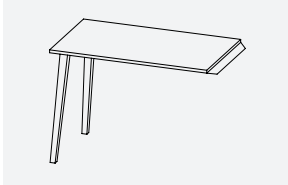

| PRODUCT | PRICE | | SIZE (INCHES) | | | WEIGHT VOL | |
|------------|----------|----------|---------------|----|----|------------|-----------------|
| | STANDARD | LAMINATE | H | W | D | LBS | FT ³ |
| AERL3624CG | 1549 | 1240 | 29 | 36 | 24 | 40 | 1.5 |
| AERL4224CG | 1647 | 1317 | 29 | 42 | 24 | 46 | 2 |
| AERL4824CG | 1745 | 1395 | 29 | 48 | 24 | 52 | 2.5 |
| AERL5424CG | 1840 | 1473 | 29 | 54 | 24 | 58 | 3 |
| AERL6024CG | 1938 | 1552 | 29 | 60 | 24 | 64 | 3.5 |

- Executive Return Left with two legs
- Connects to 29" high work table

AERR-24CG • Executive Return Right

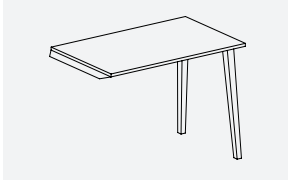

| PRODUCT | PRICE | | SIZE (INCHES) | | | WEIGHT VOL | |
|------------|----------|----------|---------------|----|----|------------|-----------------|
| | STANDARD | LAMINATE | H | W | D | LBS | FT ³ |
| AERR3624CG | 1549 | 1240 | 29 | 36 | 24 | 40 | 1.5 |
| AERR4224CG | 1647 | 1317 | 29 | 42 | 24 | 46 | 2 |
| AERR4824CG | 1745 | 1395 | 29 | 48 | 24 | 52 | 2.5 |
| AERR5424CG | 1840 | 1473 | 29 | 54 | 24 | 58 | 3 |
| AERR6024CG | 1938 | 1552 | 29 | 60 | 24 | 64 | 3.5 |

- Executive Return Right with two legs
- Connects to 29" high work table

BRIDGES • TECHNICAL INFORMATION

- All Bridges have Cross Grain veneer pattern.
- To remove Cross Grain veneer pattern from the top, delete suffix "CG" from the product code. (Available at no upcharge)
- GM5C-TC grommet location is standard.

BRIDGES • GUIDELINES FOR ORDERING PRODUCT

CODES: The price list uses a product coding system that is specific to each of the units. The product description (next to the code) explains in detail construction of the unit.

SPECIFICATION EXAMPLE OF BRIDGES

PRODUCT CODE: A3624T-COPL-CG

A = Corby Series

3624 = Width x Depth

T = Bridge Top

COPL = Undercut on Left edge and CG = Cross Grain

CHOOSE FINISH OPTION:

Standard Finish: Veneer top and matching hardwood edge. Please see page A.18

Laminate Finish: Please add "/P" to the end of the product code, includes HP laminate top and matching 3mm edge. Please see page A.18

Optional Grommet Locations - please see page A.10

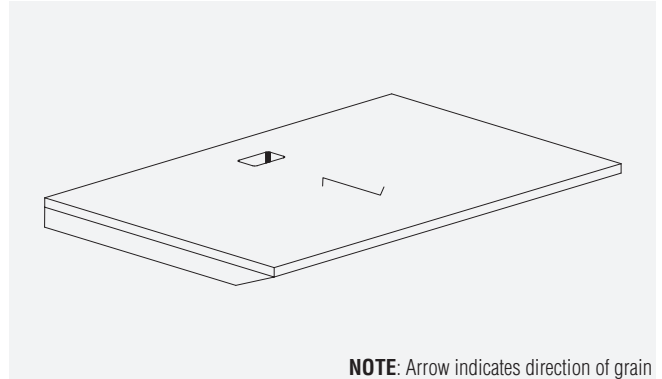

NOTE: Arrow indicates direction of grain

A-20T-COPL-CG • Executive Bridge Top Left, 20" Deep

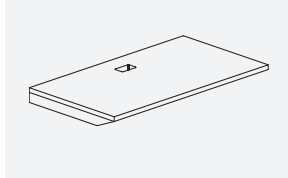

| PRODUCT | PRICE | | SIZE (INCHES) | | | WEIGHT VOL | |
|----------------|----------|----------|---------------|----|----|------------|-----------------|
| | STANDARD | LAMINATE | H | W | D | LBS | FT ³ |
| A3620T-COPL-CG | 667 | 534 | 1.5 | 36 | 20 | 29 | 1 |
| A4220T-COPL-CG | 782 | 626 | 1.5 | 42 | 20 | 33 | 1.5 |
| A4820T-COPL-CG | 899 | 718 | 1.5 | 48 | 20 | 37 | 2 |
| A5420T-COPL-CG | 1013 | 811 | 1.5 | 54 | 20 | 41 | 2.5 |
| A6020T-COPL-CG | 1126 | 903 | 1.5 | 60 | 20 | 45 | 3 |
| A6620T-COPL-CG | 1242 | 994 | 1.5 | 66 | 20 | 49 | 3.5 |
| A7220T-COPL-CG | 1357 | 1088 | 1.5 | 72 | 20 | 53 | 4 |

- Executive Bridge Top Left
- Undercut edge side connects to 29" high work table and other side sits on top of 20" deep Pedestal/Riser box.

A-20T-COPR-CG • Executive Bridge Top Right, 20" Deep

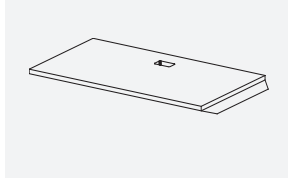

| PRODUCT | PRICE | | SIZE (INCHES) | | | WEIGHT VOL | |
|----------------|----------|----------|---------------|----|----|------------|-----------------|
| | STANDARD | LAMINATE | H | W | D | LBS | FT ³ |
| A3620T-COPR-CG | 667 | 534 | 1.5 | 36 | 20 | 29 | 1 |
| A4220T-COPR-CG | 782 | 626 | 1.5 | 42 | 20 | 33 | 1.5 |
| A4820T-COPR-CG | 899 | 718 | 1.5 | 48 | 20 | 37 | 2 |
| A5420T-COPR-CG | 1013 | 811 | 1.5 | 54 | 20 | 41 | 2.5 |
| A6020T-COPR-CG | 1126 | 903 | 1.5 | 60 | 20 | 45 | 3 |
| A6620T-COPR-CG | 1242 | 994 | 1.5 | 66 | 20 | 49 | 3.5 |
| A7220T-COPR-CG | 1357 | 1088 | 1.5 | 72 | 20 | 53 | 4 |

- Executive Bridge Top Right
- Undercut edge side connects to 29" high work table and other side sits on top of 20" deep Pedestal/Riser box.

A-24T-COPL-CG • Executive Bridge Top Left, 24" Deep

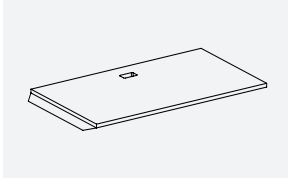

| PRODUCT | PRICE | | SIZE (INCHES) | | | WEIGHT VOL | |
|----------------|----------|----------|---------------|----|----|------------|-----------------|
| | STANDARD | LAMINATE | H | W | D | LBS | FT ³ |
| A3624T-COPL-CG | 694 | 556 | 1.5 | 36 | 24 | 38 | 1.5 |
| A4224T-COPL-CG | 811 | 649 | 1.5 | 42 | 24 | 44 | 2 |
| A4824T-COPL-CG | 927 | 741 | 1.5 | 48 | 24 | 50 | 2.5 |
| A5424T-COPL-CG | 1042 | 833 | 1.5 | 54 | 24 | 56 | 3 |
| A6024T-COPL-CG | 1156 | 926 | 1.5 | 60 | 24 | 62 | 3.5 |
| A6624T-COPL-CG | 1271 | 1018 | 1.5 | 66 | 24 | 68 | 4 |
| A7224T-COPL-CG | 1387 | 1109 | 1.5 | 72 | 24 | 74 | 4.5 |

- Executive Bridge Top Left
- Undercut edge side connects to 29" high work table and other side sits on top of Credenza/Riser box.

A-24T-COPR-CG • Executive Bridge Top Right, 24" Deep

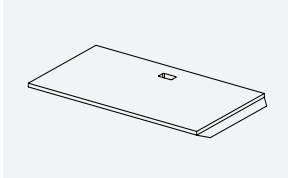

| PRODUCT | PRICE | | SIZE (INCHES) | | | WEIGHT VOL | |
|----------------|----------|----------|---------------|----|----|------------|-----------------|
| | STANDARD | LAMINATE | H | W | D | LBS | FT ³ |
| A3624T-COPR-CG | 694 | 556 | 1.5 | 36 | 24 | 38 | 1.5 |
| A4224T-COPR-CG | 811 | 649 | 1.5 | 42 | 24 | 44 | 2 |
| A4824T-COPR-CG | 927 | 741 | 1.5 | 48 | 24 | 50 | 2.5 |
| A5424T-COPR-CG | 1042 | 833 | 1.5 | 54 | 24 | 56 | 3 |
| A6024T-COPR-CG | 1156 | 926 | 1.5 | 60 | 24 | 62 | 3.5 |
| A6624T-COPR-CG | 1271 | 1018 | 1.5 | 66 | 24 | 68 | 4 |
| A7224T-COPR-CG | 1387 | 1109 | 1.5 | 72 | 24 | 74 | 4.5 |

- Executive Bridge Top Right
- Undercut edge side connects to 29" high work table and other side sits on top of Credenza/Riser box.

A-32T-COPL-CG • Executive Bridge Top Left, 32" Deep

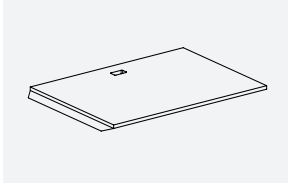

| PRODUCT | PRICE | | SIZE (INCHES) | | | WEIGHT VOL | |
|----------------|----------|----------|---------------|----|----|------------|-----------------|
| | STANDARD | LAMINATE | H | W | D | LBS | FT ³ |
| A3632T-COPL-CG | 927 | 741 | 1.5 | 36 | 32 | 53 | 2 |
| A4232T-COPL-CG | 1080 | 865 | 1.5 | 42 | 32 | 57 | 2.5 |
| A4832T-COPL-CG | 1235 | 988 | 1.5 | 48 | 32 | 61 | 3 |
| A5432T-COPL-CG | 1389 | 1111 | 1.5 | 54 | 32 | 65 | 3.5 |
| A6032T-COPL-CG | 1540 | 1232 | 1.5 | 60 | 32 | 69 | 4 |
| A6632T-COPL-CG | 1693 | 1355 | 1.5 | 66 | 32 | 73 | 4.5 |
| A7232T-COPL-CG | 1848 | 1478 | 1.5 | 72 | 32 | 77 | 5 |

- Executive Bridge Top Left
- Undercut edge side connects to 29" high work table and other side sits on top of Credenza/Riser box.

A-32T-COPR-CG • Executive Bridge Top Right, 32" Deep

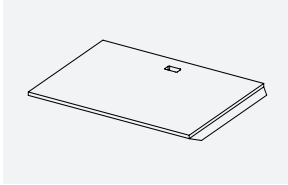

| PRODUCT | PRICE | | SIZE (INCHES) | | | WEIGHT VOL | |
|----------------|----------|----------|---------------|----|----|------------|-----------------|
| | STANDARD | LAMINATE | H | W | D | LBS | FT ³ |
| A3632T-COPR-CG | 927 | 741 | 1.5 | 36 | 32 | 53 | 2 |
| A4232T-COPR-CG | 1080 | 865 | 1.5 | 42 | 32 | 57 | 2.5 |
| A4832T-COPR-CG | 1235 | 988 | 1.5 | 48 | 32 | 61 | 3 |
| A5432T-COPR-CG | 1389 | 1111 | 1.5 | 54 | 32 | 65 | 3.5 |
| A6032T-COPR-CG | 1540 | 1232 | 1.5 | 60 | 32 | 69 | 4 |
| A6632T-COPR-CG | 1693 | 1355 | 1.5 | 66 | 32 | 73 | 4.5 |
| A7232T-COPR-CG | 1848 | 1478 | 1.5 | 72 | 32 | 77 | 5 |

- Executive Bridge Top Right
- Undercut edge side connects to 29" high work table and other side sits on top of Credenza/Riser box.

32" WIDE FREESTANDING PEDESTAL AND STORAGE • TECHNICAL INFORMATION

- All Pedestals and Storage units are shipped assembled.
- Freestanding Pedestals and Storage may be used as stand alone units or as the Peninsula Table Support (20" and 27.5" height units).
- To support the Peninsula Table with 20"H Pedestal, the Riser Box is required (see Tables / Accessories section).
- Pedestal and Storage units are available in two base heights: 4" (xxLB = Low Base) or 11.5" (xxHB = High Base)
- All drawer fronts have one vertical handle (PL89) installed.
- Front locking is standard on the Pedestals with box/file and file drawers.
- Optional locking and handles on doors (Storage units) are available (see Accessories section).
- Optional Cushions (32" x 14") for Pedestal tops are available (see Accessories section).

PEDESTALS AND STORAGE • GUIDELINES FOR ORDERING PRODUCT

CODES: The price list uses a product coding system that is specific to each of the units. The product description (next to the code) explains in detail construction of the unit.

SPECIFICATION EXAMPLE OF A PEDESTAL

PRODUCT CODE:

AP1LB
 A = Corby Series
 P = Pedestal
 1 = Product ID number (Freestanding Pedestal 20"H x 32"W x 20"D)
 LB = Low Base

CHOOSE FINISH OPTION:

Standard Finish: Veneer top, chassis, fronts and matching hardwood legs. Please see page A.18
 Laminate Finish: Please add "/P" to the end of the product code, includes HP laminate top, LP laminate chassis and fronts with painted hardwood legs. Please see page A.18

LOCK:

Choose Optional Lock on doors (see Accessories section)

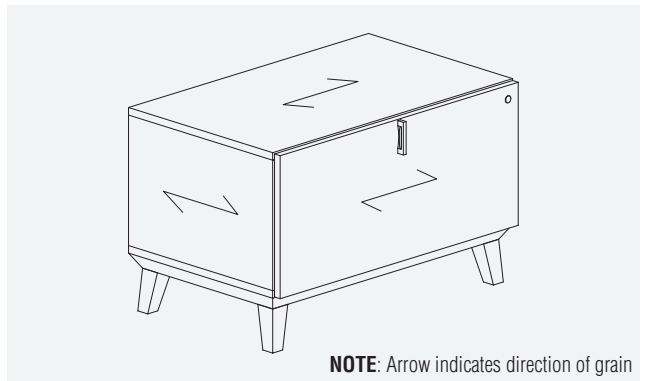

AP1LB • 20"H Freestanding Pedestal

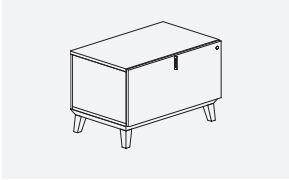

| PRODUCT | PRICE | | SIZE (INCHES) | | | WEIGHT VOL | | <ul style="list-style-type: none"> • Freestanding pedestal with front locking lateral drawer • Low base |
|---------|----------|----------|---------------|----|----|------------|-----------------|---|
| | STANDARD | LAMINATE | H | W | D | LBS | FT ³ | |
| AP1LB | 2190 | 1751 | 20 | 32 | 20 | 106 | 9 | |

AP2LB • 20"H Freestanding Pedestal

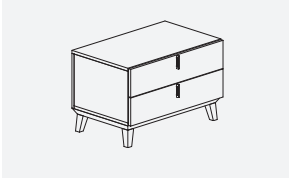

| PRODUCT | PRICE | | SIZE (INCHES) | | | WEIGHT VOL | | <ul style="list-style-type: none"> • Freestanding pedestal with two box drawers • Low base |
|---------|----------|----------|---------------|----|----|------------|-----------------|--|
| | STANDARD | LAMINATE | H | W | D | LBS | FT ³ | |
| AP2LB | 2175 | 1741 | 20 | 32 | 20 | 105 | 9 | |

AP3LB • 20"H Freestanding Pedestal

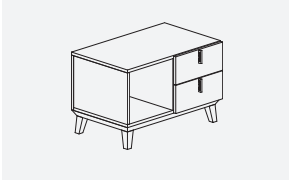

| PRODUCT | PRICE | | SIZE (INCHES) | | | WEIGHT VOL | | <ul style="list-style-type: none"> • Freestanding pedestal with open cabinet left, two box drawers right • Low base |
|---------|----------|----------|---------------|----|----|------------|-----------------|---|
| | STANDARD | LAMINATE | H | W | D | LBS | FT ³ | |
| AP3LB | 2312 | 1850 | 20 | 32 | 20 | 105 | 9 | |

AP4LB • 20"H Freestanding Pedestal

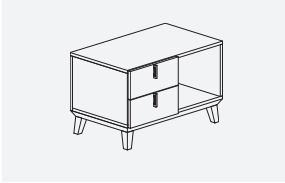

| PRODUCT | PRICE | | SIZE (INCHES) | | | WEIGHT VOL | |
|---------|----------|----------|---------------|----|----|------------|-----------------|
| | STANDARD | LAMINATE | H | W | D | LBS | FT ³ |
| AP4LB | 2312 | 1850 | 20 | 32 | 20 | 105 | 9 |

- Freestanding pedestal with two box drawers left, open cabinet right
- Low base

AP5LB • 20"H Freestanding Pedestal

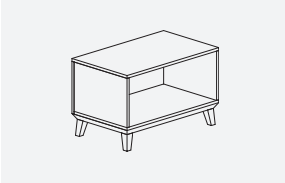

| PRODUCT | PRICE | | SIZE (INCHES) | | | WEIGHT VOL | |
|---------|----------|----------|---------------|----|----|------------|-----------------|
| | STANDARD | LAMINATE | H | W | D | LBS | FT ³ |
| AP5LB | 1892 | 1514 | 20 | 32 | 20 | 86 | 9 |

- Freestanding pedestal with open cabinet
- Low base

AP1LB32 • 20"H Freestanding Pedestal

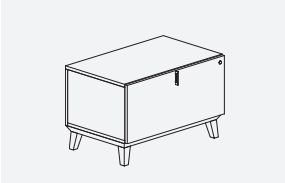

| PRODUCT | PRICE | | SIZE (INCHES) | | | WEIGHT VOL | |
|---------|----------|----------|---------------|----|----|------------|-----------------|
| | STANDARD | LAMINATE | H | W | D | LBS | FT ³ |
| AP1LB32 | 2325 | 1860 | 20 | 32 | 32 | 136 | 14 |

- Freestanding pedestal with front locking lateral drawer
- Can be used to support peninsula table in conjunction with the Riser Box (ASPBOX2814) - optional
- Low base

AP2LB32 • 20"H Freestanding Pedestal



| PRODUCT | PRICE | | SIZE (INCHES) | | | WEIGHT VOL | |
|---------|----------|----------|---------------|----|----|------------|-----------------|
| | STANDARD | LAMINATE | H | W | D | LBS | FT ³ |
| AP2LB32 | 2312 | 1850 | 20 | 32 | 32 | 135 | 14 |

- Freestanding pedestal with two box drawers
- Can be used to support peninsula table in conjunction with the Riser Box (ASPBOX2814) - optional
- Low base

AP3LB32 • 20"H Freestanding Pedestal



| PRODUCT | PRICE | | SIZE (INCHES) | | | WEIGHT VOL | |
|---------|----------|----------|---------------|----|----|------------|-----------------|
| | STANDARD | LAMINATE | H | W | D | LBS | FT ³ |
| AP3LB32 | 2446 | 1957 | 20 | 32 | 32 | 135 | 14 |

- Freestanding pedestal with open cabinet left, two box drawers right
- Can be used to support peninsula table in conjunction with the Riser Box (ASPBOX2814) - optional
- Low base

AP4LB32 • 20"H Freestanding Pedestal



| PRODUCT | PRICE | | SIZE (INCHES) | | | WEIGHT VOL | |
|---------|----------|----------|---------------|----|----|------------|-----------------|
| | STANDARD | LAMINATE | H | W | D | LBS | FT ³ |
| AP4LB32 | 2446 | 1957 | 20 | 32 | 32 | 135 | 14 |

- Freestanding pedestal with two box drawers left, open cabinet right
- Can be used to support peninsula table in conjunction with the Riser Box (ASPBOX2814) - optional
- Low base

AP5LB32 • 20"H Freestanding Pedestal

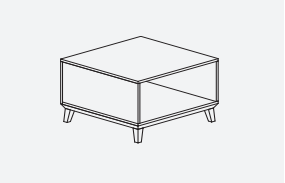

| PRODUCT | PRICE | | SIZE (INCHES) | | | WEIGHT VOL | |
|---------|----------|----------|---------------|----|----|------------|-----------------|
| | STANDARD | LAMINATE | H | W | D | LBS | FT ³ |
| AP5LB32 | 2028 | 1624 | 20 | 32 | 32 | 116 | 14 |

- Freestanding pedestal with open cabinet
- Can be used to support peninsula table in conjunction with the Riser Box (ASPBOX2814) - optional
- Low base

AP6LB • 28”H Freestanding Pedestal

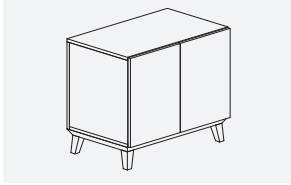

| PRODUCT | PRICE | | SIZE (INCHES) | | | WEIGHT VOL | |
|---------|----------|----------|---------------|----|----|------------|-----------------|
| | STANDARD | LAMINATE | H | W | D | LBS | FT ³ |
| AP6LB | 2299 | 1839 | 27.5 | 32 | 20 | 117 | 12 |

- Freestanding storage cabinet with two doors, one adjustable shelf
- Low base

AP7LB • 28”H Freestanding Pedestal

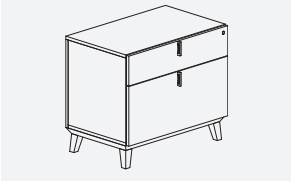

| PRODUCT | PRICE | | SIZE (INCHES) | | | WEIGHT VOL | |
|---------|----------|----------|---------------|----|----|------------|-----------------|
| | STANDARD | LAMINATE | H | W | D | LBS | FT ³ |
| AP7LB | 2933 | 2347 | 27.5 | 32 | 20 | 124 | 12 |

- Freestanding pedestal with front locking lateral and box drawer
- Low base

AP8LB • 28”H Freestanding Pedestal

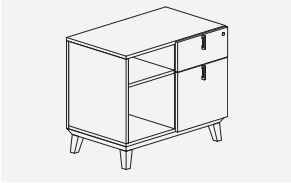

| PRODUCT | PRICE | | SIZE (INCHES) | | | WEIGHT VOL | |
|---------|----------|----------|---------------|----|----|------------|-----------------|
| | STANDARD | LAMINATE | H | W | D | LBS | FT ³ |
| AP8LB | 3067 | 2455 | 27.5 | 32 | 20 | 127 | 12 |

- Freestanding pedestal, open with fixed shelf left, front locking box file drawer right
- Low base

AP9LB • 28”H Freestanding Pedestal



| PRODUCT | PRICE | | SIZE (INCHES) | | | WEIGHT VOL | |
|---------|----------|----------|---------------|----|----|------------|-----------------|
| | STANDARD | LAMINATE | H | W | D | LBS | FT ³ |
| AP9LB | 3067 | 2455 | 27.5 | 32 | 20 | 127 | 12 |

- Freestanding pedestal with front locking box file drawer left, open with fixed - shelf right
- Low base

AP1HB • 28”H Freestanding Pedestal

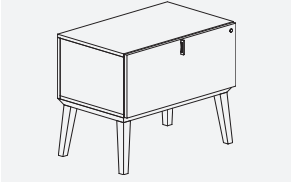

| PRODUCT | PRICE | | SIZE (INCHES) | | | WEIGHT VOL | |
|---------|----------|----------|---------------|----|----|------------|-----------------|
| | STANDARD | LAMINATE | H | W | D | LBS | FT ³ |
| AP1HB | 2461 | 1967 | 27.5 | 32 | 20 | 111 | 12 |

- Freestanding pedestal with front locking lateral drawer
- High base

AP2HB • 28”H Freestanding Pedestal

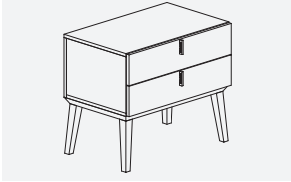

| PRODUCT | PRICE | | SIZE (INCHES) | | | WEIGHT VOL | |
|---------|----------|----------|---------------|----|----|------------|-----------------|
| | STANDARD | LAMINATE | H | W | D | LBS | FT ³ |
| AP2HB | 2446 | 1957 | 27.5 | 32 | 20 | 110 | 12 |

- Freestanding pedestal with two box drawers
- High base

AP3HB • 28”H Freestanding Pedestal

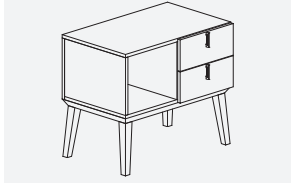

| PRODUCT | PRICE | | SIZE (INCHES) | | | WEIGHT VOL | |
|---------|----------|----------|---------------|----|----|------------|-----------------|
| | STANDARD | LAMINATE | H | W | D | LBS | FT ³ |
| AP3HB | 2312 | 1850 | 27.5 | 32 | 20 | 110 | 12 |

- Freestanding pedestal with open cabinet left, two box drawers right
- High base

AP4HB • 28”H Freestanding Pedestal



| PRODUCT | PRICE | | SIZE (INCHES) | | | WEIGHT VOL | |
|---------|----------|----------|---------------|----|----|------------|-----------------|
| | STANDARD | LAMINATE | H | W | D | LBS | FT ³ |
| AP4HB | 2312 | 1850 | 27.5 | 32 | 20 | 110 | 12 |

- Freestanding pedestal with two box drawers left, open cabinet right
- High base

AP5HB • 28”H Freestanding Pedestal

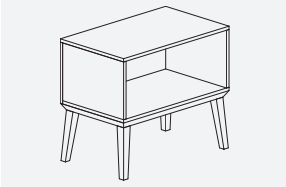

| PRODUCT | PRICE | | SIZE (INCHES) | | | WEIGHT VOL | |
|---------|----------|----------|---------------|----|----|------------|-----------------|
| | STANDARD | LAMINATE | H | W | D | LBS | FT ³ |
| AP5HB | 1892 | 1514 | 27.5 | 32 | 20 | 91 | 12 |

- Freestanding pedestal with open cabinet
- High base

AP1HB32 • 28”H Freestanding Pedestal

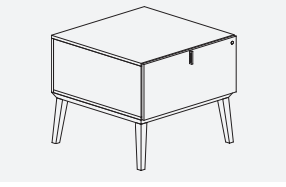

| PRODUCT | PRICE | | SIZE (INCHES) | | | WEIGHT VOL | |
|---------|----------|----------|---------------|----|----|------------|-----------------|
| | STANDARD | LAMINATE | H | W | D | LBS | FT ³ |
| AP1HB32 | 2595 | 2076 | 27.5 | 32 | 32 | 141 | 18 |

- Freestanding pedestal with front locking lateral drawer
- Can be used to support peninsula table
- High base

AP2HB32 • 28”H Freestanding Pedestal

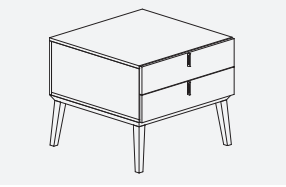

| PRODUCT | PRICE | | SIZE (INCHES) | | | WEIGHT VOL | |
|---------|----------|----------|---------------|----|----|------------|-----------------|
| | STANDARD | LAMINATE | H | W | D | LBS | FT ³ |
| AP2HB32 | 2582 | 2067 | 27.5 | 32 | 32 | 140 | 18 |

- Freestanding pedestal with two box drawers
- Can be used to support peninsula table
- High base

AP3HB32 • 28”H Freestanding Pedestal

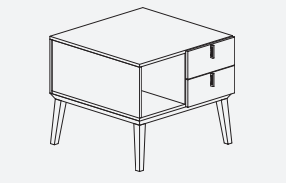

| PRODUCT | PRICE | | SIZE (INCHES) | | | WEIGHT VOL | |
|---------|----------|----------|---------------|----|----|------------|-----------------|
| | STANDARD | LAMINATE | H | W | D | LBS | FT ³ |
| AP3HB32 | 2446 | 1957 | 27.5 | 32 | 32 | 140 | 18 |

- Freestanding pedestal with open cabinet left, two box drawers right
- Can be used to support peninsula table
- High base

AP4HB32 • 28”H Freestanding Pedestal

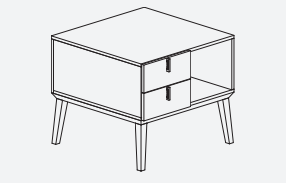

| PRODUCT | PRICE | | SIZE (INCHES) | | | WEIGHT VOL | |
|---------|----------|----------|---------------|----|----|------------|-----------------|
| | STANDARD | LAMINATE | H | W | D | LBS | FT ³ |
| AP4HB32 | 2446 | 1957 | 27.5 | 32 | 32 | 140 | 18 |

- Freestanding pedestal with two box drawers left, open cabinet right
- Can be used to support peninsula table
- High base

AP5HB32 • 28”H Freestanding Pedestal

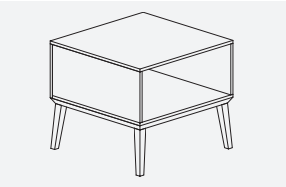

| PRODUCT | PRICE | | SIZE (INCHES) | | | WEIGHT VOL | |
|---------|----------|----------|---------------|----|----|------------|-----------------|
| | STANDARD | LAMINATE | H | W | D | LBS | FT ³ |
| AP5HB32 | 2028 | 1624 | 27.5 | 32 | 32 | 121 | 18 |

- Freestanding pedestal with open cabinet
- Can be used to support peninsula table
- High base

AP6HB • 35”H Freestanding Pedestal

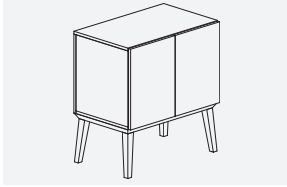

| PRODUCT | PRICE | | SIZE (INCHES) | | | WEIGHT VOL | |
|---------|----------|----------|---------------|----|----|------------|-----------------|
| | STANDARD | LAMINATE | H | W | D | LBS | FT ³ |
| AP6HB | 2569 | 2055 | 35 | 32 | 20 | 122 | 15 |

- Freestanding storage cabinet with two doors, one adjustable shelf
- High base

AP7HB • 35”H Freestanding Pedestal

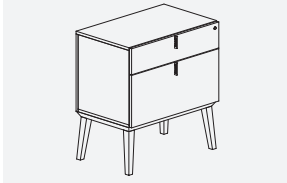

| PRODUCT | PRICE | | SIZE (INCHES) | | | WEIGHT VOL | |
|---------|----------|----------|---------------|----|----|------------|-----------------|
| | STANDARD | LAMINATE | H | W | D | LBS | FT ³ |
| AP7HB | 3204 | 2563 | 35 | 32 | 20 | 129 | 15 |

- Freestanding pedestal with front locking lateral and box drawer
- High base

AP8HB • 35”H Freestanding Pedestal

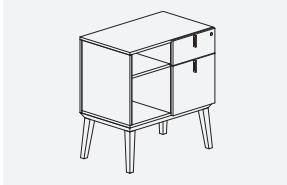

| PRODUCT | PRICE | | SIZE (INCHES) | | | WEIGHT VOL | |
|---------|----------|----------|---------------|----|----|------------|-----------------|
| | STANDARD | LAMINATE | H | W | D | LBS | FT ³ |
| AP8HB | 3340 | 2672 | 35 | 32 | 20 | 132 | 15 |

- Freestanding pedestal open with fixed shelf left, front locking box file drawer right
- High base

AP9HB • 35”H Freestanding Pedestal

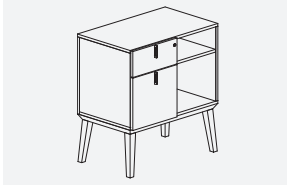

| PRODUCT | PRICE | | SIZE (INCHES) | | | WEIGHT VOL | |
|---------|----------|----------|---------------|----|----|------------|-----------------|
| | STANDARD | LAMINATE | H | W | D | LBS | FT ³ |
| AP9HB | 3340 | 2672 | 35 | 32 | 20 | 132 | 15 |

- Freestanding pedestal with front locking box file drawer left, open with fixed - shelf right
- High base

64"W and 96"W FREESTANDING CREDENZAS • TECHNICAL INFORMATION

- All Credenzas are shipped assembled.
- Freestanding Credenzas may be used as stand alone units or as the Peninsula Table Support (20" and 27.5" Height units)
- To support the Peninsula Table with 20"H Credenza, the Riser Box is required (see Tables or Accessories section).
- Credenza units are available in two base heights: 4" (xxLB = Low Base), or 11.5" (xxHB = High Base).
- All drawer fronts have vertical handle (PL89) installed where indicated.
- Front locking is standard on the Credenzas with box/lateral and lateral drawers.
- Optional locking on doors (storage units) are available. Add suffix LO at the end of product code (e.g: AC17LB-LO).
- Optional Cushions (32" x 14") for Credenza tops are available (see Accessories section).

FREESTANDING CREDENZAS • GUIDELINES FOR ORDERING PRODUCT

CODES: The price list uses a product coding system that is specific to each of the units. The product description (next to the code) explains in detail the construction of the unit.

SPECIFICATION EXAMPLE OF A 96"W FREESTANDING CREDENZA

PRODUCT CODE: AC17LB

A = Corby Series

C = Credenza

17 = Product ID number (Freestanding Credenza 20H" x 96"W x 20"D)

LB = Low Base (4")

CHOOSE FINISH OPTION:

Standard Finish: Veneer top, chassis, fronts and matching hardwood legs. Please see page A.18

Laminate Finish: Please add "/P" to the end of the product code, includes HP laminate top, LP laminate chassis and fronts with painted hardwood legs. Please see page A.18

LOCK:

Choose optional lock on doors (see Accessories section).

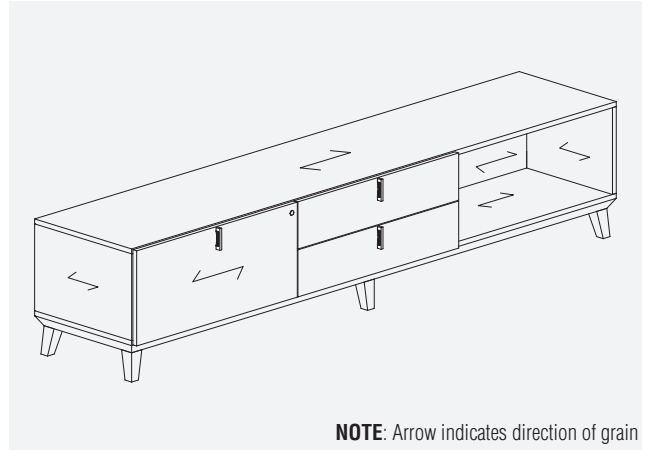

NOTE: Arrow indicates direction of grain

AC1LLB • 20"H Freestanding Credenza, 64"W

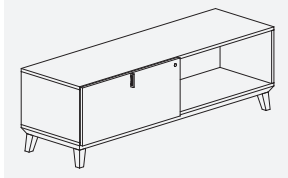

| PRODUCT | PRICE | | SIZE (INCHES) | | | WEIGHT VOL | |
|---------|----------|----------|---------------|----|----|------------|-----------------|
| | STANDARD | LAMINATE | H | W | D | LBS | FT ³ |
| AC1LLB | 3881 | 3104 | 20 | 64 | 20 | 161 | 17 |

- Freestanding credenza with front locking lateral drawer left, open right
- Low base

AC1RLB • 20"H Freestanding Credenza, 64"W

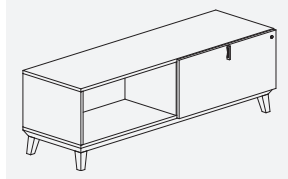

| PRODUCT | PRICE | | SIZE (INCHES) | | | WEIGHT VOL | |
|---------|----------|----------|---------------|----|----|------------|-----------------|
| | STANDARD | LAMINATE | H | W | D | LBS | FT ³ |
| AC1RLB | 3881 | 3104 | 20 | 64 | 20 | 161 | 17 |

- Freestanding credenza, open left, front locking lateral drawer right
- Low base

AC2LB • 20"H Freestanding Credenza, 64"W

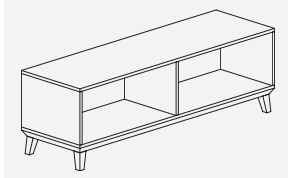

| PRODUCT | PRICE | | SIZE (INCHES) | | | WEIGHT VOL | |
|---------|----------|----------|---------------|----|----|------------|-----------------|
| | STANDARD | LAMINATE | H | W | D | LBS | FT ³ |
| AC2LB | 3313 | 2651 | 20 | 64 | 20 | 141 | 17 |

- Freestanding credenza, open left and right
- Low base

AC3LB • 20”H Freestanding Credenza, 64”W

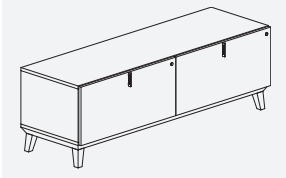

| PRODUCT | PRICE | | SIZE (INCHES) | | | WEIGHT VOL | |
|---------|----------|----------|---------------|----|----|------------|-----------------|
| | STANDARD | LAMINATE | H | W | D | LBS | FT ³ |
| AC3LB | 4311 | 3449 | 20 | 64 | 20 | 180 | 17 |

- Freestanding credenza, two front locking lateral drawers
- Low base

AC4LLB • 20”H Freestanding Credenza, 64”W

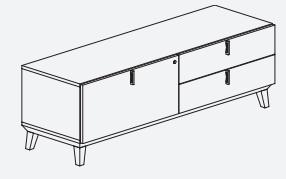

| PRODUCT | PRICE | | SIZE (INCHES) | | | WEIGHT VOL | |
|---------|----------|----------|---------------|----|----|------------|-----------------|
| | STANDARD | LAMINATE | H | W | D | LBS | FT ³ |
| AC4LLB | 4299 | 3439 | 20 | 64 | 20 | 179 | 17 |

- Freestanding credenza, front locking lateral drawer left, two box drawers right
- Low base

AC4RLB • 20”H Freestanding Credenza, 64”W

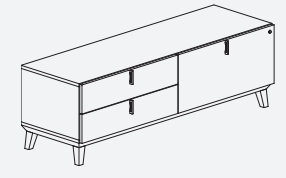

| PRODUCT | PRICE | | SIZE (INCHES) | | | WEIGHT VOL | |
|---------|----------|----------|---------------|----|----|------------|-----------------|
| | STANDARD | LAMINATE | H | W | D | LBS | FT ³ |
| AC4RLB | 4299 | 3439 | 20 | 64 | 20 | 179 | 17 |

- Freestanding credenza, two box drawers left, front locking lateral drawer right
- Low base

AC5LLB • 20”H Freestanding Credenza, 64”W

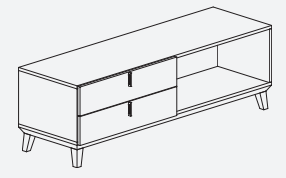

| PRODUCT | PRICE | | SIZE (INCHES) | | | WEIGHT VOL | |
|---------|----------|----------|---------------|----|----|------------|-----------------|
| | STANDARD | LAMINATE | H | W | D | LBS | FT ³ |
| AC5LLB | 3881 | 3104 | 20 | 64 | 20 | 160 | 17 |

- Freestanding credenza, two box drawers left, open right
- Low base

AC5RLB • 20”H Freestanding Credenza, 64”W

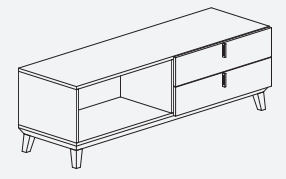

| PRODUCT | PRICE | | SIZE (INCHES) | | | WEIGHT VOL | |
|---------|----------|----------|---------------|----|----|------------|-----------------|
| | STANDARD | LAMINATE | H | W | D | LBS | FT ³ |
| AC5RLB | 3881 | 3104 | 20 | 64 | 20 | 160 | 17 |

- Freestanding credenza, open left, two box drawers right
- Low base

AC6LB • 20”H Freestanding Credenza, 64”W

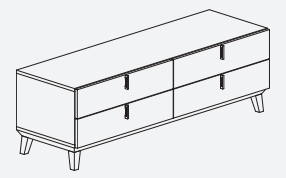

| PRODUCT | PRICE | | SIZE (INCHES) | | | WEIGHT VOL | |
|---------|----------|----------|---------------|----|----|------------|-----------------|
| | STANDARD | LAMINATE | H | W | D | LBS | FT ³ |
| AC6LB | 4149 | 3320 | 20 | 64 | 20 | 179 | 17 |

- Freestanding credenza, four box drawers
- Low base

AC7LB • 28”H Freestanding Credenza, 64”W

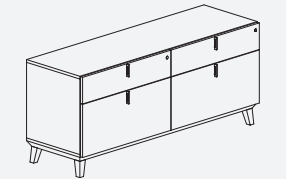

| PRODUCT | PRICE | | SIZE (INCHES) | | | WEIGHT VOL | |
|---------|----------|----------|---------------|----|----|------------|-----------------|
| | STANDARD | LAMINATE | H | W | D | LBS | FT ³ |
| AC7LB | 5204 | 4162 | 27.5 | 64 | 20 | 213 | 23 |

- Freestanding credenza, front locking lateral drawer with box drawer left and right
- Low base

AC8LLB • 28”H Freestanding Credenza, 64”W

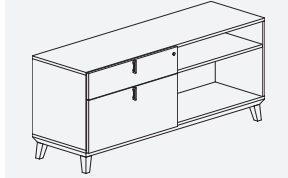

| PRODUCT | PRICE | | SIZE (INCHES) | | | WEIGHT | VOL |
|---------|----------|----------|---------------|----|----|--------|-----------------|
| | STANDARD | LAMINATE | H | W | D | LBS | FT ³ |
| AC8LLB | 4622 | 3699 | 27.5 | 64 | 20 | 194 | 23 |

- Freestanding credenza, front locking lateral drawer with box drawer left, open with fixed shelf right
- Low base

AC8RLB • 28”H Freestanding Credenza, 64”W

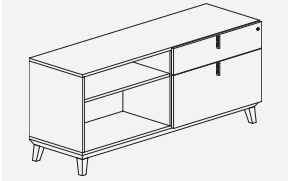

| PRODUCT | PRICE | | SIZE (INCHES) | | | WEIGHT | VOL |
|---------|----------|----------|---------------|----|----|--------|-----------------|
| | STANDARD | LAMINATE | H | W | D | LBS | FT ³ |
| AC8RLB | 4622 | 3699 | 27.5 | 64 | 20 | 194 | 23 |

- Freestanding credenza, open with fixed shelf left, front locking lateral drawer with box drawer right
- Low base

AC9LB • 28”H Freestanding Credenza, 64”W

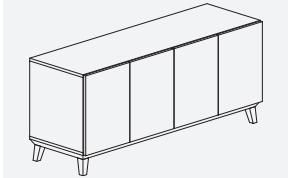

| PRODUCT | PRICE | | SIZE (INCHES) | | | WEIGHT | VOL |
|---------|----------|----------|---------------|----|----|--------|-----------------|
| | STANDARD | LAMINATE | H | W | D | LBS | FT ³ |
| AC9LB | 4595 | 3676 | 27.5 | 64 | 20 | 189 | 23 |

- Freestanding credenza, four doors with two adjustable shelves
- Low base

AC10LLB • 28”H Freestanding Credenza, 64”W

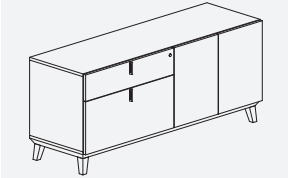

| PRODUCT | PRICE | | SIZE (INCHES) | | | WEIGHT | VOL |
|---------|----------|----------|---------------|----|----|--------|-----------------|
| | STANDARD | LAMINATE | H | W | D | LBS | FT ³ |
| AC10LLB | 4893 | 3916 | 27.5 | 64 | 20 | 206 | 23 |

- Freestanding credenza, front locking lateral drawer with box drawer left, two doors with adjustable shelf right
- Low base

AC10RLB • 28”H Freestanding Credenza, 64”W

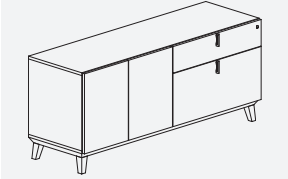

| PRODUCT | PRICE | | SIZE (INCHES) | | | WEIGHT | VOL |
|---------|----------|----------|---------------|----|----|--------|-----------------|
| | STANDARD | LAMINATE | H | W | D | LBS | FT ³ |
| AC10RLB | 4893 | 3916 | 27.5 | 64 | 20 | 206 | 23 |

- Freestanding credenza, two doors with adjustable shelf left, front locking lateral drawer with box drawer right
- Low base

AC1LHB • 28”H Freestanding Credenza, 64”W

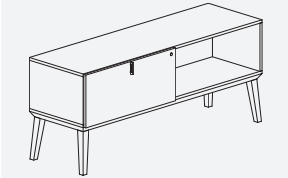

| PRODUCT | PRICE | | SIZE (INCHES) | | | WEIGHT | VOL |
|---------|----------|----------|---------------|----|----|--------|-----------------|
| | STANDARD | LAMINATE | H | W | D | LBS | FT ³ |
| AC1LHB | 4149 | 3320 | 27.5 | 64 | 20 | 166 | 23 |

- Freestanding credenza, front locking lateral drawer left, open right
- High base

AC1RHB • 28”H Freestanding Credenza, 64”W

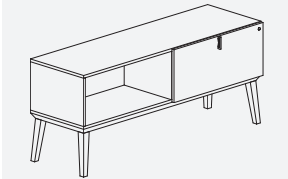

| PRODUCT | PRICE | | SIZE (INCHES) | | | WEIGHT | VOL |
|---------|----------|----------|---------------|----|----|--------|-----------------|
| | STANDARD | LAMINATE | H | W | D | LBS | FT ³ |
| AC1RHB | 4149 | 3320 | 27.5 | 64 | 20 | 166 | 23 |

- Freestanding credenza, open left, front locking lateral drawer right
- High base

AC2HB • 28”H Freestanding Credenza, 64”W

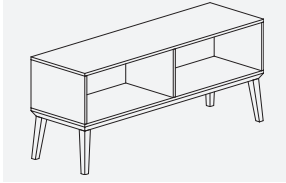

| PRODUCT | PRICE | | SIZE (INCHES) | | | WEIGHT VOL | |
|---------|----------|----------|---------------|----|----|------------|-----------------|
| | STANDARD | LAMINATE | H | W | D | LBS | FT ³ |
| AC2HB | 3582 | 2864 | 27.5 | 64 | 20 | 146 | 23 |

- Freestanding credenza, open left, open right
- High base

AC3HB • 28”H Freestanding Credenza, 64”W

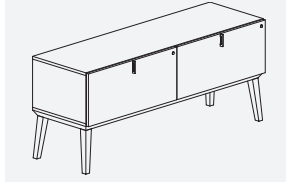

| PRODUCT | PRICE | | SIZE (INCHES) | | | WEIGHT VOL | |
|---------|----------|----------|---------------|----|----|------------|-----------------|
| | STANDARD | LAMINATE | H | W | D | LBS | FT ³ |
| AC3HB | 4447 | 3560 | 27.5 | 64 | 20 | 185 | 23 |

- Freestanding credenza, two front locking lateral drawers
- High base

AC4LHB • 28”H Freestanding Credenza, 64”W

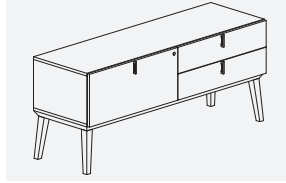

| PRODUCT | PRICE | | SIZE (INCHES) | | | WEIGHT VOL | |
|---------|----------|----------|---------------|----|----|------------|-----------------|
| | STANDARD | LAMINATE | H | W | D | LBS | FT ³ |
| AC4LHB | 4433 | 3548 | 27.5 | 64 | 20 | 184 | 23 |

- Freestanding credenza, front locking lateral drawer left, two box drawers right
- High base

AC4RHB • 28”H Freestanding Credenza, 64”W

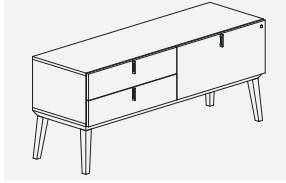

| PRODUCT | PRICE | | SIZE (INCHES) | | | WEIGHT VOL | |
|---------|----------|----------|---------------|----|----|------------|-----------------|
| | STANDARD | LAMINATE | H | W | D | LBS | FT ³ |
| AC4RHB | 4433 | 3548 | 27.5 | 64 | 20 | 184 | 23 |

- Freestanding credenza, two box drawers left, front locking lateral right
- High base

AC5LHB • 28”H Freestanding Credenza, 64”W

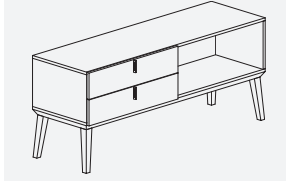

| PRODUCT | PRICE | | SIZE (INCHES) | | | WEIGHT VOL | |
|---------|----------|----------|---------------|----|----|------------|-----------------|
| | STANDARD | LAMINATE | H | W | D | LBS | FT ³ |
| AC5LHB | 4149 | 3320 | 27.5 | 64 | 20 | 165 | 23 |

- Freestanding credenza, two box drawers left, open right
- High base

AC5RHB • 28”H Freestanding Credenza, 64”W

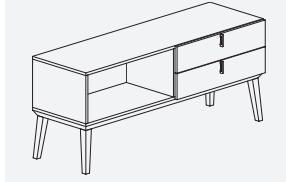

| PRODUCT | PRICE | | SIZE (INCHES) | | | WEIGHT VOL | |
|---------|----------|----------|---------------|----|----|------------|-----------------|
| | STANDARD | LAMINATE | H | W | D | LBS | FT ³ |
| AC5RHB | 4149 | 3320 | 27.5 | 64 | 20 | 165 | 23 |

- Freestanding credenza, open left, two box drawers right
- High base

AC6HB • 28”H Freestanding Credenza, 64”W

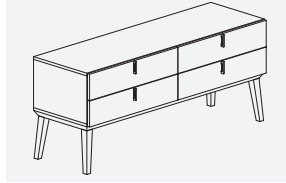

| PRODUCT | PRICE | | SIZE (INCHES) | | | WEIGHT VOL | |
|---------|----------|----------|---------------|----|----|------------|-----------------|
| | STANDARD | LAMINATE | H | W | D | LBS | FT ³ |
| AC6HB | 4419 | 3537 | 27.5 | 64 | 20 | 184 | 23 |

- Freestanding credenza with four box drawers
- High base

AC7HB • 35”H Freestanding Credenza, 64”W

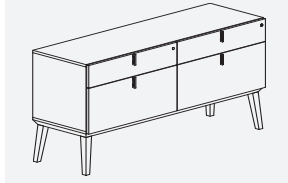

| PRODUCT | PRICE | | SIZE (INCHES) | | | WEIGHT VOL | |
|---------|----------|----------|---------------|----|----|------------|-----------------|
| | STANDARD | LAMINATE | H | W | D | LBS | FT ³ |
| AC7HB | 5475 | 4381 | 35 | 64 | 20 | 218 | 29 |

- Freestanding credenza, front locking lateral with box drawer left and right
- High base

AC8LHB • 35”H Freestanding Credenza, 64”W

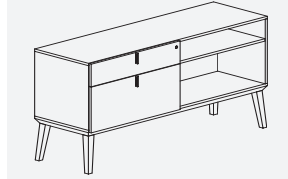

| PRODUCT | PRICE | | SIZE (INCHES) | | | WEIGHT VOL | |
|---------|----------|----------|---------------|----|----|------------|-----------------|
| | STANDARD | LAMINATE | H | W | D | LBS | FT ³ |
| AC8LHB | 4893 | 3916 | 35 | 64 | 20 | 199 | 29 |

- Freestanding credenza, front locking lateral with box drawer left, open with fixed - shelf right

AC8RHB • 35”H Freestanding Credenza, 64”W

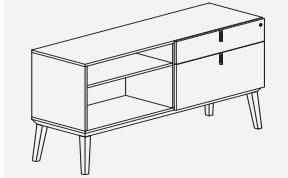

| PRODUCT | PRICE | | SIZE (INCHES) | | | WEIGHT VOL | |
|---------|----------|----------|---------------|----|----|------------|-----------------|
| | STANDARD | LAMINATE | H | W | D | LBS | FT ³ |
| AC8RHB | 4893 | 3916 | 35 | 64 | 20 | 199 | 29 |

- Freestanding credenza, open with fixed shelf left, front locking lateral with box drawer right
- High base

AC9HB • 35”H Freestanding Credenza, 64”W

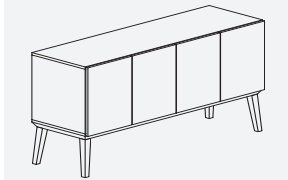

| PRODUCT | PRICE | | SIZE (INCHES) | | | WEIGHT VOL | |
|---------|----------|----------|---------------|----|----|------------|-----------------|
| | STANDARD | LAMINATE | H | W | D | LBS | FT ³ |
| AC9HB | 4866 | 3894 | 35 | 64 | 20 | 194 | 29 |

- Freestanding credenza, four doors with two adjustable shelves
- High base

AC10LHB • 35”H Freestanding Credenza, 64”W

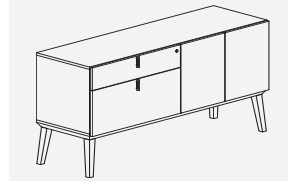

| PRODUCT | PRICE | | SIZE (INCHES) | | | WEIGHT VOL | |
|---------|----------|----------|---------------|----|----|------------|-----------------|
| | STANDARD | LAMINATE | H | W | D | LBS | FT ³ |
| AC10LHB | 5162 | 4131 | 35 | 64 | 20 | 211 | 29 |

- Freestanding credenza, front locking lateral drawer with box drawer left, two doors with adjustable shelf right
- High base

AC10RHB • 35”H Freestanding Credenza, 64”W

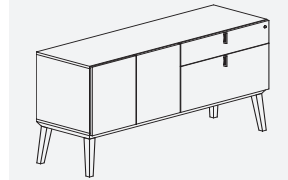

| PRODUCT | PRICE | | SIZE (INCHES) | | | WEIGHT VOL | |
|---------|----------|----------|---------------|----|----|------------|-----------------|
| | STANDARD | LAMINATE | H | W | D | LBS | FT ³ |
| AC10RHB | 5162 | 4131 | 35 | 64 | 20 | 211 | 29 |

- Freestanding credenza, two doors with adjustable shelf left, front locking lateral drawer with box drawer right
- High base

AC11LB • 20”H Freestanding Credenza, 96”W

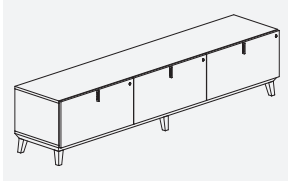

| PRODUCT | PRICE | | SIZE (INCHES) | | | WEIGHT VOL | |
|---------|----------|----------|---------------|----|----|------------|-----------------|
| | STANDARD | LAMINATE | H | W | D | LBS | FT ³ |
| AC11LB | 6434 | 5148 | 20 | 96 | 20 | 259 | 25 |

- Freestanding credenza, three front locking lateral drawers
- Low base

AC12LB • 20”H Freestanding Credenza, 96”W

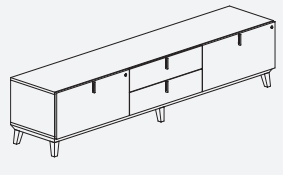

| PRODUCT | PRICE | | SIZE (INCHES) | | | WEIGHT VOL | |
|---------|----------|----------|---------------|----|----|------------|-----------------|
| | STANDARD | LAMINATE | H | W | D | LBS | FT ³ |
| AC12LB | 6421 | 5139 | 20 | 96 | 20 | 258 | 25 |

- Freestanding credenza, front locking lateral drawer left, two box drawers centre, front locking lateral drawer right
- Low base

AC13LB • 20”H Freestanding Credenza, 96”W

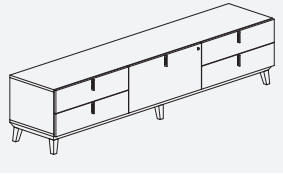

| PRODUCT | PRICE | | SIZE (INCHES) | | | WEIGHT VOL | |
|---------|----------|----------|---------------|----|----|------------|-----------------|
| | STANDARD | LAMINATE | H | W | D | LBS | FT ³ |
| AC13LB | 6408 | 5127 | 20 | 96 | 20 | 257 | 25 |

- Freestanding credenza, two box drawers left, front locking lateral drawer centre, two box drawers right
- Low base

AC14LB • 20”H Freestanding Credenza, 96”W

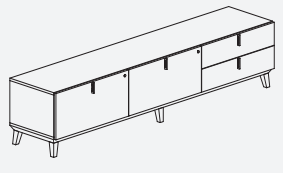

| PRODUCT | PRICE | | SIZE (INCHES) | | | WEIGHT VOL | |
|---------|----------|----------|---------------|----|----|------------|-----------------|
| | STANDARD | LAMINATE | H | W | D | LBS | FT ³ |
| AC14LB | 6421 | 5139 | 20 | 96 | 20 | 258 | 25 |

- Freestanding credenza, front locking lateral drawer left and centre, two box drawers right
- Low base

AC15LB • 20”H Freestanding Credenza, 96”W

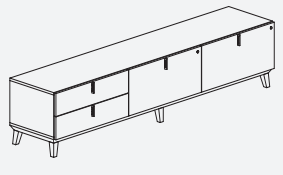

| PRODUCT | PRICE | | SIZE (INCHES) | | | WEIGHT VOL | |
|---------|----------|----------|---------------|----|----|------------|-----------------|
| | STANDARD | LAMINATE | H | W | D | LBS | FT ³ |
| AC15LB | 6421 | 5139 | 20 | 96 | 20 | 258 | 25 |

- Freestanding credenza with two box drawers left, front locking lateral drawer centre and right
- Low base

AC16LB • 20”H Freestanding Credenza, 96”W

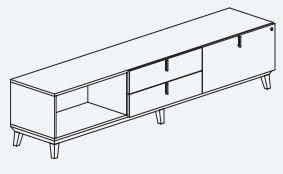

| PRODUCT | PRICE | | SIZE (INCHES) | | | WEIGHT VOL | |
|---------|----------|----------|---------------|----|----|------------|-----------------|
| | STANDARD | LAMINATE | H | W | D | LBS | FT ³ |
| AC16LB | 5987 | 4791 | 20 | 96 | 20 | 239 | 25 |

- Freestanding credenza, open left, two box drawers centre, front locking lateral drawer right
- Low base

AC17LB • 20”H Freestanding Credenza, 96”W

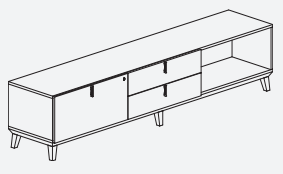

| PRODUCT | PRICE | | SIZE (INCHES) | | | WEIGHT VOL | |
|---------|----------|----------|---------------|----|----|------------|-----------------|
| | STANDARD | LAMINATE | H | W | D | LBS | FT ³ |
| AC17LB | 5987 | 4791 | 20 | 96 | 20 | 239 | 25 |

- Freestanding credenza, front locking lateral drawer left, two box drawers centre, open right
- Low base

AC18LB • 20”H Freestanding Credenza, 96”W

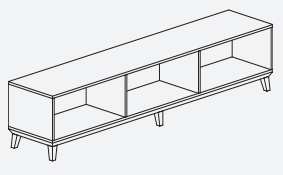

| PRODUCT | PRICE | | SIZE (INCHES) | | | WEIGHT VOL | |
|---------|----------|----------|---------------|----|----|------------|-----------------|
| | STANDARD | LAMINATE | H | W | D | LBS | FT ³ |
| AC18LB | 5135 | 4109 | 20 | 96 | 20 | 201 | 25 |

- Freestanding credenza, open left, centre and right
- Low base

AC19LB • 20”H Freestanding Credenza, 96”W

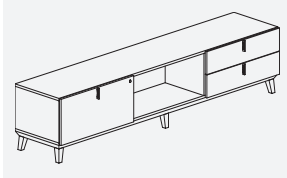

| PRODUCT | PRICE | | SIZE (INCHES) | | | WEIGHT VOL | |
|---------|----------|----------|---------------|----|----|------------|-----------------|
| | STANDARD | LAMINATE | H | W | D | LBS | FT ³ |
| AC19LB | 5987 | 4791 | 20 | 96 | 20 | 239 | 25 |

- Freestanding credenza, front locking lateral drawer left, open centre, two box drawers right
- Low base

AC20LB • 20”H Freestanding Credenza, 96”W

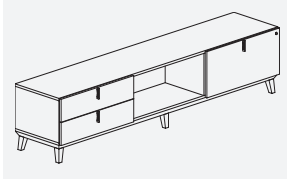

| PRODUCT | PRICE | | SIZE (INCHES) | | | WEIGHT VOL | |
|---------|----------|----------|---------------|----|----|------------|-----------------|
| | STANDARD | LAMINATE | H | W | D | LBS | FT ³ |
| AC20LB | 5987 | 4791 | 20 | 96 | 20 | 239 | 25 |

- Freestanding credenza, two box drawers left, open centre, front locking lateral drawer right
- Low base

AC21LB • 20”H Freestanding Credenza, 96”W

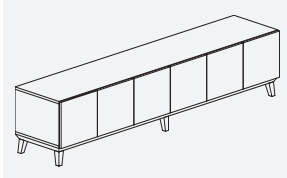

| PRODUCT | PRICE | | SIZE (INCHES) | | | WEIGHT VOL | |
|---------|----------|----------|---------------|----|----|------------|-----------------|
| | STANDARD | LAMINATE | H | W | D | LBS | FT ³ |
| AC21LB | 5677 | 4542 | 20 | 96 | 20 | 225 | 25 |

- Freestanding credenza with six doors
- Low base

AC22LB • 20”H Freestanding Credenza, 96”W

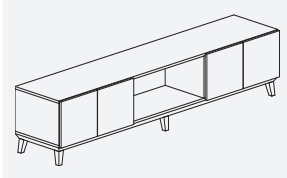

| PRODUCT | PRICE | | SIZE (INCHES) | | | WEIGHT VOL | |
|---------|----------|----------|---------------|----|----|------------|-----------------|
| | STANDARD | LAMINATE | H | W | D | LBS | FT ³ |
| AC22LB | 5542 | 4433 | 20 | 96 | 20 | 217 | 25 |

- Freestanding credenza with two doors left, open centre and two doors right
- Low base

AC23LB • 20”H Freestanding Credenza, 96”W

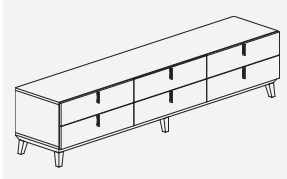

| PRODUCT | PRICE | | SIZE (INCHES) | | | WEIGHT VOL | |
|---------|----------|----------|---------------|----|----|------------|-----------------|
| | STANDARD | LAMINATE | H | W | D | LBS | FT ³ |
| AC23LB | 6394 | 5116 | 20 | 96 | 20 | 256 | 25 |

- Freestanding credenza with six box drawers
- Low base

AC24LB • 28”H Freestanding Credenza, 96”W

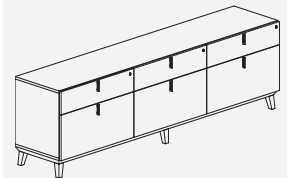

| PRODUCT | PRICE | | SIZE (INCHES) | | | WEIGHT VOL | |
|---------|----------|----------|---------------|----|----|------------|-----------------|
| | STANDARD | LAMINATE | H | W | D | LBS | FT ³ |
| AC24LB | 7069 | 5655 | 27.5 | 96 | 20 | 304 | 34 |

- Freestanding credenza, front locking lateral drawer with box drawer left, centre and right
- Low base

AC25LB • 28”H Freestanding Credenza, 96”W

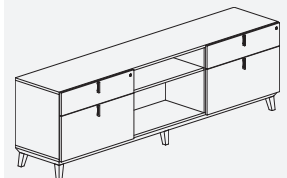

| PRODUCT | PRICE | | SIZE (INCHES) | | | WEIGHT VOL | |
|---------|----------|----------|---------------|----|----|------------|-----------------|
| | STANDARD | LAMINATE | H | W | D | LBS | FT ³ |
| AC25LB | 6421 | 5139 | 27.5 | 96 | 20 | 284 | 34 |

- Freestanding credenza, front locking lateral drawer with box drawer left, open with fixed shelf centre and front locking lateral drawer with box drawer right
- Low base

AC26LB • 28”H Freestanding Credenza, 96”W

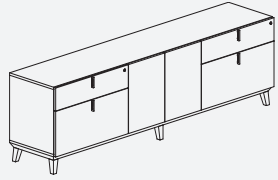

| PRODUCT | PRICE | | SIZE (INCHES) | | | WEIGHT VOL | |
|---------|----------|----------|---------------|----|----|------------|-----------------|
| | STANDARD | LAMINATE | H | W | D | LBS | FT ³ |
| AC26LB | 6556 | 5246 | 27.5 | 96 | 20 | 296 | 34 |

- Freestanding credenza, front locking lateral drawer with box drawer left, two door storage with adjustable shelf centre and front locking lateral drawer with box drawer right

AC27LB • 28”H Freestanding Credenza, 96”W

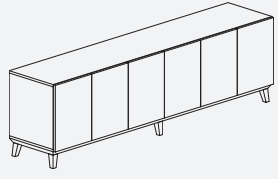

| PRODUCT | PRICE | | SIZE (INCHES) | | | WEIGHT VOL | |
|---------|----------|----------|---------------|----|----|------------|-----------------|
| | STANDARD | LAMINATE | H | W | D | LBS | FT ³ |
| AC27LB | 6081 | 4866 | 27.5 | 96 | 20 | 281 | 34 |

- Freestanding credenza, six doors with three adjustable shelves
- Low base

AC28LB • 28”H Freestanding Credenza, 96”W

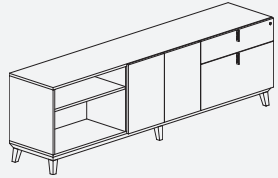

| PRODUCT | PRICE | | SIZE (INCHES) | | | WEIGHT VOL | |
|---------|----------|----------|---------------|----|----|------------|-----------------|
| | STANDARD | LAMINATE | H | W | D | LBS | FT ³ |
| AC28LB | 5906 | 4726 | 27.5 | 96 | 20 | 277 | 34 |

- Freestanding credenza, open with fixed shelf left, two door storage with adjustable shelf centre, front locking lateral drawer with box drawer right
- Low base

AC29LB • 28”H Freestanding Credenza, 96”W

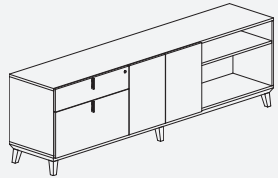

| PRODUCT | PRICE | | SIZE (INCHES) | | | WEIGHT VOL | |
|---------|----------|----------|---------------|----|----|------------|-----------------|
| | STANDARD | LAMINATE | H | W | D | LBS | FT ³ |
| AC29LB | 5906 | 4726 | 27.5 | 96 | 20 | 277 | 34 |

- Freestanding credenza, front locking lateral drawer with box drawer left, two door storage with adjustable shelf centre, open with fixed shelf right
- Low base

AC30LB • 28”H Freestanding Credenza, 96”W

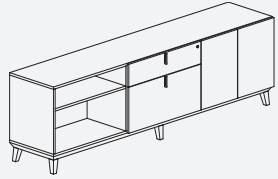

| PRODUCT | PRICE | | SIZE (INCHES) | | | WEIGHT VOL | |
|---------|----------|----------|---------------|----|----|------------|-----------------|
| | STANDARD | LAMINATE | H | W | D | LBS | FT ³ |
| AC30LB | 5906 | 4726 | 27.5 | 96 | 20 | 277 | 34 |

- Freestanding credenza, open with fixed shelf left, front locking lateral drawer with box drawer centre, two door storage with adjustable shelf right
- Low base

AC31LB • 28”H Freestanding Credenza, 96”W

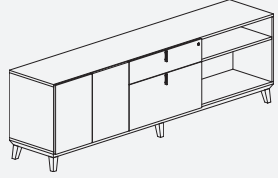

| PRODUCT | PRICE | | SIZE (INCHES) | | | WEIGHT VOL | |
|---------|----------|----------|---------------|----|----|------------|-----------------|
| | STANDARD | LAMINATE | H | W | D | LBS | FT ³ |
| AC31LB | 5906 | 4726 | 27.5 | 96 | 20 | 277 | 34 |

- Freestanding credenza, two door storage with adjustable shelf left, front locking lateral drawer with box drawer centre, open with fixed shelf right
- Low base

AC32LB • 28”H Freestanding Credenza, 96”W

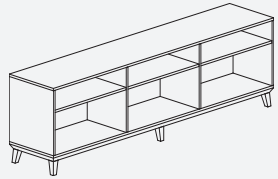

| PRODUCT | PRICE | | SIZE (INCHES) | | | WEIGHT VOL | |
|---------|----------|----------|---------------|----|----|------------|-----------------|
| | STANDARD | LAMINATE | H | W | D | LBS | FT ³ |
| AC32LB | 5677 | 4542 | 27.5 | 96 | 20 | 245 | 34 |

- Freestanding credenza, open with fixed shelf left, centre and right
- Low base

AC11HB • 28”H Freestanding Credenza, 96”W

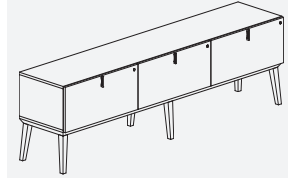

| PRODUCT | PRICE | | SIZE (INCHES) | | | WEIGHT VOL | |
|---------|----------|----------|---------------|----|----|------------|-----------------|
| | STANDARD | LAMINATE | H | W | D | LBS | FT ³ |
| AC11HB | 6703 | 5364 | 27.5 | 96 | 20 | 264 | 34 |

- Freestanding credenza, three front locking lateral drawers
- High base

AC12HB • 28”H Freestanding Credenza, 96”W

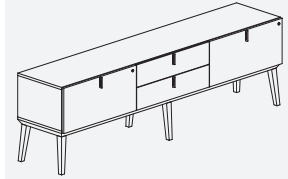

| PRODUCT | PRICE | | SIZE (INCHES) | | | WEIGHT VOL | |
|---------|----------|----------|---------------|----|----|------------|-----------------|
| | STANDARD | LAMINATE | H | W | D | LBS | FT ³ |
| AC12HB | 6691 | 5354 | 27.5 | 96 | 20 | 263 | 34 |

- Freestanding credenza, front locking lateral drawer left, two box drawers centre, front locking lateral drawer right
- High base

AC13HB • 28”H Freestanding Credenza, 96”W

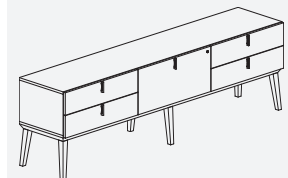

| PRODUCT | PRICE | | SIZE (INCHES) | | | WEIGHT VOL | |
|---------|----------|----------|---------------|----|----|------------|-----------------|
| | STANDARD | LAMINATE | H | W | D | LBS | FT ³ |
| AC13HB | 6676 | 5343 | 27.5 | 96 | 20 | 262 | 34 |

- Freestanding credenza, two box drawers left, front locking lateral drawer centre, two box drawers right
- High base

AC14HB • 28”H Freestanding Credenza, 96”W

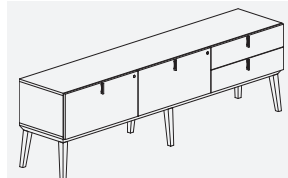

| PRODUCT | PRICE | | SIZE (INCHES) | | | WEIGHT VOL | |
|---------|----------|----------|---------------|----|----|------------|-----------------|
| | STANDARD | LAMINATE | H | W | D | LBS | FT ³ |
| AC14HB | 6691 | 5354 | 27.5 | 96 | 20 | 263 | 34 |

- Freestanding credenza, front locking lateral drawer left and centre, two box drawers right
- High base

AC15HB • 28”H Freestanding Credenza, 96”W

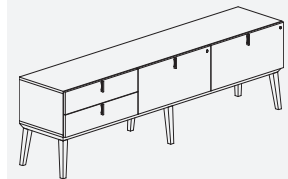

| PRODUCT | PRICE | | SIZE (INCHES) | | | WEIGHT VOL | |
|---------|----------|----------|---------------|----|----|------------|-----------------|
| | STANDARD | LAMINATE | H | W | D | LBS | FT ³ |
| AC15HB | 6691 | 5354 | 27.5 | 96 | 20 | 263 | 34 |

- Freestanding credenza with two box drawers left, front locking lateral drawer centre and right
- High base

AC16HB • 28”H Freestanding Credenza, 96”W

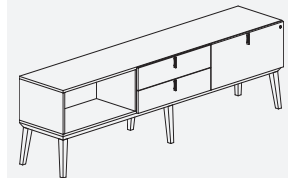

| PRODUCT | PRICE | | SIZE (INCHES) | | | WEIGHT VOL | |
|---------|----------|----------|---------------|----|----|------------|-----------------|
| | STANDARD | LAMINATE | H | W | D | LBS | FT ³ |
| AC16HB | 6257 | 5006 | 27.5 | 96 | 20 | 244 | 34 |

- Freestanding credenza, open left, two box drawers centre, front locking lateral drawer right
- High base

AC17HB • 28”H Freestanding Credenza, 96”W

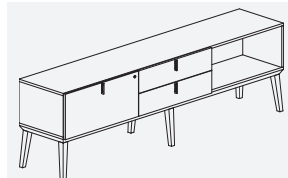

| PRODUCT | PRICE | | SIZE (INCHES) | | | WEIGHT VOL | |
|---------|----------|----------|---------------|----|----|------------|-----------------|
| | STANDARD | LAMINATE | H | W | D | LBS | FT ³ |
| AC17HB | 6257 | 5006 | 27.5 | 96 | 20 | 244 | 34 |

- Freestanding credenza, front locking lateral drawer left, two box drawers centre, open right
- High base

AC18HB • 28”H Freestanding Credenza, 96”W

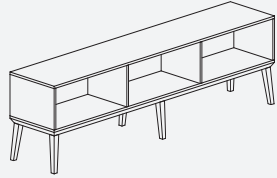

| PRODUCT | PRICE | | SIZE (INCHES) | | | WEIGHT VOL | |
|---------|----------|----------|---------------|----|----|------------|-----------------|
| | STANDARD | LAMINATE | H | W | D | LBS | FT ³ |
| AC18HB | 5407 | 4325 | 27.5 | 96 | 20 | 206 | 34 |

- Freestanding credenza, open left, centre and right
- High base

AC19HB • 28”H Freestanding Credenza, 96”W

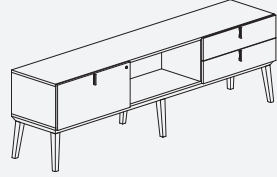

| PRODUCT | PRICE | | SIZE (INCHES) | | | WEIGHT VOL | |
|---------|----------|----------|---------------|----|----|------------|-----------------|
| | STANDARD | LAMINATE | H | W | D | LBS | FT ³ |
| AC19HB | 6257 | 5006 | 27.5 | 96 | 20 | 244 | 34 |

- Freestanding credenza, front locking lateral drawer left, open centre, two box drawers right
- High base

AC20HB • 28”H Freestanding Credenza, 96”W

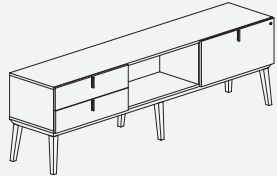

| PRODUCT | PRICE | | SIZE (INCHES) | | | WEIGHT VOL | |
|---------|----------|----------|---------------|----|----|------------|-----------------|
| | STANDARD | LAMINATE | H | W | D | LBS | FT ³ |
| AC20HB | 6257 | 5006 | 27.5 | 96 | 20 | 244 | 34 |

- Freestanding credenza, two box drawers left, open centre, front locking lateral drawer right
- High base

AC21HB • 28”H Freestanding Credenza, 96”W

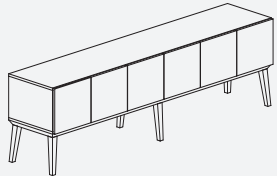

| PRODUCT | PRICE | | SIZE (INCHES) | | | WEIGHT VOL | |
|---------|----------|----------|---------------|----|----|------------|-----------------|
| | STANDARD | LAMINATE | H | W | D | LBS | FT ³ |
| AC21HB | 5948 | 4760 | 27.5 | 96 | 20 | 230 | 34 |

- Freestanding credenza with six doors
- High base

AC22HB • 28”H Freestanding Credenza, 96”W

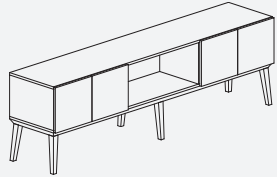

| PRODUCT | PRICE | | SIZE (INCHES) | | | WEIGHT VOL | |
|---------|----------|----------|---------------|----|----|------------|-----------------|
| | STANDARD | LAMINATE | H | W | D | LBS | FT ³ |
| AC22HB | 5810 | 4649 | 27.5 | 96 | 20 | 222 | 34 |

- Freestanding credenza with two doors left, open centre, two doors right
- High base

AC23HB • 28”H Freestanding Credenza, 96”W

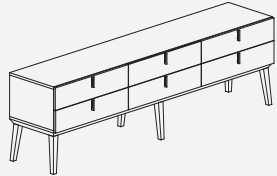

| PRODUCT | PRICE | | SIZE (INCHES) | | | WEIGHT VOL | |
|---------|----------|----------|---------------|----|----|------------|-----------------|
| | STANDARD | LAMINATE | H | W | D | LBS | FT ³ |
| AC23HB | 6664 | 5333 | 27.5 | 96 | 20 | 261 | 34 |

- Freestanding credenza with six box drawers
- High base

AC24HB • 35”H Freestanding Credenza, 96”W

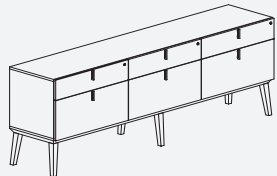

| PRODUCT | PRICE | | SIZE (INCHES) | | | WEIGHT VOL | |
|---------|----------|----------|---------------|----|----|------------|-----------------|
| | STANDARD | LAMINATE | H | W | D | LBS | FT ³ |
| AC24HB | 7340 | 5873 | 35 | 96 | 20 | 309 | 43 |

- Freestanding credenza, front locking lateral drawer with box drawer left, centre and right
- High base

AC25HB • 35”H Freestanding Credenza, 96”W

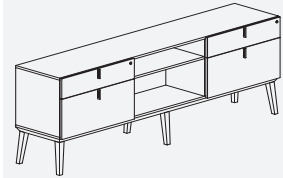

| PRODUCT | PRICE | | SIZE (INCHES) | | | WEIGHT VOL | |
|---------|----------|----------|---------------|----|----|------------|-----------------|
| | STANDARD | LAMINATE | H | W | D | LBS | FT ³ |
| AC25HB | 6691 | 5354 | 35 | 96 | 20 | 289 | 43 |

- Freestanding credenza, front locking lateral drawer with box drawer left, open with fixed shelf centre, front locking lateral drawer with box drawer right
- High base

AC26HB • 35”H Freestanding Credenza, 96”W

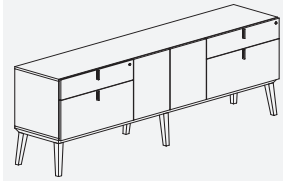

| PRODUCT | PRICE | | SIZE (INCHES) | | | WEIGHT VOL | |
|---------|----------|----------|---------------|----|----|------------|-----------------|
| | STANDARD | LAMINATE | H | W | D | LBS | FT ³ |
| AC26HB | 6824 | 5462 | 35 | 96 | 20 | 301 | 43 |

- Freestanding credenza, front locking lateral drawer with box drawer left, two door storage with adjustable shelf centre, front locking lateral drawer with box drawer right
- High base

AC27HB • 35”H Freestanding Credenza, 96”W

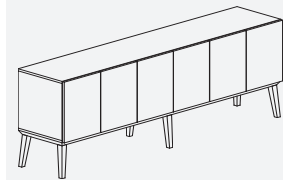

| PRODUCT | PRICE | | SIZE (INCHES) | | | WEIGHT VOL | |
|---------|----------|----------|---------------|----|----|------------|-----------------|
| | STANDARD | LAMINATE | H | W | D | LBS | FT ³ |
| AC27HB | 6353 | 5083 | 35 | 96 | 20 | 286 | 43 |

- Freestanding credenza, six doors with three adjustable shelves
- High base

AC28HB • 35”H Freestanding Credenza, 96”W

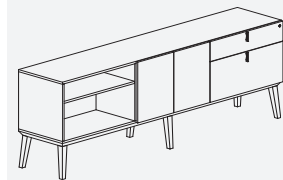

| PRODUCT | PRICE | | SIZE (INCHES) | | | WEIGHT VOL | |
|---------|----------|----------|---------------|----|----|------------|-----------------|
| | STANDARD | LAMINATE | H | W | D | LBS | FT ³ |
| AC28HB | 6175 | 4940 | 35 | 96 | 20 | 282 | 43 |

- Freestanding credenza, open with fixed shelf left, two door storage with adjustable shelf centre, front locking lateral drawer with box drawer right
- High base

AC29HB • 35”H Freestanding Credenza, 96”W

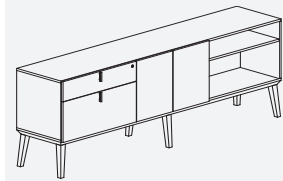

| PRODUCT | PRICE | | SIZE (INCHES) | | | WEIGHT VOL | |
|---------|----------|----------|---------------|----|----|------------|-----------------|
| | STANDARD | LAMINATE | H | W | D | LBS | FT ³ |
| AC29HB | 6175 | 4940 | 35 | 96 | 20 | 282 | 43 |

- Freestanding credenza, front locking lateral drawer with box drawer left, two door storage with adjustable shelf centre, open with fixed shelf right
- High base

AC30HB • 35”H Freestanding Credenza, 96”W

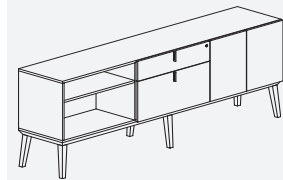

| PRODUCT | PRICE | | SIZE (INCHES) | | | WEIGHT VOL | |
|---------|----------|----------|---------------|----|----|------------|-----------------|
| | STANDARD | LAMINATE | H | W | D | LBS | FT ³ |
| AC30HB | 6175 | 4940 | 35 | 96 | 20 | 282 | 43 |

- Freestanding credenza, open with fixed shelf left, front locking lateral drawer with box drawer centre, two door storage with adjustable shelf right
- High base

AC31HB • 35”H Freestanding Credenza, 96”W

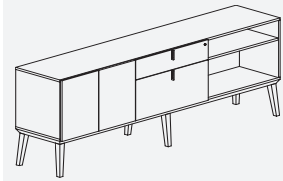

| PRODUCT | PRICE | | SIZE (INCHES) | | | WEIGHT VOL | |
|---------|----------|----------|---------------|----|----|------------|-----------------|
| | STANDARD | LAMINATE | H | W | D | LBS | FT ³ |
| AC31HB | 6175 | 4940 | 35 | 96 | 20 | 282 | 43 |

- Freestanding credenza, two door storage with adjustable shelf left, front locking lateral drawer with box drawer centre, open with fixed shelf right
- High base

AC32HB • 35”H Freestanding Credenza, 96”W

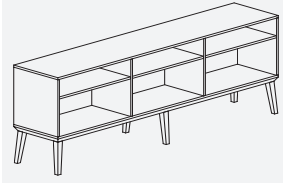

| PRODUCT | PRICE | | SIZE (INCHES) | | | WEIGHT VOL | |
|---------|----------|----------|---------------|----|----|------------|-----------------|
| | STANDARD | LAMINATE | H | W | D | LBS | FT ³ |
| AC32HB | 5948 | 4760 | 35 | 96 | 20 | 250 | 43 |

- Freestanding credenza, open with fixed shelf left, centre and right
- High base

32"W and 64"W STACK-ON BOOKCASES and STORAGE CABINETS • TECHNICAL INFORMATION

- All Stack-on Bookcases and Storage Cabinets are shipped assembled.
- Stack-on units are designed to be placed and installed on top of the Credenzas with Low or High Base.
- Stack on Units are available in three heights 29.5", 44" and 58.5".
- Back Panels of the Stack-on units are made of LP solid colour laminate.
- Optional Wood Back Panel is available at an upcharge of \$403. Add suffix "/W" at the end of the product code. (e.g. AS15/W)
- Optional locking on doors (storage units) are available. Add suffix "LO" at the end of the product code. (e.g. AS15-LO)
- Optional handles on doors (storage units) are available (see Accessories section).

STACK-ON BOOKCASES • GUIDELINES FOR ORDERING PRODUCT

CODES: The price list uses a product coding system that is specific to each of the units. The product description (next to the code) explains in detail the construction of the unit.

SPECIFICATION EXAMPLE OF A 64"W STACK-ON BOOKCASE
PRODUCT CODE: AS15 (/P for All Laminate or /W for All Wood Finish)
 A = Corby Series
 S = Stack-on Unit
 15 = Product ID number (Stack-on Bookcase 44"H x 64"W x 14.5"D)

CHOOSE FINISH OPTION:
 Standard Finish: Veneer chassis and fronts with LP laminate back panel. Please see page A.18
 Laminate Finish: Please add "/P" to the end of the product code, includes LP laminate chassis, fronts and back panel. Please see page A.18
 Veneer Back: For matching veneer cabinet back please add "/W" to the end of the product code + \$403 list to the standard price. Please see page A.18

LOCK / HANDLE:
 Choose Optional Lock or Handle on doors (see Accessories section).

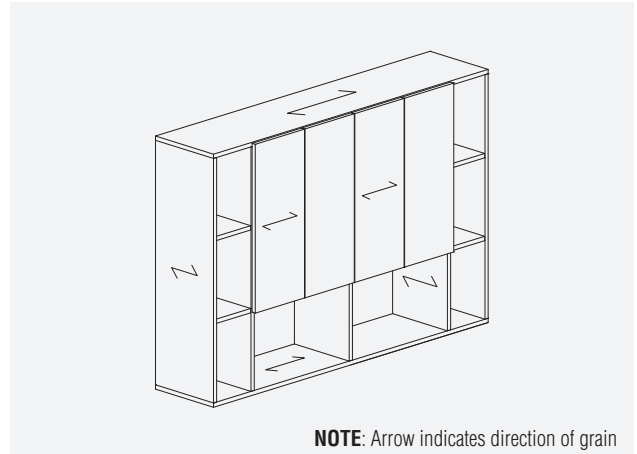

NOTE: Arrow indicates direction of grain

AS1 • 32"W Stack-on Bookcase

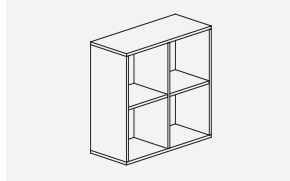

| PRODUCT | PRICE | | SIZE (INCHES) | | | WEIGHT VOL | |
|---------|----------|----------|---------------|----|------|------------|-----------------|
| | STANDARD | LAMINATE | H | W | D | LBS | FT ³ |
| AS1 | 1826 | 1462 | 29.5 | 32 | 14.5 | 69 | 9 |

- Two high stack-on bookcase with symmetrical 16" wide openings, fixed shelves
- LP laminate back
- For wood back (Standard price + \$403)

AS2L • 32"W Stack-on Bookcase

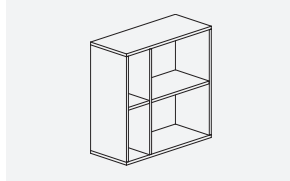

| PRODUCT | PRICE | | SIZE (INCHES) | | | WEIGHT VOL | |
|---------|----------|----------|---------------|----|------|------------|-----------------|
| | STANDARD | LAMINATE | H | W | D | LBS | FT ³ |
| AS2L | 1826 | 1462 | 29.5 | 32 | 14.5 | 69 | 9 |

- Two high stack-on bookcase with asymmetrical openings, 8" left / 24" right, fixed shelves
- LP laminate back
- For wood back (Standard price + \$403)

AS2R • 32"W Stack-on Bookcase

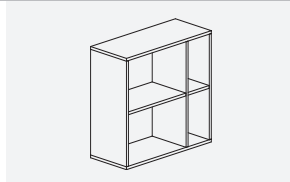

| PRODUCT | PRICE | | SIZE (INCHES) | | | WEIGHT VOL | |
|---------|----------|----------|---------------|----|------|------------|-----------------|
| | STANDARD | LAMINATE | H | W | D | LBS | FT ³ |
| AS2R | 1826 | 1462 | 29.5 | 32 | 14.5 | 69 | 9 |

- Two high stack-on bookcase with asymmetrical openings, 24" left / 8" right, fixed shelves
- LP laminate back
- For wood back (Standard price + \$403)

AS3 • 32"W Stack-on Bookcase

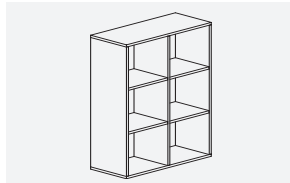

| PRODUCT | PRICE | | SIZE (INCHES) | | | WEIGHT VOL | |
|---------|----------|----------|---------------|----|------|------------|-----------------|
| | STANDARD | LAMINATE | H | W | D | LBS | FT ³ |
| AS3 | 2501 | 2002 | 44 | 32 | 14.5 | 95 | 14 |

- Three high stack-on bookcase with symmetrical 16" wide openings, fixed shelves
- LP laminate back
- For wood back (Standard price + \$403)

AS4L • 32" W Stack-on Bookcase

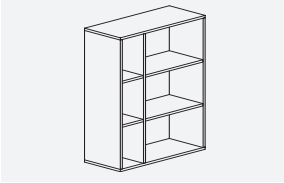

| PRODUCT | PRICE | | SIZE (INCHES) | | | WEIGHT VOL | |
|---------|----------|----------|---------------|----|------|------------|-----------------|
| | STANDARD | LAMINATE | H | W | D | LBS | FT ³ |
| AS4L | 2501 | 2002 | 44 | 32 | 14.5 | 95 | 14 |

- Three high stack-on bookcase with asymmetrical openings, 8" left / 24" right, fixed shelves
- LP laminate back
- For wood back (Standard price + \$403)

AS4R • 32" W Stack-on Bookcase

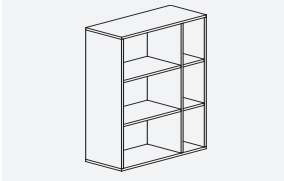

| PRODUCT | PRICE | | SIZE (INCHES) | | | WEIGHT VOL | |
|---------|----------|----------|---------------|----|------|------------|-----------------|
| | STANDARD | LAMINATE | H | W | D | LBS | FT ³ |
| AS4R | 2501 | 2002 | 44 | 32 | 14.5 | 95 | 14 |

- Three high stack-on bookcase with asymmetrical openings, 24" left / 8" right, fixed shelves
- LP laminate back
- For wood back (Standard price + \$403)

AS5L • 32" W Stack-on Bookcase

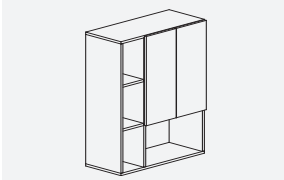

| PRODUCT | PRICE | | SIZE (INCHES) | | | WEIGHT VOL | |
|---------|----------|----------|---------------|----|------|------------|-----------------|
| | STANDARD | LAMINATE | H | W | D | LBS | FT ³ |
| AS5L | 2959 | 2368 | 44 | 32 | 14.5 | 106 | 14 |

- Three high stack-on bookcase with asymmetrical openings, 8" left / 24" right, fixed shelves, two door storage upper right with one adjustable shelf
- LP laminate back
- For wood back (Standard price + \$403)

AS5R • 32" W Stack-on Bookcase

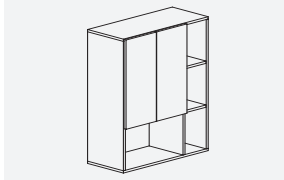

| PRODUCT | PRICE | | SIZE (INCHES) | | | WEIGHT VOL | |
|---------|----------|----------|---------------|----|------|------------|-----------------|
| | STANDARD | LAMINATE | H | W | D | LBS | FT ³ |
| AS5R | 2959 | 2368 | 44 | 32 | 14.5 | 106 | 14 |

- Three high stack-on bookcase with asymmetrical openings, 24" left / 8" right, fixed shelves, two door storage upper left with one adjustable shelf
- LP laminate back
- For wood back (Standard price + \$403)

AS6 • 32" W Stack-on Bookcase

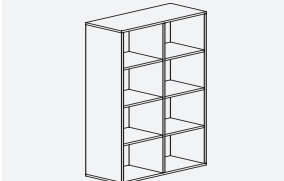

| PRODUCT | PRICE | | SIZE (INCHES) | | | WEIGHT VOL | |
|---------|----------|----------|---------------|----|------|------------|-----------------|
| | STANDARD | LAMINATE | H | W | D | LBS | FT ³ |
| AS6 | 3313 | 2651 | 58.5 | 32 | 14.5 | 111 | 18 |

- Four high stack-on bookcase with symmetrical 16" wide openings, fixed shelves
- LP laminate back
- For wood back (Standard price + \$403)

AS7L • 32" W Stack-on Bookcase

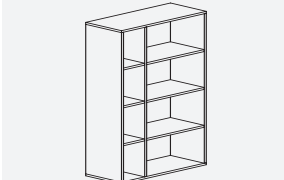

| PRODUCT | PRICE | | SIZE (INCHES) | | | WEIGHT VOL | |
|---------|----------|----------|---------------|----|------|------------|-----------------|
| | STANDARD | LAMINATE | H | W | D | LBS | FT ³ |
| AS7L | 3313 | 2651 | 58.5 | 32 | 14.5 | 111 | 18 |

- Four high stack-on bookcase with asymmetrical openings, 8" left / 24" right, fixed shelves
- LP laminate back
- For wood back (Standard price + \$403)

AS7R • 32" W Stack-on Bookcase

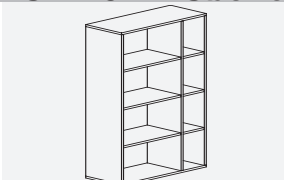

| PRODUCT | PRICE | | SIZE (INCHES) | | | WEIGHT VOL | |
|---------|----------|----------|---------------|----|------|------------|-----------------|
| | STANDARD | LAMINATE | H | W | D | LBS | FT ³ |
| AS7R | 3313 | 2651 | 58.5 | 32 | 14.5 | 111 | 18 |

- Four high stack-on bookcase with asymmetrical openings, 24" left / 8" right, fixed shelves
- LP laminate back
- For wood back (Standard price + \$403)

AS8L • 32" W Stack-on Bookcase

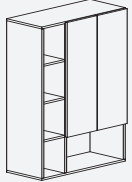

| PRODUCT | PRICE | | SIZE (INCHES) | | | WEIGHT VOL | |
|---------|----------|----------|---------------|----|------|------------|-----------------|
| | STANDARD | LAMINATE | H | W | D | LBS | FT ³ |
| AS8L | 4015 | 3213 | 58.5 | 32 | 14.5 | 129 | 18 |

- Four high stack-on bookcase with asymmetrical openings, 8" left / 24" right, fixed shelves, two door storage upper right with two adjustable shelves
- LP laminate back
- For wood back (Standard price + \$403)

AS8R • 32" W Stack-on Bookcase

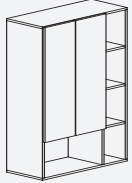

| PRODUCT | PRICE | | SIZE (INCHES) | | | WEIGHT VOL | |
|---------|----------|----------|---------------|----|------|------------|-----------------|
| | STANDARD | LAMINATE | H | W | D | LBS | FT ³ |
| AS8R | 4015 | 3213 | 58.5 | 32 | 14.5 | 129 | 18 |

- Four high stack-on bookcase with asymmetrical openings, 24" left / 8" right, fixed shelves, two door storage upper left with two adjustable shelves
- LP laminate back
- For wood back (Standard price + \$403)

AS9 • 64" W Stack-on Bookcase

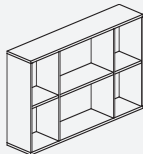

| PRODUCT | PRICE | | SIZE (INCHES) | | | WEIGHT VOL | |
|---------|----------|----------|---------------|----|------|------------|-----------------|
| | STANDARD | LAMINATE | H | W | D | LBS | FT ³ |
| AS9 | 3178 | 2541 | 29.5 | 64 | 14.5 | 119 | 18 |

- Two high stack-on bookcase, 32" open fixed shelf centre, 16" open fixed shelf either side
- LP laminate back
- For wood back (Standard price + \$403)

AS10 • 64" W Stack-on Bookcase

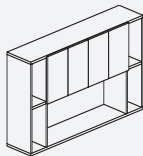

| PRODUCT | PRICE | | SIZE (INCHES) | | | WEIGHT VOL | |
|---------|----------|----------|---------------|----|------|------------|-----------------|
| | STANDARD | LAMINATE | H | W | D | LBS | FT ³ |
| AS10 | 3755 | 3004 | 29.5 | 64 | 14.5 | 134 | 18 |

- Two high stack-on bookcase, four door storage upper centre, 48" open fixed shelf lower centre and 8" open fixed shelves either side
- LP laminate back
- For wood back (Standard price + \$403)

AS11 • 64" W Stack-on Bookcase

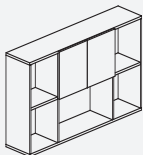

| PRODUCT | PRICE | | SIZE (INCHES) | | | WEIGHT VOL | |
|---------|----------|----------|---------------|----|------|------------|-----------------|
| | STANDARD | LAMINATE | H | W | D | LBS | FT ³ |
| AS11 | 3528 | 2823 | 29.5 | 64 | 14.5 | 127 | 18 |

- Two high stack-on bookcase, two door storage upper centre, 32" open fixed shelf lower centre, 16" open fixed shelves either side
- LP laminate back
- For wood back (Standard price + \$403)

AS12 • 64" W Stack-on Bookcase

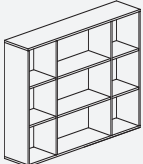

| PRODUCT | PRICE | | SIZE (INCHES) | | | WEIGHT VOL | |
|---------|----------|----------|---------------|----|------|------------|-----------------|
| | STANDARD | LAMINATE | H | W | D | LBS | FT ³ |
| AS12 | 4458 | 3568 | 44 | 64 | 14.5 | 164 | 27 |

- Three high stack-on bookcase, 32" open fixed shelves centre, 16" open fixed shelves either side
- LP laminate back
- For wood back (Standard price + \$403)

AS13 • 64" W Stack-on Bookcase

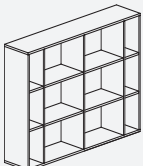

| PRODUCT | PRICE | | SIZE (INCHES) | | | WEIGHT VOL | |
|---------|----------|----------|---------------|----|------|------------|-----------------|
| | STANDARD | LAMINATE | H | W | D | LBS | FT ³ |
| AS13 | 4772 | 3818 | 44 | 64 | 14.5 | 174 | 27 |

- Three high stack-on bookcase, two 24" open fixed shelves centre, 8" open fixed shelves either side
- LP laminate back
- For wood back (Standard price + \$403)

AS14 • 64”W Stack-on Bookcase

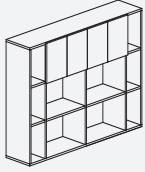

| PRODUCT | PRICE | | SIZE (INCHES) | | | WEIGHT VOL | |
|---------|----------|----------|---------------|----|------|------------|-----------------|
| | STANDARD | LAMINATE | H | W | D | LBS | FT ³ |
| AS14 | 5352 | 4281 | 44 | 64 | 14.5 | 186 | 27 |

- Three high stack-on bookcase, four door storage upper centre, two 24” open fixed shelves lower centre, 8” open fixed shelves either side
- LP laminate back
- For wood back (Standard price + \$403)

AS15 • 64”W Stack-on Bookcase

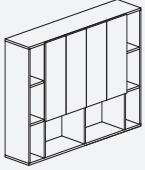

| PRODUCT | PRICE | | SIZE (INCHES) | | | WEIGHT VOL | |
|---------|----------|----------|---------------|----|------|------------|-----------------|
| | STANDARD | LAMINATE | H | W | D | LBS | FT ³ |
| AS15 | 5690 | 4554 | 44 | 64 | 14.5 | 198 | 27 |

- Three high stack-on bookcase, four door storage upper centre with adjustable shelves, two 24” open fixed shelves lower centre, 8” open fixed shelves either side
- LP laminate back
- For wood back (Standard price + \$403)

AS16 • 64”W Stack-on Bookcase

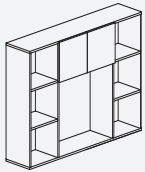

| PRODUCT | PRICE | | SIZE (INCHES) | | | WEIGHT VOL | |
|---------|----------|----------|---------------|----|------|------------|-----------------|
| | STANDARD | LAMINATE | H | W | D | LBS | FT ³ |
| AS16 | 4813 | 3852 | 44 | 64 | 14.5 | 172 | 27 |

- Three high stack-on bookcase, two door storage upper centre, 32” open shelf lower centre, 16” open fixed shelves either side
- LP laminate back
- For wood back (Standard price + \$403)

AS17 • 64”W Stack-on Bookcase

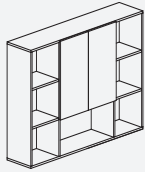

| PRODUCT | PRICE | | SIZE (INCHES) | | | WEIGHT VOL | |
|---------|----------|----------|---------------|----|------|------------|-----------------|
| | STANDARD | LAMINATE | H | W | D | LBS | FT ³ |
| AS17 | 5041 | 4033 | 44 | 64 | 14.5 | 180 | 27 |

- Three high stack-on bookcase, two door storage upper centre with adjustable shelf, 32” open fixed shelf lower centre, 16” open fixed shelves either side
- LP laminate back
- For wood back (Standard price + \$403)

AS18 • 64”W Stack-on Bookcase

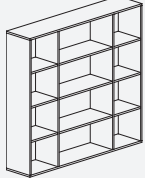

| PRODUCT | PRICE | | SIZE (INCHES) | | | WEIGHT VOL | |
|---------|----------|----------|---------------|----|------|------------|-----------------|
| | STANDARD | LAMINATE | H | W | D | LBS | FT ³ |
| AS18 | 5744 | 4598 | 58.5 | 64 | 14.5 | 208 | 35 |

- Four high stack-on bookcase, 32” open fixed shelves centre, 16” open fixed shelves either side
- LP laminate back
- For wood back (Standard price + \$403)

AS19 • 64”W Stack-on Bookcase

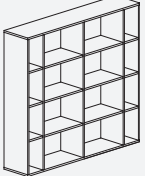

| PRODUCT | PRICE | | SIZE (INCHES) | | | WEIGHT VOL | |
|---------|----------|----------|---------------|----|------|------------|-----------------|
| | STANDARD | LAMINATE | H | W | D | LBS | FT ³ |
| AS19 | 6148 | 4919 | 58.5 | 64 | 14.5 | 222 | 35 |

- Four high stack-on bookcase, two 24” open fixed shelves centre, 8” open fixed shelves either side
- LP laminate back
- For wood back (Standard price + \$403)

AS20 • 64”W Stack-on Bookcase

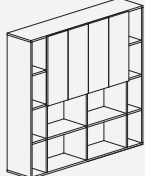

| PRODUCT | PRICE | | SIZE (INCHES) | | | WEIGHT VOL | |
|---------|----------|----------|---------------|----|------|------------|-----------------|
| | STANDARD | LAMINATE | H | W | D | LBS | FT ³ |
| AS20 | 7069 | 5655 | 58.5 | 64 | 14.5 | 245 | 35 |

- Four high stack-on bookcase, four door storage upper centre with adjustable shelves, two 24” open fixed shelves lower centre, 8” open fixed shelves either side
- LP laminate back
- For wood back (Standard price + \$403)

AS21 • 64"W Stack-on Bookcase

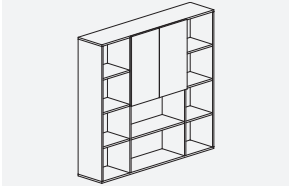

| PRODUCT | PRICE | | SIZE (INCHES) | | | WEIGHT VOL | |
|---------|----------|----------|---------------|----|------|------------|-----------------|
| | STANDARD | LAMINATE | H | W | D | LBS | FT ³ |
| AS21 | 6203 | 4963 | 58.5 | 64 | 14.5 | 224 | 35 |

- Four high stack-on bookcase, two door storage upper centre with adjustable shelf, 32" open fixed shelf lower centre, 16" open fixed shelves either side
- LP laminate back
- For wood back (Standard price + \$403)

32"W & 64"W FREESTANDING BOOKCASES and STORAGE CABINETS • TECHNICAL INFORMATION

- All Bookcases and Storage cabinets are shipped assembled.
- Bookcases and Storage cabinets are available in two base heights: 4" (xxLB = Low Base) or 11.5" (xxHB = High Base)
- Back Panels of the Bookcases and storage cabinets are made of LP solid colour laminate.
- Optional Wood Back Panel is available at an upcharge of \$403. Add suffix "/W" at the end of the product code. (e.g. AB4LHB/W)
- Optional locking on doors (storage units) are available. Add suffix "LO" at the end of the product code. (e.g. AB4LHB/LO)
- Optional handles on doors (storage units) are available (see Accessories section).

FREESTANDING BOOKCASES and STORAGE CABINETS • GUIDELINES FOR ORDERING PRODUCT

CODES: The price list uses a product coding system that is specific to each of the units. The product description (next to the code) explains in detail construction of the unit.

SPECIFICATION EXAMPLE OF A 32"W FREESTANDING BOOKCASE

PRODUCT CODE: AB4LHB (/P for All Laminate or /W for All Wood Finish)

A = Corby Series and B = Bookcase

4 = Product ID number (Freestanding Bookcase 50"H x 32"W x 14.5"D)

L = Open on Left and HB = High Base

CHOOSE FINISH OPTION:

Standard Finish: Veneer chassis and fronts with matching hardwood legs, LP laminate back panel. Please see page A.18

Laminate Finish: Please add "/P" to the end of the product code, includes LP laminate chassis, fronts and back panel with painted hardwood legs. Please see page A.18

Veneer Back: For matching veneer cabinet back please add "/W" to the end of the product code + \$403 list to the standard price. Please see page A.18

LOCK / HANDLE: Choose Optional Lock or Handle on doors (see Accessories section).

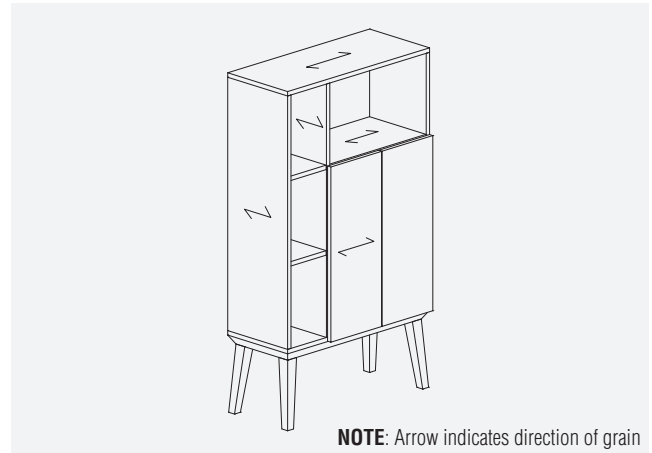

NOTE: Arrow indicates direction of grain

AB1LB • 32"W Freestanding Bookcase



| PRODUCT | PRICE | | SIZE (INCHES) | | | WEIGHT VOL | |
|---------|----------|----------|---------------|----|------|------------|-----------------|
| | STANDARD | LAMINATE | H | W | D | LBS | FT ³ |
| AB1LB | 2364 | 1892 | 35.5 | 32 | 14.5 | 101 | 11 |

- Freestanding two high bookcase with symmetrical 16" wide openings, fixed shelves
- Low base
- LP laminate back
- For wood back (Standard price + \$403)

AB2LLB • 32"W Freestanding Bookcase



| PRODUCT | PRICE | | SIZE (INCHES) | | | WEIGHT VOL | |
|---------|----------|----------|---------------|----|------|------------|-----------------|
| | STANDARD | LAMINATE | H | W | D | LBS | FT ³ |
| AB2LLB | 2364 | 1892 | 35.5 | 32 | 14.5 | 101 | 11 |

- Freestanding two high bookcase with asymmetrical openings, 8" left / 24" right, fixed shelves
- Low base
- LP laminate back
- For wood back (Standard price + \$403)

AB2RLB • 32"W Freestanding Bookcase



| PRODUCT | PRICE | | SIZE (INCHES) | | | WEIGHT VOL | |
|---------|----------|----------|---------------|----|------|------------|-----------------|
| | STANDARD | LAMINATE | H | W | D | LBS | FT ³ |
| AB2RLB | 2364 | 1892 | 35.5 | 32 | 14.5 | 101 | 11 |

- Freestanding two high bookcase with asymmetrical openings, 24" left / 8" right, fixed shelves
- Low base
- LP laminate back
- For wood back (Standard price + \$403)

AB3LB • 32"W Freestanding Bookcase

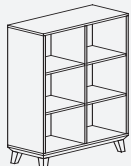

| PRODUCT | PRICE | | SIZE (INCHES) | | | WEIGHT VOL | |
|---------|----------|----------|---------------|----|------|------------|-----------------|
| | STANDARD | LAMINATE | H | W | D | LBS | FT ³ |
| AB3LB | 3040 | 2434 | 50 | 32 | 14.5 | 119 | 15 |

- Freestanding three high bookcase with symmetrical 16" wide openings, fixed shelves
- Low base
- LP laminate back
- For wood back (Standard price + \$403)

AB4LLB • 32" W Freestanding Bookcase

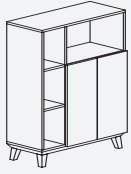

| PRODUCT | PRICE | | SIZE (INCHES) | | | WEIGHT VOL | |
|---------|----------|----------|---------------|----|------|------------|-----------------|
| | STANDARD | LAMINATE | H | W | D | LBS | FT ³ |
| AB4LLB | 3501 | 2803 | 50 | 32 | 14.5 | 138 | 15 |

- Freestanding three high bookcase with asymmetrical openings, 8" left / 24" right, fixed shelves, two door storage lower right with one adjustable shelf.
- Low base
- LP laminate back
- For wood back (Standard price + \$403)

AB4RLB • 32" W Freestanding Bookcase

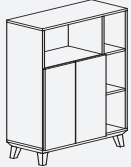

| PRODUCT | PRICE | | SIZE (INCHES) | | | WEIGHT VOL | |
|---------|----------|----------|---------------|----|------|------------|-----------------|
| | STANDARD | LAMINATE | H | W | D | LBS | FT ³ |
| AB4RLB | 3501 | 2803 | 50 | 32 | 14.5 | 138 | 15 |

- Freestanding three high bookcase with asymmetrical openings, 24" left / 8" right, fixed shelves, two door storage lower left with one adjustable shelf
- Low base
- LP laminate back
- For wood back (Standard price + \$403)

AB5LLB • 32" W Freestanding Bookcase

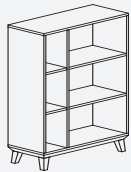

| PRODUCT | PRICE | | SIZE (INCHES) | | | WEIGHT VOL | |
|---------|----------|----------|---------------|----|------|------------|-----------------|
| | STANDARD | LAMINATE | H | W | D | LBS | FT ³ |
| AB5LLB | 3040 | 2434 | 50 | 32 | 14.5 | 126 | 15 |

- Freestanding three high bookcase with asymmetrical openings, 8" left / 24" right, fixed shelves
- Low base
- LP laminate back
- For wood back (Standard price + \$403)

AB5RLB • 32" W Freestanding Bookcase

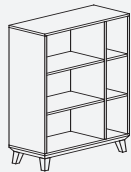

| PRODUCT | PRICE | | SIZE (INCHES) | | | WEIGHT VOL | |
|---------|----------|----------|---------------|----|------|------------|-----------------|
| | STANDARD | LAMINATE | H | W | D | LBS | FT ³ |
| AB5RLB | 3040 | 2434 | 50 | 32 | 14.5 | 126 | 15 |

- Freestanding three high bookcase with asymmetrical openings, 24" left / 8" right, fixed shelves
- Low base
- LP laminate back
- For wood back (Standard price + \$403)

AB6LB • 32" W Freestanding Bookcase

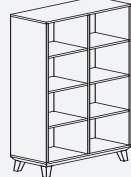

| PRODUCT | PRICE | | SIZE (INCHES) | | | WEIGHT VOL | |
|---------|----------|----------|---------------|----|------|------------|-----------------|
| | STANDARD | LAMINATE | H | W | D | LBS | FT ³ |
| AB6LB | 3853 | 3083 | 64 | 32 | 14.5 | 152 | 20 |

- Freestanding four high bookcase with symmetrical 16" wide openings, fixed shelves
- Low base
- LP laminate back
- For wood back (Standard price + \$403)

AB7LLB • 32" W Freestanding Bookcase

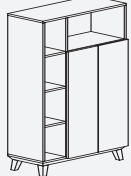

| PRODUCT | PRICE | | SIZE (INCHES) | | | WEIGHT VOL | |
|---------|----------|----------|---------------|----|------|------------|-----------------|
| | STANDARD | LAMINATE | H | W | D | LBS | FT ³ |
| AB7LLB | 4555 | 3645 | 64 | 32 | 14.5 | 169 | 20 |

- Freestanding four high bookcase with asymmetrical openings, 8" left / 24" right, fixed shelves, two door storage lower right with two adjustable shelves
- Low base
- LP laminate back
- For wood back (Standard price + \$403)

AB7RLB • 32" W Freestanding Bookcase

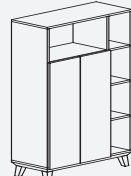

| PRODUCT | PRICE | | SIZE (INCHES) | | | WEIGHT VOL | |
|---------|----------|----------|---------------|----|------|------------|-----------------|
| | STANDARD | LAMINATE | H | W | D | LBS | FT ³ |
| AB7RLB | 4555 | 3645 | 64 | 32 | 14.5 | 169 | 20 |

- Freestanding four high bookcase with asymmetrical openings, 24" left / 8" right, fixed shelves, two door storage lower left with two adjustable shelves
- Low base
- LP laminate back
- For wood back (Standard price + \$403)

AB8LLB • 32"W Freestanding Bookcase



| PRODUCT | PRICE | | SIZE (INCHES) | | | WEIGHT VOL | |
|---------|----------|----------|---------------|----|------|------------|-----------------|
| | STANDARD | LAMINATE | H | W | D | LBS | FT ³ |
| AB8LLB | 3853 | 3083 | 64 | 32 | 14.5 | 152 | 20 |

- Freestanding four high bookcase with asymmetrical openings, 8" left / 24" right, fixed shelves
- Low base
- LP laminate back
- For wood back (Standard price + \$403)

AB8RLB • 32"W Freestanding Bookcase



| PRODUCT | PRICE | | SIZE (INCHES) | | | WEIGHT VOL | |
|---------|----------|----------|---------------|----|------|------------|-----------------|
| | STANDARD | LAMINATE | H | W | D | LBS | FT ³ |
| AB8RLB | 3853 | 3083 | 64 | 32 | 14.5 | 152 | 20 |

- Freestanding four high bookcase with asymmetrical openings, 24" left / 8" right, fixed shelves
- Low base
- LP laminate back
- For wood back (Standard price + \$403)

AB1HB • 32"W Freestanding Bookcase



| PRODUCT | PRICE | | SIZE (INCHES) | | | WEIGHT VOL | |
|---------|----------|----------|---------------|----|------|------------|-----------------|
| | STANDARD | LAMINATE | H | W | D | LBS | FT ³ |
| AB1HB | 2635 | 2109 | 42.75 | 32 | 14.5 | 106 | 13 |

- Freestanding two high bookcase with symmetrical 16" wide openings, fixed shelves
- High base
- LP laminate back
- For wood back (Standard price + \$403)

AB2LHB • 32"W Freestanding Bookcase



| PRODUCT | PRICE | | SIZE (INCHES) | | | WEIGHT VOL | |
|---------|----------|----------|---------------|----|------|------------|-----------------|
| | STANDARD | LAMINATE | H | W | D | LBS | FT ³ |
| AB2LHB | 2635 | 2109 | 42.75 | 32 | 14.5 | 106 | 13 |

- Freestanding two high bookcase with asymmetrical openings, 8" left / 24" right, fixed shelves
- High base
- LP laminate back
- For wood back (Standard price + \$403)

AB2RHB • 32"W Freestanding Bookcase



| PRODUCT | PRICE | | SIZE (INCHES) | | | WEIGHT VOL | |
|---------|----------|----------|---------------|----|------|------------|-----------------|
| | STANDARD | LAMINATE | H | W | D | LBS | FT ³ |
| AB2RHB | 2635 | 2109 | 42.75 | 32 | 14.5 | 106 | 13 |

- Freestanding two high bookcase with asymmetrical openings, 24" left / 8" right, fixed shelves
- High base
- LP laminate back
- For wood back (Standard price + \$403)

AB3HB • 32"W Freestanding Bookcase



| PRODUCT | PRICE | | SIZE (INCHES) | | | WEIGHT VOL | |
|---------|----------|----------|---------------|----|------|------------|-----------------|
| | STANDARD | LAMINATE | H | W | D | LBS | FT ³ |
| AB3HB | 3313 | 2651 | 57 | 32 | 14.5 | 119 | 18 |

- Freestanding three high bookcase with symmetrical 16" wide openings, fixed shelves
- High base
- LP laminate back
- For wood back (Standard price + \$403)

AB4LHB • 32"W Freestanding Bookcase

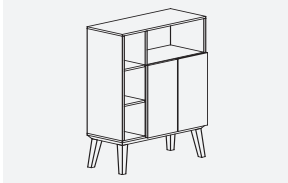

| PRODUCT | PRICE | | SIZE (INCHES) | | | WEIGHT VOL | |
|---------|----------|----------|---------------|----|------|------------|-----------------|
| | STANDARD | LAMINATE | H | W | D | LBS | FT ³ |
| AB4LHB | 3771 | 3017 | 57 | 32 | 14.5 | 143 | 18 |

- Freestanding three high bookcase with asymmetrical openings, 8" left / 24" right, fixed shelves, two door storage lower right with one adjustable shelf
- High base
- LP laminate back
- For wood back (Standard price + \$403)

AB4RHB • 32" W Freestanding Bookcase



| PRODUCT | PRICE | | SIZE (INCHES) | | | WEIGHT VOL | |
|---------|----------|----------|---------------|----|------|------------|-----------------|
| | STANDARD | LAMINATE | H | W | D | LBS | FT ³ |
| AB4RHB | 3771 | 3017 | 57 | 32 | 14.5 | 143 | 18 |

- Freestanding three high bookcase with asymmetrical openings, 24" left / 8" right, fixed shelves, two door storage lower left with one adjustable shelf
- High base
- LP laminate back
- For wood back (Standard price + \$403)

AB5LHB • 32" W Freestanding Bookcase



| PRODUCT | PRICE | | SIZE (INCHES) | | | WEIGHT VOL | |
|---------|----------|----------|---------------|----|------|------------|-----------------|
| | STANDARD | LAMINATE | H | W | D | LBS | FT ³ |
| AB5LHB | 3313 | 2651 | 57 | 32 | 14.5 | 131 | 18 |

- Freestanding three high bookcase with asymmetrical openings, 8" left / 24" right, fixed shelves
- High base
- LP laminate back
- For wood back (Standard price + \$403)

AB5RHB • 32" W Freestanding Bookcase



| PRODUCT | PRICE | | SIZE (INCHES) | | | WEIGHT VOL | |
|---------|----------|----------|---------------|----|------|------------|-----------------|
| | STANDARD | LAMINATE | H | W | D | LBS | FT ³ |
| AB5RHB | 3313 | 2651 | 57 | 32 | 14.5 | 131 | 18 |

- Freestanding three high bookcase with asymmetrical openings, 24" left / 8" right, fixed shelves
- High base
- LP laminate back
- For wood back (Standard price + \$403)

AB6HB • 32" W Freestanding Bookcase



| PRODUCT | PRICE | | SIZE (INCHES) | | | WEIGHT VOL | |
|---------|----------|----------|---------------|----|------|------------|-----------------|
| | STANDARD | LAMINATE | H | W | D | LBS | FT ³ |
| AB6HB | 4122 | 3298 | 71.5 | 32 | 14.5 | 157 | 22 |

- Freestanding four high bookcase with symmetrical 16" wide openings, fixed shelves
- High base
- LP laminate back
- For wood back (Standard price + \$403)

AB7LHB • 32" W Freestanding Bookcase



| PRODUCT | PRICE | | SIZE (INCHES) | | | WEIGHT VOL | |
|---------|----------|----------|---------------|----|------|------------|-----------------|
| | STANDARD | LAMINATE | H | W | D | LBS | FT ³ |
| AB7LHB | 4826 | 3862 | 71.5 | 32 | 14.5 | 174 | 22 |

- Freestanding four high bookcase with asymmetrical openings, 8" left / 24" right, fixed shelves, two door storage lower right with two adjustable shelves
- High base
- LP laminate back
- For wood back (Standard price + \$403)

AB7RHB • 32" W Freestanding Bookcase



| PRODUCT | PRICE | | SIZE (INCHES) | | | WEIGHT VOL | |
|---------|----------|----------|---------------|----|------|------------|-----------------|
| | STANDARD | LAMINATE | H | W | D | LBS | FT ³ |
| AB7RHB | 4826 | 3862 | 71.5 | 32 | 14.5 | 174 | 22 |

- Freestanding four high bookcase with asymmetrical openings, 24" left / 8" right, fixed shelves, two door storage lower left with two adjustable shelves
- High base
- LP laminate back
- For wood back (Standard price + \$403)

AB8LHB • 32" W Freestanding Bookcase



| PRODUCT | PRICE | | SIZE (INCHES) | | | WEIGHT VOL | |
|---------|----------|----------|---------------|----|------|------------|-----------------|
| | STANDARD | LAMINATE | H | W | D | LBS | FT ³ |
| AB8LHB | 4122 | 3298 | 71.5 | 32 | 14.5 | 157 | 22 |

- Freestanding four high bookcase with asymmetrical openings, 8" left / 24" right, fixed shelves
- High base
- LP laminate back
- For wood back (Standard price + \$403)

AB8RHB • 32" W Freestanding Bookcase



| PRODUCT | PRICE | | SIZE (INCHES) | | | WEIGHT VOL | |
|---------|----------|----------|---------------|----|------|------------|-----------------|
| | STANDARD | LAMINATE | H | W | D | LBS | FT ³ |
| AB8RHB | 4122 | 3298 | 71.5 | 32 | 14.5 | 157 | 22 |

- Freestanding four high bookcase with asymmetrical openings, 24" left / 8" right, fixed shelves
- High base
- LP laminate back
- For wood back (Standard price + \$403)

AB9LB • 64" W Freestanding Bookcase



| PRODUCT | PRICE | | SIZE (INCHES) | | | WEIGHT VOL | |
|---------|----------|----------|---------------|----|------|------------|-----------------|
| | STANDARD | LAMINATE | H | W | D | LBS | FT ³ |
| AB9LB | 4299 | 3439 | 35.5 | 64 | 14.5 | 177 | 21 |

- Freestanding two high bookcase with four door storage lower centre, 48" open fixed upper shelf and 8" open fixed shelves either side
- Low base
- LP laminate back
- For wood back (Standard price + \$403)

AB10LB • 64" W Freestanding Bookcase

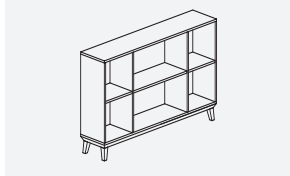

| PRODUCT | PRICE | | SIZE (INCHES) | | | WEIGHT VOL | |
|---------|----------|----------|---------------|----|------|------------|-----------------|
| | STANDARD | LAMINATE | H | W | D | LBS | FT ³ |
| AB10LB | 3717 | 2974 | 35.5 | 64 | 14.5 | 162 | 21 |

- Freestanding two high bookcase, 32" open fixed shelf centre and 16" open fixed shelves either side
- Low base
- LP laminate back
- For wood back (Standard price + \$403)

AB11LB • 64" W Freestanding Bookcase



| PRODUCT | PRICE | | SIZE (INCHES) | | | WEIGHT VOL | |
|---------|----------|----------|---------------|----|------|------------|-----------------|
| | STANDARD | LAMINATE | H | W | D | LBS | FT ³ |
| AB11LB | 3960 | 3168 | 50 | 64 | 14.5 | 217 | 30 |

- Freestanding three high bookcase, two 24" open fixed shelves centre, 8" open fixed shelves either side
- Low base
- LP laminate back
- For wood back (Standard price + \$403)

AB12LB • 64" W Freestanding Bookcase

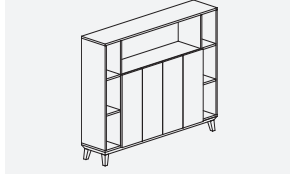

| PRODUCT | PRICE | | SIZE (INCHES) | | | WEIGHT VOL | |
|---------|----------|----------|---------------|----|------|------------|-----------------|
| | STANDARD | LAMINATE | H | W | D | LBS | FT ³ |
| AB12LB | 6229 | 4985 | 50 | 64 | 14.5 | 237 | 30 |

- Freestanding three high bookcase, four door storage lower centre with adjustable shelves, 48" open fixed shelf upper and 8" open fixed shelves either side
- Low base
- LP laminate back
- For wood back (Standard price + \$403)

AB13LB • 64" W Freestanding Bookcase



| PRODUCT | PRICE | | SIZE (INCHES) | | | WEIGHT VOL | |
|---------|----------|----------|---------------|----|------|------------|-----------------|
| | STANDARD | LAMINATE | H | W | D | LBS | FT ³ |
| AB13LB | 5580 | 4467 | 50 | 64 | 14.5 | 223 | 30 |

- Freestanding three high bookcase two door storage lower centre with adjustable shelves, 32" open fixed shelf upper and 16" open fixed shelves either side
- Low base
- LP laminate back
- For wood back (Standard price + \$403)

AB14LB • 64" W Freestanding Bookcase



| PRODUCT | PRICE | | SIZE (INCHES) | | | WEIGHT VOL | |
|---------|----------|----------|---------------|----|------|------------|-----------------|
| | STANDARD | LAMINATE | H | W | D | LBS | FT ³ |
| AB14LB | 5003 | 4003 | 50 | 64 | 14.5 | 207 | 30 |

- Freestanding three high bookcase, 32" open fixed shelves centre and 16" open fixed shelves either side
- Low base
- LP laminate back
- For wood back (Standard price + \$403)

AB15LB • 64"W Freestanding Bookcase

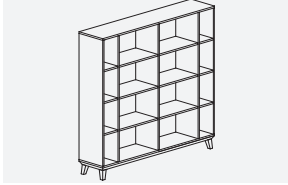

| PRODUCT | PRICE | | SIZE (INCHES) | | | WEIGHT VOL | |
|---------|----------|----------|---------------|----|------|------------|-----------------|
| | STANDARD | LAMINATE | H | W | D | LBS | FT ³ |
| AB15LB | 6691 | 5354 | 64 | 64 | 14.5 | 265 | 38 |

- Freestanding four high bookcase, two 24" open fixed shelves centre and 8" open fixed shelves either side
- Low base
- LP laminate back
- For wood back (Standard price + \$403)

AB16LB • 64"W Freestanding Bookcase



| PRODUCT | PRICE | | SIZE (INCHES) | | | WEIGHT VOL | |
|---------|----------|----------|---------------|----|------|------------|-----------------|
| | STANDARD | LAMINATE | H | W | D | LBS | FT ³ |
| AB16LB | 7610 | 6090 | 64 | 64 | 14.5 | 281 | 38 |

- Freestanding four high bookcase, four door storage lower centre with adjustable shelves, 48" open fixed upper shelves and 8" open fixed shelves either side
- Low base
- LP laminate back
- For wood back (Standard price + \$403)

AB17LB • 64"W Freestanding Bookcase



| PRODUCT | PRICE | | SIZE (INCHES) | | | WEIGHT VOL | |
|---------|----------|----------|---------------|----|------|------------|-----------------|
| | STANDARD | LAMINATE | H | W | D | LBS | FT ³ |
| AB17LB | 6744 | 5397 | 64 | 64 | 14.5 | 267 | 38 |

- Freestanding four high bookcase, two door storage lower centre with adjustable shelf, 32" open fixed upper shelves and 16" open fixed shelves either side
- Low base
- LP laminate back
- For wood back (Standard price + \$403)

AB18LB • 64"W Freestanding Bookcase



| PRODUCT | PRICE | | SIZE (INCHES) | | | WEIGHT VOL | |
|---------|----------|----------|---------------|----|------|------------|-----------------|
| | STANDARD | LAMINATE | H | W | D | LBS | FT ³ |
| AB18LB | 7744 | 6196 | 64 | 64 | 14.5 | 295 | 38 |

- Freestanding four high bookcase, four door storage lower centre with adjustable shelves, 48" open fixed upper shelf and 8" open fixed shelves either side
- Low base
- LP laminate back
- For wood back (Standard price + \$403)

AB19LB • 64"W Freestanding Bookcase

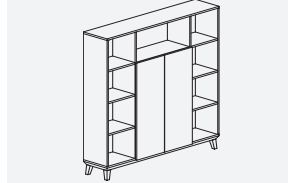

| PRODUCT | PRICE | | SIZE (INCHES) | | | WEIGHT VOL | |
|---------|----------|----------|---------------|----|------|------------|-----------------|
| | STANDARD | LAMINATE | H | W | D | LBS | FT ³ |
| AB19LB | 6879 | 5503 | 64 | 64 | 14.5 | 275 | 38 |

- Freestanding four high bookcase, two door storage lower centre with adjustable shelves, 32" open fixed upper shelf and 16" open fixed shelves either side
- Low base
- LP laminate back
- For wood back (Standard price + \$403)

AB20LB • 64"W Freestanding Bookcase



| PRODUCT | PRICE | | SIZE (INCHES) | | | WEIGHT VOL | |
|---------|----------|----------|---------------|----|------|------------|-----------------|
| | STANDARD | LAMINATE | H | W | D | LBS | FT ³ |
| AB20LB | 6283 | 5028 | 64 | 64 | 14.5 | 251 | 38 |

- Freestanding four high bookcase, 32" open fixed shelves centre and 16" open fixed shelves either side
- Low base
- LP laminate back
- For wood back (Standard price + \$403)

ATV1LB • 50"H Freestanding Media Cabinet

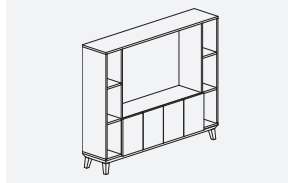

| PRODUCT | PRICE | | SIZE (INCHES) | | | WEIGHT VOL | |
|---------|----------|----------|---------------|----|------|------------|-----------------|
| | STANDARD | LAMINATE | H | W | D | LBS | FT ³ |
| ATV1LB | 5893 | 4715 | 50 | 64 | 14.5 | 222 | 30 |

- Freestanding media cabinet, 48" wide two high opening can accommodate up to a 50" monitor, four door storage lower centre, 8" open fixed shelf either side.
- Monitor mount is optional. Please see **Accessories**
- Low base
- LP laminate back
- For wood back (Standard price + \$403)

AB9HB • 64”W Freestanding Bookcase



| PRODUCT | PRICE | | SIZE (INCHES) | | | WEIGHT VOL | |
|---------|----------|----------|---------------|----|------|------------|-----------------|
| | STANDARD | LAMINATE | H | W | D | LBS | FT ³ |
| AB9HB | 4567 | 3654 | 42.75 | 64 | 14.5 | 182 | 26 |

- Freestanding two high bookcase, four door storage lower centre, 48” open fixed upper shelf and 8” open fixed shelves either side
- High base
- LP laminate back
- For wood back (Standard price + \$403)

AB10HB • 64”W Freestanding Bookcase



| PRODUCT | PRICE | | SIZE (INCHES) | | | WEIGHT VOL | |
|---------|----------|----------|---------------|----|------|------------|-----------------|
| | STANDARD | LAMINATE | H | W | D | LBS | FT ³ |
| AB10HB | 3988 | 3191 | 42.75 | 64 | 14.5 | 167 | 26 |

- Freestanding two high bookcase, 32” open fixed shelf centre and 16” open fixed shelves either side
- High base
- LP laminate back
- For wood back (Standard price + \$403)

AB11HB • 64”W Freestanding Bookcase



| PRODUCT | PRICE | | SIZE (INCHES) | | | WEIGHT VOL | |
|---------|----------|----------|---------------|----|------|------------|-----------------|
| | STANDARD | LAMINATE | H | W | D | LBS | FT ³ |
| AB11HB | 4228 | 3384 | 57 | 64 | 14.5 | 222 | 34 |

- Freestanding three high bookcase with two 24” open fixed shelves centre, 8” open fixed shelves either side
- High base
- LP laminate back
- For wood back (Standard price + \$403)

AB12HB • 64”W Freestanding Bookcase



| PRODUCT | PRICE | | SIZE (INCHES) | | | WEIGHT VOL | |
|---------|----------|----------|---------------|----|------|------------|-----------------|
| | STANDARD | LAMINATE | H | W | D | LBS | FT ³ |
| AB12HB | 6501 | 5203 | 57 | 64 | 14.5 | 242 | 34 |

- Freestanding three high bookcase, four door storage lower centre with adjustable shelves, 48” open fixed upper shelf and 8” open fixed shelves either side
- High base
- LP laminate back
- For wood back (Standard price + \$403)

AB13HB • 64”W Freestanding Bookcase



| PRODUCT | PRICE | | SIZE (INCHES) | | | WEIGHT VOL | |
|---------|----------|----------|---------------|----|------|------------|-----------------|
| | STANDARD | LAMINATE | H | W | D | LBS | FT ³ |
| AB13HB | 5851 | 4684 | 57 | 64 | 14.5 | 228 | 34 |

- Freestanding three high bookcase, two door storage lower centre with adjustable shelf, 32” open fixed upper shelf and 16” open fixed shelves either side
- High base
- LP laminate back
- For wood back (Standard price + \$403)

AB14HB • 64”W Freestanding Bookcase



| PRODUCT | PRICE | | SIZE (INCHES) | | | WEIGHT VOL | |
|---------|----------|----------|---------------|----|------|------------|-----------------|
| | STANDARD | LAMINATE | H | W | D | LBS | FT ³ |
| AB14HB | 5272 | 4217 | 57 | 64 | 14.5 | 212 | 34 |

- Freestanding three high bookcase, 32” open fixed shelves centre and 16” open fixed shelves either side
- High base
- LP laminate back
- For wood back (Standard price + \$403)

AB15HB • 64”W Freestanding Bookcase



| PRODUCT | PRICE | | SIZE (INCHES) | | | WEIGHT VOL | |
|---------|----------|----------|---------------|----|------|------------|-----------------|
| | STANDARD | LAMINATE | H | W | D | LBS | FT ³ |
| AB15HB | 6961 | 5569 | 71.5 | 64 | 14.5 | 270 | 43 |

- Freestanding four high bookcase, two 24” open fixed shelves centre and 8” open fixed shelves either side
- High base
- LP laminate back
- For wood back (Standard price + \$403)

AB16HB • 64”W Freestanding Bookcase



| PRODUCT | PRICE | | SIZE (INCHES) | | | WEIGHT VOL | |
|---------|----------|----------|---------------|----|------|------------|-----------------|
| | STANDARD | LAMINATE | H | W | D | LBS | FT ³ |
| AB16HB | 7879 | 6305 | 71.5 | 64 | 14.5 | 286 | 43 |

- Freestanding four high bookcase, four door storage lower centre with adjustable shelves, 48” open fixed upper shelves and 8” open fixed shelves either side
- High base
- LP laminate back
- For wood back (Standard price + \$403)

AB17HB • 64”W Freestanding Bookcase

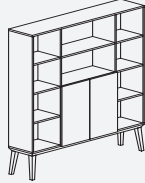

| PRODUCT | PRICE | | SIZE (INCHES) | | | WEIGHT VOL | |
|---------|----------|----------|---------------|----|------|------------|-----------------|
| | STANDARD | LAMINATE | H | W | D | LBS | FT ³ |
| AB17HB | 7015 | 5612 | 71.5 | 64 | 14.5 | 272 | 43 |

- Freestanding four high bookcase, two door storage lower centre with adjustable shelf, 32” open fixed shelves upper and 16” open fixed shelves either side
- High base
- LP laminate back
- For wood back (Standard price + \$403)

AB18HB • 64”W Freestanding Bookcase

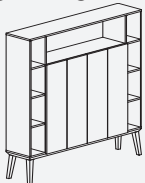

| PRODUCT | PRICE | | SIZE (INCHES) | | | WEIGHT VOL | |
|---------|----------|----------|---------------|----|------|------------|-----------------|
| | STANDARD | LAMINATE | H | W | D | LBS | FT ³ |
| AB18HB | 8015 | 6412 | 71.5 | 64 | 14.5 | 300 | 43 |

- Freestanding four high bookcase, four door storage lower centre with adjustable shelves, 48” open fixed upper shelf and 8” open fixed shelves either side
- High base
- LP laminate back
- For wood back (Standard price + \$403)

AB19HB • 64”W Freestanding Bookcase

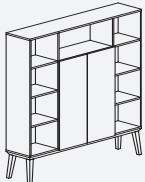

| PRODUCT | PRICE | | SIZE (INCHES) | | | WEIGHT VOL | |
|---------|----------|----------|---------------|----|------|------------|-----------------|
| | STANDARD | LAMINATE | H | W | D | LBS | FT ³ |
| AB19HB | 7150 | 5720 | 71.5 | 64 | 14.5 | 280 | 43 |

- Freestanding four high bookcase, two door storage lower centre with adjustable shelves, 32” open fixed upper shelf and 16” open fixed shelves either side
- High base
- LP laminate back
- For wood back (Standard price + \$403)

AB20HB • 64”W Freestanding Bookcase



| PRODUCT | PRICE | | SIZE (INCHES) | | | WEIGHT VOL | |
|---------|----------|----------|---------------|----|------|------------|-----------------|
| | STANDARD | LAMINATE | H | W | D | LBS | FT ³ |
| AB20HB | 6556 | 5246 | 71.5 | 64 | 14.5 | 256 | 43 |

- Freestanding four high bookcase, 32” open fixed shelves centre and 16” open fixed shelves either side
- High base
- LP laminate back
- For wood back (Standard price + \$403)

ATV1HB • 57”H Freestanding Media Cabinet



| PRODUCT | PRICE | | SIZE (INCHES) | | | WEIGHT VOL | |
|---------|----------|----------|---------------|----|------|------------|-----------------|
| | STANDARD | LAMINATE | H | W | D | LBS | FT ³ |
| ATV1HB | 6163 | 4931 | 57 | 64 | 14.5 | 227 | 34 |

- Freestanding media cabinet, 48” wide two high openings can accommodate up to a 50” monitor, four door storage lower centre and 8” open fixed shelf either side.
- Monitor mount is optional. Please see **Accessories**.
- High base
- LP laminate back
- For wood back (Standard price + \$403)

64"W FREESTANDING DIVIDER BOOKCASES • TECHNICAL INFORMATION

- All Divider Bookcases are shipped assembled.
- Divider Bookcases are available in two base heights: 4" (xxLB = Low Base) or 11.5" (xxHB = High Base)
- Back Panels of the Divider Bookcases are made of LP solid colour laminate.
- Optional Wood Back Panel is available at an upcharge of \$1320. Add suffix "/W" at the end of the product code. (e.g. AB28LB/W)

FREESTANDING DIVIDER BOOKCASES • GUIDELINES FOR ORDERING PRODUCT

CODES: The price list uses a product coding system that is specific to each of the units. The product description (next to the code) explains in detail construction of the unit.

SPECIFICATION EXAMPLE OF A 64"W FREESTANDING DIVIDER BOOKCASE

PRODUCT CODE: AB22HB (/P for All Laminate or /W for All Wood Finish)
 A = Corby Series and B = Bookcase
 22 = Product ID number (Freestanding Divider Bookcase 72"H x 64"W x 15"D)
 HB = High Base

CHOOSE FINISH OPTION:

Standard Finish: Veneer chassis with matching hardwood legs, LP laminate back panel. Please see page A.18

Laminate Finish: Please add "/P" to the end of the product code, includes LP laminate chassis and back panel with painted hardwood legs. Please see page A.18

Veneer Back: For matching veneer cabinet back please add "/W" to the end of the product code + \$1320 list to the standard price. Please see page A.18



AB22LB • 64"W Freestanding Divider Bookcase



| PRODUCT | PRICE | | SIZE (INCHES) | | | WEIGHT VOL | |
|---------|----------|----------|---------------|----|----|------------|-----------------|
| | STANDARD | LAMINATE | H | W | D | LBS | FT ³ |
| AB22LB | 7327 | 5862 | 64 | 64 | 15 | 265 | 38 |

- Freestanding four high divider bookcase with fixed shelves
- Low base
- LP laminate back

AB23LB • 64"W Freestanding Divider Bookcase



| PRODUCT | PRICE | | SIZE (INCHES) | | | WEIGHT VOL | |
|---------|----------|----------|---------------|----|----|------------|-----------------|
| | STANDARD | LAMINATE | H | W | D | LBS | FT ³ |
| AB23LB | 7327 | 5862 | 64 | 64 | 15 | 265 | 38 |

- Freestanding four high divider bookcase with fixed shelves
- Low base
- LP laminate back

AB24LB • 64"W Freestanding Divider Book-

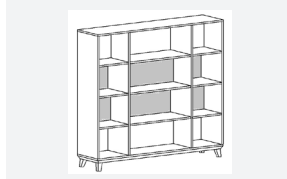

| PRODUCT | PRICE | | SIZE (INCHES) | | | WEIGHT VOL | |
|---------|----------|----------|---------------|----|----|------------|-----------------|
| | STANDARD | LAMINATE | H | W | D | LBS | FT ³ |
| AB24LB | 7327 | 5862 | 64 | 64 | 15 | 265 | 38 |

- Freestanding four high divider bookcase with fixed shelves
- Low base
- LP laminate back

AB25LB • 64"W Freestanding Divider Bookcase



| PRODUCT | PRICE | | SIZE (INCHES) | | | WEIGHT VOL | |
|---------|----------|----------|---------------|----|----|------------|-----------------|
| | STANDARD | LAMINATE | H | W | D | LBS | FT ³ |
| AB25LB | 7327 | 5862 | 64 | 64 | 15 | 265 | 38 |

- Freestanding four high divider bookcase with fixed shelves
- Low base
- LP laminate back

AB26LB • 64" W Freestanding Divider Bookcase



| PRODUCT | PRICE | | SIZE (INCHES) | | | WEIGHT VOL | |
|---------|----------|----------|---------------|----|----|------------|-----------------|
| | STANDARD | LAMINATE | H | W | D | LBS | FT ³ |
| AB26LB | 5478 | 4382 | 49 | 64 | 15 | 217 | 30 |

- Freestanding three high divider bookcase with fixed shelves
- Low base
- LP laminate back

AB27LB • 64" W Freestanding Divider Bookcase



| PRODUCT | PRICE | | SIZE (INCHES) | | | WEIGHT VOL | |
|---------|----------|----------|---------------|----|----|------------|-----------------|
| | STANDARD | LAMINATE | H | W | D | LBS | FT ³ |
| AB27LB | 5478 | 4382 | 49 | 64 | 15 | 217 | 30 |

- Freestanding three high divider bookcase with fixed shelves
- Low base
- LP laminate back

AB28LB • 64" W Freestanding Divider Book-



| PRODUCT | PRICE | | SIZE (INCHES) | | | WEIGHT VOL | |
|---------|----------|----------|---------------|----|----|------------|-----------------|
| | STANDARD | LAMINATE | H | W | D | LBS | FT ³ |
| AB28LB | 4606 | 3685 | 35 | 64 | 15 | 162 | 21 |

- Freestanding two high divider bookcase with fixed shelves
- Low base
- LP laminate back

AB29LB • 64" W Freestanding Divider Bookcase



| PRODUCT | PRICE | | SIZE (INCHES) | | | WEIGHT VOL | |
|---------|----------|----------|---------------|----|----|------------|-----------------|
| | STANDARD | LAMINATE | H | W | D | LBS | FT ³ |
| AB29LB | 4606 | 3685 | 35 | 64 | 15 | 162 | 21 |

- Freestanding two high divider bookcase with fixed shelves
- Low base
- LP laminate back

AB22HB • 64" W Freestanding Divider Bookcase



| PRODUCT | PRICE | | SIZE (INCHES) | | | WEIGHT VOL | |
|---------|----------|----------|---------------|----|----|------------|-----------------|
| | STANDARD | LAMINATE | H | W | D | LBS | FT ³ |
| AB22HB | 7623 | 6098 | 72 | 64 | 15 | 270 | 43 |

- Freestanding four high divider bookcase with fixed shelves
- High base
- LP laminate back

AB23HB • 64" W Freestanding Divider Bookcase



| PRODUCT | PRICE | | SIZE (INCHES) | | | WEIGHT VOL | |
|---------|----------|----------|---------------|----|----|------------|-----------------|
| | STANDARD | LAMINATE | H | W | D | LBS | FT ³ |
| AB23HB | 7623 | 6098 | 72 | 64 | 15 | 270 | 43 |

- Freestanding four high divider bookcase with fixed shelves
- High base
- LP laminate back

AB24HB • 64" W Freestanding Divider Bookcase



| PRODUCT | PRICE | | SIZE (INCHES) | | | WEIGHT VOL | |
|---------|----------|----------|---------------|----|----|------------|-----------------|
| | STANDARD | LAMINATE | H | W | D | LBS | FT ³ |
| AB24HB | 7623 | 6098 | 72 | 64 | 15 | 270 | 43 |

- Freestanding four high divider bookcase with fixed shelves
- High base
- LP laminate back

AB25HB • 64”W Freestanding Divider Book-



| PRODUCT | PRICE | | SIZE (INCHES) | | | WEIGHT VOL | |
|---------|----------|----------|---------------|----|----|------------|-----------------|
| | STANDARD | LAMINATE | H | W | D | LBS | FT ³ |
| AB25HB | 7623 | 6098 | 72 | 64 | 15 | 270 | 43 |

- Freestanding four high divider bookcase with fixed shelves
- High base
- LP laminate back

AB26HB • 64”W Freestanding Divider Book-

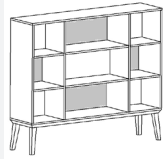

| PRODUCT | PRICE | | SIZE (INCHES) | | | WEIGHT VOL | |
|---------|----------|----------|---------------|----|----|------------|-----------------|
| | STANDARD | LAMINATE | H | W | D | LBS | FT ³ |
| AB26HB | 5774 | 4619 | 57 | 64 | 15 | 222 | 34 |

- Freestanding three high divider bookcase with fixed shelves
- High base
- LP laminate back

AB27HB • 64”W Freestanding Divider Bookcase



| PRODUCT | PRICE | | SIZE (INCHES) | | | WEIGHT VOL | |
|---------|----------|----------|---------------|----|----|------------|-----------------|
| | STANDARD | LAMINATE | H | W | D | LBS | FT ³ |
| AB27HB | 5774 | 4619 | 57 | 64 | 15 | 222 | 34 |

- Freestanding three high divider bookcase with fixed shelves
- High base
- LP laminate back

AB28HB • 64”W Freestanding Divider Bookcase



| PRODUCT | PRICE | | SIZE (INCHES) | | | WEIGHT VOL | |
|---------|----------|----------|---------------|----|----|------------|-----------------|
| | STANDARD | LAMINATE | H | W | D | LBS | FT ³ |
| AB28HB | 4752 | 3802 | 43 | 64 | 15 | 167 | 26 |

- Freestanding two high divider bookcase with fixed shelves
- High base
- LP laminate back

AB29HB • 64”W Freestanding Divider Bookcase



| PRODUCT | PRICE | | SIZE (INCHES) | | | WEIGHT VOL | |
|---------|----------|----------|---------------|----|----|------------|-----------------|
| | STANDARD | LAMINATE | H | W | D | LBS | FT ³ |
| AB29HB | 4752 | 3802 | 43 | 64 | 15 | 167 | 26 |

- Freestanding two high divider bookcase with fixed shelves
- High base
- LP laminate back

Table Tops 144" and over
(2 Sections, 6 Legs)

Table Tops up to 120"
(1 Section, 6 Legs)

CONFERENCE ROOM TABLES • GUIDELINES FOR ORDERING PRODUCT

CODES: The price list uses a numbering system with meaningful alphanumeric characters to create a simple-to-understand product number. This makes specifying the product easy and accurate.

NOTE: Arrow indicates direction of grain.

SPECIFICATION EXAMPLE OF A CONFERENCE ROOM TABLE

PRODUCT CODE: ART9632
A = Corby Series
R = Rectangular Conference Table Top
96" X 32" = Size: Width x Depth
Up to 120" = Size: Width (One Section Top)



PRODUCT CODE: ART14432
A = Corby Series
R = Rectangular Conference Table Top
144" X 32" = Size: Width x Depth
144" and over = Size: Width (Two Section Top)



FINISH: Choose Finish

ART• 32" W MAP - CONFERENCE TABLE RECTANGULAR SHAPE



| PRODUCT | PRICE | | SIZE (INCHES) | | | WEIGHT VOL | | |
|----------|----------|----------|---------------|----|-----|------------|-----------------|--------------------------------|
| | STANDARD | LAMINATE | H | W | D | LBS | FT ³ | |
| ART9632 | 11842 | 9473 | 29 | 32 | 96 | 183 | 15 | • Conference Table with 6 Legs |
| ART12032 | 12850 | 10280 | 29 | 32 | 120 | 212 | 17 | • Conference Table with 6 Legs |



| | | | | | | | | |
|----------|-------|-------|----|----|-----|-----|----|---|
| ART14432 | 13691 | 10952 | 29 | 32 | 144 | 268 | 19 | • 2 Sections Conference Table with 6 Legs |
| ART16832 | 14699 | 11758 | 29 | 32 | 168 | 296 | 21 | • 2 Sections Conference Table with 6 Legs |

ART• 42" W MAP - CONFERENCE TABLE RECTANGULAR SHAPE



| PRODUCT | PRICE | | SIZE (INCHES) | | | WEIGHT VOL | | |
|----------|----------|----------|---------------|----|-----|------------|-----------------|--------------------------------|
| | STANDARD | LAMINATE | H | W | D | LBS | FT ³ | |
| ART9642 | 13019 | 10415 | 29 | 42 | 96 | 219 | 19 | • Conference Table with 6 Legs |
| ART12042 | 14194 | 11355 | 29 | 42 | 120 | 260 | 21 | • Conference Table with 6 Legs |



| | | | | | | | | |
|----------|-------|-------|----|----|-----|-----|----|---|
| ART14442 | 15370 | 12297 | 29 | 42 | 144 | 324 | 25 | • 2 Sections Conference Table with 6 Legs |
| ART16842 | 16547 | 13237 | 29 | 42 | 168 | 360 | 27 | • 2 Sections Conference Table with 6 Legs |

ART• 48" W MAP - CONFERENCE TABLE RECTANGULAR SHAPE



| PRODUCT | PRICE | | SIZE (INCHES) | | | WEIGHT VOL | | |
|----------|----------|----------|---------------|----|-----|------------|-----------------|--------------------------------|
| | STANDARD | LAMINATE | H | W | D | LBS | FT ³ | |
| ART9648 | 13690 | 10952 | 29 | 48 | 96 | 240 | 21 | • Conference Table with 6 Legs |
| ART12048 | 15036 | 12027 | 29 | 48 | 120 | 284 | 24 | • Conference Table with 6 Legs |



| | | | | | | | | |
|----------|-------|-------|----|----|-----|-----|----|---|
| ART14448 | 16379 | 13104 | 29 | 48 | 144 | 356 | 28 | • 2 Sections Conference Table with 6 Legs |
| ART16848 | 17725 | 14180 | 29 | 48 | 168 | 400 | 30 | • 2 Sections Conference Table with 6 Legs |

ASPBOX • Riser box

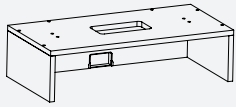

| PRODUCT | PRICE | | SIZE (INCHES) | | | WEIGHT VOL | |
|------------|----------|----------|---------------|----|----|------------|-----------------|
| | STANDARD | LAMINATE | H | W | D | LBS | FT ³ |
| ASPBOX2814 | 282 | 226 | 7.5 | 28 | 14 | 14 | 3 |
| ASPBOX2014 | 253 | 204 | 7.5 | 20 | 14 | 10 | 2 |

- 28"W Riser Box for 20"H storage to support Peninsula Table & 32" deep Bridge Top
- 20"W Riser Box for 20"H storage to support 24" deep Bridge Top

ACMP • 22"H Hanging wood modesty panel

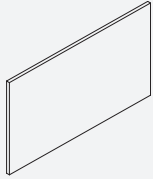

| PRODUCT | PRICE | | SIZE (INCHES) | | | WEIGHT VOL | |
|------------|----------|----------|---------------|----|------|------------|-----------------|
| | STANDARD | LAMINATE | H | W | D | LBS | FT ³ |
| ACMPW38H22 | 569 | 455 | 22 | 38 | 0.75 | 20 | 2 |
| ACMPW44H22 | 622 | 498 | 22 | 44 | 0.75 | 22 | 2 |
| ACMPW50H22 | 675 | 540 | 22 | 50 | 0.75 | 24 | 3 |
| ACMPW56H22 | 718 | 574 | 22 | 56 | 0.75 | 26 | 3 |
| ACMPW62H22 | 769 | 615 | 22 | 62 | 0.75 | 28 | 3 |

- 22" Hanging Wood Modesty Panel
- For selection of the hanging wood modesty panel, please see pages A.5 - A.6 for details.

ACMP • 15"H Hanging wood modesty panel

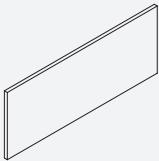

| PRODUCT | PRICE | | SIZE (INCHES) | | | WEIGHT VOL | |
|------------|----------|----------|---------------|----|------|------------|-----------------|
| | STANDARD | LAMINATE | H | W | D | LBS | FT ³ |
| ACMPW38H15 | 539 | 431 | 15 | 38 | 0.75 | 15 | 2 |
| ACMPW44H15 | 592 | 474 | 15 | 44 | 0.75 | 17 | 2 |
| ACMPW50H15 | 647 | 518 | 15 | 50 | 0.75 | 18 | 2 |
| ACMPW56H15 | 689 | 550 | 15 | 56 | 0.75 | 20 | 2 |
| ACMPW62H15 | 740 | 592 | 15 | 62 | 0.75 | 21 | 2 |
| ACMPW68H15 | 813 | 650 | 15 | 68 | 0.75 | 23 | 3 |
| ACMPW74H15 | 883 | 705 | 15 | 74 | 0.75 | 24 | 3 |

- 15" Hanging Wood Modesty Panel
- For selection of the hanging wood modesty panel, please see pages A.5 - A.6 for details.

ACU3214 • Cushion

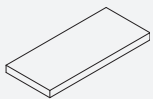

| PRODUCT | PRICE | | SIZE (INCHES) | | | WEIGHT VOL | |
|---------|----------|----------|---------------|----|----|------------|-----------------|
| | STANDARD | LAMINATE | H | W | D | LBS | FT ³ |
| ACU3214 | 879 | | 2 | 32 | 14 | | |

- Cushion - Grade 2 seating fabrics. Please refer to the following website for the current offering: <https://www.globalfurnituregroup.com/ca/resources/textiles>

FVMED + GM1K • Flat screen monitor mount with round grommet

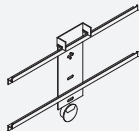

| PRODUCT | PRICE | | SIZE (INCHES) | | | WEIGHT VOL | |
|------------|----------|----------|---------------|----|---|------------|-----------------|
| | STANDARD | LAMINATE | H | W | D | LBS | FT ³ |
| FVMED+GM1K | 454 | | 17 | 28 | 2 | 14 | 0.7 |

- Flat screen monitor mount up to 50"
- To be used on Media Cabinets (ATV1LB & ATV1HB)
- GM1K (Tungsten) grommet on the back panel is included.

GM5C • Rectangular grommet

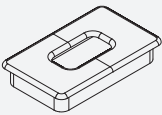

| PRODUCT | PRICE | | SIZE (INCHES) | | | WEIGHT VOL | |
|---------|----------|----------|---------------|-----|---|------------|-----------------|
| | STANDARD | LAMINATE | H | W | D | LBS | FT ³ |
| GM5C | 85 | | | 3.5 | 2 | | |

- Rectangular grommet - metal, chrome finish

DSRTMCS401 • Recessed Power Block



| PRODUCT | PRICE | | SIZE (INCHES) | | | WEIGHT VOL | |
|-------------|----------|----------|---------------|-------|------|------------|-----------------|
| | STANDARD | LAMINATE | H | W | D | LBS | FT ³ |
| DSRTMCS401B | 578 | | 4.86 | 10.78 | 4.22 | 4.3 | .51 |
| DSRTMCS401T | 578 | | 4.86 | 10.78 | 4.22 | 4.3 | .51 |
| DSRTMCS401W | 578 | | 4.86 | 10.78 | 4.22 | 4.3 | .51 |

- Single sided recessed power block with 1 regular duplex and 1 data knock-out on top, 1 power duplex on bottom. 10 ft power cord with straight plug.
- Telecom plates ordered separately.
- Available in Black - B, Tungsten - T or Designer White - W.

DSRTMCS421 • Recessed Power Block



| PRODUCT | PRICE | SIZE (INCHES) | | | WEIGHT | VOL |
|-------------|-------|---------------|-------|------|--------|-----|
| | | H | W | D | | |
| DSRTMCS421B | 759 | 4.86 | 10.78 | 4.22 | 4.5 | .51 |
| DSRTMCS421T | 759 | 4.86 | 10.78 | 4.22 | 4.5 | .51 |
| DSRTMCS421W | 759 | 4.86 | 10.78 | 4.22 | 4.5 | .51 |

- Single sided recessed power block with 1 power & USB A+C duplex and 1 data knock-out on top, 1 power duplex on bottom. USB Type A port charges max 2.4 amps at 5V and Type C port charges max 3 amps at 5V. 10 ft power cord with straight plug.
- Telecom plates ordered separately.
- Available in Black - B, Tungsten - T or

DSRTMCD602 • Recessed Power Block



| PRODUCT | PRICE | SIZE (INCHES) | | | WEIGHT | VOL |
|-------------|-------|---------------|-------|------|--------|-----|
| | | H | W | D | | |
| DSRTMCD602B | 660 | 4.86 | 10.78 | 6.22 | 5.9 | .51 |
| DSRTMCD602T | 660 | 4.86 | 10.78 | 6.22 | 5.9 | .51 |
| DSRTMCD602W | 660 | 4.86 | 10.78 | 6.22 | 5.9 | .51 |

- Double sided recessed power block with 2 regular power duplexes and 2 data knock-outs on top, 1 power duplex on bottom. 10 ft power cord with straight plug.
- Telecom plates ordered separately.
- Available in Black - B, Tungsten - T or Designer White - W.

DSRTMCD622 • Recessed Power Block



| PRODUCT | PRICE | SIZE (INCHES) | | | WEIGHT | VOL |
|-------------|-------|---------------|-------|------|--------|-----|
| | | H | W | D | | |
| DSRTMCD622B | 831 | 4.86 | 10.78 | 6.22 | 6.1 | .51 |
| DSRTMCD622T | 831 | 4.86 | 10.78 | 6.22 | 6.1 | .51 |
| DSRTMCD622W | 831 | 4.86 | 10.78 | 6.22 | 6.1 | .51 |

- Double sided recessed power block with 1 regular power duplex, 1 power & USB A+C duplex and 2 data knock-outs on top, 1 power duplex on bottom. USB Type A port charges max 2.4 amps at 5V and Type C port charges max 3 amps at 5V. 10 ft power cord with straight plug.
- Telecom plates ordered separately.
- Available in Black - B, Tungsten - T or Designer White - W.

DSRTMCD642 • Recessed Power Block



| PRODUCT | PRICE | SIZE (INCHES) | | | WEIGHT | VOL |
|-------------|-------|---------------|-------|------|--------|-----|
| | | H | W | D | | |
| DSRTMCD642B | 1001 | 4.86 | 10.78 | 6.22 | 6.3 | .51 |
| DSRTMCD642T | 1001 | 4.86 | 10.78 | 6.22 | 6.3 | .51 |
| DSRTMCD642W | 1001 | 4.86 | 10.78 | 6.22 | 6.3 | .51 |

- Double sided recessed power block with 2 power & USB A+C duplexes and 2 data knock-outs on top, 1 power duplex on bottom. USB Type A port charges max 2.4 amps at 5V and Type C port charges max 3 amps at 5V. 10 ft power cord with straight plug
- Telecom plates ordered separately.
- Available in Black - B, Tungsten - T or Designer White - W.

ABLBB • Telcom Plate



| PRODUCT | PRICE | SIZE (INCHES) | | | WEIGHT | VOL |
|---------|-------|---------------|---|---|--------|-----|
| | | H | W | D | | |
| ABLBB | 283 | | | | | |

- Black telcom plate with two RJ45 cat 6 data

ABLBBB • Telcom Plate



| PRODUCT | PRICE | SIZE (INCHES) | | | WEIGHT | VOL |
|---------|-------|---------------|---|---|--------|-----|
| | | H | W | D | | |
| ABLBBB | 552 | | | | | |

- Black telcom plate with four RJ45 cat 6 data

ABLABC514 • Telcom Plate

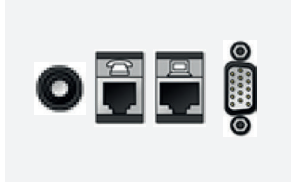

| PRODUCT | STANDARD | PRICE | SIZE (INCHES) | | | WEIGHT LBS | VOL FT ³ |
|-----------|----------|-------|---------------|---|---|------------|---------------------|
| | | | H | W | D | | |
| ABLABC514 | | 439 | | | | | |

- Black telcom plate with one RJ11 cat 3 phone, one RJ45 cat 6 data, one mini stereo and 15 pin HD VGA

ABLC51L • Telcom Plate



| PRODUCT | STANDARD | PRICE | SIZE (INCHES) | | | WEIGHT LBS | VOL FT ³ |
|---------|----------|-------|---------------|---|---|------------|---------------------|
| | | | H | W | D | | |
| ABLC51L | | 628 | | | | | |

- Black telcom plate with one mini stereo, one 15 pin HD VGA and one HDMI

ABLABC45 • Telcom Plate



| PRODUCT | STANDARD | PRICE | SIZE (INCHES) | | | WEIGHT LBS | VOL FT ³ |
|----------|----------|-------|---------------|---|---|------------|---------------------|
| | | | H | W | D | | |
| ABLABC45 | | 490 | | | | | |

- Black telcom plate with one RJ11 cat 3 phone, one RJ45 cat 6 data and one HDMI

ABL102102 • Telcom Plate

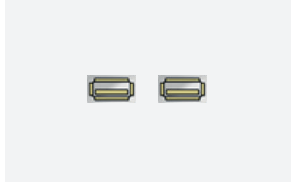

| PRODUCT | STANDARD | PRICE | SIZE (INCHES) | | | WEIGHT LBS | VOL FT ³ |
|-----------|----------|-------|---------------|---|---|------------|---------------------|
| | | | H | W | D | | |
| ABL102102 | | 257 | | | | | |

- Black telcom plate with two USB

BTC003 • Vault Desk Power Grommet

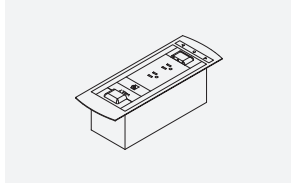

| PRODUCT | STANDARD | PRICE | SIZE (INCHES) | | | WEIGHT LBS | VOL FT ³ |
|---------|----------|-------|---------------|----|-----|------------|---------------------|
| | | | H | W | D | | |
| BTC003 | | 1647 | 4 | 12 | 4.5 | | |

- Includes 2 Power, 1 Data
- Jacks are not interchangeable
- Motorized touch control rotates top to reveal or conceal data/power connections
- 5' cord with 3 prong plug, anodized only

BRTCS • Wire Management Snake

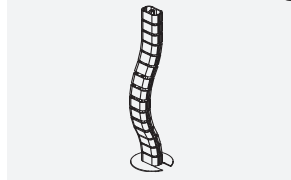

| PRODUCT | STANDARD | PRICE | SIZE (INCHES) | | | WEIGHT LBS | VOL FT ³ |
|---------|----------|-------|---------------|---|---|------------|---------------------|
| | | | H | W | D | | |
| BRTCS | | 237 | 39 | 2 | 2 | 2 | 0.5 |

- Black finish wire management

C2M • Wire Management Track

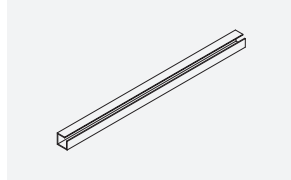

| PRODUCT | STANDARD | PRICE | SIZE (INCHES) | | | WEIGHT LBS | VOL FT ³ |
|---------|----------|-------|---------------|----|---|------------|---------------------|
| | | | H | W | D | | |
| C2M12 | | 18 | 2 | 12 | 2 | 0.3 | 1 |
| C2M24 | | 33 | 2 | 24 | 2 | 0.6 | 1 |
| C2M36 | | 48 | 2 | 36 | 2 | 0.9 | 1 |
| C2M48 | | 63 | 2 | 48 | 2 | 1.2 | 1 |
| C2M60 | | 79 | 2 | 60 | 2 | 1.5 | 1 |
| C2M72 | | 94 | 2 | 72 | 2 | 1.8 | 1 |

- Black finish

COBAR526 • L Bracket (Sets)

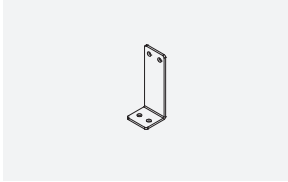

| PRODUCT | PRICE | SIZE (INCHES) | | | WEIGHT | VOL |
|----------|-------|---------------|---|---|--------|-----|
| | | STANDARD | H | W | | |
| COBAR526 | 59 | | | | | |

- Set of two
- Used for securing the stack-on units to the credenza

FRC • Foot Rest Cover (Sets)

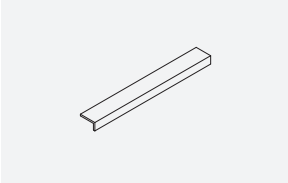

| PRODUCT | PRICE | SIZE (INCHES) | | | WEIGHT | VOL |
|---------|-------|---------------|---|---|--------|-----|
| | | STANDARD | H | W | | |
| FRC6632 | 384 | | | | | |
| FRC7232 | 414 | | | | | |
| FRC7832 | 444 | | | | | |
| FRC8432 | 473 | | | | | |
| FRC6642 | 444 | | | | | |
| FRC7242 | 473 | | | | | |
| FRC7842 | 503 | | | | | |
| FRC8442 | 532 | | | | | |

- Foot rest covers are factory installed (Only in Brushed Chrome Finish)
- For ARTC6632
- For ARTC7232
- For ARTC7832
- For ARTC8432
- For ARTC6642
- For ARTC7242
- For ARTC7842
- For ARTC8442

LO/C • Lock Assembly - Tungsten

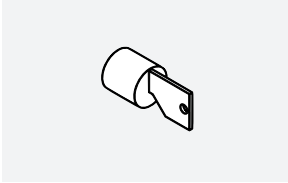

| PRODUCT | PRICE | SIZE (INCHES) | | | WEIGHT | VOL |
|-----------------|-------|---------------|---|---|--------|-----|
| | | STANDARD | H | W | | |
| LO/C (Tungsten) | 110 | | | | | |

LOB/C • Lock Drum with Key - Tungsten

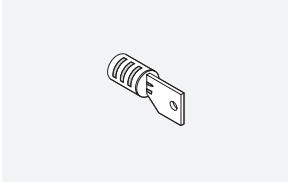

| PRODUCT | PRICE | SIZE (INCHES) | | | WEIGHT | VOL |
|---------|-------|---------------|---|---|--------|-----|
| | | STANDARD | H | W | | |
| LOB/C | 18 | | | | | |

LOCK/C • Lock Key

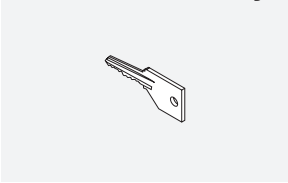

| PRODUCT | PRICE | SIZE (INCHES) | | | WEIGHT | VOL |
|---------|-------|---------------|---|---|--------|-----|
| | | STANDARD | H | W | | |
| LOCK/C | 12 | | | | | |

PL89 • Handle

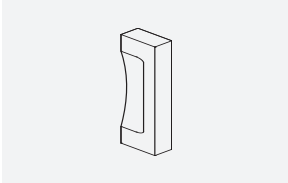

| PRODUCT | PRICE | SIZE (INCHES) | | | WEIGHT | VOL |
|---------|-------|---------------|---|---|--------|-----|
| | | STANDARD | H | W | | |
| PL89 | 48 | | | | | |

- Metal, Chrome finish

HOOK400 • Coat Hook

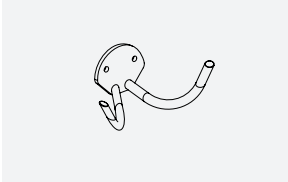

| PRODUCT | PRICE | SIZE (INCHES) | | | WEIGHT | VOL |
|---------|-------|---------------|---|---|--------|-----|
| | | STANDARD | H | W | | |
| HOOK400 | 22 | | | | | |

- Metal, Nickel finish