

Corby Price List

Effective January 2025 Canada















General Information

A

Where to Order / How to Order **A.8**
 Series Details **A.9**
 General Installation / Maintenance **A.16**
 Limited Lifetime Warranty **A.17**
 Finish Options **A.18**
 Handle and Edge Options **A.18**
 Key Alike Form **A.19**

Tables

B

-  AR • Peninsula Table
B.1
-  ART • Freestanding Work Table
B.1
-  ARTC • Freestanding Collaboration Table
B.1
-  ARC • Collaboration Media Table
B.2
-  ACSFO-GM • Wall Mount Media Storage
B.2
-  ACSFO • Wall Mount Open Storage
B.2
-  ASPBOX • Riser Box
B.2
-  FRC • Foot Rest Cover (Sets)
B.2
-  ACMP • 22”H Hanging wood modesty panel
B.2
-  CMP • 15”H Hanging wood modesty panel
B.2
-  ACT • 13”H Square Occasional Table
B.3
-  ACT • 17”H Square Occasional Table
B.3
-  ACT • 13”H Rectangular Occasional Table
B.3



ACT • 17”H Rectangular Occasional Table
B.3



ACTRO-H13 • 13”H Round Occasional Table
B.4



ACTRO-H17 • 17”H Round Occasional Table
B.4



ARO-H29 • 29”H Round Table
B.4

Returns

C



AERL-24CG • Executive Return Left
C.1



AERL-24CG • Executive Return Right
C.1

Bridges

D



A-20T-COPL-CG • Executive Bridge Top Left,
20” Deep
D.1



A-20T-COPR-CG • Executive Bridge Top Right,
20” Deep
D.1



A-24T-COPL-CG • Executive Bridge Top Left,
24” Deep
D.1



A-24T-COPR-CG • Executive Bridge Top Right,
24” Deep
D.1



A-32T-COPL-CG • Executive Bridge Top Left,
32” Deep
D.2



A-32T-COPR-CG • Executive Bridge Top Right,
32” Deep
D.2

Pedestals

E



AP1LB • 20”H Freestanding Pedestal
E.1



AP2LB • 20”H Freestanding Pedestal
E.1



AP3LB • 20”H Freestanding Pedestal
E.1



AP4LB • 20”H Freestanding Pedestal
E.2



AP5LB • 20”H Freestanding Pedestal
E.2



AP1LB32 • 20”H Freestanding Pedestal
E.2



AP2LB32 • 20”H Freestanding Pedestal
E.2



AP3LB32 • 20”H Freestanding Pedestal
E.2



AP4LB32 • 20”H Freestanding Pedestal
E.2



AP5LB32 • 20”H Freestanding Pedestal
E.2



AP6LB • 28”H Freestanding Pedestal
E.3



AP7LB • 28”H Freestanding Pedestal
E.3



AP8LB • 28”H Freestanding Pedestal
E.3



AP9LB • 28”H Freestanding Pedestal
E.3



AP1HB • 28”H Freestanding Pedestal
E.3



AP2HB • 28”H Freestanding Pedestal
E.3



AP3HB • 28”H Freestanding Pedestal
E.3



AP4HB • 28”H Freestanding Pedestal
E.4



AP5HB • 28”H Freestanding Pedestal
E.4



AP1HB32 • 28"H Freestanding Pedestal E.4



AP2HB32 • 28"H Freestanding Pedestal E.4



AP3HB32 • 28"H Freestanding Pedestal E.4



AP4HB32 • 28"H Freestanding Pedestal E.4



AP5HB32 • 28"H Freestanding Pedestal E.4



AP6HB • 35"H Freestanding Pedestal E.5



AP7HB • 35"H Freestanding Pedestal E.5



AP8HB • 35"H Freestanding Pedestal E.5



AP9HB • 35"H Freestanding Pedestal E.5



AC5RLB • 20"H Freestanding Credenza, 64"W F.2



AC6LB • 20"H Freestanding Credenza, 64"W F.2



AC7LB • 20"H Freestanding Credenza, 64"W F.2



AC8LLB • 28"H Freestanding Credenza, 64"W F.3



AC8RLB • 28"H Freestanding Credenza, 64"W F.3



AC9LB • 28"H Freestanding Credenza, 64"W F.3



AC10LLB • 28"H Freestanding Credenza, 64"W F.3



AC10RLB • 28"H Freestanding Credenza, 64"W F.3



AC1LHB • 28"H Freestanding Credenza, 64"W F.3



AC1RHB • 28"H Freestanding Credenza, 64"W F.3



AC7HB • 35"H Freestanding Credenza, 64"W F.5



AC8LHB • 35"H Freestanding Credenza, 64"W F.5



AC8RHB • 35"H Freestanding Credenza, 64"W F.5



AC9HB • 35"H Freestanding Credenza, 64"W F.5



AC10LHB • 35"H Freestanding Credenza, 64"W F.5



AC10RHB • 35"H Freestanding Credenza, 64"W F.5



AC11LB • 20"H Freestanding Credenza, 96"W F.5



AC12LB • 20"H Freestanding Credenza, 96"W F.6



AC13LB • 20"H Freestanding Credenza, 96"W F.6



AC14LB • 20"H Freestanding Credenza, 96"W F.6

Credenzas **F**



AC1LLB • 20"H Freestanding Credenza, 64"W F.1



AC2HB • 28"H Freestanding Credenza, 64"W F.4



AC15LB • 20"H Freestanding Credenza, 96"W F.6



AC1RLB • 20"H Freestanding Credenza, 64"W F.1



AC3HB • 28"H Freestanding Credenza, 64"W F.4



AC16LB • 20"H Freestanding Credenza, 96"W F.6



AC2LB • 20"H Freestanding Credenza, 64"W F.1



AC4LHB • 28"H Freestanding Credenza, 64"W F.4



AC17LB • 20"H Freestanding Credenza, 96"W F.6



AC3LB • 20"H Freestanding Credenza, 64"W F.2



AC4RHB • 28"H Freestanding Credenza, 64"W F.4



AC18LB • 20"H Freestanding Credenza, 96"W F.6



AC4LLB • 20"H Freestanding Credenza, 64"W F.2



AC5LHB • 28"H Freestanding Credenza, 64"W F.4



AC19LB • 20"H Freestanding Credenza, 96"W F.7



AC4RLB • 20"H Freestanding Credenza, 64"W F.2



AC5RHB • 28"H Freestanding Credenza, 64"W F.4



AC20LB • 20"H Freestanding Credenza, 96"W F.7



AC5LLB • 20"H Freestanding Credenza, 64"W F.2



AC6HB • 28"H Freestanding Credenza, 64"W F.4



AC21LB • 20"H Freestanding Credenza, 96"W F.7

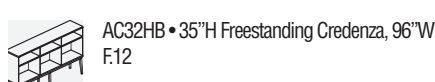
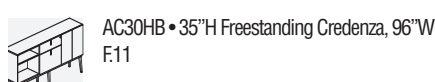
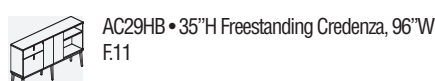
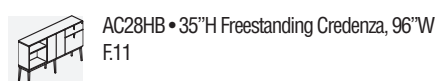
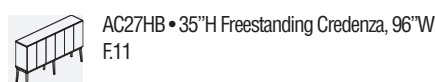
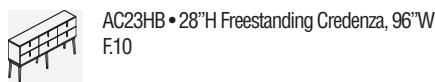
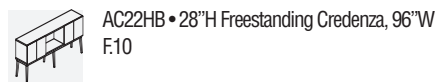
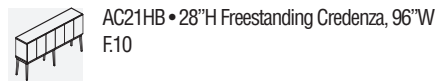
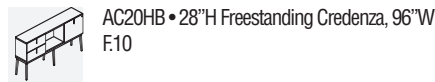
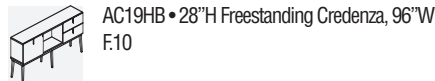
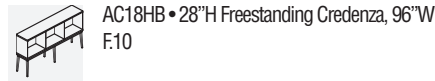
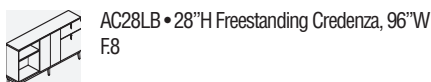
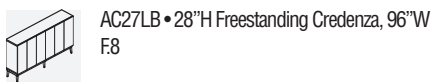

Stack-On Bookcases

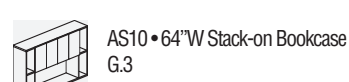
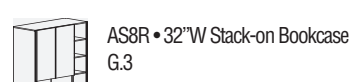
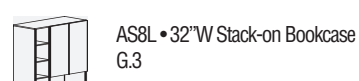
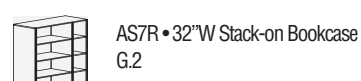
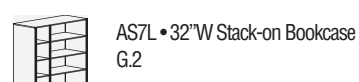
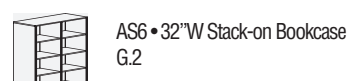
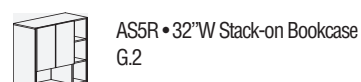
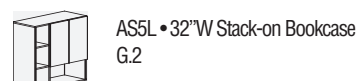
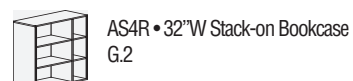
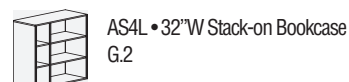
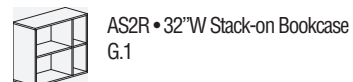
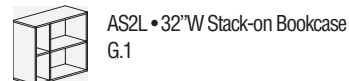
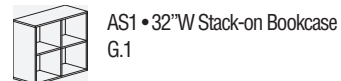



AS11 • 64"W Stack-on Bookcase
G.3



AS12 • 64"W Stack-on Bookcase
G.3



AS13 • 64"W Stack-on Bookcase
G.3



AS14 • 64"W Stack-on Bookcase
G.4



AS15 • 64"W Stack-on Bookcase
G.4



AS16 • 64"W Stack-on Bookcase
G.4



AS17 • 64"W Stack-on Bookcase
G.4



AS18 • 64"W Stack-on Bookcase
G.4



AS19 • 64"W Stack-on Bookcase
G.4



AS20 • 64"W Stack-on Bookcase
G.4



AS21 • 64"W Stack-on Bookcase
G.5



AB4RLB • 32" W Freestanding Bookcase
H.2



AB5LLB • 32" W Freestanding Bookcase
H.2



AB5RLB • 32" W Freestanding Bookcase
H.2



AB6LB • 32" W Freestanding Bookcase
H.2



AB7LLB • 32" W Freestanding Bookcase
H.2



AB7RLB • 32" W Freestanding Bookcase
H.2



AB8LLB • 32" W Freestanding Bookcase
H.3



AB8RLB • 32" W Freestanding Bookcase
H.3



AB1HB • 32" W Freestanding Bookcase
H.3



AB2LHB • 32" W Freestanding Bookcase
H.3



AB2RHB • 32" W Freestanding Bookcase
H.3



AB3HB • 32" W Freestanding Bookcase
H.3



AB4LHB • 32" W Freestanding Bookcase
H.3



AB4RHB • 32" W Freestanding Bookcase
H.4



AB5LHB • 32" W Freestanding Bookcase
H.4



AB5RHB • 32" W Freestanding Bookcase
H.4



AB6HB • 32" W Freestanding Bookcase
H.4



AB7LHB • 32" W Freestanding Bookcase
H.4



AB7RHB • 32" W Freestanding Bookcase
H.4



AB8LHB • 32" W Freestanding Bookcase
H.4



AB8RHB • 32" W Freestanding Bookcase
H.5



AB9LB • 64" W Freestanding Bookcase
H.5



AB10LB • 64" W Freestanding Bookcase
H.5



AB11LB • 64" W Freestanding Bookcase
H.5



AB12LB • 64" W Freestanding Bookcase
H.5



AB13LB • 64" W Freestanding Bookcase
H.5



AB14LB • 64" W Freestanding Bookcase
H.5



AB15LB • 64" W Freestanding Bookcase
H.6



AB16LB • 64" W Freestanding Bookcase
H.6



AB17LB • 64" W Freestanding Bookcase
H.6



AB18LB • 64" W Freestanding Bookcase
H.6



AB19LB • 64" W Freestanding Bookcase
H.6



AB20LB • 64" W Freestanding Bookcase
H.6



ATV1LB • 50" W Freestanding Media Cabinet
H.6

Freestanding Bookcases **H**



AB1LB • 32" W Freestanding Bookcase
H.1



AB2LLB • 32" W Freestanding Bookcase
H.1



AB2RLB • 32" W Freestanding Bookcase
H.1



AB3LB • 32" W Freestanding Bookcase
H.1



AB4LLB • 32" W Freestanding Bookcase
H.2



AB9HB • 64" W Freestanding Bookcase
H.7



AB10HB • 64" W Freestanding Bookcase
H.7

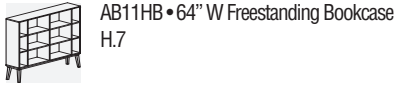

AB11HB • 64" W Freestanding Bookcase
H.7

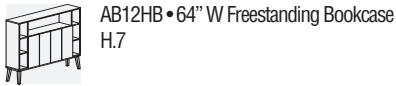

AB12HB • 64" W Freestanding Bookcase
H.7

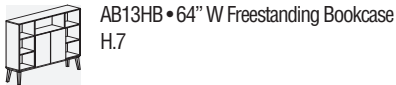

AB13HB • 64" W Freestanding Bookcase
H.7

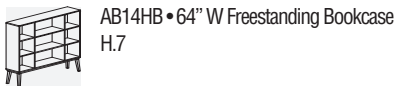

AB14HB • 64" W Freestanding Bookcase
H.7

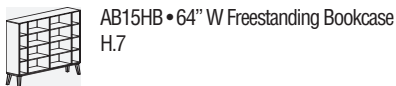

AB15HB • 64" W Freestanding Bookcase
H.7

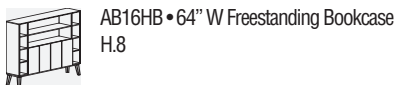

AB16HB • 64" W Freestanding Bookcase
H.8

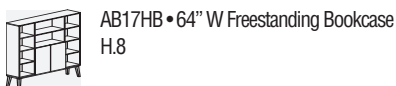

AB17HB • 64" W Freestanding Bookcase
H.8

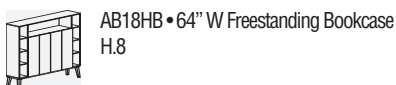

AB18HB • 64" W Freestanding Bookcase
H.8

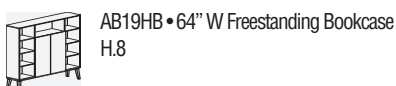

AB19HB • 64" W Freestanding Bookcase
H.8



AB20HB • 64" W Freestanding Bookcase
H.8



ATV1HB • 57" W Freestanding Media Cabinet
H.8



AB25LB • 64" W Freestanding Divider Bookcase
I.1



AB26LB • 64" W Freestanding Divider Bookcase
I.2



AB27LB • 64" W Freestanding Divider Bookcase
I.2



AB28LB • 64" W Freestanding Divider Bookcase
I.2



AB29LB • 64" W Freestanding Divider Bookcase
I.2



AB22HB • 64" W Freestanding Divider Bookcase
I.2



AB23HB • 64" W Freestanding Divider Bookcase
I.2



AB24HB • 64" W Freestanding Divider Bookcase
I.2



AB25HB • 64" W Freestanding Divider Bookcase
I.3



AB26HB • 64" W Freestanding Divider Bookcase
I.3



AB27HB • 64" W Freestanding Divider Bookcase
I.3



AB28HB • 64" W Freestanding Divider Bookcase
I.3



AB29HB • 64" W Freestanding Divider Bookcase
I.3

Freestanding Divider Bookcaes



AB22LB • 64" W Freestanding Divider Bookcase
I.1



AB23LB • 64" W Freestanding Divider Bookcase
I.1



AB24LB • 64" W Freestanding Divider Bookcase
I.1

Conference Tables

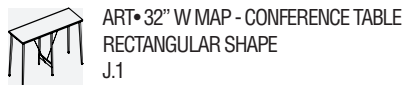

ART • 32" W MAP - CONFERENCE TABLE
RECTANGULAR SHAPE
J.1

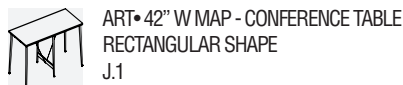

ART • 42" W MAP - CONFERENCE TABLE
RECTANGULAR SHAPE
J.1

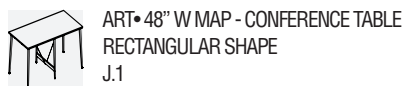

ART • 48" W MAP - CONFERENCE TABLE
RECTANGULAR SHAPE
J.1

Accessories

K



ASPBOX • Riser box
K.1



ACMP • 22" H Hanging wood modesty panel
K.1



ACMP • 15" H Hanging wood modesty panel
K.1



ACU3214 • Cushion
K.1



FVMED + GM1K • Flat screen monitor mount
with round grommet
K.1



GM5C • Rectangular grommet
K.1



DSRTMCS401 • Recessed Power Block, 401
K.1



DSRTMCS421 • Recessed Power Block, 421
K.2



DSRTMCS602 • Recessed Power Block, 602
K.2



DSRTMCS602 • Recessed Power Block, 622
K.2



DSRTMCS642 • Recessed Power Block, 642
K.2



ABLBB • Telcom Plate
K.2



ABLBBB • Telcom Plate
K.2



ABLABC514 • Telcom Plate
K.3



ABLC51L • Telcom Plate
K.3



ABLABC45 • Telcom Plate
K.3



ABL102102 • Telecom Plate
K.3



BTC003 • Vault Desk Power Grommet
K.3



BRTCS • Wire Management Snake
K.3



C2M • Wire Management Track
K.3



COBAR526 • L Bracket (Sets)
K.4



FRC • Foot Rest Cover (Sets)
K.4



LO/C • Lock Assembly - Tungsten
K.4



LOB/C • Lock Drum with Key - Tungsten
K.4



LOCK/C • Lock Key
K.4



PL89 • Handle
K.4



HOOK400 • Coat Hook
K.4

WHERE TO ORDER / HOW TO USE THIS GUIDE

	PHONE	FAX
Descor Industries, Customer Service	905-470-0010	905-470-6262

Price and Product Guide Section: Features the actual product pricing and specification instructions. This section is divided into Tables, Occasional Tables, Pedestals and Storage, Credenzas, Stack-on Bookcases and Storage Cabinets, Freestanding Bookcases and Storage Cabinets.

General Information: Includes subdivision sections of casegoods construction, varnish specification, veneers and wood solids, finishing process, general installation and hardware, maintenance, terms and conditions of sale, warranty and where to order.

ISO 9001: 2015 Registered: The Descor Factory is ISO 9001: 2015 registered for manufacturing procedures and practices of quality and quality control processes.

ISO 14001: 2015 Registered: The Descor Factory is ISO 14001: 2015 registered for environmental procedures and practices.

ANSI/BIFMA Certified: Descor casegoods have passed ANSI/BIFMA standards for product construction and durability.

FSC®: Forest Stewardship Council®. Option available on all wood veneer products by special request.

BIFMA e3: Furniture sustainability level 3.

Greenguard: All Descor Products are Greenguard certified.

Price List Effective: January 2025

HOW TO ORDER A PRODUCT

Creating a correct and complete product number ensures clean orders and accurate information for the factory. Clean orders expedite order entry and factory order scheduling, thereby, saving days, sometimes weeks off potentially extended lead-times.

It is important to indicate the correct option of finishes; wood and LP laminate (backs of Stack-on Units and Freestanding Bookcases)

For All wood finish; please add suffix "/W" at the end of the product code.
For All laminate finish; please add suffix "/P" at the end of the product code.

To view current wood, plastic laminate and fabric offering, please visit www.globalcontract.com.

To order actual wood, plastic laminate and fabric samples and cards, place request with the Global Marketing Department via fax at 416-667-0338 or via e-mail at: literaturecdn@globalfurnituregroup.com

Wood finish samples are individual 3"x 5" chips and can be obtained through the above by request.

EXAMPLE • HOW TO SPECIFY

CODES: The price list uses a product coding system that is specific to each of the units. The product description (next to the code) explains in detail construction of the unit.

SPECIFICATION EXAMPLE OF A 96" FREESTANDING CREDENZA:

PRODUCT CODE: AC17LB, all wood (AC17LB/W) and all laminate (AC17LB/P)

A = Corby Series

C = Credenza

17 = Product ID number (Freestanding Credenza 20H" x 96"W x 20"D)

LB = Low Base (4")

CHOOSE FINISH OPTION:

Standard Finish: Wood & Laminate back (e.g. AC17LB) - Please see page A.18

Laminate Finish: All Laminate (e.g. AC17LB/P) - Please see page A.18

Wood Finish: Wood & Wood back (e.g. AC17LB/W) - Please see page A.18

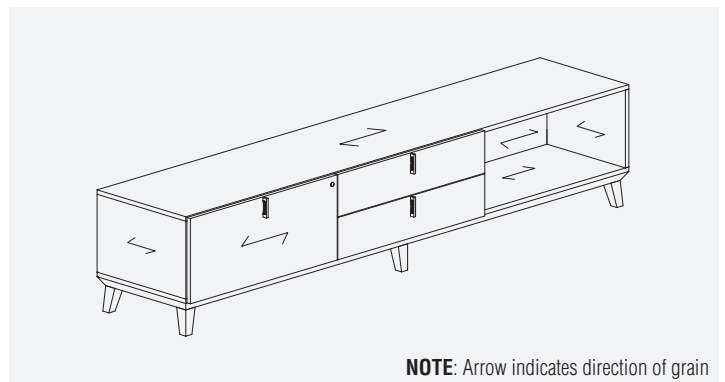

NOTE: Arrow indicates direction of grain

Series Detailing: Corby detailing is new century modern with knife edge on table tops. Solid walnut, cherry, oak and maple that band edge tops 1/8" wide by 3/4" thick for an overall thickness of 1^{3/8}".

Tapered, solid wood legs (walnut, cherry, oak and maple) are used to support the Peninsula, Work, Collaboration and Occasional Tables.

Pedestal, Credenza and Bookcase bottoms include 1^{3/8}" thick painted, bevelled profile and tapered solid wood legs (4"H or 11^{1/2}"H).

Grommets: GM5C (Chrome Finish) is optional on table tops, bridge tops and returns (see Grommet specification details on page A.4 and A.5).

CONSTRUCTION

Finish: Conversion varnish (similar to catalyzed lacquer, but tougher), 25° sheen. Descor does not buff or rub its finishes.

360° Finishing: All Descor wood casegood products are veneered and finished on the back side.

Veneers and Solids: Veneers and solids are Number One select, architectural grade "A" oak, walnut, cherry or maple. All Descor wood worksurface moulded edges are solid oak, walnut, cherry or maple.

Series Handles: All box and lateral drawers have one Vertical Handle PL89 (Chrome Finish) installed. Doors are equipped with touch latch mechanism with no handles (Optional handles available).

Pedestals, Storage Cabinets, Credenzas and Bookcases: All units are elevated 4" (xxLB = Low Base), or 11.5" (xxHB = High Base) off the floor by tapered solid wood legs.

Stack-on Bookcases and Storage Cabinets: Stack-on units are designed to be placed and installed on top of the Credenzas with Low and High Base.

Locking: Front locking is standard on the Pedestals with box/file and file drawers, Credenzas with box/lateral and lateral drawers. Optional locking on doors (Storage units) is available (see Accessories).

Drawer suspensions: Pedestal drawer suspensions are metal ball bearing type. Both box and file drawers are full extension.

Hanging file rails: Are pre-installed on file drawer perimeters. The back rail in a lateral file drawer is designed for both legal and letter size filing.

Drawer construction: Drawer sides and bottoms are maple veneer plywood with dowel construction.

Drawer fronts: The drawer front is an applied element to a four sided drawer. Drawer fronts are veneered on all surfaces. Drawer fronts can be removed or replaced in the field.

Levelling glides: Levellers have a 1" range of adjustment.

VENEERS AND SOLID WOODS

Descor provides high quality veneers and solids for our customers. Sourced from North America with a progressive approach to sustainability, ensures our vendors are protecting and maintaining the natural forests of origin.

Descor lays-up its own flat cut (cathedral pattern) in book matched set and patterns standard on cherry, maple and walnut veneer. Rift cut veneer are laid-up in a slip match method standard on oak veneer.

For additional information on veneer species, cuts and patterns, please contact your Customer Service representative.

DESCOR CONVERSION VARNISH SPECIFICATION

Descor uses conversion varnish: It is among the most durable finishes used in the contract furniture industry (more durable than catalyzed lacquer). Conversion varnish is a synthetic, catalyzed cured (chemically active) finish, containing UV inhibitors to slow the oxidizing (colour changing) effects of ultra-violet rays on wood.

Descor produces low 25° sheen. Low sheens are the most practical for commercial use as it doesn't show most scratches and are more easily touched-up than higher sheens.

Cures with heat, developed two ways:

- Chemically (catalyst reaction within the varnish itself)
- Line oven (approximately 140° F) accelerates finish curing and increases molecular density for a harder finish.

Conversion varnish has a component called "solids", produced by a combination of resins when the solvent evaporates. These solids float to the varnish surface, which is where they cure. These solids are the durable aspect of the finish.

Descor uses an "off-the-gun" technique with conversion varnish. This means the "solids" (the durable aspect of the finish) remain intact on the surface of the finish.

Descor's standard finish on oak and walnut is open pore, on cherry and maple is semi-closed pore. If a full fill finish is required for cherry and maple tops, add the suffix "2" to the finish code and add 5% to the base pricing for each product.

Custom finish is available at an up-charge (See finishes and options section).

GROMMET SPECIFICATION

OPTIONAL GM5C
GROMMET SPECIFICATION



Work and Collaboration Table
From 32" to 42" deep tops

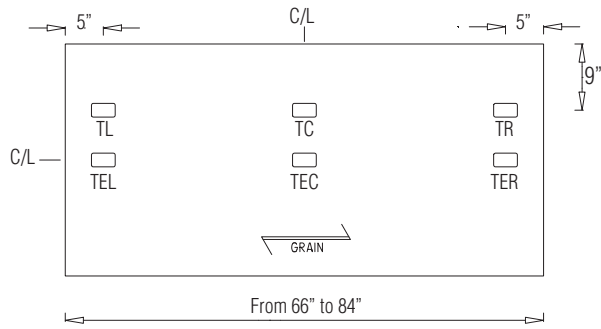

Peninsula Table
For 32" deep tops

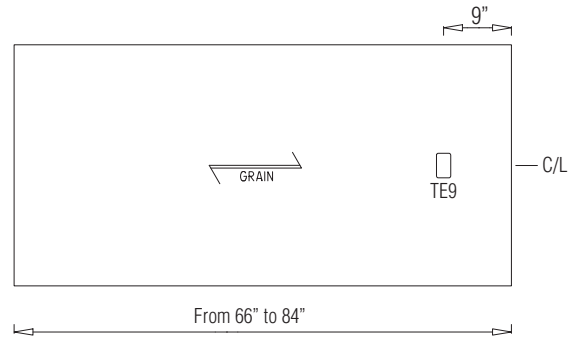

OPTIONAL POWER MANAGEMENT
GROMMET SPECIFICATION

BTC003
Work and Collaboration Tables
From 32" to 42" deep tops

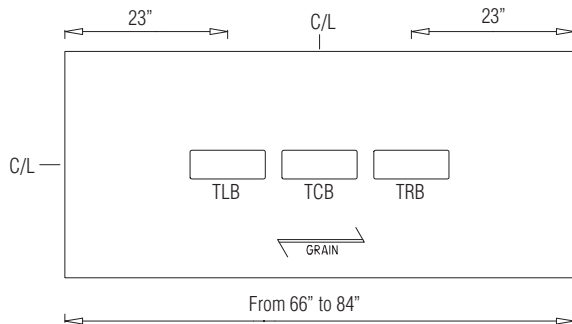
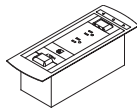

DSRTMCS401
Work and Collaboration Tables
From 32" to 42" deep tops

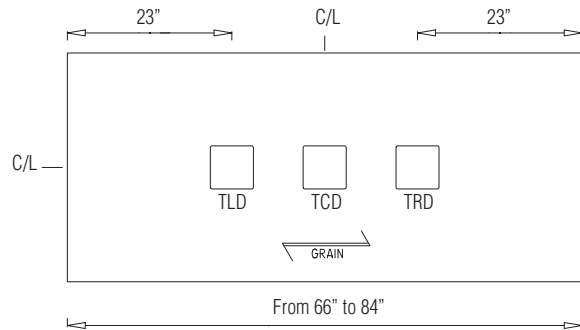

NOTE: For 66" & 72" wide tops, please select one location only.

NOTE: Cutout for each Recessed power block is available at an upcharge \$91.

GM1K
GROMMET SPECIFICATION



Freestanding Media Cabinet

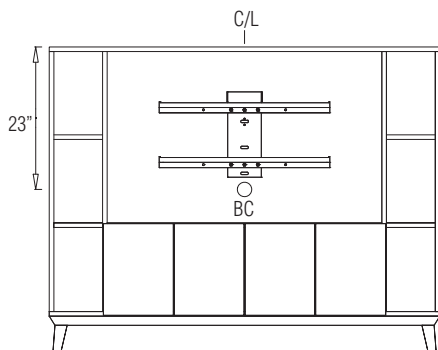

GROMMET SPECIFICATION

OPTIONAL GM5C
GROMMET SPECIFICATION



Executive Bridge Tops - AxxxxT/COPL/CG
From 20" to 32" deep tops

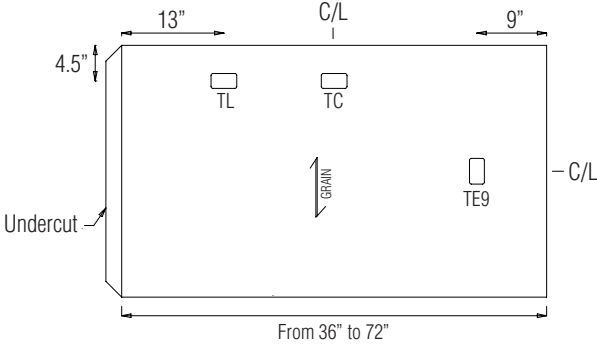

Executive Bridge Tops - AxxxxT/COPR/CG
From 20" to 32" deep tops

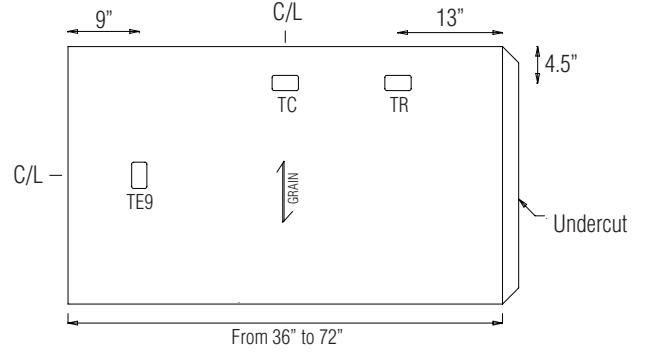

Executive Return Right - AERRxxxxCG
For 24" deep tops

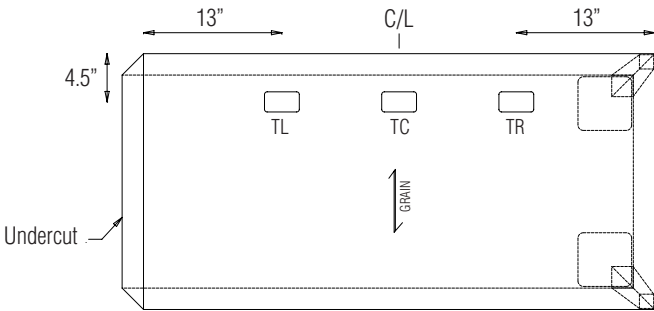

Executive Return Left - AERLxxxxCG
For 24" deep tops

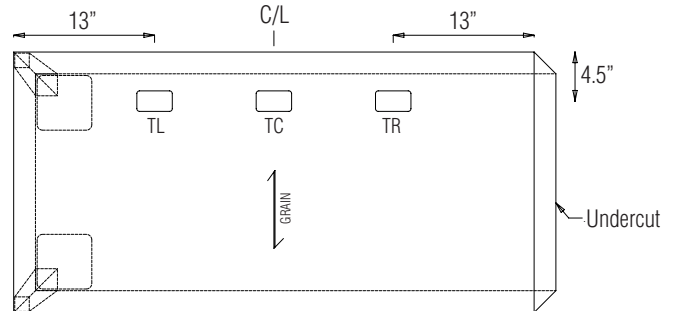

OPTIONAL WIRE MANAGEMENT CUTOUTS (C275)
CREDENZAS ONLY

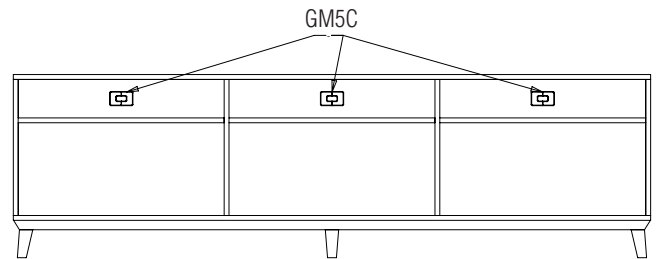
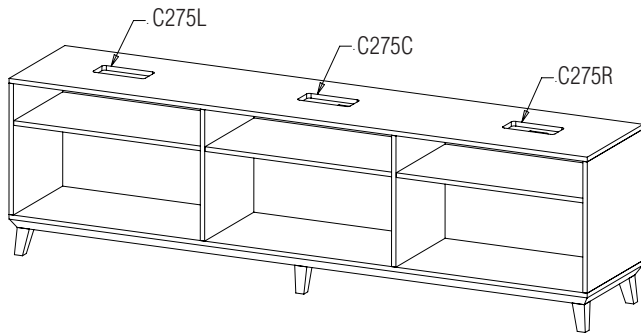

- Wire Management Cutouts available on request only for Credenzas
- To be used with Peninsula table and Executive Bridge Tops having GM5C grommet at TE9 location
- Each cutout is available at an upcharge of \$150. Add suffix "C275x" at the end of the product code. For Eg: AC32LB/C275L or AC32LB/C275C or AC32LB/C275R
- Available only on the open side of the Credenza
- Top panel will have 8" x 4" cutout
- Back panel will have GM5C grommet

MODESTY PANEL OPTIONS

- Wood Modesty Panels are available in 15" and 22" height.
- To be used on Work Tables and on the Peninsula Table with and without the Riser Box.
- Recommended position for installation is 6" inset.

PENINSULA TABLE WITH HIGH BASE PEDESTAL

MODESTY SIZES:

- ACMPW44H15 - 44" x 15" x 0.75"
- ACMPW50H15 - 50" x 15" x 0.75"
- ACMPW56H15 - 56" x 15" x 0.75"
- ACMPW62H15 - 62" x 15" x 0.75"

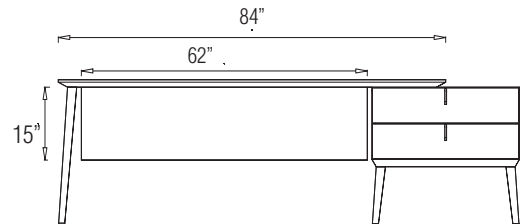
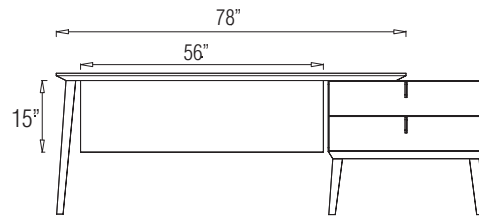
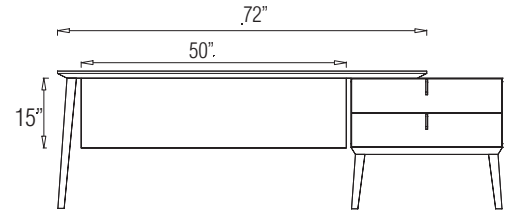
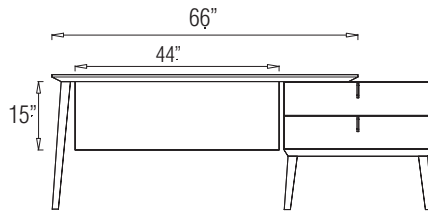

PENINSULA TABLE WITH LOW BASE PEDESTAL

MODESTY SIZES:

- ACMPW44H22 - 44" x 22" x 0.75"
- ACMPW50H22 - 50" x 22" x 0.75"
- ACMPW56H22 - 56" x 22" x 0.75"
- ACMPW62H22 - 62" x 22" x 0.75"

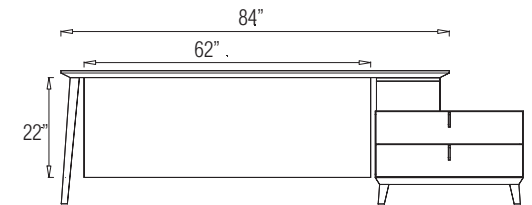
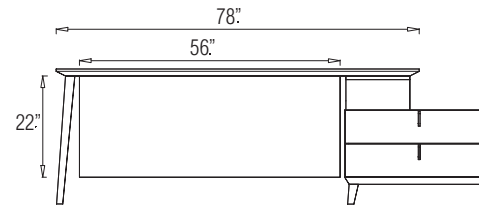
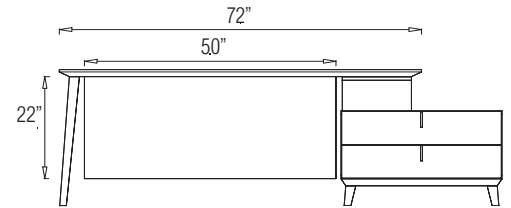
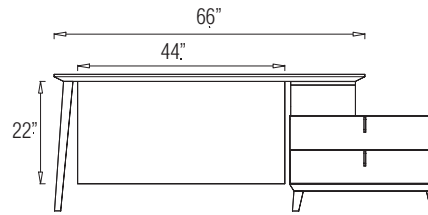

PENINSULA TABLE WITH HIGH BASE CREDENZA

MODESTY SIZES:

- ACMPW38H15 - 38" x 15" x 0.75"
- ACMPW44H15 - 44" x 15" x 0.75"
- ACMPW50H15 - 50" x 15" x 0.75"
- ACMPW56H15 - 56" x 15" x 0.75"

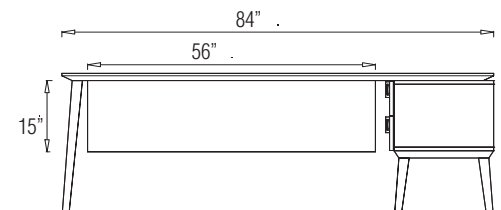
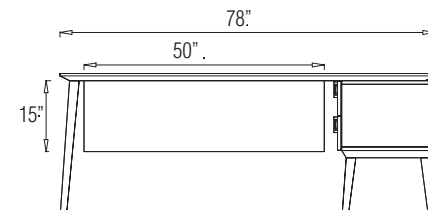
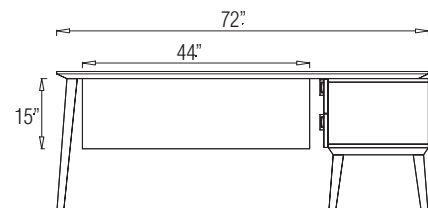
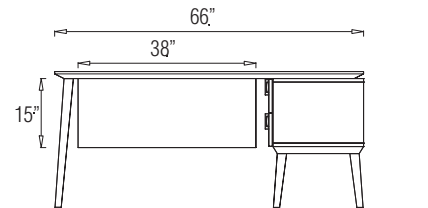

MODESTY PANEL OPTIONS

PENINSULA TABLE WITH LOW BASE CREDENZA

MODESTY SIZES:

- ACMPW38H22 - 38" x 22" x 0.75"
- ACMPW44H22 - 44" x 22" x 0.75"
- ACMPW50H22 - 50" x 22" x 0.75"
- ACMPW56H22 - 56" x 22" x 0.75"

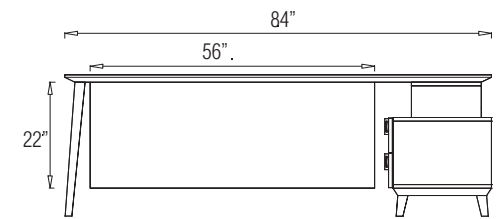
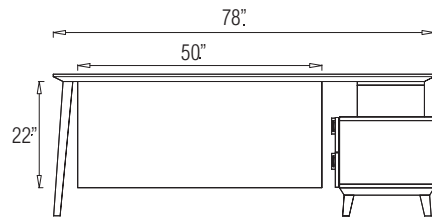
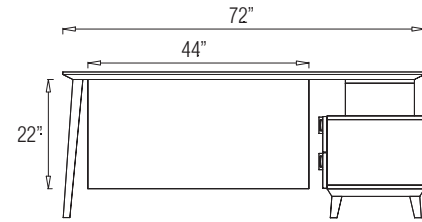
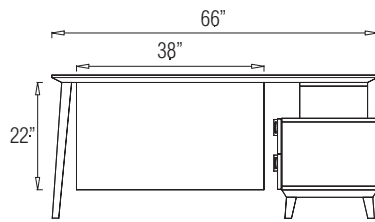

FREESTANDING WORK TABLES & COLLABORATION TABLES

MODESTY SIZES:

- ACMPW56H15 - 56" x 15" x 0.75"
- ACMPW62H15 - 62" x 15" x 0.75"
- ACMPW68H15 - 68" x 15" x 0.75"
- ACMPW74H15 - 74" x 15" x 0.75"

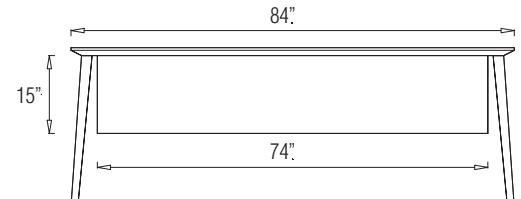
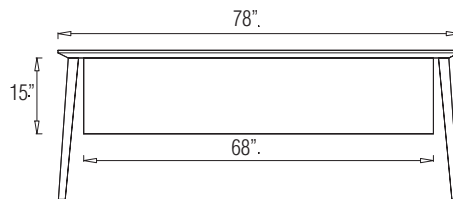
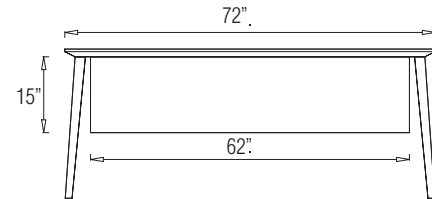
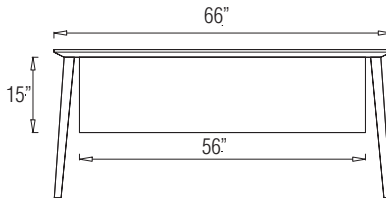

RISER BOX

- Riser Box is to be used as a spacer between the Peninsula Table and 20”H Pedestals and Credenzas.

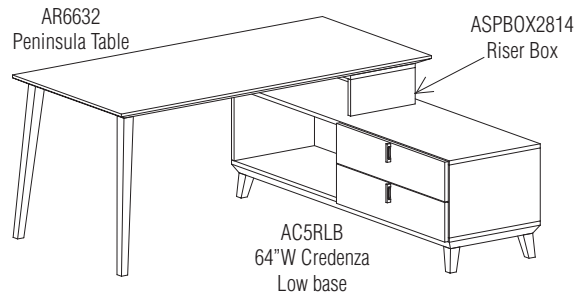
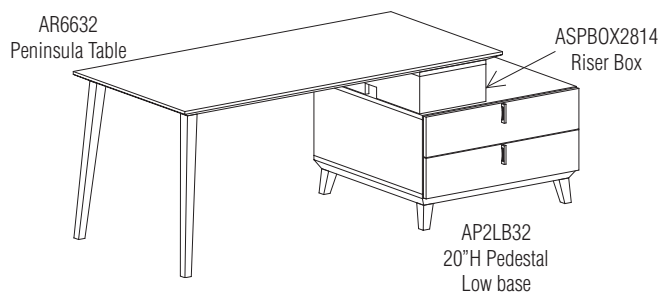

- On Peninsula Table, the Riser Box can be installed as below:

Riser Box opening is on the outside.

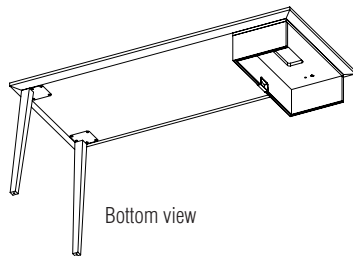

Riser Box opening is on the inside.

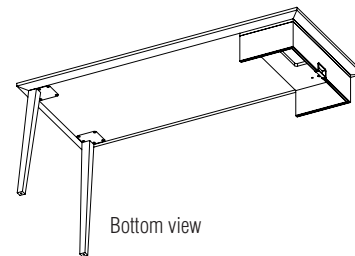

HEIGHT GRID • FLOOR UNITS

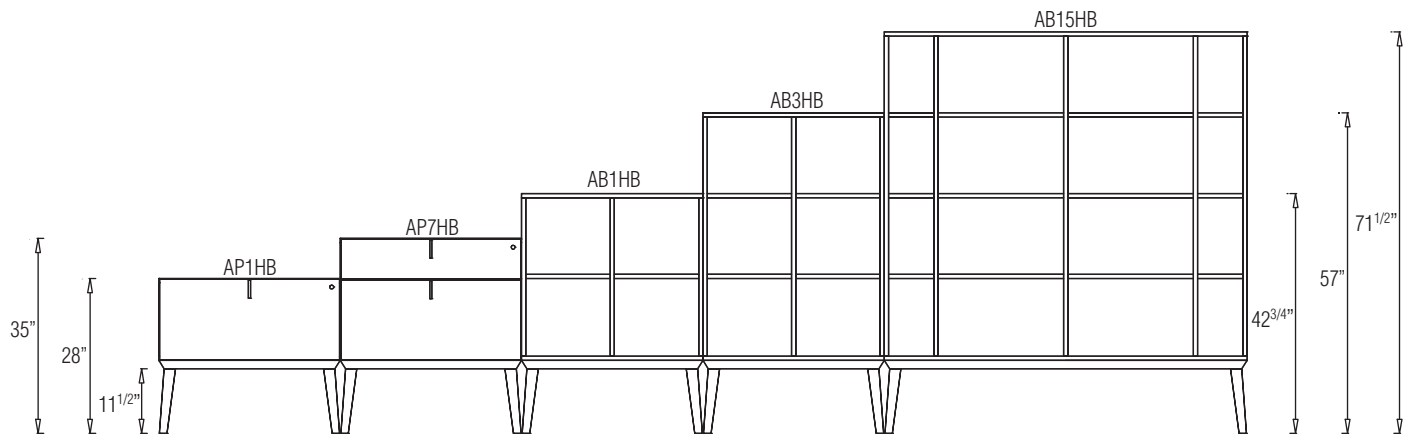
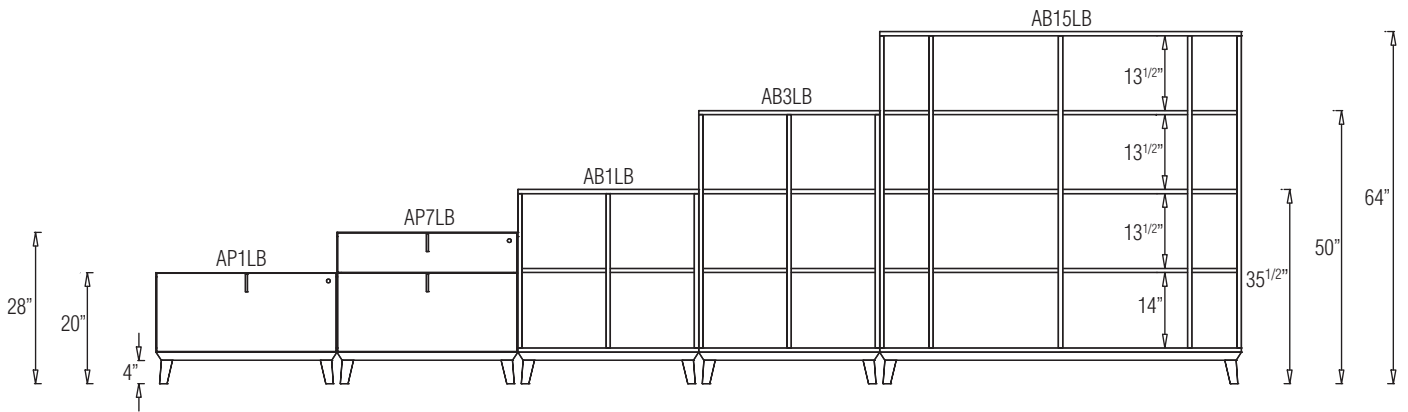

HEIGHT GRID • STACK-ON UNITS

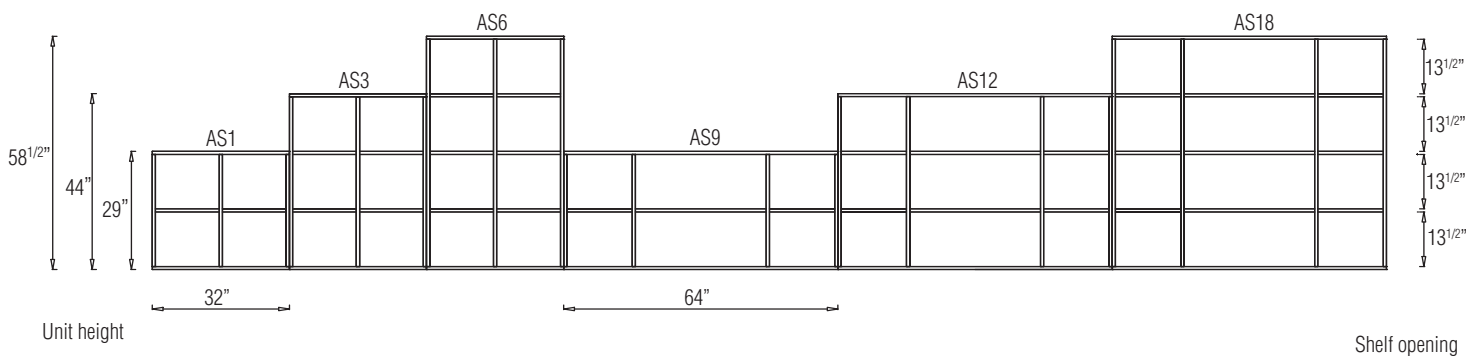

GENERAL INSTALLATION AND HARDWARE

UNCARTONING

Always uncarton wood office furniture with care. Never use a knife or sharp object of any kind to open cartons. Tear cartoning tape off by hand. Protective corner blocks, foam-wrap, and a bottom skid are included in the carton during shipping for protection.

Hardware: All necessary hardware for attaching furniture is included in the shipment.

Hanging file rails: Pre-installed on file drawer perimeters and accommodates both legal and letter size filing.

INSTALLATION

Stack-on: Descor utilizes a non-marring method of Stack-on unit attachment. They are installed with double faced tape applied to the bottom of the unit. The tape is shipped in a plastic bag found in the Stack-on unit. Removal of the Stack-on unit requires moderate pressure to be applied on the top of the unit towards the wall for at least a minute for the pressure sensitive tape to release. At the dealer or installer's discretion, additional support may be added by installing L brackets along the outside back of the attached units. These L brackets are not included in the shipment. Please see Accessories.

Riser Box: Descor utilizes both; mechanical and a non-marring method of Riser Box attachment. Riser Box is installed with double faced tape applied to the bottom of the unit and bolts that secure the unit to the underside of the Peninsula Table. The tape and bolts are shipped in a plastic bag found in the Riser Box.

Freestanding Pedestals: Have four pre-drilled pilot holes [two left (L) / two right (R)] on the inside top surface of the Pedestal top. In order to attach the Freestanding Pedestal 27.5"H (without the Riser Box) to the Peninsula Table the pedestal drawer/file must be removed. Depending on which side the Pedestal will be used, two pilot holes (L or R side) must be drilled through to allow for connection to the Peninsula Table. Assembly bolts are included in a plastic bag fastened inside the pedestal. Disassemble the Pedestals first before relocating the entire unit to avoid damage or bodily injuries.

Levelling wood office furniture properly is the most important procedure to ensure proper functioning and alignment of drawers, locks and doors. Upon completing installation, wipe furniture with a damp cloth, followed by a dry soft cloth.

CARE AND MAINTENANCE GUIDE

Wood Caseworks Care: Descor furniture is constructed to strict specifications to ensure years of satisfied use. As with all wood products, certain care requirements and periodic maintenance are necessary in order to maintain the original new appearance and function.

Finish Protection: All clear wood finishes are susceptible to scratches from rough and abrasive objects, such as staples, paper clips, ceramic coffee mugs, flower pots, picture frames, etc. Computer equipment with rubber feet can also cause discolouration and softening of the finish due to petroleum distillates in the rubber. Glass tops are the ultimate protection against scratch mishaps. The most practical protection is the use of desk-pads or blotters, paper management bins, coasters, common sense caution with rough items, and adding pressure sensitive felt to the feet or bottoms of any potentially destructive item on the Desk.

Finish Care: Wax or polish should never be used on the catalysed finish; they will give a greasy, cloudy or uneven appearance to the product. Descor's conversion varnish finish is best cleaned by wiping the surfaces with a damp cloth, followed by a soft dry cloth in the direction of the grain. If the surfaces are very dirty, use of a glass cleaning type of product is recommended.

Never use a silicon based product to dust or polish catalysed finishes. Over time, silicon may disrupt the actual molecular composition of the finish and cause it to soften and become cloudy.

Additional Tips:

- Remove any spilled liquid immediately with a blotting, rather than a wiping motion.
- Do not drag or push objects or stacks of papers across any finely finished surface.
- Avoid exposing surfaces to extreme heat, cold or humidity.
- The surface finish may be burn resistant, however, the wood underneath the finish is not and can be charred by a burning cigarette or heat producing unit.
- Exposure to strong sunlight should be avoided. The surface finish is fade-proof, however, in spite of UV inhibitors in the finish, the wood underneath may change colour (patina) where extended exposure to sunlight exists. Natural or light finished species are especially susceptible to UV colour change.
- Building maintenance and maintenance service management should be notified of the proper care instructions and procedures for your furniture to avoid damage and allow optimum appearance for years to come.
- Special care should be taken to protect wood furniture when other trades such as painters, electricians and telecommunications workers are present performing work.
- Drawer suspensions are lubricated prior to shipment. Periodic lubrication may be applied to the ball bearing housing with a high quality lubricant found in most hardware stores.
- Drawer alignment is achieved with proper levelling of desks and credenzas.
- Check levelling glides for adjustment if the furniture is moved.
- Modular furniture items, such as Peninsula Tables and Pedestals must be disassembled prior to moving or relocating to avoid damage to the furniture.
- Touch-up of wood furniture should only be attempted by a qualified re-finisher touch-up technician. Contact your furniture dealer if this need should arise.

DESCOR LIMITED LIFETIME WARRANTY

Descor will, at no cost to the original purchaser and for as long as the original purchaser owns a Descor product repair or replace with a comparable product, at Descor's option, any part or product sold after January 01, 2001, which fails as a result of a defect in its design, materials or workmanship. For all purposes of this warranty, the term "purchaser" is defined as the entity or individual acquiring a new Descor product as the initial purchase thereof either from Descor or an authorized Descor dealer.

Exceptions to this warranty include:

- Descor warrants wood casegoods products to be free from defects in materials and workmanship for a period of ten years, of single shift service, from the date of delivery.
- Lighting products and grommets are warranted for one year from date of delivery.
- Custom electrical solutions may carry varying warranty coverage.
- Descor fabrics and wood veneers are warranted for five years from the date of delivery.
- Electrical components are warranted for one year from the date of delivery.
- Moving parts, which include, glides, slides, casters, user adjustable worksurface mechanism are warranted for five years from date of delivery.
- Descor warrants its products based on a single shift (40 hours/week). Usage beyond a single shift (40 hours/week) will result in a reduction in the warranty, in proportion to the increased usage.
- Pneumatic cylinders for any product, unless otherwise stated, are warranted for ten years of single shift (40 hours/week) usage, from date of delivery.

This warranty does not include:

- Customers Own Material (COM) or finishes applied to Descor products (which include graded in fabrics that are treated as Customers Own Material).
- Wood Veneer being a natural material will have shade differences between veneer leaves. This will be more apparent between flitches. Fading on wood veneers can be caused by exposure to UV rays / sunlight.
- Wood colour, grain and stain acceptance, which may occur due to the natural elements of wood.
- Ballasts and light bulbs.
- Products which have been modified or which have not been installed or used according to Descor's application and installation guidelines or warnings.
- Products that must be replaced due to normal wear and tear, negligence, abuse, accidents or shipping damage.
- Products used for rental purposes.

In no event shall Descor be liable in either tort or contract for any loss or direct, special, incidental, consequential, or exemplary damages.

This warranty is the customer's sole remedy for product defect. Descor makes no warranties, including the express or implied warranties of merchantability and fitness purpose, other than the express warranties contain herein.

TERMS AND CONDITIONS OF SALE

Prices: Prices are subject to change without notice. All shipments are F.O.B. the plant unless otherwise indicated. All taxes are extra.

Terms: Merchandise shall be invoiced when shipped and payment is due 30 days after invoice date.

Orders: All orders are subject to acceptance by Descor head office and to the Terms of Sale which appear in current price lists.

Returns: Merchandise may not be returned without prior written consent. Upon approval, a minimum restocking charge of 35% shall be deducted from the credit note, in addition to any expense incurred should reconditioning be necessary. Return shipping must be prepaid.

Cancellations: All orders are considered firm and not subject to cancellation without our documented approval. Cancellation charges may be required based on expenses incurred during order processing.

Carriers: All shipments shall normally be made through the Buyer's specified carrier. Otherwise Descor shall use its best judgment in selecting a carrier. Prepay and Add Service Charge to cover cost of processing prepaid freight bills, a charge of \$30.00 per shipment will be made. This amount will be included in the "Freight Charges" invoiced by Descor.

Liability: Every effort is employed to effect secure packing for shipment. Descor's liability ends when the carrier issues a clear receipt, acknowledging automatically that the shipment has been received in good condition.

Claims: It is required that all merchandise be carefully examined by recipient before issuance of clear receipt to carrier. Should the shipment arrive unsound or incomplete, have carrier make proper notation on the delivery receipt and original freight bill as to discrepancy before accepting shipment. Any claim for damage or shortage must be filed by you with the delivering carrier. Descor will not accept return of merchandise damaged in transit.

Changes and Cancellations: Descor reserves the right to institute changes with regard to materials, equipment, specification and designs, as well as to discontinue models at any time without prior notice. After the date of Descor's acknowledgement of a Purchaser's order, the order may not be changed or cancelled by Purchaser without the written consent of Descor. Special order items already in production are not subject to change or cancellation under any circumstances. Other standard items already in production are subject to a minimum 35% restocking charge, based on list price. A higher percentage may apply, depending on the stage of production.

Finishes: Descor veneers and solid woods are carefully selected for color, tone and grain. Since the distinctive characteristics and nature of wood cause variations, exact matches are not always possible.

Shipping Weight: All shipping weights and cubic sizes as indicated are approximate.

Dimensions: are approximate. Please contact Descor for specific dimensions required.

FINISHES

Corby finishes can be specified three ways:

- 1- All veneer with solid hardwood legs choose from specification option # 1.
- 2- Veneer with laminate storage backs and solid hardwood legs.
 - A- Choose veneer finish option from specification option # 1.
 - B- Choose cabinet Back Solid Colour Option from specification option # 2.
- 3- All Laminate with painted hardwood legs and matching cabinet back.
 - A- Choose Laminate finish option from specification option # 3
 - B- Choose Solid hardwood legs colour from specification option # 2.
 (LP) Low pressure laminate will be used on all chassis, fronts and doors.
 (HP) High pressure laminate will be used on all tops.

Doors, fronts and user side of all tops will be edgebanded with 3mm PVC edge,all remaining parts/edges will have a standard 0.5mm PVC edge.

Specification option # 2

PAINT ON HARDWOOD LEGS

Finish Code	Colour	
BLK	Black	Solid Colour
BZD	Blizzard	Solid Colour
CGY	Custom Grey	Solid Colour
DWT	Designer White	Solid Colour
MSM	Moss	Solid Colour
SEM	Sienna	Solid Colour
SPM	Spice	Solid Colour
SRM	Surt	Solid Colour
SDT	Stonedust	Solid Colour
SOG	Storm Grey (Charcoal)	Solid Colour

Specification option # 3

ALL LAMINATE FINISHES (LP) Chassis, Fronts, Doors and (HP) Top

Top Code	Chassis, Fronts, Doors Code	Colour
ACJ	ACJ	Absolute Acajou*
ASN	ASN	Asian Night*
BLK	BLK	Black
BZD	BZD	Blizzard
CGY	CGY	Custom Grey
CMB	CMB	Clear Maple*
DES	DES	Dark Espresso*
DWT	DWT	Designer White
FAS	FAS	Fashionista*
FCL	FCL	First Class*
NBL	NBL	Noce Biondo*
NEL	NEL	Noce Leggero*
NGL	NGL	Noce Grigio*
NML	NML	Noce Medio*
SBY	SBY	Sheer Beauty*
SDT	SDT	Stonedust
SOG	SOG	Storm Grey (Charcoal)
WCR	WCR	Winter Cherry*
WHC	WHC	White Chocolate*
WHE	WHE	Walnut Heights*

Laminate Colour with * is Wood Grain Laminate

Specification option # 1

STANDARD FINISHES

Finish Code	Colour	Veneer Type	Veneer Cut
BTW	Biscotti	White Oak	Rift
JAW	Java	White Oak	Rift
CRW	Coral	White Oak	Rift
EVW	Evening Oak	White Oak	Rift
GRW	Grey on Oak	White Oak	Rift
MTW	Milestone	White Oak	Rift
CAW	Cacao Walnut	Walnut	Flat
DWW	Dark Walnut	Walnut	Flat
EWV	Espresso Walnut	Walnut	Flat
LTW	Latte Walnut	Walnut	Flat
MHW	Mahogany on Walnut	Walnut	Flat
WLW	Walnut	Walnut	Flat
NLW	Natural Walnut	Walnut	Flat
ULW	Umber Walnut	Walnut	Flat
ACW	Amber Cherry	Cherry	Flat
DCW	Dark Cherry	Cherry	Flat
RCW	Red Cherry	Cherry	Flat
WCW	Warm Cherry	Cherry	Flat
AMW	Almond Cherry	Cherry	Flat
VNW	Vintage Cherry	Cherry	Flat
HAW	Hazelnut	Maple	Flat
MPW	Natural Maple	Maple	Flat
WMW	White Maple	Maple	Flat

HANDLE

PL89 Chrome Finish



EDGE

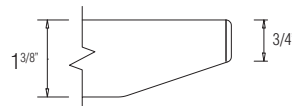

CUSHION FABRICS • GRADE 2

Cushions are standard in Global Upholstery Grade 2 - seating fabrics. Please refer to the following website for the current offering:

<https://www.globalfurnituregroup.com/ca/resources/textiles>

KEY ALIKE FORM

DATE

ACK.NO. (PROVIDED by DESCOR)

PAGE(S)

CUSTOMER PO#

SPECIAL INTRUCTIONS

INITIATED BY

ADD ON

ORIGINAL PO#

KEY NO. W420 to W500 Inclusive	TAG AREA	QUANTITY	DESCOR USE ONLY	
			Key Area Total	Checked Total
			Quantity	Print Initials

NOTE: If Key Alike Instructions are not submitted to DESCOR INDUSTRIES with the Customer's Purchase Order, all components will be keyed randomly.

SUITE 1

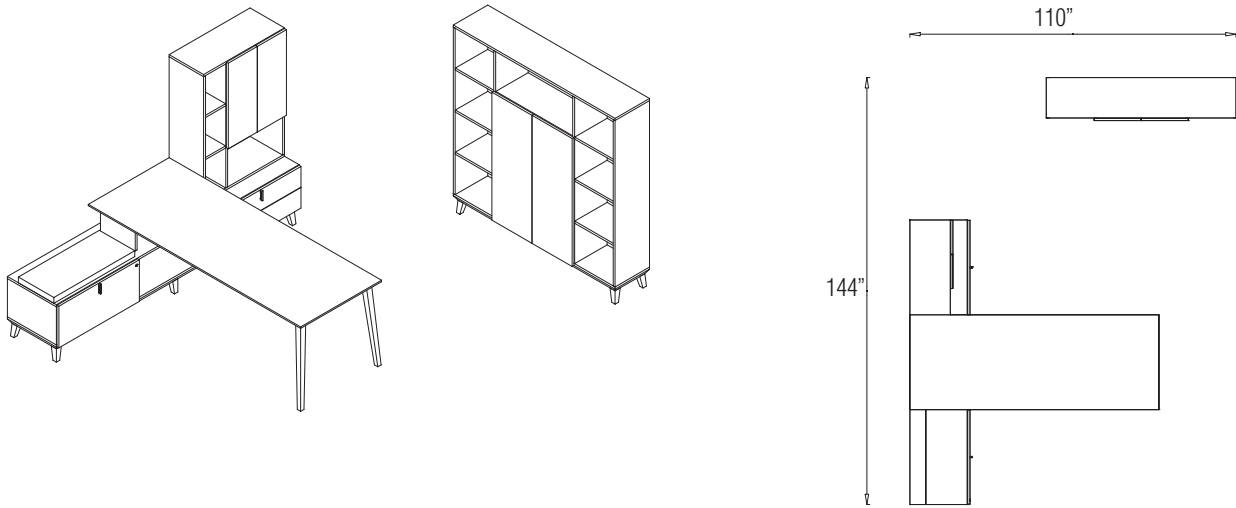

QUANTITY	CODE	DESCRIPTION	STANDARD	LAMINATE	ALL WOOD
1	AC19LB	20"H Freestanding Credenza, 96"W	6560	5248	6560
1	AS5L	Three High Stack-on Bookcase with asymmetrical openings	3169	2536	3599
1	AB19LB	64"W Freestanding Four High Bookcase	7363	5890	7794
1	ASPBOX2814	Riser Box for 20"H storage	304	242	304
1	AR8432	Peninsula table with two legs	2907	2328	2907
1	ACU3214	Cushion	941	941	941
TOTAL			\$21,235	\$17,178	\$22,096

SUITE 2

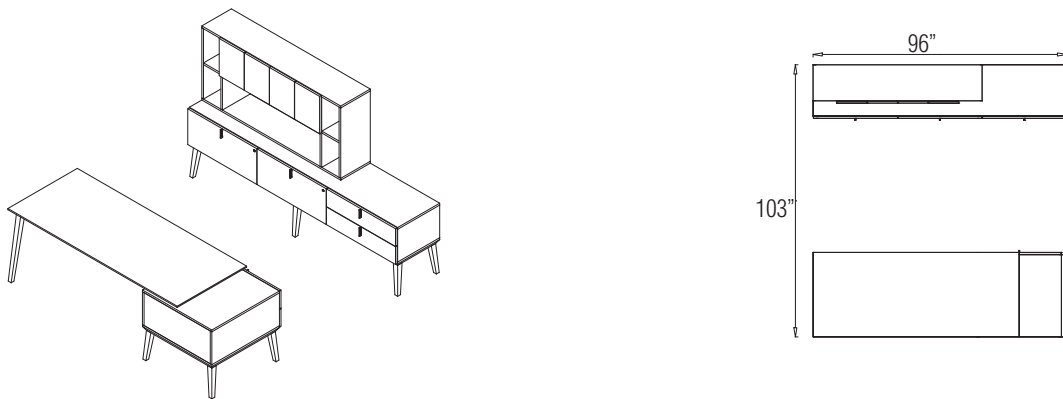

QUANTITY	CODE	DESCRIPTION	STANDARD	LAMINATE	ALL WOOD
1	AP2HB32	28"H Freestanding Pedestal with two box drawers	2765	2212	2765
1	AC14HB	28"H Freestanding Credenza, 96"W	7163	5730	7163
1	AS10	Two high Stack-on Bookcase	4023	3219	4453
1	AR7832	Peninsula table with two legs	2765	2212	2765
TOTAL			\$16,711	\$13,370	\$17,141

SUITE 3

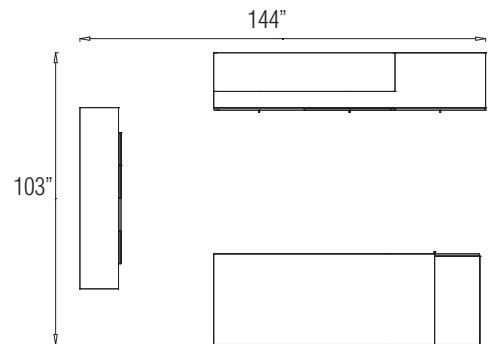
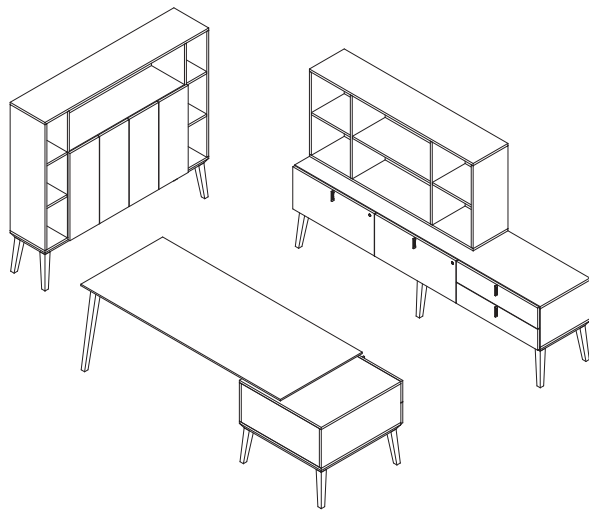

QUANTITY	CODE	DESCRIPTION	STANDARD	LAMINATE	ALL WOOD
1	AB12HB	57"H Freestanding Three High Bookcase	6959	5566	7388
1	AR7832	Peninsula table with two legs	2765	2212	2765
1	AP2HB32	28"H Freestanding Pedestal with two Box Drawers	2765	2212	2765
1	AS9	Two-High Stack-on Bookcase	3400	2722	3832
1	AC14HB	28"H Freestanding Credenza, 96"W	7163	5730	7163
		TOTAL	\$23,042	\$18,437	\$23,903

SUITE 4

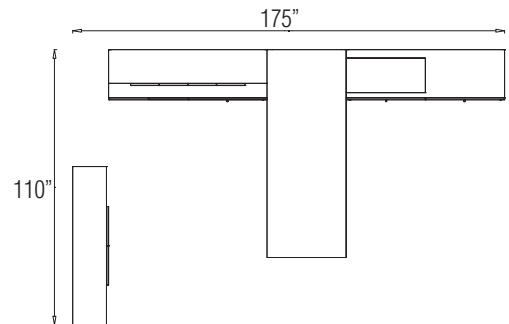
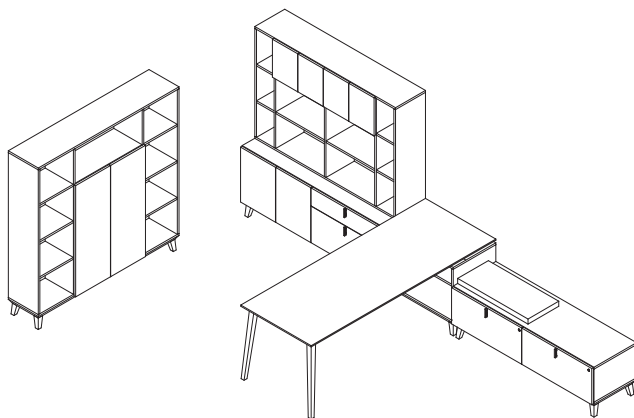

QUANTITY	CODE	DESCRIPTION	STANDARD	LAMINATE	ALL WOOD
1	AB19LB	64"H Freestanding Four High Bookcase	7363	5890	7794
1	AR8432	Peninsula table with two legs	2907	2328	2907
1	AC31LB	28"H Freestanding Credenza, 96"W	6319	5057	6319
1	AS14	Three High Stack-on Bookcase	5729	4583	6159
1	AC3LB	20"H Freestanding Credenza, 64"W	4614	3693	4614
1	ACU3214	Cushion	941	941	941
		TOTAL	\$27,866	\$22,483	\$28,297

SUITE 5

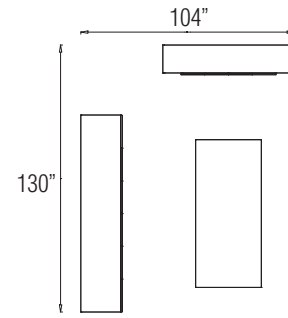
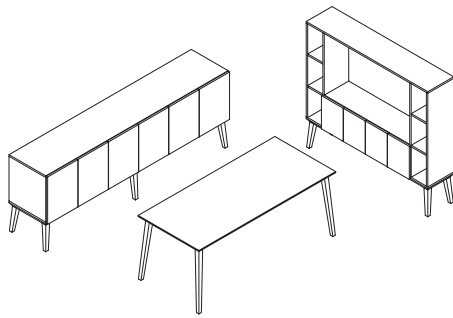

QUANTITY	CODE	DESCRIPTION	STANDARD	LAMINATE	ALL WOOD
1	AC27HB	35"H Freestanding Storage Credenza, 96"W	6799	5440	6799
1	ATV1HB	57"H Freestanding Media Cabinet	6597	5277	7027
1	ART7232	Freestanding work table with four legs	3647	2919	3647
TOTAL			\$17,039	\$13,630	\$17,469

SUITE 6

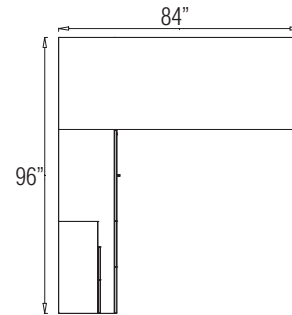
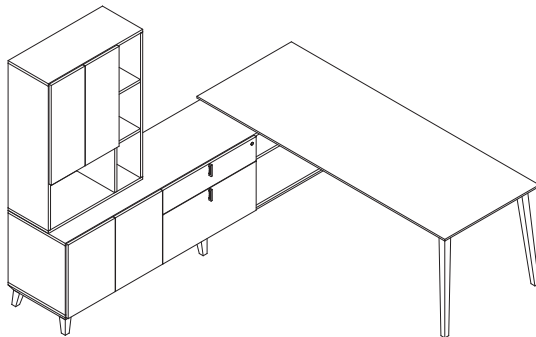

QUANTITY	CODE	DESCRIPTION	STANDARD	LAMINATE	ALL WOOD
1	AS5R	Three High Stack-on Bookcase with asymmetrical openings	3169	2536	3599
1	AC31LB	28"H Freestanding Credenza, 96"W	6319	5057	6319
1	AR8432	Peninsula table with two legs	2907	2328	2907
TOTAL			\$12,397	\$9,918	\$12,826

SUITE 7

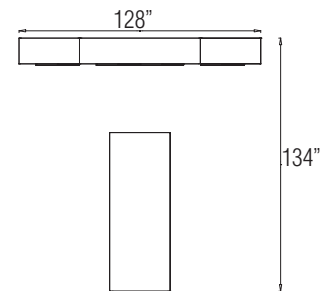
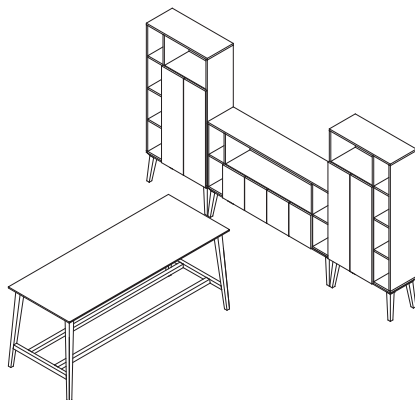

QUANTITY	CODE	DESCRIPTION	STANDARD	LAMINATE	ALL WOOD
1	AB7LHB	72"H Freestanding Four High Bookcase with asymmetrical openings	5164	4131	5595
1	AB9HB	42"H Freestanding Two High Bookcase	4889	3912	5319
1	AB7RHB	72"H Freestanding Four High Bookcase with asymmetrical openings	5164	4131	5595
1	ARTC8432	Freestanding Collaboration Table with four legs and foot rests	4932	3946	4932
TOTAL			\$20,146	\$16,116	\$21,437

SUITE 8

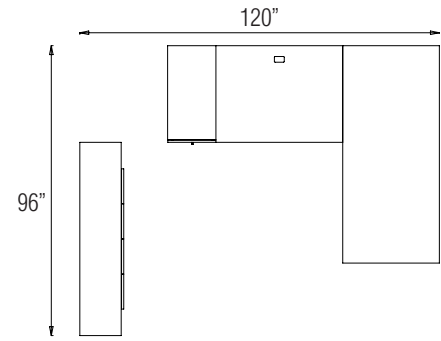
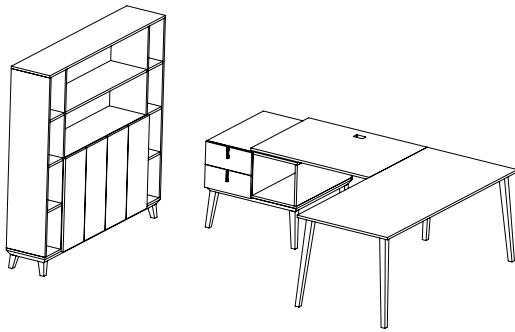

QUANTITY	CODE	DESCRIPTION	STANDARD	LAMINATE	ALL WOOD
1	AB16LB	64"W Freestanding Bookcase	8144	6515	8574
1	ART7232	Freestanding Work Table	3647	2919	3647
1	AP4HB32	28"H Freestanding Pedestal	2618	2095	2618
1	A4232T-COPR-CG	Executive Bridge Top, Undercut on right edge	1158	926	1158
TOTAL			\$15,564	\$12,452	\$15,993

SUITE 9

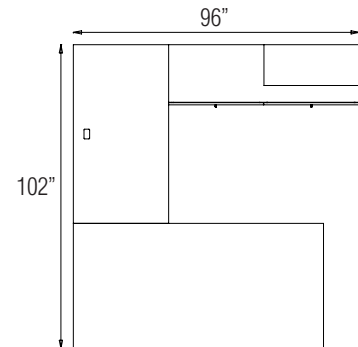
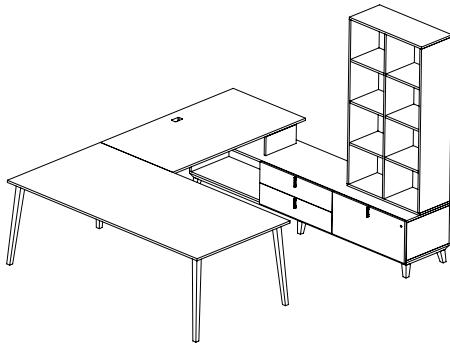

QUANTITY	CODE	DESCRIPTION	STANDARD	LAMINATE	ALL WOOD
1	ART8442	Freestanding Work Table	4513	3611	4513
1	A6032T-COPL-CG	Executive Bridge Top, Undercut on Left	1648	1320	1648
1	ASPBOX2814	Riserbox	304	242	304
1	AC16LB	20"H Freestanding Credenza	6407	5129	6407
1	AS6	32"W Stackon Bookcase	3548	2839	3978
TOTAL			\$16,414	\$13,133	\$16,846

SUITE 10

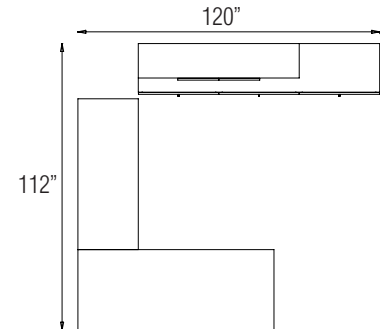
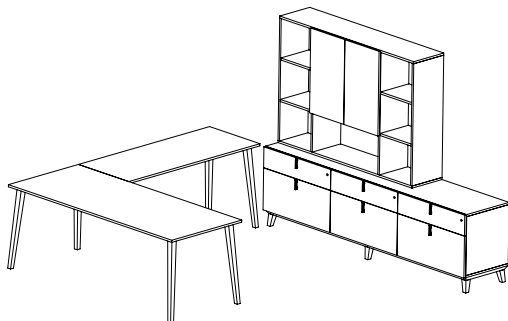

QUANTITY	CODE	DESCRIPTION	STANDARD	LAMINATE	ALL WOOD
1	ART7832	Freestanding Work Table	3777	3022	3777
1	AERR6024CG	Executive Return Right	2075	1662	2075
1	AC24LB	96"W Freestanding Credenza	7566	6053	7566
1	AS17	64"W Stackon Bookcase	5395	4316	5826
TOTAL			\$18,808	\$15,048	\$19,240

SUITE 11

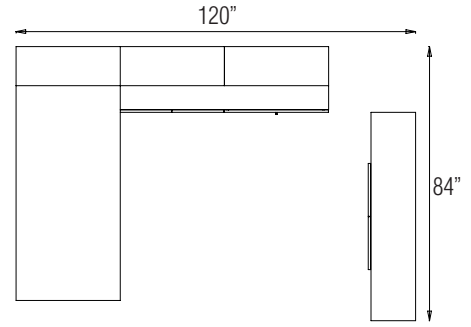
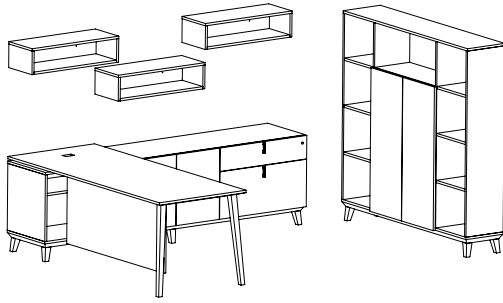

QUANTITY	CODE	DESCRIPTION	STANDARD	LAMINATE	ALL WOOD
1	AR7832/GM5CTE9	Peninsula Table with GM5C grommet	2856	2287	2856
1	ACMPW50H22	22"H Modesty Panel	724	580	724
1	AC28LB/C275L	96"W Freestanding Credenza with Wire Management Cutout on Left	6546	5237	6546
1	AB19LB	64"W Freestanding Bookcase	7363	5890	7794
3	ACSF032D12H8	Wall Mount Open Storage, Stand Alone Unit	3655	2924	3655
TOTAL			\$21,138	\$16,908	\$21,568

COLLABORATION MEDIA TABLE (ARC-32) AND WALL MOUNT MEDIA STORAGE (ACSF0-GM)

32" Wide, Wall Mount Media Storage

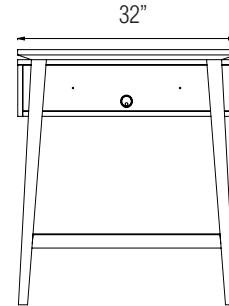
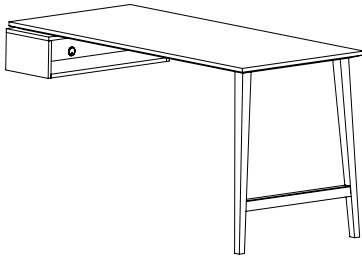

64" Wide, Wall Mount Media Storage

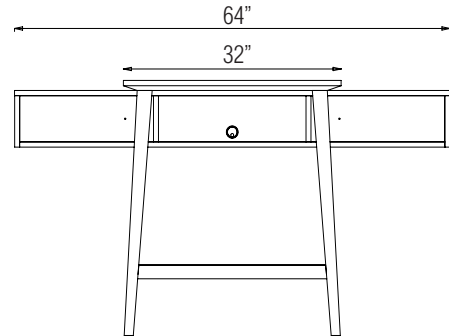
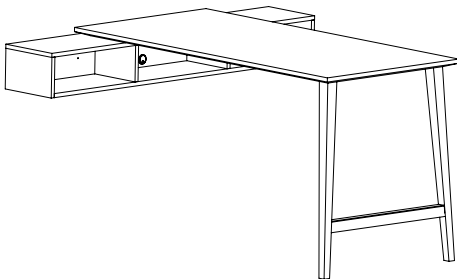

96" Wide, Wall Mount Media Storage

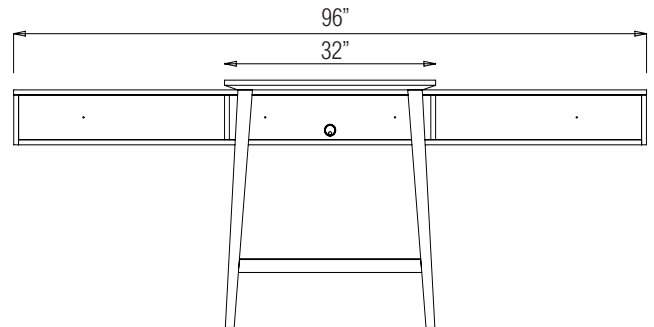
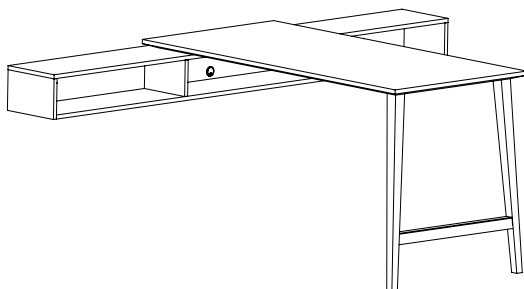

TABLES • TECHNICAL INFORMATION

- All tables are shipped Knock Down (KD). Please see assembly instructions included with the product.
- Available Modesty Panels are 15" and 22" height. Please see pages A.12 - A.13 for selection.
- Peninsula table has metal inserts installed for quick assembly to the Pedestal or Pedestal with Riser Box.

TABLES • GUIDELINES FOR ORDERING PRODUCT

CODES: The price list uses a product coding system that is specific to each of the units. The product description (next to the code) explains in detail construction of the unit.

SPECIFICATION EXAMPLE OF A FREESTANDING WORK TABLE

PRODUCT CODE: ART8432

A = Corby Series
 RT = Rectangular Table
 8432 = Width x Depth

CHOOSE FINISH OPTION:

Standard Finish: Veneer top and matching hardwood edge and legs. Please see page A.18
 Laminate Finish: Please add "/P" to the end of the product code, includes HP laminate top, matching 3mm edge and painted hardwood legs. Please see page A.18

Optional Grommet Locations - please see page A.10

Optional Modesty Panel - please see pages A.5 - A.13

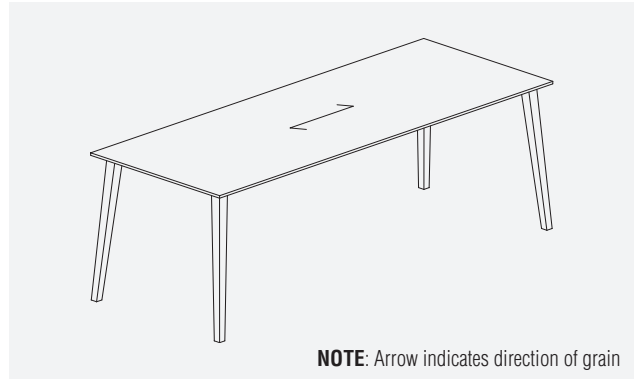

NOTE: Arrow indicates direction of grain

AR • Peninsula Table

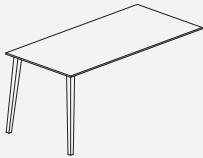

PRODUCT	PRICE		SIZE (INCHES)			WEIGHT VOL	
	STANDARD	LAMINATE	H	W	D	LBS	FT ³
AR6632	2502	2002	29	66	32	98	10
AR7232	2633	2107	29	72	32	105	11
AR7832	2764	2211	29	78	32	112	12
AR8432	2907	2325	29	84	32	119	12

- Peninsula table with two legs
- Connects to 27.5" high storage

ART • Freestanding Work Table

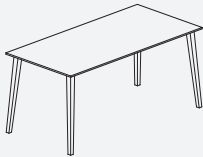

PRODUCT	PRICE		SIZE (INCHES)			WEIGHT VOL	
	STANDARD	LAMINATE	H	W	D	LBS	FT ³
ART6632	3516	2812	29	66	32	118	10
ART7232	3647	2917	29	72	32	125	11
ART7832	3777	3021	29	78	32	132	12
ART8432	3920	3136	29	84	32	139	12
ART6642	3979	3183	29	66	42	142	13
ART7242	4154	3323	29	72	42	152	13
ART7842	4326	3461	29	78	42	161	14
ART8442	4513	3610	29	84	42	170	15

- Freestanding work table with four legs

ARTC • Freestanding Collaboration Table

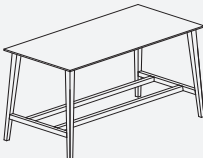

PRODUCT	PRICE		SIZE (INCHES)			WEIGHT VOL	
	STANDARD	LAMINATE	H	W	D	LBS	FT ³
ARTC6632	4527	3621	36	66	32	138	12
ARTC7232	4660	3728	36	72	32	155	13
ARTC7832	4789	3832	36	78	32	172	14
ARTC8432	4933	3946	36	84	32	189	16
ARTC6642	4992	3992	36	66	42	172	16
ARTC7242	5165	4132	36	72	42	192	17
ARTC7842	5337	4270	36	78	42	211	19
ARTC8442	5525	4420	36	84	42	230	20

- Freestanding collaboration table with four legs and foot-rests
- For optional foot-rest cover, please see Accessories.
- Please note foot-rest and leg are same colour

ARC • Collaboration Media Table

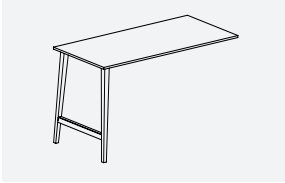

PRODUCT	PRICE		SIZE (INCHES)			WEIGHT VOL	
	STANDARD	LAMINATE	H	W	D	LBS	FT ³
ARC6632	2534	2027	36	66	32	100	10
ARC7232	2658	2126	36	72	32	107	11
ARC7832	2782	2226	36	78	32	114	12
ARC8432	2920	2337	36	84	32	120	12

- Collaboration Media Table with 2 legs
- To be used with Wall Mount Media Storage (ACSFO- GM)

ACSFO-GM • Wall Mount Media Storage

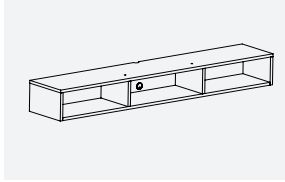

PRODUCT	PRICE		SIZE (INCHES)			WEIGHT VOL	
	STANDARD	LAMINATE	H	W	D	LBS	FT ³
ACSFO32D12H8-GM	1294	1036	8	32	12	35	2
ACSFO64D12H8-GM	1417	1134	8	64	12	50	4
ACSFO96D12H8-GM	2126	1701	8	96	12	78	6

- Wall Mount Media Storage
- To be used with Collaboration Media Table (ARC)
- GM38 grommet on the back panel is included
- For wire pass through, scoop cutouts on both top and bottom are included.
- Pre-drilled insert holes on top panel

ACSFO • Wall Mount Open Storage

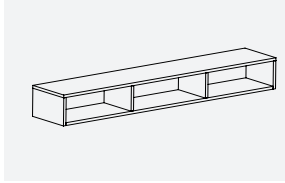

PRODUCT	PRICE		SIZE (INCHES)			WEIGHT VOL	
	STANDARD	LAMINATE	H	W	D	LBS	FT ³
ACSFO32D12H8	1218	975	8	32	12	35	2
ACSFO64D12H8	1343	1074	8	64	12	50	4
ACSFO96D12H8	2050	1639	8	96	12	78	6

- Wall Mount Open Storage
- To be used as a stand alone unit

ASPBOX • Riser Box

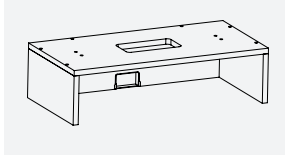

PRODUCT	PRICE		SIZE (INCHES)			WEIGHT VOL	
	STANDARD	LAMINATE	H	W	D	LBS	FT ³
ASPBOX2814	302	242	7.5	28	14	14	3
ASPBOX2014	271	216	7.5	20	14	12	2

- 28"W Riser Box for 20"H storage to support Peninsula Table & 32" deep Bridge Top
- 20"W Riser Box for 20"H storage to support 24" deep Bridge Top
- For wire pass through, grommets cut-out on both top and back are included.

FRC • Foot Rest Cover (Sets)

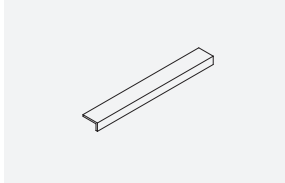

PRODUCT	PRICE		SIZE (INCHES)			WEIGHT VOL	
	STANDARD	LAMINATE	H	W	D	LBS	FT ³
FRC6632	411						
FRC7232	443						
FRC7832	475						
FRC8432	507						
FRC6642	475						
FRC7242	507						
FRC7842	538						
FRC8442	570						

- Foot rest covers are factory installed (Only in Brushed Chrome Finish)
- For ARTC6632
- For ARTC7232
- For ARTC7832
- For ARTC8432
- For ARTC6642
- For ARTC7242
- For ARTC7842
- For ARTC8442

ACMP • 22"H Hanging wood modesty panel

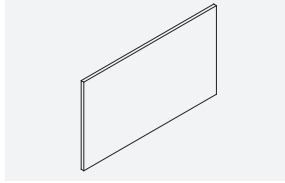

PRODUCT	PRICE		SIZE (INCHES)			WEIGHT VOL	
	STANDARD	LAMINATE	H	W	D	LBS	FT ³
ACMPW38H22	608	487	22	38	0.75	20	2
ACMPW44H22	666	533	22	44	0.75	22	2
ACMPW50H22	723	578	22	50	0.75	24	3
ACMPW56H22	769	615	22	56	0.75	26	3
ACMPW62H22	824	659	22	62	0.75	28	3

- 22" Hanging Wood Modesty Panel
- For selection of the hanging wood modesty panel, please see pages A.4 - A.5 for details.

ACMP • 15"H Hanging wood modesty panel

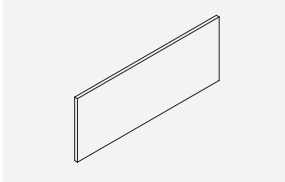

PRODUCT	PRICE		SIZE (INCHES)			WEIGHT VOL	
	STANDARD	LAMINATE	H	W	D	LBS	FT ³
ACMPW38H15	577	462	15	38	0.75	15	2
ACMPW44H15	635	507	15	44	0.75	17	2
ACMPW50H15	691	553	15	50	0.75	18	2
ACMPW56H15	736	589	15	56	0.75	20	2
ACMPW62H15	793	635	15	62	0.75	21	2
ACMPW68H15	869	696	15	68	0.75	23	3
ACMPW74H15	946	756	15	74	0.75	24	3

- 15" Hanging Wood Modesty Panel
- For selection of the hanging wood modesty panel, please see pages A.4 - A.5 for details.

OCCASIONAL TABLES • TECHNICAL INFORMATION

• All occasional tables are shipped Knock Down (KD). Please see assembly instructions.

OCCASIONAL TABLES • GUIDELINES FOR ORDERING PRODUCT

CODES: The price list uses a product coding system that is specific to each of the units. The product description (next to the code) explains in detail construction of the unit.

SPECIFICATION EXAMPLE OF AN OCCASIONAL TABLE

PRODUCT CODE:

ACT3620H17
 A = Corby Series
 CT = Occasional Table
 3620 = Width x Depth
 H17 = Height

CHOOSE FINISH OPTION:

Standard Finish: Veneer top and matching hardwood edge and legs. Please see page A.12
 Laminate Finish: Please add "/P" to the end of the product code, includes HP laminate top, matching 3mm edge and painted hardwood legs. Please see page A.12

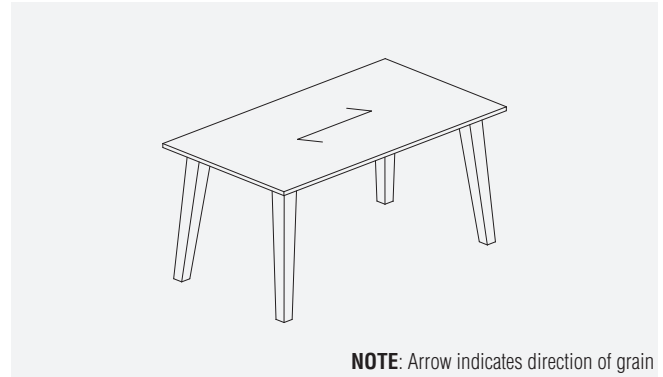

NOTE: Arrow indicates direction of grain

ACT • 13”H Square Occasional Table



PRODUCT	PRICE		SIZE (INCHES)			WEIGHT	VOL
	STANDARD	LAMINATE	H	W	D	LBS	FT ³
ACT2424H13	1854	1484	13	24	24	47	5
ACT3030H13	2083	1667	13	30	30	59	6
ACT3636H13	2358	1887	13	36	36	73	8

ACT • 17”H Square Occasional Table

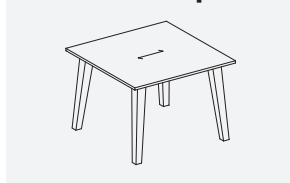

PRODUCT	PRICE		SIZE (INCHES)			WEIGHT	VOL
	STANDARD	LAMINATE	H	W	D	LBS	FT ³
ACT2424H17	2141	1713	17	24	24	52	6
ACT3030H17	2373	1899	17	30	30	64	7
ACT3636H17	2648	2118	17	36	36	78	9

ACT • 13”H Rectangular Occasional Table

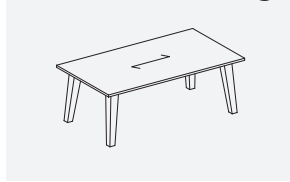

PRODUCT	PRICE		SIZE (INCHES)			WEIGHT	VOL
	STANDARD	LAMINATE	H	W	D	LBS	FT ³
ACT3620H13	1954	1563	13	36	20	52	6
ACT4220H13	2026	1621	13	42	20	57	6
ACT4820H13	2127	1702	13	48	20	61	7

ACT • 17”H Rectangular Occasional Table

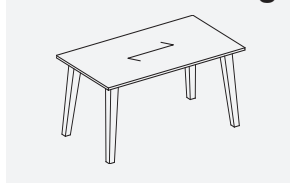

PRODUCT	PRICE		SIZE (INCHES)			WEIGHT	VOL
	STANDARD	LAMINATE	H	W	D	LBS	FT ³
ACT3620H17	2241	1792	17	36	20	57	7
ACT4220H17	2314	1851	17	42	20	62	7
ACT4820H17	2416	1932	17	48	20	66	8

ACTRO-H13 • 13”H Round Occasional Table



PRODUCT	PRICE		SIZE (INCHES)			WEIGHT	VOL
	STANDARD	LAMINATE	H	W	D	LBS	FT ³
ACTRO24H13	2066	1653	13	24	24	28	2
ACTRO30H13	2436	1948	13	30	36	40	3
ACTRO36H13	2549	2038	13	36	42	52	4

• Round Occasional Table with 13”H legs

ACTRO-H17 • 17”H Round Occasional Table

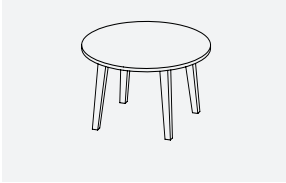

PRODUCT	PRICE		SIZE (INCHES)			WEIGHT	VOL
	STANDARD	LAMINATE	H	W	D	LBS	FT ³
ACTRO24H17	2341	1871	17	24	24	28	3
ACTRO30H17	2561	2048	17	30	30	40	4
ACTRO36H17	2823	2259	17	36	36	52	5

• Round Occasional Table with 17”H legs

ARO-H29 • 29”H Round Table



PRODUCT	PRICE		SIZE (INCHES)			WEIGHT	VOL
	STANDARD	LAMINATE	H	W	D	LBS	FT ³
ARO30H29	2871	2297	29	30	30	65	6
ARO36H29	3099	2478	29	36	36	77	7
ARO42H29	3286	2629	29	42	42	89	8

• Round Table with 29”H legs

RETURNS • TECHNICAL INFORMATION

- All Returns are shipped Knock Down (KD). Please see assembly instructions included with the product.
- All Returns have Cross Grain veneer pattern.
- To remove Cross Grain veneer pattern from the top, delete suffix "CG" from the product code. (Available at no upcharge)

RETURNS • GUIDELINES FOR ORDERING PRODUCT

CODES: The price list uses a product coding system that is specific to each of the units. The product description (next to the code) explains in detail construction of the unit.

SPECIFICATION EXAMPLE OF A RETURN

PRODUCT CODE: AERR3624CG

A = Corby Series
 ERR = Executive Return Right
 3624 = Width x Depth
 CG = Cross Grain

CHOOSE FINISH OPTION:

Standard Finish: Veneer top and matching hardwood edge and legs. Please see page A.18
 Laminate Finish: Please add "/P" to the end of the product code, includes HP laminate top, matching 3mm edge and painted hardwood legs. Please see page A.18

Optional Grommet Locations - Please see page A.10

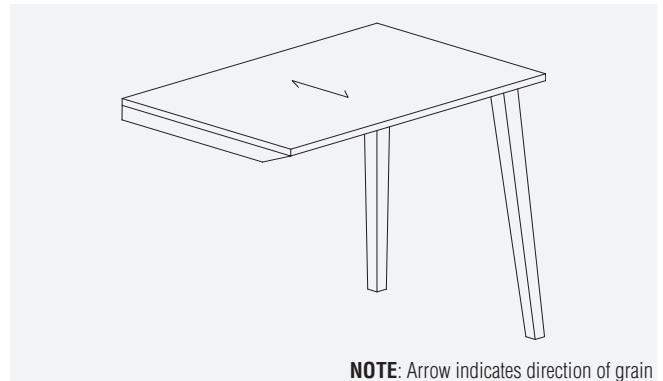

NOTE: Arrow indicates direction of grain

AERL-24CG • Executive Return Left

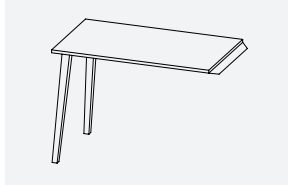

PRODUCT	PRICE		SIZE (INCHES)			WEIGHT VOL	
	STANDARD	LAMINATE	H	W	D	LBS	FT ³
AERL3624CG	1657	1327	29	36	24	40	1.5
AERL4224CG	1762	1409	29	42	24	46	2
AERL4824CG	1867	1493	29	48	24	52	2.5
AERL5424CG	1969	1576	29	54	24	58	3
AERL6024CG	2074	1661	29	60	24	64	3.5

- Executive Return Left with two legs
- Connects to 29" high work table

AERR-24CG • Executive Return Right

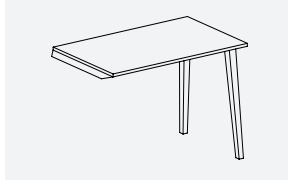

PRODUCT	PRICE		SIZE (INCHES)			WEIGHT VOL	
	STANDARD	LAMINATE	H	W	D	LBS	FT ³
AERR3624CG	1657	1327	29	36	24	40	1.5
AERR4224CG	1762	1409	29	42	24	46	2
AERR4824CG	1867	1493	29	48	24	52	2.5
AERR5424CG	1969	1576	29	54	24	58	3
AERR6024CG	2074	1661	29	60	24	64	3.5

- Executive Return Right with two legs
- Connects to 29" high work table

BRIDGES • TECHNICAL INFORMATION

- All Bridges have Cross Grain veneer pattern.
- To remove Cross Grain veneer pattern from the top, delete suffix "CG" from the product code. (Available at no upcharge)
- GM5C-TC grommet location is standard.

BRIDGES • GUIDELINES FOR ORDERING PRODUCT

CODES: The price list uses a product coding system that is specific to each of the units. The product description (next to the code) explains in detail construction of the unit.

SPECIFICATION EXAMPLE OF BRIDGES

PRODUCT CODE: A3624T-COPL-CG

A = Corby Series

3624 = Width x Depth

T = Bridge Top

COPL = Undercut on Left edge and CG = Cross Grain

CHOOSE FINISH OPTION:

Standard Finish: Veneer top and matching hardwood edge. Please see page A.18

Laminate Finish: Please add "/P" to the end of the product code, includes HP laminate top and matching 3mm edge. Please see page A.18

Optional Grommet Locations - please see page A.10

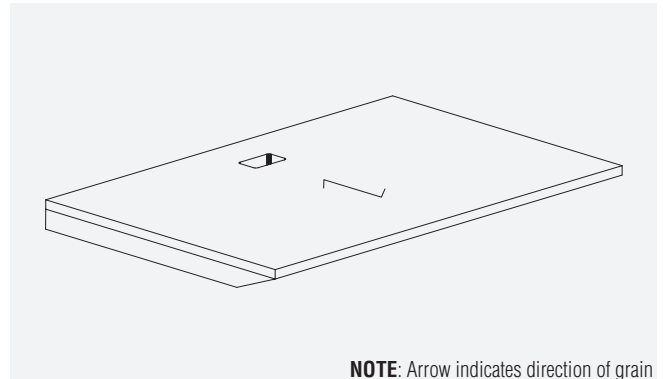

NOTE: Arrow indicates direction of grain

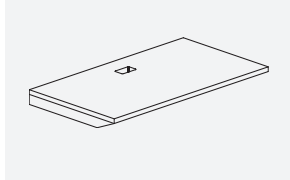
A-20T-COPL-CG • Executive Bridge Top Left, 20" Deep

PRODUCT	PRICE		SIZE (INCHES)			WEIGHT VOL	
	STANDARD	LAMINATE	H	W	D	LBS	FT ³
A3620T-COPL-CG	714	571	1.5	36	20	29	1
A4220T-COPL-CG	837	670	1.5	42	20	33	1.5
A4820T-COPL-CG	962	768	1.5	48	20	37	2
A5420T-COPL-CG	1084	868	1.5	54	20	41	2.5
A6020T-COPL-CG	1205	966	1.5	60	20	45	3
A6620T-COPL-CG	1329	1064	1.5	66	20	49	3.5
A7220T-COPL-CG	1452	1164	1.5	72	20	53	4

- Executive Bridge Top Left
- Undercut edge side connects to 29" high work table and other side sits on top of 20" deep Pedestal/Riser box.

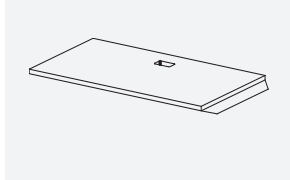
A-20T-COPR-CG • Executive Bridge Top Right, 20" Deep

PRODUCT	PRICE		SIZE (INCHES)			WEIGHT VOL	
	STANDARD	LAMINATE	H	W	D	LBS	FT ³
A3620T-COPR-CG	714	571	1.5	36	20	29	1
A4220T-COPR-CG	837	670	1.5	42	20	33	1.5
A4820T-COPR-CG	962	768	1.5	48	20	37	2
A5420T-COPR-CG	1084	868	1.5	54	20	41	2.5
A6020T-COPR-CG	1205	966	1.5	60	20	45	3
A6620T-COPR-CG	1329	1064	1.5	66	20	49	3.5
A7220T-COPR-CG	1452	1164	1.5	72	20	53	4

- Executive Bridge Top Right
- Undercut edge side connects to 29" high work table and other side sits on top of 20" deep Pedestal/Riser box.

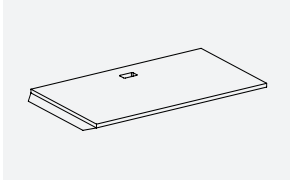
A-24T-COPL-CG • Executive Bridge Top Left, 24" Deep

PRODUCT	PRICE		SIZE (INCHES)			WEIGHT VOL	
	STANDARD	LAMINATE	H	W	D	LBS	FT ³
A3624T-COPL-CG	743	595	1.5	36	24	38	1.5
A4224T-COPL-CG	868	694	1.5	42	24	44	2
A4824T-COPL-CG	992	793	1.5	48	24	50	2.5
A5424T-COPL-CG	1115	891	1.5	54	24	56	3
A6024T-COPL-CG	1237	991	1.5	60	24	62	3.5
A6624T-COPL-CG	1360	1089	1.5	66	24	68	4
A7224T-COPL-CG	1484	1187	1.5	72	24	74	4.5

- Executive Bridge Top Left
- Undercut edge side connects to 29" high work table and other side sits on top of Credenza/Riser box.

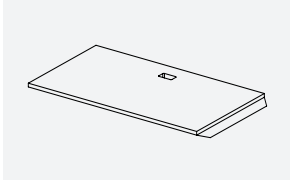
A-24T-COPR-CG • Executive Bridge Top Right, 24" Deep

PRODUCT	PRICE		SIZE (INCHES)			WEIGHT VOL	
	STANDARD	LAMINATE	H	W	D	LBS	FT ³
A3624T-COPR-CG	743	595	1.5	36	24	38	1.5
A4224T-COPR-CG	868	694	1.5	42	24	44	2
A4824T-COPR-CG	992	793	1.5	48	24	50	2.5
A5424T-COPR-CG	1115	891	1.5	54	24	56	3
A6024T-COPR-CG	1237	991	1.5	60	24	62	3.5
A6624T-COPR-CG	1360	1089	1.5	66	24	68	4
A7224T-COPR-CG	1484	1187	1.5	72	24	74	4.5

- Executive Bridge Top Right
- Undercut edge side connects to 29" high work table and other side sits on top of Credenza/Riser box.

A-32T-COPL-CG • Executive Bridge Top Left, 32" Deep

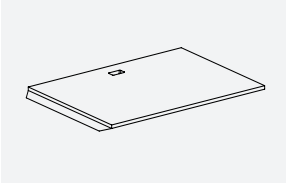

PRODUCT	PRICE		SIZE (INCHES)			WEIGHT VOL	
	STANDARD	LAMINATE	H	W	D	LBS	FT ³
A3632T-COPL-CG	992	793	1.5	36	32	53	2
A4232T-COPL-CG	1156	926	1.5	42	32	57	2.5
A4832T-COPL-CG	1321	1057	1.5	48	32	61	3
A5432T-COPL-CG	1486	1189	1.5	54	32	65	3.5
A6032T-COPL-CG	1648	1318	1.5	60	32	69	4
A6632T-COPL-CG	1812	1450	1.5	66	32	73	4.5
A7232T-COPL-CG	1977	1581	1.5	72	32	77	5

- Executive Bridge Top Left
- Undercut edge side connects to 29" high work table and other side sits on top of Credenza/Riser box.

A-32T-COPR-CG • Executive Bridge Top Right, 32" Deep

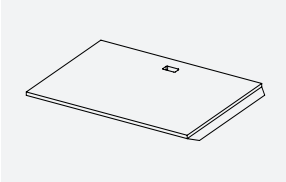

PRODUCT	PRICE		SIZE (INCHES)			WEIGHT VOL	
	STANDARD	LAMINATE	H	W	D	LBS	FT ³
A3632T-COPR-CG	992	793	1.5	36	32	53	2
A4232T-COPR-CG	1156	926	1.5	42	32	57	2.5
A4832T-COPR-CG	1321	1057	1.5	48	32	61	3
A5432T-COPR-CG	1486	1189	1.5	54	32	65	3.5
A6032T-COPR-CG	1648	1318	1.5	60	32	69	4
A6632T-COPR-CG	1812	1450	1.5	66	32	73	4.5
A7232T-COPR-CG	1977	1581	1.5	72	32	77	5

- Executive Bridge Top Right
- Undercut edge side connects to 29" high work table and other side sits on top of Credenza/Riser box.

32" WIDE FREESTANDING PEDESTAL AND STORAGE • TECHNICAL INFORMATION

- All Pedestals and Storage units are shipped assembled.
- Freestanding Pedestals and Storage may be used as stand alone units or as the Peninsula Table Support (20" and 27.5" height units).
- To support the Peninsula Table with 20"H Pedestal, the Riser Box is required (see Tables / Accessories section).
- Pedestal and Storage units are available in two base heights: 4" (xxLB = Low Base) or 11.5" (xxHB = High Base)
- All drawer fronts have one vertical handle (PL89) installed.
- Front locking is standard on the Pedestals with box/file and file drawers.
- Optional locking and handles on doors (Storage units) are available (see Accessories section).
- Optional Cushions (32" x 14") for Pedestal tops are available (see Accessories section).

PEDESTALS AND STORAGE • GUIDELINES FOR ORDERING PRODUCT

CODES: The price list uses a product coding system that is specific to each of the units. The product description (next to the code) explains in detail construction of the unit.

SPECIFICATION EXAMPLE OF A PEDESTAL

PRODUCT CODE:

AP1LB
 A = Corby Series
 P = Pedestal
 1 = Product ID number (Freestanding Pedestal 20"H x 32"W x 20"D)
 LB = Low Base

CHOOSE FINISH OPTION:

Standard Finish: Veneer top, chassis, fronts and matching hardwood legs. Please see page A.18
 Laminate Finish: Please add "/P" to the end of the product code, includes HP laminate top, LP laminate chassis and fronts with painted hardwood legs. Please see page A.18

LOCK:

Choose Optional Lock on doors (see Accessories section)

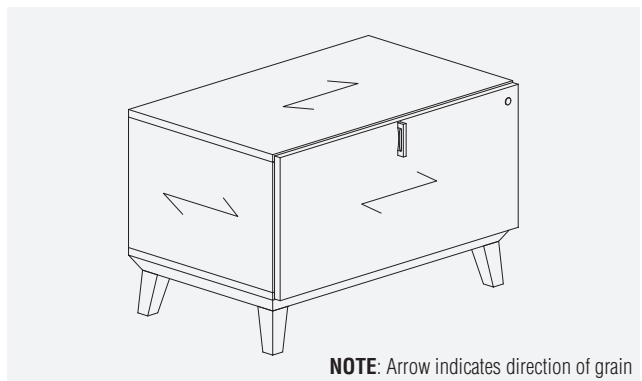

NOTE: Arrow indicates direction of grain

AP1LB • 20"H Freestanding Pedestal

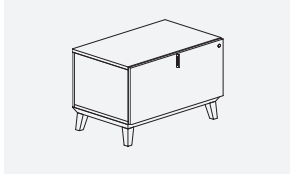

PRODUCT	PRICE		SIZE (INCHES)			WEIGHT VOL	
	STANDARD	LAMINATE	H	W	D	LBS	FT ³
AP1LB	2343	1874	20	32	20	106	9

- Freestanding pedestal with front locking lateral drawer
- Low base

AP2LB • 20"H Freestanding Pedestal

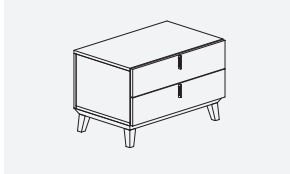

PRODUCT	PRICE		SIZE (INCHES)			WEIGHT VOL	
	STANDARD	LAMINATE	H	W	D	LBS	FT ³
AP2LB	2327	1863	20	32	20	105	9

- Freestanding pedestal with two box drawers
- Low base

AP3LB • 20"H Freestanding Pedestal

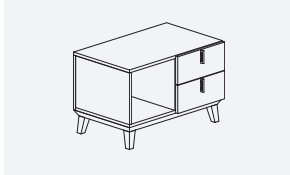

PRODUCT	PRICE		SIZE (INCHES)			WEIGHT VOL	
	STANDARD	LAMINATE	H	W	D	LBS	FT ³
AP3LB	2474	1980	20	32	20	105	9

- Freestanding pedestal with open cabinet left, two box drawers right
- Low base

AP4LB • 20”H Freestanding Pedestal



PRODUCT	PRICE		SIZE (INCHES)			WEIGHT VOL	
	STANDARD	LAMINATE	H	W	D	LBS	FT ³
AP4LB	2474	1980	20	32	20	105	9

- Freestanding pedestal with two box drawers left, open cabinet right
- Low base

AP5LB • 20”H Freestanding Pedestal

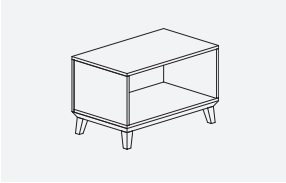

PRODUCT	PRICE		SIZE (INCHES)			WEIGHT VOL	
	STANDARD	LAMINATE	H	W	D	LBS	FT ³
AP5LB	2024	1620	20	32	20	86	9

- Freestanding pedestal with open cabinet
- Low base

AP1LB32 • 20”H Freestanding Pedestal

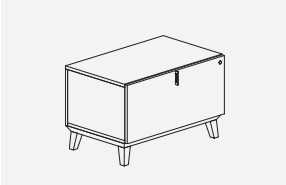

PRODUCT	PRICE		SIZE (INCHES)			WEIGHT VOL	
	STANDARD	LAMINATE	H	W	D	LBS	FT ³
AP1LB32	2488	1990	20	32	32	136	14

- Freestanding pedestal with front locking lateral drawer
- Can be used to support peninsula table in conjunction with the Riser Box (ASPBOX2814) - optional
- Low base

AP2LB32 • 20”H Freestanding Pedestal



PRODUCT	PRICE		SIZE (INCHES)			WEIGHT VOL	
	STANDARD	LAMINATE	H	W	D	LBS	FT ³
AP2LB32	2474	1980	20	32	32	135	14

- Freestanding pedestal with two box drawers
- Can be used to support peninsula table in conjunction with the Riser Box (ASPBOX2814) - optional
- Low base

AP3LB32 • 20”H Freestanding Pedestal

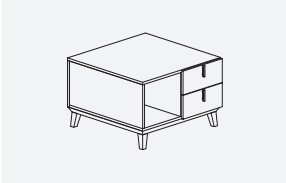

PRODUCT	PRICE		SIZE (INCHES)			WEIGHT VOL	
	STANDARD	LAMINATE	H	W	D	LBS	FT ³
AP3LB32	2617	2094	20	32	32	135	14

- Freestanding pedestal with open cabinet left, two box drawers right
- Can be used to support peninsula table in conjunction with the Riser Box (ASPBOX2814) - optional
- Low base

AP4LB32 • 20”H Freestanding Pedestal



PRODUCT	PRICE		SIZE (INCHES)			WEIGHT VOL	
	STANDARD	LAMINATE	H	W	D	LBS	FT ³
AP4LB32	2617	2094	20	32	32	135	14

- Freestanding pedestal with two box drawers left, open cabinet right
- Can be used to support peninsula table in conjunction with the Riser Box (ASPBOX2814) - optional
- Low base

AP5LB32 • 20”H Freestanding Pedestal

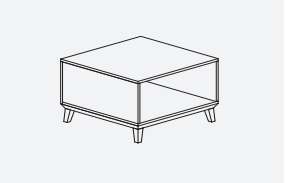

PRODUCT	PRICE		SIZE (INCHES)			WEIGHT VOL	
	STANDARD	LAMINATE	H	W	D	LBS	FT ³
AP5LB32	2170	1738	20	32	32	116	14

- Freestanding pedestal with open cabinet
- Can be used to support peninsula table in conjunction with the Riser Box (ASPBOX2814) - optional
- Low base

AP6LB • 28”H Freestanding Pedestal

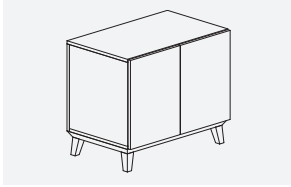

PRODUCT	PRICE		SIZE (INCHES)			WEIGHT VOL	
	STANDARD	LAMINATE	H	W	D	LBS	FT ³
AP6LB	2460	1968	27.5	32	20	117	12

- Freestanding storage cabinet with two doors, one adjustable shelf
- Low base

AP7LB • 28”H Freestanding Pedestal



PRODUCT	PRICE		SIZE (INCHES)			WEIGHT VOL	
	STANDARD	LAMINATE	H	W	D	LBS	FT ³
AP7LB	3138	2511	27.5	32	20	124	12

- Freestanding pedestal with front locking lateral and box drawer
- Low base

AP8LB • 28”H Freestanding Pedestal

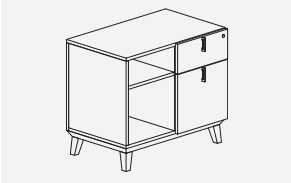

PRODUCT	PRICE		SIZE (INCHES)			WEIGHT VOL	
	STANDARD	LAMINATE	H	W	D	LBS	FT ³
AP8LB	3282	2627	27.5	32	20	127	12

- Freestanding pedestal, open with fixed shelf left, front locking box file drawer right
- Low base

AP9LB • 28”H Freestanding Pedestal



PRODUCT	PRICE		SIZE (INCHES)			WEIGHT VOL	
	STANDARD	LAMINATE	H	W	D	LBS	FT ³
AP9LB	3282	2627	27.5	32	20	127	12

- Freestanding pedestal with front locking box file drawer left, open with fixed shelf right
- Low base

AP1HB • 28”H Freestanding Pedestal

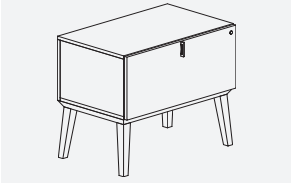

PRODUCT	PRICE		SIZE (INCHES)			WEIGHT VOL	
	STANDARD	LAMINATE	H	W	D	LBS	FT ³
AP1HB	2633	2105	27.5	32	20	111	12

- Freestanding pedestal with front locking lateral drawer
- High base

AP2HB • 28”H Freestanding Pedestal



PRODUCT	PRICE		SIZE (INCHES)			WEIGHT VOL	
	STANDARD	LAMINATE	H	W	D	LBS	FT ³
AP2HB	2617	2094	27.5	32	20	110	12

- Freestanding pedestal with two box drawers
- High base

AP3HB • 28”H Freestanding Pedestal

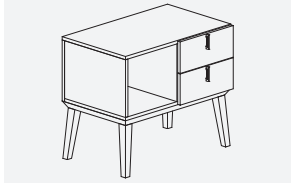

PRODUCT	PRICE		SIZE (INCHES)			WEIGHT VOL	
	STANDARD	LAMINATE	H	W	D	LBS	FT ³
AP3HB	2474	1980	27.5	32	20	110	12

- Freestanding pedestal with open cabinet left, two box drawers right
- High base

AP4HB • 28”H Freestanding Pedestal



PRODUCT	PRICE		SIZE (INCHES)			WEIGHT VOL	
	STANDARD	LAMINATE	H	W	D	LBS	FT ³
AP4HB	2474	1980	27.5	32	20	110	12

- Freestanding pedestal with two box drawers left, open cabinet right
- High base

AP5HB • 28”H Freestanding Pedestal



PRODUCT	PRICE		SIZE (INCHES)			WEIGHT VOL	
	STANDARD	LAMINATE	H	W	D	LBS	FT ³
AP5HB	2024	1620	27.5	32	20	91	12

- Freestanding pedestal with open cabinet
- High base

AP1HB32 • 28”H Freestanding Pedestal

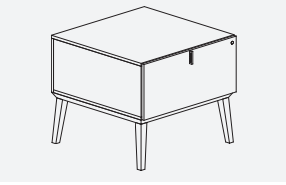

PRODUCT	PRICE		SIZE (INCHES)			WEIGHT VOL	
	STANDARD	LAMINATE	H	W	D	LBS	FT ³
AP1HB32	2777	2221	27.5	32	32	141	18

- Freestanding pedestal with front locking lateral drawer
- Can be used to support peninsula table
- High base

AP2HB32 • 28”H Freestanding Pedestal

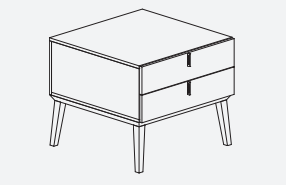

PRODUCT	PRICE		SIZE (INCHES)			WEIGHT VOL	
	STANDARD	LAMINATE	H	W	D	LBS	FT ³
AP2HB32	2763	2212	27.5	32	32	140	18

- Freestanding pedestal with two box drawers
- Can be used to support peninsula table
- High base

AP3HB32 • 28”H Freestanding Pedestal

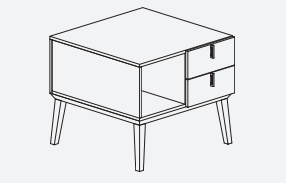

PRODUCT	PRICE		SIZE (INCHES)			WEIGHT VOL	
	STANDARD	LAMINATE	H	W	D	LBS	FT ³
AP3HB32	2617	2094	27.5	32	32	140	18

- Freestanding pedestal with open cabinet left, two box drawers right
- Can be used to support peninsula table
- High base

AP4HB32 • 28”H Freestanding Pedestal

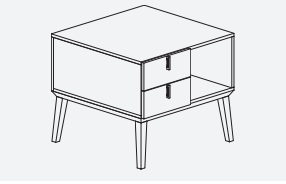

PRODUCT	PRICE		SIZE (INCHES)			WEIGHT VOL	
	STANDARD	LAMINATE	H	W	D	LBS	FT ³
AP4HB32	2617	2094	27.5	32	32	140	18

- Freestanding pedestal with two box drawers left, open cabinet right
- Can be used to support peninsula table
- High base

AP5HB32 • 28”H Freestanding Pedestal

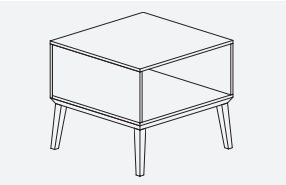

PRODUCT	PRICE		SIZE (INCHES)			WEIGHT VOL	
	STANDARD	LAMINATE	H	W	D	LBS	FT ³
AP5HB32	2170	1738	27.5	32	32	121	18

- Freestanding pedestal with open cabinet
- Can be used to support peninsula table
- High base

AP6HB • 35”H Freestanding Pedestal

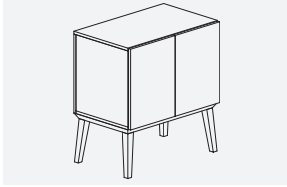

PRODUCT	PRICE		SIZE (INCHES)			WEIGHT VOL	
	STANDARD	LAMINATE	H	W	D	LBS	FT ³
AP6HB	2749	2199	35	32	20	122	15

- Freestanding storage cabinet with two doors, one adjustable shelf
- High base

AP7HB • 35”H Freestanding Pedestal

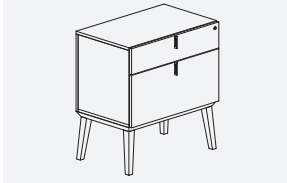

PRODUCT	PRICE		SIZE (INCHES)			WEIGHT VOL	
	STANDARD	LAMINATE	H	W	D	LBS	FT ³
AP7HB	3428	2742	35	32	20	129	15

- Freestanding pedestal with front locking lateral and box drawer
- High base

AP8HB • 35”H Freestanding Pedestal

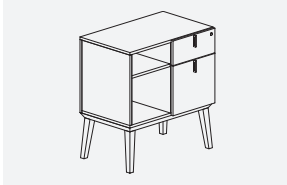

PRODUCT	PRICE		SIZE (INCHES)			WEIGHT VOL	
	STANDARD	LAMINATE	H	W	D	LBS	FT ³
AP8HB	3574	2859	35	32	20	132	15

- Freestanding pedestal open with fixed shelf left, front locking box file drawer right
- High base

AP9HB • 35”H Freestanding Pedestal

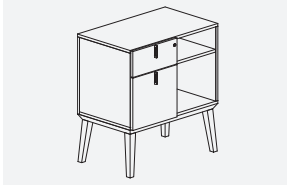

PRODUCT	PRICE		SIZE (INCHES)			WEIGHT VOL	
	STANDARD	LAMINATE	H	W	D	LBS	FT ³
AP9HB	3574	2859	35	32	20	132	15

- Freestanding pedestal with front locking box file drawer left, open with fixed - shelf right
- High base

64"W and 96"W FREESTANDING CREDENZAS • TECHNICAL INFORMATION

- All Credenzas are shipped assembled.
- Freestanding Credenzas may be used as stand alone units or as the Peninsula Table Support (20" and 27.5" Height units)
- To support the Peninsula Table with 20"H Credenza, the Riser Box is required (see Tables or Accessories section).
- Credenza units are available in two base heights: 4" (xxLB = Low Base), or 11.5" (xxHB = High Base).
- All drawer fronts have vertical handle (PL89) installed where indicated.
- Front locking is standard on the Credenzas with box/lateral and lateral drawers.
- Optional locking on doors (storage units) are available. Add suffix LO at the end of product code (e.g: AC17LB-LO).
- Optional Cushions (32" x 14") for Credenza tops are available (see Accessories section).

FREESTANDING CREDENZAS • GUIDELINES FOR ORDERING PRODUCT

CODES: The price list uses a product coding system that is specific to each of the units. The product description (next to the code) explains in detail the construction of the unit.

SPECIFICATION EXAMPLE OF A 96"W FREESTANDING CREDENZA

PRODUCT CODE: AC17LB

A = Corby Series

C = Credenza

17 = Product ID number (Freestanding Credenza 20H" x 96"W x 20"D)

LB = Low Base (4")

CHOOSE FINISH OPTION:

Standard Finish: Veneer top, chassis, fronts and matching hardwood legs. Please see page A.18

Laminate Finish: Please add "/P" to the end of the product code, includes HP laminate top, LP laminate chassis and fronts with painted hardwood legs. Please see page A.18

LOCK:

Choose optional lock on doors (see Accessories section).

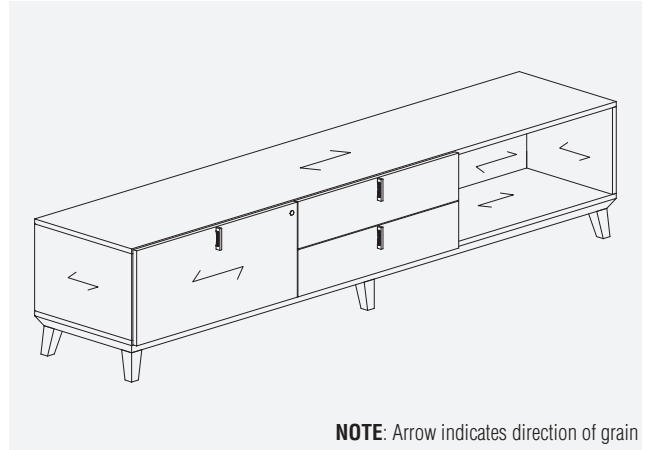

NOTE: Arrow indicates direction of grain

AC1LLB • 20"H Freestanding Credenza, 64"W

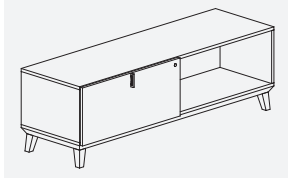

PRODUCT	PRICE		SIZE (INCHES)			WEIGHT VOL	
	STANDARD	LAMINATE	H	W	D	LBS	FT ³
AC1LLB	4153	3321	20	64	20	161	17

- Freestanding credenza with front locking lateral drawer left, open right
- Low base

AC1RLB • 20"H Freestanding Credenza, 64"W

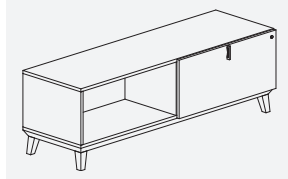

PRODUCT	PRICE		SIZE (INCHES)			WEIGHT VOL	
	STANDARD	LAMINATE	H	W	D	LBS	FT ³
AC1RLB	4153	3321	20	64	20	161	17

- Freestanding credenza, open left, front locking lateral drawer right
- Low base

AC2LB • 20"H Freestanding Credenza, 64"W

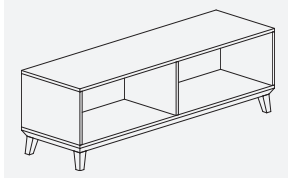

PRODUCT	PRICE		SIZE (INCHES)			WEIGHT VOL	
	STANDARD	LAMINATE	H	W	D	LBS	FT ³
AC2LB	3545	2837	20	64	20	141	17

- Freestanding credenza, open left and right
- Low base

AC3LB • 20”H Freestanding Credenza, 64”W

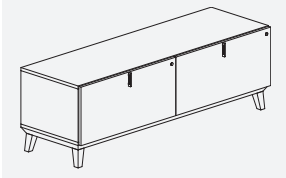

PRODUCT	PRICE		SIZE (INCHES)			WEIGHT VOL	
	STANDARD	LAMINATE	H	W	D	LBS	FT ³
AC3LB	4613	3690	20	64	20	180	17

- Freestanding credenza, two front locking lateral drawers
- Low base

AC4LLB • 20”H Freestanding Credenza, 64”W

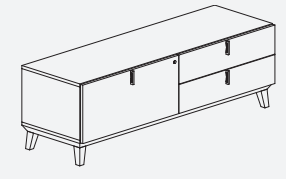

PRODUCT	PRICE		SIZE (INCHES)			WEIGHT VOL	
	STANDARD	LAMINATE	H	W	D	LBS	FT ³
AC4LLB	4600	3680	20	64	20	179	17

- Freestanding credenza, front locking lateral drawer left, two box drawers right
- Low base

AC4RLB • 20”H Freestanding Credenza, 64”W

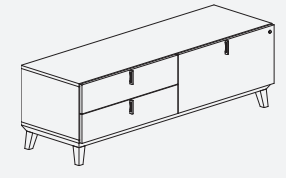

PRODUCT	PRICE		SIZE (INCHES)			WEIGHT VOL	
	STANDARD	LAMINATE	H	W	D	LBS	FT ³
AC4RLB	4600	3680	20	64	20	179	17

- Freestanding credenza, two box drawers left, front locking lateral drawer right
- Low base

AC5LLB • 20”H Freestanding Credenza, 64”W

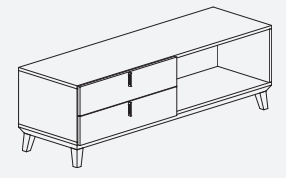

PRODUCT	PRICE		SIZE (INCHES)			WEIGHT VOL	
	STANDARD	LAMINATE	H	W	D	LBS	FT ³
AC5LLB	4153	3321	20	64	20	160	17

- Freestanding credenza, two box drawers left, open right
- Low base

AC5RLB • 20”H Freestanding Credenza, 64”W

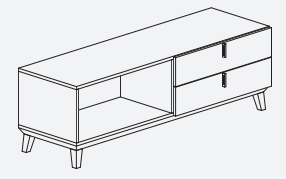

PRODUCT	PRICE		SIZE (INCHES)			WEIGHT VOL	
	STANDARD	LAMINATE	H	W	D	LBS	FT ³
AC5RLB	4153	3321	20	64	20	160	17

- Freestanding credenza, open left, two box drawers right
- Low base

AC6LB • 20”H Freestanding Credenza, 64”W

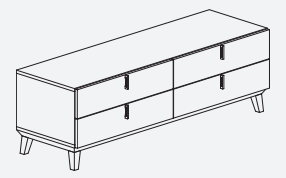

PRODUCT	PRICE		SIZE (INCHES)			WEIGHT VOL	
	STANDARD	LAMINATE	H	W	D	LBS	FT ³
AC6LB	4439	3552	20	64	20	179	17

- Freestanding credenza, four box drawers
- Low base

AC7LB • 28”H Freestanding Credenza, 64”W

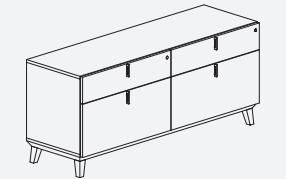

PRODUCT	PRICE		SIZE (INCHES)			WEIGHT VOL	
	STANDARD	LAMINATE	H	W	D	LBS	FT ³
AC7LB	5568	4453	27.5	64	20	213	23

- Freestanding credenza, front locking lateral drawer with box drawer left and right
- Low base

AC8LLB • 28”H Freestanding Credenza, 64”W

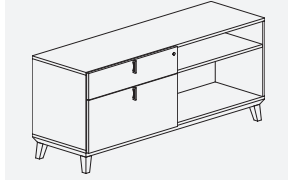

PRODUCT	PRICE		SIZE (INCHES)			WEIGHT	VOL
	STANDARD	LAMINATE	H	W	D	LBS	FT ³
AC8LLB	4946	3958	27.5	64	20	194	23

- Freestanding credenza, front locking lateral drawer with box drawer left, open with fixed shelf right
- Low base

AC8RLB • 28”H Freestanding Credenza, 64”W

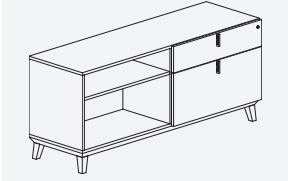

PRODUCT	PRICE		SIZE (INCHES)			WEIGHT	VOL
	STANDARD	LAMINATE	H	W	D	LBS	FT ³
AC8RLB	4946	3958	27.5	64	20	194	23

- Freestanding credenza, open with fixed shelf left, front locking lateral drawer with box drawer right
- Low base

AC9LB • 28”H Freestanding Credenza, 64”W

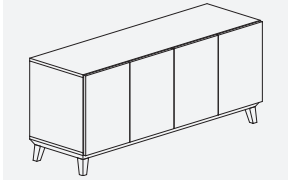

PRODUCT	PRICE		SIZE (INCHES)			WEIGHT	VOL
	STANDARD	LAMINATE	H	W	D	LBS	FT ³
AC9LB	4917	3933	27.5	64	20	189	23

- Freestanding credenza, four doors with two adjustable shelves
- Low base

AC10LLB • 28”H Freestanding Credenza, 64”W

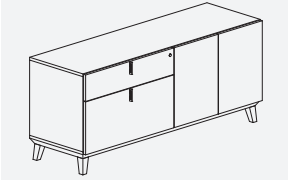

PRODUCT	PRICE		SIZE (INCHES)			WEIGHT	VOL
	STANDARD	LAMINATE	H	W	D	LBS	FT ³
AC10LLB	5236	4190	27.5	64	20	206	23

- Freestanding credenza, front locking lateral drawer with box drawer left, two doors with adjustable shelf right
- Low base

AC10RLB • 28”H Freestanding Credenza, 64”W

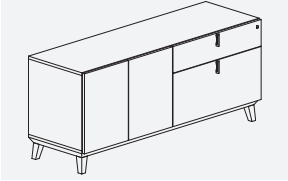

PRODUCT	PRICE		SIZE (INCHES)			WEIGHT	VOL
	STANDARD	LAMINATE	H	W	D	LBS	FT ³
AC10RLB	5236	4190	27.5	64	20	206	23

- Freestanding credenza, two doors with adjustable shelf left, front locking lateral drawer with box drawer right
- Low base

AC1LHB • 28”H Freestanding Credenza, 64”W

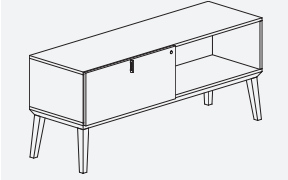

PRODUCT	PRICE		SIZE (INCHES)			WEIGHT	VOL
	STANDARD	LAMINATE	H	W	D	LBS	FT ³
AC1LHB	4439	3552	27.5	64	20	166	23

- Freestanding credenza, front locking lateral drawer left, open right
- High base

AC1RHB • 28”H Freestanding Credenza, 64”W

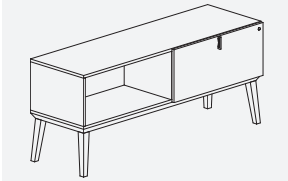

PRODUCT	PRICE		SIZE (INCHES)			WEIGHT	VOL
	STANDARD	LAMINATE	H	W	D	LBS	FT ³
AC1RHB	4439	3552	27.5	64	20	166	23

- Freestanding credenza, open left, front locking lateral drawer right
- High base

AC2HB • 28”H Freestanding Credenza, 64”W

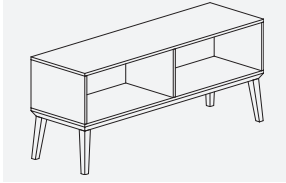

PRODUCT	PRICE		SIZE (INCHES)			WEIGHT VOL	
	STANDARD	LAMINATE	H	W	D	LBS	FT ³
AC2HB	3833	3064	27.5	64	20	146	23

- Freestanding credenza, open left, open right
- High base

AC3HB • 28”H Freestanding Credenza, 64”W

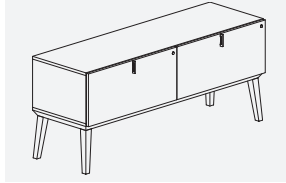

PRODUCT	PRICE		SIZE (INCHES)			WEIGHT VOL	
	STANDARD	LAMINATE	H	W	D	LBS	FT ³
AC3HB	4758	3809	27.5	64	20	185	23

- Freestanding credenza, two front locking lateral drawers
- High base

AC4LHB • 28”H Freestanding Credenza, 64”W

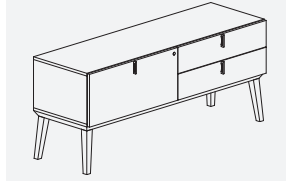

PRODUCT	PRICE		SIZE (INCHES)			WEIGHT VOL	
	STANDARD	LAMINATE	H	W	D	LBS	FT ³
AC4LHB	4743	3796	27.5	64	20	184	23

- Freestanding credenza, front locking lateral drawer left, two box drawers right
- High base

AC4RHB • 28”H Freestanding Credenza, 64”W

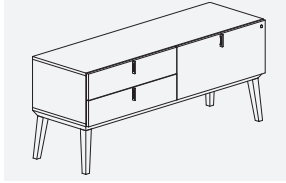

PRODUCT	PRICE		SIZE (INCHES)			WEIGHT VOL	
	STANDARD	LAMINATE	H	W	D	LBS	FT ³
AC4RHB	4743	3796	27.5	64	20	184	23

- Freestanding credenza, two box drawers left, front locking lateral right
- High base

AC5LHB • 28”H Freestanding Credenza, 64”W

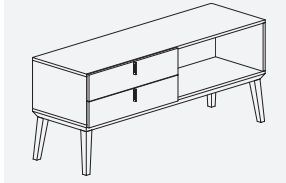

PRODUCT	PRICE		SIZE (INCHES)			WEIGHT VOL	
	STANDARD	LAMINATE	H	W	D	LBS	FT ³
AC5LHB	4439	3552	27.5	64	20	165	23

- Freestanding credenza, two box drawers left, open right
- High base

AC5RHB • 28”H Freestanding Credenza, 64”W

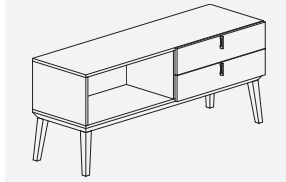

PRODUCT	PRICE		SIZE (INCHES)			WEIGHT VOL	
	STANDARD	LAMINATE	H	W	D	LBS	FT ³
AC5RHB	4439	3552	27.5	64	20	165	23

- Freestanding credenza, open left, two box drawers right
- High base

AC6HB • 28”H Freestanding Credenza, 64”W

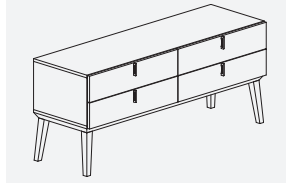

PRODUCT	PRICE		SIZE (INCHES)			WEIGHT VOL	
	STANDARD	LAMINATE	H	W	D	LBS	FT ³
AC6HB	4728	3785	27.5	64	20	184	23

- Freestanding credenza with four box drawers
- High base

AC7HB • 35”H Freestanding Credenza, 64”W

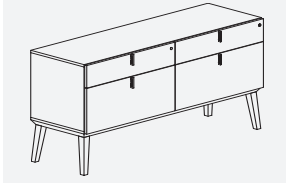

PRODUCT	PRICE		SIZE (INCHES)			WEIGHT VOL	
	STANDARD	LAMINATE	H	W	D	LBS	FT ³
AC7HB	5858	4688	35	64	20	218	29

- Freestanding credenza, front locking lateral with box drawer left and right
- High base

AC8LHB • 35”H Freestanding Credenza, 64”W

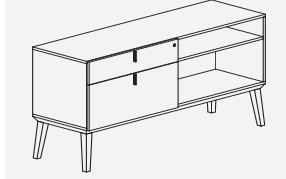

PRODUCT	PRICE		SIZE (INCHES)			WEIGHT VOL	
	STANDARD	LAMINATE	H	W	D	LBS	FT ³
AC8LHB	5236	4190	35	64	20	199	29

- Freestanding credenza, front locking lateral with box drawer left, open with fixed - shelf right

AC8RHB • 35”H Freestanding Credenza, 64”W

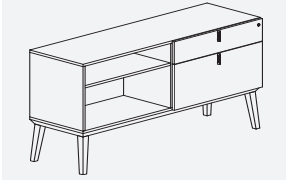

PRODUCT	PRICE		SIZE (INCHES)			WEIGHT VOL	
	STANDARD	LAMINATE	H	W	D	LBS	FT ³
AC8RHB	5236	4190	35	64	20	199	29

- Freestanding credenza, open with fixed shelf left, front locking lateral with box drawer right
- High base

AC9HB • 35”H Freestanding Credenza, 64”W

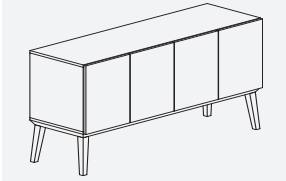

PRODUCT	PRICE		SIZE (INCHES)			WEIGHT VOL	
	STANDARD	LAMINATE	H	W	D	LBS	FT ³
AC9HB	5207	4167	35	64	20	194	29

- Freestanding credenza, four doors with two adjustable shelves
- High base

AC10LHB • 35”H Freestanding Credenza, 64”W

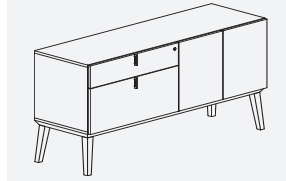

PRODUCT	PRICE		SIZE (INCHES)			WEIGHT VOL	
	STANDARD	LAMINATE	H	W	D	LBS	FT ³
AC10LHB	5523	4420	35	64	20	211	29

- Freestanding credenza, front locking lateral drawer with box drawer left, two doors with adjustable shelf right
- High base

AC10RHB • 35”H Freestanding Credenza, 64”W

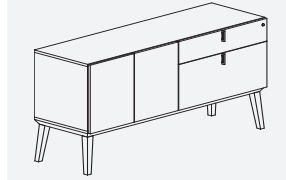

PRODUCT	PRICE		SIZE (INCHES)			WEIGHT VOL	
	STANDARD	LAMINATE	H	W	D	LBS	FT ³
AC10RHB	5523	4420	35	64	20	211	29

- Freestanding credenza, two doors with adjustable shelf left, front locking lateral drawer with box drawer right
- High base

AC11LB • 20”H Freestanding Credenza, 96”W

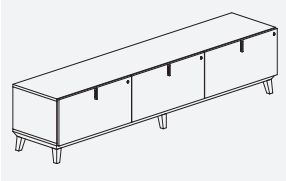

PRODUCT	PRICE		SIZE (INCHES)			WEIGHT VOL	
	STANDARD	LAMINATE	H	W	D	LBS	FT ³
AC11LB	6884	5508	20	96	20	259	25

- Freestanding credenza, three front locking lateral drawers
- Low base

AC12LB • 20”H Freestanding Credenza, 96”W

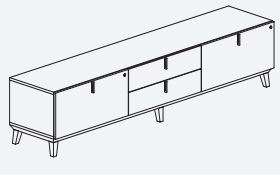

PRODUCT	PRICE		SIZE (INCHES)			WEIGHT VOL	
	STANDARD	LAMINATE	H	W	D	LBS	FT ³
AC12LB	6870	5499	20	96	20	258	25

- Freestanding credenza, front locking lateral drawer left, two box drawers centre, front locking lateral drawer right
- Low base

AC13LB • 20”H Freestanding Credenza, 96”W

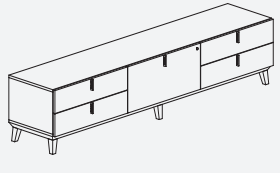

PRODUCT	PRICE		SIZE (INCHES)			WEIGHT VOL	
	STANDARD	LAMINATE	H	W	D	LBS	FT ³
AC13LB	6857	5486	20	96	20	257	25

- Freestanding credenza, two box drawers left, front locking lateral drawer centre, two box drawers right
- Low base

AC14LB • 20”H Freestanding Credenza, 96”W

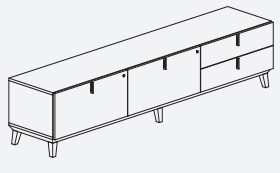

PRODUCT	PRICE		SIZE (INCHES)			WEIGHT VOL	
	STANDARD	LAMINATE	H	W	D	LBS	FT ³
AC14LB	6870	5499	20	96	20	258	25

- Freestanding credenza, front locking lateral drawer left and centre, two box drawers right
- Low base

AC15LB • 20”H Freestanding Credenza, 96”W

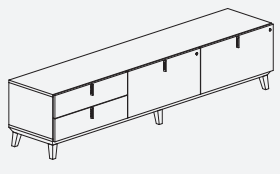

PRODUCT	PRICE		SIZE (INCHES)			WEIGHT VOL	
	STANDARD	LAMINATE	H	W	D	LBS	FT ³
AC15LB	6870	5499	20	96	20	258	25

- Freestanding credenza with two box drawers left, front locking lateral drawer centre and right
- Low base

AC16LB • 20”H Freestanding Credenza, 96”W

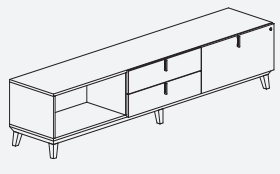

PRODUCT	PRICE		SIZE (INCHES)			WEIGHT VOL	
	STANDARD	LAMINATE	H	W	D	LBS	FT ³
AC16LB	6406	5126	20	96	20	239	25

- Freestanding credenza, open left, two box drawers centre, front locking lateral drawer right
- Low base

AC17LB • 20”H Freestanding Credenza, 96”W

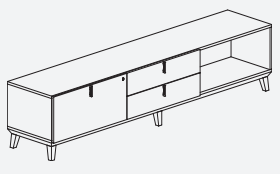

PRODUCT	PRICE		SIZE (INCHES)			WEIGHT VOL	
	STANDARD	LAMINATE	H	W	D	LBS	FT ³
AC17LB	6406	5126	20	96	20	239	25

- Freestanding credenza, front locking lateral drawer left, two box drawers centre, open right
- Low base

AC18LB • 20”H Freestanding Credenza, 96”W

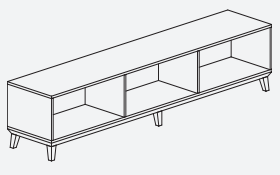

PRODUCT	PRICE		SIZE (INCHES)			WEIGHT VOL	
	STANDARD	LAMINATE	H	W	D	LBS	FT ³
AC18LB	5494	4397	20	96	20	201	25

- Freestanding credenza, open left, centre and right
- Low base

AC19LB • 20”H Freestanding Credenza, 96”W

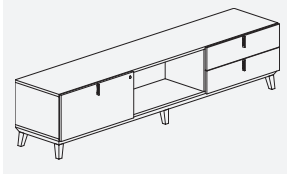

PRODUCT	PRICE		SIZE (INCHES)			WEIGHT VOL	
	STANDARD	LAMINATE	H	W	D	LBS	FT ³
AC19LB	6406	5126	20	96	20	239	25

- Freestanding credenza, front locking lateral drawer left, open centre, two box drawers right
- Low base

AC20LB • 20”H Freestanding Credenza, 96”W

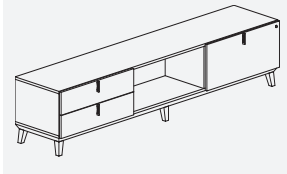

PRODUCT	PRICE		SIZE (INCHES)			WEIGHT VOL	
	STANDARD	LAMINATE	H	W	D	LBS	FT ³
AC20LB	6406	5126	20	96	20	239	25

- Freestanding credenza, two box drawers left, open centre, front locking lateral drawer right
- Low base

AC21LB • 20”H Freestanding Credenza, 96”W

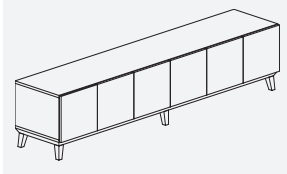

PRODUCT	PRICE		SIZE (INCHES)			WEIGHT VOL	
	STANDARD	LAMINATE	H	W	D	LBS	FT ³
AC21LB	6074	4860	20	96	20	225	25

- Freestanding credenza with six doors
- Low base

AC22LB • 20”H Freestanding Credenza, 96”W

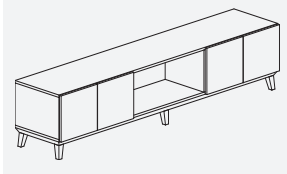

PRODUCT	PRICE		SIZE (INCHES)			WEIGHT VOL	
	STANDARD	LAMINATE	H	W	D	LBS	FT ³
AC22LB	5930	4743	20	96	20	217	25

- Freestanding credenza with two doors left, open centre and two doors right
- Low base

AC23LB • 20”H Freestanding Credenza, 96”W

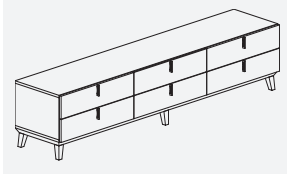

PRODUCT	PRICE		SIZE (INCHES)			WEIGHT VOL	
	STANDARD	LAMINATE	H	W	D	LBS	FT ³
AC23LB	6842	5474	20	96	20	256	25

- Freestanding credenza with six box drawers
- Low base

AC24LB • 28”H Freestanding Credenza, 96”W

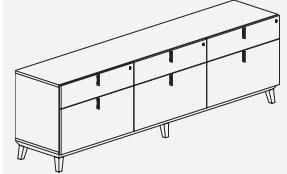

PRODUCT	PRICE		SIZE (INCHES)			WEIGHT VOL	
	STANDARD	LAMINATE	H	W	D	LBS	FT ³
AC24LB	7564	6051	27.5	96	20	304	34

- Freestanding credenza, front locking lateral drawer with box drawer left, centre and right
- Low base

AC25LB • 28”H Freestanding Credenza, 96”W

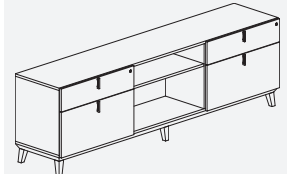

PRODUCT	PRICE		SIZE (INCHES)			WEIGHT VOL	
	STANDARD	LAMINATE	H	W	D	LBS	FT ³
AC25LB	6870	5499	27.5	96	20	284	34

- Freestanding credenza, front locking lateral drawer with box drawer left, open with fixed shelf centre and front locking lateral drawer with box drawer right
- Low base

AC26LB • 28”H Freestanding Credenza, 96”W

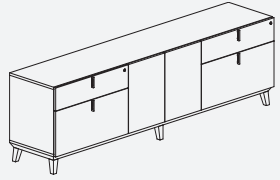

PRODUCT	PRICE		SIZE (INCHES)			WEIGHT VOL	
	STANDARD	LAMINATE	H	W	D	LBS	FT ³
AC26LB	7015	5613	27.5	96	20	296	34

- Freestanding credenza, front locking lateral drawer with box drawer left, two door storage with adjustable shelf centre and front locking lateral drawer with box drawer right

AC27LB • 28”H Freestanding Credenza, 96”W

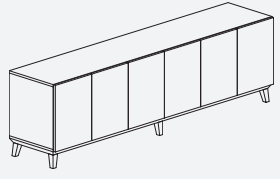

PRODUCT	PRICE		SIZE (INCHES)			WEIGHT VOL	
	STANDARD	LAMINATE	H	W	D	LBS	FT ³
AC27LB	6507	5207	27.5	96	20	281	34

- Freestanding credenza, six doors with three adjustable shelves
- Low base

AC28LB • 28”H Freestanding Credenza, 96”W

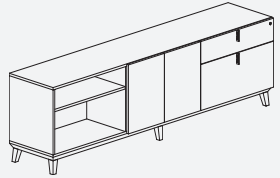

PRODUCT	PRICE		SIZE (INCHES)			WEIGHT VOL	
	STANDARD	LAMINATE	H	W	D	LBS	FT ³
AC28LB	6319	5057	27.5	96	20	277	34

- Freestanding credenza, open with fixed shelf left, two door storage with adjustable shelf centre, front locking lateral drawer with box drawer right
- Low base

AC29LB • 28”H Freestanding Credenza, 96”W

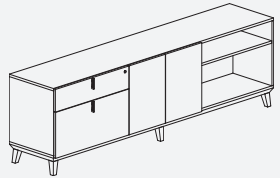

PRODUCT	PRICE		SIZE (INCHES)			WEIGHT VOL	
	STANDARD	LAMINATE	H	W	D	LBS	FT ³
AC29LB	6319	5057	27.5	96	20	277	34

- Freestanding credenza, front locking lateral drawer with box drawer left, two door storage with adjustable shelf centre, open with fixed shelf right
- Low base

AC30LB • 28”H Freestanding Credenza, 96”W

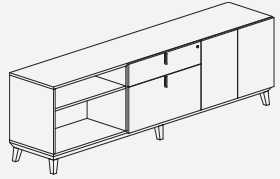

PRODUCT	PRICE		SIZE (INCHES)			WEIGHT VOL	
	STANDARD	LAMINATE	H	W	D	LBS	FT ³
AC30LB	6319	5057	27.5	96	20	277	34

- Freestanding credenza, open with fixed shelf left, front locking lateral drawer with box drawer centre, two door storage with adjustable shelf right
- Low base

AC31LB • 28”H Freestanding Credenza, 96”W

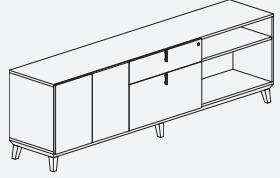

PRODUCT	PRICE		SIZE (INCHES)			WEIGHT VOL	
	STANDARD	LAMINATE	H	W	D	LBS	FT ³
AC31LB	6319	5057	27.5	96	20	277	34

- Freestanding credenza, two door storage with adjustable shelf left, front locking lateral drawer with box drawer centre, open with fixed shelf right
- Low base

AC32LB • 28”H Freestanding Credenza, 96”W

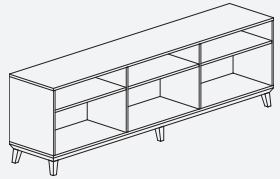

PRODUCT	PRICE		SIZE (INCHES)			WEIGHT VOL	
	STANDARD	LAMINATE	H	W	D	LBS	FT ³
AC32LB	6074	4860	27.5	96	20	245	34

- Freestanding credenza, open with fixed shelf left, centre and right
- Low base

AC11HB • 28”H Freestanding Credenza, 96”W

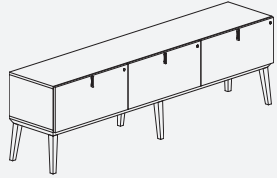

PRODUCT	PRICE		SIZE (INCHES)			WEIGHT VOL	
	STANDARD	LAMINATE	H	W	D	LBS	FT ³
AC11HB	7172	5739	27.5	96	20	264	34

- Freestanding credenza, three front locking lateral drawers
- High base

AC12HB • 28”H Freestanding Credenza, 96”W

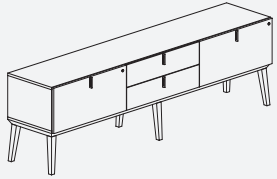

PRODUCT	PRICE		SIZE (INCHES)			WEIGHT VOL	
	STANDARD	LAMINATE	H	W	D	LBS	FT ³
AC12HB	7159	5729	27.5	96	20	263	34

- Freestanding credenza, front locking lateral drawer left, two box drawers centre, front locking lateral drawer right
- High base

AC13HB • 28”H Freestanding Credenza, 96”W

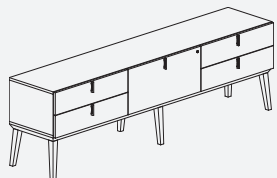

PRODUCT	PRICE		SIZE (INCHES)			WEIGHT VOL	
	STANDARD	LAMINATE	H	W	D	LBS	FT ³
AC13HB	7143	5717	27.5	96	20	262	34

- Freestanding credenza, two box drawers left, front locking lateral drawer centre, two box drawers right
- High base

AC14HB • 28”H Freestanding Credenza, 96”W

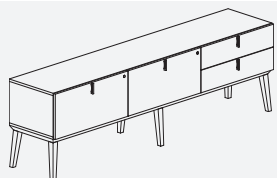

PRODUCT	PRICE		SIZE (INCHES)			WEIGHT VOL	
	STANDARD	LAMINATE	H	W	D	LBS	FT ³
AC14HB	7159	5729	27.5	96	20	263	34

- Freestanding credenza, front locking lateral drawer left and centre, two box drawers right
- High base

AC15HB • 28”H Freestanding Credenza, 96”W

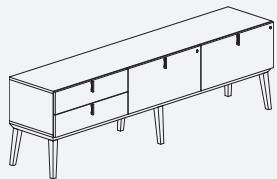

PRODUCT	PRICE		SIZE (INCHES)			WEIGHT VOL	
	STANDARD	LAMINATE	H	W	D	LBS	FT ³
AC15HB	7159	5729	27.5	96	20	263	34

- Freestanding credenza with two box drawers left, front locking lateral drawer centre and right
- High base

AC16HB • 28”H Freestanding Credenza, 96”W

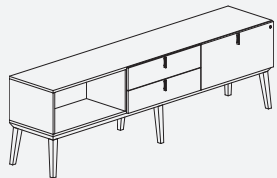

PRODUCT	PRICE		SIZE (INCHES)			WEIGHT VOL	
	STANDARD	LAMINATE	H	W	D	LBS	FT ³
AC16HB	6695	5356	27.5	96	20	244	34

- Freestanding credenza, open left, two box drawers centre, front locking lateral drawer right
- High base

AC17HB • 28”H Freestanding Credenza, 96”W

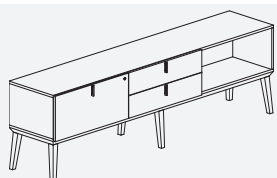

PRODUCT	PRICE		SIZE (INCHES)			WEIGHT VOL	
	STANDARD	LAMINATE	H	W	D	LBS	FT ³
AC17HB	6695	5356	27.5	96	20	244	34

- Freestanding credenza, front locking lateral drawer left, two box drawers centre, open right
- High base

AC18HB • 28”H Freestanding Credenza, 96”W

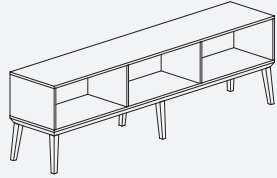

PRODUCT	PRICE		SIZE (INCHES)			WEIGHT VOL	
	STANDARD	LAMINATE	H	W	D	LBS	FT ³
AC18HB	5785	4628	27.5	96	20	206	34

- Freestanding credenza, open left, centre and right
- High base

AC19HB • 28”H Freestanding Credenza, 96”W

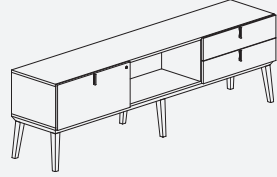

PRODUCT	PRICE		SIZE (INCHES)			WEIGHT VOL	
	STANDARD	LAMINATE	H	W	D	LBS	FT ³
AC19HB	6695	5356	27.5	96	20	244	34

- Freestanding credenza, front locking lateral drawer left, open centre, two box drawers right
- High base

AC20HB • 28”H Freestanding Credenza, 96”W

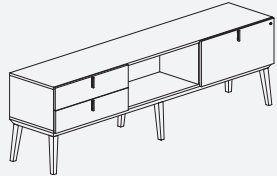

PRODUCT	PRICE		SIZE (INCHES)			WEIGHT VOL	
	STANDARD	LAMINATE	H	W	D	LBS	FT ³
AC20HB	6695	5356	27.5	96	20	244	34

- Freestanding credenza, two box drawers left, open centre, front locking lateral drawer right
- High base

AC21HB • 28”H Freestanding Credenza, 96”W

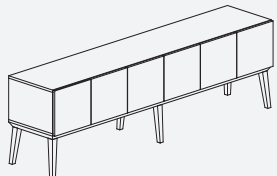

PRODUCT	PRICE		SIZE (INCHES)			WEIGHT VOL	
	STANDARD	LAMINATE	H	W	D	LBS	FT ³
AC21HB	6364	5093	27.5	96	20	230	34

- Freestanding credenza with six doors
- High base

AC22HB • 28”H Freestanding Credenza, 96”W

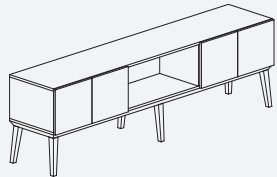

PRODUCT	PRICE		SIZE (INCHES)			WEIGHT VOL	
	STANDARD	LAMINATE	H	W	D	LBS	FT ³
AC22HB	6217	4974	27.5	96	20	222	34

- Freestanding credenza with two doors left, open centre, two doors right
- High base

AC23HB • 28”H Freestanding Credenza, 96”W

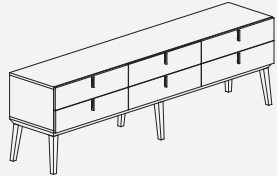

PRODUCT	PRICE		SIZE (INCHES)			WEIGHT VOL	
	STANDARD	LAMINATE	H	W	D	LBS	FT ³
AC23HB	7130	5706	27.5	96	20	261	34

- Freestanding credenza with six box drawers
- High base

AC24HB • 35”H Freestanding Credenza, 96”W

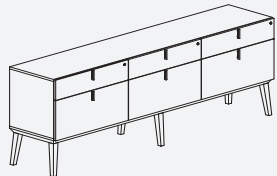

PRODUCT	PRICE		SIZE (INCHES)			WEIGHT VOL	
	STANDARD	LAMINATE	H	W	D	LBS	FT ³
AC24HB	7854	6284	35	96	20	309	43

- Freestanding credenza, front locking lateral drawer with box drawer left, centre and right
- High base

AC25HB • 35”H Freestanding Credenza, 96”W

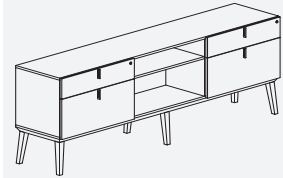

PRODUCT	PRICE		SIZE (INCHES)			WEIGHT VOL	
	STANDARD	LAMINATE	H	W	D	LBS	FT ³
AC25HB	7159	5729	35	96	20	289	43

- Freestanding credenza, front locking lateral drawer with box drawer left, open with fixed shelf centre, front locking lateral drawer with box drawer right
- High base

AC26HB • 35”H Freestanding Credenza, 96”W

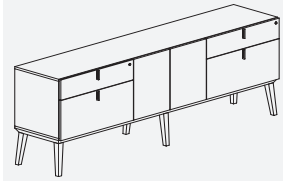

PRODUCT	PRICE		SIZE (INCHES)			WEIGHT VOL	
	STANDARD	LAMINATE	H	W	D	LBS	FT ³
AC26HB	7302	5844	35	96	20	301	43

- Freestanding credenza, front locking lateral drawer with box drawer left, two door storage with adjustable shelf centre, front locking lateral drawer with box drawer right
- High base

AC27HB • 35”H Freestanding Credenza, 96”W

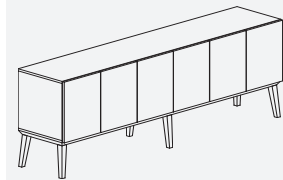

PRODUCT	PRICE		SIZE (INCHES)			WEIGHT VOL	
	STANDARD	LAMINATE	H	W	D	LBS	FT ³
AC27HB	6798	5439	35	96	20	286	43

- Freestanding credenza, six doors with three adjustable shelves
- High base

AC28HB • 35”H Freestanding Credenza, 96”W

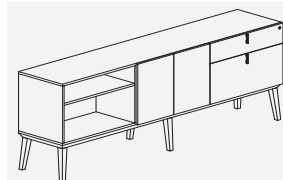

PRODUCT	PRICE		SIZE (INCHES)			WEIGHT VOL	
	STANDARD	LAMINATE	H	W	D	LBS	FT ³
AC28HB	6607	5286	35	96	20	282	43

- Freestanding credenza, open with fixed shelf left, two door storage with adjustable shelf centre, front locking lateral drawer with box drawer right
- High base

AC29HB • 35”H Freestanding Credenza, 96”W

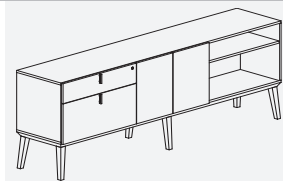

PRODUCT	PRICE		SIZE (INCHES)			WEIGHT VOL	
	STANDARD	LAMINATE	H	W	D	LBS	FT ³
AC29HB	6607	5286	35	96	20	282	43

- Freestanding credenza, front locking lateral drawer with box drawer left, two door storage with adjustable shelf centre, open with fixed shelf right
- High base

AC30HB • 35”H Freestanding Credenza, 96”W

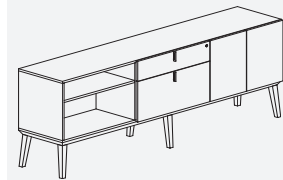

PRODUCT	PRICE		SIZE (INCHES)			WEIGHT VOL	
	STANDARD	LAMINATE	H	W	D	LBS	FT ³
AC30HB	6607	5286	35	96	20	282	43

- Freestanding credenza, open with fixed shelf left, front locking lateral drawer with box drawer centre, two door storage with adjustable shelf right
- High base

AC31HB • 35”H Freestanding Credenza, 96”W

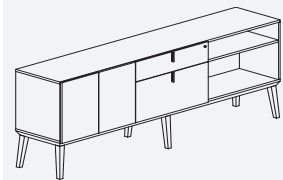

PRODUCT	PRICE		SIZE (INCHES)			WEIGHT VOL	
	STANDARD	LAMINATE	H	W	D	LBS	FT ³
AC31HB	6607	5286	35	96	20	282	43

- Freestanding credenza, two door storage with adjustable shelf left, front locking lateral drawer with box drawer centre, open with fixed shelf right
- High base

AC32HB • 35”H Freestanding Credenza, 96”W

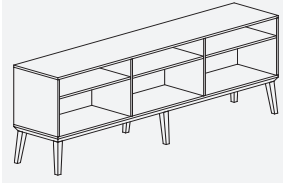

PRODUCT	PRICE		SIZE (INCHES)			WEIGHT VOL	
	STANDARD	LAMINATE	H	W	D	LBS	FT ³
AC32HB	6364	5093	35	96	20	250	43

- Freestanding credenza, open with fixed shelf left, centre and right
- High base

32"W and 64"W STACK-ON BOOKCASES and STORAGE CABINETS • TECHNICAL INFORMATION

- All Stack-on Bookcases and Storage Cabinets are shipped assembled.
- Stack-on units are designed to be placed and installed on top of the Credenzas with Low or High Base.
- Stack on Units are available in three heights 29.5", 44" and 58.5".
- Back Panels of the Stack-on units are made of LP solid colour laminate.
- Optional Wood Back Panel is available at an upcharge of \$403. Add suffix "/W" at the end of the product code. (e.g. AS15/W)
- Optional locking on doors (storage units) are available. Add suffix "LO" at the end of the product code. (e.g. AS15-LO)
- Optional handles on doors (storage units) are available (see Accessories section).

STACK-ON BOOKCASES • GUIDELINES FOR ORDERING PRODUCT

CODES: The price list uses a product coding system that is specific to each of the units. The product description (next to the code) explains in detail the construction of the unit.

SPECIFICATION EXAMPLE OF A 64"W STACK-ON BOOKCASE
PRODUCT CODE: AS15 (/P for All Laminate or /W for All Wood Finish)
 A = Corby Series
 S = Stack-on Unit
 15 = Product ID number (Stack-on Bookcase 44"H x 64"W x 14.5"D)

CHOOSE FINISH OPTION:
 Standard Finish: Veneer chassis and fronts with LP laminate back panel. Please see page A.18
 Laminate Finish: Please add "/P" to the end of the product code, includes LP laminate chassis, fronts and back panel. Please see page A.18
 Veneer Back: For matching veneer cabinet back please add "/W" to the end of the product code + \$403 list to the standard price. Please see page A.18

LOCK / HANDLE:
 Choose Optional Lock or Handle on doors (see Accessories section).

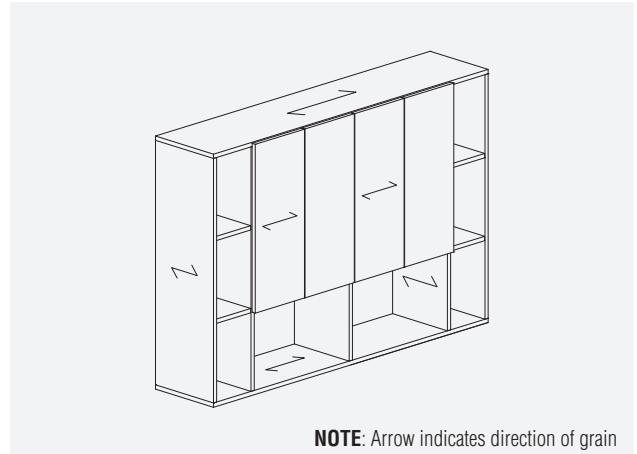

NOTE: Arrow indicates direction of grain

AS1 • 32"W Stack-on Bookcase

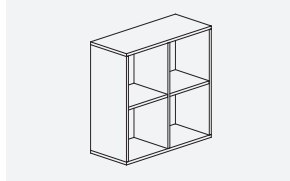

PRODUCT	PRICE		SIZE (INCHES)			WEIGHT VOL	
	STANDARD	LAMINATE	H	W	D	LBS	FT ³
AS1	1954	1564	29.5	32	14.5	69	9

- Two high stack-on bookcase with symmetrical 16" wide openings, fixed shelves
- LP laminate back
- For wood back (Standard price + \$431)

AS2L • 32"W Stack-on Bookcase

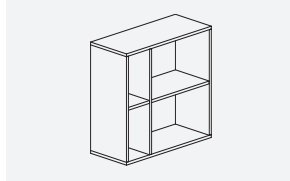

PRODUCT	PRICE		SIZE (INCHES)			WEIGHT VOL	
	STANDARD	LAMINATE	H	W	D	LBS	FT ³
AS2L	1954	1564	29.5	32	14.5	69	9

- Two high stack-on bookcase with asymmetrical openings, 8" left / 24" right, fixed shelves
- LP laminate back
- For wood back (Standard price + \$431)

AS2R • 32"W Stack-on Bookcase

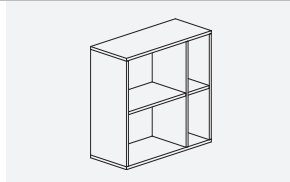

PRODUCT	PRICE		SIZE (INCHES)			WEIGHT VOL	
	STANDARD	LAMINATE	H	W	D	LBS	FT ³
AS2R	1954	1564	29.5	32	14.5	69	9

- Two high stack-on bookcase with asymmetrical openings, 24" left / 8" right, fixed shelves
- LP laminate back
- For wood back (Standard price + \$431)

AS3 • 32"W Stack-on Bookcase

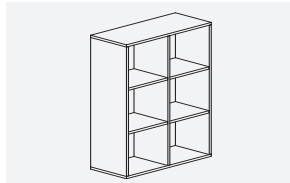

PRODUCT	PRICE		SIZE (INCHES)			WEIGHT VOL	
	STANDARD	LAMINATE	H	W	D	LBS	FT ³
AS3	2676	2142	44	32	14.5	95	14

- Three high stack-on bookcase with symmetrical 16" wide openings, fixed shelves
- LP laminate back
- For wood back (Standard price + \$431)

AS4L • 32" W Stack-on Bookcase

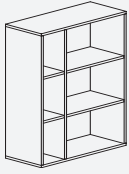

PRODUCT	PRICE		SIZE (INCHES)			WEIGHT VOL	
	STANDARD	LAMINATE	H	W	D	LBS	FT ³
AS4L	2676	2142	44	32	14.5	95	14

- Three high stack-on bookcase with asymmetrical openings, 8" left / 24" right, fixed shelves
- LP laminate back
- For wood back (Standard price + \$431)

AS4R • 32" W Stack-on Bookcase

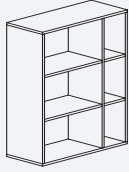

PRODUCT	PRICE		SIZE (INCHES)			WEIGHT VOL	
	STANDARD	LAMINATE	H	W	D	LBS	FT ³
AS4R	2676	2142	44	32	14.5	95	14

- Three high stack-on bookcase with asymmetrical openings, 24" left / 8" right, fixed shelves
- LP laminate back
- For wood back (Standard price + \$431)

AS5L • 32" W Stack-on Bookcase

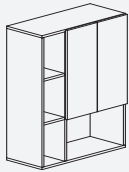

PRODUCT	PRICE		SIZE (INCHES)			WEIGHT VOL	
	STANDARD	LAMINATE	H	W	D	LBS	FT ³
AS5L	3166	2534	44	32	14.5	106	14

- Three high stack-on bookcase with asymmetrical openings, 8" left / 24" right, fixed shelves, two door storage upper right with one adjustable shelf
- LP laminate back
- For wood back (Standard price + \$431)

AS5R • 32" W Stack-on Bookcase

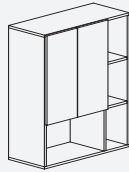

PRODUCT	PRICE		SIZE (INCHES)			WEIGHT VOL	
	STANDARD	LAMINATE	H	W	D	LBS	FT ³
AS5R	3166	2534	44	32	14.5	106	14

- Three high stack-on bookcase with asymmetrical openings, 24" left / 8" right, fixed shelves, two door storage upper left with one adjustable shelf
- LP laminate back
- For wood back (Standard price + \$431)

AS6 • 32" W Stack-on Bookcase

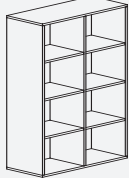

PRODUCT	PRICE		SIZE (INCHES)			WEIGHT VOL	
	STANDARD	LAMINATE	H	W	D	LBS	FT ³
AS6	3545	2837	58.5	32	14.5	111	18

- Four high stack-on bookcase with symmetrical 16" wide openings, fixed shelves
- LP laminate back
- For wood back (Standard price + \$431)

AS7L • 32" W Stack-on Bookcase

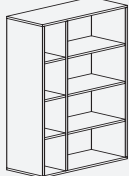

PRODUCT	PRICE		SIZE (INCHES)			WEIGHT VOL	
	STANDARD	LAMINATE	H	W	D	LBS	FT ³
AS7L	3545	2837	58.5	32	14.5	111	18

- Four high stack-on bookcase with asymmetrical openings, 8" left / 24" right, fixed shelves
- LP laminate back
- For wood back (Standard price + \$431)

AS7R • 32" W Stack-on Bookcase

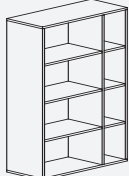

PRODUCT	PRICE		SIZE (INCHES)			WEIGHT VOL	
	STANDARD	LAMINATE	H	W	D	LBS	FT ³
AS7R	3545	2837	58.5	32	14.5	111	18

- Four high stack-on bookcase with asymmetrical openings, 24" left / 8" right, fixed shelves
- LP laminate back
- For wood back (Standard price + \$431)

AS8L • 32"W Stack-on Bookcase

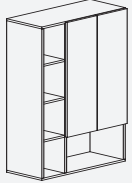

PRODUCT	PRICE		SIZE (INCHES)			WEIGHT VOL	
	STANDARD	LAMINATE	H	W	D	LBS	FT ³
AS8L	4296	3438	58.5	32	14.5	129	18

- Four high stack-on bookcase with asymmetrical openings, 8" left / 24" right, fixed shelves, two door storage upper right with two adjustable shelves
- LP laminate back
- For wood back (Standard price + \$431)

AS8R • 32"W Stack-on Bookcase

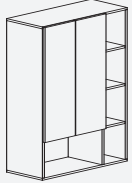

PRODUCT	PRICE		SIZE (INCHES)			WEIGHT VOL	
	STANDARD	LAMINATE	H	W	D	LBS	FT ³
AS8R	4296	3438	58.5	32	14.5	129	18

- Four high stack-on bookcase with asymmetrical openings, 24" left / 8" right, fixed shelves, two door storage upper left with two adjustable shelves
- LP laminate back
- For wood back (Standard price + \$431)

AS9 • 64"W Stack-on Bookcase

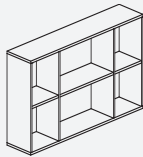

PRODUCT	PRICE		SIZE (INCHES)			WEIGHT VOL	
	STANDARD	LAMINATE	H	W	D	LBS	FT ³
AS9	3400	2719	29.5	64	14.5	119	18

- Two high stack-on bookcase, 32" open fixed shelf centre, 16" open fixed shelf either side
- LP laminate back
- For wood back (Standard price + \$431)

AS10 • 64"W Stack-on Bookcase

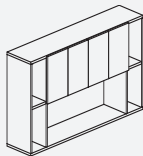

PRODUCT	PRICE		SIZE (INCHES)			WEIGHT VOL	
	STANDARD	LAMINATE	H	W	D	LBS	FT ³
AS10	4018	3214	29.5	64	14.5	134	18

- Two high stack-on bookcase, four door storage upper centre, 48" open fixed shelf lower centre and 8" open fixed shelves either side
- LP laminate back
- For wood back (Standard price + \$431)

AS11 • 64"W Stack-on Bookcase

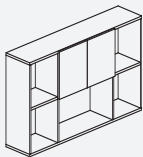

PRODUCT	PRICE		SIZE (INCHES)			WEIGHT VOL	
	STANDARD	LAMINATE	H	W	D	LBS	FT ³
AS11	3775	3021	29.5	64	14.5	127	18

- Two high stack-on bookcase, two door storage upper centre, 32" open fixed shelf lower centre, 16" open fixed shelves either side
- LP laminate back
- For wood back (Standard price + \$431)

AS12 • 64"W Stack-on Bookcase

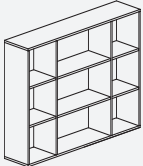

PRODUCT	PRICE		SIZE (INCHES)			WEIGHT VOL	
	STANDARD	LAMINATE	H	W	D	LBS	FT ³
AS12	4770	3818	44	64	14.5	164	27

- Three high stack-on bookcase, 32" open fixed shelves centre, 16" open fixed shelves either side
- LP laminate back
- For wood back (Standard price + \$431)

AS13 • 64"W Stack-on Bookcase

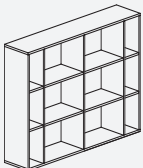

PRODUCT	PRICE		SIZE (INCHES)			WEIGHT VOL	
	STANDARD	LAMINATE	H	W	D	LBS	FT ³
AS13	5106	4085	44	64	14.5	174	27

- Three high stack-on bookcase, two 24" open fixed shelves centre, 8" open fixed shelves either side
- LP laminate back
- For wood back (Standard price + \$431)

AS14 • 64”W Stack-on Bookcase

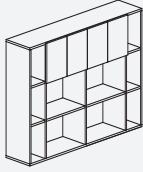

PRODUCT	PRICE		SIZE (INCHES)			WEIGHT VOL	
	STANDARD	LAMINATE	H	W	D	LBS	FT ³
AS14	5727	4581	44	64	14.5	186	27

- Three high stack-on bookcase, four door storage upper centre, two 24” open fixed shelves lower centre, 8” open fixed shelves either side
- LP laminate back
- For wood back (Standard price + \$431)

AS15 • 64”W Stack-on Bookcase

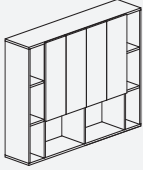

PRODUCT	PRICE		SIZE (INCHES)			WEIGHT VOL	
	STANDARD	LAMINATE	H	W	D	LBS	FT ³
AS15	6088	4873	44	64	14.5	198	27

- Three high stack-on bookcase, four door storage upper centre with adjustable shelves, two 24” open fixed shelves lower centre, 8” open fixed shelves either side
- LP laminate back
- For wood back (Standard price + \$431)

AS16 • 64”W Stack-on Bookcase

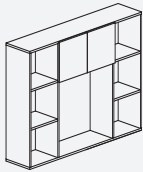

PRODUCT	PRICE		SIZE (INCHES)			WEIGHT VOL	
	STANDARD	LAMINATE	H	W	D	LBS	FT ³
AS16	5150	4122	44	64	14.5	172	27

- Three high stack-on bookcase, two door storage upper centre, 32” open shelf lower centre, 16” open fixed shelves either side
- LP laminate back
- For wood back (Standard price + \$431)

AS17 • 64”W Stack-on Bookcase

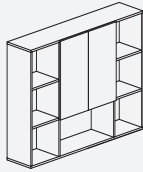

PRODUCT	PRICE		SIZE (INCHES)			WEIGHT VOL	
	STANDARD	LAMINATE	H	W	D	LBS	FT ³
AS17	5394	4315	44	64	14.5	180	27

- Three high stack-on bookcase, two door storage upper centre with adjustable shelf, 32” open fixed shelf lower centre, 16” open fixed shelves either side
- LP laminate back
- For wood back (Standard price + \$431)

AS18 • 64”W Stack-on Bookcase

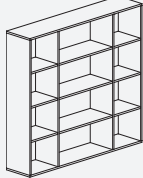

PRODUCT	PRICE		SIZE (INCHES)			WEIGHT VOL	
	STANDARD	LAMINATE	H	W	D	LBS	FT ³
AS18	6146	4920	58.5	64	14.5	208	35

- Four high stack-on bookcase, 32” open fixed shelves centre, 16” open fixed shelves either side
- LP laminate back
- For wood back (Standard price + \$431)

AS19 • 64”W Stack-on Bookcase

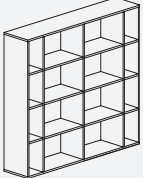

PRODUCT	PRICE		SIZE (INCHES)			WEIGHT VOL	
	STANDARD	LAMINATE	H	W	D	LBS	FT ³
AS19	6578	5263	58.5	64	14.5	222	35

- Four high stack-on bookcase, two 24” open fixed shelves centre, 8” open fixed shelves either side
- LP laminate back
- For wood back (Standard price + \$431)

AS20 • 64”W Stack-on Bookcase

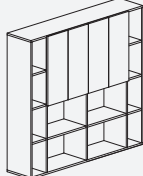

PRODUCT	PRICE		SIZE (INCHES)			WEIGHT VOL	
	STANDARD	LAMINATE	H	W	D	LBS	FT ³
AS20	7564	6051	58.5	64	14.5	245	35

- Four high stack-on bookcase, four door storage upper centre with adjustable shelves, two 24” open fixed shelves lower centre, 8” open fixed shelves either side
- LP laminate back
- For wood back (Standard price + \$431)

AS21 • 64”W Stack-on Bookcase



PRODUCT	PRICE		SIZE (INCHES)			WEIGHT VOL	
	STANDARD	LAMINATE	H	W	D	LBS	FT ³
AS21	6637	5310	58.5	64	14.5	224	35

- Four high stack-on bookcase, two door storage upper centre with adjustable shelf, 32” open fixed shelf lower centre, 16” open fixed shelves either side
- LP laminate back
- For wood back (Standard price + \$431)

32"W & 64"W FREESTANDING BOOKCASES and STORAGE CABINETS • TECHNICAL INFORMATION

- All Bookcases and Storage cabinets are shipped assembled.
- Bookcases and Storage cabinets are available in two base heights: 4" (xxLB = Low Base) or 11.5" (xxHB = High Base)
- Back Panels of the Bookcases and storage cabinets are made of LP solid colour laminate.
- Optional Wood Back Panel is available at an upcharge of \$403. Add suffix "/W" at the end of the product code. (e.g. AB4LHB/W)
- Optional locking on doors (storage units) are available. Add suffix "LO" at the end of the product code. (e.g. AB4LHB/LO)
- Optional handles on doors (storage units) are available (see Accessories section).

FREESTANDING BOOKCASES and STORAGE CABINETS • GUIDELINES FOR ORDERING PRODUCT

CODES: The price list uses a product coding system that is specific to each of the units. The product description (next to the code) explains in detail construction of the unit.

SPECIFICATION EXAMPLE OF A 32"W FREESTANDING BOOKCASE

PRODUCT CODE: AB4LHB (/P for All Laminate or /W for All Wood Finish)

A = Corby Series and B = Bookcase

4 = Product ID number (Freestanding Bookcase 50"H x 32"W x 14.5"D)

L = Open on Left and HB = High Base

CHOOSE FINISH OPTION:

Standard Finish: Veneer chassis and fronts with matching hardwood legs, LP laminate back panel. Please see page A.18

Laminate Finish: Please add "/P" to the end of the product code, includes LP laminate chassis, fronts and back panel with painted hardwood legs. Please see page A.18

Veneer Back: For matching veneer cabinet back please add "/W" to the end of the product code + \$403 list to the standard price. Please see page A.18

LOCK / HANDLE: Choose Optional Lock or Handle on doors (see Accessories section).

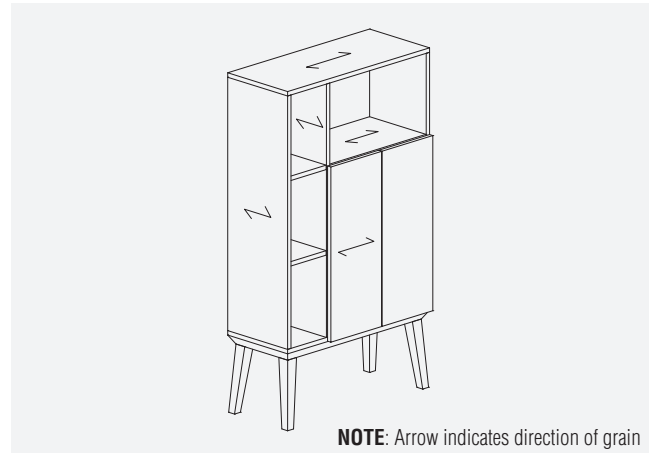

NOTE: Arrow indicates direction of grain

AB1LB • 32"W Freestanding Bookcase



PRODUCT	PRICE		SIZE (INCHES)			WEIGHT VOL	
	STANDARD	LAMINATE	H	W	D	LBS	FT ³
AB1LB	2529	2024	35.5	32	14.5	101	11

- Freestanding two high bookcase with symmetrical 16" wide openings, fixed shelves
- Low base
- LP laminate back
- For wood back (Standard price + \$431)

AB2LLB • 32"W Freestanding Bookcase



PRODUCT	PRICE		SIZE (INCHES)			WEIGHT VOL	
	STANDARD	LAMINATE	H	W	D	LBS	FT ³
AB2LLB	2529	2024	35.5	32	14.5	101	11

- Freestanding two high bookcase with asymmetrical openings, 8" left / 24" right, fixed shelves
- Low base
- LP laminate back
- For wood back (Standard price + \$431)

AB2RLB • 32"W Freestanding Bookcase

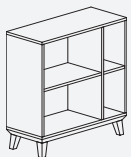

PRODUCT	PRICE		SIZE (INCHES)			WEIGHT VOL	
	STANDARD	LAMINATE	H	W	D	LBS	FT ³
AB2RLB	2529	2024	35.5	32	14.5	101	11

- Freestanding two high bookcase with asymmetrical openings, 24" left / 8" right, fixed shelves
- Low base
- LP laminate back
- For wood back (Standard price + \$431)

AB3LB • 32"W Freestanding Bookcase

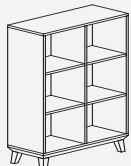

PRODUCT	PRICE		SIZE (INCHES)			WEIGHT VOL	
	STANDARD	LAMINATE	H	W	D	LBS	FT ³
AB3LB	3253	2604	50	32	14.5	119	15

- Freestanding three high bookcase with symmetrical 16" wide openings, fixed shelves
- Low base
- LP laminate back
- For wood back (Standard price + \$431)

AB4LLB • 32" W Freestanding Bookcase

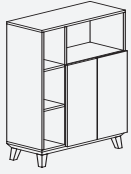

PRODUCT	PRICE		SIZE (INCHES)			WEIGHT VOL	
	STANDARD	LAMINATE	H	W	D	LBS	FT ³
AB4LLB	3746	2999	50	32	14.5	138	15

- Freestanding three high bookcase with asymmetrical openings, 8" left / 24" right, fixed shelves, two door storage lower right with one adjustable shelf.
- Low base
- LP laminate back
- For wood back (Standard price + \$431)

AB4RLB • 32" W Freestanding Bookcase

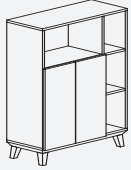

PRODUCT	PRICE		SIZE (INCHES)			WEIGHT VOL	
	STANDARD	LAMINATE	H	W	D	LBS	FT ³
AB4RLB	3746	2999	50	32	14.5	138	15

- Freestanding three high bookcase with asymmetrical openings, 24" left / 8" right, fixed shelves, two door storage lower left with one adjustable shelf
- Low base
- LP laminate back
- For wood back (Standard price + \$431)

AB5LLB • 32" W Freestanding Bookcase



PRODUCT	PRICE		SIZE (INCHES)			WEIGHT VOL	
	STANDARD	LAMINATE	H	W	D	LBS	FT ³
AB5LLB	3253	2604	50	32	14.5	126	15

- Freestanding three high bookcase with asymmetrical openings, 8" left / 24" right, fixed shelves
- Low base
- LP laminate back
- For wood back (Standard price + \$431)

AB5RLB • 32" W Freestanding Bookcase

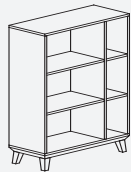

PRODUCT	PRICE		SIZE (INCHES)			WEIGHT VOL	
	STANDARD	LAMINATE	H	W	D	LBS	FT ³
AB5RLB	3253	2604	50	32	14.5	126	15

- Freestanding three high bookcase with asymmetrical openings, 24" left / 8" right, fixed shelves
- Low base
- LP laminate back
- For wood back (Standard price + \$431)

AB6LB • 32" W Freestanding Bookcase

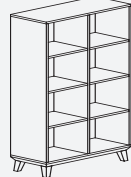

PRODUCT	PRICE		SIZE (INCHES)			WEIGHT VOL	
	STANDARD	LAMINATE	H	W	D	LBS	FT ³
AB6LB	4123	3299	64	32	14.5	152	20

- Freestanding four high bookcase with symmetrical 16" wide openings, fixed shelves
- Low base
- LP laminate back
- For wood back (Standard price + \$431)

AB7LLB • 32" W Freestanding Bookcase

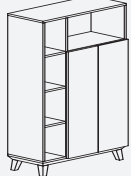

PRODUCT	PRICE		SIZE (INCHES)			WEIGHT VOL	
	STANDARD	LAMINATE	H	W	D	LBS	FT ³
AB7LLB	4874	3900	64	32	14.5	169	20

- Freestanding four high bookcase with asymmetrical openings, 8" left / 24" right, fixed shelves, two door storage lower right with two adjustable shelves
- Low base
- LP laminate back
- For wood back (Standard price + \$431)

AB7RLB • 32" W Freestanding Bookcase

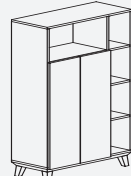

PRODUCT	PRICE		SIZE (INCHES)			WEIGHT VOL	
	STANDARD	LAMINATE	H	W	D	LBS	FT ³
AB7RLB	4874	3900	64	32	14.5	169	20

- Freestanding four high bookcase with asymmetrical openings, 24" left / 8" right, fixed shelves, two door storage lower left with two adjustable shelves
- Low base
- LP laminate back
- For wood back (Standard price + \$431)

AB8LLB • 32"W Freestanding Bookcase



PRODUCT	PRICE		SIZE (INCHES)			WEIGHT VOL	
	STANDARD	LAMINATE	H	W	D	LBS	FT ³
AB8LLB	4123	3299	64	32	14.5	152	20

- Freestanding four high bookcase with asymmetrical openings, 8" left / 24" right, fixed shelves
- Low base
- LP laminate back
- For wood back (Standard price + \$431)

AB8RLB • 32"W Freestanding Bookcase



PRODUCT	PRICE		SIZE (INCHES)			WEIGHT VOL	
	STANDARD	LAMINATE	H	W	D	LBS	FT ³
AB8RLB	4123	3299	64	32	14.5	152	20

- Freestanding four high bookcase with asymmetrical openings, 24" left / 8" right, fixed shelves
- Low base
- LP laminate back
- For wood back (Standard price + \$431)

AB1HB • 32"W Freestanding Bookcase



PRODUCT	PRICE		SIZE (INCHES)			WEIGHT VOL	
	STANDARD	LAMINATE	H	W	D	LBS	FT ³
AB1HB	2819	2257	42.75	32	14.5	106	13

- Freestanding two high bookcase with symmetrical 16" wide openings, fixed shelves
- High base
- LP laminate back
- For wood back (Standard price + \$431)

AB2LHB • 32"W Freestanding Bookcase



PRODUCT	PRICE		SIZE (INCHES)			WEIGHT VOL	
	STANDARD	LAMINATE	H	W	D	LBS	FT ³
AB2LHB	2819	2257	42.75	32	14.5	106	13

- Freestanding two high bookcase with asymmetrical openings, 8" left / 24" right, fixed shelves
- High base
- LP laminate back
- For wood back (Standard price + \$431)

AB2RHB • 32"W Freestanding Bookcase



PRODUCT	PRICE		SIZE (INCHES)			WEIGHT VOL	
	STANDARD	LAMINATE	H	W	D	LBS	FT ³
AB2RHB	2819	2257	42.75	32	14.5	106	13

- Freestanding two high bookcase with asymmetrical openings, 24" left / 8" right, fixed shelves
- High base
- LP laminate back
- For wood back (Standard price + \$431)

AB3HB • 32"W Freestanding Bookcase



PRODUCT	PRICE		SIZE (INCHES)			WEIGHT VOL	
	STANDARD	LAMINATE	H	W	D	LBS	FT ³
AB3HB	3545	2837	57	32	14.5	119	18

- Freestanding three high bookcase with symmetrical 16" wide openings, fixed shelves
- High base
- LP laminate back
- For wood back (Standard price + \$431)

AB4LHB • 32"W Freestanding Bookcase



PRODUCT	PRICE		SIZE (INCHES)			WEIGHT VOL	
	STANDARD	LAMINATE	H	W	D	LBS	FT ³
AB4LHB	4035	3228	57	32	14.5	143	18

- Freestanding three high bookcase with asymmetrical openings, 8" left / 24" right, fixed shelves, two door storage lower right with one adjustable shelf
- High base
- LP laminate back
- For wood back (Standard price + \$431)

AB4RHB • 32" W Freestanding Bookcase



PRODUCT	PRICE		SIZE (INCHES)			WEIGHT VOL	
	STANDARD	LAMINATE	H	W	D	LBS	FT ³
AB4RHB	4035	3228	57	32	14.5	143	18

- Freestanding three high bookcase with asymmetrical openings, 24" left / 8" right, fixed shelves, two door storage lower left with one adjustable shelf
- High base
- LP laminate back
- For wood back (Standard price + \$431)

AB5LHB • 32" W Freestanding Bookcase



PRODUCT	PRICE		SIZE (INCHES)			WEIGHT VOL	
	STANDARD	LAMINATE	H	W	D	LBS	FT ³
AB5LHB	3545	2837	57	32	14.5	131	18

- Freestanding three high bookcase with asymmetrical openings, 8" left / 24" right, fixed shelves
- High base
- LP laminate back
- For wood back (Standard price + \$431)

AB5RHB • 32" W Freestanding Bookcase



PRODUCT	PRICE		SIZE (INCHES)			WEIGHT VOL	
	STANDARD	LAMINATE	H	W	D	LBS	FT ³
AB5RHB	3545	2837	57	32	14.5	131	18

- Freestanding three high bookcase with asymmetrical openings, 24" left / 8" right, fixed shelves
- High base
- LP laminate back
- For wood back (Standard price + \$431)

AB6HB • 32" W Freestanding Bookcase



PRODUCT	PRICE		SIZE (INCHES)			WEIGHT VOL	
	STANDARD	LAMINATE	H	W	D	LBS	FT ³
AB6HB	4411	3529	71.5	32	14.5	157	22

- Freestanding four high bookcase with symmetrical 16" wide openings, fixed shelves
- High base
- LP laminate back
- For wood back (Standard price + \$431)

AB7LHB • 32" W Freestanding Bookcase



PRODUCT	PRICE		SIZE (INCHES)			WEIGHT VOL	
	STANDARD	LAMINATE	H	W	D	LBS	FT ³
AB7LHB	5164	4132	71.5	32	14.5	174	22

- Freestanding four high bookcase with asymmetrical openings, 8" left / 24" right, fixed shelves, two door storage lower right with two adjustable shelves
- High base
- LP laminate back
- For wood back (Standard price + \$431)

AB7RHB • 32" W Freestanding Bookcase



PRODUCT	PRICE		SIZE (INCHES)			WEIGHT VOL	
	STANDARD	LAMINATE	H	W	D	LBS	FT ³
AB7RHB	5164	4132	71.5	32	14.5	174	22

- Freestanding four high bookcase with asymmetrical openings, 24" left / 8" right, fixed shelves, two door storage lower left with two adjustable shelves
- High base
- LP laminate back
- For wood back (Standard price + \$431)

AB8LHB • 32" W Freestanding Bookcase



PRODUCT	PRICE		SIZE (INCHES)			WEIGHT VOL	
	STANDARD	LAMINATE	H	W	D	LBS	FT ³
AB8LHB	4411	3529	71.5	32	14.5	157	22

- Freestanding four high bookcase with asymmetrical openings, 8" left / 24" right, fixed shelves
- High base
- LP laminate back
- For wood back (Standard price + \$431)

AB8RHB • 32" W Freestanding Bookcase

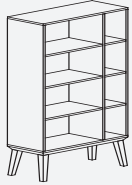

PRODUCT	PRICE		SIZE (INCHES)			WEIGHT VOL	
	STANDARD	LAMINATE	H	W	D	LBS	FT ³
AB8RHB	4411	3529	71.5	32	14.5	157	22

- Freestanding four high bookcase with asymmetrical openings, 24" left / 8" right, fixed shelves
- High base
- LP laminate back
- For wood back (Standard price + \$431)

AB9LB • 64" W Freestanding Bookcase



PRODUCT	PRICE		SIZE (INCHES)			WEIGHT VOL	
	STANDARD	LAMINATE	H	W	D	LBS	FT ³
AB9LB	4600	3680	35.5	64	14.5	177	21

- Freestanding two high bookcase with four door storage lower centre, 48" open fixed upper shelf and 8" open fixed shelves either side
- Low base
- LP laminate back
- For wood back (Standard price + \$431)

AB10LB • 64" W Freestanding Bookcase

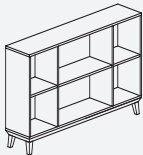

PRODUCT	PRICE		SIZE (INCHES)			WEIGHT VOL	
	STANDARD	LAMINATE	H	W	D	LBS	FT ³
AB10LB	3977	3182	35.5	64	14.5	162	21

- Freestanding two high bookcase, 32" open fixed shelf centre and 16" open fixed shelves either side
- Low base
- LP laminate back
- For wood back (Standard price + \$431)

AB11LB • 64" W Freestanding Bookcase

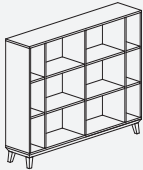

PRODUCT	PRICE		SIZE (INCHES)			WEIGHT VOL	
	STANDARD	LAMINATE	H	W	D	LBS	FT ³
AB11LB	4237	3390	50	64	14.5	217	30

- Freestanding three high bookcase, two 24" open fixed shelves centre, 8" open fixed shelves either side
- Low base
- LP laminate back
- For wood back (Standard price + \$431)

AB12LB • 64" W Freestanding Bookcase

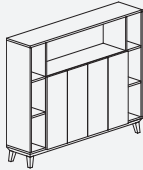

PRODUCT	PRICE		SIZE (INCHES)			WEIGHT VOL	
	STANDARD	LAMINATE	H	W	D	LBS	FT ³
AB12LB	6665	5334	50	64	14.5	237	30

- Freestanding three high bookcase, four door storage lower centre with adjustable shelves, 48" open fixed shelf upper and 8" open fixed shelves either side
- Low base
- LP laminate back
- For wood back (Standard price + \$431)

AB13LB • 64" W Freestanding Bookcase

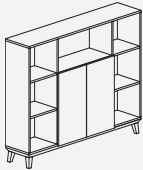

PRODUCT	PRICE		SIZE (INCHES)			WEIGHT VOL	
	STANDARD	LAMINATE	H	W	D	LBS	FT ³
AB13LB	5971	4780	50	64	14.5	223	30

- Freestanding three high bookcase two door storage lower centre with adjustable shelves, 32" open fixed shelf upper and 16" open fixed shelves either side
- Low base
- LP laminate back
- For wood back (Standard price + \$431)

AB14LB • 64" W Freestanding Bookcase

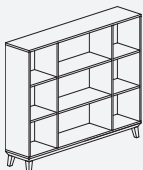

PRODUCT	PRICE		SIZE (INCHES)			WEIGHT VOL	
	STANDARD	LAMINATE	H	W	D	LBS	FT ³
AB14LB	5353	4283	50	64	14.5	207	30

- Freestanding three high bookcase, 32" open fixed shelves centre and 16" open fixed shelves either side
- Low base
- LP laminate back
- For wood back (Standard price + \$431)

AB15LB • 64"W Freestanding Bookcase

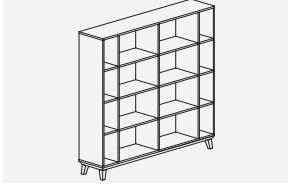

PRODUCT	PRICE		SIZE (INCHES)			WEIGHT VOL	
	STANDARD	LAMINATE	H	W	D	LBS	FT ³
AB15LB	7159	5729	64	64	14.5	265	38

- Freestanding four high bookcase, two 24" open fixed shelves centre and 8" open fixed shelves either side
- Low base
- LP laminate back
- For wood back (Standard price + \$431)

AB16LB • 64"W Freestanding Bookcase



PRODUCT	PRICE		SIZE (INCHES)			WEIGHT VOL	
	STANDARD	LAMINATE	H	W	D	LBS	FT ³
AB16LB	8143	6516	64	64	14.5	281	38

- Freestanding four high bookcase, four door storage lower centre with adjustable shelves, 48" open fixed upper shelves and 8" open fixed shelves either side
- Low base
- LP laminate back
- For wood back (Standard price + \$431)

AB17LB • 64"W Freestanding Bookcase



PRODUCT	PRICE		SIZE (INCHES)			WEIGHT VOL	
	STANDARD	LAMINATE	H	W	D	LBS	FT ³
AB17LB	7216	5775	64	64	14.5	267	38

- Freestanding four high bookcase, two door storage lower centre with adjustable shelf, 32" open fixed upper shelves and 16" open fixed shelves either side
- Low base
- LP laminate back
- For wood back (Standard price + \$431)

AB18LB • 64"W Freestanding Bookcase



PRODUCT	PRICE		SIZE (INCHES)			WEIGHT VOL	
	STANDARD	LAMINATE	H	W	D	LBS	FT ³
AB18LB	8286	6630	64	64	14.5	295	38

- Freestanding four high bookcase, four door storage lower centre with adjustable shelves, 48" open fixed upper shelf and 8" open fixed shelves either side
- Low base
- LP laminate back
- For wood back (Standard price + \$431)

AB19LB • 64"W Freestanding Bookcase

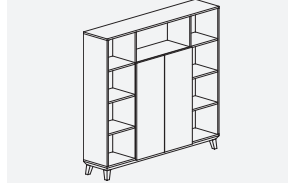

PRODUCT	PRICE		SIZE (INCHES)			WEIGHT VOL	
	STANDARD	LAMINATE	H	W	D	LBS	FT ³
AB19LB	7361	5888	64	64	14.5	275	38

- Freestanding four high bookcase, two door storage lower centre with adjustable shelves, 32" open fixed upper shelf and 16" open fixed shelves either side
- Low base
- LP laminate back
- For wood back (Standard price + \$431)

AB20LB • 64"W Freestanding Bookcase

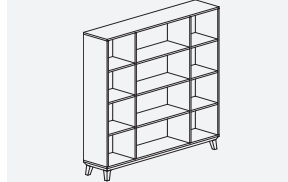

PRODUCT	PRICE		SIZE (INCHES)			WEIGHT VOL	
	STANDARD	LAMINATE	H	W	D	LBS	FT ³
AB20LB	6723	5380	64	64	14.5	251	38

- Freestanding four high bookcase, 32" open fixed shelves centre and 16" open fixed shelves either side
- Low base
- LP laminate back
- For wood back (Standard price + \$431)

ATV1LB • 50"H Freestanding Media Cabinet

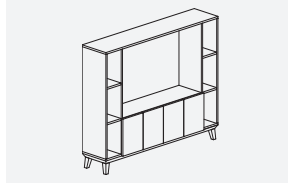

PRODUCT	PRICE		SIZE (INCHES)			WEIGHT VOL	
	STANDARD	LAMINATE	H	W	D	LBS	FT ³
ATV1LB	6306	5045	50	64	14.5	222	30

- Freestanding media cabinet, 48" wide two high opening can accommodate up to a 50" monitor, four door storage lower centre, 8" open fixed shelf either side.
- Monitor mount is optional. Please see **Accessories**
- Low base
- LP laminate back
- For wood back (Standard price + \$431)

AB9HB • 64”W Freestanding Bookcase



PRODUCT	PRICE		SIZE (INCHES)			WEIGHT VOL	
	STANDARD	LAMINATE	H	W	D	LBS	FT ³
AB9HB	4887	3910	42.75	64	14.5	182	26

- Freestanding two high bookcase, four door storage lower centre, 48” open fixed upper shelf and 8” open fixed shelves either side
- High base
- LP laminate back
- For wood back (Standard price + \$431)

AB10HB • 64”W Freestanding Bookcase



PRODUCT	PRICE		SIZE (INCHES)			WEIGHT VOL	
	STANDARD	LAMINATE	H	W	D	LBS	FT ³
AB10HB	4267	3414	42.75	64	14.5	167	26

- Freestanding two high bookcase, 32” open fixed shelf centre and 16” open fixed shelves either side
- High base
- LP laminate back
- For wood back (Standard price + \$431)

AB11HB • 64”W Freestanding Bookcase



PRODUCT	PRICE		SIZE (INCHES)			WEIGHT VOL	
	STANDARD	LAMINATE	H	W	D	LBS	FT ³
AB11HB	4524	3621	57	64	14.5	222	34

- Freestanding three high bookcase with two 24” open fixed shelves centre, 8” open fixed shelves either side
- High base
- LP laminate back
- For wood back (Standard price + \$431)

AB12HB • 64”W Freestanding Bookcase

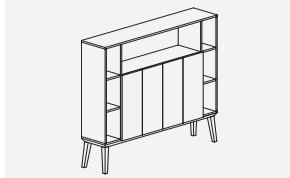

PRODUCT	PRICE		SIZE (INCHES)			WEIGHT VOL	
	STANDARD	LAMINATE	H	W	D	LBS	FT ³
AB12HB	6956	5567	57	64	14.5	242	34

- Freestanding three high bookcase, four door storage lower centre with adjustable shelves, 48” open fixed upper shelf and 8” open fixed shelves either side
- High base
- LP laminate back
- For wood back (Standard price + \$431)

AB13HB • 64”W Freestanding Bookcase



PRODUCT	PRICE		SIZE (INCHES)			WEIGHT VOL	
	STANDARD	LAMINATE	H	W	D	LBS	FT ³
AB13HB	6261	5012	57	64	14.5	228	34

- Freestanding three high bookcase, two door storage lower centre with adjustable shelf, 32” open fixed upper shelf and 16” open fixed shelves either side
- High base
- LP laminate back
- For wood back (Standard price + \$431)

AB14HB • 64”W Freestanding Bookcase



PRODUCT	PRICE		SIZE (INCHES)			WEIGHT VOL	
	STANDARD	LAMINATE	H	W	D	LBS	FT ³
AB14HB	5641	4512	57	64	14.5	212	34

- Freestanding three high bookcase, 32” open fixed shelves centre and 16” open fixed shelves either side
- High base
- LP laminate back
- For wood back (Standard price + \$431)

AB15HB • 64”W Freestanding Bookcase



PRODUCT	PRICE		SIZE (INCHES)			WEIGHT VOL	
	STANDARD	LAMINATE	H	W	D	LBS	FT ³
AB15HB	7448	5959	71.5	64	14.5	270	43

- Freestanding four high bookcase, two 24” open fixed shelves centre and 8” open fixed shelves either side
- High base
- LP laminate back
- For wood back (Standard price + \$431)

AB16HB • 64”W Freestanding Bookcase



PRODUCT	PRICE		SIZE (INCHES)			WEIGHT VOL	
	STANDARD	LAMINATE	H	W	D	LBS	FT ³
AB16HB	8431	6746	71.5	64	14.5	286	43

- Freestanding four high bookcase, four door storage lower centre with adjustable shelves, 48” open fixed upper shelves and 8” open fixed shelves either side
- High base
- LP laminate back
- For wood back (Standard price + \$431)

AB17HB • 64”W Freestanding Bookcase

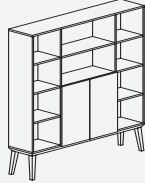

PRODUCT	PRICE		SIZE (INCHES)			WEIGHT VOL	
	STANDARD	LAMINATE	H	W	D	LBS	FT ³
AB17HB	7506	6005	71.5	64	14.5	272	43

- Freestanding four high bookcase, two door storage lower centre with adjustable shelf, 32” open fixed shelves upper and 16” open fixed shelves either side
- High base
- LP laminate back
- For wood back (Standard price + \$431)

AB18HB • 64”W Freestanding Bookcase

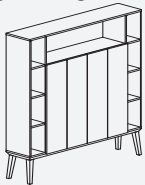

PRODUCT	PRICE		SIZE (INCHES)			WEIGHT VOL	
	STANDARD	LAMINATE	H	W	D	LBS	FT ³
AB18HB	8576	6861	71.5	64	14.5	300	43

- Freestanding four high bookcase, four door storage lower centre with adjustable shelves, 48” open fixed upper shelf and 8” open fixed shelves either side
- High base
- LP laminate back
- For wood back (Standard price + \$431)

AB19HB • 64”W Freestanding Bookcase

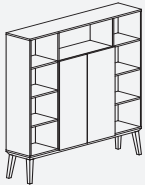

PRODUCT	PRICE		SIZE (INCHES)			WEIGHT VOL	
	STANDARD	LAMINATE	H	W	D	LBS	FT ³
AB19HB	7651	6120	71.5	64	14.5	280	43

- Freestanding four high bookcase, two door storage lower centre with adjustable shelves, 32” open fixed upper shelf and 16” open fixed shelves either side
- High base
- LP laminate back
- For wood back (Standard price + \$431)

AB20HB • 64”W Freestanding Bookcase



PRODUCT	PRICE		SIZE (INCHES)			WEIGHT VOL	
	STANDARD	LAMINATE	H	W	D	LBS	FT ³
AB20HB	7015	5613	71.5	64	14.5	256	43

- Freestanding four high bookcase, 32” open fixed shelves centre and 16” open fixed shelves either side
- High base
- LP laminate back
- For wood back (Standard price + \$431)

ATV1HB • 57”H Freestanding Media Cabinet



PRODUCT	PRICE		SIZE (INCHES)			WEIGHT VOL	
	STANDARD	LAMINATE	H	W	D	LBS	FT ³
ATV1HB	6594	5276	57	64	14.5	227	34

- Freestanding media cabinet, 48” wide two high openings can accommodate up to a 50” monitor, four door storage lower centre and 8” open fixed shelf either side.
- Monitor mount is optional. Please see **Accessories**.
- High base
- LP laminate back
- For wood back (Standard price + \$431)

64"W FREESTANDING DIVIDER BOOKCASES • TECHNICAL INFORMATION

- All Divider Bookcases are shipped assembled.
- Divider Bookcases are available in two base heights: 4" (xxLB = Low Base) or 11.5" (xxHB = High Base)
- Back Panels of the Divider Bookcases are made of LP solid colour laminate.
- Optional Wood Back Panel is available at an upcharge of \$1320. Add suffix "/W" at the end of the product code. (e.g. AB28LB/W)

FREESTANDING DIVIDER BOOKCASES • GUIDELINES FOR ORDERING PRODUCT

CODES: The price list uses a product coding system that is specific to each of the units. The product description (next to the code) explains in detail construction of the unit.

SPECIFICATION EXAMPLE OF A 64"W FREESTANDING DIVIDER BOOKCASE

PRODUCT CODE: AB22HB (/P for All Laminate or /W for All Wood Finish)
 A = Corby Series and B = Bookcase
 22 = Product ID number (Freestanding Divider Bookcase 72"H x 64"W x 15"D)
 HB = High Base

CHOOSE FINISH OPTION:

Standard Finish: Veneer chassis with matching hardwood legs, LP laminate back panel. Please see page A.18

Laminate Finish: Please add "/P" to the end of the product code, includes LP laminate chassis and back panel with painted hardwood legs. Please see page A.18

Veneer Back: For matching veneer cabinet back please add "/W" to the end of the product code + \$1320 list to the standard price. Please see page A.18



AB22LB • 64"W Freestanding Divider Bookcase



PRODUCT	PRICE		SIZE (INCHES)			WEIGHT VOL	
	STANDARD	LAMINATE	H	W	D	LBS	FT ³
AB22LB	7840	6272	64	64	15	265	38

- Freestanding four high divider bookcase with fixed shelves
- Low base
- LP laminate back

AB23LB • 64"W Freestanding Divider Bookcase



PRODUCT	PRICE		SIZE (INCHES)			WEIGHT VOL	
	STANDARD	LAMINATE	H	W	D	LBS	FT ³
AB23LB	7840	6272	64	64	15	265	38

- Freestanding four high divider bookcase with fixed shelves
- Low base
- LP laminate back

AB24LB • 64"W Freestanding Divider Book-



PRODUCT	PRICE		SIZE (INCHES)			WEIGHT VOL	
	STANDARD	LAMINATE	H	W	D	LBS	FT ³
AB24LB	7840	6272	64	64	15	265	38

- Freestanding four high divider bookcase with fixed shelves
- Low base
- LP laminate back

AB25LB • 64"W Freestanding Divider Bookcase



PRODUCT	PRICE		SIZE (INCHES)			WEIGHT VOL	
	STANDARD	LAMINATE	H	W	D	LBS	FT ³
AB25LB	7840	6272	64	64	15	265	38

- Freestanding four high divider bookcase with fixed shelves
- Low base
- LP laminate back

AB26LB • 64" W Freestanding Divider Bookcase



PRODUCT	PRICE		SIZE (INCHES)			WEIGHT VOL	
	STANDARD	LAMINATE	H	W	D	LBS	FT ³
AB26LB	5861	4689	49	64	15	217	30

- Freestanding three high divider bookcase with fixed shelves
- Low base
- LP laminate back

AB27LB • 64" W Freestanding Divider Bookcase



PRODUCT	PRICE		SIZE (INCHES)			WEIGHT VOL	
	STANDARD	LAMINATE	H	W	D	LBS	FT ³
AB27LB	5861	4689	49	64	15	217	30

- Freestanding three high divider bookcase with fixed shelves
- Low base
- LP laminate back

AB28LB • 64" W Freestanding Divider Book-



PRODUCT	PRICE		SIZE (INCHES)			WEIGHT VOL	
	STANDARD	LAMINATE	H	W	D	LBS	FT ³
AB28LB	4928	3943	35	64	15	162	21

- Freestanding two high divider bookcase with fixed shelves
- Low base
- LP laminate back

AB29LB • 64" W Freestanding Divider Bookcase



PRODUCT	PRICE		SIZE (INCHES)			WEIGHT VOL	
	STANDARD	LAMINATE	H	W	D	LBS	FT ³
AB29LB	4928	3943	35	64	15	162	21

- Freestanding two high divider bookcase with fixed shelves
- Low base
- LP laminate back

AB22HB • 64" W Freestanding Divider Bookcase



PRODUCT	PRICE		SIZE (INCHES)			WEIGHT VOL	
	STANDARD	LAMINATE	H	W	D	LBS	FT ³
AB22HB	8157	6525	72	64	15	270	43

- Freestanding four high divider bookcase with fixed shelves
- High base
- LP laminate back

AB23HB • 64" W Freestanding Divider Bookcase



PRODUCT	PRICE		SIZE (INCHES)			WEIGHT VOL	
	STANDARD	LAMINATE	H	W	D	LBS	FT ³
AB23HB	8157	6525	72	64	15	270	43

- Freestanding four high divider bookcase with fixed shelves
- High base
- LP laminate back

AB24HB • 64" W Freestanding Divider Bookcase



PRODUCT	PRICE		SIZE (INCHES)			WEIGHT VOL	
	STANDARD	LAMINATE	H	W	D	LBS	FT ³
AB24HB	8157	6525	72	64	15	270	43

- Freestanding four high divider bookcase with fixed shelves
- High base
- LP laminate back

AB25HB • 64”W Freestanding Divider Book-



PRODUCT	PRICE		SIZE (INCHES)			WEIGHT VOL	
	STANDARD	LAMINATE	H	W	D	LBS	FT ³
AB25HB	8157	6525	72	64	15	270	43

- Freestanding four high divider bookcase with fixed shelves
- High base
- LP laminate back

AB26HB • 64”W Freestanding Divider Book-



PRODUCT	PRICE		SIZE (INCHES)			WEIGHT VOL	
	STANDARD	LAMINATE	H	W	D	LBS	FT ³
AB26HB	6178	4942	57	64	15	222	34

- Freestanding three high divider bookcase with fixed shelves
- High base
- LP laminate back

AB27HB • 64”W Freestanding Divider Bookcase

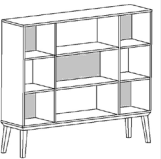

PRODUCT	PRICE		SIZE (INCHES)			WEIGHT VOL	
	STANDARD	LAMINATE	H	W	D	LBS	FT ³
AB27HB	6178	4942	57	64	15	222	34

- Freestanding three high divider bookcase with fixed shelves
- High base
- LP laminate back

AB28HB • 64”W Freestanding Divider Bookcase



PRODUCT	PRICE		SIZE (INCHES)			WEIGHT VOL	
	STANDARD	LAMINATE	H	W	D	LBS	FT ³
AB28HB	5085	4068	43	64	15	167	26

- Freestanding two high divider bookcase with fixed shelves
- High base
- LP laminate back

AB29HB • 64”W Freestanding Divider Bookcase



PRODUCT	PRICE		SIZE (INCHES)			WEIGHT VOL	
	STANDARD	LAMINATE	H	W	D	LBS	FT ³
AB29HB	5085	4068	43	64	15	167	26

- Freestanding two high divider bookcase with fixed shelves
- High base
- LP laminate back

Table Tops 120" and over
(2 Sections, 6 Legs)

Table Tops up to 96"
(1 Section, 6 Legs)

CONFERENCE ROOM TABLES • GUIDELINES FOR ORDERING PRODUCT

CODES: The price list uses a numbering system with meaningful alphanumeric characters to create a simple-to-understand product number. This makes specifying the product easy and accurate.

NOTE: Arrow indicates direction of grain.

SPECIFICATION EXAMPLE OF A CONFERENCE ROOM TABLE

PRODUCT CODE: ART9632
A = Corby Series
R = Rectangular Conference Table Top
96" X 32" = Size: Width x Depth
Up to 96" = Size: Width (One Section Top)



PRODUCT CODE: ART12032
A = Corby Series
R = Rectangular Conference Table Top
120" X 32" = Size: Width x Depth
120" and over = Size: Width (Two Section Top)



FINISH: Choose Finish

ART • 32" W MAP - CONFERENCE TABLE RECTANGULAR SHAPE



PRODUCT	PRICE		SIZE (INCHES)			WEIGHT VOL		
	STANDARD	LAMINATE	H	W	D	LBS	FT ³	
ART9632	12671	10136	29	32	96	183	15	• Conference Table with 6 Legs
ART12032	13750	11000	29	32	120	212	17	• 2 Sections Conference Table with 6 Legs
ART14432	14649	11719	29	32	144	268	19	• 2 Sections Conference Table with 6 Legs
ART16832	15728	12581	29	32	168	296	21	• 2 Sections Conference Table with 6 Legs



ART • 42" W MAP - CONFERENCE TABLE RECTANGULAR SHAPE



PRODUCT	PRICE		SIZE (INCHES)			WEIGHT VOL		
	STANDARD	LAMINATE	H	W	D	LBS	FT ³	
ART9642	13930	11144	29	42	96	219	19	• Conference Table with 6 Legs
ART12042	15188	12150	29	42	120	260	21	• 2 Sections Conference Table with 6 Legs
ART14442	16446	13158	29	42	144	324	25	• 2 Sections Conference Table with 6 Legs
ART16842	17705	14164	29	42	168	360	27	• 2 Sections Conference Table with 6 Legs



ART • 48" W MAP - CONFERENCE TABLE RECTANGULAR SHAPE



PRODUCT	PRICE		SIZE (INCHES)			WEIGHT VOL		
	STANDARD	LAMINATE	H	W	D	LBS	FT ³	
ART9648	14648	11719	29	48	96	240	21	• Conference Table with 6 Legs
ART12048	16089	12869	29	48	120	284	24	• 2 Sections Conference Table with 6 Legs
ART14448	17526	14021	29	48	144	356	28	• 2 Sections Conference Table with 6 Legs
ART16848	18966	15173	29	48	168	400	30	• 2 Sections Conference Table with 6 Legs



ASPBOX • Riser box

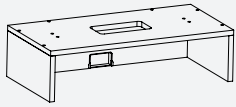

PRODUCT	PRICE		SIZE (INCHES)			WEIGHT VOL	
	STANDARD	LAMINATE	H	W	D	LBS	FT ³
ASPBOX2814	302	242	7.5	28	14	14	3
ASPBOX2014	271	218	7.5	20	14	10	2

- 28"W Riser Box for 20"H storage to support Peninsula Table & 32" deep Bridge Top
- 20"W Riser Box for 20"H storage to support 24" deep Bridge Top

ACMP • 22"H Hanging wood modesty panel

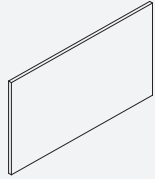

PRODUCT	PRICE		SIZE (INCHES)			WEIGHT VOL	
	STANDARD	LAMINATE	H	W	D	LBS	FT ³
ACMPW38H22	609	487	22	38	0.75	20	2
ACMPW44H22	666	533	22	44	0.75	22	2
ACMPW50H22	722	578	22	50	0.75	24	3
ACMPW56H22	768	614	22	56	0.75	26	3
ACMPW62H22	823	658	22	62	0.75	28	3

- 22" Hanging Wood Modesty Panel
- For selection of the hanging wood modesty panel, please see pages A.5 - A.6 for details.

ACMP • 15"H Hanging wood modesty panel

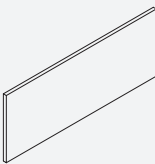

PRODUCT	PRICE		SIZE (INCHES)			WEIGHT VOL	
	STANDARD	LAMINATE	H	W	D	LBS	FT ³
ACMPW38H15	577	461	15	38	0.75	15	2
ACMPW44H15	633	507	15	44	0.75	17	2
ACMPW50H15	692	554	15	50	0.75	18	2
ACMPW56H15	737	589	15	56	0.75	20	2
ACMPW62H15	792	633	15	62	0.75	21	2
ACMPW68H15	870	696	15	68	0.75	23	3
ACMPW74H15	945	754	15	74	0.75	24	3

- 15" Hanging Wood Modesty Panel
- For selection of the hanging wood modesty panel, please see pages A.5 - A.6 for details.

ACU3214 • Cushion

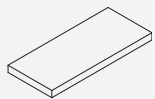

PRODUCT	PRICE		SIZE (INCHES)			WEIGHT VOL	
	STANDARD	LAMINATE	H	W	D	LBS	FT ³
ACU3214	941		2	32	14		

- Cushion - Grade 2 seating fabrics. Please refer to the following website for the current offering: <https://www.globalfurnituregroup.com/ca/resources/textiles>

FVMED + GM1K • Flat screen monitor mount with round grommet

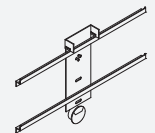

PRODUCT	PRICE		SIZE (INCHES)			WEIGHT VOL	
	STANDARD	LAMINATE	H	W	D	LBS	FT ³
FVMED+GM1K	486		17	28	2	14	0.7

- Flat screen monitor mount up to 50"
- To be used on Media Cabinets (ATV1LB & ATV1HB)
- GM1K (Tungsten) grommet on the back panel is included.

GM5C • Rectangular grommet

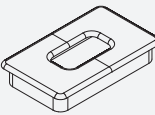

PRODUCT	PRICE		SIZE (INCHES)			WEIGHT VOL	
	STANDARD	LAMINATE	H	W	D	LBS	FT ³
GM5C	91			3.5	2		

- Rectangular grommet - metal, chrome finish

DSRTMCS401 • Recessed Power Block



PRODUCT	PRICE		SIZE (INCHES)			WEIGHT VOL	
	STANDARD	LAMINATE	H	W	D	LBS	FT ³
DSRTMCS401B	578		4.86	10.78	4.22	4.3	.51
DSRTMCS401T	578		4.86	10.78	4.22	4.3	.51
DSRTMCS401W	578		4.86	10.78	4.22	4.3	.51

NOTE: Cutout for each Recessed power block is available at an upcharge \$91.

- Single sided recessed power block with 1 regular duplex and 1 data knock-out on top, 1 power duplex on bottom. 10 ft power cord with straight plug.
- Telecom plates ordered separately.
- Available in Black - B, Tungsten - T or Designer White - W.

DSRTMCS421 • Recessed Power Block



PRODUCT	PRICE	SIZE (INCHES)			WEIGHT	VOL
		H	W	D		
DSRTMCS421B	759	4.86	10.78	4.22	4.5	.51
DSRTMCS421T	759	4.86	10.78	4.22	4.5	.51
DSRTMCS421W	759	4.86	10.78	4.22	4.5	.51

NOTE: Cutout for each Recessed power block is available at an upcharge \$91.

- Single sided recessed power block with 1 power & USB A+C duplex and 1 data knock-out on top, 1 power duplex on bottom. USB Type A port charges max 2.4 amps at 5V and Type C port charges max 3 amps at 5V. 10 ft power cord with straight plug.
- Telecom plates ordered separately.
- Available in Black - B, Tungsten - T or

DSRTMCD602 • Recessed Power Block



PRODUCT	PRICE	SIZE (INCHES)			WEIGHT	VOL
		H	W	D		
DSRTMCD602B	660	4.86	10.78	6.22	5.9	.51
DSRTMCD602T	660	4.86	10.78	6.22	5.9	.51
DSRTMCD602W	660	4.86	10.78	6.22	5.9	.51

NOTE: Cutout for each Recessed power block is available at an upcharge \$91.

- Double sided recessed power block with 2 regular power duplexes and 2 data knock-outs on top, 1 power duplex on bottom. USB Type A port charges max 2.4 amps at 5V and Type C port charges max 3 amps at 5V. 10 ft power cord with straight plug.
- Telecom plates ordered separately.
- Available in Black - B, Tungsten - T or Designer White - W.

DSRTMCD622 • Recessed Power Block



PRODUCT	PRICE	SIZE (INCHES)			WEIGHT	VOL
		H	W	D		
DSRTMCD622B	831	4.86	10.78	6.22	6.1	.51
DSRTMCD622T	831	4.86	10.78	6.22	6.1	.51
DSRTMCD622W	831	4.86	10.78	6.22	6.1	.51

NOTE: Cutout for each Recessed power block is available at an upcharge \$91.

- Double sided recessed power block with 1 regular power duplex, 1 power & USB A+C duplex and 2 data knock-outs on top, 1 power duplex on bottom. USB Type A port charges max 2.4 amps at 5V and Type C port charges max 3 amps at 5V. 10 ft power cord with straight plug.
- Telecom plates ordered separately.
- Available in Black - B, Tungsten - T or Designer White - W.

DSRTMCD642 • Recessed Power Block



PRODUCT	PRICE	SIZE (INCHES)			WEIGHT	VOL
		H	W	D		
DSRTMCD642B	1001	4.86	10.78	6.22	6.3	.51
DSRTMCD642T	1001	4.86	10.78	6.22	6.3	.51
DSRTMCD642W	1001	4.86	10.78	6.22	6.3	.51

NOTE: Cutout for each Recessed power block is available at an upcharge \$91.

- Double sided recessed power block with 2 power & USB A+C duplexes and 2 data knock-outs on top, 1 power duplex on bottom. USB Type A port charges max 2.4 amps at 5V and Type C port charges max 3 amps at 5V. 10 ft power cord with straight plug
- Telecom plates ordered separately.
- Available in Black - B, Tungsten - T or Designer White - W.

ABLBB • Telcom Plate

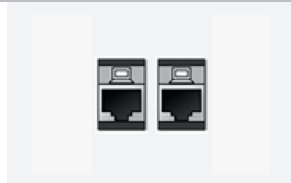

PRODUCT	PRICE	SIZE (INCHES)			WEIGHT	VOL
		H	W	D		
ABLBB	319					

- Black telcom plate with two RJ45 cat 6 data

ABLBBB • Telcom Plate



PRODUCT	PRICE	SIZE (INCHES)			WEIGHT	VOL
		H	W	D		
ABLBBB	578					

- Black telcom plate with four RJ45 cat 6 data

ABLABC514 • Telcom Plate

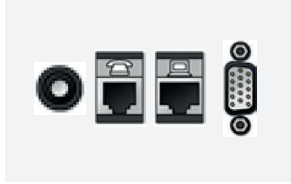

PRODUCT	PRICE	SIZE (INCHES)			WEIGHT LBS	VOL FT ³
		H	W	D		
ABLABC514	470					

- Black telcom plate with one RJ11 cat 3 phone, one RJ45 cat 6 data, one mini stereo and 15 pin HD VGA

ABLC51L • Telcom Plate



PRODUCT	PRICE	SIZE (INCHES)			WEIGHT LBS	VOL FT ³
		H	W	D		
ABLC51L	672					

- Black telcom plate with one mini stereo, one 15 pin HD VGA and one HDMI

ABLABC45 • Telcom Plate



PRODUCT	PRICE	SIZE (INCHES)			WEIGHT LBS	VOL FT ³
		H	W	D		
ABLABC45	524					

- Black telcom plate with one RJ11 cat 3 phone, one RJ45 cat 6 data and one HDMI

ABL102102 • Telcom Plate

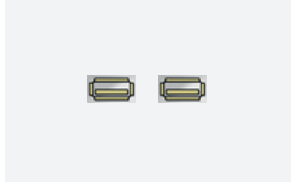

PRODUCT	PRICE	SIZE (INCHES)			WEIGHT LBS	VOL FT ³
		H	W	D		
ABL102102	275					

- Black telcom plate with two USB

BTC003 • Vault Desk Power Grommet

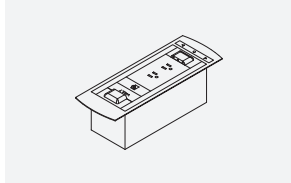

PRODUCT	PRICE	SIZE (INCHES)			WEIGHT LBS	VOL FT ³
		H	W	D		
BTC003	1762	4	12	4.5		

- Includes 2 Power, 1 Data
- Jacks are not interchangeable
- Motorized touch control rotates top to reveal or conceal data/power connections
- 5' cord with 3 prong plug, anodized only

BRTCS • Wire Management Snake

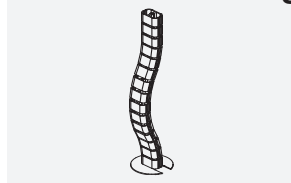

PRODUCT	PRICE	SIZE (INCHES)			WEIGHT LBS	VOL FT ³
		H	W	D		
BRTCS	254	39	2	2	2	0.5

- Black finish wire management

C2M • Wire Management Track

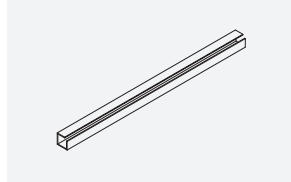

PRODUCT	PRICE	SIZE (INCHES)			WEIGHT LBS	VOL FT ³
		H	W	D		
C2M12	19	2	12	2	0.3	1
C2M24	35	2	24	2	0.6	1
C2M36	51	2	36	2	0.9	1
C2M48	67	2	48	2	1.2	1
C2M60	85	2	60	2	1.5	1
C2M72	101	2	72	2	1.8	1

- Black finish

COBAR526 • L Bracket (Sets)

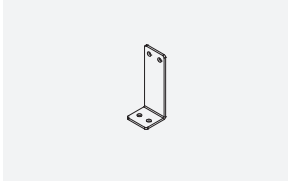

PRODUCT	PRICE	SIZE (INCHES)			WEIGHT	VOL
		STANDARD	H	W		
COBAR526	63					

- Set of two
- Used for securing the stack-on units to the credenza

FRC • Foot Rest Cover (Sets)

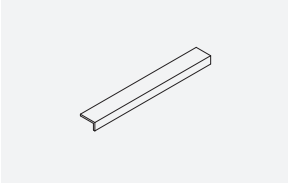

PRODUCT	PRICE	SIZE (INCHES)			WEIGHT	VOL
		STANDARD	H	W		
FRC6632	411					
FRC7232	443					
FRC7832	475					
FRC8432	506					
FRC6642	475					
FRC7242	506					
FRC7842	538					
FRC8442	569					

- Foot rest covers are factory installed (Only in Brushed Chrome Finish)
- For ARTC6632
- For ARTC7232
- For ARTC7832
- For ARTC8432
- For ARTC6642
- For ARTC7242
- For ARTC7842
- For ARTC8442

LO/C • Lock Assembly - Tungsten

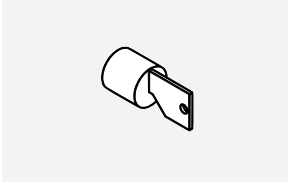

PRODUCT	PRICE	SIZE (INCHES)			WEIGHT	VOL
		STANDARD	H	W		
LO/C (Tungsten)	118					

LOB/C • Lock Drum with Key - Tungsten

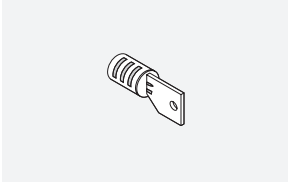

PRODUCT	PRICE	SIZE (INCHES)			WEIGHT	VOL
		STANDARD	H	W		
LOB/C	19					

LOCK/C • Lock Key

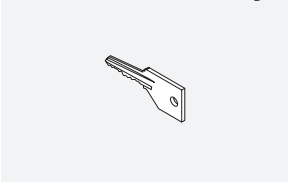

PRODUCT	PRICE	SIZE (INCHES)			WEIGHT	VOL
		STANDARD	H	W		
LOCK/C	13					

PL89 • Handle

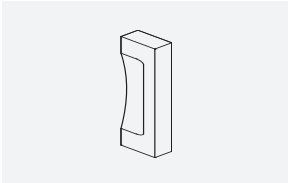

PRODUCT	PRICE	SIZE (INCHES)			WEIGHT	VOL
		STANDARD	H	W		
PL89	51					

- Metal, Chrome finish

HOOK400 • Coat Hook

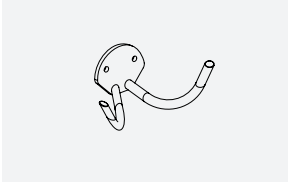

PRODUCT	PRICE	SIZE (INCHES)			WEIGHT	VOL
		STANDARD	H	W		
HOOK400	24					

- Metal, Nickel finish