

**Technical Information - Tables**

**Common**

- Tables up to and including 96" long are manufactured in one piece, 108" to 168" long are manufactured in two pieces and over 192" are manufactured in three pieces. If wood grain laminate or wood veneer is chosen, the wood grain may not line up for any tables longer than 10 feet.
- Tables in 2 or 3 pieces will have the joining edge finished, hardware will be shipped for assembly.
- Grommet locations must be specified at the time of order or it will default to "no grommet" option.
- Tables are pre-drilled with factory installed inserts for easy metal to metal base connection.

**Edge Options B & W**

- "LKD" Rectangular shape tables with edge B and W have 1" radius at each corner. For tables with square corners, please add "NR" at the end of the product code, no upcharge required.
- The "NR" option is available only with the B and W edge profiles.
- All table surfaces are High Pressure Laminate in "B" (1 1/16") or "W" (1 7/16") thickness.

**Edge Options KL/FV/KV**

- LKD" Rectangular shape tables have 90 degree corners. There is no radius corner option.
- All table surfaces are 1 3/16" thickness.
- KL is a high pressure laminate top with 3mm perimeter PVC edging with a 2" undercut knife profile.
- FV is a veneer top with a flat 3mm perimeter hardwood edge.
- KV is a veneer top with 3mm perimeter hardwood edge with a 2" undercut knife profile.

**Tables • Guidelines For Ordering Product**

**CODES:** The price list uses a numbering system with meaningful alphanumeric characters to create a simple-to-understand product number. This makes specifying the product much easier and more accurate.

**SPECIFICATION EXAMPLE OF A TABLE UNIT**

**PRODUCT CODE:**

LKD3636  
 L = Licence  
 KD = Kadin Tables  
 3636 = Size: Depth x Width

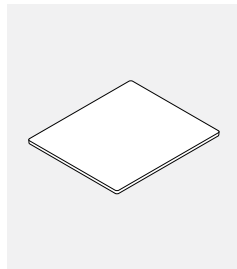

**Edge Options:**

"B" Edges	"W" Edges	"KL" Edges	"FV" Edges	"KV" Edges
Laminate surface with PVC edge	Laminate surface with PVC edge	Laminate surface with PVC edge	Veneer surface with Hardwood edge	Veneer surface with Hardwood edge
HP (B) 1.062" Thickness	HP (W) 1.437" Thickness	HP (KL) 1.187" Thickness	(FV) 1.187" Thickness	(KV) 1.187" Thickness
B	W	KL	FV	KV

**LKD Grommet locations**

**Square Table (TC Grommet Only)**

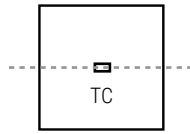

- LKD3636 accepts BG5.
- LKD4242, LKD4848, LKD5454 and LKD6060 accept all grommets and modules.

**Round Table (TC Grommet Only)**

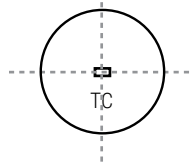

- LKD36DIA accepts BG5.
- LKD42DIA, LKD48DIA, LKD54DIA and LKD60DIA accept BG5 and MSPDM.

**Rectangular Table**

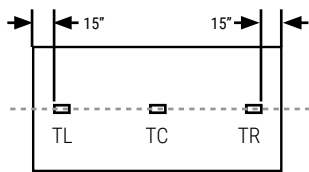

**TC GROMMET ONLY**

- LKD3648
- LKD3654
- LKD4248
- LKD4254
- LKD4854

**ONE GROMMET CHOICE ONLY - TL, TC OR TR**

- LKD3660, LKD3666, LKD3672
- LKD4260, LKD4266, LKD4272

(Accept BG5, MSPDM, GCRTMCS401, GCRTMCS421)

**UP TO 3 GROMMETS IN TL, TC AND/OR TR**

- LKD3678, LKD3684, LKD3696
- LKD4278, LKD4284, LKD4296
- LKD4878, LKD4884, LKD4896

**Rectangular Table, 2 Piece Top**

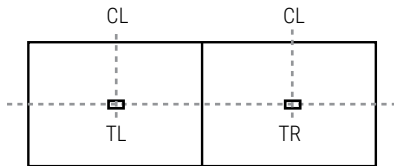

**UP TO 2 GROMMETS IN TL, AND/OR TR**

- LKD
- All sizes

**Rectangular Table, 3 Piece Top**

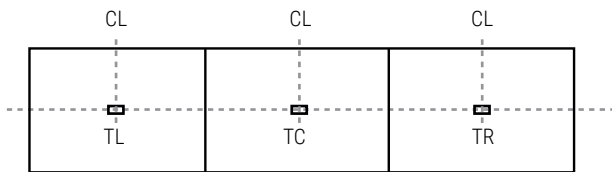

**UP TO 3 GROMMETS IN TL, TC AND/OR TR**

- LKD
- All sizes

Note: Grommet orientation follows the length of table.

**ModPower Power Solution**

- Power solutions for flexible spaces. Connect up to four units (in Canada)/six units in the USA from a single infeed with NEMA plug to deliver power and charging ports to the table top. In-surface modules and clamp on modules available.
- Easy to install; code compliant that allows users to optimize any space providing convenient power access. Perfect for training areas, meeting rooms, in-office workstations and more. Units feature tamper-resistant receptacles as well as both USB-A and USB-C charging ports.
- Easy to use connectors that are touch-safe with added latch to prevent unintended separation. Easy push together to connect, and simple press down on latch to disconnect.
- Maximum overall length not to exceed 48.5 feet per infeed. UL listed to UL962A SD, the standard for furniture power distribution units for portable/moveable work space tables.
- Certified to CSA standard C22.2 No. 203-16.
- Will work with Licence, Terina and Bridges Products.

- Surface mounted module ships with a clamp mount that will accommodate any material 1/2" to 1-1/2" thick; additional brackets are also included for screw in mounting options that can accommodate vertical or horizontal positions.
- Modules can be integrated into surfaces but the surface must be specified as a special.

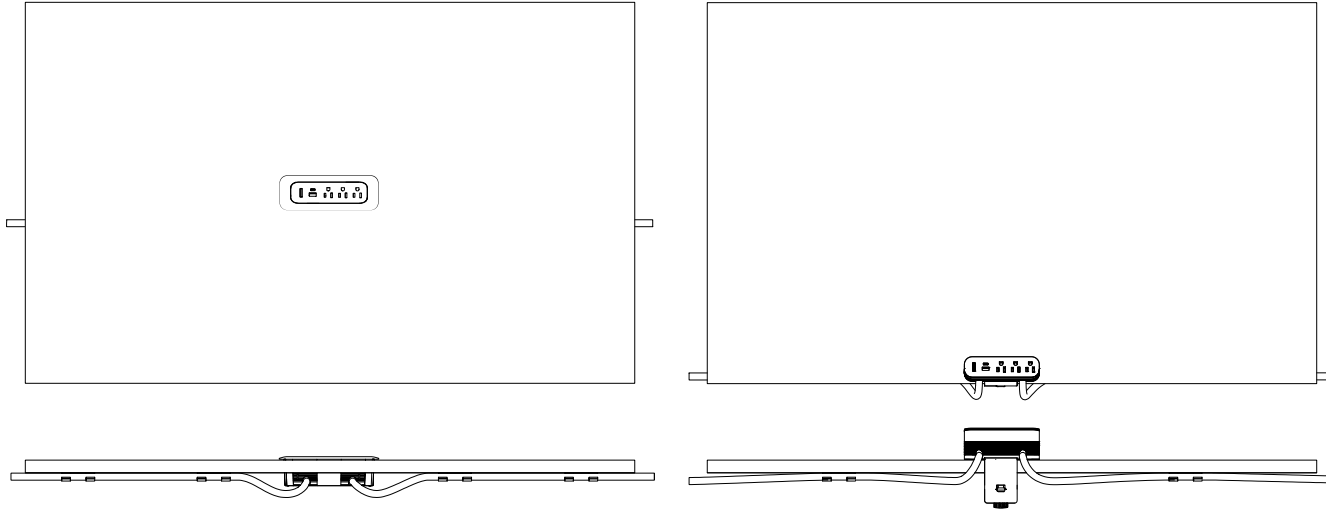
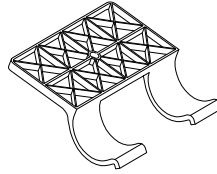

**GMDSF10 • ModPower In Surface Starter Unit**

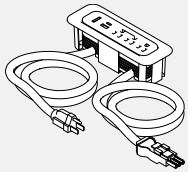

- ModPower starter unit includes one 10' cord with a NEMA plug and one 3' connector cord.
- Unit equipped with three 15A tamper resistant receptacles, one USB-A and one USB-C charging ports and a circuit breaker.
- 4 cable management cord clips included.
- MG at the end of the code indicates a magnesium finish, while WH is a white finish.

PRODUCT CODE	PRICE	DIMENSIONS			WEIGHT		VOL FT <sup>3</sup>
		H	W	D	LBS	FT <sup>3</sup>	
GMDSF10MG	597	2.63	7.63	2.63	3.44	1.0	
GMDSF10WH	597	2.63	7.63	2.63	3.44	1.0	

**GMDCF3 • ModPower In Surface Middle Unit**

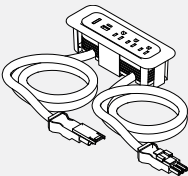

- ModPower middle unit includes two 3' connector cords.
- Unit equipped with three 15A rated 12A tamper resistant receptacles, one USB-A and one USB-C charging ports and a circuit breaker.
- 4 cable management cord clips included.
- MG at the end of the code indicates a magnesium finish, while WH is a white finish.

PRODUCT CODE	PRICE	DIMENSIONS			WEIGHT		VOL FT <sup>3</sup>
		H	W	D	LBS	FT <sup>3</sup>	
GMDCF3MG	562	2.63	7.63	2.63	2.44	1.0	
GMDCF3WH	562	2.63	7.63	2.63	2.44	1.0	

**GMDEF3 • ModPower In Surface End Unit**

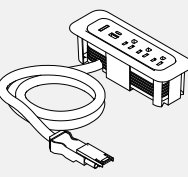

- ModPower end unit includes one 3' connector cord.
- Unit equipped with three 15A rated 12A tamper resistant receptacles, one USB-A and one USB-C charging ports and a circuit breaker.
- 2 cable management cord clips included.
- MG at the end of the code indicates a magnesium finish, while WH is a white finish.

PRODUCT CODE	PRICE	DIMENSIONS			WEIGHT		VOL FT <sup>3</sup>
		H	W	D	LBS	FT <sup>3</sup>	
GMDEF3MG	494	2.63	7.63	2.63	1.85	1.0	
GMDEF3WH	494	2.63	7.63	2.63	1.85	1.0	

**GMDSA10 • ModPower Starter Mounted Unit**

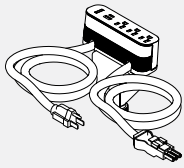

- ModPower starter unit includes one 10' cord with a NEMA plug and one 3' connector cord.
- Unit equipped with three 15A tamper resistant receptacles, one USB-A and one USB-C charging ports and a circuit breaker.
- Includes edge clamp and 3 other mounting methods; and 4 cable management cord clips.
- MG at the end of the code indicates a magnesium finish, while WH is a white finish.

PRODUCT CODE	PRICE	PRICE			WEIGHT		VOL FT <sup>3</sup>
		H	W	D	LBS		
GMDSA10MG	631	2.5	6.13	1.75	4.33	1.0	
GMDSA10WH	631	2.5	6.13	1.75	4.33	1.0	

**GMDCA3 • ModPower Middle Mounted Unit**

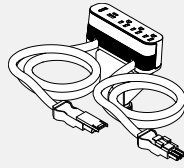

- ModPower middle unit includes two 3' connector cords.
- Unit equipped with three 15A rated 12A tamper resistant receptacles, one USB-A and one USB-C charging ports and a circuit breaker.
- Includes edge clamp and 3 other mounting methods; and 4 cable management cord clips.
- MG at the end of the code indicates a magnesium finish, while WH is a white finish.

PRODUCT CODE	PRICE	PRICE			WEIGHT		VOL FT <sup>3</sup>
		H	W	D	LBS		
GMDCA3MG	597	2.5	6.13	1.75	3.33	1.0	
GMDCA3WH	597	2.5	6.13	1.75	3.33	1.0	

**GMDEA3 • ModPower End Mounted Unit**

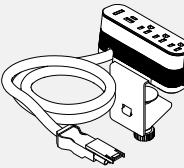

- ModPower end unit includes one 3' connector cord.
- Unit equipped with three 15A rated 12A tamper resistant receptacles, one USB-A and one USB-C charging ports and a circuit breaker.
- Includes edge clamp and 3 other mounting methods; and 2 cable management cord clips.
- MG at the end of the code indicates a magnesium finish, while WH is a white finish.

PRODUCT CODE	PRICE	PRICE			WEIGHT		VOL FT <sup>3</sup>
		H	W	D	LBS		
GMDEA3MG	528	2.5	6.13	1.75	2.75	1.0	
GMDEA3WH	528	2.5	6.13	1.75	2.75	1.0	

**GMDCLIPS • ModPower Management Clips**

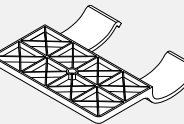

- Includes 10 clips.

PRODUCT CODE	PRICE	PRICE			WEIGHT		VOL FT <sup>3</sup>
		H	W	D	LBS		
GMDCLIPS	102	0.6	2.6	2.5	0.3	0.2	

**GMDJ36BK • ModPower Interconnecting Jumper**

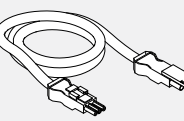

- ModPower interconnecting jumper cord to add an additional 3 feet of cord length between ModPower units.
- Package of 2, each 3 feet with male & female connector.

PRODUCT CODE	PRICE	PRICE			WEIGHT		VOL FT <sup>3</sup>
		H	W	D	LBS		
GMDJ36BK	329		36		1.38	0.9	

**LKD • Square Table**



- Leg finish option, chrome or paint.
- Beam finish, paint only.

PRODUCT CODE	PRICE					SIZE/INCHES				WEIGHT LBS	VOL FT <sup>3</sup>
	B	W	KL	FV	KV	H(B)	H(W)	W	D		
LKD3636	1158	1300	1443	1645	1702	29	29.5	36	36	73	4
LKD4242	1323	1459	1685	1960	2039	29	29.5	42	42	86	4
LKD4848	1553	1717	1960	2320	2424	29	29.5	48	48	107	5
LKD5454	1712	1911	2357	2812	2944	29	29.5	54	54	120	5
LKD6060	1886	2123	2702	3262	3427	29	29.5	60	60	135	6

**LKD • Round Table**

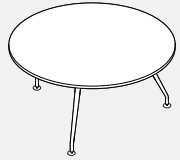

- Leg finish option, chrome or paint.
- Beam finish, paint only.

PRODUCT CODE	PRICE					SIZE/INCHES				WEIGHT LBS	VOL FT <sup>3</sup>
	B	W	KL	FV	KV	H(B)	H(W)	W	D		
LKD36DIA	934	1079	1224	1477	1548	29	29.5	36	36	66	3
LKD42DIA	1098	1235	1518	1859	1956	29	29.5	42	42	78	3
LKD48DIA	1305	1476	1847	2291	2422	29	29.5	48	48	99	4
LKD54DIA	1463	1667	2271	2832	2996	29	29.5	54	54	111	4
LKD60DIA	1635	1882	2685	3387	3584	29	29.5	60	60	126	5

**LKD4 • Round Table with 4 Legs**



- Leg finish option, chrome or paint.
- Beam finish, paint only.

PRODUCT CODE	PRICE					SIZE/INCHES				WEIGHT LBS	VOL FT <sup>3</sup>
	B	W	KL	FV	KV	H(B)	H(W)	W	D		
LKD436DIA	1158	1300	1363	1613	1686	29	29.5	36	36	66	3
LKD442DIA	1323	1459	1663	2006	2101	29	29.5	42	42	78	3
LKD448DIA	1553	1717	2021	2465	2598	29	29.5	48	48	99	4
LKD454DIA	1712	1911	2405	2968	3129	29	29.5	54	54	111	4
LKD460DIA	1886	2123	2836	3537	3735	29	29.5	60	60	126	5

**LKD • Rectangular Table**

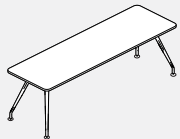

- Leg finish option, chrome or paint.
- Beam finish, paint only.

PRODUCT CODE	PRICE					SIZE/INCHES				WEIGHT LBS	VOL FT <sup>3</sup>
	B	W	KL	FV	KV	H(B)	H(W)	W	D		
LKD3648	1370	1514	1667	1938	2015	29	29.5	48	36	75	4
LKD3654	1429	1589	1823	2125	2214	29	29.5	54	36	81	4
LKD3660	1491	1667	1933	2273	2370	29	29.5	60	36	88	5
LKD3666	1553	1746	2047	2419	2525	29	29.5	66	36	95	5
LKD3672	1612	1821	2157	2562	2681	29	29.5	72	36	101	5
LKD3678	1673	1895	2268	2708	2839	29	29.5	78	36	105	5
LKD3684	1736	1973	2382	2854	2991	29	29.5	84	36	108	5
LKD3696	1858	2126	2604	3146	3301	29	29.5	96	36	115	6
LKD4248	1468	1610	1815	2128	2221	29	29.5	48	42	87	4
LKD4254	1540	1696	1985	2339	2443	29	29.5	54	42	90	5
LKD4260	1611	1783	2115	2507	2624	29	29.5	60	42	94	5
LKD4266	1685	1870	2245	2679	2803	29	29.5	66	42	101	5
LKD4272	1755	1955	2373	2846	2984	29	29.5	72	42	106	5
LKD4278	1829	2042	2502	3014	3163	29	29.5	78	42	110	6
LKD4284	1898	2128	2631	3185	3343	29	29.5	84	42	113	6
LKD4296	2043	2301	2890	3520	3703	29	29.5	96	42	129	6
LKD4854	1671	1845	2150	2556	2671	29	29.5	54	48	94	5
LKD4860	1751	1943	2296	2745	2876	29	29.5	60	48	99	5
LKD4866	1832	2037	2442	2936	3079	29	29.5	66	48	107	6
LKD4872	1913	2133	2587	3128	3285	29	29.5	72	48	114	6
LKD4878	1992	2230	2736	3321	3491	29	29.5	78	48	120	6
LKD4884	2074	2326	2881	3511	3695	29	29.5	84	48	125	6
LKD4896	2233	2519	3175	3896	4103	29	29.5	96	48	149	7

**LKD • Rectangular Table, 2 Piece Top**

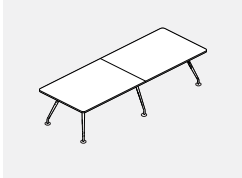

- Leg finish option, chrome or paint.
- Beam finish, paint only.

PRODUCT CODE	PRICE		SIZE / INCHES						WEIGHT		VOL FT <sup>3</sup>
	B	W	KL	FV	KV	H (B)	H (W)	W	D	LBS	
LKD36108	2557	2756	3280	3887	4062	29	29.5	108	36	154	7
LKD36120	2686	2908	3503	4180	4375	29	29.5	120	36	164	8
LKD42108	2727	2953	3603	4310	4516	29	29.5	108	42	124	8
LKD42120	2873	3120	3862	4648	4876	29	29.5	120	42	141	9
LKD48108	2932	3177	3925	4735	4969	29	29.5	108	48	127	9
LKD48120	3098	3373	4220	5117	5380	29	29.5	120	48	151	9
LKD48132	3258	3556	4511	5501	5789	29	29.5	132	48	164	10
LKD48144	3300	3605	4804	5883	6198	29	29.5	144	48	181	10
LKD48156	3580	3927	5096	6266	6606	29	29.5	156	48	191	11
LKD48168	3740	4111	5390	6650	7014	29	29.5	168	48	206	11
LKD48180	4020	4433	5684	7033	7422	29	29.5	180	48	220	12
LKD54144	3687	4039	5274	6489	6841	29	29.5	144	54	193	11
LKD54168	4040	4448	5929	7344	7758	29	29.5	168	54	214	12
LKD60144	3903	4288	5699	7049	7442	29	29.5	144	60	206	12
LKD60168	4291	4732	6424	7998	8455	29	29.5	168	60	227	13

**LKD • Rectangular Table, 3 Piece Top**



- Leg finish option, chrome or paint.
- Beam finish, paint only.

PRODUCT CODE	PRICE		SIZE / INCHES						WEIGHT		VOL FT <sup>3</sup>
	B	W	KL	FV	KV	H (B)	H (W)	W	D	LBS	
LKD48192	4521	4941	6431	7872	8290	29	29.5	192	48	279	14
LKD54192	4859	5318	7044	8662	9134	29	29.5	192	54	288	15
LKD54216	5212	5725	7700	9519	10048	29	29.5	216	54	270	16
LKD54240	5565	6133	8353	10376	10965	29	29.5	240	54	298	17
LKD60192	5146	5645	7612	9411	9935	29	29.5	192	60	257	16
LKD60216	5533	6089	8337	10360	10948	29	29.5	216	60	283	17
LKD60240	5919	6533	9059	11308	11960	29	29.5	240	60	311	18

**Technical Information - Tables**

**Tables**

- All table surfaces are High Pressure Laminate in "B" or "W" thickness.
- All tables have "T" mold edge band, unless otherwise indicated.
- Tables up to and including 96" long are manufactured in one piece, 120" to 192" long are manufactured in two pieces and over 216" are manufactured in three pieces. If wood grain laminate is chosen, the wood grain pattern will not line up.
- Tables in 2 or 3 pieces will have the joining edge finished with PVC edge (0.5mm), hardware will be shipped for assembly.
- Grommet locations must be specified at the time of order or it will default to "no grommet" option.
- Power modules and grommets are not included, they must be specified separately.
- Positions for drop in power and data grommets are intended for use on tops with the following bases: LR, LSQ, LDRUM, TELRS, TELRR, TELBS, TELBR. For any other base, please consult Customer Service Representative.
- Tables are not pre-drilled to accept legs or bases.
- "LTR" Rectangular shape tables with edge B and W have a 1" radius at each corner.
- For table tops with square corners, please add "NR" at the end of the product code, no upcharge required. The "NR" option is available only with the B and W edge profiles.
- "LBT" Boat shape tables are 6" narrower at the ends. The nominal size is identified at the centre.
- "LBTB" Boat shape tables with bow ends are 12" narrower at the ends. The nominal size is identified at the centre.
- Trapezoid tables can be used in several combinations.
- Power modules and grommets are not included, they must be specified separately.

**Bases**

- Available in variety of materials metal, high pressure laminate or low pressure laminate, please refer to specific base in price list
- "LR" Rectangular and "LSQ" square bases come standard with removable access door and cut out on the bottom of the base for pass-thru cables.
- "TELRS / TELBS" square and "TELRR / TELBR" rectangular bases come standard with cut out on the bottom of the base for pass-thru cables. Hinged access doors are optional and must be specified with an "HD" at the end of the code. There will be an upcharge of \$122 to the list price.
- Drum bases are finished in high pressure only and comes with a full bottom and notch at the top. Sand bag included. Access door is not an option.
- Drum, rectangular and square bases are shipped assembled.

**Folding Legs**

- Legs are folded by pressing the lever. Once folded, the legs are held securely by the interlocking springs.
- Includes adjustable levelers offering 12mm (1/2") of adjustment.
- Minimum special sizing for tables is 54" in length and 25" in depth.
- Sold per pair.

**Flip Top Training Tables**

- "GFT" Rectangular Flip tables with edge B and W edge have straight corners.

**Visual Board**

- Unit offered in high pressure laminate (B) comes with 2 high pressure laminate doors
- Cork board included on one inside door.
- Unit closes with a touch latch mechanism, but no lock option.
- "MG" indicates a magnetic white board.

**Tables • Guidelines For Ordering Product**

**CODES:** The price list uses a numbering system with meaningful alphanumeric characters to create a simple-to-understand product number. This makes specifying the product much easier and more accurate.

**SPECIFICATION EXAMPLE OF A TABLE UNIT**

**PRODUCT CODE:** LTS2424  
 L = Licence  
 T = Table  
 S = Square  
 2424 = Size: Depth x Width

**Edge Options:**

**"B" Edges**

HP (B) 1.062" Thickness

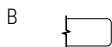

**"W" Edges**

HP (W) 1.437" Thickness

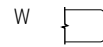

**Base Specification Guide (See Installation Manual For Examples).**

- Tables up to 96" in length require 2 T bases
- Tables 108" to 144" in length require 3 T bases
- Tables 156" to 192" in length require 4 T bases
- Tables 216" to 240" in length require 6 T bases

**FLAT BAR 3 PRONG "TTFL"**

BASE SPREAD	TOP WIDTH
18"	24W
22"	30W
24"	36W
30"	42W
36"	48W
36"	54W

**LLT/LLTT W/BULLNOSE ENDS**

BASE SPREAD	TOP WIDTH
18"	24W
26"	30W
26"	36W
30"	42W
36"	48W
36"	54W
42"	60W

**TTFLT FLAT BAR "T"**

BASE SPREAD	TOP WIDTH
18"	24W
22"	30W
24"	36W
30"	42W
36"	48W
36"	54W

**LD DRUM**

BASE SPREAD	ROUND TOP SIZE
18" dia	30" dia
18" dia	36" dia
24" dia	42" dia
24" dia	48" dia
30" dia	54" dia
30" dia	60" dia

**LSQ, TELRS & TELBS SQUARE**

BASE SPREAD	TOP SIZE
18"	30x30
18"	36x36
24"	42x42
24"	48x48
30"	54x54
30"	60x60

**LCT CROSS BASE**

BASE SPREAD	TOP SIZE
18"	24x24
24"	30x30
24"	36x36
30"	42x42
30"	48x48
36"	54x54
42"	60x60

- 1 Piece Tables up to 96" in length require 2 bases
- Tables 108" to 192" in length require 3 bases
- Tables 216" to 240" in length require 4 bases

**LR, LSQ, TELRS, TELRR, TELBS, TELBR**

BASE SPREAD	TOP WIDTH
18"	30
18"	36
24"	42
24"	48
30"	54
30"	60

**LELBA**

BASE SPREAD	TOP WIDTH
18"	30
18"	36
24"	42
30"	48
36"	54
36"	60

**TRUMPET 28H**

BASE SPREAD	TOP SIZE
18"	24x24
24"	30x30
24"	36x36
30"	42x42
30"	48x48

**FLAT SQUARE**

BASE SPREAD	TOP SIZE
18"	24x24
18"	30x30
23"	36x36
23"	42x42
30"	48x48

**FLAT DISC 28H**

BASE SPREAD	TOP SIZE
18"	24x24
18"	30x30
24"	36x36
30"	42x42
30"	48x48
36"	54x54

**FLATBAR X**

BASE SPREAD	TOP SIZE
18"	24x24
18"	30x30
24"	36x36
24"	42x42
30"	48x48
36"	54x54

**TRUMPET 40.5H**

BASE SPREAD	TOP SIZE
18"	24x24
24"	30x30
24"	36x36

**FLAT SQUARE 40.5H**

BASE SPREAD	TOP SIZE
18"	24x24
23"	30x30

**FLAT DISC 40.5H**

BASE SPREAD	TOP SIZE
18"	24x24
22"	30x30
24"	36x36

**FLATBAR X 40.5H**

BASE SPREAD	TOP SIZE
18"	24x24
22"	30x30

**LL4S W/BULLNOSE ENDS**

BASE SPREAD	TOP SIZE
18"	24x24
26"	30x30
26"	36x36
26"	42x42
30"	48x48
36"	54x54

**LHC HAT CHANNEL**

- LHC40 For Table 54" Wide
- LHC46 For Table 60" Wide
- LHC52 For Table 66" Wide
- LHC58 For Table 72" Wide
- LHC64 For Table 78" Wide
- LHC70 For Table 84" Wide

**LL4S W/BULLNOSE ENDS 40.5H**

BASE SPREAD	TOP SIZE
26"	30x30
30"	36x36
36"	42x42

Tops with post legs must be specified with HAT Channels for structural reinforcement.



**Grommet Cut Dimensions (inches)**

**BG5**

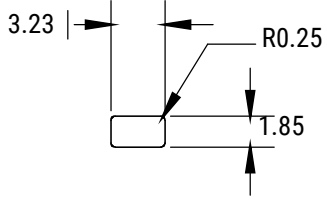
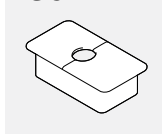

**MSPDM**

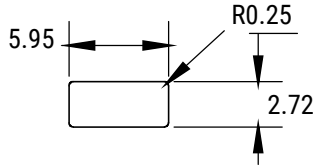
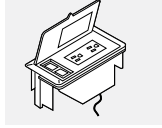

**GAAD**

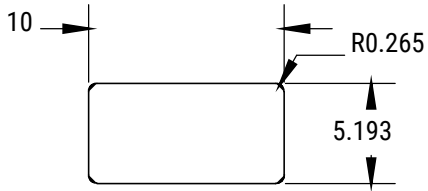
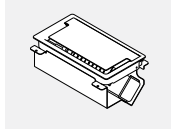

**GCRTMCS4xx**

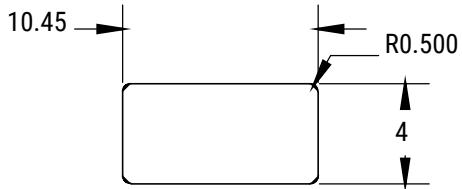
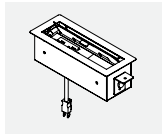

**GCRTMCS6xx**

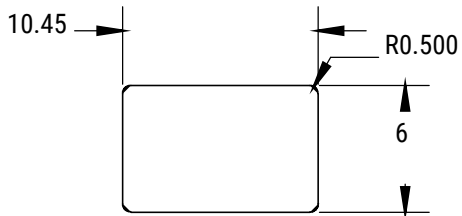
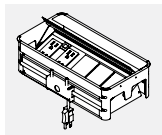
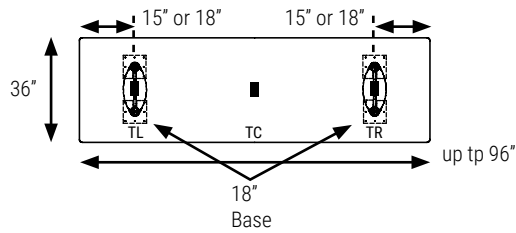

**Table Dimension Chart & Grommet Location**

LELBA - Elliptical Base

For One Piece Top

LELBA BASE SPREAD	TOP WIDTH
18"	30
18"	36
24"	42
30"	48
36"	54
36"	60



\*15" for table widths between 60" and 72" and 18" for table widths between 78" and 96"

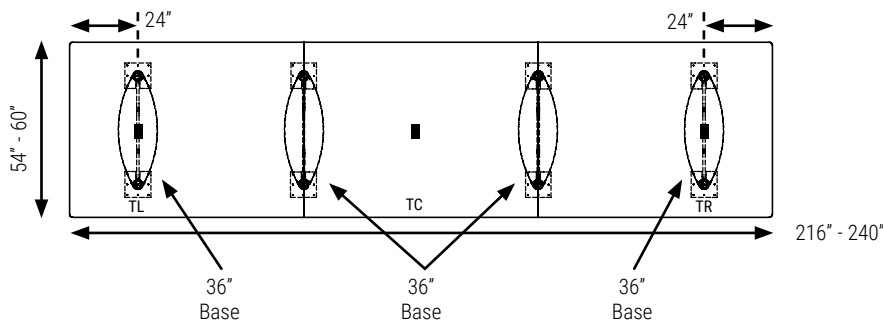
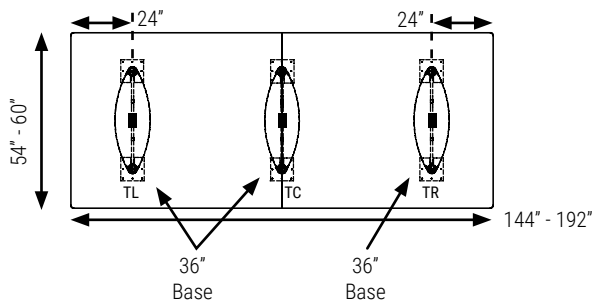
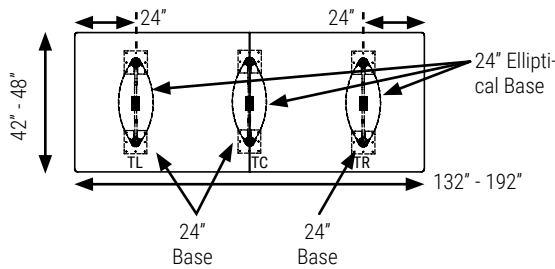
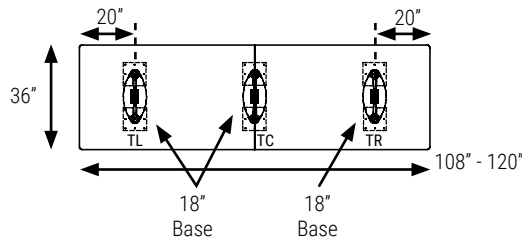

Note: Grommet orientation is perpendicular to the length of table.

**Table Dimension Chart & Grommet Location**

LR - Rectangular Base

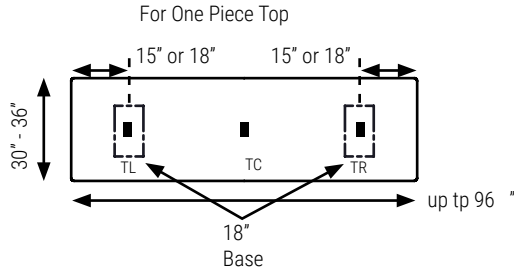

\*15" for table widths between 60" and 72" and 18" for table widths between 78" and 96"

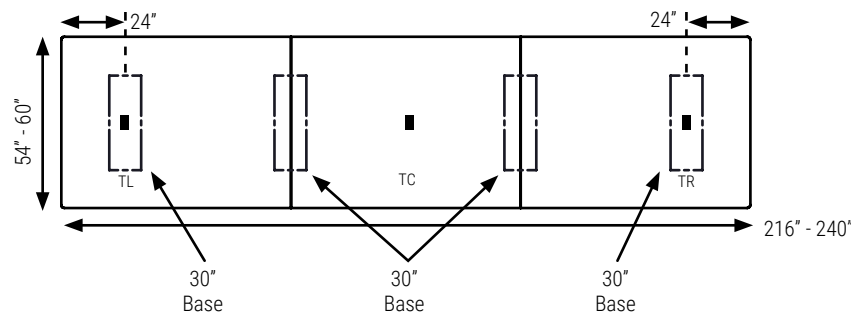
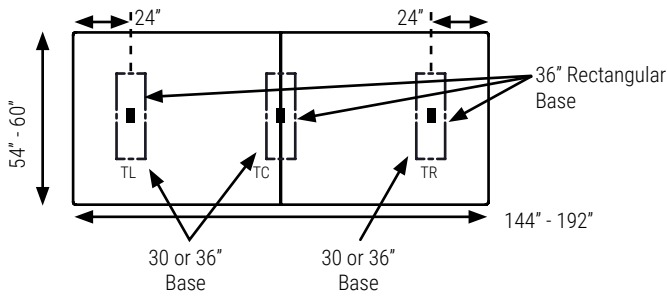
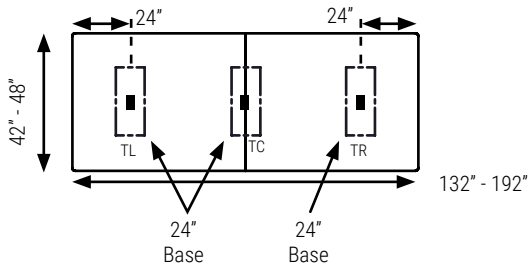
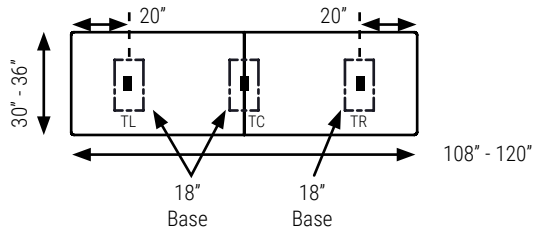

Note: Grommet orientation is perpendicular to the length of table.

**Table Dimension Chart & Grommet Location**

For One Piece Top

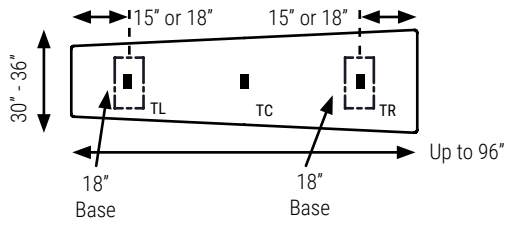

\*15" for table widths between 60" and 72" and 18" for table widths between 78" and 96"

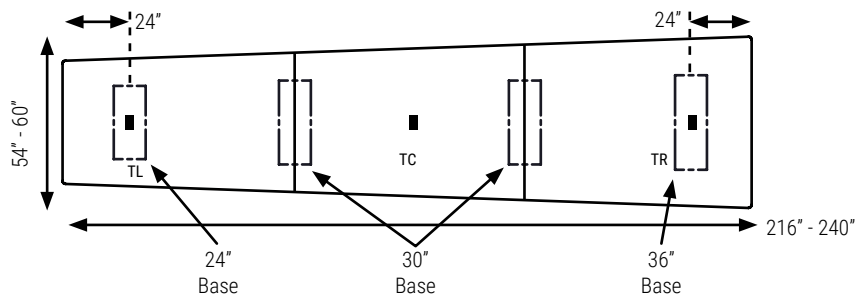
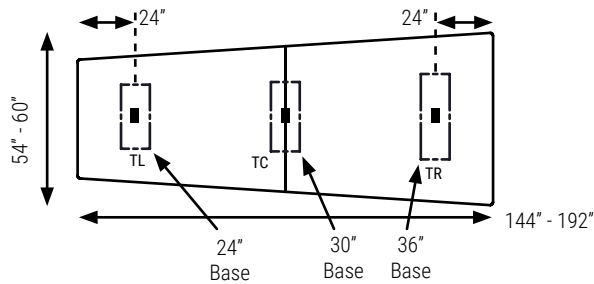
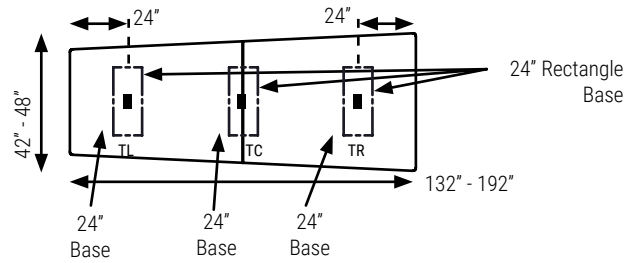
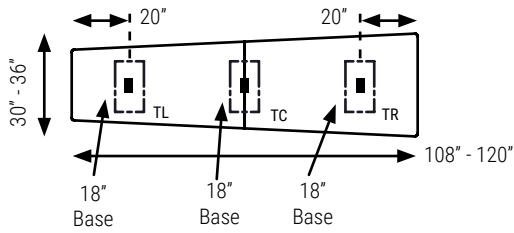

Note: Grommet orientation is perpendicular to the length of table.

**Table Dimension Chart & Grommet Location**

LELBA - Elliptical Base

For One Piece Top

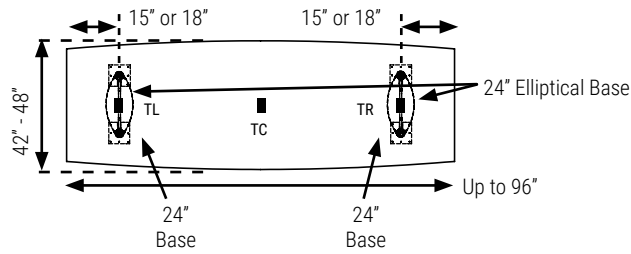

\*15" for table widths between 60" and 72" and 18" for table widths between 78" and 96"

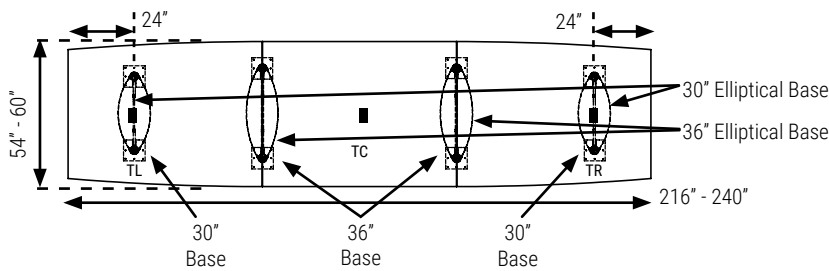
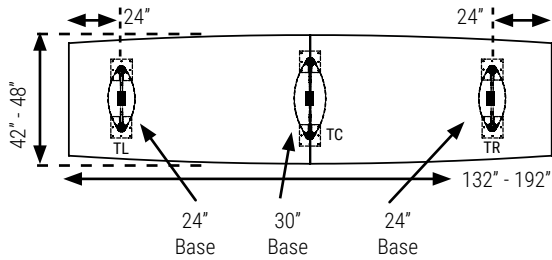
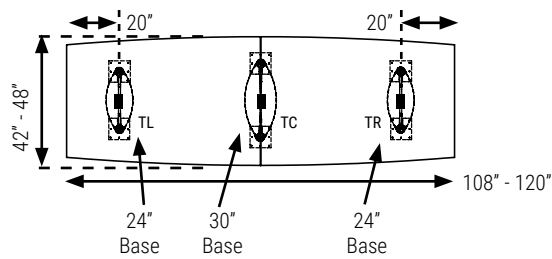

Note: Grommet orientation is perpendicular to the length of table.

**Table Dimension Chart & Grommet Location**

LELBA - Rectangular Base

For One Piece Top

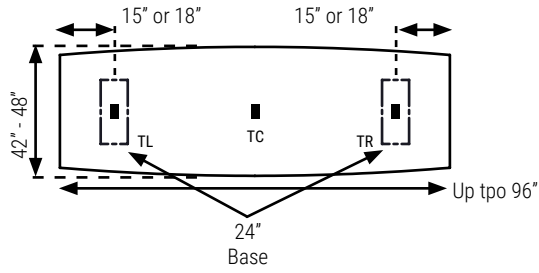

\*15\"/>

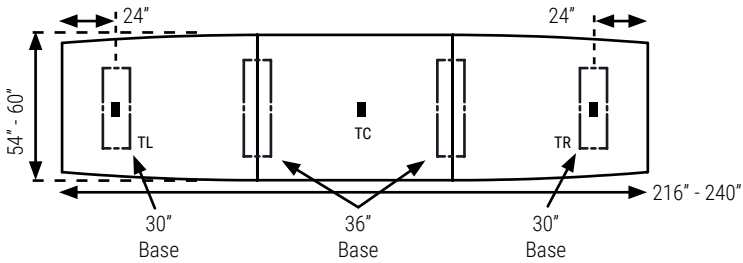
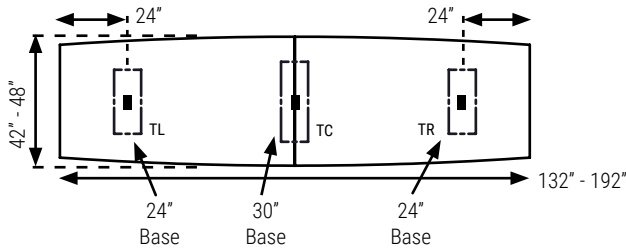
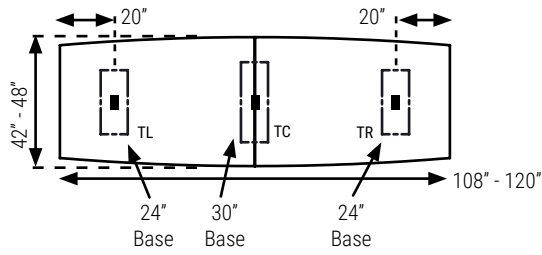

Note: Grommet orientation is perpendicular to the length of table.

**Table Dimension Chart & Grommet Location**

LR - Elliptical Base

For One Piece Top

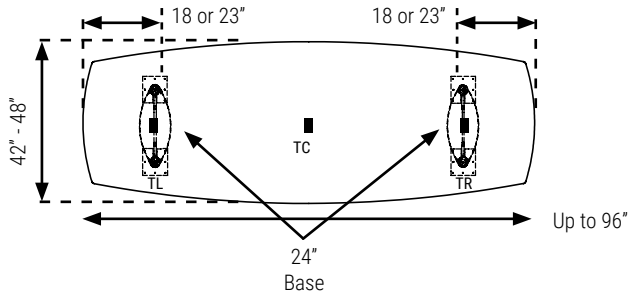

\*18" for table widths between 60" and 72" and 23" for table widths between 78" and 96"

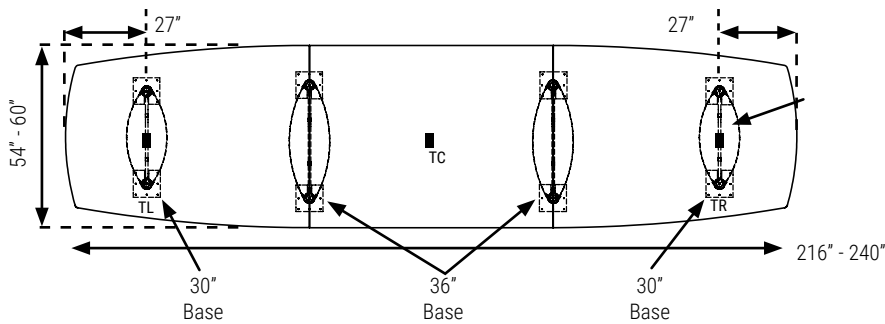
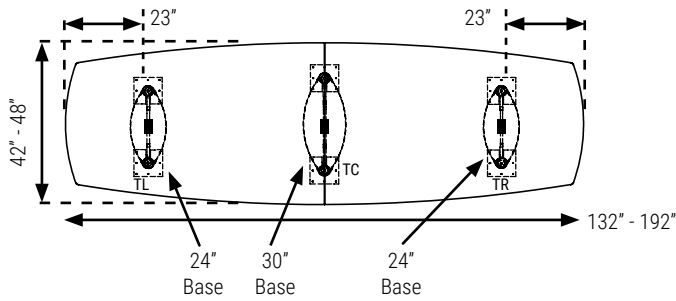
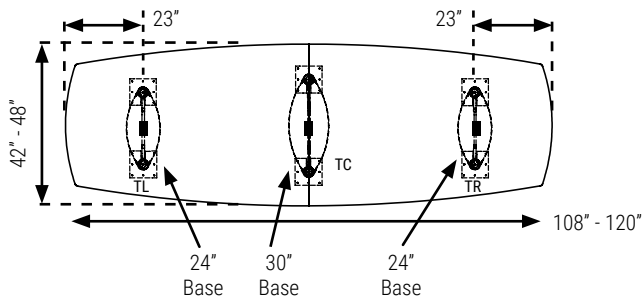

Note: Grommet orientation is perpendicular to the length of table.

**Table Dimension Chart**

LR - Rectangular Base

For One Piece Top

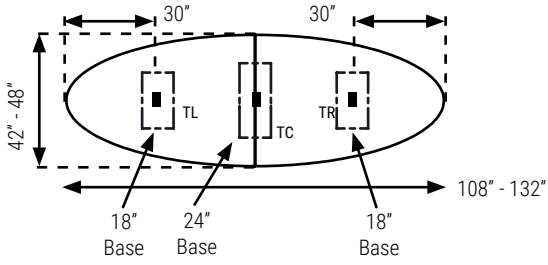
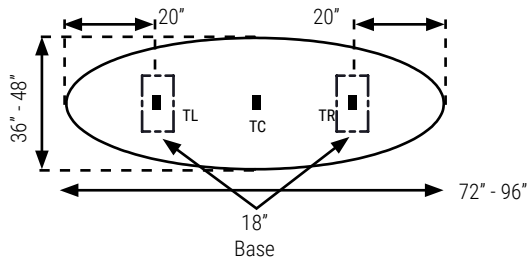

\*15" for table widths between 60" and 72" and 18" for table widths between 78" and 96"

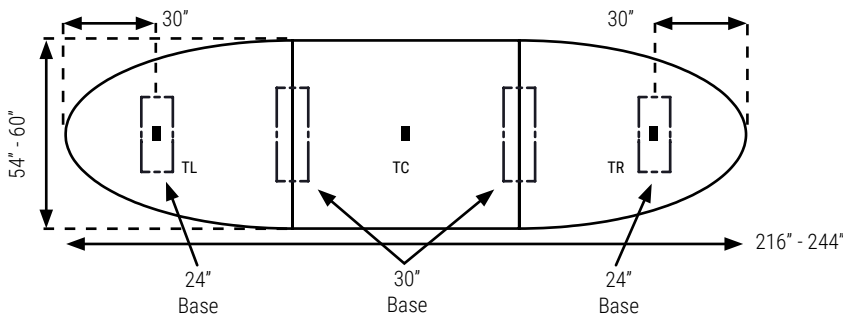
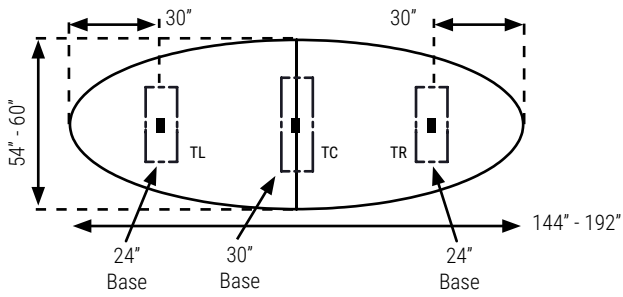

Note: Grommet orientation is perpendicular to the length of table.



**Table Dimension Chart**

LR - Rectangular Base

For One Piece Top

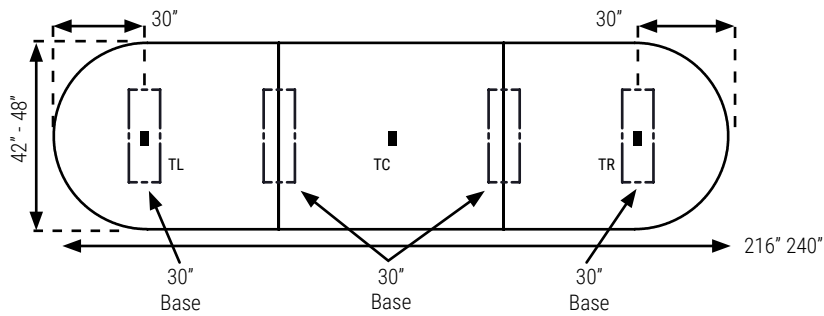
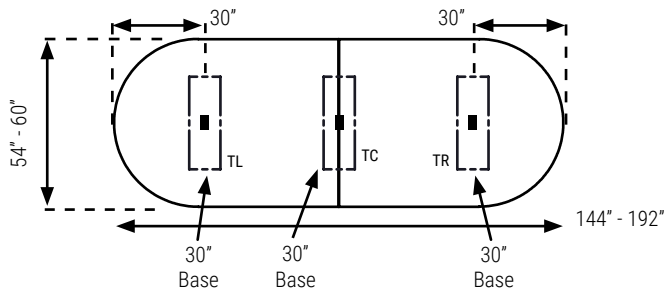
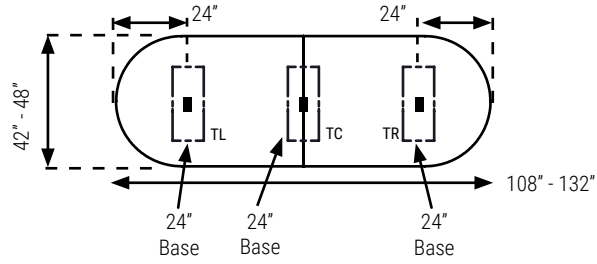
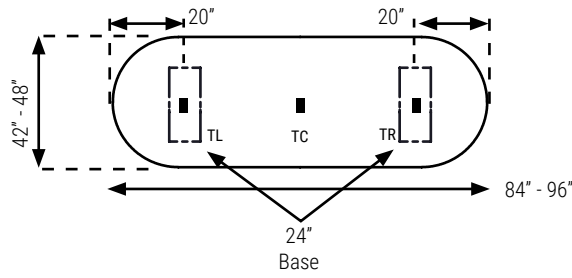

Note: Grommet orientation is perpendicular to the length of table.

**LTS • Square Table Top**

• Tops with Band W thickness have 1" radius corners.

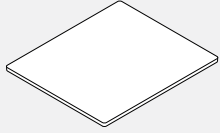

PRODUCT CODE	EDGE		SIZE/INCHES				WEIGHT LBS	VOL FT <sup>3</sup>
	B	W	H(B)	H(W)	W	D		
LTS2424	173	252	1	1.5	24	24	29	3
LTS3030	218	361	1	1.5	30	30	32	3
LTS3636	315	462	1	1.5	36	36	46	4
LTS4242	469	608	1	1.5	42	42	57	6
LTS4848	603	769	1	1.5	48	48	75	7
LTS5454	748	955	1	1.5	54	54	86	10
LTS6060	910	1159	1	1.5	60	60	99	12

**L-DIA • Circle Table Top**

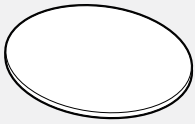

PRODUCT CODE	EDGE		SIZE/INCHES				WEIGHT LBS	VOL FT <sup>3</sup>
	B	W	H(B)	H(W)	W	D		
L24DIA	177	257	1	1.5	24 dia	24 dia	29	3
L30DIA	226	373	1	1.5	30	30	32	3
L36DIA	323	473	1	1.5	36	36	46	4
L42DIA	484	624	1	1.5	42	42	57	6
L48DIA	617	795	1	1.5	48	48	75	7
L54DIA	769	983	1	1.5	54	54	86	10
L60DIA	938	1195	1	1.5	60	60	99	12

**LTR • Rectangle Table Top**

• Tops with B and W thickness have 1" radius corners.

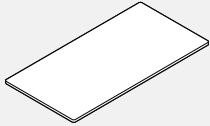

PRODUCT CODE	EDGE		SIZE/INCHES				WEIGHT LBS	VOL FT <sup>3</sup>
	B	W	H(B)	H(W)	W	D		
LTR2430	184	278	1	1.5	30	24	26	2
LTR2436	207	321	1	1.5	36	24	31	2
LTR2442	272	366	1	1.5	42	24	33	3
LTR2448	329	413	1	1.5	48	24	35	3
LTR2454	383	461	1	1.5	54	24	40	3
LTR2460	430	507	1	1.5	60	24	42	4
LTR2466	449	553	1	1.5	66	24	47	4
LTR2472	470	604	1	1.5	72	24	53	4
LTR3036	256	386	1	1.5	36	30	31	2
LTR3042	362	442	1	1.5	42	30	35	2
LTR3048	383	498	1	1.5	48	30	40	3
LTR3054	408	556	1	1.5	54	30	44	3
LTR3060	449	612	1	1.5	60	30	48	3
LTR3066	469	669	1	1.5	66	30	53	3
LTR3072	495	725	1	1.5	72	30	57	3
LTR3078	524	781	1	1.5	78	30	59	4
LTR3084	579	838	1	1.5	84	30	62	4
LTR3096	672	949	1	1.5	96	30	66	4
LTR3642	418	552	1	1.5	42	36	42	2
LTR3648	471	622	1	1.5	48	36	46	2
LTR3654	526	693	1	1.5	54	36	51	2
LTR3660	583	763	1	1.5	60	36	57	3
LTR3666	637	835	1	1.5	66	36	63	3
LTR3672	691	903	1	1.5	72	36	68	3
LTR3678	743	974	1	1.5	78	36	72	3
LTR3684	800	1047	1	1.5	84	36	74	4
LTR3696	909	1188	1	1.5	96	36	79	4
LTR4248	564	713	1	1.5	48	42	57	3
LTR4254	634	795	1	1.5	54	42	59	3
LTR4260	699	872	1	1.5	60	42	62	3
LTR4266	763	956	1	1.5	66	42	68	3
LTR4272	828	1035	1	1.5	72	42	73	3
LTR4278	894	1118	1	1.5	78	42	76	3
LTR4284	959	1198	1	1.5	84	42	78	3
LTR4296	1092	1357	1	1.5	96	42	92	4
LTR4854	715	894	1	1.5	54	48	62	3
LTR4860	789	987	1	1.5	60	48	66	3
LTR4866	865	1076	1	1.5	66	48	73	3
LTR4872	938	1166	1	1.5	72	48	79	3
LTR4878	1011	1260	1	1.5	78	48	84	3
LTR4884	1086	1350	1	1.5	84	48	88	4
LTR4896	1233	1531	1	1.5	96	48	110	4

**LTR • Rectangle Table Top 2 Piece**

- Tables larger than 192" long are manufactured in 3 pieces.
- Tops with B and W thickness have 1" radius corners.

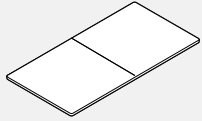

PRODUCT CODE	EDGE		SIZE/INCHES				WEIGHT LBS	VOL FT <sup>3</sup>
	B	W	H(B)	H(W)	W	D		
LTR36108	1166	1374	1	1.5	108	36	105	4
LTR36120	1286	1516	1	1.5	120	36	114	4
LTR42108	1330	1566	1	1.5	108	42	108	6
LTR42120	1464	1722	1	1.5	120	42	123	6
LTR48108	1485	1745	1	1.5	108	48	110	6
LTR48120	1641	1926	1	1.5	120	48	132	7
LTR48132	1789	2098	1	1.5	132	48	143	7
LTR48144	1815	2131	1	1.5	144	48	158	8
LTR48156	2088	2450	1	1.5	156	48	167	8
LTR48168	2234	2620	1	1.5	168	48	176	9
LTR48180	2509	2936	1	1.5	180	48	189	10
LTR48192	2534	2970	1	1.5	192	48	201	10
LTR54144	2202	2569	1	1.5	144	54	169	10
LTR54168	2534	2956	1	1.5	168	54	187	10
LTR54192	2867	3343	1	1.5	192	54	212	13
LTR54216	3196	3729	1	1.5	216	54	234	18
LTR54240	3530	4118	1	1.5	240	54	259	20
LTR60144	2417	2811	1	1.5	144	60	180	11
LTR60168	2781	3237	1	1.5	168	60	198	13
LTR60192	3148	3663	1	1.5	192	60	223	18
LTR60216	3512	4090	1	1.5	216	60	245	22
LTR60240	3880	4516	1	1.5	240	60	270	24

**LTRB • Rectangle Table Top with Bow Ends**

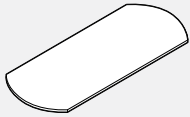

PRODUCT CODE	EDGE		SIZE/INCHES				WEIGHT LBS	VOL FT <sup>3</sup>
	B	W	H(B)	H(W)	W	D		
LTRB4284	991	1232	1	1.5	84	42	78	3
LTRB4296	1124	1399	1	1.5	96	42	92	4
LTRB4884	1119	1389	1	1.5	84	48	88	4
LTRB4896	1271	1579	1	1.5	96	48	110	4

**LTRB • Rectangle Table Top with Bow Ends 2 Piece**

- Tables larger than 192" long are manufactured in 3 pieces.

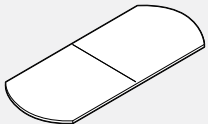

PRODUCT CODE	EDGE		SIZE/INCHES				WEIGHT LBS	VOL FT <sup>3</sup>
	B	W	H(B)	H(W)	W	D		
LTRB42108	1373	1612	1	1.5	108	42	108	6
LTRB42120	1507	1773	1	1.5	120	42	123	6
LTRB48108	1531	1792	1	1.5	108	48	110	6
LTRB48120	1690	1983	1	1.5	120	48	132	7
LTRB48132	1843	2162	1	1.5	132	48	143	7
LTRB48144	1871	2196	1	1.5	144	48	158	8
LTRB48156	2149	2519	1	1.5	156	48	167	8
LTRB48168	2302	2701	1	1.5	168	48	176	9
LTRB48180	2582	3025	1	1.5	180	48	189	10
LTRB48192	2611	3061	1	1.5	192	48	201	10
LTRB54144	2269	2643	1	1.5	144	54	169	10
LTRB54168	2613	3043	1	1.5	168	54	187	10
LTRB54192	2951	3444	1	1.5	192	54	212	13
LTRB54216	3293	3841	1	1.5	216	54	234	18
LTRB54240	3636	4239	1	1.5	240	54	259	20
LTRB60144	2487	2895	1	1.5	144	60	180	11
LTRB60168	2864	3333	1	1.5	168	60	198	13
LTRB60192	3242	3774	1	1.5	192	60	223	18
LTRB60216	3620	4213	1	1.5	216	60	245	22
LTRB60240	3995	4650	1	1.5	240	60	270	24

**LRT • Racetrack Table Top**



PRODUCT CODE	EDGE		SIZE/INCHES				WEIGHT LBS	VOL FT <sup>3</sup>
	B	W	H(B)	H(W)	W	D		
LRT4284	991	1232	1	1.5	84	42	78	3
LRT4296	1124	1399	1	1.5	96	42	92	4
LRT4884	1119	1389	1	1.5	84	48	88	4
LRT4896	1271	1579	1	1.5	96	48	110	4

**LRT • Racetrack Table Top 2 Piece**

• Tables larger than 192" long are manufactured in 3 pieces.

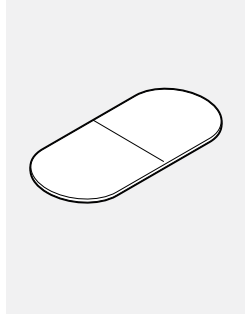

PRODUCT CODE	EDGE		SIZE / INCHES				WEIGHT		VOL FT <sup>3</sup>
	B	W	H (B)	H (W)	W	D	LBS		
LRT42108	1373	1612	1	1.5	108	42	108	6	
LRT42120	1507	1773	1	1.5	120	42	123	6	
LRT48108	1531	1792	1	1.5	108	48	110	6	
LRT48120	1690	1983	1	1.5	120	48	132	7	
LRT48132	1843	2162	1	1.5	132	48	143	7	
LRT48144	1871	2196	1	1.5	144	48	158	8	
LRT48156	2149	2519	1	1.5	156	48	167	8	
LRT48168	2302	2701	1	1.5	168	48	176	9	
LRT48180	2582	3025	1	1.5	180	48	189	10	
LRT48192	2611	3061	1	1.5	192	48	201	10	
LRT54144	2269	2643	1	1.5	144	54	169	10	
LRT54168	2613	3043	1	1.5	168	54	187	10	
LRT54192	2951	3444	1	1.5	192	54	204	10	
LRT54216	3293	3841	1	1.5	216	54	226	11	
LRT54240	3636	4239	1	1.5	240	54	253	11	
LRT60144	2487	2895	1	1.5	144	60	180	11	
LRT60168	2864	3333	1	1.5	168	60	198	13	
LRT60192	3242	3774	1	1.5	192	60	223	18	
LRT60216	3620	4213	1	1.5	216	60	245	22	
LRT60240	3995	4650	1	1.5	240	60	270	24	

**LO • Oval Table Top**

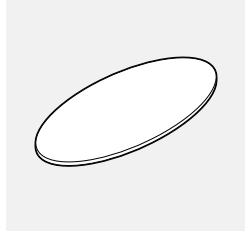

PRODUCT CODE	EDGE		SIZE / INCHES				WEIGHT		VOL FT <sup>3</sup>
	B	W	H (B)	H (W)	W	D	LBS		
LO3672	710	931	1	1.5	72	36	68	3	
LO3684	825	1076	1	1.5	84	36	74	3	
LO3696	935	1223	1	1.5	96	36	79	3	
LO4284	991	1232	1	1.5	84	42	78	3	
LO4296	1124	1399	1	1.5	96	42	92	4	
LO4884	1119	1389	1	1.5	84	48	88	4	
LO4896	1271	1579	1	1.5	96	48	110	4	

**LBT • Boat Table Top**

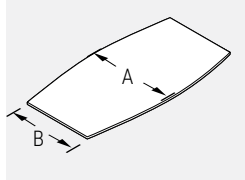

A	B
42	36
48	42

PRODUCT CODE	EDGE		SIZE / INCHES				WEIGHT		VOL FT <sup>3</sup>
	B	W	H (B)	H (W)	W	D	LBS		
LBT4284	991	1232	1	1.5	84	42	78	3	
LBT4296	1124	1399	1	1.5	96	42	92	4	
LBT4884	1119	1389	1	1.5	84	48	99	4	
LBT4896	1271	1579	1	1.5	96	48	110	4	

**LBT • Boat Table Top 2 Piece**

• Tables larger than 192" long are manufactured in 3 pieces.  
 • 6" narrower at the ends.

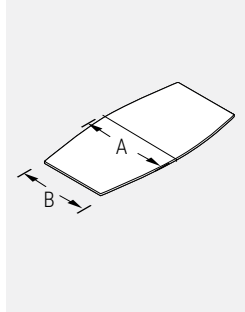

A	B
42	36
48	42
54	48
60	54

PRODUCT CODE	EDGE		SIZE / INCHES				WEIGHT		VOL FT <sup>3</sup>
	B	W	H (B)	H (W)	W	D	LBS		
LBT42108	1373	1612	1	1.5	108	42	108	6	
LBT42120	1507	1773	1	1.5	120	42	123	6	
LBT48108	1531	1792	1	1.5	108	48	110	6	
LBT48120	1690	1983	1	1.5	120	48	132	7	
LBT48132	1843	2162	1	1.5	132	48	143	7	
LBT48144	1871	2196	1	1.5	144	48	158	8	
LBT48156	2149	2519	1	1.5	156	48	167	8	
LBT48168	2302	2701	1	1.5	168	48	176	9	
LBT48180	2582	3025	1	1.5	180	48	189	10	
LBT48192	2611	3061	1	1.5	192	48	201	10	
LBT54144	2269	2643	1	1.5	144	54	169	10	
LBT54168	2613	3043	1	1.5	168	54	187	10	
LBT54192	2951	3444	1	1.5	192	54	212	13	
LBT54216	3293	3841	1	1.5	216	54	234	18	
LBT54240	3636	4239	1	1.5	240	54	259	20	
LBT60144	2487	2895	1	1.5	144	60	180	11	
LBT60168	2864	3333	1	1.5	168	60	198	13	
LBT60192	3242	3774	1	1.5	192	60	223	18	
LBT60216	3620	4213	1	1.5	216	60	245	22	
LBT60240	3995	4650	1	1.5	240	60	270	24	

**LBTB • Boat Table Top with Bow Ends**

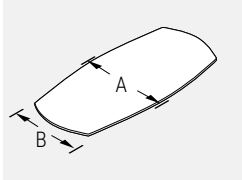

A	B
42	30
48	36

PRODUCT CODE	EDGE		SIZE / INCHES				WEIGHT LBS	VOL FT <sup>3</sup>
	B	W	H(B)	H(W)	W	D		
LBTB4284	991	1232	1	1.5	84	42	78	3
LBTB4296	1124	1399	1	1.5	96	42	92	4
LBTB4884	1119	1389	1	1.5	84	48	88	4
LBTB4896	1271	1579	1	1.5	96	48	110	4

**LBTB • Boat Table Top with Bow Ends 2 Piece**

• Tables larger than 192" long are manufactured in 3 pieces.

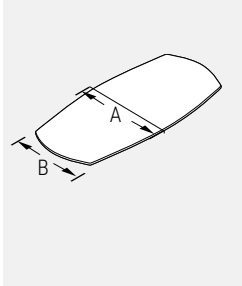

A	B
60	48
54	42
48	36
42	30

PRODUCT CODE	EDGE		SIZE / INCHES				WEIGHT LBS	VOL FT <sup>3</sup>
	B	W	H(B)	H(W)	W	D		
LBTB42108	1373	1612	1	1.5	108	42	108	6
LBTB42120	1507	1773	1	1.5	120	42	123	6
LBTB48108	1531	1792	1	1.5	108	48	110	6
LBTB48120	1690	1983	1	1.5	120	48	132	7
LBTB48132	1843	2162	1	1.5	132	48	143	7
LBTB48144	1871	2196	1	1.5	144	48	158	8
LBTB48156	2149	2519	1	1.5	156	48	167	8
LBTB48168	2302	2701	1	1.5	168	48	176	9
LBTB48180	2582	3025	1	1.5	180	48	189	10
LBTB48192	2611	3061	1	1.5	192	48	204	11
LBTB54144	2269	2643	1	1.5	144	54	176	9
LBTB54168	2613	3043	1	1.5	168	54	187	10
LBTB54192	2951	3444	1	1.5	192	54	212	13
LBTB54216	3293	3841	1	1.5	216	54	234	18
LBTB54240	3636	4239	1	1.5	240	54	259	20
LBTB60144	2487	2895	1	1.5	144	60	180	11
LBTB60168	2864	3333	1	1.5	168	60	198	13
LBTB60192	3242	3774	1	1.5	192	60	223	18
LBTB60216	3620	4213	1	1.5	216	60	245	22
LBTB60240	3995	4650	1	1.5	240	60	270	24

**LTW • Wedge Table Top**

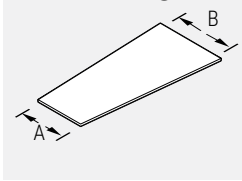

A	B
36	48

PRODUCT CODE	EDGE		SIZE / INCHES				WEIGHT LBS	VOL FT <sup>3</sup>
	B	W	H(B)	H(W)	W	D		
LTW4896	1271	1579	1	1.5	96	48	110	4

**LTW • Wedge Table Top 2 Piece**

• Tables larger than 192" long are manufactured in 3 pieces.

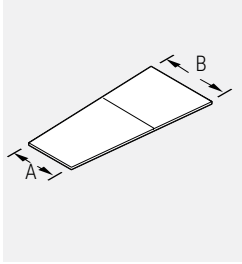

A	B
36	48
42	54
48	60

PRODUCT CODE	EDGE		SIZE / INCHES				WEIGHT LBS	VOL FT <sup>3</sup>
	B	W	H(B)	H(W)	W	D		
LTW48108	1531	1792	1	1.5	108	48	110	6
LTW48120	1690	1983	1	1.5	120	48	132	7
LTW48132	1843	2162	1	1.5	132	48	143	7
LTW48144	1871	2196	1	1.5	144	48	158	8
LTW48156	2149	2519	1	1.5	156	48	167	8
LTW48168	2302	2701	1	1.5	168	48	176	9
LTW48180	2582	3025	1	1.5	180	48	189	10
LTW48192	2611	3061	1	1.5	192	48	201	10
LTW54144	2269	2643	1	1.5	144	54	169	10
LTW54168	2613	3043	1	1.5	168	54	187	10
LTW54192	2951	3444	1	1.5	192	54	212	13
LTW54216	3293	3841	1	1.5	216	54	234	18
LTW54240	3636	4239	1	1.5	240	54	259	20
LTW60144	2487	2895	1	1.5	144	60	180	11
LTW60168	2864	3333	1	1.5	168	60	198	13
LTW60192	3242	3774	1	1.5	192	60	223	18
LTW60216	3620	4213	1	1.5	216	60	245	22
LTW60240	3995	4650	1	1.5	240	60	270	24

LTW... first dash is B, and the second dash is the length. A is not included in the code and is the smaller end.

**LTWB • Wedge Table Top with Bow Ends**

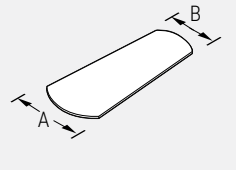

A	B
48	36

PRODUCT CODE	EDGE						WEIGHT		VOL FT <sup>3</sup>
	B	W	H(B)	H(W)	W	D	LBS		
LTWB4896	1271	1579	1	1.5	96	48	110	4	

**LTWB • Wedge Table Top with Bow Ends 2 Piece**

• Tables larger than 192" long are manufactured in 3 pieces.

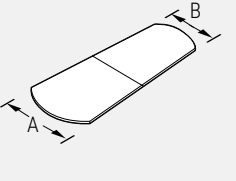

A	B
48	36
54	42
60	48

PRODUCT CODE	EDGE						WEIGHT		VOL FT <sup>3</sup>
	B	W	H(B)	H(W)	W	D	LBS		
LTWB48108	1531	1792	1	1.5	108	48	110	6	
LTWB48120	1690	1983	1	1.5	120	48	132	7	
LTWB48132	1843	2162	1	1.5	132	48	143	7	
LTWB48144	1871	2196	1	1.5	144	48	158	8	
LTWB48156	2149	2519	1	1.5	156	48	167	8	
LTWB48168	2302	2701	1	1.5	168	48	176	9	
LTWB48180	2582	3025	1	1.5	180	48	189	10	
LTWB48192	2611	3061	1	1.5	192	48	198	11	
LTWB54144	2269	2643	1	1.5	144	54	178	9	
LTWB54168	2613	3043	1	1.5	168	54	187	10	
LTWB54192	2951	3444	1	1.5	192	54	212	13	
LTWB54216	3293	3841	1	1.5	216	54	234	18	
LTWB54240	3636	4239	1	1.5	240	54	259	20	
LTWB60144	2487	2895	1	1.5	144	60	180	11	
LTWB60168	2864	3333	1	1.5	168	60	198	13	
LTWB60192	3242	3774	1	1.5	192	60	223	18	
LTWB60216	3620	4213	1	1.5	216	60	245	22	
LTWB60240	3995	4650	1	1.5	240	60	270	24	

**LHM • Halfmoon Table Top**

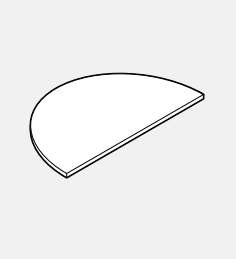

PRODUCT CODE	EDGE						WEIGHT		VOL FT <sup>3</sup>
	B	W	H(B)	H(W)	W	D	LBS		
LHM2424	177	257	1	1.5	24	24	29	3	
LHM2448	337	426	1	1.5	48	24	35	3	
LHM2460	443	524	1	1.5	60	24	42	4	
LHM2472	485	619	1	1.5	72	24	53	6	
LHM3030	226	373	1	1.5	30	30	32	3	
LHM3048	394	513	1	1.5	48	30	40	4	
LHM3060	462	633	1	1.5	60	30	48	6	
LHM3072	509	748	1	1.5	72	30	57	7	

**LTZ • Trapezoid Table Top**

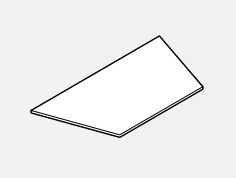

PRODUCT CODE	EDGE						WEIGHT		VOL FT <sup>3</sup>
	B	W	H(B)	H(W)	W	D	LBS		
LTZ2460	443	524	1	1.5	60	24	42	4	
LTZ2472	485	619	1	1.5	72	24	53	6	
LTZ3060	462	633	1	1.5	60	30	48	6	
LTZ3072	509	748	1	1.5	72	30	57	7	

**LW • Wave Table Top**

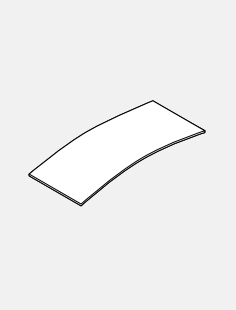

PRODUCT CODE	EDGE						WEIGHT		VOL FT <sup>3</sup>
	B	W	H(B)	H(W)	W	D	LBS		
LW2448	337	426	1	1.5	48	24	35	3	
LW2460	443	524	1	1.5	60	24	42	4	
LW2466	462	573	1	1.5	66	24	47	6	
LW2472	485	619	1	1.5	72	24	53	6	
LW3060	462	633	1	1.5	60	30	48	6	
LW3066	484	688	1	1.5	66	30	53	7	
LW3072	509	748	1	1.5	72	30	64	8	
LW3660	596	787	1	1.5	60	36	53	7	
LW3666	652	859	1	1.5	66	36	63	8	
LW3672	710	931	1	1.5	72	36	68	9	

**LCT • Cross Base for Table Tops**

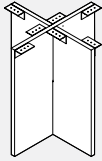

PRODUCT CODE	PRICE	SIZE/INCHES			WEIGHT LBS	VOL FT <sup>3</sup>
		H	W	D		
LCT18	469	28	18	18	29	6
LCT24	469	28	24	24	39	4
LCT30	526	28	30	30	48	6
LCT36	604	28	36	36	57	8
LCT42	677	28	42	42	62	9

**LR • Rectangular Base for Table Tops**

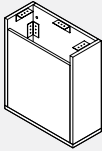

- Short side panel is removable for full wire access.

PRODUCT CODE	PRICE	SIZE/INCHES			WEIGHT LBS	VOL FT <sup>3</sup>
		H	W	D		
LR18	406	28	18	10	39	3
LR24	459	28	24	10	46	4
LR30	507	28	30	10	54	6
LR36	565	28	36	10	66	8
LR42	650	28	42	10	83	9

**LSQ • Square Base for Table Tops**

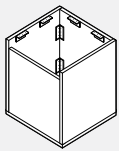

- Short side panel is removable for full wire access.

PRODUCT CODE	PRICE	SIZE/INCHES			WEIGHT LBS	VOL FT <sup>3</sup>
		H	W	D		
LSQ18	509	28	18	18	50	7
LSQ24	624	28	24	24	66	11
LSQ30	744	28	30	30	83	17

**LDRUM • Drum Base for Table Tops**

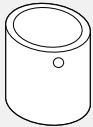

- Drum bases are finished in high pressure only and come with a full bottom.
- A 2" hole at the top to run the cables from the floor to the table top.
- Sand bag included.
- Access door is not an option.

PRODUCT CODE	PRICE	SIZE/INCHES			WEIGHT LBS	VOL FT <sup>3</sup>
		H	W	D		
LDRUM18	826	28	18	18	32	8
LDRUM24	881	28	24	24	43	11
LDRUM30	903	28	30	30	54	14

**LV • "V" Base for Table Tops**

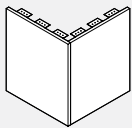

PRODUCT CODE	PRICE	SIZE/INCHES			WEIGHT LBS	VOL FT <sup>3</sup>
		H	W	D		
LV1818	271	28	18	18	29	3
LV2424	310	28	24	24	39	4
LV3030	364	28	30	30	48	6

**LELBA • Elliptical Base with Aluminum Extrusion**

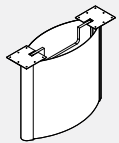

- Laminate side panels are removable for full wire access.
- Standard in metal paint finishes.
- Optional anodized aluminum finish available, please add \$50 list.

PRODUCT CODE	PRICE	SIZE/INCHES			WEIGHT LBS	VOL FT <sup>3</sup>
		H	W	D		
LELBA18	1151	28	18	9	33	2
LELBA24	1225	28	24	10	44	2
LELBA30	1374	28	30	12	55	4
LELBA36	1526	28	36	13	66	7
LELBA42	1674	28	42	14	77	9

**TELRR • Rectangular Panel Base with Anodized Aluminum Radius Corner Detail**

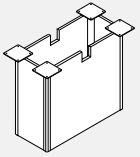

Single hinged access door is optional. Add "HD" to the end of the code. Add \$122 to list price.

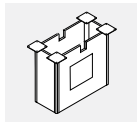

PRODUCT CODE	PRICE	SIZE/INCHES			WEIGHT LBS	VOL FT <sup>3</sup>
		H	W	D		
TELRR18	688	28	18	12	66	7
TELRR24	727	28	24	12	72	9
TELRR30	767	28	30	12	105	11
TELRR36	806	28	36	12	129	13
TELRR42	845	28	42	12	129	15

**TELBR • Rectangular Base with Rectangular Anodized Aluminum Corner Detail**

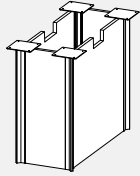

Single hinged access door is optional. Add "HD" to the end of the code. Add \$122 to list price.

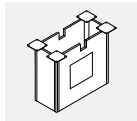

PRODUCT CODE	PRICE	SIZE/INCHES			WEIGHT LBS	VOL FT <sup>3</sup>
		H	W	D		
TELBR18	710	28	18	12	66	7
TELBR24	751	28	24	12	72	9
TELBR30	789	28	30	12	105	11
TELBR36	829	28	36	12	129	13
TELBR42	869	28	42	12	129	15

**TELSR • Square Panel Base with Anodized Aluminum Radius Corner Detail**

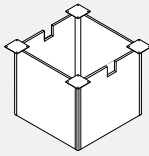

Single hinged access door is optional. Add "HD" to the end of the code. Add \$122 to list price.

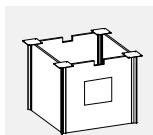

PRODUCT CODE	PRICE	SIZE/INCHES			WEIGHT LBS	VOL FT <sup>3</sup>
		H	W	D		
TELSR18	737	28	18	18	77	7
TELSR24	813	28	24	24	83	9
TELSR30	890	28	30	30	117	20
TELSR36	967	28	36	36	140	24
TELSR42	1042	28	42	42	140	24

**TELBS • Square Base with Rectangular Anodized Aluminum End Detail**

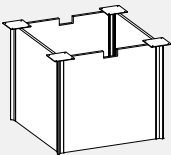

Single hinged access door is optional. Add "HD" to the end of the code. Add \$122 to list price.

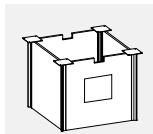

PRODUCT CODE	PRICE	SIZE/INCHES			WEIGHT LBS	VOL FT <sup>3</sup>
		H	W	D		
TELBS18	761	28	18	18	77	7
TELBS24	851	28	24	24	83	9
TELBS30	945	28	30	30	117	20
TELBS36	1051	28	36	36	140	24
TELBS42	1159	28	42	42	140	24

**TRUM • Trumpet Column Base**

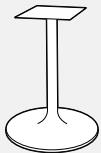

PRODUCT CODE	PRICE		SIZE/INCHES			WEIGHT LBS	VOL FT <sup>3</sup>
	PAINTED	CHROME	H	W	D		
TRUM18	430	562	28	18	18	15	9
TRUM24	493	624	28	24	24	18	13
TRUM30	800	931	28	30	30	20	15
TRUM18BH	635	765	40.5	18	18	26	18
TRUM24BH	726	858	40.5	24	24	29	15

**TTFD • Flat Disk Column Base**

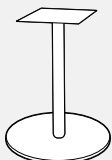

PRODUCT CODE	PRICE		SIZE/INCHES			WEIGHT LBS	VOL FT <sup>3</sup>
	PAINTED	CHROME	H	W	D		
TTFD18	768	915	28	18	18	50	9
TTFD22	829	975	28	22	22	55	13
TTFD24	891	1036	28	24	24	66	14
TTFD30	1294	1356	28	30	30	88	15
TTFD36	1723	1867	28	36	36	110	15
TTFD18BH	942	1088	40.5	18	18	72	11
TTFD22BH	1003	1148	40.5	22	22	77	15
TTFD24BH	1063	1209	40.5	24	24	110	17



**TTSQ • Flat Square Column Base**

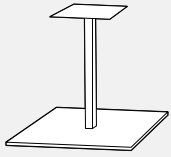

Plate size: (18"-30" 11"x11"), (36" 14"x14").  
 Column size: (18"-24" 2.1/2"), (30"-36" 3")

PRODUCT CODE	PRICE		SIZE/INCHES			WEIGHT LBS	VOL FT <sup>3</sup>
	PAINTED	CHROME	H	W	D		
TTSQ18	1076	1207	28	18	18	50	9
TTSQ23	1199	1330	28	23	23	61	13
TTSQ30	1537	1669	28	30	30	88	15
TTSQ18BH	1250	1381	40.5	18	18	72	11
TTSQ23BH	1371	1503	40.5	23	23	83	15

**TTFLTX • Flat Bar "X" Column Base**

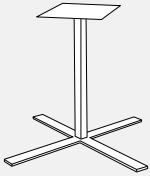

Plate size: (18"-30" 11"x11"), (36" 14"x14").  
 Column size: (18"-24" 2.1/2"), (30"-36" 3")

PRODUCT CODE	PRICE		SIZE/INCHES			WEIGHT LBS	VOL FT <sup>3</sup>
	PAINTED	CHROME	H	W	D		
TTFLTX18	1137	1342	28	18	18	15	9
TTFLTX22	1153	1357	28	22	22	17	11
TTFLTX24	1168	1373	28	24	24	18	13
TTFLTX30	1199	1374	28	30	30	20	15
TTFLTX36	1229	1433	28	36	36	22	24
TTFLTX18BH	1310	1516	40.5	18	18	26	11
TTFLTX22BH	1326	1529	40.5	22	22	28	13
TTFLTX24BH	1371	1579	40.5	24	24	29	15

**TTFLT • Flat Bar "T" Column Base**

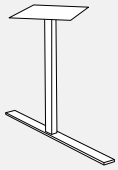

Plate size: (18"-30" 11"x11"), (36" 14"x14").  
 Column size: (18"-24" 2.1/2"), (30"-36" 3")

PRODUCT CODE	PRICE		SIZE/INCHES			WEIGHT LBS	VOL FT <sup>3</sup>
	PAINTED	CHROME	H	W	D		
TTFLT18	860	1007	28		18	9	2
TTFLT22	877	1024	28		22	10	2
TTFLT24	891	1036	28		24	11	3
TTFLT30	923	1069	28		30	13	3
TTFLT36	954	1099	28		36	15	3

**TTFL3P • Flat Bar 3 Prong Column Base**

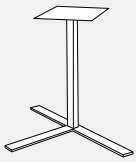
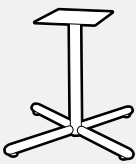

Plate size: (18"-30" 11"x11"), (36" 14"x14").  
 Column size: (18"-24" 2.1/2"), (30"-36" 3")

PRODUCT CODE	PRICE		SIZE/INCHES			WEIGHT LBS	VOL FT <sup>3</sup>
	PAINTED	CHROME	H	W	D		
TTFL3P18	1076	1282	28		18	11	7
TTFL3P22	1092	1297	28		22	12	13
TTFL3P24	1107	1312	28		24	13	15
TTFL3P30	1137	1342	28		30	15	15
TTFL3P36	1153	1357	28		36	18	24

**LL4S • 4 Star Table Leg with Bullnose End**



- Leg Plate is 11"x11" for 26" and 30" spread and 14"x14" for 36" spread.
- For the caster option specify "CS" at the end of the code with a \$77 upcharge

PRODUCT CODE	PRICE		SIZE/INCHES			WEIGHT LBS	VOL FT <sup>3</sup>
	PAINTED	CHROME	H	W	D		
LL4S18	437	553	28	18	18	15	7
LL4S26	519	635	28	26	26	18	15
LL4S30	552	669	28	30	30	20	15
LL4S36	607	724	28	36	36	22	24

**LL4S-42 • Bistro Leg with Bullnose End**



- Leg Plate is 11"x11" for 26" and 30" spread.

PRODUCT CODE	PRICE		SIZE/INCHES			WEIGHT LBS	VOL FT <sup>3</sup>
	PAINTED	CHROME	H	W	D		
LL4S2642	592	710	40.5	26	26	22	18
LL4S3042	633	750	40.5	30	30	24	23
LL4S3642	691	806	40.5	36	36	26	28

**LLT • "T" Table Leg with Bullnose End**



- Leg Plate is 11"x11"
- For the caster option specify "CS" at the end of the code with a \$37 upcharge

PRODUCT CODE	PRICE		SIZE/INCHES			WEIGHT LBS	VOL FT <sup>3</sup>
	PAINTED	CHROME	H	W	D		
LLT18	268	385	28	18	6	9	2
LLT26	284	400	28	26	6	11	3
LLT30	295	410	28	30	6	13	3
LLT36	546	662	28	36	6	15	3

**LLTT • “TT” Table Leg with Bullnose End**



- Leg Plate is 11”x 24”
- For the caster option specify “CS” at the end of the code with a \$37 upcharge

PRODUCT CODE	PRICE		SIZE/INCHES			WEIGHT		VOL FT <sup>3</sup>
	PAINTED	CHROME	H	W	D	LBS		
LLTT18	447	594	28	18	6	13	2	
LLTT26	471	617	28	26	6	20	3	
LLTT30	485	633	28	30	6	24	3	
LLTT36	699	844	28	36	6	26	3	
LLTT42	817	965	28	42	6	31	4	

**LLSQ • Square Post Leg**

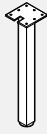

- 2.5” x 2.5” square tubular leg provides support for worksurfaces.
- Top plate welded to leg.
- 8” x 8” plate attached with #10 3/4” wood screws included.
- 1” height adjustment range.

PRODUCT CODE	PRICE		SIZE/INCHES			WEIGHT		VOL FT <sup>3</sup>
	PAINTED	CHROME	H	W	D	LBS		
LLSQ25X25H28	218	334	28	2.5	2.5	9	0.17	

**LATBL • Tapered Leg**



- Tapered leg provides support for worksurfaces.
- Top plate welded to leg.
- 8” x 8” plate attached with #10 3/4” wood screws included.
- 1” height adjustment range.
- Bottom of leg tube is a 1” diameter and top is 2 3/8” diameter.

PRODUCT CODE	PRICE		SIZE/INCHES			WEIGHT		VOL FT <sup>3</sup>
	PAINTED	CHROME	H	W	D	LBS		
LATBL28	177	301	28	3	3	9	0.17	

**BHML • Monoleg**



- 3” diameter Monoleg provides support for worksurfaces.
- Top plate welded to leg.
- 8” x 8” plate attached with #10 3/4” wood screws included.
- 1” height adjustment range.

PRODUCT CODE	PRICE		SIZE/INCHES			WEIGHT		VOL FT <sup>3</sup>
	PAINTED	CHROME	H	W	D	LBS		
BHML03	188	304	28	3	3	9	0.17	

**L2BHML • Monoleg**

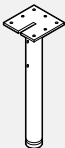

- 3” diameter Monoleg provides support for worksurfaces.
- Cut-out top plate welded to leg. Cut-out accepts 3/4” modesty panel.
- 8” x 8” plate attached with #10 3/4” wood screws included.
- 1” height adjustment range.

PRODUCT CODE	PRICE		SIZE/INCHES			WEIGHT		VOL FT <sup>3</sup>
	PAINTED	CHROME	H	W	D	LBS		
L2BHML03	188	304	28	3	3	9	0.17	

**LBHML06 • 6” Monoleg**



- 6” diameter Monoleg provides support for worksurfaces.
- Top plate welded to leg flush.
- 8” x 8” plate attached with #10 3/4” wood screws, included.
- 1” height adjustment range.
- Leg is offset flush to edge.

PRODUCT CODE	PRICE		SIZE/INCHES			WEIGHT		VOL FT <sup>3</sup>
	PAINTED	CHROME	H	W	D	LBS		
LBHML06	362	508	28	6	6	9	0.17	

**FOLDLEG • Folding Leg**



- Sold as a set of two.
- Available in only in (SIL) Silver or (BLK) Black.

PRODUCT CODE	PRICE		SIZE/INCHES			WEIGHT		VOL FT <sup>3</sup>
			H	W	D	LBS		
FOLDLEG	418		28	24.625	3	11	7	

**LHC • HAT Channel for Conference Tables**

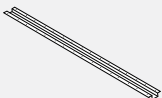

- See chart on page H.2

PRODUCT CODE	PRICE		SIZE/INCHES			WEIGHT		VOL FT <sup>3</sup>
			H	W	D	LBS		
LHC40	56		1.4	40	5	4	0.20	
LHC46	62		1.4	46	5	6	0.22	
LHC52	66		1.4	52	5	7	0.25	
LHC58	76		1.4	58	5	8	0.28	
LHC64	85		1.4	64	5	9	0.31	
LHC70	91		1.4	70	5	10	0.33	

**LVB • Visual Board**

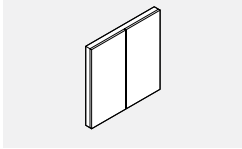

• See page H.1 for technical information.

PRODUCT CODE	FINISH		SIZE/INCHES			WEIGHT		VOL FT <sup>3</sup>
	LP/B	HP/B	H (LP/B)	W	D	LBS		
LVB48	1533	1697	48	48	8	154	10	
LVB48MG	2385	2629	48	48	8	154	10	

**MSPDM • 1 Duplex, 2 Data**



- Includes one duplex and 2 data jacks (both RJ45, Cat 6)
- Black plastic

PRODUCT CODE	PRICE	PRICE			WEIGHT		VOL FT <sup>3</sup>
		H	W	D	LBS		
MSPDM	276	2.75	6.5	3.5	2	0.1	

**ModPower Power Solution**

- Power solutions for flexible spaces. Connect up to four units (in Canada)/six units in the USA from a single infeed with NEMA plug and charging ports to the table top. In-surface modules and clamp on modules available.
- Easy to install; code compliant that allows users to optimize any space providing convenient power access. Perfect for training areas, meeting rooms, in-office workstations and more. Units feature tamper-resistant receptacles as well as both USB-A and USB-C charging ports.
- Easy to use connectors that are touch-safe with added latch to prevent unintended separation. Easy push together to connect, and simple press down on latch to disconnect.
- Maximum overall length not to exceed 48.5 feet per infeed. UL listed to UL962A SD, the standard for furniture power distribution units for portable/moveable work space tables.
- Certified to CSA standard C22.2 No. 203-16.
- Will work with Licence, Terina and Bridges Products.
- Surface mounted module ships with a clamp mount that will accommodate any material 1/2" to 1-1/2" thick; additional brackets are also included for screw in mounting options that

- can accommodate vertical or horizontal positions.
- Modules can be integrated into surfaces but the surface must be specified as a special.

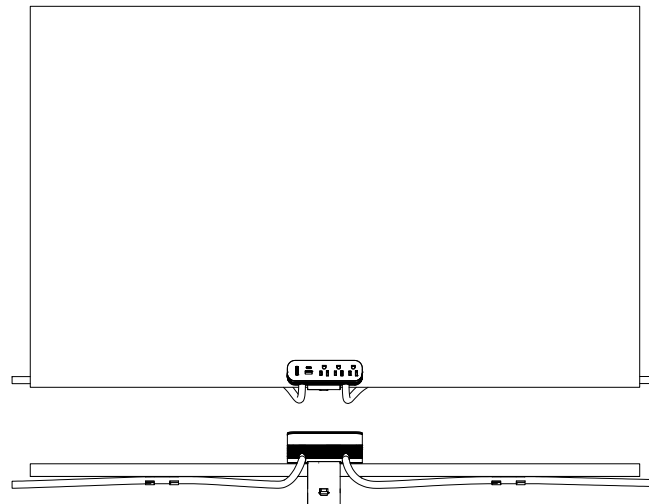
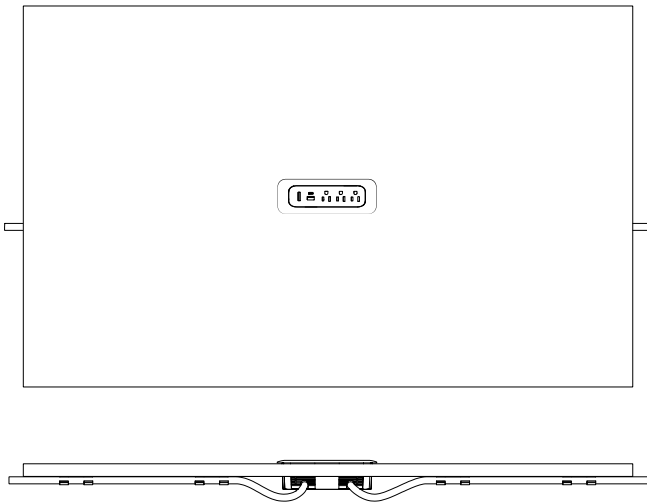
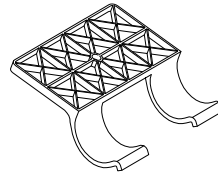

**GMDSF10 • ModPower In Surface Starter Unit**

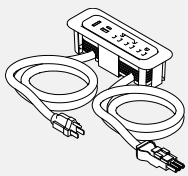

- ModPower starter unit includes one 10' cord with a NEMA plug and one 3' connector cord.
- Unit equipped with three 15A tamper resistant receptacles, one USB-A and one USB-C charging ports and a circuit breaker.
- 4 cable management cord clips included.
- MG at the end of the code indicates a magnesium finish, while WH is a white finish.

PRODUCT CODE	PRICE	PRICE			WEIGHT		VOL FT <sup>3</sup>
		H	W	D	LBS		
GMDSF10MG	597	7.63	2.75	2.63	3.44	1.0	
GMDSF10WH	597	7.63	2.75	2.63	3.44	1.0	

**GMDCF3 • ModPower In Surface Middle Unit**

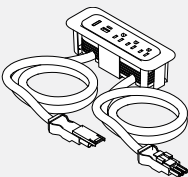

- ModPower middle unit includes two 3' connector cords.
- Unit equipped with three 15A rated 12A tamper resistant receptacles, one USB-A and one USB-C charging ports and a circuit breaker.
- 4 cable management cord clips included.
- MG at the end of the code indicates a magnesium finish, while WH is a white finish.

PRODUCT CODE	PRICE	PRICE			WEIGHT		VOL FT <sup>3</sup>
		H	W	D	LBS		
GMDCF3MG	562	7.63	2.75	2.63	2.44	1.0	
GMDCF3WH	562	7.63	2.75	2.63	2.44	1.0	

**GMDEF3 • ModPower In Surface End Unit**

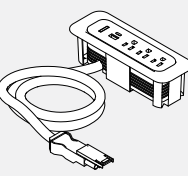

- ModPower end unit includes one 3' connector cord.
- Unit equipped with three 15A rated 12A tamper resistant receptacles, one USB-A and one USB-C charging ports and a circuit breaker.
- 2 cable management cord clips included.
- MG at the end of the code indicates a magnesium finish, while WH is a white finish.

PRODUCT CODE	PRICE	PRICE			WEIGHT		VOL FT <sup>3</sup>
		H	W	D	LBS		
GMDEF3MG	494	7.63	2.75	2.63	1.85	1.0	
GMDEF3WH	494	7.63	2.75	2.63	1.85	1.0	

**GMDSA10 • ModPower Starter Mounted Unit**

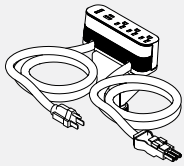

- ModPower starter unit includes one 10' cord with a NEMA plug and one 3' connector cord.
- Unit equipped with three 15A tamper resistant receptacles, one USB-A and one USB-C charging ports and a circuit breaker.
- Includes edge clamp and 3 other mounting methods; and 4 cable management cord clips.
- MG at the end of the code indicates a magnesium finish, while WH is a white finish.

PRODUCT CODE	PRICE	PRICE			WEIGHT		VOL	
		H	W	D	LBS	FT <sup>3</sup>		
GMDSA10MG	631	6.13	1.75	2.5	4.33	1.0		
GMDSA10WH	631	6.13	1.75	2.5	4.33	1.0		

**GMDCA3 • ModPower Middle Mounted Unit**

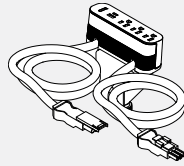

- ModPower middle unit includes two 3' connector cords.
- Unit equipped with three 15A rated 12A tamper resistant receptacles, one USB-A and one USB-C charging ports and a circuit breaker.
- Includes edge clamp and 3 other mounting methods; and 4 cable management cord clips.
- MG at the end of the code indicates a magnesium finish, while WH is a white finish.

PRODUCT CODE	PRICE	PRICE			WEIGHT		VOL	
		H	W	D	LBS	FT <sup>3</sup>		
GMDCA3MG	597	6.13	1.75	2.5	3.33	1.0		
GMDCA3WH	597	6.13	1.75	2.5	3.33	1.0		

**GMDEA3 • ModPower End Mounted Unit**

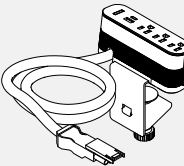

- ModPower end unit includes one 3' connector cord.
- Unit equipped with three 15A rated 12A tamper resistant receptacles, one USB-A and one USB-C charging ports and a circuit breaker.
- Includes edge clamp and 3 other mounting methods; and 2 cable management cord clips.
- MG at the end of the code indicates a magnesium finish, while WH is a white finish.

PRODUCT CODE	PRICE	PRICE			WEIGHT		VOL	
		H	W	D	LBS	FT <sup>3</sup>		
GMDEA3MG	528	6.13	1.75	2.5	2.75	1.0		
GMDEA3WH	528	6.13	1.75	2.5	2.75	1.0		

**GMDCLIPS • ModPower Management Clips**

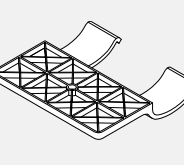

- Includes 10 clips.

PRODUCT CODE	PRICE	PRICE			WEIGHT		VOL	
		H	W	D	LBS	FT <sup>3</sup>		
GMDCLIPS	102	2.6	2.5	0.6	0.3	0.2		

**GMDJ36BK • ModPower Interconnecting Jumper**

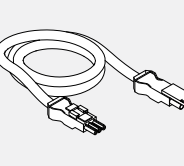

- ModPower interconnecting jumper cord to add an additional 3 feet of cord length between ModPower units.
- Package of 2, each 3 feet with male & female connector.

PRODUCT CODE	PRICE	PRICE			WEIGHT		VOL	
		H	W	D	LBS	FT <sup>3</sup>		
GMDJ36BK	329	36			1.38	0.9		

**BG5 • Rectangular Grommet**

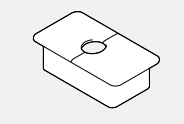

- Option (BLK) Black Plastic (GRY) Grey Plastic (WHT) White Plastic

PRODUCT CODE	PRICE	PRICE			WEIGHT		VOL	
		H	W	D	LBS	FT <sup>3</sup>		
BG5	35		3.5	2				

**Telecom Plates**



**PRODUCT CODE**  
**Black telecom plate with 2 RJ45 cat 6 data**  
 ABLBB 245



**Black telecom plate with 3 RJ45 cat 6 data**  
 ABLBBB 361



**Black telecom plate with 4 RJ45 cat 6 data**  
 ABLBBBB 476

**GCRTMCS401 • Recessed Power Block, 1 Duplex, 1 Data Knock-outs, 1 Power Duplex**

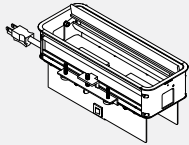

- Single sided recessed power block with 1 regular duplex and 1 data knock-out on top, 1 power duplex on bottom.
- 10 ft power cord with straight plug.
- Telecom plates ordered separately.
- Available in Black - B, Tungsten - T or Designer White - W as indicated by last letter of model number; duplexes always grey.
- Not approved for daisy-chain applications.

PRODUCT CODE	PRICE	H	W	D	WEIGHT LBS	VOL FT <sup>3</sup>
GCRTMCS401B	578	4.86	10.78	4.22	4.3	0.51
GCRTMCS401T	578	4.86	10.78	4.22	4.3	0.51
GCRTMCS401W	578	4.86	10.78	4.22	4.3	0.51

**GCRTMCS421 • Recessed Power Block, 1 Power including USB A+C, 1 Data Knock-outs, 1 Power Duplex**

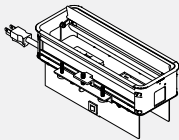

- Single sided recessed power block with 1 power and USB A+C duplex and 1 data knock-out on top, 1 power duplex on bottom.
- USB Type A port charges maximum 2.4 amps at 5V and Type C port charges maximum 3 amps at 5V.
- 10 ft power cord with straight plug.
- Telecom plates ordered separately.
- Available in Black - B, Tungsten - T or Designer White - W as indicated by last letter of model number; duplexes always grey.
- Not approved for daisy-chain applications.

PRODUCT CODE	PRICE	H	W	D	WEIGHT LBS	VOL FT <sup>3</sup>
GCRTMCS421B	759	4.86	10.78	4.22	4.3	0.51
GCRTMCS421T	759	4.86	10.78	4.22	4.3	0.51
GCRTMCS421W	759	4.86	10.78	4.22	4.3	0.51

**GCRTMCD602 • Recessed Power Block, 2 Duplex, 2 Data Knock-outs, 1 Power Duplex**

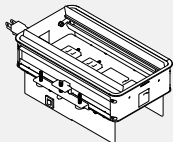

- Double sided recessed power block with 2 regular duplex and 2 data knock-outs on top, 1 power duplex on bottom.
- 10 ft power cord with straight plug.
- Telecom plates ordered separately.
- Available in Black - B, Tungsten - T or Designer White - W as indicated by last letter of model number; duplexes always grey.
- Not approved for daisy-chain applications.

PRODUCT CODE	PRICE	H	W	D	WEIGHT LBS	VOL FT <sup>3</sup>
GCRTMCD602B	660	4.86	10.78	6.22	5.9	0.51
GCRTMCD602T	660	4.86	10.78	6.22	5.9	0.51
GCRTMCD602W	660	4.86	10.78	6.22	5.9	0.51

**GCRTMCD622 • Recessed Power Block, 1 Duplex, 1 Power including USB A+C, 2 Data Knockouts, Power Duplex**

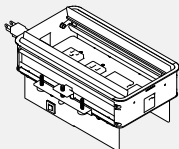

- Double sided recessed power block with 1 regular duplex, 1 power and USB A+C and 2 data knock-outs on top, 1 power duplex on bottom.
- USB Type A port charges maximum 2.4 amps at 5V and Type C port charges maximum 3 amps at 5V.
- 10 ft power cord with straight plug.
- Telecom plates ordered separately.
- Available in Black - B, Tungsten - T or Designer White - W as indicated by last letter of model number; duplexes always grey.
- Not approved for daisy-chain applications.

PRODUCT CODE	PRICE	H	W	D	WEIGHT LBS	VOL FT <sup>3</sup>
GCRTMCD622B	831	4.86	10.78	6.22	6.1	0.51
GCRTMCD622T	831	4.86	10.78	6.22	6.1	0.51
GCRTMCD622W	831	4.86	10.78	6.22	6.1	0.51

**GCRTMCD642 • Recessed Power Block, 2 Power including USB A+C, 2 Data Knock-outs, 1 Power Duplex**

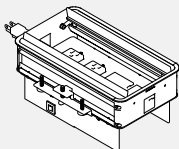

- Double sided recessed power block with 2 power and USB A+C and 2 data knock-outs on top, 1 power duplex on bottom.
- USB Type A port charges maximum 2.4 amps at 5V and Type C port charges maximum 3 amps at 5V.
- 10 ft power cord with straight plug.
- Telecom plates ordered separately.
- Available in Black - B, Tungsten - T or Designer White - W as indicated by last letter of model number; duplexes always grey.
- Not approved for daisy-chain applications.

PRODUCT CODE	PRICE	H	W	D	WEIGHT LBS	VOL FT <sup>3</sup>
GCRTMCD642B	1001	4.86	10.78	6.22	6.3	0.51
GCRTMCD642T	1001	4.86	10.78	6.22	6.3	0.51
GCRTMCD642W	1001	4.86	10.78	6.22	6.3	0.51

**Terina Tables**

Terina™ is a multi-purpose table that allows you to quickly adapt your space to suit your needs. The simple flip-top mechanism is designed for single-handed operation. Tables nest in an upright position to minimize storage space.

**Worksurfaces**

Laminate surfaces (B) are 1-1/16" thick tops constructed of 45lb. density particle board with high pressure laminate and finished on the underside of the surface with a kraft paper backing. Veneer (V) surfaces are 1-3/16" thick tops constructed of 45 lb. density particle board and are balanced on the underside with veneer (unfinished). Worksurfaces are pre-drilled for alignment of the Terina base.

**Base**

Tables feature an aluminum leg, cross beam and die-cast foot. Legs and cross beam are available in all standard panel frame painted finishes. Die-cast foot is always in polished aluminum finish. Foot span is 36". Stacking depth of 9".

**Casters**

Casters are standard on all tables. 2-3/8" dual wheel casters with manual lock. Full 360° swivel. Suggested for carpeted surfaces. Available in grey only.

**Ganging Plates**

Ganging plates are available for ganging adjoining tables together. Ganging plates are black epoxy coated steel plates with two thumbscrews.

**Wire Management**

Wire management option is a snap-in channel that fits on the interior of the leg or on the understand of the flip-top cross beam.

**Modesty Panels**

10" Modesty panel affixes to the top and base, articulating when it folds down. available in all standard LP laminate and veneer finishes.

**GFT-R • Rectangular Flip Top Training Table**

- B and V edge tops have square corners



PRODUCT CODE	PRICE					WEIGHT LBS	VOL FT³
	B	V	H	W	D		
GFT2448R	1177	1921	29	48	24	48	6
GFT2454R	1225	2062	29	54	24	53	6
GFT2460R	1274	2091	29	60	24	55	7
GFT2466R	1292	2130	29	66	24	61	7
GFT2472R	1310	2165	29	72	24	66	7
GFT3048R	1225	1965	29	48	30	53	6
GFT3054R	1252	2117	29	54	30	55	6
GFT3060R	1292	2154	29	60	30	61	7
GFT3066R	1308	2238	29	66	30	66	7
GFT3072R	1337	2316	29	72	30	68	7

**GFT-M • Folding Modesty Panel**

- Includes hardware to connect to Terina Tables.
- Woodgrain modesty panels over 60" will have the woodgrain run horizontally, whereas others will run vertically.
- Due to location of the modesty panel, only MSPDM and GMDSF10 grommets can be used on Terina tables with modesty panels.

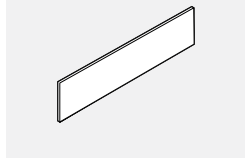

PRODUCT CODE	PRICE					WEIGHT LBS	VOL FT³
	LP	V	H	W	D		
GFT48M	290	484	10	46	0.75	11	1
GFT54M	302	543	10	52	0.75	13	1
GFT60M	314	601	10	58	0.75	15	1
GFT66M	324	656	10	64	0.75	18	2
GFT72M	339	714	10	70	0.75	20	2

**GFTCM • Wire Manager**

- Set of four
- Each piece is 10" long

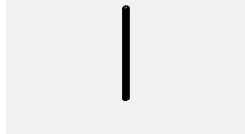

PRODUCT CODE	PRICE				WEIGHT LBS	VOL FT³
	H	W	D			
GFTCM04BLK	36	2	10	2	1	1

**GFCNGFP • Ganging Flush Plate**

- Please specify application so that inserts may be added to surface.

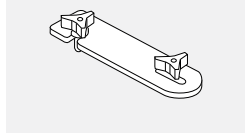

PRODUCT CODE	PRICE			WEIGHT LBS	VOL FT³
	H	W	D		
GFCNGFP	36	2.5	5	0.1	0.01

**Technical Information - Vice Versa Tables**

**Tables**

- All worksurfaces have threaded inserts for metal-to-metal connection of support hardware.
- 60" and 72" tables come standard with wire manager.
- HP tops are 1 1/16" thick laminate particle board.

**HP Top with T-Mould Edge**

- Rectangular mobile table made of 1 1/16" thick particle board with High Pressure laminate finish. HP tops have 3.5mm PVC edge.

**Viceversa Leg**

- Universal mounting plate can be used to gang 2 tables simply by rotating 45° to span 2 table tops without metal skirts.

- Table legs have a wire management channel that neatly organizes electrical and communication cables running from the worksurfaces to the floor.

- The channel is covered by a clear PVC snap-on cover.

- The Viceversa leg features a push button height adjustment mechanism. This mechanism allows the user to easily set the height of a table.

Legs have a height range of 23.5" – 30.5" in 1" increments for levelers and 25"-33" with casters.

**Viceversa legs are available with:**

- Levelers
- Locking casters.

**NOTES:**

- Levelers have a 0.5" height range.
- Levelers available in Charcoal Grey only.
- Casters available in grey with black only.
- Legs are available in our (6) standard finishes.
- Finish is durable environmentally friendly paint.

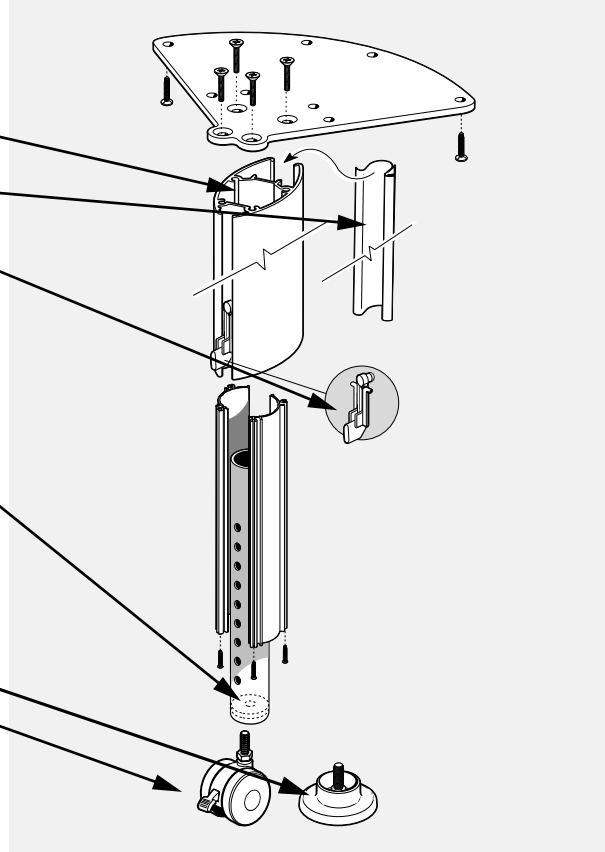

**VVRT • Rectangular Tables with 4 Legs**

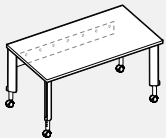

- **Tables are designed to work individually or as a group. They can be moved to meet the changing needs of an individual or group.**
- Tables come standard with 4 locking casters. Optional levelers available, please specify.
- 6" metal skirt provides strength and stability.
- Modesty Panel, Pong Panel or 6" metal skirt cannot be used on tables with 2 legs or shared tables.

PRODUCT CODE	PRICE HP	SIZE/ INCHES			WEIGHT VOL	
		H	D	W	LBS	FT³
VVRT2448HP4	900	26-32	24	48	63	7.11
VVRT2460HP4	989	26-32	24	60	71	7.36
VVRT2472HP4	1036	26-32	24	72	78	7.62
VVRT3060HP4	1081	26-32	30	60	80	7.69
VVRT3072HP4	1124	26-32	30	72	90	8.01

**VVS • Square Tables with 4 Legs**

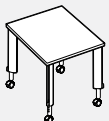

- **Square tables are designed to work individually or as a grouping. They can be moved to meet the changing needs of an individual or group.**
- Tables come standard with 4 locking casters. Optional levelers available, please specify.

PRODUCT CODE	PRICE HP	SIZE/ INCHES			WEIGHT VOL	
		H	D	W	LBS	FT³
VVS30HP4	989	26-32	30	30	71	7.2
VVS36HP4	1036	26-32	36	36	76	7.6
VVS42HP4	1081	26-32	42	42	82	8.0
VVS48HP4	1173	26-32	48	48	88	8.4

**VVR • Round Tables with 4 Legs**



- **Round tables are designed to work individually or as a group. They can be moved to meet the changing needs of an individual or group.**
- Tables come standard with 4 locking casters. Optional levelers available, please specify.

PRODUCT CODE	PRICE HP	SIZE/ INCHES			WEIGHT VOL	
		H	D	W	LBS	FT³
VVR30HP4	947	26-32	30	30	57	6.8
VVR36HP4	989	26-32	36	36	64	7
VVR42HP4	1036	26-32	42	42	71	7.2
VVR48HP4	1124	26-32	48	48	79	7.6