

Systems

Effective July 2024 Canada

PRICE LIST
systems
panel + deskking



General Information	A	Accessories	E	Licence	J
Table of Contents		Keyboard Trays and Mechanisms	E.1	Product Overview	J.1
Terms and Conditions		Computer Support	E.4	Woodgrain Chart	J.2
Lifetime Warranty		Monitor Arms	E.4	Grommet Chart	J.3
Finishes		Lights	E.8	Desks	J.6
Key Alike Form		Grommets/Power Modules/Bars	E.9	Reception Desks	J.14
		Paper Management	E.11	Desks & Return Desks	J.16
Systems		Evolve	F	Shaped Table Desks	J.33
Boulevard	B	Product Overview	F.1	Runoff Shaped Tables	J.42
Product Overview	B.1	Value Added Benefits	F.3	Floating Shaped Tables	J.43
Value Added Benefits	B.3	Woodgrain Chart	F.4	Modesty Panels	J.45
Woodgrain Chart	B.4	Graphic Panels	F.5	Storage	J.46
Boulevard 1 Technical Information	B.5	Panel Connectors and Trims	F.8	Pantry	J.75
Boulevard 1 Panels	B.6	Panel Connectors and Trims	F.34	Collaboration Tables	J.76
- Guidelines for Ordering Product		No Raceway Panels	F.46	Conference Tables	J.78
Boulevard 1 Graphic Panels	B.7	No Raceway Panel Connectors	F.50	Conference Table Bases	J.94
Boulevard 1 Panels	B.9	Freestanding Panels	F.54	Visual Board	J.98
Boulevard 1 Connectors and Trims	B.23	Acoustic Grid	F.66	Conference Table Modules	J.99
Boulevard System 3 Panel	B.30	Electrical	F.68		
System/Technical Information		Power Beam	F.74	Terina Tables	K
Boulevard System 3 Panels	B.31	Worksurface	F.94	Vice Versa Tables	L
-Guidelines for Ordering Product		Worksurface Hardware	F.107		
Boulevard System 3 Graphic Panels	B.32	Laminate Gallery Panels	F.110	Kadin Tables	M
Boulevard System 3 Panels	B.34	Storage	F.122		
Boulevard System 3 Connectors and Trims	B.52	Accessories	F.138	FreeFit Height Adjustable Tables	N
Boulevard Gallery Panels	B.56	Soft Pod	G	Product Overview	N.1
Electrical	B.62	Introduction	G.1	Bases	N.6
Worksurfaces	B.71	Planning and Application	G.3	Tops	N.10
Worksurface Hardware	B.82	Softpods and Extensions	G.18	Power/Data	N.14
Storage	B.86	Electrical	G.20	Dividers	N.17
		Storage	G.24	Accessories	N.22
Diet	C	Accessories	G.26		
Diet Panel System/Technical Information	C.1	Universal Panels	H	Priva Pods	O
Panel Connectors	C.2	Universal Divider Panels	H.1	Product Overview	O.1
Panel Connectors	C.9	Freestanding Dividers Polycarbonate	H.2	Pods	O.2
Electrical	C.15	Freestanding Dividers Felt	H.3		
Linking Panels	C.16	Freestanding Dividers Glass	H.4	Wellness Solutions	P
Linking Panel Connectors	C.18			Screens	P.1
Worksurfaces and Hardware	C.19	Desking		Booth	P.2
Storage	C.20				
Compile	D	Bridges	I		
Product Overview	D.1	Product Overview	I.1		
Panel Connectors	D.3	Woodgrain Chart	I.2		
Electrical	D.43	Leg/Handle Details	I.4		
Worksurfaces	D.47	Rectangular Leg Packages	I.5		
Worksurface Hardware	D.49	Round Leg Packages	I.13		
Storage	D.56	Rectangular Leg Components	I.17		
	D.65	Round Leg PComponents	I.19		
		Beams	I.21		
		Worksurfaces	I.24		
		Display Wall	I.27		
		Power	I.28		
		Powerbeam	I.35		
		Dividers	I.47		
		Storage	I.72		
		Collaborative Seating	I.87		

Terms and Conditions

This illustrated list price book has been designed to facilitate fast reference and easy use. The line drawings match actual products (where possible) to aid in instant recognition of each item, but they are graphic representations only.

Sales of Global Contract's products are made only on Global Contract's standard Terms and Conditions of sale which are contained in this list price book. The "Purchaser" in these Terms, Conditions and General Information shall refer to Dealers and those who originally purchase directly from Global Contract for use or re-sale. These standard Terms and Conditions may be modified or supplemented only by a separately written document signed by Global Contract's authorized personnel at its head office in Toronto, Ontario, Canada. Any term or condition contained in any purchase order or other form used by the Purchaser to order goods (including standard, printed language) which is different from, in addition to, or in any way inconsistent with Global Contract's standard Terms and Conditions shall be of no force or effect whatsoever.

All illustrations, specifications and prices in this list price book are based on the latest product information available at the time of publication. Global Contract reserves the right to make changes at any time and without prior notice to prices, colours, materials, specifications and models offered.

Description

Each product shown or described in this list price book is standard Global Contract product. Available options are noted at the beginning of each series or at the beginning of the price list. Available options may require additional delivery time and cost, and may affect the warranty given. Sizes and weights shown are approximate and are subject to slight changes from time to time.

Prices and Payment

The prices shown in this Book, as well as those quoted by Global Contract, shall be Canadian dollars for orders shipped to destinations in Canada.

The price does not include any provincial or local property license, privilege, sales, use, value added, gross receipts, G.S.T. or other like taxes which may now or hereafter be applicable to, measured by or imposed upon or with respect to the transaction, the product, its sale, its value or its use, or any services performed in connection therewith.

If shipping date requested is more than 90 days from date of order, Global Contract shall have the right to use published list prices effective at the time of shipment.

Not included in the list price is special or export packing, freight, unpacking and installation. Orders are invoiced at the time of shipment.

Orders are invoiced at the time of shipment. Terms of payment are net 30 days. All orders are subject to the Purchaser complying with Global's prevailing credit policy.

Any product sold shall remain the property of Global Contract until fully paid for. The Purchaser agrees to perform all acts which may be necessary to perfect and assure retention of title to such products to Global Contract until such time as the goods have been paid for in full.

Delivery shall occur and risk of loss or damage to the product shall pass to Purchaser F.O.B. point of shipment. Purchaser is responsible for filing claims with the carrier for losses or damage to the product occurring during transit, including concealed damage.

Prices are suggested list prices only and are subject to change without notice. Global Contract will, however, attempt to keep the Purchasers up-to-date on all developments including price changes.

Taxes

All prices shown in this list price book are exclusive of sales, use, excise, HST and other applicable taxes and duties which may be the Purchaser's responsibility as per the invoice issued by Global. If the Purchaser claims an exemption from such taxes, it shall be the Purchaser's responsibility to furnish Global with an appropriate exemption certificate at time of order.

Order Information

Global Contract requires that all orders be submitted in writing. All orders submitted to Global Contract in writing will be acknowledged on Global Contract's acknowledgement forms governing the transaction.

The details appearing on this acknowledgement will describe the items to be shipped and the approximate shipping date. It is the Purchaser's responsibility to determine that the information in the acknowledgment is correct. In the event of an error, the Purchaser must notify their Global Contract Customer Service representative immediately by telephone followed by written confirmation. Shipping dates are assigned to orders based on the items having the longest manufacturing lead time (unless instructed to partial ship).

Purchaser must indicate if multiple shipping schedules are required. Each shipment will be invoiced at time of shipping and will be subject to payment terms described above.

When ordering, please provide the following information:

1. Account number (if possible)
2. PO number
3. "Bill to" and/or "Ship to" and name and address
4. Complete model number and selected options including textiles/finishes
5. Special instructions and tag information
6. Shipping instructions, please indicate:
 - a. pick up
 - b. Global trailer program
 - c. common carrier, provide name of carrier, your account number
7. Special quote (SQ) # (if applicable)
8. Customer's Own Material (COM), Global Contract Purchased Material (GPM), Customer's Own Leather (COL) - please see below.
9. For specials and custom quoted product, please indicate the custom quote # on your PO. If changes are made to the quote, a new quote must be issued prior to submitting the order. It is the Purchaser's responsibility to determine that the information on the quote is correct. Global will not be responsible for wrong product due to errors in the quote.

The above points will be checked by Global Contract for accuracy. Global Contract will process orders using the codes provided by the Purchaser. Price discrepancy is the responsibility of the Purchaser. The Purchaser must notify Global Contract prior to invoicing.

The Purchaser is responsible for providing correct information when placing an order. If no option(s) are selected the system, will default to standard feature(s). Orders with missing/incorrect information (finish, etc.) will be put on hold until all information is complete. Orders will be scheduled for manufacturing upon receipt of complete information.

Specifications and application drawing may be requested to be supplied for examination prior to approval.

Special Colours

Use of Customer's Own Material must be approved by Global Contract prior to acceptance of order. Fabric yardage requirement will be advised by factory, and additional yardage may be required if pattern requires matching. If Customer's Own Material (C.O.M.) is difficult to apply or if product must be modified, extra charges will be made. Global Contract reserves the right to cancel an order at any time if C.O.M. is inadequate for any reason. Customer's own material should be shipped freights and duties paid to Global Contract, 565 Petrolia Road, North York, Ontario. Such shipment must be fully identified with purchaser's order number, Global Contract's acknowledgment number and the item for which material is intended. For C.O.M. prices, use Grade 1 price. Performance of C.O.M. when applied to product is the sole responsibility of the purchaser.

Deposit on Special Orders

Orders for nonstandard products may, at Global Contract's discretion, require deposit prior to scheduling of production, the amount of the deposit being credited against the total price of the project.

Changes and Cancellation

After the date of Global's acknowledgment of the Purchaser's order, the order may not be changed or cancelled by the Purchaser without the written consent of Global. Orders for products upholstered in "special order textiles" (GPM) cannot be cancelled once material has been purchased. Special order items, COM and textile-covered items already in production are not subject to change or cancellation under any circumstances. Textile-covered items are considered to be in production once the textile is scheduled for cutting. Other standard items already in production are subject to a minimum 35% cancellation charge.

Global Contract reserves the right to cancel an order at any time if Special Order is in the sole judgement of Global Contract, inadequate for any reason.

Errors and Omissions

All quotations, acknowledgments and invoices are subject to corrections for any errors and omissions.

Disclaimer

Prices shown are current manufacturer's suggested list prices at the time of printing. Updated pricing is available on Global's website. All applicable taxes are extra. Descriptions, specifications and prices are subject to change without notice. Errors and omissions are subject to correction.

Custom Wood Staining

Custom wood staining procedure for wood seating is as follows. Customer provides a sample of the desired wood finish. That sample is sent to Global Contract Customer Service. Several finished samples will be sent back. The customer/end user will sign off on the samples (keeping one for their records) and return the rest of the samples. Global Contract will not necessarily match the wood species but rather will generate a colour that will coordinate with the sample when it is applied to the wood species used in the seating frame.

Metal File Finishes

There is no upcharge for any standard file finish. Any custom file finish must be approved by Global Contract prior to acceptance of order and will be subject to an upcharge to be confirmed at time of color matching.

Wood Veneer Finishes

Because the distinctive characteristics and the nature of wood products cause variations, exact matches are not always possible. Global Contract will not be held responsible if the finishes cannot be matched.

Customer's Own Material (COM)

Use of COM must be approved by Global Contract prior to acceptance of order. Please submit the Authorization Request Form. Photocopy and use this form as often as necessary. The customer must provide a 12" x 12" textile sample and advise how the textile is to be applied and quantity of textile being sent. Textile yardage requirement will be advised by the factory, and additional yardage may be required if pattern requires matching. Upon approval from Global Contract, send textile to the COM Department at 565 Petrolia Road, North York, ON, M3J 2X8.

If COM is difficult to apply or if product is required to be modified, extra charges will apply. Global Contract reserves the right to cancel an order at any time if COM is inadequate for any reason. COM must be shipped freight and duties paid if applicable to our factory. Such shipment must be fully identified with the Purchaser's order number, and the item for which the material is intended. Performance of COM when applied to product is the sole responsibility of the Purchaser. Global Contract's standard product warranty shall not apply to COM. The COM price is the lowest published price/grade for the series. The published yardage requirement for COM orders is approximate and shown beside each item in the list price book. The yardage shown there is based on the textile requirements for cutting and sewing a single chair in a plain patterned textile. For textiles with a pattern repeat or for COM orders involving 10 or more chairs, please consult with Customer Service for recalculation of the yardage requirements as this may significantly change the textile requirement.

Textile Grading

All products are priced according to their standard textile grade. Lower grade textiles may be available but at the same price as standard textile grade.

Combining two grades of textiles may result in a revised grade. Please refer to "Fabric Grades Combination Chart" in the Seating list price book. For more than two textiles a special quotation is required.

GPM (Global Contract Purchased Material, Customer Specified)

Global Contract may purchase material specified by the customer. Use of GPM must be approved by Global Contract prior to acceptance of order. If it is difficult to apply or if product is required to be modified, extra charges will apply. Global Contract reserves the right to cancel an order at any time if GPM is inadequate for any reason. Performance of GPM when applied to product is the sole responsibility of the textile vendor. Global Contract's standard warranty will not apply to GPM materials.

Customer's Own Leather (COL)

Not all seating can be upholstered in leather. Please consult series notes for availability. COL price is the lowest published grade for the series (leather or fabric).

Upholstery Coverings

Slight variations in colour may occur between dye lots. Although Global Contract attempts to minimize these variances, they do occur and must be accepted as normal and will not be considered defects.

Leather is a Natural Product

Natural variations occur in the colour, grain and texture of leather. As a result, a degree of variation should be expected. As leather is used it develops a patina. Its colour changes slightly, it will get marked and it will stretch and pull, these are the hallmarks of genuine leather and are not considered defects.

Yardage

Required yardage (yd) is based on unmatched materials with widths of 54" for seating, 63" for panels.

Arms

A wide selection of arms are available for some series. See Arm Chart in the Seating list price book.

Cubic Measure

The stated cubage is an approximate cubic foot measure to calculate freight costs. The figure shown is the volume for one carton, (one unit per carton unless otherwise noted) and is subject to change without notice.

Delays

Global Contract's order acknowledgement will state a shipping date which Global Contract best estimate at the time the order is acknowledged. However, Global Contract shall not incur any obligation or liability to Purchaser for failure to ship by specified date unless Global Contract has agreed to an unequivocal, firm shipping date in a separately signed written document executed by its authorized personnel at its head office. In addition, Global Contract shall not be liable for any loss or damage resulting from any delay or failure in shipment or other failure to perform all or any part of the agreement between the parties with respect to the goods shown on the face of the order acknowledgments where such delay, failure, loss or damage is the proximate result of any act or any governmental authority or political subdivision thereof, revolution, riot, civil disorder or disturbance, act of enemies, delay or default in transportation, strike disputes among or between labour unions or other labour disputes, delay or inability in obtaining materials and facilities, fire, flood, act of God or any cause not within the reasonable control of Global Contract, whether of the class of causes enumerated or otherwise. Without limiting the generality of the foregoing, Global Contract may, without causing breach or incurring liability, allocate goods which are in short supply, irrespective of the rea-

sons therefore, among purchaser, in any manner which Global Contract, in its sole discretion, deems advisable.

Suspension

In the event that the Purchaser defaults in the payment of any sum due to Global Contract, or in the event the Purchaser's financial condition becomes unsatisfactory to Global Contract, Global Contract shall have the right to defer or discontinue shipment of any goods until such time as the default is cured or the Purchaser provides assurance of payment to Global Contract.

Combined Shipments

Global Contract will make every effort to combine shipments and orders on written request. However, Global Contract cannot be held responsible where such request is not complied with.

Shipments

Purchaser must select, at time of order entry, one of two methods of freight payment. Global Contract will make no end-user shipments unless special arrangements have been made.

- 1) F.O.B. point of shipment, freight collect - pick up and common carrier.
- 2) F.O.B. point of shipment, freight pre-paid and invoiced to purchaser.

The Purchaser will determine the method of transportation and routing of shipment. In the event that the purchaser does not specify method and routing, Global Contract will have shipments expedited in the manner deemed appropriate. Contact Customer Service Department, Global Contract Inc., 565 Petrolia Road, North York, Ontario M3J 2X8 (416) 739-5000 with questions concerning shipping information on acknowledged orders.

F.O.B.

F.O.B. point is Global Contract's factory, Toronto, Ontario, Canada.

Back Charges

Global Contract will not accept charges for expense incurred by the Purchaser in expediting shipments. Global Contract will not accept charges for the repair of damage by others.

Code Restrictions

Global Contract items are within the limitations of local codes.

Service

Service problems are normally handled by the Global Contract's authorized dealer, as appropriate. Where this cannot be accomplished on a local level, service problems should be referred to Customer Service Department, Global Contract Inc., 565 Petrolia Road, North York, Ontario M3J 2X8, (416) 739-5000, csr@globalcontract.com.

Storage

In the event Purchaser requests postponement of delivery beyond the scheduled shipping date after the goods have become work in progress, or at the time when Global Contract is then about to make shipment, Global Contract may transfer the goods to storage for Purchaser's account and at Purchaser's risk and expense. Such transfer to storage shall be deemed delivered to Purchaser for all purposes, including invoicing and payment.

Claims

All goods are sold F.O.B. plant. Global Contract is not responsible for damage which occurs in transit or in storage. The carrier signs for all goods received in apparently good order. It is the Purchaser's responsibility to examine goods upon receipt and to file any claims with the carrier for losses or damage to the product occurring during transit, including concealed damage. Any claims made against Global Contract for apparent defects, errors or shortages must be made by the purchaser in writing within 15 working days after any delivery. Failure by the Purchaser to do so shall constitute acceptance of the goods and a waiver of any apparent defects, errors or shortages.

Installation

Global Contract requires the use of a certified installer when installing Global Contracts' products and systems so as to avoid any installation misrepresentations and/or unnecessary delivery and installation claims.

"Customer assumes full responsibility for the attachment method of work surfaces which were not purchased as part of a complete table assembly. Failure to secure the work surface capable of supporting the load capacity listed may result in property damage and/or personal injury. Customer agrees to indemnify and hold harmless Global Upholstery Co. Inc., its affiliates, subsidiaries, officers, directors, employees and shareholders (collectively "Global") from and against any lawsuits or threat of lawsuits and all liabilities, direct or implied, claims, proceedings, actions, causes of action, damages, losses, costs and expenses, including, without limitation, legal fees whatsoever which Global may suffer or incur as a result of fulfilling your product order. Customer acknowledges that this product order will not be covered under Global's Lifetime Warranty."

Returns

No returns of goods will be accepted without written consent and shipping instruction of Global Contract. A restocking charge of 35% based on list pricing is made on all authorized returns for credit or refund, provided goods are received by Global Contract in the condition in which they left the factory. This may increase depending on the type of product. No credit will be given if goods cannot be reused. Global's Return Goods Authorization (RGA) numbers must appear prominently on all authorized returns. Special order items are in no event subject to return. All returns must be approved and authorized in writing by Global Contract Customer Service. Global reserves the right to refuse delivery of any unauthorized returns.

Tolerances

All dimensions must be limited by a specified tolerance. When not specified it is understood that Global Contract's normal tolerances and standards shall apply. When purchaser has submitted his own plans and/or specifications, Global Contract will not be responsible for the design and fitting of parts. The conforming of Global Contract products to the specified tolerance is sufficient evidence as to the correctness of the product. Standards of finish, quality and appearance shall, unless specified in writing, be the normal standards of Global Contract.

Copyright

All catalogues, photographs, drawings, price lists and other printed material are protected by copyright. All rights reserved.

Trademark

Most series names are Global Contract's trademarks.

Design

Many of the products produced by Global Contract are protected by Design Registrations, Design Patents and/or Patents. Designs and specifications are subject to change, discontinuance or additions without notice.

Offer of Sale

Possession of this price list or any other literature shall not imply Global Contract's willingness to sell the holder and shall not be construed as a direct offer of sale. If a conflict arises between: (i) prices found in software support packages furnished to the customer by Global Contract or by any other source on behalf of Global Contract; and (ii) Global-Contract's current printed price lists, then the most current shall prevail.

Testing Qualifications

Many Global products pass or exceed the most stringent industry testing standards.

This list price book is effective as of June, 2016.

For periodic updates, please check the PDF at www.globalcontract.com. After login, select Resources then Price Lists. From here you will have the option to select any of our price lists. Global Contract warrants that all commercial products are free from defects in material and workmanship, for the life of the product, to the original Purchaser.

WARNING - SEATING PRODUCTS
TO PREVENT PRODUCT FAILURE AND POSSIBLE
INJURY:

Ensure that the appropriate selection is made for the intended use of the chair including user's weight. Some chairs are not recommended for users above a certain weight. Frequently inspect the chair for visible cracks and tighten all screws, bolts and adjustable knobs. If the chair is damaged or unstable, immediately remove it from service.

Casters

The list price book specifies the caster which comes standard with each chair model. Most chairs are equipped with hard casters which are best used on carpeted surfaces. If it is intended to use the product on hard surfaces such as ceramics, concrete, linoleum or hardwood, it is recommended to use different casters. It is the responsibility of the customer to determine the standard caster for a particular product and whether such caster is appropriate for the given application.

Any information or suggestions concerning applications, specifications or compliances with codes and standards is provided solely for your convenient reference and without any representation as to accuracy or suitability. Global disclaims any legal responsibility. The user must verify and test the suitability of any information or products for his specific application. Global reserves the right to change the Terms and Conditions in the list price book without notice.

LIFETIME WARRANTY

Global Contract warrants that all commercial products are free from defects in material and workmanship, for the life of the product, to the original Purchaser.

Global Contract will repair or replace, at Global Contract's option, as the sole remedy for any defect covered by the warranty. The warranty applies to products manufactured after June 1, 2016.

This Lifetime Warranty is NOT applicable to customers who use Global Contract products for rental purposes, product installed by non-certified installer and is effective only for products, parts or components manufactured after August 1, 1998.

General Commercial Seating

Global's warranty for general commercial seating covers all chair components including pneumatic cylinders, bases, casters, glides, frames, arms, plastic seats, backs and other structural components.

Exceptions to the warranty for general commercial seating are as follows:

- Foam, textiles (as sampled on Global Contract branded and textile program cards), mesh material and electrical devices, are warranted for five (5) years
- Control mechanisms are warranted for twelve (12) years

The warranty applies to single shift, standard commercial usage, defined as a standard eight (8) hour day, forty (40) hour week for users weighing up to 300 lbs.

Textiles

Global Contract warrants Global Contract branded textiles and Global Contract carded textile programs inclusive of fabrics, vinyls and leather products for five (5) years. Global does not warrant COM (Customer's Own Material) or GPM (Global Contract Purchased Material) that are customer specified materials, or graded-in and purchased by Global Contract for a customer. For GPM or COM products, please contact the textile supplier for performance information and warranty details. Please refer to our website at www.globalcontract.com for detailed information on cleaning and care instructions. Improper usage of disinfecting/cleaning products may void the warranty.

Seating Warranty Summary

Seating Type - General Commercial Seating
Components Warranty For Original Purchaser - lifetime Use
Time For Warranty Coverage - 8 hours/5 days per week

Exceptions

Foam/textiles/mesh/electrical devices - 5 years
control mechanisms - 10 years

Files, Desks, Modular Furniture, Tables, Panels & Accessories

Global Contract warrants all components of metal storage and filing, laminate and wood veneer surfaces, laminate and wood veneer tables, metal leg components and panels for the lifetime of the product to the original Purchaser.

Exceptions to the warranty for files/desks/tables and panels are as follows:

- Electrical devices, panel and tackboard textiles, adjustable keyboard mechanisms and task lights - five (5) years
- Folding tables - one (1) year

Files, Desks, Modular Furniture, Tables, Panels & Accessories Warranty Summary**Product Type**

Metal Storage & Filing - Lifetime Warranty
No exceptions.

Laminate/Wood Veneer Surfaces and Modular Furniture - Lifetime Warranty
Exceptions: tackboard textiles, electrical devices, task lights - 5 years

Boardroom, Conference and Training Tables - Lifetime Warranty
Exceptions: electrical devices - 5 years

Panels - Lifetime Warranty

Exceptions: panel textiles, electrical devices, task lights - 5 years

Folding Tables - 1 Year Warranty

FreeFit height adjustable bases
•Movable parts and electrics - 7 years

Global's warranty does not apply (for any product category) to the following:

- Nominal or normal amount of wear and tear that can occur over time
- Failures which result from negligence, abuse, accident or misuse
- Failure to apply, install or maintain products according to Global Contract's written instructions and warnings
- Modifications, attachments or repair methods not approved by Global
- Damage caused by a carrier in transit, or delivery/installation contractors
- The matching of colours, grains or textures (wood, leather, etc.) of natural materials
- Products exposed to extreme hot or cold temperatures or excessively dry or humid environments
- Colour fastness or the matching of colour of textiles, dye lots of textile can vary
- Damage by markings or staining; damage by sharp objects or imprinting from instruments
- Damage to textiles or laminate and wood surfaces/edges from exposure to sunlight (including UV rays)
- Products used for rental purposes
- Products installed by a non-certified installer
- Purchased parts are warranted for one (1) year
- Failure to follow specific cleaning and care instructions posted on www.globacontract.com

Global Contract's warranty does not cover the costs of transportation or labour. Repair or replacement will be at Global Contract's discretion.

Non-obsolescence Policy

All Global Contract products are designed and manufactured to withstand repeated service, repair and handling, and carry a lifetime warrantee. Global Contract's goal is to ensure that products can be refurbished, disassembled or upgraded as required. In addition, standardization of many parts and components facilitate ease of maintenance, servicing, assembly, and reconfiguration or reassembly.

Global Contract will provide Purchaser with product(s) of comparable function for a term equal to the warranty period. Fabrics and finishes are updated periodically to meet the growing demand of the market. As a result, some fabrics and finishes may be discontinued before expiration of the warrantee period.

Global Contract makes no warranty that any of its products are suitable for any particular purpose and makes no other warranties, express or implied, other than those set out here. As codes and standards vary from one jurisdiction to another, references to compliance are solely for convenience and without any representation as to accuracy or suitability. Users must verify the suitability of such information or product for their specific application. In no event shall Global Contract be liable in either tort or contract for any loss or direct, special, incidental, consequential, or exemplary damages.

PANEL FINISHES

Panel Frame/Raceway/Hardware	Compile Panel Frame Options	Tempered Glass
Black	Black	Clear
Blizzard	Designer White	Frosted
Charcoal	Nevada	
Designer White	Fog	
Nevada		
Silver		
Stonedust		
Taupe		
Tungsten		

STORAGE AND WORKSURFACE FINISHES

Metal Storage Colors - Panel Frame Matches	PVC Edge Finishes - Panel Frame Matches	Worksurface PVC Edge Trim - Wood Grain Matches
Black	Black	Absolute Acajou
Blizzard	Blizzard	Asian Night
Charcoal	Brushed Cobalt	Avant Cherry
Designer White	Charcoal	Avant Honey
Nevada	Designer White	Clear Maple
Silver	Nevada	Dark Espresso
Stonedust	Silver	Fashionista
Taupe	Stonedust	First Class
Tungsten	Taupe	Noce Biondo
	Tungsten	Noce Grigio

Low Pressure Laminates (LP) Panel Frame Matches	Low Pressure Laminates (LP) Solids and Patterns	Low Pressure Laminates (LP) Wood Grain Laminates
Black	Blizzard Matrix	Absolute Acajou
Blizzard	Grey Matrix	Asian Night
Brushed Cobalt (Tungsten)	Hayden Linen	Avant Cherry
Custom Grey (Silver)	Stone Linen	Avant Honey
Designer White	Studio White Matrix	Clear Maple
Hayden Grey (Taupe)		Dark Espresso
Stonedust		Fashionista
Storm Grey (Charcoal)		First Class
String (Nevada)		Noce Biondo
		Noce Grigio

High Pressure Laminates (HP) Panel Frame Matches	High Pressure Laminates (HP) Solids and Patterns	High Pressure Laminates (HP) Wood Grain Laminates
Black	Blizzard Matrix	Absolute Acajou
Blizzard	Grey Matrix	Asian Night
Brushed Cobalt (Tungsten)	Hayden Linen	Avant Cherry
Custom Grey (Silver)	Stone Linen	Avant Honey
Designer White	Studio White Matrix	Clear Maple
Hayden Grey (Taupe)		Dark Espresso
Stonedust		Fashionista *
Storm Grey (Charcoal)		First Class *
String (Nevada)		Noce Biondo
		Noce Grigio

* The maximum length to have wood grain match will be 108" for Fashionista FAS, FirstClass FCL, Sheer Beauty SBY.

WOOD VENEER FINISHES

Custom staining service is available, cost to match finish is \$482 net.

Walnut		Maple	
Walnut	WLW	Natural Maple	MPW
Mahogany on Walnut	MHW	White Maple	WMW
Espresso Walnut	EWV	Hazelnut	HAW
Cocoa Walnut	CAW	White Oak	
Latte Walnut	LTW	Biscotti	BTW
Natural Walnut	NLW	Grey on Oak	GRW
Umber Walnut	ULW	Java	JAW
Dark Walnut	DWW	Milestone	MTW
Cherry		Evening Oak	EVW
Red Cherry	RCW	Coral	CRW
Dark Cherry	DCW		
Amber Cherry	ACW		
Warm Cherry	WCW		
Almond Cherry	AMW		
Vintage Cherry	VNW		

PET FELT COLOURS

Amethyst	AMT	Black Coffee Textured	BKC
Apricot	APR	Bone	BNE
Black	BLK	Business Grey	BGR
Blue Smoke	BSK	Claret	CLT
Carnation	CNN	Dark Chocolate Textured	DCH
Emerald	EMD	Desert Putty	DPT
Graphite	GPH	Grey	GRY
Lapis	LAP	Ice	ICE
Mist	MTS	Ivory	IVR
Navy	NVY	Light Grey	LGR
Pewter	PWT	Metro	MET
Ruby	RBY	Mocha Textured	MCH
Sunflower	SFR	Moss	MOS
White	WHT	Navy	NVY
Brick	BRI	Oyster	OYS
Denim	DEN	Sky	SKY
Harvest	HVT	Stone	STN
Shamrock	SHR	Storm Grey	SGR
		Tahiti Sand	TSA
		Willow	WIL

PREMIUM COLOURS FOR STORAGE**PANEL FABRICS GRADE 1**

Anchorage (R)	Linea (R)	Merge (R)	Tek (R)			
Birch	AN40	Queue	LN41	MG20	Finesse	TX60
Green Apple	AN41	Cord	LN42	MG21	Grain	TX61
Lapis	AN42	Twine	LN43	MG22	Essence	TX62
Straw	AN43	Thread	LN44	MG23	Warp	TX64
Wolf	AN44	Contour	LN45	MG24	Mesh	TX67
Goose	AN45	Silhouette	LN46	MG25	Form	TX69
Angora	AN46	Cable	LN47	MG26	Spice	TX71
Cumin	AN47	Route	LN48	MG27	Glacier	TX72
Asteroid	AN48	Lisbon (R)		MG28	Spring	TX73
Geranium	AN49	Gesso	LS11	MG29	Harmony	TX74
Thistle	AN50	Dusk	LS12		Smoke	TX75
Graphite	AN51	Grey	LS13	Pinpoint (R)	Pebble	TX76
Slate	AN52	Ivory	LS14	PN11		
Quarry Blue	AN53	Henna	LS15	PN12	Terrace (R)	
Onyx	AN54	Nocturnal	LS16	PN13	Terrace is 57" wide, it cannot fit on panels wider than 54", it may be railroaded, but will require special application and pricing.	
Pumpkin	AN55	Moss	LS17	PN14	Lotus	TC60
Red Delicious	AN56	Navy	LS18	PN15	Tigerlily	TC61
Sunshine	AN57	Buff	LS19	PN16	Shadow	TC62
Vanilla	AN61	Spa	LS20	PN17	Cobble	TC63
Cobalt	AN62	Loopy (R)		PN18	Cherry Blossom	TC64
Clouds	AN64	Oyster	LP60	PN19	Bluebell	TC65
Aurora (R)		Putty	LP61	PN20	Apple	TC66
Cloud	AU20	Marble	LP62		Haze	TC67
Seal	AU21	Hazelnut	LP63	SR81	Beach	TC68
Fog	AU22	Latte	LP64	SR86	Shade	TC69
Pewter	AU23	Bay	LP65	SR88	Stretch	TC69
Granite	AU24	Wild Rice	LP66	SR89	Sprint	TC70
Oat	AU25	Harbor	LP67	SR91	Roll	TC71
Coconut	AU26	Melody (R)		SR92	Dart	TC72
Latte	AU27	Spray	ME40	SR93	Zoom	TC73
Lake	AU28	Pond	ME41	SR94	Splash	TC73
Frost	AU29	Sand Bar	ME42	SR95	Whiz	TC74
Chance (R)		Silt	ME43	SR96	Flash	TC75
Mist	CN51	Pebble	ME44			
Dill	CN52	Lake	ME45			
Island	CN53	Gravel	ME46			
Plaza	CN54	Boulder	ME47			
Plaza	CN54					
Tranquil	CN55					
Malt	CN56					
Navajo	CN57					
Prairie	CN58					
Cinder	CN59					
Oasis	CN66					

Note:
(R) = Recycled Fabric

PANEL FABRICS GRADE 2

Cyclone		Quadrille (not available on Diet)	(R)
Stove Pipe	IM37	Quadrille is only 54" wide, it cannot fit	
Stainless	IM40	on panels wider than 48", it may be rail-	
Polished Pewter	IM41	roaded, but will require special application	
Welded Steel	IM43	and pricing.	
Etched Bronze	IM44	Escapade	QU30
Fired Titanium	IM46	Shenanigan	QU31
Chrome	IM49	Revelry	QU32
Dark Annealed	IM50	Spring	QU33
Karat	IM54	Regalia	QU34
Red Metal	IM55	Soiree	QU35
Oxidized Bronze	IM56	Zest	QU36
Bright Ray	IM57	Gambol	QU37
Bismuth Crystal	IM58	Leisure	QU38
Gallium Blue	IM59	Fair	QU39
		Fiesta	QU40
		Carnival	QU41
Dashing (R)		Spree	QU42
Classic Silver	DS21	Opus	QU43
Refined Marble	DS22	Jubilee	QU44
Antique Sage	DS23	Masquerade	QU45
Polished Slate	DS24	Cabaret	QU46
Genteel Beige	DS25		
Bespoke Tan	DS26		
Dapper Grey	DS27		

SEATING FABRICS

For cushions, please chose from any of the Global Furniture Group seating fabrics. Seating fabric cannot be used on panels, dividers and tackboards, please choose a panels fabric.

COM fabric is priced as grade 1.

Note:
(R) = Recycled Fabric

_BAKA - Boulevard
 _LAKA - Licence
 _AAKA - GC ADA
 _DAKA - Descor
 _BRAKA - Bridges II
 _SONBRAKA - Sonoma

SO# _____

PO TAG# _____

DATE _____

KEY #	SETS REQ'D	KEY #	SETS REQ'D	KEY #	SETS REQ'D	KEY #	SETS REQ'D	KEY #
401		431		461		491		521
402		432		462		492		522
403		433		463		493		523
404		434		464		494		524
405		435		465		495		525
406		436		466		496		526
407		437		467		497		527
408		438		468		498		528
409		439		469		499		529
410		440		470		500		530
411		441		471		501		531
412		442		472		502		532
413		443		473		503		533
414		444		474		504		534
415		445		475		505		535
416		446		476		506		536
417		447		477		507		537
418		448		478		508		538
419		449		479		509		539
420		450		480		510		540
421		451		481		511		541
422		452		482		512		542
423		453		483		513		543
424		454		484		514		544
425		455		485		515		545
426		456		486		516		546
427		457		487		517		547
428		458		488		518		548
429		459		489		519		549
430		460		490		520		550

BOULEVARD 1 PANELS

Features:

- Desk height power and data management
- Patented "Knuckle-Loc", rigid connection, prevents light and sound transmission
- Built-in acoustical/tackable properties
- Sectional multi-accent design options
- Fabric surfaces are able to be replaced on-site
- Frame incorporates 1" centred slots for component adjustability
- Requires no additional top caps, end caps, trim caps, hinges, kick plates or clips
- Simple to specify
- Reduced installation time
- Easy to reconfigure
- High-tech look/stackable grid appearance
- Rigid, no sway, straight panel sight line
- Self levelers reduce assembly time, ensure even height
- Over panels extend to 10 feet to enclose an office in fabric and glazed options
- Patented Raceway cover easily removed
- Raceway panels top and bottom portion semi tackable

Construction:

- Rigid extruded aluminum, finished frame, self-leveling 2 5/8" thick panel
- 1 1/8" sound absorbent Mineral Wool each side of hardboard septum Sizes:
- 8 Heights: 29", 37", 42", 50", 54", 58", 66" 74" and 82"
- 9 Widths: 6", 18" to 60" in 6" increments, 72" wide in selected panel configurations.

Adjustability:

- 3" glide stem permits 2 1/2" height adjustment
- Slotted at 1" increments
- Over panels, 8", 16", 24", 37" and 42" for enclosed offices (Non-slotted) Acoustic Rating
- .80NRC/26STC

Door:

- 2 door panel widths, glazed/unglazed, lockable, reversible
- 2 sliding door widths, non-lockable

Flexibility:

- Universal connector

Panel Finishes:

- 2 grades of fabric, air flow grill, glaze, tempered glass, laminate & COM

Electrical:

- Desk height 8 wire/4 circuit - 1 dedicated

Communication:

- Desk height data channel
- Raceway cover easily removed
- Fabric covered raceways available

SYSTEM 3 PANELS

Features:

- Base power and data lay-in
- Desk height power and data feed thru
- Top data lay-in
- Patented "Knuckle-Loc", rigid connection, prevents light and sound transmission
- Removable multi-functional tile design options
- Fabric surfaces are able to be replaced on-site
- Reduced installation time
- Easy to reconfigure
- High-tech look/stackable grid appearance
- Rigid, no sway, straight panel sight line
- Self levelers reduce assembly time, ensure even height
- Over panels extend height to enclose an office in fabric, glazed or laminate options
- Raceway cover easily removed

Construction:

- Rigid extruded aluminum

Sizes:

- 5 Heights: 34", 42", 50", 54", 66"
- 8 Widths: 18" to 60"

Adjustability:

- 3" glide stem permits 2 1/2" height adjustment
- Slotted at 1" centres
- Over panels, 8" and 16" (Non-slotted)

Door:

- 2 widths, glazed/solid, lockable, reversible
- 2 sliding door widths, non-lockable

Flexibility:

- Universal connector

Panel Finishes:

- Fabric, air flow accessory, tempered glass, laminate, whiteboard, corkboard (at base only)

ELECTRICAL FOR BOULEVARD 1 PANELS

Features:

- Customized power capabilities in each panel
- State-of-the-art snap-in electrical
- 8 wire with 3 regular 15 AMP circuits and 1 isolated 15 AMP circuit.
- 3N and 8K electrical available upon request.
- Snap-in installation - harnesses, junction boxes, duplexes
- Accessibility makes changing circuits easy
- Flexibility in choice of duplexes within panel: choice of circuits for each duplex; choice of quantity of duplexes (1 or 2 duplexes per panel)

- Electrical cords are concealed
- Separate large channel for data
- Change electrical without moving pedestals
- Lower installation/reconfiguration costs
- Data terminals snap into cable holder
- Floor or ceiling feed
- Duplexes accessible from both sides

ELECTRICAL FOR SYSTEM 3 PANELS

Features:

- Customized power capabilities in each panel
- State-of-the-art snap-in duplex receptacles
- 8 wire with 3 regular 15 AMP circuits and 1 isolated 15 AMP circuit
- Snap-in installation - harnesses, junction boxes, duplexes

- Accessibility makes changing circuits easy
- Flexibility in choice of duplexes within panel
- Data terminals snap into base raceway cover and mid panel electrical tile
- Floor or ceiling feed
- Duplexes accessible from both sides

WORKSURFACES / HARDWARE

Features:

- One universal cantilever support
- Pedestal eliminates need for end panel/cantilever
- Grommets are not needed
- Continuous cable accessibility across back
- Adjustable to any height, in 1" increments
- Flush abutment side edge minimize seam crevice
- Metal-to-metal connections (Metal Inserts)
- Additional cable manager under worksurface

Construction:

- Medium-density particle board 1 1/16" thick

Sizes:

- 3 Depths: 18", 24" and 30"
- 12 Widths: 18" to 84" in 6" increments

Finishes:

- Tops: High Pressure Laminate, Low Pressure Laminate or Wood
- Edges: Edge banded PVC or Wood

Types:

- Transaction, keyboard, rectangular worksurface, corner, curved, D-top, P-top, Arc-top and freestanding

OVERHEAD STORAGE

Features:

- Steel and all laminate based options
- Panel mount and up-mount options
- Completely enclosed unit for 16" overheads
- Style dependent- ship fully assembled or knocked down
- 13.5" inside height for oversized binders
- Metal-to-metal connection
- Lock secures into bottom shelf
- Doors operate smoothly
- Flipper door retrofittable on site
- Safety bracket used for extra support
- Reinforcement built in for larger unit
- Can be removed and reconfigured without disassembly

Fronts:

- Open or closed fronts
- AODA compliant options available

Sizes:

- Overheads - 7 widths in 6" increments
- Shelves - 7 widths in 6" increments
- 13.5" deep welded overheads
- 14.2" deep AODA overheads
- 16.5" deep welded overheads for EDP, ring binder, letter/legal

Paint:

- Dry epoxy powder coating

PEDESTALS

Features:

- Premium quality steel reinforced welded construction
- Double wall construction on all drawer fronts
- Fully progressive suspension system
- Centre pull
- Worksurface supporting option
- Full extension roller bearing glides on all file drawers
- Rubber bumpers for quietness
- Movable drawer divider in box drawers
 - Pencil Tray
 - Each file drawer includes a hanging file bar (22" and 28" depth only)
- 3 depths with varying filing capacity
- Random or specific keying instructions available

Construction:

- Double wall drawer fronts
- 18-20 gauge steel case components

Sizes:

- (Prime) 18", 22", 28" depth
- (9300) 19", 23", 29" depth

Types:

- Worksurface Supporting, Mobile, Freestanding

Paint:

- Dry epoxy powder coating

HOW BOULEVARD 1 CAN REDUCE YOUR COSTS

Finished Panel:

- No inventory costs for connectors, trim caps, top caps, kick plates and clips.
- Less time required to install, or to disassemble, move and re-install.

Fewer Parts:

- Only 1 universal cantilever and 3 brackets are needed to build most workstations.
- Easy to attach and remove components from panels.
- Universal post for 2-way, 3-way and 4-way applications.

Desk Height Electric:

- Ease of initial electrical installation lowers energy management costs.
- Snap-in electrical components reduce reconfiguration costs.
- Can customize power in each panel, pay only for what is required.

Simplified Specifications:

- Fewer parts and components make specifying, ordering, and verifying less work.
- Product fits a 6" planning module.

Replaceable Panels:

- Panels can be re-upholstered on site.

Communications/Data Channel:

- Desk height data channel reduces time to install and change cables.

Floor to Ceiling Enclosed Office:

- Re-usable enclosed offices with doors eliminate future costs for drywall demolition, new construction, mess and extensive cash flow.
- Depreciation expense indirectly increases cash flow.

Warranty:

- Limited Lifetime Warranty on materials and workmanship.

Product:

- Priced less than most other "A" Grade panel systems.

HOW BOULEVARD SYSTEM 3 REDUCES YOUR COSTS

Finished Panel:

- No inventory costs for connectors, top caps, kick plates and clips.
- Less time required to install, or to disassemble, move and re-install.

Fewer Parts:

- Only 1 universal cantilever and 3 brackets are needed to build most workstations.
- Easy to attach and remove components from panels.
- Universal post for 2-way, 3-way and 4-way applications.

Base Panel Electric System:

- Ease of initial electrical installation lowers energy management costs.
- Snap-in electrical components reduce reconfigurations costs.
- Can customize power in each panel, pay only for what is required.

Simplified Specifications:

- Fewer parts and components make specifying, ordering, and verifying less work.
- Product fits a 6" planning module.

Replaceable Panel Tiles:

- Over Panels and face tiles can be added and interchanged as needs change.

Communications/Data Channel:

- Base and top lay-in communications channel reduces time to install and change cables.

Warranty:

- Limited Lifetime Warranty on materials and workmanship.

Product:

- Priced less than most other "A" Grade panel systems.

Value-Added Benefits

On the following pages, we selected a grouping of Boulevard 1, System 3 configurations, some with electrical components and task lights, to give you a better understanding of our product's specifications as they relate to workstations. Our objective is to not only illustrate applications using panels and components, but also to have this serve as a pricing exercise.

All of the value-added benefits of the Boulevard 1 are standard as follows:

- Desk height power and data capabilities.
- Finished panel including top, corner and end caps.
- Sectional panel with multiple fabric options.
- Ease of installation and reconfigurations.
- Removable fabric for on-site refurbishing.
- Exceptional storage capacity in pedestals, overheads, lateral files, storage cabinets and towers.
- Simplified specifications.

All of the value-added benefits of the Boulevard System 3 are standard as follows:

- Base power and data capabilities.
- Finished panel including top and corner.
- Monolithic or Pass-Thru panels with multiple fabric options.

- Ease of installation and reconfiguration.
- Removable fabric tiles in Pass-Thru Panels for on-site refurbishing.
- Exceptional storage capacity in pedestals, overheads, lateral files, storage cabinets and towers.
- Simplified specifications.

All of the value-added benefits of the Diet System are standard as follows:

- Finished panel including top, corner and end caps.
- Sectional panels with multiple fabric options.
- Ease of installation and reconfigurations.
- Removable fabric for on-site refurbishing.
- Exceptional storage capacity in pedestals, overheads, lateral files, storage cabinets and towers.
- Simplified specifications.

When specifying Boulevard 1, Boulevard System 3 or Diet, you benefit from the ability to:

- Customize the energy management.
- Minimize the number of necessary parts.
- Offer a competitive list price.

NOTE: If Key Alike Instructions are not submitted to GLOBAL CONTRACT with the Customer's Purchase Order, all components will be keyed randomly.

WOOD GRAIN (WG) LAMINATE DIRECTION

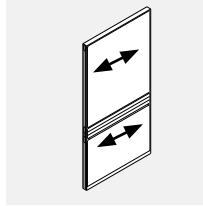

* Panel general direction will default to vertical if monolithic panel is 54" high and if raceway panels are on same order.

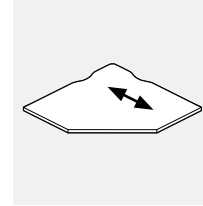
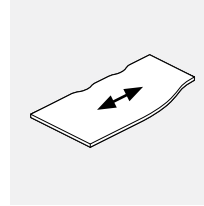
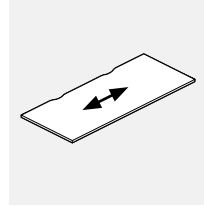
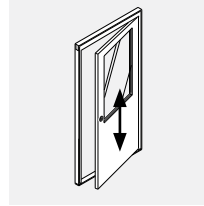

All Panels

With Exception of 66" or higher panels, the grain is vertical.

BPD
Doors.

BWS
Worksurfaces.

BWSC
Worksurfaces.

BWCF
Corner Worksurfaces.

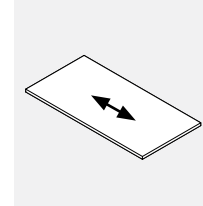
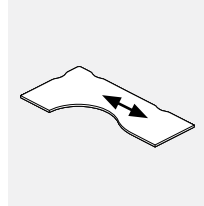
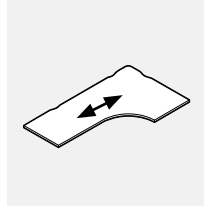
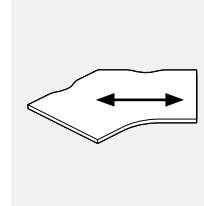
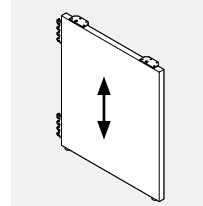
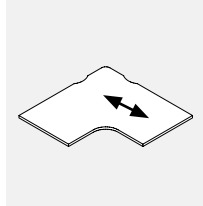

BWCL
Corner Worksurfaces.

BHFG
Full Gable.

BWAC Angled Corner
Worksurfaces

BWCE
Extended Worksurfaces.

BWCEC
Extended Worksurfaces.

BK
Desking Worksurfaces.

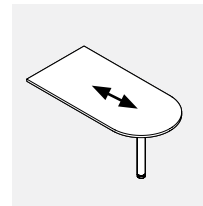
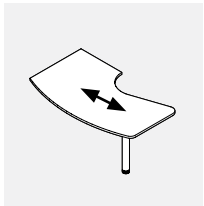
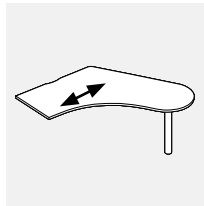
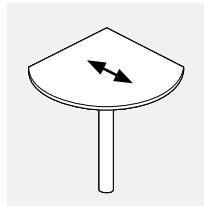
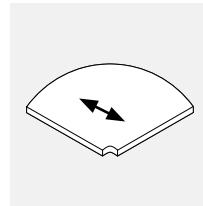
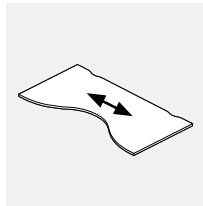

BWBT
Bow Tie Worksurfaces.

BWR
Radius Worksurfaces.

BWRTD
Teardrop Worksurfaces.

BWC
Extended "D"
Worksurfaces.

BWSL
Curvilinear
Worksurfaces.

BWD
Worksurfaces.

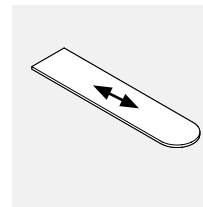
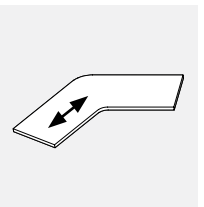
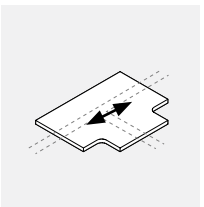
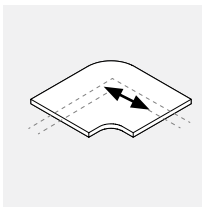
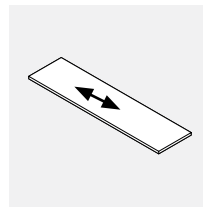
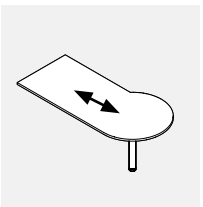

BWP
Worksurfaces.

BWT
Transaction Work-
surfaces.

BWTC
Corner Transaction
Worksurfaces.

BWTT
Transaction Work-
surfaces.

BWTAC
Transaction
Worksurfaces.

BWTD "D"
Transaction
Worksurfaces.

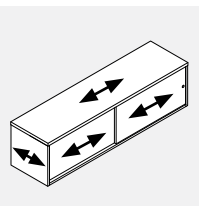
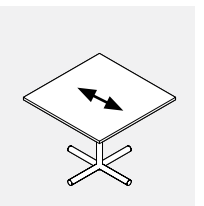
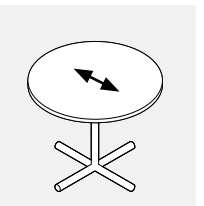
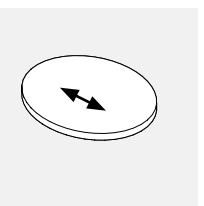
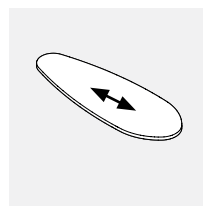
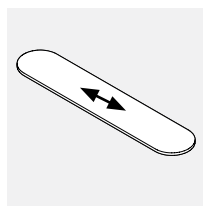

BWTD "D"
Transaction
Worksurfaces.

BWTE
Ellipse Transaction
Worksurfaces

BWTP
Round Transaction
Worksurfaces.

BWCD
Round Tables.

BWSQ
Square Tables.

BSP
Laminate Divider
Storage

Boulevard 1 Panel System

The Boulevard philosophy is based on simplicity. A product that is simple to install... simple to reconfigure... and simple to specify, without sacrificing delivery time or quality.

Technically superb and exceptionally precise aluminum extrusion and die-cast fittings achieve exact levels of consistency, panel after panel; everything fits, aligns, and assembles, first time, every time. Most of all it requires very few of the "small parts" associated with most systems. This cross-market integration is celebrated in Boulevard.

Truly a system of broad application, whether installed in a high-tech environment, factory application or executive office, Boulevard will perform! We invite you to share with us a product designed, built and marketed for a global economy.

Our Mission

Our mission is to continue to develop and offer innovative, quality office furniture to value-oriented customers, through a dealer network that provides consistent, high quality service. Our approach in the contract furniture industry is to focus on customer concerns and needs to develop products that minimize your costs of ownership. It represents the culmination of creativity, industry expertise, specialists,

and integrity to help you achieve cost-effective solutions to problems. Our vision is to create a company-wide environment that supports constant improvement and promotes customer satisfaction. We believe that as good as we are today, we must be better tomorrow. Thus, our desire to improve is both continuous and tireless.

Environmental Commitment

At Global Contract, protecting the next generations' environment is of paramount concern. Global Contract believes that it is our responsibility to help protect the environment for future generations. We continue to operate with the environment in mind, making wise business decisions that help protect the earth and its precious natural resources. Our manufacturing procedure incorporates the latest technology for painting products, using a dry epoxy powder or gel paint. This process produces no toxic residue, and therefore is environmentally safe, while other manufacturers still use the wet paint process. Our packaging, veneer selections, and reduction in waste programs all contribute to a better environment. In addition, our concern for the reduction of finishing emissions and wood dust has resulted in a healthier work environment in many ways, including this price book, printed on recycled paper.

Technical Information

Panels

- All panels are 2 5/8" thick.
- Lightweight aluminum box frame construction creates superior panel rigidity.
- Panel frame finish is durable epoxy powder coated.
- Hang-on capabilities at 1" increments.
- Patented "Knuckle-Loc" design provides solid panel-to-panel connection for fast installation and reconfiguration.
- Knuckle lock feature ensures even panel heights throughout installation.
- 3" glide stem permits 2 1/2" height adjustment.
- Panel sizes are actual, eliminating creepage.
- Panels come complete, eliminating need for separate top, corner end trim and clips.
- Fabric is replaceable on site.
- All panels include 2 "Capture Strip" panel connectors.
- Fabric retainer is clear.
- Panels are UL listed and CSA approved and have a Class "A" fire rating except when Customer's Own Material (COM) is used.
- Centre septum above raceway overlaid on either side with tackable, 1 1/8" "Sound Absorbent Mineral Board".
- For glazing - Smoke developed index 500.
- For tempered glass, add "TG" to the end of the product code and add 20% to the price regardless of fabric grade.
- Solid metal sheet is an OPT option and price accordingly, however, the sheets are 48" wide and cannot be specified on 48" and wider unless they are railroaded. Contact your Customer Service Representative for more information.

Panel Options

- Laminate, whiteboard, or corkboard may be substituted for fabric on panels only, not raceways, see "OPT" column.
- Laminate and whiteboard are held in place with a PVC retainer matching the frame colour and can be retrofitted on site.
- Laminate and whiteboard options reduce the acoustical value of the panel.

Raceway Options

- Raceways are standard in PVC matching the panel frame finish.
- Fabric Covered Raceway (FRC) available. Aluminum raceway available.
- Wood veneer raceway available.
- Face mount electrical raceway available.
- Face mount openings are 1.5x2.85 for electrical and 1.37x2.755 for data.
- Cable capacity in raceways is 83 - 0.220" dia. cables (cat.6).

Desk Height Management

- Desk height electrical and communication raceway system.
- State-of-the-art engineering.

- Snap-in modularity of all electrical components including harnesses, junction boxes, duplexes and circuit designations.
- All power and data outlets are easily accessible from both sides of panel.
- 8 wire system with 4, 15 amp circuits (including 1 dedicated circuit).
- Optional facemount electrical with 2 duplexes per panel side.
- Outlet and circuit changes accomplished without disruption to workstation.
- Large raceway cavity permits storage of excess cables and equipment cords.
- Total flexibility for 8 wire system: choice of 1, 2 or 4 duplexes per panel; choice of circuitry in each duplex .
- Unique design of fire retardant PVC raceway cover permits access to raceway without disruption to equipment on worksurfaces.
- Clip-on communication management channel (BECC01 and BPH001) included with each raceway panel.
- Communication management channel accepts modular Data/Comm terminals (not supplied by Global Contract Inc.).

Posts

- Enables connection for multiple panel runs such as 90°, 45° or 60° angles and 2 way, 3 way or 4 way.
- Provides route for base, ceiling, and worksurface cable entry to a panel.
- Self levelling feature maintains even height of all connected panels.
- Solid lightweight aluminum extrusion fits together through a unique "Knuckle-Loc" design providing rigid post-to-panel connection.
- Includes all required panel connectors and caps.
- Posts add 2 5/8" to a panel run.
- Posts are 1/8" oversized to allow for "panel wrap around" of freestanding desks.
- For all panel runs with multiple posts, this 1/8" must be allotted for.

PANELS - GUIDELINES FOR ORDERING PRODUCT

Codes

The product guide uses a numbering system with meaningful alphanumeric characters to create a simple-to-understand product number. This makes specifying the product much easier and more accurate.

Example of Panel: **BPRA6636 CHR CHR**

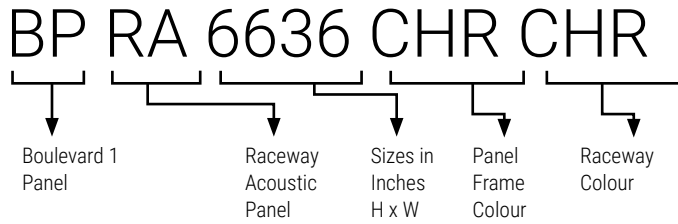

- AN50 Inside Lower Fabric
- AN50 Inside Upper Fabric
- BE21 Outside Lower Fabric
- BE21 Outside Upper Fabric

How to Specify

- Specify Boulevard 1 panel type and size by code.
- Specify panel frame finish - ie. CHR (Charcoal).
- Specify PVC raceway finish - ie. CHR (Charcoal). If PVC raceway colour not specified at time of order, default will be the panel frame colour.
- Specify all four panel fabric options if necessary.
- Some fabrics have directional pattern and cannot be applied horizontally or vertically. Panels wider than 60" will have fabrics applied horizontally (railroad). Please specify if you want adjacent panels and the rest of the installation upholstered the same way.

Example of Post: **BHP066 CHR**

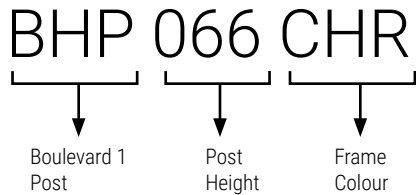

How to Specify

- Specify Boulevard 1 post by code.
- Specify frame colour - ie. CHR (Charcoal).

Raceways

PVC:

- Standard, at time of order, includes 2 covers.
- Standard, when ordering individuals: RCSxxCOL.
- Facemount raceways: RCWxxD.
- **Fabric:**
- Standard, at time of order: RCWxxFAB, \$34 per side, sold as pair, panel mounted.
- Standard, when ordering individuals: 1006FRCxx, shipped separately.
- Facemount raceways: FCRxxD.

Aluminum:

- Standard, when ordering individuals: BARCxx,
- Facemount raceways: RCAxxD.

ORDERS

Each Order Must Include

- Purchase Order
- Layout showing where the image(s) appear in the run of panels.
- A completed Price Chart, showing the location of the image(s) on each appropriate panel.

Artwork must be submitted in accordance with the following artwork specifications.

NOTE: Final artwork specification approval must be given before order can be processed.

Transfer Devices

- E-mail up to 10MB to your Global Contract Customer Service Representative.
- Courier CD/DVD/USB stick to your Global Contract Customer Service Representative.

Artwork Specifications

- Non-Photographic artwork should be vector art, saved in Adobe Illustrator (.ai) or as an EPS (.eps)
- All bitmap or photographic artwork has to be at a minimum of 100 dpi at the full size of the panel to be printed.
- We accept Adobe CS5 files.
- Any linked files must be included or imbedded.
- Leave any PSD files unflattened
- All fonts must be converted to outlines.
- Do not convert to CMYK, leave all images as RGB if possible
- No Word, Powerpoint, Publisher or other Microsoft files can be used.
- Include a PDF or .jpg for reference when sending native Photoshop or Illustrator format files.

Colour Matching

- A Pantone colour reference must be supplied or we cannot accept responsibility for correct colour.
- When it is not possible to refer to Pantone colours, we will do our best to meet your requirements.

Image Clarity

- We will advise should the selected image not lend itself to the element size requested.

NOTE:

We reserve the right to put an order on hold when the files are found to be incomplete or when documents have been either incorrectly saved. Fonts not converted to curves or the job appears not to be commercially acceptable.

Image Bleed:

To facilitate placement on the panel. Extension of the image past the finished visible area of the panel (bleed) is required

- Boulevard Panels need a 5" Bleed on all sides.

Example Of Image resolution:

The resolution required for a 36 wide x 24 high Boulevard panel at 100 dpi (minimum resolution)

The resolution required for a 36 wide x 24 high Boulevard panel at 300 dpi (higher quality)

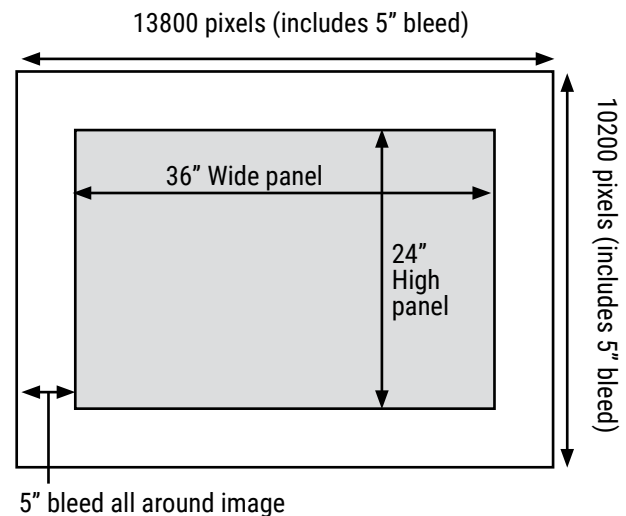
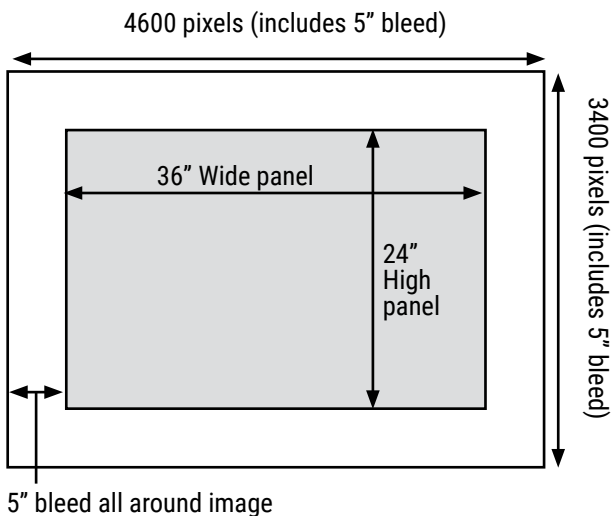

Pricing, Initial Set-Up Charge per Order:\$256 net

Boulevard 1 Panels • Below Raceway Only

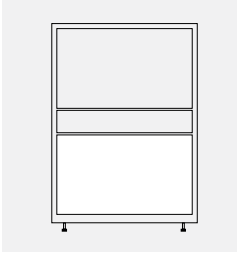

- This List applies to the following panels:
- BPRA
- BPRG
- BPRP
- BPAR

PANEL HEIGHT	PANEL WIDTH	LIST PRICE
29"	24"	300
29"	30"	353
29"	36"	409
29"	42"	462
29"	48"	521
29"	54"	572
29"	60"	622
29"	66"	673
29"	72"	725

Boulevard 1 • Above Raceway Only

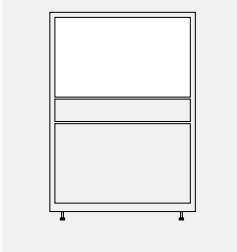

- This List applies to the following panels:
- BPRA
- BPRF

PANEL WIDTH	HEIGHT	LIST PRICE	42"	50"	54"	58"	66"	74"	82"
24"	N/A	178	211	241	308	373	433		
30"	N/A	212	251	286	366	439	512		
36"	N/A	251	290	330	418	505	592		
42"	N/A	278	330	381	474	572	673		
48"	N/A	315	371	425	534	642	768		
54"	N/A	343	403	462	586	710	827		
60"	N/A	373	439	505	642	777	908		
66"	N/A	403							
72"	N/A	439							

Boulevard Fabric Acoustic Panels

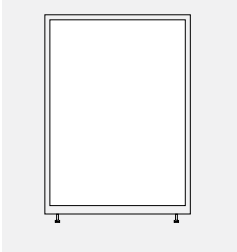

- This List applies to the following panels:
- BPGA

PANEL WIDTH	HEIGHT	LIST PRICE	42"	50"	54"	58"	66"	74"	82"
24"	396	462	495	527	586	651	718		
30"	469	541	584	622	696	768	842		
36"	541	630	673	718	805	886	972		
42"	615	710	761	813	908	1010	1106		
48"	690	799	854	908	1019	1126	1236		
54"	761	879	942	1003	1120	1246	1368		
60"	827	967	1032	1098	1229	1363	1494		
66"	893	1032							
72"	967	1120							

Boulevard 1 Over Panels

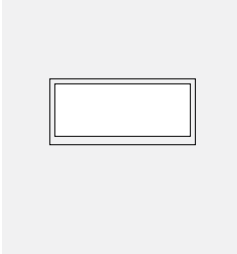

- This List applies to the following Panels:
- BPOF

PANEL WIDTH	HEIGHT	LIST PRICE	8"	16"	24"	37"	42"
24"	140	205	263	366	409		
30"	166	241	315	433	484		
36"	191	278	359	498	557		
42"	220	315	409	572	630		
48"	241	353	455	630	702		
54"	271	396	505	702	777		
60"	294	433	550	815	849		
66"	315	462	592	827	915		
72"	343	498	637	893	988		

Note: Prices shown are an upcharge to the panel price, please add to the list price of panel which you are specifying the graphic for.

BPRA • Acoustical Raceway Panel

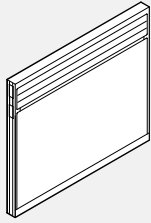

37" High

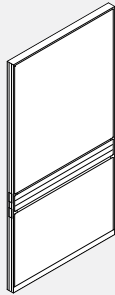

72" Wide

- Fabric above the raceway provides visual and acoustic privacy.
- Centre septum above and below raceway overlaid on either side with tackable, 1 1/8" "Sound absorbent mineral board".
- Centre septum below raceway overlaid on either side with 1 1/8" Mineral board.
- Acoustic rating of .80 NRC and 26 STC.
- OPT* = Laminate or Whiteboard.

PRODUCT CODE	PRICE			SIZE/ H	INCHES			WEIGHT VOL	
	GR1	GR2	OPT*		W	D	LBS	FT ³	
BPRA3718	513	527	541	37	18	2.61	18	1.58	
BPRA3724	573	586	601	37	24	2.61	21	2.054	
BPRA3730	633	642	660	37	30	2.61	25	2.528	
BPRA3736	684	732	783	37	36	2.61	28	3.002	
BPRA3742	741	790	842	37	42	2.61	32	3.476	
BPRA3748	799	845	898	37	48	2.61	35	3.950	
BPRA3754	857	904	956	37	54	2.61	39	4.424	
BPRA3760	911	959	1011	37	60	2.61	44	4.898	
BPRA3766	970	1029	1090	37	66	2.61	50	5.499	
BPRA3772	1029	1085	1147	37	72	2.61	56	6.000	
BPRA4218	549	575	605	42	18	2.61	22	1.782	
BPRA4224	607	635	663	42	24	2.61	28	2.317	
BPRA4230	666	693	723	42	30	2.61	32	2.852	
BPRA4236	716	771	829	42	36	2.61	36	3.387	
BPRA4242	777	831	890	42	42	2.61	40	3.921	
BPRA4248	831	888	945	42	48	2.61	44	4.456	
BPRA4254	890	945	1004	42	54	2.61	48	4.991	
BPRA4260	945	1000	1059	42	60	2.61	52	5.525	
BPRA4266	1055	1169	1291	42	66	2.61	62	6.148	
BPRA4272	1162	1277	1399	42	72	2.61	72	6.770	
BPRA5018	585	612	640	50	18	2.61	25	2.106	
BPRA5024	642	686	729	50	24	2.61	30	2.738	
BPRA5030	705	750	792	50	30	2.61	35	3.370	
BPRA5036	769	839	911	50	36	2.61	40	4.002	
BPRA5042	827	895	969	50	42	2.61	45	4.634	
BPRA5048	890	958	1032	50	48	2.61	50	5.266	
BPRA5054	948	1019	1090	50	54	2.61	55	5.898	
BPRA5060	1010	1080	1152	50	60	2.61	60	6.530	
BPRA5066	1104	1221	1342	50	66	2.61	70	7.300	
BPRA5072	1197	1312	1433	50	72	2.61	80	8.000	
BPRA5418	611	638	668	54	18	2.61	27	2.250	
BPRA5424	672	713	757	54	24	2.61	32	2.960	
BPRA5430	732	773	817	54	30	2.61	37	3.689	
BPRA5436	796	879	968	54	36	2.61	42	4.318	
BPRA5442	857	938	1029	54	42	2.61	47	4.934	
BPRA5448	920	1000	1090	54	48	2.61	52	5.666	
BPRA5454	978	1060	1151	54	54	2.61	59	6.398	
BPRA5460	1042	1123	1214	54	60	2.61	62	7.035	

BPRA • Acoustical Raceway Panel ...Cont

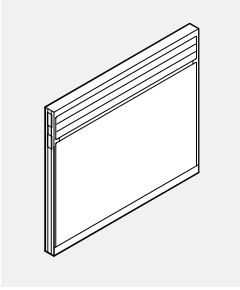

37" High

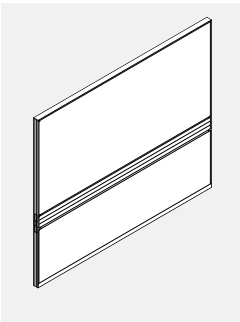
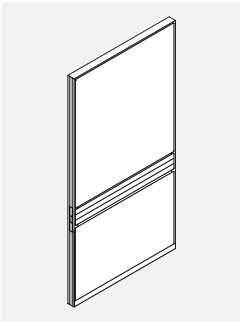

72" Wide

- Fabric above the raceway provides visual and acoustic privacy.
- Centre septum above and below raceway overlaid on either side with tackable, 1 1/8" "Sound absorbent mineral board".
- Centre septum below raceway overlaid on either side with 1 1/8" Mineral board.
- Acoustic rating of .80 NRC and 26 STC.
- OPT* = Laminate or Whiteboard.

PRODUCT CODE	PRICE			SIZE / INCHES			WEIGHT VOL	
	GR1	GR2	OPT*	H	W	D	LBS	FT ³
BPRA5818	636	663	693	58	18	2.61	28	2.431
BPRA5824	700	740	785	58	24	2.61	33	3.160
BPRA5830	757	799	842	58	30	2.61	38	3.889
BPRA5836	821	903	993	58	36	2.61	43	4.618
BPRA5842	886	968	1057	58	42	2.61	48	5.347
BPRA5848	947	1030	1119	58	48	2.61	53	6.076
BPRA5854	1010	1092	1181	58	54	2.61	58	6.806
BPRA5860	1074	1154	1246	58	60	2.61	63	7.535
BPRA6618	679	723	765	66	18	2.61	32	2.755
BPRA6624	748	802	860	66	24	2.61	37	3.581
BPRA6630	813	868	927	66	30	2.61	42	4.407
BPRA6636	877	972	1076	66	36	2.61	48	5.234
BPRA6642	942	1036	1140	66	42	2.61	53	6.060
BPRA6648	1007	1104	1205	66	48	2.61	58	6.887
BPRA6654	1071	1168	1271	66	54	2.61	63	7.713
BPRA6660	1136	1232	1335	66	60	2.61	68	8.539
BPRA7418	737	779	824	74	18	2.61	34	3.079
BPRA7424	802	858	916	74	24	2.61	39	4.002
BPRA7430	868	924	983	74	30	2.61	45	4.926
BPRA7436	935	1047	1163	74	36	2.61	50	5.850
BPRA7442	1004	1114	1230	74	42	2.61	55	6.773
BPRA7448	1070	1179	1297	74	48	2.61	60	7.697
BPRA7454	1136	1247	1364	74	54	2.61	65	8.620
BPRA7460	1202	1313	1430	74	60	2.61	70	9.544
BPRA8218	799	839	883	82	18	2.61	36	3.403
BPRA8224	867	935	1008	82	24	2.61	42	4.424
BPRA8230	935	1004	1077	82	30	2.61	48	5.444
BPRA8236	1005	1131	1262	82	36	2.61	54	6.465
BPRA8242	1074	1197	1329	82	42	2.61	60	7.486
BPRA8248	1141	1264	1398	82	48	2.61	66	8.507
BPRA8254	1209	1334	1467	82	54	2.61	72	9.528
BPRA8260	1282	1403	1537	82	60	2.61	78	10.549

BPRG • Partly Glazed Raceway Panel

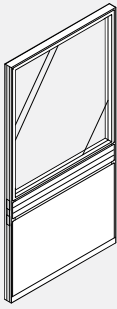

- Glazing above the raceway provides visual accessibility.
- Centre septum below raceway overlaid on either side with 1 1/8" "Sound absorbent mineral board".
- Glazing replaceable on site.
- Standard glaze is acrylic.
- For tempered glass, add "TG" to the end of the product code and add 20% to the price regardless of fabric grade or finish.
- OPT* = Laminate or Whiteboard.

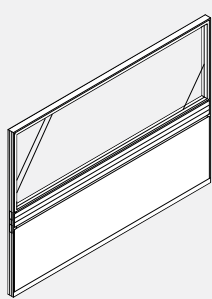

72" Wide

PRODUCT CODE	PRICE			SIZE/INCHES			WEIGHT VOL	
	GR1	GR2	OPT*	H	W	D	LBS	FT³
BPRG4218	691	702	718	42	18	2.61	22	1.782
BPRG4224	755	782	811	42	24	2.61	28	2.317
BPRG4230	820	847	877	42	30	2.61	32	2.852
BPRG4236	886	942	999	42	36	2.61	36	3.387
BPRG4242	948	1004	1062	42	42	2.61	40	3.921
BPRG4248	1015	1070	1131	42	48	2.61	44	4.456
BPRG4254	1080	1135	1195	42	54	2.61	48	4.991
BPRG4260	1143	1199	1258	42	60	2.61	52	5.525
BPRG4266	1208	1265	1329	42	66	2.61	62	6.148
BPRG4272	1274	1330	1394	42	72	2.61	72	6.770
BPRG5018	768	782	796	50	18	2.61	24	2.106
BPRG5024	831	859	889	50	24	2.61	29	2.738
BPRG5030	899	927	956	50	30	2.61	34	3.370
BPRG5036	967	1022	1081	50	36	2.61	39	4.002
BPRG5042	1032	1088	1146	50	42	2.61	44	4.634
BPRG5048	1098	1153	1210	50	48	2.61	48	5.266
BPRG5054	1165	1222	1280	50	54	2.61	54	5.898
BPRG5060	1230	1287	1345	50	60	2.61	59	6.530
BPRG5066	1271	1328	1392	50	66	2.61	70	7.300
BPRG5072	1309	1366	1399	50	72	2.61	78	8.000
BPRG5418	807	821	837	54	18	2.61	27	2.250
BPRG5424	871	901	930	54	24	2.61	30	2.960
BPRG5430	942	969	998	54	30	2.61	35	3.689
BPRG5436	1010	1064	1123	54	36	2.61	40	4.318
BPRG5442	1077	1134	1191	54	42	2.61	45	4.934
BPRG5448	1143	1199	1258	54	48	2.61	49	5.666
BPRG5454	1210	1266	1327	54	54	2.61	55	6.398
BPRG5460	1280	1335	1394	54	60	2.61	60	7.035
BPRG5818	847	860	875	58	18	2.61	26	2.431
BPRG5824	914	942	970	58	24	2.61	31	3.160
BPRG5830	983	1010	1038	58	30	2.61	36	3.889
BPRG5836	1054	1109	1166	58	36	2.61	41	4.618
BPRG5842	1122	1177	1236	58	42	2.61	46	5.347
BPRG5848	1189	1246	1304	58	48	2.61	51	6.076
BPRG5854	1258	1313	1371	58	54	2.61	56	6.806
BPRG5860	1327	1383	1440	58	60	2.61	61	7.535
BPRG6618	921	934	948	66	18	2.61	29	2.755
BPRG6624	993	1021	1051	66	24	2.61	34	3.581
BPRG6630	1064	1093	1122	66	30	2.61	39	4.407
BPRG6636	1137	1195	1252	66	36	2.61	45	5.234
BPRG6642	1209	1265	1326	66	42	2.61	50	6.060
BPRG6648	1285	1339	1398	66	48	2.61	55	6.887
BPRG6654	1355	1412	1470	66	54	2.61	60	7.713
BPRG6660	1432	1489	1548	66	60	2.61	65	8.539
BPRG7418	994	1007	1022	74	18	2.61	30	3.079
BPRG7424	1071	1099	1131	74	24	2.61	35	4.002
BPRG7430	1147	1202	1262	74	30	2.61	41	4.926
BPRG7436	1224	1280	1338	74	36	2.61	46	5.850
BPRG7442	1300	1355	1415	74	42	2.61	51	6.773
BPRG7448	1378	1433	1494	74	48	2.61	56	7.697
BPRG7454	1454	1509	1568	74	54	2.61	61	8.620
BPRG7460	1544	1599	1660	74	60	2.61	66	9.544
BPRG8218	1048	1059	1075	82	18	2.61	31	3.403
BPRG8224	1134	1162	1190	82	24	2.61	36	4.424
BPRG8230	1222	1250	1279	82	30	2.61	43	5.444
BPRG8236	1309	1365	1423	82	36	2.61	49	6.465
BPRG8242	1393	1448	1505	82	42	2.61	55	7.486
BPRG8248	1482	1537	1596	82	48	2.61	61	8.507
BPRG8254	1566	1621	1681	82	54	2.61	67	9.528
BPRG8260	1664	1722	1779	82	60	2.61	73	10.549

BPRF • Air Flow Panel

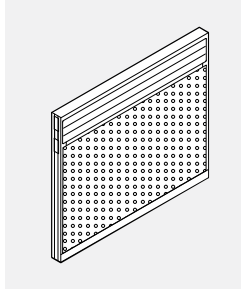

37" High

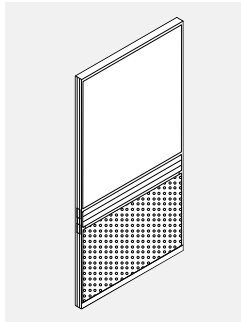

72" Wide

- Double wall of perforated metal below the raceway allows air to flow freely through the bottom of the panel.
- Centre septum above raceway overlaid on either side with tackable, 1 1/8" "Sound absorbent mineral board".
- For air flow option above the raceway, add 20% to the Grade 1 price and tag each item with "air flow above raceway". For example: BPRF4218 TAG:*air flow above raceway.
- OPT* = Laminate or Whiteboard.

PRODUCT CODE	PRICE			SIZE/INCHES			WEIGHT VOL	
	GR 1	GR 2	OPT*	H	W	D	LBS	FT ³
BPRF3718	575	-	-	37	18	2.61	18	1.58
BPRF3724	650	-	-	37	24	2.61	21	2.054
BPRF3730	733	-	-	37	30	2.61	25	2.528
BPRF3736	809	-	-	37	36	2.61	28	3.002
BPRF3742	889	-	-	37	42	2.61	32	3.476
BPRF3748	967	-	-	37	48	2.61	35	3.950
BPRF3754	1043	-	-	37	54	2.61	39	4.424
BPRF3760	1122	-	-	37	60	2.61	44	4.898
BPRF3766	1207	-	-	37	66	2.61	50	5.449
BPRF3772	1291	-	-	37	72	2.61	56	6.000
BPRF4218	594	603	609	42	18	2.61	22	1.782
BPRF4224	674	681	691	42	24	2.61	28	2.317
BPRF4230	755	761	768	42	30	2.61	32	2.852
BPRF4236	835	847	862	42	36	2.61	36	3.387
BPRF4242	916	930	944	42	42	2.61	40	3.921
BPRF4248	996	1008	1024	42	48	2.61	44	4.456
BPRF4254	1076	1089	1104	42	54	2.61	48	4.991
BPRF4260	1161	1173	1188	42	60	2.61	52	5.525
BPRF4266	1294	1353	1416	42	66	2.61	62	6.270
BPRF4272	1430	1488	1552	42	72	2.61	72	6.770
BPRF5018	668	679	696	50	18	2.61	25	2.106
BPRF5024	750	761	777	50	24	2.61	30	2.738
BPRF5030	832	845	860	50	30	2.61	35	3.370
BPRF5036	919	945	974	50	36	2.61	40	4.002
BPRF5042	1004	1032	1060	50	42	2.61	45	4.634
BPRF5048	1088	1115	1144	50	48	2.61	50	5.266
BPRF5054	1170	1199	1228	50	54	2.61	55	5.898
BPRF5060	1256	1285	1313	50	60	2.61	60	6.530
BPRF5066	1383	1439	1502	50	66	2.61	70	7.300
BPRF5072	1505	1562	1626	50	72	2.61	80	8.000
BPRF5418	692	712	733	54	18	2.61	27	2.250
BPRF5424	774	795	817	54	24	2.61	32	2.960
BPRF5430	860	882	903	54	30	2.61	37	3.689
BPRF5436	945	987	1031	54	36	2.61	42	4.318
BPRF5442	1032	1074	1118	54	42	2.61	47	4.934
BPRF5448	1118	1159	1201	54	48	2.61	52	5.666
BPRF5454	1201	1242	1287	54	54	2.61	57	6.398
BPRF5460	1288	1329	1373	54	60	2.61	62	7.035

BPRF • Air Flow Panel ...Cont

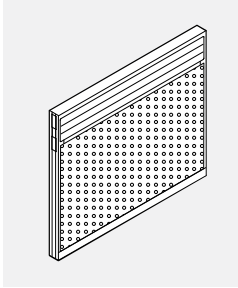

37" High

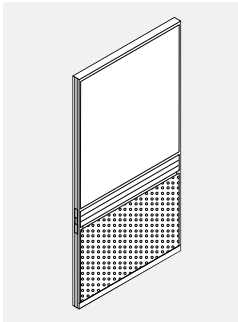

72" Wide

- Double wall of perforated metal below the raceway allows air to flow freely through the bottom of the panel.
- Centre septum above raceway overlaid on either side with tackable, 1 1/8" "Sound absorbent mineral board".
- For air flow option above the raceway, add 20% to the Grade 1 price and tag each item with "air flow above raceway". For example: BPRF4218 TAG:*air flow above raceway.
- OPT* = Laminate or Whiteboard.

PRODUCT CODE	PRICE			SIZE/INCHES			WEIGHT VOL	
	GR 1	GR 2	OPT*	H	W	D	LBS	FT ³
BPRF5818	713	733	756	58	18	2.61	28	2.431
BPRF5824	800	820	842	58	24	2.61	33	3.160
BPRF5830	889	909	931	58	30	2.61	38	3.889
BPRF5836	972	1015	1058	58	36	2.61	43	4.618
BPRF5842	1058	1099	1143	58	42	2.61	48	5.347
BPRF5848	1146	1188	1230	58	48	2.61	53	6.076
BPRF5854	1230	1272	1316	58	54	2.61	58	6.806
BPRF5860	1318	1360	1403	58	60	2.61	63	7.535
BPRF6618	761	789	818	66	18	2.61	32	2.755
BPRF6624	853	881	909	66	24	2.61	37	3.581
BPRF6630	941	968	997	66	30	2.61	42	4.407
BPRF6636	1029	1076	1126	66	36	2.61	48	5.234
BPRF6642	1177	1227	1279	66	42	2.61	53	6.060
BPRF6648	1250	1297	1349	66	48	2.61	58	6.887
BPRF6654	1354	1401	1454	66	54	2.61	63	7.713
BPRF6660	1393	1440	1493	66	60	2.61	68	8.539
BPRF7418	817	844	872	74	18	2.61	34	3.079
BPRF7424	904	932	963	74	24	2.61	39	4.002
BPRF7430	996	1024	1054	74	30	2.61	45	4.926
BPRF7436	1088	1158	1229	74	36	2.61	50	5.850
BPRF7442	1256	1326	1398	74	42	2.61	55	6.773
BPRF7448	1293	1364	1437	74	48	2.61	60	7.697
BPRF7454	1356	1427	1498	74	54	2.61	65	8.620
BPRF7460	1448	1517	1590	74	60	2.61	70	9.544
BPRF8218	881	921	966	82	18	2.61	36	3.403
BPRF8224	971	1013	1057	82	24	2.61	42	4.424
BPRF8230	1062	1104	1147	82	30	2.61	48	5.444
BPRF8236	1166	1242	1323	82	36	2.61	54	6.465
BPRF8242	1293	1370	1452	82	42	2.61	60	7.486
BPRF8248	1354	1430	1511	82	48	2.61	66	8.507
BPRF8254	1498	1575	1656	82	54	2.61	72	9.528
BPRF8260	1529	1606	1687	82	60	2.61	78	10.549

BPRAE • Raceway Panel Electrical

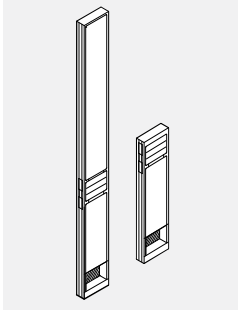

- A 6" raceway panel allows power and communication/data entry along a straight run of panels where a standard post entry cannot be utilized.
- Sections above and below the raceway are upholstered in fabric.
- Inner lower raceway area allows for single or double power feed entry and provides 1.3" x 2.9" opening for communication/data cables.
- All 6" panels must be used in conjunction with a second panel to form a standard panel width. For example: BPRAE6606 + BPRAE6618 is equivalent to BPRAE6624.
- 6" panels are not to be used as a stability panel in a panel run.

PRODUCT CODE	PRICE			SIZE/ INCHES			WEIGHT VOL	
	GR 1	GR 2	OPT*	H	W	D	LBS	FT ³
BPRAE3706	573	587	603	37	6	2.61	24	0.6
BPRAE4206	573	601	633	42	6	2.61	26	0.7
BPRAE5006	642	688	730	50	6	2.61	29	0.8
BPRAE5406	672	715	758	54	6	2.61	31	0.9
BPRAE5806	700	741	787	58	6	2.61	32	0.9
BPRAE6606	748	802	862	66	6	2.61	35	1.0
BPRAE7406	802	858	919	74	6	2.61	37	1.1
BPRAE8206	867	935	1010	82	6	2.61	41	1.2

BPRA • Raceway Panel Filler

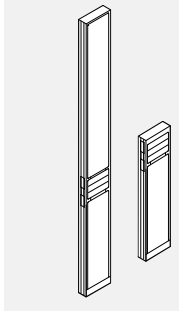

- A 6" (BPRA) raceway panel for use as a filler panel.
- Sections above and below the raceway are upholstered in fabric.
- All 6" panels must be used in conjunction with a second panel to form a standard panel width. For example: BPRA6606 + BPRA6618 is equivalent to BPRA6624.
- 6" panels are not to be used as a stability panel in a panel run.

PRODUCT CODE	PRICE			SIZE/INCHES			WEIGHT VOL	
	GR 1	GR 2	OPT*	H	W	D	LBS	FT ³
BPRA3706	573	586	601	37	6	2.61	24	0.6
BPRA4206	573	601	630	42	6	2.61	26	0.7
BPRA5006	642	686	729	50	6	2.61	29	0.8
BPRA5406	672	713	757	54	6	2.61	31	0.9
BPRA5806	700	740	785	58	6	2.61	32	0.9
BPRA6606	748	802	860	66	6	2.61	35	1.0
BPRA7406	802	858	916	74	6	2.61	37	1.1
BPRA8206	867	935	1008	82	6	2.61	41	1.2

BPRP • Pass-Thru Raceway Panel

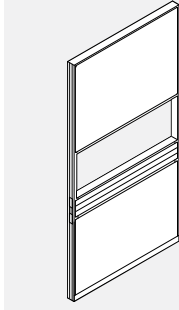

- 10.5" Open cavity allows accessibility between workstations.
- Center septum above 10.5" opening overlaid on either side with tackable, 1 1/8" mineral board.
- Center septum below raceway overlaid on either side with tackable, 1 1/8" mineral board.
- Pass-thru opening is 10.5" high starting above the raceway.
- Panel height to top of opening is fixed.

PRODUCT CODE	PRICE			SIZE/INCHES			WEIGHT VOL	
	GR 1	GR 2	OPT*	H	W	D	LBS	FT ³
BPRP6618	921	934	948	66	18	2.61	32	2.755
BPRP6624	993	1021	1051	66	24	2.61	33	3.581
BPRP6630	1064	1093	1122	66	30	2.61	38	4.407
BPRP6636	1137	1195	1252	66	36	2.61	44	5.234
BPRP6642	1209	1265	1326	66	42	2.61	49	6.060
BPRP6648	1285	1339	1398	66	48	2.61	54	6.887
BPRP6654	1355	1412	1470	66	54	2.61	59	7.713
BPRP6660	1432	1489	1548	66	60	2.61	64	8.539
BPRP7418	994	1029	1062	74	18	2.61	31	3.079
BPRP7424	1071	1126	1187	74	24	2.61	36	4.002
BPRP7430	1147	1202	1262	74	30	2.61	42	4.926
BPRP7436	1224	1290	1364	74	36	2.61	47	5.850
BPRP7442	1300	1355	1415	74	42	2.61	52	6.773
BPRP7448	1378	1470	1566	74	48	2.61	57	7.697
BPRP7454	1454	1544	1641	74	54	2.61	62	8.620
BPRP7460	1544	1599	1660	74	60	2.61	67	9.544
BPRP8218	1048	1086	1131	82	18	2.61	34	3.403
BPRP8224	1134	1187	1242	82	24	2.61	40	4.424
BPRP8230	1222	1274	1330	82	30	2.61	46	5.444
BPRP8236	1309	1405	1507	82	36	2.61	52	6.465
BPRP8242	1393	1502	1619	82	42	2.61	58	7.486
BPRP8248	1482	1591	1707	82	48	2.61	64	8.507
BPRP8254	1566	1674	1792	82	54	2.61	70	9.528
BPRP8260	1664	1774	1892	82	60	2.61	76	10.549

BPRPSD • Pass-Thru Sliding Door Kit

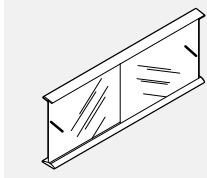

- To close the opening in a Boulevard 1 Pass-Thru Panel.
- Sliding frosted tempered glass doors.

PRODUCT CODE	PRICE	SIZE/ INCHES			WEIGHT VOL	
		H	W	D	LBS	FT ³
BPRPSD36	374	10	36	2.61	13	1.2
BPRPSD42	420	10	42	2.61	16	1.4
BPRPSD48	469	10	48	2.61	18	1.5
BPRPSD54	513	10	54	2.61	20	1.7
BPRPSD60	561	10	60	2.61	22	2.0

BPAR • Accessory Rail Panel

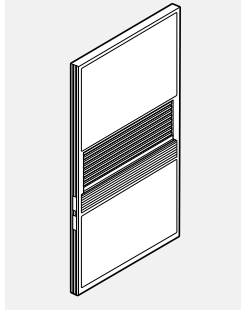

- 12" Accessory rail covers the standard pass-thru opening and allows users to hang accessories.
- Centre septum above 12" opening overlaid on either side with tackable, 1 1/8" "Sound absorbent mineral board".
- Centre septum below raceway overlaid on either side with 1 1/8" mineral board.
- Accessory rail is 12" high starting above the raceway. Panel height to top of opening is fixed.
- OPT* = Laminate or Whiteboard.

PRODUCT CODE	PRICE			SIZE/INCHES			WEIGHT VOL	
	GR 1	GR 2	OPT*	H	W	D	LBS	FT ³
BPAR6618	1075	1088	1102	66	18	2.61	35	2.755
BPAR6624	1166	1196	1224	66	24	2.61	42	3.581
BPAR6630	1282	1309	1338	66	30	2.61	49	4.407
BPAR6636	1400	1456	1516	66	36	2.61	57	5.234
BPAR6642	1549	1605	1663	66	42	2.61	65	6.060
BPAR6648	1664	1722	1779	66	48	2.61	72	6.887
BPAR6654	1784	1838	1898	66	54	2.61	79	7.713
BPAR6660	1896	1953	2011	66	60	2.61	86	8.539
BPAR7418	1151	1184	1221	74	18	2.61	38	3.079
BPAR7424	1242	1299	1356	74	24	2.61	45	4.002
BPAR7430	1356	1414	1471	74	30	2.61	53	4.926
BPAR7436	1484	1553	1623	74	36	2.61	60	5.850
BPAR7442	1634	1690	1749	74	42	2.61	68	6.773
BPAR7448	1752	1848	1949	74	48	2.61	75	7.697
BPAR7454	1874	1929	1989	74	54	2.61	82	8.620
BPAR7460	2000	2055	2114	74	60	2.61	89	9.544
BPAR8218	1198	1236	1280	82	18	2.61	41	3.403
BPAR8224	1301	1354	1412	82	24	2.61	49	4.424
BPAR8230	1427	1481	1535	82	30	2.61	57	5.444
BPAR8236	1561	1660	1760	82	36	2.61	65	6.465
BPAR8242	1723	1833	1949	82	42	2.61	74	7.486
BPAR8248	1850	1960	2079	82	48	2.61	82	8.507
BPAR8254	1983	2093	2211	82	54	2.61	90	9.528
BPAR8260	2111	2221	2338	82	60	2.61	98	10.549

BPFA • Acoustical Fabric Panel

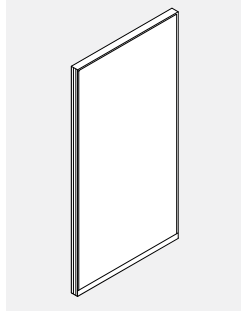

- Complete fabric panel without raceway.
- Acoustical rating of .80 NRC and 26 STC.
- Centre septum overlaid on either side with 1 1/8" Mineral board, non tackable.
- OPT* = Laminate or Whiteboard.

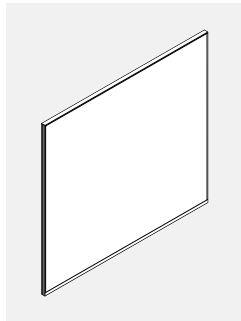

72" Wide

PRODUCT CODE	PRICE			SIZE/INCHES			WEIGHT VOL	
	GR 1	GR 2	OPT*	H	W	D	LBS	FT ³
BPFA2918	353	380	408	29	18	2.61	15	1.256
BPFA2924	381	410	443	29	24	2.61	17	1.633
BPFA2930	407	436	464	29	30	2.61	19	2.009
BPFA2936	437	493	551	29	36	2.61	21	2.386
BPFA2942	463	520	576	29	42	2.61	23	2.763
BPFA2948	493	549	607	29	48	2.61	25	3.139
BPFA2954	520	574	634	29	54	2.61	27	3.513
BPFA2960	547	603	661	29	60	2.61	29	3.893
BPFA2966	565	624	688	29	66	2.61	36	4.332
BPFA2972	586	641	-	29	72	2.61	42	4.770
BPFA4218	463	492	521	42	18	2.61	18	1.782
BPFA4224	494	550	608	42	24	2.61	21	2.317
BPFA4230	523	576	636	42	30	2.61	24	2.852
BPFA4236	552	620	694	42	36	2.61	27	3.387
BPFA4242	583	650	724	42	42	2.61	30	3.921
BPFA4248	611	678	754	42	48	2.61	33	4.456
BPFA4254	639	706	782	42	54	2.61	36	4.991
BPFA4260	671	739	813	42	60	2.61	39	5.525
BPFA4266	756	870	994	42	66	2.61	47	6.148
BPFA4272	840	956	-	42	72	2.61	54	6.770
BPFA5018	524	551	579	50	18	2.61	22	2.106
BPFA5024	556	595	639	50	24	2.61	25	2.738
BPFA5030	587	628	672	50	30	2.61	28	3.370
BPFA5036	617	701	789	50	36	2.61	31	4.002
BPFA5042	649	730	820	50	42	2.61	34	4.634
BPFA5048	678	761	851	50	48	2.61	38	5.266
BPFA5054	712	793	883	50	54	2.61	41	5.898
BPFA5060	743	826	915	50	60	2.61	43	6.530
BPFA5066	818	934	1057	50	66	2.61	53	7.300
BPFA5072	893	1008	-	50	72	2.61	62	8.000
BPFA5418	553	583	611	54	18	2.61	23	2.250
BPFA5424	586	626	671	54	24	2.61	26	2.960
BPFA5430	617	660	702	54	30	2.61	30	3.689
BPFA5436	650	732	821	54	36	2.61	34	4.318
BPFA5442	681	763	854	54	42	2.61	38	4.934
BPFA5448	715	796	886	54	48	2.61	41	5.666
BPFA5454	748	828	919	54	54	2.61	43	6.398
BPFA5460	782	865	954	54	60	2.61	46	7.035

BPFA • Acoustical Fabric Panel ...Cont

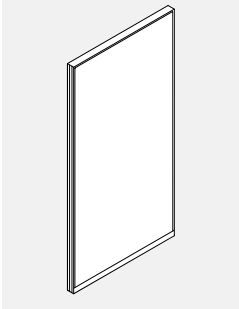

- Complete fabric panel without raceway.
- Acoustical rating of .80 NRC and 26 STC.
- Centre septum overlaid on either side with 1 1/8" Mineral board, non tackable.
- OPT* = Laminate or Whiteboard.

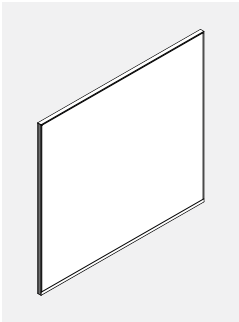

72" Wide

PRODUCT CODE	PRICE			SIZE/INCHES			WEIGHT VOL	
	GR1	GR2	OPT*	H	W	D	LBS	FT ³
BPFA5818	584	624	668	58	18	2.61	24	2.431
BPFA5824	616	672	730	58	24	2.61	27	3.160
BPFA5830	649	703	762	58	30	2.61	31	3.889
BPFA5836	679	778	881	58	36	2.61	35	4.618
BPFA5842	715	811	914	58	42	2.61	39	5.347
BPFA5848	750	844	947	58	48	2.61	42	6.076
BPFA5854	782	879	982	58	54	2.61	46	6.806
BPFA5860	818	915	1019	58	60	2.61	50	7.535
BPFA6618	637	677	723	66	18	2.61	26	2.755
BPFA6624	673	729	788	66	24	2.61	29	3.581
BPFA6630	710	765	825	66	30	2.61	34	4.407
BPFA6636	748	857	972	66	36	2.61	39	5.234
BPFA6642	785	894	1011	66	42	2.61	43	6.060
BPFA6648	821	931	1049	66	48	2.61	47	6.887
BPFA6654	859	969	1086	66	54	2.61	51	7.713
BPFA6660	894	1004	1121	66	60	2.61	55	8.539
BPFA7418	699	739	783	74	18	2.61	28	3.079
BPFA7424	736	805	879	74	24	2.61	32	4.002
BPFA7430	774	843	916	74	30	2.61	37	4.926
BPFA7436	813	935	1069	74	36	2.61	42	5.850
BPFA7442	853	974	1109	74	42	2.61	47	6.773
BPFA7448	891	1015	1147	74	48	2.61	51	7.697
BPFA7454	930	1054	1187	74	54	2.61	55	8.620
BPFA7460	970	1093	1227	74	60	2.61	60	9.544
BPFA8218	755	809	868	82	18	2.61	30	3.403
BPFA8224	795	865	936	82	24	2.61	35	4.424
BPFA8230	838	906	978	82	30	2.61	40	5.444
BPFA8236	881	1019	1164	82	36	2.61	45	6.465
BPFA8242	921	1058	1203	82	42	2.61	50	7.486
BPFA8248	965	1101	1249	82	48	2.61	55	8.507
BPFA8254	1007	1144	1290	82	54	2.61	60	9.528
BPFA8260	1052	1189	1335	82	60	2.61	65	10.549

BPFG • Glazed Panel

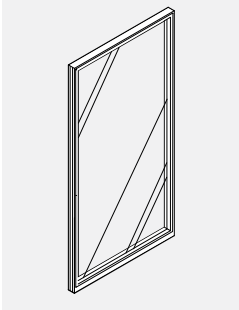

- Full-height glazing provides visual accessibility.
- Glazing is replaceable on site.
- For tempered glass, add "TG" to the end of the product code and 20% to the list price regardless of finish.

PRODUCT CODE	PRICE	SIZE/ INCHES			WEIGHT VOL	
		H	W	D	LBS	FT ³
BPFG5824	809	58	24	2.61	21	3.160
BPFG5830	891	58	30	2.61	24	3.889
BPFG5836	971	58	36	2.61	27	4.618
BPFG5842	1054	58	42	2.61	30	5.347
BPFG5848	1133	58	48	2.61	33	6.076
BPFG6624	975	66	24	2.61	25	3.581
BPFG6630	1058	66	30	2.61	28	4.407
BPFG6636	1143	66	36	2.61	31	5.234
BPFG6642	1227	66	42	2.61	34	6.060
BPFG6648	1313	66	48	2.61	37	6.887
BPFG7424	1022	74	24	2.61	28	4.002
BPFG7430	1110	74	30	2.61	31	4.926
BPFG7436	1199	74	36	2.61	34	5.850
BPFG7442	1288	74	42	2.61	37	6.773
BPFG7448	1375	74	48	2.61	40	7.697
BPFG8224	1115	82	24	2.61	31	4.424
BPFG8230	1218	82	30	2.61	34	5.444
BPFG8236	1313	82	36	2.61	37	6.465
BPFG8242	1412	82	42	2.61	40	7.486
BPFG8248	1509	82	48	2.61	43	8.507

BPOF • Fabric Over Panel

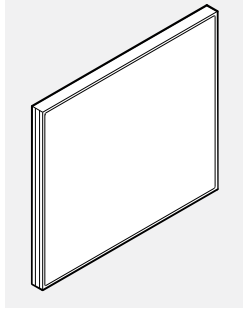

- **Attaches to top of a panel to create floor-to-ceiling wall.**
- Centre septum overlaid on either side with 1 1/8" Mineral board.
- Non-slotted.
- Factory installed PVC strip attaches and aligns over panel to top of base panel.
- PVC strip runs entire width eliminating light seepage.
- For custom heights and widths, please order size required and price as next size up. Example: 26" high, 35" wide, order BPOF2635 at \$459 Grade 1.
- Custom heights over 42" must be quoted separately.
- Overpanels can be stacked on any panel. Example: BPOF2418 stacked on BPRA4218 to give an overall height of 66".
- When stacking on 29" or 37" high B1 panels, custom height required, please contact customer service.
- Exact height should be specified when ordering, with allowance of at least 1" of free space between over panel and ceiling to accommodate height variations in ceiling and floor. Runs of over panels should be captured at either end with full height posts, wall adapters, taller panels, and/or vertical trims.
- Minimum height of 6".
- OPT* = Laminate or Whiteboard.

PRODUCT CODE	PRICE			SIZE/INCHES			WEIGHT VOL	
	GR1	GR2	OPT*	H	W	D	LBS	FT ³
BPOF0818	177	193	206	8	18	2.61	6	0.351
BPOF0824	206	233	263	8	24	2.61	6	0.468
BPOF0830	245	273	303	8	30	2.61	8	0.730
BPOF0836	284	311	341	8	36	2.61	10	0.912
BPOF0842	314	341	371	8	42	2.61	10	0.912
BPOF0848	353	380	408	8	48	2.61	12	1.094
BPOF0854	394	421	450	8	54	2.61	12	1.094
BPOF0860	421	449	477	8	60	2.61	14	1.277
BPOF0866	459	518	578	8	66	2.61	17	1.549
BPOF0872	494	551	613	08	72	2.61	20	1.820
BPOF1618	234	251	263	16	18	2.61	8	0.730
BPOF1624	266	294	322	16	24	2.61	8	0.730
BPOF1630	304	332	361	16	30	2.61	10	0.912
BPOF1636	343	372	400	16	36	2.61	12	1.094
BPOF1642	374	403	433	16	42	2.61	12	1.094
BPOF1648	413	441	470	16	48	2.61	14	1.277
BPOF1654	451	480	508	16	54	2.61	14	1.277
BPOF1660	481	508	537	16	60	2.61	15	1.368
BPOF1666	506	563	626	16	66	2.61	20	1.774
BPOF1672	557	613	675	16	72	2.61	24	2.180
BPOF2418	323	337	353	24	18	2.61	12	1.094
BPOF2424	350	377	406	24	24	2.61	14	1.422
BPOF2430	378	406	436	24	30	2.61	17	1.750
BPOF2436	405	444	490	24	36	2.61	18	2.078
BPOF2442	433	472	519	24	42	2.61	21	2.406
BPOF2448	461	501	546	24	48	2.61	22	2.734
BPOF2454	486	513	545	24	54	2.61	24	3.063
BPOF2460	513	556	597	24	60	2.61	27	3.391
BPOF2466	552	609	672	24	66	2.61	32	3.766
BPOF2472	589	646	706	24	72	2.61	36	4.140
BPOF3718	367	396	425	37	18	2.61	17	1.580
BPOF3724	398	426	457	37	24	2.61	19	2.054
BPOF3730	428	469	512	37	30	2.61	22	2.528
BPOF3736	459	527	601	37	36	2.61	24	3.006
BPOF3742	486	556	628	37	42	2.61	28	3.476
BPOF3748	519	586	660	37	48	2.61	30	3.950
BPOF3754	547	615	690	37	54	2.61	32	4.424
BPOF3760	575	642	718	37	60	2.61	34	4.898
BPOF3766	642	760	883	37	66	2.61	41	5.449
BPOF3772	712	827	-	37	72	2.61	48	6.000
BPOF4218	463	492	521	42	18	2.61	18	1.780
BPOF4224	494	550	608	42	24	2.61	21	2.310
BPOF4230	523	576	636	42	30	2.61	24	2.850
BPOF4236	552	620	694	42	36	2.61	27	3.390
BPOF4242	583	650	724	42	42	2.61	30	3.920
BPOF4248	612	679	755	42	48	2.61	33	4.460
BPOF4254	639	706	782	42	54	2.61	36	4.990
BPOF4260	671	739	813	42	60	2.61	39	5.250
BPOF4266	751	866	988	42	66	2.61	47	6.015
BPOF4272	828	944	-	42	72	2.61	54	6.780

BPOG • Glazed Over Panel

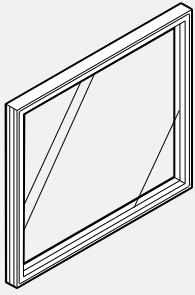

- **Attaches to top of a panel to create floor-to-ceiling wall.**
- Non-slotted.
- Factory installed PVC strip attaches and aligns over panel to top of base panel.
- PVC strip runs entire width eliminating light seepage.
- For custom heights and widths, order size required and price as next size up. Example: 26" high, 35" wide, order BPOG2635 at \$620 in acrylic.
- Custom heights over 42" must be quoted separately.
- Over panels can be stacked on any panel. Example: BPOG2418 stacked on BPRA4218 to give an overall height of 66".
- When stacking on 29" or 37" high B1 panels, custom height required, please contact customer service.
- Exact height should be specified when ordering, with allowance of at least 1" of free space between over panel and ceiling to accommodate height variations in ceiling and floor. Runs of over panels should be captured at either end with full height posts, wall adapters, taller panels, and/or vertical trims.
- Minimum height of 6".
- For tempered glass option, add "TG" to the end of the product code and 20% to the list price.

PRODUCT CODE	PRICE	SIZE/ INCHES			WEIGHT VOL	
		H	W	D	LBS	FT ³
BPOG0818	118	8	18	2.61	6	0.351
BPOG0824	147	8	24	2.61	6	0.468
BPOG0830	177	8	30	2.61	8	0.730
BPOG0836	205	8	36	2.61	10	0.912
BPOG0842	234	8	42	2.61	10	0.912
BPOG0848	267	8	48	2.61	12	1.094
BPOG0854	296	8	54	2.61	12	1.094
BPOG0860	326	8	60	2.61	14	1.277
BPOG0866	344	8	66	2.61	17	1.549
BPOG0872	364	8	72	2.61	20	1.820
BPOG1618	188	16	18	2.61	8	0.730
BPOG1624	227	16	24	2.61	8	0.730
BPOG1630	267	16	30	2.61	10	0.912
BPOG1636	314	16	36	2.61	12	1.094
BPOG1642	343	16	42	2.61	12	1.094
BPOG1648	383	16	48	2.61	14	1.277
BPOG1654	421	16	54	2.61	14	1.277
BPOG1660	462	16	60	2.61	15	1.368
BPOG1666	481	16	66	2.61	20	1.774
BPOG1672	501	16	72	2.61	24	2.180
BPOG2418	334	24	18	2.61	12	1.094
BPOG2424	378	24	24	2.61	14	1.422
BPOG2430	419	24	30	2.61	17	1.750
BPOG2436	461	24	36	2.61	18	2.078
BPOG2442	501	24	42	2.61	21	2.406
BPOG2448	545	24	48	2.61	22	2.734
BPOG2454	584	24	54	2.61	24	3.063
BPOG2460	622	24	60	2.61	27	3.391
BPOG2466	679	24	66	2.61	32	3.766
BPOG2472	739	24	72	2.61	36	4.140
BPOG3718	480	37	18	2.61	17	1.580
BPOG3724	527	37	24	2.61	19	2.054
BPOG3730	576	37	30	2.61	22	2.528
BPOG3736	620	37	36	2.61	24	3.006
BPOG3742	671	37	42	2.61	28	3.476
BPOG3748	715	37	48	2.61	30	3.950
BPOG3754	763	37	54	2.61	32	4.424
BPOG3760	809	37	60	2.61	34	4.898
BPOG3766	847	37	66	2.61	41	5.449
BPOG3772	886	37	72	2.61	48	6.000
BPOG4218	508	42	18	2.61	18	1.780
BPOG4224	560	42	24	2.61	21	2.310
BPOG4230	612	42	30	2.61	24	2.850
BPOG4236	658	42	36	2.61	27	3.390
BPOG4242	715	42	42	2.61	30	3.920
BPOG4248	763	42	48	2.61	33	4.460
BPOG4254	809	42	54	2.61	36	4.990
BPOG4260	860	42	60	2.61	39	5.250
BPOG4266	904	42	66	2.61	47	6.015
BPOG4272	948	42	72	2.61	54	6.780

BAPAS • Glass Over Panel with Round Tucks for Boulevard 1

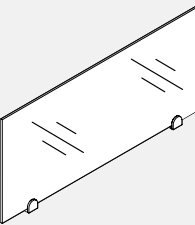

- **Glass Over Panel creates division.**
- Glass Over Panel with no frame sits on top of a Boulevard 1 Panel with clamps that are secured to the top of the panel.
- Tempered glass is 16" high.
- Custom sizes available, contact your Customer Service Representative.
- For application where the over panel is sandwiched between two taller panels, please request a special as the glass will not fit due to trims.

PRODUCT CODE	PRICE CLR	FRST	SIZE/INCHES			WEIGHT VOL	
			H	W	D	LBS	FT ³
BAPAS0824	198	228	8	24	1.3	4	0.22
BAPAS0830	222	254	8	30	1.3	5	0.30
BAPAS0836	234	275	8	36	1.3	6	0.37
BAPAS0842	254	297	8	42	1.3	7	0.43
BAPAS0848	273	314	8	48	1.3	8	0.48
BAPAS1624	212	241	16	24	1.3	8	0.44
BAPAS1630	234	268	16	30	1.3	10	0.59
BAPAS1636	252	290	16	36	1.3	12	0.73
BAPAS1642	268	311	16	42	1.3	14	0.85
BAPAS1648	273	329	16	48	1.3	16	0.96

BAPASS • Glass Over Panel with Square Pucks for Boulevard 1

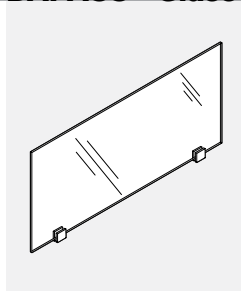

- **Glass Over Panel creates division.**
- Glass Over Panel with no frame sits on top of a Boulevard 1 Panel with clamps that are secured to the top of the panel.
- Tempered glass is 16" high.
- Custom sizes available, contact your Customer Service Representative.
- For application where the over panel is sandwiched between two taller panels, please request a special as the glass will not fit due to trims.

PRODUCT CODE	PRICE CLR	FRST	SIZE/INCHES			WEIGHT VOL	
			H	W	D	LBS	FT ³
BAPASS0824	212	241	8	24	1.3	4	0.22
BAPASS0830	234	268	8	30	1.3	5	0.30
BAPASS0836	254	290	8	36	1.3	6	0.37
BAPASS0842	268	311	8	42	1.3	7	0.43
BAPASS0848	289	329	8	48	1.3	8	0.48
BAPASS1624	228	256	16	24	1.3	8	0.44
BAPASS1630	252	283	16	30	1.3	10	0.59
BAPASS1636	266	304	16	36	1.3	12	0.73
BAPASS1642	283	328	16	42	1.3	14	0.85
BAPASS1648	290	342	16	48	1.3	16	0.96

BAPAST • Felt Over Panel with Round Pucks for Boulevard 1

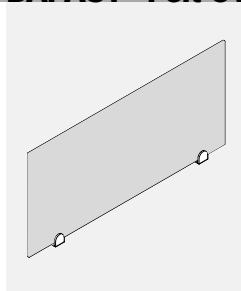

- **Felt Over Panel creates division.**
- Felt Over Panel with no frame sits on top of a Boulevard 1 panel with round clamps that are secured to the top of the panel.
- Felt panel is 8" and 16" high.
- 9mm different colours. Please specify colour.
- For application where the over panel is sandwiched between two taller panels, please request a special as the glass will not fit due to trims.

PRODUCT CODE	PRICE	SIZE/INCHES			WEIGHT VOL	
		H	W	D	LBS	FT ³
BAPAST0824	100	8	22.7	1.13	1.0	0.11
BAPAST0830	107	8	28.7	1.13	1.1	0.14
BAPAST0836	114	8	34.7	1.13	1.2	0.17
BAPAST0842	125	8	40.7	1.13	1.3	0.20
BAPAST0848	135	8	46.7	1.13	1.4	0.23
BAPAST1624	128	16	22.7	1.13	1.4	0.23
BAPAST1630	144	16	28.7	1.13	1.5	0.29
BAPAST1636	165	16	34.7	1.13	1.7	0.35
BAPAST1642	178	16	40.7	1.13	1.9	0.42
BAPAST1648	191	16	46.7	1.13	2.0	0.48

BAPASST • Felt Over Panel with Square Pucks for Boulevard 1

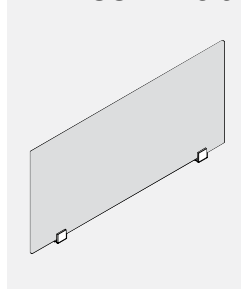

- **Felt Over Panel creates division.**
- Felt Over Panel with no frame sits on top of a Boulevard 1 panel with round clamps that are secured to the top of the panel.
- Felt panel is 8" and 16" high.
- 9mm different colours. Please specify colour.
- For application where the over panel is sandwiched between two taller panels, please request a special as the glass will not fit due to trims.

PRODUCT CODE	PRICE	SIZE/INCHES			WEIGHT VOL	
		H	W	D	LBS	FT ³
BAPASST0824	100	8	22.7	1.13	1.0	0.11
BAPASST0830	107	8	28.7	1.13	1.1	0.14
BAPASST0836	114	8	34.7	1.13	1.2	0.17
BAPASST0842	125	8	40.7	1.13	1.3	0.20
BAPASST0848	135	8	46.7	1.13	1.4	0.23
BAPASST1624	128	16	22.7	1.13	1.4	0.23
BAPASST1630	144	16	28.7	1.13	1.5	0.29
BAPASST1636	165	16	34.7	1.13	1.7	0.35
BAPASST1642	178	16	40.7	1.13	1.9	0.42
BAPASST1648	191	16	46.7	1.13	2.0	0.48

BPDS • Solid Door Panel

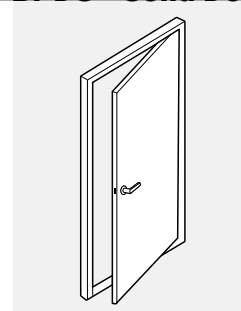

- **Aluminum frame with high pressure laminate.**
- 1 3/8" thick hollow core door.
- Actual door size:
80" x 32 1/2" in 82" x 36" frame
80" x 38 1/2" in 82" x 42" frame
- 42" wide Door Panel permits wheelchair accessibility.
- No hang-on capabilities.
- Non slotted frame.
- 180 degree swing.
- Specify Door Knob (DL01) or Door Lever (DL02).
- Lock standard.
- Handedness can be changed on site.
- Please specify Right hand (R) or Left hand (L) hung.

PRODUCT CODE	PRICE HP	SIZE/INCHES			WEIGHT VOL	
		H	W	D	LBS	FT ³
BPDS8236R	2263	82	36	2.61	61	6.465
BPDS8242R	2465	82	42	2.61	68	7.486
BPDS8236L	2263	82	36	2.61	61	6.465
BPDS8242L	2465	82	42	2.61	68	7.486

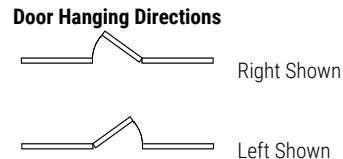

- Door Handle Option**
- Door Knob - DL01
 - Lock Standard
 - Door Lever - DL02(Default)
 - Lock Standard
 - Lever complies with all accessibility standards



BPDH • Half Glazed Door Panel

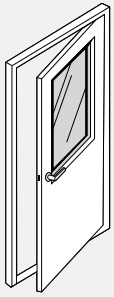

- **Aluminum frame with high pressure laminate door and window.**
- 1 3/8" thick hollow core door.
- Actual door size:
80" x 32 1/2" in 82" x 36" frame
80"x381/2" in 82"x42" frame
- 42" wide Door Panel permits wheelchair accessibility.
- No hang-on capabilities.
- 180 degree swing.
- Specify Door Knob (DL01) or Door Lever (DL02).
- Lock standard.
- Handedness can be changed on site.
- Please specify Right hand (R) or Left hand (L) hung.
- For tempered glass option, add "TG" at the end of the product code and add an upcharge of \$145 for 36" wide doors and \$174 for 42" wide doors.

PRODUCT CODE	PRICE HP	SIZE/INCHES			WEIGHT VOL	
		H	W	D	LBS	FT ³
BPDH8236R	2807	82	36	2.61	53	6.465
BPDH8242R	3068	82	42	2.61	59	7.486
BPDH8236L	2807	82	36	2.61	53	6.465
BPDH8242L	3068	82	42	2.61	59	7.486

Door Hanging Directions

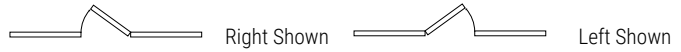

Door Handle Option

- Door Knob - DL01
- Lock Standard
- Door Lever - DL02(Default)
- Lock Standard
- Lever complies with all accessibility standards



BPDG • Solid Glazed Door Panel

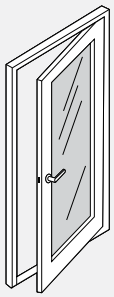

- **Aluminum frame with either high pressure laminate door and window.**
- 1 3/8" thick hollow core door.
- Actual door size:
80" x 32 1/2" in 82" x 36" frame
80"x381/2" in 82"x42" frame
- 42" wide Door Panel permits wheelchair accessibility.
- No hang-on capabilities.
- 180 degree swing.
- Specify Door Knob (DL01) or Door Lever (DL02).
- Lock standard.
- Handedness can be changed on site.
- Please specify Right hand (R) or Left hand (L) hung.
- For tempered glass option, add "TG" at the end of the product code and add an upcharge of \$293 for 36" wide doors and \$365 for 42" wide doors.
- Laminate frame is 5" thick on sides and 4" at top and bottom.

PRODUCT CODE	PRICE HP	SIZE/INCHES			WEIGHT VOL	
		H	W	D	LBS	FT ³
BPDG8236R	3227	82	36	2.61	53	6.465
BPDG8242R	3531	82	42	2.61	59	7.486
BPDG8236L	3227	82	36	2.61	53	6.465
BPDG8242L	3531	82	42	2.61	59	7.486

Door Hanging Directions

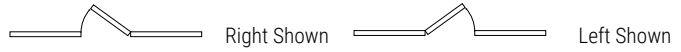

Door Handle Option

- Door Knob - DL01
- Lock Standard
- Door Lever - DL02(Default)
- Lock Standard
- Lever complies with all accessibility standards



BPDSL • Privacy Screen

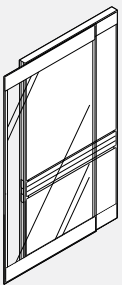

- **Provides territorial privacy in an open plan environment.**
- Lightweight, panel mounted sliding partition.
- Consists of translucent textured polycarbonate.
- Must be mounted to a straight panel of the same size.
- The face of the Privacy Screen sits 3" away from the face of the panel to which it is attached.
- Cable lay-in modules, wood trim and non-load bearing panels may be applied to the top of a panel to which the screen is attached, but not the screen itself.
- When open, the screen may interfere with access doors that open on the outside of an adjacent panel.
- Must specify left or right for the direction in which the door will slide once installed.
- Caps located on the end of the frame default to the panel frame colour.
- All hardware included.
- Can be mounted on Boulevard 1 or Boulevard System 3 panels of the same width as the Privacy Screen.
- Note: Specify left or right for the direction in which the door will slide as per examples above.

PRODUCT CODE	PRICE	SIZE/ INCHES			WEIGHT VOL	
		H	W	D	LBS	FT ³
BPDSL6636R	1923	66	36	2.61	35	5.98
BPDSL6642R	2070	66	42	2.61	42	6.93
BPDSL8136R	2308	81	36	2.61	43	7.30
BPDSL8142R	2477	81	42	2.61	50	8.45
BPDSL6636L	1923	66	36	2.61	35	5.98
BPDSL6642L	2070	66	42	2.61	42	6.93
BPDSL8136L	2308	81	36	2.61	43	7.30
BPDSL8142L	2477	81	42	2.61	50	8.45

Left Hang Option

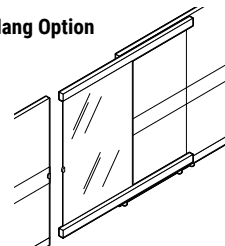

Right Hang Hung

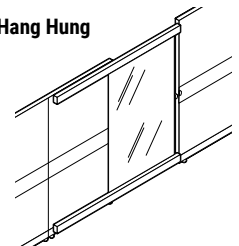

BPDSLLOCK • Privacy Screen Lock

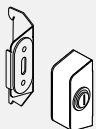

Left Hand Shown

- Lock bracket attaches to Privacy Screen with screws
- Includes strike plate bracket which attaches to slots in connector.
- Lock included.
- Available in tungsten only.
- Requires on site installation, drilling into the Privacy Screen aluminum frame.

PRODUCT CODE	PRICE	SIZE/ INCHES			WEIGHT VOL	
		H	W	D	LBS	FT ³
BPDSLLOCKR	233	2.65	1.2	0.9	1	0.2
BPDSLLOCKL	233	2.65	1.2	0.9	1	0.2

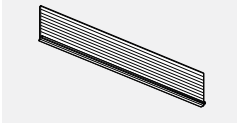
BPXCF • Ceiling Filler

- Durable PVC designed to seal a gap between ceiling and over panel.
- Available in lengths of 124" to be pressed into over panel's horizontal wing profile.
- Can be applied during installation or retrofitted later.
- For use only with Boulevard 1 panels.

PRODUCT CODE	PRICE	SIZE/INCHES			WEIGHT VOL	
		H	W	D	LBS	FT ³
BPXCF124	63	3.25	124	0.125	1	1.2

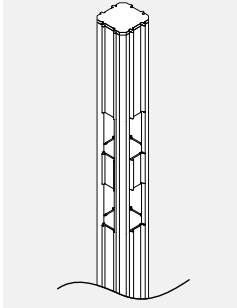
BHP • 90 Degree Post

- Enables connection for multiple panel runs such as 90 degree, 3 way and 4 way.
- Includes 2 "Capture Strip" panel connectors, 4 end strips, 4 pairs of raceway end caps, and 1 post cap.
- Posts are designed to accept the following:
 - 75 cables 5.6mm (0.220") diameter
 - 60 cables 5.6mm (0.220") diameter with 1 powerfeed
 - 45 cables 5.6mm (0.220") diameter with 2 powerfeeds

PRODUCT CODE	PRICE	SIZE/INCHES			WEIGHT VOL	
		H	W	D	LBS	FT ³
BHP029	79	29	2.61	2.61	4	0.154
BHP037	128	37	2.61	2.61	5	0.195
BHP042	141	42	2.61	2.61	5	0.221
BHP050	157	50	2.61	2.61	6	0.263
BHP054	165	54	2.61	2.61	6	0.284
BHP058	173	58	2.61	2.61	7	0.305
BHP066	189	66	2.61	2.61	8	0.346
BHP074	205	74	2.61	2.61	9	0.388
BHP082	221	82	2.61	2.61	9	0.430
BHP106	264	106	2.61	2.61	12	0.560
BHP119	283	119	2.61	2.61	13	0.622

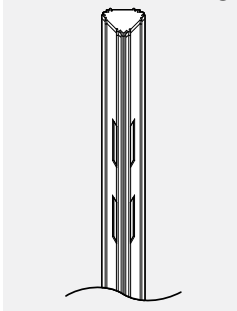
BHP45 • 45 Degree Post

- Enables connection for two panels at 45 degrees.
- Includes 2 "Capture Strip" panel connectors, 4 end strips, 2 pairs of raceway end caps, and 1 post cap.
- 45 degree post does not accept PVC or Wood End Trim.
- No power infeed/post extension capabilities.
- Posts are designed to accept 30 cables 5.6mm (0.220") diameter

PRODUCT CODE	PRICE	SIZE/INCHES			WEIGHT VOL	
		H	W	D	LBS	FT ³
BHP4529	79	29	2.61	2.61	4	0.154
BHP4537	128	37	2.61	2.61	5	0.195
BHP4542	141	42	2.61	2.61	5	0.221
BHP4550	157	50	2.61	2.61	6	0.263
BHP4554	165	54	2.61	2.61	6	0.284
BHP4558	173	58	2.61	2.61	7	0.305
BHP4566	189	66	2.61	2.61	8	0.346
BHP4574	205	74	2.61	2.61	9	0.388
BHP4582	221	82	2.61	2.61	9	0.430
BHP45106	264	106	2.61	2.61	12	0.560
BHP45119	283	119	2.61	2.61	13	0.622

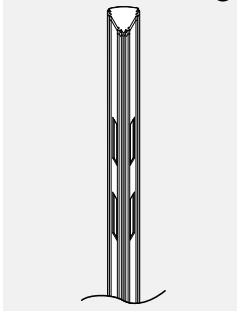
BHP60 • 60 Degree Post

- Enables connection for multiple panel runs such as 120 degrees and 3 way.
- Includes 2 "Capture Strip" panel connectors, 4 end strips, 3 pair of raceway end caps, and 1 post cap.
- No power infeed/post extension capabilities.

PRODUCT CODE	PRICE	SIZE/INCHES			WEIGHT VOL	
		H	W	D	LBS	FT ³
BHP6029	79	29	2.61	2.61	4	0.154
BHP6037	128	37	2.61	2.61	5	0.195
BHP6042	141	42	2.61	2.61	5	0.221
BHP6050	157	50	2.61	2.61	6	0.263
BHP6054	165	54	2.61	2.61	6	0.284
BHP6058	173	58	2.61	2.61	7	0.305
BHP6066	189	66	2.61	2.61	8	0.346
BHP6074	205	74	2.61	2.61	9	0.388
BHP6082	221	82	2.61	2.61	9	0.430
BHP60106	264	106	2.61	2.61	12	0.560
BHP60119	283	119	2.61	2.61	13	0.622

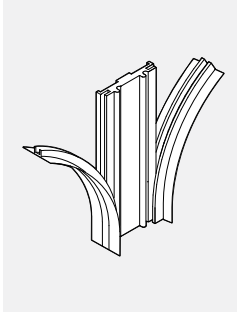
BHWA • Wall Adapter

- Starts a run of panels off an existing wall.
- Includes 2 "Capture Strip" panel connectors and 1 pair of raceway end caps.
- Mounting hardware not included. The mounting hardware selected must be based on the wall or wall stud material.
- Wall adapter adds 5/16" to a panel run.

PRODUCT CODE	PRICE	SIZE/INCHES			WEIGHT VOL	
		H	W	D	LBS	FT ³
BHWA029	55	29	2.61	0.375	4	0.01
BHWA037	58	37	2.61	0.375	5	0.013
BHWA042	62	42	2.61	0.375	5	0.015
BHWA050	66	50	2.61	0.375	6	0.018
BHWA054	70	54	2.61	0.375	6	0.020
BHWA058	72	58	2.61	0.375	7	0.021
BHWA066	78	66	2.61	0.375	8	0.024
BHWA074	87	74	2.61	0.375	9	0.027
BHWA082	90	82	2.61	0.375	9	0.030
BHWA106	116	106	2.61	0.375	12	0.039
BHWA119	133	119	2.61	0.375	13	0.043

BHWASL • Adapter Sleeve



- **Wall Adapter Sleeve is attached to the building to provide flexible support to a panel run.**
- As opposed to the BHW wall adapter, which connects to the panels securely to a wall, B1 and B3 Boulevard panels rest inside the vertical "U" channel, providing up to 3.5" of flexible adjustment.
- For panel runs taller than 66" order two Wall Adapter Sleeve and either have them cut short on site below the ceiling, or cut a rectangular hole in the ceiling tile. Rectangular slots in the Channels correspond to 66", 58", 50" and 42" high B1 and B3 panels.
- Powder coated steel; specify metal finish.
- Note: the Wall Adapter Sleeve provides flexible, connection, blocks vertical 1" increment clots and cannot, therefore, be used to support overheads and worksurfaces, they must be supported by perpendicular panels, c-legs or gables.
- Note: No fasteners are provided with the Wall Adapter Sleeve. Select the appropriate fasteners according to a structurally wall type.
- Cannot be used to support a door or panel and cannot be used with laminate, airflow or metal skin panels.

PRODUCT CODE	PRICE	SIZE/ INCHES			WEIGHT VOL	
		H	W	D	LBS	FT ³
BHWASL42	145	34.7	4	2	2.5	0.161
BHWASL50	157	42.7	4	2	3.6	0.198
BHWASL54	165	46.7	4	2	4.2	0.220
BHWASL58	169	50.7	4	2	5.1	0.244
BHWASL66	182	58.7	4	2	6.0	0.272

BHHF • High Profile Foot

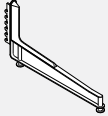

- **Provides added support to panel under load.**
- Adjustable glides included.
- Made of cast aluminum and cold rolled steel.
- Cannot be used with System 3 Panels

PRODUCT CODE	PRICE	SIZE/INCHES			WEIGHT VOL	
		H	W	D	LBS	FT ³
BHHF01	222	9	1	18.375	4	0.130

BHLF • Low Profile Foot

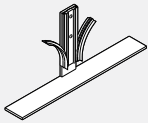

- **Stabilizes a run of panels.**
- Attaches with supplied connectors to an end of a panel.
- Made of cold rolled steel.
- Cannot be used with System 3 Panels

PRODUCT CODE	PRICE	SIZE/ INCHES			WEIGHT VOL	
		H	W	D	LBS	FT ³
BHLF01	52	6	9	2.5	7	0.230

BHPA • Panel to Panel Adapter

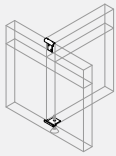

- **Enables mid panel, off-module connection.**
- Slim profile.
- Formed steel construction.
- Permanent clamps fit around base channel and fits to top rail.
- Priced as a complete kit.
- Designed for use with Boulevard 1 panels of the same height only.
- Not to be used on the panel seam, with over panels or laminate and metal faced panels.

PRODUCT CODE	PRICE	SIZE/ INCHES			WEIGHT VOL	
		H	W	D	LBS	FT ³
BHPA02	52	2	2.5	00.0	0.25	0.120

BHCS • Capture Strip Slot Cover

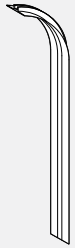

- **An extruded PVC channel to adjoin two panels or a panel to a post. Runs the full length of the panel on both sides providing a positive connection of the "Knuckle-Loc" design.**
- Priced per pair.
- Pliable side membranes cover panel slots.
- Included with panel components.
- Only to be ordered separately if required.

PRODUCT CODE	PRICE	SIZE/ INCHES			WEIGHT VOL	
		H	W	D	LBS	FT ³
BHCS29	11	29			0.21	0.09
BHCS37	12	37			0.24	0.11
BHCS42	12	42			0.28	0.13
BHCS50	13	50			0.33	0.15
BHCS54	13	54			0.31	0.17
BHCS58	15	58			0.63	0.19
BHCS66	20	66			0.40	0.19
BHCS74	21	74			0.43	0.20
BHCS82	23	82			0.47	0.20

BHCE • End Strip Slot Cover



- **End strips with pliable side membrane covers panel slots at end of run.**
- Priced per pair.
- Included with panel components.
- Only to be ordered separately if required.

PRODUCT CODE	PRICE	SIZE/ INCHES			WEIGHT VOL	
		H	W	D	LBS	FT ³
BHCE29	10	29			0.10	0.04
BHCE37	11	37			0.12	0.05
BHCE42	11	42			0.14	0.06
BHCE50	12	50			0.16	0.07
BHCE54	12	54			0.31	0.08
BHCE58	12	58			0.18	0.08
BHCE66	13	66			0.20	0.09
BHCE74	15	74			0.22	0.10
BHCE82	20	82			0.23	0.11

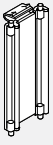
BHRC • Raceway End Cap

- Provides clean detail at the end of a panel run or post. End caps fit flush into communication and power channel entry.
- Priced per pair.
- Made of injection molded ABS.
- Included with panel components. Only to be ordered separately if required.

PRODUCT CODE	PRICE	SIZE/ INCHES			WEIGHT VOL	
		H	W	D	LBS	FT ³
BHRC02	9	3	2.61	0.5	0.04	0.02

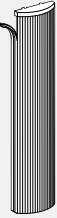
BVTE • Vertical End PVC Trim

- Provides a rounded finished detail to the end of the panel run, or a post.
- Includes 2 "Capture Strip" panel connectors and 1 injection molded top cap.
- The PVC end trim is designed to snap at the end of the panel or post.
- Site installed.

PRODUCT CODE	PRICE	SIZE/ INCHES			WEIGHT VOL	
		H	W	D	LBS	FT ³
BVTE37	41	37	2.61	0.25	0.41	0.065
BVTE42	48	42	2.61	0.25	0.48	0.074
BVTE50	54	50	2.61	0.25	0.57	0.088
BVTE54	68	54	2.61	0.25	0.62	0.095
BVTE58	75	58	2.61	0.25	0.66	0.102
BVTE66	78	66	2.61	0.25	0.75	0.115
BVTE74	83	74	2.61	0.25	0.84	0.013
BVTE82	89	82	2.61	0.25	0.93	0.143

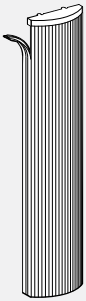
BVTS • Vertical Step Down PVC Trim

- Provides a rounded finished detail to the end of the panel run where two different height panels are specified.
- Includes 2 "Capture Strip" panel connectors and 1 injection molded top cap.
- The PVC end trim is designed to snap at the end of the panel or post.
- Site installed.
- Please specify panels to be used when ordering a 29" step (BVTS29).

PRODUCT CODE	PRICE	SIZE/ INCHES			WEIGHT VOL	
		H	W	D	LBS	FT ³
BVTS04	11	4	2.61	0.25	0.05	0.010
BVTS08	13	8	2.61	0.25	0.09	0.015
BVTS12	20	12	2.61	0.25	0.12	0.021
BVTS16	28	16	2.61	0.25	0.18	0.029
BVTS20	30	20	2.61	0.25	0.20	0.035
BVTS24	33	24	2.61	0.25	0.27	0.043
BVTS32	37	32	2.61	0.25	0.36	0.056
BVTS38	44	38	2.61	0.25	0.45	0.067
BVTS40	46	40	2.61	0.25	0.45	0.070
BVTS48	53	48	2.61	0.25	0.54	0.084
BVTS56	63	56	2.61	0.25	0.63	0.098

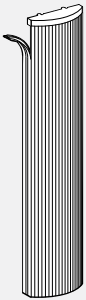
BVTS • Vertical Step Down PVC Trim for 37" High Panels

- Provides a finished detail to the end of the panel run that sits next to a 37" high panel. This PVC trim will bridge the distance between the 37" and higher panel.
- Includes 2 "Capture Strip" panel connectors and 1 injection molded top cap.
- The PVC end trim is designed to snap at the end of the panel or post.
- Site installed.
- Please specify panels to be used when ordering a 29" step (BVTS29).

PRODUCT CODE	PRICE	SIZE/ INCHES			WEIGHT VOL	
		H	W	D	LBS	FT ³
BVTS05	11	5	2.61	0.25	0.06	0.015
BVTS13	20	13	2.61	0.25	0.15	0.029
BVTS17	29	17	2.61	0.25	0.15	0.035
BVTS21	31	21	2.61	0.25	0.24	0.043
BVTS29	34	29	2.61	0.25	0.33	0.051
BVTS37	43	37	2.61	0.25	0.41	0.067
BVTS45	47	45	2.61	0.25	0.51	0.084

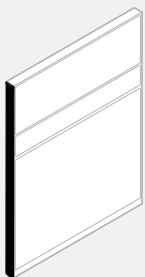
BAVTE • Aluminum Vertical End Round Trim

- Provides a finished detail to the end of a panel run.
- Aluminum radiused front section and injection molded top cap.
- Includes 2 "Capture Strip" panel connectors and 1 injection molded top cap.
- The Aluminum End Trim is designed to snap at the end of the panel or post.
- Site installed.
- BAVTE119 cannot ship via courier and must be combined with other product.

PRODUCT CODE	PRICE	SIZE/ INCHES			WEIGHT VOL	
		H	W	D	LBS	FT ³
BAVTE37	43	37	2.61	0.125	1.2	0.03
BAVTE42	48	42	2.61	0.125	1.4	0.03
BAVTE50	54	50	2.61	0.125	1.7	0.04
BAVTE54	68	54	2.61	0.125	1.8	0.04
BAVTE58	75	58	2.61	0.125	1.9	0.04
BAVTE66	78	66	2.61	0.125	2.2	0.05
BAVTE74	83	74	2.61	0.125	2.4	0.05
BAVTE82	89	82	2.61	0.125	2.7	0.06
BAVTE119	133	119	2.61	0.125	3.9	0.08

BAVTS • Aluminum Vertical End Round Trim - Standard Step Down

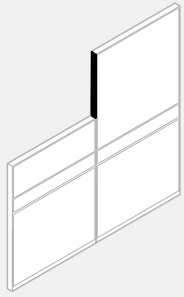

- Provides a finished detail to the end of a panel run where two different height panels are specified.
- Aluminum radiused front section and injection molded top cap.
- Includes 2 "Capture Strip" panel connectors and 1 injection molded top cap.
- The Aluminum End Trim is designed to snap at the end of the panel or post.
- Site installed.
- Specify panels to be used when ordering a 29" step.

PRODUCT CODE	PRICE	SIZE/ INCHES			WEIGHT VOL	
		H	W	D	LBS	FT ³
BAVTS04	11	4	2.61	0.125	0.2	0.01
BAVTS08	13	8	2.61	0.125	0.3	0.02
BAVTS12	20	12	2.61	0.125	0.4	0.02
BAVTS16	28	16	2.61	0.125	0.5	0.03
BAVTS20	30	20	2.61	0.125	0.7	0.04
BAVTS24	33	24	2.61	0.125	0.8	0.04
BAVTS32	37	32	2.61	0.125	1.1	0.06
BAVTS38	44	38	2.61	0.125	1.3	0.07
BAVTS40	45	40	2.61	0.125	1.3	0.07
BAVTS48	53	48	2.61	0.125	1.6	0.08
BAVTS56	63	56	2.61	0.125	1.8	0.10

BAVTSF • Aluminum Vertical End Round Trim - Step Down for 37" High Panels

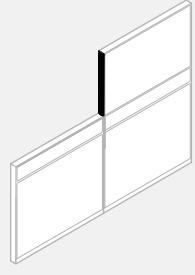

- Provides a finished detail to the end of a panel run adjacent to a 37" high panel.
- Aluminum radiused front section and injection molded top cap.
- Includes 2 "Capture Strip" panel connectors and 1 injection molded top cap.
- The Aluminum End Trim is designed to snap at the end of the panel or post.
- Site installed.

PRODUCT CODE	PRICE	SIZE/ INCHES			WEIGHT VOL	
		H	W	D	LBS	FT ³
BAVTSF05	12	5	2.61	0.125	0.2	0.02
BAVTSF13	21	13	2.61	0.125	0.4	0.03
BAVTSF17	29	17	2.61	0.125	0.6	0.04
BAVTSF21	31	21	2.61	0.125	0.7	0.04
BAVTSF29	34	29	2.61	0.125	1.0	0.05
BAVTSF37	43	37	2.61	0.125	1.2	0.07
BAVTSF45	51	45	2.61	0.125	1.5	0.08

BARC • Aluminum Raceway Cover

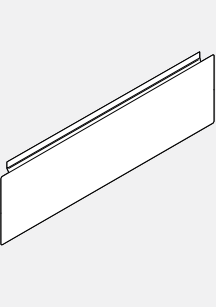

- Offers an alternative to the existing raceway options.
- Cover hinges upward for easy access to power and data/communication terminals.
- Cover may be removed for installation and reconfiguration.
- May not be used with Boulevard System 3 panels.
- Sold as singles.

PRODUCT CODE	PRICE	SIZE/ INCHES			WEIGHT VOL	
		H	W	D	LBS	FT ³
BARC06	24	00.0	5	0.125	0.3	0.001
BARC18	26	00.0	17	0.125	1.1	0.001
BARC24	31	00.0	23	0.125	1.4	0.001
BARC30	34	00.0	29	0.125	1.8	0.002
BARC36	36	00.0	35	0.125	2.2	0.002
BARC42	39	00.0	41	0.125	2.5	0.002
BARC48	41	00.0	47	0.125	2.9	0.003
BARC54	47	00.0	53	0.125	3.2	0.003
BARC60	56	00.0	59	0.125	3.7	0.003
BARC66	61	00.0	65	0.125	4.1	0.004
BARC72	65	00.0	72	0.125	4.4	0.004

Boulevard 1 • Flat Aluminum Trims

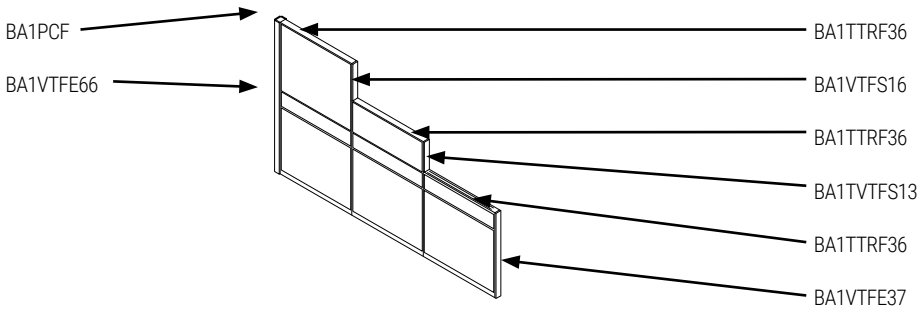

- Flat Aluminum Trims For Boulevard 1: Designed to use top and vertical trims together on the panel. Specifying vertical trims only will make them too long and will not fit correctly.
- You must specify vertical trims as a special if you are NOT using top trims.
- Post caps BA1PCF must be specified separately when using trims, .

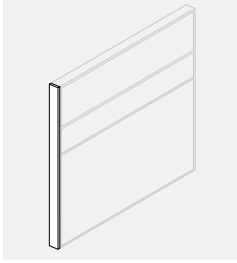
BA1VTFE • Aluminum Vertical Flat End Trim

- Provides a finish detail to the end of a panel run.
- Aluminum flat profile with injection molded top cap.
- Included: 2 "capture strip" panel connectors and 1 injection molded top cap.
- The Aluminum End Trim is designed to snap at the end of the panel or post.
- Site installed.
- For use with Aluminum Top Caps.

PRODUCT CODE	PRICE	SIZE/ INCHES			WEIGHT VOL	
		H	W	D	LBS	FT ³
BA1VTFE29	35	29	2.61	0.125	0.7	0.01
BA1VTFE37	43	37	2.61	0.125	1.0	0.02
BA1VTFE42	48	42	2.61	0.125	1.2	0.03
BA1VTFE50	54	50	2.61	0.125	1.5	0.04
BA1VTFE54	68	54	2.61	0.125	1.6	0.04
BA1VTFE58	75	58	2.61	0.125	1.7	0.04
BA1VTFE66	78	66	2.61	0.125	2.0	0.05
BA1VTFE74	83	74	2.61	0.125	2.2	0.05
BA1VTFE82	89	82	2.61	0.125	2.4	0.06

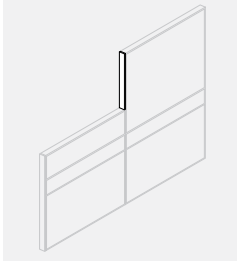
BA1VTFS • Aluminum Vertical Flat End Trim - Standard Step Down

- Provides a finish detail to the end of a panel run where 2 different height panels are specified.
- Aluminum flat profile with injection molded top cap.
- Included: 2 "capture strip" panel connectors and 1 injection molded top cap.
- The aluminum end trim is designed to snap at the end of the panel or post.
- Site installed.
- For use with Aluminum Top Caps.

PRODUCT CODE	PRICE	SIZE/ INCHES			WEIGHT VOL	
		H	W	D	LBS	FT ³
BA1VTFS04	11	4	2.61	0.125	0.1	0.01
BA1VTFS08	13	8	2.61	0.125	0.2	0.01
BA1VTFS12	20	12	2.61	0.125	0.4	0.02
BA1VTFS16	28	16	2.61	0.125	0.6	0.02
BA1VTFS20	30	20	2.61	0.125	0.6	0.03
BA1VTFS24	33	24	2.61	0.125	0.7	0.03
BA1VTFS32	37	32	2.61	0.125	0.9	0.03
BA1VTFS38	44	38	2.61	0.125	1.1	0.03
BA1VTFS40	46	40	2.61	0.125	1.1	0.03
BA1VTFS48	54	48	2.61	0.125	1.3	0.04
BA1VTFS56	63	56	2.61	0.125	1.6	0.05

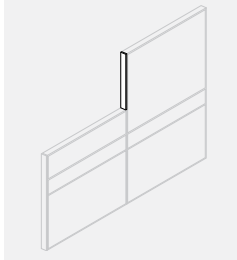
BA1VTFS • Aluminum Vertical Flat End Trim - Standard Step Down 37" High Panels

- Provides a finish detail to the end of a panel run adjacent to a 37" high panel.
- Aluminum flat profile with injection molded top cap
- Included 2 "capture strip" panel connectors and 1 injection molded top cap
- The aluminum end trim is designed to snap at the end of the panel or post
- Site installed
- Specify panels to be used when ordering a 29" step down trim.
- For use with Aluminum Top Caps.

PRODUCT CODE	PRICE	SIZE/ INCHES			WEIGHT VOL	
		H	W	D	LBS	FT ³
BA1VTFS05	12	5	2.61	0.125	0.2	0.01
BA1VTFS13	21	13	2.61	0.125	0.4	0.01
BA1VTFS17	29	17	2.61	0.125	0.4	0.01
BA1VTFS21	31	21	2.61	0.125	0.6	0.02
BA1VTFS29	34	19	2.61	0.125	0.7	0.03
BA1VTFS37	43	37	2.61	0.125	1.1	0.03
BA1VTFS45	51	45	2.61	0.125	1.3	0.04

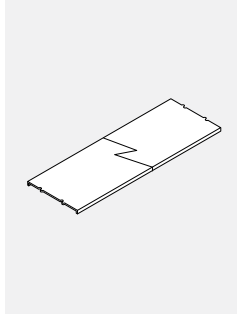
BA1TTRF • Aluminum Top Cap

- Provides a finish detail to the top of a Boulevard 1 panel.
- Designed to snap to the top of a panel rail.
- Must be used on panels of corresponding width.
- Site installed.
- For applications using transaction tops and top mounted storage, please use BHBT02FT bracket
- To be used with Flat Vertical Trim.

PRODUCT CODE	PRICE	SIZE/ INCHES			WEIGHT VOL	
		H	W	D	LBS	FT ³
BA1TTRF06	12	0.125	6	2.61	0.2	0.01
BA1TTRF18	29	0.125	18	2.61	0.6	0.02
BA1TTRF24	33	0.125	24	2.61	0.7	0.03
BA1TTRF30	35	0.125	30	2.61	0.9	0.04
BA1TTRF36	42	0.125	36	2.61	1.1	0.05
BA1TTRF42	48	0.125	42	2.61	1.3	0.06
BA1TTRF48	55	0.125	48	2.61	1.5	0.06
BA1TTRF54	68	0.125	54	2.61	1.6	0.07
BA1TTRF60	75	0.125	60	2.61	1.8	0.08
BA1TTRF66	78	0.125	66	2.61	2.0	0.09
BA1TTRF72	83	0.125	72	2.61	2.2	0.10

BA1PCF • Post Cap

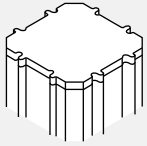

- Bridges the height difference when using Boulevard 1 panels only with Aluminum Horizontal Top Trims.
- Injection molded post cap to fit on top of 90 degree corner post.
- Extends post's overall height to the level corresponding with the height of aluminum horizontal top trim installed on standard Boulevard panel.
- Site installed.
- Used for Boulevard 1 panels when top aluminum horizontal trim is used.

PRODUCT CODE	PRICE	SIZE/ INCHES			WEIGHT VOL	
		H	W	D	LBS	FT ³
BA1PCF	9	0.25	2.61	2.61	0.02	0.01

BHBT37FT • Transaction Bracket for 37" Panels with Flat Trim

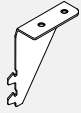

- Provides a secure attachment of a transaction worksurface for a 37" high panel with top trim.
- Includes a left and right bracket and bracket retainer clips.

PRODUCT CODE	PRICE	SIZE/ INCHES			WEIGHT VOL	
		H	W	D	LBS	FT ³
BHBT37FT	25	3.3	1.5	2.3	2.0	0.010

BHBT02FT • Transaction Bracket for 42" Panels with Flat Trim

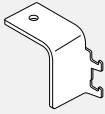

- Provides a secure attachment of a transaction worksurface for 42" high Boulevard panels with flat trim.
- Includes a left and right bracket and bracket retainer clips.

PRODUCT CODE	PRICE	SIZE/ INCHES			WEIGHT VOL	
		H	W	D	LBS	FT ³
BHBT02FT	30	4	1	3	0.5	0.007

30

FRC • Fabric Raceway Cover

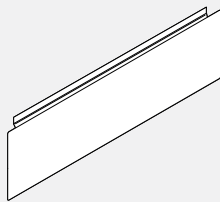

- Offers an alternative to the existing raceway options.
- Cover hinges upward for easy access to power and data/communication terminals.
- Cover may be removed for installation and reconfiguration.
- May not be used with Boulevard System 3 panels.
- Sold as singles.

PRODUCT CODE	PRICE	SIZE/ INCHES			WEIGHT VOL	
		H	W	D	LBS	FT ³
FRC24	28	7	23	0.125	1.4	0.001
FRC30	34	7	29	0.125	1.8	0.002
FRC36	36	7	35	0.125	2.2	0.002
FRC42	39	7	41	0.125	2.5	0.002
FRC48	41	7	47	0.125	2.9	0.003
FRC54	50	7	53	0.125	3.2	0.003
FRC60	53	7	59	0.125	3.7	0.003
FRC66	56	7	65	0.125	4.1	0.004
FRC72	58	7	72	0.125	4.4	0.004

RCW-D • PVC Facemount Raceway Cover

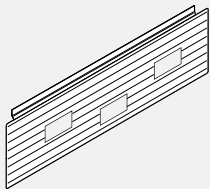

- PVC raceway cover is punched out to align with the Face Mount Power Distribution Housing and Duplexes.
- Data punch-out accepts industry standard terminal faceplates (not supplied by Global Contract Inc.) Size of opening is 1.37" x 2.755".
- Electrical cut-outs have black PVC trim. Size of opening is 1.5" x 2.85".
- May not be used with Boulevard System 3 Panels.
- Cover hinges upward for easy access to power and data/communication terminals.

PRODUCT CODE	PRICE	SIZE/ INCHES			WEIGHT VOL	
		H	W	D	LBS	FT ³
RCW24D	35	7	24	0.125	3	0.05
RCW30D	37	7	30	0.125	3	0.06
RCW36D	42	7	36	0.125	4	0.07
RCW42D	51	7	42	0.125	5	0.08
RCW48D	55	7	48	0.125	5	0.09
RCW54D	58	7	54	0.125	6	0.10
RCW60D	62	7	60	0.125	7	0.11
RCW66D	65	7	66	0.125	7	0.12
RCW72D	70	7	72	0.125	8	0.12

FCR-D • Fabric Covered Facemount Raceway

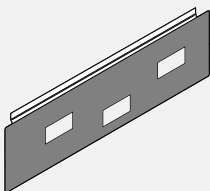

- Fabric raceway cover is punched out to align with the Face Mount Power Distribution Housing and Duplexes.
- Data punch-out accepts industry standard terminal faceplates (not supplied by Global Contract Inc.) Size of opening is 1.37" x 2.755".
- Electrical cut-outs have black PVC trim. Size of opening is 1.5" x 2.85".
- May not be used with Boulevard System 3 Panels.
- Cover hinges upward for easy access to power and data/communication terminals.

PRODUCT CODE	PRICE	SIZE/ INCHES			WEIGHT VOL	
		H	W	D	LBS	FT ³
FCR24D	80	7	24	0.125	3	0.05
FCR30D	86	7	30	0.125	3	0.06
FCR36D	89	7	36	0.125	4	0.07
FCR42D	94	7	42	0.125	5	0.08
FCR48D	100	7	48	0.125	5	0.09
FCR54D	103	7	54	0.125	6	0.10
FCR60D	109	7	60	0.125	7	0.11
FCR66D	113	7	66	0.125	7	0.12
FCR72D	120	7	72	0.125	8	0.12

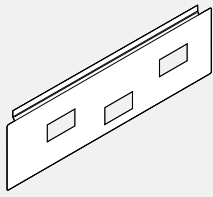
RCA-D • Aluminum Raceway Cover for Face Mounted

- Aluminum raceway cover is punched out to align with the Face Mount Power Distribution Housing and Duplexes.
- Data punch-out accepts industry standard terminal face-plates (not supplied by Global Contract Inc.) Size of opening is 1.37" x 2.755".
- Electrical cut-outs have black PVC trim. Size of opening is 1.5" x 2.85".
- May not be used with Boulevard System 3 Panels.
- Cover hinges upward for easy access to power and data/communication terminals.

PRODUCT CODE	PRICE	SIZE/ INCHES			WEIGHT VOL	
		H	W	D	LBS	FT ³
RCA24D	61	7	24	0.125	2.0	0.06
RCA30D	64	7	30	0.125	2.1	0.06
RCA36D	70	7	36	0.125	2.2	0.07
RCA42D	76	7	42	0.125	2.5	0.08
RCA48D	78	7	48	0.125	2.9	0.09
RCA54D	85	7	54	0.125	3.2	0.10
RCA60D	88	7	60	0.125	3.7	0.11
RCA66D	92	7	66	0.125	3.9	0.12
RCA72D	99	7	72	0.125	4.1	0.12

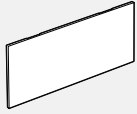
BPMB • Raceway Cover Caps

- To provide clean detail for the punch-outs of a raceway cover when the punch-outs are not in use. Order only when required.
- Made of injection molded ABS.
- B = Black
- W = White
- G = Grey

PRODUCT CODE	PRICE	SIZE/ INCHES			WEIGHT VOL	
		H	W	D	LBS	FT ³
BPMB020104B	9	1.5	3	0.125	0.04	0.02
BPMB020104G	9	1.5	3	0.125	0.04	0.02
BPMB020104W	9	1.5	3	0.125	0.04	0.02

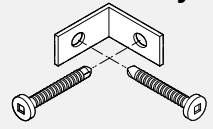
BHSL • Safety Lock

- Provides customers a higher degree of privacy.
- Safety Lock is a set of two ready made brackets and
- It is installed from the inside of a panel adjacent to an opening the door through the raceway.
- To be used for PVC raceways only.

PRODUCT CODE	PRICE
BHSL02	30

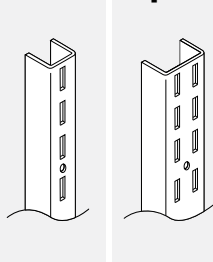
BHV • Component Wall Adapter - Single and Double

- Used to attach system components to fixed wall.
- Panel frame finish.
- The vertical wall adapter is a "U" shaped channel with a vertical row of slots with 1" centers.
- The double Component Wall Adapter has a double row of slots with 1" centers.
- Comes in 60" length only.
- Care should be taken to mount adapters only to wall studs using correct fasteners.
- Does not include mounting hardware. Mounting hardware selection to be based on wall material.
- Sold in pairs.
- Failure to do this may result in collapse of the unit and subsequent possible personal injury.

PRODUCT CODE	PRICE	SIZE/ INCHES			WEIGHT VOL	
		H	W	D	LBS	FT ³
BHV01	99	60	0.75	0.5	4	0.009
BHV02	114	60	1.50	0.5	5	0.026

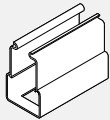
BECC01 • Cable Terminal Channel

- Houses various combinations of voice and data cables.
- 1 included with every Raceway Panel.
- Accommodates assorted snap-in modular voice and data terminals (not supplied by Global Contract Inc).
- Black only.

PRODUCT CODE	PRICE	SIZE/ INCHES			WEIGHT VOL	
		H	W	D	LBS	FT ³
BECC01	30	6	4.5	2.5	.20	0.21

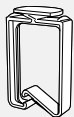
BPHC01 • Cable Terminal Channel

- Houses various combinations of voice and data cables.
- 2 included with every Raceway Panel.
- Black only.
- For use with Boulevard 1 Panels only.

PRODUCT CODE	PRICE	SIZE/ INCHES			WEIGHT VOL	
		H	W	D	LBS	FT ³
BPHC01	8	2.5	1	2	0.1	0.003

Boulevard System 3 Panel System

Boulevard System 3... The next generation of BOULEVARD offers the freedom to plan the office environment 'your way', while keeping an eye on the bottom line. Boulevard System 3 boasts a rich toolbox featuring stack-on panels, complete data/communication lay-in at the top, comprehensive power and data/communication at both the base and at desk height, a selection of interchangeable tiles, monolithic panels, up-mounted storage, new ergonomic worksurface shapes & a revised colour pallet featuring recycled fabrics... all wrapped up in a sophisticated design statement. Enjoy planning it your way and having the tools to really do it. Boulevard System 3 offers the building blocks to create the framework that perfectly suits your office environment. Combinations of fabric, glazed, open and slat wall panel surface tiles effectively support the creation of various work settings, whether open (to encourage interaction and teamwork) or traditional, with enclosed functional task organizers. Boulevard System 3 lets you plan more effectively and with more versatility than ever before. It is simple to comprehend, specify, install,

maintain and reconfigure. Offering multifunctional furnishing solutions, Boulevard System 3 can be specified on its own or used as a power/data and privacy provider, bridging freestanding/mobile furniture and panels and task related options such as worksurface shapes that help you work better. By utilizing up-mount storage, lower panel heights can be maintained without sacrificing overhead storage where and when needed. Another value-oriented tool... Consider 'Spine' planning to create a power wall that feeds data/communication to a string of perpendicular offices. Incorporate monolithic panels which offer the best cost/performance advantages for value sensitive environments with base panel raceway power/data cable distribution, while adding visual interest...and of course, reconfiguration is a breeze. Now you can have an endless visual pallet and array of practical solutions for today's ever changing and demanding workplace. When you add it all up, Boulevard System 3 gives you more value than ever before.

Technical Information

Panels

- All panels are 2 5/8" thick.
- Lightweight aluminum box frame construction creates superior panel rigidity.
- Panel frame finish is durable epoxy powder coated.
- Hang-on capabilities at 1" increments.
- Patented "Knuckle-Loc" design provides solid panel-to-panel connection for fast installation and reconfiguration.
- Knuckle lock feature ensures even panel heights throughout installation.
- 3" glide stem permits 2 1/2" height adjustment.
- Panel sizes are actual, eliminating creepage.
- Vertical end trims must be specified to give the panel a finished appearance.
- Horizontal top trims are included with all panels.
- All panels include 2 "Capture Strip" panel connectors.
- Panels are UL listed and CSA approved and have a Class "A" fire rating except when Customer's Own Material (COM) is used.
- All panels accept Over Panels (see page D.7).

Panel Options

- Laminate, whiteboard, or corkboard may be substituted for fabric on panels only, see "OPT" column.
- Laminate and whiteboard are held in place with a PVC retainer matching the frame colour and can be retrofitted on site.
- Laminate and whiteboard options reduce the acoustical value of the panel.

Monolithic Panels

- Fabric on Monolithic Panels can be re-upholstered on site.

Pass Thru Panels

- Fabric at base of Pass-Thru Panels can be re-upholstered on site.
- Tiles cannot be re-upholstered on site.

Bottom Lay-in Raceway

- Bottom raceway snaps to the bottom of the panel and can be completely removed for unobstructed cable lay-in installation.
- Bottom lay-in raceway is 60 mm (2.380") wide x 141 mm (5.560") high.
- Maximum capacity: 70 cables 5 mm (0.200) diameter, 2 parallel 8 wire, 4 circuit power distribution.
- State-of-the-art engineering.
- Snap-in modularity of all electrical components including harnesses, distribution housings, duplexes and circuit designations.
- All power and data outlets are easily accessible from both sides of panel.
- 8 wire system with 4, 15 amp circuits (including 1 dedicated circuit).
- Facemount electrical with 2 duplex per panel side.
- Included is 1 data/communication terminal bracket per side.

- Raceway cover openings of 2.71" x 1.38" can accommodate a single modular Data/Comm terminal plate per side (not supplied by Global Contract Inc).
- Opening complies with the ANSI/TIA/EIA standard furniture openings.
- Outlet and circuit changes accomplished without disruption to work station.
- Large raceway cavity permits storage of excess cables and equipment cords.
- Total flexibility for 8 wire system: choice of up to 4 duplexes per panel; choice of circuitry in each duplex .
- Unique design of fire retardant metal raceway cover permits access to raceway without disruption to equipment.

Horizontal Lay-in Channel (Excluding all panels with Embedded Glass)

- Integrated horizontal lay-in channel 33.5 mm (1.320") wide and 38 mm (1.500") high at the top of panels and on top of the door frame.
- Maximum capacity: 36 cables 5 mm (0.200") in diameter.
- Maximum cable bending radius between two perpendicular panels: 141.2 mm (5.560") [5 mm (0.200") in diameter cables].

Vertical Wire Channel

- Where applicable, the vertical wire channel connects horizontal channel above desk height with floor level raceway.
- Opening in horizontal channel allows for vertical cable passage from top lay-in channel to base raceway.
- Integrated vertical channel 76 mm (2.990") x 27 mm (1.060").
- Maximum capacity: 60 cables 5 mm (0.200") in diameter.
- Maximum cable bending radius: 141.2 mm (5.560").

Posts

- Enables connection for multiple panel runs such as 90°, 45° or 60° angle and 2 way, 3 way or 4 way.
- Starts at the top of the bottom lay-in raceway.
- 90 degree post provides route for ceiling power and data entry to a panel raceway.
- Knuckle lock feature maintains even height of all connected panels.
- Solid lightweight aluminum extrusion fits together through a unique "Knuckle-Loc" design providing rigid post-to-panel connection.
- Post has punch-outs at the top to allow for unobstructed horizontal cable passage between adjacent panels.
- Includes all required panel connectors and caps.
- Posts add 2 5/8" to a panel run.
- Posts are 1/8" oversized to allow for "panel wrap around" of freestanding desks.
- For all panel runs with multiple posts, this 1/8" must be allotted for.
- Maximum capacity:
 - 80 cables 5mm(0.200") diameter
 - 65 cables 5mm(0.200") diameter with 1 power feed
 - 50 cables 5mm (0.200") diameter with 2 power feeds

PANELS - GUIDELINES FOR ORDERING PRODUCT

Codes

The product guide uses a numbering system with meaningful alphanumeric characters to create a simple-to-understand product number. This makes specifying the product much easier and more accurate.

Example of Panel: **BPX3MA6636 CHR CHR P1 AN50 BE21**

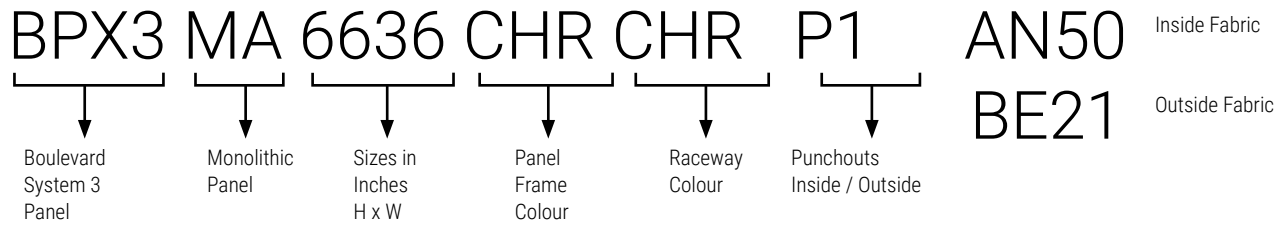

How to Specify

- Specify Boulevard System 3 panel type and size by code.
- Specify panel frame finish - ie. CHR (Charcoal).
- Specify PVC raceway finish - ie. CHR (Charcoal). If raceway colour not specified at time of order, default will be the panel frame colour.
- Specify all two panel fabric options if necessary.
- Some fabrics have directional pattern and cannot be applied horizontally or vertically. Panels wider than 60" will have fabrics applied horizontally (railroad). Please specify if you want adjacent panels and the rest of the installation upholstered the same way.
- Specify whether punchouts are required inside and outside of raceway or if no knockouts are required.
 - P2 - Punchouts on both sides.
 - P1 - Punchouts on one side.
 - NP - No punchouts.
- For special width panels, a special must be processed and additional costs apply. Please contact your customer service representative.

Example of Post: **BH3PS066 CHR**

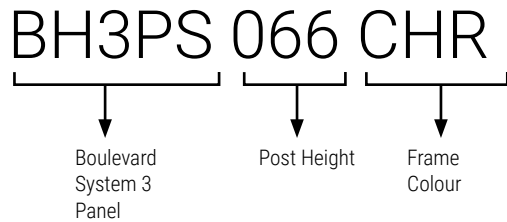

How to Specify

- Specify Boulevard System 3 post by code.
- Specify frame colour - ie. CHR (Charcoal).

ORDERS

Each Order Must Include

- Purchase Order
- Layout showing where the image(s) appear in the run of panels.
- A completed Price Chart, showing the location of the image(s) on each appropriate panel.

Artwork must be submitted in accordance with the following artwork specifications.

NOTE: Final artwork specification approval must be given before order can be processed.

Transfer Devices

- E-mail up to 10MB to your Global Contract Customer Service Representative.
- Courier CD/DVD/USB stick to your Global Contract Customer Service Representative.

Artwork Specifications

- Non-Photographic artwork should be vector art, saved in Adobe Illustrator (.ai) or as an EPS (.eps)
- All bitmap or photographic artwork has to be at a minimum of 100 dpi at the full size of the panel to be printed.
- We accept Adobe CS5 files.
- Any linked files must be included or imbedded.
- Leave any PSD files unflattened
- All fonts must be converted to outlines.
- Do not convert to CMYK, leave all images as RGB if possible
- No Word, Powerpoint, Publisher or other Microsoft files can be used.
- Include a PDF or .jpg for reference when sending native Photoshop or Illustrator format files.

Colour Matching

- A Pantone colour reference must be supplied or we cannot accept responsibility for correct colour.
- When it is not possible to refer to Pantone colours, we will do our best to meet your requirements.

Image Clarity

- We will advise should the selected image not lend itself to the element size requested.

NOTE:

We reserve the right to put an order on hold when the files are found to be incomplete or when documents have been either incorrectly saved. Fonts not converted to curves or the job appears not to be commercially acceptable.

Image Bleed:

- To facilitate placement on the panel. Extension of the image past the finished visible area of the panel (bleed) is required
- Boulevard Panels need a 5" Bleed on all sides.

Example Of Image resolution:

The resolution required for a 36 wide x 24 high Boulevard panel at 100dpi (minimum resolution)

The resolution required for a 36 wide x 24 high Boulevard panel at 300dpi (higher quality)

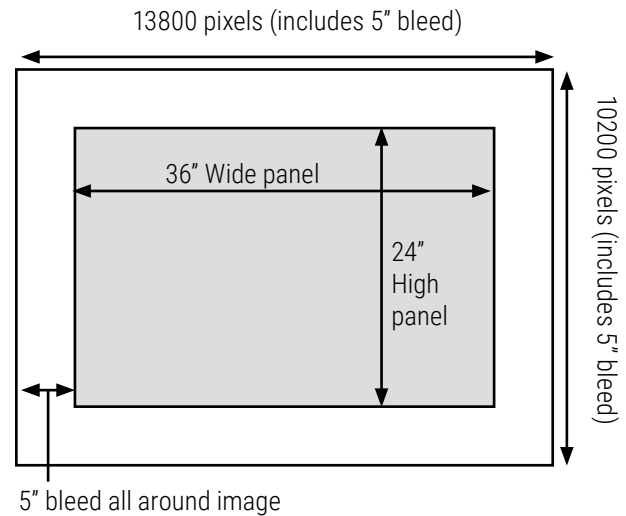
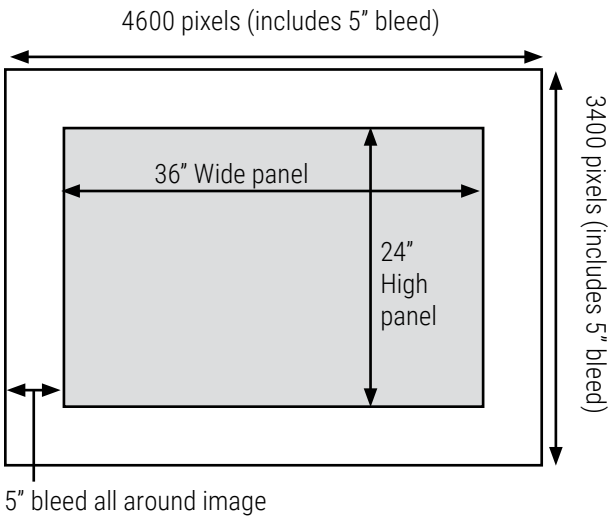

Pricing, Initial Set-Up Charge per Image:\$256 net

Boulevard System 3 Tiles

- This List applies to the following panels:
- BP3FT
- BP3ET



PANEL WIDTH	HEIGHT 8"	LIST PRICE 16"
24"	140	205
30"	168	241
36"	191	278
42"	220	315
48"	241	353
54"	271	396
60"	294	433
66"	315	462
72"	343	498

Boulevard System 3 Bottom Section of Pass-Through Panel

- This List applies to the following panels:
- BPX3PT
- BPX3PV

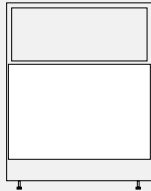

PANEL WIDTH	LIST PRICE 28"
24"	294
30"	343
36"	396
42"	455
48"	505
54"	557
60"	608
66"	660
72"	710

Boulevard System 3 Monolithic Panels

- This List applies to the following panels:
- BPX3MA
- BPX3MV

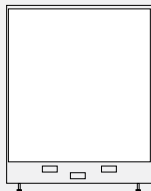

PANEL WIDTH	HEIGHT 34"	42"	50"	66"
24"	294	359	418	550
30"	343	418	498	642
36"	396	484	572	748
42"	455	550	637	849
48"	505	615	732	944
54"	557	679	799	1048
60"	608	748	879	1141
66"	660			
72"	710			

Note: Prices shown are an upcharge to the panel price, please add to the list price of panel which you are specifying the graphic for.

BPX3MA • Monolithic Acoustical Panel

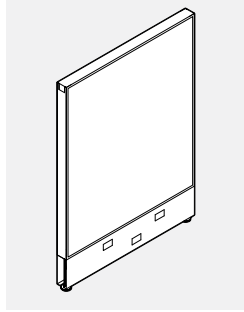

- Provides visual and acoustic privacy.
- Centre septum above raceway overlaid on either side with 1 1/8" "Sound absorbent mineral board".
- Acoustic rating of .70 NRC and 25 STC.
- OPT* = Laminate or Whiteboard
- "No Knockouts" option for raceways available at no additional charge. Please choose option for interior and/or exterior raceways.

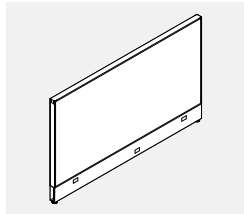

72" Wide

PRODUCT CODE	PRICE			SIZE/ INCHES			WEIGHT VOL	
	GR1	GR2	OPT*	H	W	D	LBS	FT ³
BPX3MA3418	360	381	403	34	18	2.61	11	1.337
BPX3MA3424	399	420	442	34	24	2.61	12	1.738
BPX3MA3430	439	461	481	34	30	2.61	13	2.139
BPX3MA3436	477	521	563	34	36	2.61	15	2.540
BPX3MA3442	521	561	605	34	42	2.61	16	2.941
BPX3MA3448	560	601	642	34	48	2.61	18	3.342
BPX3MA3454	603	641	688	34	54	2.61	20	3.743
BPX3MA3460	639	679	725	34	60	2.61	22	4.144
BPX3MA3466	677	735	799	34	66	2.61	26	4.612
BPX3MA3472	716	773	-	34	72	2.61	30	5.080
BPX3MA4218	386	414	443	42	18	2.61	12	1.782
BPX3MA4224	429	458	486	42	24	2.61	13	2.317
BPX3MA4230	471	499	528	42	30	2.61	15	2.852
BPX3MA4236	512	567	626	42	36	2.61	17	3.387
BPX3MA4242	557	612	671	42	42	2.61	19	3.921
BPX3MA4248	601	656	715	42	48	2.61	21	4.456
BPX3MA4254	641	699	757	42	54	2.61	23	4.991
BPX3MA4260	681	737	796	42	60	2.61	25	5.525
BPX3MA4266	751	862	983	42	66	2.61	29	6.148
BPX3MA4272	816	928	-	42	72	2.61	34	6.770
BPX3MA5018	497	536	583	50	18	2.61	13	2.106
BPX3MA5024	549	589	634	50	24	2.61	15	2.738
BPX3MA5030	603	641	688	50	30	2.61	17	3.370
BPX3MA5036	651	733	824	50	36	2.61	20	4.002
BPX3MA5042	703	787	875	50	42	2.61	23	4.634
BPX3MA5048	756	838	927	50	48	2.61	24	5.266
BPX3MA5054	806	889	977	50	54	2.61	25	5.898
BPX3MA5060	859	942	1031	50	60	2.61	27	6.530
BPX3MA5066	930	1042	1163	50	66	2.61	33	7.265
BPX3MA5072	999	1113	-	50	72	2.61	40	8.000
BPX3MA5418	519	558	603	54	18	2.61	14	2.406
BPX3MA5424	569	611	653	54	24	2.61	16	3.181
BPX3MA5430	624	666	706	54	30	2.61	19	3.907
BPX3MA5436	674	757	845	54	36	2.61	22	4.602
BPX3MA5442	729	811	901	54	42	2.61	25	5.306
BPX3MA5448	781	862	953	54	48	2.61	26	5.966
BPX3MA5454	832	915	1004	54	54	2.61	27	7.287
BPX3MA5460	886	968	1057	54	60	2.61	30	7.539
BPX3MA6618	579	649	723	66	18	2.61	14	2.755
BPX3MA6624	637	704	779	66	24	2.61	17	3.581
BPX3MA6630	690	757	829	66	30	2.61	20	4.407
BPX3MA6636	744	856	971	66	36	2.61	24	5.234
BPX3MA6642	802	911	1030	66	42	2.61	26	6.060
BPX3MA6648	857	967	1084	66	48	2.61	28	6.887
BPX3MA6654	910	1021	1137	66	54	2.61	30	7.713
BPX3MA6660	967	1076	1195	66	60	2.61	32	8.539

BPX3MV • Monolithic Acoustical Panel with Vertical Wire Channel

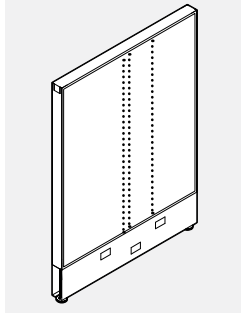

- Provides visual and acoustic privacy and allows for vertical cable passage from top lay-in channel to bottom raceway within panel.
- Centre septum above raceway overlaid on either side with 1 1/8" "Sound absorbent mineral board".
- Acoustic rating of .70 NRC and 25 STC. Includes integrated vertical wire channel.
- OPT* = Laminate or Whiteboard
- "No Knockouts" option for raceways available at no additional charge. Please choose option for interior and/or exterior raceways.

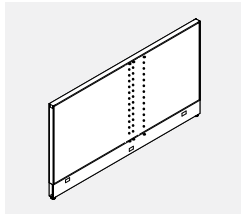

72" Wide

PRODUCT CODE	PRICE			SIZE/ INCHES			WEIGHT VOL	
	GR1	GR2	OPT*	H	W	D	LBS	FT ³
BPX3MV3430	472	494	518	34	30	2.61	15	2.139
BPX3MV3436	512	553	596	34	36	2.61	17	2.540
BPX3MV3442	552	592	637	34	42	2.61	18	2.941
BPX3MV3448	592	635	677	34	48	2.61	20	3.342
BPX3MV3454	635	674	719	34	54	2.61	22	3.743
BPX3MV3460	672	713	757	34	60	2.61	24	4.144
BPX3MV3466	760	817	881	34	66	2.61	29	4.612
BPX3MV3472	762	820	-	34	72	2.61	34	5.080
BPX3MV4230	519	546	574	42	30	2.61	17	2.852
BPX3MV4236	557	612	671	42	36	2.61	19	3.387
BPX3MV4242	604	660	718	42	42	2.61	21	3.921
BPX3MV4248	641	699	757	42	48	2.61	23	4.456
BPX3MV4254	686	740	800	42	54	2.61	25	4.991
BPX3MV4260	727	783	842	42	60	2.61	27	5.525
BPX3MV4266	803	916	1035	42	66	2.61	32	6.148
BPX3MV4272	872	987	-	42	72	2.61	38	6.770
BPX3MV5030	652	694	737	50	30	2.61	19	3.370
BPX3MV5036	706	790	881	50	36	2.61	22	4.002
BPX3MV5042	757	839	928	50	42	2.61	25	4.634
BPX3MV5048	811	893	983	50	48	2.61	26	5.266
BPX3MV5054	860	943	1032	50	54	2.61	27	5.898
BPX3MV5060	915	997	1086	50	60	2.61	29	6.530
BPX3MV5066	996	1109	1228	50	66	2.61	35	7.265
BPX3MV5072	1076	1189	-	50	72	2.61	40	8.000
BPX3MV5430	681	724	767	54	30	2.61	19	3.907
BPX3MV5436	736	818	908	54	36	2.61	22	4.602
BPX3MV5442	788	869	958	54	42	2.61	25	5.306
BPX3MV5448	842	924	1013	54	48	2.61	26	5.966
BPX3MV5454	893	974	1063	54	54	2.61	27	7.287
BPX3MV5460	947	1030	1119	54	60	2.61	30	7.539
BPX3MV6630	768	838	910	66	30	2.61	22	4.407
BPX3MV6636	820	930	1048	66	36	2.61	26	5.234
BPX3MV6642	879	988	1106	66	42	2.61	28	6.060
BPX3MV6648	932	1042	1161	66	48	2.61	30	6.887
BPX3MV6654	987	1096	1214	66	54	2.61	32	7.713
BPX3MV6660	1042	1152	1268	66	60	2.61	34	8.539

BPX3MG • Monolithic Glazed Panel

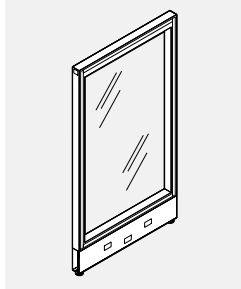

- Full-height glazing provides visual accessibility.
- Glazing is replaceable on site. Tempered clear glass standard.
- Glazing is standard on one side.
- "No Knockouts" option for raceways available at no additional charge. Please choose option for interior and/or exterior raceways.

PRODUCT CODE	PRICE	FRST	SIZE/ INCHES			WEIGHT VOL	
			H	W	D	LBS	FT ³
BPX3MG5024	872	1049	50	24	2.61	25	2.738
BPX3MG5030	1109	1329	50	30	2.61	29	3.370
BPX3MG5036	1174	1408	50	36	2.61	33	4.002
BPX3MG5042	1239	1488	50	42	2.61	36	4.634
BPX3MG5048	1305	1564	50	48	2.61	41	5.266
BPX3MG5424	930	1115	54	24	2.61	29	3.138
BPX3MG5430	1126	1353	54	30	2.61	34	3.807
BPX3MG5436	1200	1440	54	36	2.61	38	4.602
BPX3MG5442	1272	1527	54	42	2.61	43	5.334
BPX3MG5448	1343	1613	54	48	2.61	48	6.066
BPX3MG6624	1088	1306	66	24	2.61	33	3.581
BPX3MG6630	1181	1417	66	30	2.61	39	4.407
BPX3MG6636	1280	1535	66	36	2.61	44	5.234
BPX3MG6642	1370	1645	66	42	2.61	49	6.060
BPX3MG6648	1462	1756	66	48	2.61	54	6.887

BPX3PT • Pass-Thru Panel - Fabric Base

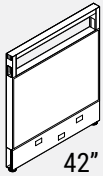

42" High

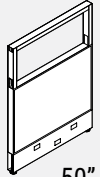

50" High

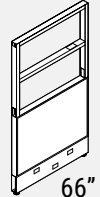

66" High

- Opening allows choice of tile above desk height.
- Solid fabric base up to 34".
- Single 8" opening above 34" for 42" high panels.
- Single 16" opening above 34" for 50" high panels.
- Two individual 16" openings above 34" for 66" high panels.
- Horizontal cable management at 34" height.
- OPT* = Laminate or Whiteboard.
- "No Knockouts" option for raceways available at no additional charge. Please choose option for interior and/or exterior raceways.

PRODUCT CODE	PRICE			SIZE/ INCHES			WEIGHT VOL	
	GR 1	GR 2	OPT*	H	W	D	LBS	FT ³
BPX3PT4218	369	397	428	42	18	2.61	14	1.689
BPX3PT4224	418	444	474	42	24	2.61	16	2.233
BPX3PT4230	462	490	521	42	30	2.61	17	2.792
BPX3PT4236	505	532	563	42	36	2.61	19	3.351
BPX3PT4242	550	576	608	42	42	2.61	21	3.908
BPX3PT4248	596	625	656	42	48	2.61	23	4.466
BPX3PT4254	640	669	700	42	54	2.61	26	5.025
BPX3PT4260	684	712	741	42	60	2.61	27	5.592
BPX3PT4266	730	788	851	42	66	2.61	32	6.148
BPX3PT4272	778	835	-	42	72	2.61	38	6.700
BPX3PT5018	369	397	428	50	18	2.61	15	2.106
BPX3PT5024	418	444	474	50	24	2.61	17	2.738
BPX3PT5030	462	490	521	50	30	2.61	18	3.370
BPX3PT5036	505	532	563	50	36	2.61	20	4.002
BPX3PT5042	550	576	608	50	42	2.61	22	4.634
BPX3PT5048	596	625	656	50	48	2.61	24	5.266
BPX3PT5054	640	669	700	50	54	2.61	27	5.898
BPX3PT5060	684	712	741	50	60	2.61	29	6.530
BPX3PT5066	730	788	851	50	66	2.61	34	7.265
BPX3PT5072	778	835	-	50	72	2.61	40	8.000
BPX3PT6618	461	490	520	66	18	2.61	19	2.755
BPX3PT6624	512	541	572	66	24	2.61	21	3.581
BPX3PT6630	569	597	628	66	30	2.61	23	4.407
BPX3PT6636	619	649	677	66	36	2.61	25	5.234
BPX3PT6642	674	703	733	66	42	2.61	27	6.060
BPX3PT6648	732	761	790	66	48	2.61	30	6.887
BPX3PT6654	782	811	840	66	54	2.61	33	7.713
BPX3PT6660	838	867	895	66	60	2.61	36	8.539

BPX3PV • Pass-Thru Panel with Vertical Wire Channel

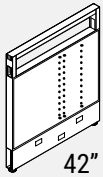

42" High

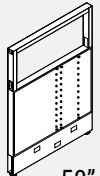

50" High

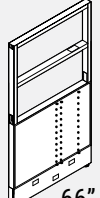

66" High

- Opening allows choice of tile above desk height. Vertical wire channel allows passage of cables from top lay-in channel to bottom raceway within panel.
- Solid fabric base up to 34".
- Single 8" opening above 34" for 42" high panels.
- Single 16" opening above 34" for 50" high panels.
- Two individual 16" openings above 34" for 66" high panels.
- Includes integrated vertical wire channel.
- Horizontal cable management at 34" height.
- OPT* = Laminate or Whiteboard.
- "No Knockouts" option for raceways available at no additional charge. Please choose option for interior and or exterior raceways.

PRODUCT CODE	PRICE			SIZE/ INCHES			WEIGHT VOL	
	GR 1	GR 2	OPT*	H	W	D	LBS	FT ³
BPX3PV4230	505	532	563	42	30	2.61	19	2.792
BPX3PV4236	550	576	608	42	36	2.61	21	3.351
BPX3PV4242	596	625	656	42	42	2.61	23	3.908
BPX3PV4248	640	669	700	42	48	2.61	23	4.466
BPX3PV4254	684	712	741	42	54	2.61	28	5.025
BPX3PV4260	733	761	792	42	60	2.61	30	5.592
BPX3PV4266	769	827	890	42	66	2.61	36	6.148
BPX3PV4272	806	865	-	42	72	2.61	42	6.700
BPX3PV5030	505	532	563	50	30	2.61	20	3.370
BPX3PV5036	550	576	608	50	36	2.61	22	4.002
BPX3PV5042	596	625	656	50	42	2.61	24	4.634
BPX3PV5048	640	669	700	50	48	2.61	26	5.266
BPX3PV5054	684	712	741	50	54	2.61	29	5.898
BPX3PV5060	733	761	792	50	60	2.61	31	6.530
BPX3PV5066	769	827	890	50	66	2.61	37	7.265
BPX3PV5072	806	865	-	50	72	2.61	44	8.000
BPX3PV6630	612	640	671	66	30	2.61	25	4.407
BPX3PV6636	668	697	726	66	36	2.61	27	5.234
BPX3PV6642	719	750	778	66	42	2.61	29	6.060
BPX3PV6648	774	803	832	66	48	2.61	32	6.887
BPX3PV6654	827	857	886	66	54	2.61	35	7.713
BPX3PV6660	882	910	941	66	60	2.61	38	8.539

BPX3PF • Pass-Tru Panel - Air Flow Base

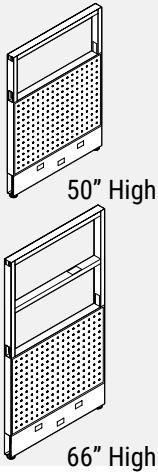

- **Allows air to flow freely through the bottom of the panel.**
- Double wall perforated metal base up to 34".
- Single 16" opening above 34" for 50" high panels.
- Two individual 16" openings above 34" for 66" high panels.
- Horizontal cable management at 34" height.
- "No Knockouts" option for raceways available at no additional charge. Please choose option for interior and/or exterior raceways.

PRODUCT CODE	PRICE	SIZE/ INCHES			WEIGHT VOL	
		H	W	D	LBS	FT ³
BPX3PF5018	520	50	18	2.61	17	2.106
BPX3PF5024	587	50	24	2.61	18	2.738
BPX3PF5030	653	50	30	2.61	20	3.370
BPX3PF5036	727	50	36	2.61	22	4.002
BPX3PF5042	800	50	42	2.61	23	4.634
BPX3PF5048	869	50	48	2.61	26	5.266
BPX3PF5054	941	50	54	2.61	28	5.898
BPX3PF5060	1008	50	60	2.61	31	6.530
BPX3PF6618	607	66	18	2.61	21	2.755
BPX3PF6624	684	66	24	2.61	23	3.581
BPX3PF6630	768	66	30	2.61	25	4.407
BPX3PF6636	849	66	36	2.61	27	5.234
BPX3PF6642	932	66	42	2.61	29	6.060
BPX3PF6648	1015	66	48	2.61	32	6.887
BPX3PF6654	1096	66	54	2.61	35	7.713
BPX3PF6660	1177	66	60	2.61	37	8.539

BPX3OP • Over Panel Frame

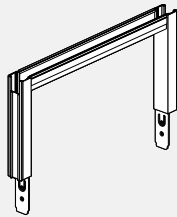

- **Attaches to the top of any Boulevard System 3 panel to create a floor-to-ceiling wall.**
- Any tile can be attached to either side to enclose the frame.
- Two non-slotted uprights at either end slide into vertical extrusions on the base panel.
- Shipped without horizontal and vertical trim; the horizontal trim from the base panel will be used.
- Openings in horizontal channels allow for vertical cable passage from top lay-in channel and behind the cover tiles
- Over Panel Frames 18" and 24" wide are not punched for vertical wire channel.
- Boulevard System 3 Over Panel is not compatible with Boulevard 1 panels.

PRODUCT CODE	PRICE	SIZE/ INCHES			WEIGHT VOL	
		H	W	D	LBS	FT ³
BPX3OP0818	90	8	18	2.61	3	0.383
BPX3OP0824	99	8	24	2.61	4	0.438
BPX3OP0830	106	8	30	2.61	4	0.656
BPX3OP0836	114	8	36	2.61	4	0.712
BPX3OP0842	127	8	42	2.61	5	0.875
BPX3OP0848	134	8	48	2.61	5	0.930
BPX3OP0854	142	8	54	2.61	6	1.040
BPX3OP0860	151	8	60	2.61	6	1.204
BPX3OP0866	168	8	66	2.61	7	1.310
BPX3OP0872	186	8	72	2.61	8	1.420
BPX3OP1618	90	16	18	2.61	4	0.638
BPX3OP1624	99	16	24	2.61	5	0.730
BPX3OP1630	106	16	30	2.61	5	1.094
BPX3OP1636	114	16	36	2.61	5	1.186
BPX3OP1642	127	16	42	2.61	6	1.459
BPX3OP1648	134	16	48	2.61	6	1.550
BPX3OP1654	142	16	54	2.61	7	1.733
BPX3OP1660	151	16	60	2.61	7	2.006
BPX3OP1666	168	16	66	2.61	9	2.165
BPX3OP1672	186	16	72	2.61	10	2.370

BPX3GMA • Monolithic Acoustical Panel with Embedded Glass

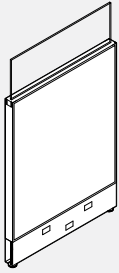

- Provides visual and acoustic privacy.
- Centre septum above raceway overlaid on either side with 1 1/8" "Sound absorbent mineral board".
- Acoustic rating of .70 NRC and 25 STC.
- OPT* = Laminate or Whiteboard
- B3 panel top trim option provided with embedded, frame-less glass pane rising 8" above the top of the panel. For instance, when installed on 42" high B3 panel, overall height will be 50" high.
- There is 1.25" gap between two adjacent glass panes.
- Glass shipped separately, Allen key to set the glass pane plumb is provided with each panel.
- 6mm tempered glass, frosted or clear.
- Square corners on glass.
- Integrated adjustable brackets and extruded aluminum trim.
- Not retrofitable on-site.
- 16" Glass available as an option, please tag 16" and add the following upcharge per panel size.

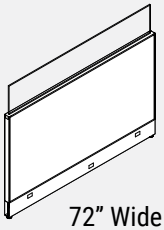

72" Wide

UPCHARGES FOR 16" GLASS

PANEL WIDTH	LIST
18	77
24	85
30	90
36	99
42	105
48	111
54	119
60	127
66	132
72	140

PRODUCT CODE	PRICE			SIZE/ INCHES			WEIGHT VOL	
	GR1	GR2	OPT*	H	W	D	LBS	FT ³
BPX3GMA3418	773	793	816	34	18	2.61	14	1.627
BPX3GMA3424	817	838	859	34	24	2.61	17	2.178
BPX3GMA3430	860	882	903	34	30	2.61	20	2.729
BPX3GMA3436	904	945	991	34	36	2.61	23	3.270
BPX3GMA3442	958	999	1043	34	42	2.61	25	3.791
BPX3GMA3448	1019	1058	1102	34	48	2.61	29	4.302
BPX3GMA3454	1093	1135	1177	34	54	2.61	32	4.853
BPX3GMA3460	1158	1198	1241	34	60	2.61	35	5.404
BPX3GMA3466	1227	1285	1348	34	66	2.61	40	6.022
BPX3GMA3472	1297	1354	-	34	72	2.61	46	6.640
BPX3GMA4218	800	827	857	42	18	2.61	15	2.072
BPX3GMA4224	845	872	903	42	24	2.61	18	2.757
BPX3GMA4230	893	921	949	42	30	2.61	22	3.442
BPX3GMA4236	938	994	1054	42	36	2.61	25	4.117
BPX3GMA4242	996	1052	1110	42	42	2.61	28	4.771
BPX3GMA4248	1058	1114	1173	42	48	2.61	32	5.416
BPX3GMA4254	1135	1190	1250	42	54	2.61	35	6.101
BPX3GMA4260	1199	1254	1313	42	60	2.61	38	6.785
BPX3GMA4266	1299	1412	1531	42	66	2.61	44	7.558
BPX3GMA4272	1396	1509	-	42	72	2.61	50	8.330
BPX3GMA5018	909	949	994	50	18	2.61	16	2.396
BPX3GMA5024	966	1005	1051	50	24	2.61	20	3.178
BPX3GMA5030	1024	1063	1109	50	30	2.61	24	3.960
BPX3GMA5036	1077	1161	1250	50	36	2.61	28	4.732
BPX3GMA5042	1143	1225	1315	50	42	2.61	32	5.484
BPX3GMA5048	1214	1294	1386	50	48	2.61	35	6.226
BPX3GMA5054	1299	1381	1470	50	54	2.61	37	7.008
BPX3GMA5060	1375	1458	1548	50	60	2.61	40	7.790
BPX3GMA5066	1480	1591	1711	50	66	2.61	48	8.675
BPX3GMA5072	1582	1694	-	50	72	2.61	56	9.560
BPX3GMA5418	930	970	1015	54	18	2.61	16	2.704
BPX3GMA5424	987	1029	1071	54	24	2.61	21	3.678
BPX3GMA5430	1047	1086	1132	54	30	2.61	26	4.560
BPX3GMA5436	1101	1183	1272	54	36	2.61	30	5.332
BPX3GMA5442	1168	1251	1339	54	42	2.61	34	7.126
BPX3GMA5448	1238	1320	1409	54	48	2.61	38	7.923
BPX3GMA5454	1326	1406	1496	54	54	2.61	41	8.423
BPX3GMA5460	1401	1484	1573	54	60	2.61	47	9.219
BPX3GMA6618	993	1060	1135	66	18	2.61	17	3.045
BPX3GMA6624	1055	1122	1197	66	24	2.61	22	4.021
BPX3GMA6630	1110	1177	1252	66	30	2.61	27	4.997
BPX3GMA6636	1170	1282	1398	66	36	2.61	32	5.964
BPX3GMA6642	1241	1351	1469	66	42	2.61	35	6.910
BPX3GMA6648	1315	1426	1541	66	48	2.61	39	7.847
BPX3GMA6654	1401	1514	1629	66	54	2.61	42	8.823
BPX3GMA6660	1483	1592	1708	66	60	2.61	45	9.799

BPX3GMG • Monolithic Glazed Panel with Embedded Glass

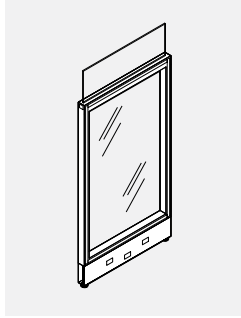

- **Full-height glazing provides visual accessibility.**
- Glazing is replaceable on site. Tempered clear glass standard.
- B3 panel top trim option provided with embedded, frame-less glass pane rising 8" above the top of the panel. For instance, when installed on 42" high B3 panel, overall height will be 50" high.
- There is 1.25" gap between two adjacent glass panes.
- Glass shipped separately, Allen key to set the glass pane plumb is provided with each panel.
- 6mm tempered glass, frosted or clear.
- Square corners on glass.
- Integrated adjustable brackets and extruded aluminum trim.
- Not retrofitable on-site.
- 16" Glass available as an option, please tag 16" and add the following upcharge per panel size.

PRODUCT CODE	PRICE	FRST	SIZE/ INCHES			WEIGHT VOL	
			H	W	D	LBS	FT ³
BPX3GMG5024	1290	1465	50	24	2.61	30	3.178
BPX3GMG5030	1529	1751	50	30	2.61	36	3.960
BPX3GMG5036	1599	1835	50	36	2.61	41	4.732
BPX3GMG5042	1680	1926	50	42	2.61	45	5.484
BPX3GMG5048	1761	2024	50	48	2.61	52	6.226
BPX3GMG5424	1345	1616	54	24	2.61	32	3.678
BPX3GMG5430	1549	1860	54	30	2.61	40	4.360
BPX3GMG5436	1626	1953	54	36	2.61	46	5.317
BPX3GMG5442	1711	2054	54	42	2.61	52	6.010
BPX3GMG5448	1802	2162	54	48	2.61	56	6.890
BPX3GMG6624	1504	1724	66	24	2.61	38	4.021
BPX3GMG6630	1604	1838	66	30	2.61	46	4.997
BPX3GMG6636	1705	1961	66	36	2.61	52	5.964
BPX3GMG6642	1811	2083	66	42	2.61	58	6.910
BPX3GMG6648	1922	2213	66	48	2.61	65	7.847

UPCHARGES FOR 16" GLASS

PANEL WIDTH	LIST
18	77
24	85
30	90
36	99
42	105
48	111
54	119
60	127
66	132
72	140

BPX3GPT • Pass-Thru Panel with Embedded Glass - Fabric Base

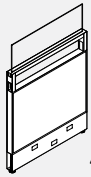

42" High

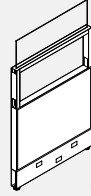

50" High

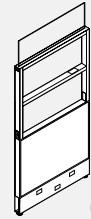

66" High

- Opening allows choice of tile above desk height.
- Solid fabric base up to 34".
- Single 8" opening above 34" for 42" high panels.
- Single 16" opening above 34" for 50" high panels.
- Two individual 16" openings above 34" for 66" high panels.
- Horizontal cable management at 34" height.
- OPT* = Laminate or Whiteboard.
- B3 panel Top trim option provided with embedded, frame-less glass pane rising 8" above the top of the panel. For instance, when installed on 42" high B3 panel, overall height will be 50" high.
- There is 1.25" gap between two adjacent glass panes.
- Glass shipped separately.
- 6mm tempered glass, frosted or clear.
- Square corners on glass.
- Integrated adjustable brackets and extruded aluminum trim.
- Not retrofittable on-site.
- 16" Glass available as an option, please tag 16" and add the following upcharge per panel size.

PRODUCT CODE	PRICE			SIZE/ H	INCHES			WEIGHT VOL	
	GR 1	GR 2	OPT*		W	D	LBS	FT ³	
BPX3GPT4218	782	809	840	42	18	2.61	17	1.979	
BPX3GPT4224	835	862	893	42	24	2.61	21	2.673	
BPX3GPT4230	883	910	942	42	30	2.61	24	3.382	
BPX3GPT4236	931	958	991	42	36	2.61	27	4.081	
BPX3GPT4242	988	1016	1048	42	42	2.61	30	4.758	
BPX3GPT4248	1056	1084	1114	42	48	2.61	34	5.426	
BPX3GPT4254	1134	1162	1191	42	54	2.61	38	6.135	
BPX3GPT4260	1200	1228	1260	42	60	2.61	40	6.852	
BPX3GPT4266	1280	1337	1399	42	66	2.61	47	7.556	
BPX3GPT4272	1357	1416	-	42	72	2.61	54	8.260	
BPX3GPT5018	782	809	840	50	18	2.61	18	2.396	
BPX3GPT5024	835	862	893	50	24	2.61	22	3.178	
BPX3GPT5030	883	910	942	50	30	2.61	25	3.960	
BPX3GPT5036	931	958	991	50	36	2.61	28	4.732	
BPX3GPT5042	988	1016	1048	50	42	2.61	31	5.484	
BPX3GPT5048	1056	1084	1114	50	48	2.61	35	6.226	
BPX3GPT5054	1134	1162	1191	50	54	2.61	39	7.008	
BPX3GPT5060	1200	1228	1260	50	60	2.61	42	7.790	
BPX3GPT5066	1280	1337	1399	50	66	2.61	49	8.675	
BPX3GPT5072	1357	1416	-	50	72	2.61	56	9.560	
BPX3GPT6618	871	902	931	66	18	2.61	22	3.045	
BPX3GPT6624	930	958	988	66	24	2.61	26	4.021	
BPX3GPT6630	992	1021	1051	66	30	2.61	30	4.997	
BPX3GPT6636	1047	1075	1104	66	36	2.61	33	5.964	
BPX3GPT6642	1114	1143	1173	66	42	2.61	36	6.910	
BPX3GPT6648	1190	1221	1250	66	48	2.61	41	7.847	
BPX3GPT6654	1274	1304	1332	66	54	2.61	45	8.823	
BPX3GPT6660	1354	1384	1414	66	60	2.61	49	9.799	

UPCHARGES FOR 16" GLASS

PANEL WIDTH	LIST
18	77
24	85
30	90
36	99
42	105
48	111
54	119
60	127
66	132
72	140

BPX3GPV • Pass-Thru Panel with Vertical Wire Channel and Embedded Glass- Fabric Base

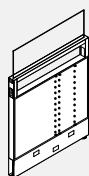

42" High

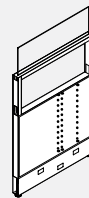

50" High

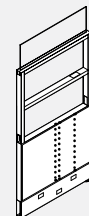

66" High

- Opening allows choice of tile above desk height. Vertical wire channel allows passage of cables from lay-in channel to bottom raceway within panel.
- Solid fabric base up to 34".
- Single 8" opening above 34" for 42" high panels.
- Single 16" opening above 34" for 50" high panels.
- Two individual 16" openings above 34" for 66" high panels.
- Includes integrated vertical wire channel.
- Horizontal cable management at 34" height.
- OPT* = Laminate or Whiteboard.
- B3 panel Top trim option provided with embedded, frame-less glass pane rising 8" above the top of the panel. For instance, when installed on 42" high B3 panel, overall height will be 50" high.
- There is 1.25" gap between two adjacent glass panes.
- Glass shipped separately, Allen key to set the glass pane plumb is provided with each panel.
- 6mm tempered glass, frosted or clear.
- Square corners on glass.
- Integrated adjustable brackets and extruded aluminum trim.
- Not retrofittable on-site.
- 16" Glass available as an option, please tag 16" and add the following upcharge per panel size.

PRODUCT CODE	PRICE			SIZE/ INCHES			WEIGHT VOL	
	GR 1	GR 2	OPT*	H	W	D	LBS	FT ³
BPX3GPV4230	927	955	986	42	30	2.61	26	3.382
BPX3GPV4236	974	1003	1033	42	36	2.61	29	4.081
BPX3GPV4242	1035	1063	1095	42	42	2.61	32	4.758
BPX3GPV4248	1099	1126	1159	42	48	2.61	37	5.426
BPX3GPV4254	1175	1202	1233	42	54	2.61	40	6.135
BPX3GPV4260	1251	1279	1309	42	60	2.61	43	6.852
BPX3GPV4266	1318	1375	1439	42	66	2.61	51	7.556
BPX3GPV4272	1388	1444	-	42	72	2.61	58	8.260
BPX3GPV5030	927	955	986	50	30	2.61	27	3.960
BPX3GPV5036	974	1003	1033	50	36	2.61	30	4.732
BPX3GPV5042	1035	1063	1095	50	42	2.61	33	5.484
BPX3GPV5048	1099	1126	1159	50	48	2.61	37	6.226
BPX3GPV5054	1175	1202	1233	50	54	2.61	41	7.008
BPX3GPV5060	1251	1279	1309	50	60	2.61	44	7.790
BPX3GPV5066	1318	1375	1439	50	66	2.61	52	8.675
BPX3GPV5072	1388	1444	-	50	72	2.61	60	9.560
BPX3GPV6630	1033	1062	1092	66	30	2.61	32	4.997
BPX3GPV6636	1093	1122	1152	66	36	2.61	35	5.964
BPX3GPV6642	1159	1188	1218	66	42	2.61	38	6.910
BPX3GPV6648	1232	1262	1290	66	48	2.61	43	7.847
BPX3GPV6654	1318	1349	1376	66	54	2.61	47	8.823
BPX3GPV6660	1398	1428	1456	66	60	2.61	51	9.799

UPCHARGES FOR 16" GLASS

PANEL WIDTH	LIST
18	77
24	85
30	90
36	99
42	105
48	111
54	119
60	127
66	132
72	140

BPX3GPF • Pass-Tru Panel with Embedded Glass - Air Flow Base

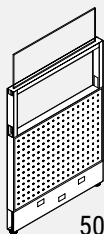

50" High

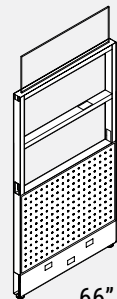

66" High

- Allows air to flow freely through the bottom of the panel.
- Double wall perforated metal base up to 34".
- Single 16" opening above 34" for 50" high panels.
- Two individual 16" openings above 34" for 66" high panels.
- Horizontal cable management at 34" height.
- B3 panel Top trim option provided with embedded, frame-less glass pane rising 8" above the top of the panel. For instance, when installed on 42" high B3 panel, overall height will be 50" high.
- There is 1.25" gap between two adjacent glass panes.
- Glass shipped separately, Allen key to set the glass pane plumb is provided with each panel.
- 6mm tempered glass, frosted or clear.
- Square corners on glass.
- Integrated adjustable brackets and extruded aluminum trim.
- Not retrofittable on-site.
- 16" Glass available as an option, please tag 16" and add the following upcharge per panel size.

PRODUCT CODE	PRICE	SIZE/ INCHES			WEIGHT VOL	
		H	W	D	LBS	FT ³
BPX3GPF5018	931	50	18	2.61	20	2.396
BPX3GPF5024	1004	50	24	2.61	23	3.178
BPX3GPF5030	1076	50	30	2.61	27	3.960
BPX3GPF5036	1153	50	36	2.61	30	4.732
BPX3GPF5042	1238	50	42	2.61	32	5.484
BPX3GPF5048	1328	50	48	2.61	37	6.226
BPX3GPF5054	1431	50	54	2.61	40	7.008
BPX3GPF5060	1526	50	60	2.61	44	7.790
BPX3GPF6618	1020	66	18	2.61	24	3.045
BPX3GPF6624	1101	66	24	2.61	28	4.021
BPX3GPF6630	1190	66	30	2.61	32	4.997
BPX3GPF6636	1275	66	36	2.61	35	5.964
BPX3GPF6642	1371	66	42	2.61	38	6.910
BPX3GPF6648	1472	66	48	2.61	43	7.847
BPX3GPF6654	1587	66	54	2.61	47	8.823
BPX3GPF6660	1695	66	60	2.61	50	9.799

UPCHARGES FOR 16" GLASS

PANEL WIDTH	LIST
18	77
24	85
30	90
36	99
42	105
48	111
54	119
60	127
66	132
72	140

BPX3GOP • Over Panel Frame with Embedded Glass

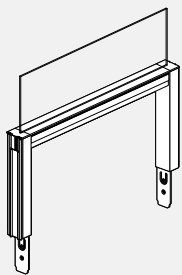

- Attaches to the top of any Boulevard System 3 panel to create a floor-to-ceiling wall.
- Any tile can be attached to either side to enclose the frame.
- Two non-slotted uprights at either end slide into vertical extrusions on the base panel.
- Shipped without horizontal and vertical trim; the horizontal trim from the base panel will be used.
- Boulevard System 3 Over Panel is not compatible with Boulevard 1 panels.
- B3 panel Top trim option provided with embedded, frame-less glass pane rising 8" above the top of the panel. For instance, when installed on 42" high B3 panel, overall height will be 50" high.
- There is 1.25" gap between two adjacent glass panes.
- Glass shipped separately, Allen key to set the glass pane plumb is provided with each panel.
- 5mm tempered glass, frosted or clear.
- Square corners on glass.
- Integrated adjustable brackets and extruded aluminum trim.
- Not retrofittable on-site.
- 16" Glass available as an option, please tag 16" and add the following upcharge per panel size.

PRODUCT CODE	PRICE	SIZE/ INCHES			WEIGHT VOL	
		H	W	D	LBS	FT ³
BPX3GOP0818	503	8	18	2.61	6	0.673
BPX3GOP0824	518	8	24	2.61	9	0.878
BPX3GOP0830	527	8	30	2.61	11	1.246
BPX3GOP0836	541	8	36	2.61	12	1.442
BPX3GOP0842	564	8	42	2.61	14	1.725
BPX3GOP0848	591	8	48	2.61	16	1.890
BPX3GOP0854	635	8	54	2.61	18	2.150
BPX3GOP0860	668	8	60	2.61	19	2.464
BPX3GOP0866	712	8	66	2.61	22	2.722
BPX3GOP0872	765	8	72	2.61	24	2.980
BPX3GOP1618	503	16	18	2.61	7	0.928
BPX3GOP1624	518	16	24	2.61	10	1.170
BPX3GOP1630	527	16	30	2.61	12	1.684
BPX3GOP1636	541	16	36	2.61	13	1.916
BPX3GOP1642	564	16	42	2.61	15	2.309
BPX3GOP1648	591	16	48	2.61	17	2.510
BPX3GOP1654	635	16	54	2.61	19	2.843
BPX3GOP1660	668	16	60	2.61	20	3.266
BPX3GOP1666	712	16	66	2.61	23	3.598
BPX3GOP1672	765	16	72	2.61	26	3.930

UPCHARGES FOR 16" GLASS

PANEL WIDTH	LIST
18	77
24	85
30	90
36	99
42	105
48	111
54	119
60	127
66	132
72	140

BPX3TMA • Monolithic Acoustical Panel with Embedded Felt Divider

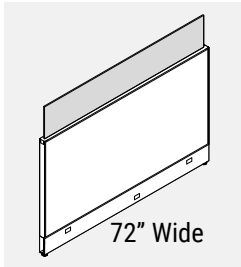
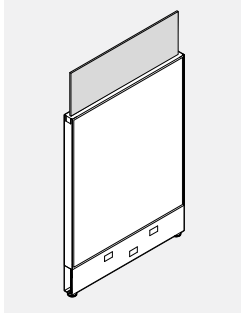

- Provides visual and acoustic privacy
- B3 panel top trim option provided with embedded, frame-less felt panel rising 8" or 16" above the top of the panel. For instance, when installed on 42" high B3 panel, overall height will be 50" high for 8" and 58" high for 16".
- There is 1.25" gap between two adjacent felt panels.
- Felt panel shipped separately.
- 9mm Felt material is tackable and comes in 18 different colours. Please specify colour.
- NOTE: List price shown is for 8" high felt only.

UPCHARGES FOR 16" FELT

PANEL WIDTH	LIST
18	24
24	29
30	37
36	45
42	54
48	56
54	61
60	73
66	78
72	86

PRODUCT CODE	PRICE			SIZE/ INCHES			WEIGHT VOL	
	GR1	GR2	OPT*	H	W	D	LBS	FT ³
BPX3TMA3418	406	426	447	34	18	2.61	11.9	1.627
BPX3TMA3424	455	473	495	34	24	2.61	14.1	2.178
BPX3TMA3430	502	523	543	34	30	2.61	16.3	2.729
BPX3TMA3436	549	589	629	34	36	2.61	18.5	3.270
BPX3TMA3442	600	639	681	34	42	2.61	19.7	3.791
BPX3TMA3448	647	688	727	34	48	2.61	22.8	4.302
BPX3TMA3454	704	744	787	34	54	2.61	25.0	4.853
BPX3TMA3460	752	792	832	34	60	2.61	27.2	5.404
BPX3TMA3466	799	853	911	34	66	2.61	31.4	6.022
BPX3TMA3472	843	898	-	34	72	2.61	36.6	6.640
BPX3TMA4218	433	460	487	42	18	2.61	12.9	2.072
BPX3TMA4224	510	537	565	42	24	2.61	15.1	2.757
BPX3TMA4230	534	561	589	42	30	2.61	18.3	3.442
BPX3TMA4236	584	635	692	42	36	2.61	20.5	4.117
BPX3TMA4242	636	689	744	42	42	2.61	22.7	4.771
BPX3TMA4248	690	740	799	42	48	2.61	25.8	5.416
BPX3TMA4254	745	799	856	42	54	2.61	28.0	6.101
BPX3TMA4260	794	845	903	42	60	2.61	30.2	6.785
BPX3TMA4266	870	978	1093	42	66	2.61	35.4	7.558
BPX3TMA4272	944	1052	-	42	72	2.61	40.6	8.330
BPX3TMA5018	543	584	625	50	18	2.61	13.9	2.396
BPX3TMA5024	603	641	684	50	24	2.61	17.1	3.178
BPX3TMA5030	666	704	745	50	30	2.61	20.3	3.960
BPX3TMA5036	722	800	883	50	36	2.61	23.5	4.732
BPX3TMA5042	785	864	947	50	42	2.61	26.7	5.484
BPX3TMA5048	843	922	1005	50	48	2.61	28.8	6.226
BPX3TMA5054	909	988	1071	50	54	2.61	30.0	7.008
BPX3TMA5060	970	1049	1133	50	60	2.61	32.2	7.790
BPX3TMA5066	1051	1158	1272	50	66	2.61	39.4	8.675
BPX3TMA5072	1126	1235	-	50	72	2.61	46.6	9.560
BPX3TMA5418	563	628	699	54	18	2.61	13.9	2.704
BPX3TMA5424	624	689	758	54	24	2.61	18.1	3.678
BPX3TMA5430	686	751	821	54	30	2.61	22.3	4.560
BPX3TMA5436	744	850	961	54	36	2.61	25.5	5.332
BPX3TMA5442	807	914	1025	54	42	2.61	28.7	7.126
BPX3TMA5448	868	972	1085	54	48	2.61	31.8	7.923
BPX3TMA5454	934	1038	1152	54	54	2.61	34.0	8.423
BPX3TMA5460	997	1101	1214	54	60	2.61	39.2	9.219
BPX3TMA6618	627	692	762	66	18	2.61	14.9	3.045
BPX3TMA6624	692	757	827	66	24	2.61	19.1	4.021
BPX3TMA6630	752	817	888	66	30	2.61	23.3	4.997
BPX3TMA6636	816	921	1032	66	36	2.61	27.5	5.964
BPX3TMA6642	882	987	1098	66	42	2.61	29.7	6.910
BPX3TMA6648	944	1049	1161	66	48	2.61	32.8	7.847
BPX3TMA6654	1013	1119	1229	66	54	2.61	35.0	8.823
BPX3TMA6660	1077	1184	1294	66	60	2.61	37.2	9.799

BPX3TMG • Monolithic Glazed Panel with Embedded Felt Divider

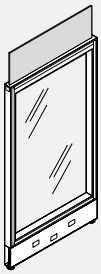

- Full-height glazing provides visual accessibility.
- B3 panel top trim option provided with embedded, frame-less felt panel rising 8" or 16" above the top of the panel. For instance, when installed on 42" high B3 panel, overall height will be 50" high for 8" and 58" high for 16".
- There is 1.25" gap between two adjacent felt panels.
- Felt panel shipped separately.
- 9mm Felt material is tackable and comes in 18 different colours. Please specify colour.
- NOTE: List price shown is for 8" high felt only.

PRODUCT CODE	PRICE		FRST	SIZE/ INCHES			WEIGHT VOL	
	GR1	GR2		H	W	D	LBS	FT ³
BPX3TMG5024	928	1101		50	24	2.61	27.1	3.178
BPX3TMG5030	1170	1392		50	30	2.61	32.3	3.960
BPX3TMG5036	1243	1480		50	36	2.61	36.5	4.732
BPX3TMG5042	1320	1568		50	42	2.61	39.7	5.484
BPX3TMG5048	1393	1651		50	48	2.61	45.8	6.226
BPX3TMG5424	985	1169		54	24	2.61	29.1	3.678
BPX3TMG5430	1189	1415		54	30	2.61	36.3	4.360
BPX3TMG5436	1271	1511		54	36	2.61	41.5	5.317
BPX3TMG5442	1352	1606		54	42	2.61	46.7	6.010
BPX3TMG5448	1431	1701		54	48	2.61	49.8	6.890
BPX3TMG6624	1141	1362		66	24	2.61	35.1	4.021
BPX3TMG6630	1242	1480		66	30	2.61	42.3	4.997
BPX3TMG6636	1351	1605		66	36	2.61	47.5	5.964
BPX3TMG6642	1451	1724		66	42	2.61	52.7	6.910
BPX3TMG6648	1552	1843		66	48	2.61	58.8	7.847

UPCHARGES FOR 16" FELT

PANEL WIDTH	LIST
18	24
24	29
30	37
36	45
42	54
48	56
54	61
60	73
66	78
72	86

BPX3TPT • Pass-Thru Panel with Embedded Felt Divider

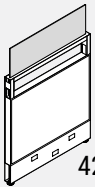

42" High

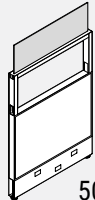

50" High

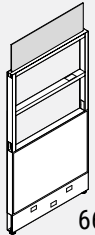

66" High

- Opening allows choice of tile above desk height.
- B3 panel top trim option provided with embedded, frame-less felt panel rising 8" or 16" above the top of the panel. For instance, when installed on 42" high B3 panel, overall height will be 50" high for 8" and 58" high for 16".
- There is 1.25" gap between two adjacent felt panels.
- Felt panel shipped separately.
- 9mm Felt material is tackable and comes in 18 different colours. Please specify colour.
- NOTE: List price shown is for 8" high felt only.

PRODUCT CODE	PRICE			FRST	SIZE/ INCHES			WEIGHT VOL	
	GR1	GR2	OPT*		H	W	D	LBS	FT ³
BPX3TPT4218	417	442	471	42	18	2.61	17	1.979	
BPX3TPT4224	471	498	527	42	24	2.61	21	2.673	
BPX3TPT4230	524	550	578	42	30	2.61	24	3.382	
BPX3TPT4236	574	601	630	42	36	2.61	27	4.081	
BPX3TPT4242	629	656	686	42	42	2.61	30	4.758	
BPX3TPT4248	686	712	740	42	48	2.61	34	5.426	
BPX3TPT4254	743	769	800	42	54	2.61	38	6.135	
BPX3TPT4260	795	822	851	42	60	2.61	40	6.852	
BPX3TPT4266	851	905	966	42	66	2.61	47	7.556	
BPX3TPT4272	906	961	-	42	72	2.61	54	8.260	
BPX3TPT5018	417	442	471	50	18	2.61	18	2.396	
BPX3TPT5024	471	498	527	50	24	2.61	22	3.178	
BPX3TPT5030	524	550	578	50	30	2.61	25	3.960	
BPX3TPT5036	574	601	630	50	36	2.61	28	4.732	
BPX3TPT5042	629	656	686	50	42	2.61	31	5.484	
BPX3TPT5048	686	712	740	50	48	2.61	35	6.226	
BPX3TPT5054	743	769	800	50	54	2.61	39	7.008	
BPX3TPT5060	795	822	851	50	60	2.61	42	7.790	
BPX3TPT5066	851	905	966	50	66	2.61	49	8.675	
BPX3TPT5072	906	961	-	50	72	2.61	56	9.560	
BPX3TPT6618	484	509	539	66	18	2.61	22	3.045	
BPX3TPT6624	546	572	601	66	24	2.61	26	4.021	
BPX3TPT6630	612	638	668	66	30	2.61	30	4.997	
BPX3TPT6636	672	699	727	66	36	2.61	33	5.964	
BPX3TPT6642	738	765	794	66	42	2.61	36	6.910	
BPX3TPT6648	805	832	862	66	48	2.61	41	7.847	
BPX3TPT6654	878	904	933	66	54	2.61	45	8.823	
BPX3TPT6660	943	969	998	66	60	2.61	49	9.799	

UPCHARGES FOR 16" FELT

PANEL WIDTH	LIST
18	24
24	29
30	37
36	45
42	54
48	56
54	61
60	73
66	78
72	86

BPX3TPV • Pass-Thru Panel with Vertical Wire Channel and Embedded Felt Divider- Fabric Base

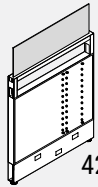

42" High

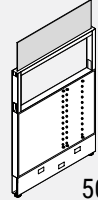

50" High

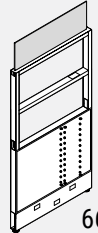

66" High

- Opening allows choice of tile above desk height. Vertical wire channel allows passage of cables from lay-in channel to bottom raceway within panel.
- B3 panel top trim option provided with embedded, frame-less felt panel rising 8" or 16" above the top of the panel. For instance, when installed on 42" high B3 panel, overall height will be 50" high for 8" and 58" high for 16".
- There is 1.25" gap between two adjacent felt panels.
- Felt panel shipped separately.
- 9mm Felt material is tackable and comes in 18 different colours. Please specify colour.
- NOTE: List price shown is for 8" high felt only.

PRODUCT CODE	PRICE			SIZE/ INCHES			WEIGHT VOL	
	GR 1	GR 2	OPT*	H	W	D	LBS	FT ³
BPX3TPV4230	567	594	624	42	30	2.61	22.3	3.382
BPX3TPV4236	620	647	675	42	36	2.61	24.5	4.081
BPX3TPV4242	677	703	733	42	42	2.61	26.7	4.758
BPX3TPV4248	729	756	785	42	48	2.61	30.8	5.426
BPX3TPV4254	787	813	842	42	54	2.61	33.0	6.135
BPX3TPV4260	845	871	902	42	60	2.61	35.2	6.852
BPX3TPV4266	890	944	1004	42	66	2.61	42.4	7.556
BPX3TPV4272	935	991	-	42	72	2.61	48.6	8.260
BPX3TPV5030	567	594	624	50	30	2.61	23.3	3.960
BPX3TPV5036	620	647	675	50	36	2.61	25.5	4.732
BPX3TPV5042	677	703	733	50	42	2.61	27.7	5.484
BPX3TPV5048	729	756	785	50	48	2.61	30.8	6.226
BPX3TPV5054	787	813	842	50	54	2.61	34.0	7.008
BPX3TPV5060	845	871	902	50	60	2.61	36.2	7.790
BPX3TPV5066	890	944	1004	50	66	2.61	43.4	8.675
BPX3TPV5072	935	991	-	50	72	2.61	50.6	9.560
BPX3TPV6630	674	701	730	66	30	2.61	28.3	4.997
BPX3TPV6636	738	765	794	66	36	2.61	30.5	5.964
BPX3TPV6642	800	826	856	66	42	2.61	32.7	6.910
BPX3TPV6648	862	889	919	66	48	2.61	36.8	7.847
BPX3TPV6654	930	956	986	66	54	2.61	40.0	8.823
BPX3TPV6660	993	1020	1049	66	60	2.61	43.2	9.799

UPCHARGES FOR 16" FELT

PANEL WIDTH	LIST
18	24
24	29
30	37
36	45
42	54
48	56
54	61
60	73
66	78
72	86

BPX3TPF • Pass-Thru Panel with Embedded Felt Divider - Air Flow Base

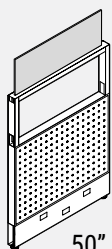

50" High

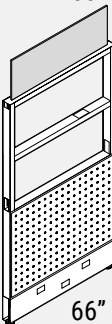

66" High

- Allows air to flow freely through the bottom of the panel.
- B3 panel top trim option provided with embedded, frameless felt panel rising 8" or 16" above the top of the panel. For instance, when installed on 42" high B3 panel, overall height will be 50" high for 8" and 58" high for 16".
- There is 1.25" gap between two adjacent felt panels.
- Felt panel shipped separately.
- 9mm Felt material is tackable and comes in 18 different colours. Please specify colour.
- NOTE: List price shown is for 8" high felt only.

PRODUCT CODE	PRICE	SIZE/ INCHES			WEIGHT VOL	
		H	W	D	LBS	FT ³
BPX3TPF5018	564	50	18	2.61	17.9	2.396
BPX3TPF5024	640	50	24	2.61	20.1	3.178
BPX3TPF5030	716	50	30	2.61	23.3	3.960
BPX3TPF5036	799	50	36	2.61	25.5	4.732
BPX3TPF5042	879	50	42	2.61	26.7	5.484
BPX3TPF5048	957	50	48	2.61	30.8	6.226
BPX3TPF5054	1042	50	54	2.61	33.0	7.008
BPX3TPF5060	1121	50	60	2.61	36.2	7.790
BPX3TPF6618	653	66	18	2.61	21.9	3.045
BPX3TPF6624	737	66	24	2.61	25.1	4.021
BPX3TPF6630	829	66	30	2.61	28.3	4.997
BPX3TPF6636	921	66	36	2.61	30.5	5.964
BPX3TPF6642	1013	66	42	2.61	32.7	6.910
BPX3TPF6648	1102	66	48	2.61	36.8	7.847
BPX3TPF6654	1199	66	54	2.61	40.0	8.823
BPX3TPF6660	1290	66	60	2.61	42.2	9.799

UPCHARGES FOR 16" FELT

PANEL WIDTH	LIST
18	24
24	29
30	37
36	45
42	54
48	56
54	61
60	73
66	78
72	86

BPX3TOP • Over Panel Frame with Embedded Felt Divider

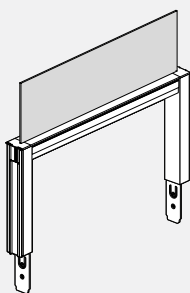

- Attaches to the top of any Boulevard System 3 panel to create a floor-to-ceiling wall
- B3 panel top trim option provided with embedded, frameless felt panel rising 8" or 16" above the top of the panel. For instance, when installed on 42" high B3 panel, overall height will be 50" high for 8" and 58" high for 16".
- There is 1.25" gap between two adjacent felt panels.
- Felt panel shipped separately.
- 9mm Felt material is tackable and comes in 18 different colours. Please specify colour.

PRODUCT CODE	PRICE	SIZE/ INCHES			WEIGHT VOL	
		H	W	D	LBS	FT ³
BPX3TOP0818	136	8	18	2.61	3.9	0.673
BPX3TOP0824	152	8	24	2.61	6.1	0.878
BPX3TOP0830	168	8	30	2.61	7.3	1.246
BPX3TOP0836	187	8	36	2.61	7.5	1.442
BPX3TOP0842	206	8	42	2.61	8.7	1.725
BPX3TOP0848	222	8	48	2.61	9.8	1.890
BPX3TOP0854	245	8	54	2.61	11.0	2.150
BPX3TOP0860	263	8	60	2.61	11.2	2.464
BPX3TOP0866	290	8	66	2.61	13.4	2.722
BPX3TOP0872	311	8	72	2.61	14.6	2.980
BPX3TOP1618	136	16	18	2.61	4.9	0.928
BPX3TOP1624	152	16	24	2.61	7.1	1.170
BPX3TOP1630	168	16	30	2.61	8.3	1.684
BPX3TOP1636	187	16	36	2.61	8.5	1.916
BPX3TOP1642	206	16	42	2.61	9.7	2.309
BPX3TOP1648	222	16	48	2.61	10.8	2.510
BPX3TOP1654	245	16	54	2.61	12.0	2.843
BPX3TOP1660	263	16	60	2.61	12.2	3.266
BPX3TOP1666	290	16	66	2.61	14.4	3.598
BPX3TOP1672	311	16	72	2.61	16.6	3.930

UPCHARGES FOR 16" FELT

PANEL WIDTH	LIST
18	24
24	29
30	37
36	45
42	54
48	56
54	61
60	73
66	78
72	86

BP3DS • Solid Door Panel

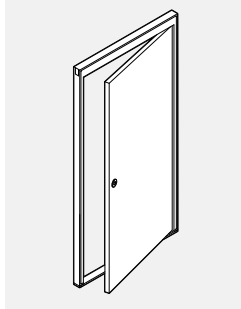

- **Aluminum frame with either high pressure laminate door.**
- 1 3/8" thick hollow core door.
- Actual door size:
79.9" x 32 1/2" in 82" x 36" frame
79.9" x 38 1/2" in 82" x 42" frame
- 42" wide Door Panel permits wheelchair accessibility.
- No hang-on capabilities.
- 180 degree swing.
- Specify Door Knob (DL01) or Door Lever (DL02).
- Lock standard.
- Handedness can be changed on site.
- Please specify Right hand (R) or Left hand (L) hung.
- Includes a Horizontal Lay-in Channel.

PRODUCT CODE	PRICE HP	SIZE/ INCHES			WEIGHT VOL	
		H	W	D	LBS	FT ³
BP3DS8236R	2263	82	36	2.61	61	6.465
BP3DS8242R	2465	82	42	2.61	68	7.486
BP3DS8236L	2263	82	36	2.61	61	6.465
BP3DS8242L	2465	82	42	2.61	68	7.486

Door Hanging Directions

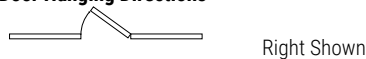

Right Shown

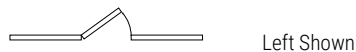

Left Shown

Door Handle Option

- Door Knob - DL01
- Lock Standard



- Door Lever - DL02 (Default)

- Lock Standard
- Lever complies with all accessibility standards



BP3DH • Half Glazed Door Panel

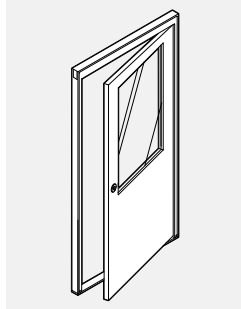

- **Aluminum frame with either high pressure laminate door and window.**
- 1 3/8" thick hollow core door.
- Actual door size:
79.9" x 32 1/2" in 82" x 36" frame
79.9" x 38 1/2" in 82" x 42" frame
- 42" wide Door Panel permits wheelchair accessibility.
- No hang-on capabilities.
- 180 degree swing.
- Specify Door Knob (DL01) or Door Lever (DL02).
- Lock standard.
- Handedness can be changed on site.
- Please specify Right hand (R) or Left hand (L) hung.
- For tempered glass option, add "TG" at the end of the product code and add an upcharge of \$145 for 36" wide doors and \$184 for 42" wide doors.
- Includes a Horizontal Lay-in Channel.

PRODUCT CODE	PRICE HP	SIZE/ INCHES			WEIGHT VOL	
		H	W	D	LBS	FT ³
BP3DH8236R	2807	82	36	2.61	53	6.465
BP3DH8242R	3068	82	42	2.61	59	7.486
BP3DH8236L	2807	82	36	2.61	53	6.465
BP3DH8242L	3068	82	42	2.61	59	7.486

Door Hanging Directions



Right Shown



Left Shown

Door Handle Option

- Door Knob - DL01
- Lock Standard



- Door Lever - DL02 (Default)

- Lock Standard
- Lever complies with all accessibility standards



BP3DG • Full Glazed Door Panel

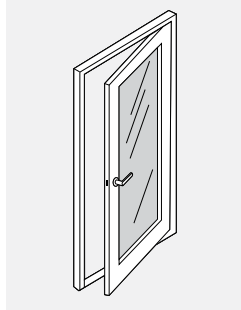

- **Aluminum frame with either high pressure laminate door and window.**
- 1 3/8" thick hollow core door.
- Actual door size:
79.9" x 32 1/2" in 82" x 36" frame
79.9" x 38 1/2" in 82" x 42" frame
- 42" wide Door Panel permits wheelchair accessibility.
- No hang-on capabilities.
- 180 degree swing.
- Specify Door Knob (DL01) or Door Lever (DL02).
- Lock standard.
- Handedness can be changed on site.
- Please specify Right hand (R) or Left hand (L) hung.
- For tempered glass option, add "TG" at the end of the product code and add an upcharge of \$293 for 36" wide doors and \$365 for 42" wide doors.
- Includes a Horizontal Lay-in Channel.
- Laminate frame is 5" thick at the sides and 4" at the top and bottom.

PRODUCT CODE	PRICE HP	SIZE/ INCHES			WEIGHT VOL	
		H	W	D	LBS	FT ³
BP3DG8236R	3227	82	36	2.61	53	6.465
BP3DG8242R	3531	82	42	2.61	59	7.486
BP3DG8236L	3227	82	36	2.61	53	6.465
BP3DG8242L	3531	82	42	2.61	59	7.486

Door Hanging Directions

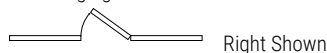

Right Shown



Left Shown

Door Handle Option

- Door Knob - DL01
- Lock Standard



- Door Lever - DL02 (Default)

- Lock Standard
- Lever complies with all accessibility standards



BPX3NET • Removable Face Tile - Electrical Tile Kit

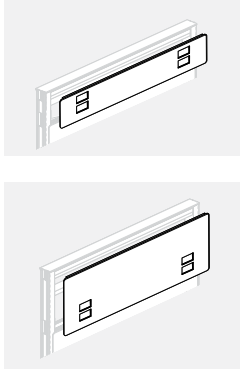

- Attaches to an 8" or 16" opening in a Pass-Thru Panel.
- Fabric covered tile with knock-out for power and data. (Data/Comm blank covers included).
- 24" wide tiles have one duplex and one data/comm opening. 30" and wider tiles have two duplex and two data/comm openings.
- Easily interchangeable on site.
- Provides access to electrical and data at a required location.
- Specify Tile Electrical Kit separately.
- Duplexes and covers must be specified separately.
- For power outlets on both sides of the panel, specify two Electrical Tiles per panel. For power outlets on one side only, specify one Electrical Tile and a Fabric Tile for the opposite side.
- OPT* = Laminate or Whiteboard.
- For use on panels manufactured after November 1, 2014

PRODUCT CODE	PRICE			SIZE/ H	INCHES			WEIGHT VOL	
	GR 1	GR 2	OPT*		W	D	LBS	FT ³	
BPX3NET0824	191	204	218	8	24	0.125	2.0	0.170	
BPX3NET0830	215	229	242	8	30	0.125	2.5	0.200	
BPX3NET0836	240	254	268	8	36	0.125	2.5	0.250	
BPX3NET0842	251	262	276	8	42	0.125	2.5	0.292	
BPX3NET0848	255	268	283	8	48	0.125	3.0	0.333	
BPX3NET0854	266	278	294	8	54	0.125	3.0	0.375	
BPX3NET0860	272	286	300	8	60	0.125	4.5	0.417	
BPX3NET0866	303	360	422	8	66	0.125	4.7	0.475	
BPX3NET0872	333	393	-	8	72	0.125	5.0	0.500	
BPX3NET1624	191	204	218	16	24	0.125	2.5	3.400	
BPX3NET1630	215	229	242	16	30	0.125	3.0	0.416	
BPX3NET1636	240	254	268	16	36	0.125	3.0	0.500	
BPX3NET1642	251	262	276	16	42	0.125	3.0	0.583	
BPX3NET1648	255	268	283	16	48	0.125	4.0	0.666	
BPX3NET1654	266	278	294	16	54	0.125	4.0	0.750	
BPX3NET1660	272	286	300	16	60	0.125	5.0	0.833	
BPX3NET1666	303	360	422	16	66	0.125	5.5	0.911	
BPX3NET1672	333	393	-	16	72	0.125	6.0	1.000	

BP3GT • Removable Face Tile - Glazed

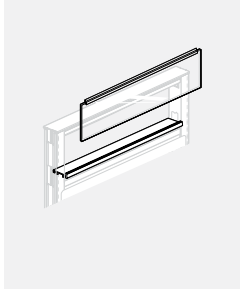

- Attaches to any opening in a Pass-Thru Panel.
- 8" or 16" high glazing provides visual accessibility and light transfer.
- Easily interchangeable on site.
- Specify one Glazed Tile for panel opening of corresponding width.
- Clear tempered glass standard.

PRODUCT CODE	PRICE	FRST	SIZE/ H	INCHES			WEIGHT VOL	
				W	D	LBS	FT ³	
BP3GT0818	100	120	8	18	2.61	2.3	0.146	
BP3GT0824	112	134	8	24	2.61	3.1	0.165	
BP3GT0830	123	147	8	30	2.61	3.9	0.200	
BP3GT0836	144	173	8	36	2.61	4.7	0.250	
BP3GT0842	168	202	8	42	2.61	5.5	0.292	
BP3GT0848	194	231	8	48	2.61	6.3	0.333	
BP3GT0854	218	262	8	54	2.61	7.1	0.375	
BP3GT0860	242	292	8	60	2.61	7.8	0.417	
BP3GT0866	268	321	8	66	2.61	8.6	0.460	
BP3GT0872	292	352	8	72	2.61	9.4	0.500	
BP3GT1618	106	127	16	18	2.61	4.3	0.292	
BP3GT1624	121	145	16	24	2.61	5.8	0.333	
BP3GT1630	140	167	16	30	2.61	7.2	0.416	
BP3GT1636	169	204	16	36	2.61	8.7	0.500	
BP3GT1642	198	238	16	42	2.61	10.2	0.583	
BP3GT1648	228	272	16	48	2.61	11.6	0.666	
BP3GT1654	256	308	16	54	2.61	13.1	0.750	
BP3GT1660	286	342	16	60	2.61	14.6	0.833	
BP3GT1666	315	361	16	66	2.61	16.0	0.911	
BP3GT1672	342	394	16	72	2.61	17.5	1.000	

BP3DGT • Removable Face Tile - Double Glazed

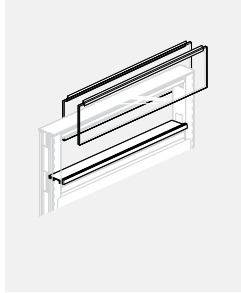

- Attaches to any opening in a Pass-Thru Panel.
- 8" or 16" high glazing provides visual accessibility and light transfer.
- Easily interchangeable on site.
- Specify one Double Glazed Tile for panel opening of corresponding width.
- Clear tempered glass standard.

PRODUCT CODE	PRICE	FRST	SIZE/ INCHES			WEIGHT VOL	
			H	W	D	LBS	FT ³
BP3DGT0818	185	220	8	18	2.61	6.0	0.292
BP3DGT0824	204	242	8	24	2.61	8.2	0.330
BP3DGT0830	227	268	8	30	2.61	10.4	0.400
BP3DGT0836	276	330	8	36	2.61	12.6	0.500
BP3DGT0842	321	385	8	42	2.61	14.7	0.584
BP3DGT0848	367	443	8	48	2.61	16.9	0.666
BP3DGT0854	417	499	8	54	2.61	19.0	0.750
BP3DGT0860	463	556	8	60	2.61	21.3	0.834
BP3DGT0866	509	611	8	66	2.61	23.4	0.920
BP3DGT0872	556	667	8	72	2.61	25.6	1.000
BP3DGT1618	196	233	16	18	2.61	10.0	0.584
BP3DGT1624	209	252	16	24	2.61	13.6	0.666
BP3DGT1630	266	318	16	30	2.61	17.1	0.832
BP3DGT1636	323	387	16	36	2.61	20.6	1.000
BP3DGT1642	377	451	16	42	2.61	24.1	1.166
BP3DGT1648	433	520	16	48	2.61	27.7	1.322
BP3DGT1654	488	586	16	54	2.61	31.2	1.500
BP3DGT1660	545	652	16	60	2.61	34.7	1.666
BP3DGT1666	600	690	16	66	2.61	38.2	1.822
BP3DGT1672	652	751	16	72	2.61	41.7	2.000

BP30T • Removable Face Tile - Open Pass-Thru Kit

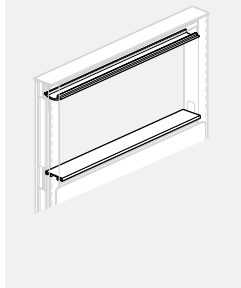

- Attaches to any opening in a Pass-Thru Panel.
- Trims and internal corners included to create an opening.
- Easily interchangeable on site.
- Specify one Pass-Thru Kit for panel opening of corresponding width.
- Kit works for 8" & 16" openings.
- Please specify panel frame colour.

PRODUCT CODE	PRICE	SIZE/ H	INCHES		WEIGHT VOL	
			W	D	LBS	FT ³
BP30T1618	18	16	18	2.61	0.4	0.292
BP30T1624	21	16	24	2.61	0.6	0.333
BP30T1630	26	16	30	2.61	0.8	0.416
BP30T1636	30	16	36	2.61	1.0	0.500
BP30T1642	34	16	42	2.61	1.1	0.583
BP30T1648	40	16	48	2.61	1.3	0.666
BP30T1654	44	16	54	2.61	1.5	0.750
BP30T1660	47	16	60	2.61	1.7	0.833
BP30T1666	52	16	66	2.61	1.9	0.911
BP30T1672	54	16	72	2.61	2.0	1.000

BP3AT • Removable Face Tile - Accessory

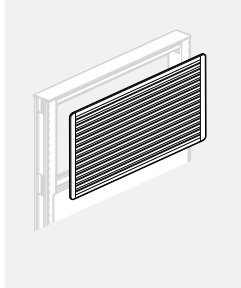

- Attaches to any opening in a Pass-Thru Panel.
- Provides support for accessories.
- Easily interchangeable on site.
- Two tile clips included.
- Specify two tiles per panel opening of corresponding width. Tiles can be combined. For example, Fabric Tile on one side and Accessory Tile on the opposite side of the same panel.
- Accessory Tile cannot be installed opposite an electrical tile.

PRODUCT CODE	PRICE	SIZE/ H	INCHES		WEIGHT VOL	
			W	D	LBS	FT ³
BP3AT0818	94	08	18	0.25	1.7	0.146
BP3AT0824	112	08	24	0.25	2.3	0.167
BP3AT0830	123	08	30	0.25	2.9	0.208
BP3AT0836	145	08	36	0.25	3.5	0.250
BP3AT0842	175	08	42	0.25	4.1	0.292
BP3AT0848	205	08	48	0.25	4.7	0.333
BP3AT0854	220	08	54	0.25	5.3	0.375
BP3AT0860	251	08	60	0.25	5.9	0.417
BP3AT0866	271	08	66	0.25	6.5	0.459
BP3AT0872	294	08	72	0.25	7.0	0.500
BP3AT1618	111	16	18	0.25	3.5	0.292
BP3AT1624	134	16	24	0.25	4.7	0.333
BP3AT1630	143	16	30	0.25	5.7	0.416
BP3AT1636	173	16	36	0.25	7.0	0.500
BP3AT1642	205	16	42	0.25	8.2	0.583
BP3AT1648	238	16	48	0.25	9.4	0.666
BP3AT1654	257	16	54	0.25	10.6	0.750
BP3AT1660	295	16	60	0.25	11.9	0.833
BP3AT1666	326	16	66	0.25	13.0	0.916
BP3AT1672	355	16	72	0.25	14.0	1.000

BP3FT • Removable Face Tile - Fabric

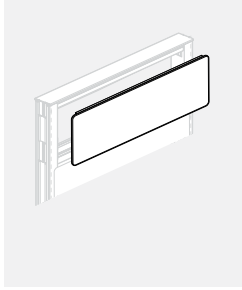

- Attaches to any opening in a Pass-Thru Panel.
- Tile clips included.
- Easily interchangeable on site.
- Specify two tiles per panel opening of corresponding width. Tiles can be combined. For example, Fabric Tile on one side and Accessory Tile on the opposite side of the same panel.
- OPT* = Laminate or Whiteboard.

PRODUCT CODE	PRICE			SIZE/ H	INCHES			WEIGHT VOL	
	GR 1	GR 2	OPT*		W	D	LBS	FT ³	
BP3FT0818	89	97	105	8	18	0.25	1	0.146	
BP3FT0824	94	103	110	8	24	0.25	1	0.165	
BP3FT0830	103	114	130	8	30	0.25	2	0.200	
BP3FT0836	127	140	154	8	36	0.25	2	0.250	
BP3FT0842	135	147	164	8	42	0.25	2	0.292	
BP3FT0848	141	154	168	8	48	0.25	3	0.333	
BP3FT0854	149	164	176	8	54	0.25	3	0.375	
BP3FT0860	154	167	182	8	60	0.25	4	0.417	
BP3FT0866	175	232	296	8	66	0.25	4	0.460	
BP3FT0872	226	298	-	8	72	0.25	4	0.500	
BP3FT1618	100	107	113	16	18	0.25	2	0.292	
BP3FT1624	106	112	120	16	24	0.25	2	0.333	
BP3FT1630	113	128	142	16	30	0.25	3	0.416	
BP3FT1636	140	152	167	16	36	0.25	3	0.500	
BP3FT1642	149	164	176	16	42	0.25	3	0.583	
BP3FT1648	156	169	186	16	48	0.25	4	0.666	
BP3FT1654	165	176	193	16	54	0.25	4	0.750	
BP3FT1660	182	240	199	16	60	0.25	5	0.833	
BP3FT1666	199	256	319	16	66	0.25	5	0.920	
BP3FT1672	246	326	-	16	72	0.25	6	1.000	

BP3OPFA • Fabric Over Panel

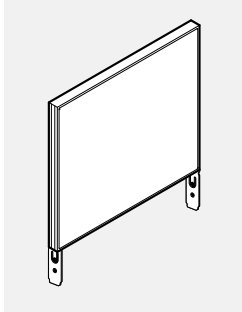

- Attaches to top of a panel to create floor-to-ceiling wall.
- Centre septum overlaid on either side with 1 1/8" "Sound absorbent mineral board".
- Non-slotted.
- Exact height should be specified when ordering, with allowance of at least 1" of free space between over panel and ceiling to accommodate height variations in ceiling and floor. Can be any height from 4.4" minimum to 15.9" maximum. Please tag exact height required.
- Runs of over panels should be captured at either end with full height posts, wall adapters, taller panels, and/or vertical trims.
- OPT* = Laminate or Whiteboard.

PRODUCT CODE	PRICE			SIZE/ H	INCHES			WEIGHT VOL	
	GR 1	GR 2	OPT*		W	D	LBS	FT ³	
BP3OPFA18	234	251	263	16	18	2.61	8	0.730	
BP3OPFA24	266	278	294	16	24	2.61	8	0.730	
BP3OPFA30	304	318	332	16	30	2.61	10	0.912	
BP3OPFA36	343	358	372	16	36	2.61	12	1.094	
BP3OPFA42	374	387	403	16	42	2.61	12	1.094	
BP3OPFA48	413	426	441	16	48	2.61	14	1.277	
BP3OPFA54	451	466	480	16	54	2.61	14	1.277	
BP3OPFA60	481	495	508	16	60	2.61	15	1.368	

BP3OPFV • Fabric Over Panel with Vertical Wire Channel

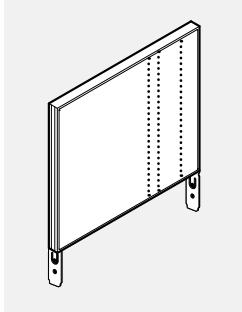

- Attaches to top of a panel to create floor-to-ceiling wall.
- Centre septum overlaid on either side with 1" sound absorbent mineral board.
- Non-slotted.
- Exact height should be specified when ordering, with allowance of at least 1" of free space between over panel and ceiling to accommodate height variations in ceiling and floor. Can be any height from 4.4" minimum to 15.9" maximum. Please tag exact height required.
- Runs of over panels should be captured at either end with full height posts, wall adapters, taller panels, and/or vertical trims.
- OPT* = Laminate or Whiteboard.

PRODUCT CODE	PRICE			SIZE/ H	INCHES			WEIGHT VOL	
	GR 1	GR 2	OPT*		W	D	LBS	FT ³	
BP3OPFV18	278	292	305	16	18	2.61	8	0.73	
BP3OPFV24	308	321	334	16	24	2.61	8	0.73	
BP3OPFV30	345	360	374	16	30	2.61	10	0.912	
BP3OPFV36	386	399	414	16	36	2.61	12	1.094	
BP3OPFV42	418	430	444	16	42	2.61	12	1.094	
BP3OPFV48	457	469	484	16	48	2.61	14	1.277	
BP3OPFV54	495	507	524	16	54	2.61	14	1.277	
BP3OPFV60	524	535	551	16	60	2.61	15	1.368	

BA3PAS • Glass Over Panel with Round Pucks for System 3

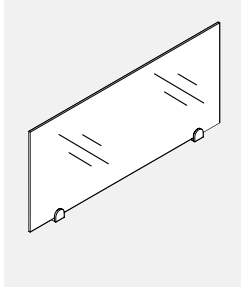

- **Glass Over Panel creates division.**
- Glass Over Panel with no frame sits on top of a System 3 Panel with clamps that are secured to the top of the panel.
- Tempered glass is 16" high.
- Custom sizes available, contact your Customer Service Representative.
- For application where the over panel is sandwiched between two taller panels, please request a special as the glass will not fit due to trims.

PRODUCT CODE	PRICE		SIZE/ H	INCHES			WEIGHT VOL	
	CLR	FRST		W	D	LBS	FT ³	
BA3PAS0824	198	228	8	24	1.3	4	0.22	
BA3PAS0830	222	254	8	30	1.3	5	0.30	
BA3PAS0836	234	275	8	36	1.3	6	0.37	
BA3PAS0842	254	297	8	42	1.3	7	0.43	
BA3PAS0848	273	314	8	48	1.3	8	0.48	
BA3PAS1624	212	241	16	24	1.3	8	0.44	
BA3PAS1630	234	268	16	30	1.3	10	0.59	
BA3PAS1636	252	290	16	36	1.3	12	0.73	
BA3PAS1642	268	311	16	42	1.3	14	0.85	
BA3PAS1648	273	329	16	48	1.3	16	0.96	

BA3PASS • Glass Over Panel with Square Pucks for System 3

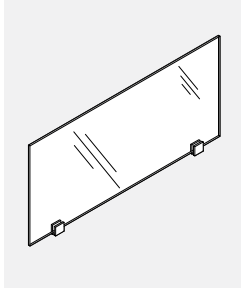

- **Glass Over Panel creates division.**
- Glass Over Panel with no frame sits on top of a System 3 Panel with clamps that are secured to the top of the panel.
- Tempered glass is 16" high.
- Custom sizes available, contact your Customer Service Representative.
- For application where the over panel is sandwiched between two taller panels, please request a special as the glass will not fit due to trims.

PRODUCT CODE	PRICE		SIZE/ H	INCHES			WEIGHT VOL	
	CLR	FRST		W	D	LBS	FT ³	
BA3PASS0824	212	241	8	24	1.3	4	0.22	
BA3PASS0830	234	268	8	30	1.3	5	0.30	
BA3PASS0836	254	290	8	36	1.3	6	0.37	
BA3PASS0842	268	311	8	42	1.3	7	0.43	
BA3PASS0848	289	329	8	48	1.3	8	0.48	
BA3PASS1624	228	256	16	24	1.3	8	0.44	
BA3PASS1630	252	283	16	30	1.3	10	0.59	
BA3PASS1636	266	304	16	36	1.3	12	0.73	
BA3PASS1642	283	328	16	42	1.3	14	0.85	
BA3PASS1648	290	342	16	48	1.3	16	0.96	

BPMB • Raceway Cover Caps

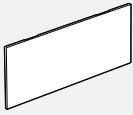

- To provide clean detail for the punch-outs of a raceway cover when the punch-outs are not in use. Order only when required.
- Made of injection molded ABS.
- B = Black
- G = Grey
- W = White

PRODUCT CODE	PRICE	SIZE/ INCHES			WEIGHT VOL	
		H	W	D	LBS	FT ³
BPMB020104B	9	1.5	3	0.125	0.04	0.02
BPMB020104G	9	1.5	3	0.125	0.04	0.02
BPMB020104W	9	1.5	3	0.125	0.04	0.02

BH3PS • 90 Degree Post



- Enables connection for multiple panel runs such as 90°, 3 way and 4 way.
- Includes 2 "Capture Strip" panel connectors, 4 end strips, 2 pairs of raceway end caps, and 1 post cap.
- Posts are designed to accept the following:
 - 75 cables 5.6mm (0.220") diameter
 - 60 ccables 5.6mm (0.220") diameter with 1 power feed
 - 45 cables 5.6mm (0.220") diameter with 2 power feeds

PRODUCT CODE	PRICE	SIZE/ INCHES			WEIGHT VOL	
		H	W	D	LBS	FT ³
BH3PS034	122	27	2.61	2.61	4	0.14
BH3PS042	134	35	2.61	2.61	5	0.18
BH3PS050	151	43	2.61	2.61	7	0.22
BH3PS054	169	47	2.61	2.61	7	0.27
BH3PS058	174	51	2.61	2.61	8	0.29
BH3PS066	182	59	2.61	2.61	8	0.31

BH3PS45 • 45 Degree Post



- Enables connection for two panels at 45°.
- Includes 2 "Capture Strip" panel connectors and 1 post cap.
- 45 degree post does not accept End Trim.
- No power infeed capabilities.
- Posts are designed to accept the following:
 - 30 cables 5.6mm (0.220") diameter

PRODUCT CODE	PRICE	SIZE/ INCHES			WEIGHT VOL	
		H	W	D	LBS	FT ³
BH3PS45034	122	27	2.61	2.61	4	0.14
BH3PS45042	134	35	2.61	2.61	5	0.18
BH3PS45050	151	43	2.61	2.61	7	0.22
BH3PS45054	169	47	2.61	2.61	7	0.27
BH3PS45058	174	51	2.61	2.61	8	0.29
BH3PS45066	182	59	2.61	2.61	8	0.31

BH3PS60 • 60 Degree Post



- Enables connection for multiple panel runs such as 120° and 3 way.
- Includes 2 "Capture Strip" panel connectors and 1 post cap.
- No power infeed capabilities.
- Posts are designed to accept the following:
 - 35 cables 5.6mm (0.220") diameter

PRODUCT CODE	PRICE	SIZE/ INCHES			WEIGHT VOL	
		H	W	D	LBS	FT ³
BH3PS60034	122	27	2.61	2.61	4	0.14
BH3PS60042	134	35	2.61	2.61	5	0.18
BH3PS60050	151	43	2.61	2.61	7	0.22
BH3PS60054	169	47	2.61	2.61	7	0.27
BH3PS60058	174	51	2.61	2.61	8	0.29
BH3PS60066	182	59	2.61	2.61	8	0.31

BH3PE • Post Extension for Over Panels



- Provides route for ceiling data or electrical cables through the post to the panel.
- Includes 2 "Capture Strip" panel connectors.

PRODUCT CODE	PRICE	SIZE/ INCHES			WEIGHT VOL	
		H	W	D	LBS	FT ³
BH3PE008	29	8	2.61	2.61	1	0.03
BH3PE016	52	16	2.61	2.61	2	0.07
BH3PE032	76	32	2.61	2.61	4	0.14
BH3PE45016	52	16	2.61	2.61	2	0.07
BH3PE45032	76	32	2.61	2.61	4	0.14
BH3PE60016	52	16	2.61	2.61	2	0.07
BH3PE60032	76	32	2.61	2.61	4	0.14

BH3PA • Off-Module Connector (Panel to Panel Adapter)

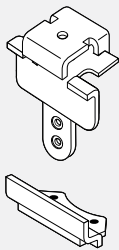

- Connects Boulevard System 3 panel to another perpendicular Boulevard System 3 Monolithic Panel off-module.
- Top and bottom brackets bolt to panel vertical of one panel and engage to top and bottom "fabric" edges of adjacent, perpendicular Monolithic Panel of even height.
- While connecting tile panel to Monolithic Panel is possible, never attempt to secure Off-Module Connectors to a tile panel.
- Once an off-module panel is secure to Monolithic Panel spine with Off-Module Connecting Kit, the raceway on the spine panel cannot be accessed and can only be opened from the opposite side.
- Special top trim required, provide application to your Customer Service Representative.
- This connector is not a load-bearing connection.
- Not to be used on the panel seam, with over panels or laminate and metal faced panels.

PRODUCT CODE	PRICE	SIZE/ INCHES			WEIGHT VOL	
		H	W	D	LBS	FT ³
BH3PA02	90	3.5			0.5	0.035

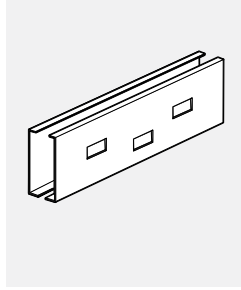
RCX3WMP2 • Raceway Cover with Punchouts Both Sides

- **Metal raceway organizes cables at the base.**
- Snaps directly into the base of the panel.
- When opened, cover's side rests on the floor, providing unobstructed access to data/power installation.
- 18" Raceway Covers do not have power and data/communication punch-outs.
- 24" Raceway covers have electrical and one data opening.
- Data opening sizing is as follows: 1.38" x 2.71".
- Comes standard with all System 3 panels.
- "No Knockouts" option for raceways available at no additional charge. Please choose option for interior and/or exterior raceways.

PRODUCT CODE	PRICE	SIZE/ INCHES			WEIGHT VOL	
		H	W	D	LBS	FT ³
RCX3WM24P2	61	5.62	24	2.61	3.3	0.21
RCX3WM30P2	66	5.62	30	2.61	4.1	0.26
RCX3WM36P2	76	5.62	36	2.61	4.9	0.31
RCX3WM42P2	87	5.62	42	2.61	5.7	0.36
RCX3WM48P2	92	5.62	48	2.61	6.6	0.42
RCX3WM54P2	101	5.62	54	2.61	7.4	0.47
RCX3WM60P2	110	5.62	60	2.61	8.3	0.52
RCX3WM66P2	114	5.62	66	2.61	9.1	0.57
RCX3WM72P2	123	5.62	72	2.61	9.8	0.62

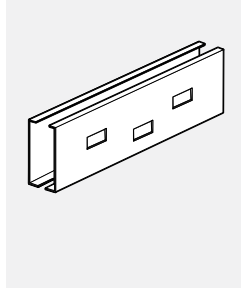
RCX3WMP1 • Raceway Cover with Punchouts One Side, None Other Side

- **Metal raceway organizes cables at the base.**
- Snaps directly into the base of the panel.
- When opened, cover's side rests on the floor, providing unobstructed access to data/power installation.
- 18" Raceway Covers do not have power and data/communication punch-outs.
- 24" Raceway covers have electrical and one data opening.
- Data opening sizing is as follows: 1.38" x 2.71".
- Comes standard with all System 3 panels.
- "No Knockouts" option for raceways available at no additional charge. Please choose option for interior and/or exterior raceways.

PRODUCT CODE	PRICE	SIZE/ INCHES			WEIGHT VOL	
		H	W	D	LBS	FT ³
RCX3WM24P1	61	5.62	24	2.61	3.3	0.21
RCX3WM30P1	66	5.62	30	2.61	4.1	0.26
RCX3WM36P1	76	5.62	36	2.61	4.9	0.31
RCX3WM42P1	87	5.62	42	2.61	5.7	0.36
RCX3WM48P1	92	5.62	48	2.61	6.6	0.42
RCX3WM54P1	101	5.62	54	2.61	7.4	0.47
RCX3WM60P1	110	5.62	60	2.61	8.3	0.52
RCX3WM66P1	114	5.62	66	2.61	9.1	0.57
RCX3WM72P1	123	5.62	72	2.61	9.8	0.62

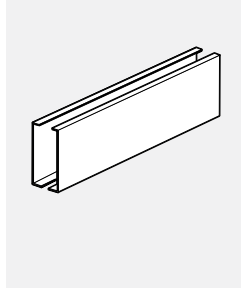
RCX3WMNP • Raceway Cover with No Punchouts Both Sides

- **Metal raceway organizes cables at the base.**
- Snaps directly into the base of the panel.
- When opened, cover's side rests on the floor, providing unobstructed access to data/power installation.

PRODUCT CODE	PRICE	SIZE/ INCHES			WEIGHT VOL	
		H	W	D	LBS	FT ³
RCX3WM18NP	54	5.62	18	2.61	2.4	0.16
RCX3WM24NP	61	5.62	24	2.61	3.3	0.21
RCX3WM30NP	66	5.62	30	2.61	4.1	0.26
RCX3WM36NP	76	5.62	36	2.61	4.9	0.31
RCX3WM42NP	87	5.62	42	2.61	5.7	0.36
RCX3WM48NP	92	5.62	48	2.61	6.6	0.42
RCX3WM54NP	101	5.62	54	2.61	7.4	0.47
RCX3WM60NP	110	5.62	60	2.61	8.3	0.52
RCX3WM66NP	114	5.62	66	2.61	9.1	0.57
RCX3WM72NP	123	5.62	72	2.61	9.8	0.62

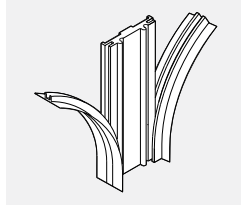
B3HWA • Wall Adapter

- **Starts a run of panels off an existing wall.**
- Includes 2 "Capture Strip" panel connectors and 1 pair of raceway end caps.
- Mounting hardware not included.
- Mounting hardware selection should be based on wall or wall stud material.
- Wall Adapter adds 5/16" to a panels run.

PRODUCT CODE	PRICE	SIZE/ INCHES			WEIGHT VOL	
		H	W	D	LBS	FT ³
B3HWA034	59	34	2.61	0.375	2	0.011
B3HWA042	62	42	2.61	0.375	3	0.015
B3HWA050	66	50	2.61	0.375	3	0.018
B3HWA054	72	54	2.61	0.375	3	0.020
B3HWA058	76	58	2.61	0.375	4	0.021
B3HWA066	78	66	2.61	0.375	4	0.021

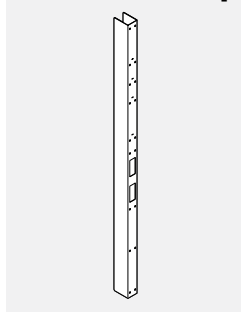
BHWASL • Adapter Sleeve

- **Wall Adapter Sleeve is attached to the building to provide flexible support to a panel run.**
- As opposed to the BHWA wall adapter, which connects to the panels rigidly to a wall, B1 and B3 Boulevard panels rest inside of the vertical "U" channel, providing up to 3.5" of flexible adjustment.
- For panel runs taller than 66" order two Wall Adapter Sleeves and either have it cut short on the site below ceiling, or cut a rectangular hole in the ceiling tile. Rectangular slots in the Channels correspond to 66", 58", 54", 50" and 42" high B1 and B3 panels.
- Powder coated steel; specify metal finish.
- Note: the Wall Adapter Sleeve provides flexible, non-structural connection, blocks vertical 1" increment clots and cannot, therefore, be used to support overheads and worksurfaces, they must be supported by perpendicular panels, c-legs or gables.
- Note: no fasteners are provided with the Wall Adapter Sleeve. Select the appropriate fasteners according to a structurally sound connection.
- Cannot be used to support a door or panel and cannot be used with laminate, airflow or metal skin panels.

PRODUCT CODE	PRICE	SIZE/ INCHES			WEIGHT VOL	
		H	W	D	LBS	FT ³
BHWASL42	145	34.7	4	2	2.5	0.161
BHWASL50	157	42.7	4	2	3.6	0.148
BHWASL54	165	46.7	4	2	4.2	0.216
BHWASL58	169	52.7	4	2	5.1	0.244
BHWASL66	182	58.7	4	2	6.0	0.272

BH3CS • Capture Strip Slot Cover

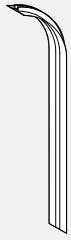

- An extruded PVC channel to adjoin two panels or a panel to a post. Runs the full length of the panel on both sides providing a positive connection of the "Knuckle-Loc" design.
- Priced per pair.
- Pliable side membranes cover panel slots.
- Included with panel components.
- Only to be ordered separately if required.

PRODUCT CODE	PRICE	SIZE/ INCHES			WEIGHT VOL	
		H	W	D	LBS	FT ³
BH3CS34	12	37			0.24	0.11
BH3CS42	12	42			0.28	0.13
BH3CS50	13	50			0.33	0.15
BH3CS54	13	54			0.31	0.17
BH3CS66	20	66			0.4	0.19

BH3CE • End Strip Slot Cover

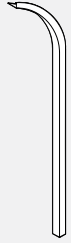

- End strips with pliable side membrane covers panel slots at end of run.
- Priced per pair.
- Included with panel components.
- Only to be ordered separately if required.

PRODUCT CODE	PRICE	SIZE/ INCHES			WEIGHT VOL	
		H	W	D	LBS	FT ³
BH3CE34	11	37			0.12	0.05
BH3CE42	11	42			0.14	0.06
BH3CE50	12	50			0.16	0.07
BH3CE54	12	54			0.31	0.08
BH3CE66	13	66			0.20	0.09

BA3VTR • Vertical Aluminum End Trim

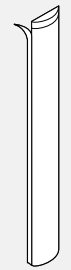

- Finishes the vertical edges of panels and posts (90 and 60 degree).
- In the case of the panel, the trim runs from the top of the panel to the bottom of the raceway, enclosing the horizontal channel openings and the raceway opening.
- In the case of the Over Panel, the trim runs from the top of the Over Panel to the bottom of the Over Panel, enclosing the horizontal channel openings.

PRODUCT CODE	PRICE	TYPE	SIZE/ INCHES			WEIGHT VOL	
			H	W	D	LBS	FT ³
BA3VTR34	37	REGULAR PANEL	34	2.61	0.25	1.1	0.03
BA3VTR42	45		42	2.61	0.25	1.4	0.03
BA3VTR50	54		50	2.61	0.25	1.7	0.04
BA3VTR54	62		54	2.61	0.25	1.9	0.04
BA3VTR58	65		58	2.61	0.25	2.1	0.05
BA3VTR66	73		66	2.61	0.25	2.2	0.05
BA3VTE16	23	OVER PANEL	16	2.61	0.25	0.5	0.03
BA3VTE32	37		32	2.61	0.25	1.1	0.06

BA3VTS • Vertical Aluminum End Trim Standard Step Down



- Finishes the vertical edges of panels and posts (90 and 60 degree).
- Trims run from the top of one panel to the top of lower panel enclosing the horizontal channel opening.

PRODUCT CODE	PRICE	SIZE/ INCHES			WEIGHT VOL	
		H	W	D	LBS	FT ³
BA3VTS04	11	4	2.61	0.25	0.2	0.010
BA3VTS08	13	8	2.61	0.25	0.3	0.015
BA3VTS12	20	12	2.61	0.25	0.4	0.022
BA3VTS16	23	16	2.61	0.25	0.5	0.030
BA3VTS20	28	20	2.61	0.25	0.7	0.039
BA3VTS24	30	24	2.61	0.25	0.9	0.045
BA3VTS32	37	32	2.61	0.25	1.1	0.060

BV3VTR • Vertical PVC End Trim

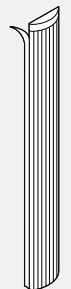

- Finishes the vertical edges of panels and posts (90 and 60 degree).
- In the case of the panel, the trim runs from the top of the panel to the bottom of the raceway, enclosing the horizontal channel openings and the raceway opening.
- In the case of the over panel, the trim runs from the top of the over panel to the bottom of the over panel, enclosing the horizontal channel openings.

PRODUCT CODE	PRICE	TYPE	SIZE/ INCHES			WEIGHT VOL	
			H	W	D	LBS	FT ³
BV3VTR34	28	REGULAR PANEL	34	2.61	0.25	0.6	0.030
BV3VTR42	29		42	2.61	0.25	0.7	0.030
BV3VTR50	34		50	2.61	0.25	0.9	0.040
BV3VTR54	36		54	2.61	0.25	1.0	0.045
BV3VTR58	39		58	2.61	0.25	1.0	0.047
BV3VTR66	42		66	2.61	0.25	1.1	0.050
BV3VTE16	21	OVER PANEL	16	2.61	0.25	0.3	0.030
BV3VTE32	28		32	2.61	0.25	0.6	0.060

BV3VTS • Vertical PVC End Trim Standard Step Down

- Finishes the vertical edges of panels and posts (90 and 60 degree).
- Trims run from the top of one panel to the top of lower panel enclosing the horizontal channel opening.

PRODUCT CODE	PRICE	SIZE/ INCHES			WEIGHT VOL	
		H	W	D	LBS	FT ³
BV3VTS04	11	3.75	2.61	0.25	0.1	0.010
BV3VTS08	13	7.75	2.61	0.25	0.1	0.015
BV3VTS12	20	11.75	2.61	0.25	0.2	0.020
BV3VTS16	22	15.75	2.61	0.25	0.3	0.030
BV3VTS20	29	19.75	2.61	0.25	0.3	0.035
BV3VTS24	24	23.75	2.61	0.25	0.4	0.045
BV3VTS32	28	31.75	2.61	0.25	0.6	0.060

BA3VTRF • Vertical Aluminum Flat End Trim

- Finishes the vertical edges of panels and posts (90 and 60 degree).
- In the case of the panel, the trim runs from the top of the panel to the bottom of the raceway, enclosing the horizontal channel openings and the raceway opening.
- In the case of the over panel, the trim runs from the top of the over panel to the bottom of the over panel, enclosing the horizontal channel openings.
- BABVTRF119 cannot ship via courier and must be combined with other product.

PRODUCT CODE	PRICE	TYPE	SIZE/ INCHES			WEIGHT VOL	
			H	W	D	LBS	FT ³
BA3VTRF34	37	REGULAR PANEL	34	2.61	0.125	1.1	0.03
BA3VTRF42	45		42	2.61	0.125	1.4	0.03
BA3VTRF50	54		50	2.61	0.125	1.7	0.04
BA3VTRF54	62		54	2.61	0.125	1.9	0.04
BA3VTRF58	65		58	2.61	0.125	1.9	0.04
BA3VTRF66	67		66	2.61	0.125	2.2	0.05
BA3VTRF119	130		119	2.61	0.125	3.6	0.08
BA3VTEF8	11	OVER PANEL	8	2.61	0.125	0.2	0.01
BA3VTEF16	23		16	2.61	0.125	0.5	0.03
BA3VTEF32	37		32	2.61	0.125	1.1	0.06

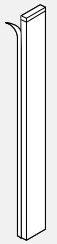
BA3VTSF • Vertical Aluminum Flat End Trim Standard Step Down

- Finishes the vertical edges of panels and posts (90 and 60 degree).
- Trims run from the top of one panel to the top of lower panel enclosing the horizontal channel opening.

PRODUCT CODE	PRICE	SIZE/ INCHES			WEIGHT VOL	
		H	W	D	LBS	FT ³
BA3VTSF04	11	3.75	2.61	0.125	0.1	0.010
BA3VTSF08	13	7.75	2.61	0.125	0.3	0.015
BA3VTSF12	20	11.75	2.61	0.125	0.4	0.020
BA3VTSF16	23	15.75	2.61	0.125	0.5	0.030
BA3VTSF20	28	19.75	2.61	0.125	0.8	0.035
BA3VTSF24	30	23.75	2.61	0.125	0.9	0.045
BA3VTSF32	37	31.75	2.61	0.125	1.1	0.060

B3LEP-NC • End of Run Gallery Panel in a T configuration, No Connectors for Additional Gallery Panels

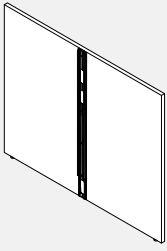

- Provides floor standing support while enclosing the end of a panel run on two sides.
- Attaches to the end of a Boulevard 1 or System 3 Panel with capture strips to form a T configuration.
- Connection is on the interior face center.
- Includes all attachment hardware and glides.
- Total height is inclusive of panel glides extended to their full height.
- 51" wide gallery panel accommodates two 24" deep surfaces while the 63" wide accommodates two 30" deep surfaces and 75" wide two 36" deep surfaces.
- Please specify LP laminate finish and PVC edge finish.
- If a wood grain laminate is chosen, grain direction run horizontally.
- Edged in PVC on three exposed edges and self edged on bottom.

PRODUCT CODE	PRICE LP	SIZE/INCHES			WEIGHT LBS	VOL FT³
		H	W	D		
B3LEP4227NC	404	42	26.5	1	29.49	0.64
B3LEP4251NC	634	42	51	1	55.17	1.24
B3LEP4263NC	710	42	63	1	68.01	1.53
B3LEP4275NC	790	42	75	1	80.86	1.82
B3LEP5027NC	471	50	26.5	1	35.25	0.77
B3LEP5051NC	736	50	51	1	65.92	1.48
B3LEP5063NC	829	50	63	1	81.27	1.82
B3LEP5075NC	936	50	75	1	96.62	2.17
B3LEP5427NC	471	54	26.5	1	38.12	0.83
B3LEP5451NC	758	54	51	1	71.3	1.59
B3LEP5463NC	854	54	63	1	87.9	1.97
B3LEP5475NC	965	54	75	1	104.49	2.34

B3LSEPL-NC • Left End of Run Single Gallery Panel in L Configuration, No Connectors for Additional Gallery Panels



- Provides floor standing support while enclosing the end of a panel run on one side.
- Attaches to the end of a Boulevard 1 or System 3 Panel with capture strips to form an L configuration.
- Connection is on interior face near it's right end.
- Includes all attachment hardware and glides.
- Total height is inclusive of panel glides extended to their full height.
- 27" wide gallery panel accommodates a 24" deep surface while the 33" wide accommodates a 30" deep surface and 39" wide a 36" deep surface.
- Please specify LP laminate finish and PVC edge finish.
- If a wood grain laminate is chosen, grain direction run horizontally.
- Edged in PVC on three exposed edges and self edged on bottom.

PRODUCT CODE	PRICE LP	SIZE/INCHES			WEIGHT LBS	VOL FT³
		H	W	D		
B3LSEPL4215NC	332	42	14.25	1	16.64	0.35
B3LSEPL4227NC	483	42	27	1	29.47	0.66
B3LSEPL4233NC	521	42	33	1	35.89	0.80
B3LSEPL4239NC	548	42	39	1	42.32	0.95
B3LSEPL5015NC	378	50	14.25	1	19.9	0.41
B3LSEPL5027NC	549	50	27	1	35.23	0.78
B3LSEPL5033NC	595	50	33	1	42.9	0.95
B3LSEPL5039NC	637	50	39	1	50.57	1.13
B3LSEPL5415NC	378	54	14.25	1	21.52	0.45
B3LSEPL5427NC	565	54	27	1	38.1	0.84
B3LSEPL5433NC	614	54	33	1	46.4	1.03
B3LSEPL5439NC	657	54	39	1	54.7	1.22

B3LSEPR-NC • Right End of Run Single Gallery Panel in L Configuration, No Connectors for Additional Gallery Panels



- Provides floor standing support while enclosing the end of a panel run on one side.
- Attaches to the end of a Boulevard 1 or System 3 Panel with capture strips to form an L configuration.
- Connection is on interior face near it's right end.
- - Includes all attachment hardware and glides.
- Total height is inclusive of panel glides extended to their full height.
- 27" wide gallery panel accommodates a 24" deep surface while the 33" wide accommodates a 30" deep surface and 39" wide a 36" deep surface.
- Please specify LP laminate finish and PVC edge finish.
- If a wood grain laminate is chosen, grain direction run horizontally.
- Edged in PVC on three exposed edges and self edged on bottom.

PRODUCT CODE	PRICE LP	SIZE/INCHES			WEIGHT LBS	VOL FT³
		H	W	D		
B3LSEPR4215NC	332	42	14.25	1	16.64	0.35
B3LSEPR4227NC	483	42	27	1	29.47	0.66
B3LSEPR4233NC	521	42	33	1	35.89	0.80
B3LSEPR4239NC	548	42	39	1	42.32	0.95
B3LSEPR5015NC	378	50	14.25	1	19.9	0.41
B3LSEPR5027NC	549	50	27	1	35.23	0.78
B3LSEPR5033NC	595	50	33	1	42.9	0.95
B3LSEPR5039NC	637	50	39	1	50.57	1.13
B3LSEPR5415NC	378	54	14.25	1	21.52	0.45
B3LSEPR5427NC	565	54	27	1	38.1	0.84
B3LSEPR5433NC	614	54	33	1	46.4	1.03
B3LSEPR5439NC	657	54	39	1	54.7	1.22

B3LMP-NC • Middle of Run Single Gallery Panel in X Configuration, No Connectors for Additional Gallery Panels

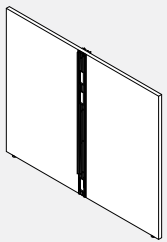

- Provides floor standing support in the middle of a panel run.
- Attaches between panels in a straight Boulevard 1 or System 3 Panel run with capture strips to form an X configuration.
- Connections are at the center of the interior and exterior faces.
- Includes all attachment hardware and glides.
- Total height is inclusive of panel glides extended to their full height.
- 51" wide gallery panel accommodates two 24" deep surfaces while the 63" wide accommodates two 30" deep surfaces and 75" wide two 36" deep surfaces.
- Please specify LP laminate finish and PVC edge finish.
- If a wood grain laminate is chosen, grain direction run horizontally.
- Edged in PVC on three exposed edges and self edged on bottom.

PRODUCT CODE	PRICE LP	SIZE/INCHES			WEIGHT LBS	VOL FT³
		H	W	D		
B3LMP4251NC	840	42	51	1	55.98	1.24
B3LMP4263NC	915	42	63	1	68.83	1.53
B3LMP4275NC	998	42	75	1	81.68	1.85
B3LMP5051NC	952	50	51	1	66.97	1.48
B3LMP5063NC	1046	50	63	1	82.32	1.82
B3LMP5075NC	1153	50	75	1	97.67	2.17
B3LMP5451NC	980	54	51	1	72.46	1.59
B3LMP5463NC	1077	54	63	1	89.06	1.97
B3LMP5475NC	1187	54	75	1	105.66	2.34

B3LSMP-NC • Middle of Run Single Gallery Panel in T Configuration, No Connectors for Additional Gallery Panels

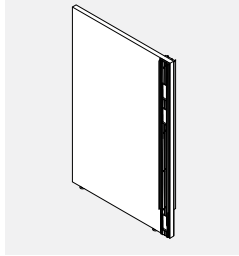

- Provides floor standing support at the middle of a panel run.
- Attaches in the middle of a straight Boulevard 1 or System 3 panel run with capture strips to form a T configuration.
- Connections are on the interior and exterior faces of one end.
- Includes all attachment hardware and glides.
- Total height is inclusive of panel glides extended to their full height.
- 27" wide gallery panel accommodates a 24" deep surface while the 33" wide accommodates a 30" deep surface and 39" wide a 36" deep surface.
- Please specify LP laminate finish and PVC edge finish.
- If a wood grain laminate is chosen, grain direction run horizontally.
- Edged in PVC on three exposed edges and self edged on bottom.

PRODUCT CODE	PRICE LP	SIZE /INCHES			WEIGHT LBS	VOL FT ³
		H	W	D		
B3LSMP4227NC	691	42	27	1	30.28	0.66
B3LSMP4233NC	727	42	33	1	36.71	0.80
B3LSMP4239NC	755	42	39	1	43.13	0.95
B3LSMP5027NC	765	50	27	1	36.28	0.78
B3LSMP5033NC	811	50	33	1	43.95	0.95
B3LSMP5039NC	853	50	39	1	51.63	1.13
B3LSMP5427NC	788	54	27	1	39.26	0.84
B3LSMP5433NC	836	54	33	1	47.56	1.03
B3LSMP5439NC	879	54	39	1	55.86	1.22

B3LEP • End of Run Gallery Panel in a T configuration, with Connectors for Additional Gallery Panels

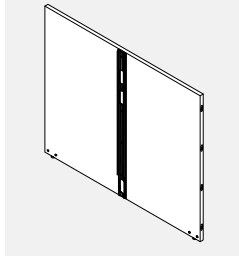

- Provides floor standing support while enclosing the end of a panel run.
- Attaches to the end of a Boulevard 1 or System 3 panel with capture strips to form a T configuration.
- Connections at both ends as well as on the middle of interior face.
- The end connections are to connect other Gallery Panels.
- The side right is compatible with right hand Gallery Panels (B3LX-PRxxxx and B3LXPRxxxxNC, B3L2PRxxxx and B3L3PRxxxx) only.
- The left side is compatible with left hand Gallery Panels (B3LX-PLxxxx and B3LXPLxxxxNC, B3L2PLxxxx and B3L3PLxxxx) only.
- The middle interior face connections are for Boulevard panels.
- Includes all attachment hardware and glides.
- Total height is inclusive of panel glides extended to their full height.
- 51" wide gallery panel accomodates two 24" deep surface while the 63" wide accomodates two 30" deep surfaces and 75" wide two 36" deep surfaces.
- Please specify LP laminate finish and PVC edge finish.
- If a wood grain laminate is chosen, grain direction run horizontally.
- Gallery panel is edged in PVC on exposed top edge only and self edged on the three other edges.

PRODUCT CODE	PRICE LP	SIZE /INCHES			WEIGHT LBS	VOL FT ³
		H	W	D		
B3LEP4251	648	42	51	1	55.25	1.24
B3LEP4263	723	42	63	1	68.1	1.53
B3LEP4275	804	42	75	1	80.95	1.82
B3LEP5051	750	50	51	1	66.01	1.48
B3LEP5063	843	50	63	1	81.36	1.82
B3LEP5075	950	50	75	1	96.71	2.17
B3LEP5451	772	54	51	1	71.38	1.59
B3LEP5463	868	54	63	1	87.98	1.97
B3LEP5475	979	54	75	1	104.58	2.34

B3LSEPL • Left End of Run Single Gallery Panel in L Configuration, with Connectors for Additional Gallery Panels

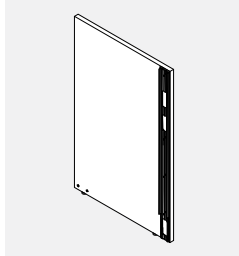

- Provides floor standing support while enclosing the end of a panel run.
- Attaches at the end of a Boulevard 1 or System 3 panel with capture strips to form an L configuration.
- Connection to the Boulevard panel is on interior face near it's right end.
- Connections for a Gallery Panel are on the left edge.
- Compatible with left hand Gallery Panels (B3LXPLxxxx and B3LXPLxxxxNC, B3L2PLxxxx and B3L3PLxxxx) only.
- Includes all attachment hardware and glides.
- Total height is inclusive of panel glides extended to their full height.
- 27" wide gallery panel accomodates a 24" deep surface while the 33" wide accomodates a 30" deep surface and 39" wide a 36" deep surface.
- Please specify LP laminate finish and PVC edge finish.
- If a wood grain laminate is chosen, grain direction run horizontally.
- Edged in PVC on two exposed edges, self edged on connecting to gallery panel edge and the bottom.

PRODUCT CODE	PRICE LP	SIZE /INCHES			WEIGHT LBS	VOL FT ³
		H	W	D		
B3LSEPL4227	490	42	27	1	29.51	0.66
B3LSEPL4233	528	42	33	1	35.94	0.80
B3LSEPL4239	554	42	39	1	42.36	0.95
B3LSEPL5027	556	50	27	1	35.27	0.78
B3LSEPL5033	603	50	33	1	42.94	0.95
B3LSEPL5039	645	50	39	1	50.62	1.13
B3LSEPL5427	572	54	27	1	38.14	0.84
B3LSEPL5433	620	54	33	1	46.44	1.03
B3LSEPL5439	663	54	39	1	54.74	1.22

B3LSEPR • Right End of Run Single Gallery Panel in L Configuration, with Connectors for additional Gallery Panels

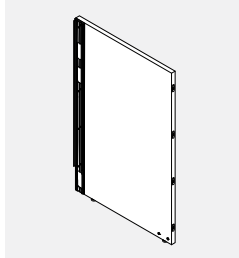

- Provides floor standing support while enclosing the end of a panel run.
- Attaches at the end of a Boulevard 1 or System 3 panel with capture strips to form an L configuration.
- Connection to the Boulevard panel is on interior face near it's left end.
- Connections for a Gallery Panel are on the right edge.
- Compatible with right hand Gallery Panels (B3LXPRxxxx and B3LXPRxxxxNC, B3L2PRxxxx and B3L3PRxxxx) only.
- Includes all attachment hardware and glides.
- Total height is inclusive of panel glides extended to their full height.
- 27" wide gallery panel accomodates a 24" deep surface while the 33" wide accomodates a 30" deep surface and 39" wide a 36" deep surface.
- Please specify LP laminate finish and PVC edge finish.
- If a wood grain laminate is chosen, grain direction run horizontally.
- Edged in PVC on two exposed edges, self edged on connecting to gallery panel edge and the bottom.

PRODUCT CODE	PRICE LP	SIZE /INCHES			WEIGHT LBS	VOL FT ³
		H	W	D		
B3LSEPR4227	490	42	27	1	29.51	0.66
B3LSEPR4233	528	42	33	1	35.94	0.80
B3LSEPR4239	554	42	39	1	42.36	0.95
B3LSEPR5027	556	50	27	1	35.27	0.78
B3LSEPR5033	603	50	33	1	42.94	0.95
B3LSEPR5039	645	50	39	1	50.62	1.13
B3LSEPR5427	572	54	27	1	38.14	0.84
B3LSEPR5433	620	54	33	1	46.44	1.03
B3LSEPR5439	663	54	39	1	54.74	1.22

B3LMP • Middle of Run Single Gallery Panel in X Configuration, with Connectors for Additional Gallery Panels

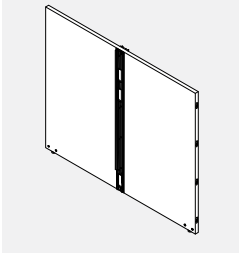

- Provides floor standing support in the middle of a panel run.
- Attached in the middle of a straight Boulevard 1 or System 3 panel run with capture strips to form an X configuration.
- Connections at both ends (for Gallery Panels) as well as on the middle of the interior and exterior faces (for Boulevard Panels).
- The right side is compatible with right hand Gallery Panels (B3LX-PRxxxx and B3LXPRxxxxNC, B3L2PRxxxx and B3L3PRxxxx) only.
- The left side is compatible with left hand Gallery Panels (B3LX-PLxxxx and B3LXPLxxxxNC, B3L2PLxxxx and B3L3PLxxxx) only.
- Includes all attachment hardware and glides.
- Total height is inclusive of panel glides extended to their full height.
- 51" wide gallery panel accommodates two 24" deep surface while the 63" wide accommodates two 30" deep surfaces and 75" wide two 36" deep surfaces.
- Please specify LP laminate finish and PVC edge finish.
- If a wood grain laminate is chosen, grain direction run horizontally.
- Edged in PVC on exposed top edge only and self edged on the three other.

PRODUCT CODE	PRICE LP	SIZE / INCHES			WEIGHT LBS	VOL FT ³
		H	W	D		
B3LMP4251	854	42	51	1	56.07	1.24
B3LMP4263	930	42	63	1	68.91	1.53
B3LMP4275	1011	42	75	1	81.76	1.82
B3LMP5051	966	50	51	1	67.06	1.48
B3LMP5063	1058	50	63	1	82.41	1.82
B3LMP5075	1166	50	75	1	97.76	2.17
B3LMP5451	994	54	51	1	72.55	1.59
B3LMP5463	1090	54	63	1	89.15	1.97
B3LMP5475	1201	54	75	1	105.74	2.34

B3LSMP - Middle of Run Single Gallery Panel in T Configuration, with Connectors for Additional Gallery Panels

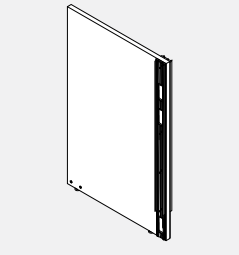

- Provides floor standing support at the middle of a panel run.
- Attached in the middle of a straight Boulevard 1 or System 3 panel run with capture strips to form a T configuration.
- Connections are on the exposed edge (for Gallery Panel) and near the opposite end on both interior and exterior faces (for Boulevard Panels).
- Compatible with left hand gallery panels (B3LXPLxxxx and B3LXPLxxxxNC, B3L2PLxxxx and B3L3PLxxxx) only.
- Includes all attachment hardware and glides.
- Total height is inclusive of panel glides extended to their full height.
- 27" wide gallery panel accommodates a 24" deep surface while the 33" wide accommodates a 30" deep surface and 39" wide a 36" deep surface.
- Please specify LP laminate finish and PVC edge finish.
- If a wood grain laminate is chosen, grain direction run horizontally.
- Edged in PVC on two exposed edges, self edged on connecting to gallery panel edge and the bottom.

PRODUCT CODE	PRICE LP	SIZE / INCHES			WEIGHT LBS	VOL FT ³
		H	W	D		
B3LSMP4227	696	42	27	1	30.33	0.66
B3LSMP4233	735	42	33	1	36.75	0.80
B3LSMP4239	761	42	39	1	43.17	0.95
B3LSMP5027	772	50	27	1	36.32	0.78
B3LSMP5033	818	50	33	1	43.99	0.95
B3LSMP5039	860	50	39	1	51.67	1.13
B3LSMP5427	795	54	27	1	39.31	0.84
B3LSMP5433	843	54	33	1	47.61	1.03
B3LSMP5439	886	54	39	1	55.91	1.22

B3LXPL • Left Gallery Panel Extension, with Connectors for Additional Gallery Panels

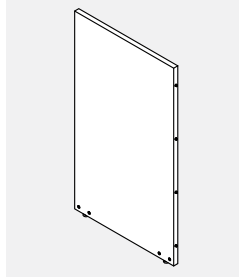

- Provides floor standing support while extending the Gallery Panels run.
- Attaches to the left edge of a Gallery Panel by the pin connectors to allow for additional Gallery Panels to be added on the left side.
- Pin connectors on the right edge and modular connectors on the left edge of the interior face.
- The right side is compatible with Gallery Panels (B3LEPxxx, B3LSEPL, B3LMPxxx, B3LSMP and B3LXPLxxx) only.
- The left side is compatible with left hand Gallery Panels (B3LX-PLxxxx and B3LXPLxxxxNC, B3L2PLxxxx and B3L3PLxxxx) only.
- Includes all attachment hardware and glides.
- Total height is inclusive of panel glides extended to their full height.
- Please specify LP laminate finish and PVC edge finish.
- If a wood grain laminate is chosen, grain direction run horizontally.
- Edged in PVC on exposed top edge only and self edges on the three other.
- Edged in PVC on two exposed edges, self edged on connecting to gallery panel edge and the bottom.

PRODUCT CODE	PRICE LP	SIZE / INCHES			WEIGHT LBS	VOL FT ³
		H	W	D		
B3LXPL4224	252	42	24	1	25.83	0.58
B3LXPL4230	290	42	30	1	32.26	0.73
B3LXPL4236	328	42	36	1	38.68	0.88
B3LXPL4242	365	42	42	1	45.11	1.02
B3LXPL4248	403	42	48	1	51.53	1.17
B3LXPL5024	300	50	24	1	30.83	0.69
B3LXPL5030	347	50	30	1	38.51	0.87
B3LXPL5036	394	50	36	1	46.18	1.04
B3LXPL5042	440	50	42	1	53.86	1.22
B3LXPL5048	487	50	48	1	61.53	1.39
B3LXPL5424	310	54	24	1	33.34	0.75
B3LXPL5430	358	54	30	1	41.64	0.94
B3LXPL5436	405	54	36	1	49.94	1.13
B3LXPL5442	452	54	42	1	58.24	1.31
B3LXPL5448	503	54	48	1	66.54	1.50

B3LXPR • Right Gallery Panel Extension, with Connectors for Additional Gallery Panels

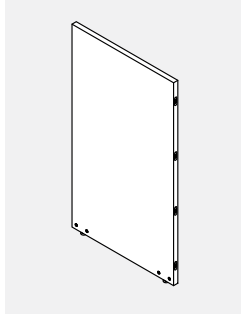

- Provides floor standing support while extending the Gallery Panels run.
- Attaches to the right edge of a Gallery Panel by the pin connectors to allow for additional Gallery Panels to be added on the right side.
- Pin connectors on the right edge and modular connectors on the left edge of the interior face.
- The right side is compatible with right hand Gallery Panels (B3LX-PRxxxx and B3LXPRxxxxNC, B3L2PRxxxx and B3L3PRxxxx) only.
- The left side is compatible with Gallery Panels (B3LEPxxx, B3LSEPRxxx, B3LMPxxx and B3LXPRxxx) only.
- Includes all attachment hardware and glides.
- Total height is inclusive of panel glides extended to their full height.
- Please specify LP laminate finish and PVC edge finish.
- If a wood grain laminate is chosen, grain direction run horizontally.
- Edged in PVC on exposed top edge only and self edges on the three other.

PRODUCT CODE	PRICE LP	SIZE /INCHES			WEIGHT LBS	VOL FT ³
		H	W	D		
B3LXPR4224	252	42	24	1	25.83	0.58
B3LXPR4230	290	42	30	1	32.26	0.73
B3LXPR4236	328	42	36	1	38.68	0.88
B3LXPR4242	365	42	42	1	45.11	1.02
B3LXPR4248	403	42	48	1	51.53	1.17
B3LXPR5024	300	50	24	1	30.83	0.69
B3LXPR5030	347	50	30	1	38.51	0.87
B3LXPR5036	394	50	36	1	46.18	1.04
B3LXPR5042	440	50	42	1	53.86	1.22
B3LXPR5048	487	50	48	1	61.53	1.39
B3LXPR5424	310	54	24	1	33.34	0.75
B3LXPR5430	358	54	30	1	41.64	0.94
B3LXPR5436	405	54	36	1	49.94	1.13
B3LXPR5442	452	54	42	1	58.24	1.31
B3LXPR5448	503	54	48	1	66.54	1.50

B3LXPL-NC • Left Gallery Panel Extension, No Connectors for Additional Gallery Panels

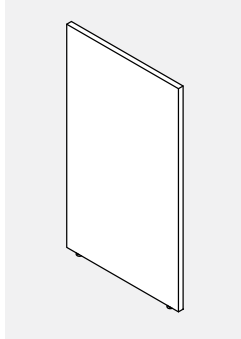

- Provides floor standing support while enclosing the end of a Gallery Panel left run.
- Attached to the left edge of a Gallery Panel by the pin connectors to finish the run.
- Pin connectors are on the right edge of the interior face.
- Compatible with gallery panels (B3LEPxxxx, B3LSEPLxxxx, B3LMPxxxx, B3LSMPxxxx and B3LXPLxxxx) only.
- Includes all attachment hardware and glides.
- Total height is inclusive of panel glides extended to their full height.
- Please specify LP laminate finish and PVC edge finish.
- If a wood grain laminate is chosen, grain direction run horizontally.
- Edged in PVC on two exposed edges, self edged on connecting to gallery panel edge and the bottom.

PRODUCT CODE	PRICE LP	SIZE /INCHES			WEIGHT LBS	VOL FT ³
		H	W	D		
B3LXPL4212NC	138	42	12	1	12.95	0.29
B3LXPL4224NC	245	42	24	1	25.8	0.58
B3LXPL4230NC	283	42	30	1	32.22	0.73
B3LXPL4236NC	320	42	36	1	38.65	0.88
B3LXPL4242NC	359	42	42	1	45.07	1.02
B3LXPL4248NC	396	42	48	1	51.5	1.17
B3LXPL5012NC	172	50	12	1	15.45	0.35
B3LXPL5024NC	294	50	24	1	30.8	0.69
B3LXPL5030NC	340	50	30	1	38.47	0.87
B3LXPL5036NC	386	50	36	1	46.15	1.04
B3LXPL5042NC	435	50	42	1	53.82	1.22
B3LXPL5048NC	481	50	48	1	61.5	1.39
B3LXPL5412NC	172	54	12	1	16.7	0.38
B3LXPL5424NC	303	54	24	1	33.3	0.75
B3LXPL5430NC	351	54	30	1	41.6	0.94
B3LXPL5436NC	398	54	36	1	49.9	1.13
B3LXPL5442NC	447	54	42	1	58.2	1.31
B3LXPL5448NC	494	54	48	1	66.5	1.50

B3LXPR-NC • Right Gallery Panel Extension, No Connectors for Additional Gallery Panels

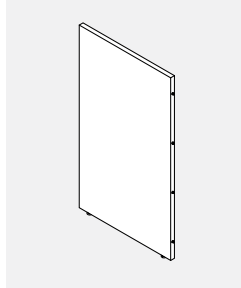

- Provides floor standing support while enclosing the end of a Gallery Panel right run.
- Attached to the right edge of a Gallery Panel by the pin connectors to finish the run.
- Pin connectors are on the left edge of the interior face.
- Compatible with gallery panels (B3LEPxxxx, B3LSEPRxxxx, B3LMPxxxx and B3LXPRxxxx) only.
- Includes all attachment hardware and glides.
- Total height is inclusive of panel glides extended to their full height.
- Please specify LP laminate finish and PVC edge finish.
- If a wood grain laminate is chosen, grain direction run horizontally.
- Edged in PVC on two exposed edges, self edged on connecting to gallery panel edge and the bottom.

PRODUCT CODE	PRICE LP	SIZE /INCHES			WEIGHT LBS	VOL FT ³
		H	W	D		
B3LXPR4212NC	138	42	12	1	12.95	0.29
B3LXPR4224NC	245	42	24	1	25.8	0.58
B3LXPR4230NC	283	42	30	1	32.22	0.73
B3LXPR4236NC	320	42	36	1	38.65	0.88
B3LXPR4242NC	359	42	42	1	45.07	1.02
B3LXPR4248NC	396	42	48	1	51.5	1.17
B3LXPR5012NC	172	50	12	1	15.45	0.35
B3LXPR5024NC	294	50	24	1	30.8	0.69
B3LXPR5030NC	340	50	30	1	38.47	0.87
B3LXPR5036NC	386	50	36	1	46.15	1.04
B3LXPR5042NC	435	50	42	1	53.82	1.22
B3LXPR5048NC	481	50	48	1	61.5	1.39
B3LXPR5412NC	172	54	12	1	16.7	0.38
B3LXPR5424NC	303	54	24	1	33.3	0.75
B3LXPR5430NC	351	54	30	1	41.6	0.94
B3LXPR5436NC	398	54	36	1	49.9	1.13
B3LXPR5442NC	447	54	42	1	58.2	1.31
B3LXPR5448NC	494	54	48	1	66.5	1.50

B3L2PR • Right Gallery Panel End of Run Return

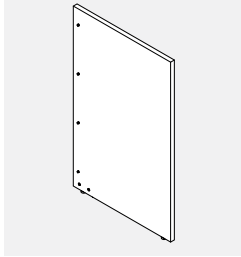

- Provides floor standing support while enclosing the end of a Gallery Panel run.
- Attaches at the Gallery Panel right edge with connectors to form an L configuration.
- Connections to Gallery Panel are on the interior face near it's left end.
- Compatible with Gallery Panels (B3LEPxxxx, B3LSEPRxxxx, B3LMPxxxx and B3LXPRxxxx) only.
- Includes all attachment hardware and glides.
- Total height is inclusive of panel glides extended to their full height.
- 25" wide gallery panel accomodates a 24" deep surface while the 31" wide accomodates a 30" deep surface and 37" wide a 36" deep surface.
- Please specify LP laminate finish and PVC edge finish.
- If a wood grain laminate is chosen, grain direction run horizontally.
- Edged in PVC on three exposed edges and self edged on the bottom edge.

PRODUCT CODE	PRICE LP	SIZE /INCHES			WEIGHT LBS	VOL FT³
		H	W	D		
B3L2PR4213	149	42	13	1	14.02	0.32
B3L2PR4225	283	42	25	1	26.87	0.61
B3L2PR4231	320	42	31	1	33.29	0.75
B3L2PR4237	347	42	37	1	39.72	0.90
B3L2PR5013	186	50	13	1	16.73	0.38
B3L2PR5025	340	50	25	1	32.08	0.72
B3L2PR5031	386	50	31	1	39.75	0.90
B3L2PR5037	428	50	37	1	47.43	1.07
B3L2PR5413	186	54	13	1	18.08	0.41
B3L2PR5425	351	54	25	1	34.68	0.78
B3L2PR5431	398	54	31	1	42.98	0.97
B3L2PR5437	441	54	37	1	51.28	1.16

B3L2PL • Left Gallery Panel End of Run Return

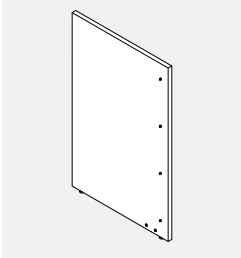

- Provides floor standing support while enclosing the end of a gallery panel run.
- Attaches at the Gallery Panel left edge with connectors to form an L configuration.
- Connections to Gallery Panel are on the interior face near it's right end.
- Compatible with Gallery Panels (B3LEPxxxx, B3LSEPLxxxx, B3LMPxxxx, B3LSMPxxxx and B3LXPLxxxx) only.
- Includes all attachment hardware and glides.
- Total height is inclusive of panel glides extended to their full height.
- 25" wide gallery panel accomodates a 24" deep surface while the 31" wide accomodates a 30" deep surface and 37" wide a 36" deep surface.
- Please specify LP laminate finish and PVC edge finish.
- If a wood grain laminate is chosen, grain direction run horizontally.
- Edged in PVC on three exposed edges and self edged on the bottom edge.

PRODUCT CODE	PRICE LP	SIZE /INCHES			WEIGHT LBS	VOL FT³
		H	W	D		
B3L2PL4213	149	42	13	1	14.02	0.32
B3L2PL4225	283	42	25	1	26.87	0.61
B3L2PL4231	320	42	31	1	33.29	0.75
B3L2PL4237	347	42	37	1	39.72	0.90
B3L2PL5013	186	50	13	1	16.73	0.38
B3L2PL5025	340	50	25	1	32.08	0.72
B3L2PL5031	386	50	31	1	39.75	0.90
B3L2PL5037	428	50	37	1	47.43	1.07
B3L2PL5413	186	54	13	1	18.08	0.41
B3L2PL5425	351	54	25	1	34.68	0.78
B3L2PL5431	398	54	31	1	42.98	0.97
B3L2PL5437	441	54	37	1	51.28	1.16

B3L3PL • Left Gallery Panel End of Run 3-Way Return

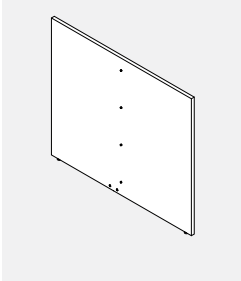

- Provides floor standing support while enclosing the end of a Gallery Panel run.
- Attaches to the Gallery Panel left edge with connectors to form an T configuration.
- Connections to Gallery Panel are on the interior face in the middle.
- Compatible with Gallery Panels (B3LEPxxxx, B3LSEPLxxxx, B3LMPxxxx, B3LSMPxxxx and B3LXPLxxxx) only.
- Includes all attachment hardware and glides.
- Total height is inclusive of panel glides extended to their full height.
- 49" wide gallery panel accomodates two 24" deep surfaces while the 61" wide accomodates two 30" deep surface and 73" wide two 36" deep surface.
- Please specify LP laminate finish and PVC edge finish.
- If a wood grain laminate is chosen, grain direction run horizontally.
- Edged in PVC on three exposed edges and self edged on the bottom edge.

PRODUCT CODE	PRICE LP	SIZE /INCHES			WEIGHT LBS	VOL FT³
		H	W	D		
B3L3PL4225	222	42	25	1	26.87	0.61
B3L3PL4249	384	42	49	1	52.57	1.19
B3L3PL4261	509	42	61	1	65.41	1.48
B3L3PL4273	591	42	73	1	78.26	1.77
B3L3PL5025	278	50	25	1	32.08	0.72
B3L3PL5049	527	50	49	1	62.77	1.42
B3L3PL5061	620	50	61	1	78.12	1.77
B3L3PL5073	727	50	73	1	93.47	2.11
B3L3PL5425	278	54	25	1	34.68	0.78
B3L3PL5449	543	54	49	1	67.88	1.53
B3L3PL5461	639	54	61	1	84.48	1.91
B3L3PL5473	750	54	73	1	101.08	2.28

B3L3PR • Right Gallery Panel End of Run 3-Way Return

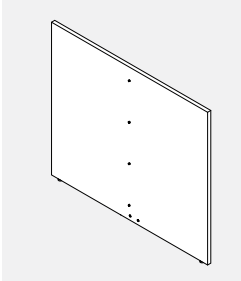

- Provides floor standing support while enclosing the end of a Gallery Panel run.
- Attaches to the Gallery Panel right edge with connectors to form an T configuration.
- Connections to Gallery Panel are on the interior face in the middle.
- Compatible with gallery panels (B3LEPxxxx, B3LSEPRxxxx, B3LMPxxxx and B3LXPRxxxx) only.
- Includes all attachment hardware and glides.
- Total height is inclusive of panel glides extended to their full height.
- 49" wide gallery panel accomodates two 24" deep surfaces while the 61" wide accomodates two 30" deep surface and 73" wide two 36" deep surface.
- Please specify LP laminate finish and PVC edge finish.
- If a wood grain laminate is chosen, grain direction run horizontally.
- Edged in PVC on three exposed edges and self edged on the bottom edge.

PRODUCT CODE	PRICE LP	SIZE /INCHES			WEIGHT LBS	VOL FT³
		H	W	D		
B3L3PR4225	222	42	25	1	26.87	0.61
B3L3PR4249	384	42	49	1	52.57	1.19
B3L3PR4261	509	42	61	1	65.41	1.48
B3L3PR4273	591	42	73	1	78.26	1.77
B3L3PR5025	278	50	25	1	32.08	0.72
B3L3PR5049	527	50	49	1	62.77	1.42
B3L3PR5061	620	50	61	1	78.12	1.77
B3L3PR5073	727	50	73	1	93.47	2.11
B3L3PR5425	278	54	25	1	34.68	0.78
B3L3PR5449	543	54	49	1	67.88	1.53
B3L3PR5461	639	54	61	1	84.48	1.91
B3L3PR5473	750	54	73	1	101.08	2.28

B3HLPBB01 • Gallery Panel Bottom Inline Bracket

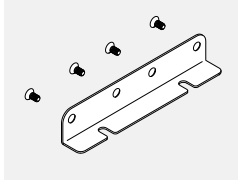

- Gallery Panel Bottom Inline Bracket connects two Gallery Panels at the bottom with screws.
- Available in standard paint colors.

PRODUCT CODE	PRICE	SIZE / INCHES			WEIGHT LBS	VOL FT ³
		H	W	D		
B3HLPBB01	34	7	1.5	8	1	0.5

B3HLPCB01 • Gallery Panel Corner Bracket

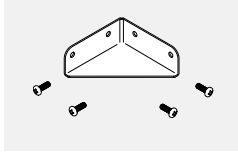

- Gallery Panel Corner Bottom bracket connects two Gallery Panels at 90 degrees.
- Available in standard paint colors.

PRODUCT CODE	PRICE	SIZE / INCHES			WEIGHT LBS	VOL FT ³
		H	W	D		
B3HLPCB01	33	7	1.5	4	4	0.5

B3PMP-GI-W • Privacy Glass for 1" Laminate Panels

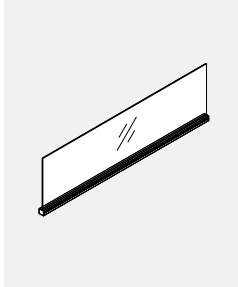

- Privacy glass integrated with aluminum top trim.
- Attaches on top of gallery panels to add privacy or divide space.
- Includes aluminum trim with channel, end caps and glass tile.
- Top rail may also be used to hang accessories.
- Glass and attachment hardware ship separately.
- Please specify standard paint finish for the channel.
- Standard in clear (CLR) or frosted (FRST).

PRODUCT CODE	PRICE	CLR	FRST	SIZE / INCHES			WEIGHT LBS	VOL FT ³
				H	W	D		
B3PMP24GI8W	195		244	8	24	1	4.84	0.11
B3PMP30GI8W	213		268	8	30	1	6.06	0.14
B3PMP36GI8W	228		283	8	36	1	7.28	0.17
B3PMP42GI8W	244		304	8	42	1	8.5	0.19
B3PMP48GI8W	254		317	8	48	1	9.72	0.22
B3PMP24GI16W	195		244	16	24	1	8.92	0.22
B3PMP30GI16W	213		268	16	30	1	11.17	0.28
B3PMP36GI16W	228		283	16	36	1	13.43	0.33
B3PMP42GI16W	244		304	16	42	1	15.68	0.39
B3PMP48GI16W	254		317	16	48	1	17.92	0.44

B3PFD-W • Felt divider for 1" Laminate Panels

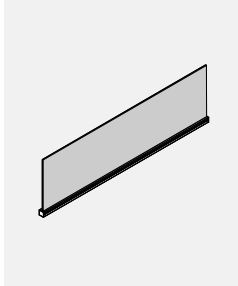

- Privacy felt integrated with aluminum top trim.
- Attaches on top of gallery panels to add privacy or divide space.
- Includes aluminum trim with channel, end caps and felt tile.
- Top rail may also be used to hang accessories.
- Felt and attachment hardware ship separately.
- Please specify standard paint finish for the channel.
- Please specify standard felt finish.

PRODUCT CODE	PRICE	SIZE / INCHES			WEIGHT LBS	VOL FT ³
		H	W	D		
B3PFD0824W	70	8	24	1	1.32	0.11
B3PFD0830W	85	8	30	1	1.65	0.14
B3PFD0836W	99	8	36	1	1.99	0.17
B3PFD0842W	111	8	42	1	2.32	0.19
B3PFD0848W	165	8	48	1	2.65	0.22
B3PFD0854W	178	8	54	1	2.98	0.25
B3PFD0860W	193	8	60	1	3.32	0.28
B3PFD0866W	204	8	66	1	3.65	0.31
B3PFD0872W	231	8	72	1	3.98	0.33
B3PFD1624W	81	16	24	1	1.83	0.22
B3PFD1630W	95	16	30	1	2.3	0.28
B3PFD1636W	113	16	36	1	2.76	0.33
B3PFD1642W	126	16	42	1	3.22	0.39
B3PFD1648W	187	16	48	1	3.68	0.44
B3PFD1654W	204	16	54	1	4.14	0.50
B3PFD1660W	219	16	60	1	4.61	0.56
B3PFD1666W	231	16	66	1	5.07	0.61
B3PFD1672W	263	16	72	1	5.53	0.67

Electrical

Affordability and widespread availability of wireless networking is gradually diminishing the need for extensive cable capacity housing. However, as our desk top equipment still requires electricity, providing access to power from within a work station is an integral part of any work place design.

The Global Contract family of power components has been assembled to address a variety of common requirements as well as to satisfy specific customer needs and budgets.

Global Contract can now offer the option of 3 duplex per panel, please contact your Customer Service Representative.

Direct Access:

When office equipment plugs directly into a wall or raised floor power source, cable troughs, as well the Boulevard panel internal cavity serve the purpose of organizing cables.

Extensions:

Keeping minimal installation costs in mind, the next natural step is the employment of fused and surge protected power bars, worksurface-clamped receptacles or floor standing power towers.

Four circuit power systems:

In the absence of a raised floor, or when office equipment is to be installed further away from wall outlets, the Boulevard panel or Bridges unit the building power supply - office equipment gap by distributing power at either floor or desk height level, or both.

While Boulevard panels are capable of surrounding a given work station with power and data outlets at multiple levels, it is important to remember that the most economical way of providing four-circuit power distribution is if the harness, junction box and receptacle system remained within the central spine structure. The cost savings here come from a number and lengths of individual connecting power harnesses.

Should there be a need to branch power from Boulevard or central spine onto adjacent, perpendicular work surfaces, the employment of fused and surge protected power bars will assist in keeping the cost under control.

However, the very same, 4-circuit system is capable of delivering a considerable amount of power as there can be up to six, 8 wire-4 circuit systems accommodated within System3 pass-thru panel. For instance: three systems at the floor level and two systems at the desk height.

Various ceiling or floor level power entry feeds are available. See the following pages for individual component description and technical specifications.

Technical Information

Wire Schematic

4-2-2 Wiring Schematic
8-Wire Shared Neutral
"3+1" -3 Utility circuits, 1 dedicated circuit.

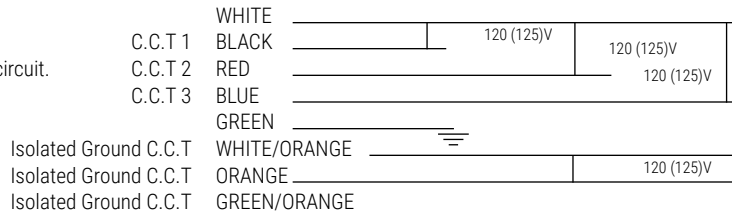

8 Wires

4 Lines (12 ga.)
2 Neutrals (10 ga.)
2 Grounds (12 ga.)

4 Circuits

3 Utility Circuits
1 Dedicated Circuits

Receptacles

Duplex – Up to 6 duplex receptacles per circuit (Up to 48 infeed)

Specifications

System rated for connection to a grounded 120/240 V, single phase*, 20A, 60Hz or 120/208 V, 3 phase, 20A, 60Hz branch circuit for U.S. and 15A if product is marked with a C-UL Mark. Outlets rated 15A max.

* When connected to Single Phase. Only Circuit 1,3 & A are available.

UL Recognised CSA Certified

Warning: It is recommended that installation of the electrical harness be made under the supervision of a licensed electrician in accordance with applicable codes and regulations.

Special Note: Always determine that harness is electrically connected to only one power supply.

STEP-BY-STEP SPECIFICATION - 8 WIRE ELECTRICAL FOR BOULEVARD 1 AND RACEWAY PANELS

STEP 1: Determine the location of the source power entry entering the panel through a post.

a) From the floor:

- i) Choose from a selection of single or double Base Feeds (BE81BF721, BE81BF722, BE81BF1441, BE81BF1442) to bring the power from the floor to the raceway channel.
- ii) Select a post adjacent to the panel (or panels if using a Double Base Feed) to which the end of the Base Feed will be attached. This panel requires a Power Distribution Housing and must be located next to the post through which the Base Feed is entering.

Note: If it is not practical to have a Power Distribution Housing in a panel adjacent to the selected Base Feed Post, use a BE8CPxxHJ Housing-to-Jumper Pass-Thru Cable to transition through the adjacent non-powered panel(s) that are between the Base Feed Post and the first powered panel. The length of the cable will equal the combined width of the non-powered panel(s).

b) From the Ceiling:

- i) Choose from a selection of single or double Ceiling Feeds (BE81CF1201, BE81CF120-2, BE81CF1441, BE81CF1442) to bring the power from the ceiling to the raceway.
- ii) Select a post adjacent to the panel (or panels if using a Double Ceiling Feed) to which the Ceiling Feed will be attached. This panel requires a Power Distribution Housing and must be located next to the post through which the Ceiling Feed is entering.

STEP 2: Determine which panels are to be powered.

- a) Use a BE81D Concealed Desk Height Power Distribution Housing or a BE8U2D Face Mount Desk Height Power Distribution Housing that corresponds with the width of each panel selected to be powered.

Note: Specify Face Mount Raceway Covers for panels that contain BE8U2D Face Mount Desk Height Power Distribution Housings.

STEP 3: Connect power to the panels.

- a) Use a BE8JC16 Jumper between two adjacent powered panels.
- b) Use a BE8JC20 Jumper between two powered panels separated by a post.
- c) **Use a BE8JM19 Shielded Mesh Jumper between two powered panels separated by a post.**
- d) Use a BE8CPxxHJ Housing-to-Jumper Pass-Thru Cable to electrically connect a BE8JM19 Shielded Mesh Jumper and a powered panel when the two are separated by one or more non-powered panels in a straight line application only.
 - i) The length of the BE8CPxxHJ Housing-to-Jumper Pass-Thru Cable will equal the combined width of the non-powered panel(s).
- e) Use a BE8CPxxHH Housing-to-Housing Pass-Thru Cable to electrically connect two powered panel separated by one or more non-powered panels in a straight line application only.
 - i) The length of the Pass-Thru Cable corresponds with the width(s) of the non-powered panels that separate two powered panels plus 16" (the termination blocks of the Power Distribution Housing are 8" in from the edge of the powered panel), plus 4" for each post.
- f) Connect two jumpers or cables together by using the I-Connector BE8C11. This functions as a female-female adapter and it allows the male ends of jumpers and pass-thru cables to connect together.

STEP 4: Designate which circuit each duplex is to tap into.

- a) Each powered panel has four (4) potential locations for duplex receptacles - 2 per side. (Exception: 24" wide panel has only two (2) potential locations - 1 per side, 18" wide panel has no locations for receptacles).
- b) At each location there is a choice of four (4) circuit options. Select the circuit option for each location.

Circuit Selections : Circuits 1, 2, and 3 are utility circuits, all sharing a ground and a neutral. Circuit A is a dedicated circuit with its own ground and neutral.

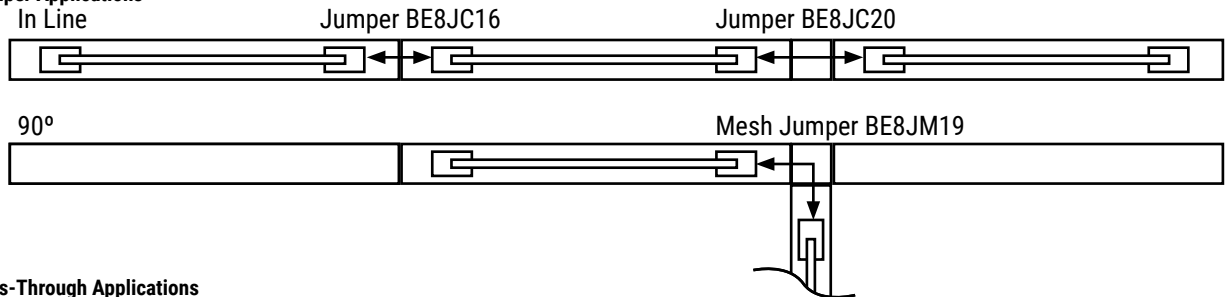
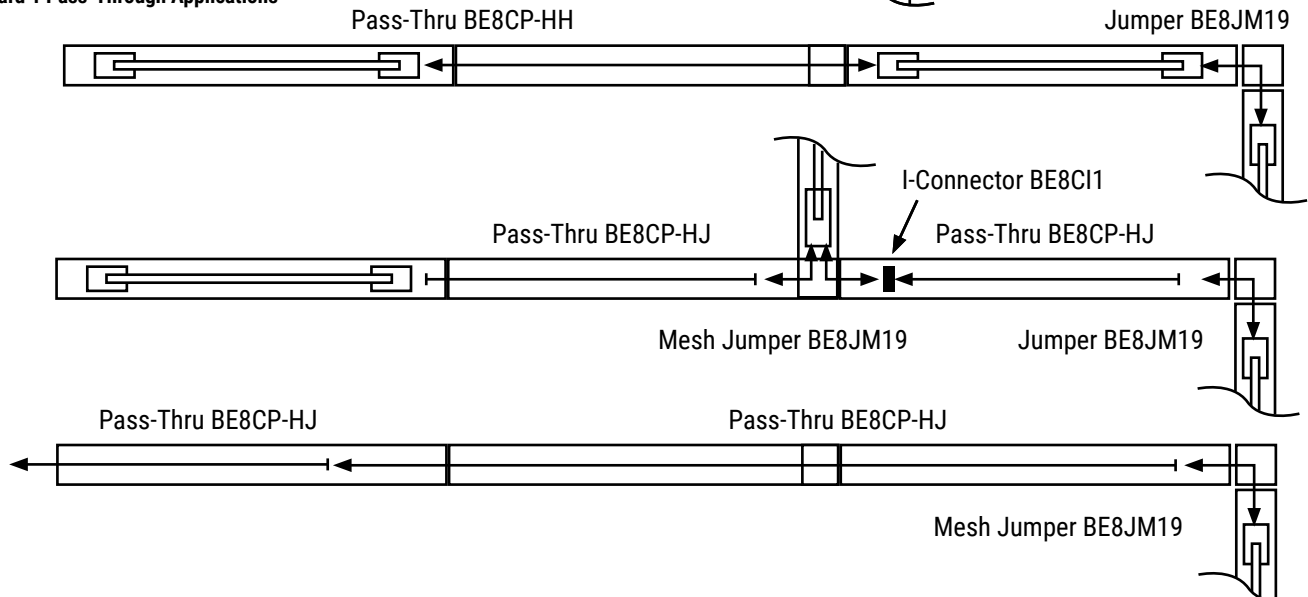
SPECIFICATION APPLICATIONS**Boulevard 1 Jumper Applications****Boulevard 1 Pass-Through Applications**

STEP-BY-STEP SPECIFICATION - 8 WIRE ELECTRICAL FOR BOULEVARD SYSTEM 3 BASE RACEWAY

STEP 1: Determine the location of the source power entry entering the panel.

- a. At the base of a panel:
 - i. Use a BE8BFxx Base Feed.
 - ii. Select the panel to which the Base Feed will be attached. This panel requires a BE83D Power Distribution Housing.
 - iii. Select the side of the panel and the receptacle outlet to which the Base Feed is to be attached.
- b. From the ceiling:
 - i. Use a BE8CFxx-1 or -2 (single or double).
 - ii. Select the post through which to feed the Ceiling Feed.
 - iii. One panel adjacent to the selected post requires a BE83D Power Distribution Housing. Attach the Ceiling Feed to the nearest end of the Power Distribution Housing.

Note: If it is not practical to have a Power Distribution Housing in a panel adjacent to the selected Ceiling Feed Post, use a BE8CPxxHJ Housing-to-Jumper Pass-Thru Cable to transition through the adjacent non-powered panel(s) that are between the Ceiling Feed Post and the first powered panel. The length of the cable will equal the combined width of the non-powered panel(s).

- c. At the base of an adjoining panel:
 - i. Use a BE83BFR72 Raceway Entry Base Feed
 - ii. Select a non-powered panel adjacent to the panel with a Power Distribution Housing.
 - iii. Choose a duplex opening on either side of the panel to insert and attach the Raceway Entry Base Feed at that point.
 - iv. The Raceway Entry Base Feed will attach to the nearest end of the Power Distribution Housing (similar to the Ceiling Feed attachment).

STEP 2: Determine which panels are to be powered.

- a. Use a BE83D Power Distribution Housing that corresponds with the width of the selected panel.

STEP 3: Connect power to the panels.

- a. Use a BE8JC16 Jumper between two adjacent powered panels.
- b. Use a BE8JC20 Jumper between two powered panels separated by a post.
- c. Use a BE8CPxxHH Housing-to-Housing Pass-Thru Cable to connect two powered panels separated by one or more non-powered panels. i. The length of the Pass-Thru Cable corresponds with the width(s) of the non-powered panels that separate two powered panels plus 16" (the termination blocks of the Power Distribution Housing are 8" in from the edge of the powered panel plus 4" for each post).

STEP 4: Designate which circuit each duplex is to tap into.

- a. Each powered panel has four (4) potential locations for duplex receptacles - 2 per side. (Exception: 24" wide panel has only two (2) potential locations - 1 per side, 18" wide panel has no locations for receptacles).
- b. At each location there is a choice of four (4) circuit options. Select the circuit option for each location.

Circuit Selections : Circuits 1, 2, and 3 are utility circuits, all sharing a ground and a neutral. Circuit A is a dedicated circuit with its own ground and neutral.

SPECIFICATION APPLICATIONS

Boulevard System 3 Jumper Applications

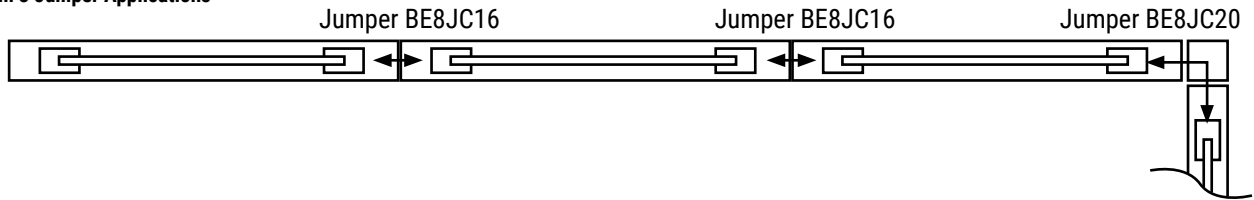

Boulevard System 3 Jumper Applications

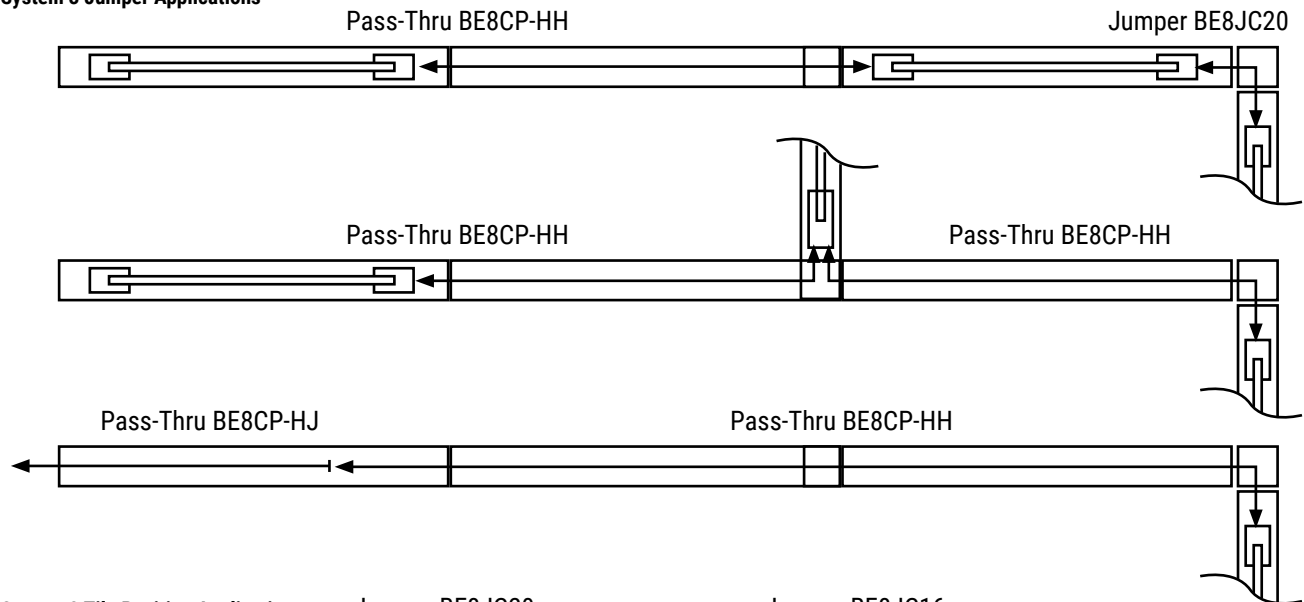

Boulevard System 3 Tile Position Application

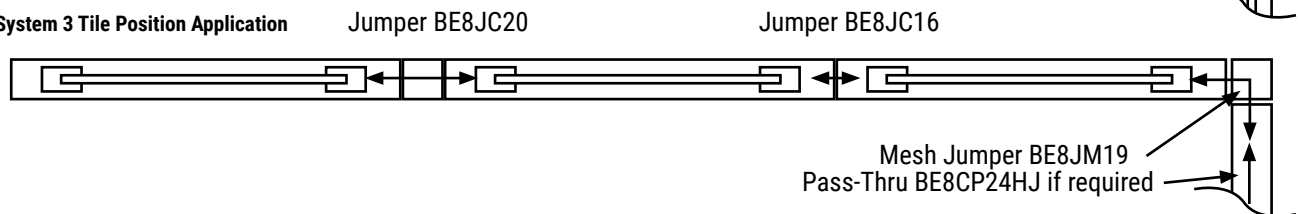

BE8CI-1 • "I" Connector

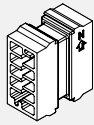

- Connects two Pass Thru Cables.
- Inline coupler used to connect two BE8CPxxHH Pass-Thru Cables.

PRODUCT CODE	PRICE	SIZE/ H	INCHES W	INCHES D	WEIGHT LBS	VOL FT ³
BE8CI1	77	1.5	1.5	4.625	0.06	0.03

BE8D • Duplex Receptacles

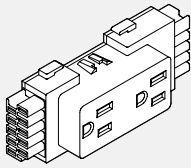

- Snaps into Power Distribution Housing.
- Up to 6 duplex receptacles per circuit.
- BE8D1 = Circuit #1 (utility circuit)
- BE8D2 = Circuit #2 (utility circuit)
- BE8D3 = Circuit #3 (utility circuit)
- BE8DA - Circuit #A (dedicated circuit)

PRODUCT CODE	PRICE	SIZE/ H	INCHES W	INCHES D	WEIGHT LBS	VOL FT ³
BE8D1	32	2	4.625	1.25	0.10	0.01
BE8D2	32	2	4.625	1.25	0.10	0.01
BE8D3	32	2	4.625	1.25	0.10	0.01
BE8DA	32	2	4.625	1.25	0.10	0.01

BE8D • USB Receptacles

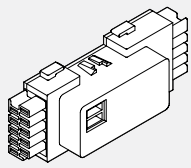

- Snaps into Power Distribution Housing.
- USB charging module provides convenient charging power access through dual ports on face of receptacles.
- Two USB ports.
- 2 amp output, considered as circuit #1.

PRODUCT CODE	PRICE	SIZE/ H	INCHES W	INCHES D	WEIGHT LBS	VOL FT ³
BE8DU1-B	216	2	4.625	1.25	0.10	0.01
BE8DU1-W	216	2	4.625	1.25	0.10	0.01

BE83BF • Reversible Base Feed (Boulevard System 3 only)

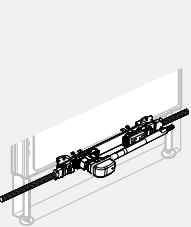

- Provides single power entry from floor circuit to raceway.
- Takes the place of a duplex receptacle by connecting to the base raceway channel of a Boulevard System 3 panel.
- BE83BF72 includes 72" long liquid-tite conduit, BE83BF144 includes 144" long liquid-tite conduit.
- Must be hard wired to power source by a licensed electrician.

PRODUCT CODE	PRICE	SIZE/ H	INCHES L	INCHES D	WEIGHT LBS	VOL FT ³
BE83BF72	321	3	72	3	3.82	2
BE83BF144	409	3	144	3	6.98	2

BE83BFR72 • Raceway Entry Base Feed (Boulevard System 3 only)

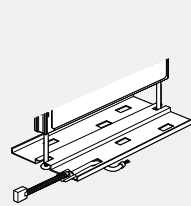

- Brings power to an adjacent panel by entering a non-powered raceway of a Boulevard System 3 panel through a duplex opening.
- Includes 72" long liquid-tite conduit.
- Must be hard wired to power source by a licensed electrician.

PRODUCT CODE	PRICE	SIZE/ H	INCHES L	INCHES D	WEIGHT LBS	VOL FT ³
BE83BFR72	397	3	88	3	4.82	2

BE8CF-1 • Ceiling Feed - Single

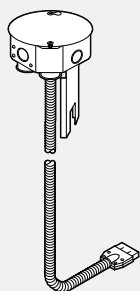

- Provides single power entry from ceiling, through post and into raceway channel.
- Power entry cable penetrates 8" into a panel and plugs into either a Power Distribution Housing or BE8CPxxHJ Pass-Thru Harness.
- Specify Post Extension separately.
- Must be hard wired to power source by a licensed electrician.

PRODUCT CODE	PRICE	SIZE/ H	INCHES L	INCHES D	WEIGHT LBS	VOL FT ³
BE8CF1201	321	6	120	6	5.24	2
BE8CF1441	435	6	144	6	5.96	2

BE8CF-2 • Ceiling Feed - Double

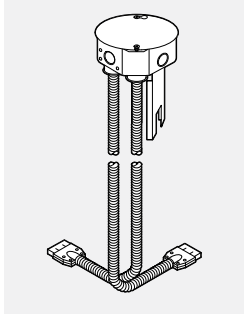

- Provides dual power entry from ceiling, through post and into raceway channel.
- Power entry cable penetrates 8" into a panel and plugs into either a Power Distribution Housing or a BE8CPxxHJ Pass-Thru Harness.
- Use 1) In middle of run to distribute power in two directions.
2) At beginning of run where second Ceiling Feed harness is connected to BE8CPxxHJ and distributes power underneath Power Distribution Housing to pick-up second circuit grouping in long panel run.
- Specify Post Extension separately.
- Must be hard wired to power source by a licensed electrician.

PRODUCT CODE	PRICE	SIZE/ INCHES			WEIGHT VOL	
		H	L	D	LBS	FT ³
BE8CF1202	564	6	120	3	5.24	2
BE8CF1442	637	6	144	3	5.96	2

BE81BF-1 • Base Feed - Single (Boulevard 1 only)

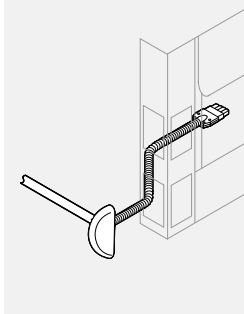

- Provides single power entry from floor, through post and into Boulevard 1 raceway channel.
- Power entry cable penetrates 8" into a panel and plugs into either a Power Distribution Housing or a BE8CPxxHJ Pass-Thru Harness.
- Power entry dome available in black only, but "Capture Strip" connector will match the post colour as standard.
- 2 1/2" clearance in depth and 5 1/2" away from any obstructions required from power entry point.
- Comes with 32" harness attached. Liquid-tite whip 72" and 144".
- Must be hard wired to power source by a licensed electrician.

PRODUCT CODE	PRICE	SIZE/ INCHES			WEIGHT VOL	
		H	L	D	LBS	FT ³
BE81BF721	317	6	107	3	3.82	2
BE81BF1441	424	6	179	3	5.96	2

BE81BF-1FL • Base Feed - Single (Boulevard 1 only)

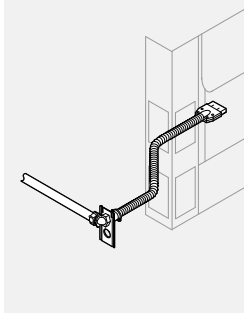

- Provides single power entry from floor, through post and into Boulevard 1 raceway channel.
- Power entry cable penetrates 8" into a panel and plugs into either a Power Distribution Housing or a BE8CPxxHJ Pass-Thru Harness.
- Power entry plate available in black only, but "Capture Strip" connector will match the post colour as standard.
- 2 1/2" clearance in depth and 5 1/2" away from any obstructions required from power entry point.
- Comes with 32" harness attached. Liquid-tite whip 72" and 144".
- Must be hard wired to power source by a licensed electrician.

PRODUCT CODE	PRICE	SIZE/ INCHES			WEIGHT VOL	
		H	L	D	LBS	FT ³
BE81BF721FL	317	6	107	3	3.82	2
BE81BF1441FL	424	6	179	3	3.82	2

BE81BF-2 • Base Feed - Double (Boulevard 1 only)

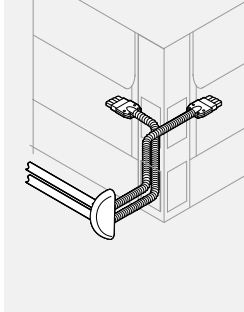

- Provides dual power entry from floor, through post and into Boulevard 1 raceway channel.
- Power entry cable penetrates 8" into a panel and plugs into either a Power Distribution Housing or a BE8CPxxHJ Pass-Thru Harness.
- Use 1) In middle of run to distribute power in two directions.
2) At beginning of run where second Base Feed Harness is connected to BE8CPxxHJ and distributes power underneath Power Distribution Housing to pick-up second circuit grouping in long panel run.
- Liquitite whip 72" and 144".
- Power entry box available in black only, but "Capture Strip" connector will match the post colour as standard.
- 2 1/2" clearance in depth and 5 1/2" away from any obstructions required from power entry point.
- Comes with 32" harness attached.
- Must be hard wired to power source by a licensed electrician.

PRODUCT CODE	PRICE	SIZE/ INCHES			WEIGHT VOL	
		H	L	D	LBS	FT ³
BE81BF722	670	6	107	3	6.98	2
BE81BF1442	894	6	179	3	6.98	2

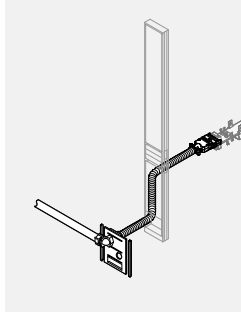
BE81BF601 • Base Feed - Single (Boulevard 1 only)

- Provides single power entry from floor, through 6" panel and into Boulevard 1 raceway panel.
- Power entry cable penetrates 8" into a panel and plugs into either a Power Distribution Housing or a BE8CPxxHJ Pass-Thru Harness.
- For 6" Power/Cable Access Panel only.
- Comes with 32" harness attached.
- Liquitite whip 72".
- Must be hard wired to power source by a licensed electrician.

PRODUCT CODE	PRICE	SIZE/ INCHES			WEIGHT VOL	
		H	L	D	LBS	FT ³
BE81BF601	345	6	107	3	4.90	0.062

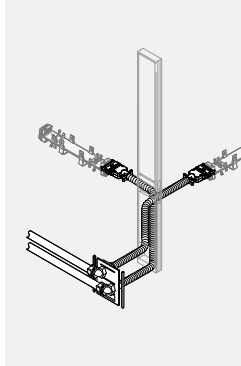
BE81BF602 • Base Feed - Double (Boulevard 1 only)

- Provides dual power entry from floor, through 6" panel and into Boulevard 1 raceway panel.
- Power entry cable penetrates 8" into a panel and plugs into either a Power Distribution Housing or a BE8CPxxHJ Pass-Thru Harness.
- Use
 1. In middle of run to distribute power in two directions.
 2. At beginning of run where second Base Feed Harness is connected to BE8CPxxHJ and distributes power underneath Power Distribution Housing to pick-up second circuit grouping in long panel run.
- For 6" Power/Cable Access Panel only.
- Comes with 2x32" harness attached.
- Liquid-tite whip 72".
- Must be hard wired to power source by a licensed electrician.

PRODUCT CODE	PRICE	SIZE/ INCHES			WEIGHT VOL	
		H	L	D	LBS	FT ³
BE81BF602	692	6	107	3	5.30	0.071

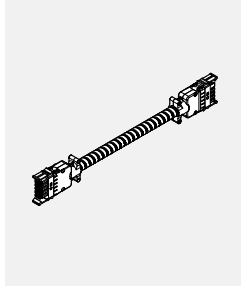
BE8JC • Jumper Cable

- Electrically connects two Power Distribution Housings.
- The BE8JC16 electrically connects two powered panels positioned side by side.
- The BE8JC20 electrically connects two powered panels separated by a post.
- Wires are concealed in a flexible metal conduit.
- Cannot go through a Boulevard 1 post in a corner application. (Please use the Jumper Cable Mesh)

PRODUCT CODE	PRICE	SIZE/ INCHES			WEIGHT VOL	
		H	L	D	LBS	FT ³
BE8JC16	145	2	16.75	0.5	0.66	1.17
BE8JC20	147	2	20.75	0.5	0.78	1.17

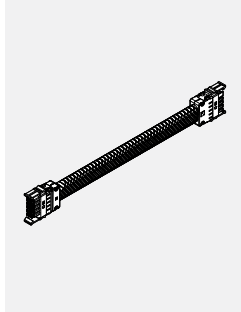
BE8JM19 • Jumper Cable Mesh

- Electrically connects two Power Distribution Housings in Boulevard 1 panels that are separated by a post in a corner application.
- BE8JM19 - Wires are covered with a durable nylon mesh.
- BE8JMS19 - Wires are concealed in a flexible metal shroud and covered with a durable nylon mesh.
- Used in System 3 Panels at tile position passing through post at corner application.

PRODUCT CODE	PRICE	SIZE/ INCHES			WEIGHT VOL	
		H	L	D	LBS	FT ³
BE8JM19	147	2	19	0.5	0.75	1.17
BE8JMS19	167	2	19	0.5	0.75	1.17

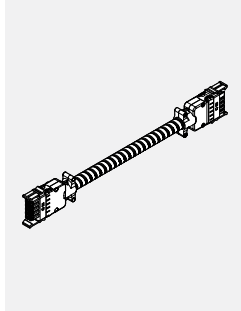
BE83BT • Base-to-Tile Cable

- Electrically connects a Base Raceway Power Distribution Housing to a Face Mount Tile Power Distribution Housing within a System 3 PV panel.
- Wires are concealed in a flexible metal conduit.
- BE83BT82 to be used on panels manufactured before November 1st, 2014 and BE83BT40 after.

PRODUCT CODE	PRICE	SIZE/ INCHES			WEIGHT VOL	
		H	L	D	LBS	FT ³
BE83BT82	174	2	82.5	0.5	3.05	1.38
BE83BT40	146	2	40.5	0.5	1.44	1.17

BE8CP-HH • Housing-to-Housing Pass-Thru Cable

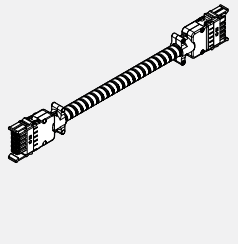

- Electrically connects two Power Distribution Housings in panels separated by one or more non-powered panels.
- Wires are concealed in a flexible metal conduit.
- **NOTE** : In Boulevard 1 and or System 3 tile position applications, the Housing-to-Housing Pass-Thru Cables can only be used in a straight run.

PRODUCT CODE	PRICE	SIZE/ INCHES			WEIGHT VOL	
		H	L	D	LBS	FT ³
BE8CP40HH	146	2	40.5	0.5	1.44	1.17
BE8CP46HH	152	2	46.5	0.5	1.71	1.17
BE8CP52HH	161	2	52.5	0.5	1.95	1.17
BE8CP58HH	167	2	58.5	0.5	2.21	1.17
BE8CP64HH	173	2	64.5	0.5	2.37	1.17
BE8CP70HH	178	2	70.5	0.5	2.6	1.17
BE8CP76HH	185	2	76.5	0.5	2.81	1.17
BE8CP82HH	194	2	82.5	0.5	3.03	1.17
BE8CP88HH	201	2	88.5	0.5	3.05	1.17
BE8CP94HH	205	2	94.5	0.5	3.30	1.17
BE8CP100HH	212	2	100.5	0.5	3.47	1.17
BE8CP106HH	220	2	106.5	0.5	3.87	1.17
BE8CP118HH	233	2	118.5	0.5	4.08	1.17
BE8CP130HH	244	2	130.5	0.5	4.73	1.17
BE8CP142HH	256	2	142.5	0.5	4.99	1.17

BE8CP-HJ • Housing-to-Jumper Pass-Thru Cable

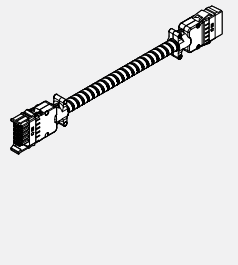

- Electrically connects a Power Distribution Housing to a Housing connection of a harness.
- Wires are concealed in a flexible metal conduit.
- **NOTE** : In both Boulevard 1 and System 3 Tile Position applications, the Housing-to-Jumper Pass-Thru Cables can only be used in a straight run.

PRODUCT CODE	PRICE	SIZE/ INCHES			WEIGHT VOL	
		H	L	D	LBS	FT ³
BE8CP24HJ	113	2	24	0.5	0.9	1.17
BE8CP30HJ	119	2	30	0.5	1.3	1.17
BE8CP36HJ	124	2	36	0.5	1.44	1.17
BE8CP42HJ	154	2	42	0.5	1.71	1.17
BE8CP48HJ	161	2	48	0.5	1.95	1.17
BE8CP54HJ	171	2	54	0.5	2.21	1.17
BE8CP60HJ	178	2	60	0.5	2.37	1.17
BE8CP72HJ	185	2	72	0.5	2.81	1.17
BE8CP84HJ	200	2	84	0.5	3.05	1.17
BE8CP96HJ	212	2	96	0.5	3.3	1.17
BE8CP108HJ	221	2	108	0.5	3.87	1.17
BE8CP120HJ	234	2	120	0.5	4.08	1.17
BE8CP144HJ	266	2	144	0.5	4.59	1.17

BE81D • Power Distribution Housing Kit - Concealed Desk Height (Boulevard 1 only)

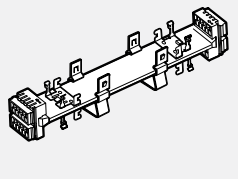

- Provides two duplex receptacles per panel for all panel widths above 24" wide.
- Power Distribution Housing is specified per panel size. eg. BE81D36 is for use with a 36" panel.

PRODUCT CODE	PRICE	SIZE/ INCHES			WEIGHT VOL	
		H	L	D	LBS	FT ³
BE81D24	180	2	9.25	2.61	0.83	1.17
BE81D30	189	2	15.25	2.61	1.28	1.17
BE81D36	200	2	21.25	2.61	1.62	1.65
BE81D42	205	2	27.25	2.61	2.00	2.00
BE81D48	216	2	33.25	2.61	2.32	2.54
BE81D54	220	2	39.25	2.61	2.66	3.20
BE81D60	221	2	45.25	2.61	3.04	3.20
BE81D66	282	2	51.25	2.61	3.49	3.25
BE81D72	310	2	57.2	2.61	3.76	3.30

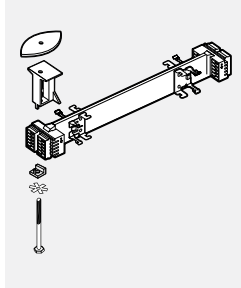
BE8U2D • Power Distribution Housing Kit - Face Mount Desk Height (Boulevard 1 only)

- Provides two duplex receptacles per panel side for all panel widths above 24" wide.
- Power Distribution Housing is specified per panel size. eg. BE8U2D36 is for use with a 36" panel.
- 24" wide panel allows for only one (1) duplex receptacle per panel side.

PRODUCT CODE	PRICE	SIZE/ H	INCHES			WEIGHT VOL	
			L	D	LBS	FT ³	
BE8U2D24	180	2	9.25	2.61	0.83	1.17	
BE8U2D30	189	2	15.25	2.61	1.28	1.17	
BE8U2D36	200	2	21.25	2.61	1.62	1.65	
BE8U2D42	205	2	27.25	2.61	2.00	2.00	
BE8U2D48	216	2	33.25	2.61	2.32	2.54	
BE8U2D54	220	2	39.25	2.61	2.66	3.20	
BE8U2D60	221	2	45.25	2.61	3.04	3.20	
BE8U2D66	282	2	51.25	2.61	3.49	3.25	
BE8U2D72	310	2	57.25	2.61	3.76	3.30	

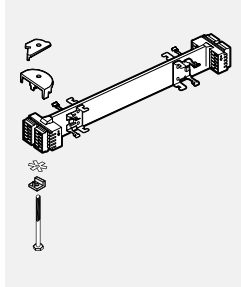
BE83D • Power Distribution Housing Kit - Base Raceway (Boulevard System 3 only)

- Provides two duplex receptacles per panel side for all panel widths above 24" wide.
- Power Distribution Housing is specified per panel size. eg. BE83D36 is for use with a 36" panel.
- 24" wide panel allows for only one (1) duplex receptacle per panel side.

PRODUCT CODE	PRICE	SIZE/ H	INCHES			WEIGHT VOL	
			L	D	LBS	FT ³	
BE83D24	180	2	9.25	2.61	0.83	1.17	
BE83D30	189	2	15.25	2.61	1.28	1.17	
BE83D36	200	2	21.25	2.61	1.62	1.65	
BE83D42	205	2	27.25	2.61	2.00	2.00	
BE83D48	216	2	33.25	2.61	2.32	2.54	
BE83D54	220	2	39.25	2.61	2.66	3.20	
BE83D60	221	2	45.25	2.61	3.04	3.20	
BE83D66	282	2	51.25	2.61	3.49	3.25	
BE83D72	310	2	57.25	2.61	3.76	3.30	

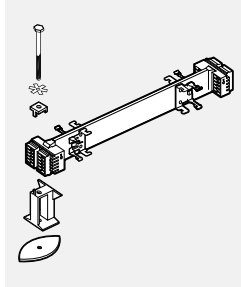
BE8U3FM • Power Distribution Housing Kit - Face Mount Tile (Boulevard System 3 only)

- Provides two duplex receptacles for all tile widths above 24". 24" wide tile allows for one (1) duplex receptacle.
- Housing and mounting hardware included.
- Specify duplexes, cables and tiles separately.
- BE83BT40 Base-to-Tile Cable is used to connect the tile mounted housing to the Power Distribution Housing tile in the base of the same "PV" panel.
- 24" wide tiles have one duplex and one data/comm opening. 30" and wider tiles have two data/comm openings.
- Note: Not compatible with panels built prior November 1st, 2014.

PRODUCT CODE	PRICE	SIZE/ H	INCHES			WEIGHT VOL	
			L	D	LBS	FT ³	
BE8U3FM24	180	2	9.25	2.61	0.83	1.17	
BE8U3FM30	189	2	15.25	2.61	1.28	1.17	
BE8U3FM36	200	2	21.25	2.61	1.62	1.65	
BE8U3FM42	205	2	27.25	2.61	2.00	2.00	
BE8U3FM48	216	2	33.25	2.61	2.32	2.54	
BE8U3FM54	220	2	39.25	2.61	2.66	3.20	
BE8U3FM60	221	2	45.25	2.61	3.04	3.20	
BE8U3FM66	282	2	51.25	2.61	3.49	3.25	
BE8U3FM72	310	2	57.25	2.61	3.76	3.30	

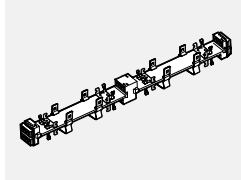
BE81D-CM • Centermount Power Distribution Housing Quad Kit - Concealed Desk Height (B1 only)

- Provides four duplex receptacles per panel for widths 36" and above.
- Centermount Distribution Housing is specified per panel size. ie. BE81D36CM is for 36" panel.
- Not available for panels less than 36" wide.

PRODUCT CODE	PRICE	SIZE/ H	INCHES			WEIGHT VOL	
			L	D	LBS	FT ³	
BE81D36CM	330	2	21.99	2.61	3.24	1.65	
BE81D42CM	340	2	27.99	2.61	4.00	2.00	
BE81D48CM	347	2	33.99	2.61	4.64	2.54	
BE81D54CM	354	2	39.99	2.61	5.32	3.20	
BE81D60CM	360	2	45.99	2.61	6.04	3.20	
BE81D66CM	420	2	51.99	2.61	6.98	3.25	
BE81D72CM	481	2	57.99	2.61	7.52	3.30	

BEPE • Post Extension

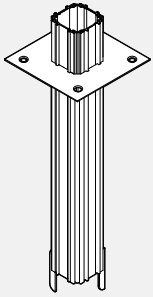

- **Lightweight aluminum pole to be used to bring power and/or data/communication cables from ceiling to a panel through a post.**
- Attaches to ceiling and post.
- Includes connectors, ceiling trim plate and screws.
- Post extension will accept:
 - 75 cables 5.6mm (0.220") dia. data cables
 - 60 cables 5.6mm (0.220") dia. data cables with 1 power feed
 - 45 cables 5.6mm (0.220") dia. data cables with 2 power feeds.
- Ceiling bezel is white only.

PRODUCT CODE	PRICE	SIZE/	INCHES		WEIGHT VOL	
			L	D	LBS	FT ³
BEPE49	113	49	2.61	5.00	0.258	
BEPE81	171	81	2.61	9.00	0.424	

BHPOST • Lay in Post Extension

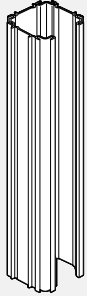

- **Three sided lightweight aluminum pole to be used to bring power and/or data/communication cables from ceiling to a panel. True lay-in application use**
- Attaches to ceiling and post.
- Includes connectors and ceiling bezel plate and screws.
- Requires vertical end trim to enclose when used in 2 way and 3 way panel run application.
- Trim encloses lay-in cable post extension, sold separately.

PRODUCT CODE	PRICE	TYPE	SIZE/ H	INCHES			WEIGHT VOL	
				L	D	LBS	FT ³	
BHPOST66	177	BASE	66	2.61	2.61	8	0.346	
BHPOSTE30	83	EXTENSION	30	2.61	2.61	5	0.195	
BHPOSTE78	215	EXTENSION	78	2.61	2.61	9	0.430	

BE2PE • Off-Module Post Extension

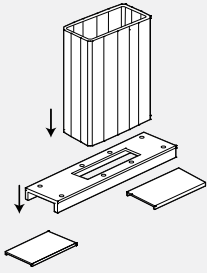

- **An alternative to the existing Ceiling Post, allows for an off-module Ceiling Feed location.**
- Attaches to the top of horizontal trim.
- Panel ceiling post consists of two aluminum extrusions for a true lay-in application.
- Includes brackets, hardware and ceiling trim plate and screws.
- Harness length will vary in length depending on post location along the panel.
- Can only be used with Boulevard System 3 "PV" and "MV" Panels.
- Requires on site cutting of top trim for placement along panel.

PRODUCT CODE	PRICE	SIZE/ H	INCHES			WEIGHT VOL	
			L	D	LBS	FT ³	
BE2PE49	255	49	7.61	3.00	5	0.258	
BE2PE81	377	81	7.61	3.00	9	0.424	

Worksurfaces

Global Contract offers a wide variety of worksurfaces and user friendly worksurface shapes to support a variety of tasks, applications and personal preferences.

- 1 1/16" particle board.
- 45 lb. density
- 100% recycled from post consumer industrial material
- "Scoops" for cable management.
- All worksurfaces have threaded inserts for metal-to-metal connection of support hardware.

- High and Low pressure worksurfaces are 3mm edge banded.
- Wood veneer surfaces or solid wood edges available.

Technical Information

Worksurfaces

- All worksurfaces have threaded inserts for metal-to-metal connection of support hardware.
- Back edge features scoop detail.
- Worksurfaces 48" or less have one scoop while those that are 54" or more have a double scoop feature with a 1/2" wire passage trough between the scoops.
- LP and HP worksurfaces are 3mm edge banded.
- LP worksurfaces are 1" thick particle board with laminate finish.
- HP worksurfaces are 1 1/16" thick particle board with laminate finish.
- T worksurfaces are 1 1/16" thick particle board with laminate finish and wood trim.
- W worksurfaces are 1 3/16" thick particle board with wood veneer finish. Edge is solid wood edge banded.
- One universal cantilever supports two abutting worksurfaces.

- 20" deep worksurfaces available at same price as 24" deep worksurfaces.
- Support hardware must be ordered separately.
- Edge banded worksurfaces without scoops available, substitute "NFL" for "SCP" at the end of the code.

Transaction Worksurfaces

- To install transaction worksurfaces to a 42" high panel, use BHBT02 bracket.
- To install transaction worksurfaces to a 37" high panel, use BHBT37 bracket.

WORKSURFACE COMPONENTS - GUIDELINES FOR ORDERING PRODUCT

Codes

The price list uses a numbering system with meaningful alphanumeric characters to create a simple-to-understand product number. This makes specifying the product much easier and more accurate.

Example of Worksurface: **BWS2460PHPMR71TCHR**

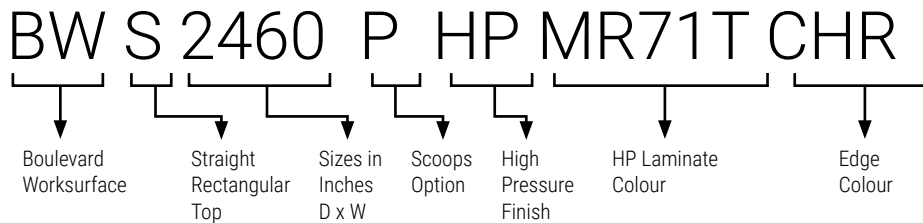

How to Specify

- Specify Boulevard worksurface type and size by code.
- Specify scoops option by adding "P" at end of code.
- Specify type of finish.
- Specify High Pressure Laminate Colour.
- Specify PVC edge colour.

Example of Hardware: **BHC24 CHR**

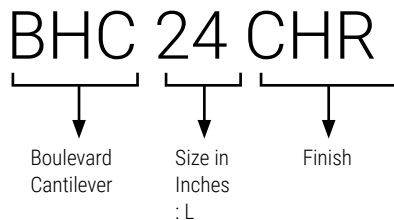

How to Specify

- Specify Boulevard hardware type and size by code.
- Specify type of finish.

BWS • Straight Rectangular Worksurface

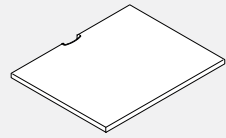

Worksurfaces 54" or Less

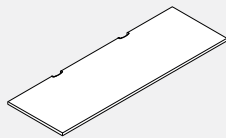

Worksurfaces 60" or Longer

• **Straight rectangular work-surfaces are non-handed and can be interchanged on site.**

• Please choose from DWT - Designer White, SIL - Silver or BLK - Black for scoop covers.

• Surfaces with wood trim (T) and complete wood (W) will not have the plastic scoop, they will remain with the curve cut scoop.

• To specify wood trim (T) or complete wood (W) surfaces, please remove the last "P" from the code, replace with "SCP" and add either a "T" or "W" and the old scoop style is going to be created.

PRODUCT CODE	PRICE LP*	GROUP			SIZE/ H	INCHES			WEIGHT VOL	
		HP*	T*	W*		W	D	LBS	FT ³	
BWS1818P	123	156	352	462	1	18	18	9	0.29	
BWS1824P	127	169	359	546	1	24	18	12	0.39	
BWS1830P	134	178	386	638	1	30	18	15	0.49	
BWS1836P	154	204	421	729	1	36	18	18	0.59	
BWS1842P	202	270	497	853	1	42	18	21	0.68	
BWS1848P	242	318	505	890	1	48	18	24	0.78	
BWS1854P	284	374	722	1024	1	54	18	27	0.88	
BWS1860P	319	410	729	1042	1	60	18	30	1.00	
BWS1866P	334	439	750	1070	1	66	18	32	1.10	
BWS1872P	352	464	774	1096	1	72	18	35	1.20	
BWS1878P	369	488	934	1168	1	78	18	38	1.30	
BWS1884P	405	530	959	1238	1	84	18	41	1.40	
BWS2418P	127	163	383	513	1	18	24	12	0.40	
BWS2424P	129	173	392	609	1	24	24	16	0.52	
BWS2430P	141	184	419	718	1	30	24	20	0.65	
BWS2436P	156	207	451	818	1	36	24	23	0.78	
BWS2442P	205	272	528	963	1	42	24	28	0.90	
BWS2448P	245	329	537	1055	1	48	24	31	1.03	
BWS2454P	290	383	750	1198	1	54	24	35	1.20	
BWS2460P	326	430	756	1227	1	60	24	39	1.30	
BWS2466P	340	449	765	1264	1	66	24	43	1.41	
BWS2472P	355	470	796	1300	1	72	24	47	1.54	
BWS2478P	381	501	862	1389	1	78	24	51	1.70	
BWS2484P	410	537	956	1480	1	84	24	55	1.80	
BWS3018P	145	186	413	612	1	18	30	15	0.50	
BWS3024P	154	202	421	736	1	24	30	20	0.70	
BWS3030P	165	218	484	851	1	30	30	25	0.97	
BWS3036P	194	256	526	986	1	36	30	30	1.06	
BWS3042P	275	362	624	1029	1	42	30	34	1.12	
BWS3048P	290	383	635	1099	1	48	30	39	1.30	
BWS3054P	317	408	816	1254	1	54	30	44	1.44	
BWS3060P	340	449	821	1291	1	60	30	49	1.60	
BWS3066P	353	469	849	1376	1	66	30	54	1.80	
BWS3072P	374	495	894	1458	1	72	30	59	2.00	
BWS3078P	398	524	971	1560	1	78	30	64	2.10	
BWS3084P	443	579	1029	1664	1	84	30	69	2.24	
BWS3672P	528	693	1082	1734	1	72	36	71	2.30	

• LP = Thermally Fused Laminate, HP = High Pressure Laminate, T= High Pressure Laminate with Wood Trim, W= Wood Veneer

BWSP • Straight Rectangular Worksurface to span a Post

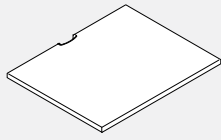

Worksurfaces 57" or Less

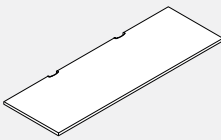

Worksurfaces 63" or Longer

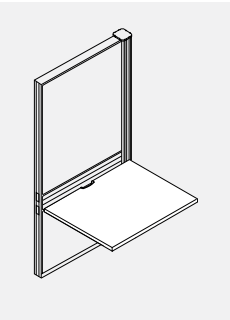

Application of Worksurface

• Straight rectangular work-surfaces are non-handed and can be interchanged on site.

• Worksurface will span the width of a post eliminating a gap between standard sizes.

• Please choose from DWT - Designer White, SIL - Silver or BLK - Black for scoop covers.

• Surfaces with wood trim (T) and complete wood (W) will not have the plastic scoop, they will remain with the curve cut scoop.

• To specify wood trim (T) or complete wood (W) surfaces, please remove the last "P" from the code, replace with "SCP" and add either a "T" or "W" and the old scoop style is going to be created.

PRODUCT CODE	PRICE LP*	GROUP HP*	T*	W*	SIZE/ INCHES			WEIGHT VOL	
					H	W	D	LBS	FT ³
BWSP1821P	127	169	359	546	1	21	18	10	0.34
BWSP1827P	134	178	386	638	1	27	18	13	0.44
BWSP1833P	154	204	421	729	1	33	18	16	0.53
BWSP1839P	202	270	497	853	1	39	18	19	0.63
BWSP1845P	242	318	505	890	1	45	18	22	0.72
BWSP1851P	284	374	605	908	1	51	18	25	0.82
BWSP1857P	319	410	729	1042	1	57	18	28	0.92
BWSP1863P	334	439	750	1070	1	63	18	31	1.01
BWSP1869P	352	464	774	1096	1	69	18	34	1.11
BWSP1875P	369	488	838	1168	1	75	18	37	1.21
BWSP1881P	405	530	884	1238	1	81	18	40	1.30
BWSP1887P	435	573	931	1313	1	87	18	43	1.40
BWSP2421P	129	173	392	609	1	21	24	14	0.45
BWSP2427P	141	184	419	718	1	27	24	17	0.60
BWSP2433P	156	207	451	818	1	33	24	21	0.70
BWSP2439P	205	272	528	963	1	39	24	25	0.83
BWSP2445P	245	329	537	1055	1	45	24	29	1.00
BWSP2451P	290	383	634	1082	1	51	24	33	1.10
BWSP2457P	326	430	756	1227	1	57	24	37	1.22
BWSP2463P	340	449	796	1264	1	63	24	41	1.34
BWSP2469P	355	470	837	1300	1	69	24	45	1.47
BWSP2475P	381	501	862	1389	1	75	24	49	1.60
BWSP2481P	410	537	910	1480	1	81	24	53	1.73
BWSP2487P	443	589	958	1568	1	87	24	57	1.90
BWSP3021P	163	202	421	736	1	21	30	17	0.56
BWSP3027P	165	218	484	851	1	27	30	22	0.72
BWSP3033P	194	256	526	986	1	33	30	27	0.88
BWSP3039P	275	362	624	1029	1	39	30	32	1.04
BWSP3045P	290	383	635	1099	1	45	30	37	1.20
BWSP3051P	317	408	699	1137	1	51	30	41	1.40
BWSP3057P	340	449	821	1291	1	57	30	46	1.51
BWSP3063P	353	469	849	1376	1	63	30	51	1.67
BWSP3069P	374	495	894	1458	1	69	30	56	1.83
BWSP3075P	398	524	971	1560	1	75	30	61	2.00
BWSP3081P	443	579	1029	1664	1	81	30	66	2.20
BWSP3087P	488	646	1085	1764	1	87	30	70	2.30
BWSP3675P	541	712	1082	1734	1	75	36	73	2.40

• LP = Thermally Fused Laminate, HP = High Pressure Laminate, T= High Pressure Laminate with Wood Trim, W= Wood Veneer

BWS • Straight Rectangular Worksurface without Flex Lip or Scoops

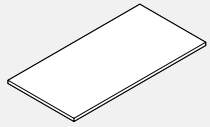

- Straight rectangular work-surfaces are non-handed and can be interchanged on site.
- Worksurface features no scoop or flex lip.

PRODUCT CODE	PRICE LP*	GROUP HP*	T*	W*	SIZE/ INCHES			WEIGHT VOL	
					H	W	D	LBS	FT ³
BWS1818NFL	123	156	233	343	1	18	18	9	0.28
BWS1824NFL	127	169	242	428	1	24	18	12	0.40
BWS1830NFL	134	178	270	523	1	30	18	15	0.50
BWS1836NFL	154	204	303	612	1	36	18	18	0.59
BWS1842NFL	202	270	380	736	1	42	18	21	0.68
BWS1848NFL	242	318	389	771	1	48	18	24	0.78
BWS1854NFL	284	374	488	792	1	54	18	27	0.88
BWS1860NFL	319	410	495	807	1	60	18	29	0.97
BWS1866NFL	334	439	518	847	1	66	18	32	1.10
BWS1872NFL	352	464	545	862	1	72	18	35	1.20
BWS1878NFL	369	488	605	934	1	78	18	38	1.30
BWS1884NFL	405	530	650	1007	1	84	18	41	1.40
BWS2418NFL	127	163	266	397	1	18	24	12	0.40
BWS2424NFL	129	173	272	493	1	24	24	16	0.52
BWS2430NFL	141	184	300	603	1	30	24	20	0.65
BWS2436NFL	156	207	334	702	1	36	24	24	0.78
BWS2442NFL	205	272	410	843	1	42	24	28	0.90
BWS2448NFL	245	329	420	938	1	48	24	31	1.03
BWS2454NFL	290	383	518	965	1	54	24	35	1.20
BWS2460NFL	326	430	524	993	1	60	24	39	1.30
BWS2466NFL	340	449	561	1032	1	66	24	43	1.41
BWS2472NFL	355	470	603	1067	1	72	24	47	1.54
BWS2478NFL	381	501	626	1158	1	78	24	51	1.70
BWS2484NFL	410	537	675	1247	1	84	24	55	1.80
BWS3018NFL	145	186	297	495	1	18	30	15	0.50
BWS3024NFL	154	202	304	619	1	24	30	20	0.65
BWS3030NFL	165	218	366	733	1	30	30	25	0.81
BWS3036NFL	194	256	408	868	1	36	30	29	1.00
BWS3042NFL	275	362	508	911	1	42	30	34	1.13
BWS3048NFL	290	383	519	982	1	48	30	39	1.30
BWS3054NFL	317	408	583	1021	1	54	30	44	1.44
BWS3060NFL	340	449	587	1058	1	60	30	49	1.60
BWS3066NFL	353	469	615	1141	1	66	30	54	1.76
BWS3072NFL	374	495	660	1164	1	72	30	59	1.91
BWS3078NFL	398	524	737	1327	1	78	30	64	2.10
BWS3084NFL	443	579	795	1430	1	84	30	69	2.24
BWS3672NFL	528	693	1082	1734	1	72	36	71	2.30

BWSC • Curvelinear Front Edge Worksurface

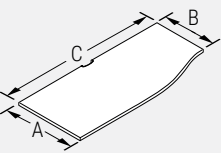

- Curvelinear front edge worksurface.
- Allows efficient use of a small footprint.
- The curve on the 30" and 36" wide worksurfaces have been modified to allow a pedestal to fit.
- Please choose from DWT - Designer White, SIL - Silver or BLK - Black for scoop covers.
- Surfaces with wood trim (T) and complete wood (W) will not have the plastic scoop, they will remain with the curve cut scoop.
- To specify wood trim (T) or complete wood (W) surfaces, please remove the last "P" from the code, replace with "SCP" and add either a "T" or "W" and the old scoop style is going to be created.
- Surfaces 60" wide will have two scoops, all others have one scoop.

PRODUCT CODE	PRICE LP*	GROUP HP*	T*	W*	SIZE/ INCHES			WEIGHT VOL	
					H	W	D	LBS	FT ³
BWSC182430P	177	233	574	944	1	30	24	18	0.65
BWSC182436P	211	281	616	1080	1	36	24	22	0.78
BWSC182442P	245	329	715	1123	1	42	24	26	0.90
BWSC182448P	281	374	724	1195	1	48	24	30	1.03
BWSC182454P	317	420	904	1350	1	54	24	34	1.20
BWSC182460P	344	469	911	1388	1	60	24	38	1.30
BWSC241830P	177	233	574	944	1	30	24	18	0.65
BWSC241836P	211	281	616	1080	1	36	24	22	0.78
BWSC241842P	245	329	715	1123	1	42	24	26	0.90
BWSC241848P	281	374	724	1195	1	48	24	30	1.03
BWSC241854P	317	420	904	1350	1	54	24	34	1.2
BWSC241860P	344	469	911	1388	1	60	24	38	1.3
BWSC243030P	186	244	710	1189	1	30	30	23	0.81
BWSC243036P	222	281	765	1288	1	36	30	28	1
BWSC243042P	303	400	895	1522	1	42	30	33	1.13
BWSC243048P	317	420	904	1540	1	48	30	38	1.3
BWSC243054P	353	469	1107	1811	1	54	30	42	1.44
BWSC243060P	380	513	1115	1827	1	60	30	47	1.6
BWSC302430P	186	244	710	1189	1	30	30	23	0.81
BWSC302436P	222	281	765	1288	1	36	30	28	1
BWSC302442P	303	400	895	1522	1	42	30	33	1.13
BWSC302448P	317	420	904	1540	1	48	30	38	1.3
BWSC302454P	353	469	1107	1811	1	54	30	42	1.44
BWSC302460P	380	513	1115	1827	1	60	30	47	1.6

NOTE: BWSC

24	18	30
A	B	C
WIDTH	WIDTH	LENGTH

• LP = Thermally Fused Laminate, HP = High Pressure Laminate, T= High Pressure Laminate with Wood Trim, W= Wood Veneer

BWCC • Curved Corner Worksurface

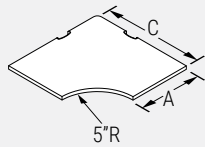

NOTE: BWCC

36	18
C	A
WIDTH	DEPTH

- Allows efficient use of corner space for computer or printer applications.

• BWCC3624 has a front radius of 12". It is not usable for keyboard support.

• Please choose from DWT - Designer White, SIL - Silver or BLK - Black for scoop covers.

• Surfaces with wood trim (T) and complete wood (W) will not have the plastic scoop, they will remain with the curve cut scoop.

• To specify wood trim (T) or complete wood (W) surfaces, please remove the last "P" from the code, replace with "SCP" and add either a "T" or "W" and the old scoop style is going to be created.

PRODUCT CODE	PRICE LP*	GROUP HP*	T*	W*	SIZE/ H	INCHES W	D	WEIGHT LBS	VOL FT ³
BWCC3618P	385	481	818	1428	1	36	36	29	1.20
BWCC3624P	426	532	818	1428	1	36	36	32	1.20
BWCC4224P	574	715	1038	1647	1	42	42	41	1.60
BWCC4230P	589	737	1038	1647	1	42	42	45	1.60
BWCC4824P	668	832	1287	2096	1	48	48	50	2.00
BWCC4830P	668	832	1287	2096	1	48	48	56	2.00

CODE	RADIUS "R"
BWCC3618P	18"
BWCC3624P	12"
BWCC4224P	18"
BWCC4230P	12"
BWCC4824P	24"
BWCC4830P	18"

NOTE: 12" radius not recommended for keyboards

BWCF • Five Sided Corner Worksurface

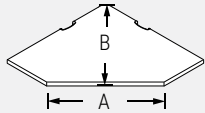

- Creates efficient use of corner space for computer or printer applications.

• Please choose from DWT - Designer White, SIL - Silver or BLK - Black for scoop covers.

• Surfaces with wood trim (T) and complete wood (W) will not have the plastic scoop, they will remain with the curve cut scoop.

• To specify wood trim (T) or complete wood (W) surfaces, please remove the last "P" from the code, replace with "SCP" and add either a "T" or "W" and the old scoop style is going to be created.

PRODUCT CODE	PRICE LP*	GROUP HP*	T*	W*	SIZE/ H	INCHES W	D	WEIGHT LBS	VOL FT ³
BWCF3012P	251	311	774	1277	1	30	30	28	1.00
BWCF3612P	331	413	882	1290	1	36	36	30	1.03
BWCF3618P	331	413	789	1290	1	36	36	31	1.20
BWCF3624P	344	433	789	1290	1	36	36	33	1.20
BWCF3630P	361	451	789	1290	1	36	36	35	1.20
BWCF4218P	471	589	994	1507	1	42	42	40	1.60
BWCF4224P	488	609	994	1507	1	42	42	45	1.60
BWCF4230P	502	633	994	1507	1	42	42	47	1.60
BWCF4818P	534	669	1082	1651	1	48	48	40	1.60
BWCF4824P	550	686	1082	1651	1	48	48	45	1.60
BWCF4830P	579	725	1082	1651	1	48	48	47	1.60

CODE	PANEL SIZES	ADJOINED WORKSURFACE DEPTH	A	B
BWCF3012P	30	12	25.5	29.8
BWCF3612P	36	12	34.0	34.0
BWCF3618P	36	18	25.5	37.9
BWCF3624P	36	24	17.0	42.1
BWCF3630P	36	30	8.5	46.4
BWCF4218P	42	18	33.9	42.1
BWCF4224P	42	24	25.5	46.4
BWCF4230P	42	30	17.0	50.6
BWCF4818P	48	18	42.4	46.4
BWCF4824P	48	24	33.9	50.6
BWCF4830P	48	30	25.5	54.8

BWCL • "L" Corner Worksurface

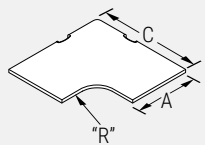

NOTE: BWCL

• 5" radius not recommended for keyboards.

36	18
C	A
WIDTH	DEPTH

- Creates efficient use of corner space for computer or printer applications.

• Please choose from DWT - Designer White, SIL - Silver or BLK - Black for scoop covers.

• Surfaces with wood trim (T) and complete wood (W) will not have the plastic scoop, they will remain with the curve cut scoop.

• To specify wood trim (T) or complete wood (W) surfaces, please remove the last "P" from the code, replace with "SCP" and add either a "T" or "W" and the old scoop style is going to be created.

PRODUCT CODE	PRICE LP*	GROUP HP*	T*	W*	SIZE/ H	INCHES W	D	WEIGHT LBS	VOL FT ³
BWCL3018P	229	284	433	1249	1	30	30	20	0.80
BWCL3024P	234	296	433	1249	1	30	30	23	0.80
BWCL3618P	344	433	585	1254	1	36	36	27	1.20
BWCL3624P	362	451	585	1254	1	36	36	31	1.20
BWCL3630P	378	471	585	1254	1	36	36	34	1.20
BWCL4218P	503	626	805	1472	1	42	42	32	1.60
BWCL4224P	520	649	805	1472	1	42	42	39	1.60
BWCL4230P	534	669	805	1472	1	42	42	44	1.60
BWCL4818P	550	688	932	1625	1	48	48	38	2.00
BWCL4824P	564	705	932	1625	1	48	48	47	2.00
BWCL4830P	583	727	932	1625	1	48	48	54	2.00

• LP = Thermally Fused Laminate, HP = High Pressure Laminate, T= High Pressure Laminate with Wood Trim, W= Wood Veneer

BWAC45 • Curved Corner Worksurface for 45 Degree Angle

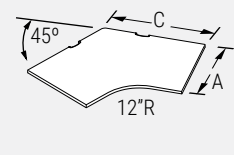

NOTE: BWAC

45°	24	18
	C	A
45° POST	WIDTH	DEPTH

- **Five sided corner unit for 45 degree Corner Posts.**
- Creates efficient use of space for computer or printer application.
- Please choose from DWT - Designer White, SIL - Silver or BLK - Black for scoop covers.
- Surfaces with wood trim (T) and complete wood (W)

PRODUCT CODE	PRICE LP*	GROUP HP*	T*	W*	SIZE/ INCHES			WEIGHT VOL	
					H	W	D	LBS	FT ³
BWAC452418P	385	481	1007	1343	1	24	18	38	1.14
BWAC452424P	399	501	1518	2026	1	24	24	42	1.29
BWAC452430P	418	521	2006	2677	1	24	30	48	1.45
BWAC453018P	497	619	1223	1628	1	30	18	53	1.61
BWAC453024P	561	702	1454	1939	1	30	24	60	1.80
BWAC453030P	622	779	1861	2481	1	30	30	66	2.01
BWAC453618P	699	869	1416	1890	1	36	18	66	2.01
BWAC453624P	774	969	1746	2323	1	36	24	71	2.16
BWAC453630P	851	1062	2198	2930	1	36	30	76	2.30

- will not have the plastic scoop, they will remain with the curve cut scoop.
- To specify wood trim (T) or complete wood (W) surfaces, please remove the last "P" from the code, replace with "SCP" and add either a "T" or "W" and the old scoop style is going to be created.

BWAC60 • Curved Corner Worksurface for 60 Degree Angle

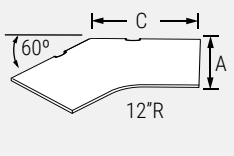

NOTE: BWAC

60°	24	18
	C	A
60° POST	WIDTH	DEPTH

- **Five sided corner unit for 60 degree Corner Posts.**
- Creates efficient use of space for computer or printer application.
- Please choose from DWT - Designer White, SIL - Silver or BLK - Black for scoop covers.
- Surfaces with wood trim (T) and complete wood (W)

PRODUCT CODE	PRICE LP*	GROUP HP*	T*	W*	SIZE/ INCHES			WEIGHT VOL	
					H	W	D	LBS	FT ³
BWAC602418P	331	413	837	1114	1	24	18	33	0.99
BWAC602424P	344	433	1003	1334	1	24	24	36	1.09
BWAC602430P	361	451	1063	1418	1	24	30	39	1.19
BWAC603018P	451	564	1025	1365	1	30	18	48	1.46
BWAC603024P	493	613	1207	1612	1	30	24	52	1.58
BWAC603030P	528	663	1315	1752	1	30	30	56	1.71
BWAC603618P	642	805	1197	1594	1	36	18	66	2.01
BWAC603624P	691	866	1416	1890	1	36	24	71	2.16
BWAC603630P	740	926	1541	2056	1	36	30	76	2.31

- will not have the plastic scoop, they will remain with the curve cut scoop.
- To specify wood trim (T) or complete wood (W) surfaces, please remove the last "P" from the code, replace with "SCP" and add either a "T" or "W" and the old scoop style is going to be created.

BWCE • Extended Curved Corner Worksurface

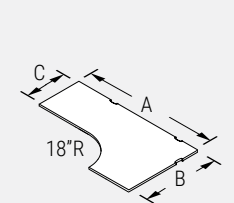

NOTE: BWCE

60	42	24
A	B	C
WIDTH	WIDTH	LENGTH

- **Extended curved corner unit with a radius user edge.**
- Creates efficient use of a corner unit.
- Please choose from DWT - Designer White, SIL - Silver or BLK - Black for scoop covers.
- Surfaces with wood trim (T) and complete wood (W) will not have the plastic scoop, they will remain with the curve cut scoop.
- To specify wood trim (T) or complete wood (W) surfaces, please remove the last "P" from the code, replace with "SCP" and add either a "T" or "W" and the old scoop style is going to be created.

PRODUCT CODE	PRICE LP*	GROUP HP*	T*	W*	SIZE/ INCHES			WEIGHT VOL	
					H	W	D	LBS	FT ³
BWCE426024P	668	832	1230	2020	1	60	42	57	2.2
BWCE426624P	736	919	1286	2107	1	66	42	62	2.5
BWCE427224P	811	1015	1440	2362	1	72	42	66	2.7
BWCE427824P	867	1084	1539	2519	1	78	42	71	2.9
BWCE428424P	934	1166	1656	2715	1	84	42	75	3.1
BWCE486024P	763	955	1528	2507	1	60	48	66	2.5
BWCE486624P	849	1060	1575	2641	1	66	48	71	2.8
BWCE487224P	928	1162	1575	2641	1	72	48	76	3.1
BWCE487824P	991	1236	1733	2842	1	78	48	83	3.3
BWCE488424P	1051	1313	1733	2842	1	84	48	93	3.6
BWCE486030P	849	1060	1528	2507	1	60	48	68	2.5
BWCE486630P	928	1162	1608	2640	1	66	48	74	2.8
BWCE487230P	991	1236	1647	2698	1	72	48	80	3.1
BWCE487830P	1051	1313	1785	2926	1	78	48	85	3.3
BWCE488430P	1124	1408	1923	3149	1	84	48	96	3.6
BWCE604224P	668	832	1230	2020	1	42	60	57	2.2
BWCE604824P	763	955	1528	2507	1	48	60	66	2.6
BWCE604830P	849	1060	1528	2507	1	48	60	68	2.6
BWCE664224P	736	919	1286	2107	1	42	66	62	2.5
BWCE664824P	849	1060	1575	2641	1	48	66	71	2.8
BWCE664830P	928	1162	1608	2640	1	48	66	74	2.8
BWCE724224P	811	1015	1440	2362	1	42	72	66	2.7
BWCE724824P	928	1162	1575	2641	1	48	72	76	3.1
BWCE724830P	991	1236	1647	2698	1	48	72	80	3.1
BWCE784224P	867	1084	1539	2519	1	42	78	71	2.9
BWCE784824P	991	1236	1733	2842	1	48	78	83	3.3
BWCE784830P	1051	1313	1785	2926	1	48	78	85	3.3
BWCE844224P	934	1166	1656	2715	1	42	84	75	3.1
BWCE844824P	1051	1313	1733	2844	1	48	84	93	3.6
BWCE844830P	1124	1408	1923	3149	1	48	84	96	3.6

• LP = Thermally Fused Laminate, HP = High Pressure Laminate, T= High Pressure Laminate with Wood Trim, W= Wood Veneer

BWCEC • Extended Curvilinear Corner Worksurface

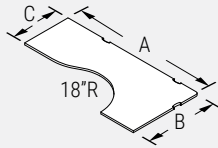

- **Extended curved corner unit with a radius user edge.**
- Creates efficient use of a corner unit.
- Please choose from DWT - Designer White, SIL - Silver or BLK - Black for scoop covers.
- Surfaces with wood trim (T) and complete wood (W) will not have the plastic scoop, they will remain with the curve cut scoop.
- To specify wood trim (T) or complete wood (W) surfaces, please remove the last "P" from the code, replace with "SCP" and add either a "T" or "W" and the old scoop style is going to be created.

PRODUCT CODE	PRICE LP*	GROUP		W*	SIZE/ INCHES			WEIGHT VOL	
		HP*	T*		A	B	C	LBS	FT ³
BWCEC366024P	626	782	1524	2030	36	60	24	59	0.05
BWCEC366624P	658	821	1581	2107	36	66	24	65	0.60
BWCEC367224P	716	895	1746	2323	36	72	24	71	0.07
BWCEC367824P	778	971	1847	2461	36	78	24	77	0.07
BWCEC368424P	868	1084	2032	2626	36	84	24	83	0.08
BWCEC426624P	757	945	1843	2457	42	66	24	76	0.07
BWCEC427224P	838	1047	2032	2710	42	72	24	83	0.08
BWCEC427824P	893	1118	2155	2872	42	78	24	90	0.08
BWCEC428424P	963	1202	2300	3066	42	84	24	96	0.09
BWCEC487230P	1022	1279	2245	2991	48	72	30	94	0.09
BWCEC487830P	1099	1375	2396	3192	48	78	30	102	0.09
BWCEC488430P	1161	1451	2548	3392	48	84	30	110	0.10
BWCEC488424P	1098	1375	2300	3066	48	84	24	110	0.10
BWCEC603624P	626	782	1524	2030	60	36	24	59	0.05
BWCEC663624P	658	821	1581	2107	66	36	24	65	0.60
BWCEC664224P	757	945	1843	2457	66	42	24	76	0.07
BWCEC723624P	716	895	1746	2323	72	36	24	71	0.07
BWCEC724224P	838	1047	2032	2710	72	42	24	83	0.08
BWCEC724830P	1022	1279	2245	2991	72	48	30	94	0.09
BWCEC783624P	778	971	1847	2461	78	36	24	77	0.07
BWCEC784224P	893	1118	2155	2872	78	42	24	89	0.08
BWCEC784830P	1099	1375	2396	3192	78	48	30	102	0.09
BWCEC843624P	868	1084	2032	2626	84	36	24	83	0.08
BWCEC844224P	963	1202	2032	2626	84	42	24	96	0.09
BWCEC844824P	1098	1375	2300	3066	84	48	24	110	0.10
BWCEC844830P	1161	1451	2548	3392	84	48	30	110	0.10

NOTE: BWSC

66	42	24
A	B	C
WIDTH	WIDTH	LENGTH

BWSL • Curvilinear Arc Worksurface

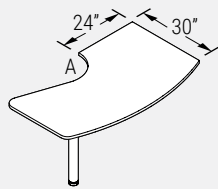

RIGHT HAND SHOWN MONOLEG MOUNTED ON THE RIGHT USER SIDE.

- **Arc shaped worksurface provides an extended conferencing area.**
- 1 BHML03 Monoleg included.
- Not recommended for use with modesty panel due to knee swing interference.
- For chrome finish on leg, please add \$106 list upcharge.

PRODUCT CODE	PRICE LP*	GROUP		W*	SIZE/ INCHES			WEIGHT VOL	
		HP*	T*		H	W	D	LBS	FT ³
BWSL3060L	867	1031	1135	1928	29	60	30	48	1.69
BWSL3066L	908	1080	1261	2160	29	66	30	53	1.85
BWSL3072L	944	1131	1388	2396	29	72	30	58	2.01
BWSL3060R	867	1031	1135	1928	29	60	30	48	1.69
BWSL3066R	908	1080	1261	2160	29	66	30	53	1.85
BWSL3072R	944	1131	1388	2396	29	72	30	58	2.01

- A = 27" for 60", 66" worksurfaces
- A = 26.5" for 72" worksurfaces

BWSL • Curvilinear Arc Worksurface

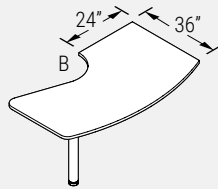

RIGHT HAND SHOWN MONOLEG MOUNTED ON THE RIGHT USER SIDE.

- **Arc shaped worksurface provides an extended conferencing area.**
- 1 BHML03 Monoleg included.
- For chrome finish on leg, please add \$106 list upcharge.

PRODUCT CODE	PRICE LP*	GROUP		W*	SIZE/ INCHES			WEIGHT VOL	
		HP*	T*		H	W	D	LBS	FT ³
BWSL3660L	983	1177	1290	2220	29	60	36	57	2.07
BWSL3666L	1063	1279	1440	2489	29	66	36	64	2.26
BWSL3672L	1140	1375	1587	2762	29	72	36	71	2.45
BWSL3660R	983	1177	1290	2220	29	60	36	57	2.07
BWSL3666R	1063	1279	1440	2489	29	66	36	64	2.26
BWSL3672R	1140	1375	1587	2762	29	72	36	71	2.45

- B = 33" for 60", 66" worksurfaces
- B = 32.5" for 72" worksurfaces

• LP = Thermally Fused Laminate, HP = High Pressure Laminate, T= High Pressure Laminate with Wood Trim, W= Wood Veneer

BWD • “D” Worksurface

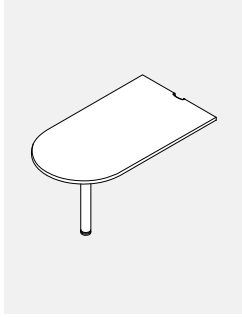

• **Rounded work surface for conferencing.**

• Supported by Monoleg at one end and panel at the opposite end.

• 1 BHML03 Monoleg included.

• Modesty panel available, see BWMP (not included).

• For chrome finish on leg, please add \$106 list upcharge.

• Please choose from DWT - Designer White, SIL - Silver or BLK - Black for scoop covers.

• Surfaces with wood trim (T) and complete wood (W) will not have the plastic scoop, they will remain with the curve cut scoop.

• To specify wood trim (T) or complete wood (W) surfaces, please remove the last “P” from the code, replace with “SCP” and add either a “T” or “W” and the old scoop style is going to be created.

PRODUCT CODE	PRICE LP*	GROUP			SIZE/ INCHES			WEIGHT VOL	
		HP*	T*	W*	H	W	D	LBS	FT ³
BWD2442P	552	640	675	1162	1	42	24	27	0.97
BWD2448P	576	673	705	1201	1	48	24	31	1.11
BWD2454P	592	691	778	1430	1	54	24	35	1.24
BWD2460P	605	704	813	1658	1	60	24	39	1.36
BWD2466P	622	732	849	1720	1	66	24	43	1.52
BWD2472P	642	756	884	1807	1	72	24	47	1.66
BWD3048P	579	675	807	1650	1	48	30	38	1.38
BWD3054P	609	712	838	1707	1	54	30	43	1.56
BWD3060P	646	757	879	1814	1	60	30	48	1.69
BWD3066P	674	793	944	1903	1	66	30	53	1.82
BWD3072P	710	839	966	1995	1	72	30	58	2.01
BWD3078P	751	890	1031	2145	1	78	30	63	2.25
BWD3084P	816	970	1096	2296	1	84	30	68	2.42

BWP • “P” Worksurface

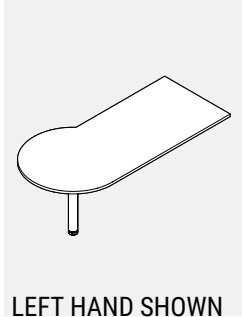

LEFT HAND SHOWN

• **Rounded work surface provides an extended conferencing area.**

• **36” diameter end.**

• Supported by monoleg at one end and panel at the opposite end.

• 1 BHML03 Monoleg included.

• Modesty panel available, see BWMP (not included).

• For chrome finish on leg, please add \$106 list upcharge.

PRODUCT CODE	PRICE LP*	GROUP			SIZE/ INCHES			WEIGHT VOL	
		HP*	T*	W*	H	W	D	LBS	FT ³
BWPL3054	851	1008	1124	2399	1	54	36	51	1.87
BWPL3060	889	1056	1135	2423	1	60	36	58	2.03
BWPL3066	963	1148	1164	2724	1	66	36	65	2.24
BWPL3072	1004	1200	1280	3027	1	72	36	70	2.41
BWPL3084	1110	1334	1618	3571	1	84	36	81	2.79
BWPR3054	851	1008	1124	2399	1	54	36	51	1.87
BWPR3060	889	1056	1135	2423	1	60	36	58	2.03
BWPR3066	963	1148	1164	2724	1	66	36	65	2.24
BWPR3072	1004	1200	1280	3027	1	72	36	70	2.41
BWPR3084	1110	1334	1618	3571	1	84	36	81	2.79

BWMP • “D” and “P” Worksurface Modesty Panel

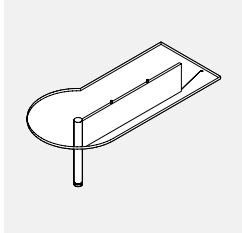

• **Made of cold rolled steel, fastens to the work surface and Monoleg for additional privacy.**

PRODUCT CODE	PRICE	GROUP			SIZE/ INCHES			WEIGHT VOL	
		HP*	T*	W*	H	W	D	LBS	FT ³
BWMP1248	122				1	32	12	12	0.4
BWMP1254	145				1	38	12	15	0.47
BWMP1260	169				1	44	12	17	0.53
BWMP1266	194				1	50	12	20	0.61
BWMP1272	218				1	56	12	22	0.66
BWMP1278	233				1	62	12	25	0.71
BWMP1284	252				1	68	12	27	0.79

BWR • Radius Worksurface

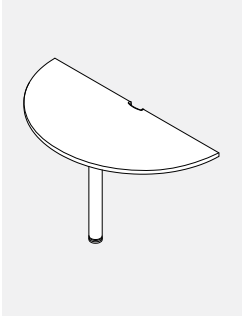

• **Rounded work surface for conferencing provides a radius corner.**

• 18” and 24” come with 1 BHML03 Monoleg and 30” comes with 2.

• Radius cut out on the straight edge allows space for aluminum trims.

• For chrome finish on leg, please add \$106 list upcharge for each leg.

• Please choose from DWT - Designer White, SIL - Silver or BLK - Black for scoop covers.

• Surfaces with wood trim (T) and complete wood (W) will not have the plastic scoop, they will remain with the curve cut scoop.

• To specify wood trim (T) or complete wood (W) surfaces, please remove the last “P” from the code and add either a “T” or “W” and the old scoop style is going to be created.

PRODUCT CODE	PRICE LP*	GROUP			SIZE/ INCHES			WEIGHT VOL	
		HP*	T*	W*	H	W	D	LBS	FT ³
BWR18P	488	561	765	1289	1	38.5	18	27	1.70
BWR24P	560	649	837	1524	1	50.5	24	41	2.20
BWR30P	941	1076	1251	2305	1	62.5	30	59	2.70

• LP = Thermally Fused Laminate, HP = High Pressure Laminate, T = High Pressure Laminate with Wood Trim, W = Wood Veneer

BWRTD • Teardrop Worksurface

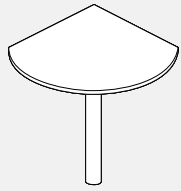

- Rounded worksurface for conferencing provides a radius corner from a work-surface to worksurface.
- 1 BHML03 Monoleg included.
- For chrome finish on leg, please add \$106 list upcharge.

PRODUCT CODE	PRICE LP*	GROUP HP*	T*	W*	SIZE/ H	INCHES			WEIGHT VOL	
						W	D	LBS	FT ³	
BWRTD18	315	358	633	777	1	18	18	24	1.60	
BWRTD24	380	430	751	938	1	24	24	33	1.90	
BWRTD30	455	552	909	1154	1	30	30	43	2.20	

BWRP • Corner Radius Worksurface with Cutout

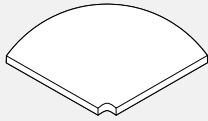

- Corner Radius Worksurface with Cut-Out allows worksurface to be used around a post.
- Cut out fits snug to the post, if trim is attached to the post, the worksurface or PVC trim may need to be cut on site to fit.

PRODUCT CODE	PRICE LP*	GROUP HP*	T*	W*	SIZE/ H	INCHES			WEIGHT VOL	
						W	D	LBS	FT ³	
BWRP1818	157	196	374	518	1	21	21	12	0.40	
BWRP2424	228	284	498	762	1	27	27	19	0.64	
BWRP3030	281	353	622	859	1	33	33	29	1.00	

BWT • Transaction Worksurface

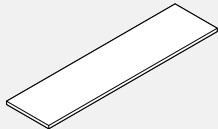

- Attaches to the top of a 37" or 42" high panel to form a transaction worksurface.
- To attach a Boulevard 1 37" high panel please specify BHBT37, all other heights specify BHBT02.
- To attach a Boulevard 1 panel with flat trim, please specify BHBT37FT or BHBT02FT.

PRODUCT CODE	PRICE LP*	GROUP HP*	T*	W*	SIZE/ H	INCHES			WEIGHT VOL	
						W	D	LBS	FT ³	
BWT1512	58	75	151	220	1	12	15	5	0.22	
BWT1518	72	99	189	251	1	18	15	7	0.30	
BWT1524	90	120	229	332	1	24	15	10	0.38	
BWT1530	109	142	268	394	1	30	15	12	0.46	
BWT1536	124	165	308	429	1	36	15	14	0.54	
BWT1542	142	188	355	497	1	42	15	17	0.62	
BWT1548	161	211	377	537	1	48	15	19	0.70	
BWT1554	173	232	425	562	1	54	15	22	0.78	
BWT1560	193	255	441	589	1	60	15	24	0.86	
BWT1566	207	276	481	647	1	66	15	28	0.94	
BWT1572	227	298	520	679	1	72	15	29	1.02	
BWT1578	242	323	561	877	1	78	15	31	1.10	
BWT1584	259	343	667	954	1	84	15	34	1.18	

BWTC • Transaction Corner Worksurface

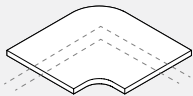

- Attaches to the top of a 37" or 42" high panel to form a corner transaction worksurface.
- Covers 12" of a panel.
- To attach a 37" high panel please specify BHBT37, all other heights specify BHBT02.
- To attach a Boulevard 1 panel with flat trim, please specify BHBT37FT or BHBT02FT.

PRODUCT CODE	PRICE LP*	GROUP HP*	T*	W*	SIZE/ H	INCHES			WEIGHT VOL	
						W	D	LBS	FT ³	
BWTC90	154	193	310	667	1	20.7	20.7	11	0.49	
BWTC45	189	234	362	693	1	21.5	21.5	12	0.53	
BWTC60	198	234	362	693	1	22.5	22.5	14	0.60	

• LP = Thermally Fused Laminate, HP = High Pressure Laminate, T= High Pressure Laminate with Wood Trim, W= Wood Veneer

BWTT • Transaction “T” Worksurface

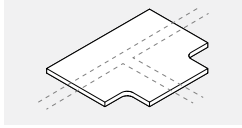

- Attaches to the top of a 37" or 42" high panel to form a "T" corner transaction worksurface
- Covers 12" of a panel.
- To attach a 37" high panel please specify BHBT37, all other heights specify BHBT02.

PRODUCT CODE	PRICE LP*	GROUP HP*	T*	W*	SIZE/ INCHES			WEIGHT VOL	
					H	W	D	LBS	FT ³
BWTT2721	166	206	326	835	1	21.5	26.5	15	0.6

BWTAC • Transaction Worksurface for 45 Degree Corner Worksurface

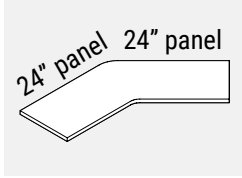

- Attaches to the top of 37" or 42" high panel to form a 45 degree corner transaction worksurface.
- To attach a 37" high panel please specify BHBT37, all other heights specify BHBT02.

PRODUCT CODE	PRICE LP*	GROUP HP*	T*	W*	SIZE/ INCHES			WEIGHT VOL	
					H	W	D	LBS	FT ³
BWTAC452415	686	859	886	1209	1	47	15	39	1.38

BWTAC • Transaction Worksurface for 60 Degree Corner Worksurface

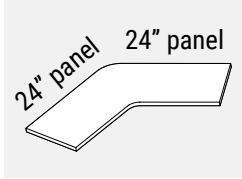

- Attaches to the top of 42" high panel to form a 60 degree corner transaction worksurface.
- To attach a 37" high panel please specify BHBT37, all other heights specify BHBT02.

PRODUCT CODE	PRICE LP*	GROUP HP*	T*	W*	SIZE/ INCHES			WEIGHT VOL	
					H	W	D	LBS	FT ³
BWTAC602415	743	930	944	1260	1	44	15	38	1.32

BWTD • Transaction “D” Worksurface

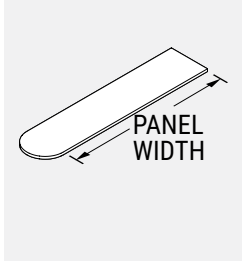

- Attaches to the top of a 37" or 42" high panel to form a transaction worksurface with a radiused end.
- Surface overhangs the panel by 7 1/2" on one side.
- To attach a 37" high panel please specify BHBT37, all other heights specify BHBT02.

PRODUCT CODE	PRICE LP*	GROUP HP*	T*	W*	SIZE/ INCHES			WEIGHT VOL	
					H	W	D	LBS	FT ³
BWTD1530	141	184	341	551	1	37.5	15	17	0.65
BWTD1536	149	198	361	585	1	43.5	15	19	0.69
BWTD1542	166	222	399	646	1	49.5	15	22	0.74
BWTD1548	186	244	419	699	1	55.5	15	25	0.77
BWTD1554	201	266	435	724	1	61.5	15	27	0.85
BWTD1560	222	294	447	744	1	67.5	15	30	0.94
BWTD1566	238	314	512	853	1	73.5	15	33	1.02
BWTD1572	257	341	575	958	1	79.5	15	35	1.10

• LP = Thermally Fused Laminate, HP = High Pressure Laminate, T= High Pressure Laminate with Wood Trim, W= Wood Veneer

BWTDD • Transaction Double “D” Worksurface

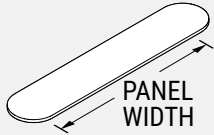

- Attaches to the top of a 37” or 42” high panel to form a transaction worksurface with 2 radius ends.
- Surface overhangs the panel by 7 1/2” on each end.
- To attach a 37” high panel please specify BHBT37, all other heights specify BHBT02.

PRODUCT CODE	PRICE LP*	GROUP			W*	SIZE/ H	INCHES			WEIGHT VOL	
		HP*	T*	W*			H	W	D	LBS	FT ³
BWTDD1548	207	276	512	853	1	63	15	28	1.00		
BWTDD1554	227	298	527	879	1	69	15	31	1.01		
BWTDD1560	242	323	541	902	1	75	15	33	1.04		
BWTDD1566	263	345	607	1007	1	81	15	35	1.13		
BWTDD1572	281	374	669	1114	1	87	15	38	1.21		

BWTE • Elliptical Transaction Worksurface

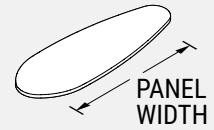

- Attaches to the top of a 37” or 42” high panel to form a transaction worksurface.
- To attach a 37” high panel please specify BHBT37, all other heights specify BHBT02.
- Depth different than standard tops.

PRODUCT CODE	PRICE LP*	GROUP			W*	SIZE/ H	INCHES			WEIGHT VOL	
		HP*	T*	W*			H	W	D	LBS	FT ³
BWTE36	331	413	991	1454	1	52	18	22	0.78		
BWTE42	378	471	991	1454	1	58	19	24	0.81		

BWTP • Oval Transaction Worksurface

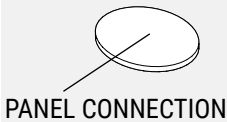

- Attaches to the top of a 37” or 42” high panel to form a transaction worksurface.
- To attach a 37” high panel please specify BHBT37, all other heights specify BHBT02.
- Must be specified at post condition or panel joint.

PRODUCT CODE	PRICE LP*	GROUP			W*	SIZE/ H	INCHES			WEIGHT VOL	
		HP*	T*	W*			H	W	D	LBS	FT ³
BWTP1518	238	296	413	596	1	15	18	10	0.35		

BWCD • Round Table



- Freestanding round meeting table with 4 prong tubular base.
- For chrome base please upcharge \$106 list.

PRODUCT CODE	PRICE LP*	GROUP			W*	SIZE/ H	INCHES			WEIGHT VOL	
		HP*	T*	W*			H	W	D	LBS	FT ³
BWCD30	490	541	827	1075	29	30 dia	30 dia	35	10.0		
BWCD36	556	622	938	1235	29	36 dia	36 dia	42	10.0		
BWCD42	681	782	1239	1671	29	42 dia	42 dia	52	11.0		

BWSQ • Square Table

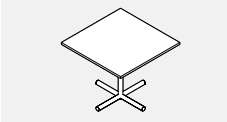

- Freestanding square meeting table with 4 prong tubular base.
- For chrome base please upcharge \$106 list.

PRODUCT CODE	PRICE LP*	GROUP			W*	SIZE/ H	INCHES			WEIGHT VOL	
		HP*	T*	W*			H	W	D	LBS	FT ³
BWSQ24	469	513	585	765	29	24	24	34	10.0		
BWSQ30	490	541	716	1008	29	30	30	38	10.0		
BWSQ36	556	622	835	1224	29	36	36	46	11.0		
BWSQ42	681	782	959	1596	29	42	42	57	11.0		

• LP = Thermally Fused Laminate, HP = High Pressure Laminate, T = High Pressure Laminate with Wood Trim, W = Wood Veneer

BHCL • “C” Leg

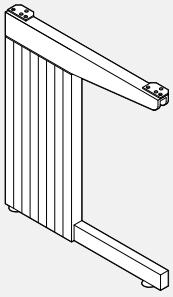

- **Attaches to panel support worksurface or to provide free-standing table support.**
- Steel structure, PVC cover.
- Universal non-handed.
- For a single rectangular freestanding worksurface application, specify two “C” Legs and one Modesty Panel of corresponding width.
- May be used as a shared leg between two adjoining worksurfaces. Specify one “C” Leg, one Modesty Panel of corresponding width, plus one Modesty Panel Extension Bracket.
- For corner worksurfaces, specify two “C” Legs, one Corner Leg and two Modesty Panels 6” shorter than rear sides of the corner worksurface.
- Can be used as a floor support in a panel attached application (similar to a cantilever).
- Includes worksurface mounting brackets with screws, Bracket Retainer Clip and panel bracket.
- Accommodates 15” knee space.
- Intended for use with flexlip worksurfaces. When used on other worksurfaces, modesty panel must be installed upside down.

PRODUCT CODE	PRICE	SIZE/ INCHES			WEIGHT VOL	
		H	W	D	LBS	FT ³
BHCL2618	220	25	1	18	7	0.27
BHCL2624	228	25	1	24	8	0.36
BHCL2918	238	28	1	18	8	0.30
BHCL2924	246	28	1	24	9	0.40

BKC • Corner Leg

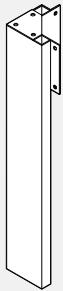

- **Five sided worksurface support.**
- Steel construction.
- Non handed.
- Includes bolts for modesty panel attachment.
- For corner worksurfaces, specify two “C” Legs, one Corner Leg and two Modesty Panels 6” shorter than rear sides of the corner worksurface.

PRODUCT CODE	PRICE	SIZE/ INCHES			WEIGHT VOL	
		H	W	D	LBS	FT ³
BKC26	140	25	7	7	3.0	0.02
BKC29	157	28	7	7	3.2	0.02

BKMP • Modesty Panel

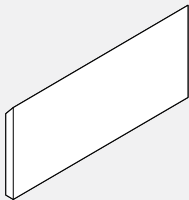

- **For rectangular worksurfaces, specify Modesty Panel of corresponding width. For corner worksurfaces, specify two Modesty Panels 6” shorter than rear side of corner worksurface.**
- Attaches between two “C” Legs, or between one “C” Leg and a Corner Leg, or a shared “C” Leg and “C” Leg at the end of a run.
- Includes brackets and screws to attach Modesty Panel to worksurface.
- For use with flex lip worksurfaces only.
- To install on “SCP” or “NFL” worksurface, modesty panel must be inverted.

PRODUCT CODE	PRICE	SIZE/ INCHES			WEIGHT VOL	
		H	W	D	LBS	FT ³
BKMP1224	165	11	24	0.25	2.75	0.17
BKMP1230	174	11	30	0.25	2.75	0.21
BKMP1236	188	11	36	0.25	3.00	0.25
BKMP1242	195	11	42	0.25	4.00	0.29
BKMP1248	206	11	48	0.25	4.50	0.33
BKMP1254	215	11	54	0.25	5.00	0.38
BKMP1260	228	11	60	0.25	5.50	0.42

BHMEB • Modesty Panel Extension Bracket



- **Modesty Panel Extension Bracket made of cold rolled steel.**
- Attaches the Modesty Panel of an adjoining worksurface to a shared “C” Leg.
- Includes all attachment hardware.

PRODUCT CODE	PRICE	SIZE/ INCHES			WEIGHT VOL	
		H	W	D	LBS	FT ³
BHMEB01	22	10	1.5	0.125	0.5	0.01

BHFG • Full Gable - Self Edged

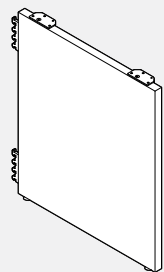

- **Provides floor standing support while enclosing an end of a run of worksurfaces.**
- Includes attachment hardware, Bracket Retainer Clip and levelling glides.
- Non-handed.
- May be used as a shared gable between two adjoining worksurfaces.

PRODUCT CODE	PRICE LP*	GROUP HP*	SIZE/ INCHES			WEIGHT VOL	
			H	W	D	LBS	FT ³
BHFG2608	142	177	25	1	8	7	0.14
BHFG2612	182	227	25	1	12	13	0.21
BHFG2618	222	276	25	1	18	13	0.27
BHFG2624	244	304	25	1	24	19	0.36
BHFG2630	329	408	25	1	30	23	0.45
BHFG2636	410	513	25	1	36	24	0.57
BHFG2908	142	177	28	1	8	7	0.16
BHFG2912	182	227	28	1	12	14	0.30
BHFG2918	222	276	28	1	18	14	0.30
BHFG2924	244	304	28	1	24	17	0.40
BHFG2930	329	408	28	1	30	21	0.50
BHFG2936	410	513	28	1	36	26	0.65

• LP = Thermally Fused Laminate, HP = High Pressure Laminate, T= High Pressure Laminate with Wood Trim, W= Wood Veneer

BHFGP • Full Gable - 3mm PVC Edged

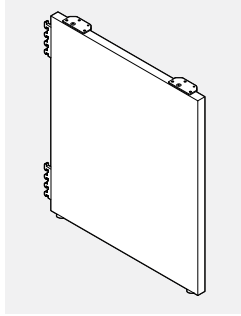

- Provides floor standing support while enclosing an end of a run of worksurfaces.
- Includes attachment hardware, Bracket Retainer Clip and levelling glides.
- Provides consistent edging matching the worksurface trim.
- Handed once installed.
- May be used as a shared gable between two adjoining worksurfaces.

PRODUCT CODE	PRICE LP*	GROUP HP*	SIZE/ INCHES			WEIGHT VOL	
			H	W	D	LBS	FT ³
BHFGP2608	142	177	25	1	8	7	0.14
BHFGP2612	182	227	25	1	12	13	0.21
BHFGP2618	222	276	25	1	18	13	0.27
BHFGP2624	244	304	25	1	24	19	0.36
BHFGP2630	329	408	25	1	30	23	0.45
BHFGP2636	410	513	25	1	36	24	0.57
BHFGP2908	142	177	28	1	8	7	0.16
BHFGP2912	182	227	28	1	12	14	0.30
BHFGP2918	222	276	28	1	18	14	0.30
BHFGP2924	244	304	28	1	24	17	0.40
BHFGP2930	329	408	28	1	30	21	0.50
BHFGP2936	410	513	28	1	36	26	0.65

BHPG • "P" Shaped Full Gable - 3mm PVC Edged

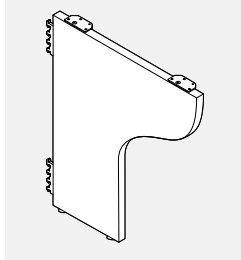

- Provides floor standing support while enclosing an end of a run of worksurfaces.
- Includes attachment hardware, Bracket Retainer Clip and levelling glides.
- Handed due to hardware attachment and PVC edge.

PRODUCT CODE	PRICE LP*	GROUP HP*	SIZE/ INCHES			WEIGHT VOL	
			H	W	D	LBS	FT ³
BHPG2624L	244	304	25	1	24	19	0.36
BHPG2924L	244	304	28	1	24	17	0.40
BHPG2624R	244	304	25	1	24	19	0.36
BHPG2924R	244	304	28	1	24	17	0.40

BHLEG • Gable Leg

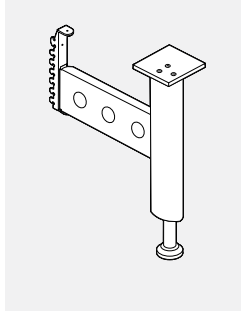

- Support the worksurface and enhances the stability of connected panels.
- Universal leg plate bolts to the underside of the worksurface.
- Can be configured on-site for left, right or shared worksurface support application on front edge
- Back edge does not have shared support.
- Tubular leg section adjusts in 1" increments, the leveller can be used for fine adjustment.
- 1" increment leg adjustment and 1" increment panel slots allow the leg of installed worksurface to be supported from 26" to 32". (Leg must be removed from panel to manually adjust.)
- Side plate is secured to the slots in the vertical of the Boulevard 1 or System 3 panels and the leg plate bolts to underside of the worksurface.
- Made of extruded aluminum and steel.
- Includes all mounting hardware to connect to panel and worksurface.

PRODUCT CODE	PRICE LP*	GROUP HP*	SIZE/ INCHES			WEIGHT VOL	
			H	W	D	LBS	FT ³
BHLEG	205		28	6	23	8	0.15

BRTHLEG • Boulevard Leg Assembly

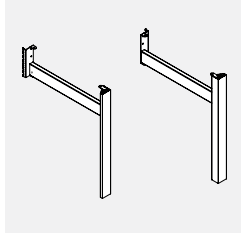

- Boulevard Leg Assembly attaches to a Boulevard panel for applications which require functionality of Boulevard panels with an open environment of Bridges tables.
- One leg with horizontal member connecting to 1" increment slots in panel's vertical frame member. Provides support to panel and panel-connected worksurface at the end of a run; design coordinated with Bridges freestanding tables.
- Supports 24" and 30" deep worksurfaces. By adding 2 BHBF01 flat brackets and 1 BHBC02 corner bracket, a single leg can then support the adjoining worksurface. Leveling glide is standard. No worksurface supporting beams, use panel cantilevers and storage for worksurface support. One aluminum leg with steel structure - specify Left or Right and 24" or 30" deep for corresponding worksurface depths. Panel bracket, dislodgment clip and worksurface hardware included.
- Anodized aluminum leg upcharge \$28.
- Please specify paint finish for support.

PRODUCT CODE	PRICE LP*	GROUP HP*	SIZE/ INCHES			WEIGHT VOL	
			H	W	D	LBS	FT ³
BRTHLEG24LL	308		28	2.5	24	9	1.25
BRTHLEG24RL	308		28	2.5	24	9	1.25
BRTHLEG30LL	323		28	2.5	30	11	1.45
BRTHLEG30RL	323		28	2.5	30	11	1.45

BRTBL • Boulevard Leg Assembly

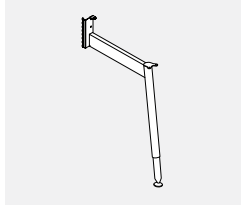

- Boulevard Leg Assembly attaches to a Boulevard panel for applications which require functionality of Boulevard panels with an open environment of Bridge 2 tables.
- Panel bracket secures the leg to the panel in 1" increments, within a 24" to 32" height range.
- Panel mounting bracket is reversible for non-handed applications.
- Supports 24" and 30" deep worksurfaces. By adding 2 BHBF01 flat brackets and 1 BHBC02 corner bracket, a single leg can then support the adjoining worksurface. Leveling glide is standard. No worksurface supporting beams, use panel cantilevers and storage for worksurface support. Panel bracket, dislodgment clip and worksurface hardware included.
- Leveling glide is standard.

PRODUCT CODE	PRICE LP*	GROUP HP*	SIZE/ INCHES			WEIGHT VOL	
			H	W	D	LBS	FT ³
BRTBL	328		28	3	24	12	1.25

• LP = Thermally Fused Laminate, HP = High Pressure Laminate, T= High Pressure Laminate with Wood Trim, W= Wood Veneer

BHML • Monoleg

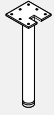

- **3" diameter Monoleg provides support for worksurfaces.**
- Top plate welded to leg.
- 8" x 8" plated attached to worksurface with #10 3/4" wood screws, included.
- 1" height adjustment range.
- For chrome finish on leg, please add \$106 list upcharge.

PRODUCT CODE	PRICE	SIZE/ INCHES			WEIGHT VOL	
		H	W	D	LBS	FT ³
BHML03	188	28	3	3	8	0.15

LATBL • Tapered Leg



- **Tapered leg provides support for worksurfaces.**
- Top plate welded to leg.
- 8" x 8" plated attached to worksurface with #10 3/4" wood screws, included.
- 1" height adjustment range.
- For chrome finish on leg, please add \$106 list upcharge.

PRODUCT CODE	PRICE	SIZE/ INCHES			WEIGHT VOL	
		H	W	D	LBS	FT ³
LATBL28	177	28	3	3	8	0.15

VVLEGLV • Leg with Leveler

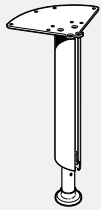

- **The Viceversa leg features a push button height adjustment mechanism. This mechanism allows the user to easily set the height of a table. The universal mounting plate can be used to gang 2 tables without metal skirt simply by rotating 45 degrees to span both tops.**
- The Viceversa Leg has a wire management channel that neatly organizes electrical and communication cables running from the worksurface to the floor.
- Legs have a height range of 25" to 32" in 1" increments (includes 1" top).
- The wire channel is covered by a clear PVC snap-on cover.
- Levelers have a 1/2" height range.
- Levelers come in charcoal only.
- Includes mounting hardware.

PRODUCT CODE	PRICE	SIZE/ INCHES			WEIGHT VOL	
		H	D	W	LBS	FT ³
VVLEGLV	177	25-32	8	10	8	1.5

VVLEGLC • Leg with Caster

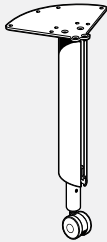

- **The Viceversa leg features a push button height adjustment mechanism. This mechanism allows the user to easily set the height of a table. The universal mounting plate can be used to gang 2 tables without metal skirt simply by rotating 45 degrees to span both tops.**
- The Viceversa Leg has a wire management channel that neatly organizes electrical and communication cables running from the worksurface to the floor.
- Legs have a height range of 26" to 33" in 1" increments.
- The wire channel is covered by a clear PVC snap-on cover.
- Casters come in grey with black only.
- Includes mounting hardware.

PRODUCT CODE	PRICE	SIZE/ INCHES			WEIGHT VOL	
		H	D	W	LBS	FT ³
VVLEGLC	177	26-33	8	10	8	1.5

VVLEGF • Fixed Height Leg



- **The Viceversa fixed height leg with leveler supports the worksurface at a fixed height of 29".**
- The Viceversa leg has a wire management channel that neatly organizes electrical and communication cables running from the worksurface to the floor.
- Leg can be installed for each corner of the worksurface or can be shared at adjoining surfaces.
- The wire channel is covered by a clear PVC snap-on cover.
- Levelers have a 1/2" height range.
- Levelers come in charcoal only.
- Includes mounting hardware.

PRODUCT CODE	PRICE	SIZE/ INCHES			WEIGHT VOL	
		H	D	W	LBS	FT ³
VVLEGF	141	28	8	10	8	1.5

BHC • Cantilever

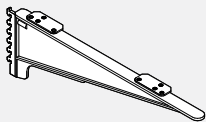

- **Universal cantilever with steel attachment bracket constructed of cast aluminum to provide support for worksurfaces.**
- Attaches a worksurface to a panel.
- May be used for shared worksurface support.
- Interchangeable in the field for left or right positioning.
- Includes Bracket Retainer Clip.

PRODUCT CODE	PRICE	SIZE/ INCHES			WEIGHT VOL	
		H	W	D	LBS	FT ³
BHC18	101	7	17	2.5	17	0.04
BHC24	118	7	23	2.5	23	0.05

• LP = Thermally Fused Laminate, HP = High Pressure Laminate, T= High Pressure Laminate with Wood Trim, W= Wood Veneer

BHBC • Corner End Bracket

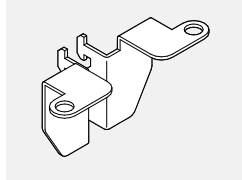

- Formed steel bracket for a corner worksurface or a straight worksurface.
- Attaches a corner of any worksurface to a panel through the panel vertical slots.
- Priced one left and one right per package.
- Includes Bracket Retainer Clip.

PRODUCT CODE	PRICE	SIZE/ INCHES			WEIGHT VOL	
		H	W	D	LBS	FT ³
BHBC02	25	3.3	1.5	2.3	2	0.007

BHBF • Flat Bracket

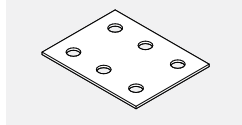

- Flat Bracket made of cold rolled steel.
- May be used to ensure alignment of neighboring worksurfaces.

PRODUCT CODE	PRICE	SIZE/ INCHES			WEIGHT VOL	
		H	W	D	LBS	FT ³
BHBF01	13	0.1	3	4	0.5	0.007

BHBT • Transaction Bracket

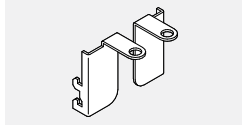

- For use on 34", 42", 50", 58", 66", 74" and 82" high Boulevard panels.
- Transaction Bracket made of cold rolled steel.
- To provide a secure attachment of a transaction worksurface.
- Priced one left and one right per package.
- Includes Bracket Retainer Clip.

PRODUCT CODE	PRICE	SIZE/ INCHES			WEIGHT VOL	
		H	W	D	LBS	FT ³
BHBT02	25	3.3	1.5	2.3	2	0.001

BHBT • Transaction Bracket for 37" High Boulevard 1 Panels

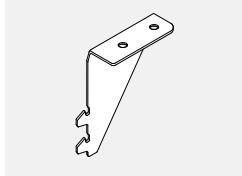

- Transaction Bracket made of cold rolled steel.
- To provide a secure attachment of a transaction worksurface for a 37" high Boulevard 1 panel only. Transaction Bracket engages with the top slots in the 37" high panel to supported for the transaction worksurface.
- Priced one left and one right per package.
- Includes Bracket Retainer Clip.

PRODUCT CODE	PRICE	SIZE/ INCHES			WEIGHT VOL	
		H	W	D	LBS	FT ³
BHBT37	30	4	1	3	0.5	0.007

BHBZ • "Z" Bracket

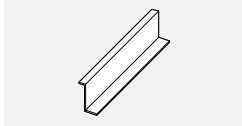

- Attaches two different heights of worksurfaces.
- To be used in conjunction with a cantilever.

PRODUCT CODE	PRICE	SIZE/ INCHES			WEIGHT VOL	
		H	W	D	LBS	FT ³
BHBZ03	79	4	21	4	2	0.190

FTATB • Boulevard Connector Kit

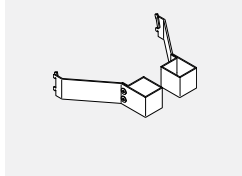

- FreeFit to Boulevard kit secures FreeFit height adjustable freestanding tables to parallel Boulevard panels.
- It provides panel/table alignment, preventing moving parts from rubbing against panel vertical surfaces and maintains 1" clearance around table surface perimeter.
- Standard metal finishes.
- All hardware included.
- Sold as a pair.

PRODUCT CODE	PRICE	SIZE/ INCHES			WEIGHT VOL	
		H	W	D	LBS	FT ³
FTATB	140	10	6.5	10	7.00	0.50

LHC • HAT Channel

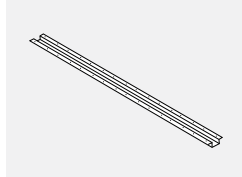

PRODUCT CODE	PRICE	SIZE/ INCHES			WEIGHT VOL	
		H	W	D	LBS	FT ³
LHC40	56	1.4	40	5	4	0.20
LHC46	62	1.4	46	5	6	0.22
LHC52	66	1.4	52	5	7	0.25
LHC58	76	1.4	58	5	8	0.28
LHC64	85	1.4	64	5	9	0.31
LHC70	91	1.4	70	5	10	0.33

• LP = Thermally Fused Laminate, HP = High Pressure Laminate, T= High Pressure Laminate with Wood Trim, W= Wood Veneer

Technical Information for 9300 Series Pedestals

General Information:

9300 Series Pedestals feature center pull handles (models ending in "C") and full pull handles (models ending in "P"). Freestanding, mobile, and worksurface supporting options available. Quality steel construction. File drawers hold letter or A4 front to back and legal side to side configurations. Products are finished in a highly durable dry epoxy powder coating and drawer body interiors are finished with 100% recycled paint. Counterweights are included in freestanding and mobile pedestals to meet applicable ANSI/BIFMA X5.9.

Features:

- Cold rolled steel construction consisting of 16 ga front and back base with 22 ga case
- Reinforced welded construction
- Inset drawer fronts and flush base
- Double wall construction on all drawer fronts
- Full extension ball bearing slides on file drawers and ¾ extension on box drawers
- Rubber bumpers on slides for quietness
- Worksurface supporting option available (includes mounting holes at top of unit)
- 1 pencil tray and 1 drawer divider are included with each unit containing a box drawer
- Each file drawer includes a hanging file bar
- Levelers provide 1" height adjustment
- Counterweights included for freestanding and mobile pedestals
- Includes lock with 2 keys
- Lock is located at the top right of the case above the top drawer
- Keyed alike option available and can be keyed alike to other storage components

Sizes:

- 15" width
- 19", 23", 29" depths
- Interior drawer depths:
- 19" Deep pedestals
- 17 1/4" deep box drawers
- 16 1/16" deep file drawers
- 23" deep pedestals
- 20 3/16" deep box drawers
- 19 7/16" deep file drawers
- 29" deep pedestals
- 26 5/16" deep box drawers
- 26 1/16" deep file drawers

Drawer Heights:

Box drawer fronts are 6"H with 5" interior height
File drawer fronts are 12"H with 10 9/16" interior height

Technical Information for Prime Series

General Information:

Prime premium filing and storage products pre-configured to suit your needs; featuring fixed front or receding doors with center pull handles and fully welded seamless tops to deliver strength and clean aesthetics. Premium quality steel construction. File drawers accommodate legal, letter or A4 sizes in back-to-front and side-to-side configurations. Products are finished in a highly durable dry epoxy powder coating and drawer body interiors are finished with 100% recycled paint.

Counterweights are recommended for use in all laterals, pedestals and freestanding files of all widths and heights to meet applicable ANSI/BIFMA X5.9. (Counterweights are offered as an option on all products where required to meet applicable ANSI/BIFMA standard)

Features

- Premium steel construction, 18-22 gauge steel components
- Full welded and reinforced case construction
- Interlock system allows only one drawer to open at a time for safety
- Most products feature full overlay fronts, with some exceptions such as units with receding doors where the front is inset in the case
- Double wall construction on all drawer and door fronts
- Full extension roller bearing glides on all drawers
- Anti-bounce-back safety feature prevents drawers from sliding open
- Receding doors slide into the cabinet and allow the shelf to be pulled out
- All pedestals are equipped with four levelling glides, providing 1.5" of height adjustment
- All other units equipped with four levelling glides providing 1" height adjustment and can be accessed from the interior of the cabinets for ease of adjustment
- On units with drawers and hinged doors, locks are located at the center of the case above the top opening
- Lock position on towers with wardrobes is below the handle when center pull is selected
- Each lock includes 2 keys; locks are standard with removable cores
- Key assignment is random or can be specified for specific key number for key alike applications

Overhead Storage:

- Overhead cabinets - 7 widths in 6" increments
- 14 5/8" high cases with interior clear height of 12"
- 13" deep units have interior clear dimension of 12.7"
- 16" deep units have interior clear dimension of 15.7"
- Open shelves - 7 widths in 6" increments
- Shelves are 12 1/2" deep with 7 1/2" high side gables

Pedestals:

- Freestanding and worksurface supporting options available
- Worksurface supporting includes mounting holes at top of unit
- 1 pencil tray and 1 drawer divider are included with each unit containing a box drawer
- File drawers hold legal, letter or A4 sizes in back-to-front and side-to-side configurations
- Each file drawer includes a hanging file bar and conversion rails
- Freestanding units BSPF can be specified with optional non-locking casters to convert to a mobile unit
- 15" width x 18", 22", 28" depths

Interior drawer depth is as follows:

- 15" deep drawers for 18" deep pedestals
- 19" deep drawers for 22" deep pedestals
- 25" deep drawers for 28" deep pedestals

File drawer capacity:

- 14 3/8" filing capacity for file drawers in 18" pedestal
- 18 3/8" filing capacity for file drawers in 22" pedestal
- 24 3/8" filing capacity for file drawers in 28" pedestal

Laterals:

- 18" depth with interior depth of 16"
- 30", 36", 42" widths
- Available in 2 to 6 drawer high (28"h – 77.6"h)

File Drawer Capacity:

- 30" wide units
 - Letter & legal side-to-side = 26 5/8"
 - Letter front-to-back = 30 1/2"
 - Legal front-to-back = 15 1/4" + 10" side space
- 36" wide units
 - Letter & legal side-to-side = 32 5/8"
 - Letter front-to-back = 30 1/2" + 6 1/2" side space
 - Legal front-to-back = 30 1/2"
- 42" wide units
 - Letter & legal side-to-side = 58 5/8"
 - Letter front-to-back = 45 3/4"
 - Legal front-to-back = 30 1/2" + 6 1/2" side space

Technical Information for Prime Series

Storage Cabinets:

- 18" depth
- 30", 36", 42" widths
- Available in 2 to 5 high configurations (28"h – 65.6"h)

Towers:

- Include coat rod and shelf to accommodate personal items
- The top of the storage compartment is perforated for ventilation
- Includes locks with 2 keys each
 - Closed storage comes with 3 locks – one of the drawers, one for the cupboard, and one for the wardrobe
 - Side open storage comes with 2 locks – one of the drawers and one for the wardrobe
- 24" depth
- 24" width
- 50", 54", and 66" nominal heights available to coordinate with Global's panel systems

STORAGE COMPONENTS - GUIDELINES FOR ORDERING PRODUCT

Codes

The price list uses a numbering system with meaningful alphanumeric characters to create a simple-to-understand product number. This makes specifying the product much easier and more accurate.

How to Specify

- Specify storage pedestal type and size by code, including depth.
- Specify metal color (eg. BLK for Black)
- Specify key random, key list provided, or key number (eg. 401)
- Specify worksurface supporting (1 = Yes, 2 = No)
- Specify counterweight if pedestal is not worksurface supporting (NN = No Counterweight)

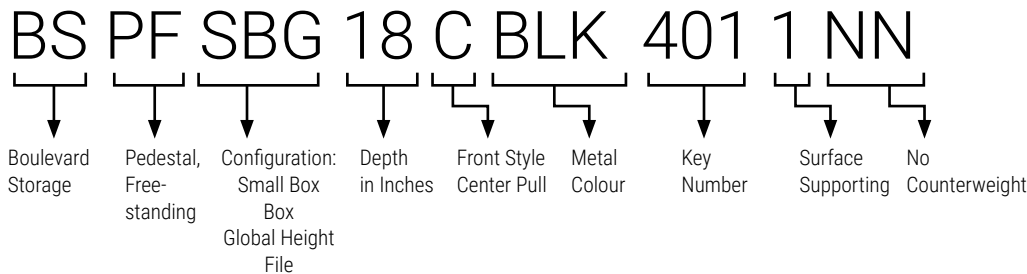

BSKSS • Panel Mount Shelf

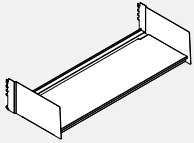

- 14" deep panel mounted storage shelf with backlip.
- Mounting brackets are included.

PRODUCT CODE	PRICE	SIZE/INCHES			WEIGHT LBS	VOL FT ³
		H	W	D		
BSKSS24	133	7.45	23.44	14.73	12.8	1.5
BSKSS30	141	7.45	29.44	14.73	14.8	1.9
BSKSS36	155	7.45	35.44	14.73	16.8	2.3
BSKSS42	161	7.45	41.44	14.73	18.8	2.6
BSKSS48	172	7.45	47.44	14.73	20.8	3.0
BSKSS54	179	7.45	53.44	14.73	22.8	3.4
BSKSS60	184	7.45	59.44	14.73	24.8	3.8

BSLSF • Flush Front Overhead Cabinet

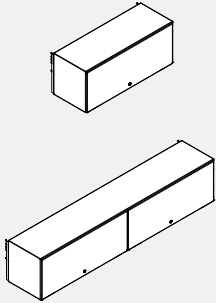

Cabinets 54" and 60" wide come with two doors

- Flush Front Overhead Cabinet is panel mounted lockable storage unit.
- The door retracts inside/within the overhead cabinet.
- Locks can be keyed alike to match other lockable storage components or keyed random to provide a dedicated lock.
- Available in 13" and 16" depths, 24" to 60" widths at 6" increments.
- Cabinets 54" and 60" wide come with two doors.
- Includes mounting hardware as specified, lock and keys.
- Lock secures into bottom shelf.
- Can be mounted at any height, however 66"h panels are recommended.
- Shipped assembled.

PRODUCT CODE	PRICE	SIZE/INCHES			WEIGHT LBS	VOL FT ³
		H	W	D		
BSLSF1324MN	540	14.62	23.87	13.5	39.3	2.7
BSLSF1330MN	558	14.62	29.87	13.5	44.3	3.4
BSLSF1336MN	614	14.62	35.87	13.5	49.3	4.1
BSLSF1342MN	672	14.62	41.87	13.5	54.3	4.8
BSLSF1348MN	731	14.62	47.87	13.5	59.3	5.5
BSLSF1354MN	788	14.62	53.87	13.5	64.3	6.2
BSLSF1360MN	844	14.62	59.87	13.5	69.3	6.8
BSLSF1624MN	893	14.62	23.87	16.5	38.6	3.4
BSLSF1630MN	916	14.62	29.87	16.5	43.9	4.2
BSLSF1636MN	960	14.62	35.87	16.5	49.2	5.0
BSLSF1642MN	1024	14.62	41.87	16.5	54.5	5.8
BSLSF1648MN	1089	14.62	47.87	16.5	59.8	6.7
BSLSF1654MN	1148	14.62	53.87	16.5	65.1	7.5
BSLSF1660MN	1200	14.62	59.87	16.5	70.4	8.4

BSADA-PM • Panel Mounted Overhead Storage Unit - AODA Compliant

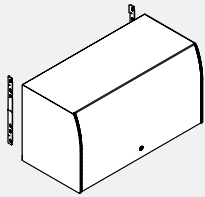

- Panel mounted metal overhead storage with opaque acrylic door. The mechanism lifts the door up and stores it out of the way, above the storage unit.
- Meets CSA B651 Barrier Free Design & AODA (Accessibility for Ontarians with Disabilities Act).
- 16" high units accept standard and A4 binders.
- All shelves are reinforced for proper weight distribution.
- Inside dimensions: 14.25" high x 13.4" deep.
- Unit includes attachment hardware, lock and mounting brackets. Back not included.
- Not recommended for use with wall rails.
- Unit can be converted to Up-Mount Overhead Storage Unit in the field by adding BSADAxKIT.
- Shipped partially assembled.

PRODUCT CODE	PRICE	SIZE/ INCHES			WEIGHT LBS	VOL FT ³
		H	W	D		
BSADA24PM	757	16	24	14.2	22	4.3
BSADA30PM	815	16	30	14.2	27	5.3
BSADA36PM	880	16	36	14.2	32	6.3
BSADA42PM	942	16	42	14.2	37	7.3
BSADA48PM	1007	16	48	14.2	42	8.3
BSADA54PM	1069	16	54	14.2	47	9.3
BSADA60PM	1133	16	60	14.2	53	10.3

BSADA-UM • Up-Mount Overhead Storage Unit - AODA Compliant

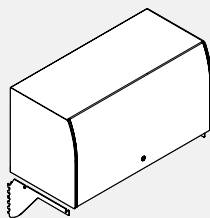

- Up mounted storage can reduce furniture costs by reducing the height of all panels to 50". Complete 50" panel installations simplify cable routing at one level, within the top lay-in channel. Up-mounted cantilevers maintain accessibility and functionality of the panels' top lay-in channel.
- Meets CSA B651 Barrier Free Design & AODA (Accessibility for Ontarians with Disabilities Act).
- 16" high units accept standard and A4 binders.
- All shelves are reinforced for proper weight distribution.
- Inside dimensions: 14.25" high x 13.4" deep.
- Unit includes attachment hardware, lock, mounting cantilevers and has a finished back.
- Unit can be converted to a Panel Mounted Overhead Storage Unit in the field by adding BSADAPMxKIT.
- Shipped partially assembled.

PRODUCT CODE	PRICE	SIZE/ INCHES			WEIGHT LBS	VOL FT ³
		H	W	D		
BSADA24UM	928	16	24	14.2	25	4.3
BSADA30UM	970	16	30	14.2	33	5.3
BSADA36UM	1016	16	36	14.2	40	6.3
BSADA42UM	1073	16	42	14.2	46	7.3
BSADA48UM	1132	16	48	14.2	53	8.3
BSADA54UM	1186	16	54	14.2	59	9.3
BSADA60UM	1255	16	60	14.2	66	10.3

BSADA-KIT • Up-Mount Conversion Kit

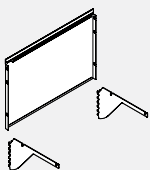

- Converts an existing Panel Mounted Overhead Storage Unit BSADA-PM to an Up-Mounted Overhead Storage unit BSADA-UM.
- When used on a 50" high panel, the top of the overhead will match the height of 66" high panels.
- Kit includes a back panel for the Overhead and Up-Mount Cantilevers.

PRODUCT CODE	PRICE	SIZE/INCHES			WEIGHT LBS	VOL FT ³
		H	W	D		
BSADA24KIT	188	16	24	2	6	0.6
BSADA30KIT	195	16	30	2	8	0.6
BSADA36KIT	204	16	36	2	10	0.7
BSADA42KIT	218	16	42	2	11	0.8
BSADA48KIT	228	16	48	2	13	0.9
BSADA54KIT	240	16	54	2	14	1.0
BSADA60KIT	253	16	60	2	15	1.1

BSADA-OMKIT • Off-Module Conversion Kit

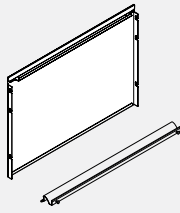

- Converts an existing Panel Mounted Storage Unit BSADA-PM to Off-Module Overhead Storage unit BSADA-OMKIT.
- Kit includes a back panel with integrated hanging bracket and an extruded bottom bracket.
- **IMPORTANT:** BSADA Overhead with Off-Module Conversion kit can only be installed on B3 fabric tile. Tiles below the overhead can be fabric, laminate and accessory tile. However, the tile the overhead is hanging on must be fabric.
- BSADA Overhead with Off-Module Conversion Kit can be suspended off of a single fabric tile, or can span two fabric tiles on two adjacent, directly interconnected panels.
- BSADA Overhead with Off-Module Conversion Kit **CANNOT** be suspended off of two panels separated by a post.

PRODUCT CODE	PRICE	SIZE/INCHES			WEIGHT VOL	
		H	W	D	LBS	FT ³
BSADA24OMKIT	188	16	24	2	6	0.5
BSADA30OMKIT	195	16	30	2	8	0.6
BSADA36OMKIT	204	16	36	2	10	0.7
BSADA42OMKIT	218	16	42	2	11	0.8
BSADA48OMKIT	228	16	48	2	13	0.9
BSADA54OMKIT	240	16	54	2	14	1.0
BSADA60OMKIT	253	16	60	2	15	1.1

BSADA-KIT • Panel Mount Conversion Kit



- Converts an existing Up-Mount Overhead Storage Unit BSADA-UM to a Panel Mounted Overhead Storage Unit BSADA-PM.
- Kit includes panel mounting brackets.

PRODUCT CODE	PRICE	SIZE/INCHES			WEIGHT VOL	
		H	W	D	LBS	FT ³
BSADAPMKIT	39	16	0.5	2	2	0.009

BSP1DO • Overhead Divider Storage for Boulevard 1 - Open Double Sided

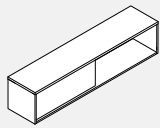

- Panel top mount allows access on both sides.
- Storage compartment internal height: 14".
- Overhead available in standard GC laminate finishes.
- Top mount on panels.
- Connecting hardware included.

PRODUCT CODE	PRICE		SIZE/INCHES			WEIGHT VOL	
	LP	HP	H	W	D	LBS	FT ³
BSP1DO36	636	716	16	36	16	81	7
BSP1DO42	655	744	16	42	16	96	8
BSP1DO48	680	784	16	48	16	100	9

BSP1LDS • Overhead Divider Storage for Boulevard 1 - Open Double Sided with Sliding Laminate Door

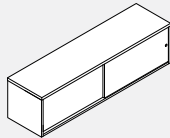

- Panel top mount allows access on both sides.
- Storage compartment internal height: 14".
- Overhead available in standard GC laminate finishes.
- Top mount on panels.
- Connecting hardware included.
- Sliding laminate doors are not locking.

PRODUCT CODE	PRICE		SIZE/INCHES			WEIGHT VOL	
	LP	HP	H	W	D	LBS	FT ³
BSP1LDS36	1997	2074	16	36	16	87	7
BSP1LDS42	2042	2135	16	42	16	103	8
BSP1LDS48	2069	2175	16	48	16	108	9

BSP1GDS • Overhead Divider Storage for Boulevard 1 - Open Double Sided with Sliding Glass Door

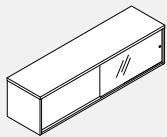

- Panel top mount allows access on both sides.
- Storage compartment internal height: 14".
- Overhead available in standard GC laminate finishes.
- Top mount on panels.
- Connecting hardware included.
- Sliding glass doors are not locking.

PRODUCT CODE	PRICE		SIZE/INCHES			WEIGHT VOL	
	LP	HP	H	W	D	LBS	FT ³
BSP1GDS36	2067	2146	16	36	16	92	7
BSP1GDS42	2102	2195	16	42	16	108	8
BSP1GDS48	2132	2237	16	48	16	113	9

BSP3DO • Overhead Divider Storage for Boulevard System 3 - Open Double Sided

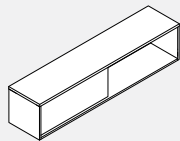

- Panel top mount allows access on both sides.
- Storage compartment internal height: 14".
- Overhead available in standard GC laminate finishes.
- Top mount on panels.
- Connecting hardware included.

PRODUCT CODE	PRICE		SIZE/INCHES			WEIGHT VOL	
	LP	HP	H	W	D	LBS	FT ³
BSP3DO36	615	695	16	36	16	81	9
BSP3DO42	641	734	16	42	16	96	10.5
BSP3DO48	669	773	16	48	16	100	12

BSP3LDS • Overhead Divider Storage for Boulevard System 3 - Open Double Sided with Sliding Laminate Door

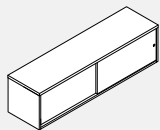

- Panel top mount allows access on both sides.
- Storage compartment internal height: 14".
- Overhead available in standard GC laminate finishes.
- Top mount on panels.
- Connecting hardware included.
- Sliding laminate doors are not locking.

PRODUCT CODE	PRICE		SIZE/INCHES			WEIGHT VOL	
	LP	HP	H	W	D	LBS	FT ³
BSP3LDS36	1977	2055	16	36	16	106	7
BSP3LDS42	2025	2115	16	42	16	126	8
BSP3LDS48	2049	2156	16	48	16	134	9

BSP3GDS • Overhead Divider Storage for Boulevard System 3 - Open Double Sided with Sliding Glass Door

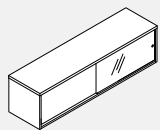

- Panel top mount allows access on both sides.
- Storage compartment internal height: 14".
- Overhead available in standard GC laminate finishes.
- Top mount on panels.
- Connecting hardware included.
- Sliding glass doors are not locking.

PRODUCT CODE	PRICE		SIZE/INCHES			WEIGHT VOL	
	LP	HP	H	W	D	LBS	FT ³
BSP3GDS36	2047	2126	16	36	16	87	6
BSP3GDS42	2081	2175	16	42	16	103	7
BSP3GDS48	2111	2217	16	48	16	107	9

BS93FPxxBFC • 9300 Series Freestanding Box File Pedestal



- One box and one file drawer pedestal.
- Freestanding, counterweight included.
- All drawers are locking.
- Box drawer includes pencil tray.

PRODUCT CODE	PRICE	SIZE/INCHES			WEIGHT LBS	VOL FT ³
		H	W	D		
BS93FP19BFC	559	21.31	15	19	50	5.1
BS93FP23BFC	566	21.31	15	23	55	6.0
BS93FP29BFC	678	21.31	15	29	64	7.5

BS93FPxxBBFC • 9300 Series Freestanding Box Box File Pedestal

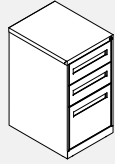

- Two box and one file drawer pedestal.
- Freestanding, counterweight included.
- All drawers are locking.
- Top box drawer includes pencil tray.

PRODUCT CODE	PRICE	SIZE/INCHES			WEIGHT LBS	VOL FT ³
		H	W	D		
BS93FP19BBFC	617	27.87	15	19	55	6.5
BS93FP23BBFC	628	27.87	15	23	68	7.7
BS93FP29BBFC	741	27.87	15	29	78	9.6

BS93FPxxFFC • 9300 Series Freestanding File File Pedestal

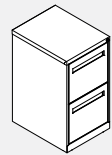

- Two file drawer pedestal.
- Freestanding, counterweight included.
- All drawers are locking.

PRODUCT CODE	PRICE	SIZE/INCHES			WEIGHT LBS	VOL FT ³
		H	W	D		
BS93FP19FFC	589	27.87	15	19	53	6.5
BS93FP23FFC	597	27.87	15	23	60	7.7
BS93FP29FFC	699	27.87	15	29	70	9.6

BS93WPxxBBFC • 9300 Series Worksurface Supporting Box Box File Pedestal

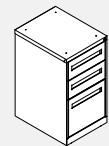

- Two box and one file drawer pedestal.
- Worksurface supporting, includes mounting holes in the top.
- All drawers are locking.
- Top box drawer includes pencil tray.
- Includes filler and brackets.

PRODUCT CODE	PRICE	SIZE/INCHES			WEIGHT LBS	VOL FT ³
		H	W	D		
BS93WP19BBFC	613	27.87	15	19	55	6.5
BS93WP23BBFC	621	27.87	15	23	68	7.7
BS93WP29BBFC	711	27.87	15	29	78	9.6

BS93WPxxFFC • 9300 Series Worksurface Supporting File File Pedestal

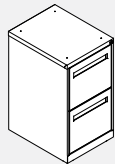

- Two file drawer pedestal.
- Worksurface supporting, includes mounting holes in the top.
- All drawers are locking.
- Includes filler and brackets.

PRODUCT CODE	PRICE	SIZE/INCHES			WEIGHT LBS	VOL FT ³
		H	W	D		
BS93WP19FFC	582	27.87	15	19	53	6.5
BS93WP23FFC	587	27.87	15	23	60	7.7
BS93WP29FFC	700	27.87	15	29	70	9.6

BS93MPxxBFC • 9300 Series Mobile Box File Pedestal

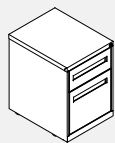

- One box and one file drawer mobile pedestal.
- Casters preinstalled, casters non-locking.
- Counterweight included.
- All drawers locking.
- Box drawer includes pencil tray.
- NOTE: Cannot be used as guest seating.

PRODUCT CODE	PRICE	SIZE/INCHES			WEIGHT LBS	VOL FT ³
		H	W	D		
BS93MP19BFC	659	21.87	15	19	66	5.2
BS93MP23BFC	681	21.87	15	23	72	6.2
BS93MP29BFC	730	21.87	15	29	92	7.6

BS93MPxxBBFC • 9300 Series Mobile Box Box File Pedestal

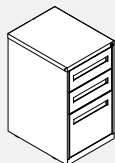

- Two box and one file drawer mobile pedestal.
- Casters preinstalled, casters non-locking.
- Counterweight included.
- All drawers locking.
- Top box drawer includes pencil tray.
- NOTE: Cannot be used as guest seating.

PRODUCT CODE	PRICE	SIZE/INCHES			WEIGHT LBS	VOL FT ³
		H	W	D		
BS93MP19BBFC	695	27.93	15	19	76	6.5
BS93MP23BBFC	702	27.93	15	23	85	7.7
BS93MP29BBFC	757	27.93	15	29	94	9.6

BS93MPxxFFC • 9300 Series Mobile File File Pedestal

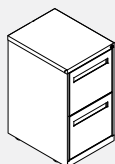

- Two file drawer pedestal.
- Casters preinstalled, casters non-locking.
- Counterweight included.
- All drawers locking.
- NOTE: Cannot be used as guest seating.

PRODUCT CODE	PRICE	SIZE/INCHES			WEIGHT LBS	VOL FT ³
		H	W	D		
BS93MP19FFC	654	27.93	15	19	73	6.5
BS93MP23FFC	681	27.93	15	23	81	7.7
BS93MP29FFC	748	27.93	15	29	90	9.6

BSPFOBFxxC • Prime Freestanding Box File Pedestal

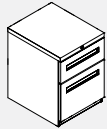

- One box and one file drawer pedestal.
- All drawers are locking.
- Box drawer includes pencil tray.
- For freestanding, to add counterweight (W2 option), add \$50 list.
- For mobile to add casters and counterweight (W1 option), add \$75 list. Adds 0.5" to height.
- NOTE: Cannot be used as guest seating.

PRODUCT CODE	PRICE	SIZE/INCHES			WEIGHT LBS	VOL FT ³
		H	W	D		
BSPFOBF18C	571	20.8	15	18	52.4	4.2
BSPFOBF22C	579	20.8	15	22	58.8	5.0
BSPFOBF28C	656	20.8	15	28	68.7	6.3

BSPFSBGxxC • Prime Box Box File Pedestal



- Two box and one file drawer pedestal.
- All drawers are locking.
- Top box drawer includes pencil tray.
- For freestanding, to add counterweight (W2 option), add \$50 list.
- For mobile to add casters and counterweight (W1 option), add \$75 list. Adds 0.5" to height.
- Top box drawer 4.8"h; middle box drawer 6.4"h; bottom file drawer 13.6"h (interior 12.5"h).
- When worksurface supporting option selected, unit includes pre-drilled top holes for attaching and filler/brackets.

PRODUCT CODE	PRICE	SIZE/INCHES			WEIGHT LBS	VOL FT ³
		H	W	D		
BSPFSBG18C	637	28	15	18	67.5	5.5
BSPFSBG22C	644	28	15	22	75.0	6.6
BSPFSBG28C	710	28	15	28	86.8	8.3

BSPFOFGxxC • Prime File File Pedestal



- Two file drawer pedestal.
- All drawers are locking.
- For freestanding, to add counterweight (W2 option), add \$50 list.
- For mobile to add casters and counterweight (W1 option), add \$75 list. Adds 0.5" to height.
- Top file drawer 11.2"h (interior 10.6"h); bottom file drawer 13.6"h (interior 12.5"h).
- When worksurface supporting option selected, unit includes pre-drilled top holes for attaching and filler/brackets.

PRODUCT CODE	PRICE	SIZE/INCHES			WEIGHT LBS	VOL FT ³
		H	W	D		
BSPFOFG18C	637	28	15	18	67.5	5.5
BSPFOFG22C	644	28	15	22	75.0	6.6
BSPFOFG28C	710	28	15	28	86.8	8.3

BSPWOBFxxC • Prime Mobile Box File Pedestal



- Mobile one box and one file drawer pedestal.
- All drawers are locking.
- 60mm casters.

PRODUCT CODE	PRICE	SIZE/INCHES			WEIGHT LBS	VOL FT ³
		H	W	D		
BSPWOBF18C	758	23.3	15	18	73.5	4.6
BSPWOBF22C	763	23.3	15	22	79.1	5.6
BSPWOBF28C	878	23.3	15	28	87.7	7.0

BSTC • Pedestal/Lateral Seat Cushion

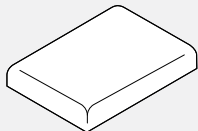

PRODUCT CODE	YRDS	SIZE/ INCHES			WEIGHT VOL	
		H	W	D	LBS	FT ³
BSTCP1518	0.75	2	15	18	5.00	0.41
BSTCP1522	0.75	2	15	22	5.25	0.45
BSTCP1528	1.00	2	15	28	5.5	0.55
BSTCL1830	1.00	2	18	30	6.0	0.55
BSTCL1836	1.25	2	18	36	6.5	0.65

PRODUCT CODE	PRICE																			
	GR1	GR2	GR3	GR4	GR5	GR6	GR7	GR8	GR9	GR10	GR11	GR12	GR13	GR14	GR15	GR16	GR17	GR18	GR19	GR20
BSTCP1518	196	226	245	272	314	353	389	422	463	503	557	633	703	779	944	1109	1274	1439	1604	1785
BSTCP1522	206	233	256	283	323	361	399	435	472	513	565	640	715	789	955	1119	1285	1451	1613	1794
BSTCP1528	259	296	326	360	414	466	518	562	613	668	737	839	936	1034	1256	1473	1696	1916	2134	2377
BSTCL1830	281	318	345	383	437	488	536	585	636	691	760	860	958	1057	1279	1496	1720	1938	2156	2399
BSTCL1836	333	380	417	461	527	590	653	712	778	844	932	1057	1179	1304	1581	1852	2130	2402	2677	2981

BSLPS0BF18xxC • Prime Box File Lateral

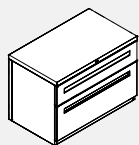

- One and a half height lateral filing cabinet.
- Fixed front drawers, top box drawer front 4.8”h bottom file drawer front 13.6”h (interior 12.5”h).
- Locking.
- Side to side hanging bars included.
- To add counterweight (W2 option), add \$410 list.

PRODUCT CODE	PRICE	SIZE/INCHES			WEIGHT LBS	VOL FT ³
		H	W	D		
BSLPS0BF1830C	1268	20.98	30	18.06	119.96	8.0
BSLPS0BF1836C	1320	20.98	36	18.06	129.86	9.5
BSLPS0BF1842C	1364	20.98	42	18.06	165.45	11.1

BSLF20G18xxC • Prime 2 High Lateral File

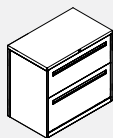

- Two high lateral filing cabinet.
- Fixed front file drawers, top drawer front 11.2”h (interior 10.6”h) bottom drawer front 13.6”h (interior 12.5”h).
- Locking.
- Side to side hanging bars included.
- To add counterweight (W2 option), add \$200 list.

PRODUCT CODE	PRICE	SIZE/INCHES			WEIGHT LBS	VOL FT ³
		H	W	D		
BSLF20G1830C	1268	28	30	18	98.7	10.5
BSLF20G1836C	1327	28	36	18	114.4	12.5
BSLF20G1842C	1399	28	42	18	129.4	14.5

BSLF30G18xxC • Prime 3 High Lateral File

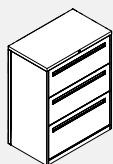

- Three high lateral filing cabinet.
- Fixed front file drawers, top & middle drawer front 11.2”h (interior 10.6”h) bottom drawer front 13.6”h (interior 12.5”h).
- Locking.
- Side to side hanging bars included.
- Will not line up with 42” high panels.
- To add counterweight (W2 option), add \$200 list.

PRODUCT CODE	PRICE	SIZE/INCHES			WEIGHT LBS	VOL FT ³
		H	W	D		
BSLF30G1830C	1662	39.2	30	18	127.9	14.5
BSLF30G1836C	1749	39.2	36	18	147.6	17.2
BSLF30G1842C	1849	39.2	42	18	167.5	20.0

BSLF40H18xxC • Prime 4 High FFFF Lateral File

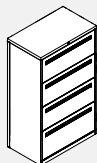

- Four high fixed front lateral filing cabinet.
- Fixed front file drawers, top drawer front 10.4” (interior 9.8”h) , second and third drawers 11.2”h (interior 10.6”h) bottom drawer front 13.6”h (interior 12.5”h).
- Locking.
- Side to side hanging bars included.
- To add counterweight (W2 option), add \$200 list.

PRODUCT CODE	PRICE	SIZE/INCHES			WEIGHT LBS	VOL FT ³
		H	W	D		
BSLF40G1830C	1950	49.6	30	18	159.1	18.2
BSLF40G1836C	2052	49.6	36	18	183.4	21.6
BSLF40G1842C	2176	49.6	42	18	208.5	25.1

BSLF40H18xxC • Prime 4 High RFFF Lateral File

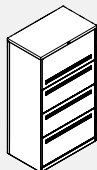

- Four high receding top door and remaining fixed front lateral filing cabinet.
- Top opening receding door + roll-out shelf 14.4” front, accepts binder height; fixed front drawers second and third drawers 11.2”h (interior 10.6”h) bottom drawer front 13.6”h (interior 12.5”h).
- Locking.
- Side to side hanging bars included.
- To add counterweight (W2 option), add \$200 list.

PRODUCT CODE	PRICE	SIZE/INCHES			WEIGHT LBS	VOL FT ³
		H	W	D		
BSLF40H1830C	2112	53.6	30	18	171.9	19.6
BSLF40H1836C	2226	53.6	36	18	198.2	23.3
BSLF40H1842C	2352	53.6	42	18	225.3	27.0

BSLF50P18xxC • Prime 5 High RFFFF Lateral File

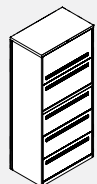

- Five high receding top door and remaining fixed front lateral filing cabinet.
- Locking.
- Side to side hanging bars included.
- Top opening receding door + roll-out shelf 14.4” front, accepts binder height; fixed front drawers below - second and third 11.2”h (interior 10.6”h) bottom drawer front 13.6”h (interior 12.5”h).
- To add counterweight (W2 option), add \$200 list.

PRODUCT CODE	PRICE	SIZE/INCHES			WEIGHT LBS	VOL FT ³
		H	W	D		
BSLF50P1830C	2751	65.6	30	18	208.9	23.9
BSLF50P1836C	2896	65.6	36	18	239.9	28.4
BSLF50P1842C	3061	65.6	42	18	272.7	32.9

BSSC21G18xxC • Prime 2 High Storage Cabinet

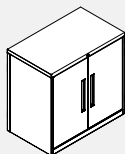

- Two high storage cabinet.
- One adjustable shelf + fixed bottom shelf.
- Locking.

PRODUCT CODE	PRICE	SIZE/INCHES			WEIGHT LBS	VOL FT ³
		H	W	D		
BSSC21G1830C	1040	28	30	18	75.08	10.5
BSSC21G1836C	1161	28	36	18	86.48	12.5
BSSC21G1842C	1262	28	42	18	95.78	14.5

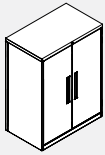
BSSC31G18xxC • Prime 3 High Storage Cabinet

- Three high storage cabinet.
- Two adjustable shelves + fixed bottom shelf.
- Will not line up to 42" high panels.
- Locking.

PRODUCT CODE	PRICE	SIZE/INCHES			WEIGHT LBS	VOL FT ³
		H	W	D		
BSSC31G1830C	1297	39.2	30	18	96.69	14.5
BSSC31G1836C	1459	39.2	36	18	111.59	17.2
BSSC31G1842C	1612	39.2	42	18	124.49	20.0

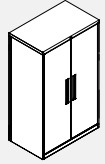
BSSC41G18xxC • Prime 4 High Storage Cabinet

- Three high storage cabinet to line up to 50" high panels.
- Three adjustable shelves + fixed bottom shelf.
- Locking.

PRODUCT CODE	PRICE	SIZE/INCHES			WEIGHT LBS	VOL FT ³
		H	W	D		
BSSC41G1830C	1502	49.6	30	18	111.22	18.2
BSSC41G1836C	1577	49.6	36	18	129.32	21.6
BSSC41G1842C	1832	49.6	42	18	145.42	25.1

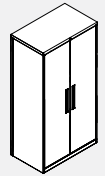
BSSC41H18xxC • Prime 4 High Storage Cabinet

- Four high storage cabinet.
- Three adjustable shelves + fixed bottom shelf.
- Locking.

PRODUCT CODE	PRICE	SIZE/INCHES			WEIGHT LBS	VOL FT ³
		H	W	D		
BSSC41H1830C	1551	53.6	30	18	120.17	19.6
BSSC41H1836C	1734	53.6	36	18	138.27	23.3
BSSC41H1842C	1920	53.6	42	18	154.37	27.0

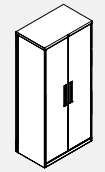
BSSC51C18xxC • Prime 5 High Storage Cabinet

- Five high storage cabinet.
- Four adjustable shelves + fixed bottom shelf.
- Locking.

PRODUCT CODE	PRICE	SIZE/INCHES			WEIGHT LBS	VOL FT ³
		H	W	D		
BSSC51C1830C	1751	65.6	30	18	138.5	23.9
BSSC51C1836C	1961	65.6	36	18	160.4	28.4
BSSC51C1842C	2176	65.6	42	18	180.4	32.9

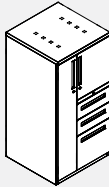
BSSLFxx24BCCL • Prime Tower, Left Wardrobe, Half Height Door, Box Box File Drawers

"4G" Tower Shown

- Left wardrobe tower with half height door and box box file drawers.
- Wardrobe section includes top shelf and coat bar.
- Hinged door compartment of 50"h and 54"h includes one adjustable shelf; 66"h includes two adjustable open shelves.
- Wardrobe section includes top perforations for ventilation.
- Three locks included - wardrobe door, hinged door shelving compartment and drawers.
- To add counterweight (W2 option), add \$105 list.

PRODUCT CODE	PRICE	SIZE/INCHES			WEIGHT LBS	VOL FT ³
		H	W	D		
BSSLF4G24BCCL	2822	49.6	24	24	176.71	19.2
BSSLF4H24BCCL	2836	53.6	24	24	181.63	19.8
BSSLF5024BCCL	2968	65.6	24	24	204.52	25.2

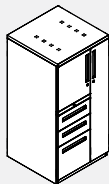
BSSLFxx24BCCR • Prime Tower, Right Wardrobe, Half Height Door, Box Box File Drawers

"4G" Tower Shown

- Right wardrobe tower with half height door and box box file drawers.
- Wardrobe section includes top shelf and coat bar.
- Hinged door compartment of 50"h and 54"h includes one adjustable shelf; 66"h includes two adjustable open shelves.
- Wardrobe section includes top perforations for ventilation.
- Three locks included - wardrobe door, hinged door shelving compartment and drawers.
- To add counterweight (W2 option), add \$105 list.

PRODUCT CODE	PRICE	SIZE/INCHES			WEIGHT LBS	VOL FT ³
		H	W	D		
BSSLF4G24BCCR	2822	49.6	24	24	176.71	19.2
BSSLF4H24BCCR	2836	53.6	24	24	181.63	19.8
BSSLF5024BCCR	2968	65.6	24	24	204.52	25.2

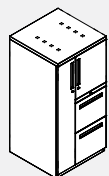
BSSLFxx24FCCL • Prime Tower, Left Wardrobe, Half Height Door, File File Drawers

"4G" Tower Shown

- Left wardrobe tower with half height door and file file drawers.
- Wardrobe section includes top shelf and coat bar.
- Hinged door compartment of 50"h and 54"h includes one adjustable shelf; 66"h includes two adjustable open shelves.
- Wardrobe section includes top perforations for ventilation.
- Three locks included - wardrobe door, hinged door shelving compartment and drawers.
- To add counterweight (W2 option), add \$105 list.

PRODUCT CODE	PRICE	SIZE/INCHES			WEIGHT LBS	VOL FT ³
		H	W	D		
BSSLF4G24FCCL	2822	49.6	24	24	181.05	19.2
BSSLF4H24FCCL	2836	53.6	24	24	186.43	19.8
BSSLF5024FCCL	2968	65.6	24	24	231.53	25.2

BSSLFxx24FCCR • Prime Tower, Right Wardrobe, Half Height Door, File File Drawers

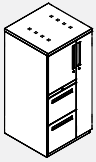

"4G" Tower Shown

- Right wardrobe tower with half height door and file file drawers.
- Wardrobe section includes top shelf and coat bar.
- Hinged door compartment of 50"h and 54"h includes one adjustable shelf; 66"h includes two adjustable open shelves.
- Wardrobe section includes top perforations for ventilation.
- Three locks included - wardrobe door, hinged door shelving compartment and drawers.
- To add counterweight (W2 option), add \$105 list.

PRODUCT CODE	PRICE	SIZE/INCHES			WEIGHT LBS	VOL FT ³
		H	W	D		
BSSLF4G24FCCR	2822	49.6	24	24	181.05	19.2
BSSLF4H24FCCR	2836	53.6	24	24	186.43	19.8
BSSLF5024FCCR	2968	65.6	24	24	231.53	25.2

BSSLSxx2424BOCL • Prime Tower, Left Wardrobe, Side Open Shelf, Box Box File Drawers

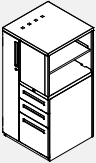

"4G" Tower Shown

- Left wardrobe tower with side open shelving and box box file drawers.
- Wardrobe section includes top shelf and coat bar.
- 50"h and 54"h include open side shelf with one adjustable shelf; 66"h includes open side shelf with two adjustable shelves.
- Wardrobe section includes top perforations for ventilation.
- Two locks included - wardrobe door and drawers.
- To add counterweight (W2 option), add \$105 list.

PRODUCT CODE	PRICE	SIZE/INCHES			WEIGHT LBS	VOL FT ³
		H	W	D		
BSSLS4G2424BOCL	3117	49.6	24	24	186.18	19.2
BSSLS4H2424BOCL	3135	53.6	24	24	186.91	19.8
BSSLS502424BOCL	3131	65.6	24	24	236.34	25.2

BSSLSxx2424BOCR • Prime Tower, Right Wardrobe, Side Open Shelf, Box Box File Drawers

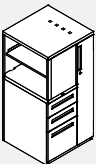

"4G" Tower Shown

- Right wardrobe tower with side open shelving and box box file drawers.
- Wardrobe section includes top shelf and coat bar.
- 50"h and 54"h include open side shelf with one adjustable shelf; 66"h includes open side shelf with two adjustable shelves.
- Wardrobe section includes top perforations for ventilation.
- Two locks included - wardrobe door and drawers.
- To add counterweight (W2 option), add \$105 list.

PRODUCT CODE	PRICE	SIZE/INCHES			WEIGHT LBS	VOL FT ³
		H	W	D		
BSSLS4G2424BOCR	3117	49.6	24	24	186.18	19.2
BSSLS4H2424BOCR	3135	53.6	24	24	186.91	19.8
BSSLS502424BOCR	3131	65.6	24	24	236.34	25.2

BSSLSxx2424FOCL • Prime Tower, Left Wardrobe, Side Open Shelf, File File Drawers

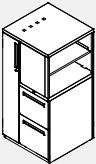

"4G" Tower Shown

- Left wardrobe tower with side open shelving and file file drawers.
- Wardrobe section includes top shelf and coat bar.
- 50"h and 54"h include open side shelf with one adjustable shelf; 66"h includes open side shelf with two adjustable shelves.
- Wardrobe section includes top perforations for ventilation.
- Two locks included - wardrobe door and drawers.
- To add counterweight (W2 option), add \$105 list.

PRODUCT CODE	PRICE	SIZE/INCHES			WEIGHT LBS	VOL FT ³
		H	W	D		
BSSLS4G2424FOCL	3117	49.6	24	24	179.54	19.2
BSSLS4H2424FOCL	3135	53.6	24	24	180.26	19.8
BSSLS502424FOCL	3131	65.6	24	24	232.55	25.2

BSSLSxx2424FOCR • Prime Tower, Right Wardrobe, Side Open Shelf, File File Drawers

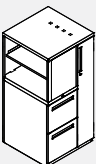

"4G" Tower Shown

- Right wardrobe tower with side open shelving and file file drawers.
- Wardrobe section includes top shelf and coat bar.
- 50"h and 54"h include open side shelf with one adjustable shelf; 66"h includes open side shelf with two adjustable shelves.
- Wardrobe section includes top perforations for ventilation.
- Two locks included - wardrobe door and drawers.
- To add counterweight (W2 option), add \$105 list.

PRODUCT CODE	PRICE	SIZE/INCHES			WEIGHT LBS	VOL FT ³
		H	W	D		
BSSLS4G2424FOCR	3117	49.6	24	24	179.54	19.2
BSSLS4H2424FOCR	3135	53.6	24	24	180.26	19.8
BSSLS502424FOCR	3131	65.6	24	24	232.55	25.2

BSWC51C18xxC • Prime Wardrobe

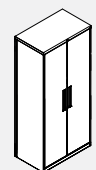

- Wardrobe cabinet.
- 30" w includes full width shelf and sde to side coat rod.
- 36" and 42"W are split with shelving on left side, wardrobe on the other.
- Locking.

PRODUCT CODE	PRICE	SIZE/INCHES			WEIGHT LBS	VOL FT ³
		H	W	D		
BSWC51C1830C	1789	65.6	30	18	125.26	23.8
BSWC51C1836C	1998	65.6	36	18	164.97	28.4
BSWC51C1842C	2198	65.6	42	18	180.59	32.9

BSCC31G18xxC • Prime Three High Combination Cabinet

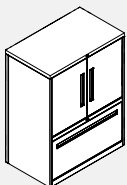

- Multi stor cabinet including hinged door upper section with one adjustable shelf; one fixed front file drawers below.
- Will not line up to 42" high panels.
- Locking.
- To add counterweight (W2 option), add \$200 list.

PRODUCT CODE	PRICE	SIZE/INCHES			WEIGHT LBS	VOL FT ³
		H	W	D		
BSCC31G1830C	2227	39.2	30	18	117.3	14.5
BSCC31G1836C	2426	39.2	36	18	135.5	17.2
BSCC31G1842C	2635	39.2	42	18	152.5	20.0

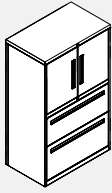
BSCC41G18xxC • Prime Four High Combination Cabinet

- Multi stor cabinet including hinged door upper section with one adjustable shelf; two fixed front file drawers below, lines up to 50" high panels.
- Locking.
- To add counterweight (W2 option), add \$200 list.

PRODUCT CODE	PRICE	SIZE/INCHES			WEIGHT LBS	VOL FT ³
		H	W	D		
BSCC41G1830C	2665	49.6	30	18	149.96	18.2
BSCC41G1836C	2853	49.6	36	18	172.96	21.6
BSCC41G1842C	3072	49.6	42	18	195.36	25.1

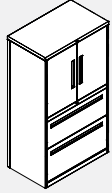
BSCC41H18xxC • Prime Four High Combination Cabinet

- Multi stor cabinet including hinged door upper section with one adjustable shelf; two fixed front file drawers below, lines up to 54" high panels.
- Locking.
- To add counterweight (W2 option), add \$200 list.

PRODUCT CODE	PRICE	SIZE/INCHES			WEIGHT LBS	VOL FT ³
		H	W	D		
BSCC41H1830C	2796	53.6	30	18	154.54	19.6
BSCC41H1836C	2992	53.6	36	18	178.54	23.3
BSCC41H1842C	3225	53.6	42	18	202.04	27.0

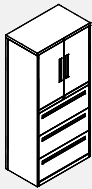
BSCC31C18xxC • Prime Five High Combination Cabinet

- Multi stor cabinet including hinged door upper section with one adjustable shelf; three fixed front file drawers below.
- Locking.
- To add counterweight (W2 option), add \$200 list.

PRODUCT CODE	PRICE	SIZE/INCHES			WEIGHT LBS	VOL FT ³
		H	W	D		
BSCC51C1830C	3083	65.6	30	18	188.5	23.9
BSCC51C1836C	3344	65.6	36	18	216.9	28.4
BSCC51C1842C	3581	65.6	42	18	245.5	32.9

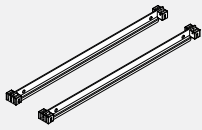
BSLFA0718 • Prime Front to Back File Bars

- Package of two, grey finish.

PRODUCT CODE	PRICE	SIZE/INCHES			WEIGHT LBS	VOL FT ³
		H	W	D		
BSLFA0718	28	1	17.3	1	1	0.04

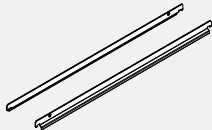
BSLFS • Prime Hanging File Bars

- Package of two, grey finish.

PRODUCT CODE	PRICE	SIZE/INCHES			WEIGHT LBS	VOL FT ³
		H	W	D		
BSLFA01	48	1.3	27.5	0.5	2	0.03
BSLFA02	48	1.3	33.5	0.5	2.4	0.04
BSLFA03	48	1.3	39.5	0.5	2.8	0.05

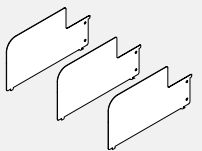
BSLFA1018 • Prime Plate Dividers

- Package of three, grey finish.

PRODUCT CODE	PRICE	SIZE/INCHES			WEIGHT LBS	VOL FT ³
		H	W	D		
BSLFA1018	61	7.25	13.5	0.2	4	0.07

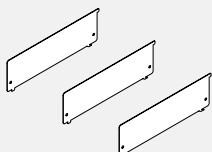
BSLFA2418 • Prime Half Height Plate Dividers

- Package of three, grey finish.

PRODUCT CODE	PRICE	SIZE/INCHES			WEIGHT LBS	VOL FT ³
		H	W	D		
BSLFA2418	45	3.95	13.5	0.2	2.2	0.04

BSLFA2018 • Prime EDP Adapters

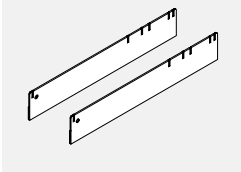

PRODUCT CODE	PRICE	SIZE/INCHES			WEIGHT LBS	VOL FT ³
		H	W	D		
BSLFA2018	51	2.6	16.5	0.15	2.5	0.02

BSK • Keys and Replacement Lock Core

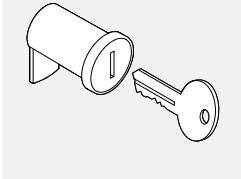

- Set of Extra Keys.
- Replacement Lock and Key.

PRODUCT CODE	PRICE	SIZE/INCHES			WEIGHT LBS	VOL FT ³
		H	W	D		
BSKY -EXTRA KEY	14	1.75	0.75	0.2	0.2	0.01
BSKC - LOCK & KEY	41	2	1	0.5	0.4	0.01

BSSA • Prime Extra Cabinet Shelves

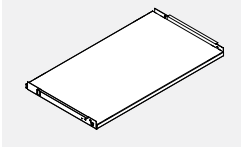

- Shelf, non-slotted.

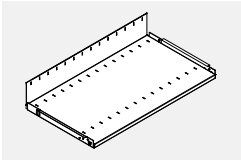

- Shelf, slotted.

PRODUCT CODE	PRICE	SIZE/INCHES			WEIGHT LBS	VOL FT ³
		H	W	D		
Shelf, non-slotted.						
BSSA11830	141	0.8	28.4	16	7.2	1.8
BSSA11836	147	0.8	34.4	16	8.4	2.2
BSSA11842	155	0.8	40.4	16	9.5	2.6
Shelf, slotted.						
BSSA21830	154	5.25	28.4	16	8.2	1.8
BSSA21836	160	5.25	34.4	16	9.6	2.2
BSSA21842	176	5.25	40.4	16	10.8	2.6

Diet Panel System

Diet represents an innovative tool for creating an economical, efficient work space, accommodating various tasks. From 42" high panels which provide an open office feel to 50" and 54" high panels, for seated privacy and 66" high panels for standing privacy, Diet effectively supports the creation of various work environments. Diet is simple, easy to comprehend, easy to specify and install, with a minimum of add-on and dedicated/handed components to maximize reconfiguration flexibility. All Diet panels ship with a set of self-leveling connectors that accommodate any angle, but also straight, 90°, three-way T and 120° configurations, as well as four-way "X". Truly universal connectors support the above panel configurations regardless of panel heights. Such a configuration and height independent connecting method eliminates the need to order additional components during future office reconfigurations. Diet is an economical, "soft wire" system with simple means of optional power and data/communication cable management trough that snaps to the

bottom of the panel. With the exception of panels with open area below the mid rail, all Diet panels are built with 6" clearance opening between the floor and the bottom rail. This feature not only serves as a simple passage for cables between back-to-back stations and an interface for a snap on cable trough, but it mainly provides ultimate flexibility of panel station placement even if one panel needs to be located right above a floor monument. Diet's slim appearance, sophisticated industrial design, detailing and advanced engineering communicate high perceived value, exceeding expectations usually related to budget products. Diet can be specified on its own, with integrated worksurface, storage and accessory support, privacy and space organization in free standing office environments. Whether combined with Boulevard system, or raised floors, Diet, as a tool, bridges mobile or stationary freestanding furniture with power/data delivery solutions, that are hard wired to a building power supply.

Technical Information

Panels

- Panels are 1.3" thick.
- Width ranges from 24" to 60" at 6" increments.
- Heights include 42", 50", 54" and 66" (nominal).
- Extruded aluminum frame surrounds a fabric wrapped interior with a 7/8" particle board frame, sandwiched between 2 pieces of 1/8" masonite.
- Panel frame finish is durable epoxy powder coated.
- Finished panel includes top, corner and end caps.
- For glazing - Smoke development index 500.
- For tempered glass, add "TG" to the end of the product code and add 20% to the price regardless of fabric grade.
- Top rail accepts Global Contract accessories, monitor arm supports, off-module shelves, and task light brackets.
- Top rail on Glazed Top Panels is not intended for use with panel mounted shelves and panel mounted overhead.
- Middle rail accepts bracket for off-module worksurface support, Global Contract accessories, off-module shelves and power bar.
- Bottom rail accepts brackets for off-module worksurface support, Global Contract accessories, off-module shelves and optional cable manager and power bar.
- Optional PVC cable manager friction fits into bottom rail.

- Two leveler are included with a 1.75" leveling range.
- Vertical frame members have integrated grooves for additional components.
- Charcoal covers are provided at front of vertical members where connectors attach.
- Panels include 3 sets of hinge connectors, 1 set of spacers and 6 pins.
- Connecting method is simple, accommodating typical configuration, as well as connection of panels at any angle, regardless of height.

Panel Options

- Laminate or whiteboard may be substituted for fabric on panels only, see "OPT" column.
 - Tackboard panels available, please add 25% upcharge.
 - Steel facing available, contact your customer service representative.
- Note:
- 42" High Diet panels do not match Boulevard 42"
 - 50" High Diet panels match Boulevard 50"
 - 54" High Diet panels do not match standard Boulevard 54"
 - 66" High Diet panels matches Boulevard 66"
 - To order 42" and 54" high Diet panels to match Boulevard, please order "BDPFF" and "BDPOF".

HOW DIET REDUCES YOUR COSTS

Finished Panel:

- No inventory costs for connectors, top caps, kick plates and clips.
- Less time required to install, or to disassemble, move and re-install.
- Open bottom panels can reduce cost and improve circulation within the office.

Fewer Parts:

- Only 1 universal cantilever and 3 brackets are needed to build most workstations.
- Easy to attach and remove components from panels.

Simplified Specifications:

- Fewer parts and components make specifying, ordering, and verifying less work.
- Product fits a 6" planning module.

Communications Channel:

- Base communication channel reduces time to install and change cables.

Warranty:

- Limited Lifetime Warranty on materials and workmanship.

DIET PANELS - GUIDELINES FOR ORDERING PRODUCT

Codes

The product guide uses a numbering system with meaningful alphanumeric characters to create a simple-to-understand product number. This makes specifying the product much easier and more accurate.

Example of Panel: **DPFRF6636 CHR**

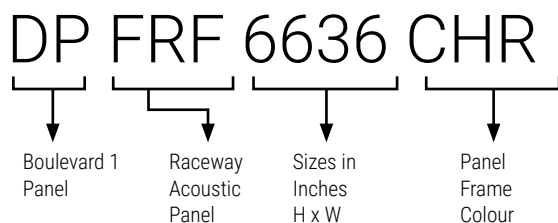

How to Specify

- Specify Diet Panel type and size by code.
- Specify panel frame finish - ie. CHR (Charcoal).
- Specify all six panel fabric options if necessary.

AN50	Inside Lower Fabric
AN50	Inside Middle Fabric
AN50	Inside Upper Fabric
BE21	Outside Lower Fabric
BE21	Outside Middle Fabric
BE21	Outside Upper Fabric

DPFF • Fabric Bottom and Fabric Top Panel

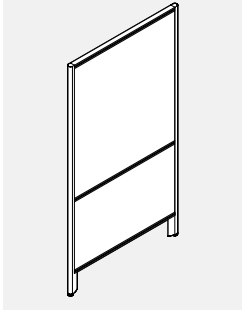

- Fabric above and below the middle rail provides visual privacy.
- Full panel with top, middle and bottom rail.
- OPT* = Laminate or Whiteboard.
- DPFF Panels do not match standard Boulevard heights of 42" and 54".
- DPFF Panels of 50" and 66" height will match standard Boulevard panel heights.

PRODUCT CODE	PRICE			SIZE/ H	INCHES			WEIGHT VOL	
	GR1	GR2	OPT*		W	D	LBS	FT ³	
DPFF4224	377	421	471	42	24	1.3	16	1.32	
DPFF4230	397	442	493	42	30	1.3	19	1.62	
DPFF4236	420	502	591	42	36	1.3	23	1.94	
DPFF4242	442	525	613	42	42	1.3	27	2.24	
DPFF4248	466	549	637	42	48	1.3	31	2.55	
DPFF4254	488	569	660	42	54	1.3	35	2.85	
DPFF4260	508	591	679	42	60	1.3	39	3.16	
DPFF5024	470	518	564	50	24	1.3	16	1.62	
DPFF5030	495	539	590	50	30	1.3	21	2.08	
DPFF5036	521	630	748	50	36	1.3	25	2.47	
DPFF5042	546	653	771	50	42	1.3	30	2.85	
DPFF5048	573	681	800	50	48	1.3	35	3.25	
DPFF5054	596	705	825	50	54	1.3	40	3.63	
DPFF5060	622	732	849	50	60	1.3	45	4.02	
DPFF5424	470	518	564	54	24	1.3	18	1.62	
DPFF5430	495	539	590	54	30	1.3	23	2.08	
DPFF5436	521	630	748	54	36	1.3	27	2.47	
DPFF5442	546	653	771	54	42	1.3	32	2.85	
DPFF5448	573	681	800	54	48	1.3	37	3.25	
DPFF5454	596	705	825	54	54	1.3	42	3.63	
DPFF5460	622	732	849	54	60	1.3	47	4.02	
DPFF6624	512	586	663	66	24	1.3	23	2.04	
DPFF6630	541	615	693	66	30	1.3	29	2.52	
DPFF6636	572	679	799	66	36	1.3	35	3.00	
DPFF6642	601	710	827	66	42	1.3	41	3.46	
DPFF6648	626	736	854	66	48	1.3	47	3.93	
DPFF6654	652	762	881	66	54	1.3	53	4.40	
DPFF6660	679	790	908	66	60	1.3	59	4.90	

BDPFF • Fabric Bottom and Fabric Top Panel to Match Boulevard Panels

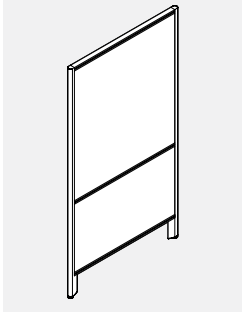

- Fabric above and below the middle rail provides visual privacy.
- Full panel with top, middle and bottom rail.
- OPT* = Laminate or Whiteboard
- Panels will match corresponding Boulevard Panel heights.

PRODUCT CODE	PRICE			SIZE/ H	INCHES			WEIGHT VOL	
	GR1	GR2	OPT*		W	D	LBS	FT ³	
BDPFF4224	377	421	471	42	24	1.3	16	1.32	
BDPFF4230	397	442	493	42	30	1.3	19	1.62	
BDPFF4236	420	502	591	42	36	1.3	23	1.94	
BDPFF4242	442	525	613	42	42	1.3	27	2.24	
BDPFF4248	466	549	637	42	48	1.3	31	2.55	
BDPFF4254	488	569	660	42	54	1.3	35	2.85	
BDPFF4260	508	591	679	42	60	1.3	39	3.16	
BDPFF5424	470	518	564	54	24	1.3	18	1.62	
BDPFF5430	495	539	590	54	30	1.3	23	2.08	
BDPFF5436	521	630	748	54	36	1.3	27	2.47	
BDPFF5442	546	653	771	54	42	1.3	32	2.85	
BDPFF5448	573	681	800	54	48	1.3	37	3.25	
BDPFF5454	596	705	825	54	54	1.3	42	3.63	
BDPFF5460	622	732	849	54	60	1.3	47	4.02	

DPOF • Open Bottom and Fabric Top Panel

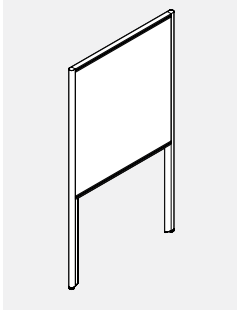

- Fabric above the middle rail provides visual privacy.
- Panel with top and middle rail only.
- Open bottom reduces cost and improves air circulation within the office.
- OPT* = Laminate or Whiteboard.
- DPOF Panels do not match standard Boulevard heights of 42" and 54".
- DPOF Panels of 50" and 66" height will match standard Boulevard panel heights.

PRODUCT CODE	PRICE			SIZE/ H	INCHES			WEIGHT VOL	
	GR1	GR2	OPT*		W	D	LBS	FT ³	
DPOF4224	246	260	275	42	24	1.3	9	1.32	
DPOF4230	263	276	292	42	30	1.3	12	1.62	
DPOF4236	304	332	361	42	36	1.3	15	1.94	
DPOF4242	318	344	374	42	42	1.3	17	2.24	
DPOF4248	333	361	392	42	48	1.3	19	2.55	
DPOF4254	350	377	406	42	54	1.3	22	2.85	
DPOF4260	362	392	420	42	60	1.3	24	3.16	
DPOF5024	310	339	367	50	24	1.3	10	1.62	
DPOF5030	330	358	386	50	30	1.3	13	2.08	
DPOF5036	394	449	507	50	36	1.3	16	2.47	
DPOF5042	413	469	527	50	42	1.3	19	2.85	
DPOF5048	433	488	547	50	48	1.3	21	3.25	
DPOF5054	450	506	564	50	54	1.3	25	3.63	
DPOF5060	470	526	585	50	60	1.3	28	4.02	
DPOF5424	310	339	367	54	24	1.3	12	1.62	
DPOF5430	330	358	386	54	30	1.3	15	2.08	
DPOF5436	394	449	507	54	36	1.3	18	2.47	
DPOF5442	413	469	527	54	42	1.3	21	2.85	
DPOF5448	433	488	547	54	48	1.3	24	3.25	
DPOF5454	450	506	564	54	54	1.3	27	3.63	
DPOF5460	470	526	585	54	60	1.3	30	4.02	
DPOF6624	378	435	493	66	24	1.3	17	2.04	
DPOF6630	400	458	518	66	30	1.3	21	2.52	
DPOF6636	471	527	586	66	36	1.3	25	3.00	
DPOF6642	520	574	634	66	42	1.3	29	3.46	
DPOF6648	545	597	658	66	48	1.3	33	3.93	
DPOF6654	565	622	679	66	54	1.3	37	4.40	
DPOF6660	589	642	702	66	60	1.3	41	4.90	

BDPOF • Open Bottom and Fabric Top Panel to Match Boulevard Panels

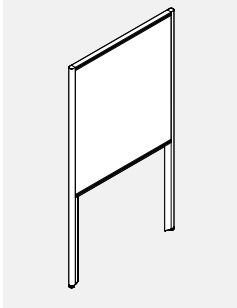

- Fabric above the middle rail provides visual privacy.
- Panel with top and middle rail only.
- Open bottom reduces cost and improves air circulation within the office.
- OPT* = Laminate or Whiteboard
- Panels will match corresponding Boulevard Panel heights.

PRODUCT CODE	PRICE			SIZE/ H	INCHES			WEIGHT VOL	
	GR1	GR2	OPT*		W	D	LBS	FT ³	
BDPOF4224	246	260	275	42	24	1.3	9	1.32	
BDPOF4230	263	276	292	42	30	1.3	12	1.62	
BDPOF4236	304	332	361	42	36	1.3	15	1.94	
BDPOF4242	318	344	374	42	42	1.3	17	2.24	
BDPOF4248	333	361	392	42	48	1.3	19	2.55	
BDPOF4254	350	377	406	42	54	1.3	22	2.85	
BDPOF4260	362	392	420	42	60	1.3	24	3.16	
BDPOF5424	310	339	367	54	24	1.3	12	1.62	
BDPOF5430	330	358	386	54	30	1.3	15	2.08	
BDPOF5436	394	449	507	54	36	1.3	18	2.47	
BDPOF5442	413	469	527	54	42	1.3	21	2.85	
BDPOF5448	433	488	547	54	48	1.3	24	3.25	
BDPOF5454	450	506	564	54	54	1.3	27	3.63	
BDPOF5460	470	526	585	54	60	1.3	30	4.02	

DPFRF • Fabric Bottom, Middle and Top Panel

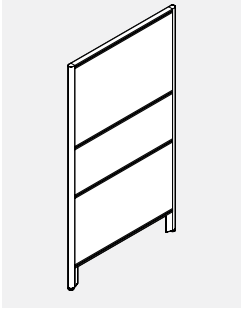

- Fabric above, below and between the middle rails provides visual privacy.
- Full panel with additional rail at 42" high.
- Upper middle rail accepts Global Contract Accessories, Monitor Arm Support and Off-Module Shelves.
- OPT* = Laminate or Whiteboard

PRODUCT CODE	PRICE			SIZE/ H	INCHES			WEIGHT VOL	
	GR1	GR2	OPT*		W	D	LBS	FT ³	
DPFRF5024	494	537	589	50	24	1.3	16	1.62	
DPFRF5030	521	552	586	50	30	1.3	21	2.08	
DPFRF5036	547	603	661	50	36	1.3	25	2.47	
DPFRF5042	574	639	710	50	42	1.3	30	2.85	
DPFRF5048	603	684	773	50	48	1.3	35	3.25	
DPFRF5054	626	706	799	50	54	1.3	40	3.63	
DPFRF5060	652	751	853	50	60	1.3	45	4.02	
DPFRF5424	494	537	589	54	24	1.3	18	1.62	
DPFRF5430	521	552	586	54	30	1.3	23	2.08	
DPFRF5436	547	603	661	54	36	1.3	27	2.47	
DPFRF5442	574	639	710	54	42	1.3	32	2.85	
DPFRF5448	603	684	773	54	48	1.3	37	3.25	
DPFRF5454	626	706	799	54	54	1.3	42	3.63	
DPFRF5460	652	735	825	54	60	1.3	47	4.02	
DPFRF6624	537	589	640	66	24	1.3	23	2.04	
DPFRF6630	569	619	672	66	30	1.3	29	2.52	
DPFRF6636	601	681	771	66	36	1.3	35	3.00	
DPFRF6642	633	725	825	66	42	1.3	41	3.46	
DPFRF6648	658	752	851	66	48	1.3	47	3.93	
DPFRF6654	686	785	890	66	54	1.3	53	4.40	
DPFRF6660	715	853	998	66	60	1.3	59	4.90	

DPORF • Open Bottom Fabric Middle and Top Panel

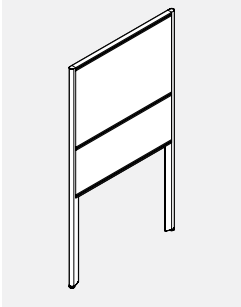

- Fabric above the middle rail provides visual privacy.
- Open bottom panel with additional rail at 42" high.
- Upper middle rail accepts Global Contract Accessories, Monitor Arm Support and Off-Module Shelves.
- Open bottom reduces cost and improves air circulation within the office.
- OPT* = Laminate or Whiteboard

PRODUCT CODE	PRICE			SIZE/ H	INCHES			WEIGHT VOL	
	GR1	GR2	OPT*		W	D	LBS	FT ³	
DPORF5024	326	358	392	50	24	1.3	10	1.62	
DPORF5030	344	378	410	50	30	1.3	13	2.08	
DPORF5036	413	446	481	50	36	1.3	16	2.47	
DPORF5042	433	474	524	50	42	1.3	19	2.85	
DPORF5048	455	498	546	50	48	1.3	21	3.25	
DPORF5054	472	519	563	50	54	1.3	25	3.63	
DPORF5060	494	545	595	50	60	1.3	28	4.02	
DPORF5424	326	358	392	54	24	1.3	12	1.62	
DPORF5430	344	378	410	54	30	1.3	15	2.08	
DPORF5436	413	446	481	54	36	1.3	18	2.47	
DPORF5442	433	474	524	54	42	1.3	21	2.85	
DPORF5448	455	498	546	54	48	1.3	24	3.25	
DPORF5454	472	524	575	54	54	1.3	27	3.63	
DPORF5460	494	545	595	54	60	1.3	30	4.02	
DPORF6624	397	441	488	66	24	1.3	17	2.04	
DPORF6630	421	466	512	66	30	1.3	21	2.52	
DPORF6636	497	567	642	66	36	1.3	25	3.00	
DPORF6642	546	622	703	66	42	1.3	29	3.46	
DPORF6648	572	641	719	66	48	1.3	33	3.93	
DPORF6654	594	672	755	66	54	1.3	37	4.40	
DPORF6660	617	691	765	66	60	1.3	41	4.90	

DPFFG • Fabric Bottom, Middle and Glazed Top Panel

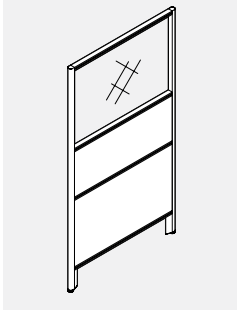

- Fabric below and between the middle rails provides visual privacy.
- Fabric bottom panel with additional rail at 28" high.
- Upper middle rail accepts Global Contract Accessories, Monitor Arm Support and Off-Module Shelves.
- Extruded aluminum frame surrounds acrylic glazing at top.
- PVC Extrusion is only Charcoal.
- For tempered glass, add "TG" to the end of the product code and add 20% to the price regardless of fabric grade.
- OPT* = Laminate or Whiteboard

PRODUCT CODE	PRICE			SIZE/ H	INCHES			WEIGHT VOL	
	GR1	GR2	OPT*		W	D	LBS	FT ³	
DPFFG5024	498	530	563	50	24	1.3	12	1.62	
DPFFG5030	546	576	611	50	30	1.3	15	2.08	
DPFFG5036	592	662	735	50	36	1.3	18	2.47	
DPFFG5042	640	710	783	50	42	1.3	21	2.85	
DPFFG5048	688	756	828	50	48	1.3	24	3.25	
DPFFG5054	737	806	881	50	54	1.3	27	3.63	
DPFFG5060	800	866	935	50	60	1.3	30	4.02	
DPFFG5424	498	530	563	54	24	1.3	17	1.62	
DPFFG5430	546	576	611	54	30	1.3	21	2.08	
DPFFG5436	592	662	735	54	36	1.3	25	2.47	
DPFFG5442	640	710	783	54	42	1.3	29	2.85	
DPFFG5448	688	756	828	54	48	1.3	33	3.25	
DPFFG5454	737	806	881	54	54	1.3	37	3.63	
DPFFG5460	800	868	942	54	60	1.3	41	4.02	
DPFFG6624	590	646	703	66	24	1.3	20	2.04	
DPFFG6630	653	710	768	66	30	1.3	25	2.52	
DPFFG6636	719	790	867	66	36	1.3	30	3.00	
DPFFG6642	785	857	932	66	42	1.3	35	3.46	
DPFFG6648	851	923	998	66	48	1.3	40	3.93	
DPFFG6654	915	987	1062	66	54	1.3	45	4.40	
DPFFG6660	994	1076	1165	66	60	1.3	50	4.90	

DPOFG • Open Bottom, Middle Fabric and Glazed Top Panel

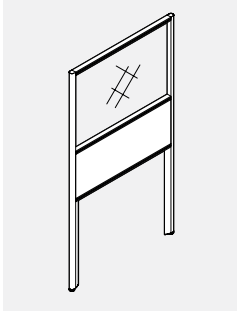

- Fabric between the middle rails.
- Open bottom panel with additional rail at 42" high.
- Upper middle rail accepts Global Contract Accessories, Monitor Arm Support and Off-Module Shelves.
- Extruded aluminum frame surrounds acrylic glazing at top.
- PVC Extrusion is only Charcoal.
- For tempered glass, add "TG" to the end of the product code and add 20% to the price regardless of fabric grade.
- OPT* = Laminate or Whiteboard

PRODUCT CODE	PRICE			SIZE/ H	INCHES			WEIGHT VOL	
	GR1	GR2	OPT*		W	D	LBS	FT ³	
DPOFG5024	393	406	420	50	24	1.3	14	1.62	
DPOFG5030	429	442	458	50	30	1.3	17	2.08	
DPOFG5036	464	476	493	50	36	1.3	20	2.47	
DPOFG5042	502	518	530	50	42	1.3	24	2.85	
DPOFG5048	537	552	565	50	48	1.3	27	3.25	
DPOFG5054	575	604	634	50	54	1.3	30	3.63	
DPOFG5060	617	646	674	50	60	1.3	34	4.02	
DPOFG5424	393	406	420	54	24	1.3	14	1.62	
DPOFG5430	429	442	458	54	30	1.3	17	2.08	
DPOFG5436	464	476	493	54	36	1.3	20	2.47	
DPOFG5442	502	518	530	54	42	1.3	24	2.85	
DPOFG5448	537	552	565	54	48	1.3	27	3.25	
DPOFG5454	575	604	634	54	54	1.3	30	3.63	
DPOFG5460	617	646	674	54	60	1.3	34	4.02	
DPOFG6624	490	502	519	66	24	1.3	17	2.04	
DPOFG6630	545	557	572	66	30	1.3	21	2.52	
DPOFG6636	601	628	658	66	36	1.3	25	3.00	
DPOFG6642	640	669	699	66	42	1.3	29	3.46	
DPOFG6648	697	725	755	66	48	1.3	33	3.93	
DPOFG6654	750	777	805	66	54	1.3	37	4.40	
DPOFG6660	809	838	867	66	60	1.3	41	4.90	

DPFG • Fabric Bottom and Glazed Top Panel

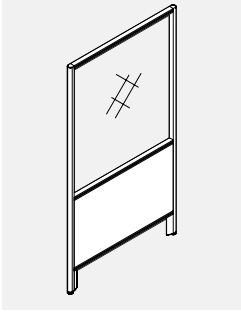

- **Fabric between the middle rails.**
- Open bottom panel with additional rail at 42" high.
- Upper middle rail accepts Global Contract Accessories, Monitor Arm Support and Off-Module Shelves.
- Open bottom reduces cost and improves air circulation within the office.
- Extruded aluminum frame surrounds acrylic glazing at top.
- PVC Extrusion is only Charcoal.
- For tempered glass, add "TG" to the end of the product code and add 20% to the price regardless of fabric grade.
- OPT* = Laminate or Whiteboard

PRODUCT CODE	PRICE			SIZE/ INCHES			WEIGHT VOL	
	GR1	GR2	OPT*	H	W	D	LBS	FT ³
DPFG4224	539	558	578	42	24	1.3	11	1.32
DPFG4230	585	603	622	42	30	1.3	14	1.62
DPFG4236	636	652	673	42	36	1.3	16	1.94
DPFG4242	677	733	792	42	42	1.3	18	2.24
DPFG4248	724	779	838	42	48	1.3	21	2.55
DPFG4254	773	828	888	42	54	1.3	23	2.85
DPFG4260	817	871	931	42	60	1.3	26	3.16
DPFG5024	651	669	691	50	24	1.3	12	1.62
DPFG5030	703	723	741	50	30	1.3	15	2.08
DPFG5036	751	767	788	50	36	1.3	18	2.47
DPFG5042	802	858	916	50	42	1.3	21	2.85
DPFG5048	849	904	965	50	48	1.3	24	3.25
DPFG5054	899	955	1013	50	54	1.3	27	3.63
DPFG5060	948	1004	1062	50	60	1.3	29	4.02
DPFG5424	651	669	691	54	24	1.3	13	1.62
DPFG5430	703	723	741	54	30	1.3	16	2.08
DPFG5436	751	767	788	54	36	1.3	20	2.47
DPFG5442	802	858	916	54	42	1.3	23	2.85
DPFG5448	849	904	965	54	48	1.3	26	3.25
DPFG5454	899	955	1013	54	54	1.3	29	3.63
DPFG5460	948	1004	1062	54	60	1.3	32	4.02
DPFG6624	706	726	748	66	24	1.3	17	2.04
DPFG6630	761	779	800	66	30	1.3	21	2.52
DPFG6636	813	868	927	66	36	1.3	24	3.00
DPFG6642	866	921	978	66	42	1.3	28	3.46
DPFG6648	916	971	1031	66	48	1.3	32	3.93
DPFG6654	970	1026	1085	66	54	1.3	36	4.40
DPFG6660	1025	1081	1139	66	60	1.3	40	4.90

DPFS • Fabric Bottom Slat Top Panel

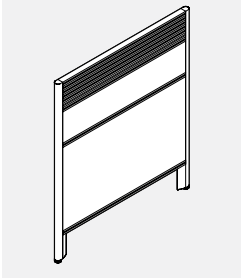

- **Integrated 6" slat rail provides flexibility of use.**
- Panel integrated slat rail accepts Global Contract Accessories, Monitor Arm Support, Off-Module Shelves, Task Light Bracket and Power Bar.
- OPT* = Laminate or Whiteboard

PRODUCT CODE	PRICE			SIZE/ INCHES			WEIGHT VOL	
	GR1	GR2	OPT*	H	W	D	LBS	FT ³
DPFS4224	385	409	437	42	24	1.3	19	1.32
DPFS4230	470	495	523	42	30	1.3	23	1.62
DPFS4236	524	591	666	42	36	1.3	28	1.94
DPFS4242	572	639	713	42	42	1.3	33	2.24
DPFS4248	616	686	758	42	48	1.3	37	2.55
DPFS4254	667	735	807	42	54	1.3	42	2.85
DPFS4260	712	781	854	42	60	1.3	47	3.16

DPFSF • Fabric Bottom, Slat Middle and Fabric Top Panel

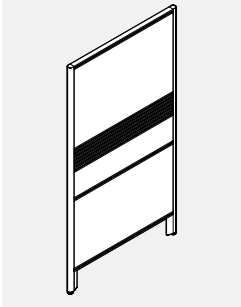

- **Integrated 6" slat rail between the middle rails provides flexibility of use. Fabric at the top provides visual privacy.**
- Panel integrated slat rail accepts Global Contract Accessories, Monitor Arm Support, Off-Module Shelves, Task Light Bracket and Power Bar.
- OPT* = Laminate or Whiteboard

PRODUCT CODE	PRICE			SIZE/ INCHES			WEIGHT VOL	
	GR1	GR2	OPT*	H	W	D	LBS	FT ³
DPFSF5024	535	561	587	50	24	1.3	21	1.62
DPFSF5030	592	617	642	50	30	1.3	28	2.08
DPFSF5036	651	722	793	50	36	1.3	34	2.47
DPFSF5042	706	778	851	50	42	1.3	40	2.85
DPFSF5048	767	837	909	50	48	1.3	46	3.25
DPFSF5054	820	889	963	50	54	1.3	52	3.63
DPFSF5060	877	945	1020	50	60	1.3	58	4.02
DPFSF5424	535	561	587	54	24	1.3	23	1.62
DPFSF5430	592	617	642	54	30	1.3	30	2.08
DPFSF5436	651	722	793	54	36	1.3	36	2.47
DPFSF5442	706	778	851	54	42	1.3	42	2.85
DPFSF5448	767	837	909	54	48	1.3	48	3.25
DPFSF5454	820	889	963	54	54	1.3	54	3.63
DPFSF5460	877	945	1020	54	60	1.3	60	4.02
DPFSF6624	615	661	710	66	24	1.3	28	2.04
DPFSF6630	675	723	771	66	30	1.3	35	2.52
DPFSF6636	741	853	969	66	36	1.3	42	3.00
DPFSF6642	802	911	1030	66	42	1.3	49	3.46
DPFSF6648	862	971	1089	66	48	1.3	56	3.93
DPFSF6654	923	1032	1148	66	54	1.3	63	4.40
DPFSF6660	982	1090	1207	66	60	1.3	70	4.90

DPOSF • Open Bottom, Slat Middle Panel

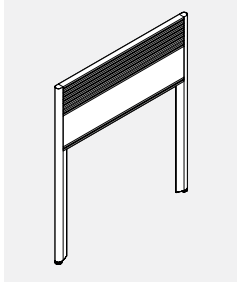

- Integrated 6" slat rail between the middle rails provides flexibility of use.
- Panel integrated slat rail accepts Global Contract Accessories, Monitor Arm Support, Off-Module Shelves, Task Light Bracket and Power Bar.
- OPT* = Laminate or Whiteboard

PRODUCT CODE	PRICE			SIZE/ H	INCHES			WEIGHT VOL	
	GR1	GR2	OPT*		W	D	LBS	FT ³	
DPOSF4224	345	355	360	42	24	1.3	12	1.32	
DPOSF4230	386	394	399	42	30	1.3	17	1.62	
DPOSF4236	428	441	457	42	36	1.3	24	1.94	
DPOSF4242	466	477	494	42	42	1.3	28	2.24	
DPOSF4248	507	523	535	42	48	1.3	36	2.55	
DPOSF4254	547	560	574	42	54	1.3	40	2.85	
DPOSF4260	585	596	612	42	60	1.3	44	3.16	

DPOSF • Open Bottom, Slat Middle and Fabric Top Panel

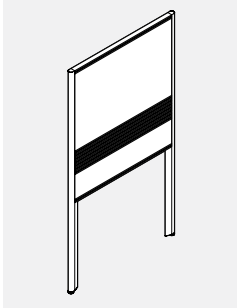

- Integrated 6" slat rail between the middle rails provides flexibility of use. Fabric above middle rail provides privacy.
- Panel integrated slat rail accepts Global Contract Accessories, Monitor Arm Support, Off-Module Shelves, Task Light Bracket and Power Bar.
- Open bottom reduces cost and improves air circulation within the office.
- OPT* = Laminate or Whiteboard

PRODUCT CODE	PRICE			SIZE/ H	INCHES			WEIGHT VOL	
	GR1	GR2	OPT*		W	D	LBS	FT ³	
DPOSF5024	461	480	502	50	24	1.3	13	1.62	
DPOSF5030	508	530	552	50	30	1.3	14	2.08	
DPOSF5036	557	596	640	50	36	1.3	21	2.47	
DPOSF5042	607	647	692	50	42	1.3	25	2.85	
DPOSF5048	652	694	737	50	48	1.3	29	3.25	
DPOSF5054	703	744	789	50	54	1.3	31	3.63	
DPOSF5060	751	790	835	50	60	1.3	35	4.02	
DPOSF5424	461	480	502	54	24	1.3	15	1.62	
DPOSF5430	508	530	552	54	30	1.3	19	2.08	
DPOSF5436	557	596	640	54	36	1.3	23	2.47	
DPOSF5442	607	647	692	54	42	1.3	27	2.85	
DPOSF5448	652	694	737	54	48	1.3	31	3.25	
DPOSF5454	703	744	789	54	54	1.3	34	3.63	
DPOSF5460	751	790	835	54	60	1.3	38	4.02	
DPOSF6624	541	575	612	66	24	1.3	18	2.04	
DPOSF6630	594	628	666	66	30	1.3	23	2.52	
DPOSF6636	646	715	788	66	36	1.3	28	3.00	
DPOSF6642	700	768	842	66	42	1.3	33	3.46	
DPOSF6648	752	832	923	66	48	1.3	38	3.93	
DPOSF6654	805	888	975	66	54	1.3	43	4.40	
DPOSF6660	857	938	1029	66	60	1.3	47	4.90	

DPOSG • Open Bottom, Slat Middle and Glazed Top Panel

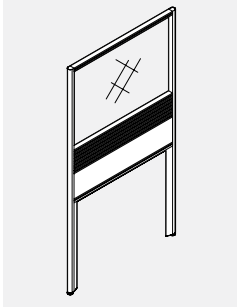

- Integrated 6" slat rail between the middle rails provides flexibility of use.
- Panel integrated slat rail accepts Global Contract Accessories, Monitor Arm Support, Off-Module Shelves, Task Light Bracket and Power Bar.
- Open bottom reduces cost and improves air circulation within the office.
- Extruded aluminum frame surrounds acrylic glazing at top.
- PVC Extrusion is only Charcoal.
- For tempered glass, add "TG" to the end of the product code and add 20% to the price regardless of fabric grade.
- OPT* = Laminate or Whiteboard

PRODUCT CODE	PRICE			SIZE/ H	INCHES			WEIGHT VOL	
	GR1	GR2	OPT*		W	D	LBS	FT ³	
DPOSG5024	684	692	697	50	24	1.3	12	1.62	
DPOSG5030	737	744	752	50	30	1.3	15	2.08	
DPOSG5036	788	801	816	50	36	1.3	18	2.47	
DPOSG5042	842	856	869	50	42	1.3	22	2.85	
DPOSG5048	891	904	920	50	48	1.3	25	3.25	
DPOSG5054	944	957	971	50	54	1.3	28	3.63	
DPOSG5060	994	1007	1022	50	60	1.3	32	4.02	
DPOSG5424	684	692	697	54	24	1.3	14	1.62	
DPOSG5430	737	744	752	54	30	1.3	17	2.08	
DPOSG5436	788	801	816	54	36	1.3	20	2.47	
DPOSG5442	842	856	869	54	42	1.3	24	2.85	
DPOSG5448	891	904	920	54	48	1.3	27	3.25	
DPOSG5454	944	957	971	54	54	1.3	30	3.63	
DPOSG5460	994	1007	1022	54	60	1.3	34	4.02	
DPOSG6624	743	752	757	66	24	1.3	17	2.04	
DPOSG6630	800	806	813	66	30	1.3	21	2.52	
DPOSG6636	854	867	882	66	36	1.3	25	3.00	
DPOSG6642	909	923	936	66	42	1.3	29	3.46	
DPOSG6648	963	974	991	66	48	1.3	33	3.93	
DPOSG6654	1020	1032	1048	66	54	1.3	37	4.40	
DPOSG6660	1076	1089	1104	66	60	1.3	41	4.90	

DPFSG • Fabric Bottom, Slat Middle and Glazed Top Panel

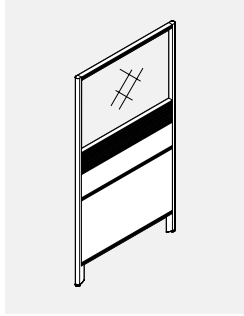

- **Integrated 6" slat rail provides flexibility of use.**
- Panel integrated slat rail accepts Global Contract Accessories, Monitor Arm Support, Off-Module Shelves, Task Light Bracket and Power Bar.
- Extruded aluminum frame surrounds acrylic glazing at top.
- PVC Extrusion is only Charcoal.
- For tempered glass, add "TG" to the end of the product code and add 20% to the price regardless of fabric grade.
- OPT* = Laminate or Whiteboard

PRODUCT CODE	PRICE			SIZE/ H	INCHES			WEIGHT VOL	
	GR1	GR2	OPT*		W	D	LBS	FT ³	
DPFSG5024	751	774	801	50	24	1.3	15	1.62	
DPFSG5030	807	832	859	50	30	1.3	19	2.08	
DPFSG5036	866	934	1007	50	36	1.3	23	2.47	
DPFSG5042	923	992	1063	50	42	1.3	27	2.85	
DPFSG5048	975	1047	1119	50	48	1.3	31	3.25	
DPFSG5054	1032	1101	1174	50	54	1.3	35	3.63	
DPFSG5060	1089	1159	1230	50	60	1.3	39	4.02	
DPFSG5424	751	774	801	54	24	1.3	17	1.62	
DPFSG5430	807	832	859	54	30	1.3	21	2.08	
DPFSG5436	866	934	1007	54	36	1.3	25	2.47	
DPFSG5442	923	992	1063	54	42	1.3	29	2.85	
DPFSG5448	975	1047	1119	54	48	1.3	33	3.25	
DPFSG5454	1032	1101	1174	54	54	1.3	37	3.63	
DPFSG5460	1089	1159	1230	54	60	1.3	41	4.02	
DPFSG6624	816	840	867	66	24	1.3	20	2.04	
DPFSG6630	877	902	928	66	30	1.3	25	2.52	
DPFSG6636	934	1003	1076	66	36	1.3	30	3.00	
DPFSG6642	994	1062	1136	66	42	1.3	35	3.46	
DPFSG6648	1056	1123	1198	66	48	1.3	40	3.93	
DPFSG6654	1114	1183	1256	66	54	1.3	45	4.40	
DPFSG6660	1177	1249	1320	66	60	1.3	50	4.90	

DPOPF • Diet Over Panel

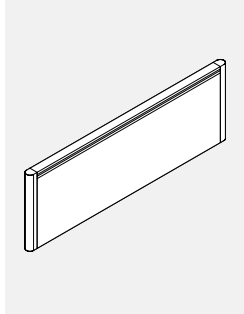

- **Over Panels attach to regular Diet Panels to provide additional visual privacy.**
- Over Panel is secured to regular Diet Panels with 4 brackets and set screws.
- Accessory loading capabilities only.
- Not for use with overhead storage.
- OPT* = Laminate or Whiteboard

PRODUCT CODE	PRICE			SIZE/ H	INCHES			WEIGHT VOL	
	GR1	GR2	OPT*		W	D	LBS	FT ³	
DPOPF1224	204	217	231	12	24	1.3	5	0.30	
DPOPF1230	232	245	260	12	30	1.3	7	0.60	
DPOPF1236	262	290	319	12	36	1.3	8	0.75	
DPOPF1242	284	311	341	12	42	1.3	9	0.88	
DPOPF1248	315	342	372	12	48	1.3	11	1.00	
DPOPF1254	344	373	403	12	54	1.3	12	1.13	
DPOPF1260	366	394	422	12	60	1.3	13	1.25	
DPOPF2424	283	310	340	24	24	1.3	10	1.00	
DPOPF2430	308	334	364	24	30	1.3	14	1.25	
DPOPF2436	329	369	413	24	36	1.3	16	1.45	
DPOPF2442	350	389	435	24	42	1.3	18	1.75	
DPOPF2448	372	413	458	24	48	1.3	22	2.00	
DPOPF2454	394	436	477	24	54	1.3	24	2.25	
DPOPF2460	418	459	502	24	60	1.3	26	2.50	

DTMPP • Table Mounted Diet Panels

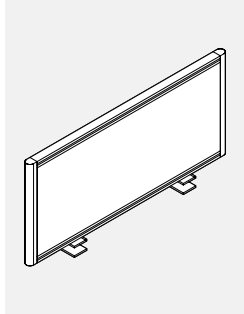

- **Creates privacy and flexibility at the end of workspaces.**
- Side Panels for sides of Viceversa® Tables or sides of workspaces available 24", and 36" widths (nominal width).
- Back Panels for sides of Viceversa® Tables available 48", 54" and 60" widths.
- Attaches with similar clamp to other clamp on accessories.
- Non tackable, non load-bearing, no hang on capabilities and not for use with transaction tops.
- Not for use with Licence product due to interference of gables and flush modesties.
- OPT* = Laminate or Whiteboard

PRODUCT CODE	PRICE			SIZE/ H	INCHES			WEIGHT VOL	
	GR1	GR2	OPT*		W	D	LBS	FT ³	
SIDE PANELS									
DTMPP24	224	234	252	16.5	21	1.3	7	0.75	
DTMPP30	240	254	268	16.5	27	1.3	8	0.94	
DTMPP36	257	286	315	16.5	33	1.3	10	1.13	
BACK PANELS									
DTMPP48	284	311	341	16.5	48	1.3	15	1.53	
DTMPP54	311	340	369	16.5	54	1.3	17	1.72	
DTMPP60	340	367	397	16.5	60	1.3	18	1.91	

DPCBM • Panel Cable Manager

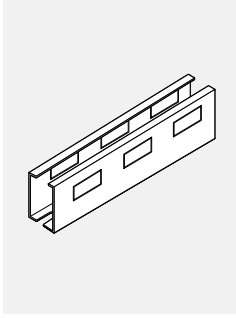

- Provides wire management for the Diet Panels.
- Extruded, dual durometer "U" channel organizes cables below panels.
- Snaps into bottom rail and into mid rail on open bottom panels.
- One data partial knock-out (2.67" wide x 1.36" high) provided on either side of the Raceway Cover accommodates terminal plates from various vendors.
- Panel Cable Manager comes in charcoal only.

PRODUCT CODE	PRICE	SIZE/ INCHES			WEIGHT VOL	
		H	W	D	LBS	FT ³
DPCBM24	15	4	18	1.3	1.3	0.07
DPCBM30	23	4	24	1.3	1.4	0.08
DPCBM36	25	4	30	1.3	1.5	0.10
DPCBM42	28	4	36	1.3	1.6	0.13
DPCBM48	30	4	42	1.3	1.7	0.15
DPCBM54	34	4	48	1.3	1.8	0.16
DPCBM60	36	4	54	1.3	1.9	0.19

DPOFM • Off Module Panel Connector

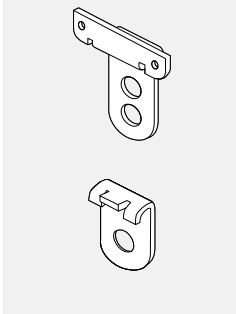

- Connects two perpendicular Diet Panels Off-Module.
- Top and bottom brackets bolt to Diet Panel verticals and engage to top and bottom rails of adjacent, perpendicular panel of even or lower height.
- Connectors can also be used to connect a panel in the middle of perpendicular DPFRF, DPORF, DPFFG, DPFSG and DPFSF at their 42" height secondary middle rail.
- Top and bottom brackets fit in place of standard hinge connectors.
- All fasteners included.

PRODUCT CODE	PRICE	SIZE/ INCHES			WEIGHT VOL	
		H	W	D	LBS	FT ³
DPOFM	58	4	3	2	1	0.08

DPPWA • Wall Adapter

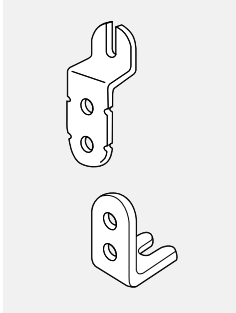

- Connects Diet Panels to walls.
- Bolts to Diet Panel vertical in place of the standard hinge connectors.
- Keyhole openings in Diet adapter slide over fasteners pre-installed to the wall.
- All fasteners included, however, the mounting hardware to affix adapter to wall not included, they will be based on type of wall material.

PRODUCT CODE	PRICE	SIZE/ INCHES			WEIGHT VOL	
		H	W	D	LBS	FT ³
DPPWA	42	40	2.5		1	0.08

DPCSTR • Casters

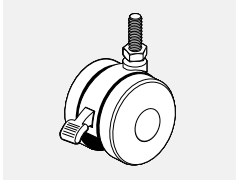

- Changes a freestanding Diet Panel to mobile.
- Must be used on two panels or more.
- Order 1 caster more than the number of panels. (Using only 1 caster where panels connect.) For example, 3 panels, 4 casters or 2 panels, 3 casters.
- Casters raise Diet Panels by a height of 1.1".

PRODUCT CODE	PRICE	SIZE/ INCHES			WEIGHT VOL	
		H	W	D	LBS	FT ³
DPCSTR	12	1.5	1.5	1.5	.25	1.02

DPLTSBKIT • Telescopic Sliding Kit

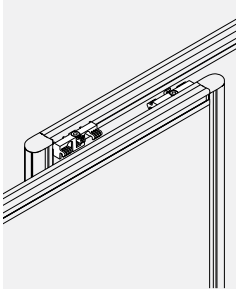

- Diet Telescopic Sliding Kit flexibly connects two standard parallel Diet panels and forms a length-adjustable partition.
- Kit consists of two top and two bottom sliding box assemblies and all the necessary connecting hardware.
- Made of black injection molded resin.
- The panels must be of the same height and equipped with top and bottom standard Diet extrusions.
- The kit can be installed as right or left on site, determining the direction of nesting/sliding.
- The kit offsets the parallel panel and the resulting gap is 12.5mm (½")
- Up to three standard Diet panels can be connected to form the length-adjustable partition.
- The kit is not intended to be used in place of a sliding door.
- The kit cannot be used with Diet overpanels or Diet Linking Panels.

PRODUCT CODE	PRICE	SIZE/ INCHES			WEIGHT VOL	
		H	W	D	LBS	FT ³
DPLTSBKIT	76	0.75	3	0.5	0.04	0.15

DBSCB • Diet to Boulevard Slot Connector

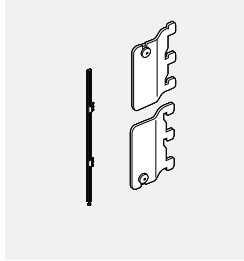

- Connects a Diet Panel to a Boulevard Panel via slots eliminating the need for the Boulevard Post and reducing the overall length and cost of a panel run.
- Connector can be installed in left or right configuration.
- Comes as a pair (Upper and lower brackets).
- Worksurfaces should be ordered based on application keeping in mind that this connector will align to the left or right of the end of the Boulevard Panel.
- Application drawings and layout must be provided for specials.

PRODUCT CODE	PRICE	SIZE/	INCHES			WEIGHT VOL	
		H	W	D	LBS	FT ³	
DBSCB02	56	3	0.5	00.0	1	0.05	

DAPPF • Diet Gap Filler

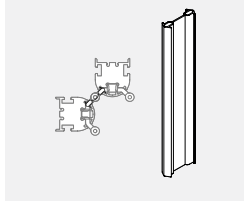

- Closes the gap between panels.
- Must be used on two or more panels.
- Order 1 DAPPF36 for a 42" high panel, 1 DAPPF36 and 1 DAPPF12 for a 54" high panel, or 1 DAPPF36 and 2 DAPPF12 for 66" high panel.

PRODUCT CODE	PRICE	SIZE/	INCHES			WEIGHT VOL	
		H	W	D	LBS	FT ³	
DAPPF12	9	9	11.5				
DAPPF36	22	36.33					

DHFFA • Single Flat Foot

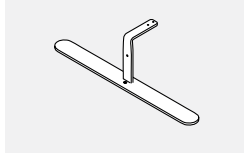

- Used to create a freestanding panel
- Foot is flat to the floor with no adjustable glides
- No load capabilities on freestanding panel
- Only for use with Fabric Bottom panels
- Can be used to retro fit existing Diet panels on site
- Not for use with Diet Linking Panels
- Specify standard panel frame paint finishes

PRODUCT CODE	PRICE	SIZE/	INCHES			WEIGHT VOL	
		H	W	D	LBS	FT ³	
DHFFA	97	6	20	2	3.48	0.15	

DHFFA02 • Flat Foot Kit

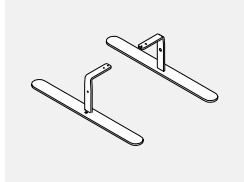

- Used to create a freestanding panel
- Feet are flat to the floor with no adjustable glides
- No load capabilities on freestanding panel
- Cannot be used with open bottom panels or Linking Panels.
- Can be used to retro fit existing Diet panels on site
- Not for use with Diet Linking Panels
- Specify standard panel frame paint finishes

PRODUCT CODE	PRICE	SIZE/	INCHES			WEIGHT VOL	
		H	W	D	LBS	FT ³	
DHFFA02	191	6	20	2	7	0.3	

DHCFAN • Single Caster Foot



- Used to create a mobile panel
- Casters are locking
- No load capabilities on mobile panel
- Only for use with Fabric Bottom panels
- Can be used to retro fit existing Diet panels on site
- Not for use with Diet Linking Panels
- Specify standard panel frame paint finishes

PRODUCT CODE	PRICE	SIZE/	INCHES			WEIGHT VOL	
		H	W	D	LBS	FT ³	
DHCFAN	127	6	20	2	3.87	0.15	

DHCFAN02 • Caster Foot Kit

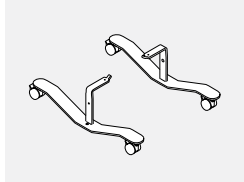

- Used to create a mobile panel
- Casters are locking
- No load capabilities on mobile panel
- Only for use with Fabric Bottom panels
- Can be used to retro fit existing Diet panels on site
- Not for use with Diet Linking Panels
- Specify standard panel frame paint finishes

PRODUCT CODE	PRICE	SIZE/	INCHES			WEIGHT VOL	
		H	W	D	LBS	FT ³	
DHCFAN02	253	6	20	2	7.7	0.3	

DHCFAL01 • Diet Caster Assembly Kit

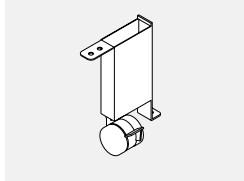

- To be used on one side to create a mobile panel with DHCFAN on the other side.
- Caster is locking.
- No load capabilities on mobile panel
- Only for use with Fabric Bottom panels.
- Can be used to retrofit existing Diet panels on site.
- Not for use with Diet Linking Panels.
- Specigy standard panel frame paint finishes.

PRODUCT CODE	PRICE	SIZE/	INCHES			WEIGHT VOL	
		H	W	D	LBS	FT ³	
DHCFAL01	61	6	1	4.8	1	0.02	

DB-P-X • Diet to Boulevard Slim Connector in “X” Configuration

• Creates a perpendicular connection between Diet Panel and Boulevard Panel that eliminates the need for special sized work-surfaces.

• Note: For use with new BDPFF & BDPOF panels.

Diet to Boulevard 1 “X” Configuration

PRODUCT CODE	PRICE	B1 HEIGHT	DIET PANEL HEIGHT	SIZE/ H	INCHES W	D	WEIGHT LBS	VOL FT ³
BDB1P4242X	128	42"	42"	42	1.3	2.6	4	0.207
BDB1P4250X	143	50"	42"	50	1.3	2.6	5	0.245
BDB1P4254X	151	54"	42"	54	1.3	2.6	5	0.264
BDB1P4258X	157	58"	42"	58	1.3	2.6	6	0.283
BDB1P4266X	173	66"	42"	66	1.3	2.6	7	0.322
BDB1P4274X	188	74"	42"	74	1.3	2.6	8	0.360
BDB1P4282X	202	82"	42"	82	1.3	2.6	9	0.399
BDB1P5050X	173	50"	50"	50	1.3	2.6	5	0.245
BDB1P5054X	173	54"	50"	54	1.3	2.6	5	0.264
BDB1P5058X	173	58"	50"	58	1.3	2.6	6	0.283
BDB1P5066X	173	66"	50"	66	1.3	2.6	7	0.322
BDB1P5074X	188	74"	50"	74	1.3	2.6	8	0.360
BDB1P5082X	202	82"	50"	82	1.3	2.6	9	0.399
BDB1P5454X	145	54"	54"	54	1.3	2.6	5	0.264
BDB1P5458X	157	58"	54"	58	1.3	2.6	6	0.283
BDB1P5466X	173	66"	54"	66	1.3	2.6	7	0.322
BDB1P5474X	188	74"	54"	74	1.3	2.6	8	0.360
BDB1P5482X	202	82"	54"	82	1.3	2.6	9	0.399
BDB1P6666X	173	66"	66"	66	1.3	2.6	7	0.322
BDB1P6674X	188	74"	66"	74	1.3	2.6	8	0.360
BDB1P6682X	202	82"	66"	82	1.3	2.6	9	0.399

Diet to System 3 “X” Configuration

PRODUCT CODE	PRICE	SYSTEM3 HEIGHT	DIET PANEL HEIGHT	SIZE/ H	INCHES W	D	WEIGHT LBS	VOL FT ³
BDB3P4242X	128	42"	42"	42	1.3	2.6	4	0.207
BDB3P4250X	143	50"	42"	50	1.3	2.6	5	0.245
BDB3P4254X	145	54"	42"	54	1.3	2.6	6	0.260
BDB3P4266X	173	66"	42"	66	1.3	2.6	7	0.322
BDB3P5050X	173	50"	50"	50	1.3	2.6	5	0.245
BDB3P5054X	145	54"	50"	54	1.3	2.6	6	0.260
BDB3P5066X	173	66"	50"	66	1.3	2.6	7	0.322
BDB3P5454X	145	54"	54"	54	1.3	2.6	6	0.260
BDB3P5466X	173	66"	54"	66	1.3	2.6	7	0.322
BDB3P6666X	173	66"	66"	66	1.3	2.6	7	0.322

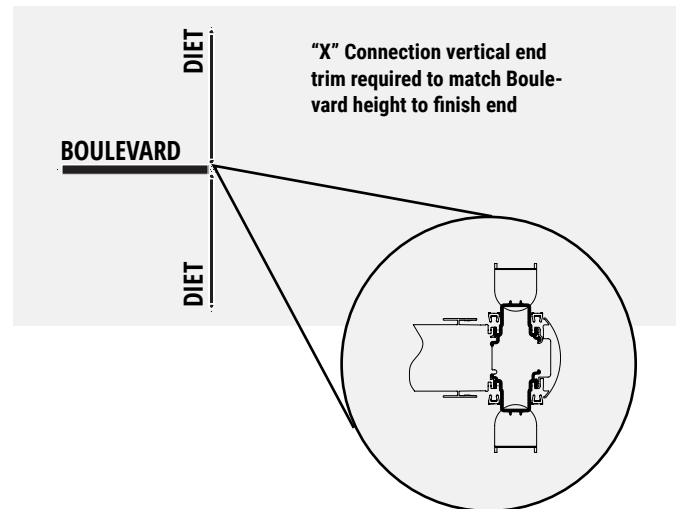
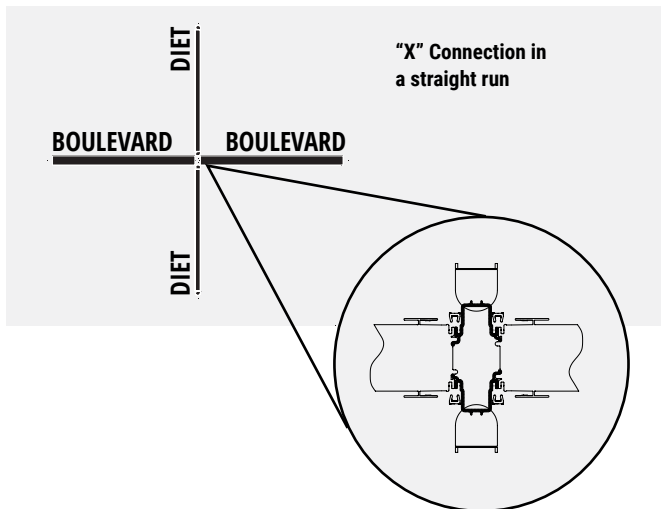

* Please specify separate end trim (round or flat) to close end.

DBXP-T • Diet to Boulevard Slim Connector in "T" Configuration

- Creates a perpendicular connection between Diet Panel and Boulevard Panel that eliminates the need for special sized worksurfaces.
- Note: For use with new BDPFF & BDPOF panels.

Diet to Boulevard 1 "T" Configuration

PRODUCT CODE	PRICE	B1 HEIGHT	DIET PANEL HEIGHT	SIZE/ H	INCHES W	D	WEIGHT LBS	VOL FT ³
BDB1P4242T	128	42"	42"	42	1.3	2.6	4	0.207
BDB1P4250T	143	50"	42"	50	1.3	2.6	5	0.245
BDB1P4254T	151	54"	42"	54	1.3	2.6	5	0.264
BDB1P4258T	157	58"	42"	58	1.3	2.6	6	0.283
BDB1P4266T	173	66"	42"	66	1.6	2.6	7	0.322
BDB1P4274T	188	74"	42"	74	1.3	2.6	8	0.360
BDB1P4282T	202	82"	42"	82	1.3	2.6	9	0.399
BDB1P5050T	173	50"	50"	50	1.3	2.6	5	0.245
BDB1P5054T	173	54"	50"	54	1.3	2.6	5	0.264
BDB1P5058T	173	58"	50"	58	1.3	2.6	6	0.283
BDB1P5066T	173	66"	50"	66	1.3	2.6	7	0.322
BDB1P5074T	188	74"	50"	74	1.3	2.6	8	0.360
BDB1P5082T	202	82"	50"	82	1.3	2.6	9	0.399
BDB1P5454T	145	54"	54"	54	1.3	2.6	6	0.245
BDB1P5458T	157	58"	54"	58	1.3	2.6	6	0.283
BDB1P5466T	173	66"	54"	66	1.3	2.6	7	0.322
BDB1P5474T	188	74"	54"	74	1.3	2.6	8	0.360
BDB1P5482T	202	82"	54"	82	1.3	2.6	9	0.399
BDB1P6666T	173	66"	66"	66	1.3	2.6	7	0.322
BDB1P6674T	188	74"	66"	74	1.3	2.6	8	0.360
BDB1P6682T	202	82"	66"	82	1.3	2.6	9	0.399

Diet to System 3 "T" Configuration

PRODUCT CODE	PRICE	SYSTEM 3 HEIGHT	DIET PANEL HEIGHT	SIZE/ H	INCHES W	D	WEIGHT LBS	VOL FT ³
BDB3P4242T	128	42"	42"	42	1.3	2.6	4	0.207
BDB3P4250T	143	50"	42"	50	1.3	2.6	5	0.245
BDB3P4254T	145	54"	42"	54	1.3	2.6	6	0.245
BDB3P4266T	173	66"	42"	66	1.3	2.6	7	0.322
BDB3P5050T	173	50"	50"	50	1.3	2.6	5	0.245
BDB3P5054T	145	54"	50"	54	1.3	2.6	6	0.245
BDB3P5066T	173	66"	50"	66	1.3	2.6	7	0.322
BDB3P5454T	145	54"	54"	54	1.3	2.6	6	0.245
BDB3P5466T	173	66"	54"	66	1.3	2.6	7	0.322
BDB3P6666T	173	66"	66"	66	1.3	2.6	7	0.322

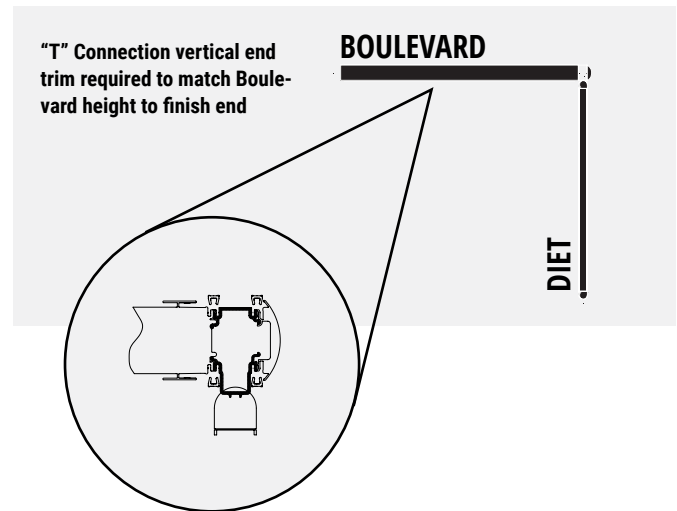
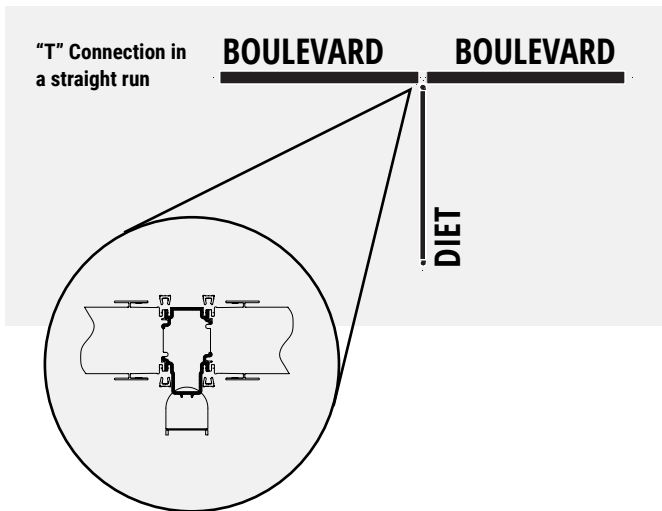

* Please specify separate end trim (round or flat) to close end.

DB-P-X • Diet to Boulevard Slim Connector in "X" Configuration

- Creates a perpendicular connection between Diet Panel and Boulevard Panel that eliminates the need for special sized worksurfaces.
- Note: For use with regular DP panels.

Diet to Boulevard 1 "X" Configuration

PRODUCT CODE	PRICE	B1 HEIGHT	DIET PANEL HEIGHT	SIZE/ H	INCHES W	D	WEIGHT LBS	VOL FT ³
DB1P4242X	128	42"	42"	42	1.3	2.6	4	0.207
DB1P4250X	143	50"	42"	50	1.3	2.6	5	0.245
DB1P4254X	154	54"	42"	54	1.3	2.6	6	0.266
DB1P4266X	173	66"	42"	66	1.3	2.6	7	0.322
DB1P4274X	188	74"	42"	74	1.3	2.6	8	0.360
DB1P4282X	202	82"	42"	82	1.3	2.6	9	0.399
DB1P5050X	173	50"	50"	50	1.3	2.6	5	0.245
DB1P5054X	173	54"	50"	54	1.3	2.6	6	0.266
DB1P5058X	173	58"	50"	58	1.3	2.6	6	0.283
DB1P5066X	173	66"	50"	66	1.3	2.6	7	0.322
DB1P5074X	188	74"	50"	74	1.3	2.6	8	0.360
DB1P5082X	202	82"	50"	82	1.3	2.6	9	0.399
DB1P5458X	157	58"	54"	58	1.3	2.6	6	0.283
DB1P5466X	173	66"	54"	66	1.3	2.6	7	0.322
DB1P5474X	188	74"	54"	74	1.3	2.6	8	0.360
DB1P5482X	202	82"	54"	82	1.3	2.6	9	0.399
DB1P6666X	173	66"	66"	66	1.3	2.6	7	0.322
DB1P6674X	188	74"	66"	74	1.3	2.6	8	0.360
DB1P6682X	202	82"	66"	82	1.3	2.6	9	0.399

Diet to System 3 "X" Configuration

PRODUCT CODE	PRICE	SYSTEM 3 HEIGHT	DIET PANEL HEIGHT	SIZE/ H	INCHES W	D	WEIGHT LBS	VOL FT ³
DB3P4242X	128	42"	42"	42	1.3	2.6	4	0.207
DB3P4250X	143	50"	42"	50	1.3	2.6	5	0.245
DB3P4266X	173	66"	42"	66	1.3	2.6	7	0.322
DB3P5050X	173	50"	50"	50	1.3	2.6	5	0.245
DB3P5066X	173	66"	50"	66	1.3	2.6	7	0.322
DB3P5466X	173	66"	54"	66	1.3	2.6	7	0.322
DB3P5454X	173	54"	54"	54	1.3	2.6	6	0.266
DB3P6666X	173	66"	66"	66	1.3	2.6	7	0.322

Diet to Boulevard 1 Overpanels

PRODUCT CODE	PRICE	OVER PANEL HEIGHT	SIZE/ H	INCHES W	D	WEIGHT LBS	VOL FT ³
DB1OPPC08X	58	8"	8	1.3	2.6	0.8	0.043
DB1OPPC16X	62	16"	16	1.3	2.6	1.6	0.082
DB1OPPC24X	64	24"	24	1.3	2.6	2.5	0.120
DB1OPPC37X	72	37"	37	1.3	2.6	3.5	0.183
DB1OPPC42X	81	42"	42	1.3	2.6	4.0	0.207

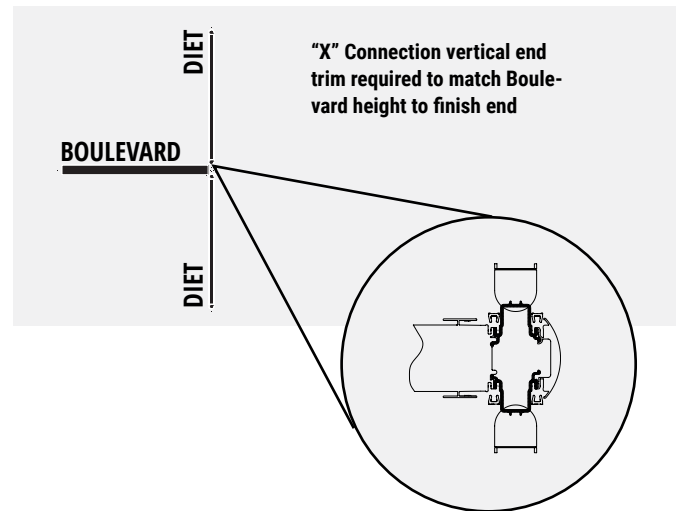
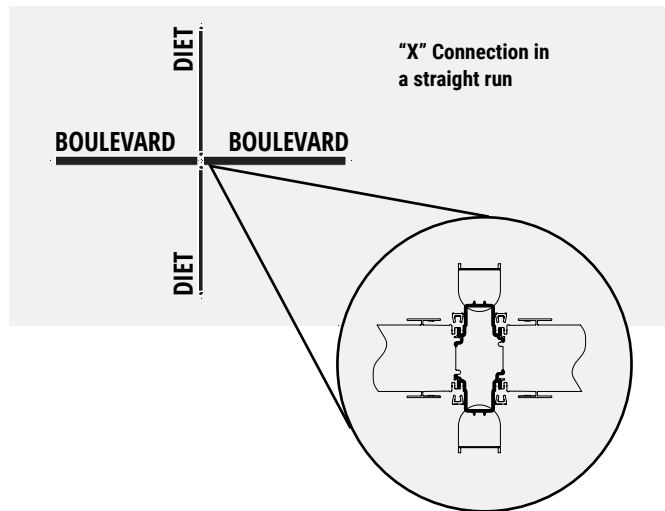

DBXP-T • Diet to Boulevard Slim Connector in “T” Configuration

• Creates a perpendicular connection between Diet Panel and Boulevard Panel that eliminates the need for special sized work-surfaces.

• Note: For use with regular DP panels.

Diet to Boulevard 1 “T” Configuration

PRODUCT CODE	PRICE	B1 HEIGHT	DIET PANEL HEIGHT	SIZE/ H	INCHES W	D	WEIGHT LBS	VOL FT ³
DB1P4242T	128	42"	42"	42	1.3	2.6	4	0.207
DB1P4250T	143	50"	42"	50	1.3	2.6	5	0.245
DB1P4258T	157	58"	42"	58	1.3	2.6	6	0.283
DB1P4266T	173	66"	42"	66	1.6	2.6	7	0.322
DB1P4274T	188	74"	42"	74	1.3	2.6	8	0.360
DB1P4282T	202	82"	42"	82	1.3	2.6	9	0.399
DB1P5050T	173	50"	50"	50	1.3	2.6	5	0.245
DB1P5058T	173	58"	50"	58	1.3	2.6	6	0.283
DB1P5066T	173	66"	50"	66	1.3	2.6	7	0.322
DB1P5074T	188	74"	50"	74	1.3	2.6	8	0.360
DB1P5082T	202	82"	50"	82	1.3	2.6	9	0.399
DB1P5458T	157	58"	54"	58	1.3	2.6	6	0.283
DB1P5466T	173	66"	54"	66	1.3	2.6	7	0.322
DB1P5474T	188	74"	54"	74	1.3	2.6	8	0.360
DB1P5482T	202	82"	54"	82	1.3	2.6	9	0.399
DB1P6666T	173	66"	66"	66	1.3	2.6	7	0.322
DB1P6674T	188	74"	66"	74	1.3	2.6	8	0.360
DB1P6682T	202	82"	66"	82	1.3	2.6	9	0.399

Diet to System 3 “T” Configuration

PRODUCT CODE	PRICE	SYSTEM 3 HEIGHT	DIET PANEL HEIGHT	SIZE/ H	INCHES W	D	WEIGHT LBS	VOL FT ³
DB3P4242T	128	42"	42"	42	1.3	2.6	4	0.207
DB3P4250T	143	50"	42"	50	1.3	2.6	5	0.245
DB3P4266T	173	66"	42"	66	1.3	2.6	7	0.322
DB3P5050T	173	50"	50"	50	1.3	2.6	5	0.245
DP3P5066T	173	66"	50"	66	1.3	2.6	7	0.322
DB3P5466T	173	66"	54"	66	1.3	2.6	7	0.322
DB3P6666T	173	66"	66"	66	1.3	2.6	7	0.322

Diet to System 3 Overpanels

PRODUCT CODE	PRICE	OVER PANEL HEIGHT	SIZE/ H	INCHES W	D	WEIGHT LBS	VOL FT ³
DB3OPPC16	62	16"	16	1.3	2.6	1.6	0.082
DB3OPPC32	72	32"	32	1.3	2.6	3.2	0.159

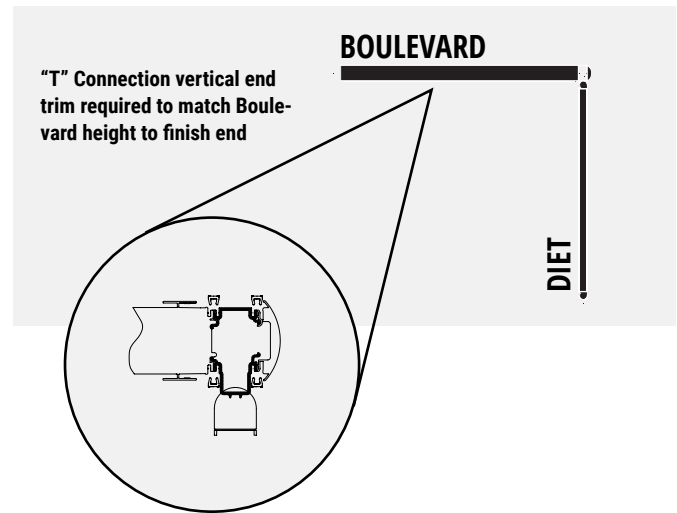
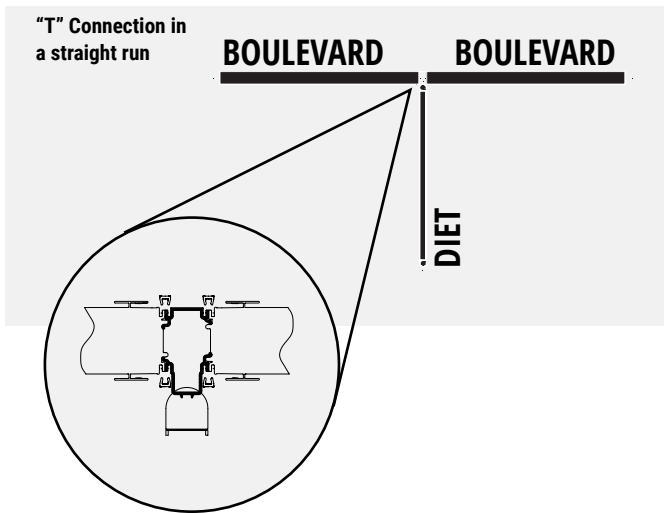

* Please specify separate end trim (round or flat) to close end.

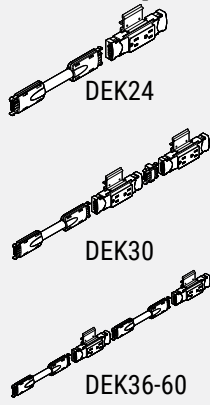
DEK • Jumper Harness

- **Kit includes all components to add power to Diet Panels.**

- Typical kit includes: 2 Duplex Receptacle Blocks (either circuit #1 or circuit #2), the Jumper Harness between the Duplex Receptacle Blocks, the Jumper Harness to the next panel, the pre-punched Raceway Cover, the aluminum Raceway Junction Cover, 2 PVC Duplex Receptacle Block Spacers and the hardware to attach the components.

- The length of the Jumper Harness between two Duplex Receptacle Blocks is based on the panel width.

- Jumper Harness going into the next panel and the aluminum Raceway Junction Covers are standard size.

- Raceway Cover and Raceway Junction Cover are Charcoal (CHR) only.

- Each kit is identified as circuit #1 (ie. DEK240"1") or circuit #2 (ie. DEK240"2").

- 24" wide panels have a single Duplex Receptacle Block only.

- 30" wide panels have 2 Duplex Receptacle Blocks, however they must be facing the same direction.

- 24" and 30" wide panels are not pre-punched for data.

- 36" to 60" wide panels are pre-punched for Duplex Receptacle Blocks on either side and for data just off-center on both sides.

PRODUCT CODE	PRICE	SIZE/ INCHES			WEIGHT VOL	
		H	W	D	LBS	FT ³
DEK2401	184	4	18	1.3	4.90	0.07
DEK3001	267	4	24	1.3	5.25	0.08
DEK3601	278	4	30	1.3	5.70	0.10
DEK4201	290	4	36	1.3	6.00	0.13
DEK4801	301	4	42	1.3	6.40	0.15
DEK5401	315	4	48	1.3	7.10	0.16
DEK6001	330	4	54	1.3	7.60	0.19
DEK2402	184	4	18	1.3	4.90	0.07
DEK3002	267	4	24	1.3	5.25	0.08
DEK3602	278	4	30	1.3	5.70	0.10
DEK4202	290	4	36	1.3	6.00	0.13
DEK4802	301	4	42	1.3	6.40	0.15
DEK5402	315	4	48	1.3	7.10	0.16
DEK6002	330	4	54	1.3	7.60	0.19

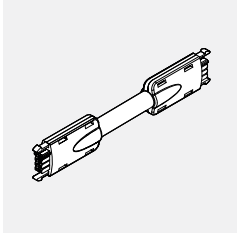
DEJH • Diet Pass-Thru Kit

- **Kit allows electrical to pass through a Diet Panel.**

- Kit includes: female-female jumper harness, Raceway Cover and Raceway Junction Cover.

- Pass-Thru harness connects to a Duplex Receptacle Block within one powered panel; passes through a non-powered panel, and the opposite end connects to another Receptacle Block within the second powered panel.

- Raceway Cover and Raceway Junction Cover are Charcoal (CHR) only.

PRODUCT CODE	PRICE	SIZE/ INCHES			WEIGHT VOL	
		H	L	D	LBS	FT ³
DEJH24	127	2	42	1	1.81	0.025
DEJH30	141	2	48	1	2.07	0.028
DEJH36	155	2	54	1	2.12	0.032
DEJH42	167	2	60	1	2.60	0.035
DEJH48	178	2	66	1	2.86	0.038
DEJH54	194	2	72	1	3.13	0.041
DEJH60	205	2	78	1	3.39	0.044

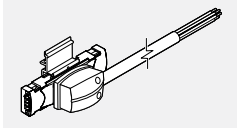
DEBF • Diet Base Feed

- **Provides single power entry from floor into raceway.**

- Single Ceiling Feed has a 6' whip, liquid tight.

- Raceway connection replaces one Duplex Receptacle Block in a standard kit.

PRODUCT CODE	PRICE	SIZE/ INCHES			WEIGHT VOL	
		H	L	D	LBS	FT ³
DEBF01	134	2	72	2	5.6	0.06

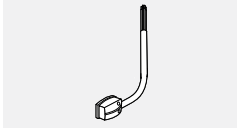
DECF • Diet Ceiling Feed

- **Provides single power entry from ceiling through a post into raceway.**

- Raceway connection replaces one Duplex Receptacle Block in a standard kit.

PRODUCT CODE	PRICE	SIZE/ INCHES			WEIGHT VOL	
		H	L	D	LBS	FT ³
DECF01	272	2	144	2	5.6	0.06

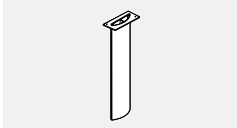
DEPE • Diet Post Extension

- **Lightweight aluminum pole manages power and data cables between ceiling and floor level raceway.**

- Aluminum extrusion with PVC extruded cover secures to the outside of the panel and passes through the worksurface scoop.

- Includes all hardware and bezel.

- Intended for use on Diet panels with fabric bottoms.

PRODUCT CODE	PRICE	SIZE/ INCHES			WEIGHT VOL	
		H	W	D	LBS	FT ³
DEPE116	174	116	4.5	1	7	0.82

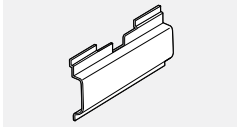
DERJC • Raceway Junction Cover

- **Provides an external cover for cables passing between adjacent, in-line panels and off-module "X" panel configurations. Also, capable of bridging two in-line panels in a "T" configuration (outside).**

- Aluminum, powder coated finish.

PRODUCT CODE	PRICE	SIZE/ INCHES			WEIGHT VOL	
		H	W	D	LBS	FT ³
DERJC	22	4.3	10	1	0.5	0.1

DPL • Linking Panel - Levelers on both legs

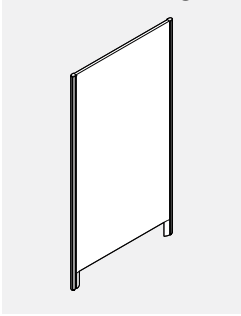

- Diet Linking Panel provides privacy.
- Aluminum extrusion comes in powder coated paint finish, DWT - Designer White or TUN - Tungsten.
- Laminate core available in DWTLPL - Designer White or ACJLP - Absolute Acajou.
- Edge banded to match laminate finish.
- Standard height of 54", 66", width in 6" increments from 24" to 60".
- Comes complete with hinge kits and levelers on both legs.

PRODUCT CODE	PRICE	SIZE/ INCHES			WEIGHT VOL	
		H	W	D	LBS	FT ³
DPL5424	385	54	24	1.3	18	1.62
DPL5430	428	54	30	1.3	23	2.08
DPL5436	470	54	36	1.3	27	2.47
DPL5442	512	54	42	1.3	32	2.85
DPL5448	556	54	48	1.3	37	3.25
DPL5454	597	54	54	1.3	42	3.63
DPL5460	639	54	60	1.3	47	4.02
DPL6624	437	66	24	1.3	23	2.04
DPL6630	484	66	30	1.3	29	2.52
DPL6636	531	66	36	1.3	35	3.00
DPL6642	576	66	42	1.3	41	3.46
DPL6648	625	66	48	1.3	47	3.93
DPL6654	671	66	54	1.3	53	4.40
DPL6660	717	66	60	1.3	59	4.90

DPLSCH • Diet Laminate Panel - Single caster on one leg, leveler on the other

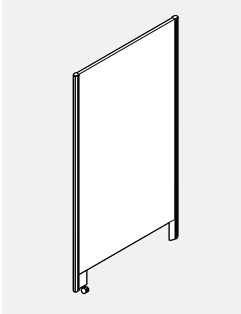

- Diet Linking Panel provides privacy.
- Aluminum extrusion comes in powder coated paint finish, DWT - Designer White or TUN - Tungsten.
- Laminate core available in DWTLPL - Designer White or ACJLP - Absolute Acajou.
- Edge banded to match laminate finish.
- Standard height of 54", 66", width in 6" increments from 24" to 60".
- Comes complete with hinge kits, caster on one leg and leveler on the other.

PRODUCT CODE	PRICE	SIZE/ INCHES			WEIGHT VOL	
		H	W	D	LBS	FT ³
DPLSCH5424	462	54	24	1.3	18	1.62
DPLSCH5430	507	54	30	1.3	23	2.08
DPLSCH5436	551	54	36	1.3	27	2.47
DPLSCH5442	595	54	42	1.3	32	2.85
DPLSCH5448	639	54	48	1.3	37	3.25
DPLSCH5454	684	54	54	1.3	42	3.63
DPLSCH5460	729	54	60	1.3	47	4.02
DPLSCH6624	515	66	24	1.3	23	2.04
DPLSCH6630	563	66	30	1.3	29	2.52
DPLSCH6636	612	66	36	1.3	35	3
DPLSCH6642	661	66	42	1.3	41	3.46
DPLSCH6648	710	66	48	1.3	47	3.93
DPLSCH6654	777	66	54	1.3	53	4.4
DPLSCH6660	806	66	60	1.3	59	4.9

DPLDF • Diet Linking Panel - Flat foot on both legs

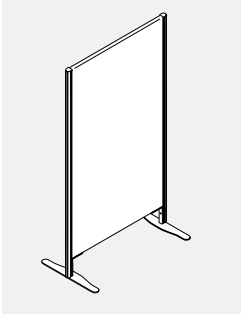

- Diet Linking Panel provides privacy.
- Aluminum extrusion comes in powder coated paint finish, DWT - Designer White or TUN - Tungsten.
- Laminate core available in DWTLPL - Designer White or ACJLP - Absolute Acajou.
- Edge banded to match laminate finish.
- Standard height of 54", 66", width in 6" increments from 24" to 60".
- Comes complete with hinge kits and flat foot on both legs.

PRODUCT CODE	PRICE	SIZE/ INCHES			WEIGHT VOL	
		H	W	D	LBS	FT ³
DPLDF5424	528	54	24	1.3	40.2	1.6
DPLDF5430	565	54	30	1.3	47.6	2.1
DPLDF5436	601	54	36	1.3	54.9	2.5
DPLDF5442	638	54	42	1.3	62.3	2.9
DPLDF5448	675	54	48	1.3	69.6	3.3
DPLDF5454	713	54	54	1.3	77.0	3.6
DPLDF5460	751	54	60	1.3	84.3	4.0
DPLDF6624	572	66	24	1.3	48.6	2.0
DPLDF6630	612	66	30	1.3	57.9	2.5
DPLDF6636	653	66	36	1.3	67.3	3.0
DPLDF6642	693	66	42	1.3	76.6	3.5
DPLDF6648	735	66	48	1.3	85.9	3.9
DPLDF6654	774	66	54	1.3	95.2	4.4
DPLDF6660	816	66	60	1.3	104.5	4.9

DPLMN • Diet Linking Panel - Double caster base on both legs

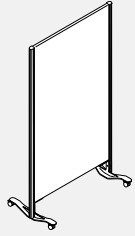

- **Diet Linking Panel provides privacy.**
- Aluminum extrusion comes in powder coated paint finish, DWT - Designer White or TUN - Tungsten.
- Laminate core available in DWTLPL - Designer White or ACJLP - Absolute Acajou.
- Edge banded to match laminate finish.
- Standard height of 54", 66", width in 6" increments from 24" to 60".
- Comes complete with hinge kits, and double caster foot on both legs.

PRODUCT CODE	PRICE	SIZE/ INCHES			WEIGHT VOL	
		H	W	D	LBS	FT ³
DPLMN5424	561	54	24	1.3	41.8	1.6
DPLMN5430	609	54	30	1.3	49.1	2.1
DPLMN5436	659	54	36	1.3	56.5	2.5
DPLMN5442	705	54	42	1.3	63.8	2.9
DPLMN5448	756	54	48	1.3	71.2	3.3
DPLMN5454	804	54	54	1.3	78.5	3.6
DPLMN5460	853	54	60	1.3	85.8	4.0
DPLMN6624	622	66	24	1.3	50.2	2.0
DPLMN6630	673	66	30	1.3	59.5	2.5
DPLMN6636	727	66	36	1.3	68.8	3.0
DPLMN6642	782	66	42	1.3	78.1	3.5
DPLMN6648	835	66	48	1.3	87.4	3.9
DPLMN6654	889	66	54	1.3	96.8	4.4
DPLMN6660	943	66	60	1.3	106.1	4.9

DPLDCMN • Diet Linking Panel - Single caster on one leg and double caster base on the other

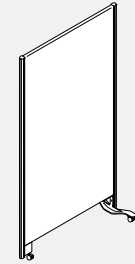

- **Diet Linking Panel provides privacy.**
- Aluminum extrusion comes in powder coated paint finish, DWT - Designer White or TUN - Tungsten.
- Laminate core available in DWTLPL - Designer White or ACJLP - Absolute Acajou.
- Edge banded to match laminate finish.
- Standard height of 54", 66", width in 6" increments from 24" to 60".
- Comes complete with hinge kits, single caster on the one leg and double caster foot on the other.

PRODUCT CODE	PRICE	SIZE/ INCHES			WEIGHT VOL	
		H	W	D	LBS	FT ³
DPLDCMN5424	527	54	24	1.3	37.6	1.6
DPLDCMN5430	574	54	30	1.3	45.0	2.1
DPLDCMN5436	620	54	36	1.3	52.3	2.5
DPLDCMN5442	668	54	42	1.3	59.7	2.9
DPLDCMN5448	715	54	48	1.3	67.0	3.3
DPLDCMN5454	760	54	54	1.3	74.4	3.6
DPLDCMN5460	806	54	60	1.3	81.7	4.0
DPLDCMN6624	584	66	24	1.3	46.0	2.0
DPLDCMN6630	635	66	30	1.3	55.3	2.5
DPLDCMN6636	686	66	36	1.3	64.7	3.0
DPLDCMN6642	736	66	42	1.3	74.0	3.5
DPLDCMN6648	788	66	48	1.3	83.3	3.9
DPLDCMN6654	838	66	54	1.3	92.6	4.4
DPLDCMN6660	890	66	60	1.3	101.9	4.9

DPLDCHN • Diet Linking Panel - Leveler on one leg and double caster base on the other

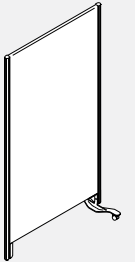

- **Diet Linking Panel provides privacy.**
- Aluminum extrusion comes in powder coated paint finish, DWT - Designer White or TUN - Tungsten.
- Laminate core available in DWTLPL - Designer White or ACJLP - Absolute Acajou.
- Edge banded to match laminate finish.
- Standard height of 54", 66", width in 6" increments from 24" to 60".
- Comes complete with hinge kits, leveler on one leg and double caster foot on the other.

PRODUCT CODE	PRICE	SIZE/ INCHES			WEIGHT VOL	
		H	W	D	LBS	FT ³
DPLDCHN5424	497	54	24	1.3	37.1	1.6
DPLDCHN5430	540	54	30	1.3	44.5	2.1
DPLDCHN5436	590	54	36	1.3	51.8	2.5
DPLDCHN5442	636	54	42	1.3	59.2	2.9
DPLDCHN5448	681	54	48	1.3	66.5	3.3
DPLDCHN5454	729	54	54	1.3	73.9	3.6
DPLDCHN5460	776	54	60	1.3	81.2	4.0
DPLDCHN6624	551	66	24	1.3	45.5	2.0
DPLDCHN6630	603	66	30	1.3	54.9	2.5
DPLDCHN6636	653	66	36	1.3	64.2	3.0
DPLDCHN6642	703	66	42	1.3	73.5	3.5
DPLDCHN6648	756	66	48	1.3	82.8	3.9
DPLDCHN6654	806	66	54	1.3	92.1	4.4
DPLDCHN6660	859	66	60	1.3	101.4	4.9

DPLWA • Wall Connection for Linking Panels

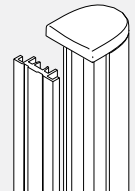

- **Wall Connection connects Linking**
- Panels to walls.
- Aluminum extrusion comes in powder coated paint finish, DWT - Designer White or TUN - Tungsten.
- Kit consists of Diet vertical extrusion, charcoal PVC cover and hinge kits.

PRODUCT CODE	PRICE	SIZE/ INCHES			WEIGHT VOL	
		H	W	D	LBS	FT ³
DPLWA54	100	54	2	2	2.3	0.13
DPLWA66	112	66	2	2	3.5	0.15

DPLEKIT • Expanding Kit

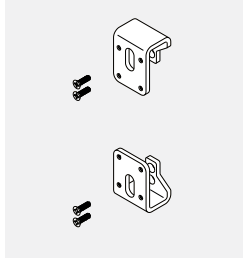

- **Expanding Kit connects two linking panels in a straight line.**
- This kit will accommodate any special width by overlapping the panels.
- Aluminum extrusion comes in powder coated paint finish, DWT - Designer White or TUN - Tungsten.
- Kit consists of a top and bottom bracket and all the hardware needed.

PRODUCT CODE	PRICE	SIZE/ INCHES			WEIGHT VOL	
		H	W	D	LBS	FT ³
DPLEKIT	174	3	2	2.0	1	0.05

DP • Door and Door Catch Kit for Linking Panels

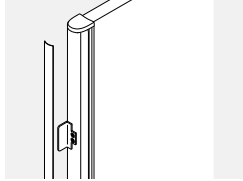

- **Door Catch Kit converts any Linking Panel into a door.**
- Aluminum extrusion comes in powder coated paint finish, DWT - Designer White or TUN - Tungsten.
- Kit consists of striker plate, two hinge kits, single caster foot assembly and 1" Diet caster

PRODUCT CODE	PRICE	SIZE/ INCHES			WEIGHT VOL	
		H	W	D	LBS	FT ³
DPDC01	109	6	3	1.3	2	0.50

DP • Over Panel for Linking Panels

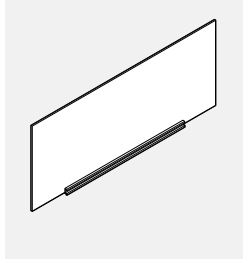

- **Over Panel sits atop of Linking Panel and bridges the gap between the top of 66" high Linking Panel and the top of the Screening Booth.**
- Kit contains aluminum extrusion and felt insert.
- Aluminum extrusion comes in powder coated paint finish, DWT - Designer White or TUN - Tungsten.

PRODUCT CODE	PRICE	SIZE/ INCHES			WEIGHT VOL	
		H	W	D	LBS	FT ³
DPLOP24	89	16.8	24	1.05	1.74	0.39
DPLOP30	105	16.8	30	1.05	2.20	0.49
DPLOP36	124	16.8	36	1.05	2.67	0.59
DPLOP42	139	16.8	42	1.05	3.14	0.70
DPLOP48	206	16.8	48	1.05	3.60	0.80
DPLOP54	224	16.8	54	1.05	4.07	0.90
DPLOP60	241	16.8	60	1.05	4.35	1.01

DP • Booth to Linking Panel Connector

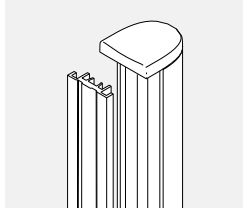

- **Booth to Linking Panel Connector facilitates the connection of a Linking Panel to the back gable edge of the Screening Booth.**
- Aluminum extrusion comes in powder coated paint finish, DWT - Designer White or TUN - Tungsten.
- Kit includes a Diet vertical extrusion, charcoal PVC cover and all hardware.

PRODUCT CODE	PRICE	SIZE/ INCHES			WEIGHT VOL	
		H	W	D	LBS	FT ³
DEBPA	77	66	3	1.3	3.5	0.15

DPVAC • Diet VAC Laminate Panels

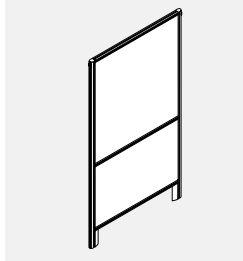

- **Special panel construction designed specifically for clinical applications.**
- Segmentated panels offer a thermally fused laminate lower and high pressure upper pressed on a lightweight core.
- Minimal footprint for storage.
- Easy to connect.
- Easy to reconfigure.
- Easy to clean.
- Laminate core available in DWTLHP/HP Designer White or ACJLP/ACJHP Absolute Acajou.
- Aluminum extrusion comes in powder coated paint finish. DWT Designer White or TUN Tungsten.
- Comes completed with hinge kits and levelers on both legs.

PRODUCT CODE	PRICE	SIZE/ INCHES			WEIGHT VOL	
		H	W	D	LBS	FT ³
DPVAC6636	669	66	36	1.3	35	3.00
DPVAC6642	690	66	42	1.3	41	3.46
DPVAC6648	703	66	48	1.3	47	3.93
DPVAC6660	1059	66	60	1.3	59	4.90

DWS • Worksurface for Diet Panels

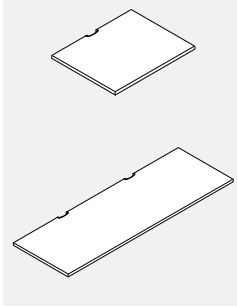

- **Worksurfaces have scoops at back to allow wires and cables to pass to and from floor level.**

- Includes support brackets (DHBRKT), 4 for worksurfaces up to 48", and 5 for any work-surface longer than 48".
- Please choose from DWT - Designer White, SIL - Silver or BLK - Black for scoop covers.

PRODUCT CODE	PRICE		SIZE/ INCHES			WEIGHT VOL	
	LP*	HP*	H	W	D	LBS	FT ³
DWS2424P	145	182	1	24	24	15	0.60
DWS2430P	154	193	1	30	24	19	0.72
DWS2436P	175	218	1	36	24	23	0.85
DWS2442P	228	286	1	42	24	27	0.98
DWS2448P	275	343	1	48	24	31	1.11
DWS2454P	323	400	1	54	24	35	1.23
DWS2460P	362	451	1	60	24	39	1.36
DWS2466P	378	471	1	66	24	43	1.49
DWS2472P	396	494	1	72	24	48	1.62
DWS3024P	169	212	1	24	30	19	0.74
DWS3030P	184	229	1	30	30	24	0.90
DWS3036P	215	270	1	36	30	29	1.06
DWS3042P	304	381	1	42	30	34	1.22
DWS3048P	323	400	1	48	30	39	1.38
DWS3054P	353	441	1	54	30	43	1.54
DWS3060P	378	471	1	60	30	48	1.69
DWS3066P	394	493	1	66	30	53	1.85
DWS3072P	417	521	1	72	30	58	2.01

BHC • Diet/Boulevard Worksurface 12" Cantilever Support

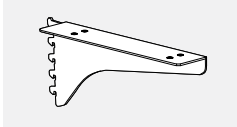

- An economical way to connect rear part of the side edge of a worksurface to the Boulevard Panel.
- Front part of the side edge of the worksurface must be supported by an off-module Diet Worksurface Bracket and locked into the adjacent Diet Panel.
- This cantilever is not a shared support

PRODUCT CODE	PRICE	SIZE/ INCHES			WEIGHT VOL	
		H	W	D	LBS	FT ³
BHC12L	40	6	2	12	2	0.03
BHC12R	40	6	2	12	2	0.03

DHLEG • Diet Gable Leg

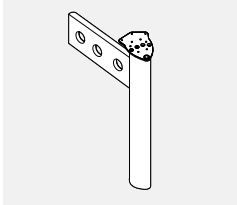

- **Universal leg, plate and side panel are non handed.**
- Supports the worksurface at 29° and enhances the stability of connected panels.
- Side plate is secured to the side of the Diet panel and leg plate bolts to worksurface.
- Made of extruded aluminum and steel.
- Levelers have 1.75" height adjustment.
- Includes all mounting hardware to connect to panel and worksurface.
- Must attach to Diet Panel vertical.

PRODUCT CODE	PRICE	SIZE/ INCHES			WEIGHT VOL	
		H	W	D	LBS	FT ³
DHLEG	205	28	23	6	12	2.02

DHBRKT • Diet Worksurface Bracket

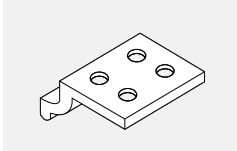

- **Extruded aluminum bracket that is bolted to the underside of the worksurface.**
- Bracket supports worksurface at any location along the mid rail of panel.
- Includes mounting hardware.
- Brackets are included for all worksurfaces DWS, 4 for worksurfaces up to 48", and 5 for any worksurface longer than 48".

PRODUCT CODE	PRICE	SIZE/ INCHES			WEIGHT VOL	
		H	W	D	LBS	FT ³
DHBRKT	10	0.75	2.25	3.25	0.1	0.05

DHTBRKT • Diet Transaction Bracket

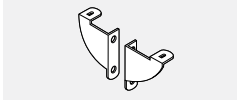

- Connects transaction tops to Diet Panels.
- Includes 1 set of two brackets and all hardware.

PRODUCT CODE	PRICE	SIZE/ INCHES			WEIGHT VOL	
		H	W	D	LBS	FT ³
DHTBRKT	40	2.5	1.2	2.5	3	0.01

DWSCSB • Diet Support Bar

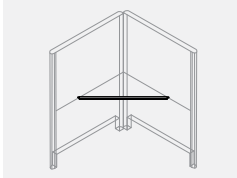

- **Supports worksurface in 90 degree corner application and eliminates the need for a leg.**
- Diagonally installed.
- If using a keyboard, spacers will be required.

PRODUCT CODE	PRICE	SIZE/ INCHES			WEIGHT VOL	
		H	W	D	LBS	FT ³
DWSCSB46	106	1	46	1	7	0.116
DWSCSB80	152	1	80	1	12	0.189

For corner application where 24" deep or smaller adjoining worksurface:
 For corner application where adjoining worksurface is larger than 24":

DHOMC • Diet Off-Module Cantilever



- **To be used with Diet Panels that have a fabric bottom.**
- Installs on horizontal rails of panels to provide worksurface support.
- Frees up space under the worksurface.

PRODUCT CODE	PRICE	SIZE/ INCHES			WEIGHT VOL	
		H	W	D	LBS	FT ³
DHOMC	106	21	3	12	4	0.42

DSOMSHLF • Diet Off Module 24" Shelf

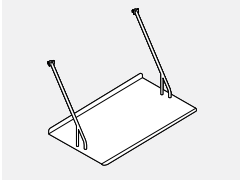

- Shelf hangs anywhere along Diet panel rails or Boulevard System 3 panel accessory tile.
- Can create a supplementary surface at worksurface level when suspended from a 42" high Diet panel.
- Shelves may be stacked, one hanging above the other from a higher rail.
- Shelf made of formed steel and includes suspended arms made of steel.

PRODUCT CODE	PRICE	SIZE/	INCHES			WEIGHT VOL	
		H	W	D	LBS	FT ³	
DSOMSHLF	239	11.5	24	12	4	1.00	

DSOS • Diet Panel Mounted Shelf

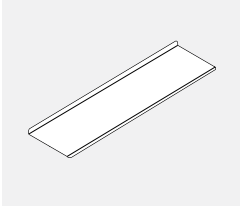

- Provides overhead storage capacity on top of 42" and 54" high Diet panels.
- Made of formed steel and includes steel mounting brackets.
- Support brackets lock to the top of Diet rail at the back and both sides of overhead.
- Must be installed on a "U" or "H" panel configuration.
- Due to structural issues, this product may not be used on top of glazed or partially glazed panels.

PRODUCT CODE	PRICE	SIZE/	INCHES			WEIGHT VOL	
		H	W	D	LBS	FT ³	
DSOS48	288	15	48	13.5	40	5.60	
DSOS60	307	15	60	13.5	52	7.00	

DOHLS • Diet Overhead Support



- To be used with Diet back panel and Diet wing panel either left or right. The support leg will support only one side and eliminate the need for a third panel.
- To be used and supported on worksurface installed at standard height. Ensure the worksurface that the leg sits on is properly supported.

PRODUCT CODE	PRICE	SIZE/	INCHES			WEIGHT VOL	
		H	W	D	LBS	FT ³	
DOHLS42	364	12	2	3.5	4	0.139	
DOHLS54	394	24	2	3.5	6	0.278	

DSADA • Easy-Up Diet Overhead

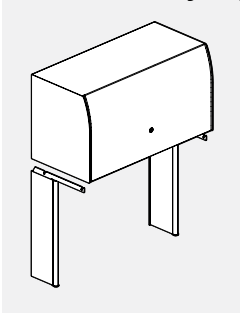

- Diet Panel mounted metal overhead storage with opaque acrylic door. The Metal finish (page A.29). mechanism lifts the door up and stores it out of the way, above the storage unit.
- Meets CSA B651 Barrier Free Design & AODA (Accessibility for Ontarians with Disabilities Act).
- Meets CSA B651 Barrier Free Design & ADA (Americans with Disabilities Act).
- 16" high units accept standard and A4 binders.
- All shelves are reinforced for proper weight distribution.
- Inside dimensions: 14.375" high x 12" deep.
- Unit includes back, support cantilevers, attachment hardware, and lock.
- Shipped partially assembled.

PRODUCT CODE	PRICE	SIZE/	INCHES			WEIGHT VOL	
		H	W	D	LBS	FT ³	
DSADA30PM	1019	16	30	14.4	33	5.3	
DSADA36PM	1063	16	36	14.4	38	6.3	
DSADA42PM	1112	16	42	14.4	43	7.3	
DSADA48PM	1166	16	48	14.4	48	8.3	
DSADA54PM	1219	16	54	14.4	53	9.3	
DSADA60PM	1279	16	60	14.4	59	10.3	

DHPEDB • Pedestal Bracket Kit for Diet Panels

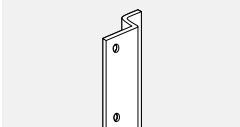

- Attaches to a metal Worksurface Supporting Pedestal at the back and connects the pedestal to the Diet Panel vertical.

PRODUCT CODE	PRICE	SIZE/	INCHES			WEIGHT VOL	
		H	W	D	LBS	FT ³	
DHPEDB	35	8	1	1	0.5	0.001	

Introduction

Compile Systems - Protecting the Environment for Future Generations

- Our environmental success story began with the challenge to create an office system that would meet today's business requirements while maintaining a firm commitment to save and protect the environment.
- Sustainability became a part of the creative focus and development of Compile that incorporates the latest technology and design features to provide excellent performance at a competitive price.
- As government and industry environment ratings such as LEED & Greenguard become more prevalent, Compile offers designers and architects functional, attractive, and economical office designs that meet these standards.
- Global Contract is a leader in reducing waste in the manufacturing of its products as well as utilizing recycled materials wherever possible. We make extensive use of recycled plastic and wood waste from other Global factories.
- Global Contract is committed to the continuous improvement of our environmental systems, the prevention of pollution, and to comply with both the spirit and the letter of all relevant environmental legislation.

- Compile Panels are 82.3% recyclable at the end of their lifespan. Nothing from a Compile Panel needs to end up in a landfill.

Compile Systems - Product Information

- Compile offers fabrics that are made from 100% recycled polyester, which means less waste going to landfills. These fabrics also reduced the demand for petroleum products, and decrease the environmental impacts of processing those petroleum products into polyester.
- Compile's epoxy powder coating process involves no liquids and is solvent free. It contains no harmful VOC's or lead. Up to 99% of over sprayed powder is reclaimed, mixed with virgin powder and resused.
- Compile's entire panel is up to 82.3% recycled.
- Compile masonite is up to 85% recycled.
- Compile recycled wood for worksurfaces is up to 85% recycled.
- Compile's entire product line is up to 99.9% recyclable.

Components • Panel Configuration

Many components make up a panel configuration. This page provides an exploded view of a sample configuration highlighting each panel component required when specifying this configuration.

- A) CMET66 66"h. End of Run Trim Insert for Panel
- B) CMFF6636 66"h. x 36"w Single Segmented Fabric Panel
- C) CHP66 66"h. Universal Corner Post
- D) CMETP66 Trim Insert for 66"h. Universal Corner Post
- E) CMPC2 Post Base Cover for 2-Way Application
- F) CMET24 24"h Trim Insert for Step Down
- G) CMFF4236N1 42"h. x 36"w Single Segmented Fabric Panel, Punchouts on one side.
- H) CMET42 42"h. End of Run Trim Insert for Panel
- I) CMRC36NP 36"w Raceway Cover without Knockouts (if ordered separately)
- J) Panel Connectors, comes standard with panels and universal corner post

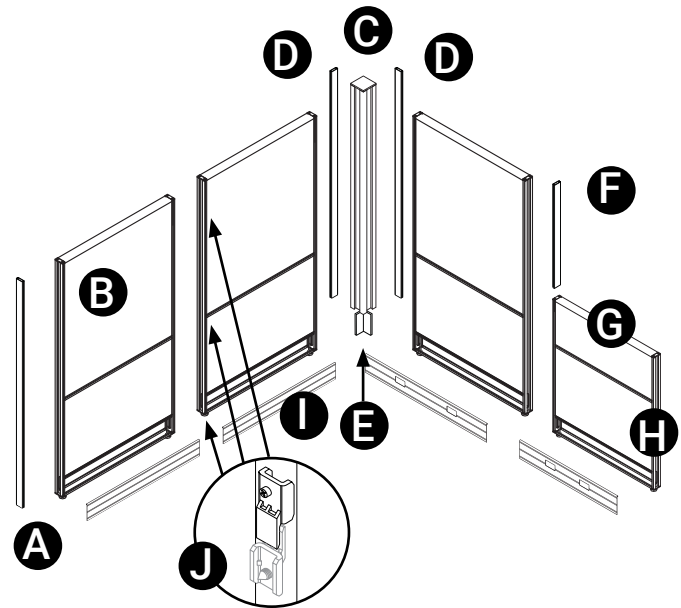

Components • Worksurfaces

- Compile thermally fused Worksurfaces are 1" thick and are finished with 3 mm PVC edging on all sides.
- Worksurfaces have pilot holes to enable proper alignment with worksurface supports.
- Most standard laminate offerings are available in thermally-fused. See laminate listings for details.
- Wood grain laminates on corner worksurfaces up to 42" available with laminate running diagonally at an upcharge. Otherwise, standard horizontal application of laminate will be used, as per drawings at right.
- Most wood grain laminate worksurfaces will have matching woodgrain trim unless specified otherwise.
- Depth of the worksurface scoops are 1 1/8" when measured from the panel the worksurface is attached to.
- All worksurfaces require support items. These are priced separately within this section.
- Grain direction for worksurfaces are as follows:
- Communication and electrical wires are routed through a cable scoop located at the back of the worksurface. When specifying a Straight Worksurface (CWS) or a Curvilinear Worksurface (CWVL), note that the number of cable scoops depends upon the width of the worksurface. All other Worksurface shapes have one scoop on panel edges.

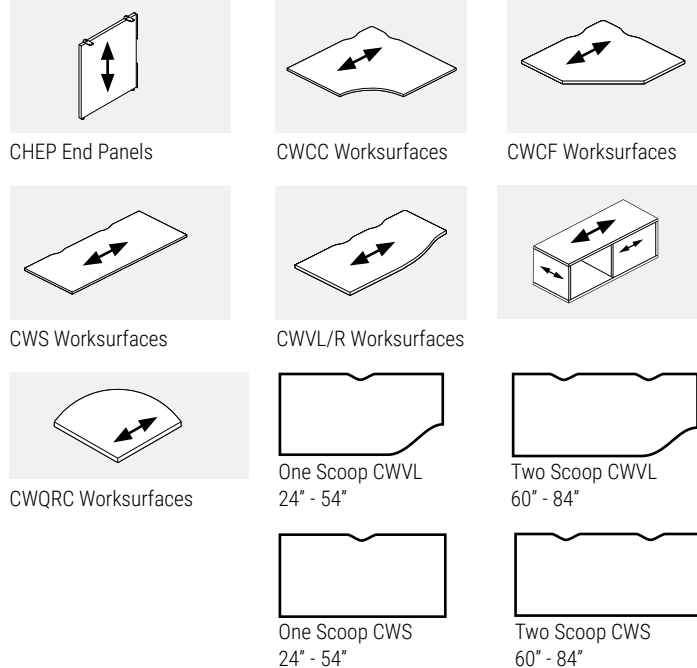

Components • Electrical

2+2 Configuration (8 wire, 4 circuit)

Two Utility Circuits [Compile's #1 & #2 circuits] share one neutral wire and one (system) ground wire. (2 hot [circuit] wires + 1 neutral wire*** + 1 green ground wire* = 4 wires)

Two Dedicated Circuits [Compile's "A" & "B" circuits] share one neutral wire and one (isolated) ground wire. (2 hot [circuit] wires + neutral wire*** + 1 green/yellow ground wire** = 4 wires)

Note: It is the ground wire that makes the difference between "Utility" and "Dedicated" circuits. Refer to Wiring Schematics found above.

*A Green ground wire is a "system" ground. This means it could be grounded to any piece of metal, including the panel.

**A Green/Yellow ground wire is isolated, within the wiring conduit, all the way back to the box at the source (building ground).

***All neutral wires are 10 gauge rather than 12 gauge meaning they are larger than normal allowing greater protection against "noise" or interference on the circuit.

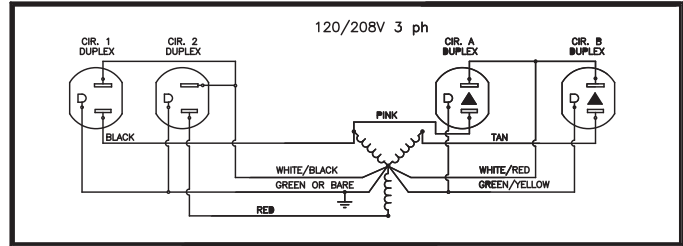
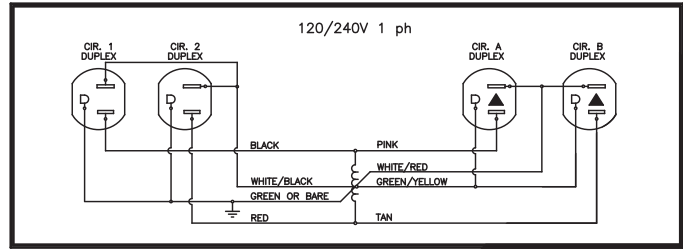

UL RECOGNIZED AND CSA CERTIFIED

Warning: It is recommended that installation of the electrical harness be made under the supervision of a licensed electrician in accordance with applicable codes and regulations.

Special Note: Always ensure that harness is electrically connected to only one power supply.

Components • Panel Configuration - Electrical

Many components make up a configuration. This page provides an exploded view of a sample configuration highlighting each Electrical component required when specifying this configuration.

A) CE8PD36 Power Distribution Housing

Note: 8 wire, 4 circuits, 2+2 configuration

B) CE8CP17 Flexible Mesh Jumper Cable (connects two panels side by side or separated by a post in a corner application)

C) CE8RD Duplex Receptacle

D) CE8CI1 "I" Connector

E) CE8CP Pass-Through Cable

Note: Must run in a straight line application only

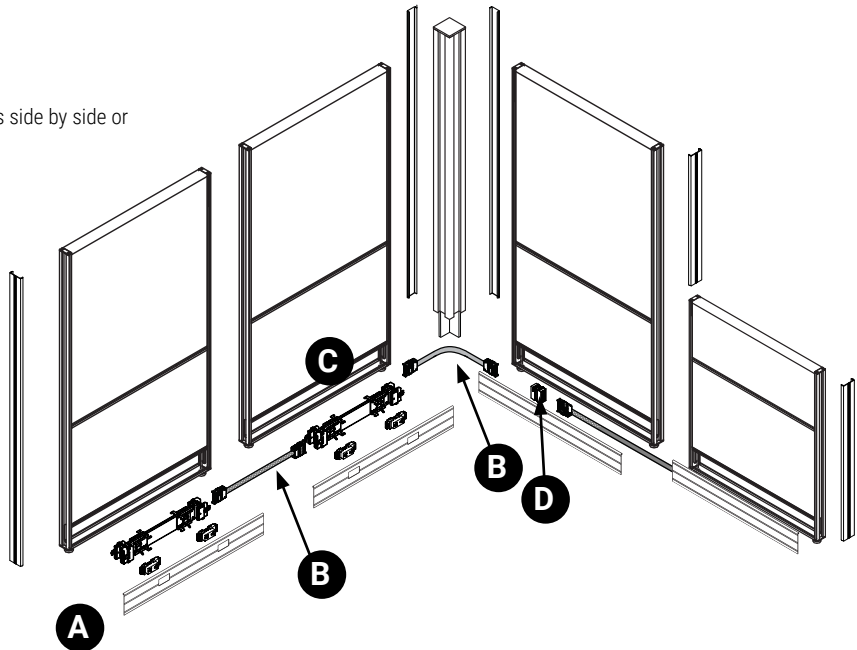

PANEL FINISHES

Panel Frame

Black
Designer White
Nevada
Fog

Glazing Options

BLK Clear
DWT Frosted
NEV
FOG
CLR
FRS

COMPILE - GUIDELINES FOR ORDERING PRODUCT

Codes

The product guide uses a numbering system with meaningful alphanumeric characters to create a simple-to-understand product number. This makes specifying the product much easier and more accurate.

Example of Panel **CMFM4236** Product Code

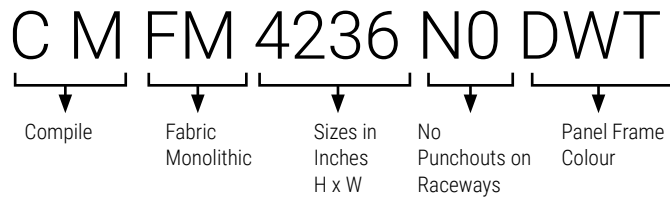

How to Specify

- Specify Compile panel type and size by code.
- Specify panel frame finish - ie. DWT (Designer White)
- Specify raceway power option.
- Specify all necessary panel fabric options.

The information listed below provides you with basic features of Compile Panels.

- Compile Panels can only be stacked one high.
- Available in four (4) basic heights: 30", 42", 54" and 66"; and seven (7) widths: 24", 30" 36", 42", 48", 54" and 60".
- 2 3/8" thick.
- Available in Monolithic and Single Segmented at just below the worksurface.
- Compile panels are not tackable.
- Raceway openings are 1.345" x 2.80".
- Opposite sides of each Module may have a different fabric within the same grade at no upcharge.
- Standard with aluminum frame.
- Individual fabric covered modules incorporated into an aluminum frame.
- Aluminum raceway covers can be ordered separately and shipped separately for reconfigurations. Raceway covers can be replaced in the field to change a panel from non powered to powered (or vice versa).

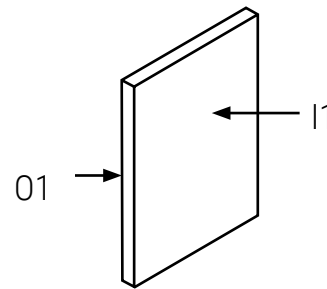

I1

AN50

Inside Fabric
Position #1

O1

BE21

Outside Fabric
Position #1

NOTE: If different grades of fabric are used on one panel, the entire panel must be priced out at the higher grade.

- On Compile Laminate and Gallery panels, if a wood grain laminate is chosen, grain direction runs horizontally.
- Base raceway lifts up and locks in an upright 90-degree position, or can be removed for open access to base raceway.
- Electric knockouts in the raceway have plastic covers that snap into place from the outside of the cover, when a duplex is not required. Electric knockout covers must be specified separately.
- 3 panel connector brackets per side for 30"h., 42"h. and 54"h. come installed on panels and 60° and 90° posts.
- 4 panel connector brackets per side for 66"h. panels come installed on panels and 60° and 90° posts.
- Panel connector brackets are opposite direction of each other per panel side, and can be removed with one screw per bracket.
- CMFF and CMFM 66" and 72" panels must have fabric railroaded. Please confirm at time of order if all panels or only those need fabric to be railroaded.

CMFM-N0 • Monolithic Non Powered Fabric Panel, No Punchouts

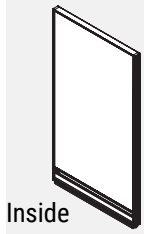

Inside

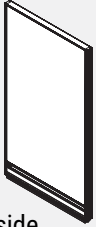

Outside

- Individual fabric-covered modules incorporated into an aluminum frame.
- Opposite sides of each module may have a different fabric within the same grade at no upcharge.
- If different grades of fabric are used on one panel, the entire panel must be priced at highest grade.
- Panels are not tackable.
- 3 Panel connector brackets per side come standard with 30”h., 42”h. and 54”h. panels.
- 4 Panel connector brackets per side come standard with 66”h. panels.
- Panels include 2 raceway covers with no punchouts, an integrated aluminum top cap and levelling glides.
- Note: Trim is not required at a straight connection between two panels of the same height.

PRODUCT CODE	PRICE		SIZE/ INCHES			WEIGHT VOL	
	GR 1	GR 2	H	W	D	LBS	FT³
CMFM3024N0	263	289	30	24	2.3	20	2.31
CMFM3030N0	326	352	30	30	2.3	25	2.85
CMFM3036N0	354	400	30	36	2.3	31	3.38
CMFM3042N0	387	437	30	42	2.3	36	3.92
CMFM3048N0	420	469	30	48	2.3	41	4.45
CMFM3054N0	463	509	30	54	2.3	46	4.99
CMFM3060N0	492	537	30	60	2.3	51	5.52
CMFM4224N0	263	289	42	24	2.3	20	2.31
CMFM4230N0	326	352	42	30	2.3	25	2.85
CMFM4236N0	354	400	42	36	2.3	31	3.38
CMFM4242N0	387	437	42	42	2.3	36	3.92
CMFM4248N0	420	469	42	48	2.3	41	4.45
CMFM4254N0	463	509	42	54	2.3	46	4.99
CMFM4260N0	492	537	42	60	2.3	51	5.52
CMFM4824N0	300	330	48	24	2.3	26	2.73
CMFM4830N0	340	369	48	30	2.3	33	3.37
CMFM4836N0	386	430	48	36	2.3	39	4.00
CMFM4842N0	441	499	48	42	2.3	46	4.63
CMFM4848N0	476	535	48	48	2.3	52	5.26
CMFM4854N0	523	579	48	54	2.3	59	5.89
CMFM4860N0	553	612	48	60	2.3	65	6.53
CMFM5424N0	300	330	54	24	2.3	26	2.73
CMFM5430N0	340	369	54	30	2.3	33	3.37
CMFM5436N0	386	430	54	36	2.3	39	4.00
CMFM5442N0	441	499	54	42	2.3	46	4.63
CMFM5448N0	476	535	54	48	2.3	52	5.26
CMFM5454N0	523	579	54	54	2.3	59	5.89
CMFM5460N0	553	612	54	60	2.3	65	6.53
CMFM6624N0	344	384	66	24	2.3	32	3.58
CMFM6630N0	400	439	66	30	2.3	40	4.40
CMFM6636N0	488	561	66	36	2.3	48	5.23
CMFM6642N0	539	613	66	42	2.3	56	6.06
CMFM6648N0	558	633	66	48	2.3	64	6.88
CMFM6654N0	574	647	66	54	2.3	72	7.71
CMFM6660N0	591	666	66	60	2.3	80	8.53

CMFM-N1 • Monolithic Non Powered Fabric Panel, Punchouts on One Side

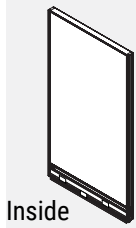

Inside



Outside

- Individual fabric-covered modules incorporated into an aluminum frame.
- Opposite sides of each module may have a different fabric within the same grade at no upcharge.
- If different grades of fabric are used on one panel, the entire panel must be priced at highest grade.
- Panels are not tackable.
- 3 Panel connector brackets per side come standard with 30"h., 42"h. and 54"h. panels.
- 4 Panel connector brackets per side come standard with 66"h. panels.
- Panels include 1 raceway cover with punchouts on one side, 1 raceway cover with no punchouts on the other, an integrated aluminum top cap and levelling glides.
- 24" wide panels have one punchout, 30" wide panels and wider have 3 punchouts.
- Note: Trim is not required at a straight connection between two panels of the same height.

PRODUCT CODE	PRICE		SIZE/ INCHES			WEIGHT VOL	
	GR 1	GR 2	H	W	D	LBS	FT ³
CMFM3024N1	263	289	30	24	2.3	20	2.31
CMFM3030N1	326	352	30	30	2.3	25	2.85
CMFM3036N1	354	400	30	36	2.3	31	3.38
CMFM3042N1	387	437	30	42	2.3	36	3.92
CMFM3048N1	420	469	30	48	2.3	41	4.45
CMFM3054N1	463	509	30	54	2.3	46	4.99
CMFM3060N1	492	537	30	60	2.3	51	5.52
CMFM4224N1	263	289	42	24	2.3	20	2.31
CMFM4230N1	326	352	42	30	2.3	25	2.85
CMFM4236N1	354	400	42	36	2.3	31	3.38
CMFM4242N1	387	437	42	42	2.3	36	3.92
CMFM4248N1	420	469	42	48	2.3	41	4.45
CMFM4254N1	463	509	42	54	2.3	46	4.99
CMFM4260N1	492	537	42	60	2.3	51	5.52
CMFM4824N1	300	330	48	24	2.3	26	2.73
CMFM4830N1	340	369	48	30	2.3	33	3.37
CMFM4836N1	386	430	48	36	2.3	39	4.00
CMFM4842N1	441	499	48	42	2.3	46	4.63
CMFM4848N1	476	535	48	48	2.3	52	5.26
CMFM4854N1	523	579	48	54	2.3	59	5.89
CMFM4860N1	553	612	48	60	2.3	65	6.53
CMFM5424N1	300	330	54	24	2.3	26	2.73
CMFM5430N1	340	369	54	30	2.3	33	3.37
CMFM5436N1	386	430	54	36	2.3	39	4.00
CMFM5442N1	441	499	54	42	2.3	46	4.63
CMFM5448N1	476	535	54	48	2.3	52	5.26
CMFM5454N1	523	579	54	54	2.3	59	5.89
CMFM5460N1	553	612	54	60	2.3	65	6.53
CMFM6624N1	344	384	66	24	2.3	32	3.58
CMFM6630N1	400	439	66	30	2.3	40	4.40
CMFM6636N1	488	561	66	36	2.3	48	5.23
CMFM6642N1	539	613	66	42	2.3	56	6.06
CMFM6648N1	558	633	66	48	2.3	64	6.88
CMFM6654N1	574	647	66	54	2.3	72	7.71
CMFM6660N1	591	666	66	60	2.3	80	8.53

CMFM-N2 • Monolithic Non Powered Fabric Panel, Punchouts on Both Sides



Inside

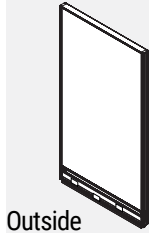

Outside

- Individual fabric-covered modules incorporated into an aluminum frame.
- Opposite sides of each module may have a different fabric within the same grade at no upcharge.
- If different grades of fabric are used on one panel, the entire panel must be priced at highest grade.
- Panels are not tackable.
- 3 Panel connector brackets per side come standard with 30”h., 42”h. and 54”h. panels.
- 4 Panel connector brackets per side come standard with 66”h. panels.
- Panels include 2 raceway covers with punchouts on both sides, an integrated aluminum top cap and levelling glides.
- 24” wide panels have two punchouts, one for electrical and one for data.
- 30” wide panels and wider have three punchouts, two for electrical and one for data.
- Note: Trim is not required at a straight connection between two panels of the same height.

PRODUCT CODE	PRICE		SIZE/ INCHES			WEIGHT VOL	
	GR 1	GR 2	H	W	D	LBS	FT ³
CMFM3024N2	263	289	30	24	2.3	20	2.31
CMFM3030N2	326	352	30	30	2.3	25	2.85
CMFM3036N2	354	400	30	36	2.3	31	3.38
CMFM3042N2	387	437	30	42	2.3	36	3.92
CMFM3048N2	420	469	30	48	2.3	41	4.45
CMFM3054N2	463	509	30	54	2.3	46	4.99
CMFM3060N2	492	537	30	60	2.3	51	5.52
CMFM4224N2	263	289	42	24	2.3	20	2.31
CMFM4230N2	326	352	42	30	2.3	25	2.85
CMFM4236N2	354	400	42	36	2.3	31	3.38
CMFM4242N2	387	437	42	42	2.3	36	3.92
CMFM4248N2	420	469	42	48	2.3	41	4.45
CMFM4254N2	463	509	42	54	2.3	46	4.99
CMFM4260N2	492	537	42	60	2.3	51	5.52
CMFM4824N2	300	330	48	24	2.3	26	2.73
CMFM4830N2	340	369	48	30	2.3	33	3.37
CMFM4836N2	386	430	48	36	2.3	39	4.00
CMFM4842N2	441	499	48	42	2.3	46	4.63
CMFM4848N2	476	535	48	48	2.3	52	5.26
CMFM4854N2	523	579	48	54	2.3	59	5.89
CMFM4860N2	553	612	48	60	2.3	65	6.53
CMFM5424N2	300	330	54	24	2.3	26	2.73
CMFM5430N2	340	369	54	30	2.3	33	3.37
CMFM5436N2	386	430	54	36	2.3	39	4.00
CMFM5442N2	441	499	54	42	2.3	46	4.63
CMFM5448N2	476	535	54	48	2.3	52	5.26
CMFM5454N2	523	579	54	54	2.3	59	5.89
CMFM5460N2	553	612	54	60	2.3	65	6.53
CMFM6624N2	344	384	66	24	2.3	32	3.58
CMFM6630N2	400	439	66	30	2.3	40	4.40
CMFM6636N2	488	561	66	36	2.3	48	5.23
CMFM6642N2	539	613	66	42	2.3	56	6.06
CMFM6648N2	558	633	66	48	2.3	64	6.88
CMFM6654N2	574	647	66	54	2.3	72	7.71
CMFM6660N2	591	666	66	60	2.3	80	8.53

CMFM-P1 • Monolithic Fabric Panel with Power Distribution Housing, Punchouts on One Side

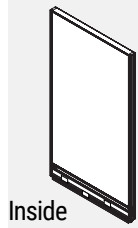

Inside

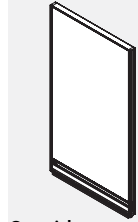

Outside

- Individual fabric-covered modules incorporated into an aluminum frame.
- Opposite sides of each module may have a different fabric within the same grade at no upcharge.
- If different grades of fabric are used on one panel, the entire panel must be priced at highest grade.
- Panels are not tackable.
- 3 Panel connector brackets per side come standard with 30"h., 42"h. and 54"h. panels.
- 4 Panel connector brackets per side come standard with 66"h. panels.
- Panels include 1 raceway cover with punchouts on one side, 1 raceway cover with no punchouts on the other, a power distribution housing, an integrated aluminum top cap and levelling glides.
- 24" wide panels have two punchouts, one for electrical and one for data.
- 30" wide panels and wider have three punchouts, two for electrical and one for data.
- Note: Trim is not required at a straight connection between two panels of the same height.
- Please specify duplex receptacles separately.

PRODUCT CODE	PRICE		SIZE/ INCHES			WEIGHT VOL	
	GR 1	GR 2	H	W	D	LBS	FT ³
CMFM3024P1	398	422	30	24	2.3	20	2.31
CMFM3030P1	506	531	30	30	2.3	25	2.85
CMFM3036P1	545	591	30	36	2.3	31	3.38
CMFM3042P1	585	634	30	42	2.3	36	3.92
CMFM3048P1	628	675	30	48	2.3	41	4.45
CMFM3054P1	673	723	30	54	2.3	46	4.99
CMFM3060P1	702	752	30	60	2.3	51	5.52
CMFM4224P1	398	422	42	24	2.3	20	2.31
CMFM4230P1	506	531	42	30	2.3	25	2.85
CMFM4236P1	545	591	42	36	2.3	31	3.38
CMFM4242P1	585	634	42	42	2.3	36	3.92
CMFM4248P1	628	675	42	48	2.3	41	4.45
CMFM4254P1	673	723	42	54	2.3	46	4.99
CMFM4260P1	702	752	42	60	2.3	51	5.52
CMFM4824P1	436	464	48	24	2.3	26	2.73
CMFM4830P1	523	551	48	30	2.3	33	3.37
CMFM4836P1	576	620	48	36	2.3	39	4.00
CMFM4842P1	637	696	48	42	2.3	46	4.63
CMFM4848P1	686	743	48	48	2.3	52	5.26
CMFM4854P1	732	790	48	54	2.3	59	5.89
CMFM4860P1	765	825	48	60	2.3	65	6.53
CMFM5424P1	436	464	54	24	2.3	26	2.73
CMFM5430P1	523	551	54	30	2.3	33	3.37
CMFM5436P1	576	620	54	36	2.3	39	4.00
CMFM5442P1	637	696	54	42	2.3	46	4.63
CMFM5448P1	686	743	54	48	2.3	52	5.26
CMFM5454P1	732	790	54	54	2.3	59	5.89
CMFM5460P1	765	825	54	60	2.3	65	6.53
CMFM6624P1	480	520	66	24	2.3	32	3.58
CMFM6630P1	584	620	66	30	2.3	40	4.40
CMFM6636P1	677	752	66	36	2.3	48	5.23
CMFM6642P1	736	809	66	42	2.3	56	6.06
CMFM6648P1	765	839	66	48	2.3	64	6.88
CMFM6654P1	785	858	66	54	2.3	72	7.71
CMFM6660P1	803	877	66	60	2.3	80	8.53

CMFM-P2 • Monolithic Fabric Panel with Power Distribution Housing, Punchouts on Both Sides

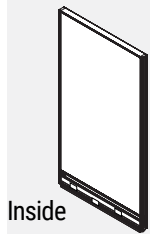

Inside

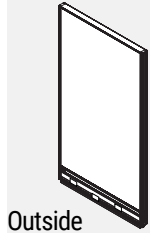

Outside

- Individual fabric-covered modules incorporated into an aluminum frame.
- Opposite sides of each module may have a different fabric within the same grade at no upcharge.
- If different grades of fabric are used on one panel, the entire panel must be priced at highest grade.
- Panels are not tackable.
- 3 Panel connector brackets per side come standard with 30"h., 42"h. and 54"h. panels.
- 4 Panel connector brackets per side come standard with 66"h. panels.
- Panels include 2 raceway covers with punchouts on both sides, a power distribution housing, an integrated aluminum top cap and levelling glides.
- 24" wide panels have two punchouts, one for electrical and one for data.
- 30" wide panels and wider have three punchouts, two for electrical and one for data.
- Note: Trim is not required at a straight connection between two panels of the same height.
- Please specify duplex receptacles separately.

PRODUCT CODE	PRICE		SIZE/ INCHES			WEIGHT VOL	
	GR 1	GR 2	H	W	D	LBS	FT³
CMFM3024P2	398	422	30	24	2.3	20	2.31
CMFM3030P2	506	531	30	30	2.3	25	2.85
CMFM3036P2	545	591	30	36	2.3	31	3.38
CMFM3042P2	585	634	30	42	2.3	36	3.92
CMFM3048P2	628	675	30	48	2.3	41	4.45
CMFM3054P2	673	723	30	54	2.3	46	4.99
CMFM3060P2	702	752	30	60	2.3	51	5.52
CMFM4224P2	398	422	42	24	2.3	20	2.31
CMFM4230P2	506	531	42	30	2.3	25	2.85
CMFM4236P2	545	591	42	36	2.3	31	3.38
CMFM4242P2	585	634	42	42	2.3	36	3.92
CMFM4248P2	628	675	42	48	2.3	41	4.45
CMFM4254P2	673	723	42	54	2.3	46	4.99
CMFM4260P2	702	752	42	60	2.3	51	5.52
CMFM4824P2	436	464	48	24	2.3	26	2.73
CMFM4830P2	523	551	48	30	2.3	33	3.37
CMFM4836P2	576	620	48	36	2.3	39	4.00
CMFM4842P2	637	696	48	42	2.3	46	4.63
CMFM4848P2	686	743	48	48	2.3	52	5.26
CMFM4854P2	732	790	48	54	2.3	59	5.89
CMFM4860P2	765	825	48	60	2.3	65	6.53
CMFM5424P2	436	464	54	24	2.3	26	2.73
CMFM5430P2	523	551	54	30	2.3	33	3.37
CMFM5436P2	576	620	54	36	2.3	39	4.00
CMFM5442P2	637	696	54	42	2.3	46	4.63
CMFM5448P2	686	743	54	48	2.3	52	5.26
CMFM5454P2	732	790	54	54	2.3	59	5.89
CMFM5460P2	765	825	54	60	2.3	65	6.53
CMFM6624P2	480	520	66	24	2.3	32	3.58
CMFM6630P2	584	620	66	30	2.3	40	4.40
CMFM6636P2	677	752	66	36	2.3	48	5.23
CMFM6642P2	736	809	66	42	2.3	56	6.06
CMFM6648P2	765	839	66	48	2.3	64	6.88
CMFM6654P2	785	858	66	54	2.3	72	7.71
CMFM6660P2	803	877	66	60	2.3	80	8.53

CMLFM-N0 • Monolithic Non Powered Laminate One Side, Fabric One Side Panel, No Punchouts

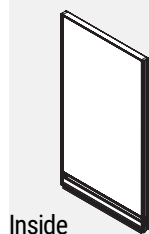

Inside

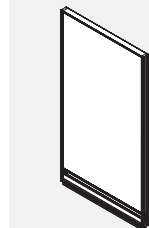

Outside

- Individual modules, one in fabric and one in laminate, incorporated into an aluminum frame.
- Panels are not tackable.
- 3 panel connector brackets per side come standard with 30"h., 42"h., and 54"h. panels.
- 4 panel connector brackets per side come standard with 66"h. panels.
- Panels include 2 raceway covers with no punchouts, an integrated aluminum top cap and levelling glides.
- Note: Trim is not required at a straight connection between two panels of the same height.

PRODUCT CODE	PRICE		SIZE/ INCHES			WEIGHT VOL	
	GR1	GR2	H	W	D	LBS	FT ³
CMLFM3024N0	380	387	30	24	2.3	20	2.31
CMLFM3030N0	443	455	30	30	2.3	25	2.85
CMLFM3036N0	505	519	30	36	2.3	31	3.38
CMLFM3042N0	574	586	30	42	2.3	36	3.92
CMLFM3048N0	620	635	30	48	2.3	41	4.45
CMLFM3054N0	692	704	30	54	2.3	46	4.99
CMLFM3060N0	748	771	30	60	2.3	51	5.52
CMLFM4224N0	450	463	42	24	2.3	20	2.31
CMLFM4230N0	526	537	42	30	2.3	25	2.85
CMLFM4236N0	605	622	42	36	2.3	31	3.38
CMLFM4242N0	686	703	42	42	2.3	36	3.92
CMLFM4248N0	744	765	42	48	2.3	41	4.45
CMLFM4254N0	828	851	42	54	2.3	46	4.99
CMLFM4260N0	908	932	42	60	2.3	51	5.52
CMLFM4824N0	534	556	48	24	2.3	26	2.73
CMLFM4830N0	628	646	48	30	2.3	33	3.37
CMLFM4836N0	719	740	48	36	2.3	39	4.00
CMLFM4842N0	815	838	48	42	2.3	46	4.63
CMLFM4848N0	890	916	48	48	2.3	52	5.26
CMLFM4854N0	991	1021	48	54	2.3	59	5.89
CMLFM5424N0	534	556	54	24	2.3	65	6.53
CMLFM5430N0	628	646	54	30	2.3	33	3.37
CMLFM5436N0	719	740	54	36	2.3	39	4.00
CMLFM5442N0	815	838	54	42	2.3	46	4.63
CMLFM5448N0	890	916	54	48	2.3	52	5.26
CMLFM5454N0	991	1021	54	54	2.3	59	5.89
CMLFM6624N0	663	679	66	24	2.3	32	3.58
CMLFM6630N0	773	796	66	30	2.3	40	4.40
CMLFM6636N0	891	919	66	36	2.3	48	5.23
CMLFM6642N0	1016	1047	66	42	2.3	56	6.06
CMLFM6648N0	1106	1140	66	48	2.3	64	6.68

CMLFM-N1 • Monolithic Non Powered Laminate One Side, Fabric Other, Punchouts on One Side

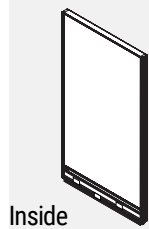

Inside

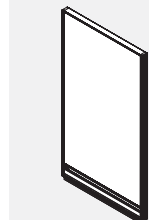

Outside

- Individual modules, one in fabric and one in laminate, incorporated into an aluminum frame.
- Panels are not tackable.
- 3 panel connector brackets per side come standard with 30"h., 42"h., and 54"h. panels.
- 4 panel connector brackets per side come standard with 66"h. panels.
- Panels include 1 raceway cover with punchouts on one side, 1 raceway cover with no punchouts on the other, an integrated aluminum top cap and levelling glides.
- 24" wide panels have two punchouts, one for electrical and one for data.
- 30" wide panels and wider have three punchouts, two for electrical and one for data.
- Note: Trim is not required at a straight connection between two panels of the same height.

PRODUCT CODE	PRICE		SIZE/ INCHES			WEIGHT VOL	
	GR1	GR2	H	W	D	LBS	FT ³
CMLFM3024N1	380	387	30	24	2.3	20	2.31
CMLFM3030N1	443	455	30	30	2.3	25	2.85
CMLFM3036N1	505	519	30	36	2.3	31	3.38
CMLFM3042N1	574	586	30	42	2.3	36	3.92
CMLFM3048N1	620	635	30	48	2.3	41	4.45
CMLFM3054N1	692	704	30	54	2.3	46	4.99
CMLFM3060N1	748	771	30	60	2.3	51	5.52
CMLFM4224N1	450	463	42	24	2.3	20	2.31
CMLFM4230N1	526	537	42	30	2.3	25	2.85
CMLFM4236N1	605	622	42	36	2.3	31	3.38
CMLFM4242N1	686	703	42	42	2.3	36	3.92
CMLFM4248N1	744	765	42	48	2.3	41	4.45
CMLFM4254N1	828	851	42	54	2.3	46	4.99
CMLFM4260N1	908	932	42	60	2.3	51	5.52
CMLFM4824N1	534	556	48	24	2.3	26	2.73
CMLFM4830N1	628	646	48	30	2.3	33	3.37
CMLFM4836N1	719	740	48	36	2.3	39	4.00
CMLFM4842N1	815	838	48	42	2.3	46	4.63
CMLFM4848N1	890	916	48	48	2.3	52	5.26
CMLFM4854N1	991	1021	48	54	2.3	59	5.89
CMLFM5424N1	534	556	54	24	2.3	65	6.53
CMLFM5430N1	628	646	54	30	2.3	33	3.37
CMLFM5436N1	719	740	54	36	2.3	39	4.00
CMLFM5442N1	815	838	54	42	2.3	46	4.63
CMLFM5448N1	890	916	54	48	2.3	52	5.26
CMLFM5454N1	991	1021	54	54	2.3	59	5.89
CMLFM6624N1	663	679	66	24	2.3	32	3.58
CMLFM6630N1	773	796	66	30	2.3	40	4.40
CMLFM6636N1	891	919	66	36	2.3	48	5.23
CMLFM6642N1	1016	1047	66	42	2.3	56	6.06
CMLFM6648N1	1106	1140	66	48	2.3	64	6.68

CMLFM-N2 • Monolithic Non Powered Laminate 1 Side, Fabric Other Panel, Punchouts on Both Sides

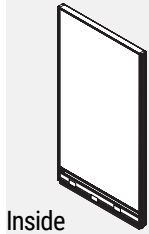

Inside

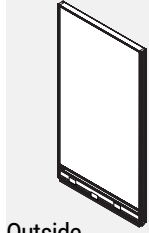

Outside

- Individual modules, one in fabric and one in laminate, incorporated into an aluminum frame.
- Panels are not tackable.
- 3 panel connector brackets per side come standard with 30”h., 42”h., and 54”h. panels.
- 4 panel connector brackets per side come standard with 66”h. panels.
- Panels include 2 raceway covers with punchouts, an integrated aluminum top cap and levelling glides.
- 24” wide panels have two punchouts, one for electrical and one for data.
- 30” wide panels and wider have three punchouts, two for electrical and one for data.
- Note: Trim is not required at a straight connection between two panels of the same height.

PRODUCT CODE	PRICE		SIZE/ INCHES			WEIGHT VOL	
	GR 1	GR 2	H	W	D	LBS	FT³
CMLFM3024N2	380	387	30	24	2.3	20	2.31
CMLFM3030N2	443	455	30	30	2.3	25	2.85
CMLFM3036N2	505	519	30	36	2.3	31	3.38
CMLFM3042N2	574	586	30	42	2.3	36	3.92
CMLFM3048N2	620	635	30	48	2.3	41	4.45
CMLFM3054N2	692	704	30	54	2.3	46	4.99
CMLFM3060N2	748	771	30	60	2.3	51	5.52
CMLFM4224N2	450	463	42	24	2.3	20	2.31
CMLFM4230N2	526	537	42	30	2.3	25	2.85
CMLFM4236N2	605	622	42	36	2.3	31	3.38
CMLFM4242N2	686	703	42	42	2.3	36	3.92
CMLFM4248N2	744	765	42	48	2.3	41	4.45
CMLFM4254N2	828	851	42	54	2.3	46	4.99
CMLFM4260N2	908	932	42	60	2.3	51	5.52
CMLFM4824N2	534	556	48	24	2.3	26	2.73
CMLFM4830N2	628	646	48	30	2.3	33	3.37
CMLFM4836N2	719	740	48	36	2.3	39	4.00
CMLFM4842N2	815	838	48	42	2.3	46	4.63
CMLFM4848N2	890	916	48	48	2.3	52	5.26
CMLFM4854N2	991	1021	48	54	2.3	59	5.89
CMLFM5424N2	534	556	54	24	2.3	65	6.53
CMLFM5430N2	628	646	54	30	2.3	33	3.37
CMLFM5436N2	719	740	54	36	2.3	39	4.00
CMLFM5442N2	815	838	54	42	2.3	46	4.63
CMLFM5448N2	890	916	54	48	2.3	52	5.26
CMLFM5454N2	991	1021	54	54	2.3	59	5.89
CMLFM6624N2	663	679	66	24	2.3	32	3.58
CMLFM6630N2	773	796	66	30	2.3	40	4.40
CMLFM6636N2	891	919	66	36	2.3	48	5.23
CMLFM6642N2	1016	1047	66	42	2.3	56	6.06
CMLFM6648N2	1106	1140	66	48	2.3	64	6.68

CMLFM-P1 • Monolithic Laminate One Side, Fabric Other Side Panel with PDH, Punchouts on One Side

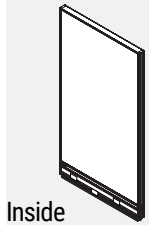

Inside

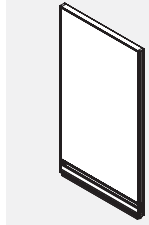

Outside

- Individual modules, one in fabric and one in laminate, incorporated into an aluminum frame.
- Panels are not tackable.
- 3 panel connector brackets per side come standard with 30”h., 42”h., and 54”h. panels.
- 4 panel connector brackets per side come standard with 66”h. panels.
- Panels include 1 raceway cover with punchouts on one side, 1 raceway cover with no punchouts on the other, a power distribution housing, an integrated aluminum top cap and levelling glides.
- 24” wide panels have two punchouts, one for electrical and one for data.
- 30” wide panels and wider have three punchouts, two for electrical and one for data.
- Note: Trim is not required at a straight connection between two panels of the same height.
- Please specify duplex receptacles separately.

PRODUCT CODE	PRICE		SIZE/ INCHES			WEIGHT VOL	
	GR 1	GR 2	H	W	D	LBS	FT³
CMLFM3024P1	507	519	30	24	2.3	20	2.31
CMLFM3030P1	626	636	30	30	2.3	25	2.85
CMLFM3036P1	692	699	30	36	2.3	31	3.38
CMLFM3042P1	761	773	30	42	2.3	36	3.92
CMLFM3048P1	818	831	30	48	2.3	41	4.45
CMLFM3054P1	891	906	30	54	2.3	46	4.99
CMLFM3060P1	957	972	30	60	2.3	51	5.52
CMLFM4224P1	579	591	42	24	2.3	20	2.31
CMLFM4230P1	699	712	42	30	2.3	25	2.85
CMLFM4236P1	787	803	42	36	2.3	31	3.38
CMLFM4242P1	871	891	42	42	2.3	36	3.92
CMLFM4248P1	943	965	42	48	2.3	41	4.45
CMLFM4254P1	1030	1052	42	54	2.3	46	4.99
CMLFM4260P1	1110	1135	42	60	2.3	51	5.52
CMLFM4824P1	663	677	48	24	2.3	26	2.73
CMLFM4830P1	801	818	48	30	2.3	33	3.37
CMLFM4836P1	901	923	48	36	2.3	39	4.00
CMLFM4842P1	1000	1025	48	42	2.3	46	4.63
CMLFM4848P1	1088	1114	48	48	2.3	52	5.26
CMLFM4854P1	1137	1190	48	54	2.3	59	5.89
CMLFM5424P1	663	677	54	24	2.3	65	6.53
CMLFM5430P1	801	818	54	30	2.3	33	3.37
CMLFM5436P1	901	923	54	36	2.3	39	4.00
CMLFM5442P1	1000	1025	54	42	2.3	46	4.63
CMLFM5448P1	1088	1114	54	48	2.3	52	5.26
CMLFM5454P1	1190	1222	54	54	2.3	59	5.89
CMLFM6624P1	792	809	66	24	2.3	32	3.58
CMLFM6630P1	945	969	66	30	2.3	40	4.40
CMLFM6636P1	1074	1099	66	36	2.3	48	5.23
CMLFM6642P1	1202	1232	66	42	2.3	56	6.06
CMLFM6648P1	1304	1338	66	48	2.3	64	6.68

CMLFM-P2 • Monolithic Laminate One Side, Fabric Other Panel with PDH, Punchouts on Both Side

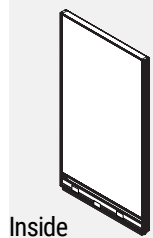

Inside

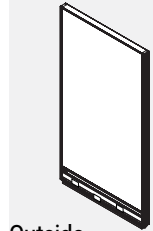

Outside

- Individual modules, one in fabric and one in laminate, incorporated into an aluminum frame.
- Panels are not tackable.
- 3 panel connector brackets per side come standard with 30"h., 42"h., and 54"h. panels.
- 4 panel connector brackets per side come standard with 66"h. panels.
- Panels include 2 raceway cover with punchouts, a power distribution housing, an integrated aluminum top cap and levelling glides.
- 24" wide panels have two punchouts, one for electrical and one for data.
- 30" wide panels and wider have three punchouts, two for electrical and one for data.
- Note: Trim is not required at a straight connection between two panels of the same height.
- Please specify duplex receptacles separately.

PRODUCT CODE	PRICE		SIZE/ INCHES			WEIGHT LBS	VOL FT ³
	GR1	GR2	H	W	D		
CMLFM3024P2	507	519	30	24	2.3	20	2.31
CMLFM3030P2	626	636	30	30	2.3	25	2.85
CMLFM3036P2	692	699	30	36	2.3	31	3.38
CMLFM3042P2	761	773	30	42	2.3	36	3.92
CMLFM3048P2	818	831	30	48	2.3	41	4.45
CMLFM3054P2	891	906	30	54	2.3	46	4.99
CMLFM3060P2	957	972	30	60	2.3	51	5.52
CMLFM4224P2	579	591	42	24	2.3	20	2.31
CMLFM4230P2	699	712	42	30	2.3	25	2.85
CMLFM4236P2	787	803	42	36	2.3	31	3.38
CMLFM4242P2	871	891	42	42	2.3	36	3.92
CMLFM4248P2	943	965	42	48	2.3	41	4.45
CMLFM4254P2	1030	1052	42	54	2.3	46	4.99
CMLFM4260P2	1110	1135	42	60	2.3	51	5.52
CMLFM4824P2	663	677	48	24	2.3	26	2.73
CMLFM4830P2	801	818	48	30	2.3	33	3.37
CMLFM4836P2	901	923	48	36	2.3	39	4.00
CMLFM4842P2	1000	1025	48	42	2.3	46	4.63
CMLFM4848P2	1088	1114	48	48	2.3	52	5.26
CMLFM4854P2	1137	1190	48	54	2.3	59	5.89
CMLFM5424P2	663	677	54	24	2.3	65	6.53
CMLFM5430P2	801	818	54	30	2.3	33	3.37
CMLFM5436P2	901	923	54	36	2.3	39	4.00
CMLFM5442P2	1000	1025	54	42	2.3	46	4.63
CMLFM5448P2	1088	1114	54	48	2.3	52	5.26
CMLFM5454P2	1190	1222	54	54	2.3	59	5.89
CMLFM6624P2	792	809	66	24	2.3	32	3.58
CMLFM6630P2	945	969	66	30	2.3	40	4.40
CMLFM6636P2	1074	1099	66	36	2.3	48	5.23
CMLFM6642P2	1202	1232	66	42	2.3	56	6.06
CMLFM6648P2	1304	1338	66	48	2.3	64	6.68

CMLLM-N0 • Monolithic Non Powered Laminate Two Sides Panel, No Punchouts

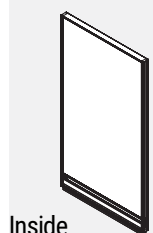

Inside

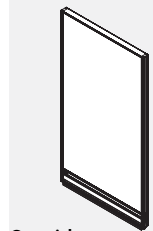

Outside

- Individual laminate modules incorporated into an aluminum frame.
- Panels are not tackable.
- 3 panel connector brackets per side come standard with 30"h., 42"h., and 54"h. panels.
- 4 panel connector brackets per side come standard with 66"h. panels.
- Panels include 2 raceway covers with no punchouts, an integrated aluminum top cap and levelling glides.
- Note: Trim is not required at a straight connection between two panels of the same height.

PRODUCT CODE	PRICE		SIZE/ INCHES			WEIGHT LBS	VOL FT ³
	H	W	D				
CMLLM3024N0	435		30	24	2.3	20	2.31
CMLLM3030N0	512		30	30	2.3	25	2.85
CMLLM3036N0	586		30	36	2.3	31	3.38
CMLLM3042N0	667		30	42	2.3	36	3.92
CMLLM3048N0	744		30	48	2.3	41	4.45
CMLLM3054N0	825		30	54	2.3	46	4.99
CMLLM3060N0	891		30	60	2.3	51	5.52
CMLLM4224N0	512		42	24	2.3	20	2.31
CMLLM4230N0	604		42	30	2.3	25	2.85
CMLLM4236N0	701		42	36	2.3	31	3.38
CMLLM4242N0	801		42	42	2.3	36	3.92
CMLLM4248N0	895		42	48	2.3	41	4.45
CMLLM4254N0	987		42	54	2.3	46	4.99
CMLLM4260N0	1075		42	60	2.3	51	5.52
CMLLM4824N0	607		48	24	2.3	26	2.73
CMLLM4830N0	719		48	30	2.3	33	3.37
CMLLM4836N0	835		48	36	2.3	39	4.00
CMLLM4842N0	954		48	42	2.3	46	4.63
CMLLM4848N0	1075		48	48	2.3	52	5.26
CMLLM4854N0	1181		48	54	2.3	59	5.89
CMLLM5424N0	607		54	24	2.3	65	6.53
CMLLM5430N0	719		54	30	2.3	33	3.37
CMLLM5436N0	835		54	36	2.3	39	4.00
CMLLM5442N0	954		54	42	2.3	46	4.63
CMLLM5448N0	1075		54	48	2.3	52	5.26
CMLLM5454N0	1181		54	54	2.3	59	5.89
CMLLM6624N0	765		66	24	2.3	32	3.58
CMLLM6630N0	908		66	30	2.3	40	4.40
CMLLM6636N0	1055		66	36	2.3	48	5.23
CMLLM6642N0	1208		66	42	2.3	56	6.06
CMLLM6648N0	1354		66	48	2.3	64	6.68

CMLLM-N1 • Monolithic Non Powered Laminate Two Sides Panel, Punchouts on One Side

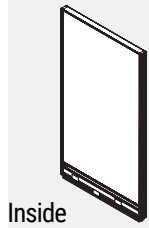

Inside

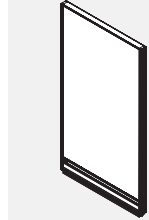

Outside

- Individual laminate modules incorporated into an aluminum frame.
- Panels are not tackable.
- 3 panel connector brackets per side come standard with 30”h., 42”h., and 54”h. panels.
- 4 panel connector brackets per side come standard with 66”h. panels.
- Panels include 1 raceway cover with punchouts on one side, 1 raceway cover with no punchouts on the other, an integrated aluminum top cap and levelling glides.
- 24” wide panels have two punchouts, one for electrical and one for data.
- 30” wide panels and wider have three punchouts, two for electrical and one for data.
- Note: Trim is not required at a straight connection between two panels of the same height.

PRODUCT CODE	PRICE	SIZE/ INCHES			WEIGHT VOL	
		H	W	D	LBS	FT ³
CMLLM3024N1	435	30	24	2.3	20	2.31
CMLLM3030N1	512	30	30	2.3	25	2.85
CMLLM3036N1	586	30	36	2.3	31	3.38
CMLLM3042N1	667	30	42	2.3	36	3.92
CMLLM3048N1	744	30	48	2.3	41	4.45
CMLLM3054N1	825	30	54	2.3	46	4.99
CMLLM3060N1	891	30	60	2.3	51	5.52
CMLLM4224N1	512	42	24	2.3	20	2.31
CMLLM4230N1	604	42	30	2.3	25	2.85
CMLLM4236N1	701	42	36	2.3	31	3.38
CMLLM4242N1	801	42	42	2.3	36	3.92
CMLLM4248N1	895	42	48	2.3	41	4.45
CMLLM4254N1	987	42	54	2.3	46	4.99
CMLLM4260N1	1075	42	60	2.3	51	5.52
CMLLM4824N1	607	48	24	2.3	26	2.73
CMLLM4830N1	719	48	30	2.3	33	3.37
CMLLM4836N1	835	48	36	2.3	39	4.00
CMLLM4842N1	954	48	42	2.3	46	4.63
CMLLM4848N1	1075	48	48	2.3	52	5.26
CMLLM4854N1	1181	48	54	2.3	59	5.89
CMLLM5424N1	607	54	24	2.3	65	6.53
CMLLM5430N1	719	54	30	2.3	33	3.37
CMLLM5436N1	835	54	36	2.3	39	4.00
CMLLM5442N1	954	54	42	2.3	46	4.63
CMLLM5448N1	1075	54	48	2.3	52	5.26
CMLLM5454N1	1181	54	54	2.3	59	5.89
CMLLM6624N1	765	66	24	2.3	32	3.58
CMLLM6630N1	908	66	30	2.3	40	4.40
CMLLM6636N1	1055	66	36	2.3	48	5.23
CMLLM6642N1	1208	66	42	2.3	56	6.06
CMLLM6648N1	1354	66	48	2.3	64	6.68

CMLLM-N2 • Monolithic Non Powered Laminate Two Sides Panel, Punchouts on Both Sides

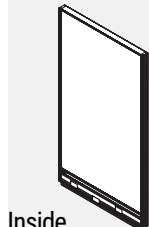

Inside

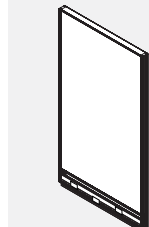

Outside

- Individual laminate modules incorporated into an aluminum frame.
- Panels are not tackable.
- 3 panel connector brackets per side come standard with 30”h., 42”h., and 54”h. panels.
- 4 panel connector brackets per side come standard with 66”h. panels.
- Panels include 2 raceway covers with punchouts, an integrated aluminum top cap and levelling glides.
- 24” wide panels have two punchouts, one for electrical and one for data.
- 30” wide panels and wider have three punchouts, two for electrical and one for data.
- Note: Trim is not required at a straight connection between two panels of the same height.

PRODUCT CODE	PRICE	SIZE/ INCHES			WEIGHT VOL	
		H	W	D	LBS	FT ³
CMLLM3024N2	435	30	24	2.3	20	2.31
CMLLM3030N2	512	30	30	2.3	25	2.85
CMLLM3036N2	586	30	36	2.3	31	3.38
CMLLM3042N2	667	30	42	2.3	36	3.92
CMLLM3048N2	744	30	48	2.3	41	4.45
CMLLM3054N2	825	30	54	2.3	46	4.99
CMLLM3060N2	891	30	60	2.3	51	5.52
CMLLM4224N2	512	42	24	2.3	20	2.31
CMLLM4230N2	604	42	30	2.3	25	2.85
CMLLM4236N2	701	42	36	2.3	31	3.38
CMLLM4242N2	801	42	42	2.3	36	3.92
CMLLM4248N2	895	42	48	2.3	41	4.45
CMLLM4254N2	987	42	54	2.3	46	4.99
CMLLM4260N2	1075	42	60	2.3	51	5.52
CMLLM4824N2	607	48	24	2.3	26	2.73
CMLLM4830N2	719	48	30	2.3	33	3.37
CMLLM4836N2	835	48	36	2.3	39	4.00
CMLLM4842N2	954	48	42	2.3	46	4.63
CMLLM4848N2	1075	48	48	2.3	52	5.26
CMLLM4854N2	1181	48	54	2.3	59	5.89
CMLLM5424N2	607	54	24	2.3	65	6.53
CMLLM5430N2	719	54	30	2.3	33	3.37
CMLLM5436N2	835	54	36	2.3	39	4.00
CMLLM5442N2	954	54	42	2.3	46	4.63
CMLLM5448N2	1075	54	48	2.3	52	5.26
CMLLM5454N2	1181	54	54	2.3	59	5.89
CMLLM6624N2	765	66	24	2.3	32	3.58
CMLLM6630N2	908	66	30	2.3	40	4.40
CMLLM6636N2	1055	66	36	2.3	48	5.23
CMLLM6642N2	1208	66	42	2.3	56	6.06
CMLLM6648N2	1354	66	48	2.3	64	6.68

CMLLM-P1 • Monolithic Laminate Two Sides Panel with PDH, Punchouts on One Side

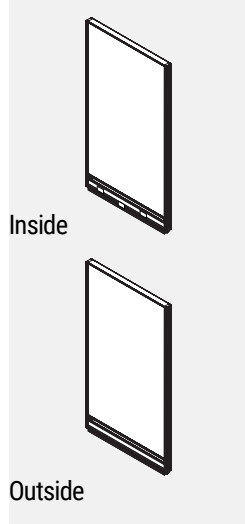

- Individual laminate modules incorporated into an aluminum frame.
- Panels are not tackable.
- 3 panel connector brackets per side come standard with 30”h., 42”h., and 54”h. panels.
- 4 panel connector brackets per side come standard with 66”h. panels.
- Panels include 1 raceway cover with punchouts on one side, 1 raceway cover with no punchouts on the other, a power distribution housing, an integrated aluminum top cap and levelling glides.
- 24” wide panels have two punchouts, one for electrical and one for data.
- 30” wide panels and wider have three punchouts, two for electrical and one for data.
- Note: Trim is not required at a straight connection between two panels of the same height.
- Please specify duplex receptacles separately.

PRODUCT CODE	PRICE	SIZE/ INCHES			WEIGHT LBS	VOL FT ³
		H	W	D		
CMLLM3024P1	562	30	24	2.3	20	2.31
CMLLM3030P1	686	30	30	2.3	25	2.85
CMLLM3036P1	767	30	36	2.3	31	3.38
CMLLM3042P1	854	30	42	2.3	36	3.92
CMLLM3048P1	943	30	48	2.3	41	4.45
CMLLM3054P1	1025	30	54	2.3	46	4.99
CMLLM3060P1	1093	30	60	2.3	51	5.52
CMLLM4224P1	640	42	24	2.3	20	2.31
CMLLM4230P1	777	42	30	2.3	25	2.85
CMLLM4236P1	883	42	36	2.3	31	3.38
CMLLM4242P1	988	42	42	2.3	36	3.92
CMLLM4248P1	1093	42	48	2.3	41	4.45
CMLLM4254P1	1188	42	54	2.3	46	4.99
CMLLM4260P1	1277	42	60	2.3	51	5.52
CMLLM4824P1	735	48	24	2.3	26	2.73
CMLLM4830P1	891	48	30	2.3	33	3.37
CMLLM4836P1	1016	48	36	2.3	39	4.00
CMLLM4842P1	1140	48	42	2.3	46	4.63
CMLLM4848P1	1272	48	48	2.3	52	5.26
CMLLM4854P1	1383	48	54	2.3	59	5.89
CMLLM5424P1	735	54	24	2.3	65	6.53
CMLLM5430P1	891	54	30	2.3	33	3.37
CMLLM5436P1	1016	54	36	2.3	39	4.00
CMLLM5442P1	1140	54	42	2.3	46	4.63
CMLLM5448P1	1272	54	48	2.3	52	5.26
CMLLM5454P1	1383	54	54	2.3	59	5.89
CMLLM6624P1	894	66	24	2.3	32	3.58
CMLLM6630P1	1081	66	30	2.3	40	4.40
CMLLM6636P1	1235	66	36	2.3	48	5.23
CMLLM6642P1	1396	66	42	2.3	56	6.06
CMLLM6648P1	1553	66	48	2.3	64	6.68

CMLLM-P2 • Monolithic Laminate Two Sides Panel with PDH, Punchouts on Both Side

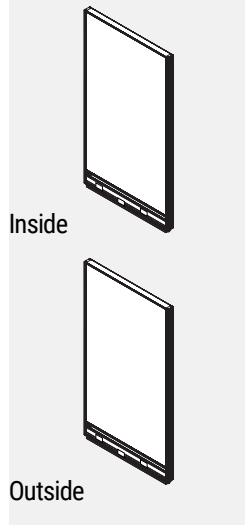

- Individual laminate modules incorporated into an aluminum frame.
- Panels are not tackable.
- 3 panel connector brackets per side come standard with 30”h., 42”h., and 54”h. panels.
- 4 panel connector brackets per side come standard with 66”h. panels.
- Panels include 2 raceway cover with punchouts, a power distribution housing, an integrated aluminum top cap and levelling glides.
- 24” wide panels have two punchouts, one for electrical and one for data.
- 30” wide panels and wider have three punchouts, two for electrical and one for data.
- Note: Trim is not required at a straight connection between two panels of the same height.
- Please specify duplex receptacles separately.

PRODUCT CODE	PRICE	SIZE/ INCHES			WEIGHT LBS	VOL FT ³
		H	W	D		
CMLLM3024P2	562	30	24	2.3	20	2.31
CMLLM3030P2	686	30	30	2.3	25	2.85
CMLLM3036P2	767	30	36	2.3	31	3.38
CMLLM3042P2	854	30	42	2.3	36	3.92
CMLLM3048P2	943	30	48	2.3	41	4.45
CMLLM3054P2	1025	30	54	2.3	46	4.99
CMLLM3060P2	1093	30	60	2.3	51	5.52
CMLLM4224P2	640	42	24	2.3	20	2.31
CMLLM4230P2	777	42	30	2.3	25	2.85
CMLLM4236P2	883	42	36	2.3	31	3.38
CMLLM4242P2	988	42	42	2.3	36	3.92
CMLLM4248P2	1093	42	48	2.3	41	4.45
CMLLM4254P2	1188	42	54	2.3	46	4.99
CMLLM4260P2	1277	42	60	2.3	51	5.52
CMLLM4824P2	735	48	24	2.3	26	2.73
CMLLM4830P2	891	48	30	2.3	33	3.37
CMLLM4836P2	1016	48	36	2.3	39	4.00
CMLLM4842P2	1140	48	42	2.3	46	4.63
CMLLM4848P2	1272	48	48	2.3	52	5.26
CMLLM4854P2	1383	48	54	2.3	59	5.89
CMLLM5424P2	735	54	24	2.3	65	6.53
CMLLM5430P2	891	54	30	2.3	33	3.37
CMLLM5436P2	1016	54	36	2.3	39	4.00
CMLLM5442P2	1140	54	42	2.3	46	4.63
CMLLM5448P2	1272	54	48	2.3	52	5.26
CMLLM5454P2	1383	54	54	2.3	59	5.89
CMLLM6624P2	894	66	24	2.3	32	3.58
CMLLM6630P2	1081	66	30	2.3	40	4.40
CMLLM6636P2	1235	66	36	2.3	48	5.23
CMLLM6642P2	1396	66	42	2.3	56	6.06
CMLLM6648P2	1553	66	48	2.3	64	6.68

CMFF-N0 • Single Segmented Non Powered Fabric Panel, No Punchouts

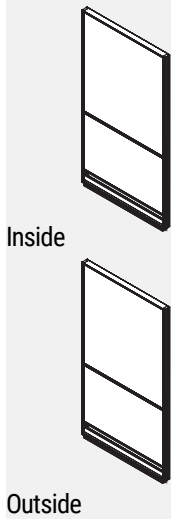

- Individual fabric-covered modules incorporated into an aluminum frame.
- Opposite sides of each module may have a different fabric within the same grade at no upcharge.
- If different grades of fabric are used on one panel, the entire panel must be priced at highest grade.
- Panels are not tackable.
- Note: Trim is not required at a straight connection between two panels of the same height.
- 3 Panel connector brackets per side come standard with 42”h. and 54”h. panels.
- 4 Panel connector brackets per side come standard with 66”h. panels.
- Panels include 2 raceway covers with no punchouts, an integrated aluminum top cap and levelling glides.

PRODUCT CODE	PRICE		SIZE/ INCHES			WEIGHT VOL	
	GR 1	GR 2	H	W	D	LBS	FT³
CMFF4224N0	286	310	42	24	2.3	20	2.31
CMFF4230N0	355	380	42	30	2.3	25	2.85
CMFF4236N0	383	430	42	36	2.3	31	3.38
CMFF4242N0	438	486	42	42	2.3	36	3.92
CMFF4248N0	468	518	42	48	2.3	41	4.45
CMFF4254N0	509	560	42	54	2.3	46	4.99
CMFF4260N0	561	609	42	60	2.3	51	5.52
CMFF4266N0	726	832	42	66	2.3	55	6.05
CMFF4272N0	763	869	42	72	2.3	60	6.60
CMFF4824N0	334	364	48	24	2.3	26	2.73
CMFF4830N0	383	410	48	30	2.3	33	3.37
CMFF4836N0	436	477	48	36	2.3	39	4.00
CMFF4842N0	499	558	48	42	2.3	46	4.63
CMFF4848N0	531	590	48	48	2.3	52	5.26
CMFF4854N0	584	640	48	54	2.3	59	5.89
CMFF4860N0	617	675	48	60	2.3	65	6.53
CMFF5424N0	334	364	54	24	2.3	26	2.73
CMFF5430N0	383	410	54	30	2.3	33	3.37
CMFF5436N0	436	477	54	36	2.3	39	4.00
CMFF5442N0	499	558	54	42	2.3	46	4.63
CMFF5448N0	531	590	54	48	2.3	52	5.26
CMFF5454N0	584	640	54	54	2.3	59	5.89
CMFF5460N0	617	675	54	60	2.3	65	6.53
CMFF6624N0	371	408	66	24	2.3	32	3.58
CMFF6630N0	413	450	66	30	2.3	40	4.40
CMFF6636N0	495	567	66	36	2.3	48	5.23
CMFF6642N0	561	635	66	42	2.3	56	6.06
CMFF6648N0	587	661	66	48	2.3	64	6.88
CMFF6654N0	641	716	66	54	2.3	72	7.71
CMFF6660N0	686	758	66	60	2.3	80	8.53

CMFF-N1 • Single Segmented Non Powered Fabric Panel, Punchouts on One Side

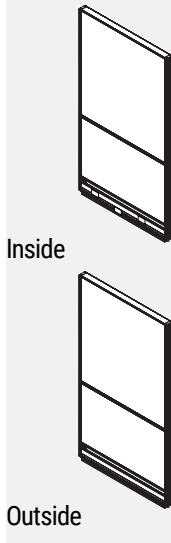

- Individual fabric-covered modules incorporated into an aluminum frame.
- Opposite sides of each module may have a different fabric within the same grade at no upcharge.
- If different grades of fabric are used on one panel, the entire panel must be priced at highest grade.
- Panels are not tackable.
- Note: Trim is not required at a straight connection between two panels of the same height.
- 3 Panel connector brackets per side come standard with 42”h. and 54”h. panels.
- 4 Panel connector brackets per side come standard with 66”h. panels.
- Panels include 1 raceway cover with punchouts on one side, 1 raceway cover with no punchouts on the other, an integrated aluminum top cap and levelling glides.
- 24” wide panels have two punchouts, one for electrical and one for data.
- 30” wide panels and wider have three punchouts, two for electrical and one for data.

PRODUCT CODE	PRICE		SIZE/ INCHES			WEIGHT VOL	
	GR 1	GR 2	H	W	D	LBS	FT³
CMFF4224N1	286	310	42	24	2.3	20	2.31
CMFF4230N1	355	380	42	30	2.3	25	2.85
CMFF4236N1	383	430	42	36	2.3	31	3.38
CMFF4242N1	438	486	42	42	2.3	36	3.92
CMFF4248N1	468	518	42	48	2.3	41	4.45
CMFF4254N1	509	560	42	54	2.3	46	4.99
CMFF4260N1	561	609	42	60	2.3	51	5.52
CMFF4266N1	726	832	42	66	2.3	55	6.05
CMFF4272N1	763	869	42	72	2.3	60	6.60
CMFF4824N1	334	364	48	24	2.3	26	2.73
CMFF4830N1	383	410	48	30	2.3	33	3.37
CMFF4836N1	436	477	48	36	2.3	39	4.00
CMFF4842N1	499	558	48	42	2.3	46	4.63
CMFF4848N1	531	590	48	48	2.3	52	5.26
CMFF4854N1	584	640	48	54	2.3	59	5.89
CMFF4860N1	617	675	48	60	2.3	65	6.53
CMFF5424N1	334	364	54	24	2.3	26	2.73
CMFF5430N1	383	410	54	30	2.3	33	3.37
CMFF5436N1	436	477	54	36	2.3	39	4.00
CMFF5442N1	499	558	54	42	2.3	46	4.63
CMFF5448N1	531	590	54	48	2.3	52	5.26
CMFF5454N1	584	640	54	54	2.3	59	5.89
CMFF5460N1	617	675	54	60	2.3	65	6.53
CMFF6624N1	371	408	66	24	2.3	32	3.58
CMFF6630N1	413	450	66	30	2.3	40	4.40
CMFF6636N1	495	567	66	36	2.3	48	5.23
CMFF6642N1	561	635	66	42	2.3	56	6.06
CMFF6648N1	587	661	66	48	2.3	64	6.88
CMFF6654N1	641	716	66	54	2.3	72	7.71
CMFF6660N1	686	758	66	60	2.3	80	8.53

CMFF-N2 • Single Segmented Non Powered Fabric Panel, Punchouts on Both Sides

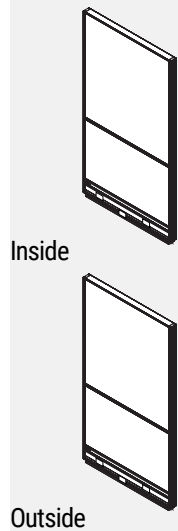

- Individual fabric-covered modules incorporated into an aluminum frame.
- Opposite sides of each module may have a different fabric within the same grade at no upcharge.
- If different grades of fabric are used on one panel, the entire panel must be priced at highest grade.
- Panels are not tackable.
- Note: Trim is not required at a straight connection between two panels of the same height.
- 3 Panel connector brackets per side come standard with 42”h. and 54”h. panels.
- 4 Panel connector brackets per side come standard with 66”h. panels.
- Panels include 2 raceway covers with punchouts on both sides, an integrated aluminum top cap and levelling glides.
- 24” wide panels have two punchouts, one for electrical and one for data.
- 30” wide panels and wider have three punchouts, two for electrical and one for data.

PRODUCT CODE	PRICE		SIZE/ INCHES			WEIGHT VOL	
	GR 1	GR 2	H	W	D	LBS	FT ³
CMFF4224N2	286	310	42	24	2.3	20	2.31
CMFF4230N2	355	380	42	30	2.3	25	2.85
CMFF4236N2	383	430	42	36	2.3	31	3.38
CMFF4242N2	438	486	42	42	2.3	36	3.92
CMFF4248N2	468	518	42	48	2.3	41	4.45
CMFF4254N2	509	560	42	54	2.3	46	4.99
CMFF4260N2	561	609	42	60	2.3	51	5.52
CMFF4266N2	726	832	42	66	2.3	55	6.05
CMFF4272N2	763	869	42	72	2.3	60	6.60
CMFF4824N2	334	364	48	24	2.3	26	2.73
CMFF4830N2	383	410	48	30	2.3	33	3.37
CMFF4836N2	436	477	48	36	2.3	39	4.00
CMFF4842N2	499	558	48	42	2.3	46	4.63
CMFF4848N2	531	590	48	48	2.3	52	5.26
CMFF4854N2	584	640	48	54	2.3	59	5.89
CMFF4860N2	617	675	48	60	2.3	65	6.53
CMFF5424N2	334	364	54	24	2.3	26	2.73
CMFF5430N2	383	410	54	30	2.3	33	3.37
CMFF5436N2	436	477	54	36	2.3	39	4.00
CMFF5442N2	499	558	54	42	2.3	46	4.63
CMFF5448N2	531	590	54	48	2.3	52	5.26
CMFF5454N2	584	640	54	54	2.3	59	5.89
CMFF5460N2	617	675	54	60	2.3	65	6.53
CMFF6624N2	371	408	66	24	2.3	32	3.58
CMFF6630N2	413	450	66	30	2.3	40	4.40
CMFF6636N2	495	567	66	36	2.3	48	5.23
CMFF6642N2	561	635	66	42	2.3	56	6.06
CMFF6648N2	587	661	66	48	2.3	64	6.88
CMFF6654N2	641	716	66	54	2.3	72	7.71
CMFF6660N2	686	758	66	60	2.3	80	8.53

CMFF-P1 • Single Segmented Powered Fabric Panel, Punchouts on One Side

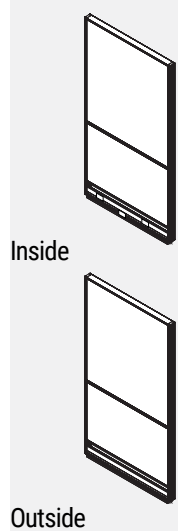

- Individual fabric-covered modules incorporated into an aluminum frame.
- Opposite sides of each module may have a different fabric within the same grade at no upcharge.
- If different grades of fabric are used on one panel, the entire panel must be priced at highest grade.
- Panels are not tackable.
- Note: Trim is not required at a straight connection between two panels of the same height.
- 3 Panel connector brackets per side come standard with 42”h. and 54”h. panels.
- 4 Panel connector brackets per side come standard with 66”h. panels.
- Panels include 1 raceway cover with punchouts on one side, 1 raceway cover with no punchouts on the other, a power distribution housing, an integrated aluminum top cap and levelling glides.
- 24” wide panels have two punchouts, one for electrical and one for data.
- 30” wide panels and wider have three punchouts, two for electrical and one for data.
- Please specify duplex receptacles separately.

PRODUCT CODE	PRICE		SIZE/ INCHES			WEIGHT VOL	
	GR 1	GR 2	H	W	D	LBS	FT ³
CMFF4224P1	420	444	42	24	2.3	20	2.31
CMFF4230P1	535	561	42	30	2.3	25	2.85
CMFF4236P1	573	620	42	36	2.3	31	3.38
CMFF4242P1	635	681	42	42	2.3	36	3.92
CMFF4248P1	674	724	42	48	2.3	41	4.45
CMFF4254P1	723	769	42	54	2.3	46	4.99
CMFF4260P1	773	821	42	60	2.3	51	5.52
CMFF4266P1	947	1054	42	66	2.3	55	6.05
CMFF4272P1	992	1097	42	72	2.3	60	6.60
CMFF4824P1	470	499	48	24	2.3	26	2.73
CMFF4830P1	563	592	48	30	2.3	33	3.37
CMFF4836P1	625	669	48	36	2.3	39	4.00
CMFF4842P1	696	755	48	42	2.3	46	4.63
CMFF4848P1	739	799	48	48	2.3	52	5.26
CMFF4854P1	793	853	48	54	2.3	59	5.89
CMFF4860P1	829	889	48	60	2.3	65	6.53
CMFF5424P1	470	499	54	24	2.3	26	2.73
CMFF5430P1	563	592	54	30	2.3	33	3.37
CMFF5436P1	625	669	54	36	2.3	39	4.00
CMFF5442P1	696	755	54	42	2.3	46	4.63
CMFF5448P1	739	799	54	48	2.3	52	5.26
CMFF5454P1	793	853	54	54	2.3	59	5.89
CMFF5460P1	829	889	54	60	2.3	65	6.53
CMFF6624P1	505	545	66	24	2.3	32	3.58
CMFF6630P1	594	634	66	30	2.3	40	4.40
CMFF6636P1	686	758	66	36	2.3	48	5.23
CMFF6642P1	757	829	66	42	2.3	56	6.06
CMFF6648P1	795	868	66	48	2.3	64	6.88
CMFF6654P1	854	927	66	54	2.3	72	7.71
CMFF6660P1	898	970	66	60	2.3	80	8.53

CMFF-P2 • Single Segmented Powered Fabric Panel, Punchouts on Both Sides

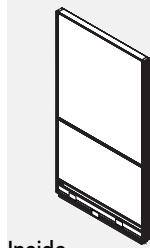

Inside

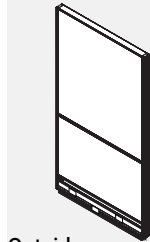

Outside

- Individual fabric-covered modules incorporated into an aluminum frame.
- Opposite sides of each module may have a different fabric within the same grade at no upcharge.
- If different grades of fabric are used on one panel, the entire panel must be priced at highest grade.
- Panels are not tackable.
- Note: Trim is not required at a straight connection between two panels of the same height.
- 3 Panel connector brackets per side come standard with 42”h. and 54”h. panels.
- 4 Panel connector brackets per side come standard with 66”h. panels.
- Panels include 2 raceway covers with punchouts on both sides, a power distribution housing, an integrated aluminum top cap and levelling glides.
- 24” wide panels have two punchouts, one for electrical and one for data.
- 30” wide panels and wider have three punchouts, two for electrical and one for data.
- Please specify duplex receptacles separately.

PRODUCT CODE	PRICE		SIZE/ INCHES			WEIGHT VOL	
	GR 1	GR 2	H	W	D	LBS	FT³
CMFF4224P2	420	444	42	24	2.3	20	2.31
CMFF4230P2	535	561	42	30	2.3	25	2.85
CMFF4236P2	573	620	42	36	2.3	31	3.38
CMFF4242P2	635	681	42	42	2.3	36	3.92
CMFF4248P2	674	724	42	48	2.3	41	4.45
CMFF4254P2	723	769	42	54	2.3	46	4.99
CMFF4260P2	773	821	42	60	2.3	51	5.52
CMFF4266P2	947	1054	42	66	2.3	55	6.05
CMFF4272P2	992	1097	42	72	2.3	60	6.60
CMFF4824P2	470	499	48	24	2.3	26	2.73
CMFF4830P2	563	592	48	30	2.3	33	3.37
CMFF4836P2	625	669	48	36	2.3	39	4.00
CMFF4842P2	696	755	48	42	2.3	46	4.63
CMFF4848P2	739	799	48	48	2.3	52	5.26
CMFF4854P2	793	853	48	54	2.3	59	5.89
CMFF4860P2	829	889	48	60	2.3	65	6.53
CMFF5424P2	470	499	54	24	2.3	26	2.73
CMFF5430P2	563	592	54	30	2.3	33	3.37
CMFF5436P2	625	669	54	36	2.3	39	4.00
CMFF5442P2	696	755	54	42	2.3	46	4.63
CMFF5448P2	739	799	54	48	2.3	52	5.26
CMFF5454P2	793	853	54	54	2.3	59	5.89
CMFF5460P2	829	889	54	60	2.3	65	6.53
CMFF6624P2	505	545	66	24	2.3	32	3.58
CMFF6630P2	594	634	66	30	2.3	40	4.40
CMFF6636P2	686	758	66	36	2.3	48	5.23
CMFF6642P2	757	829	66	42	2.3	56	6.06
CMFF6648P2	795	868	66	48	2.3	64	6.88
CMFF6654P2	854	927	66	54	2.3	72	7.71
CMFF6660P2	898	970	66	60	2.3	80	8.53

CMFL-N0 • Single Segmented Non Powered Laminate One Side Panel, No Punchouts

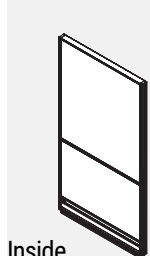

Inside

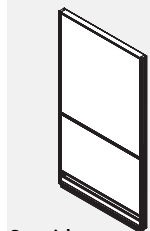

Outside

- Individual fabric or laminate covered modules incorporated into an aluminum frame.
- Modules have laminate on one side and fabric on the other.
- If different grades of fabric are used on one panel, the entire panel must be priced at highest grade.
- Panels are not tackable.
- Note: Trim is not required at a straight connection between two panels of the same height.
- 3 Panel connector brackets per side come standard with 30” to 54”h. panels.
- 4 Panel connector brackets per side come standard with 66”h. panels.
- Panels include 2 raceway covers with no punchouts, an integrated aluminum top cap and levelling glides.

PRODUCT CODE	PRICE		SIZE/ INCHES			WEIGHT VOL	
	GR 1	GR 2	H	W	D	LBS	FT³
CMFL4224N0	450	463	42	24	2.3	20	2.31
CMFL4230N0	526	537	42	30	2.3	25	2.85
CMFL4236N0	605	622	42	36	2.3	31	3.38
CMFL4242N0	686	703	42	42	2.3	36	3.92
CMFL4248N0	744	765	42	48	2.3	41	4.45
CMFL4254N0	828	853	42	54	2.3	46	4.99
CMFL4260N0	908	934	42	60	2.3	51	5.52
CMFL4824N0	534	550	48	24	2.3	26	2.73
CMFL4830N0	628	646	48	30	2.3	33	3.37
CMFL4836N0	719	740	48	36	2.3	39	4.00
CMFL4842N0	815	839	48	42	2.3	46	4.63
CMFL4848N0	890	919	48	48	2.3	52	5.26
CMFL4854N0	991	1021	48	54	2.3	59	5.89
CMFL4860N0	1089	1122	48	60	2.3	65	6.53
CMFL5424N0	534	550	54	24	2.3	26	2.73
CMFL5430N0	628	646	54	30	2.3	33	3.37
CMFL5436N0	719	740	54	36	2.3	39	4.00
CMFL5442N0	815	839	54	42	2.3	46	4.63
CMFL5448N0	890	919	54	48	2.3	52	5.26
CMFL5454N0	991	1021	54	54	2.3	59	5.89
CMFL5460N0	1089	1122	54	60	2.3	65	6.53
CMFL6624N0	663	679	66	24	2.3	32	3.58
CMFL6630N0	773	796	66	30	2.3	40	4.4
CMFL6636N0	891	920	66	36	2.3	48	5.23
CMFL6642N0	1016	1047	66	42	2.3	56	6.06
CMFL6648N0	1106	1140	66	48	2.3	64	6.88
CMFL6654N0	1228	1265	66	54	2.3	72	7.71
CMFL6660N0	1354	1396	66	60	2.3	80	8.53

CMFL-N1 • Single Segmented Non Powered Laminate One Side Panel, Punchouts on One Side

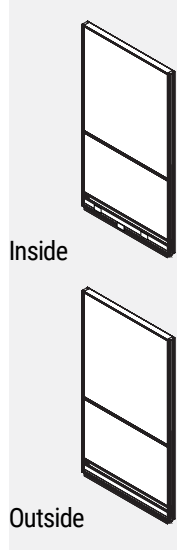

- Individual fabric or laminate covered modules incorporated into an aluminum frame.
- Modules have laminate on one side and fabric on the other.
- If different grades of fabric are used on one panel, the entire panel must be priced at highest grade.
- Panels are not tackable.
- Note: Trim is not required at a straight connection between two panels of the same height.
- 3 Panel connector brackets per side come standard with 30”h. to 54”h. panels.
- 4 Panel connector brackets per side come standard with 66”h. panels.
- Panels include 1 raceway cover with punchouts on one side, 1 raceway cover with no punchouts on the other, an integrated aluminum top cap and levelling glides.
- 24” wide panels have two punchouts, one for electrical and one for data.
- 30” wide panels and wider have three punchouts, two for electrical and one for data.

PRODUCT CODE	PRICE		SIZE/ INCHES			WEIGHT VOL	
	GR 1	GR 2	H	W	D	LBS	FT ³
CMFL4224N1	450	463	42	24	2.3	20	2.31
CMFL4230N1	526	537	42	30	2.3	25	2.85
CMFL4236N1	605	622	42	36	2.3	31	3.38
CMFL4242N1	686	703	42	42	2.3	36	3.92
CMFL4248N1	744	765	42	48	2.3	41	4.45
CMFL4254N1	828	853	42	54	2.3	46	4.99
CMFL4260N1	908	934	42	60	2.3	51	5.52
CMFL4824N1	534	550	48	24	2.3	26	2.73
CMFL4830N1	628	646	48	30	2.3	33	3.37
CMFL4836N1	719	740	48	36	2.3	39	4.00
CMFL4842N1	815	839	48	42	2.3	46	4.63
CMFL4848N1	890	919	48	48	2.3	52	5.26
CMFL4854N1	991	1021	48	54	2.3	59	5.89
CMFL4860N1	1089	1122	48	60	2.3	65	6.53
CMFL5424N1	534	550	54	24	2.3	26	2.73
CMFL5430N1	628	646	54	30	2.3	33	3.37
CMFL5436N1	719	740	54	36	2.3	39	4.00
CMFL5442N1	815	839	54	42	2.3	46	4.63
CMFL5448N1	890	919	54	48	2.3	52	5.26
CMFL5454N1	991	1021	54	54	2.3	59	5.89
CMFL5460N1	1089	1122	54	60	2.3	65	6.53
CMFL6624N1	663	679	66	24	2.3	32	3.58
CMFL6630N1	773	796	66	30	2.3	40	4.40
CMFL6636N1	891	920	66	36	2.3	48	5.23
CMFL6642N1	1016	1047	66	42	2.3	56	6.06
CMFL6648N1	1106	1140	66	48	2.3	64	6.88
CMFL6654N1	1228	1265	66	54	2.3	72	7.71
CMFL6660N1	1354	1396	66	60	2.3	80	8.53

CMFL-N2 • Single Segmented Non Powered Laminate One Side Panel, Punchouts on Both Sides

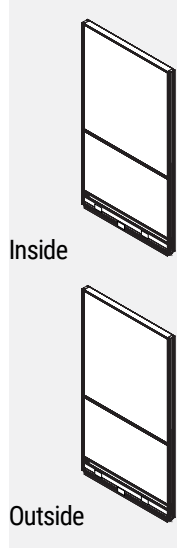

- Individual fabric or laminate covered modules incorporated into an aluminum frame.
- Modules have laminate on one side and fabric on the other.
- If different grades of fabric are used on one panel, the entire panel must be priced at highest grade.
- Panels are not tackable.
- Note: Trim is not required at a straight connection between two panels of the same height.
- 3 Panel connector brackets per side come standard with 30”h. to 54”h. panels.
- 4 Panel connector brackets per side come standard with 66”h. panels.
- Panels include 2 raceway covers with punchouts on both sides, an integrated aluminum top cap and levelling glides.
- 24” wide panels have two punchouts, one for electrical and one for data.
- 30” wide panels and wider have three punchouts, two for electrical and one for data.

PRODUCT CODE	PRICE		SIZE/ INCHES			WEIGHT VOL	
	GR 1	GR 2	H	W	D	LBS	FT ³
CMFL4224N2	450	463	42	24	2.3	20	2.31
CMFL4230N2	526	537	42	30	2.3	25	2.85
CMFL4236N2	605	622	42	36	2.3	31	3.38
CMFL4242N2	686	703	42	42	2.3	36	3.92
CMFL4248N2	744	765	42	48	2.3	41	4.45
CMFL4254N2	828	853	42	54	2.3	46	4.99
CMFL4260N2	908	934	42	60	2.3	51	5.52
CMFL4824N2	534	550	48	24	2.3	26	2.73
CMFL4830N2	628	646	48	30	2.3	33	3.37
CMFL4836N2	719	740	48	36	2.3	39	4.00
CMFL4842N2	815	839	48	42	2.3	46	4.63
CMFL4848N2	890	919	48	48	2.3	52	5.26
CMFL4854N2	991	1021	48	54	2.3	59	5.89
CMFL4860N2	1089	1122	48	60	2.3	65	6.53
CMFL5424N2	534	550	54	24	2.3	26	2.73
CMFL5430N2	628	646	54	30	2.3	33	3.37
CMFL5436N2	719	740	54	36	2.3	39	4.00
CMFL5442N2	815	839	54	42	2.3	46	4.63
CMFL5448N2	890	919	54	48	2.3	52	5.26
CMFL5454N2	991	1021	54	54	2.3	59	5.89
CMFL5460N2	1089	1122	54	60	2.3	65	6.53
CMFL6624N2	663	679	66	24	2.3	32	3.58
CMFL6630N2	773	796	66	30	2.3	40	4.40
CMFL6636N2	891	920	66	36	2.3	48	5.23
CMFL6642N2	1016	1047	66	42	2.3	56	6.06
CMFL6648N2	1106	1140	66	48	2.3	64	6.88
CMFL6654N2	1228	1265	66	54	2.3	72	7.71
CMFL6660N2	1354	1396	66	60	2.3	80	8.53

CMFL-P1 • Single Segmented Powered Laminate One Side Panel, Punchouts on One Side

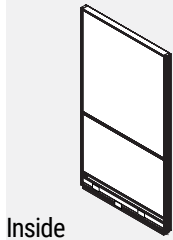

Inside

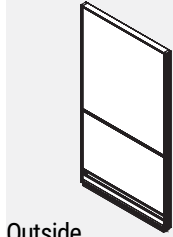

Outside

- Individual fabric or laminate covered modules incorporated into an aluminum frame.
- Modules have laminate on one side and fabric on the other.
- If different grades of fabric are used on one panel, the entire panel must be priced at highest grade.
- Panels are not tackable.
- Note: Trim is not required at a straight connection between two panels of the same height.
- 3 Panel connector brackets per side come standard with 30”h. to 54”h. panels.
- 4 Panel connector brackets per side come standard with 66”h. panels.
- Panels include 1 raceway cover with punchouts on one side, 1 raceway cover with no punchouts on the other, a power distribution housing, an integrated aluminum top cap and levelling glides.
- 24” wide panels have two punchouts, one for electrical and one for data.
- 30” wide panels and wider have three punchouts, two for electrical and one for data.
- Please specify duplex receptacles separately.

PRODUCT CODE	PRICE		SIZE/ INCHES			WEIGHT VOL	
	GR 1	GR 2	H	W	D	LBS	FT³
CMFL4224P1	586	596	42	24	2.3	20	2.31
CMFL4230P1	705	722	42	30	2.3	25	2.85
CMFL4236P1	795	813	42	36	2.3	31	3.38
CMFL4242P1	882	901	42	42	2.3	36	3.92
CMFL4248P1	954	972	42	48	2.3	41	4.45
CMFL4254P1	1038	1062	42	54	2.3	46	4.99
CMFL4260P1	1120	1146	42	60	2.3	51	5.52
CMFL4824P1	669	684	48	24	2.3	26	2.73
CMFL4830P1	809	827	48	30	2.3	33	3.37
CMFL4836P1	909	931	48	36	2.3	39	4.00
CMFL4842P1	1010	1034	48	42	2.3	46	4.63
CMFL4848P1	1098	1124	48	48	2.3	52	5.26
CMFL4854P1	1200	1230	48	54	2.3	59	5.89
CMFL4860P1	1301	1335	48	60	2.3	65	6.53
CMFL5424P1	669	684	54	24	2.3	26	2.73
CMFL5430P1	809	827	54	30	2.3	33	3.37
CMFL5436P1	909	931	54	36	2.3	39	4.00
CMFL5442P1	1010	1034	54	42	2.3	46	4.63
CMFL5448P1	1098	1124	54	48	2.3	52	5.26
CMFL5454P1	1200	1230	54	54	2.3	59	5.89
CMFL5460P1	1301	1335	54	60	2.3	65	6.53
CMFL6624P1	799	816	66	24	2.3	32	3.58
CMFL6630P1	955	977	66	30	2.3	40	4.40
CMFL6636P1	1082	1110	66	36	2.3	48	5.23
CMFL6642P1	1210	1241	66	42	2.3	56	6.06
CMFL6648P1	1313	1349	66	48	2.3	64	6.88
CMFL6654P1	1439	1476	66	54	2.3	72	7.71
CMFL6660P1	1566	1608	66	60	2.3	80	8.53

CMFL-P2 • Single Segmented Powered Laminate One Side Panel, Punchouts on Both Sides

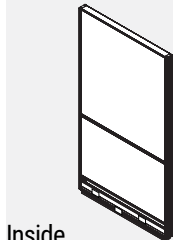

Inside

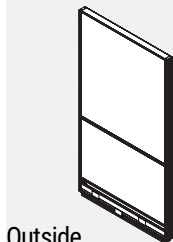

Outside

- Individual fabric or laminate covered modules incorporated into an aluminum frame.
- Modules have laminate on one side and fabric on the other.
- If different grades of fabric are used on one panel, the entire panel must be priced at highest grade.
- Panels are not tackable.
- Note: Trim is not required at a straight connection between two panels of the same height.
- 3 Panel connector brackets per side come standard with 30”h. to 54”h. panels.
- 4 Panel connector brackets per side come standard with 66”h. panels.
- Panels include 2 raceway covers with punchouts on both sides, a power distribution housing, an integrated aluminum top cap and levelling glides.
- 24” wide panels have two punchouts, one for electrical and one for data.
- 30” wide panels and wider have three punchouts, two for electrical and one for data.
- Please specify duplex receptacles separately.

PRODUCT CODE	PRICE		SIZE/ INCHES			WEIGHT VOL	
	GR 1	GR 2	H	W	D	LBS	FT³
CMFL4224P2	586	596	42	24	2.3	20	2.31
CMFL4230P2	705	722	42	30	2.3	25	2.85
CMFL4236P2	795	813	42	36	2.3	31	3.38
CMFL4242P2	882	901	42	42	2.3	36	3.92
CMFL4248P2	954	972	42	48	2.3	41	4.45
CMFL4254P2	1038	1062	42	54	2.3	46	4.99
CMFL4260P2	1120	1146	42	60	2.3	51	5.52
CMFL4824P2	669	684	48	24	2.3	26	2.73
CMFL4830P2	809	827	48	30	2.3	33	3.37
CMFL4836P2	909	931	48	36	2.3	39	4.00
CMFL4842P2	1010	1034	48	42	2.3	46	4.63
CMFL4848P2	1098	1124	48	48	2.3	52	5.26
CMFL4854P2	1200	1230	48	54	2.3	59	5.89
CMFL4860P2	1301	1335	48	60	2.3	65	6.53
CMFL5424P2	669	684	54	24	2.3	26	2.73
CMFL5430P2	809	827	54	30	2.3	33	3.37
CMFL5436P2	909	931	54	36	2.3	39	4.00
CMFL5442P2	1010	1034	54	42	2.3	46	4.63
CMFL5448P2	1098	1124	54	48	2.3	52	5.26
CMFL5454P2	1200	1230	54	54	2.3	59	5.89
CMFL5460P2	1301	1335	54	60	2.3	65	6.53
CMFL6624P2	799	816	66	24	2.3	32	3.58
CMFL6630P2	955	977	66	30	2.3	40	4.40
CMFL6636P2	1082	1110	66	36	2.3	48	5.23
CMFL6642P2	1210	1241	66	42	2.3	56	6.06
CMFL6648P2	1313	1349	66	48	2.3	64	6.88
CMFL6654P2	1439	1476	66	54	2.3	72	7.71
CMFL6660P2	1566	1608	66	60	2.3	80	8.53

CMLL-N0 • Single Segmented Non Powered Laminate Two Sides Panel, No Punchouts

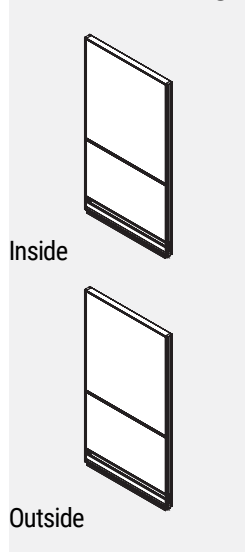

- Individual laminate covered modules incorporated into an aluminum frame.
- Opposite sides of each module may have a different laminate within the same grade at no upcharge.
- Note: Trim is not required at a straight connection between two panels of the same height.
- 3 Panel connector brackets per side come standard with 30”h. to 54”h. panels.
- 4 Panel connector brackets per side come standard with 66”h. panels.
- Panels include 2 raceway covers with no punchouts, an integrated aluminum top cap and levelling glides.

PRODUCT CODE	PRICE	SIZE/ INCHES			WEIGHT VOL	
		H	W	D	LBS	FT ³
CMLL4224N0	512	42	24	2.3	20	2.31
CMLL4230N0	604	42	30	2.3	25	2.85
CMLL4236N0	701	42	36	2.3	31	3.38
CMLL4242N0	801	42	42	2.3	36	3.92
CMLL4248N0	895	42	48	2.3	41	4.45
CMLL4254N0	987	42	54	2.3	46	4.99
CMLL4260N0	1075	42	60	2.3	51	5.52
CMLL4824N0	607	48	24	2.3	26	2.73
CMLL4830N0	719	48	30	2.3	33	3.37
CMLL4836N0	835	48	36	2.3	39	4.00
CMLL4842N0	954	48	42	2.3	46	4.63
CMLL4848N0	1075	48	48	2.3	52	5.26
CMLL4854N0	1181	48	54	2.3	59	5.89
CMLL4860N0	1287	48	60	2.3	65	6.53
CMLL5424N0	607	54	24	2.3	26	2.73
CMLL5430N0	719	54	30	2.3	33	3.37
CMLL5436N0	835	54	36	2.3	39	4.00
CMLL5442N0	954	54	42	2.3	46	4.63
CMLL5448N0	1075	54	48	2.3	52	5.26
CMLL5454N0	1181	54	54	2.3	59	5.89
CMLL5460N0	1287	54	60	2.3	65	6.53
CMLL6624N0	765	66	24	2.3	32	3.58
CMLL6630N0	908	66	30	2.3	40	4.40
CMLL6636N0	1055	66	36	2.3	48	5.23
CMLL6642N0	1208	66	42	2.3	56	6.06
CMLL6648N0	1354	66	48	2.3	64	6.88
CMLL6654N0	1496	66	54	2.3	72	7.71
CMLL6660N0	1635	66	60	2.3	80	8.53

CMLL-N1 • Single Segmented Non Powered Laminate Two Sides Panel, Punchouts on One Side

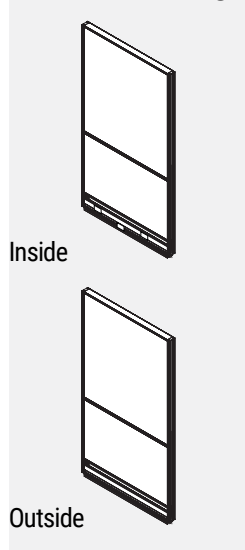

- Individual laminate covered modules incorporated into an aluminum frame.
- Opposite sides of each module may have a different laminate within the same grade at no upcharge.
- Note: Trim is not required at a straight connection between two panels of the same height.
- 3 Panel connector brackets per side come standard with 30”h. to 54”h. panels.
- 4 Panel connector brackets per side come standard with 66”h. panels.
- Panels include 1 raceway cover with punchouts on one side, 1 raceway cover with no punchouts on the other, an integrated aluminum top cap and levelling glides.
- 24” wide panels have two punchouts, one for electrical and one for data.
- 30” wide panels and wider have three punchouts, two for electrical and one for data.

PRODUCT CODE	PRICE	SIZE/ INCHES			WEIGHT VOL	
		H	W	D	LBS	FT ³
CMLL4224N1	512	42	24	2.3	20	2.31
CMLL4230N1	604	42	30	2.3	25	2.85
CMLL4236N1	701	42	36	2.3	31	3.38
CMLL4242N1	801	42	42	2.3	36	3.92
CMLL4248N1	895	42	48	2.3	41	4.45
CMLL4254N1	987	42	54	2.3	46	4.99
CMLL4260N1	1075	42	60	2.3	51	5.52
CMLL4824N1	607	48	24	2.3	26	2.73
CMLL4830N1	719	48	30	2.3	33	3.37
CMLL4836N1	835	48	36	2.3	39	4.00
CMLL4842N1	954	48	42	2.3	46	4.63
CMLL4848N1	1075	48	48	2.3	52	5.26
CMLL4854N1	1181	48	54	2.3	59	5.89
CMLL4860N1	1287	48	60	2.3	65	6.53
CMLL5424N1	607	54	24	2.3	26	2.73
CMLL5430N1	719	54	30	2.3	33	3.37
CMLL5436N1	835	54	36	2.3	39	4.00
CMLL5442N1	954	54	42	2.3	46	4.63
CMLL5448N1	1075	54	48	2.3	52	5.26
CMLL5454N1	1181	54	54	2.3	59	5.89
CMLL5460N1	1287	54	60	2.3	65	6.53
CMLL6624N1	765	66	24	2.3	32	3.58
CMLL6630N1	908	66	30	2.3	40	4.40
CMLL6636N1	1055	66	36	2.3	48	5.23
CMLL6642N1	1208	66	42	2.3	56	6.06
CMLL6648N1	1354	66	48	2.3	64	6.88
CMLL6654N1	1496	66	54	2.3	72	7.71
CMLL6660N1	1635	66	60	2.3	80	8.53

CMLL-N2 • Single Segmented Non Powered Laminate Two Sides Panel, Punchouts on Both Sides

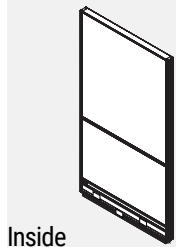

Inside

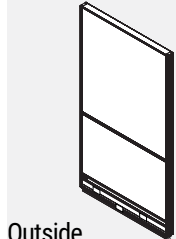

Outside

- Individual laminate covered modules incorporated into an aluminum frame.
- Opposite sides of each module may have a different laminate within the same grade at no upcharge.
- Note: Trim is not required at a straight connection between two panels of the same height.
- 3 Panel connector brackets per side come standard with 30”h. to 54”h. panels.
- 4 Panel connector brackets per side come standard with 66”h. panels.
- Panels include 2 raceway covers with punchouts on both sides, an integrated aluminum top cap and levelling glides.
- 24” wide panels have two punchouts, one for electrical and one for data.
- 30” wide panels and wider have three punchouts, two for electrical and one for data.

PRODUCT CODE	PRICE	SIZE/ INCHES			WEIGHT VOL	
		H	W	D	LBS	FT ³
CMLL4224N2	512	42	24	2.3	20	2.31
CMLL4230N2	604	42	30	2.3	25	2.85
CMLL4236N2	701	42	36	2.3	31	3.38
CMLL4242N2	801	42	42	2.3	36	3.92
CMLL4248N2	895	42	48	2.3	41	4.45
CMLL4254N2	987	42	54	2.3	46	4.99
CMLL4260N2	1075	42	60	2.3	51	5.52
CMLL4824N2	607	48	24	2.3	26	2.73
CMLL4830N2	719	48	30	2.3	33	3.37
CMLL4836N2	835	48	36	2.3	39	4.00
CMLL4842N2	954	48	42	2.3	46	4.63
CMLL4848N2	1075	48	48	2.3	52	5.26
CMLL4854N2	1181	48	54	2.3	59	5.89
CMLL4860N2	1287	48	60	2.3	65	6.53
CMLL5424N2	607	54	24	2.3	26	2.73
CMLL5430N2	719	54	30	2.3	33	3.37
CMLL5436N2	835	54	36	2.3	39	4
CMLL5442N2	954	54	42	2.3	46	4.63
CMLL5448N2	1075	54	48	2.3	52	5.26
CMLL5454N2	1181	54	54	2.3	59	5.89
CMLL5460N2	1287	54	60	2.3	65	6.53
CMLL6624N2	765	66	24	2.3	32	3.58
CMLL6630N2	908	66	30	2.3	40	4.4
CMLL6636N2	1055	66	36	2.3	48	5.23
CMLL6642N2	1208	66	42	2.3	56	6.06
CMLL6648N2	1354	66	48	2.3	64	6.88
CMLL6654N2	1496	66	54	2.3	72	7.71
CMLL6660N2	1635	66	60	2.3	80	8.53

CMLL-P1 • Single Segmented Powered Laminate Two Sides Panel, Punchouts on One Side

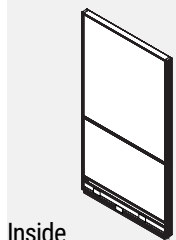

Inside

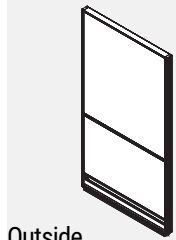

Outside

- Individual laminate covered modules incorporated into an aluminum frame.
- Opposite sides of each module may have a different laminate within the same grade at no upcharge.
- Note: Trim is not required at a straight connection between two panels of the same height.
- 3 Panel connector brackets per side come standard with 30”h. to 54”h. panels.
- 4 Panel connector brackets per side come standard with 66”h. panels.
- Panels include 1 raceway cover with punchouts on one side, 1 raceway cover with no punchouts on the other, a power distribution housing, an integrated aluminum top cap and levelling glides.
- 24” wide panels have two punchouts, one for electrical and one for data.
- 30” wide panels and wider have three punchouts, two for electrical and one for data.
- Please specify duplex receptacles separately.

PRODUCT CODE	PRICE	SIZE/ INCHES			WEIGHT VOL	
		H	W	D	LBS	FT ³
CMLL4224P1	647	42	24	2.3	20	2.31
CMLL4230P1	785	42	30	2.3	25	2.85
CMLL4236P1	891	42	36	2.3	31	3.38
CMLL4242P1	997	42	42	2.3	36	3.92
CMLL4248P1	1104	42	48	2.3	41	4.45
CMLL4254P1	1198	42	54	2.3	46	4.99
CMLL4260P1	1287	42	60	2.3	51	5.52
CMLL4824P1	740	48	24	2.3	26	2.73
CMLL4830P1	901	48	30	2.3	33	3.37
CMLL4836P1	1025	48	36	2.3	39	4.00
CMLL4842P1	1148	48	42	2.3	46	4.63
CMLL4848P1	1284	48	48	2.3	52	5.26
CMLL4854P1	1393	48	54	2.3	59	5.89
CMLL4860P1	1498	48	60	2.3	65	6.53
CMLL5424P1	740	54	24	2.3	26	2.73
CMLL5430P1	901	54	30	2.3	33	3.37
CMLL5436P1	1025	54	36	2.3	39	4
CMLL5442P1	1148	54	42	2.3	46	4.63
CMLL5448P1	1284	54	48	2.3	52	5.26
CMLL5454P1	1393	54	54	2.3	59	5.89
CMLL5460P1	1498	54	60	2.3	65	6.53
CMLL6624P1	901	66	24	2.3	32	3.58
CMLL6630P1	1089	66	30	2.3	40	4.4
CMLL6636P1	1246	66	36	2.3	48	5.23
CMLL6642P1	1405	66	42	2.3	56	6.06
CMLL6648P1	1561	66	48	2.3	64	6.88
CMLL6654P1	1706	66	54	2.3	72	7.71
CMLL6660P1	1848	66	60	2.3	80	8.53

CMLL-P2 • Single Segmented Powered Laminate Two Sides Panel, Punchouts on Both Sides

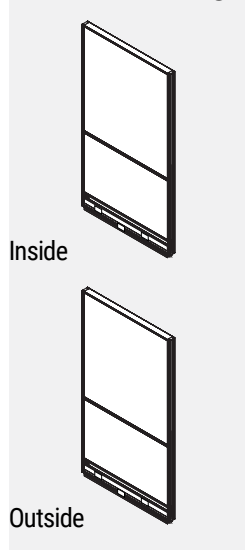

- Individual laminate covered modules incorporated into an aluminum frame.
- Opposite sides of each module may have a different laminate within the same grade at no upcharge.
- Note: Trim is not required at a straight connection between two panels of the same height.
- 3 Panel connector brackets per side come standard with 30" h. to 54" h. panels.
- 4 Panel connector brackets per side come standard with 66" h. panels.
- Panels include 2 raceway covers with punchouts on both sides, a power distribution housing, an integrated aluminum top cap and levelling glides.
- 24" wide panels have two punchouts, one for electrical and one for data.
- 30" wide panels and wider have three punchouts, two for electrical and one for data.
- Please specify duplex receptacles separately.

PRODUCT CODE	PRICE	SIZE/ INCHES			WEIGHT VOL	
		H	W	D	LBS	FT ³
CMLL4224P2	647	42	24	2.3	20	2.31
CMLL4230P2	785	42	30	2.3	25	2.85
CMLL4236P2	891	42	36	2.3	31	3.38
CMLL4242P2	997	42	42	2.3	36	3.92
CMLL4248P2	1104	42	48	2.3	41	4.45
CMLL4254P2	1198	42	54	2.3	46	4.99
CMLL4260P2	1287	42	60	2.3	51	5.52
CMLL4824P2	740	48	24	2.3	26	2.73
CMLL4830P2	901	48	30	2.3	33	3.37
CMLL4836P2	1025	48	36	2.3	39	4.00
CMLL4842P2	1148	48	42	2.3	46	4.63
CMLL4848P2	1284	48	48	2.3	52	5.26
CMLL4854P2	1393	48	54	2.3	59	5.89
CMLL4860P2	1498	48	60	2.3	65	6.53
CMLL5424P2	740	54	24	2.3	26	2.73
CMLL5430P2	901	54	30	2.3	33	3.37
CMLL5436P2	1025	54	36	2.3	39	4
CMLL5442P2	1148	54	42	2.3	46	4.63
CMLL5448P2	1284	54	48	2.3	52	5.26
CMLL5454P2	1393	54	54	2.3	59	5.89
CMLL5460P2	1498	54	60	2.3	65	6.53
CMLL6624P2	901	66	24	2.3	32	3.58
CMLL6630P2	1089	66	30	2.3	40	4.4
CMLL6636P2	1246	66	36	2.3	48	5.23
CMLL6642P2	1405	66	42	2.3	56	6.06
CMLL6648P2	1561	66	48	2.3	64	6.88
CMLL6654P2	1706	66	54	2.3	72	7.71
CMLL6660P2	1848	66	60	2.3	80	8.53

CMFW-N0 • Single Segmented Non Powered Write Board One Side Panel, No Punchouts

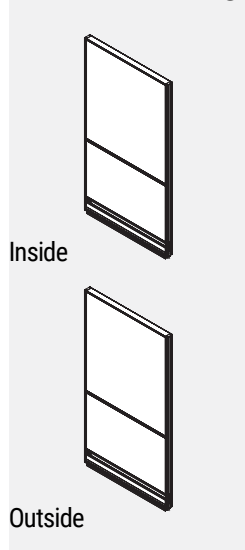

- Individual fabric or write board covered modules incorporated into an aluminum frame.
- Modules have write board on one side and fabric on the other at the top and fabric on two sides at the bottom.
- If different grades of fabric are used on one panel, the entire panel must be priced at highest grade.
- Panels are not tackable.
- Note: Trim is not required at a straight connection between two panels of the same height.
- 3 Panel connector brackets per side come standard with 30" h. to 54" h. panels.
- 4 Panel connector brackets per side come standard with 66" h. panels.
- Panels include 2 raceway covers with no punchouts, an integrated aluminum top cap and levelling glides.

PRODUCT CODE	PRICE		SIZE/ INCHES			WEIGHT VOL	
	GR 1	GR 2	H	W	D	LBS	FT ³
CMFW4824N0	480	502	48	24	2.3	26	2.73
CMFW4830N0	578	605	48	30	2.3	33	3.37
CMFW4836N0	639	671	48	36	2.3	39	4.00
CMFW4842N0	722	758	48	42	2.3	46	4.63
CMFW4848N0	813	851	48	48	2.3	52	5.26
CMFW4854N0	904	936	48	54	2.3	59	5.89
CMFW4860N0	996	1048	48	60	2.3	65	6.53
CMFW5424N0	480	502	54	24	2.3	26	2.73
CMFW5430N0	576	604	54	30	2.3	33	3.37
CMFW5436N0	639	671	54	36	2.3	39	4
CMFW5442N0	723	758	54	42	2.3	46	4.63
CMFW5448N0	813	853	54	48	2.3	52	5.26
CMFW5454N0	904	935	54	54	2.3	59	5.89
CMFW5460N0	996	1048	54	60	2.3	65	6.53
CMFW6624N0	605	635	66	24	2.3	32	3.58
CMFW6630N0	719	755	66	30	2.3	40	4.4
CMFW6636N0	800	842	66	36	2.3	48	5.23
CMFW6642N0	906	955	66	42	2.3	56	6.06
CMFW6648N0	1011	1064	66	48	2.3	64	6.88
CMFW6654N0	1126	1187	66	54	2.3	72	7.71
CMFW6660N0	1242	1309	66	60	2.3	80	8.53

CMFW-N1 • Single Segmented Non Powered Write Board One Side Panel, Punchouts on One Side

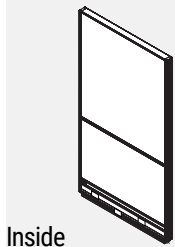

Inside

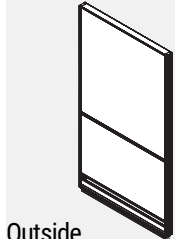

Outside

- Individual fabric or write board covered modules incorporated into an aluminum frame.
- Modules have write board on one side and fabric on the other at the top and fabric on two sides at the bottom.
- If different grades of fabric are used on one panel, the entire panel must be priced at highest grade.
- Panels are not tackable.
- Note: Trim is not required at a straight connection between two panels of the same height.
- 3 Panel connector brackets per side come standard with 30”h. to 54”h. panels.
- 4 Panel connector brackets per side come standard with 66”h. panels.
- Panels include 1 raceway cover with punchouts on one side, 1 raceway cover with no punchouts on the other, an integrated aluminum top cap and levelling glides.
- 24” wide panels have two punchouts, one for electrical and one for data.
- 30” wide panels and wider have three punchouts, two for electrical and one for data.

PRODUCT CODE	PRICE		SIZE/ INCHES			WEIGHT VOL	
	GR 1	GR 2	H	W	D	LBS	FT ³
CMFW4824N1	480	502	48	24	2.3	26	2.73
CMFW4830N1	578	605	48	30	2.3	33	3.37
CMFW4836N1	639	671	48	36	2.3	39	4.00
CMFW4842N1	722	758	48	42	2.3	46	4.63
CMFW4848N1	813	851	48	48	2.3	52	5.26
CMFW4854N1	904	936	48	54	2.3	59	5.89
CMFW4860N1	996	1048	48	60	2.3	65	6.53
CMFW5424N1	480	502	54	24	2.3	26	2.73
CMFW5430N1	576	604	54	30	2.3	33	3.37
CMFW5436N1	639	671	54	36	2.3	39	4
CMFW5442N1	723	758	54	42	2.3	46	4.63
CMFW5448N1	813	853	54	48	2.3	52	5.26
CMFW5454N1	904	935	54	54	2.3	59	5.89
CMFW5460N1	996	1048	54	60	2.3	65	6.53
CMFW6624N1	605	635	66	24	2.3	32	3.58
CMFW6630N1	719	755	66	30	2.3	40	4.4
CMFW6636N1	800	842	66	36	2.3	48	5.23
CMFW6642N1	906	955	66	42	2.3	56	6.06
CMFW6648N1	1011	1064	66	48	2.3	64	6.88
CMFW6654N1	1126	1187	66	54	2.3	72	7.71
CMFW6660N1	1242	1309	66	60	2.3	80	8.53

CMFW-N2 • Single Segmented Non Powered Write Board One Side Panel, Punchouts on Both Sides

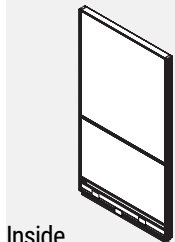

Inside

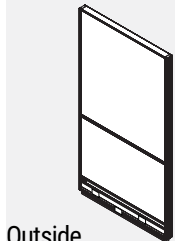

Outside

- Individual fabric or write board covered modules incorporated into an aluminum frame.
- Modules have write board on one side and fabric on the other at the top and fabric on two sides at the bottom.
- If different grades of fabric are used on one panel, the entire panel must be priced at highest grade.
- Panels are not tackable.
- Note: Trim is not required at a straight connection between two panels of the same height.
- 3 Panel connector brackets per side come standard with 30”h. to 54”h. panels.
- 4 Panel connector brackets per side come standard with 66”h. panels.
- Panels include 2 raceway covers with punchouts on both sides, an integrated aluminum top cap and levelling glides.
- 24” wide panels have two punchouts, one for electrical and one for data.
- 30” wide panels and wider have three punchouts, two for electrical and one for data.

PRODUCT CODE	PRICE		SIZE/ INCHES			WEIGHT VOL	
	GR 1	GR 2	H	W	D	LBS	FT ³
CMFW4824N2	480	502	48	24	2.3	26	2.73
CMFW4830N2	578	605	48	30	2.3	33	3.37
CMFW4836N2	639	671	48	36	2.3	39	4.00
CMFW4842N2	722	758	48	42	2.3	46	4.63
CMFW4848N2	813	851	48	48	2.3	52	5.26
CMFW4854N2	904	936	48	54	2.3	59	5.89
CMFW4860N2	996	1048	48	60	2.3	65	6.53
CMFW5424N2	480	502	54	24	2.3	26	2.73
CMFW5430N2	576	604	54	30	2.3	33	3.37
CMFW5436N2	639	671	54	36	2.3	39	4
CMFW5442N2	723	758	54	42	2.3	46	4.63
CMFW5448N2	813	853	54	48	2.3	52	5.26
CMFW5454N2	904	935	54	54	2.3	59	5.89
CMFW5460N2	996	1048	54	60	2.3	65	6.53
CMFW6624N2	605	635	66	24	2.3	32	3.58
CMFW6630N2	719	755	66	30	2.3	40	4.4
CMFW6636N2	800	842	66	36	2.3	48	5.23
CMFW6642N2	906	955	66	42	2.3	56	6.06
CMFW6648N2	1011	1064	66	48	2.3	64	6.88
CMFW6654N2	1126	1187	66	54	2.3	72	7.71
CMFW6660N2	1242	1309	66	60	2.3	80	8.53

CMFW-P1 • Single Segmented Powered Write Board One Side Panel, Punchouts on One Side

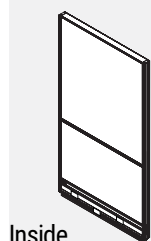

Inside

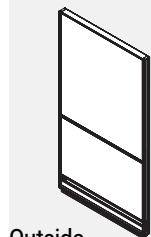

Outside

- Individual fabric or write board covered modules incorporated into an aluminum frame.
- Modules have write board on one side and fabric on the other at the top and fabric on two sides at the bottom.
- If different grades of fabric are used on one panel, the entire panel must be priced at highest grade.
- Panels are not tackable.
- Note: Trim is not required at a straight connection between two panels of the same height.
- 3 Panel connector brackets per side come standard with 30”h. to 54”h. panels.
- 4 Panel connector brackets per side come standard with 66”h. panels.
- Panels include 1 raceway cover with punchouts on one side, 1 raceway cover with no punchouts on the other, a power distribution housing, an integrated aluminum top cap and levelling glides.
- 24” wide panels have two punchouts, one for electrical and one for data.
- 30” wide panels and wider have three punchouts, two for electrical and one for data.
- Please specify duplex receptacles separately.

PRODUCT CODE	PRICE		SIZE/ INCHES			WEIGHT VOL	
	GR1	GR2	H	W	D	LBS	FT ³
CMFW4824P1	615	637	48	24	2.3	26	2.73
CMFW4830P1	758	784	48	30	2.3	33	3.37
CMFW4836P1	829	860	48	36	2.3	39	4.00
CMFW4842P1	919	955	48	42	2.3	46	4.63
CMFW4848P1	1021	1059	48	48	2.3	52	5.26
CMFW4854P1	1115	1145	48	54	2.3	59	5.89
CMFW4860P1	1207	1260	48	60	2.3	65	6.53
CMFW5424P1	615	637	54	24	2.3	26	2.73
CMFW5430P1	758	785	54	30	2.3	33	3.37
CMFW5436P1	829	860	54	36	2.3	39	4
CMFW5442P1	919	955	54	42	2.3	46	4.63
CMFW5448P1	1021	1059	54	48	2.3	52	5.26
CMFW5454P1	1115	1146	54	54	2.3	59	5.89
CMFW5460P1	1207	1260	54	60	2.3	65	6.53
CMFW6624P1	739	768	66	24	2.3	32	3.58
CMFW6630P1	901	935	66	30	2.3	40	4.4
CMFW6636P1	991	1032	66	36	2.3	48	5.23
CMFW6642P1	1102	1151	66	42	2.3	56	6.06
CMFW6648P1	1221	1274	66	48	2.3	64	6.88
CMFW6654P1	1338	1396	66	54	2.3	72	7.71
CMFW6660P1	1455	1521	66	60	2.3	80	8.53

CMFW-P2 • Single Segmented Powered Write Board One Side Panel, Punchouts on Both Sides

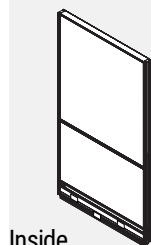

Inside

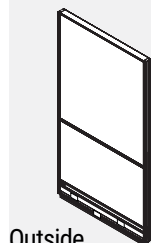

Outside

- Individual fabric or write board covered modules incorporated into an aluminum frame.
- Modules have write board on one side and fabric on the other at the top and fabric on two sides at the bottom.
- If different grades of fabric are used on one panel, the entire panel must be priced at highest grade.
- Panels are not tackable.
- Note: Trim is not required at a straight connection between two panels of the same height.
- 3 Panel connector brackets per side come standard with 30”h. to 54”h. panels.
- 4 Panel connector brackets per side come standard with 66”h. panels.
- Panels include 2 raceway covers with punchouts on both sides, a power distribution housing, an integrated aluminum top cap and levelling glides.
- 24” wide panels have two punchouts, one for electrical and one for data.
- 30” wide panels and wider have three punchouts, two for electrical and one for data.
- Please specify duplex receptacles separately.

PRODUCT CODE	PRICE		SIZE/ INCHES			WEIGHT VOL	
	GR1	GR2	H	W	D	LBS	FT ³
CMFW4824P2	615	637	48	24	2.3	26	2.73
CMFW4830P2	758	784	48	30	2.3	33	3.37
CMFW4836P2	829	860	48	36	2.3	39	4.00
CMFW4842P2	919	955	48	42	2.3	46	4.63
CMFW4848P2	1021	1059	48	48	2.3	52	5.26
CMFW4854P2	1115	1145	48	54	2.3	59	5.89
CMFW4860P2	1207	1260	48	60	2.3	65	6.53
CMFW5424P2	615	637	54	24	2.3	26	2.73
CMFW5430P2	758	785	54	30	2.3	33	3.37
CMFW5436P2	829	860	54	36	2.3	39	4
CMFW5442P2	919	955	54	42	2.3	46	4.63
CMFW5448P2	1021	1059	54	48	2.3	52	5.26
CMFW5454P2	1115	1146	54	54	2.3	59	5.89
CMFW5460P2	1207	1260	54	60	2.3	65	6.53
CMFW6624P2	739	768	66	24	2.3	32	3.58
CMFW6630P2	901	935	66	30	2.3	40	4.4
CMFW6636P2	991	1032	66	36	2.3	48	5.23
CMFW6642P2	1102	1151	66	42	2.3	56	6.06
CMFW6648P2	1221	1274	66	48	2.3	64	6.88
CMFW6654P2	1338	1396	66	54	2.3	72	7.71
CMFW6660P2	1455	1521	66	60	2.3	80	8.53

CMWW-N0 • Single Segmented Non Powered Write Board Two Sides Panel, No Punchouts

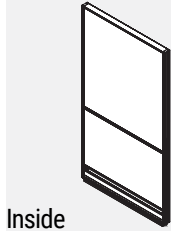

Inside

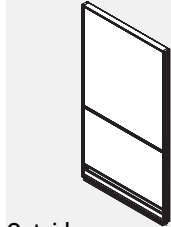

Outside

- Individual fabric or write board covered modules incorporated into an aluminum frame.
- Modules have either write board on two sides at the top and fabric on two sides at the bottom.
- If different grades of fabric are used on one panel, the entire panel must be priced at highest grade.
- Panels are not tackable.
- Note: Trim is not required at a straight connection between two panels of the same height.
- 3 Panel connector brackets per side come standard with 30”h. to 54”h. panels.
- 4 Panel connector brackets per side come standard with 66”h. panels.
- Panels include 2 raceway covers with no punchouts, an integrated aluminum top cap and levelling glides.

PRODUCT CODE	PRICE		SIZE/ INCHES			WEIGHT VOL	
	GR 1	GR 2	H	W	D	LBS	FT ³
CMWW4824N0	523	535	48	24	2.3	26	2.73
CMWW4830N0	651	668	48	30	2.3	33	3.37
CMWW4836N0	704	729	48	36	2.3	39	4.00
CMWW4842N0	801	824	48	42	2.3	46	4.63
CMWW4848N0	937	966	48	48	2.3	52	5.26
CMWW4854N0	1043	1076	48	54	2.3	59	5.89
CMWW4860N0	1151	1181	48	60	2.3	65	6.53
CMWW5424N0	523	535	54	24	2.3	26	2.73
CMWW5430N0	651	668	54	30	2.3	33	3.37
CMWW5436N0	704	729	54	36	2.3	39	4
CMWW5442N0	801	825	54	42	2.3	46	4.63
CMWW5448N0	936	966	54	48	2.3	52	5.26
CMWW5454N0	1043	1075	54	54	2.3	59	5.89
CMWW5460N0	1151	1183	54	60	2.3	65	6.53
CMWW6624N0	642	667	66	24	2.3	32	3.58
CMWW6630N0	793	820	66	30	2.3	40	4.4
CMWW6636N0	866	895	66	36	2.3	48	5.23
CMWW6642N0	986	1022	66	42	2.3	56	6.06
CMWW6648N0	1132	1170	66	48	2.3	64	6.88
CMWW6654N0	1261	1306	66	54	2.3	72	7.71
CMWW6660N0	1394	1442	66	60	2.3	80	8.53

CMWW-N1 • Single Segmented Non Powered Write Board Two Sides Panel, Punchouts on One Side

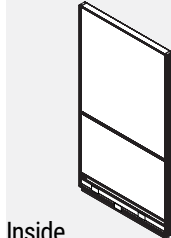

Inside

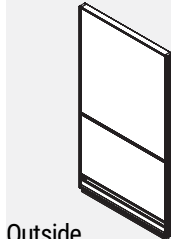

Outside

- Individual fabric or write board covered modules incorporated into an aluminum frame.
- Modules have either write board on two sides at the top and fabric on two sides at the bottom.
- If different grades of fabric are used on one panel, the entire panel must be priced at highest grade.
- Panels are not tackable.
- Note: Trim is not required at a straight connection between two panels of the same height.
- 3 Panel connector brackets per side come standard with 30”h. to 54”h. panels.
- 4 Panel connector brackets per side come standard with 66”h. panels.
- Panels include 1 raceway cover with punchouts on two sides, 1 raceway cover with no punchouts on the other, an integrated aluminum top cap and levelling glides.
- 24” wide panels have two punchouts, one for electrical and one for data.
- 30” wide panels and wider have three punchouts, two for electrical and one for data.

PRODUCT CODE	PRICE		SIZE/ INCHES			WEIGHT VOL	
	GR 1	GR 2	H	W	D	LBS	FT ³
CMWW4824N1	523	535	48	24	2.3	26	2.73
CMWW4830N1	651	668	48	30	2.3	33	3.37
CMWW4836N1	704	729	48	36	2.3	39	4.00
CMWW4842N1	801	824	48	42	2.3	46	4.63
CMWW4848N1	937	966	48	48	2.3	52	5.26
CMWW4854N1	1043	1076	48	54	2.3	59	5.89
CMWW4860N1	1151	1181	48	60	2.3	65	6.53
CMWW5424N1	523	535	54	24	2.3	26	2.73
CMWW5430N1	651	668	54	30	2.3	33	3.37
CMWW5436N1	704	729	54	36	2.3	39	4
CMWW5442N1	801	825	54	42	2.3	46	4.63
CMWW5448N1	936	966	54	48	2.3	52	5.26
CMWW5454N1	1043	1075	54	54	2.3	59	5.89
CMWW5460N1	1151	1183	54	60	2.3	65	6.53
CMWW6624N1	642	667	66	24	2.3	32	3.58
CMWW6630N1	793	820	66	30	2.3	40	4.4
CMWW6636N1	866	895	66	36	2.3	48	5.23
CMWW6642N1	986	1022	66	42	2.3	56	6.06
CMWW6648N1	1132	1170	66	48	2.3	64	6.88
CMWW6654N1	1261	1306	66	54	2.3	72	7.71
CMWW6660N1	1394	1442	66	60	2.3	80	8.53

CMWW-N2 • Single Segmented Non Powered Write Board Two Sides Panel, Punchouts on Both Sides

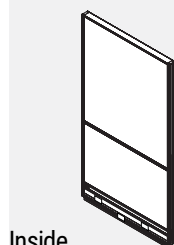

Inside

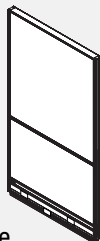

Outside

- Individual fabric or write board covered modules incorporated into an aluminum frame.
- Modules have either write board on two sides at the top and fabric on two sides at the bottom.
- If different grades of fabric are used on one panel, the entire panel must be priced at highest grade.
- Panels are not tackable.
- Note: Trim is not required at a straight connection between two panels of the same height.
- 3 Panel connector brackets per side come standard with 30”h. to 54”h. panels.
- 4 Panel connector brackets per side come standard with 66”h. panels.
- Panels include 2 raceway covers with punchouts on both sides, an integrated aluminum top cap and levelling glides.
- 24” wide panels have two punchouts, one for electrical and one for data.
- 30” wide panels and wider have three punchouts, two for electrical and one for data.

PRODUCT CODE	PRICE		SIZE/ INCHES			WEIGHT VOL	
	GR1	GR2	H	W	D	LBS	FT ³
CMWW4824N2	523	535	48	24	2.3	26	2.73
CMWW4830N2	651	668	48	30	2.3	33	3.37
CMWW4836N2	704	729	48	36	2.3	39	4.00
CMWW4842N2	801	824	48	42	2.3	46	4.63
CMWW4848N2	937	966	48	48	2.3	52	5.26
CMWW4854N2	1043	1076	48	54	2.3	59	5.89
CMWW4860N2	1151	1181	48	60	2.3	65	6.53
CMWW5424N2	523	535	54	24	2.3	26	2.73
CMWW5430N2	651	668	54	30	2.3	33	3.37
CMWW5436N2	704	729	54	36	2.3	39	4
CMWW5442N2	801	825	54	42	2.3	46	4.63
CMWW5448N2	936	966	54	48	2.3	52	5.26
CMWW5454N2	1043	1075	54	54	2.3	59	5.89
CMWW5460N2	1151	1183	54	60	2.3	65	6.53
CMWW6624N2	642	667	66	24	2.3	32	3.58
CMWW6630N2	793	820	66	30	2.3	40	4.4
CMWW6636N2	866	895	66	36	2.3	48	5.23
CMWW6642N2	986	1022	66	42	2.3	56	6.06
CMWW6648N2	1132	1170	66	48	2.3	64	6.88
CMWW6654N2	1261	1306	66	54	2.3	72	7.71
CMWW6660N2	1394	1442	66	60	2.3	80	8.53

CMWW-P1 • Single Segmented Powered Write Board Two Sides Panel, Punchouts on One Side

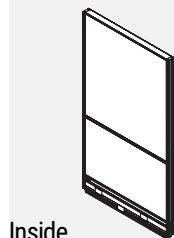

Inside

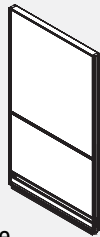

Outside

- Individual fabric or write board covered modules incorporated into an aluminum frame.
- Modules have either write board on two sides at the top and fabric on two sides at the bottom.
- If different grades of fabric are used on one panel, the entire panel must be priced at highest grade.
- Panels are not tackable.
- Note: Trim is not required at a straight connection between two panels of the same height.
- 3 Panel connector brackets per side come standard with 30”h. to 54”h. panels.
- 4 Panel connector brackets per side come standard with 66”h. panels.
- Panels include 1 raceway cover with punchouts on two sides, 1 raceway cover with no punchouts on the other, a power distribution housing, an integrated aluminum top cap and levelling glides.
- 24” wide panels have two punchouts, one for electrical and one for data.
- 30” wide panels and wider have three punchouts, two for electrical and one for data.
- Please specify duplex receptacles separately.

PRODUCT CODE	PRICE		SIZE/ INCHES			WEIGHT VOL	
	GR1	GR2	H	W	D	LBS	FT ³
CMWW4824P1	656	671	48	24	2.3	26	2.73
CMWW4830P1	832	848	48	30	2.3	33	3.37
CMWW4836P1	895	920	48	36	2.3	39	4.00
CMWW4842P1	997	1021	48	42	2.3	46	4.63
CMWW4848P1	1144	1173	48	48	2.3	52	5.26
CMWW4854P1	1254	1285	48	54	2.3	59	5.89
CMWW4860P1	1364	1395	48	60	2.3	65	6.53
CMWW5424P1	656	671	54	24	2.3	26	2.73
CMWW5430P1	832	849	54	30	2.3	33	3.37
CMWW5436P1	895	920	54	36	2.3	39	4
CMWW5442P1	997	1021	54	42	2.3	46	4.63
CMWW5448P1	1144	1173	54	48	2.3	52	5.26
CMWW5454P1	1254	1286	54	54	2.3	59	5.89
CMWW5460P1	1364	1395	54	60	2.3	65	6.53
CMWW6624P1	779	801	66	24	2.3	32	3.58
CMWW6630P1	974	1000	66	30	2.3	40	4.4
CMWW6636P1	1056	1086	66	36	2.3	48	5.23
CMWW6642P1	1181	1220	66	42	2.3	56	6.06
CMWW6648P1	1338	1378	66	48	2.3	64	6.88
CMWW6654P1	1471	1517	66	54	2.3	72	7.71
CMWW6660P1	1606	1656	66	60	2.3	80	8.53

CMWW-P2 • Single Segmented Powered Write Board Two Sides Panel, Punchouts on Both Sides

- Individual fabric or write board covered modules incorporated into an aluminum frame.
- Modules have either write board on two sides at the top and fabric on two sides at the bottom.
- If different grades of fabric are used on one panel, the entire panel must be priced at highest grade.
- Panels are not tackable.
- Note: Trim is not required at a straight connection between two panels of the same height.
- 3 Panel connector brackets per side come standard with 30”h. to 54”h. panels.
- 4 Panel connector brackets per side come standard with 66”h. panels.
- Panels include 2 raceway covers with punchouts on both sides, a power distribution housing, an integrated aluminum top cap and levelling glides.
- 24” wide panels have two punchouts, one for electrical and one for data.
- 30” wide panels and wider have three punchouts, two for electrical and one for data.
- Please specify duplex receptacles separately.

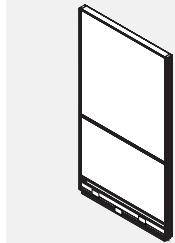

Inside

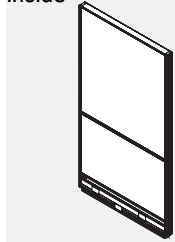

Outside

PRODUCT CODE	PRICE		SIZE/ INCHES			WEIGHT VOL	
	GR 1	GR 2	H	W	D	LBS	FT ³
CMWW4824P2	656	671	48	24	2.3	26	2.73
CMWW4830P2	832	848	48	30	2.3	33	3.37
CMWW4836P2	895	920	48	36	2.3	39	4.00
CMWW4842P2	997	1021	48	42	2.3	46	4.63
CMWW4848P2	1144	1173	48	48	2.3	52	5.26
CMWW4854P2	1254	1285	48	54	2.3	59	5.89
CMWW4860P2	1364	1395	48	60	2.3	65	6.53
CMWW5424P2	656	671	54	24	2.3	26	2.73
CMWW5430P2	832	849	54	30	2.3	33	3.37
CMWW5436P2	895	920	54	36	2.3	39	4
CMWW5442P2	997	1021	54	42	2.3	46	4.63
CMWW5448P2	1144	1173	54	48	2.3	52	5.26
CMWW5454P2	1254	1286	54	54	2.3	59	5.89
CMWW5460P2	1364	1395	54	60	2.3	65	6.53
CMWW6624P2	779	801	66	24	2.3	32	3.58
CMWW6630P2	974	1000	66	30	2.3	40	4.4
CMWW6636P2	1056	1086	66	36	2.3	48	5.23
CMWW6642P2	1181	1220	66	42	2.3	56	6.06
CMWW6648P2	1338	1378	66	48	2.3	64	6.88
CMWW6654P2	1471	1517	66	54	2.3	72	7.71
CMWW6660P2	1606	1656	66	60	2.3	80	8.53

CMFG-N0 • Single Glazed, Non Powered Fabric Panel, No Punchouts

- Individual fabric-covered module in lower position with glazed module in upper position incorporated into an aluminum frame.
- Opposite sides of each module may have a different fabric within the same grade at no upcharge.
- If different grades of fabric are used on one panel, the entire panel must be priced at highest grade.
- Panels are not tackable.
- Note: Trim is not required at a straight connection between two panels of the same height.
- 3 Panel connector brackets per side come standard with 42”h. and 54”h. panels.
- 4 Panel connector brackets per side come standard with 66”h. panels.
- Panels include 2 raceway covers with no punchouts, an integrated aluminum top cap and levelling glides.
- Standard in clear (CLR) plexi.
- Optional frosted (FRST) plexi
- Glazing starts at 29” high to the top of the panel.

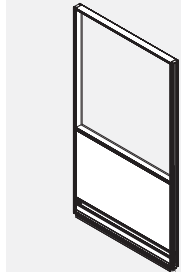

Inside

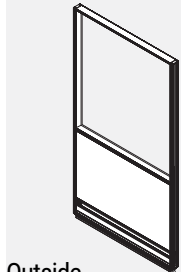

Outside

PRODUCT CODE	PRICE		SIZE/ INCHES			WEIGHT VOL	
	GR 1	GR 2	H	W	D	LBS	FT ³
CMFG4224N0	433	446	42	24	2.3	20	2.31
CMFG4230N0	474	492	42	30	2.3	25	2.85
CMFG4236N0	521	550	42	36	2.3	31	3.38
CMFG4242N0	576	607	42	42	2.3	36	3.92
CMFG4248N0	633	661	42	48	2.3	41	4.45
CMFG4254N0	715	743	42	54	2.3	46	4.99
CMFG4260N0	787	816	42	60	2.3	51	5.52
CMFG4824N0	468	481	48	24	2.3	26	2.73
CMFG4830N0	509	526	48	30	2.3	33	3.37
CMFG4836N0	582	611	48	36	2.3	39	4.00
CMFG4842N0	651	680	48	42	2.3	46	4.63
CMFG4848N0	713	741	48	48	2.3	52	5.26
CMFG4854N0	829	859	48	54	2.3	59	5.89
CMFG4860N0	938	968	48	60	2.3	65	6.53
CMFG5424N0	468	481	54	24	2.3	26	2.73
CMFG5430N0	509	526	54	30	2.3	33	3.37
CMFG5436N0	583	611	54	36	2.3	39	4.00
CMFG5442N0	651	679	54	42	2.3	46	4.63
CMFG5448N0	713	741	54	48	2.3	52	5.26
CMFG5454N0	829	859	54	54	2.3	59	5.89
CMFG5460N0	938	968	54	60	2.3	65	6.53
CMFG6624N0	601	615	66	24	2.3	32	3.58
CMFG6630N0	699	713	66	30	2.3	40	4.40
CMFG6636N0	796	826	66	36	2.3	48	5.23
CMFG6642N0	891	921	66	42	2.3	56	6.06
CMFG6648N0	977	1007	66	48	2.3	64	6.88
CMFG6654N0	1081	1110	66	54	2.3	72	7.71
CMFG6660N0	1177	1207	66	60	2.3	80	8.53

CMFG-N1 • Single Glazed, Non Powered Fabric Panel, Punchouts on One Side

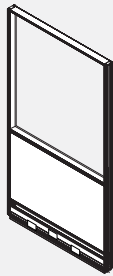

Inside

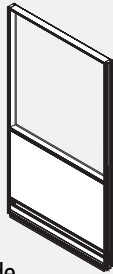

Outside

- Individual fabric-covered module in lower position with glazed module in upper position incorporated into an aluminum frame.
- Opposite sides of each module may have a different fabric within the same grade at no upcharge.
- If different grades of fabric are used on one panel, the entire panel must be priced at highest grade.
- Panels are not tackable.
- Note: Trim is not required at a straight connection between two panels of the same height.
- 3 Panel connector brackets per side come standard with 42”h. and 54”h. panels.
- 4 Panel connector brackets per side come standard with 66”h. panels.
- Panels include 1 raceway cover with punchouts on one side, 1 raceway cover with no punchouts on the other, an integrated aluminum top cap and levelling glides.
- Standard in clear (CLR) plexi.
- Optional frosted (FRST) plexi
- 24” wide panels have two punchouts, one for electrical and one for data.
- 30” wide panels and wider have three punchouts, two for electrical and one for data.
- Glazing starts at 29” high to the top of the panel.

PRODUCT CODE	PRICE		SIZE/ INCHES			WEIGHT VOL	
	GR 1	GR 2	H	W	D	LBS	FT ³
CMFG4224N1	433	446	42	24	2.3	20	2.31
CMFG4230N1	474	492	42	30	2.3	25	2.85
CMFG4236N1	521	550	42	36	2.3	31	3.38
CMFG4242N1	576	607	42	42	2.3	36	3.92
CMFG4248N1	633	661	42	48	2.3	41	4.45
CMFG4254N1	715	743	42	54	2.3	46	4.99
CMFG4260N1	787	816	42	60	2.3	51	5.52
CMFG4824N1	468	481	48	24	2.3	26	2.73
CMFG4830N1	509	526	48	30	2.3	33	3.37
CMFG4836N1	582	611	48	36	2.3	39	4.00
CMFG4842N1	651	680	48	42	2.3	46	4.63
CMFG4848N1	713	741	48	48	2.3	52	5.26
CMFG4854N1	829	859	48	54	2.3	59	5.89
CMFG4860N1	938	968	48	60	2.3	65	6.53
CMFG5424N1	468	481	54	24	2.3	26	2.73
CMFG5430N1	509	526	54	30	2.3	33	3.37
CMFG5436N1	583	611	54	36	2.3	39	4.00
CMFG5442N1	651	679	54	42	2.3	46	4.63
CMFG5448N1	713	741	54	48	2.3	52	5.26
CMFG5454N1	829	859	54	54	2.3	59	5.89
CMFG5460N1	938	968	54	60	2.3	65	6.53
CMFG6624N1	601	615	66	24	2.3	32	3.58
CMFG6630N1	699	713	66	30	2.3	40	4.40
CMFG6636N1	796	826	66	36	2.3	48	5.23
CMFG6642N1	891	921	66	42	2.3	56	6.06
CMFG6648N1	977	1007	66	48	2.3	64	6.88
CMFG6654N1	1081	1110	66	54	2.3	72	7.71
CMFG6660N1	1177	1207	66	60	2.3	80	8.53

CMFG-N2 • Single Glazed, Non Powered Fabric Panel, Punchouts on Both Sides

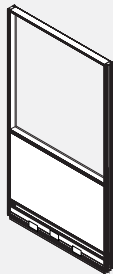

Inside

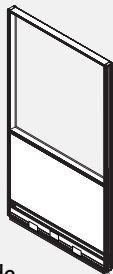

Outside

- Individual fabric-covered module in lower position with glazed module in upper position incorporated into an aluminum frame.
- Opposite sides of each module may have a different fabric within the same grade at no upcharge.
- If different grades of fabric are used on one panel, the entire panel must be priced at highest grade.
- Panels are not tackable.
- Note: Trim is not required at a straight connection between two panels of the same height.
- 3 Panel connector brackets per side come standard with 42”h. and 54”h. panels.
- 4 Panel connector brackets per side come standard with 66”h. panels.
- Panels include 2 raceway covers with punchouts on both sides, an integrated aluminum top cap and levelling glides.
- Standard in clear (CLR) plexi.
- Optional frosted (FRST) plexi
- 24” wide panels have two punchouts, one for electrical and one for data.
- 30” wide panels and wider have three punchouts, two for electrical and one for data.
- Glazing starts at 29” high to the top of the panel.

PRODUCT CODE	PRICE		SIZE/ INCHES			WEIGHT VOL	
	GR 1	GR 2	H	W	D	LBS	FT ³
CMFG4224N2	433	446	42	24	2.3	20	2.31
CMFG4230N2	474	492	42	30	2.3	25	2.85
CMFG4236N2	521	550	42	36	2.3	31	3.38
CMFG4242N2	576	607	42	42	2.3	36	3.92
CMFG4248N2	633	661	42	48	2.3	41	4.45
CMFG4254N2	715	743	42	54	2.3	46	4.99
CMFG4260N2	787	816	42	60	2.3	51	5.52
CMFG4824N2	468	481	48	24	2.3	26	2.73
CMFG4830N2	509	526	48	30	2.3	33	3.37
CMFG4836N2	582	611	48	36	2.3	39	4.00
CMFG4842N2	651	680	48	42	2.3	46	4.63
CMFG4848N2	713	741	48	48	2.3	52	5.26
CMFG4854N2	829	859	48	54	2.3	59	5.89
CMFG4860N2	938	968	48	60	2.3	65	6.53
CMFG5424N2	468	481	54	24	2.3	26	2.73
CMFG5430N2	509	526	54	30	2.3	33	3.37
CMFG5436N2	583	611	54	36	2.3	39	4.00
CMFG5442N2	651	679	54	42	2.3	46	4.63
CMFG5448N2	713	741	54	48	2.3	52	5.26
CMFG5454N2	829	859	54	54	2.3	59	5.89
CMFG5460N2	938	968	54	60	2.3	65	6.53
CMFG6624N2	601	615	66	24	2.3	32	3.58
CMFG6630N2	699	713	66	30	2.3	40	4.40
CMFG6636N2	796	826	66	36	2.3	48	5.23
CMFG6642N2	891	921	66	42	2.3	56	6.06
CMFG6648N2	977	1007	66	48	2.3	64	6.88
CMFG6654N2	1081	1110	66	54	2.3	72	7.71
CMFG6660N2	1177	1207	66	60	2.3	80	8.53

CMFG-P1 • Single Glazed, Powered Fabric Panel, Punchouts on One Side

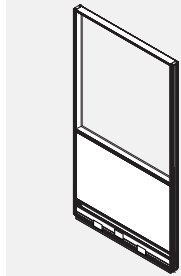

Inside

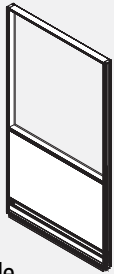

Outside

- Individual fabric-covered module in lower position with glazed module in upper position incorporated into an aluminum frame.
- Opposite sides of each module may have a different fabric within the same grade at no upcharge.
- If different grades of fabric are used on one panel, the entire panel must be priced at highest grade.
- Panels are not tackable.
- Note: Trim is not required at a straight connection between two panels of the same height.
- 3 Panel connector brackets per side come standard with 42”h. and 54”h. panels.
- 4 Panel connector brackets per side come standard with 66”h. panels.
- Panels include 1 raceway cover with punchouts on one side, 1 raceway cover with no punchouts on the other, a power distribution housing, an integrated aluminum top cap and levelling glides.
- Standard in clear (CLR) plexi.
- Optional frosted (FRST) plexi
- 24” wide panels have two punchouts, one for electrical and one for data.
- 30” wide panels and wider have three punchouts, two for electrical and one for data.
- Glazing starts at 29” high to the top of the panel.
- Please specify duplex receptacles separately.

PRODUCT CODE	PRICE		SIZE/ INCHES			WEIGHT VOL	
	GR 1	GR 2	H	W	D	LBS	FT³
CMFG4224P1	565	583	42	24	2.3	20	2.31
CMFG4230P1	658	672	42	30	2.3	25	2.85
CMFG4236P1	710	739	42	36	2.3	31	3.38
CMFG4242P1	773	802	42	42	2.3	36	3.92
CMFG4248P1	839	868	42	48	2.3	41	4.45
CMFG4254P1	926	955	42	54	2.3	46	4.99
CMFG4260P1	998	1029	42	60	2.3	51	5.52
CMFG4824P1	603	616	48	24	2.3	26	2.73
CMFG4830P1	693	706	48	30	2.3	33	3.37
CMFG4836P1	772	801	48	36	2.3	39	4.00
CMFG4842P1	847	877	48	42	2.3	46	4.63
CMFG4848P1	921	949	48	48	2.3	52	5.26
CMFG4854P1	1041	1070	48	54	2.3	59	5.89
CMFG4860P1	1151	1179	48	60	2.3	65	6.53
CMFG5424P1	603	616	54	24	2.3	26	2.73
CMFG5430P1	693	705	54	30	2.3	33	3.37
CMFG5436P1	771	801	54	36	2.3	39	4.00
CMFG5442P1	847	877	54	42	2.3	46	4.63
CMFG5448P1	921	949	54	48	2.3	52	5.26
CMFG5454P1	1041	1070	54	54	2.3	59	5.89
CMFG5460P1	1151	1179	54	60	2.3	65	6.53
CMFG6624P1	735	751	66	24	2.3	32	3.58
CMFG6630P1	881	894	66	30	2.3	40	4.40
CMFG6636P1	987	1016	66	36	2.3	48	5.23
CMFG6642P1	1088	1118	66	42	2.3	56	6.06
CMFG6648P1	1187	1217	66	48	2.3	64	6.88
CMFG6654P1	1290	1320	66	54	2.3	72	7.71
CMFG6660P1	1392	1420	66	60	2.3	80	8.53

CMFG-P2 • Single Glazed, Powered Fabric Panel, Punchouts on Both Sides

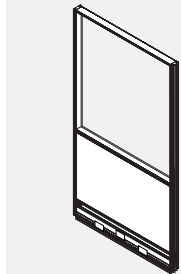

Inside

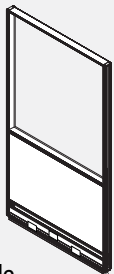

Outside

- Individual fabric-covered module in lower position with glazed module in upper position incorporated into a aluminum frame.
- Opposite sides of each module may have a different fabric within the same grade at no upcharge.
- If different grades of fabric are used on one panel, the entire panel must be priced at highest grade.
- Panels are not tackable.
- Note: Trim is not required at a straight connection between two panels of the same height.
- 3 Panel connector brackets per side come standard with 42”h. and 54”h. panels.
- 4 Panel connector brackets per side come standard with 66”h. panels.
- Panels include 2 raceway covers with punchouts on both sides, a power distribution housing, an integrated aluminum top cap and levelling glides.
- Standard in clear (CLR) plexi.
- Optional frosted (FRST) plexi
- 24” wide panels have two punchouts, one for electrical and one for data.
- 30” wide panels and wider have three punchouts, two for electrical and one for data.
- Glazing starts at 29” high to the top of the panel.
- Please specify duplex receptacles separately.

PRODUCT CODE	PRICE		SIZE/ INCHES			WEIGHT VOL	
	GR 1	GR 2	H	W	D	LBS	FT³
CMFG4224P2	565	583	42	24	2.3	20	2.31
CMFG4230P2	658	672	42	30	2.3	25	2.85
CMFG4236P2	710	739	42	36	2.3	31	3.38
CMFG4242P2	773	802	42	42	2.3	36	3.92
CMFG4248P2	839	868	42	48	2.3	41	4.45
CMFG4254P2	926	955	42	54	2.3	46	4.99
CMFG4260P2	998	1029	42	60	2.3	51	5.52
CMFG4824P2	603	616	48	24	2.3	26	2.73
CMFG4830P2	693	706	48	30	2.3	33	3.37
CMFG4836P2	772	801	48	36	2.3	39	4.00
CMFG4842P2	847	877	48	42	2.3	46	4.63
CMFG4848P2	921	949	48	48	2.3	52	5.26
CMFG4854P2	1041	1070	48	54	2.3	59	5.89
CMFG4860P2	1151	1179	48	60	2.3	65	6.53
CMFG5424P2	603	616	54	24	2.3	26	2.73
CMFG5430P2	693	705	54	30	2.3	33	3.37
CMFG5436P2	771	801	54	36	2.3	39	4.00
CMFG5442P2	847	877	54	42	2.3	46	4.63
CMFG5448P2	921	949	54	48	2.3	52	5.26
CMFG5454P2	1041	1070	54	54	2.3	59	5.89
CMFG5460P2	1151	1179	54	60	2.3	65	6.53
CMFG6624P2	735	751	66	24	2.3	32	3.58
CMFG6630P2	881	894	66	30	2.3	40	4.40
CMFG6636P2	987	1016	66	36	2.3	48	5.23
CMFG6642P2	1088	1118	66	42	2.3	56	6.06
CMFG6648P2	1187	1217	66	48	2.3	64	6.88
CMFG6654P2	1290	1320	66	54	2.3	72	7.71
CMFG6660P2	1392	1420	66	60	2.3	80	8.53

CMPLG-N0 • Single 12" Glazed at top, Non Powered Fabric Panel, No Punchouts

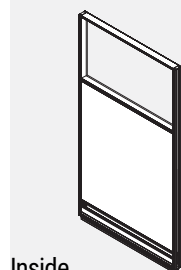

Inside

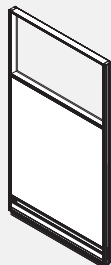

Outside

- Individual fabric-covered module in lower position with glazed module in upper position incorporated into an aluminum frame.
- Opposite sides of each module may have a different fabric within the same grade at no upcharge.
- If different grades of fabric are used on one panel, the entire panel must be priced at highest grade.
- Panels are not tackable.
- Note: Trim is not required at a straight connection between two panels of the same height.
- 3 Panel connector brackets per side come standard with 42"h. and 54"h. panels.
- 4 Panel connector brackets per side come standard with 66"h. panels.
- Panels include 2 raceway covers with no punchouts, an integrated aluminum top cap and levelling glides.
- Standard in clear (CLR) plexi.
- Optional frosted (FRST) plexi
- Glazing is 12" nominal from the top of the panel.

PRODUCT CODE	PRICE		SIZE/ INCHES			WEIGHT VOL	
	GR 1	GR 2	H	W	D	LBS	FT ³
CMPLG4224N0	433	446	42	24	2.3	20	2.31
CMPLG4230N0	474	492	42	30	2.3	25	2.85
CMPLG4236N0	521	550	42	36	2.3	31	3.38
CMPLG4242N0	576	607	42	42	2.3	36	3.92
CMPLG4248N0	633	661	42	48	2.3	41	4.45
CMPLG4254N0	715	743	42	54	2.3	46	4.99
CMPLG4260N0	787	816	42	60	2.3	51	5.52
CMPLG4824N0	463	477	48	24	2.3	26	2.73
CMPLG4830N0	534	550	48	30	2.3	33	3.37
CMPLG4836N0	595	625	48	36	2.3	39	4.00
CMPLG4842N0	670	699	48	42	2.3	46	4.63
CMPLG4848N0	737	767	48	48	2.3	52	5.26
CMPLG4854N0	815	845	48	54	2.3	59	5.89
CMPLG4860N0	886	914	48	60	2.3	65	6.53
CMPLG5424N0	463	476	54	24	2.3	26	2.73
CMPLG5430N0	534	550	54	30	2.3	33	3.37
CMPLG5436N0	595	625	54	36	2.3	39	4.00
CMPLG5442N0	669	699	54	42	2.3	46	4.63
CMPLG5448N0	737	767	54	48	2.3	52	5.26
CMPLG5454N0	816	844	54	54	2.3	59	5.89
CMPLG5460N0	886	915	54	60	2.3	65	6.53
CMPLG6624N0	509	539	66	24	2.3	32	3.58
CMPLG6630N0	590	619	66	30	2.3	40	4.40
CMPLG6636N0	656	715	66	36	2.3	48	5.23
CMPLG6642N0	732	790	66	42	2.3	56	6.06
CMPLG6648N0	809	868	66	48	2.3	64	6.88
CMPLG6654N0	893	953	66	54	2.3	72	7.71
CMPLG6660N0	970	1030	66	60	2.3	80	8.53

CMPLG-N1 • Single 12" Glazed at top, Non Powered Panel, Punchouts on One Side

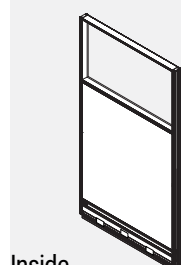

Inside

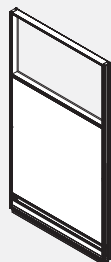

Outside

- Individual fabric-covered module in lower position with glazed module in upper position incorporated into an aluminum frame.
- Opposite sides of each module may have a different fabric within the same grade at no upcharge.
- If different grades of fabric are used on one panel, the entire panel must be priced at highest grade.
- Panels are not tackable.
- Note: Trim is not required at a straight connection between two panels of the same height.
- 3 Panel connector brackets per side come standard with 42"h. and 54"h. panels.
- 4 Panel connector brackets per side come standard with 66"h. panels.
- Panels include 1 raceway cover with punchouts on one side, 1 raceway cover with no punchouts on the other, an integrated aluminum top cap and levelling glides.
- Standard in clear (CLR) plexi.
- Optional frosted (FRST) plexi
- 24" wide panels have two punchouts, one for electrical and one for data.
- 30" wide panels and wider have three punchouts, two for electrical and one for data.
- Glazing is 12" nominal from the top of the panel.

PRODUCT CODE	PRICE		SIZE/ INCHES			WEIGHT VOL	
	GR 1	GR 2	H	W	D	LBS	FT ³
CMPLG4224N1	433	446	42	24	2.3	20	2.31
CMPLG4230N1	474	492	42	30	2.3	25	2.85
CMPLG4236N1	521	550	42	36	2.3	31	3.38
CMPLG4242N1	576	607	42	42	2.3	36	3.92
CMPLG4248N1	633	661	42	48	2.3	41	4.45
CMPLG4254N1	715	743	42	54	2.3	46	4.99
CMPLG4260N1	787	816	42	60	2.3	51	5.52
CMPLG4824N1	463	477	48	24	2.3	26	2.73
CMPLG4830N1	534	550	48	30	2.3	33	3.37
CMPLG4836N1	595	625	48	36	2.3	39	4.00
CMPLG4842N1	670	699	48	42	2.3	46	4.63
CMPLG4848N1	737	767	48	48	2.3	52	5.26
CMPLG4854N1	815	845	48	54	2.3	59	5.89
CMPLG4860N1	886	914	48	60	2.3	65	6.53
CMPLG5424N1	463	476	54	24	2.3	26	2.73
CMPLG5430N1	534	550	54	30	2.3	33	3.37
CMPLG5436N1	595	625	54	36	2.3	39	4.00
CMPLG5442N1	669	699	54	42	2.3	46	4.63
CMPLG5448N1	737	767	54	48	2.3	52	5.26
CMPLG5454N1	816	844	54	54	2.3	59	5.89
CMPLG5460N1	886	915	54	60	2.3	65	6.53
CMPLG6624N1	509	539	66	24	2.3	32	3.58
CMPLG6630N1	590	619	66	30	2.3	40	4.40
CMPLG6636N1	656	715	66	36	2.3	48	5.23
CMPLG6642N1	732	790	66	42	2.3	56	6.06
CMPLG6648N1	809	868	66	48	2.3	64	6.88
CMPLG6654N1	893	953	66	54	2.3	72	7.71
CMPLG6660N1	970	1030	66	60	2.3	80	8.53

CMPLG-N2 • Single 12" at Top, Non Powered Fabric Panel, Punchouts on Both Sides

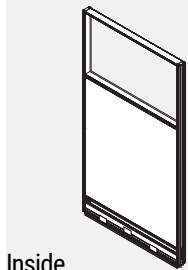

Inside

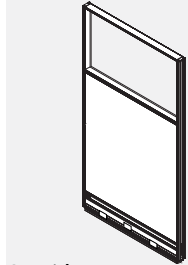

Outside

- Individual fabric-covered module in lower position with glazed module in upper position incorporated into a solid steel frame.
- Opposite sides of each module may have a different fabric within the same grade at no upcharge.
- If different grades of fabric are used on one panel, the entire panel must be priced at highest grade.
- Panels are not tackable.
- Note: Trim is not required at a straight connection between two panels of the same height.
- 3 Panel connector brackets per side come standard with 42" h. and 54" h. panels.
- 4 Panel connector brackets per side come standard with 66" h. panels.
- Panels include 2 raceway covers with punchouts on both sides, an integrated aluminum top cap and levelling glides.
- Standard in clear (CLR) plexi.
- Optional frosted (FRST) plexi
- 24" wide panels have two punchouts, one for electrical and one for data.
- 30" wide panels and wider have three punchouts, two for electrical and one for data.
- Glazing is 12" nominal from the top of the panel.

PRODUCT CODE	PRICE		SIZE/ INCHES			WEIGHT VOL	
	GR 1	GR 2	H	W	D	LBS	FT ³
CMPLG4224N2	433	446	42	24	2.3	20	2.31
CMPLG4230N2	474	492	42	30	2.3	25	2.85
CMPLG4236N2	521	550	42	36	2.3	31	3.38
CMPLG4242N2	576	607	42	42	2.3	36	3.92
CMPLG4248N2	633	661	42	48	2.3	41	4.45
CMPLG4254N2	715	743	42	54	2.3	46	4.99
CMPLG4260N2	787	816	42	60	2.3	51	5.52
CMPLG4824N2	463	477	48	24	2.3	26	2.73
CMPLG4830N2	534	550	48	30	2.3	33	3.37
CMPLG4836N2	595	625	48	36	2.3	39	4.00
CMPLG4842N2	670	699	48	42	2.3	46	4.63
CMPLG4848N2	737	767	48	48	2.3	52	5.26
CMPLG4854N2	815	845	48	54	2.3	59	5.89
CMPLG4860N2	886	914	48	60	2.3	65	6.53
CMPLG5424N2	463	476	54	24	2.3	26	2.73
CMPLG5430N2	534	550	54	30	2.3	33	3.37
CMPLG5436N2	595	625	54	36	2.3	39	4.00
CMPLG5442N2	669	699	54	42	2.3	46	4.63
CMPLG5448N2	737	767	54	48	2.3	52	5.26
CMPLG5454N2	816	844	54	54	2.3	59	5.89
CMPLG5460N2	886	915	54	60	2.3	65	6.53
CMPLG6624N2	509	539	66	24	2.3	32	3.58
CMPLG6630N2	590	619	66	30	2.3	40	4.40
CMPLG6636N2	656	715	66	36	2.3	48	5.23
CMPLG6642N2	732	790	66	42	2.3	56	6.06
CMPLG6648N2	809	868	66	48	2.3	64	6.88
CMPLG6654N2	893	953	66	54	2.3	72	7.71
CMPLG6660N2	970	1030	66	60	2.3	80	8.53

CMPLG-P1 • Single 12" Glazed at Top, Powered Fabric Panel, Punchouts on One Side

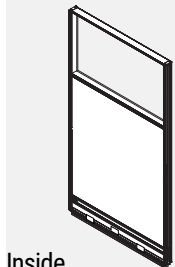

Inside

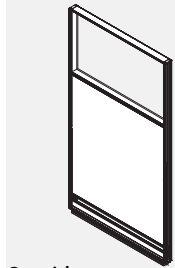

Outside

- Individual fabric-covered module in lower position with glazed module in upper position incorporated into a solid steel frame.
- Opposite sides of each module may have a different fabric within the same grade at no upcharge.
- If different grades of fabric are used on one panel, the entire panel must be priced at highest grade.
- Panels are not tackable.
- Note: Trim is not required at a straight connection between two panels of the same height.
- 3 Panel connector brackets per side come standard with 42" h. and 54" h. panels.
- 4 Panel connector brackets per side come standard with 66" h. panels.
- Panels include 1 raceway cover with punchouts on one side, 1 raceway cover with no punchouts on the other, a power distribution housing, an integrated aluminum top cap and levelling glides.
- Standard in clear (CLR) plexi.
- Optional frosted (FRST) plexi
- 24" wide panels have two punchouts, one for electrical and one for data.
- 30" wide panels and wider have three punchouts, two for electrical and one for data.
- Please specify duplex receptacles separately.
- Glazing is 12" nominal from the top of the panel.

PRODUCT CODE	PRICE		SIZE/ INCHES			WEIGHT VOL	
	GR 1	GR 2	H	W	D	LBS	FT ³
CMPLG4224P1	565	583	42	24	2.3	20	2.31
CMPLG4230P1	658	672	42	30	2.3	25	2.85
CMPLG4236P1	710	739	42	36	2.3	31	3.38
CMPLG4242P1	773	802	42	42	2.3	36	3.92
CMPLG4248P1	839	868	42	48	2.3	41	4.45
CMPLG4254P1	926	955	42	54	2.3	46	4.99
CMPLG4260P1	998	1029	42	60	2.3	51	5.52
CMPLG4824P1	596	612	48	24	2.3	26	2.73
CMPLG4830P1	716	730	48	30	2.3	33	3.37
CMPLG4836P1	785	815	48	36	2.3	39	4.00
CMPLG4842P1	866	894	48	42	2.3	46	4.63
CMPLG4848P1	946	975	48	48	2.3	52	5.26
CMPLG4854P1	1026	1055	48	54	2.3	59	5.89
CMPLG4860P1	1098	1126	48	60	2.3	65	6.53
CMPLG5424P1	596	612	54	24	2.3	26	2.73
CMPLG5430P1	716	730	54	30	2.3	33	3.37
CMPLG5436P1	787	816	54	36	2.3	39	4.00
CMPLG5442P1	866	894	54	42	2.3	46	4.63
CMPLG5448P1	945	974	54	48	2.3	52	5.26
CMPLG5454P1	1026	1056	54	54	2.3	59	5.89
CMPLG5460P1	1098	1126	54	60	2.3	65	6.53
CMPLG6624P1	646	674	66	24	2.3	32	3.58
CMPLG6630P1	771	801	66	30	2.3	40	4.40
CMPLG6636P1	845	904	66	36	2.3	48	5.23
CMPLG6642P1	928	987	66	42	2.3	56	6.06
CMPLG6648P1	1019	1076	66	48	2.3	64	6.88
CMPLG6654P1	1104	1163	66	54	2.3	72	7.71
CMPLG6660P1	1183	1241	66	60	2.3	80	8.53

CMPLG-P2 • Single 12" Glazed at Top, Powered Fabric Panel, Punchouts on Both Sides

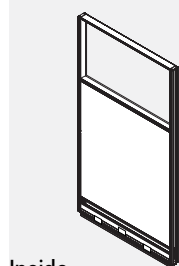

Inside

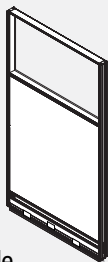

Outside

- Individual fabric-covered module in lower position with glazed module in upper position incorporated into an aluminum frame.
- Opposite sides of each module may have a different fabric within the same grade at no upcharge.
- If different grades of fabric are used on one panel, the entire panel must be priced at highest grade.
- Panels are not tackable.
- Note: Trim is not required at a straight connection between two panels of the same height.
- 3 Panel connector brackets per side come standard with 42"h. and 54"h. panels.
- 4 Panel connector brackets per side come standard with 66"h. panels.
- Panels include 2 raceway covers with punchouts on both sides, a power distribution housing, an integrated aluminum top cap and levelling glides.
- Standard in clear (CLR) plexi.
- Optional frosted (FRST) plexi
- 24" wide panels have two punchouts, one for electrical and one for data.
- 30" wide panels and wider have three punchouts, two for electrical and one for data.
- Glazing is 12" nominal from the top of the panel.
- panels and wider have 2 punchouts.
- Please specify duplex receptacles separately.

PRODUCT CODE	PRICE		SIZE/ INCHES			WEIGHT VOL	
	GR1	GR2	H	W	D	LBS	FT ³
CMPLG4224P2	565	583	42	24	2.3	20	2.31
CMPLG4230P2	658	672	42	30	2.3	25	2.85
CMPLG4236P2	710	739	42	36	2.3	31	3.38
CMPLG4242P2	773	802	42	42	2.3	36	3.92
CMPLG4248P2	839	868	42	48	2.3	41	4.45
CMPLG4254P2	926	955	42	54	2.3	46	4.99
CMPLG4260P2	998	1029	42	60	2.3	51	5.52
CMPLG4824P2	596	612	48	24	2.3	26	2.73
CMPLG4830P2	716	730	48	30	2.3	33	3.37
CMPLG4836P2	785	815	48	36	2.3	39	4.00
CMPLG4842P2	866	894	48	42	2.3	46	4.63
CMPLG4848P2	946	975	48	48	2.3	52	5.26
CMPLG4854P2	1026	1055	48	54	2.3	59	5.89
CMPLG4860P2	1098	1126	48	60	2.3	65	6.53
CMPLG5424P2	596	612	54	24	2.3	26	2.73
CMPLG5430P2	716	730	54	30	2.3	33	3.37
CMPLG5436P2	787	816	54	36	2.3	39	4.00
CMPLG5442P2	866	894	54	42	2.3	46	4.63
CMPLG5448P2	945	974	54	48	2.3	52	5.26
CMPLG5454P2	1026	1056	54	54	2.3	59	5.89
CMPLG5460P2	1098	1126	54	60	2.3	65	6.53
CMPLG6624P2	646	674	66	24	2.3	32	3.58
CMPLG6630P2	771	801	66	30	2.3	40	4.40
CMPLG6636P2	845	904	66	36	2.3	48	5.23
CMPLG6642P2	928	987	66	42	2.3	56	6.06
CMPLG6648P2	1019	1076	66	48	2.3	64	6.88
CMPLG6654P2	1104	1163	66	54	2.3	72	7.71
CMPLG6660P2	1183	1241	66	60	2.3	80	8.53

CMPG-N0 • Single 14" Glazed at Top Glazed Panel, Non Powered Fabric Panel, No Punchouts

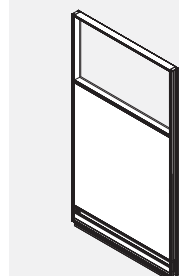

Inside



Outside

- Individual fabric-covered module in lower position with glazed module in upper position incorporated into an aluminum frame.
- Opposite sides of each module may have a different fabric within the same grade at no upcharge.
- If different grades of fabric are used on one panel, the entire panel must be priced at highest grade.
- Panels are not tackable.
- Note: Trim is not required at a straight connection between two panels of the same height.
- 3 Panel connector brackets per side come standard with 42"h. and 54"h. panels.
- 4 Panel connector brackets per side come standard with 66"h. panels.
- Panels include 2 raceway covers with no punchouts, an integrated aluminum top cap and levelling glides.
- Standard in clear (CLR) plexi.
- Optional frosted (FRST) plexi
- PVC Glass Retainer may match any panel frame finish.
- Glazing is 14" nominal from the top of the panel.

PRODUCT CODE	PRICE		SIZE/ INCHES			WEIGHT VOL	
	GR1	GR2	H	W	D	LBS	FT ³
CMPG4224N0	433	446	42	24	2.3	20	2.31
CMPG4230N0	474	492	42	30	2.3	25	2.85
CMPG4236N0	521	550	42	36	2.3	31	3.38
CMPG4242N0	576	607	42	42	2.3	36	3.92
CMPG4248N0	633	661	42	48	2.3	41	4.45
CMPG4254N0	715	743	42	54	2.3	46	4.99
CMPG4260N0	787	816	42	60	2.3	51	5.52
CMPG4824N0	463	477	48	24	2.3	26	2.73
CMPG4830N0	534	550	48	30	2.3	33	3.37
CMPG4836N0	595	625	48	36	2.3	39	4.00
CMPG4842N0	670	699	48	42	2.3	46	4.63
CMPG4848N0	737	767	48	48	2.3	52	5.26
CMPG4854N0	815	845	48	54	2.3	59	5.89
CMPG4860N0	886	914	48	60	2.3	65	6.53
CMPG5424N0	463	476	54	24	2.3	26	2.73
CMPG5430N0	534	550	54	30	2.3	33	3.37
CMPG5436N0	595	625	54	36	2.3	39	4.00
CMPG5442N0	669	699	54	42	2.3	46	4.63
CMPG5448N0	737	767	54	48	2.3	52	5.26
CMPG5454N0	816	844	54	54	2.3	59	5.89
CMPG5460N0	886	915	54	60	2.3	65	6.53
CMPG6624N0	509	539	66	24	2.3	32	3.58
CMPG6630N0	590	619	66	30	2.3	40	4.40
CMPG6636N0	656	715	66	36	2.3	48	5.23
CMPG6642N0	732	790	66	42	2.3	56	6.06
CMPG6648N0	809	868	66	48	2.3	64	6.88
CMPG6654N0	893	953	66	54	2.3	72	7.71
CMPG6660N0	970	1030	66	60	2.3	80	8.53

CMPG-N1 • Single 14" Glazed at Top Glazed Panel, Non Powered Fabric Panel, Punchouts on One Side

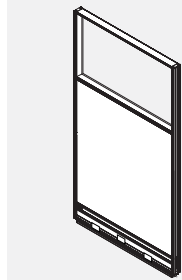

Inside

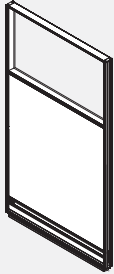

Outside

- Individual fabric-covered module in lower position with glazed module in upper position incorporated into an aluminum frame.
- Opposite sides of each module may have a different fabric within the same grade at no upcharge.
- If different grades of fabric are used on one panel, the entire panel must be priced at highest grade.
- Panels are not tackable.
- Note: Trim is not required at a straight connection between two panels of the same height.
- 3 Panel connector brackets per side come standard with 42" h. and 54" h. panels.
- 4 Panel connector brackets per side come standard with 66" h. panels.
- Panels include 1 raceway cover with punchouts on one side, 1 raceway cover with no punchouts on the other, an integrated aluminum top cap and levelling glides.
- Standard in clear (CLR) plexi.
- Optional frosted (FRST) plexi
- 24" wide panels have two punchouts, one for electrical and one for data.
- 30" wide panels and wider have three punchouts, two for electrical and one for data.
- Glazing is 14" nominal from the top of the panel.

PRODUCT CODE	PRICE		SIZE/ INCHES			WEIGHT VOL	
	GR 1	GR 2	H	W	D	LBS	FT ³
CMPG4224N1	433	446	42	24	2.3	20	2.31
CMPG4230N1	474	492	42	30	2.3	25	2.85
CMPG4236N1	521	550	42	36	2.3	31	3.38
CMPG4242N1	576	607	42	42	2.3	36	3.92
CMPG4248N1	633	661	42	48	2.3	41	4.45
CMPG4254N1	715	743	42	54	2.3	46	4.99
CMPG4260N1	787	816	42	60	2.3	51	5.52
CMPG4824N1	463	477	48	24	2.3	26	2.73
CMPG4830N1	534	550	48	30	2.3	33	3.37
CMPG4836N1	595	625	48	36	2.3	39	4.00
CMPG4842N1	670	699	48	42	2.3	46	4.63
CMPG4848N1	737	767	48	48	2.3	52	5.26
CMPG4854N1	815	845	48	54	2.3	59	5.89
CMPG4860N1	886	914	48	60	2.3	65	6.53
CMPG5424N1	463	476	54	24	2.3	26	2.73
CMPG5430N1	534	550	54	30	2.3	33	3.37
CMPG5436N1	595	625	54	36	2.3	39	4.00
CMPG5442N1	669	699	54	42	2.3	46	4.63
CMPG5448N1	737	767	54	48	2.3	52	5.26
CMPG5454N1	816	844	54	54	2.3	59	5.89
CMPG5460N1	886	915	54	60	2.3	65	6.53
CMPG6624N1	509	539	66	24	2.3	32	3.58
CMPG6630N1	590	619	66	30	2.3	40	4.40
CMPG6636N1	656	715	66	36	2.3	48	5.23
CMPG6642N1	732	790	66	42	2.3	56	6.06
CMPG6648N1	809	868	66	48	2.3	64	6.88
CMPG6654N1	893	953	66	54	2.3	72	7.71
CMPG6660N1	970	1030	66	60	2.3	80	8.53

CMPG-N2 • Single 14" Glazed at Top, Non Powered Fabric Panel, Punchouts on Both Sides

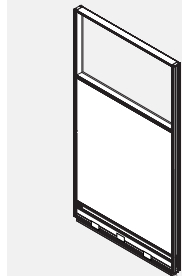

Inside

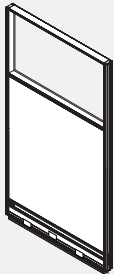

Outside

- Individual fabric-covered module in lower position with glazed module in upper position incorporated into a solid steel frame.
- Opposite sides of each module may have a different fabric within the same grade at no upcharge.
- If different grades of fabric are used on one panel, the entire panel must be priced at highest grade.
- Panels are not tackable.
- Note: Trim is not required at a straight connection between two panels of the same height.
- 3 Panel connector brackets per side come standard with 42" h. and 54" h. panels.
- 4 Panel connector brackets per side come standard with 66" h. panels.
- Panels include 2 raceway covers with punchouts on both sides, an integrated aluminum top cap and levelling glides.
- Standard in clear (CLR) plexi.
- Optional frosted (FRST) plexi
- 24" wide panels have two punchouts, one for electrical and one for data.
- 30" wide panels and wider have three punchouts, two for electrical and one for data.
- Glazing is 14" nominal from the top of the panel.

PRODUCT CODE	PRICE		SIZE/ INCHES			WEIGHT VOL	
	GR 1	GR 2	H	W	D	LBS	FT ³
CMPG4224N2	433	446	42	24	2.3	20	2.31
CMPG4230N2	474	492	42	30	2.3	25	2.85
CMPG4236N2	521	550	42	36	2.3	31	3.38
CMPG4242N2	576	607	42	42	2.3	36	3.92
CMPG4248N2	633	661	42	48	2.3	41	4.45
CMPG4254N2	715	743	42	54	2.3	46	4.99
CMPG4260N2	787	816	42	60	2.3	51	5.52
CMPG4824N2	463	477	48	24	2.3	26	2.73
CMPG4830N2	534	550	48	30	2.3	33	3.37
CMPG4836N2	595	625	48	36	2.3	39	4.00
CMPG4842N2	670	699	48	42	2.3	46	4.63
CMPG4848N2	737	767	48	48	2.3	52	5.26
CMPG4854N2	815	845	48	54	2.3	59	5.89
CMPG4860N2	886	914	48	60	2.3	65	6.53
CMPG5424N2	463	476	54	24	2.3	26	2.73
CMPG5430N2	534	550	54	30	2.3	33	3.37
CMPG5436N2	595	625	54	36	2.3	39	4.00
CMPG5442N2	669	699	54	42	2.3	46	4.63
CMPG5448N2	737	767	54	48	2.3	52	5.26
CMPG5454N2	816	844	54	54	2.3	59	5.89
CMPG5460N2	886	915	54	60	2.3	65	6.53
CMPG6624N2	509	539	66	24	2.3	32	3.58
CMPG6630N2	590	619	66	30	2.3	40	4.40
CMPG6636N2	656	715	66	36	2.3	48	5.23
CMPG6642N2	732	790	66	42	2.3	56	6.06
CMPG6648N2	809	868	66	48	2.3	64	6.88
CMPG6654N2	893	953	66	54	2.3	72	7.71
CMPG6660N2	970	1030	66	60	2.3	80	8.53

CMPG-P1 • Single 14" Glazed at Top, Powered Fabric Panel, Punchouts on One Side

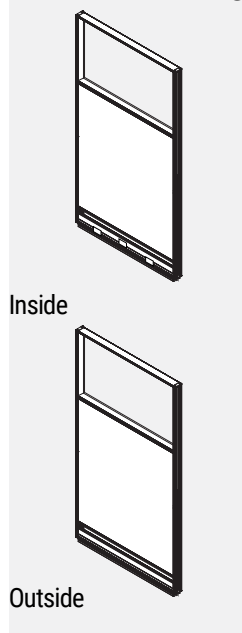

- Individual fabric-covered module in lower position with glazed module in upper position incorporated into a solid steel frame.
- Opposite sides of each module may have a different fabric within the same grade at no upcharge.
- If different grades of fabric are used on one panel, the entire panel must be priced at highest grade.
- Panels are not tackable.
- Note: Trim is not required at a straight connection between two panels of the same height.
- 3 Panel connector brackets per side come standard with 42"h. and 54"h. panels.
- 4 Panel connector brackets per side come standard with 66"h. panels.
- Panels include 1 raceway cover with punchouts on one side, 1 raceway cover with no punchouts on the other, a power distribution housing, an integrated aluminum top cap and levelling glides.
- Standard in clear (CLR) plexi.
- Optional frosted (FRST) plexi
- 24" wide panels have two punchouts, one for electrical and one for data.
- 30" wide panels and wider have three punchouts, two for electrical and one for data.
- Please specify duplex receptacles separately.
- Glazing is 14" nominal from the top of the panel.

PRODUCT CODE	PRICE		SIZE/ INCHES			WEIGHT VOL	
	GR1	GR2	H	W	D	LBS	FT ³
CMPG4224P1	565	583	42	24	2.3	20	2.31
CMPG4230P1	658	672	42	30	2.3	25	2.85
CMPG4236P1	710	739	42	36	2.3	31	3.38
CMPG4242P1	773	802	42	42	2.3	36	3.92
CMPG4248P1	839	868	42	48	2.3	41	4.45
CMPG4254P1	926	955	42	54	2.3	46	4.99
CMPG4260P1	998	1029	42	60	2.3	51	5.52
CMPG4824P1	596	612	48	24	2.3	26	2.73
CMPG4830P1	716	730	48	30	2.3	33	3.37
CMPG4836P1	785	815	48	36	2.3	39	4.00
CMPG4842P1	866	894	48	42	2.3	46	4.63
CMPG4848P1	946	975	48	48	2.3	52	5.26
CMPG4854P1	1026	1055	48	54	2.3	59	5.89
CMPG4860P1	1098	1126	48	60	2.3	65	6.53
CMPG5424P1	596	612	54	24	2.3	26	2.73
CMPG5430P1	716	730	54	30	2.3	33	3.37
CMPG5436P1	787	816	54	36	2.3	39	4.00
CMPG5442P1	866	894	54	42	2.3	46	4.63
CMPG5448P1	945	974	54	48	2.3	52	5.26
CMPG5454P1	1026	1056	54	54	2.3	59	5.89
CMPG5460P1	1098	1126	54	60	2.3	65	6.53
CMPG6624P1	646	674	66	24	2.3	32	3.58
CMPG6630P1	771	801	66	30	2.3	40	4.40
CMPG6636P1	845	904	66	36	2.3	48	5.23
CMPG6642P1	928	987	66	42	2.3	56	6.06
CMPG6648P1	1019	1076	66	48	2.3	64	6.88
CMPG6654P1	1104	1163	66	54	2.3	72	7.71
CMPG6660P1	1183	1241	66	60	2.3	80	8.53

CMPG-P2 • Single 14" Glazed at Top, Powered Fabric Panel, Punchouts on Both Sides

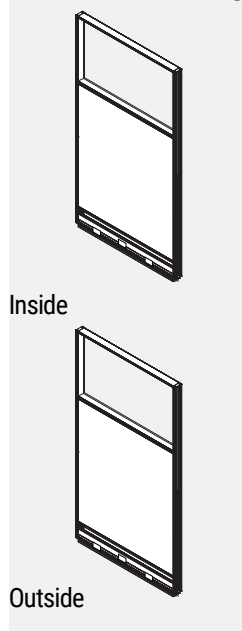

- Individual fabric-covered module in lower position with glazed module in upper position incorporated into an aluminum frame.
- Opposite sides of each module may have a different fabric within the same grade at no upcharge.
- If different grades of fabric are used on one panel, the entire panel must be priced at highest grade.
- Panels are not tackable.
- Note: Trim is not required at a straight connection between two panels of the same height.
- 3 Panel connector brackets per side come standard with 42"h. and 54"h. panels.
- 4 Panel connector brackets per side come standard with 66"h. panels.
- Panels include 2 raceway covers with punchouts on both sides, a power distribution housing, an integrated aluminum top cap and levelling glides.
- Standard in clear (CLR) plexi.
- Optional frosted (FRST) plexi
- 24" wide panels have two punchouts, one for electrical and one for data.
- 30" wide panels and wider have three punchouts, two for electrical and one for data.
- Glazing is 14" nominal from the top of the panel. panels and wider have 2 punchouts.
- Please specify duplex receptacles separately.

PRODUCT CODE	PRICE		SIZE/ INCHES			WEIGHT VOL	
	GR1	GR2	H	W	D	LBS	FT ³
CMPG4224P2	565	583	42	24	2.3	20	2.31
CMPG4230P2	658	672	42	30	2.3	25	2.85
CMPG4236P2	710	739	42	36	2.3	31	3.38
CMPG4242P2	773	802	42	42	2.3	36	3.92
CMPG4248P2	839	868	42	48	2.3	41	4.45
CMPG4254P2	926	955	42	54	2.3	46	4.99
CMPG4260P2	998	1029	42	60	2.3	51	5.52
CMPG4824P2	596	612	48	24	2.3	26	2.73
CMPG4830P2	716	730	48	30	2.3	33	3.37
CMPG4836P2	785	815	48	36	2.3	39	4.00
CMPG4842P2	866	894	48	42	2.3	46	4.63
CMPG4848P2	946	975	48	48	2.3	52	5.26
CMPG4854P2	1026	1055	48	54	2.3	59	5.89
CMPG4860P2	1098	1126	48	60	2.3	65	6.53
CMPG5424P2	596	612	54	24	2.3	26	2.73
CMPG5430P2	716	730	54	30	2.3	33	3.37
CMPG5436P2	787	816	54	36	2.3	39	4.00
CMPG5442P2	866	894	54	42	2.3	46	4.63
CMPG5448P2	945	974	54	48	2.3	52	5.26
CMPG5454P2	1026	1056	54	54	2.3	59	5.89
CMPG5460P2	1098	1126	54	60	2.3	65	6.53
CMPG6624P2	646	674	66	24	2.3	32	3.58
CMPG6630P2	771	801	66	30	2.3	40	4.40
CMPG6636P2	845	904	66	36	2.3	48	5.23
CMPG6642P2	928	987	66	42	2.3	56	6.06
CMPG6648P2	1019	1076	66	48	2.3	64	6.88
CMPG6654P2	1104	1163	66	54	2.3	72	7.71
CMPG6660P2	1183	1241	66	60	2.3	80	8.53

CMFO-N0 • Single Segmented Open Bottom Non Powered Fabric Panel, No Punchouts

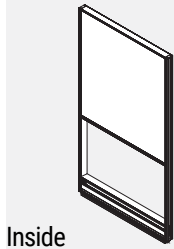

Inside

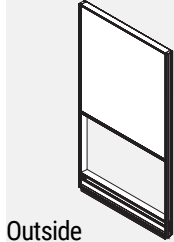

Outside

- Individual fabric-covered module in upper position incorporated into an aluminum frame.
- Bottom is open.
- Opposite sides of each module may have a different fabric within the same grade at no upcharge.
- If different grades of fabric are used on one panel, the entire panel must be priced at highest grade.
- Panels are not tackable.
- Note: Trim is not required at a straight connection between two panels of the same height.
- 3 Panel connector brackets per side come standard with 42”h. and 54”h. panels.
- 4 Panel connector brackets per side come standard with 66”h. panels.
- Panels include 2 raceway covers with no punchouts, an integrated aluminum top cap and levelling glides.
- PVC trim kit available in black only.

PRODUCT CODE	PRICE		SIZE/ INCHES			WEIGHT VOL	
	GR 1	GR 2	H	W	D	LBS	FT ³
CMFO4224N0	263	273	42	24	2.3	15	2.31
CMFO4230N0	329	339	42	30	2.3	17	2.85
CMFO4236N0	354	372	42	36	2.3	21	3.38
CMFO4242N0	406	425	42	42	2.3	24	3.92
CMFO4248N0	433	450	42	48	2.3	28	4.45
CMFO4254N0	472	498	42	54	2.3	31	4.99
CMFO4260N0	520	536	42	60	2.3	34	5.52
CMFO5424N0	310	326	54	24	2.3	20	2.73
CMFO5430N0	354	367	54	30	2.3	25	3.37
CMFO5436N0	403	418	54	36	2.3	29	4.00
CMFO5442N0	462	492	54	42	2.3	34	4.63
CMFO5448N0	493	523	54	48	2.3	38	5.26
CMFO5454N0	537	567	54	54	2.3	43	5.89
CMFO5460N0	572	601	54	60	2.3	48	6.53
CMFO6624N0	342	366	66	24	2.3	25	3.58
CMFO6630N0	383	406	66	30	2.3	31	4.40
CMFO6636N0	459	501	66	36	2.3	38	5.23
CMFO6642N0	520	561	66	42	2.3	44	6.06
CMFO6648N0	545	586	66	48	2.3	50	6.88
CMFO6654N0	594	637	66	54	2.3	56	7.71
CMFO6660N0	635	675	66	60	2.3	63	8.53

CMFO-N1 • Single Segmented Open Bottom Non Powered Fabric Panel, Punchouts on One Side

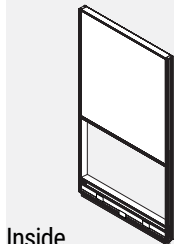

Inside

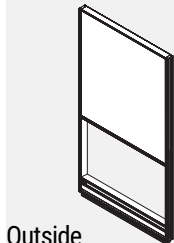

Outside

- Individual fabric-covered module in upper position incorporated into an aluminum frame.
- Bottom is open.
- Opposite sides of each module may have a different fabric within the same grade at no upcharge.
- If different grades of fabric are used on one panel, the entire panel must be priced at highest grade.
- Panels are not tackable.
- Note: Trim is not required at a straight connection between two panels of the same height.
- 3 Panel connector brackets per side come standard with 42”h. and 54”h. panels.
- 4 Panel connector brackets per side come standard with 66”h. panels.
- Panels include 1 raceway cover with punchouts on one side, 1 raceway cover with no punchouts on the other, an integrated aluminum top cap and levelling glides.
- 24” wide panels have two punchouts, one for electrical and one for data.
- 30” wide panels and wider have three punchouts, two for electrical and one for data.
- PVC trim kit available in black only.

PRODUCT CODE	PRICE		SIZE/ INCHES			WEIGHT VOL	
	GR 1	GR 2	H	W	D	LBS	FT ³
CMFO4224N1	263	273	42	24	2.3	15	2.31
CMFO4230N1	329	339	42	30	2.3	17	2.85
CMFO4236N1	354	372	42	36	2.3	21	3.38
CMFO4242N1	406	425	42	42	2.3	24	3.92
CMFO4248N1	433	450	42	48	2.3	28	4.45
CMFO4254N1	472	498	42	54	2.3	31	4.99
CMFO4260N1	520	536	42	60	2.3	34	5.52
CMFO5424N1	310	326	54	24	2.3	20	2.73
CMFO5430N1	354	367	54	30	2.3	25	3.37
CMFO5436N1	403	418	54	36	2.3	29	4.00
CMFO5442N1	462	492	54	42	2.3	34	4.63
CMFO5448N1	493	523	54	48	2.3	38	5.26
CMFO5454N1	537	567	54	54	2.3	43	5.89
CMFO5460N1	572	601	54	60	2.3	48	6.53
CMFO6624N1	342	366	66	24	2.3	25	3.58
CMFO6630N1	383	406	66	30	2.3	31	4.40
CMFO6636N1	459	501	66	36	2.3	38	5.23
CMFO6642N1	520	561	66	42	2.3	44	6.06
CMFO6648N1	545	586	66	48	2.3	50	6.88
CMFO6654N1	594	637	66	54	2.3	56	7.71
CMFO6660N1	635	675	66	60	2.3	63	8.53

CMFO-N2 • Single Segmented Open Bottom Non Powered Fabric Panel, Punchouts on Both Sides

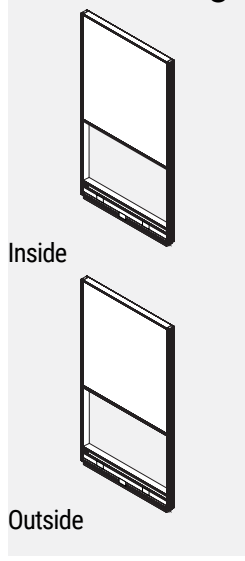

- Individual fabric-covered module in upper position incorporated into an aluminum frame.
- Bottom is open.
- Opposite sides of each module may have a different fabric within the same grade at no upcharge.
- If different grades of fabric are used on one panel, the entire panel must be priced at highest grade.
- Panels are not tackable.
- Note: Trim is not required at a straight connection between two panels of the same height.
- 3 Panel connector brackets per side come standard with 42”h. and 54”h. panels.
- 4 Panel connector brackets per side come standard with 66”h. panels.
- Panels include 2 raceway covers with punchouts on both sides, an integrated aluminum top cap and levelling glides.
- 24” wide panels have two punchouts, one for electrical and one for data.
- 30” wide panels and wider have three punchouts, two for electrical and one for data.
- PVC trim kit available in black only.

PRODUCT CODE	PRICE		SIZE/ INCHES			WEIGHT VOL	
	GR 1	GR 2	H	W	D	LBS	FT ³
CMFO4224N2	263	273	42	24	2.3	15	2.31
CMFO4230N2	329	339	42	30	2.3	17	2.85
CMFO4236N2	354	372	42	36	2.3	21	3.38
CMFO4242N2	406	425	42	42	2.3	24	3.92
CMFO4248N2	433	450	42	48	2.3	28	4.45
CMFO4254N2	472	498	42	54	2.3	31	4.99
CMFO4260N2	520	536	42	60	2.3	34	5.52
CMFO5424N2	310	326	54	24	2.3	20	2.73
CMFO5430N2	354	367	54	30	2.3	25	3.37
CMFO5436N2	403	418	54	36	2.3	29	4.00
CMFO5442N2	462	492	54	42	2.3	34	4.63
CMFO5448N2	493	523	54	48	2.3	38	5.26
CMFO5454N2	537	567	54	54	2.3	43	5.89
CMFO5460N2	572	601	54	60	2.3	48	6.53
CMFO6624N2	342	366	66	24	2.3	25	3.58
CMFO6630N2	383	406	66	30	2.3	31	4.40
CMFO6636N2	459	501	66	36	2.3	38	5.23
CMFO6642N2	520	561	66	42	2.3	44	6.06
CMFO6648N2	545	586	66	48	2.3	50	6.88
CMFO6654N2	594	637	66	54	2.3	56	7.71
CMFO6660N2	635	675	66	60	2.3	63	8.53

CMFO-P1 • Single Segmented Open Bottom Powered Fabric Panel, Punchouts on One Side

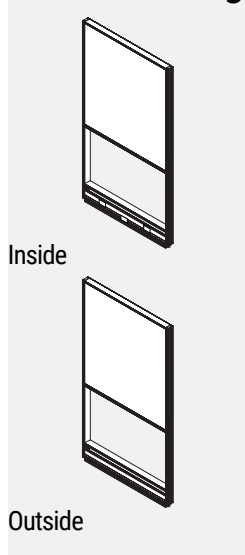

- Individual fabric-covered module in upper position incorporated into an aluminum frame.
- Bottom is open.
- Opposite sides of each module may have a different fabric within the same grade at no upcharge.
- If different grades of fabric are used on one panel, the entire panel must be priced at highest grade.
- Panels are not tackable.
- Note: Trim is not required at a straight connection between two panels of the same height.
- 3 Panel connector brackets per side come standard with 42”h. and 54”h. panels.
- 4 Panel connector brackets per side come standard with 66”h. panels.
- Panels include 1 raceway cover with punchouts on one side, 1 raceway cover with no punchouts on the other, a power distribution housing, an integrated aluminum top cap and levelling glides.
- 24” wide panels have two punchouts, one for electrical and one for data.
- 30” wide panels and wider have three punchouts, two for electrical and one for data.
- Please specify duplex receptacles separately.
- PVC trim kit available in black only.

PRODUCT CODE	PRICE		SIZE/ INCHES			WEIGHT VOL	
	GR 1	GR 2	H	W	D	LBS	FT ³
CMFO4224P1	389	399	42	24	2.3	15	2.31
CMFO4230P1	497	506	42	30	2.3	17	2.85
CMFO4236P1	530	550	42	36	2.3	21	3.38
CMFO4242P1	587	607	42	42	2.3	24	3.92
CMFO4248P1	625	642	42	48	2.3	28	4.45
CMFO4254P1	669	678	42	54	2.3	31	4.99
CMFO4260P1	716	735	42	60	2.3	34	5.52
CMFO5424P1	436	449	54	24	2.3	20	2.73
CMFO5430P1	524	536	54	30	2.3	25	3.37
CMFO5436P1	578	592	54	36	2.3	29	4.00
CMFO5442P1	642	673	54	42	2.3	34	4.63
CMFO5448P1	686	715	54	48	2.3	38	5.26
CMFO5454P1	735	763	54	54	2.3	43	5.89
CMFO5460P1	768	799	54	60	2.3	48	6.53
CMFO6624P1	468	492	66	24	2.3	25	3.58
CMFO6630P1	551	574	66	30	2.3	31	4.40
CMFO6636P1	635	675	66	36	2.3	38	5.23
CMFO6642P1	701	743	66	42	2.3	44	6.06
CMFO6648P1	736	779	66	48	2.3	50	6.88
CMFO6654P1	790	832	66	54	2.3	56	7.71
CMFO6660P1	831	872	66	60	2.3	63	8.53

CMFO-P2 • Single Segmented Open Bottom Powered Fabric Panel, Punchouts on Both Sides

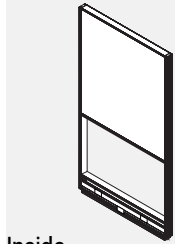

Inside

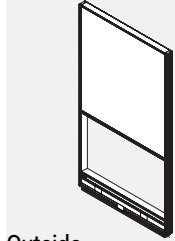

Outside

- Individual fabric-covered module in upper position incorporated into an aluminum frame.
- Bottom is open.
- Opposite sides of each module may have a different fabric within the same grade at no upcharge.
- If different grades of fabric are used on one panel, the entire panel must be priced at highest grade.
- Panels are not tackable.
- Note: Trim is not required at a straight connection between two panels of the same height.
- 3 Panel connector brackets per side come standard with 42”h. and 54”h. panels.
- 4 Panel connector brackets per side come standard with 66”h. panels.
- Panels include 2 raceway covers with punchouts on both sides, a power distribution housing, an integrated aluminum top cap and levelling glides.
- 24” wide panels have two punchouts, one for electrical and one for data.
- 30” wide panels and wider have three punchouts, two for electrical and one for data.
- Please specify duplex receptacles separately.
- PVC trim kit available in black only.

PRODUCT CODE	PRICE		SIZE/ INCHES			WEIGHT VOL	
	GR 1	GR 2	H	W	D	LBS	FT ³
CMFO4224P2	389	399	42	24	2.3	15	2.31
CMFO4230P2	497	506	42	30	2.3	17	2.85
CMFO4236P2	530	550	42	36	2.3	21	3.38
CMFO4242P2	587	607	42	42	2.3	24	3.92
CMFO4248P2	625	642	42	48	2.3	28	4.45
CMFO4254P2	669	678	42	54	2.3	31	4.99
CMFO4260P2	716	735	42	60	2.3	34	5.52
CMFO5424P2	436	449	54	24	2.3	20	2.73
CMFO5430P2	524	536	54	30	2.3	25	3.37
CMFO5436P2	578	592	54	36	2.3	29	4.00
CMFO5442P2	642	673	54	42	2.3	34	4.63
CMFO5448P2	686	715	54	48	2.3	38	5.26
CMFO5454P2	735	763	54	54	2.3	43	5.89
CMFO5460P2	768	799	54	60	2.3	48	6.53
CMFO6624P2	468	492	66	24	2.3	25	3.58
CMFO6630P2	551	574	66	30	2.3	31	4.40
CMFO6636P2	635	675	66	36	2.3	38	5.23
CMFO6642P2	701	743	66	42	2.3	44	6.06
CMFO6648P2	736	779	66	48	2.3	50	6.88
CMFO6654P2	790	832	66	54	2.3	56	7.71
CMFO6660P2	831	872	66	60	2.3	63	8.53

CMOF • Compile Fabric Over Panel

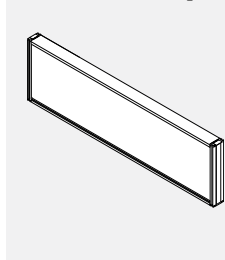

- Individual fabric-covered modules incorporated into an aluminum frame.
- Opposite sides of each module may have a different fabric within the same grade at no upcharge.
- If different grades of fabric are used on one panel, the entire panel must be priced at highest grade.
- Panels are not tackable.
- 2 Panel connector brackets per side are standard
- CHSD Compile Slider Kit for Over Panel required for installation and is included with each over panel.
- Note: Trim is not required at a straight connection between two panels of the same height.
- **Note: All over panels are non load bearing.**

PRODUCT CODE	PRICE		SIZE/ INCHES			WEIGHT VOL	
	GR 1	GR 2	H	W	D	LBS	FT ³
CMOF1224	130	151	12	24	2.3	8	0.38
CMOF1230	153	173	12	30	2.3	10	0.48
CMOF1236	169	190	12	36	2.3	12.4	0.58
CMOF1242	193	212	12	42	2.3	14.4	0.67
CMOF1248	224	242	12	48	2.3	16.4	0.7
CMOF1254	231	252	12	54	2.3	18.4	0.86
CMOF1260	275	295	12	60	2.3	20.4	0.96
CMOF1624	152	175	16	30	2.3	15	0.64
CMOF1630	177	202	16	36	2.3	18.6	0.77
CMOF1636	188	211	16	42	2.3	21.6	0.89
CMOF1642	226	248	16	48	2.3	24.6	1.02
CMOF1648	256	279	16	54	2.3	27.6	1.15
CMOF1654	268	293	16	60	2.3	30.6	1.28
CMOF1660	315	339	16	66	2.3	33.6	1.42
CMOF2424	196	233	24	24	2.3	16	0.77
CMOF2430	228	260	24	30	2.3	20	0.96
CMOF2436	255	289	24	36	2.3	24.8	1.15
CMOF2442	288	320	24	42	2.3	28.8	1.34
CMOF2448	308	341	24	48	2.3	32.8	1.53
CMOF2454	342	375	24	54	2.3	36.8	1.73
CMOF2460	394	426	24	60	2.3	40.8	1.92

CMOLF • Compile Laminate One Side, Fabric One Side Over Panel

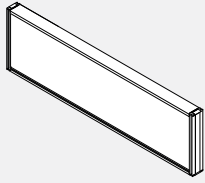

- Individual modules, one side in fabric and one side in laminate, incorporated into an aluminum frame.
- Panels are not tackable.
- 2 Panel connector brackets per side are standard
- CHSD Compile Slider Kit for Over Panel required for installation and is included with each over panel.
- Note: Trim is not required at a straight connection between two panels of the same height.
- **Note: All over panels are non load bearing.**

PRODUCT CODE	PRICE		SIZE/ INCHES			WEIGHT VOL	
	GR 1	GR 2	H	W	D	LBS	FT ³
CMOLF1224	147	156	12	24	2.3	8	0.38
CMOLF1230	173	182	12	30	2.3	10	0.48
CMOLF1236	195	205	12	36	2.3	12.4	0.58
CMOLF1242	222	231	12	42	2.3	14.4	0.67
CMOLF1248	256	266	12	48	2.3	16.4	0.7
CMOLF1254	268	277	12	54	2.3	18.4	0.86
CMOLF1260	317	326	12	60	2.3	20.4	0.96
CMOLF1624	174	187	16	30	2.3	15	0.64
CMOLF1630	209	222	16	36	2.3	18.6	0.77
CMOLF1636	231	242	16	42	2.3	21.6	0.89
CMOLF1642	263	275	16	48	2.3	24.6	1.02
CMOLF1648	300	311	16	54	2.3	27.6	1.15
CMOLF1654	318	330	16	60	2.3	30.6	1.28
CMOLF1660	369	381	16	66	2.3	33.6	1.41
CMOLF2424	230	245	24	24	2.3	16	0.77
CMOLF2430	275	292	24	30	2.3	20	0.96
CMOLF2436	304	320	24	36	2.3	24.8	1.15
CMOLF2442	343	360	24	42	2.3	28.8	1.34
CMOLF2448	374	392	24	48	2.3	32.8	1.53
CMOLF2454	417	431	24	54	2.3	36.8	1.73
CMOLF2460	474	492	24	60	2.3	40.8	1.92

CMOLL • Compile Laminate Two Sides Over Panel

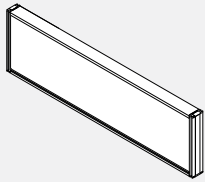

- Individual laminate modules incorporated into an aluminum frame.
- Panels are not tackable.
- 2 Panel connector brackets per side are standard
- CHSD Compile Slider Kit for Over Panel required for installation and is included with each over panel.
- Note: Trim is not required at a straight connection between two panels of the same height.
- **Note: All over panels are non load bearing.**

PRODUCT CODE	PRICE		SIZE/ INCHES			WEIGHT VOL	
	GR 1	GR 2	H	W	D	LBS	FT ³
CMOLL1224	163		12	24	2.3	8	0.38
CMOLL1230	186		12	30	2.3	10	0.48
CMOLL1236	218		12	36	2.3	12.4	0.58
CMOLL1242	248		12	42	2.3	14.4	0.67
CMOLL1248	286		12	48	2.3	16.4	0.7
CMOLL1254	303		12	54	2.3	18.4	0.86
CMOLL1260	354		12	60	2.3	20.4	0.96
CMOLL1624	194		16	24	2.3	12	0.51
CMOLL1630	230		16	30	2.3	15	0.64
CMOLL1636	262		16	36	2.3	18.6	0.77
CMOLL1642	297		16	42	2.3	21.6	0.89
CMOLL1648	340		16	48	2.3	24.6	1.02
CMOLL1654	362		16	54	2.3	27.6	1.15
CMOLL1660	420		16	60	2.3	30.6	1.28
CMOLL2424	260		24	24	2.3	16	0.77
CMOLL2430	307		24	30	2.3	20	0.96
CMOLL2436	350		24	36	2.3	24.8	1.15
CMOLL2442	396		24	42	2.3	28.8	1.34
CMOLL2448	435		24	48	2.3	32.8	1.53
CMOLL2454	484		24	54	2.3	36.8	1.73
CMOLL2460	551		24	60	2.3	40.8	1.92

CMOG • Compile Glazed Over Panel

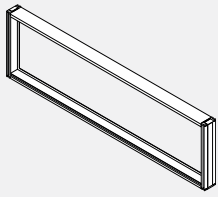

- Individual glazed module incorporated into an aluminum frame.
- Standard in clear (CLR) plexi.
- Optional frosted (FRST) plexi.
- Panels are not tackable.
- 2 Panel connector brackets per side are standard
- The PVC trim for glass can be different finish than the frame of the over panels, please specify two finishes.
- CHSD Compile Slider Kit for Over Panel required for installation and is included with each over panel.
- Note: Trim is not required at a straight connection between two panels of the same height.
- **Note: All over panels are non load bearing.**

PRODUCT CODE	PRICE	SIZE/ INCHES			WEIGHT VOL	
		H	W	D	LBS	FT ³
CMOG1224	118	12	24	2.3	8	0.38
CMOG1230	135	12	30	2.3	10	0.48
CMOG1236	151	12	36	2.3	12.4	0.58
CMOG1242	169	12	42	2.3	14.4	0.67
CMOG1248	195	12	48	2.3	16.4	0.7
CMOG1254	204	12	54	2.3	18.4	0.86
CMOG1260	241	12	60	2.3	20.4	0.96
CMOG1624	135	16	24	2.3	12	0.51
CMOG1630	156	16	30	2.3	15	0.64
CMOG1636	174	16	36	2.3	18.6	0.77
CMOG1642	196	16	42	2.3	21.6	0.89
CMOG1648	226	16	48	2.3	24.6	1.02
CMOG1654	232	16	54	2.3	27.6	1.15
CMOG1660	275	16	60	2.3	30.6	1.28
CMOG2424	173	24	24	2.3	16	0.77
CMOG2430	188	24	30	2.3	20	0.96
CMOG2436	220	24	36	2.3	24.8	1.15
CMOG2442	246	24	42	2.3	28.8	1.34
CMOG2448	265	24	48	2.3	32.8	1.53
CMOG2454	294	24	54	2.3	36.8	1.73
CMOG2460	340	24	60	2.3	40.8	1.92

CMOFW • Compile One Side Write Board Over Panel

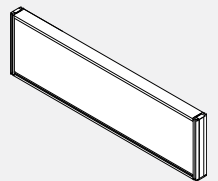

- Individual fabric or write board covered modules incorporated into an aluminum frame.
- Modules have write board on one side and fabric on the other.
- Panels are not tackable.
- 2 Panel connector brackets per side are standard
- CHSD Compile Slider Kit for Over Panel required for installation and is included with each over panel.
- Note: Trim is not required at a straight connection between two panels of the same height.
- **Note: All over panels are non load bearing.**

PRODUCT CODE	PRICE		SIZE/ INCHES			WEIGHT VOL	
	GR 1	GR 2	H	W	D	LBS	FT ³
CMOFW1224	165	174	12	24	2.3	8	0.38
CMOFW1230	195	205	12	30	2.3	10	0.48
CMOFW1236	222	231	12	36	2.3	12.4	0.58
CMOFW1242	254	263	12	42	2.3	14.4	0.67
CMOFW1248	279	290	12	48	2.3	16.4	0.7
CMOFW1254	309	319	12	54	2.3	18.4	0.86
CMOFW1260	360	369	12	60	2.3	20.4	0.96
CMOFW1624	198	209	16	24	2.3	12	0.51
CMOFW1630	234	246	16	30	2.3	15	0.64
CMOFW1636	268	279	16	36	2.3	18.6	0.77
CMOFW1642	304	317	16	42	2.3	21.6	0.89
CMOFW1648	347	360	16	48	2.3	24.6	1.02
CMOFW1654	372	384	16	54	2.3	27.6	1.15
CMOFW1660	429	441	16	60	2.3	30.6	1.28
CMOFW2424	257	273	24	24	2.3	16	0.77
CMOFW2430	296	311	24	30	2.3	20	0.96
CMOFW2436	362	378	24	36	2.3	24.8	1.15
CMOFW2442	406	422	24	42	2.3	28.8	1.34
CMOFW2448	428	443	24	48	2.3	32.8	1.53
CMOFW2454	510	527	24	54	2.3	36.8	1.73
CMOFW2460	567	584	24	60	2.3	40.8	1.92

CMOWW• Compile Write Board Two Sides Over Panel

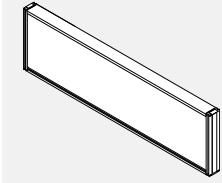

- Individual write board covered modules incorporated into an aluminum frame.
- Modules have write board on both sides.
- Panels are not tackable.
- 2 Panel connector brackets per side are standard
- CHSD Compile Slider Kit for Over Panel required for installation and is included with each over panel.
- Note: Trim is not required at a straight connection between two panels of the same height.
- **Note: All over panels are non load bearing.**

PRODUCT CODE	PRICE	SIZE/ INCHES			WEIGHT VOL	
		H	W	D	LBS	FT ³
CMOWW1224	201	12	24	2.3	8	0.38
CMOWW1230	232	12	30	2.3	10	0.48
CMOWW1236	276	12	36	2.3	12.4	0.58
CMOWW1242	309	12	42	2.3	14.4	0.67
CMOWW1248	362	12	48	2.3	16.4	0.7
CMOWW1254	383	12	54	2.3	18.4	0.86
CMOWW1260	442	12	60	2.3	20.4	0.96
CMOWW1624	245	16	24	2.3	12	0.51
CMOWW1630	295	16	30	2.3	15	0.64
CMOWW1636	339	16	36	2.3	18.6	0.77
CMOWW1642	387	16	42	2.3	21.6	0.89
CMOWW1648	443	16	48	2.3	24.6	1.02
CMOWW1654	480	16	54	2.3	27.6	1.15
CMOWW1660	549	16	60	2.3	30.6	1.28
CMOWW2424	337	24	24	2.3	16	0.77
CMOWW2430	404	24	30	2.3	20	0.96
CMOWW2436	466	24	36	2.3	24.8	1.15
CMOWW2442	532	24	42	2.3	28.8	1.34
CMOWW2448	590	24	48	2.3	32.8	1.53
CMOWW2454	659	24	54	2.3	36.8	1.73
CMOWW2460	744	24	60	2.3	40.8	1.92

BPDSL • Sliding Door

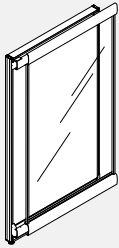

- Provides territorial privacy in an open plan environment.
- Lightweight, panel mounted sliding partition.
- Consists of translucent polycarbonate.
- Must be mounted to a straight panel of the same size.
- The face of the Privacy Screen sits 3" away from the face of the panel to which it is attached.
- When open, the screen may interfere with access doors that open on the outside of an adjacent panel.
- Caps located on the end of the frame default to the panel frame colour.
- Four sliders included for each door.
- Can be mounted on panels of the same width.
- Note: Specify left or right for the direction in which the door will slide as per examples above.

PRODUCT CODE	PRICE	SIZE/ INCHES			WEIGHT VOL	
		H	W	D	LBS	FT ³
BPDSL6636R	1923	66	36	2.61	35	5.98
BPDSL6642R	2070	66	42	2.61	42	6.93
BPDSL6636L	1923	66	36	2.61	35	5.98
BPDSL6642L	2070	66	42	2.61	42	6.93

Left Hang Option

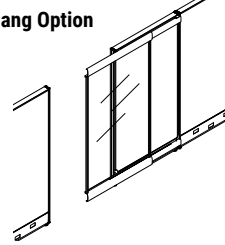

Right Hang Hung

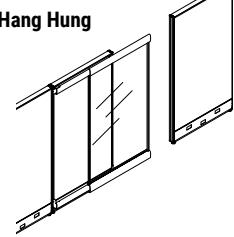

CMPS • Privacy Glass

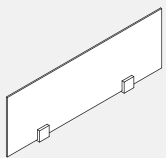

- Privacy Glass with no frame sits on top of a Panel with clamps that are secured to the top of the panel to provide division.
- Tempered glass is 12", 9" or 6" high (nominal).
- Custom sizes available, contact your Customer Service Representative.
- Square clamps included.

PRODUCT CODE	PRICE		SIZE/ INCHES			WEIGHT VOL	
	CLR	FRST	H	W	D	LBS	FT ³
12"							
CMPS24	194	220	12	24	1.3	8	0.44
CMPS30	213	242	12	30	1.3	10	0.59
CMPS36	228	263	12	36	1.3	12	0.73
CMPS42	242	284	12	42	1.3	14	0.88
CMPS48	251	297	12	48	1.3	16	0.96
CMPS54	251	297	12	54	1.3	18	1.13
CMPS60	290	329	12	60	1.3	20	1.28
9"							
CMPS0924	194	220	9	24	1.3	8	0.44
CMPS0930	213	242	9	30	1.3	10	0.59
CMPS0936	228	263	9	36	1.3	12	0.73
CMPS0942	242	284	9	42	1.3	14	0.88
CMPS0948	251	297	9	48	1.3	18	0.98
CMPS0954	251	297	9	54	1.3	18	1.13
CMPS0960	290	329	9	60	1.3	20	1.28
6"							
CMPS0624	194	220	6	24	1.3	8	0.44
CMPS0630	213	242	6	30	1.3	10	0.59
CMPS0636	228	263	6	36	1.3	12	0.73
CMPS0642	242	284	6	42	1.3	14	0.88
CMPS0648	251	297	6	48	1.3	18	0.98
CMPS0654	251	297	6	54	1.3	18	1.13
CMPS0660	290	329	6	60	1.3	20	1.28

CMPSG • Integrated Privacy Glass Divider

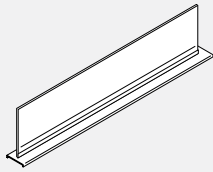

- Privacy Glass integrated with aluminum top trim.
- Attaches on top of panels to add privacy or divide space Includes aluminum trim with channel and glass tile.
- Standard in clear (CLR) or frosted (FRST) glass.
- Glass and attachment hardware to ship seperately.

PRODUCT CODE	PRICE		SIZE/INCHES			WEIGHT VOL	
	CLR	FRST	H	W	D	LBS	FT ³
CMPSG0624	177	222	6.40	22.67	2.41	3.54	0.20
CMPSG0630	194	244	6.40	28.67	2.41	4.49	0.26
CMPSG0636	206	257	6.40	34.67	2.41	5.44	0.31
CMPSG0642	222	276	6.40	40.67	2.41	6.39	0.36
CMPSG0648	231	288	6.40	46.67	2.41	7.34	0.42
CMPSG0654	238	297	6.40	52.67	2.41	8.29	0.47
CMPSG0660	244	303	6.40	58.67	2.41	9.23	0.52
CMPSG0924	177	222	9.40	22.67	2.41	4.99	0.30
CMPSG0930	194	244	9.40	28.67	2.41	6.32	0.38
CMPSG0936	206	257	9.40	34.67	2.41	7.66	0.46
CMPSG0942	222	276	9.40	40.67	2.41	8.99	0.53
CMPSG0948	231	288	9.40	46.67	2.41	10.33	0.61
CMPSG0954	238	297	9.40	52.67	2.41	11.66	0.69
CMPSG0960	244	303	9.40	58.67	2.41	13.00	0.77
CMPSG1224	177	222	12.40	22.67	2.41	6.43	0.39
CMPSG1230	194	244	12.40	28.67	2.41	8.15	0.50
CMPSG1236	206	257	12.40	34.67	2.41	9.87	0.60
CMPSG1242	222	276	12.40	40.67	2.41	11.59	0.70
CMPSG1248	231	288	12.40	46.67	2.41	13.31	0.81
CMPSG1254	238	297	12.40	52.67	2.41	15.04	0.91
CMPSG1260	244	303	12.40	58.67	2.41	16.76	1.02

CMPEEG • Integrated Privacy Glass Extended Divider

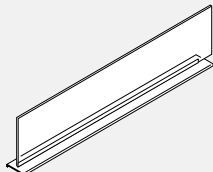

- Privacy Glass integrated with aluminum top trim.
- Glass is longer to extend partially over the post for a corner application.
- Attaches on top of panels to add privacy or divide space Includes aluminum trim with channel and glass tile.
- Standard in clear (CLR) or frosted (FRST) glass.
- Glass and attachment hardware to ship seperately.

PRODUCT CODE	PRICE		SIZE/INCHES			WEIGHT VOL	
	CLR	FRST	H	W	D	LBS	FT ³
CMPEEG0624	177	222	6.4	23.88	2.41	3.54	0.21
CMPEEG0630	194	244	6.4	29.88	2.41	4.49	0.27
CMPEEG0636	206	257	6.4	35.88	2.41	5.44	0.32
CMPEEG0642	222	276	6.4	41.88	2.41	6.39	0.37
CMPEEG0648	231	288	6.4	47.88	2.41	7.34	0.43
CMPEEG0654	238	297	6.4	53.88	2.41	8.29	0.48
CMPEEG0660	244	303	6.4	59.88	2.41	9.23	0.54
CMPEEG0924	177	222	9.4	23.88	2.41	4.99	0.31
CMPEEG0930	194	244	9.4	29.88	2.41	6.32	0.39
CMPEEG0936	206	257	9.4	35.88	2.41	7.66	0.47
CMPEEG0942	222	276	9.4	41.88	2.41	8.99	0.55
CMPEEG0948	231	288	9.4	47.88	2.41	10.33	0.63
CMPEEG0954	238	297	9.4	53.88	2.41	11.66	0.71
CMPEEG0960	244	303	9.4	59.88	2.41	13	0.79
CMPEEG1224	177	222	12.4	23.88	2.41	6.43	0.41
CMPEEG1230	194	244	12.4	29.88	2.41	8.15	0.52
CMPEEG1236	206	257	12.4	35.88	2.41	9.87	0.62
CMPEEG1242	222	276	12.4	41.88	2.41	11.59	0.73
CMPEEG1248	231	288	12.4	47.88	2.41	13.31	0.83
CMPEEG1254	238	297	12.4	53.88	2.41	15.04	0.93
CMPEEG1260	244	303	12.4	59.88	2.41	16.76	1.04

CMPSF • Integrated Felt Divider

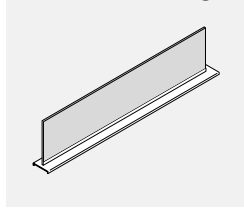

- Privacy felt panel intergrated with aluminum top trim.
- Attaches on top of panels to add privacy or divide space. Includes aluminum trim with channel and felt tile.
- Felt and attachment hardware to ship seperaretyly.
- 9mm Felt material is tackable and comes in 18 different colours. Please specify colour.

PRODUCT CODE	PRICE	SIZE /INCHES			WEIGHT VOL	
		H	W	D	LBS	FT ³
CMPSF0624	64	6.33	22.42	2.41	1.21	0.20
CMPSF0630	76	6.33	28.42	2.41	1.54	0.25
CMPSF0636	89	6.33	34.42	2.41	1.86	0.30
CMPSF0642	100	6.33	40.42	2.41	2.19	0.36
CMPSF0648	151	6.33	46.42	2.41	2.51	0.41
CMPSF0654	164	6.33	52.42	2.41	2.84	0.46
CMPSF0660	175	6.33	58.42	2.41	3.16	0.52
CMPSF0924	64	9.33	22.42	2.41	1.48	0.29
CMPSF0930	76	9.33	28.42	2.41	1.87	0.37
CMPSF0936	89	9.33	34.42	2.41	2.27	0.45
CMPSF0942	100	9.33	40.42	2.41	2.66	0.53
CMPSF0948	151	9.33	46.42	2.41	3.06	0.60
CMPSF0954	164	9.33	52.42	2.41	3.45	0.68
CMPSF0960	175	9.33	58.42	2.41	3.85	0.76
CMPSF1224	64	12.33	22.42	2.41	1.74	0.39
CMPSF1230	76	12.33	28.42	2.41	2.20	0.49
CMPSF1236	89	12.33	34.42	2.41	2.67	0.59
CMPSF1242	100	12.33	40.42	2.41	3.14	0.70
CMPSF1248	151	12.33	46.42	2.41	3.60	0.80
CMPSF1254	164	12.33	52.42	2.41	4.07	0.90
CMPSF1260	175	12.33	58.42	2.41	4.53	1.01

CMPEF • Integrated Felt Extended Divider

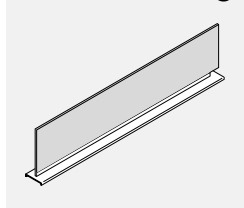

- Privacy felt panel intergrated with aluminum top trim.
- Felt is longer to extend partially over the post for a corner application.
- Attaches on top of panels to add privacy or divide space. Includes aluminum trim with channel and felt tile.
- Felt and attachment hardware to ship seperaretyly.
- 9mm Felt material is tackable and comes in 18 different colours. Please specify colour.

PRODUCT CODE	PRICE	SIZE /INCHES			WEIGHT VOL	
		H	W	D	LBS	FT ³
CMPEF0624	64	6.33	23.88	2.41	1.21	0.21
CMPEF0630	76	6.33	29.88	2.41	1.54	0.36
CMPEF0636	89	6.33	35.88	2.41	1.86	0.32
CMPEF0642	100	6.33	41.88	2.41	2.19	0.37
CMPEF0648	151	6.33	47.88	2.41	2.51	0.42
CMPEF0654	164	6.33	53.88	2.41	2.84	0.48
CMPEF0660	175	6.33	59.88	2.41	3.16	0.53
CMPEF0924	64	9.33	23.88	2.41	1.48	0.31
CMPEF0930	76	9.33	29.88	2.41	1.87	0.39
CMPEF0936	89	9.33	35.88	2.41	2.27	0.47
CMPEF0942	100	9.33	41.88	2.41	2.66	0.55
CMPEF0948	151	9.33	47.88	2.41	3.06	0.62
CMPEF0954	164	9.33	53.88	2.41	3.45	0.7
CMPEF0960	175	9.33	59.88	2.41	3.85	0.78
CMPEF1224	64	12.33	23.88	2.41	1.74	0.41
CMPEF1230	76	12.33	29.88	2.41	2.2	0.51
CMPEF1236	89	12.33	35.88	2.41	2.67	0.62
CMPEF1242	100	12.33	41.88	2.41	3.14	0.72
CMPEF1248	151	12.33	47.88	2.41	3.6	0.82
CMPEF1254	164	12.33	53.88	2.41	4.07	0.93
CMPEF1260	175	12.33	59.88	2.41	4.53	1.03

CMLEP-NC • End of Run Gallery Panel With No End Connection

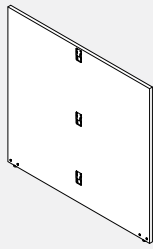

- Provides floor standing support while enclosing the end of a panel run.
- Attached at the end of a straight panel run with connectors to form a T configuration.
- No connections at both ends, connection is at the center interior face.
- Includes all attachment hardware and glides.
- Total height is inclusive of panel glides extended to their full height.
- 51" wide gallery panel accommodates two 24" deep surface while the 63" wide accommodates two 30" deep surfaces.
- Please specify LP laminate finish and PVC edge finish.
- If a wood grain laminate is chosen, grain direction run horizontally.
- Gallery panel is edged in PVC on exposed edges and self edged on bottom.

PRODUCT CODE	PRICE LP	SIZE/INCHES			WEIGHT LBS	VOL FT ³
		H	W	D		
CMLEP4227NC	290	42	26.25	1	28.70	0.64
CMLEP4251NC	508	42	50.30	1	57.25	3.67
CMLEP4263NC	589	42	62.30	1	70.75	4.54
CMLEP4827NC	319	48	26.25	1	32.80	0.73
CMLEP4851NC	558	48	50.30	1	65.50	4.19
CMLEP4863NC	648	48	62.30	1	80.95	5.19
CMLEP5427NC	348	54	26.25	1	36.90	0.82
CMLEP5451NC	608	54	50.30	1	73.65	4.72
CMLEP5463NC	706	54	62.30	1	91.05	5.84

CMLMP-NC • Middle of Run Gallery Panel With No End Connection

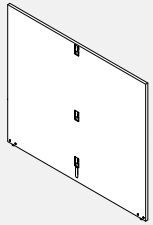

- Provides floor standing support in the middle of a panel run.
- Attached in the middle of a straight panel run with connectors to form an X configuration..
- No connections at both ends, connection is at center on both faces.
- Includes all attachment hardware and glides.
- Total height is inclusive of panel glides extended to their full height.
- 51" wide gallery panel accommodates two 24" deep surface while the 63" wide accommodates two 30" deep surfaces.
- Please specify LP laminate finish and PVC edge finish.
- If a wood grain laminate is chosen, grain direction run horizontally.
- Gallery panel is edged in PVC on exposed edges and self edged on bottom.

PRODUCT CODE	PRICE LP	SIZE/INCHES			WEIGHT LBS	VOL FT ³
		H	W	D		
CMLMP4251NC	590	42	50.30	1	57.25	3.67
CMLMP4263NC	672	42	62.30	1	70.75	4.54
CMLMP4851NC	639	48	50.30	1	65.50	4.19
CMLMP4863NC	730	48	62.30	1	80.95	5.19
CMLMP5451NC	690	54	50.30	1	73.65	4.72
CMLMP5463NC	790	54	62.30	1	91.05	5.84

CMLSEPL-NC • Single End Of Run Gallery Panel With No End Connection

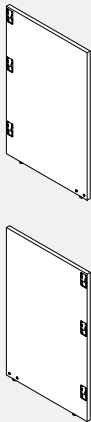

- Provides floor standing support while enclosing the end of a panel run.
- Attached at the end of a straight panel run with connectors to form an L configuration.
- No connection at ends, connection is on interior face at one end.
- Includes all attachment hardware and glides.
- Total height is inclusive of panel glides extended to their full height.
- 27" wide gallery panel accommodates a 24" deep surface while the 33" wide accommodates a 30" deep surface.
- Please specify LP laminate finish and PVC edge finish.
- If a wood grain laminate is chosen, grain direction run horizontally.
- Gallery panel is edged in PVC on exposed edges and self edged on bottom.

PRODUCT CODE	PRICE LP	SIZE/INCHES			WEIGHT LBS	VOL FT ³
		H	W	D		
CMLSEPL4215NC	218	42	14.25	1	15.72	0.35
CMLSEPR4215NC	218	48	14.25	1	15.72	0.40
CMLSEPL4815NC	237	48	14.25	1	17.95	0.40
CMLSEPR4815NC	237	48	14.25	1	17.95	0.40
CMLSEPL5415NC	255	54	14.25	1	20.18	0.45
CMLSEPR5415NC	255	54	14.25	1	20.18	0.45
CMLSEPL4227NC	385	42	26.30	1	29.99	1.9
CMLSEPR4227NC	385	42	26.30	1	29.99	1.9
CMLSEPL4827NC	421	48	26.30	1	34.28	2.2
CMLSEPR4827NC	421	48	26.30	1	34.28	2.2
CMLSEPL5427NC	459	54	26.30	1	38.56	2.5
CMLSEPR5427NC	459	54	26.30	1	38.56	2.5
CMLSEPL4233NC	398	42	32.33	1	36.77	2.4
CMLSEPR4233NC	398	42	32.33	1	36.77	2.4
CMLSEPL4833NC	435	48	32.33	1	42.03	2.7
CMLSEPR4833NC	435	48	32.33	1	42.03	2.7
CMLSEPL5433NC	471	54	32.33	1	47.3	3.0
CMLSEPR5433NC	471	54	32.33	1	47.3	3.0

CMLSMP-NC • Single Middle of Run Gallery Panel With No End Connection



- Provides floor standing support at the middle of a panel run.
- Attached in the middle of a straight panel run with connectors to form a T configuration.
- No connections at the exposed end, connection is at both the interior and exterior face near the opposite end.
- Includes all attachment hardware and glides.
- Total height is inclusive of panel glides extended to their full height.
- 27" wide gallery panel accommodates a 24" deep surface while the 33" wide accommodates a 30" deep surface.
- Please specify LP laminate finish and PVC edge finish.
- If a wood grain laminate is chosen, grain direction run horizontally.
- Gallery panel is edged in PVC on exposed edges and self edged on bottom.

PRODUCT CODE	PRICE LP	SIZE/INCHES			WEIGHT LBS	VOL FT ³
		H	W	D		
CMLSMP4227NC	469	42	26.30	1	30.14	1.92
CMLSMP4827NC	505	48	26.30	1	34.42	2.19
CMLSMP5427NC	540	54	26.30	1	38.72	2.47
CMLSMP4233NC	483	42	32.30	1	36.92	2.36
CMLSMP4833NC	520	48	32.30	1	42.18	2.69
CMLSMP5433NC	557	54	32.30	1	47.45	3.03

CMLEP • End Of Run Gallery Panel With End Connections

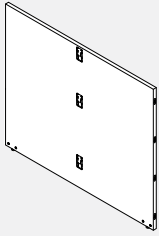

- Provides floor standing support while enclosing the end of a panel run.
- Attached at the end of a straight panel run with connectors to form a T configuration.
- Connections at both ends as well as the center on the interior face.
- Includes all attachment hardware and glides.
- Total height is inclusive of panel glides extended to their full height.
- 51" wide gallery panel accommodates two 24" deep surface while the 63" wide accommodates two 30" deep surfaces.
- Please specify LP laminate finish and PVC edge finish.
- If a wood grain laminate is chosen, grain direction run horizontally.
- Gallery panel is edged in PVC on exposed edges and self edged on edge connecting to panel and bottom edge.

PRODUCT CODE	PRICE LP	SIZE/INCHES			WEIGHT VOL	
		H	W	D	LBS	FT ³
CMLEP4251	527	42	50.30	1	57.25	3.67
CMLEP4263	608	42	62.30	1	70.75	4.54
CMLEP4851	576	48	50.30	1	65.50	4.19
CMLEP4863	668	48	62.30	1	80.95	5.19
CMLEP5451	627	54	50.30	1	73.65	4.72
CMLEP5463	726	54	62.30	1	91.05	5.84

CMLMP • Middle of Run Gallery Panel With End Connections

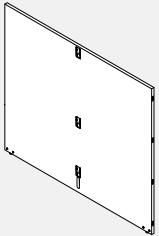

- Provides floor standing support in the middle of a panel run.
- Attached in the middle of a straight panel run with connectors to form an X configuration.
- Connections at both ends as well as the center on the interior and exterior face.
- Includes all attachment hardware and glides.
- Total height is inclusive of panel glides extended to their full height.
- 51" wide gallery panel accommodates two 24" deep surface while the 63" wide accommodates two 30" deep surfaces.
- Please specify LP laminate finish and PVC edge finish.
- If a wood grain laminate is chosen, grain direction run horizontally.
- Gallery panel is edged in PVC on exposed edges and self edged on edge connecting to panel and bottom edge.

PRODUCT CODE	PRICE LP	SIZE/INCHES			WEIGHT VOL	
		H	W	D	LBS	FT ³
CMLMP4251	594	42	50.30	1	57.25	3.67
CMLMP4263	675	42	62.30	1	70.75	4.54
CMLMP4851	646	48	50.30	1	65.50	4.19
CMLMP4863	735	48	62.30	1	80.95	5.19
CMLMP5451	694	54	50.30	1	73.65	4.72
CMLMP5463	794	54	62.30	1	91.05	5.84

CMLSEPL • Single End Panel With End Connections

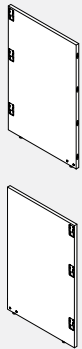

- Provides floor standing support while enclosing the end of a panel run.
- Attached at the end of a straight panel run with connectors to form an L configuration.
- Connections are at the exposed end on one side and near the end on the other interior face.
- Total height is inclusive of panel glides extended to their full height.
- 27" wide gallery panel accommodates a 24" deep surface while the 33" wide accommodates a 30" deep surface.
- Please specify LP laminate finish and PVC edge finish.
- If a wood grain laminate is chosen, grain direction run horizontally.
- Gallery panel is edged in PVC on exposed edges and self edged on edge connecting to panel and bottom edge.

PRODUCT CODE	PRICE LP	SIZE/INCHES			WEIGHT VOL	
		H	W	D	LBS	FT ³
CMLSEPL4227	396	42	26.30	1	29.99	1.9
CMLSEPR4227	396	42	26.30	1	29.99	1.9
CMLSEPL4827	431	48	26.30	1	34.28	2.2
CMLSEPR4827	431	48	26.30	1	34.28	2.2
CMLSEPL5427	468	54	26.30	1	38.56	2.5
CMLSEPR5427	468	54	26.30	1	38.56	2.5
CMLSEPL4233	407	42	32.33	1	36.77	2.4
CMLSEPR4233	407	42	32.33	1	36.77	2.4
CMLSEPL4833	444	48	32.33	1	42.03	2.7
CMLSEPR4833	444	48	32.33	1	42.03	2.7
CMLSEPL5433	482	54	32.33	1	47.3	3.0
CMLSEPR5433	482	54	32.33	1	47.3	3.0

CMLSMP • Single Middle of Run Gallery Panel With End Connections

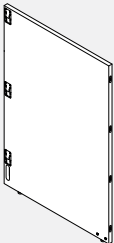

- Provides floor standing support at the middle of a panel run.
- Attached in the middle of a straight panel run with connectors to form a T configuration
- Connections are at the exposed end and at the interior and exterior near the opposite end, allows for left connection of CML2PL only.
- Includes all attachment hardware and glides.
- Total height is inclusive of panel glides extended to their full height.
- 27" wide gallery panel accommodates a 24" deep surface while the 33" wide accommodates a 30" deep surface.
- Please specify LP laminate finish and PVC edge finish.
- If a wood grain laminate is chosen, grain direction run horizontally.
- Gallery panel is edged in PVC on exposed edges and self edged on edge connecting to panel and bottom edge.

PRODUCT CODE	PRICE LP	SIZE/INCHES			WEIGHT VOL	
		H	W	D	LBS	FT ³
CMLSMP4227	480	42	26.30	1.00	30.14	1.92
CMLSMP4827	514	48	26.30	1.00	34.42	2.19
CMLSMP5427	550	54	26.30	1.00	38.72	2.47
CMLSMP4233	493	42	32.30	1.00	36.92	2.36
CMLSMP4833	530	48	32.30	1.00	42.18	2.69
CMLSMP5433	567	54	32.30	1.00	47.45	3.03

CML2PL • Left Two Way Return End of Run Gallery Panel With End Connections



- Provides floor standing support while enclosing the end of a panel run.
- Attached at the end of a gallery panel with connectors to form an L configuration.
- Connections are at one exposed end.
- Includes all attachment hardware and glides.
- Total height is inclusive of panel glides extended to their full height.
- 25" wide gallery panel accommodates a 24" deep surface while the 31" wide accommodates a 30" deep surface.
- Please specify LP laminate finish and PVC edge finish.
- If a wood grain laminate is chosen, grain direction run horizontally.
- Gallery panel is edged in PVC on exposed edges and self edged on edge connecting to panel and bottom edge.

PRODUCT CODE	PRICE LP	SIZE/INCHES			WEIGHT VOL	
		H	W	D	LBS	FT ³
CML2PL4213	149	42	13	1	14.16	0.32
CML2PL4225	314	42	25	1	27.14	1.82
CML2PL4231	321	42	31	1	33.62	2.26
CML2PL4813	167	48	13	1	16.19	0.36
CML2PL4825	349	48	25	1	31.04	2.08
CML2PL4831	359	48	31	1	38.47	2.58
CML2PL5413	186	54	13	1	18.22	0.41
CML2PL5425	384	54	25	1	34.95	2.34
CML2PL5431	396	54	31	1	43.31	2.91

CML2PR • Right Two Way Return End of Run Gallery Panel With End Connections



- Provides floor standing support while enclosing the end of a panel run.
- Attached at the end of a gallery panel with connectors to form an L configuration.
- Connections are at one exposed end.
- Includes all attachment hardware and glides.
- Total height is inclusive of panel glides extended to their full height.
- 25" wide gallery panel accommodates a 24" deep surface while the 31" wide accommodates a 30" deep surface.
- Please specify LP laminate finish and PVC edge finish.
- If a wood grain laminate is chosen, grain direction run horizontally.
- Gallery panel is edged in PVC on exposed edges and self edged on edge connecting to panel and bottom edge.

PRODUCT CODE	PRICE LP	SIZE/INCHES			WEIGHT VOL	
		H	W	D	LBS	FT ³
CML2PR4213	149	42	13	1	14.16	0.32
CML2PR4225	314	42	25	1	27.14	1.82
CML2PR4231	321	42	31	1	33.62	2.26
CML2PR4813	167	48	13	1	16.19	0.36
CML2PR4825	349	48	25	1	31.04	2.08
CML2PR4831	359	48	31	1	38.47	2.58
CML2PR5413	186	54	13	1	18.22	0.41
CML2PR5425	384	54	25	1	34.95	2.34
CML2PR5431	396	54	31	1	43.31	2.91

CML3PL • Left Three Way Return End of Run Gallery Panel

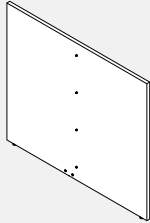

- Provides floor standing support while enclosing the end of a gallery panel run.
- Attached at the end of a gallery panel with connectors to form a T configuration.
- There are no connections at the exposed ends. Connection is at the center of the interior face.
- Connects to CMLXPL or CMLSEPL.
- Includes all attachment hardware and glides.
- Total height is inclusive of panel glides extended to their full height.
- 49" wide gallery panel accommodates two 24" deep surface while the 61" wide accommodates two 30" deep surfaces.
- Please specify LP laminate finish and PVC edge finish.
- If a wood grain laminate is chosen, grain direction run horizontally.
- Gallery panel is edged in PVC on exposed edges and self edged on edge connecting to panel and bottom edge.

PRODUCT CODE	PRICE LP	SIZE/INCHES			WEIGHT VOL	
		H	W	D	LBS	FT ³
CML3PL4225	222	42	25	1.3	27.14	0.79
CML3PL4249	435	42	49	1	53.09	3.57
CML3PL4261	514	42	61	1	66.06	4.45
CML3PL4825	249	48	25	1.3	31.04	0.90
CML3PL4849	484	48	49	1	60.74	4.08
CML3PL4861	574	48	61	1	75.60	5.08
CML3PL5425	278	54	25	1.3	34.95	1.02
CML3PL5449	534	54	49	1	68.40	4.59
CML3PL5461	634	54	61	1	85.13	5.72

CML3PR • Right Three Way Return End of Run Gallery Panel

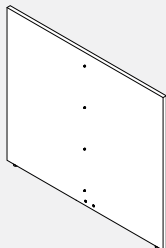

- Provides floor standing support while enclosing the end of a gallery panel run.
- Attached at the end of a gallery panel with connectors to form a T configuration.
- There are no connections at the exposed ends. Connection is at the center of the interior face.
- Connects to CMLXPR or CMLSEPR.
- Includes all attachment hardware and glides.
- Total height is inclusive of panel glides extended to their full height.
- 49" wide gallery panel accommodates two 24" deep surface while the 61" wide accommodates two 30" deep surfaces.
- Please specify LP laminate finish and PVC edge finish.
- If a wood grain laminate is chosen, grain direction run horizontally.
- Gallery panel is edged in PVC on exposed edges and self edged on edge connecting to panel and bottom edge.

PRODUCT CODE	PRICE LP	SIZE/INCHES			WEIGHT VOL	
		H	W	D	LBS	FT ³
CML3PR4225	222	42	25	1.3	27.14	0.79
CML3PR4249	435	42	49	1	53.09	3.57
CML3PR4261	514	42	61	1	66.06	4.45
CML3PR4825	249	48	25	1.3	31.04	0.90
CML3PR4849	484	48	49	1	60.74	4.08
CML3PR4861	574	48	61	1	75.60	5.08
CML3PR5425	278	54	25	1.3	34.95	1.02
CML3PR5449	534	54	49	1	68.40	4.59
CML3PR5461	634	54	61	1	85.13	5.72

CMLXPL • Left Extension End of Run Return Gallery Panel With End Connection

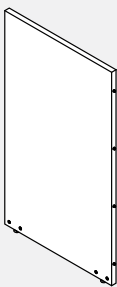

- Provides floor standing support while enclosing the end of a gallery panel run.
- Attached at the end of a panel to allow for extending the gallery panel run.
- Connections at both exposed ends, one to connect to the panel and one to connect to another gallery panel.
- Includes all attachment hardware and glides.
- Total height is inclusive of panel glides extended to their full height.
- Please specify LP laminate finish and PVC edge finish.
- If a wood grain laminate is chosen, grain direction run horizontally.
- Gallery panel is edged in PVC on exposed edges and self edges on edge connecting to panel.

PRODUCT CODE	PRICE LP	SIZE/INCHES			WEIGHT VOL	
		H	W	D	LBS	FT ³
CMLXPL4212	138	42	12.3	1	13.08	0.30
CMLXPL4224	260	42	24	1	26.1	1.75
CMLXPL4230	305	42	30	1	32.59	2.19
CMLXPL4236	350	42	36	1	39.07	2.63
CMLXPL4242	441	42	42	1	45.56	3.06
CMLXPL4248	455	42	48	1	52.05	3.50
CMLXPL4812	154	48	12.3	1	14.95	0.34
CMLXPL4824	268	48	24	1	29.85	2.00
CMLXPL4830	315	48	30	1	37.27	2.50
CMLXPL4836	361	48	36	1	44.7	3.00
CMLXPL4842	455	48	42	1	52.12	3.50
CMLXPL4848	468	48	48	1	59.55	4.00
CMLXPL5412	172	54	12.3	1	16.83	0.38
CMLXPL5424	286	54	24	1	33.55	2.25
CMLXPL5430	336	54	30	1	41.92	2.81
CMLXPL5436	385	54	36	1	50.28	3.38
CMLXPL5442	437	54	42	1	58.64	3.94
CMLXPL5448	536	54	48	1	67.01	4.50

CMLXPR • Right Extension End of Run Return Gallery Panel With End Connection

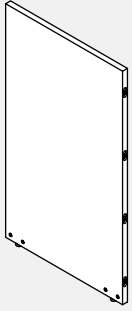

- Provides floor standing support while enclosing the end of a gallery panel run.
- Attached at the end of a panel to allow for extending the gallery panel run.
- Connections are at both exposed ends, one to connect to the panel and one to connect to another gallery panel.
- Includes all attachment hardware and glides.
- Total height is inclusive of panel glides extended to their full height.
- Please specify LP laminate finish and PVC edge finish.
- If a wood grain laminate is chosen, grain direction run horizontally.
- Gallery panel is edged in PVC on exposed edges and self edged on edge connecting to panel.

PRODUCT CODE	PRICE LP	SIZE/INCHES			WEIGHT VOL	
		H	W	D	LBS	FT ³
CMLXPR4212	138	42	12.3	1	13.08	0.30
CMLXPR4224	260	42	24	1	26.1	1.75
CMLXPR4230	305	42	30	1	32.59	2.19
CMLXPR4236	350	42	36	1	39.07	2.63
CMLXPR4242	441	42	42	1	45.56	3.06
CMLXPR4248	455	42	48	1	52.05	3.50
CMLXPR4812	154	48	12.3	1	14.95	0.34
CMLXPR4824	268	48	24	1	29.85	2.00
CMLXPR4830	315	48	30	1	37.27	2.50
CMLXPR4836	361	48	36	1	44.7	3.00
CMLXPR4842	455	48	42	1	52.12	3.50
CMLXPR4848	468	48	48	1	59.55	4.00
CMLXPR5412	172	54	12.3	1	16.83	0.38
CMLXPR5424	286	54	24	1	33.55	2.25
CMLXPR5430	336	54	30	1	41.92	2.81
CMLXPR5436	385	54	36	1	50.28	3.38
CMLXPR5442	437	54	42	1	58.64	3.94
CMLXPR5448	536	54	48	1	67.01	4.50

CMLXPL-NC • Extension End of Run, Left, No Connection

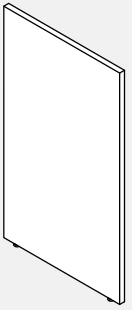

- Provides floor standing support while enclosing the end of a gallery panel run.
- Attached at the end of a gallery panel to extend the gallery panel run.
- Connections only at one exposed end.
- Includes all attachment hardware and glides.
- Total height is inclusive of panel glides extended to their full height.
- Please specify LP laminate finish and PVC edge finish.
- If a wood grain laminate is chosen, grain direction run horizontally.
- Gallery panel is edged in PVC on exposed edges and self edged on edge connecting to panel.

PRODUCT CODE	PRICE LP	SIZE/INCHES			WEIGHT VOL	
		H	W	D	LBS	FT ³
CMLXPL4224NC	257	42	24	1	26.05	1.75
CMLXPL4230NC	303	42	30	1	32.54	2.19
CMLXPL4236NC	349	42	36	1	39.03	2.63
CMLXPL4242NC	439	42	42	1	45.52	3.06
CMLXPL4248NC	451	42	48	1	52.01	3.50
CMLXPL4824NC	266	48	24	1	29.8	2.00
CMLXPL4830NC	314	48	30	1	37.23	2.50
CMLXPL4836NC	359	48	36	1	44.66	3.00
CMLXPL4842NC	451	48	42	1	52.08	3.50
CMLXPL4848NC	466	48	48	1	59.51	4.00
CMLXPL5424NC	284	54	24	1	33.55	2.25
CMLXPL5430NC	334	54	30	1	41.92	2.81
CMLXPL5436NC	384	54	36	1	50.28	3.38
CMLXPL5442NC	435	54	42	1	58.64	3.94
CMLXPL5448NC	534	54	48	1	67.01	4.50

CMLXPR-NC • Extension End of Run, Right, No Connection

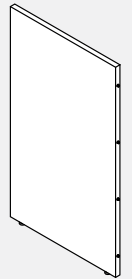

- Provides floor standing support while enclosing the end of a gallery panel run.
- Attached at the end of a gallery panel to extend the gallery panel run.
- Connections only at one exposed end.
- Includes all attachment hardware and glides.
- Total height is inclusive of panel glides extended to their full height.
- Please specify LP laminate finish and PVC edge finish.
- If a wood grain laminate is chosen, grain direction run horizontally.
- Gallery panel is edged in PVC on exposed edges and self edged on edge connecting to panel.

PRODUCT CODE	PRICE LP	SIZE/INCHES			WEIGHT VOL	
		H	W	D	LBS	FT ³
CMLXPR4224NC	257	42	24	1	26.05	1.75
CMLXPR4230NC	303	42	30	1	32.54	2.19
CMLXPR4236NC	349	42	36	1	39.03	2.63
CMLXPR4242NC	439	42	42	1	45.52	3.06
CMLXPR4248NC	451	42	48	1	52.01	3.5
CMLXPR4824NC	266	48	24	1	29.8	2
CMLXPR4830NC	314	48	30	1	37.23	2.5
CMLXPR4836NC	359	48	36	1	44.66	3
CMLXPR4842NC	451	48	42	1	52.08	3.5
CMLXPR4848NC	466	48	48	1	59.51	4
CMLXPR5424NC	284	54	24	1	33.55	2.25
CMLXPR5430NC	334	54	30	1	41.92	2.81
CMLXPR5436NC	384	54	36	1	50.28	3.38
CMLXPR5442NC	435	54	42	1	58.64	3.94
CMLXPR5448NC	534	54	48	1	67.01	4.5

CMHLPBB01 • Gallery Panel Bracket

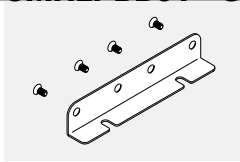

- Gallery panel bottom bracket connects two gallery end panels at bottom with screws.
- Available in standard paint colors.
- Screws are included with the bracket.

PRODUCT CODE	PRICE	SIZE / INCHES			WEIGHT VOL	
		H	W	D	LBS	FT ³
CMHLPBB01	34	1.5	8.00	1	0.5	0.11

CMHLPCB01 • Gallery Panel Corner Bracket

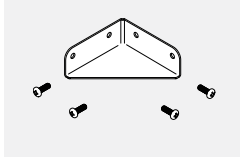

- Gallery panel corner bottom bracket connects two laminate panels at 90 degrees.
- Available in standard paint colors.
- Screws are included with the bracket.

PRODUCT CODE	PRICE	SIZE / INCHES			WEIGHT VOL	
		H	W	D	LBS	FT ³
CMHLPCB01	33	1.5	4.00	4	0.5	0.11

CMPMP-GI-W • Privacy Glass for 1" Laminate Gallery Panels

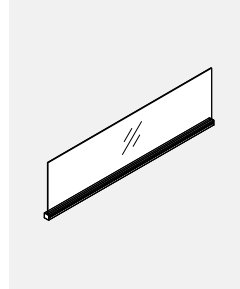

- **Privacy glass integrated with aluminum top trim.**
- Attaches on top of gallery panels to add privacy or divide space.
- Includes aluminum trim with channel, end caps and glass tile.
- Top rail may also be used to hang accessories.
- Glass and attachment hardware ship separately.
- Please specify standard paint finish for the channel.
- Standard in clear (CLR) or frosted (FRST).

PRODUCT CODE	PRICE	FRST	SIZE / INCHES			WEIGHT LBS	VOL FT ³
			H	W	D		
CMPMP24GI6W	195	244	6	24	1	3.58	0.08
CMPMP30GI6W	213	268	6	30	1	4.48	0.10
CMPMP36GI6W	228	283	6	36	1	5.37	0.13
CMPMP42GI6W	244	304	6	42	1	6.26	0.15
CMPMP48GI6W	254	317	6	48	1	7.16	0.17
CMPMP24GI9W	195	244	9	24	1	4.77	0.13
CMPMP30GI9W	213	268	9	30	1	5.97	0.16
CMPMP36GI9W	228	283	9	36	1	7.16	0.19
CMPMP42GI9W	244	304	9	42	1	8.35	0.22
CMPMP48GI9W	254	317	9	48	1	9.55	0.25
CMPMP24GIW	195	244	12	24	1	4.77	0.17
CMPMP30GIW	213	268	12	30	1	5.97	0.21
CMPMP36GIW	228	283	12	36	1	7.16	0.25
CMPMP42GIW	244	304	12	42	1	8.35	0.29
CMPMP48GIW	254	317	12	48	1	9.55	0.33

CMPFD-W • Privacy Felt for 1" Laminate Gallery Panels

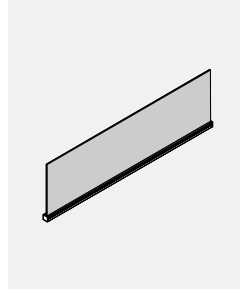

- **Privacy felt integrated with aluminum top trim.**
- Attaches on top of gallery panels to add privacy or divide space.
- Includes aluminum trim with channel, end caps and felt tile.
- Top rail may also be used to hang accessories.
- Felt and attachment hardware ship separately.
- Please specify standard paint finish for the channel.
- Please specify standard felt finish.

PRODUCT CODE	PRICE	SIZE / INCHES			WEIGHT LBS	VOL FT ³	
		H	W	D			
CMPFD0624W	70		6	24	1	1.42	0.08
CMPFD0630W	85		6	30	1	1.73	0.10
CMPFD0636W	99		6	36	1	2.03	0.13
CMPFD0642W	111		6	42	1	2.34	0.15
CMPFD0648W	165		6	48	1	2.64	0.17
CMPFD0654W	178		6	54	1	2.95	0.19
CMPFD0660W	193		6	60	1	3.25	0.21
CMPFD0666W	204		6	66	1	3.56	0.23
CMPFD0672W	231		6	72	1	3.86	0.25
CMPFD0924W	70		9	24	1	2.26	0.13
CMPFD0930W	85		9	30	1	2.77	0.16
CMPFD0936W	99		9	36	1	3.29	0.19
CMPFD0942W	111		9	42	1	3.8	0.22
CMPFD0948W	165		9	48	1	4.32	0.25
CMPFD0954W	178		9	54	1	4.83	0.28
CMPFD0960W	193		9	60	1	5.35	0.31
CMPFD0966W	204		9	66	1	6.68	0.34
CMPFD0972W	231		9	72	1	7.2	0.38
CMPFD1224W	70		12	24	1	2.26	0.17
CMPFD1230W	85		12	30	1	2.77	0.21
CMPFD1236W	99		12	36	1	3.29	0.25
CMPFD1242W	111		12	42	1	3.8	0.29
CMPFD1248W	165		12	48	1	4.32	0.33
CMPFD1254W	178		12	54	1	4.83	0.38
CMPFD1260W	193		12	60	1	5.35	0.42
CMPFD1266W	204		12	66	1	6.68	0.46
CMPFD1272W	231		12	72	1	7.2	0.50

CHP • 90 Degree Corner Post Kits



- Standard Compile paint options.
- Specify the corner post height that matches the tallest or smallest panel connection.
- 6" shorter than panel height to accommodate electric in base.
- Made of aluminum.
- 2-Way Kits include 2 trims (CMETP), 2 way post base (CMPC) and post cap (CMPC).
- 3-Way Kits include 1 trim (CMTEP), 3 way post base (CMPC) and post cap (CMPC).
- 4 Way Kits includes post cap (CMPC) only.

PRODUCT CODE	PRICE	SIZE/ INCHES			WEIGHT VOL	
		H	W	D	LBS	FT ³
2-Way Kits						
CHP30-2	101	30	2.3	2.3	5	0.22
CHP42-2	101	42	2.3	2.3	5	0.22
CHP46-2	106	46	2.3	2.3	5	0.22
CHP48-2	122	48	2.3	2.3	5	0.22
CHP54-2	122	54	2.3	2.3	5	0.22
CHP58-2	132	58	2.3	2.3	5	0.22
CHP60-2	132	60	2.3	2.3	5	0.22
CHP64-2	153	64	2.3	2.3	5	0.22
CHP66-2	147	66	2.3	2.3	5	0.22
CHP70-2	156	70	2.3	2.3	5	0.22
CHP72-2	153	72	2.3	2.3	5	0.22
CHP78-2	174	78	2.3	2.3	5	0.22
CHP82-2	184	82	2.3	2.3	5	0.22
CHP90-2	184	90	2.3	2.3	5	0.22
3-Way Kits						
CHP30-3	88	30	2.3	2.3	5	0.22
CHP42-3	88	42	2.3	2.3	5	0.22
CHP46-3	97	46	2.3	2.3	5	0.22
CHP48-3	107	48	2.3	2.3	5	0.22
CHP54-3	107	54	2.3	2.3	5	0.22
CHP58-3	120	58	2.3	2.3	5	0.22
CHP60-3	120	60	2.3	2.3	5	0.22
CHP64-3	128	64	2.3	2.3	5	0.22
CHP66-3	132	66	2.3	2.3	5	0.22
CHP70-3	139	70	2.3	2.3	5	0.22
CHP72-3	139	72	2.3	2.3	5	0.22
CHP78-3	156	78	2.3	2.3	5	0.22
CHP82-3	165	82	2.3	2.3	5	0.22
CHP90-3	182	90	2.3	2.3	5	0.22
4-Way Kits						
CHP30-4	66	30	2.3	2.3	5	0.22
CHP42-4	66	42	2.3	2.3	5	0.22
CHP46-4	87	46	2.3	2.3	5	0.22
CHP48-4	86	48	2.3	2.3	5	0.22
CHP54-4	86	54	2.3	2.3	5	0.22
CHP58-4	99	58	2.3	2.3	5	0.22
CHP60-4	99	60	2.3	2.3	5	0.22
CHP64-4	103	64	2.3	2.3	5	0.22
CHP66-4	109	66	2.3	2.3	5	0.22
CHP70-4	113	70	2.3	2.3	5	0.22
CHP72-4	113	72	2.3	2.3	5	0.22
CHP78-4	129	78	2.3	2.3	5	0.22
CHP82-4	135	82	2.3	2.3	5	0.22
CHP90-4	151	90	2.3	2.3	5	0.22

CHOP • 90 Degree Corner Post Kits for Over Panels



- Standard Compile paint options.
- Specify the corner post height that matches the height of the over panel
- Made of aluminum.

PRODUCT CODE	PRICE	SIZE/ INCHES			WEIGHT VOL	
		H	W	D	LBS	FT ³
CHOP12-4	26	12	2.3	2.3	5	0.22
CHOP16-4	40	16	2.3	2.3	5	0.22
CHOP24-4	39	24	2.3	2.3	5	0.22

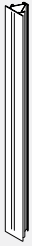
CHP2W • 60 Degree 2 Way Corner Post

- Standard Compile paint options.
- Specify the corner post height that matches the tallest or smallest panel connection.
- Note: Made of aluminum.
- Outer part is full panel height, inner part is 6" shorter.
- Post cap included.

PRODUCT CODE	PRICE	SIZE/ INCHES			WEIGHT VOL	
		H	W	D	LBS	FT ³
CHP2W30	66	30	2.3	2.3	5	0.22
CHP2W42	66	42	2.3	2.3	5	0.22
CHP2W46	73	46	2.3	2.3	5	0.22
CHP2W48	86	48	2.3	2.3	5	0.22
CHP2W54	86	54	2.3	2.3	5	0.22
CHP2W58	90	58	2.3	2.3	5	0.22
CHP2W60	100	60	2.3	2.3	5	0.22
CHP2W64	109	64	2.3	2.3	5	0.22
CHP2W66	109	66	2.3	2.3	5	0.22
CHP2W70	114	70	2.3	2.3	5	0.22
CHP2W72	114	72	2.3	2.3	5	0.22
CHP2W78	129	78	2.3	2.3	5	0.22
CHP2W82	135	82	2.3	2.3	5	0.22
CHP2W90	149	90	2.3	2.3	5	0.22

CHP3W • 60 Degree 3 Way Corner Post

- Standard Compile paint options.
- Specify the corner post height that matches the tallest or smallest panel connection.
- 6" shorter than panel height to accommodate electric in base.
- Note: Made of aluminum.
- Actual post size is 6" shorter than panel height.
- Post cap included.

PRODUCT CODE	PRICE	SIZE/ INCHES			WEIGHT VOL	
		H	W	D	LBS	FT ³
CHP3W30	66	30	2.3	2.3	5	0.22
CHP3W42	66	42	2.3	2.3	5	0.22
CHP3W46	73	46	2.3	2.3	5	0.22
CHP3W48	86	48	2.3	2.3	5	0.22
CHP3W54	86	54	2.3	2.3	5	0.22
CHP3W58	90	58	2.3	2.3	5	0.22
CHP3W60	100	60	2.3	2.3	5	0.22
CHP3W64	109	64	2.3	2.3	5	0.22
CHP3W66	109	66	2.3	2.3	5	0.22
CHP3W70	114	70	2.3	2.3	5	0.22
CHP3W72	114	72	2.3	2.3	5	0.22
CHP3W78	129	78	2.3	2.3	5	0.22
CHP3W82	135	82	2.3	2.3	5	0.22
CHP3W90	149	90	2.3	2.3	5	0.22

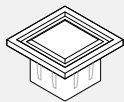
CMPC • 90 Degree Post Cap

- Included with any post.
- Specified separately for reconfiguration purposes.
- Available in standard Compile paint options.

PRODUCT CODE	PRICE	SIZE/ INCHES			WEIGHT VOL	
		H	W	D	LBS	FT ³
CMPC	7	0.7	2.5	2.5	0.02	0.01

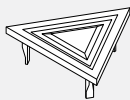
CMPC • 60 Degree Post Cap

- Included with any post.
- Specified separately for reconfiguration purposes.
- Available in standard Compile paint options.

PRODUCT CODE	PRICE	SIZE/ INCHES			WEIGHT VOL	
		H	W	D	LBS	FT ³
CMPC60	7	0.7	2.5	2.5	0.02	0.01

CMPC • Post Base Cover

- Included with any post kit.
- Specified separately for reconfiguration purposes.
- Available in standard Compile paint options.
- Available for 2-way and 3-way configurations.
- Note: Finish is smooth plastic.

PRODUCT CODE	PRICE		SIZE/INCHES			WEIGHT VOL	
			H	W	D	LBS	FT ³
CMPC1	11	3-Way	5	2.3	0.33	0.04	0.02
CMPC2	12	2-Way	5	2.3	2.31	0.08	0.04

CEPE • Data Post Extension

- Data Post extension comes with 4 trims, 3 brackets, connecting hardware and ceiling bezel and two post clips.
- Data Post extension available in standard Compile paint options. (Ceiling bezel available in white only.)
- Includes cut out along the post for easy cable insert.

PRODUCT CODE	PRICE	SIZE/INCHES			WEIGHT VOL	
		H	W	D	LBS	FT ³
CEPE64	184	64	2.3	2.3	9	0.42
CEPE82	238	82	2.3	2.3	9	0.42

CMET • End of Run Insert for Panel



- End of Run inserts are not included with panels.
- Cannot be used for a 60° and 90° post application.
- Used at the end of each panel run and cannot be used to attach a panel run to a fixed wall.
- Vertical trims must be specified separately. Trim snaps in the panel at the end of run.
- Available in standard Compile paint options.

PRODUCT CODE	PRICE	SIZE/INCHES			WEIGHT VOL	
		H	W	D	LBS	FT ³
CMET16	11	16	2.3	0.5	0.12	0.01
CMET30	13	30	2.3	0.5	0.12	0.05
CMET42	13	42	2.3	0.5	0.74	0.05
CMET46	13	46	2.3	0.5	0.74	0.05
CMET48	13	48	2.3	0.5	0.82	0.18
CMET54	13	54	2.3	0.5	0.90	0.18
CMET58	14	58	2.3	0.5	0.9	0.18
CMET60	14	60	2.3	0.5	1.48	0.31
CMET64	17	64	2.3	0.5	1.48	0.31
CMET66	17	66	2.3	0.5	1.48	0.31
CMET70	18	70	2.3	0.5	1.48	0.31
CMET72	18	72	2.3	0.5	1.48	0.31
CMET78	20	78	2.3	0.5	2.06	0.44
CMET82	21	82	2.3	0.5	2.06	0.44
CMET90	23	90	2.3	0.5	2.06	0.44

CMET • End of Run Trim Insert for Step Down



- Specify for any step down application and to meet the taller post or panel.
- Trim snaps in the post or end of run at a change in height.
- Available in standard Compile paint options.

PRODUCT CODE	PRICE	SIZE/INCHES			WEIGHT VOL	
		H	W	D	LBS	FT ³
CEMT06	4	6	2.3	0.5	0.06	0.05
CMET12	8	12	2.3	0.5	0.12	0.05
CMET24	11	24	2.3	0.5	0.12	0.05
CMET36	13	36	2.3	0.5	0.12	0.05

CMETP • Trim Insert for Corner Post



- Trim installs on all sides of an exposed Corner Post.
- Specify to equal post height.
- Vertical trims must be specified separately. Trim snaps in the post.
- Available in standard Compile paint options.

PRODUCT CODE	PRICE	SIZE/INCHES			WEIGHT VOL	
		H	W	D	LBS	FT ³
CMETP30	13	30	2.3	0.5	0.12	0.05
CMETP42	13	42	2.3	0.5	0.74	0.05
CMETP46	13	46	2.3	0.5	0.74	0.05
CMETP48	15	48	2.3	0.5	0.82	1.18
CMETP54	15	54	2.3	0.5	0.90	0.18
CMETP58	14	58	2.3	0.5	0.9	0.18
CMETP60	15	60	2.3	0.5	2.06	0.44
CMETP64	17	64	2.3	0.5	1.48	0.31
CMETP66	17	66	2.3	0.5	1.48	0.31
CMETP70	18	70	2.3	0.5	1.48	0.31
CMETP72	18	72	2.3	0.5	2.06	0.44
CMETP78	20	78	2.3	0.5	2.06	0.44
CMETP82	21	82	2.3	0.5	2.06	0.44
CMETP90	23	90	2.3	0.5	2.06	0.44

CHWA • Wall Mount Extrusion

- Starts a run of panels off an existing wall.
- Includes panel connectors.
- Mounting hardware not included. The mounting hardware selected must be based on the wall or wall stud material.
- Wall adapter adds 5/16" to a panel run.

PRODUCT CODE	PRICE	SIZE / INCHES			WEIGHT VOL	
		H	W	D	LBS	FT ³
CHWA30	36	30	2.3	0.5	0.12	0.05
CHWA42	36	42	2.3	0.5	0.74	0.05
CHWA54	45	54	2.3	0.5	0.90	0.18
CHWA66	54	66	2.3	0.5	1.48	0.31

CWMA • Wall Vertical Channel

- Used to attach system components to fixed wall.
- Panel frame finish.
- Comes in 60" length only.
- Care should be taken to mount adapters only to wall studs using correct fasteners.
- Does not include mounting hardware. Mounting hardware selection to be based on wall material.
- Sold in pairs.
- Failure to do this may result in collapse of the unit and subsequent possible personal injury.

PRODUCT CODE	PRICE	SIZE / INCHES			WEIGHT VOL	
		H	W	D	LBS	FT ³
CWMA60	30	60	0.6	0.7	1.07	0.006

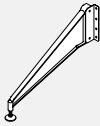
CHHF01 • High Profile Foot

- Provides added support to a panel or worksurface under load.
- Includes Compile attachment bracket and two levelling glides to adapt to different panel clearances.

PRODUCT CODE	PRICE	SIZE / INCHES			WEIGHT VOL	
		H	W	D	LBS	FT ³
CHHF01	242	6	1	21	2.80	0.15

CMPS01 • Post Separator

- Creates a diagonal division within a compile post.
- Please specify post height.

PRODUCT CODE	PRICE	SIZE / INCHES			WEIGHT VOL	
		H	W	D	LBS	FT ³
CMPS01	132	96	3.25	14 gauge	0.01	0.015

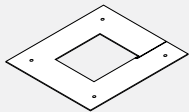
CBEZEL • Post Extension Bezel

- Finishes the connection between post extension and ceiling.
- Comes in white only.
- Includes screws.

PRODUCT CODE	PRICE	SIZE / INCHES			WEIGHT VOL	
		H	W	D	LBS	FT ³
CBEZEL	11	0.06	6	6	0.01	0.006

CMRC • Raceway Cover Without Punchouts (Each)

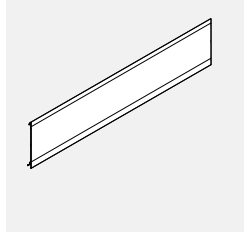

- Durable extruded aluminum.

PRODUCT CODE	PRICE	SIZE/INCHES			WEIGHT VOL	
		H	W	D	LBS	FT ³
CMRC24NP	15	5	24	0.8	1.9	0.06
CMRC30NP	20	5	30	0.8	2.0	0.06
CMRC36NP	22	5	36	0.8	2.2	0.07
CMRC42NP	24	5	42	0.8	2.5	0.08
CMRC48NP	26	5	48	0.8	2.9	0.09
CMRC54NP	33	5	54	0.8	3.2	0.10
CMRC60NP	35	5	60	0.8	3.7	0.11

CMHLPF • Flat Leg for Freestanding Panels

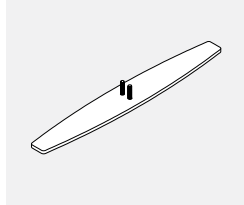

- Single flat leg for end of run/wing applications where the customer is looking for more stability.
- Kit will contains one legs and all attachment hardware.
- For the installation the customer will have to remove the existing levelers on the panel and replace it with the legs.
- Please specify paint finish.

PRODUCT CODE	PRICE	SIZE/ INCHES			WEIGHT VOL	
		H	W	D	LBS	FT ³
CMHLPF01	79	0.31	21	3	3	0.01

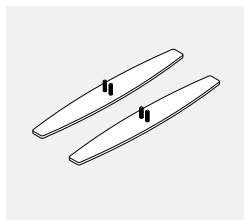

- Double kit for freestanding applications.
- Kit will contains two legs and all attachment hardware.
- For the installation the customer will have to remove the existing levelers on the panel and replace it with the legs.
- Please specify paint finish.

PRODUCT CODE	PRICE	SIZE/ INCHES			WEIGHT VOL	
		H	W	D	LBS	FT ³
CMHLPF02	157	0.31	21	3	6	0.02

CMHLLP01 • Low Profile Foot

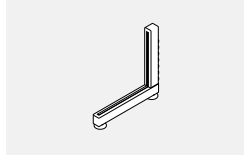

- Provides added support to a panel under load.
- Adjustable glides and connectors included.
- Made of powder coated steel.
- Please choose panel frame finish.

PRODUCT CODE	PRICE	SIZE/INCHES			WEIGHT VOL	
		H	W	D	LBS	FT ³
CMHLLP01	119	12	11	1.1	2.87	0.08

CMHLLP02 • Low Profile Foot, Set of 2

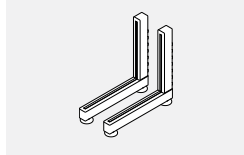

- Provides added support to a panel under load.
- Adjustable glides and connectors included.
- Made of powder coated steel.
- Please choose panel frame finish.
- Set includes 2 complete legs.

PRODUCT CODE	PRICE	SIZE/INCHES			WEIGHT VOL	
		H	W	D	LBS	FT ³
CMHLLP02	238	12	11	1.1	5.74	0.17

CMRCB01 • Electrical Blank Cover

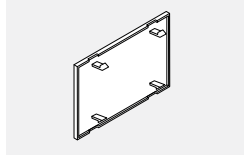

- Fills punchout when opening is not used.
- Available in Black (BLK), Tungsten (TUN), White (WHT) and Nevada (NEV).
- Note: Punchout covers are made of plastic.

PRODUCT CODE	PRICE	SIZE/INCHES			WEIGHT VOL	
		H	W	D	LBS	FT ³
CMRCB01	13	1.5	2.756	0.01	0.04	0.02

CMRC • Raceway Cover With Punchouts (Each)

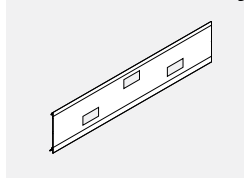

- Cover not included
- Raceway Punchout Cover must be added to openings where duplex receptacles are not used.
- Durable extruded aluminum.
- 24" wide panels have two punchouts, one for electrical and one for data.
- 30" wide panels and wider have three punchouts, two for electrical and one for data.

PRODUCT CODE	PRICE	SIZE/INCHES			WEIGHT VOL	
		H	W	D	LBS	FT ³
CMRC24PO	15	5	24	0.8	1.9	0.06
CMRC30PO	20	5	30	0.8	2.0	0.06
CMRC36PO	22	5	36	0.8	2.2	0.07
CMRC42PO	24	5	42	0.8	2.5	0.08
CMRC48PO	26	5	48	0.8	2.9	0.09
CMRC54PO	33	5	54	0.8	3.2	0.10
CMRC60PO	35	5	60	0.8	3.7	0.11
CMRC66PO	39	5	66	0.8	4.0	0.12
CMRC72PO	43	5	72	0.8	4.4	0.13

CE8PD • Power Distribution Housing

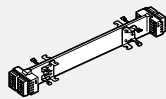

- Power distribution housing is specified per panel size (e.g. CE8PD36 is for use in a 36" panel).
- 8 wire, 4 circuits (A and B circuit dedicated). Provides two duplex receptacles per panel side on all panel widths except the 24" wide panel.
- 24" wide panel allows for only one (1) duplex receptacle on one panel side.
- Each power distribution housing supports 15 amps.
- Must specify Raceway Cover with punchouts on panels, where Power Distribution Housings will be utilized. (Panel Kits P1 and P2)

PRODUCT CODE	PRICE	SIZE/INCHES			WEIGHT VOL	
		H	W	D	LBS	FT ³
CE8PD24	142	2	9.25	2.3	0.83	1.17
CE8PD30	189	2	15.25	2.3	1.28	1.17
CE8PD36	200	2	21.25	2.3	1.62	1.65
CE8PD42	205	2	27.25	2.3	2.00	2.00
CE8PD48	216	2	33.25	2.3	2.32	2.54
CE8PD54	220	2	39.25	2.3	2.66	3.20
CE8PD60	221	2	45.25	2.3	3.04	3.20
CE8PD66	230	2	51.25	2.3	3.42	3.48
CE8PD72	238	2	57.25	2.3	3.80	3.48

CE8CP • 17" Mesh Jumper Cable

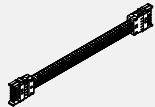

- 17" mesh jumper.
- Jumper cable is used to pass through a post or connect two panels together.

PRODUCT CODE	PRICE	SIZE/INCHES			WEIGHT VOL	
		H	W	D	LBS	FT ³
CE8CP17	135	2	17	0.5	0.71	0.67

CE8CP • Pass Through Cable

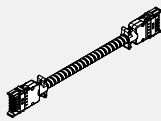

- Flexible metal conduit is used to distribute electrical power through non-powered panels.
- Metal conduit pass through cables should be in used in a straight runs. Metal conduit pass through cables cannot go around a post.
- Flexible conduit is required to turn a post. This only comes as 17"w. If panels at the posts do not all have power distribution housings, they must be added even if duplexes are not specified.
- To calculate the length of a Pass-Through Cable, add the widths of the non-powered panels separating the powered panels (panels with distribution housing attached). To this add 16" (distance from the edge of the panel to the distribution housing x 2).
- Add additional 3" when passing through a corner post.

PRODUCT CODE	PRICE	SIZE/INCHES			WEIGHT VOL	
		H	W	D	LBS	FT ³
CE8CP40	149	2	40.5	0.5	1.44	1.17
CE8CP46	154	2	46.5	0.5	1.71	1.17
CE8CP52	161	2	52.5	0.5	1.95	1.17
CE8CP58	171	2	58.5	0.5	2.21	1.17
CE8CP64	178	2	64.5	0.5	2.37	1.17
CE8CP70	182	2	70.5	0.5	2.60	1.17
CE8CP76	185	2	76.5	0.5	2.81	1.17
CE8CP82	194	2	82.5	0.5	3.03	1.17
CE8CP88	200	2	88.5	0.5	3.05	1.17
CE8CP94	207	2	94.5	0.5	3.30	1.17
CE8CP100	212	2	100.5	0.5	3.47	1.17
CE8CP106	221	2	106.5	0.5	3.87	1.17
CE8CP118	234	2	118.5	0.5	4.08	1.17
CE8CP130	255	2	130.5	0.5	4.73	1.17
CE8CP142	266	2	142.5	0.5	4.99	1.17

CE8CI • "I" Connector

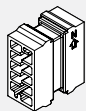

- Female - Female connector connects two Pass-Through Cables .
- Connects 17" Flexible Jumper Cable or ceiling feeds to pass through cables.

PRODUCT CODE	PRICE	SIZE/INCHES			WEIGHT VOL	
		H	W	D	LBS	FT ³
CE8CI1	74	1.5	1.5	4.625	0.06	0.03

CE8RD • Duplex Receptacle

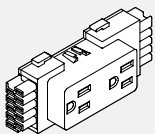

- Up to 6 receptacles per circuit.
- Duplex Receptacles standard in Black (BLK).
- CE8RD1 = Circuit #1 (utility circuit)
- CE8RD2 = Circuit #2 (utility circuit)
- CE8RDA = Circuit A (dedicated)
- CE8RDB = Circuit B (dedicated)
- Note:
- CE8RD1 and CE8RD2 (#1 and #2 share common ground)
- CE8RDA and CE8RDB (A and B share dedicated ground)

PRODUCT CODE	PRICE	SIZE/INCHES			WEIGHT VOL	
		H	W	D	LBS	FT ³
CE8RD1	32	2	4.625	1.25	0.10	0.01
CE8RD2	32	2	4.625	1.25	0.10	0.01
CE8RDA	32	2	4.625	1.25	0.10	0.01
CE8RDB	32	2	4.625	1.25	0.10	0.01

CMEUSB • USB Receptacle

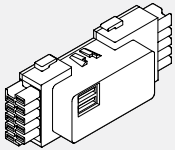

- USB charging module provides convenient charging power access through dual ports on face of the receptacle.
- Two USB ports.
- 2 Amp output via two USB ports.

PRODUCT CODE	PRICE	SIZE/INCHES			WEIGHT VOL	
		H	W	D	LBS	FT ³
CMEUSB01WHT	216	2	4.625	1.25	0.10	0.01
CMEUSB01BLK	216	2	4.625	1.25	0.10	0.01

CE8EC • Ceiling Power Entry

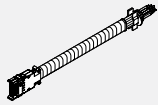

- Snaps into the end of Power Distribution Housing.
- Flexible metal conduit extends into the ceiling through a corner post and post extension (both ordered seperately).
- Must be hard wired to source power by a licensed electrician.
- 4" Junction Box included.

PRODUCT CODE	PRICE	SIZE/INCHES			WEIGHT VOL	
		H	L	D	LBS	FT ³
CE8EC1	244	2	132	0.5	5.24	2.00
CE8EC2	435	2	144	0.5	5.96	2.00

CE8FR • Base Feed

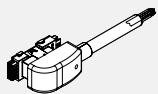

- Takes the place of a duplex receptable by snapping into the base power way.
- CE8FR1 Includes 72" long flexible metal conduit. CE8FR2 Includes 144" long flexible metal conduit.
- Must be hard wired to source power by a licensed electrician.

PRODUCT CODE	PRICE	SIZE/INCHES			WEIGHT VOL	
		H	W	D	LBS	FT ³
CE8FR1	321	6	72	3	3.82	2
CE8FR2	413	6	144	3	5.96	2

GCLEDES • Undercabinet LED Task Light

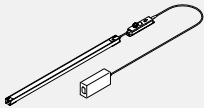

- Linear LED Light.
- Includes light fixture with lens and ON/OFF switch.
- Magnet mounted with adhesive metal plates.
- Plug-in power supply with 72" cord length plus 78" DC cord.

Technical information:

- 4100 K Colour Temperature
- 90 Colour Rendering Index
- 30,000 hrs rated Lifespan
- Total power input per light, 9.0 for 24", 13.5 per 36" and 18.0 for 48"

PRODUCT CODE	PRICE	SIZE/	INCHES		WEIGHT VOL	
		H	W	D	LBS	FT ³
GCLEDES24	164	1	22.9	1	2.5	0.135
GCLEDES36	189	1	33.5	1	2.8	0.161
GCLEDES48	209	1	45.5	1	3.2	0.213

GCLEDES-DCS • Undercabinet Daisychain LED Light

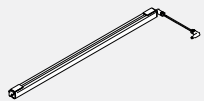

- Undercabinet LED light, 48 inches nominal size , daisy-chain unit with 1 meter (39 inches) linking cable but no power supply.
- Daisychain units can only be linked up to a total of 48 Watts for all lights on one power supply. This equates to a maximum of 10 feet total nominal length of lights per power supply.

Technical information:

- 4100 K Colour Temperature
- 90 Colour Rendering Index
- 30,000 hrs rated Lifespan
- Total power input per light, 9.0 for 24", 13.5 per 36" and 18.0 for 48"

PRODUCT CODE	PRICE	SIZE/	INCHES		WEIGHT VOL	
		H	W	D	LBS	FT ³
GCLEDES24DSC	134	1	24	1	2.5	0.135
GCLEDES36DSC	157	1	36	1	2.8	0.161
GCLEDES48DSC	178	1	48	1	3.2	0.213

GCLEDESOS • Occupancy Sensor and Dimmer

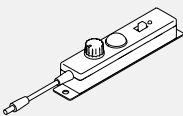

- Inline add-on controller for dimming & occupancy sensor.
- Included, from right to left, a rotary dimmer control, an occupancy sensor and a sensor bypass switch.

PRODUCT CODE	PRICE	SIZE/	INCHES		WEIGHT VOL	
		H	W	D	LBS	FT ³
GCLEDESOS	66	6	2.5	2	0.4	0.500

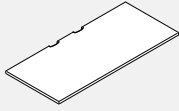
CWS • Rectangular Worksurface

- All tops are thermally fused 1" thick with pilot holes to enable proper alignment with worksurface supports. Wood screws must be used.
- Compile worksurfaces feature a 3mm edge.
- Support hardware must be ordered separately.
- All surfaces longer than 54" have 2 scoops, all others have one.
- Please choose from DWT - Designer White, SIL- Silver or BLK - Black for scoop covers.
- Note: Width and depth dimensions listed include a nominal measurement (3/8") to account for wire management between the worksurface and adjoining panel.

PRODUCT CODE	PRICE LP	SIZE/INCHES			WEIGHT VOL	
		H	W	D	LBS	FT ³
CWS2424P	129	1	24	24	16	0.52
CWS2430P	141	1	30	24	20	0.62
CWS2436P	156	1	36	24	23	0.78
CWS2442P	205	1	42	24	28	0.90
CWS2448P	245	1	48	24	31	1.03
CWS2454P	290	1	54	24	35	1.20
CWS2460P	326	1	60	24	39	1.30
CWS2466P	340	1	66	24	43	1.41
CWS2472P	355	1	72	24	47	1.54
CWS2478P	381	1	78	24	51	1.70
CWS2484P	410	1	84	24	55	1.80
CWS2490P	472	1	90	24	58	1.96
CWS2496P	502	1	96	24	63	2.10
CWS3024P	154	1	24	30	20	0.70
CWS3030P	165	1	30	30	25	0.97
CWS3036P	194	1	36	30	30	1.06
CWS3042P	275	1	42	30	34	1.12
CWS3048P	290	1	48	30	39	1.30
CWS3054P	317	1	54	30	44	1.44
CWS3060P	340	1	60	30	49	1.60
CWS3066P	353	1	66	30	54	1.80
CWS3072P	374	1	72	30	59	2.00
CWS3078P	398	1	78	30	64	2.10
CWS3084P	443	1	84	30	69	2.24

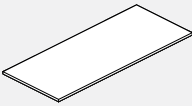
CWSNSCP • Rectangular Worksurface, No Scoops

- All tops are thermally fused 1" thick with pilot holes to enable proper alignment with worksurface supports. Wood screws must be used.
- Compile worksurfaces feature a 3mm edge.
- Support hardware must be ordered separately. See the listings in this section.
- All surfaces have no scoops.

PRODUCT CODE	PRICE LP	SIZE/INCHES			WEIGHT VOL	
		H	W	D	LBS	FT ³
CWS2424NSCP	129	1	24	24	16	0.52
CWS2430NSCP	141	1	30	24	20	0.62
CWS2436NSCP	156	1	36	24	23	0.78
CWS2442NSCP	205	1	42	24	28	0.90
CWS2448NSCP	245	1	48	24	31	1.03
CWS2454NSCP	290	1	54	24	35	1.20
CWS2460NSCP	326	1	60	24	39	1.30
CWS2466NSCP	340	1	66	24	43	1.41
CWS2472NSCP	355	1	72	24	47	1.54
CWS2478NSCP	381	1	78	24	51	1.70
CWS2484NSCP	410	1	84	24	55	1.80
CWS2490NSCP	472	1	90	24	58	1.96
CWS2496NSCP	502	1	96	24	63	2.10
CWS3024NSCP	154	1	24	30	20	0.70
CWS3030NSCP	165	1	30	30	25	0.97
CWS3036NSCP	194	1	36	30	30	1.06
CWS3042NSCP	275	1	42	30	34	1.12
CWS3048NSCP	290	1	48	30	39	1.30
CWS3054NSCP	317	1	54	30	44	1.44
CWS3060NSCP	340	1	60	30	49	1.60
CWS3066NSCP	353	1	66	30	54	1.80
CWS3072NSCP	374	1	72	30	59	2.00
CWS3078NSCP	398	1	78	30	64	2.10
CWS3084NSCP	443	1	84	30	69	2.24

CWSP • Worksurface to Span a Post

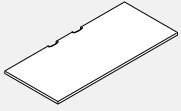

- All tops are thermally fused 1" thick with pilot holes to enable proper alignment with worksurface supports. Wood screws must be used.
- Compile worksurfaces feature a 3mm edge.
- Support hardware must be ordered separately.
- All surfaces longer than 54" have 2 scoops, all others have one.
- Please choose from DWT - Designer White, SIL- Silver or BLK - Black for scoop covers.
- Note: Width and depth dimensions listed include a nominal measurement (3/8") to account for wire management between the worksurface and adjoining panel.

PRODUCT CODE	PRICE LP	SIZE/INCHES			WEIGHT VOL	
		H	W	D	LBS	FT ³
CWSP2426P	141	1	26	24	17	0.60
CWSP2432P	156	1	32	24	21	0.70
CWSP2438P	205	1	38	24	25	0.83
CWSP2444P	245	1	44	24	29	1.00
CWSP2450P	290	1	50	24	33	1.10
CWSP2456P	326	1	56	24	37	1.22
CWSP2462P	340	1	62	24	41	1.34
CWSP2468P	355	1	68	24	45	1.47
CWSP2474P	380	1	74	24	49	1.60
CWSP2480P	410	1	80	24	53	1.73
CWSP2486P	443	1	86	24	57	1.90
CWSP3026P	165	1	26	30	22	0.72
CWSP3032P	194	1	32	30	27	0.88
CWSP3038P	275	1	38	30	32	1.04
CWSP3044P	290	1	44	30	37	1.20
CWSP3050P	317	1	50	30	41	1.40
CWSP3056P	340	1	56	30	46	1.51
CWSP3062P	353	1	62	30	51	1.67
CWSP3068P	374	1	68	30	56	1.83
CWSP3074P	398	1	74	30	61	2.00
CWSP3080P	443	1	80	30	66	2.20
CWSP3086P	488	1	86	30	70	2.30

CWVL • Left Curvilinear Worksurface

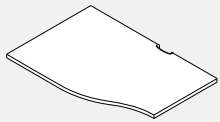

- All tops are thermally fused 1" thick with pilot holes to enable proper alignment with worksurface supports. Wood screws must be used.
- Compile worksurfaces feature a 3mm edge.
- When deepest end equals 24", the opposite depth is 18".
- When deepest end equals 30", the opposite depth is 24".
- Support hardware must be ordered separately.
- All surfaces longer than 54" have 2 scoops, all others have one.
- Please choose from DWT - Designer White, SIL- Silver or BLK - Black for scoop covers.
- Note: Width and depth dimensions listed include a nominal measurement (3/8") to account for wire management between the worksurface and adjoining panel.

PRODUCT CODE	PRICE LP	SIZE/INCHES			WEIGHT VOL	
		H	W	D	LBS	FT ³
CWVL2424P	167	1	24	24	15	0.59
CWVL2430P	177	1	30	24	18	0.65
CWVL2436P	211	1	36	24	22	0.78
CWVL2442P	245	1	42	24	26	0.90
CWVL2448P	281	1	48	24	30	1.03
CWVL2454P	317	1	54	24	34	1.20
CWVL2460P	344	1	60	24	38	1.30
CWVL2466P	381	1	66	24	43	1.49
CWVL2472P	408	1	72	24	47	1.62
CWVL2478P	501	1	78	24	57	2.16
CWVL2484P	727	1	84	24	61	2.33
CWVL3024P	169	1	24	30	19	0.74
CWVL3030P	186	1	30	30	23	0.81
CWVL3036P	222	1	36	30	28	1.00
CWVL3042P	303	1	42	30	33	1.13
CWVL3048P	317	1	48	30	38	1.30
CWVL3054P	353	1	54	30	42	1.44
CWVL3060P	380	1	60	30	47	1.60
CWVL3066P	408	1	66	30	52	1.81
CWVL3072P	438	1	72	30	59	2.01
CWVL3078P	634	1	78	30	72	2.71
CWVL3084P	809	1	84	30	77	2.91

CWVR • Right Curvilinear Worksurface

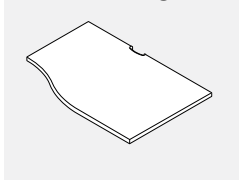

- All tops are thermally fused 1" thick with pilot holes to enable proper alignment with worksurface supports. Wood screws must be used.
- Compile worksurfaces feature a 3mm edge.
- When deepest end equals 24", the opposite depth is 18". When deepest end equals 30", the opposite depth is 24".
- Support hardware must be ordered separately.
- All surfaces longer than 54" have 2 scoops, all others have one.
- Please choose from DWT - Designer White, SIL- Silver or BLK - Black for scoop covers.
- Note: Width and depth dimensions listed include a nominal measurement (3/8") to account for wire management between the worksurface and adjoining panel.

PRODUCT CODE	PRICE LP	SIZE/INCHES			WEIGHT VOL	
		H	W	D	LBS	FT ³
CWVR2424P	167	1	24	24	15	0.59
CWVR2430P	177	1	30	24	18	0.65
CWVR2436P	211	1	36	24	22	0.78
CWVR2442P	245	1	42	24	26	0.90
CWVR2448P	281	1	48	24	30	1.03
CWVR2454P	317	1	54	24	34	1.20
CWVR2460P	344	1	60	24	38	1.30
CWVR2466P	381	1	66	24	43	1.49
CWVR2472P	408	1	72	24	47	1.62
CWVR2478P	501	1	78	24	57	2.16
CWVR2484P	727	1	84	24	61	2.33
CWVR3024P	169	1	24	30	19	0.74
CWVR3030P	186	1	30	30	23	0.81
CWVR3036P	222	1	36	30	28	1.00
CWVR3042P	303	1	42	30	33	1.13
CWVR3048P	317	1	48	30	38	1.30
CWVR3054P	353	1	54	30	42	1.44
CWVR3060P	380	1	60	30	47	1.60
CWVR3066P	408	1	66	30	52	1.81
CWVR3072P	438	1	72	30	59	2.01
CWVR3078P	634	1	78	30	72	2.71
CWVR3084P	809	1	84	30	77	2.91

CWBT • Transition Worksurface

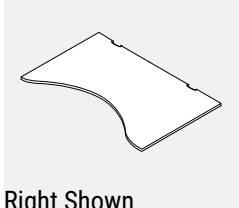

Right Shown

- Support hardware must be ordered separately.
- Please choose from DWT - Designer White, SIL- Silver or BLK - Black for scoop covers.
- Opposing side of the 30" deep surface has a depth of 24"
- Must be specified as right or left handed.

PRODUCT CODE	PRICE LP	SIZE/INCHES			WEIGHT VOL	
		H	W	D	LBS	FT ³
CWBTL302460P	596	1	60	30	55	2.08
CWBTL302466P	658	1	66	30	61	2.29
CWBTL302472P	681	1	72	30	66	2.50
CWBTR302460P	596	1	60	30	55	2.08
CWBTR302466P	658	1	66	30	61	2.29
CWBTR302472P	681	1	72	30	66	2.50

CWCC • Corner Curved Worksurface

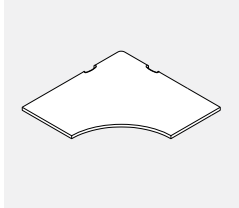

- All tops are thermally fused 1" thick with pilot holes to enable proper alignment with worksurface supports. Wood screws must be used.
- Compile worksurfaces feature a 3mm edge.
- Support hardware must be ordered separately.
- Please choose from DWT - Designer White, SIL- Silver or BLK - Black for scoop covers.
- Note: Width and depth dimensions listed include a nominal measurement (3/8") to account for wire management between the worksurface and adjoining panel.
- "WG" indicates diagonal woodgrain.
- "WG" worksurface over 42" cannot be done on the diagonal.

PRODUCT CODE	PRICE LP	SIZE/INCHES			WEIGHT VOL	
		H	W	D	LBS	FT ³
CWCC3618P	385	1	36	36	29	1.20
CWCC3624P	426	1	36	36	32	1.20
CWCC3618WGP	558	1	36	36	29	1.20
CWCC3624WGP	718	1	36	36	32	1.20
CWCC4224P	574	1	42	42	41	1.60
CWCC4230P	589	1	42	42	45	1.60
CWCC4224WGP	821	1	42	42	41	1.60
CWCC4230WGP	935	1	42	42	45	1.60
CWCC4824P	668	1	48	48	50	2.00
CWCC4830P	668	1	48	48	56	2.00

CWCF • Five Sided Worksurface

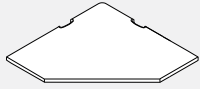

- All tops are thermally fused 1" thick with pilot holes to enable proper alignment with worksurface supports. Wood screws must be used.
- Compile worksurfaces feature a 3mm edge.
- Support hardware must be ordered separately.
- Please choose from DWT - Designer White, SIL- Silver or BLK - Black for scoop covers.
- Note: Width and depth dimensions listed include a nominal measurement (3/8") to account for wire management between the worksurface and adjoining panel.
- "WG" indicates diagonal woodgrain.
- "WG" worksurface over 42" cannot be done on the diagonal.

PRODUCT CODE	PRICE LP	SIZE/INCHES			WEIGHT VOL	
		H	W	D	LBS	FT ³
CWCF3618P	331	1	36	36	29	1.20
CWCF3624P	344	1	36	36	32	1.20
CWCF3618WGP	547	1	36	36	29	1.20
CWCF3624WGP	603	1	36	36	32	1.20
CWCF4224P	488	1	42	42	41	1.60
CWCF4230P	502	1	42	42	45	1.60
CWCF4224WGP	811	1	42	42	41	1.60
CWCF4230WGP	884	1	42	42	45	1.60
CWCF4824P	550	1	48	48	50	2.00
CWCF4830P	579	1	48	48	56	2.00

CWC6 • Corner Curved Worksurface for 60° post

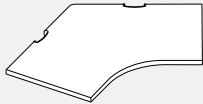

- When specifying wood grain laminate for worksurfaces 42" wide or less, grain will be run diagonally.
- Please add "WG" to the end of the product code and add 50% upcharge to the list price.
- Support hardware must be ordered separately.
- Please choose from DWT - Designer White, SIL- Silver or BLK - Black for scoop covers.

PRODUCT CODE	PRICE LP	SIZE/INCHES			WEIGHT VOL	
		H	W	D	LBS	FT ³
CWC62424P	387	1	24	24	21.25	0.47
CWC62430P	688	1	30	24	28.59	0.64
CWC62436P	777	1	36	24	35.94	0.80
CWC62442P	1187	1	42	24	43.28	0.96
CWC62448P	1291	1	48	24	50.63	1.13
CWC63024P	387	1	24	30	23.72	0.53
CWC63030P	688	1	30	30	32.94	0.73
CWC63036P	777	1	36	30	42.16	0.94
CWC63042P	1187	1	42	30	51.38	1.14
CWC63048P	1291	1	48	30	60.60	1.35

CWCEL • Extended Curved Corner Left

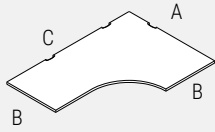

- For 48" wide ("C" dimension) worksurfaces, there are two cable scoops, all others have three.
- All tops are thermally fused 1" thick with pilot holes to enable proper alignment with worksurface supports. Wood screws must be used.
- Compile worksurfaces feature a 3mm edge.
- Support hardware must be ordered separately.
- Please choose from DWT - Designer White, SIL- Silver or BLK - Black for scoop covers.
- Note: Width and depth dimensions listed include a nominal measurement (3/8") to account for wire management between the worksurface and adjoining panel.

NOTE: CWCEL

A	B	C
DEPTH	DEPTH	WIDTH

PRODUCT CODE	PRICE LP	SIZE/INCHES			WEIGHT VOL	
		H	W "C"	D "A"	LBS	FT ³
CWCEL362448P	583	1	48	36	43.92	1.25
CWCEL362460P	636	1	60	36	52.79	1.50
CWCEL362466P	700	1	66	36	57.18	1.62
CWCEL362472P	773	1	72	36	61.58	1.75
CWCEL362478P	825	1	78	36	65.98	1.87
CWCEL362484P	890	1	84	36	70.38	2.00
CWCEL422460P	668	1	60	42	57.18	1.63
CWCEL422466P	736	1	66	42	61.58	1.57
CWCEL422472P	811	1	72	42	65.98	1.87
CWCEL422478P	867	1	78	42	70.38	2.00
CWCEL422484P	934	1	84	42	74.78	2.00
CWCEL423060P	752	1	60	42	63.78	1.82
CWCEL423066P	825	1	66	42	69.28	1.96
CWCEL423072P	902	1	72	42	74.78	2.12
CWCEL423078P	967	1	78	42	80.28	2.28
CWCEL423084P	1031	1	84	42	85.78	2.43
CWCEL482460P	763	1	60	48	65.18	1.90
CWCEL482466P	849	1	66	48	71.39	1.92
CWCEL482472P	928	1	72	48	76.18	1.95
CWCEL482478P	991	1	78	48	74.78	2.20
CWCEL482484P	1051	1	84	48	96.78	3.66
CWCEL483060P	849	1	60	48	68.18	1.93
CWCEL483066P	928	1	66	48	73.68	2.09
CWCEL483072P	991	1	72	48	79.18	2.25
CWCEL483078P	1051	1	78	48	84.68	2.40
CWCEL483084P	1124	1	84	48	90.18	2.56

CWCER • Extended Curved Corner Right

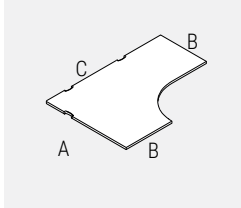

- For 48" wide ("C" dimension) worksurfaces, there are two cable scoops, all others have three.
- All tops are thermally fused 1" thick with pilot holes to enable proper alignment with worksurface supports. Wood screws must be used.
- Compile worksurfaces feature a 3mm edge.
- Support hardware must be ordered separately.
- Please choose from DWT - Designer White, SIL- Silver or BLK - Black for scoop covers.
- Note: Width and depth dimensions listed include a nominal measurement (3/8") to account for wire management between the worksurface and adjoining panel.

NOTE: CWCER

A	B	C
DEPTH	DEPTH	WIDTH

PRODUCT CODE	PRICE LP	SIZE/INCHES			WEIGHT VOL	
		H	W"C"	D"A"	LBS	FT ³
CWCER362448P	583	1	48	36	43.92	1.25
CWCER362460P	636	1	60	36	52.79	1.50
CWCER362466P	700	1	66	36	57.18	1.62
CWCER362472P	773	1	72	36	61.58	1.75
CWCER362478P	825	1	78	36	65.98	1.87
CWCER362484P	890	1	84	36	70.38	2.00
CWCER422460P	668	1	60	42	57.18	1.63
CWCER422466P	736	1	66	42	61.58	1.57
CWCER422472P	811	1	72	42	65.98	1.87
CWCER422478P	867	1	78	42	70.38	2.00
CWCER422484P	934	1	84	42	74.78	2.00
CWCER423060P	752	1	60	42	63.78	1.82
CWCER423066P	825	1	66	42	69.28	1.96
CWCER423072P	902	1	72	42	74.78	2.12
CWCER423078P	967	1	78	42	80.28	2.28
CWCER423084P	1031	1	84	42	85.78	2.43
CWCER482460P	763	1	60	48	65.18	1.90
CWCER482466P	849	1	66	48	71.39	1.92
CWCER482472P	928	1	72	48	76.18	1.95
CWCER482478P	991	1	78	48	74.78	2.20
CWCER482484P	1051	1	84	48	96.78	3.66
CWCER483060P	849	1	60	48	68.18	1.93
CWCER483066P	928	1	66	48	73.68	2.09
CWCER483072P	991	1	72	48	79.18	2.25
CWCER483078P	1051	1	78	48	84.68	2.40
CWCER483084P	1124	1	84	48	90.18	2.56

CWD • "D" Worksurface

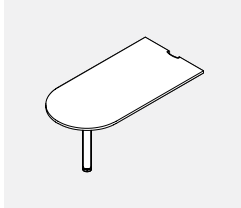

- Includes Monoleg available in standard compile finishes.
- All tops are thermally fused 1" thick with pilot holes to enable proper alignment with worksurface supports. Wood screws must be used.
- Compile worksurfaces feature a 3mm edge.
- Support hardware must be ordered separately. See the listings in this section.
- Please choose from DWT - Designer White, SIL- Silver or BLK - Black for scoop covers.
- Note: Width and depth dimensions listed include a nominal measurement (3/8") to account for wire management between the worksurface and adjoining panel.

PRODUCT CODE	PRICE LP	SIZE/INCHES			WEIGHT VOL	
		H	W	D	LBS	FT ³
CWD2442P	552	1	42	24	28.00	0.98
CWD2448P	576	1	48	24	32.00	1.11
CWD2460P	605	1	60	24	40.00	1.36
CWD2472P	642	1	72	24	48.00	1.61
CWD3042P	556	1	42	30	35.00	1.10
CWD3048P	579	1	48	30	39.00	1.37
CWD3060P	646	1	60	30	49.00	1.69
CWD3072P	710	1	72	30	59.00	2.01

CWSW • Straight Wedge Worksurface

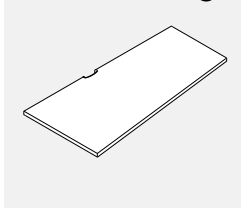

- All tops are thermally fused 1" thick with pilot holes to enable proper alignment with worksurface supports. Wood screws must be used.
- Compile worksurfaces feature a 3mm edge.
- Support hardware must be ordered separately.
- All surfaces longer than 48" have 2 scoops, all others have one.
- Please choose from DWT - Designer White, SIL- Silver or BLK - Black for scoop covers.
- Note: Width and depth dimensions listed include a nominal measurement (3/8") to account for wire management between the worksurface and adjoining panel.

PRODUCT CODE	PRICE LP	SIZE/INCHES			WEIGHT VOL	
		H	W	D	LBS	FT ³
CWSW241848P	278	1	48	24	30.00	0.58
CWSW241854P	311	1	54	24	34.00	0.65
CWSW241860P	344	1	60	24	38.00	0.73
CWSW241866P	381	1	66	24	42.00	0.80
CWSW241872P	417	1	72	24	46.00	0.88
CWSW302448P	344	1	48	30	38.00	0.75
CWSW302454P	392	1	54	30	42.00	0.84
CWSW302460P	435	1	60	30	47.00	0.94
CWSW302466P	476	1	66	30	51.00	1.03
CWSW302472P	521	1	72	30	56.00	1.13
CWSW182448P	278	1	48	24	30.00	0.58
CWSW182454P	311	1	54	24	34.00	0.65
CWSW182460P	344	1	60	24	38.00	0.73
CWSW182466P	381	1	66	24	42.00	0.80
CWSW182472P	417	1	72	24	46.00	0.88
CWSW243048P	344	1	48	30	38.00	0.75
CWSW243054P	392	1	54	30	42.00	0.84
CWSW243060P	435	1	60	30	47.00	0.94
CWSW243066P	476	1	66	30	51.00	1.03
CWSW243072P	521	1	72	30	56.00	1.13

CWSW-NSCP • Straight Wedge Worksurface

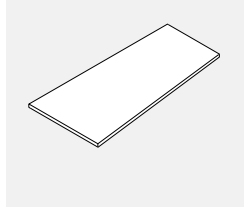

- All tops are thermally fused 1" thick with pilot holes to enable proper alignment with worksurface supports. Wood screws must be used.
- Compile worksurfaces feature a 3mm edge.
- Support hardware must be ordered separately. See the listings in this section.
- All worksurfaces have no scoops.

PRODUCT CODE	PRICE LP	SIZE /INCHES			WEIGHT VOL	
		H	W	D	LBS	FT ³
CWSW241848NSCP	278	1	48	24	30.00	0.58
CWSW241854NSCP	311	1	54	24	34.00	0.65
CWSW241860NSCP	344	1	60	24	38.00	0.73
CWSW241866NSCP	381	1	66	24	42.00	0.80
CWSW241872NSCP	417	1	72	24	46.00	0.88
CWSW302448NSCP	344	1	48	30	38.00	0.75
CWSW302454NSCP	392	1	54	30	42.00	0.84
CWSW302460NSCP	435	1	60	30	47.00	0.94
CWSW302466NSCP	476	1	66	30	51.00	1.03
CWSW302472NSCP	521	1	72	30	56.00	1.13
CWSW182448NSCP	278	1	48	24	30.00	0.58
CWSW182454NSCP	311	1	54	24	34.00	0.65
CWSW182460NSCP	344	1	60	24	38.00	0.73
CWSW182466NSCP	381	1	66	24	42.00	0.80
CWSW182472NSCP	417	1	72	24	46.00	0.88
CWSW243048NSCP	344	1	48	30	38.00	0.75
CWSW243054NSCP	392	1	54	30	42.00	0.84
CWSW243060NSCP	435	1	60	30	47.00	0.94
CWSW243066NSCP	476	1	66	30	51.00	1.03
CWSW243072NSCP	521	1	72	30	56.00	1.13

CWHL/R • Hatchet Worksurface

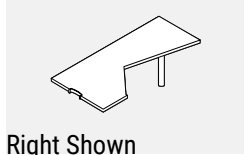

- Wood grain laminate not available on the diagonal.
- Must be specified either left or right.
- Includes Monoleg, available in standard compile finishes.
- Please choose from DWT - Designer White, SIL- Silver or BLK - Black for scoop covers.

Right Shown

PRODUCT CODE	PRICE LP		SIZE /INCHES			WEIGHT VOL	
			H	W	D	LBS	FT ³
CWHL3672P	1048	Left	1	72	36	73.00	2.70
CWHR3672P	1048	Right	1	72	36	73.00	2.70

CWQL/R • Quarter Round Worksurface

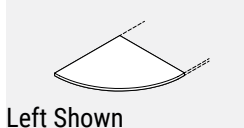

Left Shown

- The worksurface edge running along the panel face is a slightly different length than that of the worksurface end, causing the surface to be handed.
- The user edge abutting the adjacent worksurface runs straight for 2" before starting to curve.

PRODUCT CODE	PRICE LP		SIZE /INCHES			WEIGHT VOL	
			H	W	D	LBS	FT ³
CWQL2424	194	Left	1	24	24	16	0.52
CWQL3030	251		1	30	30	25	0.81
CWQR2424	194	Right	1	24	24	16	0.52
CWQR3030	251		1	30	30	25	0.81

CWQRC • Quarter Round Corner Worksurface

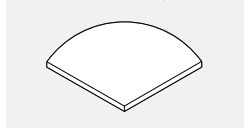

- Wraps around a 90° corner post.
- Putting the adjacent worksurface runs straight for 3" before starting to curve.
- Note: Width and depth dimensions listed include a nominal measurement (3/8") to account for wire management between the worksurface and adjoining panel.

PRODUCT CODE	PRICE LP	SIZE /INCHES			WEIGHT VOL	
		H	W	D	LBS	FT ³
CWQRC2424	228	1	24	24	17.00	0.58
CWQRC3030	281	1	30	30	25.50	0.86

CWT • Straight Transaction Worksurface

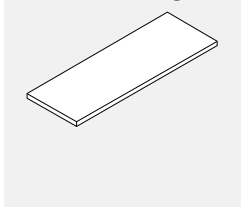

- Support hardware must be ordered separately.
- All tops are thermally fused 1" thick with pilot holes to enable proper alignment with worksurface supports. Wood screws must be used.
- Compile worksurfaces feature a 3mm edge.

PRODUCT CODE	PRICE LP	SIZE / INCHES			WEIGHT VOL	
		H	W	D	LBS	FT ³
CWT1512	55	1	12	15	5	0.22
CWT1518	67	1	18	15	7	0.30
CWT1524	87	1	24	15	10	0.38
CWT1530	103	1	30	15	12	0.46
CWT1536	119	1	36	15	14	0.54
CWT1542	135	1	42	15	17	0.62
CWT1548	152	1	48	15	19	0.70
CWT1554	165	1	54	15	22	0.78
CWT1560	184	1	60	15	24	0.86
CWT1566	198	1	66	15	28	0.94
CWT1572	215	1	72	15	29	1.02
CWT1578	231	1	78	15	31	1.10
CWT1584	246	1	84	15	34	1.18

CWTCL90 • "L" Corner Transaction Surface

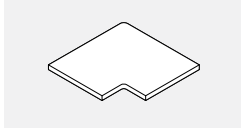

- Used where two panels meet at a 90° angle.
- Support hardware must be ordered separately.

PRODUCT CODE	PRICE	SIZE / INCHES			WEIGHT VOL	
		H	W	D	LBS	FT ³
CWTCL90	154	1	20.7	15	12.00	0.75

CW9T • Corner Transaction Surface for 90° Post

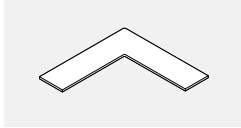

- Used where two panels meet at a 90° angle.
- Support hardware must be ordered separately.

Note: CW9T15 xx Panel Width

PRODUCT CODE	PRICE	SIZE / INCHES			WEIGHT VOL	
		H	W	D	LBS	FT ³
CW9T1524	163	1	32.7	15	10.00	0.70
CW9T1530	257	1	38.7	15	12.00	0.75
CW9T1536	362	1	44.7	15	14.00	0.82
CW9T1542	494	1	50.7	15	16.00	0.95
CW9T1548	646	1	56.7	15	18.00	1.00

CHMSL1 • Round Mid Support Leg



- Available in standard compile standard panel frame colours.
- Includes levelling glide, PVC sleeve and 4.8" x 4.8" plate.
- 1.5" diameter.

PRODUCT CODE	PRICE	LEG DIAMETER	SIZE / INCHES			WEIGHT VOL	
			H	W	D	LBS	FT ³
CHMSL1	75	1.5	28	4.8	4.8	8	0.15

CHMSL2 • Square Mid Support Leg



- Available in standard compile standard panel frame colours.
- Includes levelling glide, PVC sleeve and 4.8" x 4.8" plate.

PRODUCT CODE	PRICE	LEG SIZE	SIZE / INCHES			WEIGHT VOL	
			H	W	D	LBS	FT ³
CHMSL2	75	1.5	28	4.8	4.8	8	0.15

BHML • Monoleg



- Provides support for a worksurface.
- Includes an adjustable foot and an attachment plate.
- 3" diameter.
- 1" Height adjustment range.

PRODUCT CODE	PRICE	SIZE / INCHES			WEIGHT VOL	
		H	W	D	LBS	FT ³
BHML03	188	28	3	3	8	0.15

CMHCL1 • Round Corner Leg With Leveler

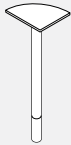

- Provides support for worksurface.
- Includes levelling glide, PVC Sleeve and attachment plate.
- 1.5" diameter.
- Available in standard paint colours.
- Legs can be used in the corner of a single worksurface or be rotated 45 degrees to support the corners of two worksurfaces.

PRODUCT CODE	PRICE	SIZE / INCHES			WEIGHT VOL	
		H	W	D	LBS	FT ³
CMHCL1	105	28	3	3	8	0.15

CMHCL2 • Square Corner Leg With Leveler

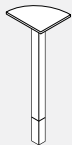

- Provides support for worksurface.
- Includes levelling glide, PVC Sleeve and attachment plate.
- 1.5" diameter.
- Available in standard paint colours.
- Legs can be used in the corner of a single worksurface or be rotated 45 degrees to support the corners of two worksurfaces.

PRODUCT CODE	PRICE	SIZE / INCHES			WEIGHT VOL	
		H	W	D	LBS	FT ³
CMHCL2	105	28	3	3	8	0.15

CHC • Cantilever



- CHC15 come with wood screws and 3 hole slider, while CHC22 comes with wood screws & 4 hole slider.
- Corresponding panel frame colours only.
- Cantilevers do not share support.

PRODUCT CODE	PRICE	SIZE / INCHES			WEIGHT VOL	
		H	W	D	LBS	FT ³
CHC15L	47	5	1.2	15.2	2	0.04
CHC15R	47	5	1.2	15.2	2	0.04
CHC22L	78	8	1.2	21.5	2.6	0.06
CHC22R	78	8	1.2	21.5	2.6	0.06

CHCB2 • Corner and Transaction Bracket

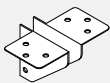

- Attaches the corner of any worksurface to a panel connector.
- Priced and shipped in pairs.
- Available in Standard paint colours.
- Cannot be used off modular.
- Comes with a 2 hole slider.

PRODUCT CODE	PRICE	SIZE / INCHES			WEIGHT VOL	
		H	W	D	LBS	FT ³
CHCB2	21	3	1.81	3	0.5	0.02

CH • Worksurface Bracket

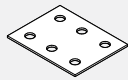

- Black (BLK) only

PRODUCT CODE	PRICE	SIZE / INCHES			WEIGHT VOL		
		H	W	D	LBS	FT ³	
CHFB1	20	Flat Bracket	0.1	3	4	0.5	0.007

CHWB • Mid Span Bracket



- Attaches to a segmented panel.
- Must be specified with a worksurface longer than 48".
- Zinc finish only.

PRODUCT CODE	PRICE	SIZE / INCHES			WEIGHT VOL	
		H	W	D	LBS	FT ³
CHWB1	12	0.5	2.8	2.1	0.5	0.02

DHPEDB • Pedestal Bracket



- Available in standard paint colours.
- Attaches pedestal to panel and end panel.

PRODUCT CODE	PRICE	SIZE / INCHES			WEIGHT VOL	
		H	W	D	LBS	FT ³
DHPEDB	35	8	1	1	0.5	0.001

CHEP • End Panel

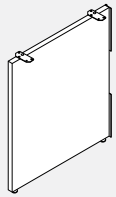

- Supports the worksurface and enhances the stability of connected panels.
- Provides solid support at the end of a run of worksurfaces.
- Finished in thermally-fused laminate.
- Includes 2 flat brackets (black), 2 pedestal brackets (frame colour) and required screws.
- End panel height is inclusive of panel glides extended to their fullest height.
- If wood grains is selected, grain runs vertically.
- Note: May be used as a shared gable between two adjoining worksurfaces.

PRODUCT CODE	PRICE	SIZE / INCHES			WEIGHT VOL	
		H	W	D	LBS	FT ³
CHEP2924	232	28	1	24	17	0.40
CHEP2930	272	28	1	30	21	0.50

CHMEGR • Metal End Gable - Right

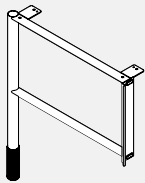

- Support the worksurface and enhances the stability of connected panels.
- Includes a levelling glide, decorative PVC sleeve to cover the glide and two hole slider.

PRODUCT CODE	PRICE	SIZE / INCHES			WEIGHT VOL	
		H	W	D	LBS	FT ³
CHMEG18R	227	28	4	17	5.20	0.55
CHMEG24R	242	28	4	23	6.00	0.73
CHMEG30R	257	28	4	29	6.80	0.90

CHMEGL • Metal End Gable - Left

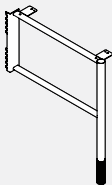

- Support the worksurface and enhances the stability of connected panels.
- Includes a levelling glide, decorative PVC sleeve to cover the glide and two hole slider.

PRODUCT CODE	PRICE	SIZE / INCHES			WEIGHT VOL	
		H	W	D	LBS	FT ³
CHMEG18L	227	28	4	17	5.20	0.55
CHMEG24L	242	28	4	23	6.00	0.73
CHMEG30L	257	28	4	29	6.80	0.90

CHMSL • Metal Mid Support Leg

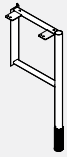

- Supports the adjoining worksurfaces and enhances the stability of connected panels.
- Includes a levelling glide and decorative PVC sleeve to cover the glide.
- **Should not be used as an end support.**

PRODUCT CODE	PRICE	SIZE/INCHES			WEIGHT VOL	
		H	W	D	LBS	FT ³
CHMSL12	194	28	4	11	4.60	0.36

CHWSRL01 • Worksurface round Support Leg

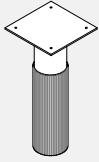

- Provides supports when worksurface overhangs 21”h Double Wall Storage or 1.5H 1200 Series Cabinet Storage must have File Top.
- Must be used to support the worksurface in conjunction with panel mounted hardware.
- Contains a levelling glide and PVC sleeve.
- 1.5 diameter round tube.
- Available in BLK (Black) only

PRODUCT CODE	PRICE	SIZE/ INCHES			WEIGHT VOL	
		H	W	D	LBS	FT ³
CHWSRL01	45	4.5	3	3	1.00	0.03

CMHLEG • Compile Bridges Leg Assembly

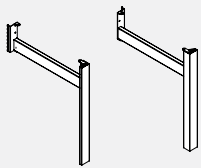

- **Compile Bridges Leg Assembly attaches to a Compile panel for applications which require functionality of Compile panels with an open environment of Bridges tables.**
- One leg with horizontal member connecting to 1” increment slots in panel’s vertical frame member. Provides support to panel and panel-connected worksurface at the end of a run; design coordinated with Bridges freestanding tables.
- Supports 24” and 30” deep worksurfaces. By adding 2 CHFB1 flat brackets and 1 CHCB2 corner bracket, a single leg can then support the adjoining worksurface. Leveling glide is standard. No worksurface supporting beams, use panel cantilevers and storage for worksurface support. One aluminum leg with steel structure - specify Left or Right and 24” or 30” deep for corresponding worksurface depths. Panel bracket, dislodgment clip and worksurface hardware included.
- Anodized aluminum leg upcharge \$23.
- Please specify paint finish for support.

PRODUCT CODE	PRICE	SIZE/INCHES			WEIGHT VOL	
		H	W	D	LBS	FT ³
CMHLEG24LL	308	28	2.5	24	9	1.25
CMHLEG24RL	308	28	2.5	24	9	1.25
CMHLEG30LL	323	28	2.5	30	11	1.45
CMHLEG30RL	323	28	2.5	30	11	1.45

CMHC • HAT Channel

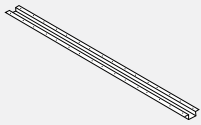

- Support worksurfaces.

PRODUCT CODE	PRICE	SIZE/INCHES			WEIGHT VOL	
		H	W	D	LBS	FT ³
CMHC40	56	1.4	40	5	4	0.20
CMHC46	62	1.4	46	5	6	0.22
CMHC52	66	1.4	52	5	7	0.25
CMHC58	76	1.4	58	5	8	0.28
CMHC64	85	1.4	64	5	9	0.31
CMHC70	91	1.4	70	5	10	0.33

CM0100LKCLIP • Lock Clip



- Use to hold and lock 2 panels or panel post together and prevents disconnection.

PRODUCT CODE	PRICE	SIZE/INCHES			WEIGHT VOL	
		H	W	D	LBS	FT ³
CM0100LKCLIP	7	2.6	0.75	0.32	0.026	0.001

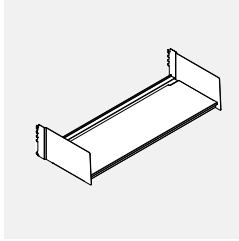
CSSL13 • Panel Mount Shelf

- 13" deep panel-mounted storage shelf with backlip.
- Mounting brackets are included.

PRODUCT CODE	PRICE	SIZE/INCHES			WEIGHT VOL	
		H	W	D	LBS	FT ³
CSSL1324	146	5	24	13	11	1.28
CSSL1330	152	5	30	13	12	1.28
CSSL1336	154	5	36	13	13	1.28
CSSL1342	166	5	42	13	15	1.70
CSSL1348	182	5	48	13	16	1.70
CSSL1354	195	5	54	13	19	2.12
CSSL1360	204	5	60	13	21	2.12

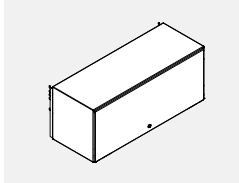
CSOF13 • Flush Front KD Overhead Cabinet

- Door retracts up and over the cabinet.
- Ready for quick assembly on site.
- Quality steel construction.
- Mounting brackets are included.
- 60" unit is reinforced for proper weight distribution.
- Inside dimensions: 12" h. x 12.75" d.

PRODUCT CODE	PRICE	SIZE/INCHES			WEIGHT VOL	
		H	W	D	LBS	FT ³
CSOF1324	499	14.5	24	13	27	1.28
CSOF1330	517	14.5	30	13	31	1.28
CSOF1336	573	14.5	36	13	34	1.28
CSOF1342	630	14.5	42	13	38	1.70
CSOF1348	690	14.5	48	13	43	1.70
CSOF1354	747	14.5	54	13	48	2.12
CSOF1360	803	14.5	60	13	53	2.12

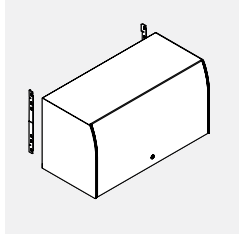
CMADA • Panel Mounted Overhead Storage, AODA Compliant

- Panel mounted metal overhead storage with opaque acrylic door. The mechanism lifts the door up and stores it out of the way, above the storage unit.
- Meets CSA B651 Barrier Free Design & AODA (Accessibility for Ontarians with Disabilities Act).
- 16" high units accept standard and A4 binders.
- All shelves are reinforced for proper weight distribution.
- Inside dimensions: 14.25" high x 13.4" deep.
- Unit includes attachment hardware, lock and mounting brackets. Back not included.
- Shipped partially assembled.

PRODUCT CODE	PRICE	SIZE/INCHES			WEIGHT VOL	
		H	W	D	LBS	FT ³
CMADA30PM	815	16	30	14.2	27	5.3
CMADA36PM	880	16	36	14.2	32	6.3
CMADA42PM	942	16	42	14.2	37	7.3
CMADA48PM	1007	16	48	14.2	42	8.3
CMADA54PM	1069	16	54	14.2	47	9.3
CMADA60PM	1133	16	60	14.2	53	10.3

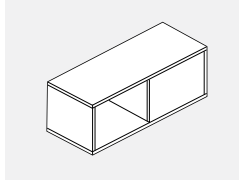
CMDAOH • Center Mount Overhead

- Inside dimensions 13" high x 13" deep.
- Laminate Overhead.
- Available in standard Compile laminate finishes.
- Top mount on panels.
- Overhead Support Brackets included.

PRODUCT CODE	PRICE	SIZE/INCHES			WEIGHT VOL	
		H	W	D	LBS	FT ³
CMDAOH36	1102	15	36	14.12	10	4.4
CMDAOH42	1186	15	42	14.12	11	5.1
CMDAOH48	1236	15	48	14.12	12	5.8
CMDAOH54	1327	15	54	14.12	13	6.6
CMDAOH60	1374	15	60	14.12	14	7.3

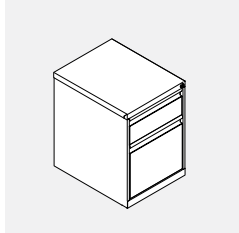
CS93FPxxBFP • 9300 Series Freestanding Box File Pedestal

- One box and one file drawer pedestal.
- Freestanding, counterweight included.
- All drawers are locking.
- Box drawer includes pencil tray.

PRODUCT CODE	PRICE	SIZE/INCHES			WEIGHT VOL	
		H	W	D	LBS	FT ³
CS93FP19BFP	524	21.31	15	19	50	5.1
CS93FP23BFP	531	21.31	15	23	55	6.0
CS93FP29BFP	642	21.31	15	29	64	7.5

CS93FPxxBBFP • 9300 Series Freestanding Box Box File Pedestal

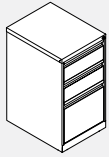

- Two box and one file drawer pedestal.
- Freestanding, counterweight included.
- All drawers are locking.
- Top box drawer includes pencil tray.

PRODUCT CODE	PRICE	SIZE/INCHES			WEIGHT VOL	
		H	W	D	LBS	FT ³
CS93FP19BBFP	568	27.87	15	19	55	6.5
CS93FP23BBFP	578	27.87	15	23	68	7.7
CS93FP29BBFP	692	27.87	15	29	78	9.6

CS93FPxxFFP • 9300 Series Freestanding File File Pedestal

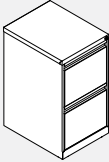

- Two file drawer pedestal.
- Freestanding, counterweight included.
- All drawers are locking.

PRODUCT CODE	PRICE	SIZE/INCHES			WEIGHT VOL	
		H	W	D	LBS	FT ³
CS93FP19FFP	547	27.87	15	19	53	6.5
CS93FP23FFP	554	27.87	15	23	60	7.7
CS93FP29FFP	656	27.87	15	29	70	9.6

CS93WPxxBBFP • 9300 Series Worksurface Supporting Box Box File Pedestal

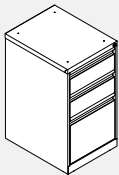

- Two box and one file drawer pedestal.
- Worksurface supporting, includes mounting holes in the top.
- All drawers are locking.
- Top box drawer includes pencil tray.
- Includes filler and brackets.

PRODUCT CODE	PRICE	SIZE/INCHES			WEIGHT VOL	
		H	W	D	LBS	FT ³
CS93WP19BBFP	563	27.87	15	19	55	6.5
CS93WP23BBFP	571	27.87	15	23	68	7.7
CS93WP29BBFP	662	27.87	15	29	78	9.6

CS93WPxxFFP • 9300 Series Worksurface Supporting File File Pedestal

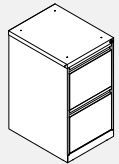

- Two file drawer pedestal.
- Worksurface supporting, includes mounting holes in the top.
- All drawers are locking.
- Includes filler and brackets.

PRODUCT CODE	PRICE	SIZE/INCHES			WEIGHT VOL	
		H	W	D	LBS	FT ³
CS93WP19FFP	540	27.87	15	19	53	6.5
CS93WP23FFP	545	27.87	15	23	60	7.7
CS93WP29FFP	658	27.87	15	29	70	9.6

CS93MPxxBFP • 9300 Series Mobile Box File Pedestal

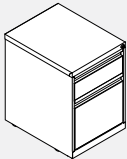

- One box and one file drawer mobile pedestal.
- Casters preinstalled, casters non-locking.
- Counterweight included.
- All drawers locking.
- Box drawer includes pencil tray.
- NOTE: Cannot be used as guest seating.

PRODUCT CODE	PRICE	SIZE/INCHES			WEIGHT VOL	
		H	W	D	LBS	FT ³
CS93MP19BFP	624	27.87	15	19	66	5.2
CS93MP23BFP	646	27.87	15	23	72	6.2
CS93MP29BFP	694	27.87	15	29	92	7.6

CS93MPxxBBFP • 9300 Series Mobile Box Box File Pedestal

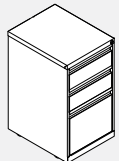

- Two box and one file drawer mobile pedestal.
- Casters preinstalled, casters non-locking.
- Counterweight included.
- All drawers locking.
- Top box drawer includes pencil tray.
- NOTE: Cannot be used as guest seating.

PRODUCT CODE	PRICE	SIZE/INCHES			WEIGHT VOL	
		H	W	D	LBS	FT ³
CS93MP19BBFP	646	27.87	15	19	76	6.5
CS93MP23BBFP	653	27.87	15	23	85	7.7
CS93MP29BBFP	708	27.87	15	29	94	9.6

CS93MPxxFFP • 9300 Series Mobile File File Pedestal

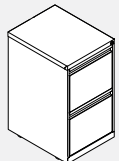

- Two file drawer pedestal.
- Casters preinstalled, casters non-locking.
- Counterweight included.
- All drawers locking.
- NOTE: Cannot be used as guest seating.

PRODUCT CODE	PRICE	SIZE/INCHES			WEIGHT VOL	
		H	W	D	LBS	FT ³
CS93MP19FFP	612	27.87	15	19	73	6.5
CS93MP23FFP	638	27.87	15	23	81	7.7
CS93MP29FFP	706	27.87	15	29	90	9.6

BSPFOBFxxC • Prime Freestanding Box File Pedestal

- One box and one file drawer pedestal.
- All drawers are locking.
- Box drawer includes pencil tray.
- For freestanding, to add counterweight (W2 option), add \$50 list.
- For mobile, to add casters and counterweight (W1 option), add \$75 list. Adds 0.5" to height.
- NOTE: Cannot be used as guest seating.

PRODUCT CODE	PRICE	SIZE / INCHES			WEIGHT VOL	
		H	W	D	LBS	FT ³
BSPFOBF18C	571	20.8	15	18	52.4	4.2
BSPFOBF22C	579	20.8	15	22	58.8	5.0
BSPFOBF28C	656	20.8	15	28	68.7	6.3

BSPFSBGxxC • Prime Box Box File Pedestal

- Two box and one file drawer pedestal.
- All drawers are locking.
- Top box drawer includes pencil tray.
- For freestanding, to add counterweight (W2 option), add \$50 list.
- For mobile, to add casters and counterweight (W1 option), add \$75 list. Adds 0.5" to height.
- Top box drawer 4.8"h; middle box drawer 6.4"h; bottom file drawer 13.6"h (interior 12.5"h).
- When worksurface supporting option selected, unit includes pre-drilled top holes for attaching and filler/brackets.

PRODUCT CODE	PRICE	SIZE / INCHES			WEIGHT VOL	
		H	W	D	LBS	FT ³
BSPFSBG18C	637	28	15	18	67.5	5.5
BSPFSBG22C	644	28	15	22	75.0	6.6
BSPFSBG28C	710	28	15	28	86.8	8.3

BSPFOFGxxC • Prime File File Pedestal

- Two file drawer pedestal.
- All drawers are locking.
- For freestanding, to add counterweight (W2 option), add \$50 list.
- For mobile, to add casters and counterweight (W1 option), add \$75 list. Adds 0.5" to height.
- Top file drawer 11.2"h (interior 10.6"h); bottom file drawer 13.6"h (interior 12.5"h).
- When worksurface supporting option selected, unit includes pre-drilled top holes for attaching and filler/brackets.

PRODUCT CODE	PRICE	SIZE / INCHES			WEIGHT VOL	
		H	W	D	LBS	FT ³
BSPFOFG18C	637	28	15	18	67.5	5.5
BSPFOFG22C	644	28	15	22	75.0	6.6
BSPFOFG28C	710	28	15	28	86.8	8.3

BSPWOBFxxC • Prime Mobile Box File Pedestal

- Mobile one box and one file drawer pedestal.
- All drawers are locking.
- 60mm casters.

PRODUCT CODE	PRICE	SIZE / INCHES			WEIGHT VOL	
		H	W	D	LBS	FT ³
BSPWOBF18C	758	23.3	15	18	73.5	4.6
BSPWOBF22C	763	23.3	15	22	79.1	5.6
BSPWOBF28C	878	23.3	15	28	87.7	7.0

Boulevard, Boulevard System 3, Compile, Diet & Evolve Ergonomic Solutions

Helping Office Inhabitants be Healthy and Efficient

- Ergonomic Computer Accessories
- Energy Efficient Lighting and Power Accessories
- Paper Management Accessories
- Workstation Enhancement Accessories

For use with Boulevard, Boulevard System 3, Compile, Diet and Evolve (unless otherwise specified).

GAKSM01 • Keyboard Support Mechanism

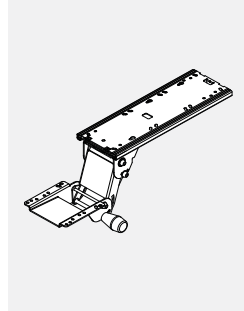

PRODUCT CODE	PRICE	SIZE / INCHES			WEIGHT VOL	
		H	W	D	LBS	FT ³
GAKSM01	244	4.3	9	23.8	9.2	0.533

- Height Range 6" (+1.0"/-5.5")
- Soft Touch Knob tilt adjustable range +15°/-15°
- 360° base swivel

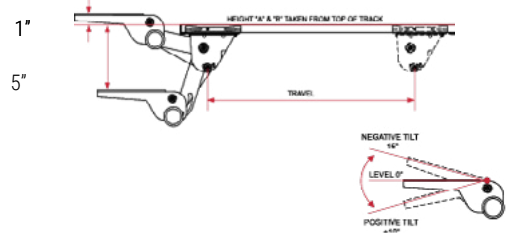

- Soft Touch Knob for simultaneous height & tilt adjustment.
- Spring-assist mechanism helps counter balance weight of keyboard & tray.
- Low-profile design for maximum leg room.
- Includes 21.75" under worksurface Glide Track
- Optional Glide Tracks available at no upcharge:
 - 12" Glide Track add suffix "12" (EXAMPLE GAKSM0112)
 - 18" Glide Track add suffix "18" (EXAMPLE GAKSM0118)
- Available in black only
- To be used with keyboard trays, sold separately.

GAKSML • Slim Fit Keyboard Support Mechanism

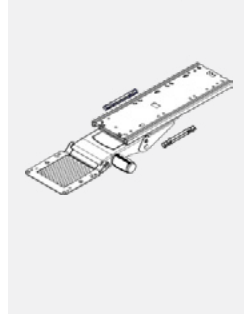

PRODUCT CODE	PRICE	SIZE / INCHES			WEIGHT VOL	
		H	W	D	LBS	FT ³
GAKSML	321	4.75	9.5	24	9	0.627
GAKSMLW	321	4.75	9.5	24	9	0.627

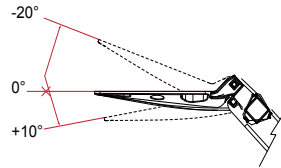
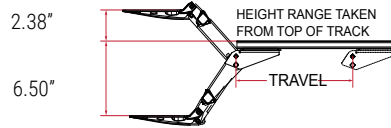

- Height Range 8.88" (+2.38" / - 6.5")
- Tilt Range (+10° / -20°)
- 360° Swivel.
- Meets ANSI/HFES, 100-2007 conformance requirement for height clearance.
- Super slim mechanism design increases clearance under the worksurface.
- Height & depth indicator incorporated together in an intelligently designed dashboard.
- Patented Lift-N-Lock™ height adjustment without knobs or levers automatically locks into position with release of tray for better AODA/Barrier Free compliance.
- Easy access to tilt control knob.
- Designed for disassembly and fully recyclable.
- Includes 21.75" undersurface Glide Track.
- Optional Glide Tracks available:
 - 12" Glide Track add suffix "12" (EXAMPLE GAKSML12)
 - 18" Glide Track add suffix "18" (EXAMPLE GAKSML18)
- "W" Indicated white finish.

GAKSM02 • Lift-N-Lock Keyboard Support Mechanism

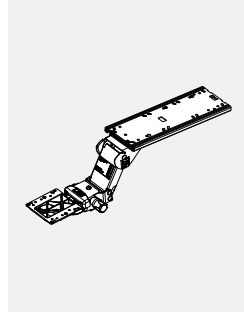

PRODUCT CODE	PRICE	SIZE / INCHES			WEIGHT VOL	
		H	W	D	LBS	FT ³
GAKSM02	321	4.3	9	23.8	9.7	0.533

- Height Range 8.38" (+2.25"/-6.13")
- Dial-Tilt Gauge shows precise tilt angles from +10°/-15° positions.
- 360° base swivel

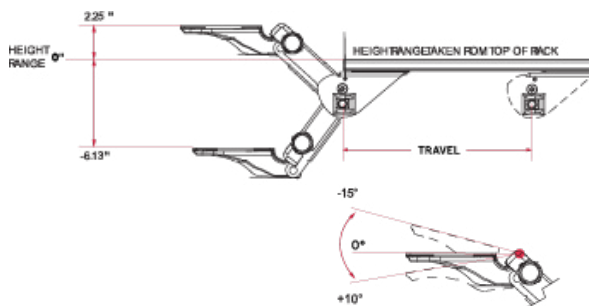

- Patent Pending Height Indicator Gauge allows for precise height setting when used by multiple users, or for returning to optimal height setting after storage.
- Exceeds BIFMA performance standards.
- Includes 21.75" under worksurface Glide Track
- Optional Glide Tracks available at no upcharge:
 - 12" Glide Track add suffix "12" (EXAMPLE GAKSM0212)
 - 18" Glide Track add suffix "18" (EXAMPLE GAKSM0218)
- Available in Black Only
- To be used with keyboard trays, sold separately.

NOTE: Positive Tilt Lockout available. Contact your Customer Service Representative.

- Patented Lift-N-Lock™ height adjustment without knobs or levelers automatically locks into position with release of tray for greater. Meets CSA B651 Barrier Free Design & AODA (Accessibility for Ontarians with Disabilities Act).

GAKSM03 • Lift-N-Lock Keyboard Support Mechanism

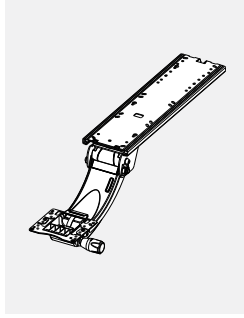

- Patent Pending Height Indicator Gauge allows for precise height setting when used by multiple users, or for returning to optimal height setting after storage.
- Curved neck allows user to be closer to the desk when in standing position.
- Exceeds BIFMA performance standards.

- Includes 21.75" under worksurface Glide Track
- Optional Glide Tracks available at no upcharge:
 - 12" Glide Track add suffix "12" (EXAMPLE GAKSM0312)
 - 18" Glide Track add suffix "18" (EXAMPLE GAKSM0318)
- Available in black only
- To be used with keyboard trays, sold separately.

NOTE: Positive Tilt Lockout available. Contact your Customer Service Representative.

- Maximizes ergonomic support for both seated and standing positions.
- Patented Lift-N-Lock™ height adjustment without knobs or levelers automatically locks into position with release of tray for greater. Meets CSA B651 Barrier Free Design & AODA (Accessibility for Ontarians with Disabilities Act).

PRODUCT CODE	PRICE	SIZE/ INCHES			WEIGHT VOL	
		H	W	D	LBS	FT ³
GAKSM03	519	5.8	9	23.8	11.3	0.719

- Height Range 14.13" (+8.25"/-5.88")
- Dial-Tilt Gauge shows precise tilt angles from +10°/-15° positions.
- 360° base swivel

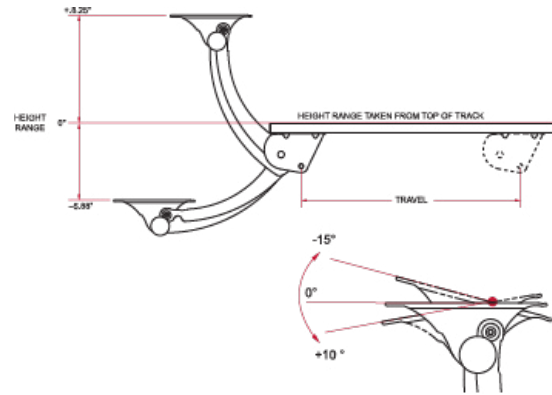

GAKSM05 • Fixed Mount Trackless Keyboard Arm

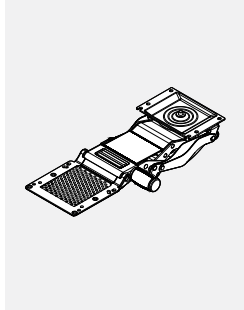

Features:

- Direct Mount, no track required. Ideal solution for Bridges and FreeFit Tables.
- Total height adjustment of 5.73" (-1.25" to -6.98" under the desk surface).
- Enhanced patented Lift-N-Lock™ braking mechanism.
- Soft Touch Knob Dial Tilt with +10° to -15° tilt angles.
- Low profile tray head.
- Separate height and tilt gauges.
- 360° of swivel.
- Optional factory or field installable tilt lockout available.

Benefits:

- Full storage in 9 3/8" undersurface space.
- Exceeds HFES & BIFMA 5th percentile seated keyboarding heights (HFES 22" BIFMA 22.6").
- Easy height adjustment, providing superior lock up and stability with infinite adjustment.
- ADA Compliant tilt adjustment with easily accessible tilt knob.
- Greater knee clearance under desking surface.

PRODUCT CODE	PRICE	SIZE/ INCHES			WEIGHT VOL	
		H	W	D	LBS	FT ³
GAKSM05	300	5	13	9	6	0.317
GAKSM05W	300	5	13	9	6	0.317

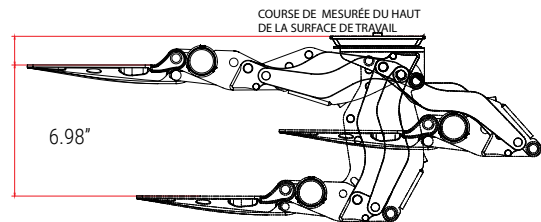

- Allows accurate, repeatable tray placement.
- Allows side to side arm movement.
- Locks out positive tilt for specific ergonomic applications or users preference.
- Provides increased storage where space permits.
- "W" indicated white finish.

GATM01 • Tray with Sliding Mouse Support

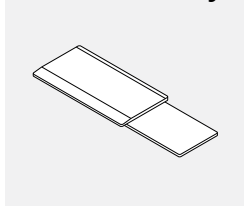

MDF Tray:

- Formed MDF with Textured Finish.
- Foam Anti-skid mat.

Sliding Retractable Mouse Support:

- ABS tray
- Sliding Retractable Mouse Support slides below the tray for left or right mouse positioning.
- Extends 9.91" beyond the end of the Keyboard Tray.
 - 33% recycled content by weight content) and 92.64% recyclable.
- Available in black only

PRODUCT CODE	PRICE	SIZE/ INCHES			WEIGHT VOL	
		H	W	D	LBS	FT ³
GATM01	245	2	21.3	10.5	7	0.259

GATM02 • 27" HDPE Tray with Two Mousing Surfaces

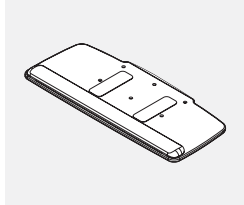

HDPE Tray:

- 1/2" thick High Density Polyethylene with textured finish.
- Includes removable plug-in, gel free foam palm rest.
- Anti-skid strips.

Mousing Surface:

- Keyboard and Mouse can be set up left or right.
- Includes Mouse Fence with Cable Manager.
 - 92.64% recyclable.
- Available in black only

PRODUCT CODE	PRICE	SIZE/ INCHES			WEIGHT VOL	
		H	W	D	LBS	FT ³
GATM02	317	1	27	11	6	0.179

GATM03 • Phenolic Tray with Height Adjustable Mouse Support

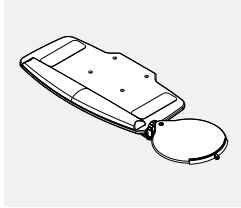

Height Adjustable Mouse Support:

- Ergonomic adjustment of tilt, swivel & height adjustment.
- Can be mounted either left or right.
- Includes mouse fence with cable manager.
- Available in black or white.
- "W" indicates white finish.

PRODUCT CODE	PRICE	SIZE/ H	INCHES W	D	WEIGHT LBS	VOL FT ³
GATM03	341	2.8	20.5	11	5.8	0.429
GATM03W	341	2.8	20.5	11	5.8	0.429

Phenolic Tray:

- Solid low profile keyboard tray.
- Graphite finish helps hide fingerprints and smudges.
- Includes removable plug-in, gel-free foam palm rest.
- Includes foam Anti-skid strips.

GATM04 • HDPE Tray with Height Adjustable Mouse Support

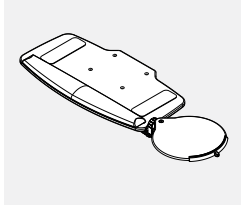

HDPE Tray:

- 1/2" thick High Density Polyethylene with textured finish.
- Includes removable plug-in, gel free foam palm rest.
- 45% recycled content by weight (45%Post Industrial content) and 99.97% recyclable.
- Includes foam anti-skid strips.

PRODUCT CODE	PRICE	SIZE/ H	INCHES W	D	WEIGHT LBS	VOL FT ³
GATM04	383	3.2	20.5	11	6	0.5

Height Adjustable Mouse Support:

- Ergonomic adjustment of tilt, swivel & height adjustment.
- Can be mounted either left or right.
- Includes mouse fence with cable manager.
 - 92.64% recyclable.
- Available in black only.

GAGTA01 • Glide Tray Adapter (set of 2)

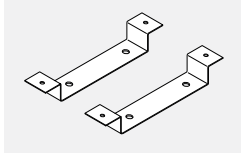

- Attaches to Glide Tracks of all Keyboard Mechanisms and Sliding CPU Holders found within this price list.
- Mounting hardware included.
- Available in black only.
- Not required for use with GAKSM05.

PRODUCT CODE	PRICE	SIZE/ H	INCHES W	D	WEIGHT LBS	VOL FT ³
GAGTA01	88	2.5	9	2	0.5	0.025

- Accommodates the placement of sliding keyboard mechanisms and CPU holders below the cross beam of a Bridges tables.

Keyboard Combination Chart • Package Codes and Pricing

- "W" at the end of the code designates white keyboard.
- "W" before 2 numbers designates white mechanism.
- "W" in both places in code designates white keyboard and mechanism.



 GAKSM01	GAKSP0101 \$492	GAKSP0102 \$560	GAKSP0103 / GAKSP103W \$586	GAKSP0104 \$626
 GAKSML/GAKSMLW	GAKSPML01 / GAKSPMLW01 \$564	GAKSPML02 / GAKSPMLW02 \$637	GAKSPML03 / GAKSPML03W / GAKSPMLW03 / GAKSPMLW03W \$662	GAKSPML04 / GAKSPMLW04 \$702
 GAKSM02	GAKSP0201 \$564	GAKSP0202 \$637	GAKSP0203 / GAKSP0203W \$662	GAKSP0204 \$702
 GAKSM03	GAKSP0301 \$762	GAKSP0302 \$832	GAKSP0303 / GAKSP0303W \$858	GAKSP0304 \$898
 GAKSM05/GAKSM05W	GAKSP0501 / GAKSP0501W \$547	GAKSP0502 / GAKSP0502W \$616	GAKSP0503 / GAKSP0503W / GAKSP0503W \$640	GAKSP0504 / GAKSP05W04 \$681

GACPU01 • Fixed Mount CPU Holder

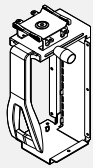

- Fully adjustable clamping mechanism to accept tower CPU's with a wide range of 3.5" to 9.3" and a height range of 12.5" to 22.5".
- Soft Touch knob for side clamp adjustment and bayonet lance for vertical height adjustment.
- Directly mounts to underside of desk surface.
- CPU Holder can also be mounted directly to an upright desk leg surface or wall, via side mounting holes.
- Manufactured from Steel and Engineered Resin, providing rugged durability and support.
- Available in Black Only

PRODUCT CODE	PRICE	SIZE/ INCHES			WEIGHT VOL	
		H	W	D	LBS	FT ³
GACPU01	202	18.5	11.7	9.2	9	1.152

GACPU02 • CPU Holder on Glide Track

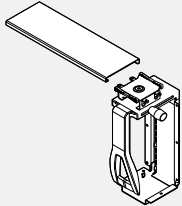

- Accepts tower CPU's with a width range of 3.5" to 9.3" and a height range of 12.5" to 22.5".
- Soft Touch knob for side clamp adjustment and bayonet lance for vertical height adjustment.
- 12" Glide Track mounted and 360° swivel for easy access for rear of CPU
- Manufactured from Steel and Engineered Resin, providing rugged durability and support.
- Available in Black Only

PRODUCT CODE	PRICE	SIZE/ INCHES			WEIGHT VOL	
		H	W	D	LBS	FT ³
GACPU02	290	18.5	11.7	9.2	12.6	1.152

GACPUH • Woof CPU Holder

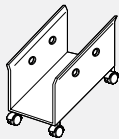

- Provides convenience access to front and back of CPU.
- Expandable width accommodates various sizes of CPU's. Adjusts from 7" to 10".
- Includes 4 locking casters and 4 protective "O" rings.
- Available in Tungsten Only

PRODUCT CODE	PRICE	SIZE/ INCHES			WEIGHT VOL	
		H	W	D	LBS	FT ³
GACPUH	187	11	16	7-10	5	1.0

GAAKS1818 • CRT Corner Plate

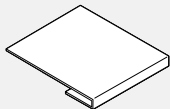

- Converts two abutting worksurfaces in a 90° corner into a 45° angle keyboard worksurface.
- Keyboard mechanism not included.
- Fits worksurfaces 1" to 1.25" thick.
- Available in Panel Frame Finish

PRODUCT CODE	PRICE	SIZE/ INCHES			WEIGHT VOL	
		H	W	D	LBS	FT ³
GAAKS1818	99	1.25	18	18	3.7	0.454

GAMA1 • Single Clamp Mount Monitor Arm

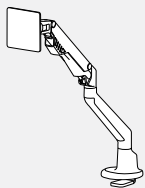

- Finger touch dynamic height adjustment, 12" height range. 4.4 to 19.8 lbs. per monitor loading capacity; accepts screen size 17"-30".
- Maximum monitor width of 34".
- Maximum of 20.5" extension from rear of desk to back of monitor, folds to 4.5".
- Tilt, pan and landscape to portrait rotation; quick release VESA plate, 180 degree lock out.
- Clamp mount and grommet mount options included, accommodates 0.5" to 2" thick tops.
- Accepts mini slide arm GAMS.
- Available in Tungsten (TUN)

PRODUCT CODE	PRICE	SIZE/ INCHES			WEIGHT VOL	
		H	W	D	LBS	FT ³
GAMA1	460	21		5.5	6.6	0.4

GAMA2 • Double Clamp Mount Monitor Arm

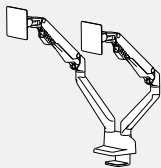

- Finger touch dynamic height adjustment, 12" height range. 4.4 to 19.8 lbs. per monitor loading capacity; accepts screen size 17"-30".
- Maximum monitor width of 34".
- Maximum of 20.5" extension from rear of desk to back of monitor, folds to 4.5".
- Tilt, pan and landscape to portrait rotation; quick release VESA plate, 180 degree lock out.
- Clamp mount and grommet mount options included, accommodates 0.5" to 2" thick tops.
- Accepts mini slide arm GAMS.
- Available in Tungsten (TUN)

PRODUCT CODE	PRICE	SIZE/ INCHES			WEIGHT VOL	
		H	W	D	LBS	FT ³
GAMA2	807	21		5.5	12.8	1

GAMS • Mini Slide Monitor Arm

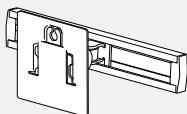

- Works with GAMA1 and GAMA2 monitor arms.
- 9" slide, loading capacity 13.2lbs.
- Quick release VESA plate.
- Available in Tungsten (TUN)

PRODUCT CODE	PRICE	SIZE/ INCHES			WEIGHT VOL	
		H	W	D	LBS	FT ³
GAMS	160	4.5	11	6	3.3	0.3

Monitor Arm Specs

- VESA Mounting plate contains 75 mm & 100 mm mounting configuration
- VESA Plate head is fully adjustable with 180° of tilt, 180° of swivel and 360° of rotation for portrait to landscape viewing
- Keyhole slots in VESA Plate for quick mounting of Display Screen
- Counterbalance spring mechanism does not contain gas cylinders (that are prone to leakage)
- Cable Management provided on arm swivel joints
- Arm components manufactured from 100% recyclable aluminum die cast material, providing stability and durability
- 13" Arm height adjustment on 11" Stainless Steel Pole.
- Pole Support Ring doubles as cable manager.
- 360° of arm swivel around pole.
- Desk Clamp and Grommet mounting options standard on pole applications.
- Monitor arms available in Silver (SIL), Black (BLK), or White (WHT).

GAMCSSDE • Double Extension Monitor Arm for Single Screen

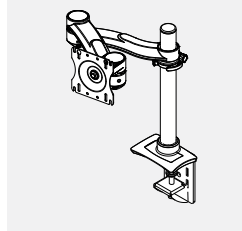

Monitor Arm Single Screen Dual Arm Extension.

- 9 1/2" reach from centre of pole to front of VESA Plate
- Display Viewing - 180° of tilt, 180° of swivel and 360° of rotation.
- Quick Mount Versa Plate.
- 12" Pole Adjustment.
- 9" Chrome pole adjustment.
- Available in Silver (SIL), Black (BLK) or White (WHT).
- Post is chromed.

PRODUCT CODE	PRICE	SIZE/ INCHES			WEIGHT VOL	
		H	W	D	LBS	FT ³
GAMCSSDE	506	29.3	6.8	9.5	7.5	1.095

GAMCSSDEH • Double Extension with Height Adjustable Monitor Arm for Single Screen

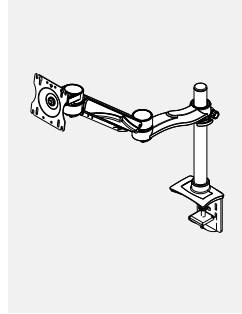

Double extension with height adjustable monitor arm for single screen frees up worksurface space and supports a sit/stand working posture.

- Attaches to the edge of the worksurface or through a grommet.
- Monitor arm adjusts from 3" to 12" from the worksurface.
- Counterbalanced arm provides an additional 13" of height adjustment.
- Monitor connecting bracket swivels 360 degrees and tilts +/- 90 degrees (180 degrees).
- Double extension has 19" of back and forth movement to allow for different focal depths of viewing comfort.
- Built-in cable clips on underside of extension arms and pole base allows organized cable management.
- Available in Silver (SIL), Black (BLK) or White (WHT).
- Post is chromed.

PRODUCT CODE	PRICE	SIZE/ INCHES			WEIGHT VOL	
		H	W	D	LBS	FT ³
GAMCSSDEH	609	29.3	6.8	9.5	8.2	1.095

GAMCDSDE • Monitor Arms for Dual Screens

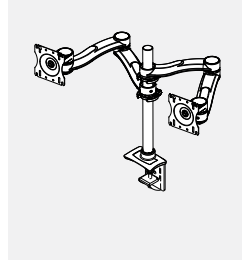

Double extension monitor arms for dual screens frees up worksurface space.

- Used for side-by-side or back-to-back applications.
- Attaches to the edge of the worksurface or through a grommet.
- Monitor arm adjusts from 3" to 12" from the worksurface.
- Monitor connecting extension has 19" of back and forth movement to allow for different focal depths of viewing comfort.
- Max 32" screen width.
- Built-in cable clips on underside of extension arms and pole base allows organized cable management.
- Available in Silver (SIL), Black (BLK) or White (WHT).
- Post is chromed.

PRODUCT CODE	PRICE	SIZE/ INCHES			WEIGHT VOL	
		H	W	D	LBS	FT ³
GAMCDSDE	898	29.3	6.8	9.5	10.7	1.095

GAMCDSDEH • Double Extension with Height Adjustable Monitor Arms for Dual Screens

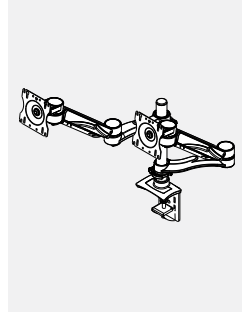

Double extension with height adjustable monitor arms for dual screens frees up the worksurface space and supports a sit/stand working posture.

- Used for side-by-side or back-to-back applications.
- Attaches to the edge of the worksurface or through a grommet.
- Monitor arm adjusts from 3" to 12" from the worksurface.
- Counterbalanced arm provides an additional 13" of height adjustment.
- Monitor connecting bracket swivels 360 degrees and tilts +/- 90 degrees (180 degrees).
- Double extension has 19" of back and forth movement to allow for different focal depths of viewing comfort.
- Built-in cable clips on underside of extension arms and pole base allows organized cable management.
- Max 35" screen width.
- Available in Silver (SIL), Black (BLK) or White (WHT).
- Post is chromed.

PRODUCT CODE	PRICE	SIZE/ INCHES			WEIGHT VOL	
		H	W	D	LBS	FT ³
GAMCDSDEH	1114	29.3	6.8	9.5	12.2	1.095

GAMLDM20 • Single Screen Monitor Arm for 5 to 20lbs

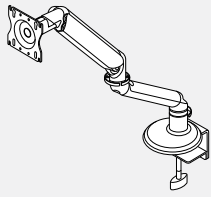

- Comes with clamp and grommet mount, ideal for all desk mounting configurations, minimizing SKU's.
- Adjustable counterbalance cylinder provides smooth 14 1/2" of height adjustment with fingertip control. - counterbalances monitors from 5 lbs. to 20 lbs.
- Double extension arms provide a maximum of 26 3/4" extension from the rear edge of the mounting surface to the VESA Plate for greater monitor adjustment on deep or corner workstations.
- Arms fold back to a minimum dimension of 4 1/2" to provide maximum desk utilization.
- Monitor mounting bracket, with Quick Connect adaptor, contains both 75mm & 100mm hole patterns to match most screen types and compliant with VESA mounting standards.
- Weight gauge provided to allow for quick and easy counterbalance adjustment of the arm prior to installing the screen. Saves time and guesswork especially for multiple arm installations.
- VESA Plate rotates for portrait or landscape viewing with 180° side to side rotation and -90° to +45° tilt for optimal viewing adjustment.
- Die cast aluminum construction provides greater stability and contains high recycled material content with full recyclability.
- Adjustable rotation limiter to restrict arm rotation to 180°, preventing arms from hitting walls.
- Comes with all tools and mounting hardware for quick and easy installation (Tool-free).
- Available in Silver (SIL), Black (BLK) or White (WHT).

PRODUCT CODE	PRICE	SIZE/ INCHES			WEIGHT VOL	
		H	W	D	LBS	FT ³
GAMLDM20	471	38	6	8.5	10.23	1.122

GAMLDM30 • Single Screen Monitor Arm for 10 to 30lbs

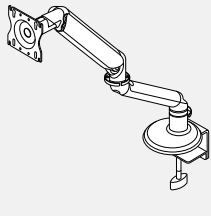

- Comes with clamp and grommet mount, ideal for all desk mounting configurations, minimizing multiple SKU's
- Adjustable counterbalance cylinder provides smooth 14 1/2" of height adjustment with fingertip control - counterbalances monitors from 10 lbs. to 30 lbs.
- Double extension arms provides a maximum of 26.7" extension from the rear edge of the mounting surface to the VESA Plate for greater monitor adjustment on deep or corner workstations
- Arms fold back to a minimum dimension of 4 1/2" to provide maximum desk utilization
- Monitor mounting bracket with Quick Connect adaptor, contains both 75mm & 100mm hole patterns to match most screen types and compliant with VESA mounting standards
- Weight gauge provided to allow for quick and easy counterbalance adjustment of the arm prior to installing the screen.
- Saves time and guesswork especially for multiple arm installations VESA Plate rotates for portrait and landscape viewing with 180° side to side rotation and -90° to +45° tilt for optimal viewing adjustment
- Die cast aluminum construction provides greater stability and contains high recycled material content with full recyclability
- Adjustable rotation limiter to restrict arm rotation to 180°, preventing arms from contacting walls
- Comes with all tools and mounting hardware for quick and easy installation (Tool-free)
- Available in Silver (SIL), Black (BLK) or White (WHT).

PRODUCT CODE	PRICE	SIZE/ INCHES			WEIGHT VOL	
		H	W	D	LBS	FT ³
GAMLDM30	505	38	6	8.5	10.23	1.122

GAMLDM40 • Dual Screen Monitor Arm for combined 15 to 40lbs

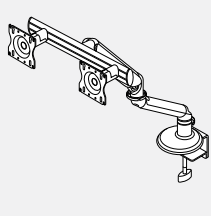

- Comes with clamp and grommet mount, ideal for all desk mounting configurations, minimizing multiple SKU's
- Adjustable counterbalance cylinder provides smooth 14 1/2" of height adjustment with fingertip control and a counterbalance range from 15 lbs. to 40 lbs.
- Double extension arms provide a maximum of 30 3/4" extension from the rear edge of the mounting surface to the VESA Plate for greater monitor adjustment on deep or corner workstations
- Arms fold back to a minimum dimension of 8 3/8" to provide maximum desk utilization
- Monitor mounting bracket with Quick Connect Adaptor, contains both 75mm & 100mm hole patterns to match most screen types and is compliant with VESA mounting standards
- Weight gauge provided to allow for quick and easy counterbalance adjustment of the arm prior to installing the screen. Saves time and guesswork especially for multiple arm installations.
- VESA Plate rotates for portrait and landscape viewing with 180° side to side rotation and -90° to +45° tilt for optimal viewing adjustment
- Die cast aluminum construction provides greater stability and contains high recycled material content with full recyclability
- Adjustable rotation limiter to restrict arm rotation to 180°, preventing arms from contacting walls
- Comes with all tools and mounting hardware for quick and easy installation (Tool-free)
- Available in Silver (SIL), Black (BLK) or White (WHT).

PRODUCT CODE	PRICE	SIZE/ INCHES			WEIGHT VOL	
		H	W	D	LBS	FT ³
GAMLDM40	607	38	6.25	8.5	12.75	1.168

BLVELEDVS • LED Single Arm Lamp

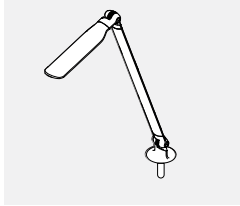

- **7 System watts, 18-fractional LEDs.**
- 3500K 250 lumens, 84 CRI.
- Soft touch - instant on, fade to off.
- Infinite dimming 100% down to 15%, last state memory.
- Standard 10 hours turn off (ATO).
- 50,000 hour life LEDs.
- 15 watt, 24 volt wall transformer, 6' cord.
- White (WHT) Silver (SIL) or Black (BLK) - Must specify colour choice.
- UL, CUL and CSA compliant, ETL Listed.
- Base not included.

PRODUCT CODE	PRICE	SIZE/ INCHES			WEIGHT VOL	
		H	W	D	LBS	FT ³
BLVELEDVS	616	8	7	33	7.3	0.98
With Occupancy Sensor						
BLVELEDVSO	920	10	9	35	8.3	1.51

BLVELEDVD • LED Double Arm Lamp

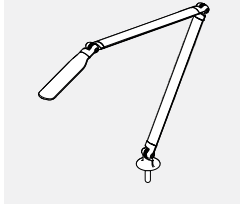

- **7 System watts, 18-fractional LEDs.**
- 3500K 250 lumens, 84 CRI.
- Double arm articulation with 20" base to head reaches.
- Soft touch - instant on, fade to off.
- Infinite dimming 100% down to 15%, last state memory.
- Standard 10 hours turn off (ATO).
- 50,000 hour life LEDs.
- 15 watt, 24 volt wall transformer, 6' cord.
- White (WHT) Silver (SIL) or Black (BLK) - Must specify colour choice.
- UL, CUL and CSA compliant, ETL Listed.
- Base not included.

PRODUCT CODE	PRICE	SIZE/ INCHES			WEIGHT VOL	
		H	W	D	LBS	FT ³
BLVELEDVD	646	8	7	33	7.6	1.02
With Occupancy Sensor						
BLVELEDVDO	931	10	9	35	8.6	1.57

BLVELEDRS • LED Single Arm Lamp

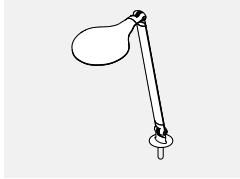

- **7 System watts, 18-fractional LEDs.**
- 3500K 250 lumens, 84 CRI.
- Soft touch - instant on, fade to off.
- Infinite dimming 100% down to 15%, last state memory.
- Standard 10 hours turn off (ATO).
- 50,000 hour life LEDs.
- 15 watt, 24 volt wall transformer, 6' cord.
- White (WHT) Silver (SIL) or Black (BLK) - Must specify colour choice.
- UL, CUL and CSA compliant, ETL Listed.
- Base not included.

PRODUCT CODE	PRICE	SIZE/ INCHES			WEIGHT VOL	
		H	W	D	LBS	FT ³
BLVELEDRS	616	8	7	33	7.3	0.98
With Occupancy Sensor						
BLVELEDRSO	920	10	9	35	8.3	1.51

BLVELEDRD • LED Double Arm Lamp

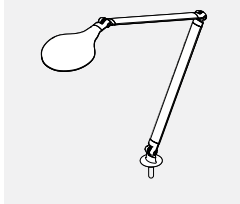

- **7 System watts, 18-fractional LEDs.**
- 3500K 250 lumens, 84 CRI.
- Double arm articulation with 20" base to head reaches.
- Soft touch - instant on, fade to off.
- Infinite dimming 100% down to 15%, last state memory.
- Standard 10 hours turn off (ATO).
- 50,000 hour life LEDs.
- 15 watt, 24 volt wall transformer, 6' cord.
- White (WHT) Silver (SIL) or Black (BLK) - Must specify colour choice.
- UL, CUL and CSA compliant, ETL Listed.
- Base not included.

PRODUCT CODE	PRICE	SIZE/ INCHES			WEIGHT VOL	
		H	W	D	LBS	FT ³
BLVELEDRD	633	8	7	33	7.6	1.02
With Occupancy Sensor						
BLVELEDRDO	931	10	9	35	8.6	1.57

Lamp Mounting Options



- White (WHT) Silver (SIL) or Black (BLK) - Must specify colour choice.

Grommet Mount

PRODUCT CODE	PRICE	SIZE/ H	INCHES W	D	WEIGHT LBS	VOL FT ³
BLVELEDASM	155	3	6	6	3	0.06



Worksurface Clamp Mount

PRODUCT CODE	PRICE	SIZE/ H	INCHES W	D	WEIGHT LBS	VOL FT ³
BLVELEDASCM	155	3	6	6	2	0.04



Slat Wall Mount

PRODUCT CODE	PRICE	SIZE/ H	INCHES W	D	WEIGHT LBS	VOL FT ³
BLVELEDASW	155	3	6	6	3	0.06



Panel Mount

PRODUCT CODE	PRICE	SIZE/ H	INCHES W	D	WEIGHT LBS	VOL FT ³
BLVELEDAPM	155	3	6	6	3	0.06

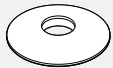

Freestanding Base

PRODUCT CODE	PRICE	SIZE/ H	INCHES W	D	WEIGHT LBS	VOL FT ³
BLVELEDAFS	173	4	12	12	6	0.50

GCLEDES • Undercabinet LED Task Light

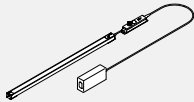

Linear LED Light.

- Includes light fixture with lens and ON/OFF switch.
- Magnet mounted with optional adhesive metal plates.
- Plug-in power supply with 72" cord length plus 78" DC cord.

Technical information:

- 4100 K Colour Temperature
- 90 Colour Rendering Index
- 30,000 hrs rated Lifespan
- Total power input per light, 9.0 for 24", 13.5 per 36" and 18.0 for 48"

PRODUCT CODE	PRICE	SIZE/ H	INCHES W	D	WEIGHT LBS	VOL FT ³
GCLEDES24	164	1	22.9	1	2.5	0.135
GCLEDES36	189	1	33.5	1	2.8	0.161
GCLEDES48	209	1	45.5	1	3.2	0.213

GCLEDES-DCS • Undercabinet Daisychain LED Light

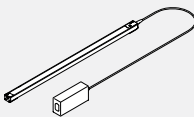

- Undercabinet LED light, 48 inches nominal size, daisychain unit with 1 meter (39 inches) linking cable but no power supply.
- Daisychain units can only be linked up to a total of 48 Watts for all lights on one power supply. This equates to a maximum of 10 feet total nominal length of lights per power supply.

Technical information:

- 4100 K Colour Temperature
- 90 Colour Rendering Index
- 30,000 hrs rated Lifespan
- Total power input per light, 9.0 for 24", 13.5 per 36" and 18.0 for 48"

PRODUCT CODE	PRICE	SIZE/ H	INCHES W	D	WEIGHT LBS	VOL FT ³
GCLEDES24DSC	134	1	24	1	2.5	0.135
GCLEDES36DSC	157	1	36	1	2.8	0.161
GCLEDES48DSC	178	1	48	1	3.2	0.213

GCLEDESOS • Occupancy Sensor and Dimmer

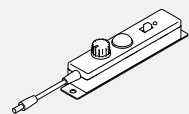

- Inline add-on controller for dimming & occupancy sensor.
- Included, from right to left, a rotary dimmer control, an occupancy sensor and a sensor bypass switch.

PRODUCT CODE	PRICE	SIZE/ H	INCHES W	D	WEIGHT LBS	VOL FT ³
GCLEDESOS	66	6	2.5	2	0.4	0.500

BEMAE • Mini-Adapt Power Module



- **Accessory Data/Power House.**
- Attaches to scoop at the back of a worksurface.
- BEMAE1 includes 2 simplex outlets, 6' power cord.
- Available in Black Only

PRODUCT CODE	PRICE	SIZE/ INCHES			WEIGHT VOL	
		H	W	D	LBS	FT ³
BEMAE1	193	2	3.625	3	2.5	0.149

BRED50 • Duo Module

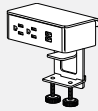

- **The duo power module is completely integrated with a mounting clamp to attach to the edge of a worksurface.**
- Provides two outlets and two 2.1 amp USB ports.
- White face plate, outlets and bracket; 72" long three-prong cord.

PRODUCT CODE	PRICE	SIZE/ INCHES			WEIGHT VOL	
		H	W	D	LBS	FT ³
BRED50	615	1.8	5.5	3.2	2.50	0.14

BRED50AC • Duo Module with A+C



- **The Duo power module is completely integrated with a mounting clamp to attach to the edge of a worksurface.**
- Provides two 15 Amp 120 Volt AC Receptacles; 2.4 amp USB-A port and 60 watt USB-C power delivery port.
- 10' long three-prong cord.
- Available in W - White or B - Black as indicated by last letter of model number.

PRODUCT CODE	PRICE	SIZE/ INCHES			WEIGHT VOL	
		H	W	D	LBS	FT ³
BRED50ACW	695	3	5.5	3.2	3	0.2
BRED50ACB	695	3	5.5	3.2	3	0.2

BREDU51 • Duo Under Module

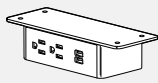

- **The duo under power module comes with a thin flush mounting bracket to attach to the underside of a work surface or above work surface shelves.**
- Provides two outlets and two 2.1 amp USB ports.
- White face plate, outlets and brackets; 72" long three-prong cord.

PRODUCT CODE	PRICE	SIZE/ INCHES			WEIGHT VOL	
		H	W	D	LBS	FT ³
BREDU51	537	1.8	5.5	2.8	2.5	0.14

BREDU51AC • Duo Under Module with A+C

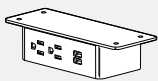

- **The Duo under power module comes with a thin flush mounting bracket to attach to the underside of a work surface or above work surface shelves.**
- Provides two 15 Amp 120 Volt AC Receptacles; 2.4 amp USB-A port and 60 watt USB-C power delivery port.
- 10' long three-prong cord.
- Available in W - White or B - Black as indicated by last letter of model number.

PRODUCT CODE	PRICE	SIZE/ INCHES			WEIGHT VOL	
		H	W	D	LBS	FT ³
BREDU51ACW	695	1.8	5.5	2.8	3	0.2
BREDU51ACB	695	1.8	5.5	2.8	3	0.2

BREDB52 • Duo Bezel Module



- **The duo bezel power module is embedded and flush-mounted in a piece of furniture or a work surface.**
- Provides two outlets and two 2.1 amp USB ports.
- White face plate, outlets and bezel; 72" long three-prong cord.
- Note: Will not work on W thick worksurfaces, please contact your Customer Service Representative for specific surface applications.

PRODUCT CODE	PRICE	SIZE/ INCHES			WEIGHT VOL	
		H	W	D	LBS	FT ³
BREDB52	576	4	6.5	3.2	2.5	0.14

BRETP53 • Trio Plus Module

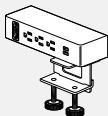

- **The trio plus power module is completely integrated with a mounting clamp to attach to the edge of a work surface or above work surface shelves.**
- Provides three outlets and two 2.1 amp USB ports and an adapter kit containing blank cover, HDMI, RJ45 or VGA adapter brackets. Note: HDMI, RJ45 and VGA connectors are not included.
- White face plate, outlets, adapters and brackets; 72" long three-prong cord.

PRODUCT CODE	PRICE	SIZE/ INCHES			WEIGHT VOL	
		H	W	D	LBS	FT ³
BRETP53	693	1.8	8	3.2	2.5	0.14

BRETPB55 • Trio Plus Bezel Module



- **The trio plus bezel power module is embedded and flush-mounted in a piece of furniture or a work surface.**
- Provides three outlets and two 2.1 amp USB ports and an adapter kit containing blank cover, HDMI, RJ45 or VGA adapter brackets. Note: HDMI, RJ45 and VGA connectors are not included.
- White face plate, outlets, adapters and bezel; 72" long three-prong cord.
- Will not work on W thick worksurfaces, please contact your Customer Service Representative for specific surface applications.

PRODUCT CODE	PRICE	SIZE/ INCHES			WEIGHT VOL	
		H	W	D	LBS	FT ³
BRETPB55	662	4	9	3.2	2.5	0.14

Telecom Plates

Note: To be used in conjunction with BPG-DPS21 and BPGDPS41.



PRODUCT CODE	PRICE
Black telcom plate with 2 RJ45 cat 6 data ABLBB	245

Black telcom plate with 3 RJ45 cat 6 data ABLBBB	361
--	-----

Black telcom plate with 4 RJ45 cat 6 data ABLBBBB	476
---	-----

GCRTMCS401 • Recessed Power Block, 1 Duplex, 1 Data Knock-outs, 1 Power Duplex

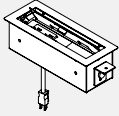

- Single sided recessed power block with 1 regular duplex and 1 data knock-out on top, 1 power duplex on bottom.
- 10 ft power cord with straight plug.
- Telecom plates ordered separately.
- Available in Black - B, Tungsten - T or Designer White - W as indicated by last letter of model number; duplexes always grey.
- Not approved for daisy-chain applications.

PRODUCT CODE	PRICE	H	W	D	WEIGHT LBS	VOL FT ³
GCRTMCS401B	578	10.78	4.22	4.86	4.3	0.51
GCRTMCS401T	578	10.78	4.22	4.86	4.3	0.51
GCRTMCS401W	578	10.78	4.22	4.86	4.3	0.51

GCRTMCS421 • Recessed Power Block, 1 Power including USB A+C, 1 Data Knock-outs, 1 Power Duplex

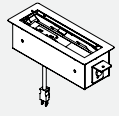

- Single sided recessed power block with 1 power and USB A+C duplex and 1 data knock-out on top, 1 power duplex on bottom.
- USB Type A port charges maximum 2.4 amps at 5V and Type C port charges maximum 3 amps at 5V.
- 10 ft power cord with straight plug.
- Telecom plates ordered separately.
- Available in Black - B, Tungsten - T or Designer White - W as indicated by last letter of model number; duplexes always grey.
- Not approved for daisy-chain applications.

PRODUCT CODE	PRICE	H	W	D	WEIGHT LBS	VOL FT ³
GCRTMCS421B	759	10.78	4.22	4.86	4.3	0.51
GCRTMCS421T	759	10.78	4.22	4.86	4.3	0.51
GCRTMCS421W	759	10.78	4.22	4.86	4.3	0.51

GCRTMCS602 • Recessed Power Block, 2 Duplex, 2 Data Knock-outs, 1 Power Duplex

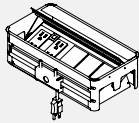

- Double sided recessed power block with 2 regular duplex and 2 data knock-outs on top, 1 power duplex on bottom.
- 10 ft power cord with straight plug.
- Telecom plates ordered separately.
- Available in Black - B, Tungsten - T or Designer White - W as indicated by last letter of model number; duplexes always grey.
- Not approved for daisy-chain applications.

PRODUCT CODE	PRICE	H	W	D	WEIGHT LBS	VOL FT ³
GCRTMCD602B	660	10.78	6.22	4.86	5.9	0.51
GCRTMCD602T	660	10.78	6.22	4.86	5.9	0.51
GCRTMCD602W	660	10.78	6.22	4.86	5.9	0.51

GCRTMCS602 • Recessed Power Block, 2 Duplex, 2 Data Knock-outs, 1 Power Duplex

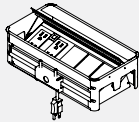

- Double sided recessed power block with 1 regular duplex, 1 power and USB A+C and 2 data knock-outs on top, 1 power duplex on bottom.
- USB Type A port charges maximum 2.4 amps at 5V and Type C port charges maximum 3 amps at 5V.
- 10 ft power cord with straight plug.
- Telecom plates ordered separately.
- Available in Black - B, Tungsten - T or Designer White - W as indicated by last letter of model number; duplexes always grey.
- Not approved for daisy-chain applications.

PRODUCT CODE	PRICE	H	W	D	WEIGHT LBS	VOL FT ³
GCRTMCD622B	831	10.78	6.22	4.86	6.1	0.51
GCRTMCD622T	831	10.78	6.22	4.86	6.1	0.51
GCRTMCD622W	831	10.78	6.22	4.86	6.1	0.51

GCRTMCS622 • Recessed Power Block, 2 Power including USB A+C, 2 Data Knock-outs, 1 Power Duplex

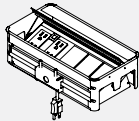

- Double sided recessed power block with 2 power and USB A+C and 2 data knock-outs on top, 1 power duplex on bottom.
- USB Type A port charges maximum 2.4 amps at 5V and Type C port charges maximum 3 amps at 5V.
- 10 ft power cord with straight plug.
- Telecom plates ordered separately.
- Available in Black - B, Tungsten - T or Designer White - W as indicated by last letter of model number; duplexes always grey.
- Not approved for daisy-chain applications.

PRODUCT CODE	PRICE	H	W	D	WEIGHT LBS	VOL FT ³
GCRTMCD642B	1001	10.78	6.22	4.86	6.3	0.51
GCRTMCD642T	1001	10.78	6.22	4.86	6.3	0.51
GCRTMCD642W	1001	10.78	6.22	4.86	6.3	0.51

DABAR • Power Bar

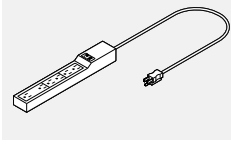

- Power bar with 5 + 1 receptacles (one spaced wide for adapter use), built-in transient voltage surge suppressor and power switch.
- Standard with 10' cord.
- Integrated key hole mounting in the back.
- Rating 15A, 125V, AC 60Hz, 1875W.
- Suppressed voltage rating: 330V peak.

PRODUCT CODE	PRICE	SIZE/	INCHES			WEIGHT VOL	
		H	W	D	LBS	FT ³	
DABAR	63			12	2	0.02	

BABC • Wire Manager

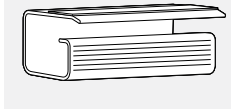

- Attaches to the underside of the worksurface with a peel and stick adhesive that is located on the top of the wire manager. Comes 10 per package.
- Black only

PRODUCT CODE	PRICE	SIZE/	INCHES			WEIGHT VOL	
		H	W	D	LBS	FT ³	
BABC04	40	2	4	2	2	0.14	

BRACS • Cable Snake

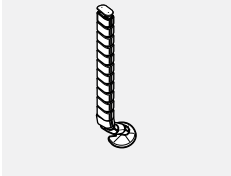

- Flexible cable management trough.
- Two pathways within the snake, one for data/communication and one for routing power cables.
- Clear (CLR) available only.

PRODUCT CODE	PRICE	SIZE/	INCHES			WEIGHT VOL	
		H	W	D	LBS	FT ³	
BRACS	123	30	8		3	0.19	
BRACSH	207	49	8		5	0.27	

ModPower Power Solution

- Power solutions for flexible spaces. Connect up to four units (in Canada)/six units in the USA from a single infeed with NEMA plug to deliver power and charging ports to the table top. In-surface modules and clamp on modules available.
- Easy to install; code compliant that allows users to optimize any space providing convenient power access. Perfect for training areas, meeting rooms, in-office workstations and more. Units feature tamper-resistant receptacles as well as both USB-A and USB-C charging ports.
- Easy to use connectors that are touch-safe with added latch to prevent unintended separation. Easy push together to connect, and simple press down on latch to disconnect.
- Maximum overall length not to exceed 48.5 feet per infeed. UL listed to UL962A SD, the standard for furniture power distribution units for portable/moveable work space tables.
- Certified to CSA standard C22.2 No. 203-16.
- Will work with Licence, Terina and Bridges Products.
- Surface mounted module ships with a clamp mount that will accommodate any material 1/2" to 1-1/2" thick; additional brackets are also included for screw in mounting options that can accommodate vertical or horizontal positions.
- Modules can be integrated into surfaces but the surface must be specified as a special.

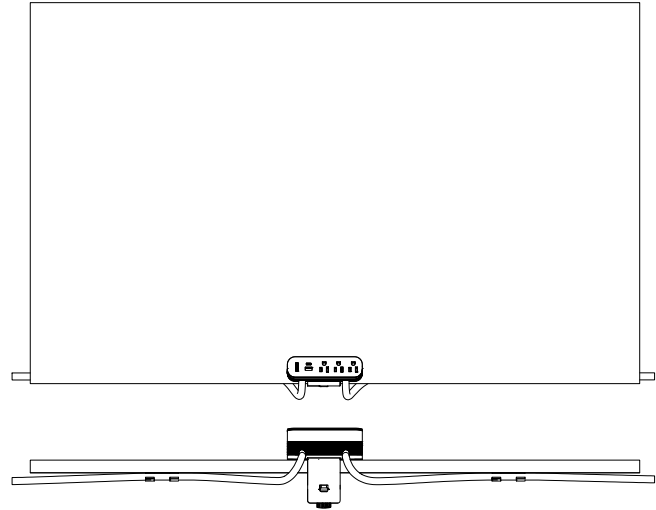
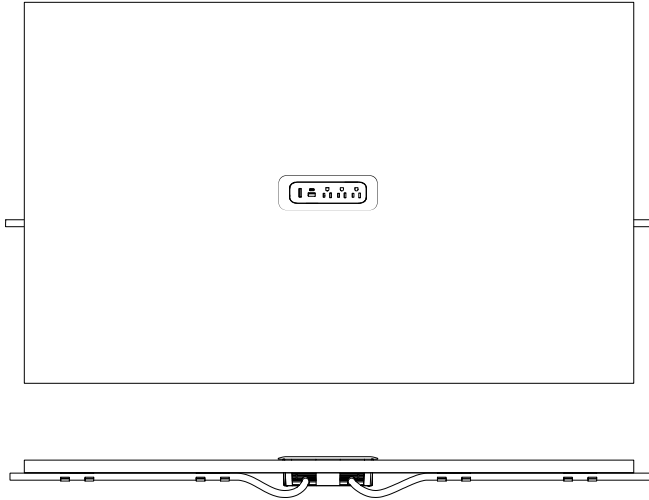
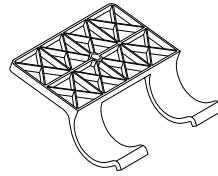

GMDSF10 • ModPower In Surface Starter Unit

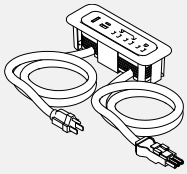

- ModPower starter unit includes one 10' cord with a NEMA plug and one 3' connector cord.
- Unit equipped with three 15A tamper resistant receptacles, one USB-A and one USB-C charging ports and a circuit breaker.
- 4 cable management cord clips included.
- MG at the end of the code indicates a magnesium finish, while WH is a white finish.

PRODUCT CODE	PRICE	DIMENSIONS			WEIGHT LBS	VOL FT ³
		H	W	D		
GMDSF10MG	597	2.63	7.63	2.63	3.44	1.0
GMDSF10WH	597	2.63	7.63	2.63	3.44	1.0

GMDCF3 • ModPower In Surface Middle Unit

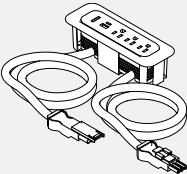

- ModPower middle unit includes two 3' connector cords.
- Unit equipped with three 15A rated 12A tamper resistant receptacles, one USB-A and one USB-C charging ports and a circuit breaker.
- 4 cable management cord clips included.
- MG at the end of the code indicates a magnesium finish, while WH is a white finish.

PRODUCT CODE	PRICE	DIMENSIONS			WEIGHT LBS	VOL FT ³
		H	W	D		
GMDCF3MG	562	2.63	7.63	2.63	2.44	1.0
GMDCF3WH	562	2.63	7.63	2.63	2.44	1.0

GMDEF3 • ModPower In Surface End Unit

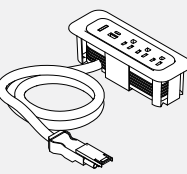

- ModPower end unit includes one 3' connector cord.
- Unit equipped with three 15A rated 12A tamper resistant receptacles, one USB-A and one USB-C charging ports and a circuit breaker.
- 2 cable management cord clips included.
- MG at the end of the code indicates a magnesium finish, while WH is a white finish.

PRODUCT CODE	PRICE	DIMENSIONS			WEIGHT LBS	VOL FT ³
		H	W	D		
GMDEF3MG	494	2.63	7.63	2.63	1.85	1.0
GMDEF3WH	494	2.63	7.63	2.63	1.85	1.0

GMDSA10 • ModPower Starter Mounted Unit

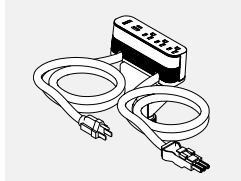

- ModPower starter unit includes one 10' cord with a NEMA plug and one 3' connector cord.
- Unit equipped with three 15A tamper resistant receptacles, one USB-A and one USB-C charging ports and a circuit breaker.
- Includes edge clamp and 3 other mounting methods; and 4 cable management cord clips.
- MG at the end of the code indicates a magnesium finish, while WH is a white finish.

PRODUCT CODE	PRICE	DIMENSIONS			WEIGHT		VOL	
		H	W	D	LBS	FT ³		
GMDSA10MG	631	2.5	6.13	1.75	4.33	1.0		
GMDSA10WH	631	2.5	6.13	1.75	4.33	1.0		

GMDCA3 • ModPower Middle Mounted Unit

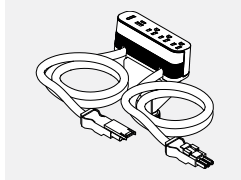

- ModPower middle unit includes two 3' connector cords.
- Unit equipped with three 15A rated 12A tamper resistant receptacles, one USB-A and one USB-C charging ports and a circuit breaker.
- Includes edge clamp and 3 other mounting methods; and 4 cable management cord clips.
- MG at the end of the code indicates a magnesium finish, while WH is a white finish.

PRODUCT CODE	PRICE	DIMENSIONS			WEIGHT		VOL	
		H	W	D	LBS	FT ³		
GMDCA3MG	597	2.5	6.13	1.75	3.33	1.0		
GMDCA3WH	597	2.5	6.13	1.75	3.33	1.0		

GMDEA3 • ModPower End Mounted Unit



- ModPower end unit includes one 3' connector cord.
- Unit equipped with three 15A rated 12A tamper resistant receptacles, one USB-A and one USB-C charging ports and a circuit breaker.
- Includes edge clamp and 3 other mounting methods; and 2 cable management cord clips.
- MG at the end of the code indicates a magnesium finish, while WH is a white finish.

PRODUCT CODE	PRICE	DIMENSIONS			WEIGHT		VOL	
		H	W	D	LBS	FT ³		
GMDEA3MG	528	2.5	6.13	1.75	2.75	1.0		
GMDEA3WH	528	2.5	6.13	1.75	2.75	1.0		

GMDCLIPS • ModPower Management Clips

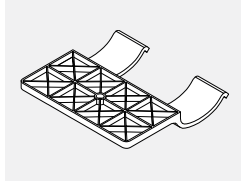

- Includes 10 clips.

PRODUCT CODE	PRICE	DIMENSIONS			WEIGHT		VOL	
		H	W	D	LBS	FT ³		
GMDCLIPS	102	0.6	2.6	2.5	0.3	0.2		

GMDJ36BK • ModPower Interconnecting Jumper

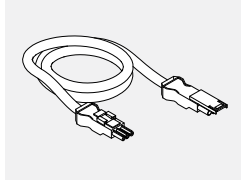

- ModPower interconnecting jumper cord to add an additional 3 feet of cord length between ModPower units.
- Package of 2, each 3 feet with male & female connector.

PRODUCT CODE	PRICE	DIMENSIONS			WEIGHT		VOL	
		H	W	D	LBS	FT ³		
GMDJ36BK	329		36		1.38	0.9		

GMDPC22W • Slim Desktop Power Module, 2 Duplex

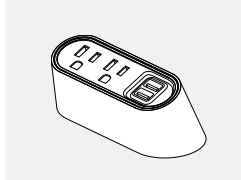

- Desktop power center with two 15A tamper resistant power receptacles, one USB-A and one USB-C (provides 3.1A); 10' power cord.
- Includes three mounting options (i) a screw-in mounting plate for forward facing outlets; or (ii) an under surface mount bracket; or (iii) a clamp mounting kit for 0.5-1.5" thick surfaces.
- Gloss white body with grey face.

PRODUCT CODE	PRICE	DIMENSIONS			WEIGHT		VOL	
		H	W	D	LBS	FT ³		
GMDPC22W	449	2.25	4.88	2.25	2.5	0.5		

GMDPC32W • Slim Desktop Power Module, 3 Duplex

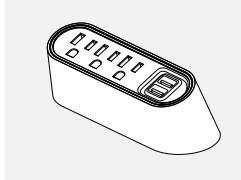

- Desktop power center with three 15A tamper resistant power receptacles, one USB-A and one USB-C (provides 3.1A); 10' power cord.
- Includes three mounting options (i) a screw-in mounting plate for forward facing outlets; or (ii) an under surface mount bracket; or (iii) a clamp mounting kit for 0.5-1.5" thick surfaces.
- Gloss white body with grey face.

PRODUCT CODE	PRICE	DIMENSIONS			WEIGHT		VOL	
		H	W	D	LBS	FT ³		
GMDPC32W	586	2.25	6.00	2.25	2.6	0.5		

BAVC • Vertical Wire Channel

- PVC extrusion attaches to panel vertical to provide enclosure for a power or light cord.
- Available in 16" and 32" lengths, six per package.
- Can be cut to required lengths on site.
- Panel frame finish

PRODUCT CODE	PRICE	SIZE/ INCHES			WEIGHT VOL	
		H	W	D	LBS	FT ³
BAVC016	37		16		0.5	0.018
BAVC032	78		32		1.0	0.036

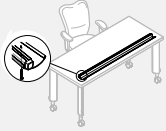
VVCM • Wire Manager

- Replacement wire manager can be added to Viceversa tables. Wire manager neatly organizes and stores electrical and communication cables.
- Two lengths, 46" for tops 60" and under, 58" for tops 72".
- Mounts below surface via threaded metal inserts.
- Integrated steel reinforcement bar.
- Not required on oval, 1/2 ellipse, 1/2 moon, square or round table.

PRODUCT CODE	PRICE	SIZE/ INCHES			WEIGHT VOL	
		H	W	D	LBS	FT ³
VVCM43	114	3	5	46	8	0.67
VVCM55	135	3	5	58	9	0.85

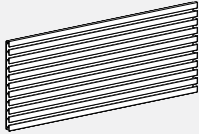
BAR • Panel Mounted Slotted Accessory Rail for Boulevard

- Includes 10 horizontal slats for hanging capacity.
- Includes mousing hardware.
- Panel frame finish

Hangs on standard Boulevard panels and accepts standard accessories.

PRODUCT CODE	PRICE	SIZE/ INCHES			WEIGHT VOL	
		H	W	D	LBS	FT ³
BAR18	156	10.6	18	0.5	3	0.12
BAR24	171	10.6	24	0.5	4	0.17
BAR30	189	10.6	30	0.5	5	0.22
BAR36	205	10.6	36	0.5	6	0.26
BAR42	224	10.6	42	0.5	7	0.31
BAR48	239	10.6	48	0.5	8	0.35
BAR54	254	10.6	54	0.5	9	0.43
BAR60	272	10.6	60	0.5	10	0.49

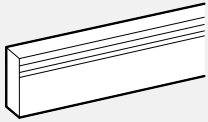
BALB • Panel Mounted Load Bar for Boulevard

- Can be panel mounted or wall mounted on rail (BHV01 or BHV02).
- Includes mousing brackets and end caps.
- Panel frame finish

PRODUCT CODE	PRICE	SIZE/ INCHES			WEIGHT VOL	
		H	W	D	LBS	FT ³
BALB18	118	3.5	18	0.75	2	0.031
BALB24	129	3.5	24	0.75	2	0.038
BALB30	142	3.5	30	0.75	3	0.048
BALB36	157	3.5	36	0.75	3	0.057
BALB42	182	3.5	42	0.75	4	0.067
BALB48	207	3.5	48	0.75	4	0.076
BALB54	227	3.5	54	0.75	5	0.086
BALB60	240	3.5	60	0.75	5	0.096

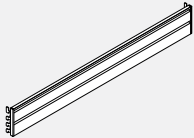
BADLB • Panel Mounted Accessory Rail for Boulevard

- Enables accessory items to be hung from a panel.
- Includes end caps and mounting brackets.

PRODUCT CODE	PRICE	SIZE/ INCHES			WEIGHT VOL	
		H	W	D	LBS	FT ³
BADLB18	189	4.23	18	1.53	2.34	0.07
BADLB24	199	4.23	24	1.53	2.88	0.09
BADLB30	211	4.23	30	1.53	3.42	0.11
BADLB36	224	4.23	36	1.53	3.97	0.13
BADLB42	233	4.23	42	1.53	4.51	0.16
BADLB48	246	4.23	48	1.53	5.05	0.18
BADLB54	257	4.23	54	1.53	5.59	0.20
BADLB60	267	4.23	60	1.53	6.13	0.22

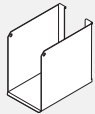
BABB01 • Binder Bin

- Load bar/accessory rail mounted metal binder bin.
- Panel frame finish

PRODUCT CODE	PRICE	SIZE/ INCHES			WEIGHT VOL	
		H	W	D	LBS	FT ³
BABB01	56	9	5.75	9.25	1.85	0.21

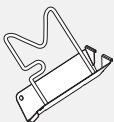
BAFS01 • Flip Sorter

- Load bar/accessory rail mounted metal flip sorter. Comes with chome wire.
- Panel frame finish

PRODUCT CODE	PRICE	SIZE/ INCHES			WEIGHT VOL	
		H	W	D	LBS	FT ³
BAFS01	39	9	3	9	0.6	0.14

BASS01 • Slant Sorter

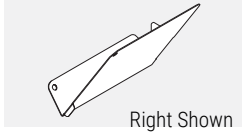

Right Shown

- Load bar/accessory rail mounted metal slant sorter.
- Panel frame finish

PRODUCT CODE	PRICE	SIZE/ INCHES			WEIGHT VOL	
		H	W	D	LBS	FT ³
BASS01R	34	9.25	2.75	9	1	0.28
BASS01L	34	9.25	2.75	9	1	0.28

BALT • Letter Tray/Legal Tray

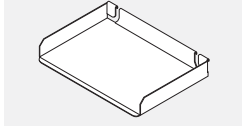

- Load bar/accessory rail mounted metal letter or legal tray.
- Panel frame finish

PRODUCT CODE	PRICE	SIZE/ INCHES			WEIGHT VOL	
		H	W	D	LBS	FT ³
BALT01	42	1.75	12	8.75	0.5	0.15
BALT01LGL	56	1.75	14.7	8.75	0.5	0.15

BAMB01 • Media Bin

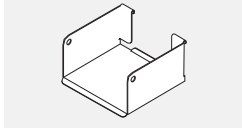

- Load bar/accessory rail mounted metal media bin.
- Panel frame finish

PRODUCT CODE	PRICE	SIZE/ INCHES			WEIGHT VOL	
		H	W	D	LBS	FT ³
BAMB01	42	3	5.75	5.25	0.8	0.05

BAUT01 • Utility Tray

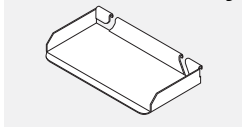

- Load bar/accessory rail mounted metal utility tray.
- Panel frame finish

PRODUCT CODE	PRICE	SIZE/ INCHES			WEIGHT VOL	
		H	W	D	LBS	FT ³
BAUT01	29	1	7.5	4	0.5	0.02

BAPP01 • Mail Box

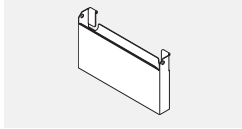

- Freestanding unit or load bar/accessory rail mounted.
- Panel frame finish

PRODUCT CODE	PRICE	SIZE/ INCHES			WEIGHT VOL	
		H	W	D	LBS	FT ³
BAPP01	70	7	12	1.75	2	0.25

BATH01 • Telephone Holder

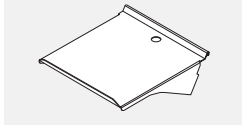

- Load bar/rail mounted telephone holder.
- Panel frame finish

PRODUCT CODE	PRICE	SIZE/ INCHES			WEIGHT VOL	
		H	W	D	LBS	FT ³
BATH01	66	2	8	10	2	0.26

BAPD • Pencil Drawer

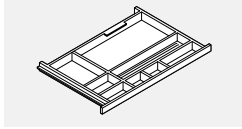

- Provides accommodation for writing instruments and small items at the workspace.
- Attaches to the underside of workspace with drawer slides.
- Available in Black ABS Only

PRODUCT CODE	PRICE	SIZE/ INCHES			WEIGHT VOL	
		H	W	D	LBS	FT ³
BAPD2015	129	1.5	22.5	17.75	2	0.300

BAHO • Coat Hook



- Over the panel mounted coat hook for Boulevard 1 panels only. Priced six per package.
- Panel Frame Finish

PRODUCT CODE	PRICE	SIZE/ INCHES			WEIGHT VOL	
		H	W	D	LBS	FT ³
BAHO3080	61	3	1	3	0.2	0.001

BAHB3CH • Coat Hook for System 3

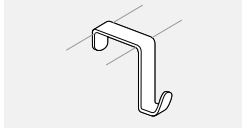

- Over the panel mounted coat hook for Boulevard, System 3 panels or Boulevard 1 panels with top trim. Priced six per package.
- Panel Frame Finish

PRODUCT CODE	PRICE	SIZE/ INCHES			WEIGHT VOL	
		H	W	D	LBS	FT ³
BAHB3CH	81	3	1	3	0.2	0.001

DAHOCH • Coat Hook for Diet

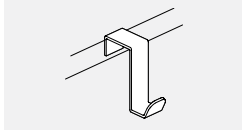

- Panel mounted coat hook Diet Panels.
- Panel Frame Finish

PRODUCT CODE	PRICE	SIZE/ INCHES			WEIGHT VOL	
		H	W	D	LBS	FT ³
DAHOCH	28	3	0.75	3	0.2	0.001

BPNP • Boulevard Name Plate

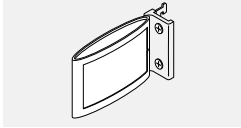

- Name plate attaches to 1" increment slots of Boulevard. It can be set either as a single-sided (parallel to panel surface) or double-sided (perpendicular to panel surface) - for aisle applications, displaying name on both sides).
- Injection molded frame and die-cast base with black rubberized finish. Steel bracket and fasteners included
- Includes two slide-in name cards.

PRODUCT CODE	PRICE	SIZE/ INCHES			WEIGHT VOL	
		H	W	D	LBS	FT ³
BPNP01	80	3.3	5.3	1.25	0.3	0.013

DPN01 • Diet Name Plate

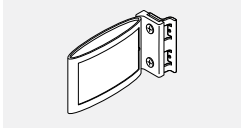

- Name plate can be set either as a single-sided (parallel to panel surface) or double-sided (perpendicular to panel surface - for aisle applications, displaying name on both sides).
- Injection molded frame and die-cast base with black rubberized finish. Steel bracket and fasteners included.
- Includes two slide-in name cards.

PRODUCT CODE	PRICE	SIZE/ INCHES			WEIGHT VOL	
		H	W	D	LBS	FT ³
DPNP01	80	3.3	5.3	1.25	0.3	0.013

BHTPO1 • Bracket to connect Licence Towers to Boulevard Panels

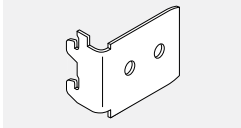

- Panel Frame Finish

PRODUCT CODE	PRICE	SIZE/ INCHES			WEIGHT VOL	
		H	W	D	LBS	FT ³
BHTPO1	62	2	2.5	1	2	0.05

BATB • Fabric Tackboard for Boulevard

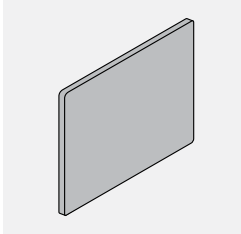

- To provide a tackable surface for notes and memos in a work area. Panel mounted.
- Includes mounting brackets.
- Class "A" Fire Rated Fabric.

PRODUCT CODE	PRICE		SIZE/ INCHES			WEIGHT VOL	
	GR1	GR2	H	W	D	LBS	FT ³
BATB2430	289	303	24	30		3	0.416
BATB2436	330	342	24	36		4	0.500
BATB2442	377	392	24	42		4	0.583
BATB2448	420	449	24	48		5	0.666
BATB2454	464	494	24	54		5	0.750
BATB2460	509	539	24	60		6	0.833
BATB2472	617	658	24	72		6	0.999

BAWB • Write Board for Boulevard

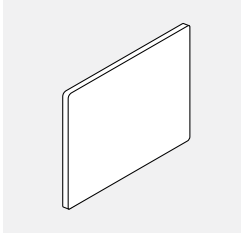

- To provide a writing surface in a work area. Panel mounted.
- Includes mounting brackets.
- Black Trim Only

PRODUCT CODE	PRICE	SIZE/ INCHES			WEIGHT VOL	
		H	W	D	LBS	FT ³
BAWB2436	340	24	36		13	0.500
BAWB2442	380	24	42		15	0.583
BAWB2448	441	24	48		18	0.666

BAMT12 • Marker Tray

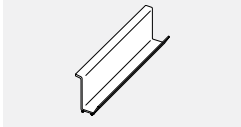

- Marker tray intended for BATB and BAWB only.

PRODUCT CODE	PRICE	SIZE/ INCHES			WEIGHT VOL	
		H	W	D	LBS	FT ³
BAMT12	99		12		0.5	0.01

BATP • Touch Up Paint Kit

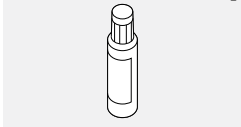

- Paint to match panel frame colours for easy touch ups. 1/2o. (15ml) bottle

PRODUCT CODE	PRICE	SIZE/ INCHES			WEIGHT VOL	
		H	W	D	LBS	FT ³
BATP91	40				0.41	0.1

CATB • Tackboard for Compile

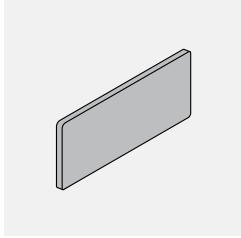

- Mounting brackets included.

PRODUCT CODE	PRICE		SIZE/INCHES			WEIGHT VOL	
	GR1	GR2	H	W	D	LBS	FT ³
CATB1024	186	194	10	24	1	1	0.175
CATB1030	195	206	10	30	1	1	0.208
CATB1036	215	229	10	36	1	2	0.250
CATB1042	238	252	10	42	1	2	0.291
CATB1048	262	276	10	48	1	3	0.333
CATB1054	288	308	10	54	1	3	0.370
CATB1060	308	330	10	60	1	4	0.415
CATB2124	268	276	21	24	1	2	0.340
CATB2130	289	303	21	30	1	2	0.406
CATB2136	330	342	21	36	1	3	0.490
CATB2142	377	392	21	42	1	3	0.573
CATB2148	420	449	21	48	1	4	0.656
CATB2154	464	494	21	54	1	4	0.740
CATB2160	509	539	21	60	1	5	0.823
CATB2424	268	276	24	24	1	3	0.350
CATB2430	289	303	24	30	1	3	0.416
CATB2436	330	342	24	36	1	4	0.500
CATB2442	377	392	24	42	1	4	0.583
CATB2448	420	449	24	48	1	5	0.666
CATB2454	464	494	24	54	1	5	0.750
CATB2460	509	539	24	60	1	6	0.833

CAWB • Whiteboard for Compile

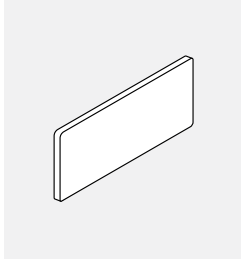

- Mounting brackets included.

PRODUCT CODE	PRICE	SIZE/INCHES			WEIGHT VOL	
		H	W	D	LBS	FT ³
CAWB1024	163	10	24	0.625	5	0.210
CAWB1036	184	10	36	0.625	6	0.394
CAWB1042	205	10	42	0.625	7	0.470
CAWB1048	233	10	48	0.625	8	0.540
CAWB2124	271	21	24	0.625	11	0.400
CAWB2136	323	21	36	0.625	12	0.485
CAWB2142	361	21	42	0.625	14	0.564
CAWB2148	420	21	48	0.625	17	0.621
CAWB2424	271	24	24	0.625	12	0.422
CAWB2436	323	24	36	0.625	13	0.500
CAWB2442	361	24	42	0.625	15	0.583
CAWB2448	420	24	48	0.625	18	0.666

CALB • Load Bar for Compile

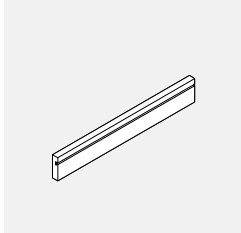

- Available in standard panel frame colours.
- Mounting brackets and clear end caps included.
- Optional - Load Bar can connect to each other to create a "Slat Wall".

PRODUCT CODE	PRICE	SIZE/INCHES			WEIGHT VOL	
		H	W	D	LBS	FT ³
CALB24	129	2.25	24	1	2	0.083
CALB30	142	2.25	30	1	3	0.048
CALB36	156	2.25	36	1	3	0.057
CALB42	182	2.25	42	1	4	0.067
CALB48	207	2.25	48	1	4	0.076
CALB54	227	2.25	54	1	5	0.086
CALB60	240	2.25	60	1	5	0.096

CMECC • Cable Cover for Compile

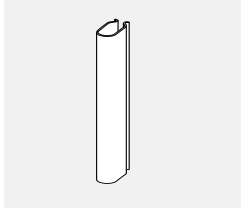

- Available in standard panel frame colours.
- Comes 6 per package

PRODUCT CODE	PRICE	SIZE/INCHES			WEIGHT VOL	
		H	W	D	LBS	FT ³
CMECC21	30	21	0.5	1	0.5	0.018
CMECC36	54	36	0.5	1	1.0	0.036

CMCH01 • Coat Hook for Compile

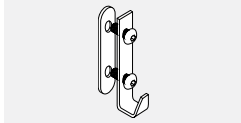

- Coat hook for Compile panels.

PRODUCT CODE	PRICE	SIZE/ INCHES			WEIGHT VOL	
		H	W	D	LBS	FT ³
CMCH01	42	5.5	0.65	1	0.06	0.001

ENVIRONMENTAL COMMITMENT

Evolve Systems-Protecting the Environment for Future Generations

- Our environmental success story began with the challenge to create an office system that would meet today's business requirements while maintaining a firm commitment to save and protect the environment.
- Sustainability became a part of the creative focus and development of Evolve that incorporates the latest technology and design features to provide excellent performance at a competitive price.
- As government and industry environment ratings such as LEED become more prevalent, Evolve offers designers and architects functional, attractive, and economical office designs that meet these standards.
- Evolve is a leader in reducing waste and recycling materials in the manufacture of its products. We make extensive use of recycled plastic and wood waste from other Global factories.
- Evolve is committed to exercise diligence in the continuous improvement of our environmental systems, the prevention of pollution, and to comply with both the spirit and the letter of all relevant environmental legislation.
- Evolve panels are 100% recyclable at the end of their lifespan. Nothing from an Evolve panel needs to end up in a landfill.

Evolve Systems-Product Information

- Evolve offers fabrics that are made from 100% recycled polyester, which means less waste going to landfills, reduced demand for petroleum products, and fewer environmental impacts from the processing of petroleum products into polyester.
- Evolve has developed a panel interior made from 100% recycled wood and polypropylene. Through innovative design and technology, Evolve utilizes waste that would have normally been sent to landfill.
- Evolve panels are insulated with a mineral fibre insulation made from slag (an inert steel by-product) and basalt rock. This material's high density provides maximum sound absorption to reduce noise in the work environment. Mineral fibre insulation is fire resistant, water repellent and will not support the growth of fungi or mildew.

Evolve Systems-Special Product

- When ordering specials, copies of the Special Quote Form (SQ's) must be submitted with the order to ensure accuracy of the special product.

PANELS

• Panel Fabric modules consist of Module Frames, Module Interiors and Fabric Skins.

Module Construction

- Module Frames feature a combination of 100% recycled PVC horizontal extrusions and unique, molded vertical ends made from equal parts of 100% recycled polypropylene and 100% recycled wood (from Global's factory waste).
- Module Interiors feature honeycomb made from 75% recycled kraft paper and acoustical mineral board derived from slag (inert steel by-product) and volcanic material.

Fabric

- Fabric offerings include selections woven with 100% recycled yarn.

Panel Frame

- Panel Frame is made of cold rolled steel which has a recycled content of 25%. **Metal Components/Raceway Finish**

- All metal components are painted with environmentally friendly epoxy powder.
- Raceway interiors are coated with recycled epoxy powder.

Panel Options

- Factory installed Panel Modules are available in 6", 12", 18" and 24" heights and a variety of options including: Semi-Tackable Fabric Acoustic, Glass, Open, Slatwall, Laminate and

Whiteboard Modules.

- Standard Fabric Acoustic Panels come in a variety of heights: 30", 42", 54" and 66". Monolithic Panels are available in 42", 48", 54".
- Panel Extension Modules attach to the top of the base structural panels. These are offered in 6", 12", 18" and 24" heights and can be stacked one on top of the other to create a visually continuous panel in excess of 14'-0" high.
- Panels can be modified on-site by swapping fabric modules for glazed, open, laminate or whiteboard modules at any time after the initial installation. Panels can also be altered in height by replacing the vertical liners (panel sides) and adding or subtracting modules as required.
- Panel widths come in 8 sizes including: 18", 24", 30", 36", 42", 48", 54" and 60".
- All Fabric Modules are semi-tackable.
- One sided and two sided whiteboard modules are available.
- Panels conform to CGSB and ANSI/BIFMA standards.
- Evolve panels carry an acoustical rating of .65 NRC and 20 STC.
- Rigid, steel panel frame is 2 7/8" thick.
- Levelling glides extend 2 1/2".

VOICE/DATA AND ELECTRIC POWER

- Voice/data cables can be laid in at both the base and the top of the panel.
- 8 wire, 4 circuit electrical capability, 2 utility + 2 dedicated circuits, each with 10 gauge (oversized) neutrals. All circuits are 20 amps (15 CSA).
- Additional 8 wire features. No tools required.

- Both power and data is available at desk height.
- Raceway Cover opening sizes conform to the ANSI/TIA/EIA Furniture Opening Standard of 1.37 x 2.68.
- Panels and electrical components are CSA/UL approved.

WORKSURFACES

- Worksurfaces come in a variety of shapes and sizes. Essentially, they are 18", 24" or 30" deep and are available in 6" increments from 24" to 72" wide. Custom tops are available at a modest upcharge and on the same delivery schedule.
- Cable scoops located at the back of each worksurface provide routing of power and data cables.

- Metal inserts for the connection of supporting hardware.
- Thermally fused and high pressure laminate tops are available, both with tough PVC edging.
- All worksurfaces utilize balanced construction.
- Curved worksurfaces incorporate ergonomic design.

OVERHEAD STORAGE

Features:

- Steel and all laminate based options
- Panel mount and up-mount options
- Completely enclosed unit for 16" overheads
- Style dependent- ship fully assembled or knocked down
- 13.5" inside height for oversized binders
- Metal-to-metal connection
- Lock secures into bottom shelf
- Doors operate smoothly
- Flipper door retrofittable on site
- Safety bracket used for extra support
- Reinforcement built in for larger unit
- Can be removed and reconfigured without disassembly

Fronts:

- Open or closed fronts
- AODA compliant options available

Sizes:

- Overheads - 7 widths in 6" increments
- Shelves - 7 widths in 6" increments
- 13.5" deep welded overheads
- 14.2" deep AODA overheads
- 16.5" deep welded overheads for EDP, ring binder, letter/legal

Paint:

- Dry epoxy powder coating

PEDESTALS

Features:

- Premium quality steel reinforced welded construction
- Double wall construction on all drawer fronts
- Fully progressive suspension system
- Full pull
- Worksurface supporting option
- Full extension roller bearing glides on all file drawers
- Rubber bumpers for quietness
- Movable drawer divider in box drawers
 - Pencil Tray
 - Each file drawer includes a hanging file bar (22" and 28" depth only)
- 3 depths with varying filing capacity
- Random or specific keying instructions available

Construction:

- Double wall drawer fronts
- 18-20 gauge steel case components

Sizes:

- (Prime) 18", 22", 28" depth
- (9300) 19", 23", 29" depth

Types:

- Worksurface Supporting, Mobile, Freestanding

Paint:

- Dry epoxy powder coating

WARRANTIES AND PERFORMANCE

- Lifetime Warranty.
- Non Obsolescence Warranty.
- Aggressive product pricing.
- Reduced cost of assembly and reconfiguration.
- Exceptions: panel textiles, electrical devices and task lights - 5 years.
- ISO9001:2000 Registered.
- ISO14001:2004 Registered.
- Greenguard Certified.
- ANSI/BIFMA CGSB testing on all products.
- Run through capability.

PANELS • TECHNICAL INFORMATION

- Evolve panels are 2 7/8" thick. They are available in four (5) basic heights: 30", 42", 48", 54" and 66" and eight (8) widths: 18" to 60" in 6" increments.
- Individual fabric covered acoustic modules incorporated into a rigid steel frame.
- Opposite side of each module may have a different fabric within the same grade at no upcharge.
- If different grades of fabric are used on one panel, the entire panel must be priced at highest grade.
- A low profile top cap is included. It allows for storage of up to 8, 5mm (0.002") diameter data cables.
- No panel creep.
- All Panels, except Monolithic are composed of a 6" raceway module and a 24"

high base module. Subsequent heights are created by adding either a 12" high module or a 24" high module.

- Raceway openings are 1.37 x 2.68
- 12" high and 24" high modules of all types (fabric, laminate, glass, open) are available for field installation. Contact your Customer Service Representative for requirements and installation.
- Frosted glazing is available at an upcharge, please contact your Customer Service Representative.
- Laminate for laminate panels cannot be replaced in the field, complete module must be ordered.
- Writeboard for Writeboard panels cannot be replaced in the field, complete module must be ordered.

PANEL CONNECTORS • TECHNICAL INFORMATION

Panel Connectors

- Available in one-way, two-way, three-way or four-way based on the configuration.
- Available with either PVC or Aluminum Trims.
- 6" high connectors cannot be stacked on top of each other.

Panel Trims

- Available in PVC or Aluminum.

COMPONENTS

A. EVPERA66

End-of-Run Kit (Wall mount) Note: adds 1" to the width of a panel run.

B. EVPFA6636

Fabric Acoustic Panel Note: there is no panel creep.

C. EVPIC66

Inline Panel Connector

D. EVPCPA266

Two-Way Corner Post Note: trim kit included. Post Connectors can be custom manufactured with or without slots on one side only. Contact your Evolve Customer Service Representative for a special quote.

E. EVPVTLA66

Vertical "L" Trim Note: Can be purchased separately when required for reconfiguration

F. EVPVC66

Variable-Height Connector Note: Connector height must reference taller panel. (Must be ordered separately).

G. EVPTVA24

Panel Trim Variable-Height

H. EVPFA4236

Fabric Acoustic Panel

I. EVPTNTA36

Panel Top Notched Trim

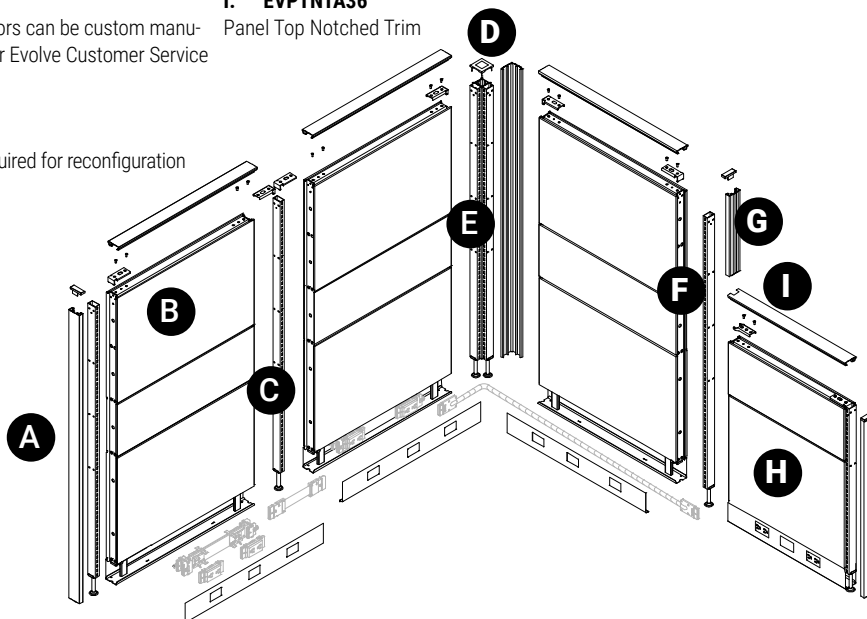

CONNECTORS • TECHNICAL INFORMATION

Slotted connectors and trim are included with each Variable-Height Corner Post. The height of each slotted connector must be specified when ordering a Variable-Height Corner Post. Slotted connector height is determined by the height of the connecting panel run.

Example:

Step 1 Specify base code listed on pricing page.

Fabric Acoustic Panel:

Step 2 Specify slotted connector heights.

Note: To specify height, use the first number of the connecting panel run height dimension.

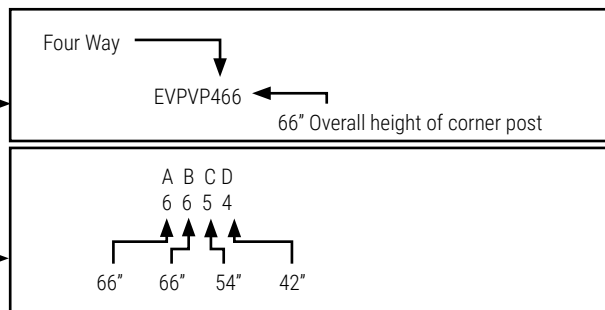

PANELS

- The entire Evolve panel and the processes to manufacture it are designed to save and protect the environment. Evolve panels are made from recycled materials and are 100% recyclable.
- Evolve makes it easy to select a panel function type and height that is suitable for your application.
- The extension module makes private offices available, with the use of Panel Extension Modules combined with a door.
- When Panel Extension Modules are used in the initial installation in conjunction with low panels (30" to 42"), future panel height flexibility is attained while maintaining storage hang-on capabilities up to 66".
- Panel frames can be totally disassembled in the field. Panel modules can be reconfigured or replaced and panel heights altered as changing circumstances demand.
- This level of flexibility makes it easy to select the correct height of panel to suit your requirements.
- Whiteboards incorporated into the panel remove the need for add-ons.
- The quality, and performance level of these panels has been tested to equal or exceed the requirements of the Canadian and US governments.
- Classified as acoustic, these panels meet the acoustical requirements of both Canadian and US governments.
- Solid steel panel frame combined with easy to assemble panel to panel clamps, create a rigid panel wall.
- Panel glide adjustment enables the client to deal with severe uneven floors of a building.

VOICE/DATA AND ELECTRIC POWER

- The base raceway cavity can accommodate 140 Category 5 data cables or 48 Category 5 data cables when the power distribution housings are present. In addition, 8 Category 5 data cables can be housed within a standard Panel Top Cap and 50 Category 5 cables can be accommodated in the optional High Profile Top Cap. This is a "true lay-in" method whereby cables can be run from the ceiling to worksurface without needing to be "fished".
- Evolve's 8 wire system provides two utility circuits plus two separate dedicated circuits (2+2).
- Snap-in Power Distribution Housings and lay-in Jumper and Pass-Through cables enable quick and simple electrical installation and modification by a qualified electrician. Circuits can easily be added, or exchanged (circuit #1 for circuit #2, circuit #1 for dedicated circuit #A or #B etc. if all are connected to base)
- The Desk Top Data/Power House attaches to the back of the worksurface to provide access to two simplex power outlets and two voice/data outlets.
- Standard Data Face Mount Plates can be used without the need of adapter plates (supplied by others).

WORKSURFACES

- The addition of custom sizes shows a commitment to client satisfaction that not every manufacturer offers. With this choice of product, we can tailor each installation to your requirements.
- This convenient scoop feature, together with a 3/8" gap between the worksurface and the panel, allows access to cables without having grommet holes in the worksurface.
- Metal-to-metal connection ensures that, no matter how many times you reconfigure your product, it will perform over the long term.
- Highest quality, thermally fused laminated surfaces ensure lasting durability. High pressure laminates are also available for those areas where rugged use is expected. A 3mm PVC edge banding is used on both options, to take the knocks of everyday wear and tear.
- Whether thermally fused or high pressure, all worksurfaces are manufactured with equal laminates on both sides of the worksurface to deter warpage.
- Curved worksurfaces are ergonomically designed to facilitate the interaction between the keyboard, mouse and worksurface.

STORAGE

- Steel construction guarantees the performance of the product over the long term. Welded joints with a full top, back and base ensure that the pedestal will sit square and adequately support the worksurface where necessary.
- Due to the quality of the construction and the slides, the pedestal drawers will continue to operate efficiently for the lifetime of the furniture. The rubber bumpers dampen the noise of closing a drawer and stop any metal-to metal contact.
- The pencil tray is double width for extra storage.
- The glides enable you to level the cabinet to the floor and or worksurface. This convenient adjustment feature allows the installer to adjust the height of the cabinet while it is under the worksurface. This saves time in the installation process.
- For additional security and piece of mind. These locks can be keyed alike or master keyed for additional convenience.
- Quality construction with no exposed metal edges. Recessed handle offers uncluttered aesthetic.
- The construction of the drawer enables you to hang files from the drawer side so no extra hardware is necessary. File drawers accept legal, letter and metric sized files.
- Some manufacturers use the same drawer for their 24" deep pedestal as they do for their 30" deep pedestal. The 24" deep drawer gives you only 19.5" of filing. This is 25% extra filing in every file pedestal drawer.
- Worksurface supporting pedestal feature saves you money as you do not have to buy worksurface supporting hardware. Each pedestal comes with a finished end panel. The addition of a non handed bracket enables the pedestal to attach to a structural panel.
- This item, which is shipped knocked down, is more economically priced to minimize shipping damage. The lock is optional in the 12" overhead and included in the 13" overhead. The base shelf features a back lip which stops binders touching the fabric of the panel it is mounted on. All components are metal and the door slides are roller bearing for longer life.
- These rugged overhead units are extremely well priced yet accommodate a full load of binders with ease. They can be mounted above or below the worksurface.
- Storage Towers provide storage without pedestals or binder bins. This allows for greater flexibility in worksurface heights and increases the viability of 54" panels.
- "Environmentally friendly" epoxy powder coat is 15 times more durable in independent testing than a wet paint spray. This helps maintain the look of the product over its many years of service.

WARRANTIES AND PERFORMANCE

- For peace of mind over the long term, we cover you with a comprehensive warranty that is supported by our dealer network.
- We agree to make product available for a period of 20 years from the date of purchase. This product will be 100% compatible with your existing system.
- Evolve is priced well below other major "A" grade products on the market.
- Some installation companies claim that the Evolve System panels can be installed in half the time it takes to install most of our competitor's panels. This cost saving can amount to thousands of dollars over the lifetime of our furniture.
- Your assurance of consistent quality to an international standard. Evolve Systems is committed to design, manufacture and distribute superior quality office furniture, which meets or exceeds the requirements of our customers.
- Confirmation that Evolve is committed: (1) to providing product that, through their entire life cycle, minimize negative environmental impacts on the environment, (2) to continuous improvement to our environmental systems and programs and, (3) to comply to all relevant environmental legislation and regulations.
- Evolve Systems meets LEED requirements for office furniture.
- Evolve components are tested to the highest standard in the industry. This is your assurance of quality and longevity.
- On occasion, parts and pieces get missed. The run-through program is an emergency production space that we use to make items you need in a hurry.

WOOD GRAIN (WG) LAMINATE DIRECTION

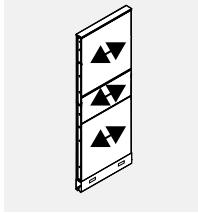

EVP Panels

With Exception of 66" high monolithic panels, they are vertical.

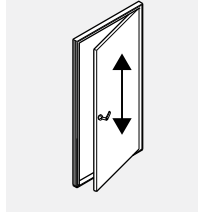

EVPD Doors.

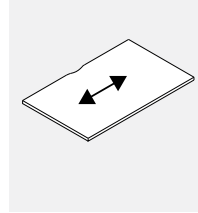

EVWS Worksurfaces.

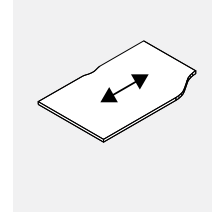

EVWVL/R Worksurfaces.

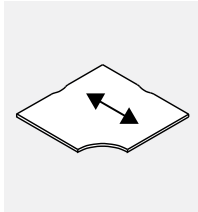

EVWCC Worksurfaces.

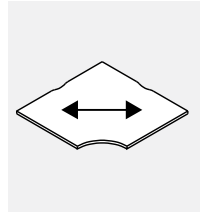

EVWCC-WG Worksurfaces.

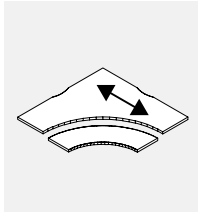

EVWCCK Worksurfaces.

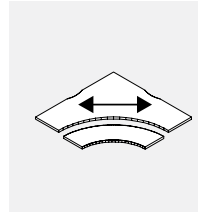

EVWCCK-WG Worksurfaces.

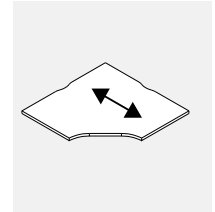

EVWCK Worksurfaces.

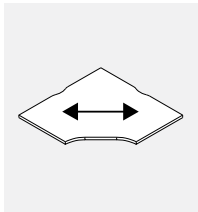

EVWCK-WG Worksurfaces.

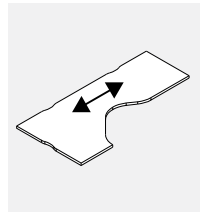

EVWCF Worksurfaces.

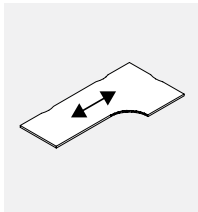

EVWCE Worksurfaces.

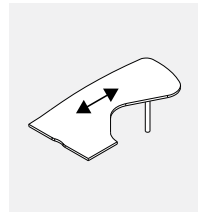

EVWHL/R Worksurfaces.

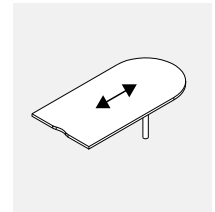

EVWD Worksurfaces.

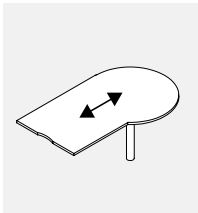

EVWP Worksurfaces.

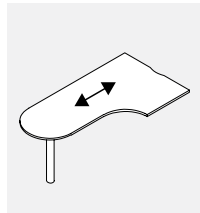

EVWPL/R Worksurfaces.

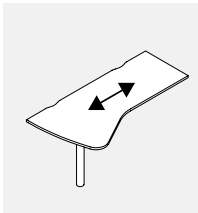

EVWWL/R Worksurfaces.

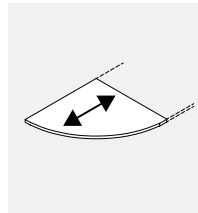

EVQR and EVWQRC Worksurfaces.

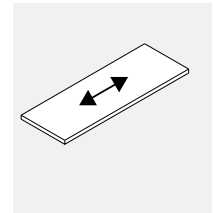

EVWT, EVWTV, EVWTE, EVWTEV, EVWTD, EVWTDV, EVWTDV Worksurfaces.

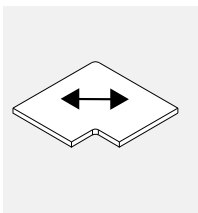

EVWTCL-WG Worksurfaces.

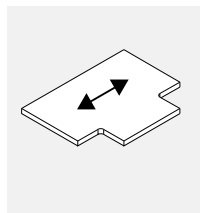

EVWTC Worksurfaces.

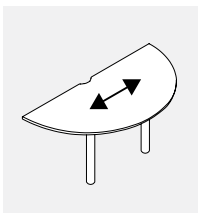

EVWR Worksurfaces.

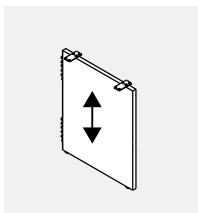

EVHP/EVLMP End Panels.

WG - indicated woodgrain in cross pattern

ORDERS

Each Order Must Include

Purchase Order
 Layout showing where the image(s) appear in the run of panels.
 A completed Price Chart, showing the location of the image(s) on each appropriate panel.

Artwork must be submitted in accordance with the following artwork specifications.

NOTE: Final artwork specification approval must be given before order can be processed.

Transfer Devices

- E-mail up to 10MB to your Evolve/Global Contract Customer Service Representative.
- Courier CD/DVD/USB stick to your Evolve/Global Contract Customer Service Representative.

Artwork Specifications

- Non-Photographic artwork should be vector art. Saved in Adobe Illustrator (.ai) or as an EPS (.eps)
- All bitmap or photographic artwork has to be at a minimum of 100 dpi at the full size of the panel to be printed.
- We accept Adobe CS5 files.
- Any linked files must be included or imbedded.
- Leave any PSD files un-flattened
- All fonts must be converted to outlines.
- Do not convert to CMYK, leave all images as RGB if possible
- No Word, Powerpoint, Publisher or other Microsoft files can be used.
- Include a PDF or .jpg for reference when sending native Photoshop or Illustrator format files.

Colour Matching

- A Pantone colour reference must be supplied or we cannot accept responsibility for correct colour or colour correction.
- When it is not possible to refer to Pantone colours, we will do our best to meet your requirements.

Image Clarity

- We will advise should the selected image not lend itself to the element size requested.

NOTE:

We reserve the right to put an order on hold when the files are found to be incomplete or when documents have been either incorrectly saved, fonts have not been converted to curves or the job appears not to be commercially acceptable.

Image Bleed:

To facilitate placement on the panel. Extension of the image past the finished visible area of the panel (bleed) is required.
 • Evolve Panels need a 3" bleed on all sides.

Example of Image resolution:

The resolution required for a 36 wide x 24 high Evolve panel at 100dpi (minimum resolution)

The resolution required for a 36 wide x 24 high Evolve panel at 300dpi (higher quality)

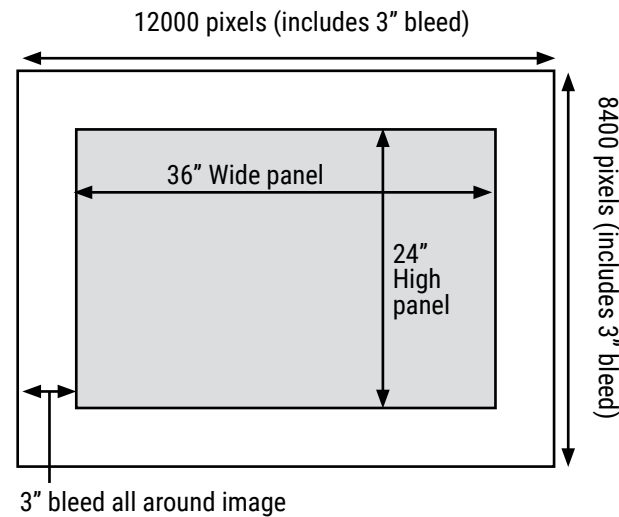
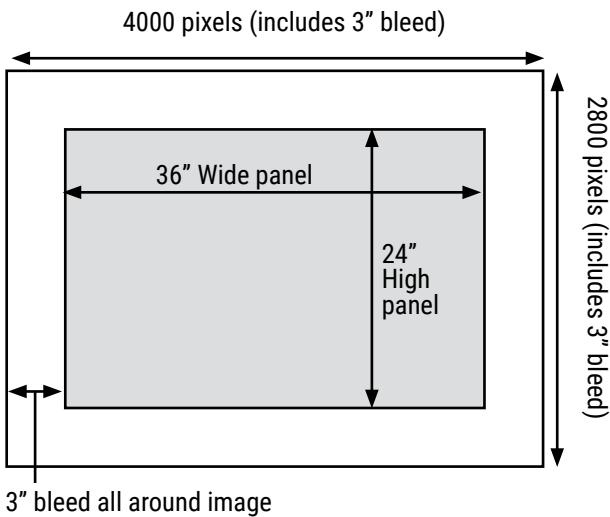

Pricing Initial Set-Up Charge per Image: \$256 net

Evolve 12" Modules

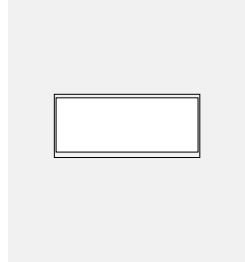

PANEL WIDTH	LIST PRICE
24"	140
30"	174
36"	211
42"	242
48"	281
54"	319
60"	355

- Applies to the following panels:
- EVPFA
 - EVFPF
 - EVPF1W
 - EVPF2W
 - EVPF1S
 - EVPF2S
 - EVPFGT
 - EVFPFGTU
 - EVPFOL
 - EVFPFOL
 - EVPFO
 - EVPFPO
 - EVPFE12
 - EVPFPE

Evolve 24" Modules

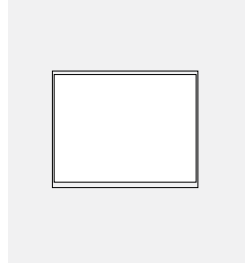

PANEL WIDTH	LIST PRICE
24"	275
30"	352
36"	420
42"	493
48"	562
54"	636
60"	704

- Applies to the following panels:
- EVPFA
 - EVFPF
 - EVPF1W
 - EVPF2W
 - EVPF1S
 - EVPF2S
 - EVPFGT
 - EVFPFGTU
 - EVPFOL
 - EVPFO
 - EVPFPFO
 - EVPFOX
 - EVPFE24
 - EVFPFGTU
 - EVPFGTX
 - EVPFOL

Evolve Monolithic Panels

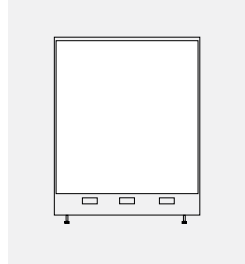

PANEL WIDTH	HEIGHT 42"	LIST PRICE 48"	54"	66"
24"	420	493	562	705
30"	539	633	719	901
36"	646	756	865	1080
42"	756	882	1008	1260
48"	865	1008	1151	1439
54"	970	1134	1294	1617
60"	1080	1260	1439	1799

- Applies to the following panels:
- EVPFAM

Note: Prices shown are an upcharge to the panel price, please add to the list price of panel which you are specifying the graphic for.

EVOLVE SYSTEMS - GRAPHIC PANEL EXAMPLE PROCEDURE

STEP 1: Customer orders the following EVPFA6636 panel with;

- Bottom module inside face (24/36 size fabric) with image 01.
- Middle module inside face (12/36 size fabric) with image 02.
- All other fabric material is regular fabric - top module inside face and all outside module faces.

STEP 2: On the regular panel - replace fabric pieces with corresponding graphic pieces.

STEP 3: Enter separate lines in order for the corresponding fabric image graphic pieces:

- EVPGRP1236 for the middle module inside face
- EVPGRP2436 for the bottom module inside face

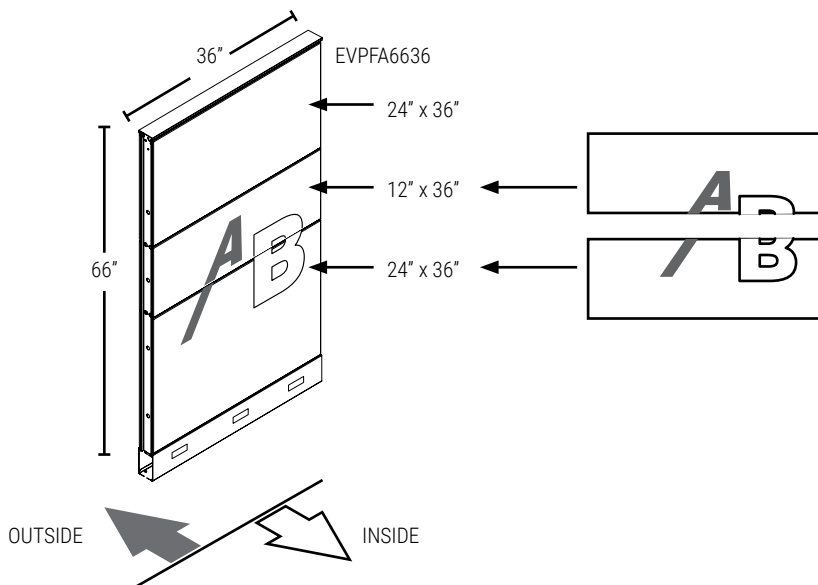

Note: To order, please use graphic codes below

(A)
EVPGRP1236

(B)
EVPGRP2436

PANELS • TECHNICAL INFORMATION

- Evolve panels are 2 7/8" thick. They are available in four (5) basic heights: 30", 42", 48" and 54" and eight (8) widths: 18" to 60" in 6" increments.
- Individual fabric covered acoustic modules incorporated into a rigid steel frame.
- Opposite side of each module may have a different fabric within the same grade at no upcharge.
- If different grades of fabric are used on one panel, the entire panel must be priced at highest grade.
- A low profile top cap is included.
- No panel creep.
- All Panels, except Monolithic are composed of a 6" raceway module and a 24" high base module. Subsequent heights are created by adding either a 12" high module or a 24" high module.
- Raceway openings are 1.37 x 2.68
- 12" high and 24" high modules of all types (fabric, laminate, glass, open) are available for field installation. Contact your Customer Service Representative.
- Frosted glazing is available at an upcharge, please contact your Customer Service Representative.
- Laminate for laminate panels cannot be replaced in the field, complete module must be ordered.
- Writeboard for Writeboard panels cannot be replaced in the field, complete module must be ordered.
- Panels 18" wide have no knockout, panels 24" wide have 1 knockout, panels 30" have 2 knockouts and panels 36" to 60" have 3 knockouts.

PANEL EXTENSION MODULES • TECHNICAL INFORMATION

- 6", 12", 18" and 24" Panel Extension Modules attach to the top of the panel.
- Modules can be stacked to add privacy or divide space.
- Each side of a fabric module may have a different fabric within the same grade at no upcharge.
- When extension modules are used, the double or single clamp is moved to the top of the extension for panel connection.

PANELS • GUIDELINES FOR ORDERING PRODUCT

The price list uses a numbering system with meaningful alphanumeric characters to create a simple-to-understand product number. This makes specifying the product much easier and more accurate.

EXAMPLE OF PANEL CODE

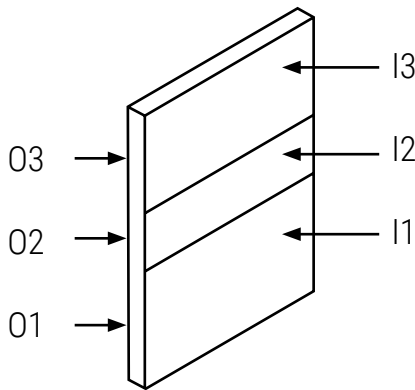
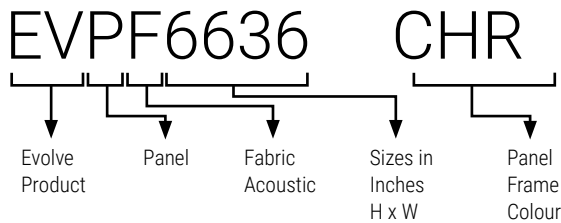

I1	AN50	Inside Fabric Position #1
I2	AN50	Inside Fabric Position #2
I3	AN50	Inside Fabric Position #3
O1	BE21	Outside Fabric Position #1
O2	BE21	Outside Fabric Position #2
O3	BE21	Outside Fabric Position #3

HOW TO SPECIFY

- Specify Evolve panel type and size by code.
- Specify panel frame finish - ie. CHR (Charcoal).
- Specify all necessary panel fabric options.

NOTE: If different grades of fabric are used on one panel, the entire panel must be priced out at the higher grade.

EVPFA • Fabric Acoustic Panel

- Standard panels incorporate a single 12" or 24" module or combination of 12" and 24" modules above the 30" base section. Application is based on panel height.
- 66" high panel can be configured with 12" at the top of the panel, see EVPFA66-S.

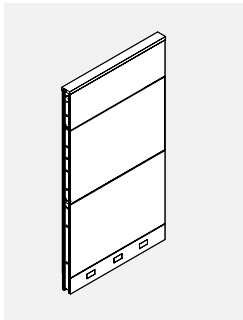
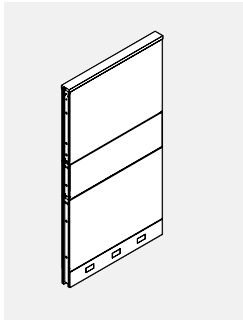
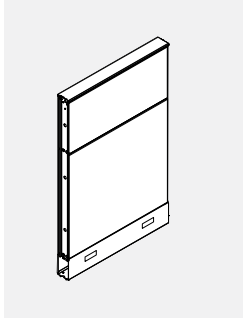

PRODUCT CODE	PRICE		SIZE/ H	INCHES			WEIGHT LBS	VOL FT ³
	GR 1	GR 2		W	D			
EVPFA3018	296	308	30	18	2.875	15.38	1.23	
EVPFA3024	309	326	30	24	2.875	18.20	1.63	
EVPFA3030	342	361	30	30	2.875	21.76	2.00	
EVPFA3036	367	389	30	36	2.875	24.80	2.38	
EVPFA3042	396	421	30	42	2.875	26.49	2.76	
EVPFA3048	438	468	30	48	2.875	32.00	3.13	
EVPFA3054	472	505	30	54	2.875	35.31	3.51	
EVPFA3060	507	546	30	60	2.875	38.20	3.89	
EVPFA4218	328	344	42	18	2.875	20.58	1.71	
EVPFA4224	344	371	42	24	2.875	24.60	2.31	
EVPFA4230	400	430	42	30	2.875	29.35	2.81	
EVPFA4236	433	468	42	36	2.875	35.60	3.38	
EVPFA4242	494	532	42	42	2.875	39.29	3.92	
EVPFA4248	532	576	42	48	2.875	43.20	4.45	
EVPFA4254	589	638	42	54	2.875	47.52	4.98	
EVPFA4260	646	700	42	60	2.875	51.60	5.52	
EVPFA5418	352	374	54	18	2.875	23.98	2.19	
EVPFA5424	385	418	54	24	2.875	27.80	2.94	
EVPFA5430	439	476	54	30	2.875	33.15	3.62	
EVPFA5436	490	534	54	36	2.875	37.40	4.31	
EVPFA5442	553	607	54	42	2.875	40.69	4.99	
EVPFA5448	616	674	54	48	2.875	48.20	5.67	
EVPFA5454	671	736	54	54	2.875	52.92	6.35	
EVPFA5460	718	790	54	60	2.875	57.40	7.03	
EVPFA6618	442	472	66	18	2.875	29.98	2.68	
EVPFA6624	476	520	66	24	2.875	35.00	3.58	
EVPFA6630	528	576	66	30	2.875	41.54	4.40	
EVPFA6636	619	677	66	36	2.875	49.00	5.23	
EVPFA6642	701	767	66	42	2.875	54.29	6.06	
EVPFA6648	751	825	66	48	2.875	60.20	6.08	
EVPFA6654	817	899	66	54	2.875	65.93	7.70	
EVPFA6660	883	972	66	60	2.875	71.60	8.53	
EVPFA6618S	442	472	66	18	2.875	29.98	2.68	
EVPFA6624S	476	520	66	24	2.875	35.00	3.58	
EVPFA6630S	528	576	66	30	2.875	41.54	4.40	
EVPFA6636S	619	675	66	36	2.875	49.00	5.23	
EVPFA6642S	701	767	66	42	2.875	54.29	6.06	
EVPFA6648S	751	825	66	48	2.875	60.20	6.88	
EVPFA6654S	817	899	66	54	2.875	65.93	6.88	
EVPFA6660S	883	972	66	60	2.875	71.60	8.53	

EVFPF • Fabric Acoustic Panel Premium

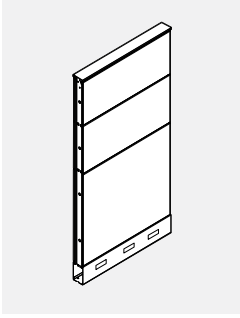

• Premium panels incorporate 12" high acoustic modules above the 30" base section.

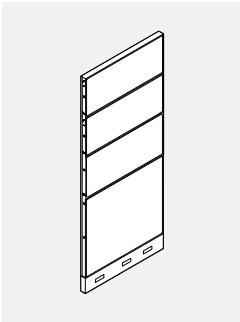

PRODUCT CODE	PRICE		SIZE/ INCHES			WEIGHT LBS	VOL FT ³
	GR1	GR2	H	W	D		
EVFPF5418	410	437	54	18	2.875	26.18	2.19
EVFPF5424	438	470	54	24	2.875	31.40	2.06
EVFPF5430	484	524	54	30	2.875	37.34	2.58
EVFPF5436	572	616	54	36	2.875	46.80	3.09
EVFPF5442	642	697	54	42	2.875	52.49	3.61
EVFPF5448	686	743	54	48	2.875	54.80	4.36
EVFPF5454	733	800	54	54	2.875	60.13	6.35
EVFPF5460	774	847	54	60	2.875	65.40	5.16
EVFPF6618	521	551	66	18	2.875	32.18	2.68
EVFPF6624	557	595	66	24	2.875	38.60	3.58
EVFPF6630	616	666	66	30	2.875	45.73	4.40
EVFPF6636	725	785	66	36	2.875	58.40	5.23
EVFPF6642	818	884	66	42	2.875	66.09	6.06
EVFPF6648	879	954	66	48	2.875	66.80	6.88
EVFPF6654	956	1036	66	54	2.875	73.14	7.70
EVFPF6660	1024	1114	66	60	2.875	79.60	8.53

EVPFAM • Fabric Acoustic Panel Monolithic

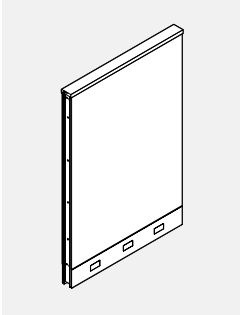

• Monolithic panels incorporate a single acoustic module within a solid rigid steel frame.

PRODUCT CODE	PRICE		SIZE/ INCHES			WEIGHT LBS	VOL FT ³
	GR1	GR2	H	W	D		
EVPFAM4218	303	331	42	18	2.875	20.58	1.71
EVPFAM4224	323	358	42	24	2.875	23.40	2.31
EVPFAM4230	369	409	42	30	2.875	26.96	2.85
EVPFAM4236	396	443	42	36	2.875	30.00	3.38
EVPFAM4242	439	494	42	42	2.875	31.69	3.92
EVPFAM4248	477	539	42	48	2.875	37.20	4.45
EVPFAM4254	526	594	42	54	2.875	40.51	4.98
EVPFAM4260	572	646	42	60	2.875	43.40	5.52
EVPFAM4818	309	337	48	18	2.875	21.38	1.92
EVPFAM4824	340	373	48	24	2.875	24.40	2.62
EVPFAM4830	392	433	48	30	2.875	27.76	3.23
EVPFAM4836	426	473	48	36	2.875	30.80	3.85
EVPFAM4842	476	531	48	42	2.875	32.49	4.45
EVPFAM4848	520	579	48	48	2.875	37.80	5.06
EVPFAM4854	573	640	48	54	2.875	41.31	5.66
EVPFAM4860	622	697	48	60	2.875	44.20	6.27
EVPFAM5418	311	340	54	18	2.875	24.58	2.19
EVPFAM5424	342	377	54	24	2.875	27.40	2.94
EVPFAM5430	397	438	54	30	2.875	30.96	3.62
EVPFAM5436	442	492	54	36	2.875	34.00	4.31
EVPFAM5442	495	550	54	42	2.875	35.69	4.99
EVPFAM5448	537	601	54	48	2.875	41.20	5.67
EVPFAM5454	592	662	54	54	2.875	44.51	6.35
EVPFAM5460	647	724	54	60	2.875	47.40	7.03
EVPFAM6618	386	414	66	18	2.875	27.58	2.68
EVPFAM6624	421	457	66	24	2.875	30.40	3.58
EVPFAM6630	476	521	66	30	2.875	33.96	4.40
EVPFAM6636	553	603	66	36	2.875	37.00	5.23
EVPFAM6642	622	675	66	42	2.875	38.69	6.06
EVPFAM6648	675	737	66	48	2.875	44.20	6.88
EVPFAM6654	751	818	66	54	2.875	47.51	7.70
EVPFAM6660	826	901	66	60	2.875	50.40	8.53

EVPH1S • Laminate Panel - One Side

• Laminate faces on one side of all modules provide durable, washable surfaces. Opposite side is fabric.

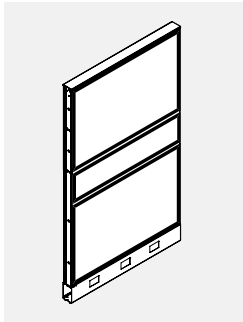
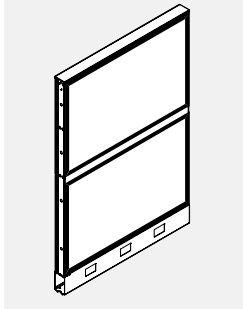

PRODUCT CODE	PRICE		SIZE/ INCHES			WEIGHT LBS	VOL FT ³
	GR 1	GR 2	H	W	D		
EVPH1S3018	353	359	30	18	2.875	15.88	1.23
EVPH1S3024	421	430	30	24	2.875	18.70	1.63
EVPH1S3030	494	503	30	30	2.875	22.26	2.00
EVPH1S3036	561	574	30	36	2.875	24.85	2.58
EVPH1S3042	637	650	30	42	2.875	26.99	2.76
EVPH1S3048	691	703	30	48	2.875	32.05	3.13
EVPH1S3054	767	783	30	54	2.875	35.81	3.51
EVPH1S3060	839	857	30	60	2.875	38.07	3.89
EVPH1S4218	419	428	42	18	2.875	21.38	1.71
EVPH1S4224	501	513	42	24	2.875	22.13	2.31
EVPH1S4230	585	597	42	30	2.875	30.15	2.31
EVPH1S4236	672	692	42	36	2.875	36.40	3.38
EVPH1S4242	761	782	42	42	2.875	40.09	3.92
EVPH1S4248	828	851	42	48	2.875	44.00	4.45
EVPH1S4254	921	945	42	54	2.875	48.32	4.98
EVPH1S4260	1008	1035	42	60	2.875	52.40	5.52
EVPH1S5418	493	505	54	18	2.875	24.98	2.19
EVPH1S5424	594	611	54	24	2.875	28.80	2.94
EVPH1S5430	699	718	54	30	2.875	34.15	3.62
EVPH1S5436	800	824	54	36	2.875	38.40	4.31
EVPH1S5442	904	931	54	42	2.875	41.69	4.99
EVPH1S5448	988	1020	54	48	2.875	49.20	5.67
EVPH1S5454	1099	1134	54	54	2.875	53.92	6.35
EVPH1S5460	1209	1249	54	60	2.875	58.40	7.03
EVPH1S6618	611	626	66	18	2.875	31.29	2.68
EVPH1S6624	736	757	66	24	2.875	36.30	3.58
EVPH1S6630	859	884	66	30	2.875	42.84	4.40
EVPH1S6636	992	1021	66	36	2.875	50.30	5.23
EVPH1S6642	1131	1162	66	42	2.875	55.59	6.06
EVPH1S6648	1228	1265	66	48	2.875	61.50	5.23
EVPH1S6654	1365	1406	66	54	2.875	67.23	7.70
EVPH1S6660	1504	1553	66	60	2.875	72.90	8.53

EVPH2S • Laminate Panel - Two Sides

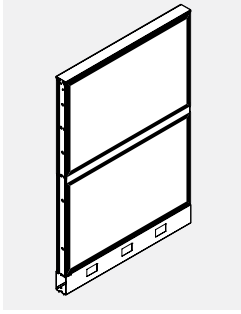

- Laminate faces on both sides of all modules provide durable, washable surfaces.

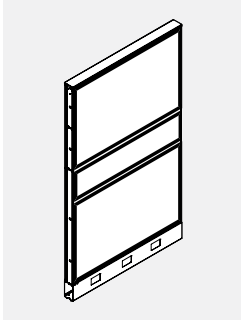

PRODUCT CODE	PRICE	SIZE/ INCHES			WEIGHT LBS	VOL FT ³
		H	W	D		
EVPH2S3018	394	30	18	2.875	16.38	1.23
EVPH2S3024	481	30	24	2.875	19.20	1.63
EVPH2S3030	569	30	30	2.875	22.76	2.00
EVPH2S3036	650	30	36	2.875	25.80	2.58
EVPH2S3042	740	30	42	2.875	27.49	2.76
EVPH2S3048	827	30	48	2.875	33.00	3.35
EVPH2S3054	916	30	54	2.875	36.31	3.95
EVPH2S3060	992	30	60	2.875	39.20	4.52
EVPH2S4218	469	42	18	2.875	22.18	1.71
EVPH2S4224	569	42	24	2.875	26.20	2.31
EVPH2S4230	671	42	30	2.875	30.95	2.85
EVPH2S4236	779	42	36	2.875	37.20	3.38
EVPH2S4242	890	42	42	2.875	40.89	3.92
EVPH2S4248	996	42	48	2.875	42.80	4.45
EVPH2S4254	1096	42	54	2.875	49.12	5.52
EVPH2S4260	1196	42	60	2.875	53.20	5.52
EVPH2S5418	549	54	18	2.875	25.98	2.19
EVPH2S5424	673	54	24	2.875	29.80	2.94
EVPH2S5430	800	54	30	2.875	35.15	3.62
EVPH2S5436	927	54	36	2.875	39.40	4.31
EVPH2S5442	1058	54	42	2.875	42.69	4.99
EVPH2S5448	1195	54	48	2.875	50.20	5.67
EVPH2S5454	1313	54	54	2.875	52.92	6.35
EVPH2S5460	1430	54	60	2.875	59.40	7.03
EVPH2S6618	691	66	18	2.875	32.58	2.68
EVPH2S6624	851	66	24	2.875	37.60	3.58
EVPH2S6630	1008	66	30	2.875	44.14	4.40
EVPH2S6636	1170	66	36	2.875	51.60	5.23
EVPH2S6642	1343	66	42	2.875	56.89	6.06
EVPH2S6648	1504	66	48	2.875	62.80	6.88
EVPH2S6654	1663	66	54	2.875	68.53	7.70
EVPH2S6660	1816	66	60	2.875	74.20	8.53

EVPF1W • Writeboard Panel - One Side

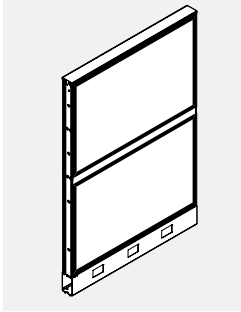

- Writing surface is built into the top module on one side of the panel, alleviating the need for a panel-mounted Writeboard.
- Use of erasable Writeboard markers only.

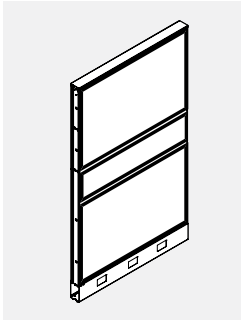

PRODUCT CODE	PRICE		SIZE/ INCHES			WEIGHT LBS	VOL FT ³
	GR1	GR2	H	W	D		
EVPF1W5418	428	443	54	18	2.875	24.98	2.19
EVPF1W5424	532	558	54	24	2.875	28.80	2.94
EVPF1W5430	640	671	54	30	2.875	34.15	3.62
EVPF1W5436	710	744	54	36	2.875	38.40	4.31
EVPF1W5442	802	842	54	42	2.875	41.69	4.99
EVPF1W5448	903	947	54	48	2.875	49.20	5.67
EVPF1W5454	1005	1038	54	54	2.875	53.92	6.35
EVPF1W5460	1107	1163	54	60	2.875	58.40	7.03
EVPF1W6618	546	565	66	18	2.875	30.48	2.57
EVPF1W6624	672	703	66	24	2.875	35.50	3.58
EVPF1W6630	799	838	66	30	2.875	42.04	4.40
EVPF1W6636	889	935	66	36	2.875	49.50	5.23
EVPF1W6642	1007	1059	66	42	2.875	54.79	6.06
EVPF1W6648	1123	1184	66	48	2.875	60.70	6.88
EVPF1W6654	1252	1317	66	54	2.875	66.43	7.70
EVPF1W6660	1381	1454	66	60	2.875	72.10	8.53

EVPF2W • Writeboard Panel - Two Side

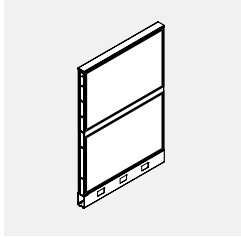

- Writing surface is built into the top module on both sides of the panel, alleviating the need for 2 panel-mounted Writeboards.
- Use of erasable Writeboard markers only.

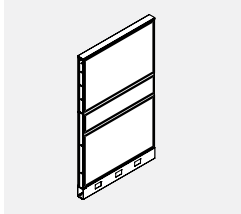

PRODUCT CODE	PRICE		SIZE/ INCHES			WEIGHT LBS	VOL FT ³
	GR 1	GR 2	H	W	D		
EVPF2W5418	462	473	54	18	2.875	25.48	2.19
EVPF2W5424	579	595	54	24	2.875	29.30	2.94
EVPF2W5430	724	741	54	30	2.875	34.65	3.62
EVPF2W5436	785	809	54	36	2.875	38.90	4.31
EVPF2W5442	890	916	54	42	2.875	42.19	4.99
EVPF2W5448	1041	1071	54	48	2.875	49.70	5.67
EVPF2W5454	1161	1195	54	54	2.875	54.51	6.35
EVPF2W5460	1279	1315	54	60	2.875	58.90	7.03
EVPF2W6618	576	595	66	18	2.875	30.98	2.57
EVPF2W6624	716	740	66	24	2.875	36.00	3.58
EVPF2W6630	882	910	66	30	2.875	42.54	4.40
EVPF2W6636	963	996	66	36	2.875	50.00	5.23
EVPF2W6642	1095	1135	66	42	2.875	55.29	6.06
EVPF2W6648	1256	1301	66	48	2.875	61.20	6.88
EVPF2W6654	1400	1452	66	54	2.875	66.93	7.70
EVPF2W6660	1549	1605	66	60	2.875	72.60	8.53

EVPF1S • Slat Wall Panel - One Sided

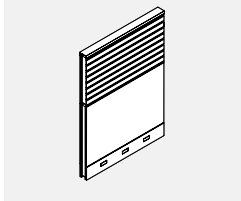

- Standard panels incorporating a single 12" or 24" module or combination of 12" and 24" modules above the 30" base section.
- Slat module is only on one side, fabric on the other.
- 66" high panel can be configured with either a 24" slat module at the top, see EVPF1S66, or a 12" slat module at the centre, see EVPF1S66M.

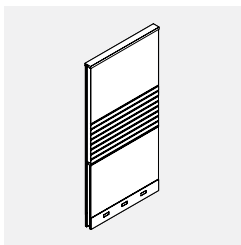
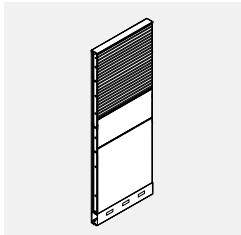
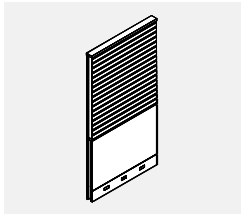

PRODUCT CODE	PRICE		SIZE/ INCHES			WEIGHT LBS	VOL FT ³
	GR 1	GR 2	H	W	D		
EVPF1S4218	372	387	42	18	2.875	13.50	1.71
EVPF1S4224	407	428	42	24	2.875	33.50	2.31
EVPF1S4230	476	502	42	30	2.875	45.50	2.85
EVPF1S4236	526	556	42	36	2.875	49.50	3.38
EVPF1S4242	607	639	42	42	2.875	54.50	3.92
EVPF1S4248	651	690	42	48	2.875	60.50	4.47
EVPF1S4254	725	765	42	54	2.875	67.50	4.98
EVPF1S4260	795	840	42	60	2.875	74.50	5.52
EVPF1S5418	450	470	54	18	2.875	36.50	2.19
EVPF1S5424	512	536	54	24	2.875	36.40	2.94
EVPF1S5430	594	624	54	30	2.875	40.40	3.62
EVPF1S5436	674	710	54	36	2.875	44.40	4.31
EVPF1S5442	767	806	54	42	2.875	46.40	5.67
EVPF1S5448	858	902	54	48	2.875	48.40	5.67
EVPF1S5454	941	991	54	54	2.875	50.00	6.35
EVPF1S5460	1019	1074	54	60	2.875	52.40	7.03
EVPF1S6618	545	567	66	18	2.875	42.00	2.57
EVPF1S6624	605	637	66	24	2.875	48.00	3.58
EVPF1S6630	684	724	66	30	2.875	50.00	4.40
EVPF1S6636	805	853	66	36	2.875	54.00	5.23
EVPF1S6642	911	966	66	42	2.875	60.00	6.06
EVPF1S6648	992	1052	66	48	2.875	67.00	6.88
EVPF1S6654	1086	1152	66	54	2.875	80.00	7.07
EVPF1S6660	1181	1254	66	60	2.875	86.00	8.53
EVPF1S6618M	488	518	66	18	2.875	42.00	2.57
EVPF1S6624M	537	575	66	24	2.875	48.00	3.58
EVPF1S6630M	605	649	66	30	2.875	50.00	4.40
EVPF1S6636M	713	765	66	36	2.875	54.00	5.23
EVPF1S6642M	811	870	66	42	2.875	60.00	6.06
EVPF1S6648M	870	938	66	48	2.875	67.00	6.88
EVPF1S6654M	954	1029	66	54	2.875	80.00	7.70
EVPF1S6660M	1032	1114	66	60	2.875	86.00	8.53

EVVPF2S • Slat Wall Module Panel - Two Sided

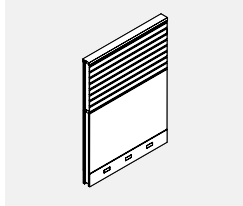

- Standard panels incorporating a single 12" or 24" module or combination of 12" and 24" modules above the 30" base section.
- Slat module is only on both sides.
- 66" high panel can be configured with either a 24" slat module at the top, see EVVPF2S66, or a 12" slat module at the centre, see EVVPF2S66-M.

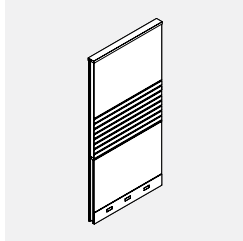
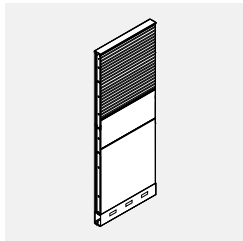
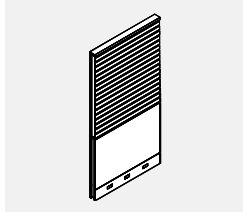

PRODUCT CODE	PRICE		SIZE/ INCHES			WEIGHT LBS	VOL FT ³
	GR1	GR2	H	W	D		
EVVPF2S4218	399	413	42	18	2.875	16.50	1.71
EVVPF2S4224	446	463	42	24	2.875	36.50	2.31
EVVPF2S4230	527	547	42	30	2.875	48.50	2.85
EVVPF2S4236	586	609	42	36	2.875	52.50	3.38
EVVPF2S4242	674	701	42	42	2.875	57.50	3.92
EVVPF2S4248	733	763	42	48	2.875	63.50	4.47
EVVPF2S4254	817	851	42	54	2.875	70.50	4.98
EVVPF2S4260	895	932	42	60	2.875	77.50	5.52
EVVPF2S5418	526	537	54	18	2.875	38.50	2.19
EVVPF2S5424	613	630	54	24	2.875	44.40	2.94
EVVPF2S5430	722	739	54	30	2.875	46.40	3.62
EVVPF2S5436	827	851	54	36	2.875	48.40	4.31
EVVPF2S5442	945	971	54	42	2.875	50.40	4.99
EVVPF2S5448	1063	1095	54	48	2.875	52.40	5.67
EVVPF2S5454	1170	1203	54	54	2.875	54.40	6.35
EVVPF2S5460	1277	1313	54	60	2.875	56.40	7.03
EVVPF2S6618	616	636	66	18	2.875	45.00	2.57
EVVPF2S6624	704	730	66	24	2.875	51.00	3.58
EVVPF2S6630	811	840	66	30	2.875	53.00	4.40
EVVPF2S6636	957	993	66	36	2.875	57.00	5.23
EVVPF2S6642	1092	1133	66	42	2.875	63.00	6.06
EVVPF2S6648	1198	1242	66	48	2.875	70.40	6.88
EVVPF2S6654	1318	1368	66	54	2.875	83.40	7.70
EVVPF2S6660	1439	1495	66	60	2.875	89.40	8.53
EVVPF2S6618M	519	541	66	18	2.875	45.00	2.57
EVVPF2S6624M	576	609	66	24	2.875	51.00	3.58
EVVPF2S6630M	652	693	66	30	2.875	53.00	4.40
EVVPF2S6636M	774	821	66	36	2.875	57.00	5.23
EVVPF2S6642M	882	934	66	42	2.875	63.00	6.06
EVVPF2S6648M	949	1010	66	48	2.875	70.40	6.88
EVVPF2S6654M	1043	1110	66	54	2.875	83.40	7.70
EVVPF2S6660M	1134	1205	66	60	2.875	89.40	8.53

EVVPF2S-F • Frameless Slat Wall Module Panel - Two Sided

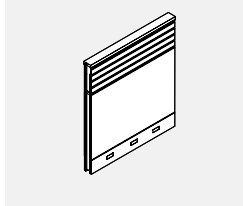

- Slat Wall is manufactured with 2 snap-in sections.
- Accessories can be hung on Slat Wall. Please see accessories section for additional details.
- For 42" H Slat Wall Panel only Aluminum Top Trim can be used. Aluminum Top Trim is included.
- Stackability: Evolve panels can be increased in height in 6", 12" and 24" increments. See module listing for part numbers.

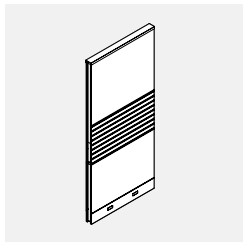
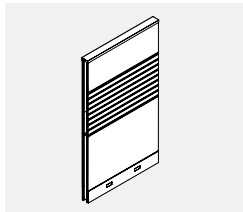

PRODUCT CODE	PRICE		SIZE/ INCHES			WEIGHT LBS	VOL FT ³
	GR1	GR2	H	W	D		
EVVPF2S4224F	400	418	42	24	2.875	33.50	2.31
EVVPF2S4230F	471	492	42	30	2.875	45.50	2.81
EVVPF2S4236F	550	573	42	36	2.875	49.50	3.38
EVVPF2S4242F	622	649	42	42	2.875	54.50	3.92
EVVPF2S4248F	690	719	42	48	2.875	60.50	4.45
EVVPF2S4254F	762	796	42	54	2.875	67.50	4.98
EVVPF2S4260F	840	877	42	60	2.875	74.50	5.52
EVVPF2S5424F	547	572	54	24	2.875	36.40	2.94
EVVPF2S5430F	639	669	54	30	2.875	40.40	3.62
EVVPF2S5436F	741	778	54	36	2.875	44.40	4.31
EVVPF2S5442F	842	882	54	42	2.875	46.60	4.99
EVVPF2S5448F	934	978	54	48	2.875	48.40	5.67
EVVPF2S5454F	1058	1109	54	54	2.875	50.40	6.35
EVVPF2S5460F	1139	1196	54	60	2.875	52.40	7.03
EVVPF2S6624F	605	637	66	24	2.875	48.00	3.58
EVVPF2S6630F	705	748	66	30	2.875	50.00	4.40
EVVPF2S6636F	835	882	66	36	2.875	54.00	5.23
EVVPF2S6642F	938	992	66	42	2.875	60.00	6.06
EVVPF2S6648F	1038	1099	66	48	2.875	67.00	6.08
EVVPF2S6654F	1143	1208	66	54	2.875	80.00	7.70
EVVPF2S6660F	1256	1329	66	60	2.875	86.00	8.53

EVPFGT • Fabric Glazed Panel - Tempered Glass

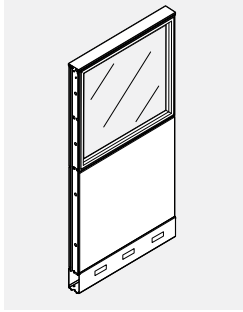

- Fabric Glazed Panel consists of individual fabric covered acoustic module in lower position(s) with one 12" or 24" glazed module in upper position.
- Glazing is replaceable on site.

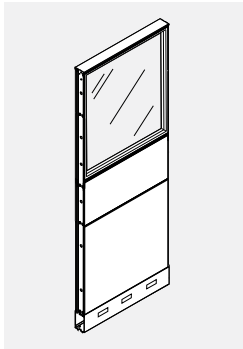

PRODUCT CODE	PRICE		SIZE/ INCHES			WEIGHT		VOL FT ³
	GR1	GR2	H	W	D	LBS		
EVPFGT4218	394	407	42	18	2.875	23.96	1.71	
EVPFGT4224	464	480	42	24	2.875	28.98	2.31	
EVPFGT4230	526	546	42	30	2.875	34.62	2.85	
EVPFGT4236	591	615	42	36	2.875	39.76	3.38	
EVPFGT4242	653	679	42	42	2.875	43.45	3.92	
EVPFGT4248	715	744	42	48	2.875	51.56	4.45	
EVPFGT4254	802	837	42	54	2.875	56.87	4.98	
EVPFGT4260	884	921	42	60	2.875	61.95	5.52	
EVPFGT5418	435	446	54	18	2.875	28.25	2.19	
EVPFGT5424	505	523	54	24	2.875	34.76	2.94	
EVPFGT5430	587	607	54	30	2.875	41.80	3.62	
EVPFGT5436	668	692	54	36	2.875	48.34	4.31	
EVPFGT5442	748	773	54	42	2.875	53.12	4.99	
EVPFGT5448	816	845	54	48	2.875	62.11	5.67	
EVPFGT5454	945	978	54	54	2.875	68.42	6.35	
EVPFGT5460	1074	1110	54	60	2.875	74.49	7.03	
EVPFGT6618	552	572	66	18	2.875	34.25	2.68	
EVPFGT6624	641	668	66	24	2.875	41.96	3.58	
EVPFGT6630	741	771	66	30	2.875	50.19	4.40	
EVPFGT6636	845	882	66	36	2.875	59.94	5.23	
EVPFGT6642	955	994	66	42	2.875	66.72	6.06	
EVPFGT6648	1034	1081	66	48	2.875	74.11	6.88	
EVPFGT6654	1190	1239	66	54	2.875	81.43	7.70	
EVPFGT6660	1349	1403	66	60	2.875	88.69	8.53	

EVFPFGT • Fabric Glazed Panel Premium - Tempered Glass

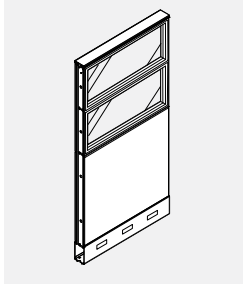

- Fabric Glazed Panel consists of individual fabric covered acoustic module in lower position with 2 or 3 glazed modules in upper position.
- Glazing is replaceable on site.

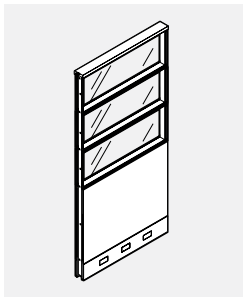

PRODUCT CODE	PRICE		SIZE/ INCHES			WEIGHT		VOL FT ³
	GR1	GR2	H	W	D	LBS		
EVFPFGT5418	526	537	54	18	2.875	32.95	2.19	
EVFPFGT5424	633	649	54	24	2.875	40.16	2.06	
EVFPFGT5430	705	727	54	30	2.875	47.89	2.58	
EVFPFGT5436	785	807	54	36	2.875	55.14	3.09	
EVFPFGT5442	872	902	54	42	2.875	60.82	3.61	
EVFPFGT5448	959	992	54	48	2.875	71.78	4.36	
EVFPFGT5454	1075	1109	54	54	2.875	78.83	6.35	
EVFPFGT5460	1188	1225	54	60	2.875	86.09	5.16	
EVFPFGT6618	658	671	66	18	2.875	42.33	2.68	
EVFPFGT6624	793	811	66	24	2.875	51.74	3.58	
EVFPFGT6630	889	909	66	30	2.875	61.55	5.23	
EVFPFGT6636	982	1005	66	36	2.875	70.90	5.23	
EVFPFGT6642	1095	1121	66	42	2.875	78.58	6.06	
EVFPFGT6648	1205	1236	66	48	2.875	91.87	6.88	
EVFPFGT6654	1364	1396	66	54	2.875	101.20	6.88	
EVFPFGT6660	1522	1560	66	60	2.875	110.64	6.30	

EVPFGTU • Fabric 12" Glazed Panel - Tempered Glass

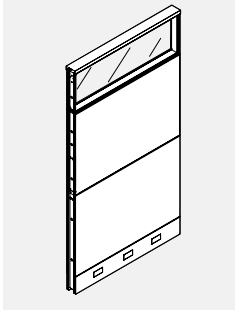

- Fabric 12" Glazed Panel incorporates one 12" glazed module and one 24" fabric modules above the 30" base section.
- Glazing is replaceable on site.

PRODUCT CODE	PRICE		SIZE/ INCHES			WEIGHT LBS	VOL FT ³
	GR1	GR2	H	W	D		
EVPFGTU6618	556	579	66	18	2.875	33.36	2.68
EVPFGTU6624	650	681	66	24	2.875	39.38	3.58
EVPFGTU6630	741	782	66	30	2.875	46.81	4.40
EVPFGTU6636	835	882	66	36	2.875	53.17	5.23
EVPFGTU6642	938	992	66	42	2.875	58.45	6.06
EVPFGTU6648	1021	1081	66	48	2.875	68.56	6.88
EVPFGTU6654	1139	1203	66	54	2.875	75.28	7.70
EVPFGTU6660	1256	1329	66	60	2.875	81.95	8.53

EVFPFGTU • Fabric 12" Glazed Panel Premium - Tempered Glass

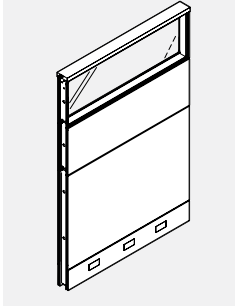

- Premium Fabric 12" Glazed Panel incorporates one 12" glazed module and 1 or 2 12" fabric module or 2 fabric modules above a 30" base section.
- Glazing is replaceable on site.

PRODUCT CODE	PRICE		SIZE/ INCHES			WEIGHT LBS	VOL FT ³
	GR1	GR2	H	W	D		
EVFPFGTU5418	509	530	54	18	2.875	29.56	2.19
EVFPFGTU5424	603	626	54	24	2.875	35.78	2.06
EVFPFGTU5430	679	710	54	30	2.875	42.61	2.58
EVFPFGTU5436	768	803	54	36	2.875	50.97	3.09
EVFPFGTU5442	860	902	54	42	2.875	56.65	3.61
EVFPFGTU5448	934	978	54	48	2.875	63.16	4.36
EVFPFGTU5454	1048	1096	54	54	2.875	69.48	7.70
EVFPFGTU5460	1162	1218	54	60	2.875	75.75	5.16
EVFPFGTU6618	633	656	66	18	2.875	35.56	2.68
EVFPFGTU6624	739	771	66	24	2.875	42.98	3.58
EVFPFGTU6630	839	879	66	30	2.875	51.00	4.38
EVFPFGTU6636	945	993	66	36	2.875	62.56	5.23
EVFPFGTU6642	1069	1121	66	42	2.875	70.25	6.06
EVFPFGTU6648	1153	1214	66	48	2.875	75.16	7.23
EVFPFGTU6654	1291	1360	66	54	2.875	82.50	7.70
EVFPFGTU6660	1432	1505	66	60	2.875	82.95	6.30

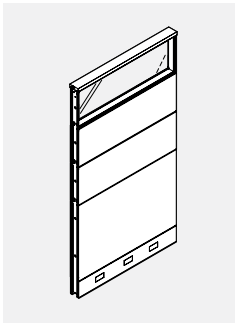

EVPMGTU • Monolithic 12" Glazed Panel - Tempered Glass

- Monolithic 12" Glazed Panel incorporates one 12" glazed module at the top of an otherwise Monolithic Panel.
- Glazing is replaceable on site.

PRODUCT CODE	PRICE		SIZE/ INCHES			WEIGHT LBS	VOL FT ³
	GR1	GR2	H	W	D		
EVPMGTU4818	450	474	48	18	2.875	26.96	1.92
EVPMGTU4824	527	562	48	24	2.875	31.98	2.62
EVPMGTU4830	613	653	48	30	2.875	37.62	3.23
EVPMGTU4836	703	754	48	36	2.875	42.77	3.85
EVPMGTU4842	778	831	48	42	2.875	46.45	4.45
EVPMGTU4848	847	909	48	48	2.875	54.45	5.06
EVPMGTU4854	941	1005	48	54	2.875	59.87	5.66
EVPMGTU4860	1032	1109	48	60	2.875	67.15	6.27
EVPMGTU5418	464	493	54	18	2.875	29.56	2.19
EVPMGTU5424	539	575	54	24	2.875	34.58	2.94
EVPMGTU5430	616	686	54	30	2.875	40.22	3.62
EVPMGTU5436	686	781	54	36	2.875	45.37	4.31
EVPMGTU5442	768	815	54	42	2.875	49.05	4.99
EVPMGTU5448	847	963	54	48	2.875	57.16	5.67
EVPMGTU5454	927	1056	54	54	2.875	62.47	6.32
EVPMGTU5460	1007	1153	54	60	2.875	67.55	7.03
EVPMGTU6618	497	525	66	18	2.875	33.96	2.68
EVPMGTU6624	596	634	66	24	2.875	38.98	3.58
EVPMGTU6630	686	727	66	30	2.875	44.62	4.40
EVPMGTU6636	760	807	66	36	2.875	49.77	5.23
EVPMGTU6642	845	902	66	42	2.875	53.45	6.06
EVPMGTU6648	934	996	66	48	2.875	61.16	6.88
EVPMGTU6654	1024	1092	66	54	2.875	66.87	6.88
EVPMGTU6660	1111	1188	66	60	2.875	71.95	8.53

EVPFGTX • Fabric 36" Glazed Panel - Tempered Glass

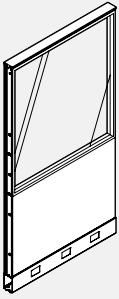

- Fabric 36" Glazed Panel incorporates one 36" glazed module above the 30" base section.
- Glazing is replaceable on site.

PRODUCT CODE	PRICE		SIZE/ INCHES			WEIGHT		VOL FT ³
	GR 1	GR 2	H	W	D	LBS		
EVPFGTX6618	639	652	66	18	2.875	35.45	4.23	
EVPFGTX6624	706	725	66	24	2.875	42.54	5.23	
EVPFGTX6630	820	839	66	30	2.875	50.15	6.23	
EVPFGTX6636	932	956	66	36	2.875	57.26	6.23	
EVPFGTX6642	1043	1070	66	42	2.875	63.02	6.56	
EVPFGTX6648	1141	1173	66	48	2.875	72.99	6.88	
EVPFGTX6654	1256	1289	66	54	2.875	80.28	7.70	
EVPFGTX6660	1370	1406	66	60	2.875	87.32	8.53	

EVPXGT • Fully Glazed Monolithic Panel - Tempered Glass

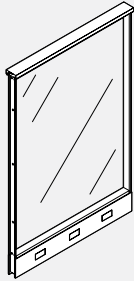

- Fully Glazed Monolithic Panel incorporates one glazed module into a rigid steel frame.
- Glazing is replaceable on site.

PRODUCT CODE	PRICE	SIZE/ INCHES			WEIGHT		VOL FT ³
		H	W	D	LBS		
EVPXGT4218	421	42	18	2.875	26.05	1.71	
EVPXGT4224	464	42	24	2.875	32.14	2.31	
EVPXGT4230	539	42	30	2.875	37.96	3.11	
EVPXGT4236	609	42	36	2.875	43.86	3.46	
EVPXGT4242	677	42	42	2.875	48.02	4.46	
EVPXGT4818	374	48	18	2.875	29.02	1.92	
EVPXGT4824	481	48	24	2.875	35.61	2.62	
EVPXGT4830	534	48	30	2.875	41.93	3.23	
EVPXGT4836	658	48	36	2.875	48.33	3.85	
EVPXGT4842	691	48	42	2.875	52.98	4.45	
EVPXGT5418	469	54	18	2.875	31.60	2.19	
EVPXGT5424	550	54	24	2.875	37.60	2.58	
EVPXGT5430	638	54	30	2.875	45.48	3.29	
EVPXGT5436	718	54	36	2.875	52.39	4.58	
EVPXGT5442	800	54	42	2.875	57.54	5.58	
EVPXGT6618	549	66	18	2.875	37.54	2.68	
EVPXGT6624	636	66	24	2.875	45.61	3.58	
EVPXGT6630	736	66	30	2.875	53.43	3.99	
EVPXGT6636	826	66	36	2.875	61.32	4.58	
EVPXGT6642	921	66	42	2.875	67.46	5.58	

EVPGPT • Fully Glazed Premium Panel - Tempered Glass

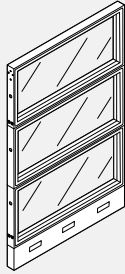

- Fully Glazed Premium Panel incorporates all 12" glazed modules above the 6" base raceway channel.
- Glazing is replaceable on site.

PRODUCT CODE	PRICE	SIZE/ INCHES			WEIGHT		VOL FT ³
		H	W	D	LBS		
EVPGPT4218	590	42	18	2.875	32.13	1.71	
EVPGPT4224	722	42	24	2.875	39.74	2.31	
EVPGPT4230	802	42	30	2.875	47.56	2.85	
EVPGPT4236	872	42	36	2.875	50.90	3.38	
EVPGPT4242	970	42	42	2.875	54.98	3.92	
EVPGPT4248	1077	42	48	2.875	72.27	4.45	
EVPGPT4254	1189	42	54	2.875	70.89	4.98	
EVPGPT4260	1294	42	60	2.875	87.44	5.52	
EVPGPT5418	750	54	18	2.875	35.19	2.19	
EVPGPT5424	921	54	24	2.875	49.76	2.58	
EVPGPT5430	1019	54	30	2.875	52.08	3.62	
EVPGPT5436	1109	54	36	2.875	64.54	4.31	
EVPGPT5442	1230	54	42	2.875	72.62	4.99	
EVPGPT5448	1374	54	48	2.875	78.11	5.67	
EVPGPT5454	1515	54	54	2.875	86.04	6.35	
EVPGPT5460	1650	54	60	2.875	94.09	7.03	
EVPGPT6618	909	66	18	2.875	41.15	2.68	
EVPGPT6624	1115	66	24	2.875	50.96	3.58	
EVPGPT6630	1232	66	30	2.875	60.47	3.58	
EVPGPT6636	1345	66	36	2.875	76.14	4.58	
EVPGPT6642	1494	66	42	2.875	86.22	6.06	
EVPGPT6648	1664	66	48	2.875	90.11	6.88	
EVPGPT6654	1836	66	54	2.875	99.05	7.70	
EVPGPT6660	2003	66	60	2.875	108.29	8.53	

EVPGT • Fully Glazed Panel - Tempered Glass

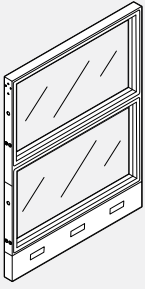

- 54" H Fully Glazed Panels incorporates two 24" Glazed modules.
- Stackability: Evolve Panels can be increased in height in 6", 12" of 24" increments.
- See Extension Module listings for part numbers.
- Standard in clear (CLR)
- Frosted Glass (FRST) upcharge varies. Contact EVOLVE Customer Support for details.
- Glazing is replaceable on site.

PRODUCT CODE	PRICE	SIZE/ INCHES			WEIGHT LBS	VOL FT ³
		H	W	D		
EVPGT5418	601	54	18	2.875	35.19	2.19
EVPGT5424	736	54	24	2.875	49.76	2.58
EVPGT5430	813	54	30	2.875	52.08	3.62
EVPGT5436	889	54	36	2.875	64.54	4.31
EVPGT5442	986	54	42	2.875	72.62	4.99
EVPGT5448	1099	54	48	2.875	78.11	5.67
EVPGT5454	1209	54	54	2.875	86.04	6.35
EVPGT5460	1320	54	60	2.875	94.09	7.03

EVPFOL • Open Bottom Panel

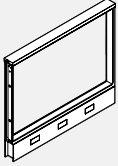

- Open Bottom Panel incorporates a 24" opening in the base section to provide maximum air circulation and access to electrical or data panels.

PRODUCT CODE	PRICE		SIZE/ INCHES			WEIGHT LBS	VOL FT ³
	GR1	GR2	H	W	D		
EVPFOL3018	229	-	30	18	2.875	17.08	1.23
EVPFOL3024	262	-	30	24	2.875	19.20	1.63
EVPFOL3030	297	-	30	30	2.875	23.05	2.00
EVPFOL3036	329	-	30	36	2.875	25.80	2.38
EVPFOL3042	360	-	30	42	2.875	27.99	2.76
EVPFOL3048	387	-	30	48	2.875	34.00	3.13
EVPFOL3054	420	-	30	54	2.875	37.71	3.51
EVPFOL3060	450	-	30	60	2.875	41.00	3.89
EVPFOL4218	344	354	42	18	2.875	22.28	1.71
EVPFOL4224	397	406	42	24	2.875	25.60	2.31
EVPFOL4230	450	462	42	30	2.875	30.65	2.85
EVPFOL4236	505	519	42	36	2.875	36.60	3.38
EVPFOL4242	562	575	42	42	2.875	40.79	3.92
EVPFOL4248	607	620	42	48	2.875	45.20	4.45
EVPFOL4254	667	684	42	54	2.875	49.92	4.98
EVPFOL4260	722	739	42	60	2.875	54.40	5.52
EVPFOL5418	392	405	54	18	2.875	25.68	2.19
EVPFOL5424	447	464	54	24	2.875	28.80	2.94
EVPFOL5430	509	530	54	30	2.875	34.45	3.24
EVPFOL5436	574	596	54	36	2.875	38.40	4.31
EVPFOL5442	639	667	54	42	2.875	42.19	4.99
EVPFOL5448	691	722	54	48	2.875	50.20	5.67
EVPFOL5454	757	790	54	54	2.875	55.32	6.35
EVPFOL5460	821	858	54	60	2.875	60.20	7.03
EVPFOL6618	508	528	66	18	2.875	31.68	2.68
EVPFOL6624	585	609	66	24	2.875	36.00	3.58
EVPFOL6630	671	700	66	30	2.875	42.84	4.40
EVPFOL6636	752	787	66	36	2.875	50.00	5.23
EVPFOL6642	845	886	66	42	2.875	55.79	6.06
EVPFOL6648	909	955	66	48	2.875	62.20	6.88
EVPFOL6654	1003	1054	66	54	2.875	68.33	7.70
EVPFOL6660	1095	1151	66	60	2.875	74.40	8.53

EVPFPOL • Open Bottom Panel Premium

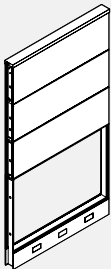

- Open Bottom Premium Panel incorporates a 24" opening in the base section to provide maximum air circulation and access to electrical or data panels.
- 12" high acoustic modules incorporated above the 30" base section.

PRODUCT CODE	PRICE		SIZE/ INCHES			WEIGHT LBS	VOL FT ³
	GR1	GR2	H	W	D		
EVPFPOL5418	462	473	54	18	2.875	27.88	2.19
EVPFPOL5424	532	551	54	24	2.875	32.40	2.94
EVPFPOL5430	608	628	54	30	2.875	38.64	3.24
EVPFPOL5436	681	704	54	36	2.875	47.80	4.31
EVPFPOL5442	769	796	54	42	2.875	53.99	4.99
EVPFPOL5448	825	856	54	48	2.875	56.80	5.67
EVPFPOL5454	910	944	54	54	2.875	62.53	6.35
EVPFPOL5460	994	1031	54	60	2.875	68.20	7.03
EVPFPOL6618	579	597	66	18	2.875	33.88	1.84
EVPFPOL6624	672	697	66	24	2.875	39.60	2.52
EVPFPOL6630	763	795	66	30	2.875	47.03	3.15
EVPFPOL6636	862	898	66	36	2.875	59.40	5.23
EVPFPOL6642	972	1013	66	42	2.875	67.59	4.41
EVPFPOL6648	1042	1088	66	48	2.875	68.80	6.06
EVPFPOL6654	1159	1207	66	54	2.875	75.54	7.70
EVPFPOL6660	1266	1322	66	60	2.875	82.40	6.30

EVPF0 • Fabric Open Panel 12" Opening

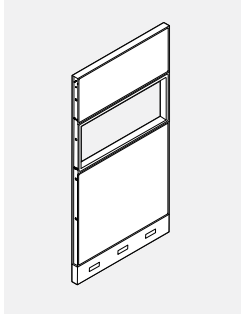

- Fabric Open Panel incorporates a 12" opening above the 30" base section to provide pass-through convenience.

PRODUCT CODE	PRICE		SIZE/ INCHES			WEIGHT		VOL FT ³
	GR 1	GR 2	H	W	D	LBS		
EVPF05418	470	490	54	18	2.875	26.58	2.19	
EVPF05424	547	572	54	24	2.875	31.80	2.94	
EVPF05430	634	662	54	30	2.875	37.64	3.38	
EVPF05436	715	751	54	36	2.875	45.00	4.31	
EVPF05442	806	845	54	42	2.875	49.69	4.99	
EVPF05448	869	915	54	48	2.875	55.20	5.67	
EVPF05454	965	1013	54	54	2.875	60.53	6.35	
EVPF05460	1057	1113	54	60	2.875	65.80	7.03	
EVPF06618	520	545	66	18	2.875	30.38	2.68	
EVPF06624	601	634	66	24	2.875	35.40	3.58	
EVPF06630	688	726	66	30	2.875	41.84	5.86	
EVPF06636	785	831	66	36	2.875	47.20	5.23	
EVPF06642	883	935	66	42	2.875	51.49	6.06	
EVPF06648	956	1016	66	48	2.875	60.60	6.88	
EVPF06654	1058	1123	66	54	2.875	66.33	7.70	
EVPF06660	1161	1232	66	60	2.875	72.00	8.53	

EVPFPO • Fabric Open Premium Panel 12" Opening

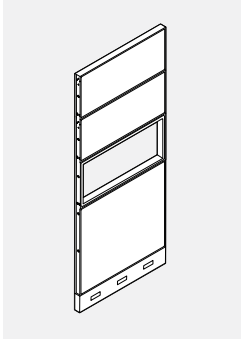

- Fabric Open Premium Panel incorporates a 12" opening above the 30" base section to provide pass-through convenience.
- Two 12" fabric acoustic modules are placed above the 12" opening.

PRODUCT CODE	PRICE		SIZE/ INCHES			WEIGHT		VOL FT ³
	GR 1	GR 2	H	W	D	LBS		
EVPFPO6618	589	613	66	18	2.875	32.58	1.84	
EVPFPO6624	681	715	66	24	2.875	39.00	3.58	
EVPFPO6630	787	826	66	30	2.875	46.03	4.47	
EVPFPO6636	890	935	66	36	2.875	56.60	5.23	
EVPFPO6642	1011	1063	66	42	2.875	63.29	6.06	
EVPFPO6648	1089	1148	66	48	2.875	67.20	6.88	
EVPFPO6654	1209	1277	66	54	2.875	73.54	7.70	
EVPFPO6660	1329	1401	66	60	2.875	80.00	8.53	

EVPF0X • Fabric Open Premium Panel 24" Opening

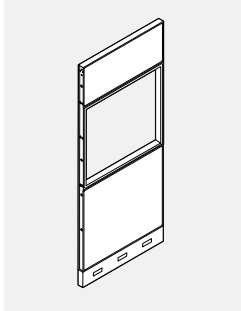

- Fabric Open Premium Panel incorporates a 24" opening above the 30" base section to provide pass-through convenience.
- May or may not have a 12" fabric acoustic module above the 24" opening.

PRODUCT CODE	PRICE		SIZE/ INCHES			WEIGHT		VOL FT ³
	GR 1	GR 2	H	W	D	LBS		
EVPF0X5418	392	405	54	18	2.875	25.68	2.19	
EVPF0X5424	447	464	54	24	2.875	28.80	2.94	
EVPF0X5430	509	530	54	30	2.875	34.45	3.38	
EVPF0X5436	574	596	54	36	2.875	38.40	4.31	
EVPF0X5442	638	666	54	42	2.875	42.19	4.99	
EVPF0X5448	688	718	54	48	2.875	50.20	5.67	
EVPF0X5454	756	789	54	54	2.875	55.32	6.35	
EVPF0X5460	821	858	54	60	2.875	60.20	7.03	
EVPF0X6618	508	528	66	18	2.875	31.68	2.68	
EVPF0X6624	585	609	66	24	2.875	36.00	3.58	
EVPF0X6630	688	716	66	30	2.875	42.84	5.86	
EVPF0X6636	752	787	66	36	2.875	50.00	5.23	
EVPF0X6642	845	886	66	42	2.875	55.79	6.06	
EVPF0X6648	909	955	66	48	2.875	62.20	6.88	
EVPF0X6654	1003	1054	66	54	2.875	68.33	7.70	
EVPF0X6660	1095	1151	66	60	2.875	74.40	8.53	

EVPFSG5M66 - Reception Panels, 24" Fabric Bottom Module and 6" Pass Thru

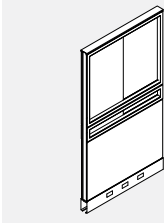

- Reception panel incorporates glazed tempered glass module and pass thru module within steel frame.
- 6" pass thru with sliding tempered glass door module.
- 24" fabric bottom module.
- Aluminum low profile top is included.
- Stackability: Evolve panels can be increased in height in 6", 12", 24" increments. See module listing for part numbers.

PRODUCT CODE	PRICE	SIZE/ INCHES			WEIGHT LBS	VOL FT ³
		H	W	D		
EVPFSG5M6636	986	66	36	2.875	70.9	5.23
EVPFSG5M6642	1098	66	42	2.875	78.58	6.06
EVPFSG5M6648	1208	66	48	2.875	91.87	6.88

EVPFSG3M66 - Reception Panels, 30" Fabric Bottom Module and 6" Pass Thru

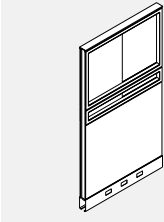

- Reception panel incorporates glazed tempered glass module and pass thru module within steel frame.
- 6" pass thru with sliding tempered glass door module.
- 30" fabric bottom module.
- Aluminum low profile top is included.
- Stackability: Evolve panels can be increased in height in 6", 12", 24" increments. See module listing for part numbers.

PRODUCT CODE	PRICE	SIZE/ INCHES			WEIGHT LBS	VOL FT ³
		H	W	D		
EVPFSG3M6636	1022	66	36	2.875	70.9	5.23
EVPFSG3M6642	1115	66	42	2.875	78.58	6.06
EVPFSG3M6648	1210	66	48	2.875	91.87	6.88

EVPFSG2M66 - Reception Panels, 24" Fabric Bottom Module and 12" Pass Thru

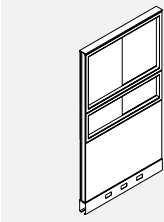

- Reception panel incorporates glazed tempered glass module and pass thru module within steel frame.
- 12" pass thru with sliding tempered glass door module.
- 24" fabric bottom module.
- Aluminum low profile top is included.
- Stackability: Evolve panels can be increased in height in 6", 12", 24" increments. See module listing for part numbers.

PRODUCT CODE	PRICE	SIZE/ INCHES			WEIGHT LBS	VOL FT ³
		H	W	D		
EVPFSG2M6636	969	66	36	2.875	70.9	5.23
EVPFSG2M6642	1068	66	42	2.875	78.58	6.06
EVPFSG2M6648	1176	66	48	2.875	91.87	6.88

EVPHSG5M66 - Reception Panels, 24" Laminate Bottom Module and 6" Pass Thru

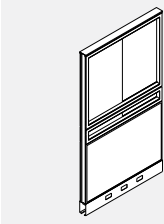

- Reception panel incorporates glazed tempered glass module and pass thru module within steel frame.
- 6" pass thru with sliding tempered glass door module.
- 24" laminate bottom module.
- Aluminum low profile top is included.
- Stackability: Evolve panels can be increased in height in 6", 12", 24" increments. See module listing for part numbers.

PRODUCT CODE	PRICE	SIZE/ INCHES			WEIGHT LBS	VOL FT ³
		H	W	D		
EVPHSG5M6636	1104	66	36	2.875	70.9	5.23
EVPHSG5M6642	1197	66	42	2.875	78.58	6.06
EVPHSG5M6648	1289	66	48	2.875	91.87	6.88

EVPHSG3M66 - Reception Panels, 30" Laminate Bottom Module and 6" Pass Thru

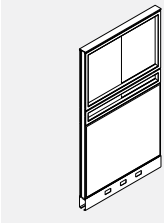

- Reception panel incorporates glazed tempered glass module and pass thru module within steel frame.
- 6" pass thru with sliding tempered glass door module.
- 30" laminate bottom module.
- Aluminum low profile top is included.
- Stackability: Evolve panels can be increased in height in 6", 12", 24" increments. See module listing for part numbers.

PRODUCT CODE	PRICE	SIZE/ INCHES			WEIGHT LBS	VOL FT ³
		H	W	D		
EVPHSG3M6636	1104	66	36	2.875	70.9	5.23
EVPHSG3M6642	1197	66	42	2.875	78.58	6.06
EVPHSG3M6648	1289	66	48	2.875	91.87	6.88

EVPHSG2M66 - Reception Panels, 24" Laminate Bottom Module and 12" Pass Thru

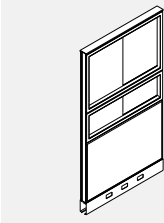

- Reception panel incorporates glazed tempered glass module and pass thru module within steel frame.
- 12" pass thru with sliding tempered glass door module.
- 24" laminate bottom module.
- Aluminum low profile top is included.
- Stackability: Evolve panels can be increased in height in 6", 12", 24" increments. See module listing for part numbers.

PRODUCT CODE	PRICE	SIZE/ INCHES			WEIGHT LBS	VOL FT ³
		H	W	D		
EVPHSG2M6636	1080	66	36	2.875	70.9	5.23
EVPHSG2M6642	1169	66	42	2.875	78.58	6.06
EVPHSG2M6648	1264	66	48	2.875	91.87	6.88

EVPPAF • Air Flow Panel

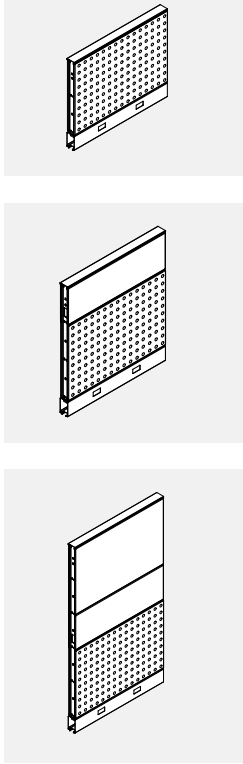

- Metal Air Flow Panel.
- Stackability: Evolve panels can be increased in height in 6", 12", 24" increments. See module listing for part numbers.

PRODUCT CODE	PRICE		SIZE/ INCHES			WEIGHT LBS	VOL FT ³
	GR 1	GR 2	H	W	D		
EVPPAF3024	387	-	30	24	2.875	22.08	1.63
EVPPAF3030	461	-	30	30	2.875	26.51	2.00
EVPPAF3036	509	-	30	36	2.875	29.67	2.38
EVPPAF3042	564	-	30	42	2.875	32.19	2.76
EVPPAF3048	638	-	30	48	2.875	39.10	3.13
EVPPAF3054	733	-	30	54	2.875	43.37	3.51
EVPPAF3060	827	-	30	60	2.875	47.15	3.89
EVPPAF4224	494	502	42	24	2.875	29.44	2.31
EVPPAF4230	585	594	42	30	2.875	35.25	2.81
EVPPAF4236	650	662	42	36	2.875	42.09	3.38
EVPPAF4242	724	736	42	42	2.875	46.91	3.92
EVPPAF4248	817	831	42	48	2.875	51.98	4.45
EVPPAF4254	930	947	42	54	2.875	57.41	4.98
EVPPAF4260	944	965	42	60	2.875	62.56	5.52
EVPPAF5424	553	569	54	24	2.875	33.12	2.94
EVPPAF5430	637	656	54	30	2.875	39.62	3.62
EVPPAF5436	715	737	54	36	2.875	44.16	4.31
EVPPAF5442	796	824	54	42	2.875	48.52	4.99
EVPPAF5448	894	926	54	48	2.875	57.73	5.67
EVPPAF5454	1042	1076	54	54	2.875	63.62	6.35
EVPPAF5460	1135	1170	54	60	2.875	69.23	7.03
EVPPAF6624	646	671	66	24	2.875	41.40	3.58
EVPPAF6630	762	792	66	30	2.875	49.27	4.40
EVPPAF6636	856	890	66	36	2.875	57.50	5.23
EVPPAF6642	954	993	66	42	2.875	64.16	6.06
EVPPAF6648	1074	1119	66	48	2.875	71.53	6.08
EVPPAF6654	1218	1265	66	54	2.875	78.58	7.70
EVPPAF6660	1350	1405	66	60	2.875	85.56	8.53

EVPPPAF • Premium Air Flow Panel

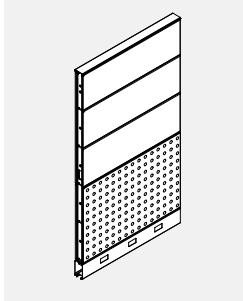

- Metal Air Flow Panel.
- Each side of panel may have different fabric within same grade at no upcharge.
- There is no panel creep.
- Stackability: Evolve panels can be increased in height in 6", 12", 24" increments. See module listing for part numbers.

PRODUCT CODE	PRICE		SIZE/ INCHES			WEIGHT LBS	VOL FT ³
	GR 1	GR 2	H	W	D		
EVPPPAF5424	615	634	54	24	2.875	37.26	2.94
EVPPPAF5430	703	725	54	30	2.875	44.44	3.62
EVPPPAF5436	790	815	54	36	2.875	54.97	4.31
EVPPPAF5442	877	903	54	42	2.875	62.09	4.99
EVPPPAF5448	993	1024	54	48	2.875	65.32	5.67
EVPPPAF5454	1123	1159	54	54	2.875	73.06	6.35
EVPPPAF5460	1256	1291	54	60	2.875	78.43	7.03
EVPPPAF6624	704	730	66	24	2.875	45.54	3.58
EVPPPAF6630	828	859	66	30	2.875	54.08	4.40
EVPPPAF6636	928	965	66	36	2.875	68.31	5.23
EVPPPAF6642	1031	1070	66	42	2.875	77.73	6.06
EVPPPAF6648	1170	1218	66	48	2.875	79.12	6.08
EVPPPAF6654	1318	1368	66	54	2.875	86.87	7.70
EVPPPAF6660	1470	1524	66	60	2.875	94.76	8.53

EVPPMAF • Premium Air Flow Panel

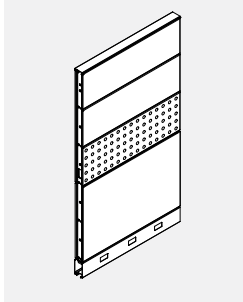

- Metal Air Flow Panel.
- Each side of panel may have different fabric within same grade at no upcharge.
- There is no panel creep.
- Stackability: Evolve panels can be increased in height in 6", 12", 24" increments. See module listing for part numbers.

PRODUCT CODE	PRICE		SIZE/ INCHES			WEIGHT LBS	VOL FT ³
	GR 1	GR 2	H	W	D		
EVPPMAF5424	675	701	54	24	2.875	36.57	2.94
EVPPMAF5430	801	829	54	30	2.875	43.29	3.62
EVPPMAF5436	910	945	54	36	2.875	51.75	4.31
EVPPMAF5442	1024	1062	54	42	2.875	57.14	4.99
EVPPMAF5448	1141	1188	54	48	2.875	63.48	5.67
EVPPMAF5454	1291	1342	54	54	2.875	69.61	6.35
EVPPMAF5460	1441	1497	54	60	2.875	75.67	7.03
EVPPMAF6624	768	801	66	24	2.875	44.85	3.58
EVPPMAF6630	908	947	66	30	2.875	52.93	4.40
EVPPMAF6636	1032	1080	66	36	2.875	65.09	5.23
EVPPMAF6642	1158	1208	66	42	2.875	72.78	6.06
EVPPMAF6648	1291	1353	66	48	2.875	77.28	6.08
EVPPMAF6654	1456	1522	66	54	2.875	84.58	7.70
EVPPMAF6660	1620	1694	66	60	2.875	92.00	8.53

EVPDS • Door Panel - Solid

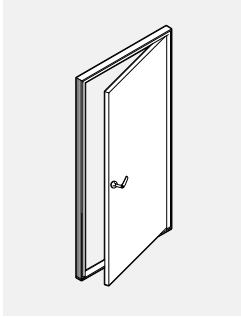

- 90° Door Panel height = 66" high panel plus one 24" or two 12" Panel Extension Modules.
- 1 3/8" thick hollow core door.
- Handedness can be changed in the field.
- Handle sold separately. Specify type of handle required.

PRODUCT CODE	PRICE	SIZE/ INCHES			WEIGHT LBS	VOL FT ³
		H	W	D		
EVPDS7836L	2287	78	36	2.875	64.00	7.50
EVPDS7836R	2287	78	36	2.875	64.00	7.50
EVPDS7842L	2660	78	42	2.875	74.00	8.50
EVPDS7842R	2660	78	42	2.875	74.00	8.50
EVPDS8436L	2408	84	36	2.875	62.00	7.00
EVPDS8436R	2408	84	36	2.875	62.00	7.00
EVPDS8442L	2787	84	42	2.875	72.00	8.00
EVPDS8442R	2787	84	42	2.875	72.00	8.00
EVPDS9036L	2417	90	36	2.875	66.00	8.00
EVPDS9036R	2417	90	36	2.875	66.00	8.00
EVPDS9042L	2787	90	42	2.875	76.00	9.00
EVPDS9042R	2787	90	42	2.875	76.00	9.00

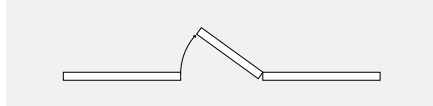

RIGHT HAND HUNG

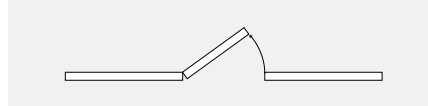

LEFT HAND HUNG

EVPDG • Full Glazed Door panel

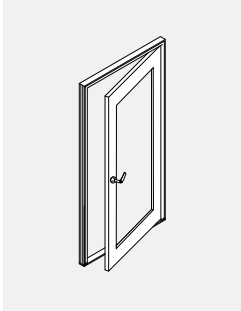

- All door surfaces are high pressure laminate with window.
- If laminate is selected in wood grain, the grain runs vertical.
- HP laminate finish available in all standard finishes.
- Select frame color from standard trim color.s
- 84" Door panel height is 66"h panel and 18" H Panel extension modules.
- 90" Door panel height is 66"h panel and 24" H or two 12" H Panel extension modules.
- Door and door trim can be specified left or right handed.
- Handedness of Door can be changed in field.
- Door Sizes:
 36" W door is 33.63" W without frame (This door is not ADA compliant)
 42" W door is 39.63" W without frame
 84" H door is 81.50" H without frame
 90" H door is 87.50" H without frame
- Customer is responsible to confirm and meet, city, county or any other municipality codes in relation to door clearances.
- Knob or lever to be ordered separately.

PRODUCT CODE	PRICE CLR	FRST	SIZE/INCHES			WEIGHT LBS	VOL FT ³
			H	W	D		
EVPDG8436L	2682	2779	84	36	2.875	62	7
EVPDG8436R	2682	2779	84	36	2.875	62	7
EVPDG8442L	3054	3149	84	42	2.875	72	8
EVPDG8442R	3054	3149	84	42	2.875	72	8
EVPDG9036L	2682	2779	90	36	2.875	66	8
EVPDG9036R	2682	2779	90	36	2.875	66	8
EVPDG9042L	3054	3149	90	42	2.875	76	9
EVPDG9042R	3054	3149	90	42	2.875	76	9

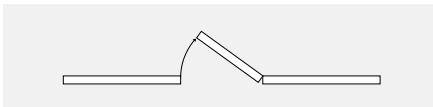

RIGHT HAND HUNG

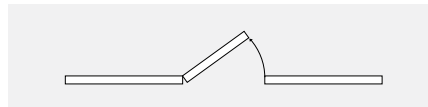

LEFT HAND HUNG

EVPDSL • Door Handles

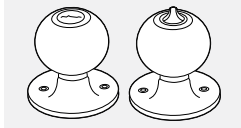

EVPDSL01

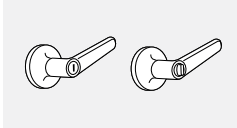

EVPDSL02

PRODUCT CODE	PRICE	SIZE/ INCHES			WEIGHT LBS	VOL FT ³
		H	W	D		
EVPDSL01	87				0.50	0.50
EVPDSL02	123				0.30	0.10

EVPDSL • Sliding Door

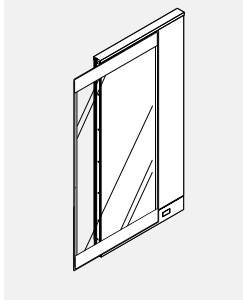

- Provides territorial privacy in an open plan environment.
 - Lightweight, panel mounted sliding partition.
 - Consists of translucent textured polycarbonate.
 - Must be mounted to a panel of the same size.
 - The face of the Privacy Screen sits 3" away from the face of the panel to which it is attached.
 - When open, the screen may interfere with raceway doors that open on the outside of an adjacent panel.
 - Must specify left or right for the direction in which the door will slide once installed.
 - Caps located on the end of the frame default to the panel frame colour.
 - All hardware included.
- Note: Specify left or right for the direction in which the door will slide as per examples above.

PRODUCT CODE	PRICE	SIZE/ INCHES			WEIGHT VOL	
		H	W	D	LBS	FT ³
EVPDSL6636R	1923	66	36	2.61	35	5.98
EVPDSL6636L	1923	66	36	2.61	35	5.98
EVPDSL6642R	2070	66	42	2.61	42	6.93
EVPDSL6642L	2070	66	42	2.61	42	6.93
EVPDSL8136R	2308	81	36	2.61	43	7.30
EVPDSL8136L	2308	81	36	2.61	43	7.30
EVPDSL8142R	2477	81	42	2.61	50	8.45
EVPDSL8142L	2477	81	42	2.61	50	8.45

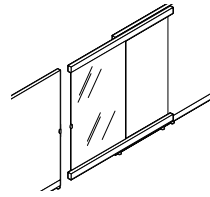

Left Hand Option

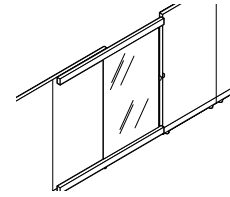

Right Hand Option

EVPDSLLOCK • Sliding Door Lock

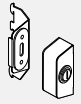

Left Hand Shown

- Lock bracket attaches to Sliding door with screws
- Includes strike plate bracket which attaches to slots in connector.
- Lock included.
- Available in tungsten only.

PRODUCT CODE	PRICE	SIZE/INCHES			WEIGHT VOL	
		H	W	D	LBS	FT ³
EVPDSLLOCKR	233	2.65	1.2	0.9	1.0	0.2
EVPDSLLOCKL	233	2.65	1.2	0.9	1.0	0.2

EVAFMB01 • Floor Mount Plate

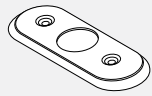

- Attached to floor.
- Secures panel to floor.
- Attachment screws not included.
- Care should be taken to use correct fasteners for type of floor.
- Available in chrome finish only.

PRODUCT CODE	PRICE	SIZE/ INCHES			WEIGHT VOL	
		H	W	D	LBS	FT ³
EVAFMB01	70	0.25	5	2.5	0.2	0.02

EVPFE • Panel Extension Module

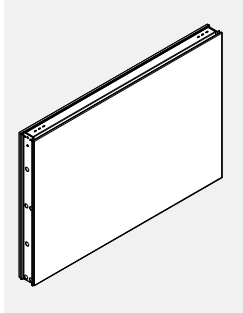

- Single modules are 6", 12", 18" or 24" high.
- When ordering Panel Extension Module, additional connectors are required.

PRODUCT CODE	PRICE		SIZE/ INCHES			WEIGHT VOL	
	GR 1	GR 2	H	W	D	LBS	FT ³
EVPFE0618	149	155	6	18	2.875	4.80	0.21
EVPFE0624	154	164	6	24	2.875	6.40	0.29
EVPFE0630	169	178	6	30	2.875	7.40	0.36
EVPFE0636	189	201	6	36	2.875	8.20	0.43
EVPFE0642	211	226	6	42	2.875	9.40	0.51
EVPFE0648	228	241	6	48	2.875	10.20	0.58
EVPFE0654	246	263	6	54	2.875	14.40	0.65
EVPFE0660	268	286	6	60	2.875	16.00	0.73
EVPFE1218	149	155	12	18	2.875	7.40	0.38
EVPFE1224	154	163	12	24	2.875	8.60	0.50
EVPFE1230	169	178	12	30	2.875	9.60	0.63
EVPFE1236	189	201	12	36	2.875	12.80	0.75
EVPFE1242	211	224	12	42	2.875	14.80	0.88
EVPFE1248	228	241	12	48	2.875	15.00	1.00
EVPFE1254	246	263	12	54	2.875	16.20	1.12
EVPFE1260	268	286	12	60	2.875	17.80	1.25
EVPFE1818	184	195	18	18	2.875	9.01	0.54
EVPFE1824	191	205	18	24	2.875	10.47	0.72
EVPFE1830	206	227	18	30	2.875	11.93	0.90
EVPFE1836	239	260	18	36	2.875	13.39	1.08
EVPFE1842	266	292	18	42	2.875	14.84	1.26
EVPFE1848	289	318	18	48	2.875	16.29	1.44
EVPFE1854	315	345	18	54	2.875	17.76	1.62
EVPFE1860	342	371	18	60	2.875	19.21	1.80
EVPFE2418	184	195	24	18	2.875	10.60	0.75
EVPFE2424	191	206	24	24	2.875	12.32	1.00
EVPFE2430	206	227	24	30	2.875	14.03	1.25
EVPFE2436	239	260	24	36	2.875	15.75	1.50
EVPFE2442	266	292	24	42	2.875	17.46	1.75
EVPFE2448	289	318	24	48	2.875	19.17	2.00
EVPFE2454	315	345	24	54	2.875	20.89	2.25
EVPFE2460	342	380	24	60	2.875	22.60	2.50

EVPFPE • Panel Extension Module Premium

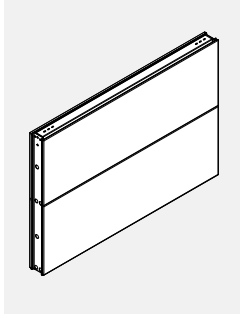

- Two 12" modules are incorporated into one 24" high metal frame.
- When ordering Panel Extension Module, additional connectors are required.

PRODUCT CODE	PRICE		SIZE/ INCHES			WEIGHT LBS	VOL FT ³
	GR 1	GR 2	H	W	D		
EVPFPE2418	252	262	24	18	2.875	13.90	1.02
EVPFPE2424	268	284	24	24	2.875	16.80	1.42
EVPFPE2430	298	318	24	30	2.875	19.58	1.75
EVPFPE2436	340	362	24	36	2.875	26.40	2.07
EVPFPE2442	380	406	24	42	2.875	31.04	2.40
EVPFPE2448	407	437	24	48	2.875	38.40	2.73
EVPFPE2454	450	484	24	54	2.875	30.90	2.25
EVPFPE2460	493	528	24	60	2.875	34.00	3.39

EVPW1SE • Writeboard Extension Module - One Side

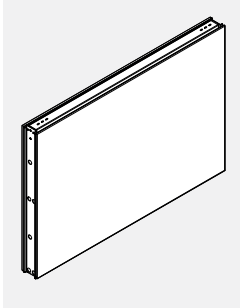

- Single 18" or 24" high module with Writeboard on one side and fabric on the other side.
- Use of erasable Writeboard markers only.
- When ordering Panel Extension Module, additional connectors are required.

PRODUCT CODE	PRICE		SIZE/ INCHES			WEIGHT LBS	VOL FT ³
	GR 1	GR 2	H	W	D		
EVPW1SE0618	206	211	06	18	3	2.77	0.25
EVPW1SE0624	240	251	06	24	3	3.20	0.35
EVPW1SE0630	272	276	06	30	3	3.63	0.43
EVPW1SE0636	310	317	06	36	3	4.06	0.51
EVPW1SE0642	350	356	06	42	3	4.49	0.60
EVPW1SE0648	383	392	06	48	3	4.91	0.68
EVPW1SE0654	433	441	06	54	3	5.34	0.76
EVPW1SE0660	455	463	06	60	3	5.77	0.84
EVPW1SE0666	474	485	06	66	3	6.17	0.91
EVPW1SE0672	526	534	06	72	3	6.57	0.99
EVPW1SE1218	206	211	12	18	3	5.55	0.51
EVPW1SE1224	240	251	12	24	3	6.41	0.71
EVPW1SE1230	272	276	12	30	3	7.26	0.87
EVPW1SE1236	310	317	12	36	3	8.12	1.03
EVPW1SE1242	350	356	12	42	3	8.98	1.20
EVPW1SE1248	383	392	12	48	3	9.83	1.36
EVPW1SE1254	433	441	12	54	3	10.69	1.53
EVPW1SE1260	455	463	12	60	3	11.55	1.69
EVPW1SE1266	474	485	12	66	3	12.41	1.85
EVPW1SE1272	526	534	12	72	3	13.27	1.99
EVPW1SE1818	226	230	18	18	2.875	9.44	0.54
EVPW1SE1824	255	262	18	24	2.875	10.90	0.72
EVPW1SE1830	284	294	18	30	2.875	12.35	0.90
EVPW1SE1836	334	345	18	36	2.875	13.81	1.08
EVPW1SE1842	378	393	18	42	2.875	15.27	1.26
EVPW1SE1848	417	435	18	48	2.875	16.72	1.44
EVPW1SE1854	451	469	18	54	2.875	18.18	1.62
EVPW1SE1860	488	505	18	60	2.875	19.64	1.80
EVPW1SE2418	226	230	24	18	2.875	11.10	1.02
EVPW1SE2424	255	263	24	24	2.875	12.82	2.07
EVPW1SE2430	284	295	24	30	2.875	14.53	2.17
EVPW1SE2436	334	345	24	36	2.875	16.25	2.27
EVPW1SE2442	378	393	24	42	2.875	17.96	2.37
EVPW1SE2448	417	430	24	48	2.875	19.67	2.47
EVPW1SE2454	451	469	24	54	2.875	21.39	2.25
EVPW1SE2460	488	505	24	60	2.875	23.10	3.47

EVPW2SE • Writeboard Extension Module - Two Side

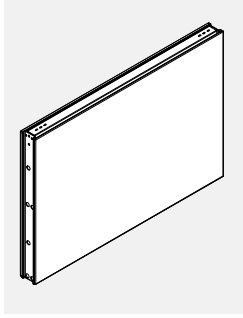

- Single 18" or 24" high module with Writeboard on both sides.
- Use of erasable Writeboard markers only.
- When ordering Panel Extension Module, additional connectors are required.

PRODUCT CODE	PRICE	SIZE/ INCHES			WEIGHT VOL	
		H	W	D	LBS	FT ³
EVPW2SE0618	227	06	18	3	2.77	0.25
EVPW2SE0624	266	06	24	3	3.20	0.35
EVPW2SE0630	309	06	30	3	3.63	0.43
EVPW2SE0636	353	06	36	3	4.06	0.51
EVPW2SE0642	398	06	42	3	4.49	0.60
EVPW2SE0648	447	06	48	3	4.91	0.68
EVPW2SE0654	519	06	54	3	5.34	0.76
EVPW2SE0660	528	06	60	3	5.77	0.84
EVPW2SE0666	539	06	66	3	6.17	0.91
EVPW2SE0672	609	06	72	3	6.57	0.99
EVPW2SE1218	227	12	18	3	5.55	0.51
EVPW2SE1224	266	12	24	3	6.41	0.71
EVPW2SE1230	309	12	30	3	7.26	0.87
EVPW2SE1236	353	12	36	3	8.12	1.03
EVPW2SE1242	398	12	42	3	8.98	1.20
EVPW2SE1248	447	12	48	3	9.83	1.36
EVPW2SE1254	519	12	54	3	10.69	1.53
EVPW2SE1260	528	12	60	3	11.55	1.69
EVPW2SE1266	539	12	66	3	12.41	1.85
EVPW2SE1272	609	12	72	3	13.27	1.99
EVPW2SE1818	271	18	18	2.875	10.29	0.54
EVPW2SE1824	318	18	24	2.875	11.75	0.72
EVPW2SE1830	364	18	30	2.875	13.20	0.90
EVPW2SE1836	433	18	36	2.875	14.66	1.08
EVPW2SE1842	488	18	42	2.875	16.12	1.26
EVPW2SE1848	546	18	48	2.875	17.57	1.44
EVPW2SE1854	604	18	54	2.875	19.03	1.62
EVPW2SE1860	658	18	60	2.875	20.49	1.80
EVPW2SE2418	271	24	18	2.875	12.10	0.75
EVPW2SE2424	318	24	24	2.875	13.82	2.07
EVPW2SE2430	364	24	30	2.875	15.53	2.17
EVPW2SE2436	433	24	36	2.875	17.25	2.27
EVPW2SE2442	488	24	42	2.875	18.96	2.37
EVPW2SE2448	546	24	48	2.875	20.67	2.73
EVPW2SE2454	604	24	54	2.875	22.39	2.35
EVPW2SE2460	658	24	60	2.875	24.10	3.39

EVPGTE • Tempered Glass Panel Extension Module

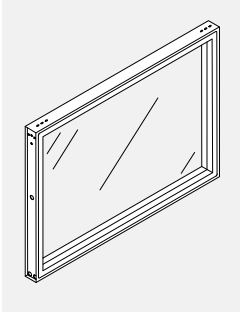

- Single 6", 12", 18" or 24" high module with glazing.
- When ordering Panel Extension Module, additional connectors are required.

PRODUCT CODE	PRICE	SIZE/ INCHES			WEIGHT LBS	VOL FT ³
		H	W	D		
EVPGTE0618	296	6	18	2.875	7.60	0.18
EVPGTE0624	318	6	24	2.875	9.24	0.25
EVPGTE0630	385	6	30	2.875	10.78	0.31
EVPGTE0636	400	6	36	2.875	12.32	0.37
EVPGTE0642	493	6	42	2.875	14.10	0.43
EVPGTE0648	550	6	48	2.875	15.80	0.50
EVPGTE0654	603	6	54	2.875	17.42	0.56
EVPGTE0660	647	6	60	2.875	19.28	0.63
EVPGTE1218	296	12	18	2.875	10.06	0.38
EVPGTE1224	318	12	24	2.875	12.08	0.50
EVPGTE1230	385	12	30	2.875	14.10	0.63
EVPGTE1236	400	12	36	2.875	16.12	0.75
EVPGTE1242	493	12	42	2.875	18.24	0.88
EVPGTE1248	550	12	48	2.875	20.56	1.00
EVPGTE1254	603	12	54	2.875	22.66	1.12
EVPGTE1260	647	12	60	2.875	25.00	1.25
EVPGTE1818	446	18	18	2.875	12.00	0.54
EVPGTE1824	459	18	24	2.875	14.93	0.72
EVPGTE1830	490	18	30	2.875	17.77	0.90
EVPGTE1836	535	18	36	2.875	20.57	1.08
EVPGTE1842	609	18	42	2.875	23.31	1.26
EVPGTE1848	681	18	48	2.875	25.94	1.44
EVPGTE1854	740	18	54	2.875	28.51	1.62
EVPGTE1860	795	18	60	2.875	31.28	1.80
EVPGTE2418	446	24	18	2.875	14.12	0.75
EVPGTE2424	459	24	24	2.875	17.56	1.00
EVPGTE2430	490	24	30	2.875	20.90	1.25
EVPGTE2436	535	24	36	2.875	24.20	1.50
EVPGTE2442	609	24	42	2.875	27.42	1.75
EVPGTE2448	681	24	48	2.875	30.52	2.00
EVPGTE2454	740	24	54	2.875	33.54	2.25
EVPGTE2460	795	24	60	2.875	36.80	2.50

EVPGPTE • Tempered Glass Premium Panel Extension Module

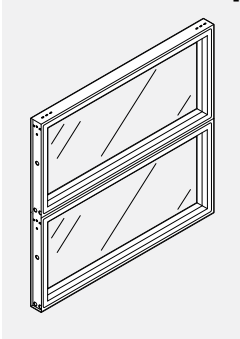

- Two 12" high glazed modules are incorporated into one 24" high metal frame.
- When ordering Panel Extension Module, additional connectors are required.

PRODUCT CODE	PRICE	SIZE/ INCHES			WEIGHT LBS	VOL FT ³
		H	W	D		
EVPGPTE2418	439	24	18	2.875	18.82	1.02
EVPGPTE2424	488	24	24	2.875	22.96	1.42
EVPGPTE2430	556	24	30	2.875	26.99	1.42
EVPGPTE2436	636	24	36	2.875	31.04	1.54
EVPGPTE2442	705	24	42	2.875	35.12	1.72
EVPGPTE2448	792	24	48	2.875	39.99	2.73
EVPGPTE2454	862	24	54	2.875	43.95	3.06
EVPGPTE2460	934	24	60	2.875	48.40	3.39

EVPH1SE • Laminate Extension Module - One Side

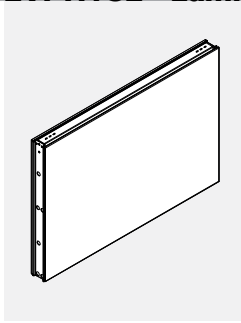

- Laminate face on one side of the module provides durable, washable surfaces. Opposite side is fabric.
- When ordering Panel Extension Module, additional connectors are required.

PRODUCT CODE	PRICE		SIZE/ INCHES			WEIGHT LBS	VOL FT ³
	GR 1	GR 2	H	W	D		
EVPH1SE0618	206	211	6	18	2.875	2.77	0.25
EVPH1SE0624	240	251	6	24	2.875	3.20	0.35
EVPH1SE0630	272	276	6	30	2.875	3.63	0.43
EVPH1SE0636	310	317	6	36	2.875	4.06	0.51
EVPH1SE0642	350	356	6	42	2.875	4.49	0.60
EVPH1SE0648	383	392	6	48	2.875	4.91	0.68
EVPH1SE0654	433	441	6	54	2.875	5.34	0.76
EVPH1SE0660	455	463	6	60	2.875	5.77	0.84
EVPH1SE1218	206	211	12	18	2.875	5.55	0.51
EVPH1SE1224	240	251	12	24	2.875	6.41	0.71
EVPH1SE1230	272	276	12	30	2.875	7.26	0.87
EVPH1SE1236	310	317	12	36	2.875	8.12	1.03
EVPH1SE1242	350	356	12	42	2.875	8.98	1.20
EVPH1SE1248	383	392	12	48	2.875	9.83	1.36
EVPH1SE1254	433	441	12	54	2.875	10.69	1.53
EVPH1SE1260	455	463	12	60	2.875	11.55	1.69
EVPH1SE1818	268	273	18	18	2.875	9.44	0.54
EVPH1SE1824	330	337	18	24	2.875	10.90	0.72
EVPH1SE1830	380	389	18	30	2.875	12.35	0.90
EVPH1SE1836	435	444	18	36	2.875	13.81	1.08
EVPH1SE1842	490	503	18	42	2.875	15.27	1.26
EVPH1SE1848	537	553	18	48	2.875	16.72	1.44
EVPH1SE1854	584	601	18	54	2.875	18.18	1.62
EVPH1SE1860	641	667	18	60	2.875	19.64	1.80
EVPH1SE2418	278	284	24	18	2.875	11.10	1.02
EVPH1SE2424	330	339	24	24	2.875	12.82	1.42
EVPH1SE2430	380	392	24	30	2.875	14.53	1.75
EVPH1SE2436	435	444	24	36	2.875	16.25	2.07
EVPH1SE2442	490	502	24	42	2.875	17.96	2.40
EVPH1SE2448	537	553	24	48	2.875	19.67	2.73
EVPH1SE2454	584	597	24	54	2.875	21.39	3.06
EVPH1SE2460	641	662	24	60	2.875	23.10	3.39

EVPH2SE • Laminate Extension Module - Two Sides

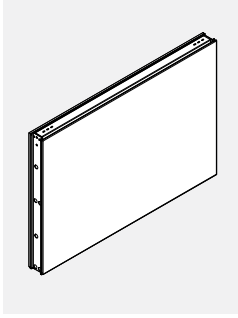

- Laminate face on both sides of the module provides durable, washable surfaces.
- When ordering Panel Extension Module, additional connectors are required.

PRODUCT CODE	PRICE	SIZE/ INCHES			WEIGHT LBS	VOL FT ³
		H	W	D		
EVPH2SE0618	227	6	18	2.875	3.03	0.26
EVPH2SE0624	266	6	24	2.875	3.46	0.36
EVPH2SE0630	309	6	30	2.875	3.89	0.44
EVPH2SE0636	353	6	36	2.875	4.32	0.52
EVPH2SE0642	398	6	42	2.875	4.74	0.60
EVPH2SE0648	447	6	48	2.875	5.17	0.69
EVPH2SE0654	519	6	54	2.875	5.60	0.77
EVPH2SE0660	528	6	60	2.875	6.03	0.85
EVPH2SE1218	227	12	18	2.875	6.05	0.51
EVPH2SE1224	266	12	24	2.875	6.91	0.71
EVPH2SE1230	309	12	30	2.875	7.77	0.88
EVPH2SE1236	353	12	36	2.875	8.63	1.04
EVPH2SE1242	398	12	42	2.875	9.48	1.20
EVPH2SE1248	447	12	48	2.875	10.34	1.37
EVPH2SE1254	519	12	54	2.875	11.20	1.53
EVPH2SE1260	528	12	60	2.875	12.05	1.70
EVPH2SE1818	319	18	18	2.875	10.29	0.54
EVPH2SE1824	392	18	24	2.875	11.75	0.72
EVPH2SE1830	455	18	30	2.875	13.20	0.90
EVPH2SE1836	526	18	36	2.875	14.66	1.08
EVPH2SE1842	596	18	42	2.875	16.12	1.26
EVPH2SE1848	674	18	48	2.875	17.57	1.44
EVPH2SE1854	740	18	54	2.875	19.03	1.62
EVPH2SE1860	799	18	60	2.875	20.49	1.80
EVPH2SE2418	319	24	18	2.875	12.10	1.02
EVPH2SE2424	392	24	24	2.875	13.82	1.42
EVPH2SE2430	455	24	30	2.875	15.53	1.75
EVPH2SE2436	526	24	36	2.875	17.25	2.07
EVPH2SE2442	596	24	42	2.875	18.96	2.40
EVPH2SE2448	674	24	48	2.875	20.67	2.73
EVPH2SE2454	740	24	54	2.875	22.39	3.06
EVPH2SE2460	799	24	60	2.875	24.10	3.39

EVPOE • Open Panel Extension Module

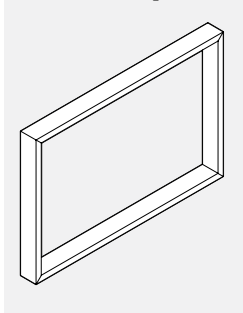

- Provides an opening within a run of panels at a desired location.
- When ordering Panel Extension Module, additional connectors are required.

PRODUCT CODE	PRICE	SIZE/ INCHES			WEIGHT LBS	VOL FT ³
		H	W	D		
EVPOE0618	239	6	18	2.875	6.22	0.26
EVPOE0624	245	6	24	2.875	7.40	0.29
EVPOE0630	298	6	30	2.875	8.48	0.36
EVPOE0636	314	6	36	2.875	9.56	0.43
EVPOE0642	381	6	42	2.875	10.88	0.51
EVPOE0648	429	6	48	2.875	12.12	0.58
EVPOE0654	469	6	54	2.875	13.25	0.65
EVPOE0660	505	6	60	2.875	14.68	0.73
EVPOE1218	239	12	18	2.875	7.30	0.51
EVPOE1224	245	12	24	2.875	8.40	0.59
EVPOE1230	298	12	30	2.875	9.50	0.82
EVPOE1236	314	12	36	2.875	10.60	1.00
EVPOE1242	381	12	42	2.875	11.84	1.00
EVPOE1248	429	12	48	2.875	13.20	1.18
EVPOE1254	469	12	54	2.875	14.38	1.25
EVPOE1260	505	12	60	2.875	15.80	1.32
EVPOE1818	319	18	18	2.875	7.74	0.54
EVPOE1824	358	18	24	2.875	9.18	0.72
EVPOE1830	381	18	30	2.875	10.53	0.90
EVPOE1836	418	18	36	2.875	11.88	1.08
EVPOE1842	471	18	42	2.875	13.09	1.26
EVPOE1848	530	18	48	2.875	14.22	1.44
EVPOE1854	575	18	54	2.875	15.28	1.62
EVPOE1860	619	18	60	2.875	16.56	1.80
EVPOE2418	319	24	18	2.875	8.60	1.02
EVPOE2424	358	24	24	2.875	10.20	1.42
EVPOE2430	381	24	30	2.875	11.70	1.75
EVPOE2436	418	24	36	2.875	13.20	1.95
EVPOE2442	471	24	42	2.875	14.54	2.40
EVPOE2448	530	24	48	2.875	15.80	2.73
EVPOE2454	575	24	54	2.875	16.98	3.06
EVPOE2460	619	24	60	2.875	18.40	3.39

EVPAE • Air Flow Extension Module

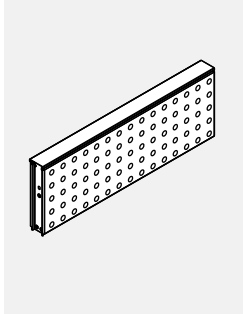

- Metal Air Flow Panel Extension
- Attaches to top of panel
- Panel Extension Modules are not load bearing above 66"
- When ordering Panel Extension Module, additional connectors are required.

PRODUCT CODE	PRICE	SIZE/ INCHES			WEIGHT LBS	VOL FT ³
		H	W	D		
EVPAE1224	262	12	24	2.875	9.66	0.59
EVPAE1230	309	12	30	2.875	10.93	0.82
EVPAE1236	352	12	36	2.875	12.19	1.00
EVPAE1242	389	12	42	2.875	13.62	1.05
EVPAE1248	439	12	48	2.875	15.18	1.18
EVPAE1260	579	12	60	2.875	18.17	1.32
EVPAE1824	329	18	24	2.875	10.56	0.72
EVPAE1830	383	18	30	2.875	12.11	0.90
EVPAE1836	422	18	36	2.875	13.66	1.08
EVPAE1842	464	18	42	2.875	15.05	1.26
EVPAE1848	531	18	48	2.875	16.35	1.44
EVPAE1860	690	18	60	2.875	19.04	1.80
EVPAE2424	329	24	24	2.875	11.73	1.42
EVPAE2430	383	24	30	2.875	13.46	1.75
EVPAE2436	422	24	36	2.875	15.18	1.95
EVPAE2442	464	24	42	2.875	16.72	2.40
EVPAE2448	531	24	48	2.875	18.17	2.73
EVPAE2460	690	24	60	2.875	21.16	3.39

EVPSGE - Pass Thru Sliding Tempered Glass Extension Module

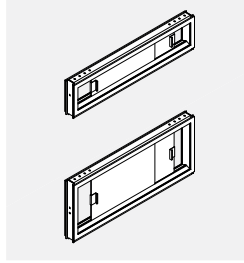

- Pass thru module with sliding tempered glass door.
- Attaches on top of a panel.
- Module can be stacked to add privacy or divide space.
- Panel extension module is not load bearing if installed higher than 66" High.
- When ordering panel extension modules, additional connectors are required.

PRODUCT CODE	PRICE		SIZE/ INCHES			WEIGHT		VOL FT ³
	CLR	GR1	H	W	D	LBS		
EVPSGE0636	288		6	36	2.875	12.32	0.37	
EVPSGE0642	307		6	42	2.875	14.1	0.43	
EVPSGE0648	373		6	48	2.875	15.8	0.5	
EVPSGE1236	347		12	36	2.875	16.12	0.75	
EVPSGE1242	367		12	42	2.875	18.24	0.88	
EVPSGE1248	386		12	48	2.875	20.56	1	

EVPSGXE - Talk Thru Tempered Glass Extension Module

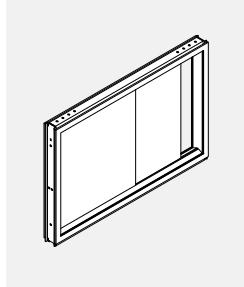

- Talk thru tempered glass module.
- Attaches on top of a panel.
- Module can be stacked to add privacy or divide space.
- Panel extension module is not load bearing if installed higher than 66" High.
- When ordering panel extension modules, additional connectors are required.

PRODUCT CODE	PRICE		SIZE/ INCHES			WEIGHT		VOL FT ³
	CLR	GR1	H	W	D	LBS		
EVPSGXE2436	447		24	36	2.875	24.2	1.25	
EVPSGXE2442	494		24	42	2.875	27.42	1.75	
EVPSGXE2448	537		24	48	2.875	30.52	2	
EVPSGXE3036	488		30	36	2.875	28.1	1.87	
EVPSGXE3042	550		30	42	2.875	31.56	2.2	
EVPSGXE3048	595		30	48	2.875	35.28	2.5	

EVPFEB • Fabric Panel Bridge Module

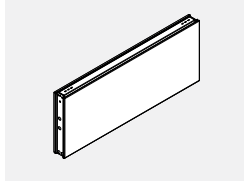

- Bridge modules connects two panels above an opening.
- Requires bridge extension connectors and connects with clamps on top and at bottom.
- Aluminum trim for bottom to be ordered separately.

PRODUCT CODE	PRICE		SIZE/INCHES			WEIGHT		VOL FT ³
	GR1	GR2	H	W	D	LBS		
EVPFEB0618	149	155	6	18	2.88	4.80	0.21	
EVPFEB0624	154	164	6	24	2.88	6.40	0.29	
EVPFEB0630	169	178	6	30	2.88	7.40	0.36	
EVPFEB0636	189	201	6	36	2.88	8.20	0.43	
EVPFEB0642	211	226	6	42	2.88	9.40	0.51	
EVPFEB0648	228	241	6	48	2.88	10.20	0.58	
EVPFEB0654	246	263	6	54	2.88	14.40	0.65	
EVPFEB0660	268	286	6	60	2.88	16.00	0.73	
EVPFEB1218	149	155	12	18	2.88	7.40	0.38	
EVPFEB1224	154	163	12	24	2.88	8.60	0.50	
EVPFEB1230	169	178	12	30	2.88	9.60	0.63	
EVPFEB1236	189	201	12	36	2.88	12.80	0.75	
EVPFEB1242	211	224	12	42	2.88	14.80	0.88	
EVPFEB1248	228	241	12	48	2.88	15.00	1.00	
EVPFEB1254	246	263	12	54	2.88	16.20	1.12	
EVPFEB1260	268	286	12	60	2.88	17.80	1.25	
EVPFEB1818	184	195	18	18	2.88	9.01	0.54	
EVPFEB1824	191	205	18	24	2.88	10.47	0.72	
EVPFEB1830	206	227	18	30	2.88	11.93	0.90	
EVPFEB1836	239	260	18	36	2.88	13.39	1.08	
EVPFEB1842	266	292	18	42	2.88	14.84	1.26	
EVPFEB1848	289	318	18	48	2.88	16.29	1.44	
EVPFEB1854	315	345	18	54	2.88	17.76	1.62	
EVPFEB1860	342	371	18	60	2.88	19.21	1.80	
EVPFEB2418	184	195	24	18	2.88	10.60	0.75	
EVPFEB2424	191	206	24	24	2.88	12.32	1.00	
EVPFEB2430	206	227	24	30	2.88	14.03	1.25	
EVPFEB2436	239	260	24	36	2.88	15.75	1.50	
EVPFEB2442	266	292	24	42	2.88	17.46	1.75	
EVPFEB2448	289	318	24	48	2.88	19.17	2.00	
EVPFEB2454	315	345	24	54	2.88	20.89	2.25	
EVPFEB2460	342	380	24	60	2.88	22.60	2.50	

EVPGTEB • Tempered Glass Bridge Module

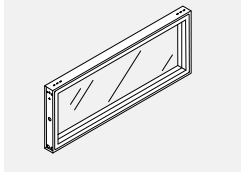

- Bridge modules connects two panels above an opening.
- Requires bridge extension connectors and connects with clamps at bottom.
- Standard in clear (CLR).
- Frosted glass available with a 40% upcharge.
- When ordering bridge modules, additional bridge connectors are required.
- Aluminum trim for bottom to be ordered separately.

PRODUCT CODE	PRICE	SIZE/INCHES			WEIGHT LBS	VOL FT³
		H	W	D		
EVPGTEB0618	255	6	18	3	7.60	0.18
EVPGTEB0624	273	6	24	3	9.24	0.25
EVPGTEB0630	332	6	30	3	10.78	0.31
EVPGTEB0636	345	6	36	3	12.32	0.37
EVPGTEB0642	424	6	42	3	14.10	0.43
EVPGTEB0648	474	6	48	3	15.80	0.50
EVPGTEB0654	519	6	54	3	17.42	0.56
EVPGTEB0660	557	6	60	3	19.28	0.63
EVPGTEB1218	255	12	18	3	10.06	0.38
EVPGTEB1224	273	12	24	3	12.08	0.50
EVPGTEB1230	332	12	30	3	14.10	0.63
EVPGTEB1236	345	12	36	3	16.12	0.75
EVPGTEB1242	424	12	42	3	18.24	0.88
EVPGTEB1248	474	12	48	3	20.56	1.00
EVPGTEB1254	519	12	54	3	22.66	1.12
EVPGTEB1260	557	12	60	3	25.00	1.25
EVPGTEB1818	384	18	18	3	12.00	0.54
EVPGTEB1824	395	18	24	3	14.93	0.72
EVPGTEB1830	422	18	30	3	17.77	0.90
EVPGTEB1836	461	18	36	3	20.57	1.08
EVPGTEB1842	525	18	42	3	23.31	1.26
EVPGTEB1848	587	18	48	3	25.94	1.44
EVPGTEB1854	638	18	54	3	28.51	1.62
EVPGTEB1860	685	18	60	3	31.28	1.80
EVPGTEB2418	384	24	18	3	14.12	0.75
EVPGTEB2424	395	24	24	3	17.56	1.00
EVPGTEB2430	422	24	30	3	20.90	1.25
EVPGTEB2436	461	24	36	3	24.20	1.50
EVPGTEB2442	525	24	42	3	27.42	1.75
EVPGTEB2448	587	24	48	3	30.52	2.00
EVPGTEB2454	638	24	54	3	33.54	2.25
EVPGTEB2460	685	24	60	3	36.80	2.50

EVPH1SEB • Laminate Bridge Module - Single Sided

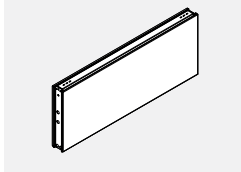

- Bridge modules connects two panels above an opening.
- Requires bridge extension connectors and connects with clamps at bottom.
- Laminate face on one side of module provides durable, washable surface.
- Panel extension module is not load bearing if installed higher than 66" high.
- When ordering bridge modules, additional bridge connectors are required.
- Aluminum trim for bottom to be ordered separately.

PRODUCT CODE	PRICE		SIZE/INCHES			WEIGHT LBS	VOL FT³
	GR1	GR2	H	W	D		
EVPH1SEB0618	177	182	6	18	3	2.77	0.25
EVPH1SEB0624	207	215	6	24	3	3.20	0.35
EVPH1SEB0630	235	238	6	30	3	3.63	0.43
EVPH1SEB0636	268	272	6	36	3	4.06	0.51
EVPH1SEB0642	301	307	6	42	3	4.49	0.60
EVPH1SEB0648	329	336	6	48	3	4.91	0.68
EVPH1SEB0654	373	380	6	54	3	5.34	0.76
EVPH1SEB0660	391	399	6	60	3	5.77	0.84
EVPH1SEB1218	177	182	12	18	3	5.55	0.51
EVPH1SEB1224	207	215	12	24	3	6.41	0.71
EVPH1SEB1230	235	238	12	30	3	7.26	0.87
EVPH1SEB1236	268	272	12	36	3	8.12	1.03
EVPH1SEB1242	301	307	12	42	3	8.98	1.20
EVPH1SEB1248	329	336	12	48	3	9.83	1.36
EVPH1SEB1254	373	380	12	54	3	10.69	1.53
EVPH1SEB1260	391	399	12	60	3	11.55	1.69
EVPH1SEB1818	231	236	18	18	3	9.44	0.54
EVPH1SEB1824	284	291	18	24	3	10.90	0.72
EVPH1SEB1830	327	335	18	30	3	12.35	0.90
EVPH1SEB1836	374	383	18	36	3	13.81	1.08
EVPH1SEB1842	422	434	18	42	3	15.27	1.26
EVPH1SEB1848	463	477	18	48	3	16.72	1.44
EVPH1SEB1854	502	518	18	54	3	18.18	1.62
EVPH1SEB1860	554	574	18	60	3	19.64	1.80
EVPH1SEB2418	231	236	24	18	3	11.10	1.02
EVPH1SEB2424	284	291	24	24	3	12.82	1.42
EVPH1SEB2430	327	335	24	30	3	14.53	1.75
EVPH1SEB2436	374	383	24	36	3	16.25	2.07
EVPH1SEB2442	422	434	24	42	3	17.96	2.40
EVPH1SEB2448	463	477	24	48	3	19.67	2.73
EVPH1SEB2454	502	518	24	54	3	21.39	3.06
EVPH1SEB2460	554	574	24	60	3	23.10	3.39

EVPH2SEB • Laminate Bridge Module - Double Sided

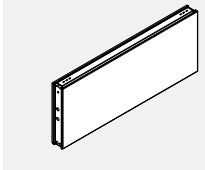

- Bridge modules connects two panels above an opening.
- Requires bridge extension connectors and connects with clamps at bottom.
- Laminate face on two sides of module provides durable, washable surface.
- Panel extension module is not load bearing if installed higher than 66" high.
- When ordering panel extension modules, additional connectors are required.
- Aluminum trim for bottom to be ordered separately.

PRODUCT CODE	PRICE	SIZE / INCHES			WEIGHT LBS	VOL FT ³
		H	W	D		
EVPH2SEB0618	194	6	18	3	3.03	0.26
EVPH2SEB0624	229	6	24	3	3.46	0.36
EVPH2SEB0630	267	6	30	3	3.89	0.44
EVPH2SEB0636	303	6	36	3	4.32	0.52
EVPH2SEB0642	343	6	42	3	4.74	0.60
EVPH2SEB0648	386	6	48	3	5.17	0.69
EVPH2SEB0654	446	6	54	3	5.60	0.77
EVPH2SEB0660	455	6	60	3	6.03	0.85
EVPH2SEB1218	194	12	18	3	6.05	0.51
EVPH2SEB1224	229	12	24	3	6.91	0.71
EVPH2SEB1230	267	12	30	3	7.77	0.88
EVPH2SEB1236	303	12	36	3	8.63	1.04
EVPH2SEB1242	343	12	42	3	9.48	1.20
EVPH2SEB1248	386	12	48	3	10.34	1.37
EVPH2SEB1254	446	12	54	3	11.20	1.53
EVPH2SEB1260	455	12	60	3	12.05	1.70
EVPH2SEB1818	275	18	18	3	10.29	0.54
EVPH2SEB1824	336	18	24	3	11.75	0.72
EVPH2SEB1830	391	18	30	3	13.20	0.90
EVPH2SEB1836	453	18	36	3	14.66	1.08
EVPH2SEB1842	514	18	42	3	16.12	1.26
EVPH2SEB1848	581	18	48	3	17.57	1.44
EVPH2SEB1854	638	18	54	3	19.03	1.62
EVPH2SEB1860	688	18	60	3	20.49	1.80
EVPH2SEB2418	275	24	18	3	12.10	1.02
EVPH2SEB2424	336	24	24	3	13.82	1.42
EVPH2SEB2430	391	24	30	3	15.53	1.75
EVPH2SEB2436	453	24	36	3	17.25	2.07
EVPH2SEB2442	514	24	42	3	18.96	2.40
EVPH2SEB2448	581	24	48	3	20.67	2.73
EVPH2SEB2454	638	24	54	3	22.39	3.06
EVPH2SEB2460	688	24	60	3	24.10	3.39

EVPMP-GI-P • Panel Mount Privacy Glass for U Channel, Extended at Both Ends

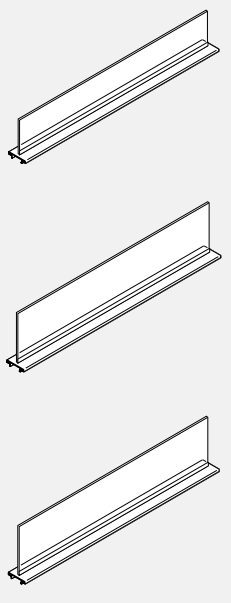

- Privacy Glass integrated with aluminum top trim.
- Attaches on top of panels to add privacy or divide space
- Includes aluminum trim with channel and glass tile.
- Standard in clear (CLR), frosted (FRST) or writeable (WRW) glass.
- Aluminum trim must be specified for entire station when ordering panel mount privacy glass.
- Glass and attachment hardware ship seperately.

PRODUCT CODE	PRICE			SIZE/ INCHES			WEIGHT		VOL FT ³
	CLR	FRST	WRW	H	W	D	LBS		
EVPMP24GI6P	195	244	-	6	24	2.875	2.39	0.25	
EVPMP30GI6P	213	268	-	6	30	2.875	2.99	0.32	
EVPMP36GI6P	228	283	-	6	36	2.875	3.58	0.37	
EVPMP42GI6P	244	304	-	6	42	2.875	4.18	0.43	
EVPMP48GI6P	254	317	-	6	48	2.875	4.78	0.50	
EVPMP54GI6P	262	328	-	6	54	2.875	5.38	0.56	
EVPMP60GI6P	268	333	-	6	60	2.875	5.97	0.63	
EVPMP66GI6P	410	546	-	6	66	2.875	6.57	0.69	
EVPMP72GI6P	437	570	-	6	72	2.875	7.16	0.76	
EVPMP24GI9P	195	244	-	9	24	2.875	3.58	0.38	
EVPMP30GI9P	213	268	-	9	30	2.875	4.48	0.47	
EVPMP36GI9P	228	283	-	9	36	2.875	5.37	0.56	
EVPMP42GI9P	244	304	-	9	42	2.875	6.26	0.65	
EVPMP48GI9P	254	317	-	9	48	2.875	7.16	0.75	
EVPMP54GI9P	262	328	-	9	54	2.875	8.06	0.84	
EVPMP60GI9P	268	333	-	9	60	2.875	8.96	0.94	
EVPMP66GI9P	410	546	-	9	66	2.875	9.85	1.04	
EVPMP72GI9P	437	570	-	9	72	2.875	10.74	1.13	
EVPMP24GIP	195	244	340	12	24	2.875	4.77	0.50	
EVPMP30GIP	213	268	347	12	30	2.875	5.97	0.63	
EVPMP36GIP	228	283	353	12	36	2.875	7.16	0.75	
EVPMP42GIP	244	304	389	12	42	2.875	8.35	0.87	
EVPMP48GIP	254	317	426	12	48	2.875	9.55	1.00	
EVPMP54GIP	262	328	461	12	54	2.875	10.75	1.12	
EVPMP60GIP	268	333	497	12	60	2.875	11.95	1.25	
EVPMP66GIP	410	546	681	12	66	2.875	13.05	1.37	
EVPMP72GIP	437	570	713	12	72	2.875	14.25	1.51	

EVPMPN-GIP • 12" Integrated Panel Mounted Privacy Glass, 1 Notch

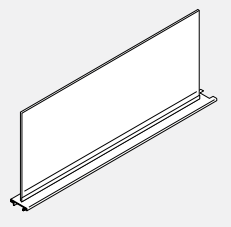

- Privacy Glass Integrated with aluminum top trim.
- Attaches on top of panels to add privacy or divide space.
- Includes aluminum top trim with channel with notched end and glass tile.
- Standard in clear (CLR) or frosted (FRST) glass
- Aluminum trim must be specified for entire station when ordering panel mount privacy glass.
- Glass and attachment hardware to ship separately.

PRODUCT CODE	PRICE			SIZE/ INCHES			WEIGHT		VOL FT ³
	CLR	FRST		H	W	D	LBS		
EVPMPN24GIP	195	244		12	24	2.875	4.77	0.50	
EVPMPN30GIP	213	268		12	30	2.875	5.97	0.63	
EVPMPN36GIP	228	283		12	36	2.875	7.16	0.75	
EVPMPN42GIP	244	304		12	42	2.875	8.35	0.87	
EVPMPN48GIP	254	317		12	48	2.875	9.55	1.00	
EVPMPN54GIP	262	328		12	54	2.875	10.75	1.12	
EVPMPN60GIP	268	333		12	60	2.875	11.95	1.25	

EVPMPDN-GIP • 12" Integrated Panel Mounted Privacy Glass, 2 Notches

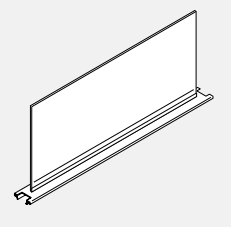

- Privacy Glass Integrated with aluminum top trim.
- Attaches on top of panels to add privacy or divide space.
- Includes aluminum top trim with channel with notched ends and glass tile.
- Standard in clear (CLR) or frosted (FRST) glass
- Aluminum trim must be specified for entire station when ordering panel mount privacy glass.
- Glass and attachment hardware to ship separately.

PRODUCT CODE	PRICE			SIZE/ INCHES			WEIGHT		VOL FT ³
	CLR	FRST		H	W	D	LBS		
EVPMPDN24GIP	195	244		12	24	2.875	4.77	0.50	
EVPMPDN30GIP	213	268		12	30	2.875	5.97	0.63	
EVPMPDN36GIP	228	283		12	36	2.875	7.16	0.75	
EVPMPDN42GIP	244	304		12	42	2.875	8.35	0.87	
EVPMPDN48GIP	254	317		12	48	2.875	9.55	1.00	
EVPMPDN54GIP	262	328		12	54	2.875	10.75	1.12	
EVPMPDN60GIP	268	333		12	60	2.875	11.95	1.25	

EVPMP-GI-PDU • Panel Mount Privacy Glass for U Channel, Extended at Both Ends

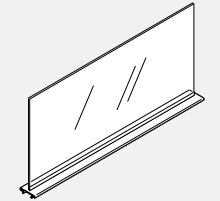
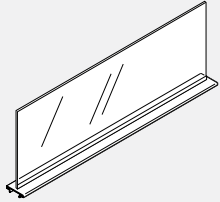
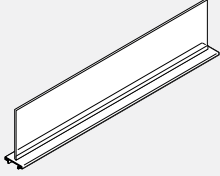
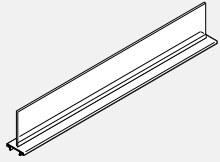

- Privacy glass integrated within aluminum top trim to be used with U channel, with connector for Gallery Panels.
- Attaches on top of panels to add privacy or divide space
- Includes aluminum trim with channel and glass tile
- Standard in clear (CLR) or frosted (FRST) glass
- Aluminium trim must be specified for entire station when ordering panel mount privacy glass.
- Glass and attachment hardware to ship separately
- Trim and glass extended for U channel from both ends.

PRODUCT CODE	PRICE		SIZE/ INCHES			WEIGHT VOL	
	CLR	FRST	H	W	D	LBS	FT ³
EVPMP24GI6PDU	206	256	6	25.25		2.39	0.25
EVPMP30GI6PDU	218	273	6	31.25		2.99	0.32
EVPMP36GI6PDU	234	294	6	37.25		3.58	0.37
EVPMP42GI6PDU	242	304	6	43.25		4.18	0.43
EVPMP48GI6PDU	252	315	6	49.25		4.78	0.50
EVPMP54GI6PDU	256	321	6	55.25		5.38	0.56
EVPMP60GI6PDU	396	524	6	61.25		5.97	0.63
EVPMP66GI6PDU	420	548	6	67.25		6.57	0.69
EVPMP72GI6PDU	444	572	6	73.25		7.16	0.76
EVPMP24GI9PDU	206	256	9	25.25		3.58	0.38
EVPMP30GI9PDU	218	273	9	31.25		4.48	0.47
EVPMP36GI9PDU	234	294	9	37.25		5.37	0.56
EVPMP42GI9PDU	242	304	9	43.25		6.26	0.65
EVPMP48GI9PDU	252	315	9	49.25		7.16	0.75
EVPMP54GI9PDU	256	321	9	55.25		8.06	0.84
EVPMP60GI9PDU	396	524	9	61.25		8.96	0.94
EVPMP66GI9PDU	420	548	9	67.25		9.85	1.04
EVPMP72GI9PDU	444	572	9	73.25		10.74	1.13
EVPMP24GIPDU	206	256	12	25.25		4.77	0.50
EVPMP30GIPDU	218	273	12	31.25		5.97	0.63
EVPMP36GIPDU	234	294	12	37.25		7.16	0.75
EVPMP42GIPDU	242	304	12	43.25		8.35	0.87
EVPMP48GIPDU	252	315	12	49.25		9.55	1.00
EVPMP54GIPDU	256	321	12	55.25		10.75	1.12
EVPMP60GIPDU	396	524	12	61.25		11.94	1.25
EVPMP66GIPDU	420	548	12	67.25		13.13	1.38
EVPMP72GIPDU	444	572	12	73.25		14.32	1.51
EVPMP24GI18PDU	381	437	18	25.25		7.16	0.75
EVPMP30GI18PDU	406	444	18	31.25		8.96	0.94
EVPMP36GI18PDU	422	490	18	37.25		10.74	1.13
EVPMP42GI18PDU	448	535	18	43.25		12.53	1.31
EVPMP48GI18PDU	464	579	18	49.25		14.33	1.50
EVPMP54GI18PDU	480	626	18	55.25		16.13	1.69
EVPMP60GI18PDU	537	712	18	61.25		17.91	1.88
EVPMP66GI18PDU	570	744	18	67.25		19.70	2.06
EVPMP72GI18PDU	603	777	18	73.25		21.48	2.25

EVPMP-GI-PU • Panel Mount Privacy Glass for U Channel, Extended at One End

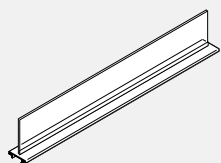

- Privacy glass integrated within aluminum top trim to be used with U channel, with connector for Gallery Panels.
- Attaches on top of panels to add privacy or divide space.
- Includes aluminum trim with channel and glass tile.
- Standard in clear (CLR) or frosted (FRST) glass.
- Aluminium trim must be specified for entire station when ordering panel mount privacy glass.
- Glass and attachment hardware to ship separately.
- Trim and glass extended for U channel on one end.

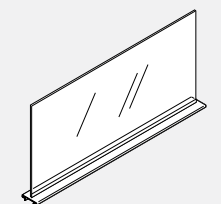
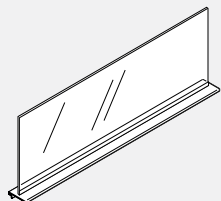
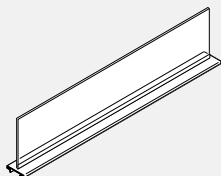

PRODUCT CODE	PRICE		SIZE/ INCHES			WEIGHT VOL	
	CLR	FRST	H	W	D	LBS	FT³
EVPMP24GI6PU	206	256	6	24.625		2.39	0.25
EVPMP30GI6PU	218	273	6	30.625		2.99	0.32
EVPMP36GI6PU	234	294	6	36.625		3.58	0.37
EVPMP42GI6PU	242	304	6	42.625		4.18	0.43
EVPMP48GI6PU	252	315	6	48.625		4.78	0.50
EVPMP54GI6PU	256	321	6	54.625		5.38	0.56
EVPMP60GI6PU	396	524	6	60.625		5.97	0.63
EVPMP66GI6PU	420	548	6	66.625		6.57	0.69
EVPMP72GI6PU	444	572	6	72.625		7.16	0.76
EVPMP24GI9PU	206	256	9	24.625		3.58	0.38
EVPMP30GI9PU	218	273	9	30.625		4.48	0.47
EVPMP36GI9PU	234	294	9	36.625		5.37	0.56
EVPMP42GI9PU	242	304	9	42.625		6.26	0.65
EVPMP48GI9PU	252	315	9	48.625		7.16	0.75
EVPMP54GI9PU	256	321	9	54.625		8.06	0.84
EVPMP60GI9PU	396	524	9	60.625		8.96	0.94
EVPMP66GI9PU	420	548	9	66.625		9.85	1.04
EVPMP72GI9PU	444	572	9	72.625		10.74	1.13
EVPMP24GI12PU	206	256	12	24.625		4.77	0.50
EVPMP30GI12PU	218	273	12	30.625		5.97	0.63
EVPMP36GI12PU	234	294	12	36.625		7.16	0.75
EVPMP42GI12PU	242	304	12	42.625		8.35	0.87
EVPMP48GI12PU	252	315	12	48.625		9.55	1.00
EVPMP54GI12PU	256	321	12	54.625		10.75	1.12
EVPMP60GI12PU	396	524	12	60.625		11.94	1.25
EVPMP66GI12PU	420	548	12	66.625		13.13	1.38
EVPMP72GI12PU	444	572	12	72.625		14.32	1.51
EVPMP24GI18PU	381	437	18	24.625		7.16	0.75
EVPMP30GI18PU	406	444	18	30.625		8.96	0.94
EVPMP36GI18PU	422	490	18	36.625		10.74	1.13
EVPMP42GI18PU	448	535	18	42.625		12.53	1.31
EVPMP48GI18PU	464	579	18	48.625		14.33	1.50
EVPMP54GI18PU	480	626	18	54.625		16.13	1.69
EVPMP60GI18PU	537	712	18	60.625		17.91	1.88
EVPMP66GI18PU	570	744	18	66.625		19.70	2.06
EVPMP72GI18PU	603	777	18	72.625		21.48	2.25

EVFDK-P • Panel Mount Privacy Felt

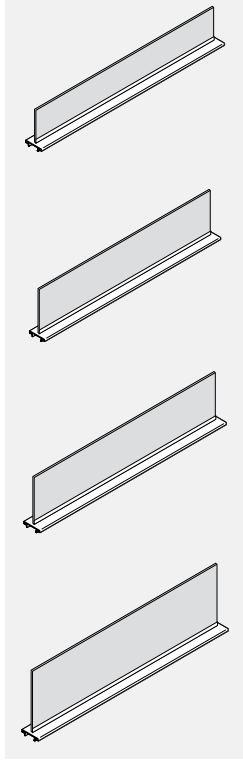

- Privacy felt panel intergrated within aluminum top trim.
- Attaches on top of panels to add privacy or divide space.
- Includes aluminum trim with channel and felt tile.
- Aluminum trim must be specified for entire station when ordering panel mount privacy felt.
- Felt and attachment hardware to ship seperately.
- 9mm Felt material is tackable and comes in 18 different colours. Please specify colour.

PRODUCT CODE	PRICE	SIZE/ INCHES			WEIGHT LBS	VOL FT ³
		H	W	D		
EVFDK0624P	70	6	24	2.83	1.42	0.25
EVFDK0630P	85	6	30	2.83	1.73	0.32
EVFDK0636P	99	6	36	2.83	2.03	0.37
EVFDK0642P	110	6	42	2.83	2.34	0.43
EVFDK0648P	165	6	48	2.83	2.64	0.50
EVFDK0654P	178	6	54	2.83	2.95	0.56
EVFDK0660P	193	6	60	2.83	3.25	0.63
EVFDK0666P	204	6	66	2.83	3.56	0.69
EVFDK0672P	231	6	72	2.83	3.86	0.76
EVFDK0924P	70	9	24	2.83	1.63	0.38
EVFDK0930P	85	9	30	2.83	1.99	0.47
EVFDK0936P	99	9	36	2.83	2.35	0.56
EVFDK0942P	110	9	42	2.83	2.70	0.65
EVFDK0948P	165	9	48	2.83	3.06	0.75
EVFDK0954P	178	9	54	2.83	3.42	0.84
EVFDK0960P	193	9	60	2.83	3.78	0.94
EVFDK0966P	204	9	66	2.83	4.13	1.04
EVFDK0972P	231	9	72	2.83	4.49	1.13
EVFDK1224P	70	12	24	2.83	1.84	0.50
EVFDK1230P	85	12	30	2.83	2.25	0.63
EVFDK1236P	99	12	36	2.83	2.66	0.75
EVFDK1242P	110	12	42	2.83	3.07	0.87
EVFDK1248P	165	12	48	2.83	3.48	1.00
EVFDK1254P	178	12	54	2.83	3.89	1.12
EVFDK1260P	193	12	60	2.83	4.30	1.25
EVFDK1266P	204	12	66	2.83	5.12	1.38
EVFDK1272P	231	12	72	2.83	5.53	1.51
EVFDK1824P	89	18	24	2.83	2.26	0.75
EVFDK1830P	105	18	30	2.83	2.77	0.94
EVFDK1836P	124	18	36	2.83	3.29	1.13
EVFDK1842P	139	18	42	2.83	3.80	1.31
EVFDK1848P	206	18	48	2.83	4.32	1.50
EVFDK1854P	224	18	54	2.83	4.83	1.69
EVFDK1860P	241	18	60	2.83	5.35	1.88
EVFDK1866P	254	18	66	2.83	6.68	2.06
EVFDK1872P	289	18	72	2.83	7.20	2.25

EVFDK-PU • Panel Mount Privacy Divider for U Channel

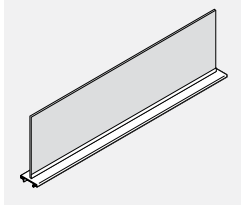

- Attaches on top of panels to add privacy or divide space.
- Privacy felt divider integrated within aluminum top trim to be used with U channel, with connector for Gallery Panels.
- Includes aluminum trim with channel and felt tile.
- Felt and attachment hardware ship separately.
- 9 mm felt material is tackable. Please specify felt finish.
- Aluminum top trim available in standard paint finishes.

PRODUCT CODE	PRICE	SIZE / INCHES			WEIGHT		VOL FT ³
		H	W	D	LBS		
EVFDK0618PU	70	6	18.62	2.83	1.42	0.25	
EVFDK0624PU	84	6	24.62	2.83	1.73	0.32	
EVFDK0630PU	98	6	30.62	2.83	2.03	0.37	
EVFDK0636PU	110	6	36.62	2.83	2.34	0.43	
EVFDK0642PU	165	6	42.62	2.83	2.64	0.50	
EVFDK0648PU	179	6	48.62	2.83	2.95	0.56	
EVFDK0654PU	193	6	54.62	2.83	3.25	0.63	
EVFDK0660PU	205	6	60.62	2.83	3.56	0.69	
EVFDK0666PU	231	6	66.62	2.83	3.86	0.76	
EVFDK0672PU	259	6	72.62	2.83	4.16	0.83	
EVFDK0918PU	70	9	18.62	2.83	1.63	0.38	
EVFDK0924PU	84	9	24.62	2.83	1.99	0.47	
EVFDK0930PU	98	9	30.62	2.83	2.35	0.56	
EVFDK0936PU	110	9	36.62	2.83	2.70	0.65	
EVFDK0942PU	165	9	42.62	2.83	3.06	0.75	
EVFDK0948PU	179	9	48.62	2.83	3.42	0.84	
EVFDK0954PU	193	9	54.62	2.83	3.78	0.94	
EVFDK0960PU	205	9	60.62	2.83	4.13	1.04	
EVFDK0966PU	231	9	66.62	2.83	4.49	1.13	
EVFDK0972PU	259	9	72.62	2.83	4.85	1.22	
EVFDK1218PU	70	12	18.62	2.83	1.84	0.50	
EVFDK1224PU	84	12	24.62	2.83	2.25	0.63	
EVFDK1230PU	98	12	30.62	2.83	2.66	0.75	
EVFDK1236PU	110	12	36.62	2.83	3.07	0.87	
EVFDK1242PU	165	12	42.62	2.83	3.48	1.00	
EVFDK1248PU	179	12	48.62	2.83	3.89	1.12	
EVFDK1254PU	193	12	54.62	2.83	4.30	1.25	
EVFDK1260PU	205	12	60.62	2.83	5.12	1.38	
EVFDK1266PU	231	12	66.62	2.83	5.53	1.51	
EVFDK1272PU	259	12	72.62	2.83	5.94	1.64	
EVFDK1818PU	89	18	18.62	2.83	2.83	0.75	
EVFDK1824PU	106	18	24.62	2.83	2.77	0.94	
EVFDK1830PU	124	18	30.62	2.83	3.29	1.13	
EVFDK1836PU	139	18	36.62	2.83	3.80	1.31	
EVFDK1842PU	207	18	42.62	2.83	4.32	1.50	
EVFDK1848PU	224	18	48.62	2.83	4.83	1.69	
EVFDK1854PU	243	18	54.62	2.83	5.35	1.88	
EVFDK1860PU	255	18	60.62	2.83	6.68	2.06	
EVFDK1866PU	289	18	66.62	2.83	7.20	2.25	
EVFDK1872PU	325	18	72.62	2.83	7.72	2.44	

EVFDK-PDU • Panel Mount Privacy Divider for U channel , Extended at Both Ends

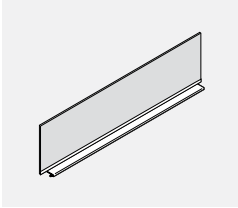

- Attaches on top of panels to add privacy or divide space.
- Privacy felt divider integrated within aluminum top trim to be used with U channel, with connector for Gallery Panels.
- Includes aluminum trim with channel and felt tile.
- Felt and attachment hardware ship separately.
- 9 mm felt material is tackable. Please specify felt finish.
- Aluminum top trim available in standard paint finishes.

PRODUCT CODE	PRICE	SIZE/INCHES			WEIGHT LBS	VOL FT ³
		H	W	D		
EVFDK0618PDU	70	6	19.25	2.83	1.42	0.25
EVFDK0624PDU	84	6	25.25	2.83	1.73	0.32
EVFDK0630PDU	98	6	31.25	2.83	2.03	0.37
EVFDK0636PDU	110	6	37.25	2.83	2.34	0.43
EVFDK0642PDU	165	6	43.25	2.83	2.64	0.50
EVFDK0648PDU	179	6	49.25	2.83	2.95	0.56
EVFDK0654PDU	193	6	55.25	2.83	3.25	0.63
EVFDK0660PDU	205	6	61.25	2.83	3.56	0.69
EVFDK0666PDU	231	6	67.25	2.83	3.86	0.76
EVFDK0672PDU	259	6	73.25	2.83	4.16	0.83
EVFDK0918PDU	70	9	19.25	2.83	1.63	0.38
EVFDK0924PDU	84	9	25.25	2.83	1.99	0.47
EVFDK0930PDU	98	9	31.25	2.83	2.35	0.56
EVFDK0936PDU	110	9	37.25	2.83	2.70	0.65
EVFDK0942PDU	165	9	43.25	2.83	3.06	0.75
EVFDK0948PDU	179	9	49.25	2.83	3.42	0.84
EVFDK0954PDU	193	9	55.25	2.83	3.78	0.94
EVFDK0960PDU	205	9	61.25	2.83	4.13	1.04
EVFDK0966PDU	231	9	67.25	2.83	4.49	1.13
EVFDK0972PDU	259	9	73.25	2.83	4.85	1.22
EVFDK1218PDU	70	12	19.25	2.83	1.84	0.50
EVFDK1224PDU	84	12	25.25	2.83	2.25	0.63
EVFDK1230PDU	98	12	31.25	2.83	2.66	0.75
EVFDK1236PDU	110	12	37.25	2.83	3.07	0.87
EVFDK1242PDU	165	12	43.25	2.83	3.48	1.00
EVFDK1248PDU	179	12	49.25	2.83	3.89	1.12
EVFDK1254PDU	193	12	55.25	2.83	4.30	1.25
EVFDK1260PDU	205	12	61.25	2.83	5.12	1.38
EVFDK1266PDU	231	12	67.25	2.83	5.53	1.51
EVFDK1272PDU	259	12	73.25	2.83	5.94	1.64
EVFDK1818PDU	89	18	19.25	2.83	2.83	0.75
EVFDK1824PDU	106	18	25.25	2.83	2.77	0.94
EVFDK1830PDU	124	18	31.25	2.83	3.29	1.13
EVFDK1836PDU	139	18	37.25	2.83	3.80	1.31
EVFDK1842PDU	207	18	43.25	2.83	4.32	1.50
EVFDK1848PDU	224	18	49.25	2.83	4.83	1.69
EVFDK1854PDU	243	18	55.25	2.83	5.35	1.88
EVFDK1860PDU	255	18	61.25	2.83	6.68	2.06
EVFDK1866PDU	289	18	67.25	2.83	7.20	2.25
EVFDK1872PDU	325	18	73.25	2.83	7.72	2.44

EVFDK12-PN • 12" Panel Mount Privacy Felt 1 Notch

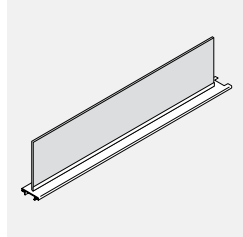

- Privacy felt panel intergrated within aluminum top trim.
- Attaches on top of panels to add privacy or divide space. Includes aluminum trim with channel and felt tile.
- Aluminum trim must be specified for entire station when ordering panel mount privacy felt.
- Felt and attachment hardware to ship seperately.
- 9mm Felt material is tackable. Please specify colour.

PRODUCT CODE	PRICE	SIZE/ INCHES			WEIGHT LBS	VOL FT³
		H	W	D		
EVFDK1224PN	70	12	24	2.83	1.84	0.50
EVFDK1230PN	85	12	30	2.83	2.25	0.63
EVFDK1236PN	99	12	36	2.83	2.66	0.75
EVFDK1242PN	110	12	42	2.83	3.07	0.87
EVFDK1248PN	165	12	48	2.83	3.48	1.00
EVFDK1254PN	178	12	54	2.83	3.89	1.12
EVFDK1260PN	193	12	60	2.83	4.30	1.25

EVFDK12-PDN • 12" Panel Mount Privacy Felt 2 Notch

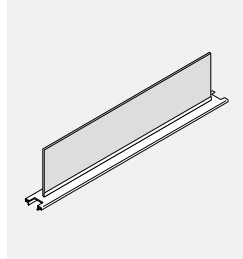

- Privacy felt panel intergrated within aluminum top trim.
- Attaches on top of panels to add privacy or divide space. Includes aluminum trim with channel and felt tile.
- Aluminum trim must be specified for entire station when ordering panel mount privacy felt.
- Felt and attachment hardware to ship seperately.
- 9mm Felt material is tackable. Please specify colour.

PRODUCT CODE	PRICE	SIZE/ INCHES			WEIGHT LBS	VOL FT³
		H	W	D		
EVFDK1224PDN	70	12	24	2.83	1.84	0.50
EVFDK1230PDN	85	12	30	2.83	2.25	0.63
EVFDK1236PDN	99	12	36	2.83	2.66	0.75
EVFDK1242PDN	110	12	42	2.83	3.07	0.87
EVFDK1248PDN	165	12	48	2.83	3.48	1.00
EVFDK1254PDN	178	12	54	2.83	3.89	1.12
EVFDK1260PDN	193	12	60	2.83	4.30	1.25

EVFPDK06-PCF • 6" H Panel Mount Privacy Divider Ceiling Filler Kit

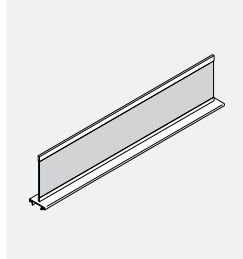

- Privacy Felt Divider integrated within aluminum top trim.
- Includes aluminum trim with channel and Felt tile.
- Felt tile and attachment hardware to ship separately.
- Please specify felt finish.
- Aluminum top trim available in standard paint finishes.
- PVC cap for closing gap at ceiling included.
- PVC cap available in white only.
- Felt ceiling filler should be used to close the gap between top of panel and ceiling.

PRODUCT CODE	PRICE	SIZE/ INCHES			WEIGHT LBS	VOL FT³
		H	W	D		
EVFPDK0618PCF	73	6	18	2.83	1.11	0.20
EVFPDK0624PCF	80	6	24	2.83	1.42	0.26
EVFPDK0630PCF	97	6	30	2.83	1.73	0.32
EVFPDK0636PCF	112	6	36	2.83	2.03	0.37
EVFPDK0642PCF	127	6	42	2.83	2.34	0.43
EVFPDK0648PCF	190	6	48	2.83	2.64	0.43
EVFPDK0654PCF	206	6	54	2.83	2.95	0.56
EVFPDK0660PCF	222	6	60	2.83	3.25	0.63
EVFPDK0666PCF	233	6	66	2.83	3.56	0.69
EVFPDK0672PCF	266	6	72	2.83	3.86	0.76

EVFDK06-PCF • 6" H Panel Mount Privacy Divider Ceiling Filler Kit

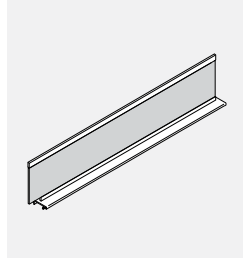

- Privacy Felt Divider integrated with aluminum top trim.
- Includes aluminum trim with channel and Felt tile.
- Felt tile and attachment hardware to ship separately.
- Please specify felt finish.
- Felt tile is longer and overhangs half of the width of post.
- Aluminum trim is width of panel.
- Aluminum top trim available in standard paint finishes.
- PVC cap for closing gap at ceiling included.
- PVC cap available in white only.
- Felt ceiling filler should be used to close the gap between top of panel and ceiling.

PRODUCT CODE	PRICE	SIZE/ INCHES			WEIGHT LBS	VOL FT³
		H	W	D		
EVFDK0619PCF	80	6	19.75	2.83	1.42	0.26
EVFDK0625PCF	97	6	25.75	2.83	1.73	0.32
EVFDK0631PCF	112	6	31.75	2.83	2.03	0.37
EVFDK0637PCF	127	6	37.75	2.83	2.34	0.43
EVFDK0643PCF	190	6	43.75	2.83	2.64	0.43
EVFDK0649PCF	206	6	49.75	2.83	2.95	0.56
EVFDK0655PCF	222	6	55.75	2.83	3.25	0.63
EVFDK0661PCF	233	6	61.75	2.83	3.56	0.69
EVFDK0667PCF	266	6	67.75	2.83	3.86	0.76
EVFDK0673PCF	297	6	73.75	2.83	4.16	0.83

POST CONFIGURATIONS • TECHNICAL INFORMATION

As illustrated in the example below, start with position "A" and continue clock-wise specifying the height of each slotted connector.

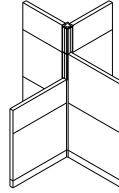
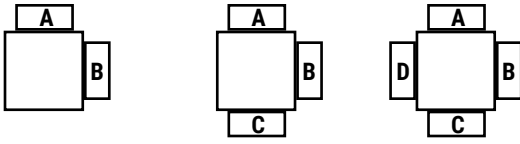

PANEL EXTENSION MODULES

When ordering Panel Extension Modules, Inline Panel Extension Connectors (EVPIEC) must be ordered separately.

Inline Panel Extension Connectors connect two panel extension modules of equal height in a straight run.

Extension connectors do not provide support for hang-on storage above 66".

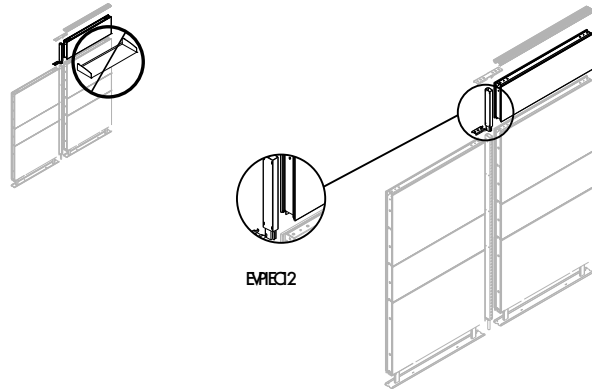

VPIC • Inline Panel Connector

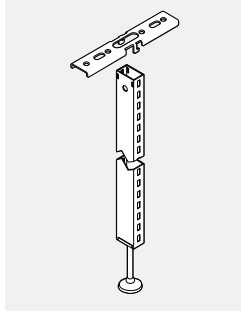

- Connects two panels of equal height in a straight run.
- Provides slotted support for worksurfaces and hang-on storage components.
- Includes slotted connectors with leveling glide and connection hardware.

PRODUCT CODE	PRICE	SIZE/INCHES		WEIGHT VOL	
		H	W	LBS	FT ³
VPIC30	61	30	2	3.30	0.50
VPIC42	65	42	2	4.60	0.07
VPIC48	67	48	2	5.25	0.07
VPIC54	72	54	2	5.90	0.09
VPIC66	81	66	2	7.20	0.10

VPVC • Variable Height Connector

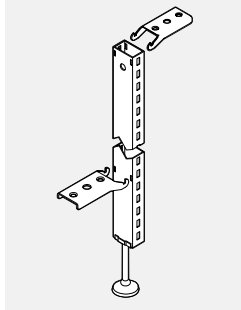

- Connects two panels of different heights in a straight run.
- Connector must reference taller panel.
- Can be used for any variation of panel heights.
- Provides slotted support for worksurfaces and hang-on storage components.
- Includes slotted connector with levelling glide and connection hardware.
- Variable-height trim must be ordered separately, see EVPTV or EVPTVA.

PRODUCT CODE	PRICE	SIZE/INCHES		WEIGHT VOL	
		H	W	LBS	FT ³
VPVC42	72	42	2	4.60	0.70
VPVC48	75	48	2	5.25	0.70
VPVC54	76	54	2	5.90	0.90
VPVC66	85	66	2	7.20	0.10

VEPERA • End of Run Kit (Wall Mount)

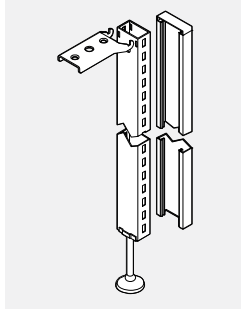

- Finishes the end of each panel run and can be used to attach a panel run to a fixed wall.
- Adds 1" to the width of a panel run.
- Provides slotted support for worksurfaces and hang-on storage components.
- Includes slotted connector with levelling glide, connection hardware and trim kit.
- Can be attached to face of another panel to provide off-modular panel connection by screwing the trim to the horizontals of the panel.

PRODUCT CODE	PRICE	TYPE	SIZE/INCHES		WEIGHT VOL	
			H	W	LBS	FT ³
VEPERA30	76	Aluminum	30	2.875	3.30	0.07
VEPERA42	91	Aluminum	42	2.875	4.60	0.10
VEPERA48	97	Aluminum	48	2.875	6.75	0.10
VEPERA54	109	Aluminum	54	2.875	5.09	0.18
VEPERA66	122	Aluminum	66	2.875	7.20	0.22

VEPUERA • Upmount End of Run Kit

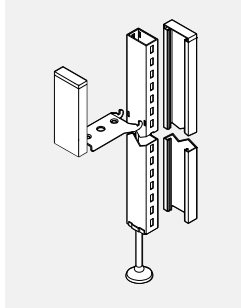

- Replaces the standard End-of-Run Kit VEPERA.
- Used at the end of a panel run to support worksurfaces and Upmount overhead storage.
- Can attach a panel run to a fixed wall.
- Adds 1" to the width of a panel run.
- Includes slotted connector with levelling glide, connection hardware, Upmount End-of-Run Trim EVPUET and one Upmount Extension Trim EVPUET12.

PRODUCT CODE	PRICE	TYPE	SIZE/INCHES		WEIGHT VOL	
			H	W	LBS	FT ³
VEPUERA66	134	Aluminum	66	2.875	7.20	0.22

EVPCPA1 • One Way Post

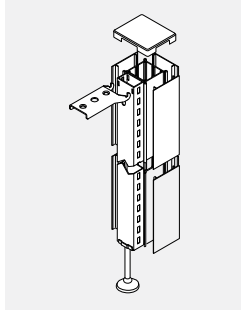

- Replaces an VEPERA End-of-Run Post Kit at the end of a run of panels.
- Used with EVDPE Post Extension to allow for ceiling entry at end of panel run.
- Adds 2 7/8" to the end of a run of panels.
- Provides slotted support for worksurfaces and hang-on storage components.
- Includes corner post, one slotted connector with levelling glides, attachment hardware and trim.

PRODUCT CODE	PRICE	TYPE	SIZE/INCHES			WEIGHT VOL	
			H	W	D	LBS	FT ³
EVPCPA130	100	Aluminum	30	2.875		4.97	0.24
EVPCPA142	114	Aluminum	42	2.875		6.93	0.33
EVPCPA148	135	Aluminum	48	2.875		7.93	0.38
EVPCPA154	155	Aluminum	54	2.875		8.93	0.43
EVPCPA166	193	Aluminum	66	2.875		10.87	0.53

EVPIPA2 • Inline Two Way Post

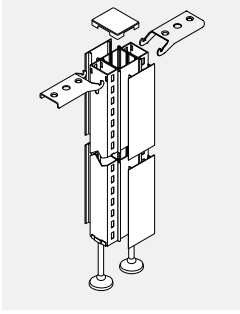

- Connects two panels of equal height in a straight line in place of an EVPIC Inline Panel Connector.
- Adds 2 7/8" to the end of a run of panels.
- Provides slotted support for worksurfaces and hang-on storage components.
- Includes corner post, two slotted connectors with levelling glides, attachment hardware and trim.

PRODUCT CODE	PRICE	TYPE	SIZE/ H	INCHES W	WEIGHT LBS	VOL FT ³
EVPIPA230	157	Aluminum	30	2.875	8.20	0.31
EVPIPA242	201	Aluminum	42	2.875	11.50	0.43
EVPIPA248	211	Aluminum	48	2.875	13.50	0.54
EVPIPA254	244	Aluminum	54	2.875	15.00	0.61
EVPIPA266	290	Aluminum	66	2.875	19.00	0.75

EVPCPA2 • Two Way Corner Post

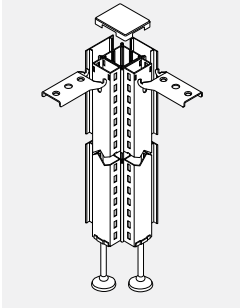

- Attaches two panels of equal height in 90° configuration.
- Provides slotted support for worksurfaces and hang-on storage components.
- Includes corner post, two slotted connectors with levelling glides, attachment hardware and trim.

PRODUCT CODE	PRICE	TYPE	SIZE/ H	INCHES W	WEIGHT LBS	VOL FT ³
EVPCPA230	157	Aluminum	30	2.875	8.50	0.31
EVPCPA242	201	Aluminum	42	2.875	11.50	0.43
EVPCPA248	211	Aluminum	48	2.875	11.50	0.43
EVPCPA254	244	Aluminum	54	2.875	15.00	0.61
EVPCPA266	290	Aluminum	66	2.875	19.00	0.75

EVPCPA3 • Three Way Corner Post

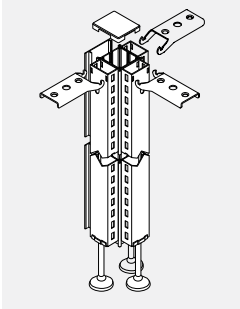

- Attaches three panels of equal height in a "T" configuration.
- Provides slotted support for worksurfaces and hang-on storage components.
- Includes corner post, three slotted connectors with levelling glides, attachment hardware top cap and trim.

PRODUCT CODE	PRICE	TYPE	SIZE/ H	INCHES W	WEIGHT LBS	VOL FT ³
EVPCPA330	189	Aluminum	30	2.875	11.80	0.36
EVPCPA342	252	Aluminum	42	2.875	16.10	0.50
EVPCPA348	278	Aluminum	48	2.875	18.75	0.61
EVPCPA354	308	Aluminum	54	2.875	20.50	0.70
EVPCPA366	362	Aluminum	66	2.875	26.20	0.85

EVPCP4 • Four Way Corner Post

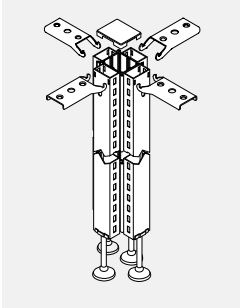

- Attaches four panels of equal height in an "X" configuration.
- Provides slotted support for worksurfaces and hang-on storage components.
- Includes corner post, four slotted connectors with levelling glides, attachment hardware and top cap.

PRODUCT CODE	PRICE	TYPE	SIZE/ H	INCHES W	WEIGHT LBS	VOL FT ³
EVPCP430	207	Aluminum	30	2.875	15.50	0.41
EVPCP442	271	Aluminum	42	2.875	21.00	0.57
EVPCP448	298	Aluminum	48	2.875	24.00	0.68
EVPCP454	329	Aluminum	54	2.875	26.50	0.79
EVPCP466	385	Aluminum	66	2.875	33.20	0.95

EVPVPA2 • Two Way Variable Height Corner Post

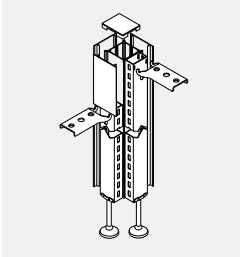

- Attaches two panels of different heights at a corner.
- Specify the corner post height that matches the tallest panel attached to the post face.
- Provides slotted support for worksurfaces and hang-on storage components.
- Includes corner post, two slotted connectors with levelling glides, attachment hardware and trim.
- Configuration of connecting panels must be specified. ie. 54/66. See Technical Information at the beginning of this section.

PRODUCT CODE	PRICE	TYPE	SIZE/ H	INCHES W	WEIGHT LBS	VOL FT ³
EVPVPA242	201	Aluminum	42	2.875	10.00	1.30
EVPVPA248	222	Aluminum	48	2.875	13.50	1.50
EVPVPA254	244	Aluminum	54	2.875	17.00	1.80
EVPVPA266	290	Aluminum	66	2.875	20.50	2.10

EVPVPA3 • Three Way Variable Height Corner Post

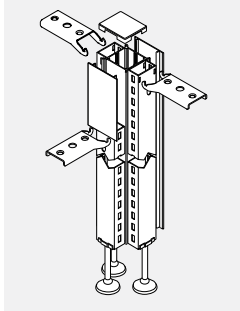

- Attaches three panels of different heights in a "T" configuration.
- Specify the corner post height that matches the tallest panel attached to the post face.
- Provides slotted support for worksurfaces and hang-on storage components.
- Includes corner post, three slotted connectors with levelling glides, attachment hardware and trim.
- Configuration of connecting panels must be specified. ie. 54/42/66. See Technical information page at the beginning of this section.

PRODUCT CODE	PRICE	TYPE	SIZE/ INCHES		WEIGHT VOL	
			H	W	LBS	FT ³
EVPVPA342	252	Aluminum	42	2.875	12.50	0.30
EVPVPA348	278	Aluminum	48	2.875	15.50	0.66
EVPVPA354	308	Aluminum	54	2.875	18.50	0.68
EVPVPA366	362	Aluminum	66	2.875	24.20	0.90

EVPVPA4 • Four Way Variable Height Corner Post

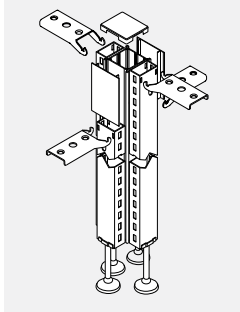

- Attaches four panels of different heights in an "X" configuration.
- Specify the corner post height that matches the tallest panel attached to the post face.
- Provides slotted support for worksurfaces and hang-on storage components.
- Includes corner post, four slotted connectors with levelling glides, attachment hardware and trim.
- Configuration of connecting panels must be specified. ie. 42/66/54/42. See Technical information page at the beginning of this section.

PRODUCT CODE	PRICE	TYPE	SIZE/ INCHES		WEIGHT VOL	
			H	W	LBS	FT ³
EVPVPA442	284	Aluminum	42	2.875	18.50	0.35
EVPVPA448	314	Aluminum	48	2.875	20.50	0.70
EVPVPA454	343	Aluminum	54	2.875	24.50	1.05
EVPVPA466	405	Aluminum	66	2.875	30.20	1.40

EVPIEC • Inline Panel Extension Connector - Non Slotted

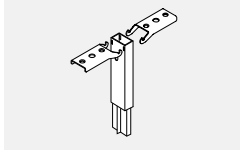

- Connects two panel extension modules of equal height in a straight run.
- Does not provide support for hang-on storage components.

PRODUCT CODE	PRICE	TYPE	SIZE/ INCHES		WEIGHT VOL	
			H	W	LBS	FT ³
EVPIEC06	29		6	2	1.00	0.06
EVPIEC12	29		12	2	2.00	0.12
EVPIEC18	35		18	2	3.00	0.18
EVPIEC24	35		24	2	4.00	0.24

EVPIECS • Inline Panel Extension Connector - Slotted

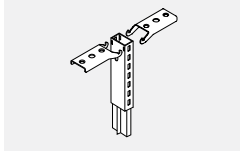

- Connects two panel extension modules of equal height in a straight run.
- Provides slotted support up to 66" high for worksurfaces and hang-on storage components.

PRODUCT CODE	PRICE	TYPE	SIZE/ INCHES		WEIGHT VOL	
			H	W	LBS	FT ³
EVPIECS06	36		6	2	1.00	0.06
EVPIECS12	36		12	2	2.00	0.12
EVPIECS18	42		18	2	3.00	0.18
EVPIECS24	42		24	2	4.00	0.24

EVPEERA • End of Run Extension - Non Slotted

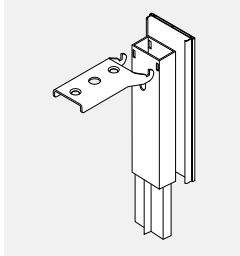

- Extends an End-of-Run Kit.
- Does not provide support for hang-on storage components.
- Includes Inline Panel Extension Connector (EVPIEC) and Panel Extension Trim (EVPTEA).

PRODUCT CODE	PRICE	TYPE	SIZE/ INCHES		WEIGHT VOL	
			H	W	LBS	FT ³
EVPEERA06	33	Aluminum	6	2.875	1.00	0.06
EVPEERA12	33	Aluminum	12	2.875	2.00	0.12
EVPEERA18	39	Aluminum	18	2.875	3.00	0.18
EVPEERA24	39	Aluminum	24	2.875	4.00	0.24

EVPEERSA • End of Run Extension - Slotted

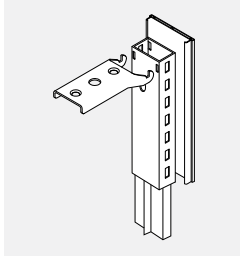

- Extends an End-of-Run Kit.
- Provides slotted support up to 66" high for worksurfaces and hang-on storage components.
- Includes Inline Panel Extension Connector (EVPIECS) and Panel Extension Trim (EVPTE or EVPTEA).

PRODUCT CODE	PRICE	TYPE	SIZE/ INCHES		WEIGHT VOL	
			H	W	LBS	FT ³
EVPEERSA06	39	Aluminum	6	2.875	1.00	0.06
EVPEERSA12	39	Aluminum	12	2.875	2.00	0.12
EVPEERSA18	59	Aluminum	18	2.875	3.00	0.18
EVPEERSA24	59	Aluminum	24	2.875	4.00	0.24

EVPCEPA1 • One Way Post Extension - Non Slotted

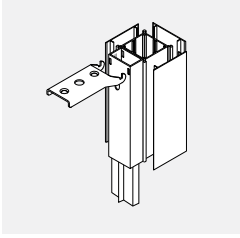

- Attaches to a corner post at the end of a run of panel extension modules.
- Includes corner extension post, one non-slotted connector, attachment hardware and trim.

PRODUCT CODE	PRICE	TYPE	SIZE/ INCHES		WEIGHT VOL	
			H	W	LBS	FT ³
EVPCEPA106	64	Aluminum	6	2.875	2.00	0.07
EVPCEPA112	64	Aluminum	12	2.875	4.00	0.14
EVPCEPA118	88	Aluminum	18	2.875	6.00	0.21
EVPCEPA124	88	Aluminum	24	2.875	8.00	0.28

EVPCEPSA1 • One Way Post Extension - Slotted

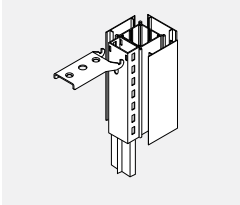

- Attaches to a corner post at the end of a run of panel extension modules.
- Provides slotted support up to 66" high for worksurfaces and hang-on storage components.
- Includes corner extension post, one slotted connector, attachment hardware and trim.

PRODUCT CODE	PRICE	TYPE	SIZE/ INCHES		WEIGHT VOL	
			H	W	LBS	FT ³
EVPCEPSA106	86	Aluminum	6	2.875	2.00	0.07
EVPCEPSA112	86	Aluminum	12	2.875	4.00	0.14
EVPCEPSA118	109	Aluminum	18	2.875	6.00	0.21
EVPCEPSA124	109	Aluminum	24	2.875	8.00	0.28

EVPCEIPA2 • Inline Post Extension - Non Slotted

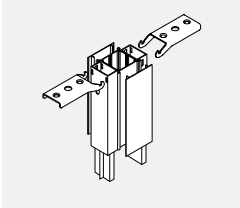

- Attaches to a corner post and connects two panel extension modules in a straight line.
- Includes corner extension post, two non-slotted connectors, attachment hardware and trim.

PRODUCT CODE	PRICE	TYPE	SIZE/ INCHES		WEIGHT VOL	
			H	W	LBS	FT ³
EVPCEIPA206	87	Aluminum	6	2.875	2.00	0.07
EVPCEIPA212	87	Aluminum	12	2.875	4.00	0.14
EVPCEIPA218	136	Aluminum	18	2.875	6.00	0.18
EVPCEIPA224	136	Aluminum	24	2.875	8.00	0.28

EVPCEIPSA2 • Inline Post Extension - Slotted

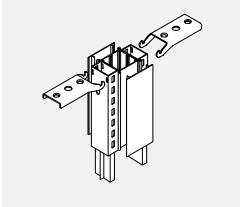

- Attaches to a corner post and connects two panel extension modules in a straight line.
- Provides slotted support up to 66" high for worksurfaces and hang-on storage components.
- Includes corner extension post, two slotted connectors, attachment hardware and trim.

PRODUCT CODE	PRICE	TYPE	SIZE/ INCHES		WEIGHT VOL	
			H	W	LBS	FT ³
EVPCEIPSA206	87	Aluminum	6	2.875	2.00	0.07
EVPCEIPSA212	87	Aluminum	12	2.875	4.00	0.14
EVPCEIPSA218	136	Aluminum	18	2.875	6.00	0.18
EVPCEIPSA224	136	Aluminum	24	2.875	8.00	0.28

EVPCEPA2 • Two Way Post Extension - Non Slotted

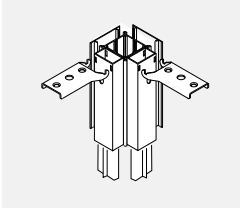

- Connects two panel extension modules of equal height in a corner "L" configuration.
- Includes corner extension post, two non-slotted connectors, attachment hardware and trim.

PRODUCT CODE	PRICE	TYPE	SIZE/ INCHES		WEIGHT VOL	
			H	W	LBS	FT ³
EVPCEPA206	70	Aluminum	6	2.875	2.00	0.07
EVPCEPA212	70	Aluminum	12	2.875	4.00	0.14
EVPCEPA218	118	Aluminum	18	2.875	6.00	0.21
EVPCEPA224	118	Aluminum	24	2.875	8.00	0.28

EVPCEPSA2 • Two Way Post Extension - Slotted

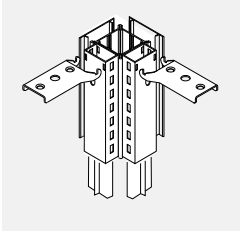

- Connects two panel extension modules of equal height in a 90° configuration.
- Includes corner extension post, two slotted connectors, attachment hardware and trim.

PRODUCT CODE	PRICE	TYPE	SIZE/ INCHES		WEIGHT VOL	
			H	W	LBS	FT ³
EVPCEPSA206	87	Aluminum	6	2.875	2.00	0.07
EVPCEPSA212	87	Aluminum	12	2.875	4.00	0.14
EVPCEPSA218	136	Aluminum	18	2.875	6.00	0.21
EVPCEPSA224	136	Aluminum	24	2.875	8.00	0.28

EVPCEPA3 • Three Way Post Extension - Non Slotted

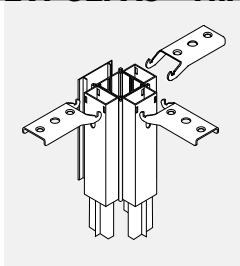

- Connects three panel extension modules of equal height in a corner "T" configuration.
- Includes corner extension post, three non-slotted connectors, attachment hardware and trim.

PRODUCT CODE	PRICE	TYPE	SIZE/ H	INCHES W	WEIGHT LBS	VOL FT ³
EVPCEPA306	78	Aluminum	6	2.875	3.00	0.08
EVPCEPA312	78	Aluminum	12	2.875	6.00	0.16
EVPCEPA318	129	Aluminum	18	2.875	9.00	0.24
EVPCEPA324	129	Aluminum	24	2.875	12.00	0.32

EVPCEPSA3 • Three Way Post Extension - Slotted

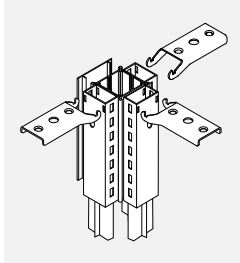

- Connects three panel extension modules of equal height in a corner "T" configuration.
- Includes corner extension post, three slotted connectors, attachment hardware and trim.

PRODUCT CODE	PRICE	TYPE	SIZE/ H	INCHES W	WEIGHT LBS	VOL FT ³
EVPCEPSA306	100	Aluminum	6	2.875	3.00	0.08
EVPCEPSA312	100	Aluminum	12	2.875	6.00	0.16
EVPCEPSA318	156	Aluminum	18	2.875	9.00	0.24
EVPCEPSA324	156	Aluminum	24	2.875	12.00	0.32

EVPCEP4 • Four Way Post Extension - Non Slotted

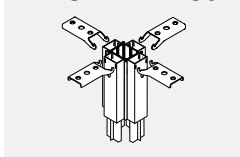

- Connects four panel extension modules of equal height in a corner "X" configuration.
- Includes corner extension post, four non-slotted connectors and attachment hardware.

PRODUCT CODE	PRICE	SIZE/ H	INCHES W	WEIGHT LBS	VOL FT ³
EVPCEP406	72	6	2.875	4.00	0.09
EVPCEP412	72	12	2.875	8.00	0.18
EVPCEP418	114	18	2.875	12.00	0.27
EVPCEP424	114	24	2.875	16.00	0.36

EVPCEPS4 • Four Way Extension Post - Slotted

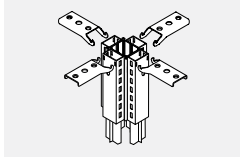

- Connects four panel extension modules of equal height in a corner "X" four-way configuration.
- Includes corner extension post, four slotted connectors and attachment hardware.

PRODUCT CODE	PRICE	SIZE/ H	INCHES W	WEIGHT LBS	VOL FT ³
EVPCEPS406	103	6	2.875	4.00	0.09
EVPCEPS412	103	12	2.875	8.00	0.18
EVPCEPS418	141	18	2.875	12.00	0.27
EVPCEPS424	154	24	2.875	16.00	0.36

EVP4PA • Two Way 45° Corner Post

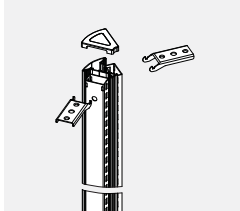

- Attaches two Panels of equal height in a 135° configuration.
- Provides slotted support for worksurfaces and hang-on storage components.
- Includes corner post, two slotted connectors with leveling glides and connecting hardware.
- Connectors available without slots as a special at no upcharge. Contact Customer Support.
- Does not allow to run wires under top trim.

PRODUCT CODE	PRICE	SIZE/ H	INCHES W	WEIGHT LBS	VOL FT ³
EVP4PA230	143	30	3.65	8.50	0.310
EVP4PA242	182	42	3.65	11.50	0.430
EVP4PA248	191	48	3.65	13.50	0.540
EVP4PA254	222	54	3.65	15.00	0.610
EVP4PA266	263	66	3.65	19.00	0.750

EVP4VPA • Variable Height Two Way 45° Corner Post - Aluminum

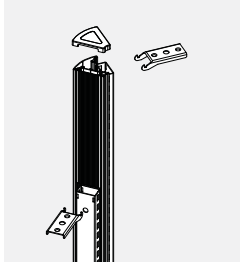

- Attaches two Panels of different height in a 135° configuration.
- Specify the corner post height that matches the tallest panel attached to the post face.
- Provides slotted support for worksurfaces and hang-on storage components.
- Includes corner post, two slotted connectors with leveling glides and connecting hardware.
- Connectors available without slots as a special at no upcharge. Contact Customer Support.
- Do not allow to run wires under the top trim.

PRODUCT CODE	PRICE	SIZE/ H	INCHES W	WEIGHT LBS	VOL FT ³
EVP4VPA242	191	42	3.65	8.50	0.310
EVP4VPA248	212	48	3.65	11.50	0.430
EVP4VPA254	233	54	3.65	13.50	0.540
EVP4VPA266	278	66	3.65	15.00	0.610

EVP4CEPSA • One Way 45° Corner Post Extension - Slotted - Aluminum

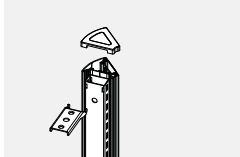

- Attached to a corner post at the end of run of panel extension modules.
- Provides slotted support up to 66" high for worksurfaces and hang-on storage components.
- Includes corner extension post, one slotted connectors, connecting hardware and trim kit.

PRODUCT CODE	PRICE	SIZE/ H	INCHES W	WEIGHT LBS	VOL FT ³
EVP4CEPSA106	78	6	3.65	6	3.65
EVP4CEPSA112	81	12	3.65	12	3.65
EVP4CEPSA118	106	18	3.65	18	3.65
EVP4CEPSA124	106	24	3.65	24	3.65

EVP4CEPA • One Way 45° Corner Post Extension - Non Slotted - Aluminum

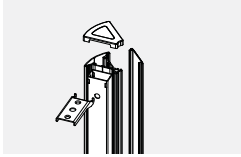

- Attached to a corner post at the end of run of panel extension modules.
- Includes corner extension post, one non-slotted connectors, connecting hardware and trim kit.

PRODUCT CODE	PRICE	SIZE/ H	INCHES W	WEIGHT LBS	VOL FT ³
EVP4CEPA106	59	6	3.65	6	3.65
EVP4CEPA112	63	12	3.65	12	3.65
EVP4CEPA118	85	18	3.65	18	3.65
EVP4CEPA124	85	24	3.65	24	3.65

EVP6PA2 • Two Way 60° Corner Post - Aluminum

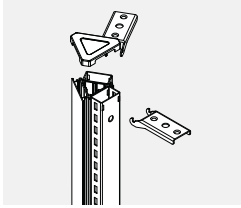

- Attaches two Panels of equal height in a 120° configuration.
- Provides slotted support for worksurfaces and hang-on storage components.
- Includes corner post, two slotted connectors with leveling glides, connecting hardware and trim kit.
- Connectors available without slots as a special at no upcharge. Contact Customer Support.

PRODUCT CODE	PRICE	SIZE/ H	INCHES W	WEIGHT LBS	VOL FT ³
EVP6PA230	152	30	3.65	8.50	0.310
EVP6PA242	189	42	3.65	11.50	0.430
EVP6PA248	206	48	3.65	13.50	0.540
EVP6PA254	234	54	3.65	15.00	0.610
EVP6PA266	278	66	3.65	19.00	0.750

EVP6P3 • Three Way 60° Corner Post

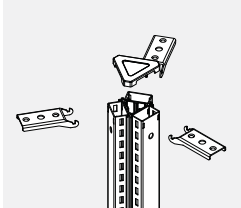

- Attaches three panels of equal height in a 120° configuration.
- Provides slotted support for worksurfaces and hang-on storage components.
- Includes corner post, two slotted connectors with leveling glides and connecting hardware.
- Connectors available without slots as a special at no upcharge. Contact Customer Support.

PRODUCT CODE	PRICE	SIZE/ H	INCHES W	WEIGHT LBS	VOL FT ³
EVP6P330	164	30	3.65	11.90	0.360
EVP6P342	220	42	3.65	16.10	0.500
EVP6P348	242	48	3.65	18.75	0.610
EVP6P354	268	54	3.65	20.50	0.700
EVP6P366	317	66	3.65	26.20	0.850

EVP6VPA2 • Variable Height Two Way 60° Corner Post - Aluminum

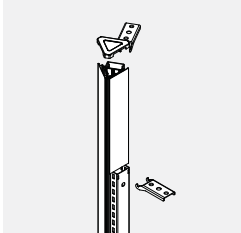

- Attaches two Panels of different height in a 120° configuration.
- Specify the corner post height that matches the tallest panel attached to the post face.
- Provides slotted support for worksurfaces and hang-on storage components.
- Includes corner post, two slotted connectors with leveling glides, connecting hardware and trim kit.
- Connectors available without slots as a special at no upcharge. Contact Customer Support

PRODUCT CODE	PRICE	SIZE/ H	INCHES W	WEIGHT LBS	VOL FT ³
EVP6VPA242	191	30	3.65	12.50	0.490
EVP6VPA248	212	42	3.65	15.40	0.660
EVP6VPA254	233	48	3.65	19.00	0.700
EVP6VPA266	278	54	3.65	22.50	0.750

EVP6VPA3 • Variable Height Three Way 60° Corner Post - Aluminum

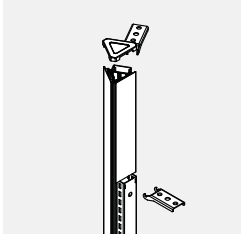

- Attaches two Panels of different height in a 120° configuration.
- Specify the corner post height that matches the tallest panel attached to the post face.
- Provides slotted support for worksurfaces and hang-on storage components.
- Includes corner post, two slotted connectors with leveling glides, connecting hardware and trim kit.
- Connectors available without slots as a special at no upcharge. Contact Customer Support

PRODUCT CODE	PRICE	SIZE/ H	INCHES W	WEIGHT LBS	VOL FT ³
EVP6VPA342	240	30	3.65	18.50	0.550
EVP6VPA348	268	42	3.65	20.50	0.700
EVP6VPA354	304	48	3.65	24.50	1.050
EVP6VPA366	350	54	3.65	30.20	1.400

EVP4CEPS2 • Two Way 45° Corner Post Extension - Slotted

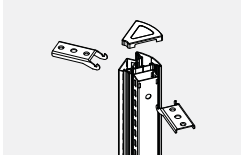

- Used to connect two panel extension modules of equal height.
- Provides slotted support up to 66" high for worksurfaces and hang-on storage components.
- Includes corner extension post, two slotted connectors and connecting hardware.

PRODUCT CODE	PRICE	SIZE/ H	INCHES W	WEIGHT LBS	VOL FT ³
EVP4CEPS206	72	6	3.65	6	3.65
EVP4CEPS212	72	12	3.65	12	3.65
EVP4CEPS218	112	18	3.65	18	3.65
EVP4CEPS224	112	24	3.65	24	3.65

EVP4CEP2 • Two Way 45° Corner Post Extension - Non Slotted

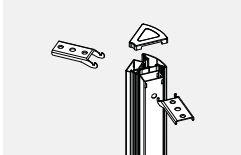

- Used to connect two panel extension modules of equal height.
- Includes corner extension post, two non-slotted connectors and connecting hardware.

PRODUCT CODE	PRICE	SIZE/ H	INCHES W	WEIGHT LBS	VOL FT ³
EVP4CEP206	58	6	3.65	6	3.65
EVP4CEP212	58	12	3.65	12	3.65
EVP4CEP218	105	18	3.65	18	3.65
EVP4CEP224	105	24	3.65	24	3.65

EVP6CEPSA • One Way 60° Corner Post Extension - Slotted - Aluminum

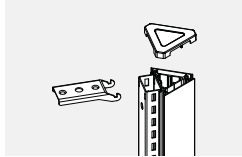

- Attached to a corner post at the end of run of panel extension modules.
- Provides slotted support up to 66" high for worksurfaces and hang-on storage components.
- Includes corner extension post, one slotted connectors, connecting hardware and trim kit.

PRODUCT CODE	PRICE	SIZE/ H	INCHES W	WEIGHT LBS	VOL FT ³
EVP6CEPSA106	78	6	3.65	6	3.65
EVP6CEPSA112	81	12	3.65	12	3.65
EVP6CEPSA118	106	18	3.65	18	3.65
EVP6CEPSA124	106	24	3.65	24	3.65

EVP6CEPA • One Way 60° Corner Post Extension - Non Slotted - Aluminum

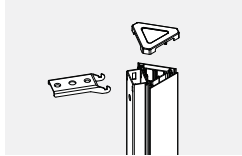

- Attached to a corner post at the end of run of panel extension modules.
- Includes corner extension post, one non-slotted connectors, connecting hardware and trim kit.

PRODUCT CODE	PRICE	SIZE/ H	INCHES W	WEIGHT LBS	VOL FT ³
EVP6CEPA106	59	6	3.65	6	3.65
EVP6CEPA112	63	12	3.65	12	3.65
EVP6CEPA118	85	18	3.65	18	3.65
EVP6CEPA124	85	24	3.65	24	3.65

EVP6CEPSA2 • Two Way 60° Corner Post Extension - Slotted - Aluminum

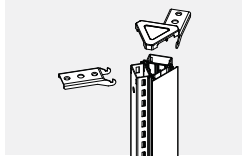

- Used to connect two panel extension modules of equal height.
- Provides slotted support up to 66" high for worksurfaces and hang-on storage components.
- Includes corner extension post, two non-slotted connectors, connecting hardware and trim kit.

PRODUCT CODE	PRICE	SIZE/ H	INCHES W	WEIGHT LBS	VOL FT ³
EVP6CEPSA206	85	6	3.65	6	3.65
EVP6CEPSA212	85	12	3.65	12	3.65
EVP6CEPSA218	132	18	3.65	18	3.65
EVP6CEPSA224	132	24	3.65	24	3.65

EVP6CEPA2 • Two Way 60° Corner Post Extension - Non Slotted - Aluminum

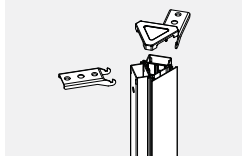

- Used to connect two panel extension modules of equal height.
- Includes corner extension post, two non-slotted connectors, connecting hardware and trim kit.

PRODUCT CODE	PRICE	SIZE/ H	INCHES W	WEIGHT LBS	VOL FT ³
EVP6CEPA206	70	6	3.65	6	3.65
EVP6CEPA212	79	12	3.65	12	3.65
EVP6CEPA218	113	18	3.65	18	3.65
EVP6CEPA224	113	24	3.65	24	3.65

EVP6CEPS3 • Three Way 60° Corner Post Extension - Slotted

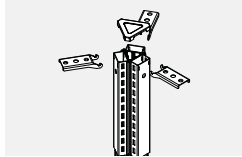

- Used to connect two panel extension modules of equal height.
- Provides slotted support up to 66" high for worksurfaces and hang-on storage components.
- Includes corner extension post, two slotted connectors and connecting hardware

PRODUCT CODE	PRICE	SIZE/ H	INCHES W	WEIGHT LBS	VOL FT ³
EVP6CEPS306	86	6	3.65	6	3.65
EVP6CEPS312	86	12	3.65	12	3.65
EVP6CEPS318	135	18	3.65	18	3.65
EVP6CEPS324	135	24	3.65	24	3.65

EVP6CEP3 • Three Way 60° Corner Post Extension - Non Slotted

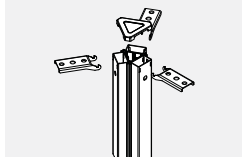

- Used to connect two panel extension modules of equal height.
- Includes corner extension post, two non-slotted connectors and connecting hardware.

PRODUCT CODE	PRICE	SIZE/ H	INCHES W	WEIGHT LBS	VOL FT ³
EVP6CEP306	67	6	3.65	6	3.65
EVP6CEP312	67	12	3.65	12	3.65
EVP6CEP318	109	18	3.65	18	3.65
EVP6CEP324	109	24	3.65	24	3.65

EVPVTFA • Flat Trim - Aluminum

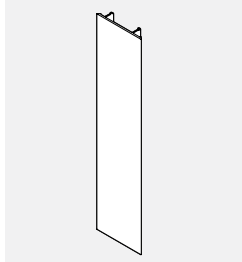

- Finishes exposed faces of one way, two way, three way and inline posts.
- For reconfiguration and replacement use only.

PRODUCT CODE	PRICE	SIZE/ H	INCHES W	WEIGHT LBS	VOL FT ³
EVPVTFA30	15	29.125	2.875	0.39	0.05
EVPVTFA36	15	35.125	2.875	0.44	0.06
EVPVTFA42	22	41.125	2.875	0.56	0.07
EVPVTFA48	23	47.125	2.875	0.62	0.08
EVPVTFA54	24	53.125	2.875	0.75	0.09
EVPVTFA66	26	65.125	2.875	0.86	0.12
EVPVTFA78	29	77.125	2.875	0.85	0.12
EVPVTFA90	30	89.125	2.875	0.88	0.15

EVPVTFEA • Flat Variable Height Extension Trim - Aluminum

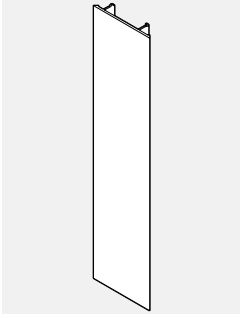

- Finishes exposed faces of one way, two way, three way and inline post extensions.
- For reconfiguration and replacement use only.

PRODUCT CODE	PRICE	SIZE/ H	INCHES W	WEIGHT LBS	VOL FT ³
EVPVTFEA06	11	6.375	2.875	0.12	0.01
EVPVTFEA12	12	12.375	2.875	0.16	0.02
EVPVTFEA18	13	18.375	2.875	0.28	0.03
EVPVTFEA24	13	24.375	2.875	0.32	0.04
EVPVTFEA30	15	30.375	2.875	0.36	0.05
EVPVTFEA36	20	36.375	2.875	0.40	0.06
EVPVTFEA42	22	42.375	2.875	0.44	0.07
EVPVTFEA48	23	48.375	2.875	0.48	0.08
EVPVTFEA54	24	54.375	2.875	0.52	0.09
EVPVTFEA66	26	66.375	2.875	0.56	0.10
EVPVTFEA78	29	78.375	2.875	0.64	0.12
EVPVTFEA90	30	90.375	2.875	0.72	0.14

EVPTVA • Panel Trim Variable Height - Aluminum

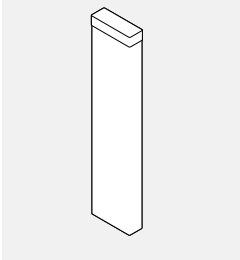

- Attaches to the exposed end of the taller panel when 2 panels of different height meet in straight run.
- Must be ordered separately.

PRODUCT CODE	PRICE	SIZE/ H	INCHES W	WEIGHT LBS	VOL FT ³
EVPTVA06	22	5.621	2.875	0.10	0.03
EVPTVA12	25	11.621	2.875	0.20	0.03
EVPTVA18	33	18.621	2.875	0.22	0.04
EVPTVA24	39	23.621	2.875	0.20	0.10
EVPTVA30	51	29.621	2.875	0.20	0.15
EVPTVA36	59	35.621	2.875	0.30	0.20

EVPERTA • End of Run Trim - Aluminum

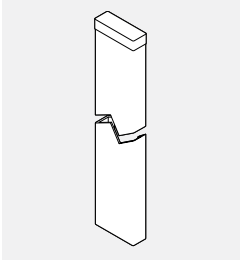

- Finishes the exposed connector at the end of a run of panels.
- Slotted connector not included.
- For reconfiguration and replacement use only.

PRODUCT CODE	PRICE	SIZE/ H	INCHES W	WEIGHT LBS	VOL FT ³
EVPERTA30	52	28.815	2.875	1.00	0.65
EVPERTA42	62	40.815	2.875	1.40	0.70
EVPERTA48	66	46.815	2.875	1.60	0.90
EVPERTA54	76	52.815	2.875	1.80	0.95
EVPERTA66	87	64.815	2.875	2.20	0.98
EVPERTA78	94	76.815	2.875	1.12	0.15
EVPERTA84	103	82.815	2.875	1.20	0.16
EVPERTA90	103	88.815	2.875	1.29	0.18

EVPTEA • Panel Extension Trim - Aluminum

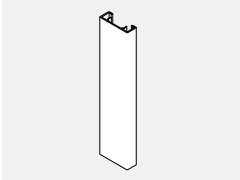

- Attaches to bottom of exposed end of panel to provide extension for End-of-Run trim when using panel extensions.
- Does not include slotted connector or connecting hardware.

PRODUCT CODE	PRICE	SIZE/ H	INCHES W	WEIGHT LBS	VOL FT ³
EVPTEA06	22	6	2.875	0.08	0.03
EVPTEA12	25	12	2.875	0.10	0.03
EVPTEA18	33	18	2.875	0.12	0.03
EVPTEA24	39	24	2.875	0.20	0.60

EVPUETA12 • Upmount Extension Trim - Aluminum

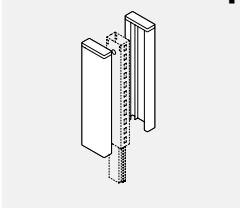

- Attaches to the Upmount Extension Connector EVPUESA12 or to an Inline Connector EVPVC66 66" high.
- Used to finish the exposed Upmount Extension Connector on both sides.
- Priced in pairs.

PRODUCT CODE	PRICE	SIZE/ H	INCHES W	WEIGHT LBS	VOL FT ³
EVPUETA12	39	12	2.875	0.20	0.03

EVPIECH • 12" Channel for Center Mount Overhead

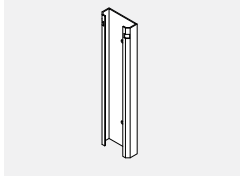

- 12" channel to attaches panel to the side of a pre-installed center mount overhead with screws.
- Includes 12" channel and connecting hardware.

PRODUCT CODE	PRICE	SIZE/INCHES			WEIGHT LBS	VOL FT ³
		H	W	D		
EVPIECH12	37	12	3		1.32	0.12

EVPTTA • Panel Top Trim Aluminum

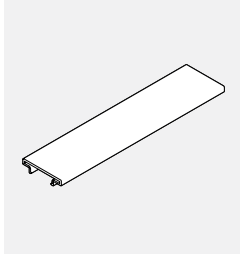

- Comes standard on all panels.
- Supplied at no charge.
- Field install no longer necessary.

PRODUCT CODE	PRICE	SIZE/INCHES			WEIGHT LBS	VOL FT ³	
		H	W	D			
EVPTTA18	12	18			2.875	0.18	0.03
EVPTTA24	15	24			2.875	0.22	0.04
EVPTTA30	22	30			2.875	0.29	0.05
EVPTTA36	24	36			2.875	0.30	0.06
EVPTTA42	28	42			2.875	0.34	0.07
EVPTTA48	33	48			2.875	0.38	0.08
EVPTTA54	36	54			2.875	0.42	0.09
EVPTTA60	42	60			2.875	0.46	0.10

EVPTNTA • Panel Top Notched Trim Aluminum

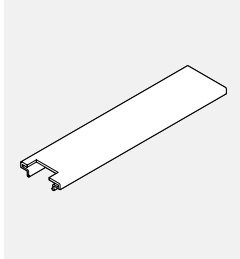

- Comes standard on all panels.
- Used when connecting a lower panel to a higher panel.
- To be used when shipping new panels with aluminum trim.
- Supplied at no charge when using panels in variable height configurations.
- Field install no longer necessary.

PRODUCT CODE	PRICE	SIZE/INCHES			WEIGHT LBS	VOL FT ³	
		H	W	D			
EVPTNTA18	13	18			2.875	0.18	0.03
EVPTNTA24	20	24			2.875	0.22	0.04
EVPTNTA30	23	30			2.875	0.26	0.05
EVPTNTA36	25	36			2.875	0.30	0.06
EVPTNTA42	29	42			2.875	0.34	0.07
EVPTNTA48	34	48			2.875	0.38	0.08
EVPTNTA54	37	54			2.875	0.42	0.09
EVPTNTA60	45	60			2.875	0.46	0.10

EVPTDNTA • Panel Top Double Notched Trim Aluminum

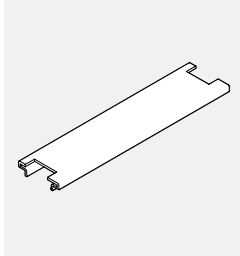

- Comes standard on all panels.
- Used when connecting a lower panel to two higher panels.
- To be used when shipping new panels with aluminum trim.
- Supplied at no charge when using panels in variable height configurations.
- Field install no longer necessary.

PRODUCT CODE	PRICE	SIZE/INCHES			WEIGHT LBS	VOL FT ³	
		H	W	D			
EVPTDNTA18	15	18			2.875	0.18	0.03
EVPTDNTA24	22	24			2.875	0.22	0.04
EVPTDNTA30	24	30			2.875	0.26	0.05
EVPTDNTA36	26	36			2.875	0.30	0.06
EVPTDNTA42	30	42			2.875	0.34	0.07
EVPTDNTA48	35	48			2.875	0.38	0.08
EVPTDNTA54	39	54			2.875	0.42	0.09
EVPTDNTA60	47	60			2.875	0.46	0.10

EVPTTCA - Aluminum Top Trim with Channel for Acoustic Grid

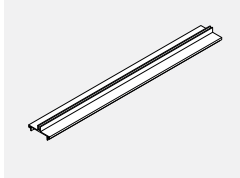

- Top trim with channel.
- Available in standard paint colors.
- Note: Trim can span inline connector, but not a post.

PRODUCT CODE	PRICE	SIZE/INCHES			WEIGHT LBS	VOL FT ³
		H	W	D		
EVPTTCA18	13	18	2 7/8		0.18	0.03
EVPTTCA24	16	24	2 7/8		0.22	0.04
EVPTTCA30	24	30	2 7/8		0.29	0.05
EVPTTCA36	27	36	2 7/8		0.30	0.06
EVPTTCA42	30	42	2 7/8		0.34	0.07
EVPTTCA48	35	48	2 7/8		0.38	0.08
EVPTTCA54	39	54	2 7/8		0.42	0.09
EVPTTCA60	46	60	2 7/8		0.46	0.10
EVPTTCA66	49	66	2 7/8		0.50	0.11
EVPTTCA72	52	72	2 7/8		0.54	0.12
EVPTTCA78	58	78	2 7/8		0.58	0.13
EVPTTCA84	63	84	2 7/8		0.62	0.14
EVPTTCA90	71	90	2 7/8		0.66	0.15
EVPTTCA96	82	96	2 7/8		0.70	0.16

EVSC12 • Slot Cover



- Covers the slots of a slotted connector between panels as well as a corner post and end-of-run kit.
- Sold by the foot and cut on site by the installers.
- To order the required length, calculate the sum of the length of all inline connectors (including the posts and end-of-run kit) and multiply by 2.

PRODUCT CODE	PRICE	SIZE/ INCHES	WEIGHT LBS	VOL FT ³
EVSC12	4	12 1	0.01	0.01

EVECC310 • Wire Manager

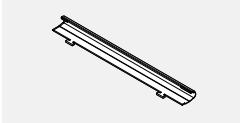

- Attaches to panels vertically between modules to provide enclosures for power or data cords.
- Sold in packages of 6.
- Can be overlapped to achieve required length.

PRODUCT CODE	PRICE	SIZE/ INCHES	WEIGHT LBS	VOL FT ³
EVECC310	39	10 1	0.01	0.01

EVHLPF01 • Low Profile Foot

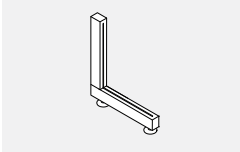

- Used to provide additional support to panel run without adding panels.
- Connects to inline connector or end of run at base of panels.

PRODUCT CODE	PRICE	SIZE/ INCHES	WEIGHT LBS	VOL FT ³
EVHLPF01	97	11 11 1	2.6	0.07

EVCLVAR • Connector Variable Height Clamp

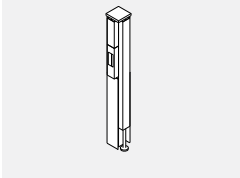

- Used for connecting two panels of variable height.

PRODUCT CODE	PRICE	SIZE/ INCHES	WEIGHT LBS	VOL FT ³
EVCLVAR	8	H W D	0.5	0.01

EVPIECBS • Bridge Panel Inline Extension Connector

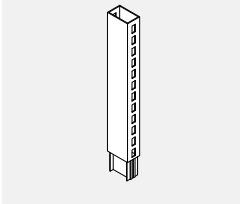

- Connects bridge panel to inline extension connector.
- Includes one bridge extension connector and connecting hardware.

PRODUCT CODE	PRICE	SIZE/INCHES	WEIGHT LBS	VOL FT ³
EVPIECBS06	28	6 3 3	1.00	0.06
EVPIECBS12	28	12 3 3	2.00	0.12
EVPIECBS18	33	18 3 3	3.00	0.18
EVPIECBS24	33	24 3 3	4.00	0.24

EVPEERBSA • Bridge Panel End of Run Extension Connector - Aluminum Trim

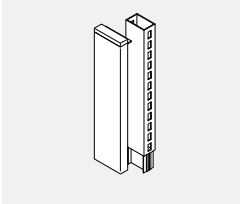

- Connects at end of run of bridge panel and can attach panel to fixed wall.
- Adds 1" to width of panel run.
- Provides slotted support for worksurfaces and hang on components up to 66" high.
- Includes one slotted bridge extension connector and connecting hardware and trim kit.

PRODUCT CODE	PRICE	SIZE/INCHES	WEIGHT LBS	VOL FT ³
EVPEERBSA06	33	6 3 3	1.00	0.06
EVPEERBSA12	33	12 3 3	2.00	0.12
EVPEERBSA18	50	18 3 3	3.00	0.18
EVPEERBSA24	50	24 3 3	4.00	0.24

EVPICBS • Bridge Panel Inline Connector without Aluminum Insert

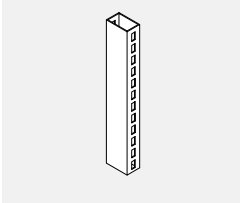

- Connects two bridge panel to inline connector.
- Inline connector in middle between two bridge panels, above opening, using double clamp at bottom.
- Includes one bridge extension connector without aluminum insert and connecting hardware.

PRODUCT CODE	PRICE	SIZE/INCHES	WEIGHT LBS	VOL FT ³
EVPICBS06	31	6 3 3	1.00	0.06
EVPICBS12	31	12 3 3	2.00	0.12
EVPICBS18	37	18 3 3	3.00	0.18
EVPICBS24	37	24 3 3	4.00	0.24

EVPCEPB1 • Bridge Panel Corner Extension Post 1-way



- Connects at end of a run of extension modules.
- Post and connecting hardware add 3.25" to power beam run.
- Includes one extension post, one slotted extension connectors for bridge panel, connecting hardware and trim kit.

PRODUCT CODE	PRICE	SIZE/INCHES			WEIGHT VOL	
		H	W	D	LBS	FT ³
EVPCEPBSA106	73	6	3	3	2.00	0.07
EVPCEPBSA112	73	12	3	3	4.00	0.14
EVPCEPBSA118	94	18	3	3	6.00	0.21
EVPCEPBSA124	94	24	3	3	8.00	0.14

EVPCEPB4 • Bridge Panel Corner Extension Post 4-way

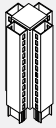

- Connects four bridge panels in 90 degree configuration.
- Post and connecting hardware add 3.25" to power beam run.
- Includes one extension post, four one slotted extension connectors for bridge panel, connecting hardware and trim kit.

PRODUCT CODE	PRICE	SIZE/INCHES			WEIGHT VOL	
		H	W	D	LBS	FT ³
EVPCEPBS406	97	6	3	3	4.00	0.09
EVPCEPBS412	97	12	3	3	8.00	0.18
EVPCEPBS418	152	18	3	3	12.00	0.27
EVPCEPBS424	152	24	3	3	16.00	0.36

EVPCEPB3 • Bridge Panel Corner Extension Post 3-way

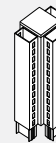

- Connects three bridge panels in 90 degree configuration.
- Post and connecting hardware add 3.25" to power beam run.
- Includes one extension post, three one slotted extension connectors for bridge panel, connecting hardware and trim kit.

PRODUCT CODE	PRICE	SIZE/INCHES			WEIGHT VOL	
		H	W	D	LBS	FT ³
EVPCEPBSA306	86	6	3	3	3.00	0.08
EVPCEPBSA312	86	12	3	3	6.00	0.16
EVPCEPBSA318	135	18	3	3	9.00	0.24
EVPCEPBSA324	135	24	3	3	12.00	0.32

EVPCEPB2 • Bridge Panel Corner Extension Post 2-way



- Connects two bridge panels in 90 degree configuration.
- Post and connecting hardware add 3.25" to power beam run.
- Includes one extension post, two one slotted extension connectors for bridge panel, connecting hardware and trim kit.

PRODUCT CODE	PRICE	SIZE/INCHES			WEIGHT VOL	
		H	W	D	LBS	FT ³
EVPCEPBSA206	74	6	3	3	2.00	0.07
EVPCEPBSA212	74	12	3	3	4.00	0.14
EVPCEPBSA218	118	18	3	3	6.00	0.21
EVPCEPBSA224	118	24	3	3	8.00	0.14

EVPCEIPBSA2 • Bridge Panel Inline 2-way Post Extension

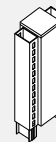

- Connects two bridge panels in straight run.
- Post and connecting hardware add 3.25" to power beam run.
- Includes one extension post, two slotted extension connectors for bridge panel, connecting hardware and trim kit.

PRODUCT CODE	PRICE	SIZE/INCHES			WEIGHT VOL	
		H	W	D	LBS	FT ³
EVPCEIPBSA206	74	6	3	3	2.00	0.07
EVPCEIPBSA212	74	12	3	3	4.00	0.14
EVPCEIPBSA218	118	18	3	3	6.00	0.21
EVPCEIPBSA224	118	24	3	3	8.00	0.14

NO RACEWAY PANELS • TECHNICAL INFORMATION

- Evolve panels are 2 7/8" thick. They are available in four (5) basic heights: 30", 42", 48", 54" and 66" and eight (8) widths: 18" to 60" in 6" increments.
- Individual fabric covered acoustic modules incorporated into a rigid steel frame.
- Opposite side of each module may have a different fabric within the same grade at no upcharge.
- If different grades of fabric are used on one panel, the entire panel must be priced at highest grade.
- A low profile top cap is included.
- No panel creep.
- 12" high and 24" high modules of 2 types (fabric and laminate) are available for field installation. Contact your Customer Service Representative.
- Laminate for laminate panels cannot be replaced in the field, complete module must be ordered.

PANELS • GUIDELINES FOR ORDERING PRODUCT

The price list uses a numbering system with meaningful alphanumeric characters to create a simple-to-understand product number. This makes specifying the product much easier and more accurate.

EXAMPLE OF PANEL CODE

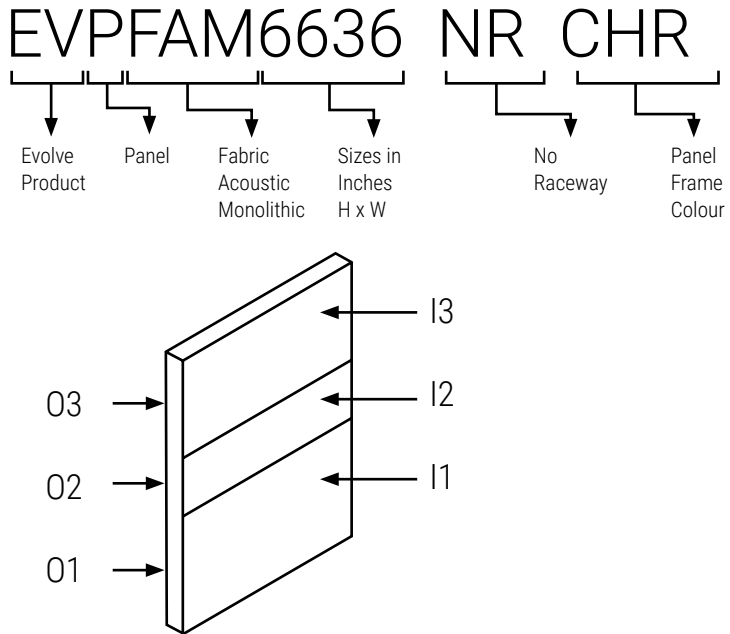

I1	AN50	Inside Fabric Position #1
I2	AN50	Inside Fabric Position #2
I3	AN50	Inside Fabric Position #3
O1	BE21	Outside Fabric Position #1
O2	BE21	Outside Fabric Position #2
O3	BE21	Outside Fabric Position #3

HOW TO SPECIFY

- Specify Evolve panel type and size by code.
- Specify panel frame finish - ie. CHR (Charcoal).
- Specify all necessary panel fabric options.

NOTE: If different grades of fabric are used on one panel, the entire panel must be priced out at the higher grade.

EVPFA-NR • Segmented (No Raceway) Panel

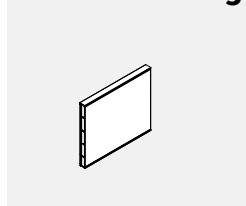

- Segmented (No Raceway) panel incorporates fabric modules within steel frame.
- There is no base raceway in No Raceway Panels to accommodate electric.
- **No Raceway connectors to be used.**
- Fabric covered modules are tackable and acoustical.
- Each side of fabric module may have different fabric within the same grade at no charge.
- If different grades of fabric are used, the entire module must be price at highest grade.
- Aluminum low profile top and bottom cap is included.
- Stackability: Evolve panels can be increased in height in 6", 12", 24" increments. See module listing for part numbers.

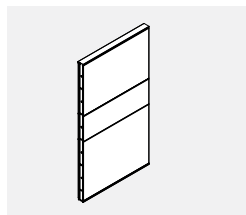
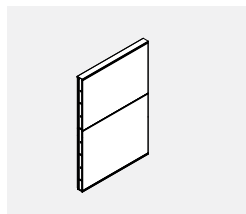
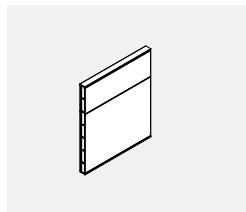

PRODUCT CODE	PRICE		SIZE/ INCHES			WEIGHT	VOL
	GR 1	GR 2	H	W	D	LBS	FT ³
EVPFA3018NR	296	308	30	18	2.875	15.38	1.23
EVPFA3024NR	309	361	30	24	2.875	18.20	1.63
EVPFA3030NR	342	361	30	30	2.875	21.76	2.00
EVPFA3036NR	367	389	30	36	2.875	24.80	2.38
EVPFA3042NR	396	421	30	42	2.875	26.49	2.76
EVPFA3048NR	438	468	30	48	2.875	32.00	3.13
EVPFA3054NR	472	505	30	54	2.875	35.31	3.51
EVPFA3060NR	507	546	30	60	2.875	38.20	3.89
EVPFA4218NR	328	344	42	18	2.875	20.58	1.71
EVPFA4224NR	344	371	42	24	2.875	24.60	2.31
EVPFA4230NR	400	430	42	30	2.875	29.35	2.81
EVPFA4236NR	433	468	42	36	2.875	35.60	3.38
EVPFA4242NR	494	532	42	42	2.875	39.29	3.92
EVPFA4248NR	532	576	42	48	2.875	43.20	4.45
EVPFA4254NR	589	638	42	54	2.875	47.52	4.98
EVPFA4260NR	646	700	42	60	2.875	51.60	5.52
EVPFA4818NR	352	374	48	18	2.875	23.98	2.19
EVPFA4824NR	385	418	48	24	2.875	27.80	2.94
EVPFA4830NR	439	476	48	30	2.875	33.15	3.62
EVPFA4836NR	490	534	48	36	2.875	37.40	4.31
EVPFA4842NR	553	607	48	42	2.875	40.69	4.99
EVPFA4848NR	616	674	48	48	2.875	48.20	5.67
EVPFA4854NR	671	736	48	54	2.875	52.92	6.35
EVPFA4860NR	718	790	48	60	2.875	57.40	7.03
EVPFA5418NR	352	374	54	18	2.875	23.98	2.19
EVPFA5424NR	385	418	54	24	2.875	27.80	2.94
EVPFA5430NR	439	476	54	30	2.875	33.15	3.62
EVPFA5436NR	490	534	54	36	2.875	37.40	4.31
EVPFA5442NR	553	607	54	42	2.875	40.69	4.99
EVPFA5448NR	616	674	54	48	2.875	48.20	5.67
EVPFA5454NR	671	736	54	54	2.875	52.92	6.35
EVPFA5460NR	718	790	54	60	2.875	57.40	7.03
EVPFA6618NR	442	472	66	18	2.875	29.98	2.68
EVPFA6624NR	343	520	66	24	2.875	35.00	3.58
EVPFA6630NR	528	576	66	30	2.875	41.54	4.40
EVPFA6636NR	619	677	66	36	2.875	49.00	5.23
EVPFA6642NR	701	767	66	42	2.875	54.29	6.06
EVPFA6648NR	751	825	66	48	2.875	60.20	6.08
EVPFA6654NR	817	899	66	54	2.875	65.93	7.70
EVPFA6660NR	883	972	66	60	2.875	71.60	8.53

EVPFAM-NR • Monolithic (No Raceway) Panel

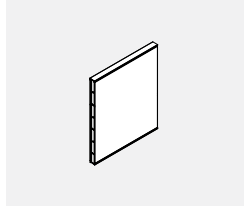

- Monolithic (No Raceway) panel incorporates fabric modules within steel frame.
- There is no base raceway in No Raceway Panels to accommodate electric.
- **No Raceway connectors to be used.**
- Fabric covered modules are tackable and acoustical.
- Each side of fabric module may have different fabric within the same grade at no charge.
- If different grades of fabric are used, the entire module must be price at highest grade.
- Aluminum low profile top and bottom cap is included.
- Stackability: Evolve panels can be increased in height in 6", 12", 24" increments. See module listing for part numbers.

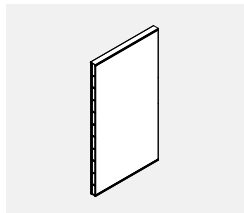
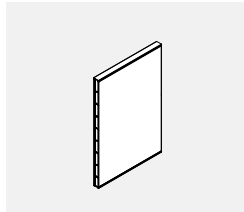
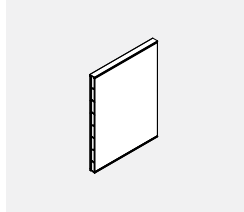

PRODUCT CODE	PRICE		SIZE/ INCHES			WEIGHT	VOL
	GR 1	GR 2	H	W	D	LBS	FT ³
EVPFAM4218NR	303	331	42	18	2.875	20.58	1.71
EVPFAM4224NR	323	358	42	24	2.875	23.40	2.31
EVPFAM4230NR	369	409	42	30	2.875	26.96	2.85
EVPFAM4236NR	396	443	42	36	2.875	30.00	3.38
EVPFAM4242NR	439	494	42	42	2.875	31.69	3.92
EVPFAM4248NR	477	539	42	48	2.875	37.20	4.45
EVPFAM4254NR	526	594	42	54	2.875	40.51	4.98
EVPFAM4260NR	572	646	42	60	2.875	43.40	5.52
EVPFAM4818NR	309	337	48	18	2.875	21.38	1.92
EVPFAM4824NR	340	373	48	24	2.875	24.40	2.62
EVPFAM4830NR	392	433	48	30	2.875	27.76	3.23
EVPFAM4836NR	426	473	48	36	2.875	30.80	3.85
EVPFAM4842NR	476	531	48	42	2.875	32.49	4.45
EVPFAM4848NR	520	579	48	48	2.875	37.80	5.06
EVPFAM4854NR	573	640	48	54	2.875	41.31	5.66
EVPFAM4860NR	622	697	48	60	2.875	44.20	6.27
EVPFAM5418NR	311	340	54	18	2.875	24.58	2.19
EVPFAM5424NR	342	377	54	24	2.875	27.40	2.94
EVPFAM5430NR	397	438	54	30	2.875	30.96	3.62
EVPFAM5436NR	442	492	54	36	2.875	34.00	4.31
EVPFAM5442NR	495	550	54	42	2.875	35.69	4.99
EVPFAM5448NR	537	601	54	48	2.875	41.20	5.67
EVPFAM5454NR	592	662	54	54	2.875	44.51	6.35
EVPFAM5460NR	647	724	54	60	2.875	47.40	7.03
EVPFAM6618NR	386	414	66	18	2.875	27.58	2.68
EVPFAM6624NR	421	457	66	24	2.875	30.40	3.58
EVPFAM6630NR	476	521	66	30	2.875	33.96	4.40
EVPFAM6636NR	553	603	66	36	2.875	37.00	5.23
EVPFAM6642NR	622	675	66	42	2.875	38.69	6.06
EVPFAM6648NR	675	737	66	48	2.875	44.20	6.88
EVPFAM6654NR	751	818	66	54	2.875	47.51	7.70
EVPFAM6660NR	826	901	66	60	2.875	50.40	8.53
EVPFAM9018NR	684	732	90	18	2.875	38.18	3.43
EVPFAM9024NR	736	794	90	24	2.875	42.72	4.58
EVPFAM9030NR	818	895	90	30	2.875	47.99	5.65
EVPFAM9036NR	952	1035	90	36	2.875	52.75	6.73

EVPH1S-NR • Laminate (No Raceway) Panel Single Sided

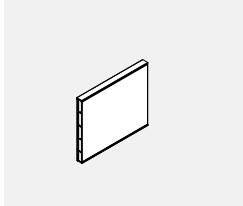

- Laminate (No Raceway) panel incorporates single sided laminate modules within steel frame.
- Opposite side is fabric covered.
- Laminate faces on all modules provide durable, washable surface on Single sided of the panel.

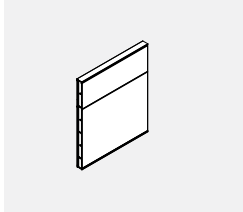

- Available in high pressure laminate only.
- If wood grain is selected, grain runs horizontally.
- There is no base raceway in No Raceway Panels to accommodate electric.

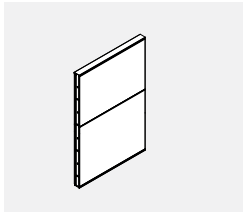

- **No Raceway connectors to be used.**
- If different grades of fabric are used, the entire module must be price at highest grade.
- Aluminum low profile top and bottom cap is included.

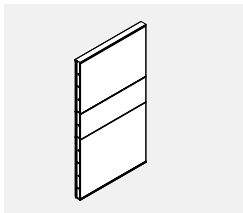

- Stackability: Evolve panels can be increased in height in 6", 12", 24" increments. See module listing for part numbers.

PRODUCT CODE	PRICE		SIZE/ H	INCHES			WEIGHT LBS	VOL FT ³
	GR 1	GR 2		W	D			
EVPH1S3018NR	362	369	30	18	2.875	15.88	1.23	
EVPH1S3024NR	435	443	30	24	2.875	18.70	1.63	
EVPH1S3030NR	508	519	30	30	2.875	22.26	2.00	
EVPH1S3036NR	576	592	30	36	2.875	24.85	2.38	
EVPH1S3042NR	656	669	30	42	2.875	26.99	2.76	
EVPH1S3048NR	711	725	30	48	2.875	32.05	3.13	
EVPH1S3054NR	790	806	30	54	2.875	35.81	3.51	
EVPH1S3060NR	865	882	30	60	2.875	38.07	3.89	
EVPH1S4218NR	430	468	42	18	2.875	21.38	1.71	
EVPH1S4224NR	515	530	42	24	2.875	22.13	2.31	
EVPH1S4230NR	601	616	42	30	2.875	30.15	2.81	
EVPH1S4236NR	692	712	42	36	2.875	36.40	3.38	
EVPH1S4242NR	783	805	42	42	2.875	40.09	3.92	
EVPH1S4248NR	853	877	42	48	2.875	44.00	4.45	
EVPH1S4254NR	948	972	42	54	2.875	48.32	4.98	
EVPH1S4260NR	1037	1068	42	60	2.875	52.40	5.52	
EVPH1S5418NR	507	521	54	18	2.875	24.98	2.19	
EVPH1S5424NR	612	629	54	24	2.875	28.80	2.94	
EVPH1S5430NR	719	739	54	30	2.875	34.15	3.62	
EVPH1S5436NR	824	847	54	36	2.875	38.40	4.31	
EVPH1S5442NR	932	958	54	42	2.875	41.69	4.99	
EVPH1S5448NR	1019	1051	54	48	2.875	49.20	5.67	
EVPH1S5454NR	1133	1166	54	54	2.875	53.92	6.35	
EVPH1S5460NR	1247	1286	54	60	2.875	58.40	7.03	
EVPH1S6618NR	629	646	66	18	2.875	31.29	2.68	
EVPH1S6624NR	758	779	66	24	2.875	36.30	3.58	
EVPH1S6630NR	884	910	66	30	2.875	42.84	4.40	
EVPH1S6636NR	1021	1052	66	36	2.875	50.30	5.23	
EVPH1S6642NR	1163	1197	66	42	2.875	55.59	6.06	
EVPH1S6648NR	1265	1304	66	48	2.875	61.50	6.08	
EVPH1S6654NR	1406	1450	66	54	2.875	67.23	7.70	
EVPH1S6660NR	1549	1598	66	60	2.875	72.90	8.53	

EVPH2S-NR • Laminate (No Raceway) Panel Double Sided

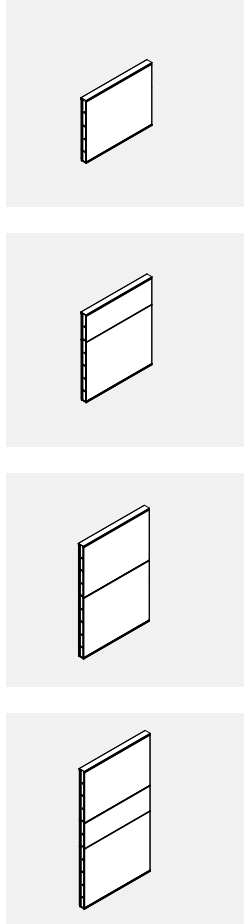

- Laminate (No Raceway) panel incorporates double sided laminate modules within steel frame
- Laminate faces on all modules provide durable, washable surface on both sides of the panel
- Available in high pressure laminate only
- If wood grain is selected, grain runs horizontally
- There is no base raceway in No Raceway Panels to accommodate electric
- **No Raceway connectors to be used.**
- Aluminum low profile top and bottom cap is included
- Stackability: Evolve panels can be increased in height in 6", 12", 24" increments. See module listing for part numbers.

PRODUCT CODE	PRICE	SIZE/ INCHES			WEIGHT LBS	VOL FT ³
		H	W	D		
EVPH2S3018NR	405	30	18	2.875	16.38	1.23
EVPH2S3024NR	495	30	24	2.875	19.20	1.63
EVPH2S3030NR	586	30	30	2.875	22.76	2.00
EVPH2S3036NR	669	30	36	2.875	25.80	2.38
EVPH2S3042NR	762	30	42	2.875	27.49	2.76
EVPH2S3048NR	851	30	48	2.875	33.00	3.13
EVPH2S3054NR	944	30	54	2.875	36.31	3.51
EVPH2S3060NR	1021	30	60	2.875	39.20	3.89
EVPH2S4218NR	483	42	18	2.875	22.18	1.71
EVPH2S4224NR	586	42	24	2.875	26.20	2.31
EVPH2S4230NR	691	42	30	2.875	30.95	2.81
EVPH2S4236NR	803	42	36	2.875	37.20	3.38
EVPH2S4242NR	916	42	42	2.875	40.89	3.92
EVPH2S4248NR	1025	42	48	2.875	42.80	4.45
EVPH2S4254NR	1128	42	54	2.875	49.12	4.98
EVPH2S4260NR	1230	42	60	2.875	53.20	5.52
EVPH2S5418NR	564	54	18	2.875	25.98	2.19
EVPH2S5424NR	693	54	24	2.875	29.80	2.94
EVPH2S5430NR	824	54	30	2.875	35.15	3.62
EVPH2S5436NR	955	54	36	2.875	39.40	4.31
EVPH2S5442NR	1090	54	42	2.875	42.69	4.99
EVPH2S5448NR	1229	54	48	2.875	50.20	5.67
EVPH2S5454NR	1353	54	54	2.875	52.92	6.35
EVPH2S5460NR	1473	54	60	2.875	59.40	7.03
EVPH2S6618NR	711	66	18	2.875	32.58	2.68
EVPH2S6624NR	877	66	24	2.875	37.60	3.58
EVPH2S6630NR	1037	66	30	2.875	44.14	4.40
EVPH2S6636NR	1205	66	36	2.875	51.60	5.23
EVPH2S6642NR	1386	66	42	2.875	56.89	6.06
EVPH2S6648NR	1549	66	48	2.875	62.80	6.08
EVPH2S6654NR	1713	66	54	2.875	68.53	7.70
EVPH2S6660NR	1871	66	60	2.875	74.20	8.53

EVPXGT-NR • Fully Glazed (No Raceway) Panel

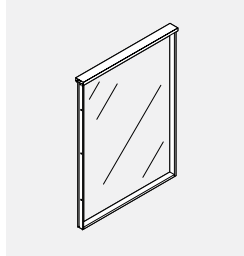

- **EVPXGTNR - Fully Glazed Monolithic No Raceway Panel.**
- There is no base raceway in No Raceway Panels to accommodate electric.
- No Raceway connectors to be used.
- Fully Glazed Monolithic No Raceway panel are incorporated in solid steel frame.
- Standard in clear (CLR).
- Frosted glass (FRST) 40% upcharge.
- Size 90"x36"W is maximum size allowed.
- Panel height to align with standard door height.
- Aluminum low profile top and bottom cap is included.

PRODUCT CODE	PRICE	SIZE/ INCHES			WEIGHT LBS	VOL FT ³
		H	W	D		
EVPXGT9018NR	761	90	18	2.875	15.88	1.23
EVPXGT9024NR	869	90	24	2.875	18.70	1.63
EVPXGT9030NR	986	90	30	2.875	22.26	2.00
EVPXGT9036NR	1068	90	36	2.875	24.85	2.38

EVPGTNR-NR • Fully Glazed Segmented (No Raceway) Panel

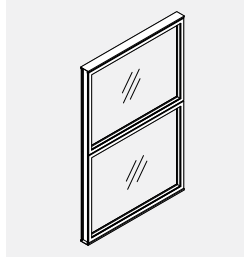

- **Fully Glazed Segmented No Raceway Panel with solid steel frame..**
- There is no base raceway in No Raceway Panels to accommodate electrical.
- No Raceway connectors to be used.
- Standard in clear (CLR).
- Frosted glass (FRST) 40% upcharge.
- Aluminum low profile top and bottom cap is included.

PRODUCT CODE	PRICE	SIZE/ INCHES			WEIGHT LBS	VOL FT ³
		H	W	D		
EVPGT4818NR	607	48	18	2.875	35.19	2.19
EVPGT4824NR	743	48	24	2.875	49.76	2.94
EVPGT4830NR	821	48	30	2.875	52.08	3.62
EVPGT4836NR	898	48	36	2.875	64.54	4.31
EVPGT4842NR	994	48	42	2.875	72.62	4.99
EVPGT4848NR	1110	48	48	2.875	78.11	5.67
EVPGT4854NR	1221	48	54	2.875	86.04	6.35
EVPGT4860NR	1332	48	60	2.875	94.09	7.03

EVPIC-NR • Inline Connector (No Raceway) Panel



- Connects two No Raceway panel in straight run.
- Provides slotted support for worksurfaces and hang on components.
- Includes one slotted connector with leveling glide and connecting hardware.
- Connectors available without slots, as a special at no extra charge. Contact customer support.

PRODUCT CODE	PRICE	SIZE/INCHES			WEIGHT		VOL FT ³
		H	W	D	LBS		
EVPIC30NR	61	30	2		3.30	0.05	
EVPIC42NR	65	42	2		4.60	0.07	
EVPIC48NR	67	48	2		5.25	0.07	
EVPIC54NR	72	54	2		5.90	0.09	
EVPIC66NR	81	66	2		7.20	0.10	

EVVIC-NR • Inline Connector (No Raceway) Panel



- Connects two 90" H No Raceway panel in straight run.
- Includes one slotted connector with leveling glide and connecting hardware.
- Connectors are without slots.
- To be used only with 90" H NR Glazed Panels

PRODUCT CODE	PRICE	SIZE/INCHES			WEIGHT		VOL FT ³
		H	W	D	LBS		
EVVIC90NR	114	90	2		11.2	0.19	

EVVVC-NR • Inline Variable Height Connector (No Raceway) Panel



- Connects two No Raceway panels of differing height in straight run.
- Connector must reference taller panel.
- Can be used for any variation of pane height.
- Variable height trim must be ordered separately (see EVPTVA).
- Provides slotted support for worksurfaces and hang on components.
- Includes one slotted connector with leveling glide and connecting hardware.
- Connectors available without slots, as a special at no extra charge. Contact customer support.

PRODUCT CODE	PRICE	SIZE/INCHES			WEIGHT		VOL FT ³
		H	W	D	LBS		
EVVVC42NR	72	42	2		4.60	0.07	
EVVVC48NR	75	48	2		5.25	0.07	
EVVVC54NR	76	54	2		5.90	0.09	
EVVVC66NR	85	66	2		7.20	0.10	

EVPERA-NR • End of Run Post Kit for (No Raceway) Panel

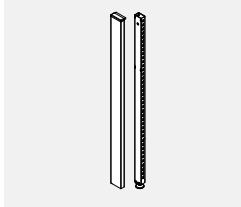

- Connects at end of No Raceway panel and can attach to a panel to fixed wall.
- Adds 1" to width of panel run.
- Provides slotted support for worksurfaces and hang on components.
- Includes one slotted connector with leveling glide and connecting hardware and trim kit.
- Can be attached to face of another panel to provide off modular connection.
- Connectors available without slots, as a special at no extra charge. Contact customer support.

PRODUCT CODE	PRICE	SIZE/INCHES			WEIGHT		VOL FT ³
		H	W	D	LBS		
EVPERA30NR	76	30	2		3.30	0.07	
EVPERA42NR	91	42	2		4.60	0.10	
EVPERA48NR	97	48	2		5.25	0.10	
EVPERA54NR	109	54	2		5.90	0.18	
EVPERA66NR	122	66	2		7.20	0.22	

EVPERA-NR • End of Run Post Kit for (No Raceway) Panel

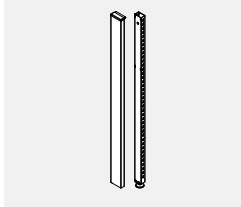

- Connects two 90" H No Raceway panel and can attach to a panel to fixed wall.
- Adds 1" width of panel run.
- Includes one slotted connector with leveling glide and connecting hardware and trim kit.
- Can be attached to face of another panel to provide off modular connection.
- Connectors are without slots.
- To be used only with 90" H NR Glazed Panels

PRODUCT CODE	PRICE	SIZE/INCHES			WEIGHT		VOL FT ³
		H	W	D	LBS		
EVPERA90NR	157	90	2		11.2	0.19	

EVPCPA2-NR • Two Way Corner Post (No Raceway) Panel



- Connects two No Raceway panel of equal height in 90 degree configuration.
- Post and connecting hardware add 3.25" to power beam run.
- Provides slotted support for worksurfaces and hang on components.
- Includes post, panel connectors and power beam connectors, post with trim all around, levelling glide, hardware and trim kit.
- Connectors available without slots, as a special at no extra charge. Contact customer support.

PRODUCT CODE	PRICE	SIZE/INCHES			WEIGHT LBS	VOL FT³
		H	W	D		
EVPCPA230NR	157	30	2.875		8.50	0.31
EVPCPA242NR	201	42	2.875		11.50	0.43
EVPCPA248NR	211	48	2.875		11.50	0.54
EVPCPA254NR	244	54	2.875		15.00	0.61
EVPCPA266NR	290	66	2.875		19.00	0.75

EVPCPA2-NR • Two Way Corner Post (No Raceway) Panel



- Connects two No Raceway panel of equal height in 90 degree configuration.
- Post and connecting hardware add 3.25" to power beam run.
- Includes post, panel connectors and power beam connectors, post with trim all around, levelling glide, hardware and trim kit.
- Connectors are without slots.
- To be used only with 90" H NR Glazed Panels

PRODUCT CODE	PRICE	SIZE/INCHES			WEIGHT LBS	VOL FT³
		H	W	D		
EVPCPA290NR	400	90	2.875		27	1.03

EVPCPA3-NR • Three Way Corner Post (No Raceway) Panel



- Connects three No Raceway panel of equal height in "T" configuration.
- Post and connecting hardware add 3.25" to power beam run.
- Provides slotted support for worksurfaces and hang on components.
- Includes post, panel connectors and power beam connectors, post with trim all around, levelling glide, hardware and trim kit.
- Connectors available without slots, as a special at no extra charge. Contact customer support.

PRODUCT CODE	PRICE	SIZE/INCHES			WEIGHT LBS	VOL FT³
		H	W	D		
EVPCPA330NR	189	30	2.875		11.80	0.36
EVPCPA342NR	252	42	2.875		16.10	0.50
EVPCPA348NR	278	48	2.875		18.75	0.61
EVPCPA354NR	308	54	2.875		20.50	0.70
EVPCPA366NR	362	66	2.875		26.20	0.85

EVPCPA3-NR • Three Way Corner Post (No Raceway) Panel



- Connects three No Raceway panel of equal height in "T" configuration.
- Post and connecting hardware add 3.25" to power beam run.
- Includes post, panel connectors and power beam connectors, post with trim all around, levelling glide, hardware and trim kit.
- Connectors are without slots.
- To be used only with 90" H NR Glazed Panels

PRODUCT CODE	PRICE	SIZE/INCHES			WEIGHT LBS	VOL FT³
		H	W	D		
EVPCPA390NR	485	90	2.875		38.2	1.17

EVPCPA4-NR • Four Way Corner Post (No Raceway) Panel



- Connects four No Raceway panel of equal height in "+" configuration.
- Post and connecting hardware add 3.25" to power beam run.
- Provides slotted support for worksurfaces and hang on components.
- Includes post, panel connectors and power beam connectors, post with trim all around, levelling glide, hardware and trim kit.
- Connectors available without slots, as a special at no extra charge. Contact customer support.

PRODUCT CODE	PRICE	SIZE/INCHES			WEIGHT LBS	VOL FT³
		H	W	D		
EVPCPA430NR	207	30	2.875		15.5	0.40
EVPCPA442NR	271	42	2.875		21.00	0.57
EVPCPA448NR	298	48	2.875		24.00	0.68
EVPCPA454NR	329	54	2.875		26.50	0.79
EVPCPA466NR	385	66	2.875		33.20	0.95

EVPCPA4-NR • Four Way Corner Post (No Raceway) Panel



- Connects three No Raceway panel of equal height in "+" configuration.
- Post and connecting hardware add 3.25" to power beam run.
- Includes post, panel connectors and power beam connectors, post with trim all around, levelling glide, hardware and trim kit.
- Connectors are without slots.
- To be used only with 90" H NR Glazed Panels

PRODUCT CODE	PRICE	SIZE/INCHES			WEIGHT LBS	VOL FT³
		H	W	D		
EVPCPA490NR	495	90	2.875		49.2	1.31

EVPIPA2-NR • Inline Two Way Corner Post (No Raceway Panel)



- Connects two No Raceway panel of equal height in straight run.
- Post and connecting hardware add 3.25" to power beam run.
- Provides slotted support for worksurfaces and hang on components.
- Includes post, panel connectors and power beam connectors, post with trim all around, levelling glide, hardware and trim kit.
- Connectors available without slots, as a special at no extra charge. Contact customer support.

PRODUCT CODE	PRICE	SIZE/INCHES			WEIGHT LBS	VOL FT ³
		H	W	D		
EVPIPA230NR	157	30	2.875		8.20	0.31
EVPIPA242NR	201	42	2.875		11.50	0.43
EVPIPA248NR	211	48	2.875		13.50	0.54
EVPIPA254NR	244	54	2.875		15.00	0.61
EVPIPA266NR	290	66	2.875		19.00	0.75

EVPIPA2-NR • Inline Two Way Corner Post (No Raceway Panel)



- Connects three No Raceway panel of equal height in a straight run.
- Post and connecting hardware add 3.25" to power beam run.
- Includes post, panel connectors and power beam connectors, post with trim all around, levelling glide, hardware and trim kit.
- Connectors are without slots.
- To be used only with 90° H NR Glazed Panels

PRODUCT CODE	PRICE	SIZE/INCHES			WEIGHT LBS	VOL FT ³
		H	W	D		
EVPIPA290NR	420	90	2.875		27	1.03

EVPCPA1-NR • One Way Corner Post (No Raceway Panel)



- Connects at end of No Raceway panel run in place of EVPERA- End of run post kit.
- Should not be used to attach pane to fixed wall.
- Post and connecting hardware add 3.25" to power beam run.
- Provides slotted support for worksurfaces and hang on components.
- Includes post, panel connectors and power beam connectors, post with trim all around, levelling glide, hardware and trim kit.
- Connectors available without slots, as a special at no extra charge. Contact customer support.

PRODUCT CODE	PRICE	SIZE/INCHES			WEIGHT LBS	VOL FT ³
		H	W	D		
EVPCPA130NR	100	30	2.875		4.97	0.24
EVPCPA142NR	114	42	2.875		6.93	0.33
EVPCPA148NR	135	48	2.875		7.93	0.38
EVPCPA154NR	155	54	2.875		8.93	0.43
EVPCPA166NR	193	66	2.875		10.87	0.53

EVPCPA1-NR • Inline One Way Corner Post (No Raceway Panel)



- Connects three No Raceway panel of equal height in a straight run.
- Should not be used to attach pane to fixed wall.
- Post and connecting hardware add 3.25" to power beam run.
- Includes post, panel connectors and power beam connectors, post with trim all around, levelling glide, hardware and trim kit.
- Connectors are without slots.
- To be used only with 90° H NR Glazed Panels

PRODUCT CODE	PRICE	SIZE/INCHES			WEIGHT LBS	VOL FT ³
		H	W	D		
EVPCPA190NR	276	90	2.875		14.87	0.67

EVVPC-PNR • Inline variable height connector Panel (No Raceway Panel)



- Connects Panel to No Raceway panels of differing height in straight run.
- Connector must reference taller panel.
- Can be used for any variation of panel height.
- Variable height trim must be ordered separately (see EVPTVA).
- Provides slotted support for worksurfaces and hang on components.
- Includes one slotted connector with leveling glide and connecting hardware.
- Connectors available without slots, as a special at no extra charge. Contact your Customer Service Representative.

PRODUCT CODE	PRICE	SIZE/INCHES			WEIGHT LBS	VOL FT ³
		H	W	D		
EVVPC42PNR	72	42	2		4.60	0.07
EVVPC48PNR	75	48	2		5.25	0.07
EVVPC54PNR	76	54	2		5.90	0.09
EVVPC66PNR	85	66	2		7.20	0.10

EVPCPA2-PNR • Two Way Corner Post (No Raceway Panel)



- Connects No Raceway panel and Panel of equal height in 90 degree configuration.
- Post and connecting hardware add 3.25" to power beam run.
- Provides slotted support for worksurfaces and hang on components.
- Includes post, panel connectors and power beam connectors, post with trim all around, levelling glide, hardware and trim kit.
- Connectors available without slots, as a special at no extra charge. Contact customer support.

PRODUCT CODE	PRICE	SIZE/INCHES			WEIGHT LBS	VOL FT ³
		H	W	D		
EVPCPA230PNR	157	30	2.875		8.50	0.31
EVPCPA242PNR	201	42	2.875		11.50	0.43
EVPCPA248PNR	211	48	2.875		11.50	0.54
EVPCPA254PNR	244	54	2.875		15.00	0.61
EVPCPA266PNR	290	66	2.875		19.00	0.75

EVPCPA3-NR • Three Way Corner Post (No Raceway Panel)



- Connects two No Raceway panel and Panel of equal height in "T" configuration.
- Post and connecting hardware add 3.25" to power beam run.
- Provides slotted support for worksurfaces and hang on components.
- Includes post, panel connectors and power beam connectors, post with trim all around, levelling glide, hardware and trim kit.
- Connectors available without slots, as a special at no extra charge. Contact customer support.

PRODUCT CODE	PRICE	SIZE/INCHES			WEIGHT LBS	VOL FT³
		H	W	D		
EVPCPA330PNR	189	30	2.875		11.80	0.36
EVPCPA342PNR	252	42	2.875		16.10	0.50
EVPCPA348PNR	278	48	2.875		18.75	0.61
EVPCPA354PNR	308	54	2.875		20.50	0.70
EVPCPA366PNR	362	66	2.875		26.20	0.85

EVPIC-PNR • Inline connector Panel (No Raceway Panel)



- Connects Panel to No Raceway panel in straight run
- Provides slotted support for worksurfaces and hang on components
- Includes one slotted connector with leveling glide and connecting hardware
- Connectors available without slots, as a special at no extra charge. Contact your Customer Service Representative.

PRODUCT CODE	PRICE	SIZE/INCHES			WEIGHT LBS	VOL FT³
		H	W	D		
EVPIC30PNR	61	30	2		3.30	0.05
EVPIC42PNR	65	42	2		4.60	0.07
EVPIC48PNR	67	48	2		5.25	0.07
EVPIC54PNR	72	54	2		5.90	0.09
EVPIC66PNR	81	66	2		7.20	0.10

EVPIC-PNR • Inline connector Panel (No Raceway Panel)



- Connects 90" H No Raceway panel to 90" H door in straight run.
- Includes one non slotted connector with leveling glide and connecting hardware.
- Connectors are without slots.
- Note: To be used only with 90" H NR Glazed Panels and 90" H door.

PRODUCT CODE	PRICE	SIZE/INCHES			WEIGHT LBS	VOL FT³
		H	W	D		
EVPIC90PNR	114	90	2		11.2	0.19

EVPCPA4-NR • Four Way Corner Post (No Raceway Panel)



- Connects two No Raceway panel and two Panel of equal height in "+" configuration.
- Post and connecting hardware add 3.25" to power beam run.
- Provides slotted support for worksurfaces and hang on components.
- Includes post, panel connectors and power beam connectors, post with trim all around, levelling glide, hardware and trim kit
- Connectors available without slots, as a special at no extra charge. Contact customer support.

PRODUCT CODE	PRICE	SIZE/INCHES			WEIGHT LBS	VOL FT³
		H	W	D		
EVPCPA430PNR	207	30	2.875		15.5	0.40
EVPCPA442PNR	271	42	2.875		21.00	0.57
EVPCPA448PNR	298	48	2.875		24.00	0.68
EVPCPA454PNR	329	54	2.875		26.50	0.79
EVPCPA466PNR	385	66	2.875		33.20	0.95

EVPIPA2-NR • Inline Two Way Corner Post (No Raceway Panel)



- Connects No Raceway panel and Panel of equal height in straight run.
- Post and connecting hardware add 3.25" to power beam run.
- Provides slotted support for worksurfaces and hang on components.
- Includes post, panel connectors and power beam connectors, post with trim all around, levelling glide, hardware and trim kit.
- Connectors available without slots, as a special at no extra charge. Contact customer support.
- Note: Inline two way post must be used when No Panel and Panel are next to each other in run

PRODUCT CODE	PRICE	SIZE/INCHES			WEIGHT LBS	VOL FT³
		H	W	D		
EVPIPA230PNR	157	30	2.875		8.20	0.31
EVPIPA242PNR	201	42	2.875		11.50	0.43
EVPIPA248PNR	211	48	2.875		13.50	0.54
EVPIPA254PNR	244	54	2.875		15.00	0.61
EVPIPA266PNR	290	66	2.875		19.00	0.75

EVPERCHxxNR • Laminate Panel Connector with U Channel (No Raceway Panel)



- U channel attaches with screws to laminate end panel or laminate middle panel.
- Evolve NO Raceway Panels attach to connector.
- U Channel is welded to a No Raceway Connector.
- Includes No Raceway connector with U channel and hardware.

PRODUCT CODE	PRICE	SIZE/INCHES			WEIGHT LBS	VOL FT³
		H	W	D		
EVPERCH42NR	129	42	2.875		4.60	0.14
EVPERCH48NR	136	48	2.875		5.09	0.18
EVPERCH54NR	147	54	2.875		6.75	0.22

EVPPXGT • Freestanding Glazed Monolithic Privacy Panel

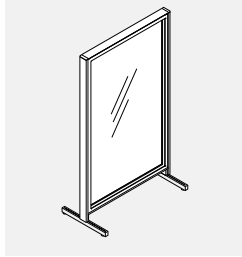

- Includes panel with two connectors with T legs with glides and end of run trims.
- Available in standard clear (CLR) tempered glass
- Available in standard frosted (FRST) tempered glass
- 22"d T-Legs (9.5" extension on each side of panel)
- Glazing is replaceable on site.

PRODUCT CODE	PRICE		SIZE/INCHES			WEIGHT LBS	VOL FT ³
	CLR	FRST	H	W	D		
EVPPXGT4218	536	646	42	18	2.875	50.53	2.46
EVPPXGT4224	591	723	42	24	2.875	58.14	3.06
EVPPXGT4230	640	794	42	30	2.875	65.96	3.6
EVPPXGT4236	691	862	42	36	2.875	69.3	4.13
EVPPXGT4242	745	941	42	42	2.875	73.38	4.67
EVPPXGT5418	625	760	54	18	2.875	56.19	2.99
EVPPXGT5424	690	850	54	24	2.875	70.76	3.38
EVPPXGT5430	750	932	54	30	2.875	73.08	4.42
EVPPXGT5436	806	1015	54	36	2.875	85.54	5.11
EVPPXGT5442	871	1106	54	42	2.875	93.62	5.79
EVPPXGT6618	722	882	66	18	2.875	62.74	3.48
EVPPXGT6624	792	982	66	24	2.875	70.81	4.38
EVPPXGT6630	862	1081	66	30	2.875	78.63	4.79
EVPPXGT6636	928	1174	66	36	2.875	86.52	5.38
EVPPXGT6642	1007	1282	66	42	2.875	92.66	6.38

EVPPXGT-F • Freestanding Glazed Monolithic Privacy Panel with Flat Foot

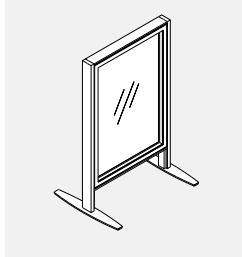

- Includes panel with two connectors with flat foot and end of run trims
- Available in standard clear (CLR) tempered glass
- Available in standard frosted (FRST) tempered glass
- Flat foot does not extend past end trim, no gaps between end trims
- 22"d T-Legs (9.5" extension on each side of panel)
- Glazing is replaceable on site.

PRODUCT CODE	PRICE		SIZE/INCHES			WEIGHT LBS	VOL FT ³
	CLR	FRST	H	W	D		
EVPPXGT4218F	536	646	42	18	2.875	50.53	2.46
EVPPXGT4224F	591	723	42	24	2.875	58.14	3.06
EVPPXGT4230F	640	794	42	30	2.875	65.96	3.6
EVPPXGT4236F	691	862	42	36	2.875	69.3	4.13
EVPPXGT4242F	745	941	42	42	2.875	73.38	4.67
EVPPXGT5418F	625	760	54	18	2.875	56.19	2.99
EVPPXGT5424F	690	850	54	24	2.875	70.76	3.38
EVPPXGT5430F	750	932	54	30	2.875	73.08	4.42
EVPPXGT5436F	806	1015	54	36	2.875	85.54	5.11
EVPPXGT5442F	871	1106	54	42	2.875	93.62	5.79
EVPPXGT6618F	722	882	66	18	2.875	62.74	3.48
EVPPXGT6624F	792	982	66	24	2.875	70.81	4.38
EVPPXGT6630F	862	1081	66	30	2.875	78.63	4.79
EVPPXGT6636F	928	1174	66	36	2.875	86.52	5.38
EVPPXGT6642F	1007	1282	66	42	2.875	92.66	6.38

EVPPXGT-FS • Freestanding Glazed Monolithic Privacy Panel with Shared Flat Foot

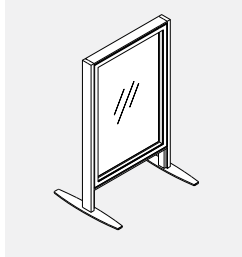

- Includes panel with two connectors with flat foot and end of run trims
- Available in standard clear (CLR) tempered glass
- Available in standard frosted (FRST) tempered glass
- Shared flat foot with connector in middle of flat foot
- 22"d T-Legs (9.5" extension on each side of panel)
- Glazing is replaceable on site.

PRODUCT CODE	PRICE		SIZE/INCHES			WEIGHT LBS	VOL FT ³
	CLR	FRST	H	W	D		
EVPPXGT4218FS	536	646	42	18	2.875	50.53	2.46
EVPPXGT4224FS	591	723	42	24	2.875	58.14	3.06
EVPPXGT4230FS	640	794	42	30	2.875	65.96	3.6
EVPPXGT4236FS	691	862	42	36	2.875	69.3	4.13
EVPPXGT4242FS	745	941	42	42	2.875	73.38	4.67
EVPPXGT5418FS	625	760	54	18	2.875	56.19	2.99
EVPPXGT5424FS	690	850	54	24	2.875	70.76	3.38
EVPPXGT5430FS	750	932	54	30	2.875	73.08	4.42
EVPPXGT5436FS	806	1015	54	36	2.875	85.54	5.11
EVPPXGT5442FS	871	1106	54	42	2.875	93.62	5.79
EVPPXGT6618FS	722	882	66	18	2.875	62.74	3.48
EVPPXGT6624FS	792	982	66	24	2.875	70.81	4.38
EVPPXGT6630FS	862	1081	66	30	2.875	78.63	4.79
EVPPXGT6636FS	928	1174	66	36	2.875	86.52	5.38
EVPPXGT6642FS	1007	1282	66	42	2.875	92.66	6.38

EVPPXGT-M • Mobile Glazed Monolithic Panel

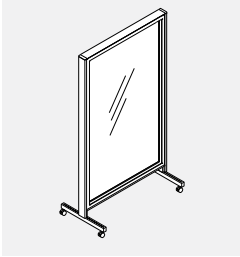

- Includes panel with two connectors with T legs with castors and end of run trims
- Available in standard clear (CLR) tempered glass
- Available in standard frosted (FRST) tempered glass
- Available in standard writeable (WRW) glass.
- 22"d T-Legs (9.5" extension on each side of panel)
- 1" locking casters
- Glazing is replaceable on site.

PRODUCT CODE	PRICE			SIZE/INCHES			WEIGHT LBS	VOL FT ³
	CLR	FRST	WRW	H	W	D		
EVPPXGT4218M	603	712	-	42	18	2.875	50.53	2.46
EVPPXGT4224M	658	789	-	42	24	2.875	58.14	3.06
EVPPXGT4230M	706	860	-	42	30	2.875	65.96	3.6
EVPPXGT4236M	757	928	-	42	36	2.875	69.3	4.13
EVPPXGT4242M	813	1007	-	42	42	2.875	73.38	4.67
EVPPXGT5418M	691	826	1103	54	18	2.875	56.19	2.99
EVPPXGT5424M	756	916	1271	54	24	2.875	70.76	3.38
EVPPXGT5430M	816	998	1431	54	30	2.875	73.08	4.42
EVPPXGT5436M	872	1081	1590	54	36	2.875	85.54	5.11
EVPPXGT5442M	938	1173	1757	54	42	2.875	93.62	5.79
EVPPXGT6618M	788	948	1296	66	18	2.875	62.74	3.48
EVPPXGT6624M	858	1048	1492	66	24	2.875	70.81	4.38
EVPPXGT6630M	928	1147	1685	66	30	2.875	78.63	4.79
EVPPXGT6636M	994	1240	1873	66	36	2.875	86.52	5.38
EVPPXGT6642M	1073	1349	2079	66	42	2.875	92.66	6.38

EVPPGT • Freestanding Segmented Glazed Privacy Panels

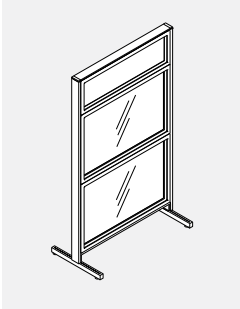

- Includes panel with two connectors with T legs with glides and end of run trims
- Available in standard clear (CLR) tempered glass
- Available in standard frosted (FRST) tempered glass
- 22"d T-Legs (9.5" extension on each side of panel)
- Glazing is replaceable on site.

PRODUCT CODE	PRICE			SIZE/INCHES			WEIGHT LBS	VOL FT ³
	CLR	FRST		H	W	D		
EVPPGT5424	712	883		54	24	2.875	70.8	3.38
EVPPGT5430	782	982		54	30	2.875	73.1	4.42
EVPPGT5436	851	1077		54	36	2.875	85.5	5.11
EVPPGT5442	926	1184		54	42	2.875	93.6	5.79
EVPPGT5448	999	1287		54	48	2.875	99.1	6.47
EVPPGT5454	1077	1396		54	54	2.875	107	7.15
EVPPGT5460	1144	1491		54	60	2.875	115.1	7.83
EVPPGT6624	891	1122		66	24	2.875	78.63	4.38
EVPPGT6630	975	1242		66	30	2.875	86.52	4.79
EVPPGT6636	1111	1432		66	36	2.875	92.66	5.38
EVPPGT6642	1205	1564		66	42	2.875	98.19	6.38
EVPPGT6648	1302	1700		66	48	2.875	105.48	7.68
EVPPGT6654	1408	1849		66	54	2.875	112.52	8.5
EVPPGT6660	1524	2009		66	60	2.875	129.3	9.33

EVPPGT-M • Mobile Segmented Glazed Privacy Panels

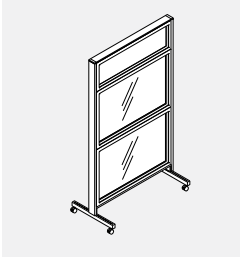

- Includes panel with two connectors with T legs with castors and end of run trims
- Available in standard clear (CLR) tempered glass
- Available in standard frosted (FRST) tempered glass
- 22"d T-Legs (9.5" extension on each side of panel)
- 1" locking casters
- Glazing is replaceable on site.

PRODUCT CODE	PRICE			SIZE/INCHES			WEIGHT LBS	VOL FT ³
	CLR	FRST		H	W	D		
EVPPGT5424M	778	949		54	24	2.875	70.8	3.38
EVPPGT5430M	849	1048		54	30	2.875	73.1	4.42
EVPPGT5436M	919	1144		54	36	2.875	85.5	5.11
EVPPGT5442M	992	1250		54	42	2.875	93.6	5.79
EVPPGT5448M	1067	1353		54	48	2.875	99.1	6.47
EVPPGT5454M	1144	1463		54	54	2.875	107	7.15
EVPPGT5460M	1210	1557		54	60	2.875	115.1	7.83
EVPPGT6624M	957	1188		66	24	2.875	78.63	4.38
EVPPGT6630M	1042	1309		66	30	2.875	86.52	4.79
EVPPGT6636M	1177	1498		66	36	2.875	92.66	5.38
EVPPGT6642M	1272	1630		66	42	2.875	98.19	6.38
EVPPGT6648M	1368	1766		66	48	2.875	105.48	7.68
EVPPGT6654M	1475	1915		66	54	2.875	112.52	8.5
EVPPGT6660M	1591	2076		66	60	2.875	129.3	9.33

EVPPHGT • Freestanding Segmented Glazed and Laminate Privacy Panels - Two Sides

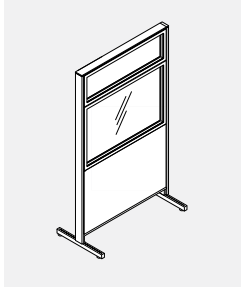

- 30" base panel with laminate faces both sides provides for durable and washable surfaces
- Available in standard clear (CLR) tempered glass
- Available in standard frosted (FRST) tempered glass
- 22"d T-Legs (9.5" extension on each side of panel)
- Glazing is replaceable on site.

PRODUCT CODE	PRICE		SIZE/INCHES			WEIGHT LBS	VOL FT ³
	CLR	FRST	H	W	D		
EVPPHGT5424	754	845	54	24	2.875	55.8	3.38
EVPPHGT5430	837	947	54	30	2.875	62.8	4.42
EVPPHGT5436	922	1051	54	36	2.875	69.3	5.11
EVPPHGT5442	1007	1152	54	42	2.875	74.1	5.79
EVPPHGT5448	1090	1251	54	48	2.875	83.1	6.47
EVPPHGT5454	1181	1360	54	54	2.875	89.4	7.15
EVPPHGT5460	1260	1454	54	60	2.875	95.5	7.83
EVPPHGT6624	932	1056	66	24	2.875	70.81	4.38
EVPPHGT6630	1031	1175	66	30	2.875	78.63	4.79
EVPPHGT6636	1162	1332	66	36	2.875	86.52	5.38
EVPPHGT6642	1262	1452	66	42	2.875	92.66	6.38
EVPPHGT6648	1364	1574	66	48	2.875	98.19	7.68
EVPPHGT6654	1480	1713	66	54	2.875	105.48	8.5
EVPPHGT6660	1617	1877	66	60	2.875	116.2	9.33

EVPPHGT-M • Mobile Segmented Glazed and Laminate Privacy Panels - Two Sides

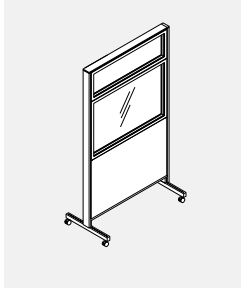

- 30" base panel with laminate faces both sides provides for durable and washable surfaces
- Available in standard clear (CLR) tempered glass
- Available in standard frosted (FRST) tempered glass
- 22"d T-Legs (9.5" extension on each side of panel)
- 1" locking casters
- Glazing is replaceable on site.

PRODUCT CODE	PRICE		SIZE/INCHES			WEIGHT LBS	VOL FT ³
	CLR	FRST	H	W	D		
EVPPHGT5424M	820	911	54	24	2.875	55.8	3.38
EVPPHGT5430M	903	1013	54	30	2.875	62.8	4.42
EVPPHGT5436M	988	1118	54	36	2.875	69.3	5.11
EVPPHGT5442M	1073	1218	54	42	2.875	74.1	5.79
EVPPHGT5448M	1157	1317	54	48	2.875	83.1	6.47
EVPPHGT5454M	1247	1427	54	54	2.875	89.4	7.15
EVPPHGT5460M	1326	1520	54	60	2.875	95.5	7.83
EVPPHGT6624M	998	1122	66	24	2.875	70.81	4.38
EVPPHGT6630M	1097	1241	66	30	2.875	78.63	4.79
EVPPHGT6636M	1228	1399	66	36	2.875	86.52	5.38
EVPPHGT6642M	1328	1518	66	42	2.875	92.66	6.38
EVPPHGT6648M	1430	1641	66	48	2.875	98.19	7.68
EVPPHGT6654M	1546	1779	66	54	2.875	105.48	8.5
EVPPHGT6660M	1683	1943	66	60	2.875	116.2	9.33

EVPPHGTU • Freestanding Segmented Glazed and Laminate Privacy Panels - Two Sides

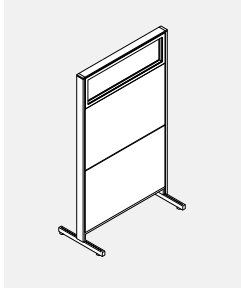

- Laminate faces both sides provides for durable and washable surfaces
- Available in standard clear (CLR) tempered glass
- Available in standard frosted (FRST) tempered glass
- 22"d T-Legs (9.5" extension on each side of panel)
- 12" Glazed segment
- Glazing is replaceable on site.

PRODUCT CODE	PRICE		SIZE/INCHES			WEIGHT LBS	VOL FT ³
	CLR	FRST	H	W	D		
EVPPHGTU5424	868	987	54	24	2.875	49.2	3.38
EVPPHGTU5430	965	1100	54	30	2.875	55.8	4.42
EVPPHGTU5436	1062	1220	54	36	2.875	62.8	5.11
EVPPHGTU5442	1159	1334	54	42	2.875	69.3	5.79
EVPPHGTU5448	1256	1451	54	48	2.875	74.1	6.47
EVPPHGTU5454	1362	1575	54	54	2.875	83.1	7.15
EVPPHGTU5460	1458	1693	54	60	2.875	89.4	7.83
EVPPHGTU6624	972	1104	66	24	2.875	53.34	4.38
EVPPHGTU6630	1085	1240	66	30	2.875	60.76	4.79
EVPPHGTU6636	1222	1405	66	36	2.875	68.18	5.38
EVPPHGTU6642	1332	1537	66	42	2.875	76.2	6.38
EVPPHGTU6648	1442	1670	66	48	2.875	87.76	7.68
EVPPHGTU6654	1569	1822	66	54	2.875	95.45	8.5
EVPPHGTU6660	1706	1986	66	60	2.875	99.7	9.33

EVPPHGTU-M • Mobile Segmented Glazed and Laminate Privacy Panels - Two Sides

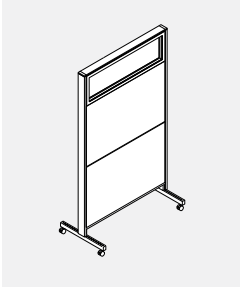

- Laminate faces both sides provides for durable and washable surfaces
- Available in standard clear (CLR) tempered glass
- Available in standard frosted (FRST) tempered glass
- 22"d T-Legs (9.5" extension on each side of panel)
- 1" locking casters
- 12" Glazed segment
- Glazing is replaceable on site.

PRODUCT CODE	PRICE		SIZE/INCHES			WEIGHT LBS	VOL FT ³
	CLR	FRST	H	W	D		
EVPPHGTU5424M	934	1054	54	24	2.875	49.2	3.38
EVPPHGTU5430M	1031	1166	54	30	2.875	55.8	4.42
EVPPHGTU5436M	1128	1286	54	36	2.875	62.8	5.11
EVPPHGTU5442M	1225	1400	54	42	2.875	69.3	5.79
EVPPHGTU5448M	1323	1517	54	48	2.875	74.1	6.47
EVPPHGTU5454M	1428	1642	54	54	2.875	83.1	7.15
EVPPHGTU5460M	1524	1759	54	60	2.875	89.4	7.83
EVPPHGTU6624M	1038	1170	66	24	2.875	53.34	4.38
EVPPHGTU6630M	1152	1306	66	30	2.875	60.76	4.79
EVPPHGTU6636M	1288	1471	66	36	2.875	68.18	5.38
EVPPHGTU6642M	1399	1604	66	42	2.875	76.2	6.38
EVPPHGTU6648M	1509	1736	66	48	2.875	87.76	7.68
EVPPHGTU6654M	1635	1888	66	54	2.875	95.45	8.5
EVPPHGTU6660M	1772	2052	66	60	2.875	99.7	9.33

EVPPH2S • Freestanding Segmented Laminate Privacy Panels - Two Sides

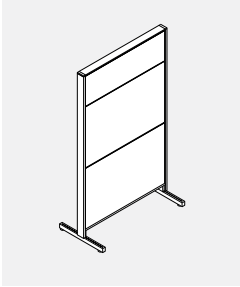

- All laminate faces both sides provides for durable and washable surfaces
- 22"d T-Legs (9.5" extension on each side of panel)

PRODUCT CODE	PRICE	SIZE/INCHES			WEIGHT LBS	VOL FT ³
		H	W	D		
EVPPH2S5424	794	54	24	2.875	50.8	3.38
EVPPH2S5430	891	54	30	2.875	56.2	4.42
EVPPH2S5436	993	54	36	2.875	60.4	5.11
EVPPH2S5442	1088	54	42	2.875	63.7	5.79
EVPPH2S5448	1181	54	48	2.875	71.2	6.47
EVPPH2S5454	1282	54	54	2.875	73.9	7.15
EVPPH2S5460	1373	54	60	2.875	80.4	7.83
EVPPH2S6624	961	66	24	2.875	62.8	4.38
EVPPH2S6630	1088	66	30	2.875	69.3	4.79
EVPPH2S6636	1230	66	36	2.875	76.8	5.38
EVPPH2S6642	1353	66	42	2.875	82.1	6.38
EVPPH2S6648	1472	66	48	2.875	88	7.68
EVPPH2S6654	1597	66	54	2.875	93.7	8.5
EVPPH2S6660	1730	66	60	2.875	95.2	9.33

EVPPH2S-M • Mobile Segmented Laminate Privacy Panels - Two Sides

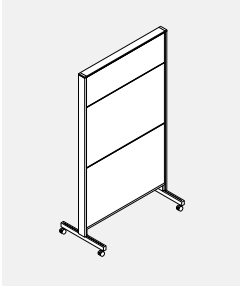

- All laminate faces both sides provides for durable and washable surfaces
- Includes panel with two connectors with T legs with castors and end of run trims
- 22"d T-Legs (9.5" extension on each side of panel)
- 1" locking casters

PRODUCT CODE	PRICE	SIZE/INCHES			WEIGHT LBS	VOL FT ³
		H	W	D		
EVPPH2S5424M	860	54	24	2.875	50.8	3.38
EVPPH2S5430M	957	54	30	2.875	56.2	4.42
EVPPH2S5436M	1059	54	36	2.875	60.4	5.11
EVPPH2S5442M	1154	54	42	2.875	63.7	5.79
EVPPH2S5448M	1247	54	48	2.875	71.2	6.47
EVPPH2S5454M	1349	54	54	2.875	73.9	7.15
EVPPH2S5460M	1439	54	60	2.875	80.4	7.83
EVPPH2S6624M	1029	66	24	2.875	62.8	4.38
EVPPH2S6630M	1154	66	30	2.875	69.3	4.79
EVPPH2S6636M	1297	66	36	2.875	76.8	5.38
EVPPH2S6642M	1419	66	42	2.875	82.1	6.38
EVPPH2S6648M	1539	66	48	2.875	88	7.68
EVPPH2S6654M	1663	66	54	2.875	93.7	8.5
EVPPH2S6660M	1796	66	60	2.875	95.2	9.33

EVPPF2W • Freestanding Segmented Write Board Privacy Panels

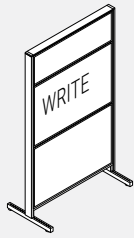

- Writing surface is built into the top module on both sides of the panel, alleviating the need for a panel-mounted Writeboard.
- Use of erasable Writeboard markers only.
- 22"d T-Legs (9.5" extension on each side of panel)

PRODUCT CODE	PRICE		SIZE/INCHES			WEIGHT LBS	VOL FT ³
	GR1	GR2	H	W	D		
EVPPF2W5424	767	782	54	24	2.875	49.8	3.38
EVPPF2W5430	859	879	54	30	2.875	55.2	4.42
EVPPF2W5436	952	971	54	36	2.875	59.4	5.11
EVPPF2W5442	1042	1068	54	42	2.875	62.7	5.79
EVPPF2W5448	1147	1176	54	48	2.875	70.2	6.47
EVPPF2W5454	1246	1290	54	54	2.875	74.9	7.15
EVPPF2W5460	1335	1373	54	60	2.875	79.4	7.83
EVPPF2W6624	927	942	66	24	2.875	57.8	4.38
EVPPF2W6630	1086	1106	66	30	2.875	62.8	4.79
EVPPF2W6636	1224	1246	66	36	2.875	69.3	5.38
EVPPF2W6642	1352	1376	66	42	2.875	76.8	6.38
EVPPF2W6648	1492	1520	66	48	2.875	82.1	7.68
EVPPF2W6654	1620	1664	66	54	2.875	88	8.5
EVPPF2W6660	1782	1813	66	60	2.875	98.3	9.33

EVPPF2W-M • Mobile Segmented Write Board Privacy Panels

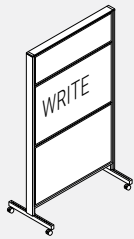

- Writing surface is built into the top module on both sides of the panel, alleviating the need for a panel-mounted Writeboard.
- Use of erasable Writeboard markers only.
- 22"d T-Legs (9.5" extension on each side of panel)
- 1" locking casters

PRODUCT CODE	PRICE		SIZE/INCHES			WEIGHT LBS	VOL FT ³
	GR1	GR2	H	W	D		
EVPPF2W5424M	833	849	54	24	2.875	49.8	3.38
EVPPF2W5430M	926	945	54	30	2.875	55.2	4.42
EVPPF2W5436M	1018	1037	54	36	2.875	59.4	5.11
EVPPF2W5442M	1109	1134	54	42	2.875	62.7	5.79
EVPPF2W5448M	1214	1242	54	48	2.875	70.2	6.47
EVPPF2W5454M	1312	1356	54	54	2.875	74.9	7.15
EVPPF2W5460M	1401	1439	54	60	2.875	79.4	7.83
EVPPF2W6624M	993	1008	66	24	2.875	57.8	4.38
EVPPF2W6630M	1153	1173	66	30	2.875	62.8	4.79
EVPPF2W6636M	1290	1312	66	36	2.875	69.3	5.38
EVPPF2W6642M	1418	1442	66	42	2.875	76.8	6.38
EVPPF2W6648M	1558	1586	66	48	2.875	82.1	7.68
EVPPF2W6654M	1686	1731	66	54	2.875	88	8.5
EVPPF2W6660M	1849	1879	66	60	2.875	98.3	9.33

EVPPH2W • Freestanding Segmented Write Board and Laminate Privacy Panels



- 30" base panel with laminate faces both sides provides for durable and washable surfaces
- Writing surface is built into upper modules on both sides of the panel, alleviating the need for a panel-mounted Writeboard.
- Use of erasable Writeboard markers only.
- 22"d T-Legs (9.5" extension on each side of panel)

PRODUCT CODE	PRICE		SIZE/INCHES			WEIGHT LBS	VOL FT ³
	GR1	GR2	H	W	D		
EVPPH2W5424	843		54	24	2.875	50.8	3.38
EVPPH2W5430	953		54	30	2.875	56.2	4.42
EVPPH2W5436	1067		54	36	2.875	60.4	5.11
EVPPH2W5442	1174		54	42	2.875	63.7	5.79
EVPPH2W5448	1277		54	48	2.875	71.2	6.47
EVPPH2W5454	1392		54	54	2.875	73.9	7.15
EVPPH2W5460	1495		54	60	2.875	80.4	7.83
EVPPH2W6624	994		66	24	2.875	62.8	4.38
EVPPH2W6630	1179		66	30	2.875	69.34	4.79
EVPPH2W6636	1348		66	36	2.875	76.8	5.38
EVPPH2W6642	1483		66	42	2.875	82.09	6.38
EVPPH2W6648	1623		66	48	2.875	88	7.68
EVPPH2W6654	1766		66	54	2.875	93.73	8.5
EVPPH2W6660	1914		66	60	2.875	95.2	9.33

EVPPH2W-M • Mobile Segmented Write Board and Laminate Privacy Panels



- 30" base panel with laminate faces both sides provides for durable and washable surfaces
- Writing surface is built into upper modules on both sides of the panel, alleviating the need for a panel-mounted Writeboard.
- Use of erasable Writeboard markers only.
- 22"d T-Legs (9.5" extension on each side of panel)

PRODUCT CODE	PRICE		SIZE/INCHES			WEIGHT LBS	VOL FT ³
	GR1	GR2	H	W	D		
EVPPH2W5424M	909		54	24	2.875	50.8	3.38
EVPPH2W5430M	1019		54	30	2.875	56.2	4.42
EVPPH2W5436M	1133		54	36	2.875	60.4	5.11
EVPPH2W5442M	1240		54	42	2.875	63.7	5.79
EVPPH2W5448M	1343		54	48	2.875	71.2	6.47
EVPPH2W5454M	1458		54	54	2.875	73.9	7.15
EVPPH2W5460M	1561		54	60	2.875	80.4	7.83
EVPPH2W6624M	1060		66	24	2.875	62.8	4.38
EVPPH2W6630M	1246		66	30	2.875	69.34	4.79
EVPPH2W6636M	1414		66	36	2.875	76.8	5.38
EVPPH2W6642M	1549		66	42	2.875	82.09	6.38
EVPPH2W6648M	1689		66	48	2.875	88	7.68
EVPPH2W6654M	1833		66	54	2.875	93.73	8.5
EVPPH2W6660M	1980		66	60	2.875	95.2	9.33

EVPRGLA • Acoustic Grid - 60" wide

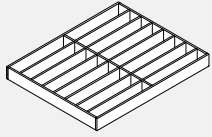

Configuration: 30" - 30"

- PET felt Acoustic Grid to be installed on top of Evolve panels.
- Acoustic Grid kit includes felt pieces, aluminum channel and all necessary hardware.
- PET felt slats run from side to side.
- PET felt pieces available in standard PET felt colours.
- Top trim with channel and beam above opening to be ordered separately.
- Shipped KD.
- For a different felt color for the outer PET frame, choose the code with a D at the end.

PRODUCT CODE	PRICE	SIZE/INCHES			WEIGHT LBS	VOL FT³
		H	W	D		
EVPRGLA4860	1918	5.5	60	48	18.25	9.2
EVPRGLA6060	2274	5.5	60	60	19.02	11.5
EVPRGLA7260	2630	5.5	60	72	22.04	13.8
EVPRGLA8460	2984	5.5	60	84	25.06	16.0
EVPRGLA9060	3163	5.5	60	90	26.57	17.2
EVPRGLA9660	3367	5.5	60	96	28.29	18.3
EVPRGLA4860D	1918	5.5	60	48	18.25	9.2
EVPRGLA6060D	2274	5.5	60	60	19.02	11.5
EVPRGLA7260D	2630	5.5	60	72	22.04	13.8
EVPRGLA8460D	2984	5.5	60	84	25.06	16.0
EVPRGLA9060D	3163	5.5	60	90	26.57	17.2
EVPRGLA9660D	3367	5.5	60	96	28.29	18.3

EVPRGLA • Acoustic Grid - 72" wide

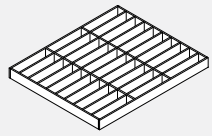

Configuration: 24" - 24" - 24"

- PET felt Acoustic Grid to be installed on top of Evolve panels.
- Acoustic Grid kit includes felt pieces, aluminum channel and all necessary hardware.
- PET felt slats run from side to side.
- PET felt pieces available in standard PET felt colours.
- Top trim with channel and beam above opening to be ordered separately.
- Shipped KD.
- For a different felt color for the outer PET frame, choose the code with a D at the end.

PRODUCT CODE	PRICE	SIZE/INCHES			WEIGHT LBS	VOL FT³
		H	W	D		
EVPRGLA4872	2309	5.5	72	48	20.10	11.0
EVPRGLA6072	2739	5.5	72	60	23.96	13.8
EVPRGLA7272	3168	5.5	72	72	27.81	16.5
EVPRGLA8472	3597	5.5	72	84	31.67	19.3
EVPRGLA9072	3813	5.5	72	90	33.60	20.6
EVPRGLA9672	4054	5.5	72	96	35.75	22.0
EVPRGLA4872D	2309	5.5	72	48	20.10	11.0
EVPRGLA6072D	2739	5.5	72	60	23.96	13.8
EVPRGLA7272D	3168	5.5	72	72	27.81	16.5
EVPRGLA8472D	3597	5.5	72	84	31.67	19.3
EVPRGLA9072D	3813	5.5	72	90	33.60	20.6
EVPRGLA9672D	4054	5.5	72	96	35.75	22.0

EVPRGLA • Acoustic Grid - 84" wide

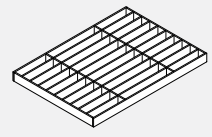

Configuration: 24" - 36" - 24"

- PET felt Acoustic Grid to be installed on top of Evolve panels.
- Acoustic Grid kit includes felt pieces, aluminum channel and all necessary hardware.
- PET felt slats run from side to side.
- PET felt pieces available in standard PET felt colours.
- Top trim with channel and beam above opening to be ordered separately.
- Shipped KD.
- For a different felt color for the outer PET frame, choose the code with a D at the end.

PRODUCT CODE	PRICE	SIZE/INCHES			WEIGHT LBS	VOL FT³
		H	W	D		
EVPRGLA4884	2580	5.5	84	48	22.15	12.8
EVPRGLA6084	3055	5.5	84	60	26.35	16.0
EVPRGLA7284	3530	5.5	84	72	30.54	19.3
EVPRGLA8484	4004	5.5	84	84	34.74	22.5
EVPRGLA9084	4241	5.5	84	90	36.83	24.1
EVPRGLA9684	4505	5.5	84	96	39.14	25.7
EVPRGLA4884D	2580	5.5	84	48	22.15	12.8
EVPRGLA6084D	3055	5.5	84	60	26.35	16.0
EVPRGLA7284D	3530	5.5	84	72	30.54	19.3
EVPRGLA8484D	4004	5.5	84	84	34.74	22.5
EVPRGLA9084D	4241	5.5	84	90	36.83	24.1
EVPRGLA9684D	4505	5.5	84	96	39.14	25.7

EVPRGLA • Acoustic Grid - 90" wide

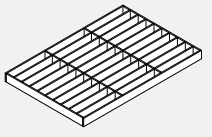

Configuration: 30" - 30" - 30"

- PET felt Acoustic Grid to be installed on top of Evolve panels.
- Acoustic Grid kit includes felt pieces, aluminum channel and all necessary hardware.
- PET felt slats run from side to side.
- PET felt pieces available in standard PET felt colours.
- Top trim with channel and beam above opening to be ordered separately.
- Shipped KD.
- For a different felt color for the outer PET frame, choose the code with a D at the end.

PRODUCT CODE	PRICE	SIZE/INCHES			WEIGHT LBS	VOL FT³
		H	W	D		
EVPRGLA4890	2679	5.5	90	48	23.27	13.8
EVPRGLA6090	3176	5.5	90	60	27.65	17.2
EVPRGLA7290	3674	5.5	90	72	30.04	20.6
EVPRGLA8490	4171	5.5	90	84	36.42	24.1
EVPRGLA9090	4420	5.5	90	90	38.62	25.8
EVPRGLA9690	4696	5.5	90	96	41.01	27.5
EVPRGLA4890D	2679	5.5	90	48	23.27	13.8
EVPRGLA6090D	3176	5.5	90	60	27.65	17.2
EVPRGLA7290D	3674	5.5	90	72	30.04	20.6
EVPRGLA8490D	4171	5.5	90	84	36.42	24.1
EVPRGLA9090D	4420	5.5	90	90	38.62	25.8
EVPRGLA9690D	4696	5.5	90	96	41.01	27.5

EVPRGLA • Acoustic Grid - 96" wide

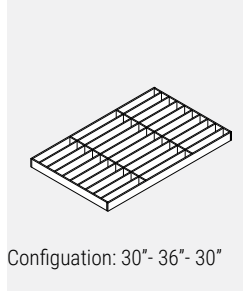

Configuration: 30"- 36"- 30"

- PET felt Acoustic Grid to be installed on top of Evolve panels.
- Acoustic Grid kit includes felt pieces, aluminum channel and all necessary hardware.
- PET felt slats run from side to side.
- PET felt pieces available in standard PET felt colours.
- Top trim with channel and beam above opening to be ordered separately.
- Shipped KD.
- For a different felt color for the outer PET frame, choose the code with a D at the end.

PRODUCT CODE	PRICE	SIZE/INCHES			WEIGHT		VOL
		H	W	D	LBS	FT ³	
EVPRGLA4896	2877	5.5	96	48	24.47	14.7	
EVPRGLA6096	3398	5.5	96	60	29.02	18.3	
EVPRGLA7296	3918	5.5	96	72	33.56	22.0	
EVPRGLA8496	4437	5.5	96	84	38.11	25.7	
EVPRGLA9096	4698	5.5	96	90	40.38	27.5	
EVPRGLA9696	4983	5.5	96	96	42.86	29.3	
EVPRGLA4896D	2877	5.5	96	48	24.47	14.7	
EVPRGLA6096D	3398	5.5	96	60	29.02	18.3	
EVPRGLA7296D	3918	5.5	96	72	33.56	22.0	
EVPRGLA8496D	4437	5.5	96	84	38.11	25.7	
EVPRGLA9096D	4698	5.5	96	90	40.38	27.5	
EVPRGLA9696D	4983	5.5	96	96	42.86	29.3	

EVPRGLA • Acoustic Grid - 144" wide

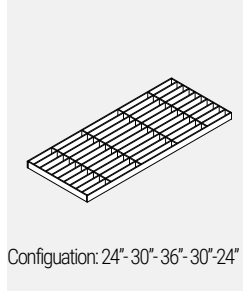

Configuration: 24"- 30"- 36"- 30"- 24"

- PET felt Acoustic Grid to be installed on top of Evolve panels.
- Acoustic Grid kit includes felt pieces, aluminum channel and all necessary hardware.
- PET felt slats run from side to side.
- PET felt pieces available in standard PET felt colours.
- Top trim with channel and beam above opening to be ordered separately.
- Shipped KD.
- For a different felt color for the outer PET frame, choose the code with a D at the end.

PRODUCT CODE	PRICE	SIZE/INCHES			WEIGHT		VOL
		H	W	D	LBS	FT ³	
EVPRGLA120144	7432	6	144	120	73.86	55.0	
EVPRGLA120144D	7432	6	144	120	73.86	55.0	

STEP BY STEP SPECIFICATION • 8 WIRE ELECTRICAL SYSTEM

Step 1 Determine the location of the power source entering the panel run.

1. At the base of the panel.
 - a) Use EVE8FR Reversible Floor Power Entry (default to EVE8FR).
 - b) Select the panel to which the Floor Power Entry will be attached. This panel requires an EVE8PD Power Distribution Housing.
 - c) Select the side of the panel and the receptacle outlet to which the Floor Power Entry is to be attached.
2. From the ceiling.
 - a) Use EVE8EC1 Ceiling Power Entry.
 - b) Select the post through which to feed the Ceiling Power Entry.
 - c) One panel adjacent to the selected post requires an EVE8PD Power Distribution Housing.
 - d) Attach Ceiling Power entry to the nearest end of the Power Distribution Housing.

Step 2 Determine which panels are to be powered.

1. Use EVE8PD Power Distribution Housing that corresponds with the width of the panel.

Step 3 Connect power to the powered panels.

1. Use EVE8CP16 Jumper Cable between two adjacent powered panels.
2. Use EVE8CP20 Jumper Cable between two adjacent powered panels separated by a post.

3. Use EVE8CP Pass-Through Cables to connect powered panels that are separated by one or more non-powered panels (maximum distance between the powered panels is 12 feet).

- a) The length of the Pass-Through Cable is calculated by adding together the widths of the non-powered panels that separate the two powered panels and applying an additional 16" to the total. (EVE8PD Power Distribution Housing is positioned 8" in from the ends of the powered panel.)
- b) An additional 4" must be added to the Pass-Through Cable for each post that the cable passes through.

4. From the price list, select the EVE8CP Pass-Through Cable that matches the calculated length. If the length is between listed sizes, use the next size up.

Step 4 Determine the location and circuitry of the receptacles.

1. Each powered panel has four (4) potential locations for EVE8RD Duplex Receptacles – 2 per side. (Exception: 24" wide panel has only two potential locations – 1 per side, 18" wide panel has no locations for receptacles.)

2. At each receptacle location there is a choice of four (4) circuit options.

Select a circuit option for each location.

Circuits one and two are utility circuits; circuits A and B are dedicated circuits.

DEFINITION OF COMPONENTS**Power Distribution Housing**

Power Distribution Housing must be specified for each panel where power is required. Order a power kit for the panel width requiring power. The kit is field installed.

Jumper Cable

A Jumper Cable must be ordered to connect two powered panels. The EVE8CP16 connects two powered panels. The EVE8CP20 connects two powered panels with a 90° connector post between the panels (two-way, three-way, four-way configurations).

A Pass-Through Cable

A Pass-Through Cable allows cables to be passed from a powered panel through one or more non-powered panels (panels that do not require electrical outlets) to connect to another powered panel. (See Step-by-Step Specification for details.)

Duplex Receptacles

Duplex Receptacles snap into place in the power housing. Four circuits may be specified. Circuits A and B are dedicated. Up to two duplexes per side may be installed in a power way for panels 30" and wider. 24" panels will accept one Duplex Receptacle per side. 18" panels will not accept Duplex Receptacles.

Power Entry

To power an Evolve panel, order either a floor power entry or a ceiling power entry. A floor power entry module will take the place of a duplex receptacle by snapping into the base power way.

Desktop Data/Power Receptacle

This module is positioned in the scoop of an Evolve worksurface and provides two simplex plugs and two voice/data ports or two simplex plugs only and two voice data only. A 6 foot power cord can be plugged into a powered Evolve raceway.

WIRE SCHEMATIC

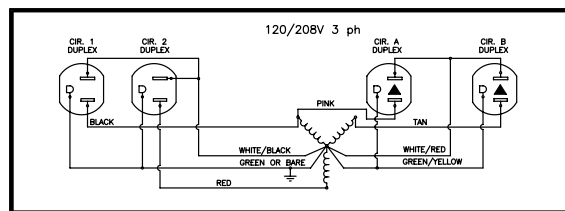
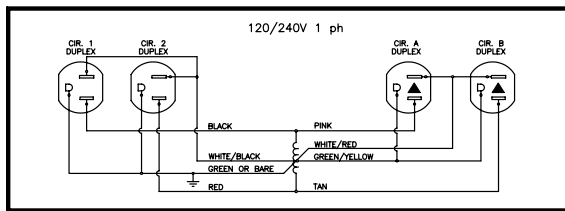

4-2-2 Wiring Schematic
8-Wire Shared Neutral
"2+2" – 2 Utility circuits, 2 dedicated

8 Wires

4 Lines (12 ga.)
2 Neutrals (10 ga.)
2 Grounds (12 ga.)

4 Circuits

2 Utility Circuits
2 Dedicated Circuits

Receptacles

Duplex – Up to 6 receptacles per circuit (Up to 48 infeed)

Specifications

System rated for connection to a grounded 120/240 V, single phase, 20A, 60Hz or 120/208 V, 3 phase, 20A, 60Hz branch circuit for U.S. and 15A if product is marked with a C-UL Mark. Outlets rated 15A max.

UL RECOGNIZED AND CSA CERTIFIED

Warning: It is recommended that installation of the electrical harness be made under the supervision of a licensed electrician in accordance with applicable codes and regulations.

Special Note: Always determine that harness is electrically connected to only one power supply.

COMPONENTS REQUIRED

- a) EVE8PD42 • Power Distribution Housing
Note: 8 wire, 4 circuits (A and B circuits access dedicated circuits).
- b) EVE8CP16 • Jumper Cable
Note: EVE8CP16 connects two powered panels positioned side by side. EVE8CP20 connects two powered panels separated by a post.
- c) EVE8RD • Duplex Receptacle
Note: 1 and 2 access utility circuits.
- d) EVE8CP • Pass-Through Cable
Note: An "I" connector is available to connect 2 Pass-Through Cables.

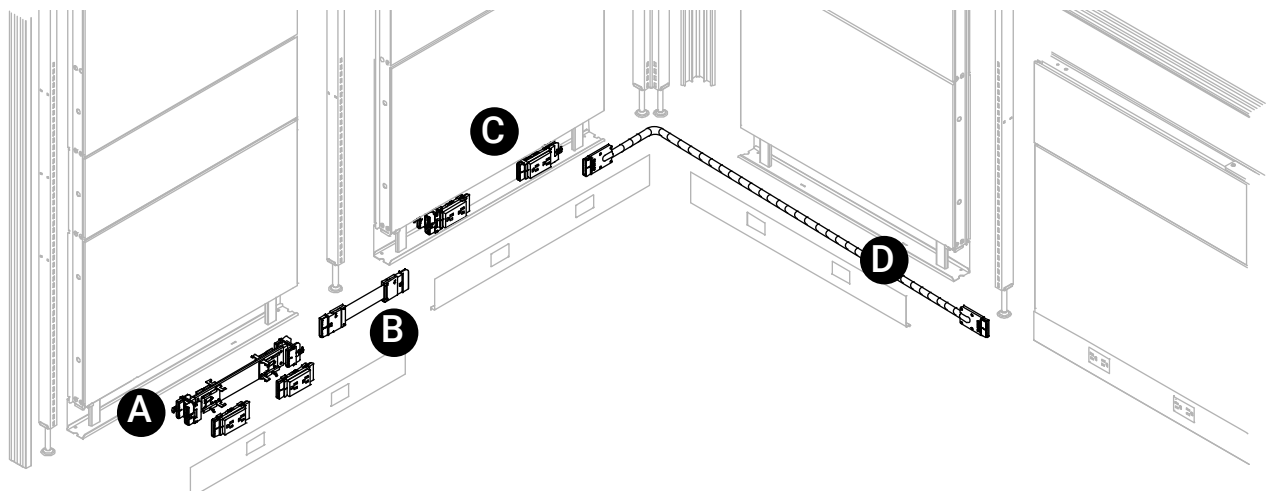

EVE8CI-1 • "I" Connector

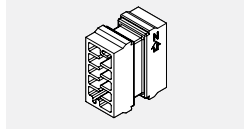

- Female - Female connector used to connect two Pass-Through Cables.

PRODUCT CODE	PRICE	SIZE/ H	INCHES W	D	WEIGHT LBS	VOL FT ³
EVE8CI-1	77	15	15	0.75	0.06	0.20

EVE8RD • Duplex Receptacles

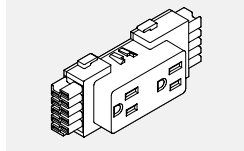

- Up to 6 duplex receptacles per circuit.
- EVE8RD1 = Circuit #1 (utility circuit)
- EVE8RD2 = Circuit #2 (utility circuit)
- EVE8RDA = Circuit #A (dedicated)
- EVE8RDB = Circuit #B (dedicated)

PRODUCT CODE	PRICE	SIZE/ H	INCHES W	D	WEIGHT LBS	VOL FT ³
EVE8RD1	32	2	4.625	1.25	0.16	0.01
EVE8RD2	32	2	4.625	1.25	0.16	0.01
EVE8RDA	32	2	4.625	1.25	0.16	0.01
EVE8RDB	32	2	4.625	1.25	0.16	0.01

EVEUSB01 • Duplex Receptacles

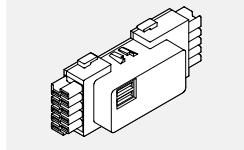

- The USB charging module provides convenient charging power access through dual ports on face of the receptacle.
- Two USB ports.
- 2 Amp output via two USB ports, considered as circuit #1.
- Available in white, black.

PRODUCT CODE	PRICE	SIZE/ H	INCHES W	D	WEIGHT LBS	VOL FT ³
EVEUSB01WHT	216	2	4.625	1.25	0.16	0.01
EVEUSB01BLK	207	2	4.625	1.25	0.16	0.01

EVE8RDx-20 • Duplex Receptacles, 20AMP

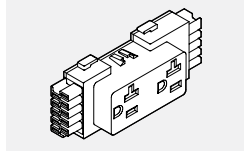

- Up to 6 receptacles per circuit (24 per infeed) not to exceed total 20 Amps per circuit.
- EVE8RD1 = Circuit #1 (utility circuit)
- EVE8RD2 = Circuit #2 (utility circuit)
- EVE8RDA = Circuit #A (dedicated)
- EVE8RDB = Circuit #B (dedicated)

PRODUCT CODE	PRICE	SIZE/ H	INCHES W	D	WEIGHT LBS	VOL FT ³
EVE8RD1-20	36	2	4.625	1.25	0.16	0.01
EVE8RD2-20	36	2	4.625	1 1/4	0.16	0.01
EVE8RDA-20	36	2	4.625	1 1/4	0.16	0.01
EVE8RDB-20	36	2	4.625	1 1/4	0.16	0.01

EVE8FR1 • Reversible Floor Power Entry

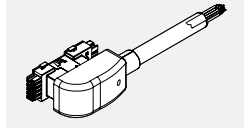

- Takes the place of a duplex receptacle by snapping into the base power way.
- Includes 72" long liquid-tight conduit.
- Must be hard wired to source power by a licenced electrician.

PRODUCT CODE	PRICE	SIZE/ L	INCHES W	WEIGHT LBS	VOL FT ³
EVE8FR1	321	72	72	3.82	2.00

EVE8FR2 • Reversible Floor Power Entry

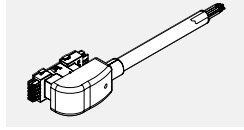

- Takes the place of a duplex receptacle by snapping into the base power way.
- Includes 144" long liquid-tight conduit.
- Must be hard wired to source power by a licenced electrician.

PRODUCT CODE	PRICE	SIZE/ L	INCHES W	WEIGHT LBS	VOL FT ³
EVE8FR2	413	144	144	6.98	2.00

EVE8FP • Floor Power Supply

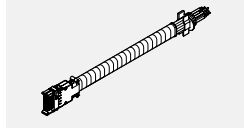

- Snaps in end of power distribution housing
- Includes flexible vinyl conduit
- Must be hard wired to source by licensed electrician
- Diameter is 0,85"

PRODUCT CODE	PRICE	SIZE/ L	INCHES W	WEIGHT LBS	VOL FT ³
EVE8F1P	321	72	72	3.82	2
EVE8F2P	413	144	144	6.98	2

EVE8PD • Power Distribution Housing

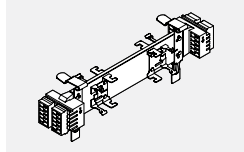

- Power housing is specified per panel size. eg. EVE8PD36 is for use with a 36" panel.
- 8 wire, 4 circuits (A and B circuits are dedicated).
- Provides two duplex receptacles per panel side on all panel widths above the 24" wide panel.
- 24" wide panel allows for only one (1) duplex receptacle per panel side.

PRODUCT CODE	PRICE	SIZE/ W	INCHES W	WEIGHT LBS	VOL FT ³
EVE8PD24	142	9.25	9.25	0.83	1.17
EVE8PD30	189	15.25	15.25	1.28	1.17
EVE8PD36	200	21.25	21.25	1.62	1.65
EVE8PD42	205	27.25	27.25	2.00	2.00
EVE8PD48	216	33.25	33.25	0.18	0.16
EVE8PD54	220	39.25	39.25	2.66	3.20
EVE8PD60	221	45.25	45.25	3.04	3.20
EVE8PD66	230	51.25	51.25	3.49	3.25
EVE8PD72	238	57.20	57.20	3.76	3.30

EVE8CT • Transition Cable

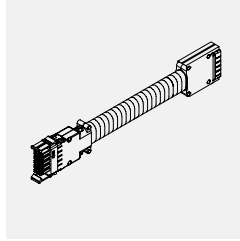

- The EVE8CT16 electrically connects an EVEPD Power Distribution Housing (pre-April 1, 2005) to an EVE8PD Power Distribution Housing when connecting powered panels that are positioned side by side.
- The EVE8CT20 electrically connects an EVEPD Power Distribution Housing (pre-April 1, 2005) to an EVE8PD Power Distribution Housing when connecting powered panels that are separated by a post.
- If there is one or more pass-through panels that contain the old Power Distribution Housing (pre-April 1, 2005) and a panel that contains the new Power Distribution Housing, then an EVE9CI-1 "I" Connector can be attached to the Transition Jumper Cable. This allows for the addition of an appropriate EVE8CP Pass-Through Cable to span the gap between the EVE8CT Transition Cable and the EVE8PD Power Distribution Housing.

PRODUCT CODE	PRICE	SIZE/ L	INCHES L	WEIGHT LBS	VOL FT ³
EVE8CT16	116	16	16	0.78	1.17
EVE8CT20	134	20	20	0.92	1.17

EVE8CP • Jumper Cable

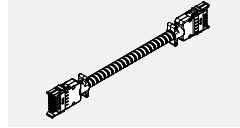

- The EVE8CP16 electrically connects two powered panels positioned side by side.
- The EVE8CP20 electrically connects two powered panels separated by a post.

PRODUCT CODE	PRICE	SIZE/ L	INCHES L	WEIGHT LBS	VOL FT ³
EVE8CP16	116	16	16	0.66	1.17
EVE8CP20	134	20	20	0.78	1.17

EVE8CP-H • Hybrid Pass Through Cables with Wire Mesh

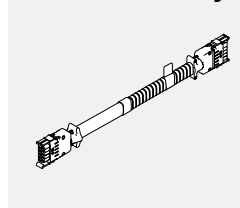

- Flexible metal conduit with wire mesh distributes electrical power through non powered panels.
- To calculate the length of Hybrid Pass Through Cable, add the width of non powered panels separating the powered panels. To this add 16" (distance from edge of the panels to power distribution housing x2).
- Please add an additional 3" when passing through a post. Please see the beginning of this section.
- Hybrid Pass Through Cables with wire mesh allows connection at 90 degree post and one end for Power Beam.

PRODUCT CODE	PRICE	SIZE/INCHES			WEIGHT LBS	VOL FT ³
		H	W	D		
EVE8CP40-H	178		40		1.44	1.17
EVE8CP46-H	185		46		1.71	1.17
EVE8CP52-H	193		52		1.95	1.17
EVE8CP58-H	205		58		2.21	1.17
EVE8CP64-H	214		64		2.37	1.17
EVE8CP70-H	218		70		2.60	1.17
EVE8CP76-H	222		76		2.81	1.17
EVE8CP82-H	232		82		3.03	1.17
EVE8CP88-H	240		88		3.05	1.17
EVE8CP94-H	248		94		3.42	1.17
EVE8CP100-H	255		100		3.47	1.17
EVE8CP106-H	265		106		3.87	1.17
EVE8CP118-H	281		118		4.08	1.17
EVE8CP130-H	306		130		4.73	1.17
EVE8CP142-H	319		142		4.89	1.17

EVE8CP • Pass Through Cable

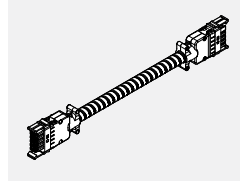

- Flexible metal conduit is used to distribute electrical power through non-powered panels.
- To calculate the length of a Pass-Through Cable, add the widths of the non-powered panels separating the powered panels (panels with distribution housing attached). To this, add 16" (distance from the edge of the panel to the distribution housing x 2). See Technical Information page at the beginning of this section.

PRODUCT CODE	PRICE	SIZE/ L	INCHES L	WEIGHT LBS	VOL FT ³
EVE8CP40	149	40	40	1.44	1.17
EVE8CP46	154	46	46	1.71	1.17
EVE8CP52	161	52	52	1.95	1.17
EVE8CP58	171	58	58	2.21	1.17
EVE8CP64	178	64	64	2.37	1.17
EVE8CP70	182	70	70	2.60	1.17
EVE8CP76	185	76	76	2.81	1.17
EVE8CP82	194	82	82	3.03	1.17
EVE8CP88	200	88	88	3.05	1.17
EVE8CP94	207	94	94	3.92	1.17
EVE8CP100	212	100	100	3.47	1.17
EVE8CP106	221	106	106	3.87	1.17
EVE8CP118	234	118	118	4.08	1.17
EVE8CP130	255	130	130	4.73	1.17
EVE8CP142	266	142	142	4.59	1.17

EVH8RC • Raceway Covers

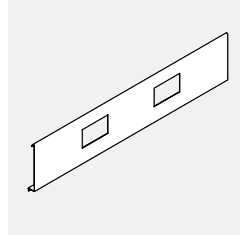

- Raceway Covers with 1.35 x 2.68" duplex receptacle openings.
- Includes 2 receptacle opening shields.
- Raceway Covers are sold individually.
- Used when adding to existing panel installation ordered prior to April 1, 2005.

PRODUCT CODE	PRICE	SIZE/ INCHES		WEIGHT LBS	VOL FT ³
		H	W		
EVH8RC24	29	6	24	1.00	0.11
EVH8RC30	36	6	30	1.10	0.12
EVH8RC36	40	6	36	1.20	0.13
EVH8RC42	47	6	42	1.30	0.14
EVH8RC48	56	6	48	1.40	0.15
EVH8RC54	64	6	54	1.40	0.15
EVH8RC60	66	6	60	1.50	0.16

EVB8RA • Raceway Opening Adapter

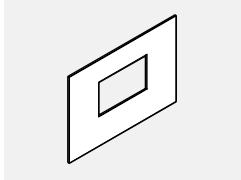

- Used when using new electrical and adding to existing panel installation ordered prior to April 1, 2005.
- PVC Adapter reduces the size of the Duplex Receptacle opening to accommodate the new style Duplex Receptacles.
- Pressure fits inside existing (old style) Raceway Cover.
- Opening size is 1.35" x 2.68".
- Sold in packs of 12, black only.

PRODUCT CODE	PRICE	SIZE/	INCHES	WEIGHT	VOL
			W	LBS	FT ³
EVB8RA01	90		16	0.01	0.01

EVE8EC • Ceiling Power Entry

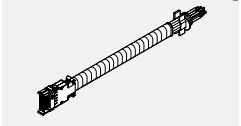

- Snaps into the end of Power Distribution Housing.
- Flexible metal conduit extends into the ceiling through a corner post and post extension (both ordered separately).
- Must be hard wired to source power by a licensed electrician.
- 4" Junction Box included.

PRODUCT CODE	PRICE	SIZE/	INCHES	WEIGHT	VOL
		L	LBS	FT ³	
EVE8EC1	244		132	5.24	2.00
EVE8EC2	435		144	5.96	2.00

EVDPE • Post Extension Data/Comm Lay-in

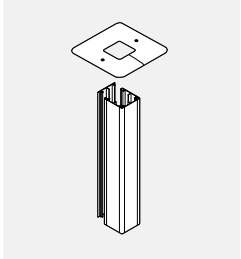

- Attaches to the top of a post to bring power and/or data cables from the ceiling to panel power way.
- Three-sided power pole with snap-on fourth side.
- Post extension can be opened on one side for lay-in for power and/or data cables.
- Made of aluminum and can be field cut.
- Accommodates up to 25 CAT5 cables with electric. Accommodates up to 45 CAT5 cables without electric.
- Ceiling infeed installed on one way post with T Leg requires securing post with two Floor mount plates.
- Post extension bigger than 82" is made of two parts.

PRODUCT CODE	PRICE	SIZE/	INCHES	WEIGHT	VOL
		H	W	LBS	FT ³
EVDPE64	155	64	2.875	3.00	0.70
EVDPE82	191	82	2.875	4.20	0.80
EVDPE88	293	88	2.875	4.50	0.85
EVDPE94	314	94	2.875	4.80	0.92
EVDPE100	334	100	2.875	5.12	0.97

EVDP4E • 45° Post Extension Data/Comm Lay-in

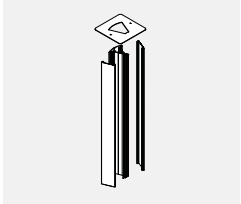

- Attached to the top of the 45° Corner Post to bring power and/or data cables from the ceiling to the panel run through.
- Cable Capacity
 - 40 CAT5 cables without electric feed.
 - 10 CAT5 cables with electric feed.

PRODUCT CODE	PRICE	SIZE/	INCHES	WEIGHT	VOL
		H	W	LBS	FT ³
EVDP4E64	157	64	3.65	3.00	0.70
EVDP4E82	212	82	3.65	4.20	0.80

EVDP6E • 60° Post Extension Data/Comm Lay-in

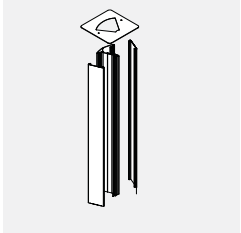

- Attached to the top of the 60° Corner Post to bring power and/or data cables from the ceiling to the panel run through.
- Post extension can be opened on one side for lay-in power and/or data cables.
- Made of aluminum and can be field cut.
- Two sided power pole with snap-on third side.
- Cable Capacity
 - 32 CAT5 cables without electric.
 - 15 CAT5 cables with electric

PRODUCT CODE	PRICE	SIZE/	INCHES	WEIGHT	VOL
		H	W	LBS	FT ³
EVDP6E64	152	64	2	3.00	0.70
EVDP6E82	186	82	2	4.20	0.80

EVEJBC1 • Hardwire Junction Box

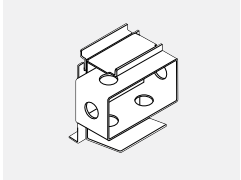

- Provides economical single circuit capability.
- Can be used in addition to 8 wire system to support isolated hospital power.
- Can be retrofitted in any size of panel at the receptacle location.
- Gives access from one side only at each location.
- Customer to supply conduit, wiring, receptacle, and face plate.
- A licensed electrician must provide hardwire connection with the junction box.

PRODUCT CODE	PRICE	WEIGHT	VOL
		LBS	FT ³
EVEJBC1	95	1.50	0.02

Power Beam

- All metal components are painted with environmentally friendly epoxy powder.
- Raceway interiors are coated with recycled epoxy powder.
- The entire Evolve Power Beam and the processes used to manufacture it are designed to save and protect the environment. Evolve panels are made from recycled materials and are 100% recyclable.
- Components conform to CGSB and ANSI/BIFMA Standards.
- The quality and performance level of these panels have been tested to equal or exceed the requirements of the U.S. Government.
- Power Beam has a steel frame and is 2 7/8" thick. Corner posts create a panel creep of 3 1/4".
- Leveling glides extend 1 1/2" high.

Power Beam Options

- Power Beams are available in the following heights: 24", 30", and 36".
- Module widths come in seven (7) sizes: 36", 42", 48", 54", 60", 66" and 72".
- Straight, 90 degree & 120 degree.

Extension Module Options

- Acoustic Fabric (Tackable), Glazed, Open, Laminate, Whiteboard, Air Flow.
- Attaches to the top of the Power Beam or another extension module (not to exceed 42" above finished floor).
- Offered in 6", 12", and 18" heights.
- Can be stacked up to 42" high above the finished floor (A.F.F.).

Beam Reconfiguration

- Extension Modules can be modified on site by replacing fabric modules with Glazed, Open, Laminate, Whiteboard or Air Flow at any time after the initial installation.
- Fabric can be replaced easily; using pre-cut segments of fabric, a drawstring (C-Jex) is sewn in around the edges. Then a rubber spline is used to 'screen' the fabric in place.

Voice/Data And Electrical Power

- NOTE: Panels and Electric components are CSA/UL approved. Tools are not required to install electrical in the Power Beam.

Electric Information

- Electric can be run in all three Power Beam heights (24" h, 30" h or 36" h).
- 8-Wire, 4 circuit capability
- 2 utility + 2 dedicated circuits
- 10 gauge (oversized) neutrals
- All circuits can support up to 15 a max.
- Contact Evolve customer care for additional wiring options.

Raceway Information

- Raceway knockouts sizes conform to the ANSI/TIA/ EIA Furniture Opening Standard of 1.38" x 2.71".
- Power Beam raceway covers 36"-60" wide accommodate knockouts for two electrical duplexes and one communication face plate on each side. 66" wide beam accommodates 4 electrical duplexes and one communication face plate on each side. 72" wide beam accommodates 4 duplex receptacles and 2 communication face plates on each side.
- Standard data face mount plates can be used without the need of adapter plates (supplied by others).
- Cabling capacities (calculations below are based on .25" diameter communication cables.)
- Power Modules:
 - Without electric – 65 Cables
 - With electric – 54 Cables
- Panel Connectors - 90 Degree Connector Posts:
 - Without electric – 45 cables
 - With electric – 25 Cables

Work Tables

- Freestanding tables
 - Foli height adjustable (23" or 29"d)
 - Bungee (20", 24" or 30"d)
 - Junction (20", 24" or 30"d)
 - 2gether (18" or 24"d)

Power Beam is a freestanding beam system and does not support attachment of an Evolve brackets or overhead storage including cantilevers or other support brackets.

Features, Benefits & General Information

Technical Features of Power Beam:

- Evolve Power Beam is 2 7/8" thick.
- An aluminum low profile top cap is included with Power Beams.
- Power Beam will accommodate 65 x 0.25" diameter communication cables without electrical or 54 x 0.25" diameter communication cables with electrical.
- 90-degree post extension accommodates 45 x 0.25" diameter communication cables without electrical and 25 x 0.25" diameter communication cables with electric.
- Raceway knockout openings are 1.38" x 2.71".

Basic Features of Power Beam

- Power Beam is available in three (3) heights: 24" h, 30" h and 36" h; and seven (7) widths: 36" w, 42" w, 48" w, 54" w, 60" w, 66" w and 72" w.
- There is no panel creep in a straight Beam-to-Beam configuration; however, a corner post (2, 3, 4 way) will add 3.25" inches to a beam run.

Basic Features of Extension Modules

- Extension modules stack on the top of a Power Beam or another extension module (maximum height - 42" h, above finished floor).
- Fabric extension modules may have different fabrics on opposite sides within the same grade with no up-charge.
- If different grades of fabric are used on one module, the entire modules will be priced utilizing the fabric with the highest grade.

Power Beam Parts

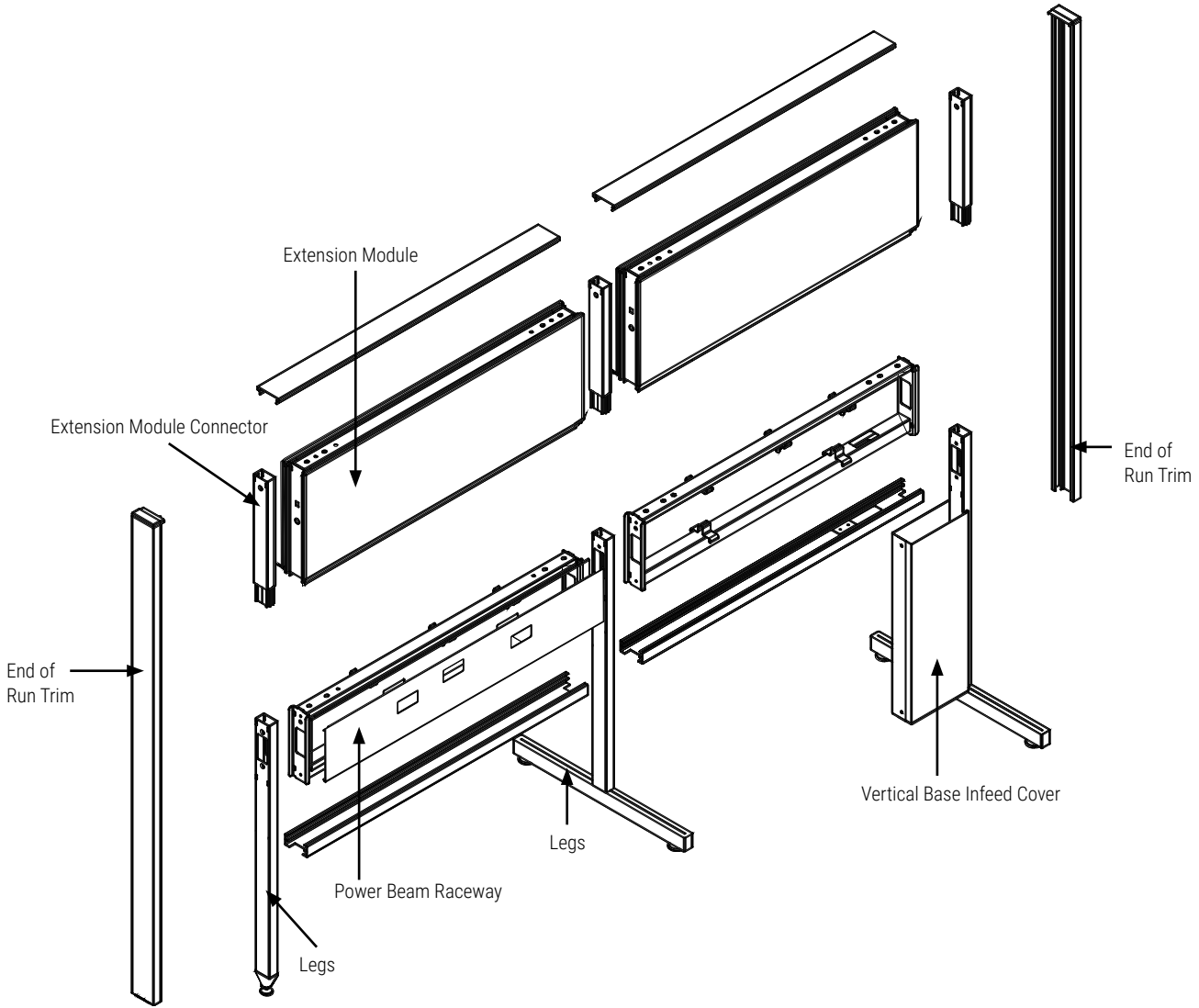

Extension Module Materials

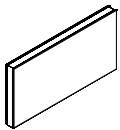

Fabric

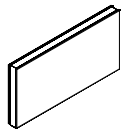

Laminate

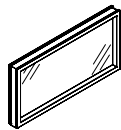

Glass



Write Board

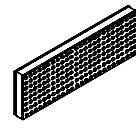

Airflow

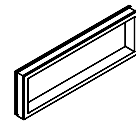

Open

EVPB • Power Beam

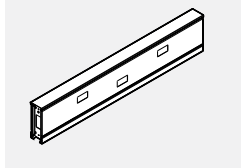

- Aluminum top trim and bottom trim included
- No access for base infeed
- Support legs ordered separately

PRODUCT CODE	PRICE	SIZE/ INCHES			WEIGHT VOL	
		H	W	D	LBS	FT ³
EVPB36	195	6	36	2.875	15.5	0.48
EVPB42	215	6	42	2.875	17.1	0.56
EVPB48	233	6	48	2.875	18.6	0.64
EVPB54	255	6	54	2.875	20.2	0.72
EVPB60	278	6	60	2.875	21.8	0.80

EVPB • 6" High Power Beam

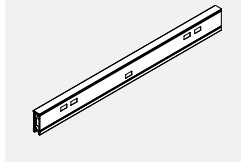

- One piece aluminum top trim and one piece aluminum bottom trim included.

PRODUCT CODE	PRICE	SIZE/ INCHES			WEIGHT VOL	
		H	W	D	LBS	FT ³
EVPB66	435	6	66	2.875	31	0.91
EVPB72	450	6	72	2.875	32	1.00

EVPBE • Power Beam with Electrical Cut-out for Base Feed

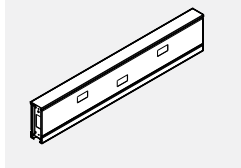

- Power beam with bottom cut out (on one end) for base infeed
- Aluminum top and bottom trims included
- Bottom trim has a cut out on one side for electrical access and a bracket to connect to the vertical base infeed cover (ordered separately)
- Vertical base infeed cover with support leg ordered separately

PRODUCT CODE	PRICE	SIZE/ INCHES			WEIGHT VOL	
		H	W	D	LBS	FT ³
EVPBE36	206	6	36	2.875	15.5	0.48
EVPBE42	229	6	42	2.875	17.1	0.56
EVPBE48	251	6	48	2.875	18.6	0.64
EVPBE54	270	6	54	2.875	20.2	0.72
EVPBE60	295	6	60	2.875	21.8	0.80

EVPBE • Power Beam Kit with Electrical Cut-out for Base Feed

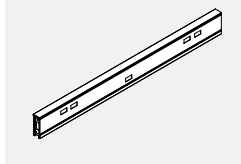

- 66" Power Beam Kit consists of (1) 30" Power Beam and (1) 36" Power Beam with bottom cut out on one side for a base infeed. In-line connector and hardware included.
- Vertical base infeed cover with support leg ordered separately.

PRODUCT CODE	PRICE	SIZE/ INCHES			WEIGHT VOL	
		H	W	D	LBS	FT ³
EVPBE66	461	6	66	2.875	31	0.91
EVPBE72	476	6	72	2.875	32	1.00

EVPBEP-KIT • Power Beam with Electrical Cut-out for Pass Through Cabinet

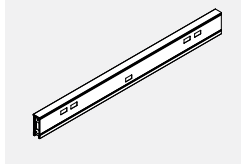

- Power beam with electrical cutout for base feed from pass through cabinet.
- Aluminum top trim included.
- 60" Power beam kit includes two 30" power distribution housing (EVE8PD30) and jumper cable (EVE8CP17).
- 72" Power beam kit includes two 36" power distribution housing (EVE8PD36) and jumper cable (EVE8CP17).
- Provides two duplex receptacle per panel side.
- Power beam base feed to be ordered separately.
- Power beam storage cabinet with pass through to be ordered separately (EVPBSCGDP or EVPBSCP).
- Note: To be used with cable pass through cabinet EVPBSSCGDPR/L.

PRODUCT CODE	PRICE	SIZE/ INCHES			WEIGHT VOL	
		H	W	D	LBS	FT ³
EVPBEP60KIT	717	6	60	2.875	23.4	0.86
EVPBEP72KIT	909	6	72	2.875	25.1	0.96

EVPBEP-KIT01 • Power Beam with Electrical Cut-out for Pass Through Cabinet with Two Raceway Covers per Side

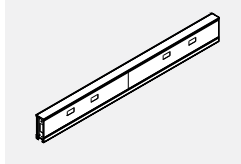

- Power beam with electrical cut out for base feed from pass through cabinet.
- Aluminum top trim included.
- 60" Power beam kit includes two 30" raceway covers per side.
- 72" Power beam kit includes two 36" raceway covers per side.
- 60" Power beam kit includes two 30" power distribution housing (EVE8PD30) and jumper cable (EVE8CP17).
- 72" Power beam kit includes two 36" power distribution housing (EVE8PD36) and jumper cable (EVE8CP17).
- Provides four duplex receptacle per panel side.
- Power beam base feed to be ordered separately.
- Power beam storage cabinet with pass through to be ordered separately (EVPBSCGDP or EVPBSCP).
- Note: To be used with cable pass through cabinet EVPBSSCGDPR/L.

PRODUCT CODE	PRICE	SIZE/ INCHES			WEIGHT VOL	
		H	W	D	LBS	FT ³
EVPBEP60KIT01	717	6	60	2.875	23.4	0.88
EVPBEP72KIT01	909	6	72	2.875	25.1	0.96

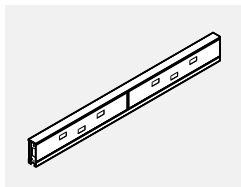

EVPBFCL • Vertical Base Power Feed Cover with Leg

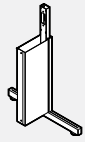

- Connects to Power Beam Kit with electrical cut out.
- Includes vertical cover and slotted connector support leg with foot.
- Power Beam kit with electrical cut out ordered separately.
- Base infed ordered separately.

PRODUCT CODE	PRICE	SIZE/ INCHES			WEIGHT VOL	
		H	W	D	LBS	FT ³
EVPBFCL24	177	24	6	21	10.1	1.75
EVPBFCL30	198	30	6	21	11.2	2.18
EVPBFCL36	218	36	6	21	12.3	2.62

EVPBFCSL • Base Power Feed Cover with Single Leg

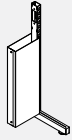

- Connects to Power Beam Kit with electrical cut out
- Includes vertical cover and slotted connector support with single leg.
- For one sided Power beam application.
- Laminate end panels must be attached to single leg at the end of power beam run for stability.
- Laminate end panels to be ordered separately.
- End of run trim below power beam included.
- Power beam with electrical cut out to be ordered separately.
- Note: Cannot be used with Power Beam storage or Power Beam overhead.

PRODUCT CODE	PRICE	SIZE/ INCHES			WEIGHT VOL	
		H	W	D	LBS	FT ³
EVPBFCSL24	169	24	6	21	10.10	1.75
EVPBFCSL30	189	30	6	21	11.20	2.18
EVPBFCSL36	207	36	6	21	12.30	2.62

EVPBFCLS • Vertical Base Power Feed Cover with Slotted Leg

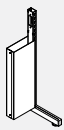

- Slotted connector allows for the attachment of brackets for worksurfaces.
- Connects two Power Beams on equal height.
- Includes vertical covers, slotted connector with leg and end of run trim below the Power Beam.
- Note: Power Beam must be installed in stable configuration using two way posts, three way posts or four way posts to provide support for worksurfaces.

PRODUCT CODE	PRICE	SIZE/ INCHES			WEIGHT VOL	
		H	W	D	LBS	FT ³
EVPBFCLS24	169	24	6	21	10.10	1.75
EVPBFCLS30	189	30	6	21	11.20	2.18
EVPBFCLS36	207	36	6	21	12.30	2.62

EVPBFCEG • Vertical Base Power Feed Cover with Glide



- Connects to Power Beam Kit with electrical cut out
- Includes vertical cover and slotted connector support leg with glide.
- Power Beam Kit with electrical cut out ordered separately.
- Base infed ordered separately.

PRODUCT CODE	PRICE	SIZE/ INCHES			WEIGHT VOL	
		H	W	D	LBS	FT ³
EVPBFCEG24	147	24	6	3	7.1	0.25
EVPBFCEG30	166	30	6	3	8.4	0.31
EVPBFCEG36	186	36	6	3	9.7	0.38

EVPBFCEGS • Vertical Base Power Feed Cover with Glide and Slotted Connector



- Slotted connector allows for the attachment of brackets for worksurfaces.
- Connects two Power Beams on equal height.
- Includes vertical covers, slotted connector with glide base and end of run trim below Power Beam.
- Power Beam with electrical cut out to be ordered separately.
- Note: Power Beam must be installed in stable configuration using two way posts, three way posts or four way posts to provide support for worksurfaces.

PRODUCT CODE	PRICE	SIZE/ INCHES			WEIGHT VOL	
		H	W	D	LBS	FT ³
EVPBFCEGS24	140	24	6	3	7.10	0.25
EVPBFCEGS30	157	30	6	3	8.40	0.31
EVPBFCEGS36	176	36	6	3	9.70	0.38

EVPBFCEGS • Vertical Base Power Feed Cover with Glide



- 42" H Slotted connector allows to attached brackets for worksurfaces
- Connects to electrical cut out power beam
- Includes vertical covers and slotted connector with glide base
- End of run trim below power beam included
- Power beam with electrical cut out to be ordered separately
- Note: Power beam to be installed in stable configuration using two way posts, three way posts, four way posts to provide support for worksurfaces

PRODUCT CODE	PRICE	SIZE/ INCHES			WEIGHT VOL	
		H	W	D	LBS	FT ³
EVPB24FCGS42	173	42	6	3	10.40	0.43
EVPB30FCGS42	185	42	6	3	10.40	0.43
EVPB36FCGS42	204	42	6	3	10.40	0.43

EVPBGFC • Power Beam Gallery Base Feed Cover



- Connects to electrical cut out power beam attached to gallery panels.
- Includes vertical covers and slotted connector attaches to gallery panel.
- Power beam with electrical cut out to be ordered separately.

PRODUCT CODE	PRICE	SIZE/ INCHES			WEIGHT VOL	
		H	W	D	LBS	FT ³
EVPBGFC24	142	24	6	3	7.1	0.25
EVPBGFC30	161	30	6	3	8.40	0.31
EVPBGFC36	177	36	6	3	9.70	0.38

EVPBGDP • Power Beam Gallery Panel Data Post / Comm Lay-in



- Attaches to Power beam gallery end panel to bring power and/or data cables from ceiling to power beam.
- Three-sided power pole with snap-on fourth side.
- Made of aluminum and can be field cut.
- Standard data post extension used above.
- Accommodates up to 25 CAT 5 cables with electric, up to 45 CAT 5 cables without electric.
- Standard data post extension to be ordered separately.
- Standard code is for 24" H power beam. Please add at code end for option. B- 30" H Power beam. C- 36" H Power beam.

PRODUCT CODE	PRICE	SIZE/ INCHES			WEIGHT VOL	
		H	W	D	LBS	FT ³
EVPBGDP42	135	42	2	2	2.20	0.60
EVPBGDP48	150	48	2	2	3.00	0.70
EVPBGDP54	184	54	2	2	4.20	0.80

EVE8FR3PBD • Double Entry for Power Beam

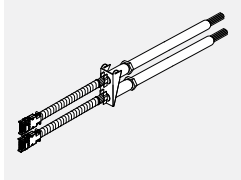

- Each power feed entry snaps into separate power distribution housing.
- Includes two 84" long flexible vinyl conduit.
- Includes double bracket to attach to Verticle base power feed cover leg.
- Must be installed in middle between two power beams, one base feed plugs to powerbeam on opposite side of leg than attached bracket.
- Vertical base power feed cover with leg to be ordered seperately.
- Must be hardwired to source by licenced electrician.
- Note: Always determine that harness is electrically connected to only one power supply.

PRODUCT CODE	PRICE	SIZE/ INCHES			WEIGHT VOL	
		H	W	D	LBS	FT ³
EVE8FR3PBD	601		84		7.64	2.00

EVHCBP01 • Ceiling Bracket for Post

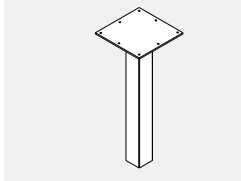

- Used to secure corner post to ceiling.
- 4.8"x4.8" top plate with 1.5x1.5 square tube 12" H, square tube fits inside aluminum corner post.
- Square tube can slide in post, bracket pushed to ceiling to be secured.

PRODUCT CODE	PRICE	SIZE/ INCHES			WEIGHT VOL	
		H	W	D	LBS	FT ³
EVHCBP01	58	12	4.8	4.8	3.2	0.18

EVHCBIC01 • Ceiling Bracket for Inline Connector

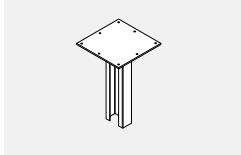

- Used to secure corner post to ceiling .
- 4.8"x4.8" top plate with 7.5"h insert in middle of plate, insert its inside connector.
- 7.5" H insert can slide in connector, bracket pushed to ceiling to secure.
- Note: Care should be taken to attach ceiling brackets to secure ceiling using correct fasteners.
- Failure to do so may result in collapse of unit and subsequent possible injury.

PRODUCT CODE	PRICE	SIZE/ INCHES			WEIGHT VOL	
		H	W	D	LBS	FT ³
EVHCBIC01	58	7.5	4.8	4.8	3.2	0.18

EVHCBER01 • Ceiling Bracket for End of Run Connector

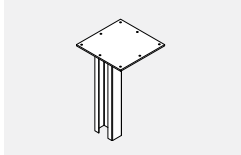

- Used to secure corner post to ceiling.
- 4.8"x4.8" top plate with 7.5"h insert in middle of plate, insert its inside connector.
- 7.5" H insert can slide in connector , bracket pushed to ceiling to secure.
- Note: Care should be taken to attach ceiling brackets to secure ceiling using correct fasteners.
- Failure to do so may result in collapse of unit and subsequent possible injury.

PRODUCT CODE	PRICE	SIZE/ INCHES			WEIGHT VOL	
		H	W	D	LBS	FT ³
EVHCBIC01	58	7.5	4.8	4.8	3.2	0.18

EVPBL • Power Beam Connector with Leg

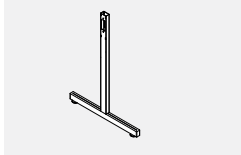

- Connects two Power Beams in a straight run.
- 24"h -- 18" open to floor.
- 30"h -- 24" open to floor.
- 36"h -- 30" open to floor.

PRODUCT CODE	PRICE	SIZE/ INCHES			WEIGHT VOL	
		H	W	D	LBS	FT ³
EVPBL24	90	24	18	3	5.9	0.30
EVPBL30	94	30	18	3	7.2	0.38
EVPBL36	100	36	18	3	8.5	0.45

EVPBLS • Power Beam Slotted Connector with Leg



- Slotted connector allows for the attachment of brackets for worksurfaces.
- Connects two Power Beams on equal height.
- Includes slotted connector with leg, glides and connecting hardware.
- Note: Power Beam must be installed in stable configuration using two way posts, three way posts or four way posts to provide support for worksurfaces.

PRODUCT CODE	PRICE	SIZE/ INCHES			WEIGHT VOL	
		H	W	D	LBS	FT ³
EVPBLS24	87	24	18	3	5.90	0.30
EVPBLS30	90	30	18	3	7.20	0.38
EVPBLS36	94	36	18	3	8.50	0.45

EVPBLFF • Power Beam Leg with Flat Foot

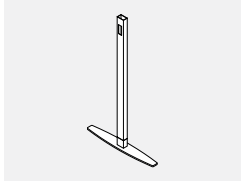

- Connects two power beams on equal height.
- Includes connector with flat foot, connecting hardware
- Note: Leg has to be used next to Post legs with glides.
- When specifiing please keep sequence post leg with glide, leg with flat foot, post leg with glide.
- Only post legs with glide provides adjustment for levelling power beams run.

PRODUCT CODE	PRICE	SIZE/ INCHES			WEIGHT VOL	
		H	W	D	LBS	FT ³
EVPBLFF24	105	24	21		5.9	0.30
EVPBLFF30	109	30	21		7.2	0.38
EVPBLFF36	114	36	21		8.5	0.45

EVPBSL • Power Beam Single Leg

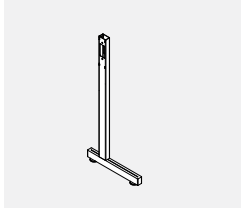

- Connects two Power Beams on equal height.
- Includes non slotted connector with leg, glides and connecting hardware.
- For one sided power beam application.
- Laminate end panels must be attached to single leg at end of power beam run for stability.
- Laminate end panels to be ordered seperately.
- Note: It can not be used with Power Beam storage or Power Beam overhead.

PRODUCT CODE	PRICE	SIZE/ INCHES			WEIGHT VOL	
		H	W	D	LBS	FT ³
EVPBSL24	87	24	15	3	5.9	0.21
EVPBSL30	90	30	15	3	7.2	0.26
EVPBSL36	94	36	15	3	8.5	0.32

EVPBGICB • Power Beam Connector with Base for Glide



- Connects two Power Beams in a straight run.
- 24" h -- 18" open to floor.
- 30" h -- 24" open to floor.
- 36" h -- 30" open to floor.

PRODUCT CODE	PRICE	SIZE/ INCHES			WEIGHT VOL	
		H	W	D	LBS	FT ³
EVPBGICB24	61	24	2	3	3.30	0.03
EVPBGICB30	63	30	2	3	4.60	0.04
EVPBGICB36	65	36	2	3	5.90	0.04

EVPBGICBS • Power Beam Slotted Connector with Base for Glide



- Slotted connector allows for the attachment of brackets for worksurfaces.
- Connects two Power Beams of equal heights.
- Includes slotted connector with glide and connecting hardware.
- Note: Power Beam must be installed in stable configuration using two way posts, three way posts or four way posts to provide support for worksurfaces.

PRODUCT CODE	PRICE	SIZE/ INCHES			WEIGHT VOL	
		H	W	D	LBS	FT ³
EVPBGICBS24	57	24	2	3	3.30	0.03
EVPBGICBS30	59	30	2	3	4.60	0.04
EVPBGICBS36	62	36	2	3	5.90	0.04

EVPBGICBS • Power Beam Connector with Base for Glide



- 42" H Slotted connector allows to attached brackets for worksurfaces
- Connects two power beams on equal height and extension panel above
- Includes slotted connector with glide and connecting hardware
- Note: Power beam to be installed in stable configuration using two way posts, three way posts, four way posts to provide support for worksurfaces

PRODUCT CODE	PRICE	SIZE/ INCHES			WEIGHT VOL	
		H	W	D	LBS	FT ³
EVPB24GICBS42	90	42	2		6.60	0.16
EVPB30GICBS42	90	42	2		6.60	0.16
EVPB36GICBS42	90	42	2		6.60	0.16

EVPB24CPA • One Way Post with T Leg for 24" H Power Beam

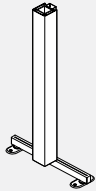

- One way post attaches to end of power beam run.
- Post and connecting hardware add 3.25 to power beam run.
- Includes post power beam T leg, post with trim all round, leveling glide, hardware and trim kit.
- Includes two floor mount plates to secure post to floor.

PRODUCT CODE	PRICE	SIZE/ INCHES			WEIGHT VOL	
		H	W	D	LBS	FT ³
EVPB24CPA124	246	24	3	3	5.5	0.75
EVPB24CPA130	260	30	3	3	8.5	0.94
EVPB24CPA136	271	36	3	3	11.5	1.12
EVPB24CPA142	304	42	3	3	15	1.31

EVPB30CPA • One Way Post with T Leg for 30" H Power Beam

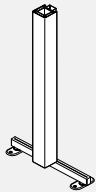

- One way post attaches to end of power beam run.
- Post and connecting hardware add 3.25 to power beam run.
- Includes post power beam T leg, post with trim all round, leveling glide, hardware and trim kit.
- Includes two floor mount plates to secure post to floor.

PRODUCT CODE	PRICE	SIZE/ INCHES			WEIGHT VOL	
		H	W	D	LBS	FT ³
EVPB30CPA130	260	30	3	3	8.5	0.94
EVPB30CPA136	271	36	3	3	11.5	1.12
EVPB30CPA142	304	42	3	3	15	1.31

EVPB36CPA • One Way Post with T Leg for 36" H Power Beam

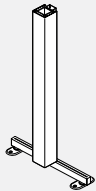

- One way post attaches to end of power beam run.
- Post and connecting hardware add 3.25 to power beam run.
- Includes post power beam T leg, post with trim all round, leveling glide, hardware and trim kit.
- Includes two floor mount plates to secure post to floor.

PRODUCT CODE	PRICE	SIZE/ INCHES			WEIGHT VOL	
		H	W	D	LBS	FT ³
EVPB36CPA136	271	36	3	3	11.5	1.12
EVPB36CPA142	304	42	3	3	15	1.31

EVPBCEPLA4 • Power Beam 4-way Corner Post



- Connects four power beams of equal height in 90 degree configuration.
- Post and connecting hardware add 3.25" to power beam run.
- Includes one post, four nonslotted power beam connectors, post with trim all around, levelling glide, hardware and trim kit.

PRODUCT CODE	PRICE	SIZE/ INCHES			WEIGHT VOL	
		H	W	D	LBS	FT ³
EVPBCEPLA424	171	24	3	3	6.30	0.22
EVPBCEPLA430	191	30	3	3	7.60	0.27
EVPBCEPLA436	186	36	3	3	8.90	0.33

EVPBCEPLA3 • Power Beam 3-way Corner Post



- Connects three power beams of equal height in 90 degree configuration.
- Post and connecting hardware add 3.25" to power beam run.
- Includes one post, three nonslotted power beam connectors, post with trim all around, levelling glide, hardware and trim kit.

PRODUCT CODE	PRICE	SIZE/ INCHES			WEIGHT VOL	
		H	W	D	LBS	FT ³
EVPBCEPLA324	144	24	3	3	5.80	0.22
EVPBCEPLA330	149	30	3	3	7.10	0.27
EVPBCEPLA336	156	36	3	3	8.40	0.33

EVPBCEPLA2 • Power Beam 2-way Corner Post



- Includes one post, four nonslotted power beam connectors, post with trim all around, levelling glide, hardware and trim kit.
- Connects four power beams of equal height in 90 degree configuration.
- Post and connecting hardware add 3.25" to power beam run.

PRODUCT CODE	PRICE	SIZE/ INCHES			WEIGHT VOL	
		H	W	D	LBS	FT ³
EVPBCEPLA224	130	24	3	3	5.30	0.22
EVPBCEPLA230	135	30	3	3	6.60	0.27
EVPBCEPLA236	143	36	3	3	7.90	0.33

EVPBCIPLA2 • Power Beam In Line 2-way Corner Post



- Connects two power beams of equal height in inline configuration.
- Post and connecting hardware add 3.25" to power beam run.
- Includes one post, two nonslotted power beam connectors, post with trim all around, levelling glide, hardware and trim kit.

PRODUCT CODE	PRICE	SIZE/ INCHES			WEIGHT VOL	
		H	W	D	LBS	FT ³
EVPBCIPLA224	130	24	3	3	5.30	0.22
EVPBCIPLA230	135	30	3	3	6.60	0.27
EVPBCIPLA236	143	36	3	3	7.90	0.33

EVPB6CEPLA3 • Power Beam 3-way 120 Degree Corner Post



- Connects three power beams of equal height in 120 degree configuration.
- Includes one post, three nonslotted power beam connectors, post with trim all around, levelling glide, hardware and trim kit.

PRODUCT CODE	PRICE	SIZE/ INCHES			WEIGHT VOL	
		H	W	D	LBS	FT ³
EVPB6CEPLA324	166	24	3	3	5.30	0.22
EVPB6CEPLA330	169	30	3	3	6.60	0.27
EVPB6CEPLA336	177	36	3	3	7.90	0.33

EVPB6CEPLA2 - Power Beam 2-way 120 Degree Corner Post



- Connects three power beams of equal height in 120 degree configuration.
- Includes one post, three nonslotted power beam connectors, post with trim all around, levelling glide, hardware and trim kit.

PRODUCT CODE	PRICE	SIZE/ INCHES			WEIGHT VOL	
		H	W	D	LBS	FT ³
EVPB6CEPLA224	166	24	3	3	5.30	0.22
EVPB6CEPLA230	169	30	3	3	6.60	0.27
EVPB6CEPLA236	177	36	3	3	7.90	0.33

EVPBIEC • Extension Connector for Power Beam



- Attaches to power beam connector.
- Includes non slotted extension connector and connecting hardware.
- Must be attached to power beam connector with provided screw before installing power beam.

PRODUCT CODE	PRICE	SIZE/ INCHES			WEIGHT VOL	
		H	W	D	LBS	FT ³
EVPBIEC06	29	6	2.875	3	1.0	0.06
EVPBIEC12	29	12	2.875	3	2.0	0.12
EVPBIEC18	35	18	2.875	3	3.0	0.18
EVPBIEC24	35	24	2.875	3	4.0	0.24

EVPBIEC • Slotted Extension Connector for Power Beam



- Attaches to Power Beam connector.
- Includes slotted extension connector and connecting hardware.
- Must be attached to Power Beam connector with provided screw before installing Power Beam.

PRODUCT CODE	PRICE	SIZE/ INCHES			WEIGHT VOL	
		H	W	D	LBS	FT ³
EVPBIECS06	29	6	2.875	3	1.00	0.06
EVPBIECS12	29	12	2.875	3	2.00	0.12
EVPBIECS18	35	18	2.875	3	3.00	0.18
EVPBIECS24	35	24	2.875	3	4.00	0.24

EVPBCEP4 • Power Beam Corner Extension Post 4 Way

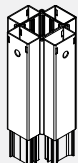

- Connects four extension modules in 90 degree configuration.
- Post and connecting hardware add 3.25" to power beam run.
- Includes one extension post, four non slotted extension connectors for power beam, connecting hardware and trim kit Power Beam.
- Corner Extension Post is not stackable.

PRODUCT CODE	PRICE	SIZE/ INCHES			WEIGHT VOL	
		H	W	D	LBS	FT ³
EVPBCEP406	72	6	3	3	4	0.09
EVPBCEP412	72	12	3	3	8	0.18
EVPBCEP418	114	18	3	3	12	0.27
EVPBCEP424	114	24	3	3	16	0.36

EVPBCEPA3 • Power Beam Corner Extension Post 3 Way

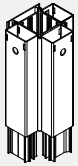

- Connects four extension modules in 90 degree configuration.
- Post and connecting hardware add 3.25" to power beam run.
- Includes one extension post, three non slotted extension connectors for power beam, connecting hardware and trim kit.
- Power Beam Corner Extension Post is not stackable.

PRODUCT CODE	PRICE	SIZE/ INCHES			WEIGHT VOL	
		H	W	D	LBS	FT ³
EVPBCEPA306	78	6	3	3	3	0.08
EVPBCEPA312	78	12	3	3	6	0.16
EVPBCEPA318	129	18	3	3	9	0.24
EVPBCEPA324	129	24	3	3	12	0.32

EVPBCEPA2 • Power Beam Corner Extension Post 2 Way

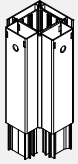

- Connects four extension modules in 90 degree configuration.
- Post and connecting hardware add 3.25" to power beam run.
- Includes one extension post, two non slotted extension connectors for power beam, connecting hardware and trim kit.
- Power Beam Corner Extension Post is not stackable.

PRODUCT CODE	PRICE	SIZE/ INCHES			WEIGHT VOL	
		H	W	D	LBS	FT ³
EVPBCEPA206	70	6	3	3	2	0.07
EVPBCEPA212	70	12	3	3	4	0.14
EVPBCEPA218	118	18	3	3	6	0.21
EVPBCEPA224	118	24	3	3	8	0.28

EVPBCEIPA2 • Power Beam In Line Corner Extension Post 2 Way

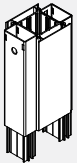

- Connects four extension modules in inline configuration.
- Post and connecting hardware add 3.25" to power beam run.
- Includes one extension post, two non slotted extension connectors for power beam, connecting hardware and trim kit.
- Power Beam Corner Extension Post is not stackable.

PRODUCT CODE	PRICE	SIZE/ INCHES			WEIGHT VOL	
		H	W	D	LBS	FT ³
EVPBCEIPA206	87	6	3	3	2	0.07
EVPBCEIPA212	87	12	3	3	4	0.14
EVPBCEIPA218	122	18	3	3	6	0.21
EVPBCEIPA224	122	24	3	3	8	0.28

EVPBCEPA1 • Power Beam Corner Extension Post 1 Way

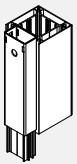

- Connects at end of run of extension modules.
- Post and connecting hardware add 3.25" to power beam run.
- Includes one extension post, one non slotted extension connectors for power beam, connecting hardware and trim kit.
- Power Beam Corner Extension Post is not stackable.

PRODUCT CODE	PRICE	SIZE/ INCHES			WEIGHT VOL	
		H	W	D	LBS	FT ³
EVPBCEPA106	64	6	3	3	2	0.07
EVPBCEPA112	64	12	3	3	4	0.14
EVPBCEPA118	88	18	3	3	6	0.21
EVPBCEPA124	88	24	3	3	6	0.21

EVPB6CEP3 • Power Beam 120 Degree Corner Extension Post 3 Way



- Connects three extension modules in 120 degree configuration.
- Includes one extension post, three non slotted extension connectors for power beam, connecting hardware and trim kit.
- Power Beam Corner Extension Post is not stackable.

PRODUCT CODE	PRICE	SIZE/ INCHES			WEIGHT VOL	
		H	W	D	LBS	FT ³
EVPB6CEP306	105	6	3	3	3	0.08
EVPB6CEP312	105	12	3	3	6	0.16
EVPB6CEP318	166	18	3	3	9	0.24
EVPB6CEP324	166	24	3	3	12	0.32

EVPB6CEPA2 • Power Beam 120 Degree Corner Extension Post 2 Way



- Connects two extension modules in 120 degree configuration.
- Includes one extension post, two non slotted extension connectors for power beam, connecting hardware and trim kit.
- Power Beam Corner Extension Post is not stackable.

PRODUCT CODE	PRICE	SIZE/ INCHES			WEIGHT VOL	
		H	W	D	LBS	FT ³
EVPB6CEPA206	89	6	3	3	2	0.07
EVPB6CEPA212	89	12	3	3	4	0.14
EVPB6CEPA218	139	18	3	3	6	0.21
EVPB6CEPA224	139	24	3	3	8	0.28

EVPB6CEPA1 • Power Beam 60 Degree Corner Extension Post 1 Way

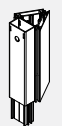

- Connects one extension module in 120 degree configuration.
- Includes one extension post, three non slotted extension connectors for power beam, connecting hardware and trim kit.
- Power Beam Corner Extension Post is not stackable.

PRODUCT CODE	PRICE	SIZE/ INCHES			WEIGHT VOL	
		H	W	D	LBS	FT ³
EVPB6CEPA106	59	6	3	3	2	0.07
EVPB6CEPA112	63	12	3	3	4	0.14
EVPB6CEPA118	85	18	3	3	6	0.21
EVPB6CEPA124	85	24	3	3	8	0.28

EVPB24CPA • Panel to 24" H Power Beam 4 Way Corner Post

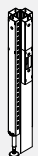

- Connects two panels and two 24" H power beams in 90 degree configuration.
- Post and connecting hardware add 3.25" to power beam run.
- Includes post, panel connectors and power beam connectors, post with trim all around, levelling glide, hardware and trim kit
- Pass thru only for power beam.

PRODUCT CODE	PRICE	SIZE/ INCHES			WEIGHT VOL	
		H	W	D	LBS	FT ³
EVPB24CPA430	218	30	3	3	15.5	0.41
EVPB24CPA436	284	36	3	3	18	0.48
EVPB24CPA442	284	42	3	3	21	0.57

EVPB30CPA • Panel to 30" H Power Beam 4 Way Corner Post



- Connects two panels and two 24" H power beams in 90 degree configuration.
- Post and connecting hardware add 3.25" to power beam run.
- Includes post, panel connectors and power beam connectors, post with trim all around, levelling glide, hardware and trim kit.
- Pass thru only for power beam.

PRODUCT CODE	PRICE	SIZE/ INCHES			WEIGHT VOL	
		H	W	D	LBS	FT ³
EVPB30CPA430	218	30	3	3	15.5	0.41
EVPB30CPA436	284	36	3	3	18	0.48
EVPB30CPA442	284	42	3	3	21	0.57

EVPB36CPA • Panel to 36" H Power Beam 4 Way Corner Post



- Connects two panels and two 24" H power beams in 90 degree configuration.
- Post and connecting hardware add 3.25" to power beam run.
- Includes post, panel connectors and power beam connectors, post with trim all around, levelling glide, hardware and trim kit.
- Pass thru only for power beam.

PRODUCT CODE	PRICE	SIZE/ INCHES			WEIGHT VOL	
		H	W	D	LBS	FT ³
EVPB36CPA436	284	36	3	3	18	0.48
EVPB36CPA442	284	42	3	3	21	0.57

EVPB24CPSA4 • Panel to 24" H Power Beam 4 Way Corner Post - Slotted

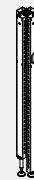

- Connects two panels and two 24" H power beams in a 90 degree configuration.
- Post and connecting hardware add 3.25" to the power beam run.
- Includes post, panel connectors, power beam connectors, post with trim all around, levelling glide, hardware and trim kit.
- Pass thru only for power beam, power beam leg slotted.

PRODUCT CODE	PRICE	SIZE/ INCHES			WEIGHT VOL	
		H	W	D	LBS	FT ³
EVPB24CPSA430	218	30	3	3	15.5	0.41
EVPB24CPSA436	284	36	3	3	18	0.48
EVPB24CPSA442	284	42	3	3	21	0.57

EVPB30CPSA4 • Panel to 30" H Power Beam 4 Way Corner Post - Slotted



- Connects two panels and two 30" H power beams in a 90 degree configuration.
- Post and connecting hardware add 3.25" to the power beam run.
- Includes post, panel connectors, power beam connectors, post with trim all around, levelling glide, hardware and trim kit.
- Pass thru only for power beam, power beam leg slotted.

PRODUCT CODE	PRICE	SIZE/ INCHES			WEIGHT VOL	
		H	W	D	LBS	FT ³
EVPB30CPSA430	218	30	3	3	15.5	0.41
EVPB30CPSA436	284	36	3	3	18	0.48
EVPB30CPSA442	284	42	3	3	21	0.57

EVPB36CPSA4 • Panel to 36" H Power Beam 4 Way Corner Post - Slotted



- Connects two panels and two 36" H power beams in a 90 degree configuration.
- Post and connecting hardware add 3.25" to the power beam run.
- Includes post, panel connectors, power beam connectors, post with trim all around, levelling glide, hardware and trim kit.
- Pass thru only for power beam, power beam leg slotted.

PRODUCT CODE	PRICE	SIZE/ INCHES			WEIGHT VOL	
		H	W	D	LBS	FT ³
EVPB36CPSA436	284	36	3	3	18	0.48
EVPB36CPSA442	284	42	3	3	21	0.57

EVPB24CPA • Panel to 24" H Power Beam 3 Way Corner Post



- Connects panels and 24" H power beams in 90 degree configuration.
- Post and connecting hardware add 3.25" to power beam run.
- Includes post, panel connectors and power beam connectors, post with trim all around, levelling glide, hardware and trim kit.
- Pass thru only for power beam.

PRODUCT CODE	PRICE	SIZE/ INCHES			WEIGHT VOL	
		H	W	D	LBS	FT ³
EVPB24CPA330	198	30	3	3	11.8	0.36
EVPB24CPA336	263	36	3	3	13	0.42
EVPB24CPA342	263	42	3	3	16.1	0.50

EVPB30CPA • Panel to 30" H Power Beam 3 Way Corner Post



- Connects panels and 30" H power beams in 90 degree configuration.
- Post and connecting hardware add 3.25" to power beam run.
- Includes post, panel connectors and power beam connectors, post with trim all around, levelling glide, hardware and trim kit.
- Pass thru only for power beam.

PRODUCT CODE	PRICE	SIZE/ INCHES			WEIGHT VOL	
		H	W	D	LBS	FT ³
EVPB30CPA330	198	30	3	3	11.8	0.36
EVPB30CPA336	263	36	3	3	13	0.42
EVPB30CPA342	263	42	3	3	16.1	0.50

EVPB36CPA • Panel to 36" H Power Beam 3 Way Corner Post



- Connects panels and 36" H power beams in 90 degree configuration.
- Post and connecting hardware add 3.25" to power beam run.
- Includes post, panel connectors and power beam connectors, post with trim all around, levelling glide, hardware and trim kit.
- Pass thru only for power beam.

PRODUCT CODE	PRICE	SIZE/ INCHES			WEIGHT LBS	VOL FT ³
		H	W	D		
EVPB36CPA336	263	36	3	3	13	0.42
EVPB36CPA342	263	42	3	3	16.1	0.50

EVPB24CPSA3 • Panel to 24" H Power Beam 3 Way Corner Post - Slotted



- Connects panels and 24" H power beam in a 90 degree configuration.
- Post and connecting hardware add 3.25" to the power beam run.
- Includes post, panel connectors, power beam connectors, post with trim all around, levelling glide, hardware and trim kit.
- Pass thru only for power beam, power beam leg slotted.

PRODUCT CODE	PRICE	SIZE/ INCHES			WEIGHT LBS	VOL FT ³
		H	W	D		
EVPB24CPSA330	198	30	3	3	11.8	0.36
EVPB24CPSA336	263	36	3	3	13	0.42
EVPB24CPSA342	263	42	3	3	16.1	0.50

EVPB30CPSA3 • Panel to 30" H Power Beam 3 Way Corner Post - Slotted

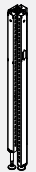

- Connects panels and 30" H power beam in a 90 degree configuration.
- Post and connecting hardware add 3.25" to the power beam run.
- Includes post, panel connectors, power beam connectors, post with trim all around, levelling glide, hardware and trim kit.
- Pass thru only for power beam, power beam leg slotted.

PRODUCT CODE	PRICE	SIZE/ INCHES			WEIGHT LBS	VOL FT ³
		H	W	D		
EVPB30CPSA330	198	30	3	3	11.8	0.36
EVPB30CPSA336	263	36	3	3	13	0.42
EVPB30CPSA342	263	42	3	3	16.1	0.50

EVPB36CPSA3 • Panel to 36" H Power Beam 3 Way Corner Post - Slotted

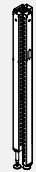

- Connects panels and 36" H power beam in a 90 degree configuration.
- Post and connecting hardware add 3.25" to the power beam run.
- Includes post, panel connectors, power beam connectors, post with trim all around, levelling glide, hardware and trim kit.
- Pass thru only for power beam, power beam leg slotted.

PRODUCT CODE	PRICE	SIZE/ INCHES			WEIGHT LBS	VOL FT ³
		H	W	D		
EVPB36CPSA336	263	36	3	3	13	0.42
EVPB36CPSA342	263	42	3	3	16.1	0.50

EVPB24CPA • Panel to 24" H Power Beam 2 Way Corner Post



- Connects one panels and one 24" H power beams in 90 degree configuration.
- Post and connecting hardware add 3.25" to power beam run.
- Includes post, panel connectors and power beam connectors, post with trim all around, levelling glide, hardware and trim kit.
- Pass thru only for power beam.

PRODUCT CODE	PRICE	SIZE/ INCHES			WEIGHT LBS	VOL FT ³
		H	W	D		
EVPB24CPA230	166	30	3	3	8.5	0.31
EVPB24CPA236	206	36	3	3	11.5	0.37
EVPB24CPA242	206	42	3	3	15	0.43

EVPB30CPA • Panel to 30" H Power Beam 2 Way Corner Post



- Connects one panels and one 30" H power beams in 90 degree configuration.
- Post and connecting hardware add 3.25" to power beam run.
- Includes post, panel connectors and power beam connectors, post with trim all around, levelling glide, hardware and trim kit.
- Pass thru only for power beam.

PRODUCT CODE	PRICE	SIZE/ INCHES			WEIGHT LBS	VOL FT ³
		H	W	D		
EVPB30CPA230	166	30	3	3	8.5	0.31
EVPB30CPA236	206	36	3	3	11.5	0.37
EVPB30CPA242	206	42	3	3	15	0.43

EVPB36CPA • Panel to 36" H Power Beam 2 Way Corner Post



- Connects one panels and one 36" H power beams in 90 degree configuration.
- Post and connecting hardware add 3.25" to power beam run.
- Includes post, panel connectors and power beam connectors, post with trim all around, levelling glide, hardware and trim kit.
- Pass thru only for power beam.

PRODUCT CODE	PRICE	SIZE/ INCHES			WEIGHT LBS	VOL FT ³
		H	W	D		
EVPB36CPA236	206	36	3	3	11.5	0.37
EVPB36CPA242	206	42	3	3	15	0.43

EVPB24CPSA2 • Panel to 24" H Power Beam 2 Way Corner Post - Slotted



- Connects one panels and one 24" H power beams in 90 degree configuration.
- Post and connecting hardware add 3.25" to the power beam run.
- Includes post, panel connectors, power beam connectors, post with trim all around, levelling glide, hardware and trim kit.
- Pass thru only for power beam, power beam leg slotted.

PRODUCT CODE	PRICE	SIZE/INCHES			WEIGHT LBS	VOL FT ³
		H	W	D		
EVPB24CPSA230	166	30	3	3	8.5	0.31
EVPB24CPSA236	206	36	3	3	11.5	0.37
EVPB24CPSA242	206	42	3	3	15	0.43

EVPB30CPSA2 • Panel to 30" H Power Beam 2 Way Corner Post - Slotted



- Connects one panels and one 30" H power beams in 90 degree configuration.
- Post and connecting hardware add 3.25" to the power beam run.
- Includes post, panel connectors, power beam connectors, post with trim all around, levelling glide, hardware and trim kit.
- Pass thru only for power beam, power beam leg slotted.

PRODUCT CODE	PRICE	SIZE/INCHES			WEIGHT LBS	VOL FT ³
		H	W	D		
EVPB30CPSA230	166	30	3	3	8.5	0.31
EVPB30CPSA236	206	36	3	3	11.5	0.37
EVPB30CPSA242	206	42	3	3	15	0.43

EVPB36CPSA2 • Panel to 36" H Power Beam 2 Way Corner Post - Slotted



- Connects one panels and one 36" H power beams in 90 degree configuration.
- Post and connecting hardware add 3.25" to the power beam run.
- Includes post, panel connectors, power beam connectors, post with trim all around, levelling glide, hardware and trim kit.
- Pass thru only for power beam, power beam leg slotted.

PRODUCT CODE	PRICE	SIZE/INCHES			WEIGHT LBS	VOL FT ³
		H	W	D		
EVPB36CPSA236	206	36	3	3	11.5	0.37
EVPB36CPSA242	206	42	3	3	15	0.43

EVPB24CPA3-P • Panel to two 24" Power Beam 3 Way Corner Post



- Connects two 24" H power beams with panel in T configuration.
- Post and connecting hardware add 3.25" to power beam run.
- Includes post, panel connectors and power beam connectors, post with trim all around, levelling glide, hardware and trim kit.
- Pass thru only for power beam.

PRODUCT CODE	PRICE	SIZE/ H	INCHES		WEIGHT LBS	VOL FT ³
			W	D		
EVPB24CPA330P	189	30	3	3	11.8	0.36
EVPB24CPA336P	252	36	3	3	13	0.42
EVPB24CPA342P	252	42	3	3	16.1	0.5

EVPB30CPA3-P • Panel to two 30" Power Beam 3 Way Corner Post



- Connects two 24" H power beams with panel in T configuration.
- Post and connecting hardware add 3.25" to power beam run.
- Includes post, panel connectors and power beam connectors, post with trim all around, levelling glide, hardware and trim kit.
- Pass thru only for power beam.

PRODUCT CODE	PRICE	SIZE/ H	INCHES		WEIGHT LBS	VOL FT ³
			W	D		
EVPB30CPA330P	189	30	3	3	11.8	0.36
EVPB30CPA336P	252	36	3	3	13	0.42
EVPB30CPA342P	252	42	3	3	16.1	0.5

EVPB36CPA3-P • Panel to two 36" Power Beam 3 Way Corner Post



- Connects two 24" H power beams with panel in T configuration.
- Post and connecting hardware add 3.25" to power beam run.
- Includes post, panel connectors and power beam connectors, post with trim all around, levelling glide, hardware and trim kit.
- Pass thru only for power beam.

PRODUCT CODE	PRICE	SIZE/ H	INCHES		WEIGHT LBS	VOL FT ³
			W	D		
EVPB36CPA336P	252	36	3	3	13	0.42
EVPB36CPA342P	252	42	3	3	16.1	0.5

EVPB24CPSA3-P • Panel to two 24" H Power Beam 3 Way Corner Post



- Connects two 24" H power beams with panel in a T configuration.
- Post and connecting hardware add 3.25" to the power beam run.
- Includes post, panel connectors, power beam connectors, post with trim all around, levelling glide, hardware and trim kit.
- Pass thru only for power beam, power beam leg slotted.

PRODUCT CODE	PRICE	SIZE/INCHES			WEIGHT LBS	VOL FT ³
		H	W	D		
EVPB24CPSA330P	189	30	3	3	11.8	0.36
EVPB24CPSA336P	252	36	3	3	13	0.42
EVPB24CPSA342P	252	42	3	3	16.1	0.50

EVPB30CPSA3-P • Panel to two 30" H Power Beam 3 Way Corner Post



- Connects two 30" H power beams with panel in a T configuration.
- Post and connecting hardware add 3.25" to the power beam run.
- Includes post, panel connectors, power beam connectors, post with trim all around, levelling glide, hardware and trim kit.
- Pass thru only for power beam, power beam leg slotted.

PRODUCT CODE	PRICE	SIZE/INCHES			WEIGHT LBS	VOL FT ³
		H	W	D		
EVPB30CPSA330P	189	30	3	3	11.8	0.36
EVPB30CPSA336P	252	36	3	3	13	0.42
EVPB30CPSA342P	252	42	3	3	16.1	0.50

EVPB36CPSA3-P • Panel to two 36" H Power Beam 3 Way Corner Post

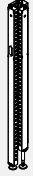

- Connects two 36" H power beams with panel in a T configuration.
- Post and connecting hardware add 3.25" to the power beam run.
- Includes post, panel connectors, power beam connectors, post with trim all around, levelling glide, hardware and trim kit.
- Pass thru only for power beam, power beam leg slotted.

PRODUCT CODE	PRICE	SIZE/INCHES			WEIGHT LBS	VOL FT ³
		H	W	D		
EVPB36CPSA336P	252	36	3	3	13	0.42
EVPB36CPSA342P	252	42	3	3	16.1	0.50

EVPFE • Fabric Panel Extension Module

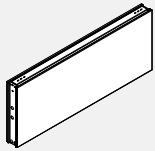

- Attaches on top of a panel.
- Module can be stacked to add privacy or divide space.
- Each side of fabric module may have different fabric within that same grade at no charge. If different grades of fabric are used, the entire module must be priced at highest grade.
- When ordering panel extension modules, additional connectors are required.
- Panel extension modules cannot be installed higher than 42" high above finished floor.

PRODUCT CODE	PRICE		SIZE/ INCHES			WEIGHT LBS	VOL FT ³
	GR1	GR2	H	W	D		
EVPFE0618	149	155	6	18	2.875	4.80	0.21
EVPFE0624	154	164	6	24	2.875	6.40	0.29
EVPFE0630	169	178	6	30	2.875	7.40	0.36
EVPFE0636	189	201	6	36	2.875	8.20	0.43
EVPFE0642	211	226	6	42	2.875	9.40	0.51
EVPFE0648	228	241	6	48	2.875	10.20	0.58
EVPFE0654	246	263	6	54	2.875	14.40	0.65
EVPFE0660	268	286	6	60	2.875	16.00	0.73
EVPFE0666	289	308	6	66	2.875	17.6	0.91
EVPFE0672	309	330	6	72	2.875	18.2	0.99
EVPFE1218	149	155	12	18	2.875	7.40	0.38
EVPFE1224	154	163	12	24	2.875	8.60	0.50
EVPFE1230	169	178	12	30	2.875	9.60	0.63
EVPFE1236	189	201	12	36	2.875	12.80	0.75
EVPFE1242	211	224	12	42	2.875	14.80	0.88
EVPFE1248	228	241	12	48	2.875	15.00	1.00
EVPFE1254	246	263	12	54	2.875	16.20	1.12
EVPFE1260	268	286	12	60	2.875	17.80	1.25
EVPFE1266	289	308	12	66	2.875	19.0	1.37
EVPFE1272	309	330	12	72	2.875	20.2	1.45
EVPFE1818	184	195	18	18	2.875	9.01	0.54
EVPFE1824	191	205	18	24	2.875	10.47	0.72
EVPFE1830	206	227	18	30	2.875	11.93	0.90
EVPFE1836	239	260	18	36	2.875	13.39	1.08
EVPFE1842	266	292	18	42	2.875	14.84	1.26
EVPFE1848	289	318	18	48	2.875	16.29	1.44
EVPFE1854	315	345	18	54	2.875	17.76	1.62
EVPFE1860	342	371	18	60	2.875	19.21	1.80
EVPFE1866	371	394	18	66	2.875	20.7	1.98
EVPFE1872	397	422	18	72	2.875	22.2	2.16

EVPGTE • Tempered Glass Panel Extension Module

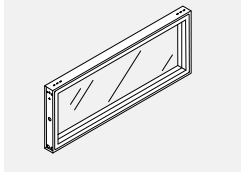

- Attaches on top of a panel.
- Module can be stacked to add privacy or divide space.
- Panel extension module is not load bearing above 66" high.
- Standard in lear (CLR).
- Frosted glass (FRST) upcharge varies. Contact Evolve customer service representative for details.
- When ordering panel extension modules, additional connectors are required.

PRODUCT CODE	PRICE	SIZE/ INCHES			WEIGHT LBS	VOL FT ³
		H	W	D		
EVPGTE0618	296	6	18	2.875	7.60	0.18
EVPGTE0624	318	6	24	2.875	9.24	0.25
EVPGTE0630	385	6	30	2.875	10.78	0.31
EVPGTE0636	400	6	36	2.875	12.32	0.37
EVPGTE0642	493	6	42	2.875	14.10	0.43
EVPGTE0648	550	6	48	2.875	15.80	0.50
EVPGTE0654	603	6	54	2.875	17.42	0.56
EVPGTE0660	647	6	60	2.875	19.28	0.63
EVPGTE0666	693	6	66	2.875	21.1	0.91
EVPGTE0672	744	6	72	2.875	22.9	0.99
EVPGTE1218	296	12	18	2.875	10.06	0.38
EVPGTE1224	318	12	24	2.875	12.08	0.50
EVPGTE1230	385	12	30	2.875	14.10	0.63
EVPGTE1236	400	12	36	2.875	16.12	0.75
EVPGTE1242	493	12	42	2.875	18.24	0.88
EVPGTE1248	550	12	48	2.875	20.56	1.00
EVPGTE1254	603	12	54	2.875	22.66	1.12
EVPGTE1260	647	12	60	2.875	25.00	1.25
EVPGTE1266	693	12	66	2.875	27.4	1.37
EVPGTE1272	744	12	72	2.875	29.9	1.45
EVPGTE1818	446	18	18	2.875	12.00	0.54
EVPGTE1824	459	18	24	2.875	14.93	0.72
EVPGTE1830	490	18	30	2.875	17.77	0.90
EVPGTE1836	535	18	36	2.875	20.57	1.08
EVPGTE1842	609	18	42	2.875	23.31	1.26
EVPGTE1848	681	18	48	2.875	25.94	1.44
EVPGTE1854	740	18	54	2.875	28.51	1.62
EVPGTE1860	795	18	60	2.875	31.28	1.80
EVPGTE1866	849	18	66	2.875	33.9	1.98
EVPGTE1872	908	18	72	2.875	35.7	2.16

EVPW1SE • Write Board Extension Module - One Side

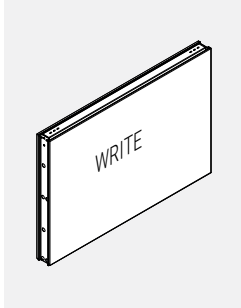

- Attaches on top of a beam.
- Provides writing surface on one side and fabric on the other side.
- Modules can be stacked to add privacy or to divide space.
- Panel Extension Modules cannot install higher than 42" high above finished floor.
- When ordering Beam Extension Modules, additional connectors are required.

PRODUCT CODE	PRICE		SIZE/ INCHES			WEIGHT LBS	VOL FT ³
	GR1	GR2	H	W	D		
EVPW1SE1818	226	230	18	18	2.875	9.44	0.54
EVPW1SE1824	255	262	18	24	2.875	10.90	0.72
EVPW1SE1830	284	294	18	30	2.875	12.35	0.90
EVPW1SE1836	334	345	18	36	2.875	13.81	1.08
EVPW1SE1842	378	393	18	42	2.875	15.27	1.26
EVPW1SE1848	417	435	18	48	2.875	16.72	1.44
EVPW1SE1854	451	469	18	54	2.875	18.18	1.62
EVPW1SE1860	488	505	18	60	2.875	19.64	1.80
EVPW1SE1866	524	541	18	66	2.875	21.70	1.98
EVPW1SE1872	560	576	18	72	2.875	23.30	2.16

EVPW2SE • Write Board Extension Module - Two Side

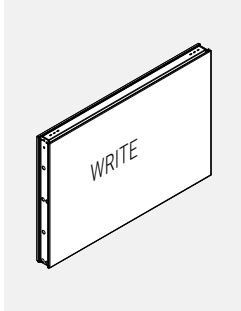

- Attaches on top of a panel.
- Provides writing surface on two sides.
- Modules can be stacked to add privacy or to divide space.
- Panel Extension Modules cannot install higher than 42" above finished floor
- When ordering Panel Extension Modules, additional connectors are required.

PRODUCT CODE	PRICE	SIZE/ INCHES			WEIGHT LBS	VOL FT ³
		H	W	D		
EVPW2SE1818	271	18	18	2.875	10.29	0.54
EVPW2SE1824	318	18	24	2.875	11.75	0.72
EVPW2SE1830	364	18	30	2.875	13.20	0.90
EVPW2SE1836	433	18	36	2.875	14.66	1.08
EVPW2SE1842	488	18	42	2.875	16.12	1.26
EVPW2SE1848	546	18	48	2.875	17.57	1.44
EVPW2SE1854	604	18	54	2.875	19.03	1.62
EVPW2SE1860	658	18	60	2.875	20.49	1.80
EVPW2SE1866	712	18	66	2.875	21.70	1.98
EVPW2SE1872	769	18	72	2.875	23.30	2.16

EVPH1SE • Laminate Extension Module - One Side

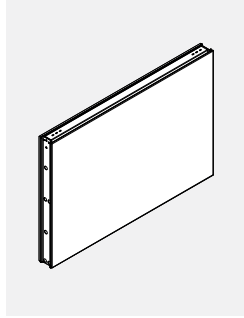

- Attaches on top of a beam.
- Laminate module provides a durable, washable surface on one side and fabric on the other side.
- Modules can be stacked to add privacy or to divide space.
- Panel Extension Modules cannot install higher than 42”h. above finished floor.
- When ordering Panel Extension Modules, additional connectors are required.
- Available in high pressure laminate finishes only.

PRODUCT CODE	PRICE		SIZE/ INCHES			WEIGHT LBS	VOL FT ³
	GR1	GR2	H	W	D		
EVPH1SE0618	206	211	6	18	2.875	2.77	0.25
EVPH1SE0624	240	251	6	24	2.875	3.20	0.35
EVPH1SE0630	272	276	6	30	2.875	3.63	0.43
EVPH1SE0636	310	317	6	36	2.875	4.06	0.51
EVPH1SE0642	350	356	6	42	2.875	4.49	0.60
EVPH1SE0648	383	392	6	48	2.875	4.91	0.68
EVPH1SE0654	433	441	6	54	2.875	5.34	0.76
EVPH1SE0660	455	463	6	60	2.875	5.77	0.84
EVPH1SE0666	474	485	6	66	3	17.6	0.91
EVPH1SE0672	526	534	6	72	3	18.2	0.99
EVPH1SE1218	206	211	12	18	2.875	5.55	0.51
EVPH1SE1224	240	251	12	24	2.875	6.41	0.71
EVPH1SE1230	272	276	12	30	2.875	7.26	0.87
EVPH1SE1236	310	317	12	36	2.875	8.12	1.03
EVPH1SE1242	350	356	12	42	2.875	8.98	1.20
EVPH1SE1248	383	392	12	48	2.875	9.83	1.36
EVPH1SE1254	433	441	12	54	2.875	10.69	1.53
EVPH1SE1260	455	463	12	60	2.875	11.55	1.69
EVPH1SE1266	474	485	12	66	3	19.0	1.37
EVPH1SE1272	526	534	12	72	3	20.2	1.45
EVPH1SE1818	268	273	18	18	2.875	9.44	0.54
EVPH1SE1824	330	337	18	24	2.875	10.90	0.72
EVPH1SE1830	380	389	18	30	2.875	12.35	0.90
EVPH1SE1836	435	444	18	36	2.875	13.81	1.08
EVPH1SE1842	490	503	18	42	2.875	15.27	1.26
EVPH1SE1848	537	553	18	48	2.875	16.72	1.44
EVPH1SE1854	584	601	18	54	2.875	18.18	1.62
EVPH1SE1860	641	667	18	60	2.875	19.64	1.80
EVPH1SE1866	702	733	18	66	3	20.7	1.98
EVPH1SE1872	748	779	18	72	3	22.2	2.16

EVPH2SE • Laminate Extension Module - Two Sides

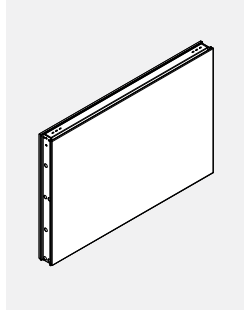

- Attaches on top of a beam.
- Laminate faces on both sides of the module provide durable, washable surfaces
- Modules can be stacked to add privacy or to divide space.
- Panel Extension Modules cannot install higher than 42”h. above finished floor.
- When ordering Panel Extension Modules, additional connectors are required.
- Available in high pressure laminate finishes only.

PRODUCT CODE	PRICE		SIZE/ INCHES			WEIGHT LBS	VOL FT ³
	GR1	GR2	H	W	D		
EVPH2SE0618	227		6	18	2.875	3.03	0.26
EVPH2SE0624	266		6	24	2.875	3.46	0.36
EVPH2SE0630	309		6	30	2.875	3.89	0.44
EVPH2SE0636	353		6	36	2.875	4.32	0.52
EVPH2SE0642	398		6	42	2.875	4.74	0.60
EVPH2SE0648	447		6	48	2.875	5.17	0.69
EVPH2SE0654	519		6	54	2.875	5.60	0.77
EVPH2SE0660	528		6	60	2.875	6.03	0.85
EVPH2SE0666	539		6	66	2.875	21.1	0.91
EVPH2SE0672	609		6	72	2.875	22.9	0.99
EVPH2SE1218	227		12	18	2.875	6.05	0.51
EVPH2SE1224	266		12	24	2.875	6.91	0.71
EVPH2SE1230	309		12	30	2.875	7.77	0.88
EVPH2SE1236	353		12	36	2.875	8.63	1.04
EVPH2SE1242	398		12	42	2.875	9.48	1.20
EVPH2SE1248	447		12	48	2.875	10.34	1.37
EVPH2SE1254	519		12	54	2.875	11.20	1.53
EVPH2SE1260	528		12	60	2.875	12.05	1.70
EVPH2SE1266	539		12	66	2.875	27.4	1.37
EVPH2SE1272	609		12	72	2.875	29.9	1.45
EVPH2SE1818	319		18	18	2.875	10.29	0.54
EVPH2SE1824	392		18	24	2.875	11.75	0.72
EVPH2SE1830	455		18	30	2.875	13.20	0.90
EVPH2SE1836	526		18	36	2.875	14.66	1.08
EVPH2SE1842	596		18	42	2.875	16.12	1.26
EVPH2SE1848	674		18	48	2.875	17.57	1.44
EVPH2SE1854	740		18	54	2.875	19.03	1.62
EVPH2SE1860	799		18	60	2.875	20.49	1.80
EVPH2SE1866	856		18	66	2.875	33.9	1.98
EVPH2SE1872	921		18	72	2.875	35.7	2.16

EVPAE • Air Flow Extension Module

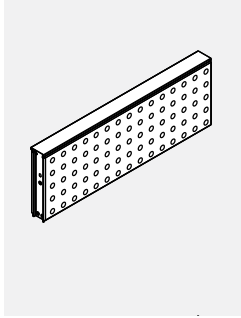

- Metal air flow panel extension.
- Attaches to top of beam.
- Modules can be stacked to add privacy or to divide space.
- Panel Extension Modules cannot install higher than 42”h. above finished floor.
- When ordering Panel Extension Modules, additional connectors are required.

PRODUCT CODE	PRICE	SIZE/ INCHES			WEIGHT	
		H	W	D	LBS	FT ³
EVPAE1224	262	12	24	2.875	9.66	0.59
EVPAE1230	309	12	30	2.875	10.93	0.82
EVPAE1236	352	12	36	2.875	12.19	1.00
EVPAE1242	389	12	42	2.875	13.62	1.05
EVPAE1248	439	12	48	2.875	15.18	1.18
EVPAE1260	579	12	60	2.875	18.17	1.32
EVPAE1824	329	18	24	2.875	10.56	0.72
EVPAE1830	383	18	30	2.875	12.11	0.90
EVPAE1836	422	18	36	2.875	13.66	1.08
EVPAE1842	464	18	42	2.875	15.05	1.26
EVPAE1848	531	18	48	2.875	16.35	1.44
EVPAE1860	690	18	60	2.875	19.04	1.80

EVPOE • Open Panel Extension Module

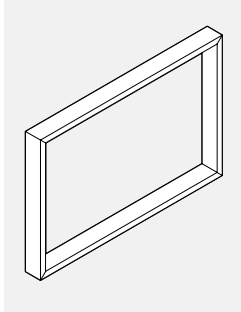

- Attaches to top portion of a beam.
- Modules can be stacked to add privacy or to divide space.
- Panel Extension Modules cannot install higher than 42”h. above finished floor.
- When ordering Panel Extension Modules, additional connectors are required.

PRODUCT CODE	PRICE	SIZE/ INCHES			WEIGHT	
		H	W	D	LBS	FT ³
EVPOE0618	239	6	18	2.875	6.22	0.26
EVPOE0624	245	6	24	2.875	7.40	0.29
EVPOE0630	298	6	30	2.875	8.48	0.36
EVPOE0636	314	6	36	2.875	9.56	0.43
EVPOE0642	381	6	42	2.875	10.88	0.51
EVPOE0648	429	6	48	2.875	12.12	0.58
EVPOE0654	469	6	54	2.875	13.25	0.65
EVPOE0660	505	6	60	2.875	14.68	0.73
EVPOE1218	239	12	18	2.875	7.30	0.51
EVPOE1224	245	12	24	2.875	8.40	0.59
EVPOE1230	298	12	30	2.875	9.50	0.82
EVPOE1236	314	12	36	2.875	10.60	1.00
EVPOE1242	381	12	42	2.875	11.84	1.00
EVPOE1248	429	12	48	2.875	13.20	1.18
EVPOE1254	469	12	54	2.875	14.38	1.25
EVPOE1260	505	12	60	2.875	15.80	1.32
EVPOE1818	319	18	18	2.875	7.74	0.54
EVPOE1824	358	18	24	2.875	9.18	0.72
EVPOE1830	381	18	30	2.875	10.53	0.90
EVPOE1836	418	18	36	2.875	11.88	1.08
EVPOE1842	471	18	42	2.875	13.09	1.26
EVPOE1848	530	18	48	2.875	14.22	1.44
EVPOE1854	575	18	54	2.875	15.28	1.62
EVPOE1860	619	18	60	2.875	16.56	1.80

EVPMP-GIP • Panel Mount Privacy Glass

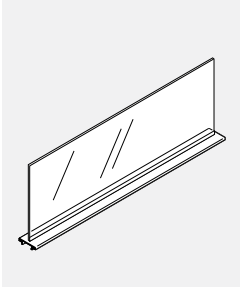

- Attaches on top of Power Beam or extension modules to add privacy or divide space.
- Privacy Glass is integrated into the aluminum top trim.
- Includes aluminum trim with channel and glass tile
- Glass and attachment hardware ship separately.
- Standard in clear (CLR), frosted (FRST) or writeable (WRW) glass.
- Privacy glass modules may stack on top of Power Beam or extension modules at 42" h. to achieve a height up to 54"h. above finished floor

PRODUCT CODE	PRICE			SIZE/ INCHES			WEIGHT LBS	VOL FT ³
	CLR	FRST	WRW	H	W	D		
EVPMP24GI6P	195	244	-	6	24	2.875	2.39	0.25
EVPMP30GI6P	213	268	-	6	30	2.875	2.99	0.32
EVPMP36GI6P	228	283	-	6	36	2.875	3.58	0.37
EVPMP42GI6P	244	304	-	6	42	2.875	4.18	0.43
EVPMP48GI6P	254	317	-	6	48	2.875	4.78	0.50
EVPMP54GI6P	262	328	-	6	54	2.875	5.38	0.56
EVPMP60GI6P	268	333	-	6	60	2.875	5.97	0.63
EVPMP66GI6P	410	546	-	6	66	2.875	6.57	0.69
EVPMP72GI6P	437	570	-	6	72	2.875	7.16	0.76
EVPMP24GI9P	195	244	-	9	24	2.875	3.58	0.38
EVPMP30GI9P	213	268	-	9	30	2.875	4.48	0.47
EVPMP36GI9P	228	283	-	9	36	2.875	5.37	0.56
EVPMP42GI9P	244	304	-	9	42	2.875	6.26	0.65
EVPMP48GI9P	254	317	-	9	48	2.875	7.16	0.75
EVPMP54GI9P	262	328	-	9	54	2.875	8.06	0.84
EVPMP60GI9P	268	333	-	9	60	2.875	8.96	0.94
EVPMP66GI9P	410	546	-	9	66	2.875	9.85	1.04
EVPMP72GI9P	437	570	-	9	72	2.875	10.74	1.13
EVPMP24GIP	195	244	340	12	24	2.875	4.77	0.50
EVPMP30GIP	213	268	347	12	30	2.875	5.97	0.63
EVPMP36GIP	228	283	353	12	36	2.875	7.16	0.75
EVPMP42GIP	244	304	389	12	42	2.875	8.35	0.87
EVPMP48GIP	254	317	426	12	48	2.875	9.55	1.00
EVPMP54GIP	262	328	461	12	54	2.875	10.75	1.12
EVPMP60GIP	268	333	497	12	60	2.875	11.95	1.25
EVPMP66GIP	410	546	681	12	66	2.875	13.05	1.37
EVPMP72GIP	437	570	713	12	72	2.875	14.25	1.51
EVPMP24GI18P	281	352	-	18	24	2.875	7.16	0.75
EVPMP30GI18P	308	385	-	18	30	2.875	8.96	0.94
EVPMP36GI18P	328	408	-	18	36	2.875	10.74	1.13
EVPMP42GI18P	352	440	-	18	42	2.875	12.53	1.31
EVPMP48GI18P	364	457	-	18	48	2.875	14.33	1.50
EVPMP54GI18P	377	471	-	18	54	2.875	16.13	1.69
EVPMP60GI18P	385	482	-	18	60	2.875	17.91	1.88
EVPMP66GI18P	537	712	-	18	66	2.875	19.70	2.06
EVPMP72GI18P	571	744	-	18	72	2.875	21.48	2.25

EVPBSCGD • Power Beam Shared Storage Cabinet with Sliding Glass Door



Left Hand Shown

- Inside dimensions 13"high x 13"deep.
- Laminate storage cabinet, available in standard Evolve laminate finishes.
- Available in Tempered frosted glass only, glass with handle.
- Tracks for sliding glass available in Tungsten only.
- To be installed under power beam between T legs.
- Power Beam Storage cabinet attaches to the bottom of the power beam with brackets.
- For ease of installation, levelers in middle included.
- **Note: To be used with 24"h. Power Beam only.**

PRODUCT CODE	PRICE	SIZE/ INCHES			WEIGHT LBS	VOL FT ³
		H	W	D		
EVPBSCGDR60	1734	15	58.75	16	80.46	8.33
EVPBSCGDR72	1893	15	70.75	16	96.60	10.00
EVPBSCGDL60	1734	15	58.75	16	80.46	8.33
EVPBSCGDL72	1893	15	70.75	16	96.60	10.00

EVPBSCGDP • Power Beam Shared Storage Cabinet with Sliding Glass Door and Cable Pass Through

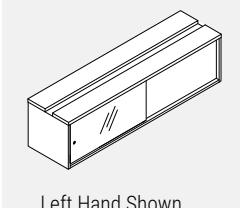

Left Hand Shown

- Inside dimensions 13"high x 13"deep.
- Laminate storage cabinet, available in standard Evolve laminate finishes.
- Available in Tempered frosted glass only, glass with handle.
- Tracks for sliding glass available in Tungsten only.
- To be installed under power beam between T legs.
- Power Beam Storage cabinet attaches to the bottom of the power beam with brackets.
- For ease of installation, levelers in middle included.
- **Note: To be used with 24"h. Power Beam only, EVPBEP-KIT and 60" and 72" widths only.**
- Cabinet with cable pass through in the middle to bring power to power beam above
- Includes metal cover for easy access to wires
- Electrics not included
- Power beam base feed to be ordered separately.
- Power beam kit with electrical cut out in middle to be ordered separately. (EVPBEP-KIT)

PRODUCT CODE	PRICE	SIZE/ INCHES			WEIGHT LBS	VOL FT ³
		H	W	D		
EVPBSCGDPR60	2092	15	58.75	16	80.46	8.33
EVPBSCGDPR72	2213	15	70.75	16	96.60	10.00
EVPBSCGDPL60	2092	15	58.75	16	80.46	8.33
EVPBSCGDPL72	2213	15	70.75	16	96.60	10.00

EVPBSC • Power Beam Shared Storage Cabinet, Open

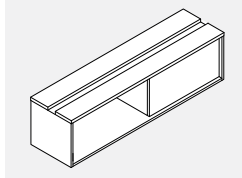

- Inside dimensions 13"high x 13"deep.
- Laminate storage cabinet, without doors, available in standard Evolve laminate finishes.
- To be installed under power beam between T legs.
- Power Beam Storage cabinet attaches to bottom of power beam with brackets.
- For ease of installation, levelers in middle included.
- Note: It can not be converted to cabinet with glass door.
- **Note: To be used with 24" Power Beam only.**

PRODUCT CODE	PRICE	SIZE/ INCHES			WEIGHT VOL	
		H	W	D	LBS	FT ³
EVPBSCR60	1110	15	58.75	16	80.46	8.33
EVPBSCR72	1133	15	70.75	16	96.6	10.00
EVPBSCCL60	1110	15	58.75	16	80.46	8.33
EVPBSCCL72	1133	15	70.75	16	96.6	10.00

EVPBSCP • Power Beam Shared Storage Cabinet, Open and Cable Pass Through

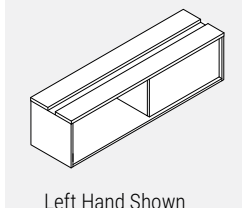

Left Hand Shown

- Inside dimensions 13"high x 13"deep.
- Laminate storage cabinet, without doors, available in standard Evolve laminate finishes.
- To be installed under power beam between T legs.
- Power Beam Storage cabinet attaches to bottom of power beam with brackets.
- For ease of installation, levelers in middle included.
- Note: It can not be converted to cabinet with glass door.
- **Note: To be used with 24" Power Beam only, EVPBEP-KIT.**
- Cabinet with cable pass through in the middle to bring power to power beam above.
- Includes metal cover for easy access to wires.
- Electrics not included.
- Power beam base feed to be ordered separately.
- Power beam kit with electrical cut out in middle to be ordered separately. (EVPBEP-KIT).

PRODUCT CODE	PRICE	SIZE/ INCHES			WEIGHT VOL	
		H	W	D	LBS	FT ³
EVPBSCP60	1238	15	58.75	16	80.46	8.33
EVPBSCP72	1306	15	70.75	16	96.6	10.00
EVPBSCPL60	1238	15	58.75	16	80.46	8.33
EVPBSCPL72	1306	15	70.75	16	96.6	10.00

EVSDAOH • Power Beam Dual Access Overhead

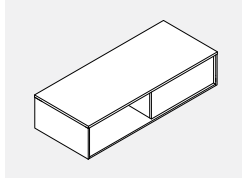

- Inside dimensions 6.5" high x 13"deep.
- Laminate Overhead.
- Available in standard Evolve laminate finishes.
- Power Beam storage cabinet must be installed at the bottom for stability.
- Top mount on power beam.
- Dual Access Overhead Support Brackets to be ordered separately.
- Power Beam legs for storage to be ordered separately.
- Power Beam legs for storage must be used.

PRODUCT CODE	PRICE	SIZE/ INCHES			WEIGHT VOL	
		H	W	D	LBS	FT ³
EVSDAOH60	1104	8.5	60	16	51.5	5.00
EVSDAOH72	1126	8.6	72	16	60.2	6.00

EVSDAOHBRKIT • Brackets for Dual Access Overhead

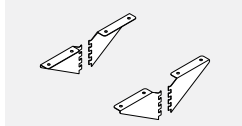

- Brackets support Dual access overhead
- To be used with Power Beam Channel
- Available in standard paint colors
- Brackets and screws included

PRODUCT CODE	PRICE	SIZE/INCHES			WEIGHT LBS	VOL FT ³
		H	W	D		
EVSDAOHBRKIT	129	5	5	1.5	2.00	0.08

EVPBL • 36" Power Beam Connector with Leg for Storage



- Connects 24" Power Beams on equal height.
- Includes non slotted connector with leg, glides and connecting hardware.
- Must be used with overhead.

PRODUCT CODE	PRICE	SIZE/ INCHES			WEIGHT VOL	
		H	W	D	LBS	FT ³
EVPBL36S	102	36	18		8.5	0.45

EVPBLERT • End of Run Trim for Connector

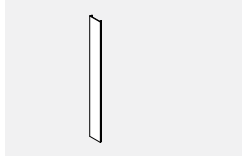

- Specify to match height of beam or total height with extension modules

PRODUCT CODE	PRICE	SIZE/ INCHES			WEIGHT VOL	
		H	W	D	LBS	FT ³
EVPBLERT24	52	21.4	2.875	3	1.0	0.04
EVPBLERT30	59	27.4	2.875	3	1.4	0.04
EVPBLERT36	62	33.4	2.875	3	1.6	0.06
EVPBLERT42	66	39.4	2.875	3	1.8	0.07
EVPBLERT48	69	45.4	2.875	3	2.00	0.08
EVPBLERT54	72	51.4	2.875	3	2.20	0.09
EVPBLERT66	83	63.4	2.875	3	2.60	1.10

EVPBLEP • Laminate End Panel for Power Beam

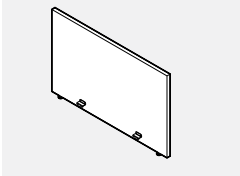

- Connects to a power beam support leg with foot at the end of a run
- Includes brackets to attach to support leg with foot
- Finished in thermally fused laminate. If wood grain is selected, grain runs horizontally
- Laminate End Panel height is inclusive of panel glides extended to their full height
- Laminate end panel must connect to a support leg with foot and will not connect to a support leg with glide
- Must be used with Connectors with T-Leg

PRODUCT CODE	PRICE	SIZE/ INCHES			WEIGHT VOL	
		H	W	D	LBS	FT ³
EVPBLEP2451	317	24	51	1	32.81	0.73
EVPBLEP3051	396	30	51	1	39.38	0.88
EVPBLEP3651	473	36	51	1	45.94	1.02
EVPBLEP4251	710	42	51	1	52.50	1.24
EVPBLEP2463	359	24	63	1	37.50	0.83
EVPBLEP3063	451	30	63	1	45.00	1.00
EVPBLEP3663	541	36	63	1	52.50	1.17
EVPBLEP4263	792	42	63	1	60.00	1.53

EVPBLEP • Laminate End Panel for Power Beam, Single Leg

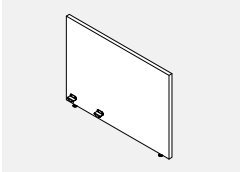

- EVPBLEP - Laminate End Panel for Power Beam.
- Attaches to power beam connector with single leg.
- For one sided Power beam application.
- Includes brackets to attached to attached to leg.
- Finished in thermally fused laminate, if wood grain is selected, grain runs horizontally.
- Laminate End Panel height is inclusive of panel glides extended to their full height.
- EVPBLEP-30 to be used for 24" deep worksurface.
- EVPBLEP-36 to be used for 30" deep worksurfaces

PRODUCT CODE	PRICE	SIZE/ INCHES			WEIGHT VOL	
		H	W	D	LBS	FT ³
EVPBLEP2430	257	24	30	1	19.30	0.42
EVPBLEP3030	279	30	30	1	23.16	0.52
EVPBLEP3630	300	36	30	1	27.02	0.64
EVPBLEP4230	377	42	30	1	30.88	0.74
EVPBLEP2436	303	24	36	1	21.43	0.55
EVPBLEP3036	314	30	36	1	25.71	0.64
EVPBLEP3636	353	36	36	1	30.00	0.75
EVPBLEP4236	451	42	36	1	34.29	0.90

EVE8PD • Power Distribution Housing

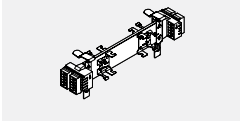

- Power housing is specified per beam size (e.g. EVE8PD36 is for use in a 36" beam).
- 8 wire, 4 circuits (2+2 configuration).
- Accommodates two duplex receptacles per panel side.

PRODUCT CODE	PRICE	SIZE/ INCHES		WEIGHT VOL	
		W	D	LBS	FT ³
EVE8PD24	142	24	9.25	0.83	1.17
EVE8PD30	189	30	15.25	1.28	1.17
EVE8PD36	200	36	21.25	1.62	1.65
EVE8PD42	205	42	27.25	2.00	2.00
EVE8PD48	216	48	33.25	0.18	0.16
EVE8PD54	220	54	39.25	2.66	3.20
EVE8PD60	221	60	45.25	3.04	3.20

EVE8PD • Power Distribution Housing

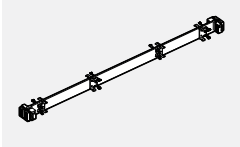

- Power housing is specified per beam size (e.g. EVE8PD72 is for use in a 72" beam).
- 8 wire, 4 circuits (2+2 configuration).
- Provides two duplex receptacle to be plugged directly to power distribution housing and then as option additional two duplex receptacle to be connected to it with "I" connector, per panel size.
- Both duplex receptacles connected by "I" connector must be same circuit.
- Each power distribution housing supports 15-20 amps.
- Duplex receptacles and "I" connectors to be ordered separately.

PRODUCT CODE	PRICE	SIZE/ INCHES		WEIGHT VOL	
		W	D	LBS	FT ³
EVE8PD66	230	66	43.5	3.44	3.30
EVE8PD72	238	72	45.5	3.84	3.40

EVE8CP • Jumper Cable

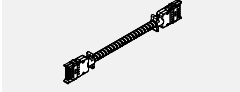

- The EVE8CP16 electrically connects two powered panels positioned side by side.
- The EVE8CP20 electrically connects two powered panels separated by a post.

PRODUCT CODE	PRICE	SIZE/ INCHES	WEIGHT VOL	
			L	LBS FT ³
EVE8CP16	110	16	0.66	1.17
EVE8CP20	129	20	0.78	1.17

EVE8CP18 • Flexible Mesh Jumper Cable

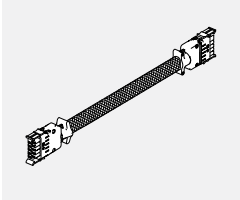

- Electrically connects two powered panels separated by post.
- Used to connect two power distribution housing in Power Beam at 90 degrees.

PRODUCT CODE	PRICE	SIZE/ INCHES			WEIGHT VOL	
		H	W	D	LBS	FT ³
EVE8CP18	134			18.5	0.78	1.17

EVE8CP • Pass Through Cable

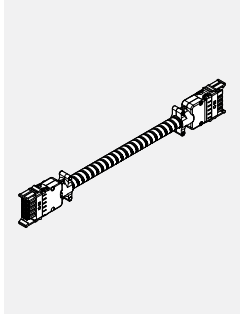

- Flexible metal conduit is used to distribute electrical power through non-powered panels.
- To calculate the length of a Pass-Through Cable, add the widths of the non-powered panels separating the powered panels (panels with distribution housing attached). To this, add 16" (distance from the edge of the panel to the distribution housing x 2). See Technical Information page at the beginning of this section.

PRODUCT CODE	PRICE	SIZE/ INCHES			WEIGHT VOL	
		L			LBS	FT ³
EVE8CP40	143	40			1.44	1.17
EVE8CP46	147	46			1.71	1.17
EVE8CP52	154	52			1.95	1.17
EVE8CP58	164	58			2.21	1.17
EVE8CP64	171	64			2.37	1.17
EVE8CP70	174	70			2.60	1.17
EVE8CP76	177	76			2.81	1.17
EVE8CP82	186	82			3.03	1.17
EVE8CP88	191	88			3.05	1.17
EVE8CP94	198	94			3.92	1.17
EVE8CP100	204	100			3.47	1.17
EVE8CP106	212	106			3.87	1.17
EVE8CP118	226	118			4.08	1.17
EVE8CP130	245	185			4.73	1.17
EVE8CP142	255	142			4.59	1.17

EVE8CPxx-H • Hybrid Pass Through Cables with Wire Mesh

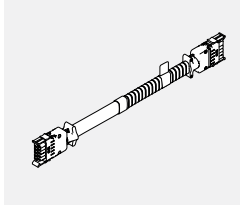

- Flexible metal conduit with wire mesh distributes electrical power through non powered panels.
- To calculate the length of Hybrid Pass Through Cable, add the width of non powered panels separating the powered panels. To this add 16" (distance from edge of the panels to power distribution housing x2).
- Please add an additional 3" when passing through a post. Please see the the beginning of this section.
- Hybrid Pass Through Cables with wire mesh allows connection at 90 degree post and one end for Power Beam.

PRODUCT CODE	PRICE	SIZE/INCHES			WEIGHT VOL	
		H	W	D	LBS	FT ³
EVE8CP40-H	178		40		1.44	1.17
EVE8CP46-H	185		46		1.71	1.17
EVE8CP52-H	193		52		1.95	1.17
EVE8CP58-H	205		58		2.21	1.17
EVE8CP64-H	214		64		2.37	1.17
EVE8CP70-H	218		70		2.60	1.17
EVE8CP76-H	222		76		2.81	1.17
EVE8CP82-H	232		82		3.03	1.17
EVE8CP88-H	240		88		3.05	1.17
EVE8CP94-H	248		94		3.42	1.17
EVE8CP100-H	255		100		3.47	1.17
EVE8CP106-H	265		106		3.87	1.17
EVE8CP118-H	281		118		4.08	1.17
EVE8CP130-H	306		130		4.73	1.17
EVE8CP142-H	319		142		4.89	1.17

EVE8CI-1 • "I" Connector

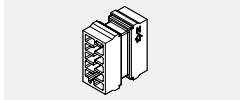

- Female - Female connector used to connect two Pass-Through Cables.

PRODUCT CODE	PRICE	SIZE/ INCHES			WEIGHT VOL	
		H	W	D	LBS	FT ³
EVE8CI-1	77	15	15	0.75	0.06	0.20

EVE8RD • Duplex Receptacles

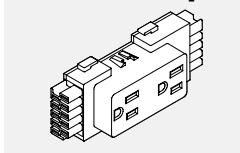

- Up to 6 duplex receptacles per circuit.
- EVE8RD1 = Circuit #1 (utility circuit)
- EVE8RD1 = Circuit #2 (utility circuit)
- EVE8RDA = Circuit #A (dedicated)
- EVE8RDB = Circuit #B (dedicated)

PRODUCT CODE	PRICE	SIZE/ INCHES			WEIGHT VOL	
		H	W	D	LBS	FT ³
EVE8RD1	32	2	4.625	1.25	0.16	0.01
EVE8RD2	32	2	4.625	1.25	0.16	0.01
EVE8RDA	32	2	4.625	1.25	0.16	0.01
EVE8RDB	32	2	4.625	1.25	0.16	0.01

EVEUSB01 • Duplex Receptacles

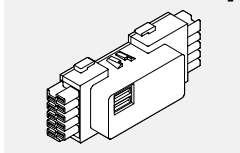

- The USB charging module provides convenient charging power access through dual ports on face of the receptacle.
- Two USB ports.
- 2 Amp output via two USB ports, considered as circuit #1.
- Available in white, black.

PRODUCT CODE	PRICE	SIZE/ INCHES			WEIGHT VOL	
		H	W	D	LBS	FT ³
EVEUSB01WHT	216	2	4.625	1.25	0.16	0.01
EVEUSB01BLK	216	2	4.625	1.25	0.16	0.01

EVE8FR3PB • Floor Power Entry for Power Beam

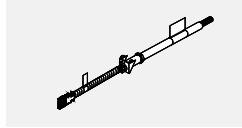

- Snaps into the power distribution housing.
- Includes 84" long flexible vinyl conduit.
- Includes bracket to attach to vertical raceway panel.
- Must be hard wire to source by licenced electrician.

PRODUCT CODE	PRICE	SIZE/ INCHES			WEIGHT VOL	
		H	W	D	LBS	FT ³
EVE8FR3PB	395	3	84	2	3.82	2.00

EVE8EC • Ceiling Power Entry

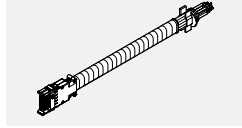

- Snaps into the end of the Power Distribution Housing.
- Flexible metal conduit extends into the ceiling through a corner post and post extension (both ordered separately).
- Must be hard wired to source power by a licensed electrician.
- 4" Junction Box included.

PRODUCT CODE	PRICE	SIZE/ INCHES			WEIGHT VOL	
		L	LBS	FT ³	LBS	FT ³
EVE8EC1	244		132		5.24	2.00
EVE8EC2	435		144		5.96	2.00

EVE8FR3PBP • Power Entry for Power Beam for Wall Plate Infeed

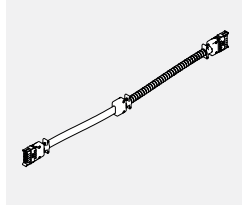

- Snaps into power distribution housing.
- Includes 48" long flexible vinyl conduit with connector.
- Includes bracket to attach to vertical raceway panel
- Power Beam with electrical cut out must be ordered.
- 71" long base feed will work with 24" and 36" H Power Beam.
- Note: EVE8FR3PBP will only work with Wall Plate Infeed EVE8WPIPB.

PRODUCT CODE	PRICE	SIZE/ INCHES			WEIGHT VOL	
		H	W	D	LBS	FT ³
EVE8FR3PBP	339	3	71	2	3.82	2.00

EVE8WPIPB • Wall Plate Infeed for Power Beam

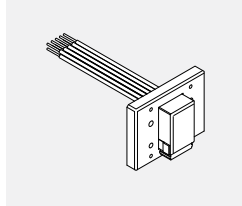

- - Wall plate infeed must be installed and hardwired to source by licensed electrician.
- Note: EVE8FR3PBP will only work with Wall Plate Infeed EVE8WPIPB.

PRODUCT CODE	PRICE	SIZE/ INCHES			WEIGHT VOL	
		H	W	D	LBS	FT ³
EVE8WPIPB	552	5.25	5.25	1.75	1.00	0.10

EVEJBC1PB • Hardwire Junction Box for Power Beam

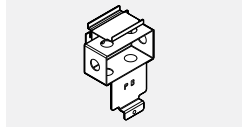

- Can be retrofitted in any size of panel at the receptacle location.
- Gives access from one side only at each location.
- Customer to supply conduit, wiring, receptacle, and face plate 2 per Power Beam.
- A licensed electrician must provide hard wire connection with the junction box.
- For use with Power Beam only.

PRODUCT CODE	PRICE	WEIGHT VOL	
		LBS	FT ³
EVEJBC1PB	95	1.50	0.02

EVDPE • Post Extension Data/Comm Lay-in

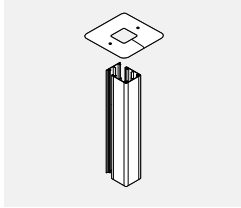

- Attaches to the top of a post to bring power and/or data cables from the ceiling to panel power way.
- Three-sided power pole with snap-on fourth side.
- Post extension can be opened on one side for lay-in for power and/or data cables.
- Made of aluminum and can be field cut.
- Accommodates up to 25 CAT5 cables with electric. Accommodates up to 45 CAT5 cables without electric.

PRODUCT CODE	PRICE	SIZE/ INCHES		WEIGHT VOL	
		H	W	LBS	FT ³
EVDPE64	155	64	2.875	3.00	0.70
EVDPE82	191	82	2.875	4.20	0.80
EVDPE88	293	88	2.875	4.50	0.85
EVDPE94	314	94	2.875	4.80	0.92
EVDPE100	334	100	2.875	5.12	0.97

EVDP4E • 45° Post Extension Data/Comm Lay-in

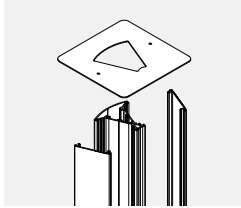

- Attached to the top of the 45° Corner Post to bring power and/or data cables from the ceiling to the panel run through.
- Cable capacity
 - 40 CAT5 cables without electric feed.
 - 10 CAT5 cables with electric feed.

PRODUCT CODE	PRICE	SIZE/ INCHES		WEIGHT VOL	
		H	W	LBS	FT ³
EVDP4E64	157	64	3.65	3.00	0.70
EVDP4E82	212	82	3.65	4.20	0.80

EVDP6E • 60° Post Extension Data/Comm Lay-in

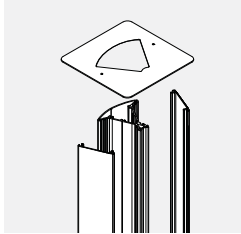

- Attached to the top of the 60° Corner Post to bring power and/or data cables from the ceiling to the panel run through.
- Post extension can be opened on one side for lay-in power and/or data cables.
- Made of aluminum and can be field cut.
- Two sided power pole with snap-on third side.
- Cable capacity
 - 32 CAT5 cables without electric.
 - 15 CAT5 cables with electric

PRODUCT CODE	PRICE	SIZE/ INCHES		WEIGHT VOL	
		H	W	LBS	FT ³
EVDP6E64	152	64	2	3.00	0.70
EVDP6E82	186	82	2	4.20	0.80

EVPBECH34 • Wire Manager Kit



- Provides cable management from Power Beam to Height Adjustable Table.
- Includes bracket to attach to bottom trim of Power Beam.
- Cables fit easily.
- Includes a neoprene wire manager sock, bracket and screws.
- Neoprene available in black only.
- Specify bracket paint finish.

PRODUCT CODE	PRICE	SIZE/ INCHES			WEIGHT VOL	
		H	W	D	LBS	FT ³
EVPBECH34	409	1	41	2	0.60	0.04

EVPBT01 • Power Beam Tray

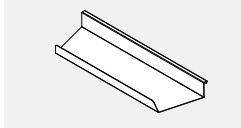

- Power beam tray provides support for wires.
- Can be used with power beam only.
- Available in standard and premium paint finishes.

PRODUCT CODE	PRICE	SIZE/ INCHES			WEIGHT VOL	
		H	W	D	LBS	FT ³
EVPBT01	29	12	1.25	3.5	0.60	0.04

EVAFMB01 • Floor Mount Plate

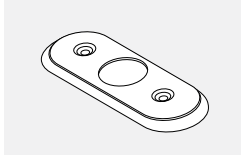

- Attached to floor.
- Secures panel to floor.
- Attachment screws not included.
- Care should be taken to use correct fasteners for type of floor.
- Available in chrome finish only.

PRODUCT CODE	PRICE	SIZE/ INCHES			WEIGHT VOL	
		H	W	D	LBS	FT ³
EVAFMB01	70	0.25	5	2.5	0.2	0.02

WORKSURFACES • TECHNICAL INFORMATION

- All worksurfaces have threaded inserts for metal-to-metal connection of support hardware.
- Back edge features scoop detail and sits 3/8" away from the face of a panel for wire management. Scoop depth is 3/4" at centre.
- Communication and electrical wires are routed through the cable scoop at the back of the worksurface.
- Straight or Curvilinear Worksurfaces 48" or less have one scoop while those that are 54" or more two scoops. All other worksurface shapes have one scoop.
- LP and HP worksurfaces are 3.5 mm edge banded.
- LP worksurfaces are 1" thick particle board with laminate finish.
- HP worksurfaces are 1 1/16" thick particle board with laminate finish overall.
- All support hardware must be ordered separately.
- Wood grain laminates on corner worksurfaces may run diagonal to the adjacent worksurfaces. Specify "WG" at the end of the worksurface code.
- Please use "Wood Grain Direction" chart at the beginning of the price list.

WORKSURFACES • GUIDELINE FOR ORDERING PRODUCT

The price list uses a numbering system with meaningful alphanumeric characters to create a simple-to-understand product number. This makes specifying the product much easier and more accurate.

EXAMPLE OF WORKSURFACE CODE

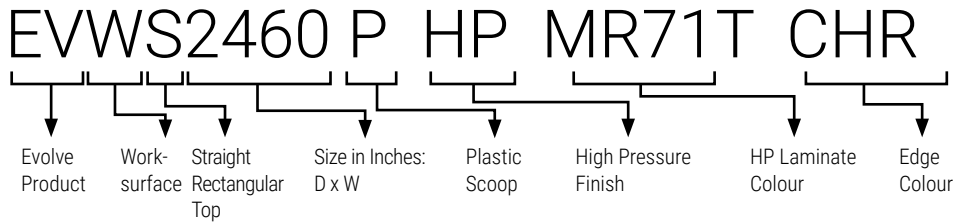

HOW TO SPECIFY

- Specify Evolve worksurface type and size by code.
- Specify type of finish.
- Specify High or LOW Pressure Laminate Colour.
- Specify PVC edge colour.

EVWS • Straight Worksurface

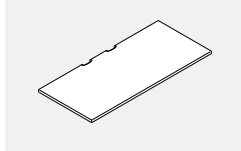

- Straight rectangular worksurfaces are non-handed and can be interchanged on site.
- Please choose from DWT - Designer White, SIL - Silver or BLK - Black for scoop covers.

PRODUCT CODE	PRICE		SIZE/ INCHES			WEIGHT VOL	
	LP	HP	H	W	D	LBS	FT ³
EVWS1818P	123	156	1	18	18	12.50	0.37
EVWS1824P	127	169	1	24	18	13.50	0.40
EVWS1830P	134	178	1	30	18	16.50	0.54
EVWS1836P	154	204	1	36	18	19.50	0.63
EVWS1842P	202	270	1	42	18	23.25	0.73
EVWS1848P	242	318	1	48	18	26.25	0.83
EVWS1854P	284	374	1	54	18	29.25	0.93
EVWS1860P	319	410	1	60	18	33.00	1.02
EVWS1866P	334	439	1	66	18	36.75	1.12
EVWS1872P	352	464	1	72	18	39.75	1.21
EVWS1878P	369	488	1	78	18	38.50	1.23
EVWS1884P	405	530	1	84	18	39.75	1.21
EVWS1890P	526	774	1	90	18	48.75	1.53
EVWS1896P	561	827	1	96	18	51.75	1.73
EVWS2418P	127	163	1	18	24	12.00	0.50
EVWS2424P	129	173	1	24	24	18.00	60.00
EVWS2430P	141	184	1	30	24	22.00	0.72
EVWS2436P	156	207	1	36	24	26.00	0.85
EVWS2442P	205	272	1	42	24	31.00	0.98
EVWS2448P	245	329	1	48	24	35.00	1.11
EVWS2454P	290	383	1	54	24	39.00	1.23
EVWS2460P	326	430	1	60	24	44.00	1.36
EVWS2466P	340	449	1	66	24	49.00	1.49
EVWS2472P	355	470	1	72	24	53.00	1.62
EVWS2478P	381	501	1	78	24	57.18	2.16
EVWS2484P	410	537	1	84	24	61.50	2.33
EVWS2490P	526	774	1	90	24	64.50	2.53
EVWS2496P	561	827	1	96	24	68.50	2.73
EVWS3018P	145	186	1	18	30	15.30	0.63
EVWS3024P	154	202	1	24	30	22.00	0.74
EVWS3030P	165	218	1	30	30	28.00	0.90
EVWS3036P	194	256	1	36	30	33.00	1.06
EVWS3042P	275	362	1	42	30	38.00	1.22
EVWS3048P	290	383	1	48	30	44.00	1.38
EVWS3054P	317	408	1	54	30	49.00	1.54
EVWS3060P	340	449	1	60	30	55.00	1.69
EVWS3066P	353	469	1	66	30	60.00	1.85
EVWS3072P	374	495	1	72	30	66.00	2.01
EVWS3078P	398	524	1	78	30	71.48	2.70
EVWS3084P	443	579	1	84	30	76.98	2.92
EVWS3090P	656	969	1	90	30	81.98	3.12
EVWS3096P	701	1033	1	96	30	68.50	3.32
EVWS3672P	528	691	1	72	36	79.20	2.42

EVWS • Straight Worksurface to Span a Post

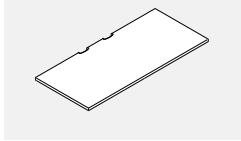

- Straight rectangular worksurfaces are non-handed and can be interchanged on site.
- Worksurface will span the width of a post eliminating a gap between standard sizes.
- Please choose from DWT - Designer White, SIL - Silver or BLK - Black for scoop covers.

PRODUCT CODE	PRICE		SIZE/ H	INCHES			WEIGHT VOL	
	LP	HP		W	D	LBS	FT ³	
EVWSP1827P	134	178	1	27	18	16.50	0.54	
EVWSP1833P	169	204	1	33	18	19.50	0.53	
EVWSP1839P	202	270	1	39	18	23.25	0.73	
EVWSP1845P	242	318	1	45	18	26.25	0.83	
EVWSP1851P	284	374	1	51	18	29.25	0.93	
EVWSP1857P	319	410	1	57	18	33.00	1.02	
EVWSP1863P	334	439	1	63	18	36.75	1.12	
EVWSP1869P	352	464	1	69	18	39.75	1.21	
EVWSP1875P	369	488	1	75	18	42.75	1.33	
EVWSP1881P	405	530	1	81	18	45.75	1.43	
EVWSP2427P	141	184	1	27	24	22.00	0.72	
EVWSP2433P	156	207	1	33	24	26.00	0.85	
EVWSP2439P	205	272	1	39	24	31.00	0.98	
EVWSP2445P	245	329	1	45	24	35.00	1.11	
EVWSP2451P	290	383	1	51	24	39.00	1.23	
EVWSP2457P	326	430	1	57	24	44.00	1.36	
EVWSP2463P	340	449	1	63	24	49.00	1.49	
EVWSP2469P	355	470	1	69	24	53.00	1.62	
EVWSP2475P	381	501	1	75	24	57.18	2.16	
EVWSP2481P	410	537	1	81	24	61.50	2.33	
EVWSP3027P	165	218	1	27	30	28.00	0.90	
EVWSP3033P	194	256	1	33	30	33.00	1.06	
EVWSP3039P	275	362	1	39	30	38.00	1.22	
EVWSP3045P	290	383	1	45	30	44.00	1.38	
EVWSP3051P	317	408	1	51	30	49.00	1.54	
EVWSP3057P	340	449	1	57	30	55.00	1.69	
EVWSP3063P	353	469	1	63	30	60.00	1.85	
EVWSP3069P	374	495	1	69	30	66.00	2.01	
EVWSP3075P	398	524	1	75	30	71.48	2.70	
EVWSP3081P	443	579	1	81	30	76.98	2.92	

EVWVL • Curvilinear Worksurface Left

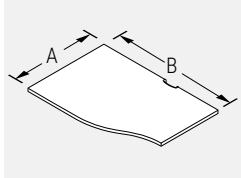

- When deepest end equals 24", the opposite depth is 18".
- When deepest end equals 30", the opposite depth is 24".
- Please choose from DWT - Designer White, SIL - Silver or BLK - Black for scoop covers.

NOTE: EVWV

24	36
A	B
DEPTH	WIDTH

PRODUCT CODE	PRICE		SIZE/ H	INCHES			WEIGHT VOL	
	LP	HP		W	D	LBS	FT ³	
EVWVL2424P	167	226	1	24	24	15.00	0.59	
EVWVL2430P	177	233	1	30	24	19.00	0.72	
EVWVL2436P	211	281	1	36	24	23.00	0.85	
EVWVL2442P	245	329	1	42	24	27.00	0.98	
EVWVL2448P	281	374	1	48	24	31.00	1.11	
EVWVL2454P	317	420	1	54	24	35.00	1.23	
EVWVL2460P	344	469	1	60	24	39.00	1.36	
EVWVL2466P	381	513	1	66	24	43.00	1.49	
EVWVL2472P	408	561	1	72	24	47.00	1.62	
EVWVL3024P	169	232	1	24	30	19.00	0.74	
EVWVL3030P	186	244	1	30	30	24.00	0.90	
EVWVL3036P	222	281	1	36	30	29.00	1.06	
EVWVL3042P	303	400	1	42	30	34.00	1.22	
EVWVL3048P	317	420	1	48	30	39.00	1.38	
EVWVL3054P	353	469	1	54	30	44.00	1.54	
EVWVL3060P	380	513	1	60	30	49.00	1.69	
EVWVL3066P	408	561	1	66	30	54.00	1.85	
EVWVL3072P	438	608	1	72	30	59.00	2.01	
EVWVL3078P	634	809	1	78	30	71.48	2.71	
EVWVL3084P	809	825	1	84	30	76.98	2.91	

EVWVR • Curvilinear Worksurface Right

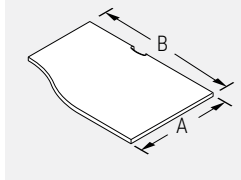

- When deepest end equals 24", the opposite depth is 18".
- When deepest end equals 30", the opposite depth is 24".
- Please choose from DWT - Designer White, SIL - Silver or BLK - Black for scoop covers.

NOTE: EVWV

24	36
A	B
DEPTH	WIDTH

PRODUCT CODE	PRICE		SIZE/ INCHES			WEIGHT VOL	
	LP	HP	H	W	D	LBS	FT ³
EVWVR2424P	167	226	1	24	24	15.00	0.59
EVWVR2430P	177	233	1	30	24	19.00	0.72
EVWVR2436P	211	281	1	36	24	23.00	0.85
EVWVR2442P	245	329	1	42	24	27.00	0.98
EVWVR2448P	281	374	1	48	24	31.00	1.11
EVWVR2454P	317	420	1	54	24	35.00	1.23
EVWVR2460P	344	469	1	60	24	39.00	1.36
EVWVR2466P	381	513	1	66	24	43.00	1.49
EVWVR2472P	408	561	1	72	24	47.00	1.62
EVWVR3024P	169	232	1	24	30	19.00	0.74
EVWVR3030P	186	244	1	30	30	24.00	0.90
EVWVR3036P	222	281	1	36	30	29.00	1.06
EVWVR3042P	303	400	1	42	30	34.00	1.22
EVWVR3048P	317	420	1	48	30	39.00	1.38
EVWVR3054P	353	469	1	54	30	44.00	1.54
EVWVR3060P	380	513	1	60	30	49.00	1.69
EVWVR3066P	408	561	1	66	30	54.00	1.85
EVWVR3072P	438	608	1	72	30	59.00	2.01
EVWVR3078P	634	809	1	78	30	71.48	2.71
EVWVR3084P	735	825	1	84	30	76.98	2.71

EVWNL • Notched Worksurface Left

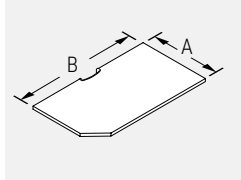

- When deepest end equals 24", the opposite depth is 18".
- When deepest end equals 30", the opposite depth is 24".
- The user edge is 6" shorter than the overall length.
- Please choose from DWT - Designer White, SIL - Silver or BLK - Black for scoop covers.

NOTE: EVWN

24	36
A	B
DEPTH	WIDTH

PRODUCT CODE	PRICE		SIZE/ INCHES			WEIGHT VOL	
	LP	HP	H	W	D	LBS	FT ³
EVWNL2424P	167	226	1	24	24	15.00	0.59
EVWNL2430P	177	233	1	30	24	19.00	0.72
EVWNL2436P	211	281	1	36	24	23.00	0.85
EVWNL2442P	245	329	1	42	24	27.00	0.98
EVWNL2448P	281	374	1	48	24	31.00	1.11
EVWNL2454P	317	420	1	54	24	35.00	1.23
EVWNL2460P	344	469	1	60	24	39.00	1.36
EVWNL2466P	381	513	1	66	24	43.00	1.49
EVWNL2472P	408	561	1	72	24	47.00	1.62
EVWNL3024P	169	232	1	24	30	19.00	0.74
EVWNL3030P	186	244	1	30	30	24.00	0.90
EVWNL3036P	222	281	1	36	30	29.00	1.06
EVWNL3042P	303	400	1	42	30	34.00	1.22
EVWNL3048P	317	420	1	48	30	39.00	1.38
EVWNL3054P	353	469	1	54	30	44.00	1.54
EVWNL3060P	380	513	1	60	30	49.00	1.69
EVWNL3066P	408	561	1	66	30	54.00	1.85
EVWNL3072P	438	608	1	72	30	59.00	2.01
EVWNL3078P	634	809	1	78	30	71.48	2.70
EVWNL3084P	809	825	1	84	30	76.98	2.92

EVWNR • Notched Worksurface Right

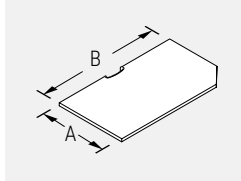

- When deepest end equals 24", the opposite depth is 18".
- When deepest end equals 30", the opposite depth is 24".
- The user edge is 6" shorter than the overall length.
- Please choose from DWT - Designer White, SIL - Silver or BLK - Black for scoop covers.

NOTE: EVWN

24	36
A	B
DEPTH	WIDTH

PRODUCT CODE	PRICE		SIZE/ INCHES			WEIGHT VOL	
	LP	HP	H	W	D	LBS	FT ³
EVWNR2424P	167	226	1	24	24	15.00	0.59
EVWNR2430P	177	233	1	30	24	19.00	0.72
EVWNR2436P	211	281	1	36	24	23.00	0.85
EVWNR2442P	245	329	1	42	24	27.00	0.98
EVWNR2448P	281	374	1	48	24	31.00	1.11
EVWNR2454P	317	420	1	54	24	35.00	1.23
EVWNR2460P	344	469	1	60	24	39.00	1.36
EVWNR2466P	381	513	1	66	24	43.00	1.49
EVWNR2472P	408	561	1	72	24	27.00	1.62
EVWNR3024P	169	232	1	24	24	19.00	0.74
EVWNR3030P	186	244	1	30	30	24.00	0.90
EVWNR3036P	222	281	1	36	30	29.00	1.06
EVWNR3042P	303	400	1	42	30	34.00	1.22
EVWNR3048P	317	420	1	48	30	39.00	1.38
EVWNR3054P	353	469	1	54	30	44.00	1.54
EVWNR3060P	380	513	1	60	30	49.00	1.69
EVWNR3066P	408	561	1	66	30	54.00	1.85
EVWNR3072P	438	608	1	72	30	59.00	2.01
EVWNR3078P	634	809	1	78	30	71.48	2.70
EVWNR3084P	809	825	1	84	30	76.98	2.92

EVWC4C • Corner Curved Worksurface For 45° Post

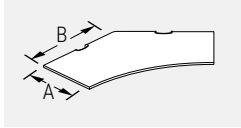

NOTE:
A= 18, 24, 30
B= 24, 30, 36, 42, 48

- "WG" at the end of the code indicates wood grain laminate on the diagonal.
- "WG" worksurface over 42" cannot be done on the diagonal.
- Support hardware must be ordered separately. See the listing in this section.
- Please choose from DWT - Designer White, SIL - Silver or BLK - Black for scoop covers.

PRODUCT CODE	PRICE		1SIZE/ H	INCHES		WEIGHT VOL	
	LP	HP		W	D	LBS	FT³
EVWC4C1824P	385	481	1	24	18	19.38	0.43
EVWC4C1830P	497	619	1	30	18	24.87	0.55
EVWC4C1836P	699	869	1	36	18	30.36	0.67
EVWC4C1842P	1132	1414	1	42	18	35.78	0.80
EVWC4C1848P	1318	1648	1	48	18	41.28	0.92
EVWC4C2424P	399	501	1	24	24	24.04	0.53
EVWC4C2430P	561	702	1	30	24	31.38	0.70
EVWC4C2436P	774	969	1	36	24	38.72	0.86
EVWC4C2442P	1132	1414	1	42	24	46.07	1.02
EVWC4C2448P	1483	1851	1	48	24	53.41	1.19
EVWC4C3024P	418	521	1	24	30	27.94	0.62
EVWC4C3030P	622	779	1	30	30	37.16	0.83
EVWC4C3036P	851	1062	1	36	30	46.38	1.03
EVWC4C3042P	1268	1590	1	42	30	55.60	1.24
EVWC4C3048P	1648	2059	1	48	30	64.82	1.44
EVWC4C1824WGP	578	721	1	24	18	19.38	0.43
EVWC4C1830WGP	746	929	1	30	18	24.87	0.55
EVWC4C1836WGP	1048	1304	1	36	18	30.36	0.67
EVWC4C1842WGP	1698	2120	1	42	18	35.78	0.80
EVWC4C2424WGP	599	751	1	24	24	24.04	0.53
EVWC4C2430WGP	842	1053	1	30	24	31.38	0.70
EVWC4C2436WGP	1162	1454	1	36	24	38.72	0.86
EVWC4C2442WGP	1698	2120	1	42	24	46.07	1.02
EVWC4C3024WGP	627	782	1	24	30	27.94	0.62
EVWC4C3030WGP	932	1168	1	30	30	37.16	0.83
EVWC4C3036WGP	1277	1592	1	36	30	46.38	1.03
EVWC4C3042WGP	1902	2384	1	42	30	55.60	1.24

EVWC4K • Keyboard Corner Worksurface For 45° Post

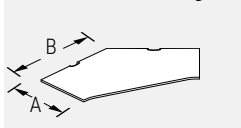

NOTE:
A= 18, 24, 30
B= 24, 30, 36, 42, 48

- "WG" at the end of the code indicates wood grain laminate on the diagonal.
- "WG" worksurface over 42" cannot be done on the diagonal.
- Support hardware must be ordered separately. See the listing in this section.
- Please choose from DWT - Designer White, SIL - Silver or BLK - Black for scoop covers.

PRODUCT CODE	PRICE		SIZE/ H	INCHES		WEIGHT VOL	
	LP	HP		W	D	LBS	FT³
EVWC4K1824P	410	518	1	24	18	19.38	0.43
EVWC4K1830P	637	795	1	30	18	24.87	0.55
EVWC4K1836P	904	1134	1	36	18	30.36	0.67
EVWC4K1842P	1132	1414	1	42	18	35.78	0.80
EVWC4K1848P	1318	1648	1	48	18	41.28	0.92
EVWC4K2424P	494	617	1	24	24	24.04	0.53
EVWC4K2430P	740	927	1	30	24	31.38	0.70
EVWC4K2436P	1035	1293	1	36	24	38.72	0.86
EVWC4K2442P	1132	1414	1	42	24	46.07	1.02
EVWC4K2448P	1483	1851	1	48	24	53.41	1.19
EVWC4K3024P	576	722	1	24	30	27.94	0.62
EVWC4K3030P	915	1058	1	30	30	37.16	0.83
EVWC4K3036P	1035	1293	1	36	30	46.38	1.03
EVWC4K3042P	1268	1590	1	42	30	55.60	1.24
EVWC4K3048P	1648	2059	1	48	30	64.82	1.44
EVWC4K1824WGP	615	777	1	24	18	19.38	0.43
EVWC4K1830WGP	955	1193	1	30	18	24.87	0.55
EVWC4K1836WGP	1356	1701	1	36	18	30.36	0.67
EVWC4K1842WGP	1698	2120	1	42	18	35.78	0.80
EVWC4K2424WGP	741	926	1	24	24	24.04	0.53
EVWC4K2430WGP	1110	1391	1	30	24	31.38	0.70
EVWC4K2436WGP	1553	1939	1	36	24	38.72	0.86
EVWC4K2442WGP	1698	2120	1	42	24	46.07	1.02
EVWC4K3024WGP	865	1082	1	24	30	27.94	0.62
EVWC4K3030WGP	1373	1587	1	30	30	37.16	0.83
EVWC4K3036WGP	1553	1939	1	36	30	46.38	1.03
EVWC4K3042WGP	1902	2384	1	42	30	55.60	1.24

EVW4T • Corner Transaction Surface For 45° Post

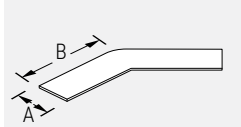

- Support hardware must be ordered separately. See the listing in this section.
- For use with laminate end and middle panels.

NOTE:
A= 15
B= 24, 30, 36, 42, 48

PRODUCT CODE	PRICE		SIZE/ H	INCHES		WEIGHT VOL	
	LP	HP		W	D	LBS	FT³
EVW4T1524	565	705	1	24	15	19.14	0.43
EVW4T1530	705	883	1	30	15	23.78	0.53
EVW4T1536	988	1235	1	36	15	28.39	0.63
EVW4T1542	1318	1648	1	42	15	32.99	0.73
EVW4T1548	1414	1764	1	48	15	37.58	0.84

EVWC6C • Corner Curved Worksurface For 60° Post

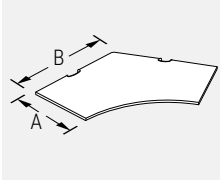

- "WG" at the end of the code indicates wood grain laminate on the diagonal.
- "WG" worksurface over 42" cannot be done on the diagonal.
- Support hardware must be ordered separately. See the listing in this section.
- Please choose from DWT - Designer White, SIL - Silver or BLK - Black for scoop covers.

NOTE:
A= 18, 24, 30
B= 24, 30, 36, 42, 48

PRODUCT CODE	PRICE		SIZE/ H	INCHES		WEIGHT VOL	
	LP	HP		W	D	LBS	FT ³
EVWC6C1824P	331	413	1	24	18	17.76	0.39
EVWC6C1830P	451	564	1	30	18	23.26	0.52
EVWC6C1836P	642	805	1	36	18	28.75	0.64
EVWC6C1842P	947	1042	1	42	18	34.17	0.76
EVWC6C1848P	1291	1421	1	48	18	39.66	0.88
EVWC6C2424P	344	433	1	24	24	21.25	0.47
EVWC6C2430P	493	613	1	30	24	28.59	0.64
EVWC6C2436P	691	866	1	36	24	35.94	0.80
EVWC6C2442P	1187	1301	1	42	24	43.28	0.96
EVWC6C2448P	1291	1421	1	48	24	50.63	1.13
EVWC6C3024P	361	451	1	24	30	23.72	0.53
EVWC6C3030P	528	663	1	30	30	32.94	0.73
EVWC6C3036P	740	926	1	36	30	42.16	0.94
EVWC6C3042P	1187	1301	1	42	30	51.38	1.14
EVWC6C3048P	1291	1421	1	48	30	60.60	1.35
EVWC6C1824WGP	497	619	1	24	18	17.76	0.39
EVWC6C1830WGP	677	846	1	30	18	23.26	0.52
EVWC6C1836WGP	964	1208	1	36	18	28.75	0.64
EVWC6C1842WGP	1421	1563	1	42	18	34.17	0.76
EVWC6C2424WGP	516	650	1	30	24	28.59	0.64
EVWC6C2430WGP	739	919	1	36	24	35.94	0.80
EVWC6C2436WGP	1036	1299	1	42	24	43.28	0.96
EVWC6C2442WGP	1780	1952	1	48	24	50.63	1.13
EVWC6C3024WGP	541	677	1	24	30	23.72	0.53
EVWC6C3030WGP	792	995	1	30	30	32.94	0.73
EVWC6C3036WGP	1110	1389	1	36	30	42.16	0.94
EVWC6C3042WGP	1780	1952	1	42	30	51.38	1.14

EVWC6K • Keyboard Corner Worksurface For 60° Post

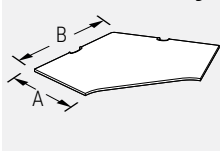

- "WG" at the end of the code indicates wood grain laminate on the diagonal.
- "WG" worksurface over 42" cannot be done on the diagonal.
- Support hardware must be ordered separately. See the listing in this section.
- Please choose from DWT - Designer White, SIL - Silver or BLK - Black for scoop covers.

NOTE:
A= 18, 24, 30
B= 24, 30, 36, 42, 48

PRODUCT CODE	PRICE		SIZE/ H	INCHES		WEIGHT VOL	
	LP	HP		W	D	LBS	FT ³
EVWC6K1824P	323	356	1	24	18	17.76	0.39
EVWC6K1830P	519	569	1	30	18	23.26	0.52
EVWC6K1836P	777	853	1	36	18	28.75	0.64
EVWC6K1842P	947	1042	1	42	18	34.17	0.76
EVWC6K1848P	1291	1421	1	48	18	39.66	0.88
EVWC6K2430P	688	760	1	30	24	28.59	0.64
EVWC6K2436P	777	853	1	36	24	35.94	0.80
EVWC6K2442P	947	1042	1	42	24	43.28	0.96
EVWC6K2448P	1291	1421	1	48	24	50.63	1.13
EVWC6K3030P	688	760	1	30	30	32.94	0.73
EVWC6K3036P	773	999	1	36	30	42.16	0.94
EVWC6K3042P	1057	1370	1	42	30	51.38	1.14
EVWC6K3048P	1284	1669	1	48	30	60.60	1.35
EVWC6K1824WGP	485	535	1	24	18	17.76	0.39
EVWC6K1830WGP	779	853	1	30	18	23.26	0.52
EVWC6K1836WGP	1165	1279	1	36	18	28.75	0.64
EVWC6K1842WGP	1421	1563	1	42	18	34.17	0.76
EVWC6K2430WGP	1031	1140	1	30	24	28.59	0.64
EVWC6K2436WGP	1165	1279	1	36	24	35.94	0.80
EVWC6K2442WGP	1421	1563	1	42	24	43.28	0.96
EVWC6K3030WGP	1031	1140	1	30	30	32.94	0.73
EVWC6K3036WGP	1160	1498	1	36	30	42.16	0.94
EVWC6K3042WGP	1586	2054	1	42	30	51.38	1.14

EVW6T • Corner Transaction Surface For 60° Post

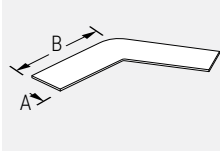

- Support hardware must be ordered separately. See the listing in this section.
- For use with laminate end and middle panels.

NOTE:
A= 15
B= 24, 30, 36, 42, 48

PRODUCT CODE	PRICE		SIZE/ H	INCHES		WEIGHT VOL	
	LP	HP		W	D	LBS	FT ³
EVW6T1518	330	422	1	18	15	14.53	0.32
EVW6T1524	520	671	1	24	15	19.17	0.43
EVW6T1530	674	872	1	30	15	23.78	0.53
EVW6T1536	941	1220	1	36	15	28.39	0.63
EVW6T1542	1024	1326	1	42	15	32.97	0.73
EVW6T1548	1338	1733	1	48	15	34.17	0.76

EVWCC • Corner Curved Worksurface

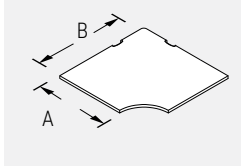

- "WG" at the end of the code indicates wood grain laminate on the diagonal.
- "WG" worksurface over 42" cannot be done on the diagonal.
- Please choose from DWT - Designer White, SIL - Silver or BLK - Black for scoop covers.

NOTE: EVWCC

18	36
A	B
DEPTH	WIDTH

PRODUCT CODE	PRICE		SIZE/ H	INCHES			WEIGHT VOL	
	LP	HP		W	D	LBS	FT ³	
EVWCC3618P	385	481	1	36	18	24.00	1.27	
EVWCC3624P	426	532	1	36	24	30.00	1.47	
EVWCC4224P	574	715	1	42	24	47.00	1.70	
EVWCC4230P	589	737	1	42	30	53.00	1.98	
EVWCC4824P	668	832	1	48	24	53.00	2.67	
EVWCC4830P	668	832	1	48	30	55.00	2.67	
EVWCC3618WGP	428	550	1	36	18	19.80	0.75	
EVWCC3624WGP	471	607	1	36	24	30.00	1.47	
EVWCC4224WGP	638	820	1	42	24	47.00	1.70	
EVWCC4230WGP	691	889	1	42	30	53.00	1.96	

EVWCKK • Corner Worksurface with Curved Keyboard Support

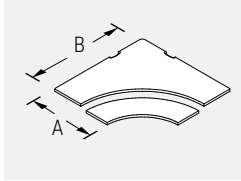

- Keyboard mechanism is included.
- Must be supported with two 24" Cantilevers and 2 Flat Brackets (ordered separately).
- "WG" worksurface over 42" cannot be done on the diagonal.
- "WG" at the end of the code indicates wood grain laminate on the diagonal.
- Keyboard Support is 11" deep, adjusts 6" above and 6" below surface with a positive/negative tilt (+15° to -15°).
- Please choose from DWT - Designer White, SIL - Silver or BLK - Black for scoop covers.

NOTE: EVWCC

24	42
A	B
DEPTH	WIDTH

PRODUCT CODE	PRICE		SIZE/ H	INCHES			WEIGHT VOL	
	LP	HP		W	D	LBS	FT ³	
EVWCKK4224P	1202	1334	1	42	24	38.00	0.95	
EVWCKK4230P	1277	1423	1	42	30	42.00	1.15	
EVWCKK4824P	1349	1515	1	48	24	48.00	1.55	
EVWCKK4830P	1383	1558	1	48	30	50.00	1.65	
EVWCKK4224WGP	1290	1458	1	42	24	38.00	0.95	
EVWCKK4230WGP	1381	1559	1	42	30	42.00	1.15	

EVWCK • Corner Keyboard Worksurface

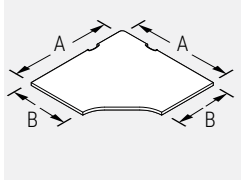

- "WG" at the end of the code indicates wood grain laminate on the diagonal.
- "WG" worksurface over 42" cannot be done on the diagonal.
- Please choose from DWT - Designer White, SIL - Silver or BLK - Black for scoop covers.

NOTE: EVWC

24	36
A	B
DEPTH	WIDTH

PRODUCT CODE	PRICE		SIZE/ H	INCHES			WEIGHT VOL	
	LP	HP		W	D	LBS	FT ³	
EVWCK3618P	377	470	1	36	18	39.59	1.50	
EVWCK3624P	417	520	1	36	24	39.59	1.50	
EVWCK4224P	553	693	1	42	24	53.89	2.04	
EVWCK4230P	572	713	1	42	30	53.89	2.04	
EVWCK4824P	641	803	1	48	24	70.39	2.67	
EVWCK4830P	641	803	1	48	30	70.39	2.67	
EVWCK3618WGP	428	534	1	36	18	34.00	1.27	
EVWCK3624WGP	470	587	1	36	24	45.00	1.69	
EVWCK4224WGP	636	793	1	42	24	47.00	1.70	
EVWCK4230WGP	686	858	1	42	30	58.00	2.12	

EVWCF • Five Sided Worksurface

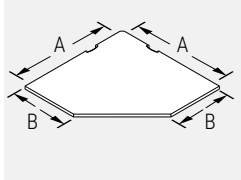

- "WG" at the end of the code indicates wood grain laminate on the diagonal.
- "WG" worksurface over 42" cannot be done on the diagonal.
- Please choose from DWT - Designer White, SIL - Silver or BLK - Black for scoop covers.

NOTE: EVWC

24	36
A	B
DEPTH	WIDTH

PRODUCT CODE	PRICE		SIZE/ H	INCHES			WEIGHT VOL	
	LP	HP		W	D	LBS	FT ³	
EVWCF3012P	251	311	1	30	24	11.00	0.42	
EVWCF3612P	331	413	1	36	24	13.20	0.50	
EVWCF3618P	331	413	1	36	18	19.80	0.75	
EVWCF3624P	344	433	1	36	24	26.40	1.00	
EVWCF4224P	488	609	1	42	24	30.79	1.17	
EVWCF4230P	502	633	1	42	30	38.49	1.46	
EVWCF4824P	550	686	1	48	24	35.19	1.33	
EVWCF4830P	579	725	1	48	30	43.99	1.67	
EVWCF3618WGP	428	550	1	36	18	34.00	1.27	
EVWCF3624WGP	471	607	1	36	24	45.00	1.69	
EVWCF4224WGP	638	820	1	42	24	47.00	1.70	
EVWCF4230WGP	691	889	1	42	30	58.75	2.12	

EVWKKR • Angle Front Edge Worksurface

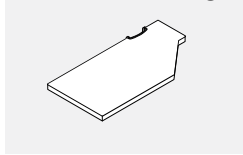

- To be used with EVWCF3012SCP & EVWCF-3612SCP Corner Worksurface
- Creates efficient, compact keyboard corner workstation
- For use with flat screen monitors
- Please choose from DWT - Designer White, SIL - Silver or BLK - Black for scoop covers.

PRODUCT CODE	PRICE		SIZE/ INCHES			WEIGHT VOL	
	LP	HP	H	W	D	LBS	FT ³
EVWKKR2448P	244	304	1	48	24	35.00	1.11
EVWKKL2448P	244	304	1	48	24	35.00	1.11
EVWKKR2442P	213	267	1	42	24	31.00	0.98
EVWKKL2442P	213	267	1	42	24	31.00	0.98
EVWKKR2436P	184	229	1	36	24	26.00	0.85
EVWKKL2436P	184	229	1	36	24	26.00	0.85

EVWCC • Non-Symmetrical Corner Curved Worksurface

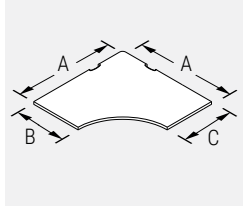

- Please specify starting at the first "A" on the left side and then continuing clockwise.
- "WG" worksurface over 42" cannot be done on the diagonal.
- Please choose from DWT - Designer White, SIL - Silver or BLK - Black for scoop covers.

PRODUCT CODE	PRICE		SIZE/ INCHES			WEIGHT VOL	
	LP	HP	W(A)	D(B)	D(C)	LBS	FT ³
EVWCC36361824P	426	646	36	18	24	30.00	1.47
EVWCC36362418P	426	646	36	24	18	30.00	1.47
EVWCC36362430P	501	679	36	24	30	30.00	1.47
EVWCC36363024P	501	679	36	30	24	30.00	1.47
EVWCC42421824P	574	715	42	18	24	53.89	2.04
EVWCC42422418P	574	715	42	24	18	53.89	2.04
EVWCC42422430P	589	737	42	24	30	53.89	2.04
EVWCC42423024P	589	737	42	30	24	53.89	2.04
EVWCC48482430P	668	832	48	24	30	70.38	2.66
EVWCC48483024P	668	832	48	30	24	70.38	2.66
EVWCC36361824WGP	532	677	36	18	24	30.00	1.47
EVWCC36362418WGP	532	677	36	24	18	30.00	1.47
EVWCC36362430WGP	562	715	36	24	30	30.00	1.47
EVWCC36363024WGP	562	715	36	30	24	30.00	1.47
EVWCC42421824WGP	647	840	42	18	24	53.89	2.04
EVWCC42422418WGP	647	840	42	24	18	53.89	2.04
EVWCC42422430WGP	701	901	42	24	30	53.89	2.04
EVWCC42423024WGP	701	901	42	30	24	53.89	2.04

NOTE: EVWCC

36	36	18	24
A	A	B	C
WIDTH	WIDTH	DEPTH	DEPTH

EVWCK • Non-Symmetrical Corner Keyboard Worksurface

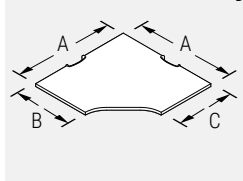

- Please specify starting at the first "A" on the left side and then continuing clockwise
- "WG" worksurface over 42" cannot be done on the diagonal.
- Please choose from DWT - Designer White, SIL - Silver or BLK - Black for scoop covers.

PRODUCT CODE	PRICE		SIZE/ INCHES			WEIGHT VOL	
	LP	HP	W(A)	D(B)	D(C)	LBS	FT ³
EVWCK36361824P	437	663	36	18	24	39.59	1.50
EVWCK36362418P	437	663	36	24	24	39.59	1.50
EVWCK42421824P	583	727	42	18	24	53.89	2.04
EVWCK42422418P	583	727	42	24	18	53.89	2.04
EVWCK42422430P	601	750	42	24	30	53.89	2.04
EVWCK42423024P	601	750	42	30	24	53.89	2.04
EVWCK48482430P	674	843	48	24	30	70.38	2.66
EVWCK48483024P	674	843	48	30	24	70.38	2.66
EVWCK36361824WGP	521	733	36	18	24	39.59	1.50
EVWCK36362418WGP	521	733	36	24	24	39.59	1.50
EVWCK42421824WGP	647	840	42	18	24	53.89	2.04
EVWCK42422418WGP	647	840	42	24	18	53.89	2.04
EVWCK42422430WGP	712	924	42	24	30	53.89	2.04
EVWCK42423024WGP	712	924	42	30	24	53.89	2.04

NOTE: EVWCC

36	36	18	24
A	A	B	C
WIDTH	WIDTH	DEPTH	DEPTH

EVWCF • Non-Symmetrical Five Sided Worksurface

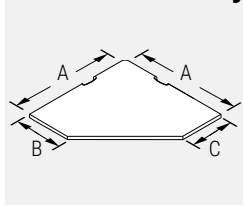

- Please specify starting at the first "A" on the left side and then continuing clockwise.
- "WG" worksurface over 42" cannot be done on the diagonal.
- Please choose from DWT - Designer White, SIL - Silver or BLK - Black for scoop covers.

PRODUCT CODE	PRICE		SIZE/ INCHES			WEIGHT VOL	
	LP	HP	W(A)	D(B)	D(C)	LBS	FT ³
EVWCF36361824P	406	619	36	18	24	30.00	1.47
EVWCF36362418P	406	619	36	24	18	30.00	1.47
EVWCF36362430P	426	646	36	24	30	30.00	1.47
EVWCF36363024P	426	646	36	30	24	30.00	1.47
EVWCF42421824P	488	672	42	18	24	53.89	2.04
EVWCF42422418P	488	672	42	24	18	53.89	2.04
EVWCF42422430P	560	732	42	24	30	53.89	2.04
EVWCF42423024P	560	732	42	30	24	53.89	2.04
EVWCF48482430P	611	813	48	24	30	70.38	2.66
EVWCF48483024P	611	813	48	30	24	70.38	2.66
EVWCF36361824WGP	541	702	36	18	24	30.00	1.47
EVWCF36362418WGP	541	702	36	24	18	30.00	1.47
EVWCF36362430WGP	575	757	36	24	30	30.00	1.47
EVWCF36363024WGP	575	757	36	30	24	30.00	1.47
EVWCF42421824WGP	584	756	42	18	24	53.89	2.04
EVWCF42422418WGP	584	756	42	24	18	53.89	2.04
EVWCF42422430WGP	611	793	42	24	30	53.89	2.04
EVWCF42423024WGP	611	793	42	30	24	53.89	2.04

NOTE: EVWCC

36	36	18	24
A	A	B	C
WIDTH	WIDTH	DEPTH	DEPTH

EVWL • "L" Worksurface

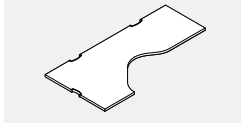

- There are three cable scoops on this worksurface.
- Wood grain laminate not available on the diagonal.
- Must be specified either left or right.
- Please choose from DWT - Designer White, SIL - Silver or BLK - Black for scoop covers.

PRODUCT CODE	PRICE		SIZE/INCHES			WEIGHT VOL	
	LP	HP	H	W	D	LBS	FT ³
EVWLL2472P	716	895	1	72	24	73.00	2.70
EVWLR2472P	716	895	1	72	24	73.00	2.70

EVWBTL • Transition Worksurface

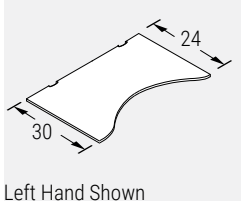

Left Hand Shown

- Support hardware must be ordered separately. See the listing in this section of the price list.
- Opposing side of 30" deep Transition Worksurface has depth of 24".
- Scoops located on back edge only.
- Must be specified as right or left handed.
- Please choose from DWT - Designer White, SIL - Silver or BLK - Black for scoop covers.

PRODUCT CODE	PRICE		SIZE/INCHES			WEIGHT VOL	
	LP	HP	W	D	D2	LBS	FT ³
EVWBTL3060P	545	678	60	30	24	54.99	2.08
EVWBTL3066P	601	748	66	30	24	60.49	2.29
EVWBTL3072P	651	817	72	30	24	65.99	2.50
EVWBTR3060P	545	678	60	30	24	54.99	2.08
EVWBTR3066P	596	748	66	30	24	60.49	2.29
EVWBTR3072P	651	817	72	30	24	60.49	2.29

EVWBTL • Transition Worksurface

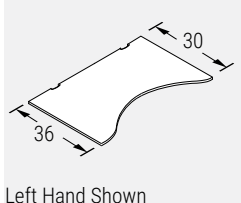

Left Hand Shown

- Support hardware must be ordered separately. See the listing in this section of the price list.
- Opposing side of 36" deep Transition Worksurface has depth of 30".
- Scoops located on back edge only.
- Must be specified as right or left handed.
- Please choose from DWT - Designer White, SIL - Silver or BLK - Black for scoop covers.

PRODUCT CODE	PRICE		SIZE/ INCHES			WEIGHT VOL	
	LP	HP	W	D	D2	LBS	FT ³
EVWBTL3660P	651	832	60	36	30	65.99	2.50
EVWBTL3666P	716	898	66	36	30	72.59	2.75
EVWBTL3672P	782	978	72	36	30	79.19	3.00
EVWBTR3660P	651	817	60	36	30	65.99	2.50
EVWBTR3666P	716	898	66	36	30	72.59	2.75
EVWBTR3672P	782	978	72	36	30	79.19	3.00

EVWCEL • Extended Curved Corner - Left

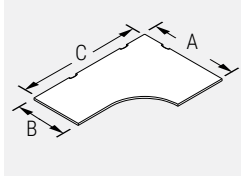

- For 48" wide ("C" dimension) worksurfaces, there are two cable scoops, all others have three.
- Wood grain laminate not available on the diagonal.
- Please choose from DWT - Designer White, SIL - Silver or BLK - Black for scoop covers.

NOTE: EVWCE

36	24	72
A	B	C
DEPTH	DEPTH	WIDTH

PRODUCT CODE	PRICE		SIZE/ INCHES			WEIGHT VOL	
	LP	HP	A	B	C	LBS	FT ³
EVWCEL362448P	583	722	36	24	48	43.92	1.25
EVWCEL362460P	636	792	36	24	60	52.79	1.50
EVWCEL362466P	700	869	36	24	66	57.18	1.62
EVWCEL362472P	773	965	36	24	72	61.58	1.75
EVWCEL362478P	825	1031	36	24	78	65.98	1.87
EVWCEL362484P	890	1110	36	24	84	70.38	2.00
EVWCEL422460P	668	832	42	24	60	57.18	1.63
EVWCEL422466P	736	919	42	24	66	61.58	1.57
EVWCEL422472P	811	1015	42	24	72	65.98	1.87
EVWCEL422478P	867	1084	42	24	78	70.38	2.00
EVWCEL422484P	934	1166	42	24	84	74.78	2.00
EVWCEL423060P	752	942	42	30	60	63.78	1.82
EVWCEL423066P	825	1031	42	30	66	69.28	1.96
EVWCEL423072P	902	1126	42	30	72	74.78	2.12
EVWCEL423078P	967	1207	42	30	78	80.28	2.28
EVWCEL423084P	1031	1287	42	30	84	85.78	2.43
EVWCEL482460P	763	955	48	24	60	65.18	1.90
EVWCEL482466P	849	1060	48	24	66	69.78	3.66
EVWCEL482472P	928	1162	48	24	72	76.18	1.95
EVWCEL482478P	991	1236	48	24	78	74.78	1.20
EVWCEL482484P	1051	1313	48	24	84	123.17	4.66
EVWCEL483060P	849	1060	48	30	60	68.18	1.93
EVWCEL483066P	928	1162	48	30	66	73.68	2.09
EVWCEL483072P	991	1236	48	30	72	79.18	2.25
EVWCEL483078P	1051	1313	48	30	78	84.68	2.40
EVWCEL483084P	1124	1408	48	30	84	90.18	2.56

EVWCER • Extended Curved Corner - Right

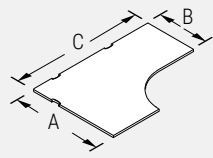

- For 48" wide ("C" dimension) worksurfaces, there are two cable scoops, all others have three finishes.
- Wood grain laminate not available on the diagonal.
- Please choose from DWT - Designer White, SIL - Silver or BLK - Black for scoop covers.

NOTE: EVWCE

36	24	72
A	B	C
DEPTH	DEPTH	WIDTH

PRODUCT CODE	PRICE		SIZE/ INCHES			WEIGHT VOL	
	LP	HP	A	B	C	LBS	FT ³
EVWCER362448P	583	722	36	24	48	43.92	1.25
EVWCER362460P	636	792	36	24	60	52.79	1.50
EVWCER362466P	700	869	36	24	66	57.18	1.62
EVWCER362472P	773	965	36	24	72	61.58	1.75
EVWCER362478P	825	1031	36	24	78	65.98	1.87
EVWCER362484P	890	1110	36	24	84	70.38	2.00
EVWCER422460P	668	832	42	24	60	57.18	1.63
EVWCER422466P	736	919	42	24	66	61.58	1.57
EVWCER422472P	811	1015	42	24	72	65.98	1.87
EVWCER422478P	867	1084	42	24	78	70.38	2.00
EVWCER422484P	934	1166	42	24	84	74.78	2.00
EVWCER423060P	752	942	42	30	60	63.78	1.82
EVWCER423066P	825	1031	42	30	66	69.28	1.96
EVWCER423072P	902	1126	42	30	72	74.78	2.12
EVWCER423078P	967	1207	42	30	78	80.28	2.28
EVWCER423084P	1031	1287	42	30	84	85.78	2.43
EVWCER482460P	763	955	48	24	60	65.18	1.90
EVWCER482466P	849	1060	48	24	66	96.78	3.66
EVWCER482472P	928	1162	48	24	72	76.18	1.95
EVWCER482478P	991	1236	48	24	78	74.78	1.20
EVWCER482484P	1051	1313	48	24	84	123.17	4.66
EVWCER483060P	849	1060	48	30	60	68.18	1.93
EVWCER483066P	928	1162	48	30	66	73.68	2.09
EVWCER483072P	991	1236	48	30	72	79.18	2.25
EVWCER483078P	1051	1313	48	30	78	84.68	2.40
EVWCER483084P	1124	1408	48	30	84	90.18	2.56

EVWH • Hatchet Worksurface

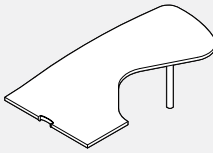

Right Hand Shown

- Cable scoop is in the middle of the 36" wide edge.
- Wood grain laminate not available on the diagonal.
- Must be specified either left or right.
- Includes monoleg.
- Please choose from DWT - Designer White, SIL - Silver or BLK - Black for scoop covers.

PRODUCT CODE	PRICE		SIZE/ INCHES			WEIGHT VOL	
	LP	HP	H	W	D	LBS	FT ³
EVWHL3672P	1048	1261	1	72	30	73.00	2.70
EVWHR3672P	1048	1261	1	72	30	73.00	2.70

EVWSH • Hatchet Worksurface - Straight Front

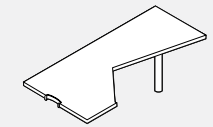

Right Hand Shown

- Cable scoop is in the middle of the 36" wide edge.
- Wood grain laminate not available on the diagonal.
- Support hardware must be ordered separately.
- Must be specified either left or right.
- Includes monoleg.
- Please choose from DWT - Designer White, SIL - Silver or BLK - Black for scoop covers.

PRODUCT CODE	PRICE		SIZE/ INCHES			WEIGHT VOL	
	LP	HP	H	W	D	LBS	FT ³
EVWSHL3672P	997	1200	1	72	30	73.00	2.70
EVWSHR3672P	997	1200	1	72	30	73.00	2.70

EVWD • "D" Worksurface

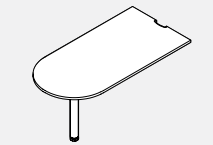

- Cable scoop is at the centre of the end.
- Includes monoleg.
- Please choose from DWT - Designer White, SIL - Silver or BLK - Black for scoop covers.

PRODUCT CODE	PRICE		SIZE/ INCHES			WEIGHT VOL	
	LP	HP	H	W	D	LBS	FT ³
EVWD2442P	552	640	1	42	24	28.00	0.98
EVWD2448P	576	673	1	48	24	32.00	1.11
EVWD2460P	605	704	1	60	24	40.00	1.36
EVWD2472P	642	756	1	72	24	48.00	1.61
EVWD3048P	579	675	1	48	30	39.00	1.37
EVWD3060P	646	757	1	60	30	49.00	1.69
EVWD3072P	710	839	1	72	30	59.00	2.01

EVWPT • "P" Top Worksurface

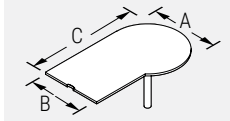

Left Hand Shown

- Cable scoop is at the center of the panel with edge.
- Must be specified either left or right.
- Includes monoleg.
- Please choose from DWT - Designer White, SIL - Silver or BLK - Black for scoop covers.

NOTE: EVWCE

24	60	30
A	B	C
DEPTH	DEPTH	WIDTH

PRODUCT CODE	PRICE		SIZE/ H	INCHES			WEIGHT VOL	
	LP	HP		W	D	LBS	FT ³	
EVWPTL245430P	750	911	1	54	24	39.50	1.50	
EVWPTL246030P	805	963	1	60	24	54.99	2.08	
EVWPTL246630P	821	1043	1	66	24	60.48	2.29	
EVWPTL247230P	868	1088	1	72	24	65.98	2.50	
EVWPTL306036P	889	1107	1	60	30	65.98	2.50	
EVWPTL306636P	963	1148	1	66	30	72.58	2.75	
EVWPTL307236P	1004	1200	1	72	30	79.00	2.41	
EVWPTR245430P	750	911	1	54	24	39.50	1.50	
EVWPTR246030P	805	963	1	60	24	54.99	2.08	
EVWPTR246630P	821	1043	1	66	24	60.48	2.29	
EVWPTR247230P	868	1088	1	72	24	65.98	2.50	
EVWPTR306036P	889	1107	1	60	30	65.98	2.50	
EVWPTR306636P	963	1148	1	66	30	72.58	2.75	
EVWPTR307236P	1004	1200	1	72	30	79.00	2.41	

EVWW • Wedge Worksurface

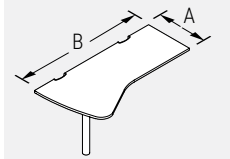

Left Hand Shown

- Two cable scoops on the back side of worksurface.
- Must be specified either left or right.
- Includes monoleg.
- Conference end is 10" wider than "A".
- Please choose from DWT - Designer White, SIL - Silver or BLK - Black for scoop covers.

NOTE: EVWC

18	48
A	B
DEPTH	WIDTH

PRODUCT CODE	PRICE		SIZE/ H	INCHES			WEIGHT VOL	
	LP	HP		W	D	LBS	FT ³	
EVWWL2460P	634	739	1	60	24	51.99	1.81	
EVWWL2466P	671	788	1	66	24	56.39	1.98	
EVWWL2472P	706	838	1	72	24	60.79	2.15	
EVWWL2478P	793	992	1	78	24	65.18	2.31	
EVWWL2484P	805	1005	1	84	24	69.58	2.48	
EVWWL3060P	730	860	1	60	30	62.99	2.23	
EVWWL3066P	777	923	1	66	30	68.44	2.44	
EVWWL3072P	826	983	1	72	30	73.98	2.65	
EVWWR2460P	634	739	1	60	24	51.99	1.81	
EVWWR2466P	671	788	1	66	24	56.39	1.98	
EVWWR2472P	706	838	1	72	24	60.79	2.15	
EVWWR2478P	793	992	1	78	24	65.18	2.31	
EVWWR2484P	805	1005	1	84	24	69.58	2.48	
EVWWR3060P	730	860	1	60	30	62.99	2.23	
EVWWR3066P	777	923	1	66	30	68.48	2.44	
EVWWR3072P	826	983	1	72	30	73.98	2.65	

EVWPL • Piano Top Worksurface Left

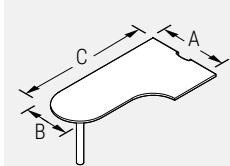

Left Hand Shown

- Cable scoop is at the center of the panel with edge.
- Must be specified either left or right.
- Includes monoleg.
- Works with EVWMP modesty.
- Please choose from DWT - Designer White, SIL - Silver or BLK - Black for scoop covers.

NOTE: EVWP

36	18	48
A	B	C
DEPTH	DEPTH	WIDTH

PRODUCT CODE	PRICE		SIZE/ H	INCHES			WEIGHT VOL	
	LP	HP		W	D	LBS	FT ³	
EVWPL361848P	706	838	1	48	36	52.79	2.00	
EVWPL361854P	750	889	1	54	36	59.39	2.25	
EVWPL361860P	789	941	1	60	36	65.99	2.50	
EVWPL361866P	832	992	1	66	36	72.59	2.75	
EVWPL361872P	870	1041	1	72	36	79.18	3.00	
EVWPL362448P	715	843	1	48	24	52.79	2.75	
EVWPL362454P	755	893	1	54	24	59.39	2.25	
EVWPL362460P	799	945	1	60	24	65.58	1.68	
EVWPL362466P	838	996	1	66	24	73.00	2.23	
EVWPL362472P	877	1047	1	72	24	79.18	3.00	
EVWPL422454P	809	963	1	54	42	69.29	2.63	
EVWPL422460P	857	1021	1	60	42	75.58	1.88	
EVWPL422466P	903	1080	1	66	42	85.68	3.21	
EVWPL422472P	947	1136	1	72	42	92.38	3.51	
EVWPL423060P	871	1042	1	60	42	76.99	2.92	
EVWPL423066P	924	1106	1	66	42	84.68	3.21	
EVWPL423072P	971	1164	1	72	42	92.38	3.50	
EVWPL482460P	972	1166	1	60	48	87.98	3.33	
EVWPL482466P	1031	1238	1	66	48	87.98	3.33	
EVWPL482472P	1088	1312	1	72	48	105.58	4.00	
EVWPL483066P	1034	1247	1	66	48	96.78	3.66	
EVWPL483072P	1092	1316	1	72	48	105.58	4.00	

EVWPR • Piano Top Worksurface Right

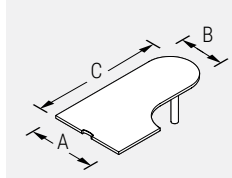

Right Hand Shown

- Cable scoop is at the center of the panel with edge.
- Must be specified either left or right.
- Includes monoleg.
- Works with EVWMP modesty.
- Please choose from DWT - Designer White, SIL - Silver or BLK - Black for scoop covers.

NOTE: EVWP

36	18	48
A	B	C
DEPTH	DEPTH	WIDTH

PRODUCT CODE	PRICE		SIZE/ INCHES			WEIGHT VOL	
	LP	HP	H	W	D	LBS	FT ³
EVWPR361848P	706	838	1	48	36	52.79	2.00
EVWPR361854P	750	889	1	54	36	59.39	2.25
EVWPR361860P	789	941	1	60	36	65.99	2.50
EVWPR361866P	832	992	1	66	36	72.59	2.75
EVWPR361872P	870	1041	1	72	36	79.18	3.00
EVWPR362448P	715	843	1	48	24	52.79	2.75
EVWPR362454P	755	893	1	54	24	59.39	2.25
EVWPR362460P	799	945	1	60	24	65.58	1.68
EVWPR362466P	838	996	1	66	24	73.00	2.23
EVWPR362472P	877	1047	1	72	24	79.18	3.00
EVWPR422454P	809	963	1	54	42	69.29	2.63
EVWPR422460P	857	1021	1	60	42	75.58	1.88
EVWPR422466P	903	1080	1	66	42	85.68	3.21
EVWPR422472P	947	1136	1	72	42	92.38	2.27
EVWPR423060P	871	1042	1	60	42	76.99	2.92
EVWPR423066P	924	1106	1	66	42	84.68	3.21
EVWPR423072P	971	1164	1	72	42	92.38	3.50
EVWPR482460P	972	1166	1	60	48	87.98	2.25
EVWPR482466P	1031	1238	1	66	48	78.00	3.66
EVWPR482472P	1088	1312	1	72	48	105.58	4.00
EVWPR483066P	1034	1247	1	66	48	96.78	3.66
EVWPR483072P	1092	1316	1	72	48	105.58	4.00

EVWQR/L • Quarter Round Panel Worksurface

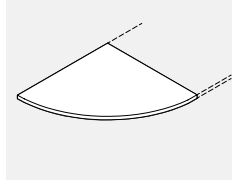

Left Hand Shown

- The worksurface edge running along the panel face is a slightly different length than that of the worksurface end, causing the surface to be handed.
- The user edge abutting the adjacent worksurface runs straight for 3" before starting to curve.

PRODUCT CODE	PRICE		SIZE/ INCHES			WEIGHT VOL	
	LP	HP	H	W	D	LBS	FT ³
EVWQRL1818	135	169	1	18	18	9	0.30
EVWQRL2424	194	240	1	24	24	16	0.52
EVWQRL3030	251	311	1	30	30	25	0.81
EVWQRR1818	135	169	1	18	18	9	0.30
EVWQRR2424	194	240	1	24	24	16	0.52
EVWQRR3030	251	311	1	30	30	25	0.81

EVWQRC • Quarter Round Panel Corner Worksurface



- Wraps around a 90° corner post.
- Putting the adjacent worksurface runs straight for 3" before starting to curve.

PRODUCT CODE	PRICE		SIZE/ INCHES			WEIGHT VOL	
	LP	HP	H	W	D	LBS	FT ³
EVWQRC1818	157	196	1	21	21	12.00	0.38
EVWQRC2424	228	284	1	27	27	17.00	0.58
EVWQRC3030	281	353	1	33	33	25.50	0.86

EVWMP • Worksurface Modesty Panel

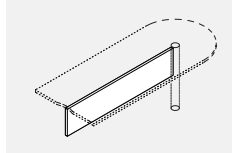

- Modesty panel fastens to the worksurface and Monoleg to provide additional privacy and support.
- Made of cold rolled steel and is epoxy powder coated.
- For "D", Hatchet and Piano Top Worksurfaces only (ordered separately).

PRODUCT CODE	PRICE		SIZE/ INCHES			WEIGHT VOL	
	LP	HP	H	W	D	LBS	FT ³
EVWMP1242	130		13	26	1	4.00	0.22
EVWMP1248	147		13	32	1	5.00	0.25
EVWMP1260	169		13	44	1	6.00	0.30
EVWMP1272	218		13	56	1	8.00	2.00

EVWR • Radius Worksurface

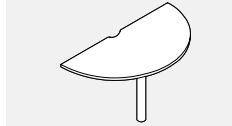

- Rounded worksurface for conferencing provides a radius corner from a worksurface to worksurface.
- 18" and 24" come with one monoleg and 30" comes with two monolegs.
- Radius cut out on the straight edge allows space for trims.
- Please choose from DWT - Designer White, SIL - Silver or BLK - Black for scoop covers.

PRODUCT CODE	PRICE		SIZE/ INCHES			WEIGHT VOL	
	LP	HP	H	W	D	LBS	FT ³
EVWR18P	488	561	29	39	19.5	24.00	0.74
EVWR24P	560	649	29	51	25.5	34.00	1.16
EVWR30P	941	1076	29	63	31.5	51.00	1.76

EVTTE • Teardrop Extension Table



- Stand-alone mobile table.

PRODUCT CODE	PRICE		SIZE/ INCHES			WEIGHT VOL	
	LP	HP	H	W	D	LBS	FT ³
EVTTE29247	480	562	27	29	29	30.00	15.00
EVTTE34307	526	617	27	34	34	35.00	18.00
EVTTE29249	564	647	29	29	29	30.00	19.00
EVTTE34309	611	703	29	34	34	35.00	19.00

EVWT • Straight Transaction Surface

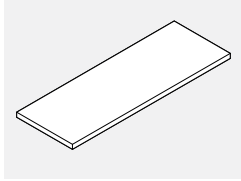

- Support hardware must be ordered separately.
- All tops are thermally fused 1" thick with pilot holes to enable proper alignment with worksurface supports. Wood screws must be used.
- Evolve worksurfaces feature a 3mm edge.

PRODUCT CODE	PRICE		SIZE/ INCHES			WEIGHT VOL	
	LP	HP	H	W	D	LBS	FT ³
EVWT1512	58	75	1	12	15	6.00	0.22
EVWT1518	72	99	1	18	15	8.00	0.30
EVWT1524	90	120	1	24	15	10.00	0.38
EVWT1530	109	142	1	30	15	13.00	0.46
EVWT1536	124	165	1	36	15	15.00	0.54
EVWT1542	142	188	1	42	15	18.00	0.62
EVWT1548	161	211	1	48	15	20.00	0.70
EVWT1554	173	232	1	54	15	23.00	0.78
EVWT1560	193	255	1	60	15	25.00	0.86
EVWT1566	207	276	1	66	15	29.00	0.94
EVWT1572	227	298	1	72	15	30.00	1.02
EVWT1578	242	323	1	78	15	32.00	1.10
EVWT1584	259	343	1	84	15	35.00	1.18

EVWTV • Straight Transaction Surface with Cut-out

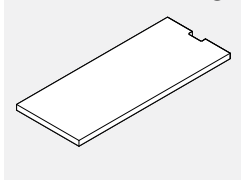

- Used where a transaction surface butts up against a taller panel

PRODUCT CODE	PRICE		SIZE/ INCHES			WEIGHT VOL	
	LP	HP	H	W	D	LBS	FT ³
EVWTV1524	101	130	1	24	15	10.00	0.38
EVWTV1530	122	155	1	30	15	13.00	0.46
EVWTV1536	135	175	1	36	15	15.00	0.54
EVWTV1542	155	198	1	42	15	18.00	0.62
EVWTV1548	171	224	1	48	15	20.57	0.70
EVWTV1554	186	244	1	54	15	22.57	0.75
EVWTV1560	204	267	1	60	15	26.00	0.92
EVWTV1566	222	289	1	66	15	28.00	1.00
EVWTV1572	238	310	1	72	15	30.00	1.08

EVWTCL • "L" Corner Transaction Surface

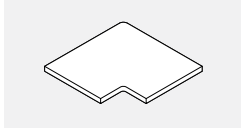

- Used where two panels meet at a 90° angle.
- For Wood Grain Laminate, use code ending with "WG".

PRODUCT CODE	PRICE		SIZE/ INCHES			WEIGHT VOL	
	LP	HP	H	W	D	LBS	FT ³
EVWTCL90	166	206	1	21	15	12.00	0.75
EVWTCL90WG	202	253	1	21	15	12.00	0.75

EVWTCT • "T" Corner Transaction Surface

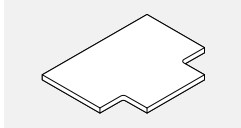

- Used where three panels meet.
- For Wood Grain Laminate, use code ending with "WG".

PRODUCT CODE	PRICE		SIZE/ INCHES			WEIGHT VOL	
	LP	HP	H	W	D	LBS	FT ³
EVWTCT90	166	206	1	27	15	16.00	1.00

EVWTE • End Transaction Surface

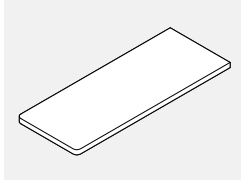

- Surface has rounded corners at one end.

PRODUCT CODE	PRICE		SIZE/ INCHES			WEIGHT VOL	
	LP	HP	H	W	D	LBS	FT ³
EVWTE1512	58	75	1	14	15	12.00	0.54
EVWTE1518	72	99	1	20	15	14.00	0.58
EVWTE1524	101	130	1	26	15	16.00	0.61
EVWTE1530	122	155	1	32	15	20.00	0.69
EVWTE1536	135	175	1	38	15	20.00	0.70
EVWTE1542	155	198	1	44	15	23.00	0.74
EVWTE1548	171	224	1	50	15	26.00	0.77
EVWTE1554	186	244	1	56	15	28.00	0.85
EVWTE1560	204	267	1	62	15	31.00	0.94
EVWTE1566	222	289	1	68	15	34.00	1.02
EVWTE1572	238	310	1	74	15	36.00	1.10

EVWTEV • End Transaction Surface with Cut-out

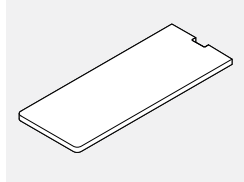

- Used at the end of a panel run where the surface butts up against a taller panel.
- Surface has rounded corners at one end.

PRODUCT CODE	PRICE		SIZE/ H	INCHES			WEIGHT VOL	
	LP	HP		W	D	LBS	FT ³	
EVWTEV1524	113	142	1	26	15	16.00	0.61	
EVWTEV1530	132	166	1	32	15	18.00	0.65	
EVWTEV1536	147	189	1	38	15	20.00	0.69	
EVWTEV1542	166	211	1	44	15	23.00	0.74	
EVWTEV1548	184	233	1	50	15	32.00	1.22	
EVWTEV1554	196	256	1	56	15	36.00	1.32	
EVWTEV1560	215	278	1	62	15	36.00	1.30	
EVWTEV1566	232	300	1	68	15	30.24	1.14	
EVWTEV1572	251	323	1	74	15	40.00	1.38	

EVW9TL • Corner Transaction Top for 90 degree Left

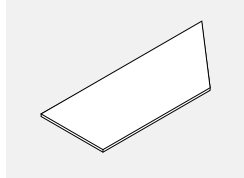

PRODUCT CODE	PRICE		SIZE/ H	INCHES			WEIGHT VOL	
	LP	HP		W	D	LBS	FT ³	
EVW9TL1524	383	564	1	33	15	15.00	0.54	
EVW9TL1530	461	684	1	39	15	18.00	0.62	
EVW9TL1536	535	792	1	45	15	20.00	0.70	
EVW9TL1542	613	903	1	51	15	23.00	0.78	
EVW9TL1548	691	1019	1	57	15	25.00	0.86	

EVW9TR • Corner Transaction Top for 90 degree Right

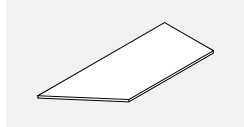

PRODUCT CODE	PRICE		SIZE/ H	INCHES			WEIGHT VOL	
	LP	HP		W	D	LBS	FT ³	
EVW9TR1524	383	564	1	33	15	15.00	0.54	
EVW9TR1530	461	684	1	39	15	18.00	0.62	
EVW9TR1536	535	792	1	45	15	20.00	0.70	
EVW9TR1542	613	903	1	51	15	23.00	0.78	
EVW9TR1548	691	1019	1	57	15	25.00	0.86	

EVWTD • End “D” Transaction Surface

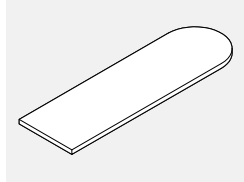

- Used at the end of a panel run where surface can overhang.

PRODUCT CODE	PRICE		SIZE/ H	INCHES			WEIGHT VOL	
	LP	HP		W	D	LBS	FT ³	
EVWTD1530	141	184	1	37	15	18.00	0.65	
EVWTD1536	149	198	1	43	15	20.00	0.69	
EVWTD1542	166	222	1	49	15	23.00	0.74	
EVWTD1548	186	244	1	55	15	26.00	0.77	
EVWTD1554	201	266	1	61	15	28.00	0.85	
EVWTD1560	222	294	1	67	15	31.00	0.94	
EVWTD1566	238	314	1	73	15	34.00	1.02	
EVWTD1572	257	341	1	79	15	36.00	1.10	

EVWTDV • End “D” Transaction Surface with Cut-out

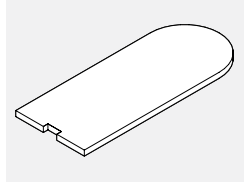

- Used at the end of a panel run where the surface butts up against a taller panel on one end and can overhang at the other.

PRODUCT CODE	PRICE		SIZE/ H	INCHES			WEIGHT VOL	
	LP	HP		W	D	LBS	FT ³	
EVWTDV1530	145	195	1	37	15	18.00	0.65	
EVWTDV1536	157	211	1	43	15	20.00	0.69	
EVWTDV1542	174	232	1	49	15	23.00	0.74	
EVWTDV1548	193	256	1	55	15	26.00	0.77	
EVWTDV1554	206	276	1	61	15	28.00	0.85	
EVWTDV1560	228	303	1	67	15	31.00	0.94	

EVWTD • Double “D” Transaction Surface

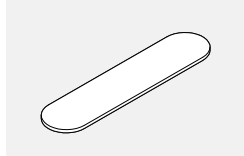

- Support hardware must be ordered separately.
- All tops are thermally fused 1" thick with pilot holes to enable proper alignment with worksurface supports. Wood screws must be used.
- Evolve worksurfaces feature a 3mm edge.

PRODUCT CODE	PRICE		SIZE/ H	INCHES			WEIGHT VOL	
	LP	HP		W	D	LBS	FT ³	
EVWTD • Double “D” Transaction Surface	207	276	1	62	15	28.00	0.85	
EVWTD • Double “D” Transaction Surface	242	323	1	74	15	31.00	0.94	
EVWTD • Double “D” Transaction Surface	281	374	1	86	15	36.00	1.10	

EVHEP • End Panel

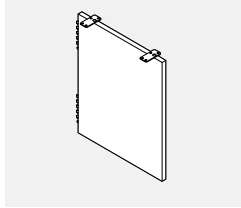

- Attaches a worksurface to a panel connector.
- Provides solid support at the end of a run of worksurfaces.
- Shipped with pedestal brackets and flat brackets.
- Glides are installed.
- Please specify metal colour for brackets.

PRODUCT CODE	PRICE	SIZE/ INCHES			WEIGHT VOL	
		H	W	D	LBS	FT ³
EVHEP2618	182	26	1	18	15.00	0.30
EVHEP2624	232	25	1	24	16.00	0.35
EVHEP2630	272	25	1	30	20.00	0.45
EVHEP2918	191	28	1	18	18.00	0.40
EVHEP2924	232	28	1	24	18.00	0.40
EVHEP2930	272	28	1	30	22.00	0.50

EVHS • Support Leg

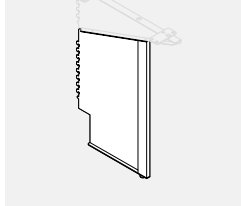

- Used in conjunction with an EVHC Cantilever of the same hand.
- Attaches a worksurface to a panel connector.
- Provides extra support where needed.
- May be used to support two convergent worksurfaces.
- Available in BLK (Black) only.

PRODUCT CODE	PRICE	SIZE/ INCHES			WEIGHT VOL	
		H	W	D	LBS	FT ³
EVHSL2618	122	22	1	10	6.00	0.24
EVHSL2624	122	22	1	10	6.00	0.31
EVHSL2918	129	25	1	10	7.00	0.30
EVHSL2924	129	25	1	10	7.00	0.33
EVHSR2618	122	22	1	10	6.00	0.24
EVHSR2624	122	22	1	10	6.00	0.31
EVHSR2918	129	25	1	10	7.00	0.30
EVHSR2924	129	25	1	10	7.00	0.33

EVHC • Cantilever

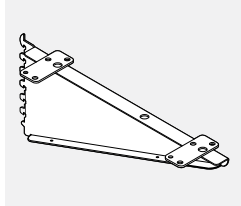

- Attaches a worksurface to a panel connector.
- May be used to support two convergent worksurfaces.
- Priced individually.
- Available in BLK (Black) only.

PRODUCT CODE	PRICE	SIZE/ INCHES			WEIGHT VOL	
		H	W	D	LBS	FT ³
EVHC12L	90	8	1	12	2.00	0.04
EVHC18L	90	8	1	18	2.00	0.04
EVHC24L	101	8	1	24	3.00	0.05
EVHC12R	90	8	1	12	2.00	0.04
EVHC18R	90	8	1	18	2.00	0.04
EVHC24R	101	8	1	24	3.00	0.50

EVHMEGR • Metal End Gable - Right

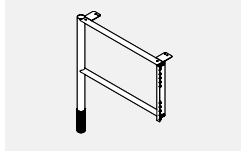

- Support the worksurface and enhances the stability of connected panels.
- Includes a leveling glide and decorative PVC sleeve to cover the glide.

PRODUCT CODE	PRICE	SIZE/ INCHES			WEIGHT VOL	
		H	W	D	LBS	FT ³
EVHMEG18R	227	28	4	17	5.20	0.55
EVHMEG24R	242	28	4	23	6.00	0.73
EVHMEG30R	257	28	4	29	6.80	0.90

EVHMEGL • Metal End Gable - Left

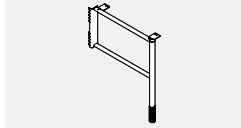

- Support the worksurface and enhances the stability of connected panels.
- Includes a leveling glide and decorative PVC sleeve to cover the glide.

PRODUCT CODE	PRICE	SIZE/ INCHES			WEIGHT VOL	
		H	W	D	LBS	FT ³
EVHMEG18L	227	28	4	17	5.20	0.55
EVHMEG24L	242	28	4	23	6.00	0.73
EVHMEG30L	257	28	4	29	6.80	0.90

EVHMSL • Metal Mid Support Leg

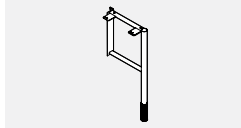

- Supports the adjoining worksurfaces and enhances the stability of connected panels.
- Includes a leveling glide and decorative PVC sleeve to cover the glide.
- **Should not be used as an end support.**

PRODUCT CODE	PRICE	SIZE/ INCHES			WEIGHT VOL	
		H	W	D	LBS	FT ³
EVHMSL12	194	28	4	11	4.60	0.36

EVHMSL1 • Mid Support Leg

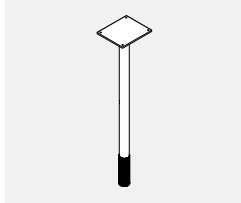

- Provides additional support for worksurface.
- Includes leveling glide, PVC Sleeve and 4.8" x 4.8" attachment plate.
- 1.5 diameter tube.
- Available in standard paint colours.

PRODUCT CODE	PRICE	SIZE/ INCHES			WEIGHT VOL	
		H	W	D	LBS	FT ³
EVHMSL1	75	28			3.20	0.37

EVHMSL2 • Mid Support Leg

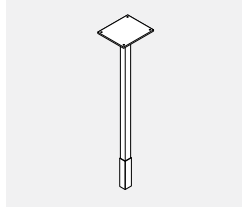

- Provides additional support for worksurface.
- Includes leveling glide, PVC Sleeve and 4.8" x 4.8" attachment plate.
- 1.5" square tube.
- Available in standard paint colours.

PRODUCT CODE	PRICE	SIZE/ H	INCHES H W D	WEIGHT LBS	VOL FT ³
EVHMSL2	75	28		3.20	0.37

EVHMSCL18 • Mid Support Leg with Cantilever Bracket

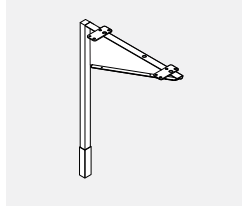

- Provides additional support for worksurface.
- Includes leveling glide, PVC Sleeve and 4.8" x 4.8" attachment plate.
- 1.5" square tube.
- Available in standard paint colours.

PRODUCT CODE	PRICE	SIZE/ H	INCHES H W D	WEIGHT LBS	VOL FT ³
EVHMSCL18	112	28	18 1.5	5.2	0.55

EVTHLEG • Evolve Bridges Leg

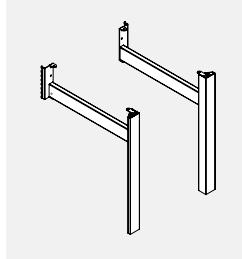

- Leg assembly attaches to panel for application which requires functionality of panels with open environment of Bridges tables.
- One leg with horizontal member connects to 1" increment slots in connector.
- Provides support to panel and panel connected 24" & 30" worksurface at end of run-design coordinated with Bridges freestanding tables.
- One leg can support 2 adjoining worksurface by specifying 2 flat brackets.
- Leveling glide is standard.
- Panel cantilever and storage must be for worksurface support.
- One aluminum leg with steel structure - specify left or right and 24" or 30" deep for corresponding worksurface depth.
- Panel bracket, dislodgment clip and worksurface hardware included.
- Anodized aluminum upcharge \$37.
- Please specify paint finish for support.

PRODUCT CODE	PRICE	SIZE/ H	INCHES H W D	WEIGHT LBS	VOL FT ³
EVTHLEG24LL	343	28	2.5 24	9	1.25
EVTHLEG24RL	343	28	2.5 24	9	1.25
EVTHLEG30LL	361	28	2.5 30	11	1.45
EVTHLEG30RL	361	28	2.5 30	11	1.45

EVHH • High Profile Foot

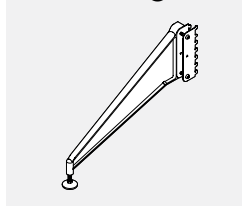

- Provides added support to a panel or worksurface under load.
- Two leveling glides included to adapt to different panel clearances.

PRODUCT CODE	PRICE	SIZE/ H	INCHES H W D	WEIGHT LBS	VOL FT ³
EVHHF01	242	6	1 21	2.80	0.15

EVHML • Monoleg

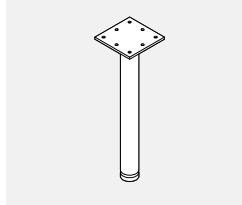

- Provides support for a worksurface.
- Includes an adjustable foot and an attachment plate.
- 3" diameter.
- 1" Height adjustment range.

PRODUCT CODE	PRICE	SIZE/ H	INCHES H W D	WEIGHT LBS	VOL FT ³
EVHML1	188	28	8 8	8.00	0.15

EVHCB • Corner Bracket

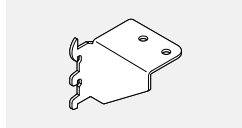

- Attaches the corner of any worksurface to a panel connector.
- Priced per pair.
- Available in BLK (Black) only.

PRODUCT CODE	PRICE	SIZE/ H	INCHES H W D	WEIGHT LBS	VOL FT ³
EVHCB2	25	2	3.5 2.5	0.50	0.02

EVHTB • Transaction Bracket



- Securely attaches a transaction surface to the top of a panel.
- Priced per pair.

PRODUCT CODE	PRICE	SIZE/ INCHES			WEIGHT VOL	
		H	W	D	LBS	FT ³
EVHTB2	25	3.5	3.5	2.5	0.50	0.02

EVHFB • Flat Bracket

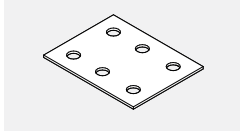

- Must be used in conjunction with cantilevers or transaction brackets to ensure alignment of neighbouring surfaces.

PRODUCT CODE	PRICE	SIZE/ INCHES			WEIGHT VOL	
		H	W	D	LBS	FT ³
EVHFB1	20	0.125	3	4	0.50	0.01

EVHQB • “Z” Bracket

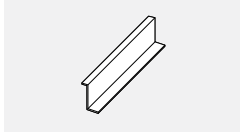

- Used to attach two different worksurface heights with a 3” difference.
- Must be used in conjunction with a cantilever.
- Available in BLK (Black) only.

PRODUCT CODE	PRICE	SIZE/ INCHES			WEIGHT VOL	
		H	W	D	LBS	FT ³
EVHQB1	52	3	17	4	2.00	0.19

EVHPB • Pedestal Bracket

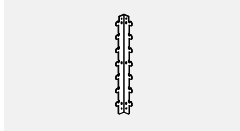

- Attaches to back edge of a pedestal and connects pedestal to panel connector.

PRODUCT CODE	PRICE	SIZE/ INCHES			WEIGHT VOL	
		H	W	D	LBS	FT ³
EVHPB1	28	12	1	1	0.50	0.50

EVHSC • Worksurface Support Channel

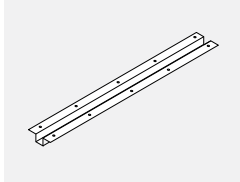

- EVHSC40 for table 54” wide.
- EVHSC46 for table 60” wide.
- EVHSC52 for table 66” wide.
- EVHSC58 for table 72” wide.
- EVHSC64 for table 78” wide.
- EVHSC70 for table 84” wide.
- Tops with post legs should be specified with support channel for structural reinforcement.
- Support channel attaches to underside of worksurface with screws.
- Support channel should be 14” shorter than top length.
- Screws included.
- Painted Black.

PRODUCT CODE	PRICE	SIZE/ INCHES			WEIGHT VOL	
		H	W	D	LBS	FT ³
EVHSC40	56	40	5	4	0.20	
EVHSC46	62	46	5	6	0.22	
EVHSC52	66	52	5	7	0.25	
EVHSC58	76	58	5	8	0.28	
EVHSC64	85	64	5	9	0.31	
EVHSC70	91	70	5	10	0.33	

EVHV • Wall Adapter

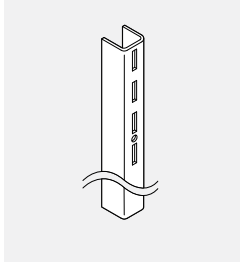

- A “U” shaped channel used to attach system components to a fixed wall.
- Slots are 1” on centre.
- Sold per pair.
- Care should be taken to mount adapters only to wall studs using correct fasteners.
- Failure to do this may result in collapse of the unit and subsequent possible personal injury.
- Mounting hardware is not included.
- Mounting hardware selection to be based on wall material

PRODUCT CODE	PRICE	SIZE/ INCHES			WEIGHT VOL	
		H	W	D	LBS	FT ³
EVHV01	72	60	0.5	0.5	4.00	0.01

EVHOMB • Off Module Worksurface Bracket

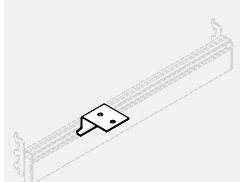

- Supports the worksurface in the work station corner in the case where an adjoining panel is wider than the worksurface.
- Enhances the stability of the worksurface.
- Can be used only in conjunction with the Top Load Bar (EVALB2xx - xx being the panel width - ordered separately)

PRODUCT CODE	PRICE	SIZE/ INCHES			WEIGHT VOL	
		H	W	D	LBS	FT ³
EVHOMB1	15	1.6	3	2.73	0.50	0.02

EVLEP • Laminate End Panel

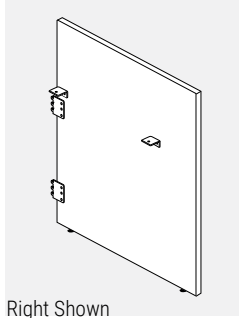

Right Shown

- Attaches to end of run connector.
- Finished in thermally fused laminate.
- Includes attachment flat brackets.
- Includes support brackets to attach worksurface.
- Laminate End Panel height is inclusive of panel glides extended to their full height.
- If wood grain is selected, grain runs vertically.
- Three sides are PVC edged while fourth edge is self-edge. Please choose a PVC edge colour.

PRODUCT CODE	PRICE LP	SIZE/ INCHES		WEIGHT VOL	
		H	W	LBS	FT ³
EVLEPR4224	317	42	24	26.25	0.58
EVLEPR4230	396	42	30	32.81	0.73
EVLEPR4236	473	42	36	39.38	0.88
EVLEPR4242	552	42	42	45.94	1.02
EVLEPR4248	635	42	48	52.50	1.17
EVLEPL4224	317	42	24	30.00	0.67
EVLEPL4230	396	42	30	37.50	0.83
EVLEPL4236	473	42	36	45.00	1.00
EVLEPL4242	552	42	42	52.50	1.17
EVLEPL4248	635	42	48	60.00	1.33
EVLEPR4824	359	48	24	26.25	0.58
EVLEPR4830	451	48	30	32.81	0.73
EVLEPR4836	541	48	36	39.38	0.88
EVLEPR4842	633	48	42	45.94	1.02
EVLEPR4848	722	48	48	52.50	1.17
EVLEPL4824	359	48	24	30.00	0.67
EVLEPL4830	451	48	30	37.50	0.83
EVLEPL4836	541	48	36	45.00	1.00
EVLEPL4842	633	48	42	52.50	1.17
EVLEPL4848	722	48	48	60.00	1.33

EVLMP • Laminate Middle Panel

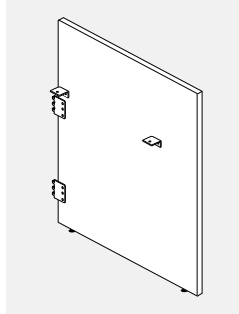

- Attaches to double inline connector.
- Finished in thermally fused laminate.
- Includes attachment flat brackets.
- Includes support brackets to attach worksurfaces on both sides on middle panel.
- Laminate Middle Panel height is inclusive of panel glides extended to their full height.
- If wood grain is selected, grain runs vertically.
- Three sides are PVC edged while fourth edge is self-edge. Please choose a PVC edge colour.

PRODUCT CODE	PRICE LP	SIZE/ INCHES		WEIGHT VOL	
		H	W	LBS	FT ³
EVLMP4224	353	42	24	26.25	0.58
EVLMP4230	429	42	30	32.81	0.73
EVLMP4236	509	42	36	39.38	0.88
EVLMP4242	590	42	42	45.94	1.02
EVLMP4248	674	42	48	52.50	1.17
EVLMP4824	394	48	24	30.00	0.67
EVLMP4830	488	48	30	37.50	0.83
EVLMP4836	578	48	36	45.00	1.00
EVLMP4842	669	48	42	52.50	1.17
EVLMP4848	760	48	48	60.00	1.33

EVLEP-A • Laminate End Panel with Accessory Rail

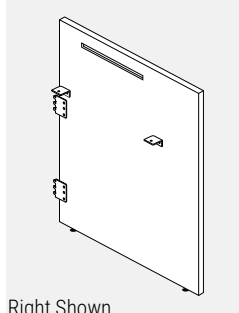

Right Shown

- Attaches to end of run connector.
- Finished in thermally fused laminate.
- Includes attachment flat brackets and accessory rail on inside.
- Includes support brackets to attach worksurface.
- Laminate End Panel height is inclusive of panel glides extended to their full height.
- If wood grain is selected, grain runs vertically.
- Three sides are PVC edged while fourth edge is self-edge. Please choose a PVC edge colour.

PRODUCT CODE	PRICE LP	SIZE/ INCHES		WEIGHT VOL	
		H	W	LBS	FT ³
EVLEPR4224A	359	42	24	26.25	0.58
EVLEPR4230A	437	42	30	32.81	0.73
EVLEPR4236A	519	42	36	39.38	0.88
EVLEPR4242A	596	42	42	45.94	1.02
EVLEPR4248A	679	42	48	52.50	1.17
EVLEPL4224A	359	42	24	30.00	0.67
EVLEPL4230A	437	42	30	37.50	0.83
EVLEPL4236A	519	42	36	45.00	1.00
EVLEPL4242A	596	42	42	52.50	1.17
EVLEPL4248A	679	42	48	60.00	1.33
EVLEPR4824A	399	48	24	26.25	0.58
EVLEPR4830A	486	48	30	32.81	0.73
EVLEPR4836A	549	48	36	39.38	0.88
EVLEPR4842A	625	48	42	45.94	1.02
EVLEPR4848A	767	48	48	52.50	1.17
EVLEPL4824A	399	48	24	30.00	0.67
EVLEPL4830A	486	48	30	37.50	0.83
EVLEPL4836A	549	48	36	45.00	1.00
EVLEPL4842A	625	48	42	52.50	1.17
EVLEPL4848A	767	48	48	60.00	1.33

EVLMP-A • Laminate Middle Panel with Accessory Rail

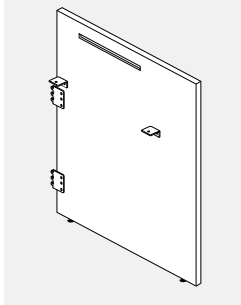

- Attaches to double inline connector.
- Finished in thermally fused laminate.
- Includes accessory rail on both sides of middle panel.
- Includes attachment flat brackets and accessory rail on both sides.
- Includes support brackets to attach worksurfaces on both sides on middle panel.
- Laminate Middle Panel height is inclusive of panel glides extended to their full height.
- If wood grain is selected, grain runs vertically.
- Three sides are PVC edged while fourth edge is self-edge. Please choose a PVC edge colour.

PRODUCT CODE	PRICE LP	SIZE / INCHES		WEIGHT VOL	
		H	W	LBS	FT ³
EVLMP4224A	405	42	24	26.25	0.58
EVLMP4230A	484	42	30	32.81	0.73
EVLMP4236A	565	42	36	39.38	0.88
EVLMP4242A	642	42	42	45.94	1.02
EVLMP4248A	729	42	48	52.50	1.17
EVLMP4824A	443	48	24	30.00	0.67
EVLMP4830A	541	48	30	37.50	0.83
EVLMP4836A	633	48	36	45.00	1.00
EVLMP4842A	722	48	42	52.50	1.17
EVLMP4848A	813	48	48	60.00	1.33

EV4LXP • Laminate Panel Four Way

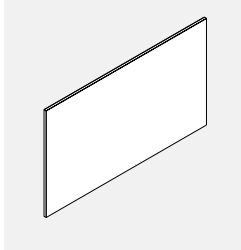

- Panel connects "+" configuration with extension panel
- Finished in thermally fused laminate
- Laminate extension Panel height is inclusive of panel glides extended to their full height
- If wood grain is selected, grain runs horizontally
- Corner connecting brackets to be ordered separately

PRODUCT CODE	PRICE LP	SIZE / INCHES		WEIGHT VOL	
		H	W	LBS	FT ³
EV4LXP4249	519	42	49	53.59	1.19
EV4LXP4261	619	42	61	66.72	1.48
EV4LXP4273	718	42	73	79.84	1.77
EV4LXP4849	589	48	49	61.25	1.36
EV4LXP4861	723	48	61	76.25	1.69
EV4LXP4873	859	48	73	91.25	2.03
EV4LXP5449	658	54	49	68.91	1.53
EV4LXP5461	859	54	61	85.78	1.91
EV4LXP5473	993	54	73	102.66	2.28

EVLXPML • Laminate Extension Panel

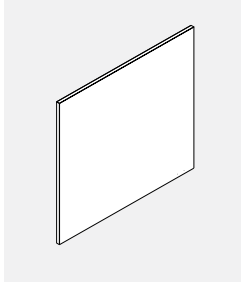

- Locking connection on one sides, no connection at end
- Finished in thermally fused laminate
- Laminate extension Panel height is inclusive of panel glides extended to their full height
- If wood grain is selected, grain runs horizontally
- Bottom connecting brackets to be ordered separately

PRODUCT CODE	PRICE LP	SIZE / INCHES		WEIGHT VOL	
		H	W	LBS	FT ³
EVLXPML4224	276	42	24	26.25	0.58
EVLXPML4230	336	42	30	32.81	0.73
EVLXPML4236	375	42	36	39.38	0.88
EVLXPML4242	422	42	42	45.94	1.02
EVLXPML4248	484	42	48	52.50	1.17
EVLXPMR4224	276	42	24	26.25	0.58
EVLXPMR4230	336	42	30	32.81	0.73
EVLXPMR4236	375	42	36	39.38	0.88
EVLXPMR4242	422	42	42	45.94	1.02
EVLXPMR4248	484	42	48	52.50	1.17
EVLXPML4824	318	48	24	30.00	0.67
EVLXPML4830	367	48	30	37.50	0.83
EVLXPML4836	419	48	36	45.00	1.00
EVLXPML4842	469	48	42	52.50	1.17
EVLXPML4848	519	48	48	60.00	1.33
EVLXPMR4824	318	48	24	30.00	0.67
EVLXPMR4830	367	48	30	37.50	0.83
EVLXPMR4836	419	48	36	45.00	1.00
EVLXPMR4842	469	48	42	52.50	1.17
EVLXPMR4848	519	48	48	60.00	1.33
EVLXPML5424	345	54	24	33.75	0.75
EVLXPML5430	405	54	30	42.19	0.94
EVLXPML5436	463	54	36	50.63	1.13
EVLXPML5442	527	54	42	59.06	1.31
EVLXPML5448	619	54	48	67.50	1.50
EVLXPMR5424	345	54	24	33.75	0.75
EVLXPMR5430	405	54	30	42.19	0.94
EVLXPMR5436	463	54	36	50.63	1.13
EVLXPMR5442	527	54	42	59.06	1.31
EVLXPMR5448	619	54	48	67.50	1.50

EV2LXP • Laminate Extension Panel Two Way

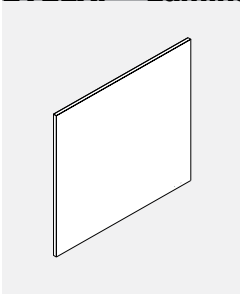

- Panel connects at 90 degree with extension panel
- Finished in thermally fused laminate
- Laminate extension Panel height is inclusive of panel glides extended to their full height
- If wood grain is selected, grain runs horizontally
- Corner connecting brackets to be ordered separately

PRODUCT CODE	PRICE LP	SIZE/INCHES		WEIGHT LBS	VOL FT ³
		H	W		
EV2LXPL4225	276	42	25	27.34	0.61
EV2LXPL4231	336	42	31	33.91	0.75
EV2LXPL4237	375	42	37	40.47	0.90
EV2LXPL4243	422	42	43	47.03	1.05
EV2LXPL4249	484	42	49	53.59	1.19
EV2LXPR4225	276	42	25	27.34	0.61
EV2LXPR4231	336	42	31	33.91	0.75
EV2LXPR4237	375	42	37	40.47	0.90
EV2LXPR4243	422	42	43	47.03	1.05
EV2LXPR4249	484	42	49	53.59	1.19
EV2LXPL4825	318	48	25	31.25	0.69
EV2LXPL4831	367	48	31	38.75	0.86
EV2LXPL4837	419	48	37	46.25	1.03
EV2LXPL4843	469	48	43	53.75	1.19
EV2LXPL4849	519	48	49	61.25	1.36
EV2LXPR4825	318	48	25	31.25	0.69
EV2LXPR4831	367	48	31	38.75	0.86
EV2LXPR4837	419	48	37	46.25	1.03
EV2LXPR4843	469	48	43	53.75	1.19
EV2LXPR4849	519	48	49	61.25	1.36
EV2LXPL5425	372	54	25	35.16	0.78
EV2LXPL5431	425	54	31	43.59	0.97
EV2LXPL5437	480	54	37	52.03	1.16
EV2LXPL5443	583	54	43	60.47	1.34
EV2LXPL5449	658	54	49	68.91	1.53
EV2LXPR5425	372	54	25	35.16	0.78
EV2LXPR5431	425	54	31	43.59	0.97
EV2LXPR5437	480	54	37	52.03	1.16
EV2LXPR5443	583	54	43	60.47	1.34
EV2LXPR5449	658	54	49	68.91	1.53

EV3LXP • Laminate Extension Panel Three Way

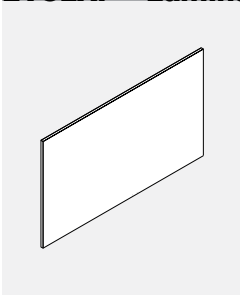

- Panel connects "T" configuration with extension panel
- Finished in thermally fused laminate
- Laminate extension Panel height is inclusive of panel glides extended to their full height
- If wood grain is selected, grain runs horizontally
- Corner connecting brackets to be ordered separately

PRODUCT CODE	PRICE LP	SIZE/INCHES		WEIGHT LBS	VOL FT ³
		H	W		
EV3LXPL4249	519	42	49	53.59	1.19
EV3LXPL4261	619	42	61	66.72	1.48
EV3LXPL4273	718	42	73	79.84	1.77
EV3LXPR4249	519	42	49	53.59	1.19
EV3LXPR4261	619	42	61	66.72	1.48
EV3LXPR4273	718	42	73	79.84	1.77
EV3LXPL4849	589	48	49	61.25	1.36
EV3LXPL4861	723	48	61	76.25	1.69
EV3LXPL4873	859	48	73	91.25	2.03
EV3LXPR4849	589	48	49	61.25	1.36
EV3LXPR4861	723	48	61	76.25	1.69
EV3LXPR4873	859	48	73	91.25	2.03
EV3LXPL5449	658	54	49	68.91	1.53
EV3LXPL5461	859	54	61	85.78	1.91
EV3LXPL5473	993	54	73	102.66	2.28
EV3LXPR5449	658	54	49	68.91	1.53
EV3LXPR5461	859	54	61	85.78	1.91
EV3LXPR5473	993	54	73	102.66	2.28

EV4LXPM • Laminate Extension Panel for Four Way Configuration

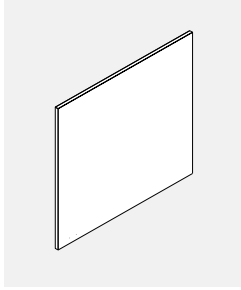

- Locking connection on one side only for four way panel
- Finished in thermally fused laminate
- Universal to be used on both sides of four way laminate panel
- Laminate extension Panel height is inclusive of panel glides extended to their full height
- If wood grain is selected, grain runs horizontally
- Bottom connecting brackets to be ordered separately

PRODUCT CODE	PRICE LP	SIZE/INCHES		WEIGHT LBS	VOL FT ³
		H	W		
EV4LXPM4224	276	42	24	26.25	0.58
EV4LXPM4230	336	42	30	32.81	0.73
EV4LXPM4236	375	42	36	39.38	0.88
EV4LXPM4242	422	42	42	45.94	1.02
EV4LXPM4248	484	42	48	52.50	1.17
EV4LXPM4824	318	48	24	30.00	0.67
EV4LXPM4830	367	48	30	37.50	0.83
EV4LXPM4836	419	48	36	45.00	1.00
EV4LXPM4842	469	48	42	52.50	1.17
EV4LXPM4848	519	48	48	60.00	1.33
EV4LXPM5424	345	54	24	33.75	0.75
EV4LXPM5430	405	54	30	42.19	0.94
EV4LXPM5436	463	54	36	50.63	1.13
EV4LXPM5442	527	54	42	59.06	1.31
EV4LXPM5448	619	54	48	67.50	1.50

EVLXPML-NC - Laminate Extension Panel, No End Connection

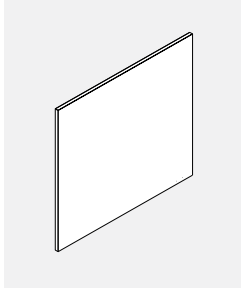

- Locking connection on one sides, no connection at end
- Finished in thermally fused laminate
- Laminate extension Panel height is inclusive of panel glides extended to their full height
- If wood grain is selected, grain runs horizontally
- Bottom connecting brackets to be ordered separately

PRODUCT CODE	PRICE LP	SIZE/INCHES		WEIGHT LBS	VOL FT ³
		H	W		
EVLXPML4224NC	276	42	24	26.25	0.58
EVLXPML4230NC	336	42	30	32.81	0.73
EVLXPML4236NC	375	42	36	39.38	0.88
EVLXPML4242NC	422	42	42	45.94	1.02
EVLXPML4248NC	484	42	48	52.50	1.17
EVLXPMR4224NC	276	42	24	26.25	0.58
EVLXPMR4230NC	336	42	30	32.81	0.73
EVLXPMR4236NC	375	42	36	39.38	0.88
EVLXPMR4242NC	422	42	42	45.94	1.02
EVLXPMR4248NC	484	42	48	52.50	1.17
EVLXPML4824NC	318	48	24	30.00	0.67
EVLXPML4830NC	367	48	30	37.50	0.83
EVLXPML4836NC	419	48	36	45.00	1.00
EVLXPML4842NC	469	48	42	52.50	1.17
EVLXPML4848NC	519	48	48	60.00	1.33
EVLXPMR4824NC	318	48	24	30.00	0.67
EVLXPMR4830NC	367	48	30	37.50	0.83
EVLXPMR4836NC	419	48	36	45.00	1.00
EVLXPMR4842NC	469	48	42	52.50	1.17
EVLXPMR4848NC	519	48	48	60.00	1.33
EVLXPML5424NC	345	54	24	33.75	0.75
EVLXPML5430NC	405	54	30	42.19	0.94
EVLXPML5436NC	463	54	36	50.63	1.13
EVLXPML5442NC	527	54	42	59.06	1.31
EVLXPML5448NC	619	54	48	67.50	1.50
EVLXPMR5424NC	345	54	24	33.75	0.75
EVLXPMR5430NC	405	54	30	42.19	0.94
EVLXPMR5436NC	463	54	36	50.63	1.13
EVLXPMR5442NC	527	54	42	59.06	1.31
EVLXPMR5448NC	619	54	48	67.50	1.50

EVLEPDS • Laminate Gallery Panel

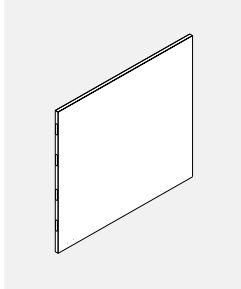

- Attaches to end of run connector with "U" channel
- To be installed at end of panel run
- Finished in thermally fused laminate
- Locking connection both sides
- Laminate Gallery Panel height is inclusive of panel glides extended to their full height
- If wood grain is selected, grain runs horizontally
- End of run connector with "U" channel and bottom connecting brackets to be ordered separately

PRODUCT CODE	PRICE LP	SIZE/INCHES		WEIGHT LBS	VOL FT ³
		H	W		
EVLEPDS4251	519	42	51	55.78	1.24
EVLEPDS4263	675	42	63	68.91	1.53
EVLEPDS4275	832	42	75	82.03	1.82
EVLEPDS4851	589	48	51	63.75	1.42
EVLEPDS4863	750	48	63	78.75	1.75
EVLEPDS4875	910	48	75	93.75	2.08
EVLEPDS5451	658	54	51	71.72	1.59
EVLEPDS5463	859	54	63	88.59	1.97
EVLEPDS5475	993	54	75	105.47	2.34

EVLEPDC • Laminate Gallery Panel

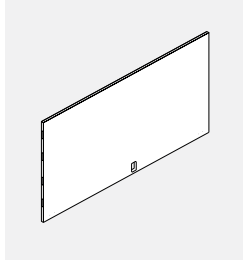

- Attaches in middle of panel run with connector with "U" channel
- To be installed in middle between two panels in straight run
- Finished in thermally fused laminate
- Locking connection both sides
- Laminate Gallery Panel height is inclusive of panel glides extended to their full height
- If wood grain is selected, grain runs horizontally
- End of run connector with "U" channel and bottom connecting brackets to be ordered separately

PRODUCT CODE	PRICE LP	SIZE/INCHES		WEIGHT LBS	VOL FT ³
		H	W		
EVLEPDC4251	519	42	51	55.78	1.24
EVLEPDC4263	675	42	63	68.91	1.53
EVLEPDC4275	832	42	75	82.03	1.82
EVLEPDC4851	589	48	51	63.75	1.42
EVLEPDC4863	750	48	63	78.75	1.75
EVLEPDC4875	910	48	75	93.75	2.08
EVLEPDC5451	658	54	51	71.72	1.59
EVLEPDC5463	859	54	63	88.59	1.97
EVLEPDC5475	993	54	75	105.47	2.34

EVLEPSSL/R • Laminate Gallery Panel, End Connection on One Side

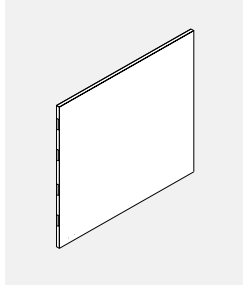

- Attaches to end of run connector with "U" channel
- To be installed at end of panel run on one side
- Finished in thermally fused laminate
- Locking connection on one side
- Laminate Gallery Panel height is inclusive of panel glides extended to their full height
- If wood grain is selected, grain runs horizontally
- End of run connector with "U" channel and bottom connecting brackets to be ordered separately

PRODUCT CODE	PRICE LP	SIZE/INCHES		WEIGHT LBS	VOL FT ³
		H	W		
EVLEPSSL4227	336	42	27	29.53	0.66
EVLEPSSL4233	375	42	33	36.09	0.80
EVLEPSSL4239	422	42	39	42.66	0.95
EVLEPSSL4245	484	42	45	49.22	1.09
EVLEPSSL4251	519	42	51	55.78	1.24
EVLEPSSL4827	367	48	27	33.75	0.75
EVLEPSSL4833	419	48	33	41.25	0.92
EVLEPSSL4839	469	48	39	48.75	1.08
EVLEPSSL4845	519	48	45	56.25	1.25
EVLEPSSL4851	589	48	51	63.75	1.42
EVLEPSSL5427	405	54	27	37.97	0.84
EVLEPSSL5433	463	54	33	46.41	1.03
EVLEPSSL5439	527	54	39	54.84	1.22
EVLEPSSL5445	619	54	45	63.28	1.41
EVLEPSSL5451	658	54	51	71.72	1.59
EVLEPSSR4227	336	42	27	29.53	0.66
EVLEPSSR4233	375	42	33	36.09	0.80
EVLEPSSR4239	422	42	39	42.66	0.95
EVLEPSSR4245	484	42	45	49.22	1.09
EVLEPSSR4251	519	42	51	55.78	1.24
EVLEPSSR4827	367	48	27	33.75	0.75
EVLEPSSR4833	419	48	33	41.25	0.92
EVLEPSSR4839	469	48	39	48.75	1.08
EVLEPSSR4845	519	48	45	56.25	1.25
EVLEPSSR4851	589	48	51	63.75	1.42
EVLEPSSR5427	405	54	27	37.97	0.84
EVLEPSSR5433	463	54	33	46.41	1.03
EVLEPSSR5439	527	54	39	54.84	1.22
EVLEPSSR5445	619	54	45	63.28	1.41
EVLEPSSR5451	658	54	51	71.72	1.59

EVLEPSC • Laminate Gallery Panel

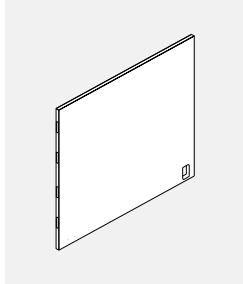

- Attaches in middle of panel run with connector with "U" channel
- To be installed in middle between two panels in straight run on one side
- Cut out for electrics at power beam height
- Finished in thermally fused laminate
- Locking connection on one side
- Laminate Gallery Panel height is inclusive of panel glides extended to their full height
- If wood grain is selected, grain runs horizontally
- End of run connector with "U" channel and bottom connecting brackets to be ordered separately

PRODUCT CODE	PRICE LP	SIZE/INCHES		WEIGHT LBS	VOL FT ³
		H	W		
EVLEPSC4227	336	42	27	29.53	0.66
EVLEPSC4233	375	42	33	36.09	0.80
EVLEPSC4239	422	42	39	42.66	0.95
EVLEPSC4245	484	42	45	49.22	1.09
EVLEPSC4251	519	42	51	55.78	1.24
EVLEPSC4827	367	48	27	33.75	0.75
EVLEPSC4833	419	48	33	41.25	0.92
EVLEPSC4839	469	48	39	48.75	1.08
EVLEPSC4845	519	48	45	56.25	1.25
EVLEPSC4851	589	48	51	63.75	1.42
EVLEPSC5427	405	54	27	37.97	0.84
EVLEPSC5433	463	54	33	46.41	1.03
EVLEPSC5439	527	54	39	54.84	1.22
EVLEPSC5445	619	54	45	63.28	1.41
EVLEPSC5451	658	54	51	71.72	1.59

EVLEPDS-NC • Laminate Gallery Panel, No End Connection at Both Sides

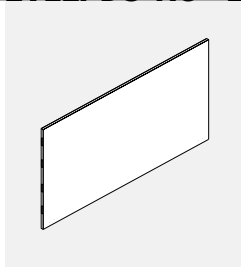

- Attaches to end of run connector with "U" channel
- To be installed at end of panel run
- Finished in thermally fused laminate
- Locking connection both sides
- Laminate Gallery Panel height is inclusive of panel glides extended to their full height
- If wood grain is selected, grain runs horizontally
- End of run connector with "U" channel and bottom connecting brackets to be ordered separately

PRODUCT CODE	PRICE LP	SIZE / INCHES		WEIGHT LBS	VOL FT ³
		H	W		
EVLEPDS4251NC	519	42	51	55.78	1.24
EVLEPDS4263NC	675	42	63	68.91	1.53
EVLEPDS4275NC	832	42	75	82.03	1.82
EVLEPDS4851NC	589	48	51	63.75	1.42
EVLEPDS4863NC	750	48	63	78.75	1.75
EVLEPDS4875NC	910	48	75	93.75	2.08
EVLEPDS5451NC	658	54	51	71.72	1.59
EVLEPDS5463NC	859	54	63	88.59	1.97
EVLEPDS5475NC	993	54	75	105.47	2.34

EVLEPDC-NC • Laminate Gallery Middle Panel, No End Connection at Both Sides

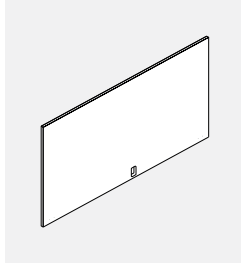

- Attaches in middle of panel run with connector with "U" channel
- To be installed in middle between two panels in straight run
- Finished in thermally fused laminate
- No connection both sides
- Laminate Gallery Panel height is inclusive of panel glides extended to their full height
- If wood grain is selected, grain runs horizontally
- End of run connector with "U" channel and bottom connecting brackets to be ordered separately

PRODUCT CODE	PRICE LP	SIZE / INCHES		WEIGHT LBS	VOL FT ³
		H	W		
EVLEPDC4251NC	519	42	51	55.78	1.24
EVLEPDC4263NC	675	42	63	68.91	1.53
EVLEPDC4275NC	832	42	75	82.03	1.82
EVLEPDC4851NC	589	48	51	63.75	1.42
EVLEPDC4863NC	750	48	63	78.75	1.75
EVLEPDC4875NC	910	48	75	93.75	2.08
EVLEPDC5451NC	658	54	51	71.72	1.59
EVLEPDC5463NC	859	54	63	88.59	1.97
EVLEPDC5475NC	993	54	75	105.47	2.34

EVLEPSS-NC • Laminate Gallery End Panel, No End Connection at Both Sides

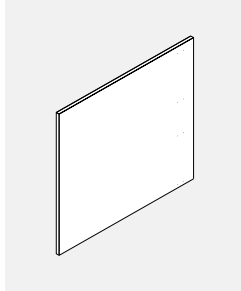

- Attaches in middle of panel run with connector with "U" channel
- To be installed in middle between two panels in straight run
- Finished in thermally fused laminate
- No connection both sides
- Laminate Gallery Panel height is inclusive of panel glides extended to their full height
- If wood grain is selected, grain runs horizontally
- End of run connector with "U" channel and bottom connecting brackets to be ordered separately

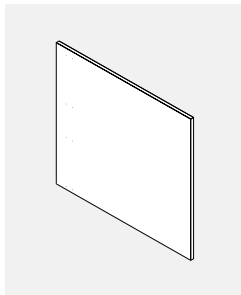

PRODUCT CODE	PRICE LP	SIZE / INCHES		WEIGHT LBS	VOL FT ³
		H	W		
EVLEPSSL4227NC	336	42	27	29.53	0.66
EVLEPSSL4233NC	375	42	33	36.09	0.80
EVLEPSSL4239NC	422	42	39	42.66	0.95
EVLEPSSL4245NC	484	42	45	49.22	1.09
EVLEPSSL4251NC	519	42	51	55.78	1.24
EVLEPSSL4827NC	367	48	27	33.75	0.75
EVLEPSSL4833NC	419	48	33	41.25	0.92
EVLEPSSL4839NC	469	48	39	48.75	1.08
EVLEPSSL4845NC	519	48	45	56.25	1.25
EVLEPSSL4851NC	589	48	51	63.75	1.42
EVLEPSSL5427NC	405	54	27	37.97	0.84
EVLEPSSL5433NC	463	54	33	46.41	1.03
EVLEPSSL5439NC	527	54	39	54.84	1.22
EVLEPSSL5445NC	619	54	45	63.28	1.41
EVLEPSSL5451NC	658	54	51	71.72	1.59
EVLEPSSR4227NC	336	42	27	29.53	0.66
EVLEPSSR4233NC	375	42	33	36.09	0.80
EVLEPSSR4239NC	422	42	39	42.66	0.95
EVLEPSSR4245NC	484	42	45	49.22	1.09
EVLEPSSR4251NC	519	42	51	55.78	1.24
EVLEPSSR4827NC	367	48	27	33.75	0.75
EVLEPSSR4833NC	419	48	33	41.25	0.92
EVLEPSSR4839NC	469	48	39	48.75	1.08
EVLEPSSR4845NC	519	48	45	56.25	1.25
EVLEPSSR4851NC	589	48	51	63.75	1.42
EVLEPSSR5427NC	405	54	27	37.97	0.84
EVLEPSSR5433NC	463	54	33	46.41	1.03
EVLEPSSR5439NC	527	54	39	54.84	1.22
EVLEPSSR5445NC	619	54	45	63.28	1.41
EVLEPSSR5451NC	658	54	51	71.72	1.59

EVLEPSC-NC • Laminate Gallery Middle One Side Panel, No End Connection at Both Sides

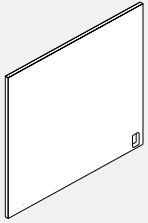

- Attaches in middle of panel run with connector with "U" channel
- To be installed in middle between two panels in straight run on one side
- Cut out for electrics at power beam height
- Finished in thermally fused laminate
- No connection both sides
- Laminate Gallery Panel height is inclusive of panel glides extended to their full height
- If wood grain is selected, grain runs horizontally
- End of run connector with "U" channel and bottom connecting brackets to be ordered separately

PRODUCT CODE	PRICE LP	SIZE/INCHES		WEIGHT LBS	VOL FT ³
		H	W		
EVLEPSC4227NC	336	42	27	29.53	0.66
EVLEPSC4233NC	375	42	33	36.09	0.80
EVLEPSC4239NC	422	42	39	42.66	0.95
EVLEPSC4245NC	484	42	45	49.22	1.09
EVLEPSC4251NC	519	42	51	55.78	1.24
EVLEPSC4827NC	367	48	27	33.75	0.75
EVLEPSC4833NC	419	48	33	41.25	0.92
EVLEPSC4839NC	469	48	39	48.75	1.08
EVLEPSC4845NC	519	48	45	56.25	1.25
EVLEPSC4851NC	589	48	51	63.75	1.42
EVLEPSC5427NC	405	54	27	37.97	0.84
EVLEPSC5433NC	463	54	33	46.41	1.03
EVLEPSC5439NC	527	54	39	54.84	1.22
EVLEPSC5445NC	619	54	45	63.28	1.41
EVLEPSC5451NC	658	54	51	71.72	1.59

EVPBLEPDS • Laminate Gallery Panel for Power Beam, End Connection

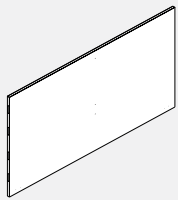

- Attaches to power beam channel
- To be installed at end of power beam run
- Finished in thermally fused laminate
- Locking connection both sides
- Laminate Gallery Panel height is inclusive of panel glides extended to their full height
- If wood grain is selected, grain runs horizontally
- Power beam channel and bottom connecting bracket to be ordered separately

PRODUCT CODE	PRICE LP	SIZE/INCHES		WEIGHT LBS	VOL FT ³
		H	W		
EVPBLEPDS4251	519	42	51	55.78	1.24
EVPBLEPDS4263	675	42	63	68.91	1.53
EVPBLEPDS4275	832	42	75	82.03	1.82
EVPBLEPDS4851	589	48	51	63.75	1.42
EVPBLEPDS4863	750	48	63	78.75	1.75
EVPBLEPDS4875	910	48	75	93.75	2.08
EVPBLEPDS5451	658	54	51	71.72	1.59
EVPBLEPDS5463	859	54	63	88.59	1.97
EVPBLEPDS5475	993	54	75	105.47	2.34

EVPBLEPDC • Laminate Gallery Panel for Power Beam, Middle Connection

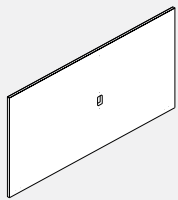

- Attaches to power beam channel
- To be installed in middle between two power beam in straight run
- Cut out for electrics at power beam height
- Finished in thermally fused laminate
- Locking connection both sides
- Laminate Gallery Panel height is inclusive of panel glides extended to their full height
- If wood grain is selected, grain runs horizontally
- Power beam channel and bottom connecting bracket to be ordered separately
- Standard code is for 24" H Power Beam
- Please add at code end "B" for 30" H Power Beam or "C" for 36" H Power Beam

PRODUCT CODE	PRICE LP	SIZE/INCHES		WEIGHT LBS	VOL FT ³
		H	W		
EVPBLEPDC4251	519	42	51	55.78	1.24
EVPBLEPDC4263	675	42	63	68.91	1.53
EVPBLEPDC4275	832	42	75	82.03	1.82
EVPBLEPDC4851	589	48	51	63.75	1.42
EVPBLEPDC4863	750	48	63	78.75	1.75
EVPBLEPDC4875	910	48	75	93.75	2.08
EVPBLEPDC5451	658	48	51	63.75	1.42
EVPBLEPDC5463	859	48	63	78.75	1.75
EVPBLEPDC5475	993	48	75	93.75	2.08

EVPBLEPSSL/R • Laminate Gallery Panel for Power Beam, End Connection on One Side

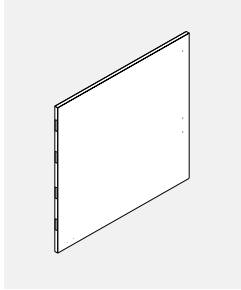

- Attaches to power beam channel
- To be installed at end of power beam run on one side
- Finished in thermally fused laminate
- Locking connection on one side
- Laminate Gallery Panel height is inclusive of panel glides extended to their full height
- If wood grain is selected, grain runs horizontally
- Power beam channel and bottom connecting bracket to be ordered separately

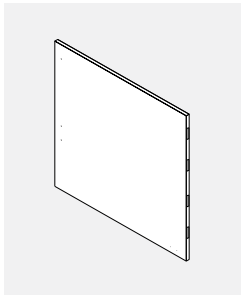

PRODUCT CODE	PRICE LP	SIZE/INCHES		WEIGHT LBS	VOL FT ³
		H	W		
EVPBLEPSSL4227	336	42	27	29.53	0.66
EVPBLEPSSL4233	375	42	33	36.09	0.80
EVPBLEPSSL4239	422	42	39	42.66	0.95
EVPBLEPSSL4245	484	42	45	49.22	1.09
EVPBLEPSSL4251	519	42	51	55.78	1.24
EVPBLEPSSL4827	367	48	27	33.75	0.75
EVPBLEPSSL4833	419	48	33	41.25	0.92
EVPBLEPSSL4839	469	48	39	48.75	1.08
EVPBLEPSSL4845	519	48	45	56.25	1.25
EVPBLEPSSL4851	589	48	51	63.75	1.42
EVPBLEPSSL5427	405	54	27	37.97	0.84
EVPBLEPSSL5433	463	54	33	46.41	1.03
EVPBLEPSSL5439	527	54	39	54.84	1.22
EVPBLEPSSL5445	619	54	45	63.28	1.41
EVPBLEPSSL5451	658	54	51	71.72	1.59
EVPBLEPSSR4227	336	42	27	29.53	0.66
EVPBLEPSSR4233	375	42	33	36.09	0.80
EVPBLEPSSR4239	422	42	39	42.66	0.95
EVPBLEPSSR4245	484	42	45	49.22	1.09
EVPBLEPSSR4251	519	42	51	55.78	1.24
EVPBLEPSSR4827	367	48	27	33.75	0.75
EVPBLEPSSR4833	419	48	33	41.25	0.92
EVPBLEPSSR4839	469	48	39	48.75	1.08
EVPBLEPSSR4845	519	48	45	56.25	1.25
EVPBLEPSSR4851	589	48	51	63.75	1.42
EVPBLEPSSR5427	405	54	27	37.97	0.84
EVPBLEPSSR5433	463	54	33	46.41	1.03
EVPBLEPSSR5439	527	54	39	54.84	1.22
EVPBLEPSSR5445	619	54	45	63.28	1.41
EVPBLEPSSR5451	658	54	51	71.72	1.59

EVPBLEPSC • Laminate Gallery Panel for Power Beam, Middle Connection on One Side

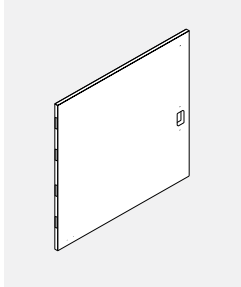

- Attaches to power beam channel
- To be installed in middle between two power beam in straight run on one side
- Cut out for electrics at power beam height
- Finished in thermally fused laminate
- Locking connection on one side
- Laminate Gallery Panel height is inclusive of panel glides extended to their full height
- If wood grain is selected, grain runs horizontally
- Power beam channel and bottom connecting bracket to be ordered separately
- Standard code is for 24" H Power Beam
- Please add at code end "B" for 30"h Power Beam or "C" for 36"h Power Beam

PRODUCT CODE	PRICE LP	SIZE/INCHES		WEIGHT LBS	VOL FT ³
		H	W		
EVPBLEPSC4227	336	42	27	29.53	0.66
EVPBLEPSC4233	375	42	33	36.09	0.80
EVPBLEPSC4239	422	42	39	42.66	0.95
EVPBLEPSC4245	484	42	45	49.22	1.09
EVPBLEPSC4251	519	42	51	55.78	1.24
EVPBLEPSC4827	367	48	27	33.75	0.75
EVPBLEPSC4833	419	48	33	41.25	0.92
EVPBLEPSC4839	469	48	39	48.75	1.08
EVPBLEPSC4845	519	48	45	56.25	1.25
EVPBLEPSC4851	589	48	51	63.75	1.42
EVPBLEPSC5427	405	54	27	37.97	0.84
EVPBLEPSC5433	463	54	33	46.41	1.03
EVPBLEPSC5439	527	54	39	54.84	1.22
EVPBLEPSC5445	619	54	45	63.28	1.41
EVPBLEPSC5451	658	54	51	71.72	1.59

EVPBLEPDS-NC • Laminate Gallery Panel for Power Beam, No End Connection

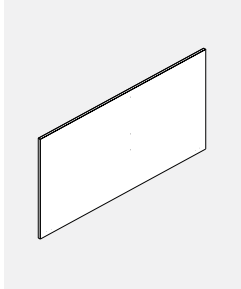

- Attaches to power beam channel
- To be installed at end of power beam run
- Finished in thermally fused laminate
- No connection both sides
- Laminate Gallery Panel height is inclusive of panel glides extended to their full height
- If wood grain is selected, grain runs horizontally
- Power beam channel and bottom connecting bracket to be ordered separately

PRODUCT CODE	PRICE LP	SIZE/INCHES		WEIGHT LBS	VOL FT ³
		H	W		
EVPBLEPDS4251NC	519	42	51	55.78	1.24
EVPBLEPDS4263NC	675	42	63	68.91	1.53
EVPBLEPDS4275NC	832	42	75	82.03	1.82
EVPBLEPDS4851NC	589	48	51	63.75	1.42
EVPBLEPDS4863NC	750	48	63	78.75	1.75
EVPBLEPDS4875NC	910	48	75	93.75	2.08
EVPBLEPDS5451NC	658	54	51	71.72	1.59
EVPBLEPDS5463NC	859	54	63	88.59	1.97
EVPBLEPDS5475NC	993	54	75	105.47	2.34

EVPBLEPDC-NC • Laminate Gallery Middle Panel for Power Beam, No End Connection at Both Sides

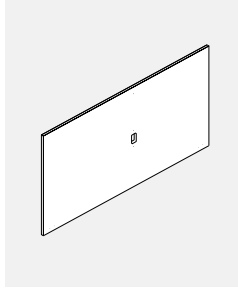

- Attaches to power beam channel
- To be installed in middle between two power beam in straight run
- Cut out for electrics at power beam height
- Finished in thermally fused laminate
- No connection both sides
- Laminate Gallery Panel height is inclusive of panel glides extended to their full height
- If wood grain is selected, grain runs horizontally
- Power beam channel and bottom connecting bracket to be ordered separately
- Standard code is for 24" H Power Beam
- Please add at code end "B" for 30"h Power Beam or "C" for 36"h Power Beam

PRODUCT CODE	PRICE LP	SIZE/INCHES		WEIGHT LBS	VOL FT ³
		H	W		
EVPBLEPDC4251NC	519	42	51	55.78	1.24
EVPBLEPDC4263NC	675	42	63	68.91	1.53
EVPBLEPDC4275NC	832	42	75	82.03	1.82
EVPBLEPDC4851NC	589	48	51	63.75	1.42
EVPBLEPDC4863NC	750	48	63	78.75	1.75
EVPBLEPDC4875NC	910	48	75	93.75	2.08
EVPBLEPDC5451NC	658	48	51	63.75	1.42
EVPBLEPDC5463NC	859	48	63	78.75	1.75
EVPBLEPDC5475NC	993	48	75	93.75	2.08

EVPBLEPSS-NC • Laminate Gallery End Panel for Power Beam, No End Connection at Both Sides

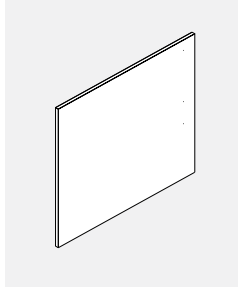

- Attaches to power beam channel
- To be installed at end of power beam run on one side
- Finished in thermally fused laminate
- No connection both sides
- Laminate Gallery Panel height is inclusive of panel glides extended to their full height
- If wood grain is selected, grain runs horizontally
- Power beam channel and bottom connecting bracket to be ordered separately

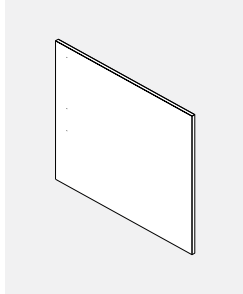

PRODUCT CODE	PRICE LP	SIZE/INCHES		WEIGHT LBS	VOL FT ³
		H	W		
EVPBLEPSSL4227NC	336	42	27	29.53	0.66
EVPBLEPSSL4233NC	375	42	33	36.09	0.80
EVPBLEPSSL4239NC	422	42	39	42.66	0.95
EVPBLEPSSL4245NC	484	42	45	49.22	1.09
EVPBLEPSSL4251NC	519	42	51	55.78	1.24
EVPBLEPSSL4827NC	367	48	27	33.75	0.75
EVPBLEPSSL4833NC	419	48	33	41.25	0.92
EVPBLEPSSL4839NC	469	48	39	48.75	1.08
EVPBLEPSSL4845NC	519	48	45	56.25	1.25
EVPBLEPSSL4851NC	589	48	51	63.75	1.42
EVPBLEPSSL5427NC	405	54	27	37.97	0.84
EVPBLEPSSL5433NC	463	54	33	46.41	1.03
EVPBLEPSSL5439NC	527	54	39	54.84	1.22
EVPBLEPSSL5445NC	619	54	45	63.28	1.41
EVPBLEPSSL5451NC	658	54	51	71.72	1.59
EVPBLEPSSR4227NC	336	42	27	29.53	0.66
EVPBLEPSSR4233NC	375	42	33	36.09	0.80
EVPBLEPSSR4239NC	422	42	39	42.66	0.95
EVPBLEPSSR4245NC	484	42	45	49.22	1.09
EVPBLEPSSR4251NC	519	42	51	55.78	1.24
EVPBLEPSSR4827NC	367	48	27	33.75	0.75
EVPBLEPSSR4833NC	419	48	33	41.25	0.92
EVPBLEPSSR4839NC	469	48	39	48.75	1.08
EVPBLEPSSR4845NC	519	48	45	56.25	1.25
EVPBLEPSSR4851NC	589	48	51	63.75	1.42
EVPBLEPSSR5427NC	405	54	27	37.97	0.84
EVPBLEPSSR5433NC	463	54	33	46.41	1.03
EVPBLEPSSR5439NC	527	54	39	54.84	1.22
EVPBLEPSSR5445NC	619	54	45	63.28	1.41
EVPBLEPSSR5451NC	658	54	51	71.72	1.59

EVPBLEPSC-NC • Laminate Gallery Middle One Side Panel for Power Beam, No End Connection at Both Sides

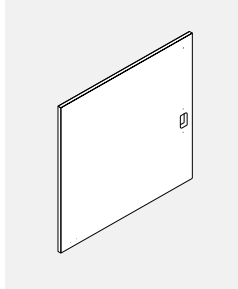

- Attaches to power beam channel
- To be installed in middle between two power beam in straight run on one side
- Cut out for electrics at power beam height
- Finished in thermally fused laminate
- No connection both sides
- Laminate Gallery Panel height is inclusive of panel glides extended to their full height
- If wood grain is selected, grain runs horizontally
- Power beam channel and bottom connecting bracket to be ordered separately
- Standard code is for 24" H Power Beam
- Please add at code end "B" for 30"h Power Beam or "C" for 36" Power Beam

PRODUCT CODE	PRICE LP	SIZE/INCHES		WEIGHT LBS	VOL FT ³
		H	W		
EVPBLEPSC4227NC	336	42	27	29.53	0.66
EVPBLEPSC4233NC	375	42	33	36.09	0.80
EVPBLEPSC4239NC	422	42	39	42.66	0.95
EVPBLEPSC4245NC	484	42	45	49.22	1.09
EVPBLEPSC4251NC	519	42	51	55.78	1.24
EVPBLEPSC4827NC	367	48	27	33.75	0.75
EVPBLEPSC4833NC	419	48	33	41.25	0.92
EVPBLEPSC4839NC	469	48	39	48.75	1.08
EVPBLEPSC4845NC	519	48	45	56.25	1.25
EVPBLEPSC4851NC	589	48	51	63.75	1.42
EVPBLEPSC5427NC	405	54	27	37.97	0.84
EVPBLEPSC5433NC	463	54	33	46.41	1.03
EVPBLEPSC5439NC	527	54	39	54.84	1.22
EVPBLEPSC5445NC	619	54	45	63.28	1.41
EVPBLEPSC5451NC	658	54	51	71.72	1.59

EVHLPBB01 • Laminate Panel Bracket

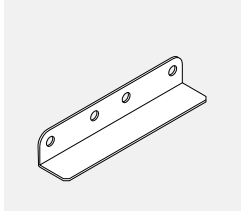

- Laminate panel bottom bracket connects two laminate end panels at bottom with screws
- Available in standard paint colors
- Bracket and screws included

PRODUCT CODE	PRICE	SIZE/INCHES			WEIGHT LBS	VOL FT ³
		H	W	D		
EVHLPBB01	34	1.5	8	1	0.50	0.11

EVHLPCB01 • Laminate Panel Corner Bracket

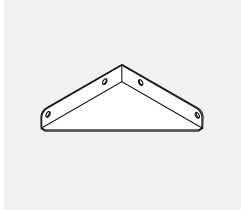

- Laminate panel corner bottom bracket connects two laminate panels at 90 degree
- Available in standard paint colors
- Bracket and screws included

PRODUCT CODE	PRICE	SIZE/INCHES			WEIGHT LBS	VOL FT ³
		H	W	D		
EVHLPCB01	33	1.5	4	4	0.50	0.11

EVPERCH • Connector with U Channel



- U channel attaches with screws to laminate end panel or laminate middle panel
- Evolve panels attaches to connector
- Pass thru at bottom and beltline location for power/data
- U channel is welded to connector
- Includes connector with U channel and hardware

PRODUCT CODE	PRICE	SIZE/INCHES		WEIGHT LBS	VOL FT ³
		H	W		
EVPERCH42	129	42	2.875	4.60	0.14
EVPERCH48	136	48	2.875	5.09	0.18
EVPERCH54	147	54	2.875	6.75	0.22

EVPBIECH • Power Beam Channel

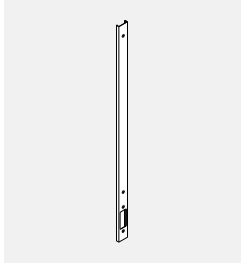

- One piece channel for power beam and extension module above, attaches to laminate panels with screws
- Power beam attaches to channel with clamps and extension module attaches above
- Channel has cut out for power beam electrics to run thru laminate panel

Note

- It is not stackable.
- It can not be stacked with standard extension connector above it.

PRODUCT CODE	PRICE	SIZE/INCHES		WEIGHT LBS	VOL FT ³
		H	W		
EVPBIECH12	37	12	2.875	1.32	0.12
EVPBIECH18	41	18	2.875	1.94	0.18
EVPBIECH24	51	24	2.875	2.60	0.24
EVPBIECH30	54	30	2.875	3.30	0.30
EVPBIECH36	59	36	2.875	4.60	0.36

EVSL12 • Laminated Shelf for Reception Panels

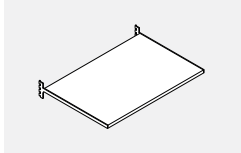

- Laminated Wood Shelf Panel Mounted
- Shelf thickness 1"
- Available in LP
- Includes attachment hardware

PRODUCT CODE	PRICE	SIZE/INCHES			WEIGHT LBS	VOL FT ³
		H	W	D		
EVSL1218	191	1.125	18	12	4.98	0.13
EVSL1224	206	1.125	24	12	6.64	0.17
EVSL1230	219	1.125	30	12	8.3	0.21
EVSL1236	232	1.125	36	12	9.96	0.25
EVSL1242	246	1.125	42	12	11.63	0.29
EVSL1248	260	1.125	48	12	13.29	0.33

EVPTTAU • Connector with U Channel Top Trim Aluminum

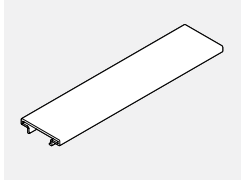

- Aluminum top trim longer by 0.625" to cover width of connector with U channel
- Trim can not span a post
- Available in standard paint colors

PRODUCT CODE	PRICE	SIZE/INCHES		WEIGHT LBS	VOL FT ³
		W	D		
EVPTTAU24	18	24.625	0.19	0.04	
EVPTTAU30	23	30.625	0.24	0.05	
EVPTTAU36	26	36.625	0.28	0.06	
EVPTTAU42	29	42.625	0.33	0.07	
EVPTTAU48	34	48.625	0.37	0.08	
EVPTTAU54	37	54.625	0.42	0.09	
EVPTTAU60	45	60.625	0.46	0.10	
EVPTTAU66	47	66.625	0.51	0.11	
EVPTTAU72	48	72.625	0.56	0.12	
EVPTTAU78	55	78.625	0.60	0.13	
EVPTTAU84	58	84.625	0.65	0.14	

EVPTTA • Aluminum Top Trim for Double Inline Connector (for use with laminate end and middle panels)

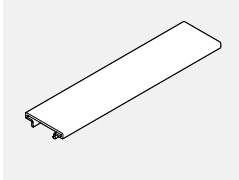

- Used for panels in middle of run of panels with Double Inline Connector.
- Aluminum Top Trim covers panel and one Double Inline Connector.
- Available in standard paint colours.
- Note: Trim can not span a Post Connector.

PRODUCT CODE	PRICE	SIZE/INCHES	WEIGHT LBS	VOL FT ³
EVPTTA25	18	25.125	0.19	0.04
EVPTTA31	23	31.125	0.24	0.05
EVPTTA37	26	37.125	0.28	0.06
EVPTTA43	29	43.125	0.33	0.07
EVPTTA49	34	49.125	0.37	0.08
EVPTTA55	37	55.125	0.42	0.09
EVPTTA61	45	61.125	0.46	0.10
EVPTTA67	47	67.125	0.51	0.11
EVPTTA73	48	73.125	0.56	0.12
EVPTTA79	55	79.125	0.60	0.13
EVPTTA85	58	83.125	0.65	0.14

EVPTTA • Aluminum Top Trim for Double Inline Connector (for use with laminate end and middle panels)

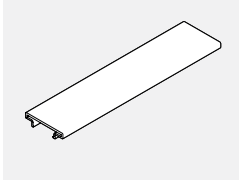

- Used for panels next to end of run trim in run of panels with Double Inline Connector.
- Available in standard paint colours.
- Note: Trim can not span a Post Connector.

PRODUCT CODE	PRICE	SIZE/INCHES	WEIGHT LBS	VOL FT ³
EVPTTA24	13	24	0.22	0.04
EVPTTA30	22	30	0.29	0.05
EVPTTA36	24	36	0.30	0.06
EVPTTA42	28	42	0.34	0.07
EVPTTA48	33	48	0.38	0.08
EVPTTA54	36	54	0.42	0.09
EVPTTA60	42	60	0.46	0.10
EVPTTA66	45	66	0.50	0.11
EVPTTA72	47	72	0.55	0.12
EVPTTA78	54	78	0.59	0.12
EVPTTA84	58	84	0.64	0.13

EVPGDCP • Gallery panel data post

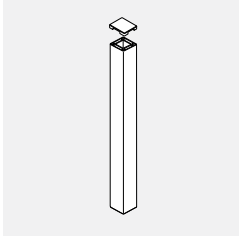

- One way post attaches to Gallery Panel at the end to bring power and/or data cables from ceiling to Evolve panels.
- Accommodates up to 25 CAT 5 cables with electric. Accommodates up to 45 CAT 5 cables without electric.
- Middle Gallery panel with bottom cut out for electrics must be ordered.
- Standard data post extension used above.
- Standard data post extension to be ordered separately.
- Choose standard paint finish.

PRODUCT CODE	PRICE	SIZE/H	INCHES W	WEIGHT LBS	VOL FT ³
EVPGDCP42	171	42	3		
EVPGDCP48	202	48	3		
EVPGDCP54	220	54	3		

EVMPMP-GI6W • Privacy Glass for 1" Laminate Panels

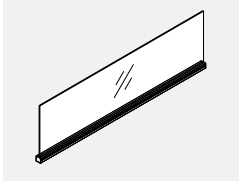

- Privacy glass integrated with aluminum trim.
- Attaches on top of 1" laminate panels to add privacy or divide space.
- Includes aluminum trim with end caps and glass tile.
- Aluminum trim has rail for accessories.
- Standard in clear (CLR), frosted (FRST) or writeable (WRW) glass.
- Glass and attachment hardware to ship separately.

PRODUCT CODE	PRICE			SIZE/INCHES			WEIGHT VOL	
	CL'	FRST	WRW	H	W	D	LBS	FT ³
EVMPMP24GI6W	195	244	-	6	24	1	2.39	0.25
EVMPMP30GI6W	213	268	-	6	30	1	2.99	0.32
EVMPMP36GI6W	228	283	-	6	36	1	3.58	0.37
EVMPMP42GI6W	244	304	-	6	42	1	4.18	0.43
EVMPMP48GI6W	254	317	-	6	48	1	4.78	0.50
EVMPMP24GI9W	195	244	-	9	24	1	3.58	0.25
EVMPMP30GI9W	213	268	-	9	30	1	4.48	0.32
EVMPMP36GI9W	228	283	-	9	36	1	5.37	0.37
EVMPMP42GI9W	244	304	-	9	42	1	6.26	0.43
EVMPMP48GI9W	254	317	-	9	48	1	7.16	0.50
EVMPMP24GIW	195	244	340	12	24	1	4.77	0.50
EVMPMP30GIW	213	268	347	12	30	1	5.97	0.63
EVMPMP36GIW	228	283	353	12	36	1	7.16	0.75
EVMPMP42GIW	244	304	389	12	42	1	8.35	0.87
EVMPMP48GIW	254	317	426	12	48	1	9.55	1.00

EVFPDW • Felt divider for 1" Laminate Panels

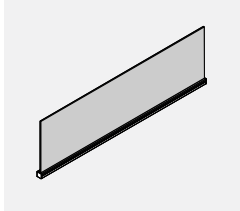

- Privacy Felt Divider integrated with aluminum top trim. Attaches on top of laminate panels to add privacy or divide space.
- Includes aluminum trim with channel and felt tile.
- Felt and attachment hardware to ship separately.
- 9 mm felt material is tackable and comes in 18 different colors. Please specify felt finish.
- Aluminum top trim available in standard paint finishes.

PRODUCT CODE	PRICE	SIZE/INCHES			WEIGHT VOL	
		H	W	D	LBS	FT ³
EVFPD0624W	70	6	24	1	1.42	0.26
EVFPD0630W	85	6	30	1	1.73	0.32
EVFPD0636W	99	6	36	1	2.03	0.37
EVFPD0642W	111	6	42	1	2.34	0.43
EVFPD0648W	165	6	48	1	2.64	0.50
EVFPD0654W	178	6	54	1	2.95	0.56
EVFPD0660W	193	6	60	1	3.25	0.63
EVFPD0666W	204	6	66	1	3.56	0.69
EVFPD0672W	231	6	72	1	3.86	0.76
EVFPD0924W	70	9	24	1	1.63	0.38
EVFPD0930W	85	9	30	1	1.99	0.47
EVFPD0936W	99	9	36	1	2.35	0.56
EVFPD0942W	111	9	42	1	2.70	0.65
EVFPD0948W	165	9	48	1	3.06	0.75
EVFPD0954W	178	9	54	1	3.42	0.84
EVFPD0960W	193	9	60	1	3.78	0.94
EVFPD0966W	204	9	66	1	4.13	1.04
EVFPD0972W	231	9	72	1	4.49	1.13
EVFPD1224W	70	12	24	1	1.84	0.50
EVFPD1230W	85	12	30	1	2.25	0.63
EVFPD1236W	99	12	36	1	2.66	0.75
EVFPD1242W	111	12	42	1	3.07	0.87
EVFPD1248W	165	12	48	1	3.48	1.00
EVFPD1254W	178	12	54	1	3.89	1.12
EVFPD1260W	193	12	60	1	4.30	1.25
EVFPD1266W	204	12	66	1	5.12	1.38
EVFPD1272W	231	12	72	1	5.53	1.51
EVFPD1824W	89	18	24	1	2.26	0.75
EVFPD1830W	105	18	30	1	2.77	0.94
EVFPD1836W	124	18	36	1	3.29	1.13
EVFPD1842W	139	18	42	1	3.80	1.31
EVFPD1848W	206	18	48	1	4.32	1.50
EVFPD1854W	224	18	54	1	4.83	1.69
EVFPD1860W	241	18	60	1	5.35	1.88
EVFPD1866W	254	18	66	1	6.68	2.06
EVFPD1872W	289	18	72	1	7.20	2.25

EVPDIC • Double Inline Panel Connector (for use with Laminate Middle Panels)

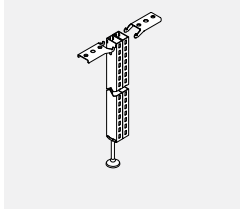

- Used to connect Laminate Middle Panel to panels of equal height in straight run.
- Aluminum Top Trim for Double Inline Connector must be used.
- Provides slotted support for worksurfaces and hang on storage compartments. Includes two slotted post with levelling glide and connection hardware.
- Connectors available without clots as special at no charge. Contact Customer Service.

PRODUCT CODE	PRICE	SIZE/	INCHES	WEIGHT VOL	
		H	W	LBS	FT ³
EVPDIC42	132	42	2	9.20	0.14
EVPDIC48	140	48	2	10.50	0.14

EVPDVTF • Double Connector Trim (for use with Laminate Middle Panels)

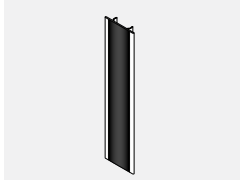

- Attaches to exposed side of double Inline Connector
- Must be ordered separately when Laminate Middle Panel is attached only to one side of Double Inline Connector.

PRODUCT CODE	PRICE	SIZE/	INCHES	WEIGHT VOL	
		H	W	LBS	FT ³
EVPDVTF42	13	42	2	0.52	0.07
EVPDVTF48	20	48	2	0.75	0.09

Technical Information for 9300 Series Pedestals

General Information:

9300 Series Pedestals feature center pull handles (models ending in "C") and full pull handles (models ending in "P"). Freestanding, mobile, and worksurface supporting options available. Quality steel construction. File drawers hold letter or A4 front to back and legal side to side configurations. Products are finished in a highly durable dry epoxy powder coating and drawer body interiors are finished with 100% recycled paint. Counterweights are included in freestanding and mobile pedestals to meet applicable ANSI/BIFMA X5.9.

Features:

- Cold rolled steel construction consisting of 16 ga front and back base with 22 ga case
- Reinforced welded construction
- Inset drawer fronts and flush base
- Double wall construction on all drawer fronts
- Full extension ball bearing slides on file drawers and ¾ extension on box drawers
- Rubber bumpers on slides for quietness
- Worksurface supporting option available (includes mounting holes at top of unit)
- 1 pencil tray and 1 drawer divider are included with each unit containing a box drawer
- Each file drawer includes a hanging file bar
- Levelers provide 1" height adjustment
- Counterweights included for freestanding and mobile pedestals
- Includes lock with 2 keys
- Lock is located at the top right of the case above the top drawer
- Keyed alike option available and can be keyed alike to other storage components

Sizes:

- 15" width
- 19", 23", 29" depths
- Interior drawer depths:
- 19" Deep pedestals
- 17 1/4" deep box drawers
- 16 1/16" deep file drawers
- 23" deep pedestals
- 20 3/16" deep box drawers
- 19 7/16" deep file drawers
- 29" deep pedestals
- 26 5/16" deep box drawers
- 26 1/16" deep file drawers

Drawer Heights:

Box drawer fronts are 6"H with 5" interior height
 File drawer fronts are 12"H with 10 9/16" interior height

Technical Information for Prime Series

General Information:

Prime premium filing and storage products pre-configured to suit your needs; featuring fixed front or receding doors with full pull handles and fully welded seamless tops to deliver strength and clean aesthetics. Premium quality steel construction. File drawers accommodate legal, letter or A4 sizes in back-to-front and side-to-side configurations. Products are finished in a highly durable dry epoxy powder coating and drawer body interiors are finished with 100% recycled paint.

Counterweights are recommended for use in all laterals, pedestals and freestanding files of all widths and heights to meet applicable ANSI/BIFMA X5.9. (Counterweights are offered as an option on all products where required to meet applicable ANSI/BIFMA standard)

Features

- Premium steel construction, 18-22 gauge steel components
- Full welded and reinforced case construction
- Interlock system allows only one drawer to open at a time for safety
- Most products feature full overlay fronts, with some exceptions such as units with receding doors where the front is inset in the case
- Double wall construction on all drawer and door fronts
- Full extension roller bearing glides on all drawers
- Anti-bounce-back safety feature prevents drawers from sliding open
- Receding doors slide into the cabinet and allow the shelf to be pulled out
- All pedestals are equipped with four levelling glides, providing 1.5" of height adjustment
- All other units equipped with four levelling glides providing 1" height adjustment and can be accessed from the interior of the cabinets for ease of adjustment
- On units with drawers and hinged doors, locks are located at the center of the case above the top opening
- Lock position on towers with wardrobes is below the handle when center pull is selected
- Each lock includes 2 keys; locks are standard with removable cores
- Key assignment is random or can be specified for specific key number for key alike applications

Overhead Storage:

- Overhead cabinets - 7 widths in 6" increments
- 14 5/8" high cases with interior clear height of 12"
- 13" deep units have interior clear dimension of 12.7"
- 16" deep units have interior clear dimension of 15.7"
- Open shelves - 7 widths in 6" increments
- Shelves are 12 1/2" deep with 7 1/2" high side gables

Pedestals:

- Freestanding and worksurface supporting options available
- Worksurface supporting includes mounting holes at top of unit
- 1 pencil tray and 1 drawer divider are included with each unit containing a box drawer
- File drawers hold legal, letter or A4 sizes in back-to-front and side-to-side configurations
- Each file drawer includes a hanging file bar and conversion rails
- Freestanding units BSPF can be specified with optional non-locking casters to convert to a mobile unit
- 15" width x 18", 22", 28" depths

Interior drawer depth is as follows:

- 15" deep drawers for 18" deep pedestals
- 19" deep drawers for 22" deep pedestals
- 25" deep drawers for 28" deep pedestals

File drawer capacity:

- 14 3/8" filing capacity for file drawers in 18" pedestal
- 18 3/8" filing capacity for file drawers in 22" pedestal
- 24 3/8" filing capacity for file drawers in 28" pedestal

Laterals:

- 18" depth with interior depth of 16"
- 30", 36", 42" widths
- Available in 2 to 6 drawer high (28"h – 77.6"h)

File Drawer Capacity:

- 30" wide units
 - Letter & legal side-to-side = 26 5/8"
 - Letter front-to-back = 30 1/2"
 - Legal front-to-back = 15 1/4" + 10" side space
- 36" wide units
 - Letter & legal side-to-side = 32 5/8"
 - Letter front-to-back = 30 1/2" + 6 1/2" side space
 - Legal front-to-back = 30 1/2"
- 42" wide units
 - Letter & legal side-to-side = 58 5/8"
 - Letter front-to-back = 45 3/4"
 - Legal front-to-back = 30 1/2" + 6 1/2" side space

Technical Information for Prime Series

Storage Cabinets:

- 18" depth
- 30", 36", 42" widths
- Available in 2 to 5 high configurations (28"h – 65.6"h)

Towers:

- Include coat rod and shelf to accommodate personal items
- The top of the storage compartment is perforated for ventilation
- Includes locks with 2 keys each
 - Closed storage comes with 3 locks – one of the drawers, one for the cupboard, and one for the wardrobe
 - Side open storage comes with 2 locks – one of the drawers and one for the wardrobe
- 24" depth
- 24" width
- 50", 54", and 66" nominal heights available to coordinate with Global's panel systems

STORAGE COMPONENTS - GUIDELINES FOR ORDERING PRODUCT

Codes

The price list uses a numbering system with meaningful alphanumeric characters to create a simple-to-understand product number. This makes specifying the product much easier and more accurate.

How to Specify

- Specify storage pedestal type and size by code, including depth.
- Specify metal color (eg. BLK for Black)
- Specify key random, key list provided, or key number (eg. 401)
- Specify worksurface supporting (1 = Yes, 2 = No)
- Specify counterweight if pedestal is not worksurface supporting (NN = No Counterweight)

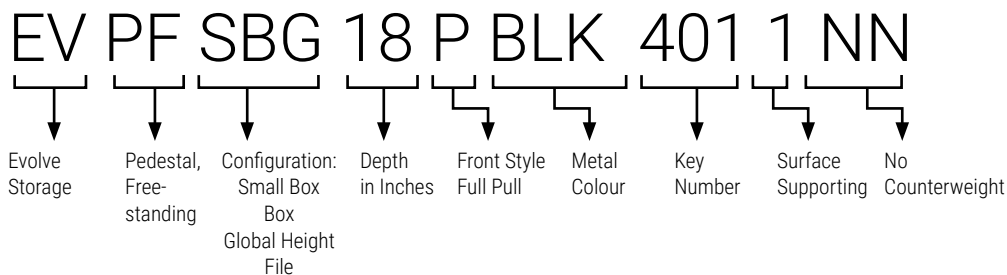

EVSLs • Low Profile Shelf

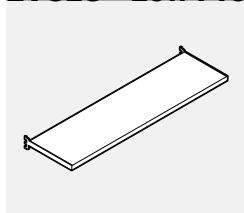

- Laminated Wood Shelf Panel Mounted
- Shelf thickness 1.125".
- Available in LP only.
- Includes attachment hardware.

PRODUCT CODE	PRICE	SIZE/ INCHES			WEIGHT VOL	
		H	W	D	LBS	FT ³
EVSLs0818	204	1.125	18	8.5	3.98	0.09
EVSLs0824	222	1.125	24	8.5	5.31	0.12
EVSLs0830	241	1.125	30	8.5	6.64	0.15
EVSLs0836	256	1.125	36	8.5	7.97	0.18
EVSLs0842	276	1.125	42	8.5	9.30	0.21
EVSLs0848	292	1.125	48	8.5	10.63	0.24

EKSS • Panel Mount Shelf

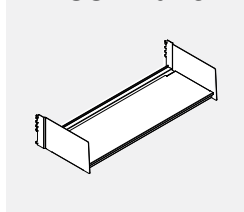

- 14" deep panel mounted storage shelf with backlip.
- Mounting brackets are included.

PRODUCT CODE	PRICE	SIZE/ INCHES			WEIGHT VOL	
		H	W	D	LBS	FT ³
EKSS24	133	7.45	23.44	14.73	12.8	1.5
EKSS30	141	7.45	29.44	14.73	14.8	1.9
EKSS36	155	7.45	35.44	14.73	16.8	2.3
EKSS42	161	7.45	41.44	14.73	18.8	2.6
EKSS48	172	7.45	47.44	14.73	20.8	3.0
EKSS54	179	7.45	53.44	14.73	22.8	3.4
EKSS60	184	7.45	59.44	14.73	24.8	3.8

EVLSF • Flush Front Overhead Cabinet

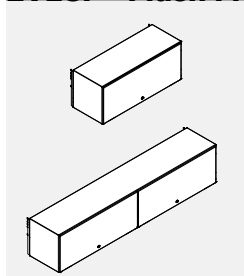

Cabinets 54" and 60" wide come with two doors

- Flush Front Overhead Cabinet is panel mounted lockable storage unit.
- The door retracts inside/within the overhead cabinet.
- Locks can be keyed alike to match other lockable storage components or keyed random to provide a dedicated lock.
- Available in 13" and 16" depths, 24" to 60" widths at 6" increments.
- Cabinets 54" and 60" wide come with two doors.
- Includes mounting hardware as specified, lock and keys.
- Lock secures into bottom shelf.
- Can be mounted at any height, however 66"h panels are recommended.
- Shipped assembled.

PRODUCT CODE	PRICE	SIZE/ INCHES			WEIGHT VOL	
		H	W	D	LBS	FT ³
EVLSF1324MN	540	14.62	23.87	13.5	39.30	2.7
EVLSF1330MN	558	14.62	29.87	13.5	44.3	3.4
EVLSF1336MN	614	14.62	35.87	13.5	49.3	4.1
EVLSF1342MN	672	14.62	41.87	13.5	54.3	4.8
EVLSF1348MN	731	14.62	47.87	13.5	59.3	5.5
EVLSF1354MN	788	14.62	53.87	13.5	64.3	6.2
EVLSF1360MN	844	14.62	59.87	13.5	69.3	6.8
EVLSF1624MN	893	14.62	23.87	16.5	38.6	3.4
EVLSF1630MN	916	14.62	29.87	16.5	43.9	4.2
EVLSF1636MN	960	14.62	35.87	16.5	49.2	5.0
EVLSF1642MN	1024	14.62	41.87	16.5	54.5	5.8
EVLSF1648MN	1089	14.62	47.87	16.5	59.8	6.7
EVLSF1654MN	1148	14.62	53.87	16.5	65.1	7.5
EVLSF1660MN	1200	14.62	59.87	16.5	70.4	8.4

EVADA-PM • Easy-Up Panel Mounted Overhead Storage Unit - AODA Compliant

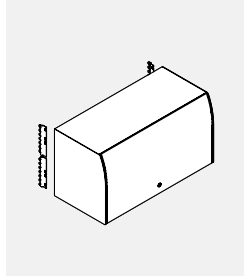

- Meets CSA B651 Barrier Free Design & AODA (Accessibility for Ontarians with Disabilities Act).
- 16" high units accept standard and A4 binders.
- All shelves are reinforced for proper weight distribution.
- Inside dimensions: 14.25" high x 13.4" deep.
- Unit includes attachment hardware, lock and mounting brackets. Back not included.
- Not recommended for use with wall rails.
- Unit can be converted to an Up-Mount Overhead Storage in the field by adding EVADA-KIT.
- Shipped partially assembled.

With opaque acrylic door. The mechanism lifts the door up and stores it out of the way, above the storage unit.

PRODUCT CODE	PRICE	SIZE/ INCHES			WEIGHT VOL	
		H	W	D	LBS	FT ³
EVADA30PM	815	16	30	14.2	27.00	5.30
EVADA36PM	880	16	36	14.2	32.00	6.30
EVADA42PM	942	16	42	14.2	37.00	7.30
EVADA48PM	1007	16	48	14.2	42.00	8.30
EVADA54PM	1069	16	54	14.2	47.00	9.30
EVADA60PM	1133	16	60	14.2	53.00	10.30

EVADAPMKIT • Panel Mount Conversion Kit

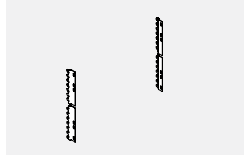

- Converts an existing Up-Mount Overhead Storage Unit EVADA-UM to a Panel Mounted Overhead Storage Unit EVADA-PM.
- Kit includes panel mounting brackets.

PRODUCT CODE	PRICE	SIZE/ INCHES			WEIGHT VOL	
		H	W	D	LBS	FT ³
EVADAPMKIT	39	16	0.5	2	2.00	0.01

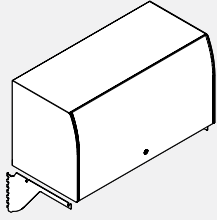
EVADA-UM • Easy-Up Up-Mount Overhead Storage Unit - AODA Compliant

- Meets CSA B651 Barrier Free Design & AODA (Accessibility for Ontarians with Disabilities Act).
- 16" high units accept standard and A4 binders.
- All shelves are reinforced for proper weight distribution.
- Inside dimensions: 14.25" high x 13.4" deep.
- Unit includes attachment hardware, lock, mounting cantilevers and has a finished back.
- Unit can be converted to an Panel Mounted Overhead Storage Unit in the field by adding EVADAPM-KIT.
- Shipped partially assembled.

PRODUCT CODE	PRICE	SIZE/ INCHES			WEIGHT VOL	
		H	W	D	LBS	FT ³
EVADA30UM	970	16	30	14.2	33.00	5.30
EVADA36UM	1016	16	36	14.2	40.00	6.30
EVADA42UM	1073	16	42	14.2	46.00	7.30
EVADA48UM	1132	16	48	14.2	53.00	8.30
EVADA54UM	1186	16	54	14.2	59.00	9.30
EVADA60UM	1255	16	60	14.2	66.00	10.30

Up-mounted storage can reduce furniture costs by reducing the height of all panels to 54". Complete 54" panel installations simplify cable routing at one level, below the top cap. Up-mounted cantilevers maintain accessibility and functionality of the panels' top lay-in channel below the top cap.

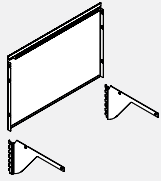
EVADA-KIT • Up-Mount Conversion Kit

- Converts an existing Panel Mounted Overhead Storage Unit EVADA-PM to an Up-Mounted Overhead Storage Unit EVADA-UM.
- When used on a 54" high panel, the top of the overhead can match the height of 66" high panels.
- Kit includes a back panel for the Overhead and Up-Mount Cantilevers.

PRODUCT CODE	PRICE	SIZE/ INCHES			WEIGHT VOL	
		H	W	D	LBS	FT ³
EVADA30KIT	195	16	30	2	8.00	0.60
EVADA36KIT	204	16	36	2	10.00	0.70
EVADA42KIT	218	16	42	2	11.00	0.80
EVADA48KIT	228	16	48	2	13.00	0.90
EVADA54KIT	240	16	54	2	14.00	1.00
EVADA60KIT	253	16	60	2	15.00	1.10

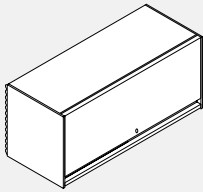
EVSOD • Double Wall Overhead Flipper Door Storage Unit

- 15" deep panel mounted overhead storage unit with metal sides, retracting flipper door.
- 15" deep units accept BASD12 binder plate dividers.
- All cabinets 54" and longer are reinforced for proper weight distribution.
- Inside dimensions are 12.5" high by 13.5" deep.
- Includes attachment hardware, lock and mounting brackets.
- Not recommended for use with wall rails.
- Shipped KD.

PRODUCT CODE	PRICE	SIZE/ INCHES			WEIGHT VOL	
		H	W	D	LBS	FT ³
EVSOD1330	493	15.4	30	14.7	53.00	2.33
EVSOD1336	545	15.4	36	14.7	54.00	2.33
EVSOD1342	601	15.4	42	14.7	56.00	2.33
EVSOD1348	655	15.4	48	14.7	58.00	3.33
EVSOD1354	710	15.4	54	14.7	60.00	3.33
EVSOD1360	763	15.4	60	14.7	62.00	3.33

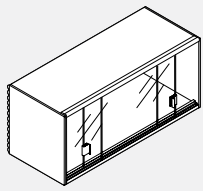
EVSODGD • Double Wall Overhead Glass Sliding Door Unit

- Overheads are combination of EVSOD Overheads without door with a specially designed door.
- Available in Tempered Frosted Glass option only. In standard Evolve paint finishes.
- Glass overheads available in standard widths of 30" - 60".
- Quality steel construction.
- Panel mount (mounting brackets included).
- Inside dimensions 13" high x 13" deep.
- Tracks for sliding door available in Tungsten only.
- Please use EVSOFD01 for Overhead Divider.

PRODUCT CODE	PRICE	SIZE/ INCHES			WEIGHT VOL	
		H	W	D	LBS	FT ³
EVSODGD1330	734	15.4	30	14.7	53.00	2.33
EVSODGD1336	765	15.4	36	14.7	54.00	2.33
EVSODGD1342	806	15.4	42	14.7	56.00	2.33
EVSODGD1348	861	15.4	48	14.7	58.00	3.33
EVSODGD1354	894	15.4	54	14.7	60.00	3.33
EVSODGD1360	922	15.4	60	14.7	62.00	3.33

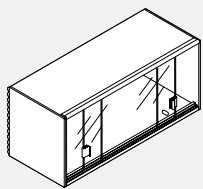
EVSODGDL • Double Wall Overhead Glass Sliding Door with Lock Unit

- Sliding Overheads are combination of EVSOD Overheads with specially designed door.
- Available in Tempered Frosted Glass option only. In standard Evolve paint finishes.
- Glass overheads available in standard widths of 30" - 60".
- Quality steel construction.
- Panel mount (mounting brackets included).
- Inside dimensions 13" high x 13" deep.
- Tracks for sliding door available in Tungsten only.
- Push in Lock, No Keys alike.
- Please use EVSOFD01 for Overhead Divider.

PRODUCT CODE	PRICE	SIZE/ INCHES			WEIGHT VOL	
		H	W	D	LBS	FT ³
EVSODGDL1330	835	15.4	30	14.7	53.00	2.33
EVSODGDL1336	866	15.4	36	14.7	54.00	2.33
EVSODGDL1342	909	15.4	42	14.7	56.00	2.33
EVSODGDL1348	960	15.4	48	14.7	58.00	2.33
EVSODGDL1354	993	15.4	54	14.7	60.00	3.33
EVSODGDL1360	1024	15.4	60	14.7	62.00	3.33

EVSODS • Double Wall Overhead with Shelf Flipper Door Storage Unit

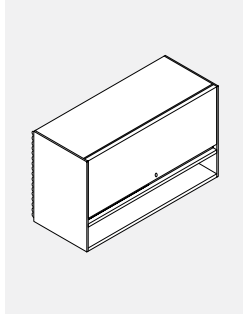

- Retracting flipper door unit on top of lower panel adds privacy without the expense of an over panel.
- 15" deep units accepts BAPD03 binder plate dividers.
- All cabinets 54" and longer are reinforced for proper weight distribution.
- Inside dimensions: 12" high x 14 3/4" deep.
- Includes attachment hardware, lock and mounting brackets.
- Not recommended for use with wall rails, must be used attached to panels by the cantilevers provided.
- Features a completely finished back.
- Shipped KD.
- Please use EVSOFD01 for Overhead Divider.

PRODUCT CODE	PRICE	SIZE/ INCHES			WEIGHT VOL	
		H	W	D	LBS	FT ³
EVSODS1330	565	22.4	30	14.7	63.00	2.33
EVSODS1336	627	22.4	36	14.7	64.00	2.33
EVSODS1342	691	22.4	42	14.7	66.00	2.33
EVSODS1348	755	22.4	48	14.7	68.00	3.33
EVSODS1354	818	22.4	54	14.7	70.00	3.33
EVSODS1360	878	22.4	60	14.7	72.00	3.33

EVSDAHL36 • Dual Access Overhead Left

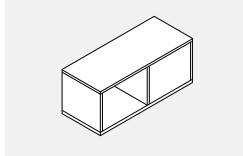

- Inside dimensions 13" high x 13" deep.
- Laminate Overhead.
- Available in standard Evolve laminate finishes.
- Top mount on panels.
- Dual Access Overhead Support Brackets to be ordered separately.

PRODUCT CODE	PRICE	SIZE/ INCHES			WEIGHT VOL	
		H	W	D	LBS	FT ³
EVSDAHL36	1007	15	36	14.12	46.97	4.40
EVSDAHL42	1085	15	42	14.12	52.84	5.13
EVSDAHL48	1130	15	48	14.12	58.90	5.87
EVSDAHL54	1210	15	54	14.12	64.97	6.61
EVSDAHL60	1256	15	60	14.12	71.03	7.35

EVSDAHR36 • Dual Access Overhead Right

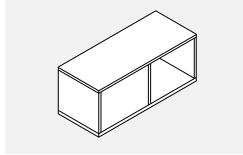

- Inside dimensions 13" high x 13" deep.
- Laminate Overhead.
- Available in standard Evolve laminate finishes.
- Top mount on panels.
- Dual Access Overhead Support Brackets to be ordered separately.

PRODUCT CODE	PRICE	SIZE/ INCHES			WEIGHT VOL	
		H	W	D	LBS	FT ³
EVSDAHR36	1007	15	36	14.12	46.97	4.40
EVSDAHR42	1085	15	42	14.12	52.84	5.13
EVSDAHR48	1130	15	48	14.12	58.90	5.87
EVSDAHR54	1210	15	54	14.12	64.97	6.61
EVSDAHR60	1256	15	60	14.12	71.03	7.35

EVSDAHLBKTE • End of run Bracket

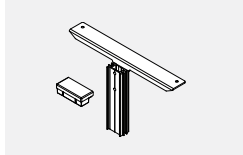

- Bracket supports dual access overhead on one side only.
- Includes one bracket, aluminum insert and end of run plastic cap.
- End of run plastic cap attaches to end of run trim.
- Bracket available in standard Evolve paint finishes.

PRODUCT CODE	PRICE	SIZE/ INCHES			WEIGHT VOL	
		H	W	D	LBS	FT ³
EVSDAHLBKTE	88	6.5	2	12	1	0.09

EVSDAHLBKTS • Inline Single Bracket



- Bracket supports dual access overhead on one side only.
- Includes one bracket, aluminum insert and inline plastic cap.
- Inline plastic cap and top trim align.
- Bracket available in standard Evolve paint finishes.
- Note: Single clamps must be used when inline single bracket is used.

PRODUCT CODE	PRICE	SIZE/ INCHES			WEIGHT VOL	
		H	W	D	LBS	FT ³
EVSDAHLBKTS	88	6.5	4	12	1.6	0.09

EVSDAHLBKTD • Double Bracket

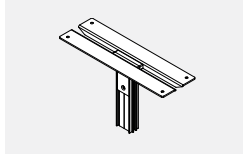

- Double Bracket supports sides of dual access overheads when overhead are side by side.
- Includes two brackets, aluminum insert and plastic caps.
- Plastic caps installed between bracket.
- Brackets available in standard Evolve paint finishes.
- Note: Single clamps must be used when double bracket is used.

PRODUCT CODE	PRICE	SIZE/ INCHES			WEIGHT VOL	
		H	W	D	LBS	FT ³
EVSDAHLBKTD	176	6.5	4	12	1.6	0.18

EVSSOHL • Top Mount KD Overhead with Sliding Glass Door Left

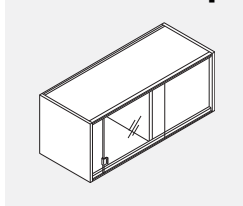

- Inside dimensions 13" high x 13" deep
- Laminate side walls and divider, available in standard laminate finishes
- Metal shelves and back wall, available in standard paint finishes
- Available in tempered frosted glass only
- Tracks for sliding glass available in Tungsten only
- Top mount on panels
- Ready for quick assembly on site
- Top Mount Overhead Support Brackets to be ordered separately.

PRODUCT CODE	PRICE	SIZE/ INCHES			WEIGHT VOL	
		H	W	D	LBS	FT ³
EVSSOHL30	1018	15	30	15	63.00	3.66
EVSSOHL36	1124	15	36	15	64.00	4.40
EVSSOHL42	1239	15	42	15	66.00	5.13
EVSSOHL48	1319	15	48	15	68.00	5.87
EVSSOHL54	1396	15	54	15	70.00	6.61
EVSSOHL60	1525	15	60	15	72.00	7.35

EVSSOHR • Top Mount KD Overhead with Sliding Glass Door Right

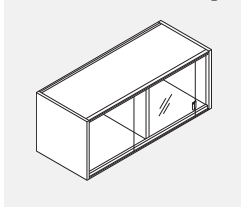

- Inside dimensions 13" high x 13" deep.
- Laminate side walls and divider, available in standard laminate finishes.
- Metal shelves and back wall, available in standard paint finishes.
- Available in tempered frosted glass only.
- Tracks for sliding glass available in Tungsten only.
- Top mount on panels.
- Ready for quick assembly on site .
- Top Mount Overhead Support Brackets to be ordered separately.

PRODUCT CODE	PRICE	SIZE/ H	INCHES W	D	WEIGHT LBS	VOL FT ³
EVSSOHR30	1018	15	30	15	63.00	3.66
EVSSOHR36	1124	15	36	15	64.00	4.40
EVSSOHR42	1239	15	42	15	66.00	5.13
EVSSOHR48	1319	15	48	15	68.00	5.87
EVSSOHR54	1396	15	54	15	70.00	6.61
EVSSOHR60	1525	15	60	15	72.00	7.35

EVSSOHBKTE • End of run Top Mount Overhead Bracket

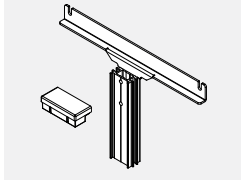

- Bracket supports Top Mount KD overhead on one side only.
- Includes one bracket , aluminum insert and end of run plastic cap.
- End of run plastic cap attaches to end of run trim.
- Bracket available in standard Evolve paint finishes.

PRODUCT CODE	PRICE	SIZE/ H	INCHES W	D	WEIGHT LBS	VOL FT ³
EVSSOHBKTE	88	6	2	12	1	0.07

EVSSOHBKTS • Inline Single Top Mount Overhead Bracket

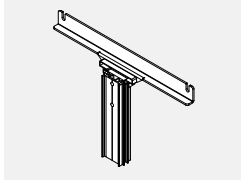

- Bracket supports Top Mount KD overhead on one side only.
- Includes one bracket , aluminum insert and inline plastic cap.
- Inline plastic cap and top trim align.
- Bracket available in standard Evolve paint finishes.
- **Note:** Single clamps must be used when inline single bracket is used.

PRODUCT CODE	PRICE	SIZE/ H	INCHES W	D	WEIGHT LBS	VOL FT ³
EVSSOHBKTS	88	15	36	12	1	0.07

EVSSOHBKTD • Double Top Mount Overhead Bracket

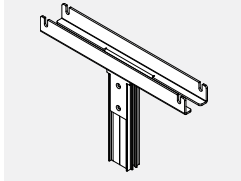

- Double Bracket supports sides of Top Mount KD overheads when overhead are side by side.
- Includes two brackets, aluminum insert and plastic caps.
- Plastic caps installed between brackets.
- Brackets available in standard Evolve paint finishes.
- **Note:** Single clamps must be used when double bracket is used.

PRODUCT CODE	PRICE	SIZE/ H	INCHES W	D	WEIGHT LBS	VOL FT ³
EVSSOHBKTD	88	15	36	12	1.6	0.09

EVSODOMB • Overhead Off Module Mount Conversion Kit

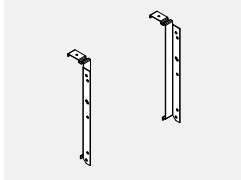

- Converts any existing EVSOD or EVADA overheads to off module installed.
- Allows to install overhead of different widths of Premium Panel.
- Attaches to top horizontal tube of Premium Fabric Panel.
- Brackets allow to install Double Wall Overhead or AODA overhead.
- Kit includes pair of brackets.
- Available in standard paint finishes.

PRODUCT CODE	PRICE	SIZE/ H	INCHES W	D	WEIGHT LBS	VOL FT ³
EVSODOMB	92	12.37	1	4.37	0.25	0.09

EVSHJB • "J" Bars for Double Wall Overhead

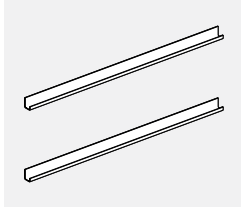

- Converts existing panel mounted double wall overhead EVSOD13, EVSODGD13, EVSODGDL13 to a wall mounted Double wall Overhead
- Available in standard Evolve paint finishes.
- **NOTE:** Care should b taken to fasten the "J" Bars only to wall studs with correct fasteners. Failure to do so may result in collapse of unit and subsequent possible personal injury.

PRODUCT CODE	PRICE	SIZE/ H	INCHES W	D	WEIGHT LBS	VOL FT ³
EVSHJB30	26	1.4	30	1		
EVSHJB36	32	1.4	36	1		
EVSHJB42	32	1.4	42	1		
EVSHJB48	35	1.4	48	1		
EVSHJB54	39	1.4	54	1		
EVSHJB60	43	1.4	60	1		

EV93FPxxBFP • 9300 Series Freestanding Box File Pedestal

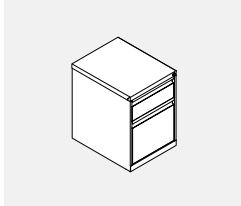

- One box and one file drawer pedestal.
- Freestanding, counterweight included.
- All drawers are locking.
- Box drawer includes pencil tray.

PRODUCT CODE	PRICE	SIZE/ H	INCHES W	D	WEIGHT LBS	VOL FT ³
EV93FP19BFP	559	21.31	15	19	50	5.1
EV93FP23BFP	566	21.31	15	23	55	6.0
EV93FP29BFP	678	21.31	15	29	64	7.5

EV93FPxxBBFP • 9300 Series Freestanding Box Box File Pedestal

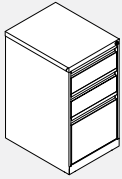

- Two box and one file drawer pedestal.
- Freestanding, counterweight included.
- All drawers are locking.
- Top box drawer includes pencil tray.

PRODUCT CODE	PRICE	SIZE/ INCHES			WEIGHT VOL	
		H	W	D	LBS	FT ³
EV93FP19BBFP	617	27.87	15	19	55	6.5
EV93FP23BBFP	628	27.87	15	23	68	7.7
EV93FP29BBFP	741	27.87	15	29	78	9.6

EV93FPxxFFP • 9300 Series Freestanding File File Pedestal

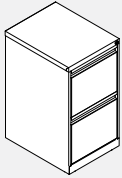

- Two file drawer pedestal.
- Freestanding, counterweight included.
- All drawers are locking.

PRODUCT CODE	PRICE	SIZE/ INCHES			WEIGHT VOL	
		H	W	D	LBS	FT ³
EV93FP19FFP	589	27.87	15	19	53	6.5
EV93FP23FFP	597	27.87	15	23	60	7.7
EV93FP29FFP	699	27.87	15	29	70	9.6

EV93WPxxBBFP • 9300 Series Worksurface Supporting Box Box File Pedestal

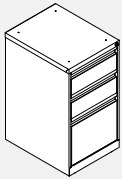

- Two box and one file drawer pedestal.
- Worksurface supporting, includes mounting holes in the top.
- All drawers are locking.
- Top box drawer includes pencil tray.
- To use as a worksurface supporting pedestal, please specify EVHPB6 separately.

PRODUCT CODE	PRICE	SIZE/ INCHES			WEIGHT VOL	
		H	W	D	LBS	FT ³
EV93WP19BBFP	613	27.87	15	19	55	6.5
EV93WP23BBFP	621	27.87	15	23	68	7.7
EV93WP29BBFP	711	27.87	15	29	78	9.6

EV93WPxxFFP • 9300 Series Worksurface Supporting File File Pedestal

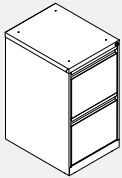

- Two file drawer pedestal.
- Worksurface supporting, includes mounting holes in the top.
- All drawers are locking.
- To use as a worksurface supporting pedestal, please specify EVHPB6 separately.

PRODUCT CODE	PRICE	SIZE/ INCHES			WEIGHT VOL	
		H	W	D	LBS	FT ³
EV93WP19FFP	582	27.87	15	19	53	6.5
EV93WP23FFP	587	27.87	15	23	60	7.7
EV93WP29FFP	700	27.87	15	29	70	9.6

EV93MPxxBFP • 9300 Series Mobile Box File Pedestal

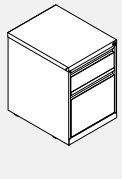

- One box and one file drawer mobile pedestal.
- Casters preinstalled, casters non-locking.
- Counterweight included.
- All drawers locking.
- Box drawer includes pencil tray.
- NOTE: Cannot be used as guest seating.

PRODUCT CODE	PRICE	SIZE/ INCHES			WEIGHT VOL	
		H	W	D	LBS	FT ³
EV93MP19BFP	659	21.87	15	19	66	5.2
EV93MP23BFP	681	21.87	15	23	72	6.2
EV93MP29BFP	730	21.87	15	29	92	7.6

EV93MPxxBBFP • 9300 Series Mobile Box Box File Pedestal

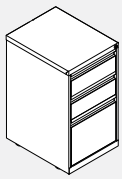

- Two box and one file drawer mobile pedestal.
- Casters preinstalled, casters non-locking.
- Counterweight included.
- All drawers locking.
- Top box drawer includes pencil tray.
- NOTE: Cannot be used as guest seating.

PRODUCT CODE	PRICE	SIZE/ INCHES			WEIGHT VOL	
		H	W	D	LBS	FT ³
EV93MP19BBFP	695	27.93	15	19	76	6.5
EV93MP23BBFP	702	27.93	15	23	85	7.7
EV93MP29BBFP	757	27.93	15	29	94	9.6

EV93MPxxFFP • 9300 Series Mobile File File Pedestal

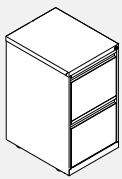

- Two file drawer pedestal.
- Casters preinstalled, casters non-locking.
- Counterweight included.
- All drawers locking.
- NOTE: Cannot be used as guest seating.

PRODUCT CODE	PRICE	SIZE/ INCHES			WEIGHT VOL	
		H	W	D	LBS	FT ³
EV93MP19FFP	654	27.93	15	19	73	6.5
EV93MP23FFP	681	27.93	15	23	81	7.7
EV93MP29FFP	748	27.93	15	29	90	9.6

EVPF0BFxxP • Prime Freestanding Box File Pedestal

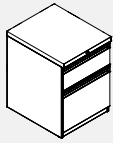

- One box and one file drawer pedestal.
- All drawers are locking.
- Box drawer includes pencil tray.
- For freestanding, to add counterweight (W2 option), add \$50 list.
- For mobile to add casters and counterweight (W1 option), add \$75 list. Adds 0.5" to height.
- NOTE: Cannot be used as guest seating.

PRODUCT CODE	PRICE	SIZE/ INCHES			WEIGHT VOL	
		H	W	D	LBS	FT ³
EVPF0BF18P	571	20.8	15	18	52.4	4.2
EVPF0BF22P	579	20.8	15	22	58.8	5.0
EVPF0BF28P	656	20.8	15	28	68.7	6.3

EVPF5BGxxP • Prime Box Box File Pedestal

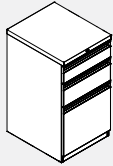

- Two box and one file drawer pedestal.
- All drawers are locking.
- Top box drawer includes pencil tray.
- For freestanding, to add counterweight (W2 option), add \$50 list.
- For mobile to add casters and counterweight (W1 option), add \$75 list. Adds 0.5" to height.
- Top box drawer 4.8" h; middle box drawer 6.4" h; bottom file drawer 13.6" h (interior 12.5" h).
- When worksurface supporting option selected, unit includes pre-drilled top holes for attaching.
- To use as a worksurface supporting pedestal, please specify EVHPB5 separately.

PRODUCT CODE	PRICE	SIZE/ INCHES			WEIGHT VOL	
		H	W	D	LBS	FT ³
EVPF5BG18P	637	28	15	18	67.5	5.5
EVPF5BG22P	644	28	15	22	75	6.6
EVPF5BG28P	710	28	15	28	86.8	8.3

EVPF0FGxxP • Prime File File Pedestal

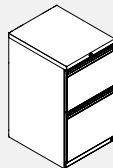

- Two file drawer pedestal.
- All drawers are locking.
- For freestanding, to add counterweight (W2 option), add \$50 list.
- For mobile to add casters and counterweight (W1 option), add \$75 list. Adds 0.5" to height.
- Top file drawer 11.2" h (interior 10.6" h); bottom file drawer 13.6" h (interior 12.5" h).
- When worksurface supporting option selected, unit includes pre-drilled top holes for attaching.
- To use as a worksurface supporting pedestal, please specify EVHPB5 separately.

PRODUCT CODE	PRICE	SIZE/ INCHES			WEIGHT VOL	
		H	W	D	LBS	FT ³
EVPF0FG18P	637	28	15	18	67.5	5.5
EVPF0FG22P	644	28	15	22	75	6.6
EVPF0FG28P	710	28	15	28	86.8	8.3

EVPW0BFxxP • Prime Mobile Box File Pedestal



- Mobile one box and one file drawer pedestal.
- All drawers are locking.
- 60mm casters.

PRODUCT CODE	PRICE	SIZE/ INCHES			WEIGHT VOL	
		H	W	D	LBS	FT ³
EVPW0BF18P	758	23.3	15	18	73.5	4.6
EVPW0BF22P	763	23.3	15	22	79.1	5.6
EVPW0BF28P	878	23.3	15	28	87.7	7.0

EVWSSFxxP • Prime Mobile Box Box File Pedestal

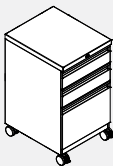

- Mobile two box and one file drawer pedestal.
- All drawers are locking.
- 60mm casters.

PRODUCT CODE	PRICE	SIZE/ INCHES			WEIGHT VOL	
		H	W	D	LBS	FT ³
EVWSSF18P	800	26.5	15	18	82.9	5.2
EVWSSF22P	807	26.5	15	22	89.3	6.3
EVWSSF28P	928	26.5	15	28	99.2	7.9

EVSTC • Pedestal/Lateral Seat Cushion

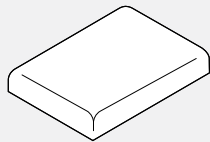

PRODUCT CODE	YRDS	SIZE/ INCHES			WEIGHT VOL	
		H	W	D	LBS	FT ³
EVSTCL1830	1.00	2	18	30	6.00	0.55
EVSTCL1836	1.25	2	18	36	6.00	0.65
EVSTCP1518	0.75	2	15	18	5.00	0.41
EVSTCP1522	1.00	2	15	22	5.25	0.45
EVSTCP1528	1.00	2	15	28	5.50	0.55

• C.O.M. Fabrics are priced as Grade 3.

PRODUCT CODE	PRICE																			
	GR1	GR2	GR3	GR4	GR5	GR6	GR7	GR8	GR9	GR10	GR11	GR12	GR13	GR14	GR15	GR16	GR17	GR18	GR19	GR20
EVSTCL1830	281	318	345	383	437	488	536	585	636	691	760	860	958	1057	1279	1496	1720	1938	2156	2399
EVSTCL1836	333	380	417	461	527	590	653	712	778	844	932	1057	1179	1304	1581	1852	2130	2402	2677	2981
EVSTCP1518	196	226	245	272	314	353	389	422	463	503	557	633	703	779	944	1109	1274	1439	1604	1785
EVSTCP1522	206	233	256	283	323	361	399	435	472	513	565	640	715	789	955	1119	1285	1451	1613	1794
EVSTCP1528	259	296	326	360	414	466	518	562	613	668	737	839	936	1034	1256	1473	1696	1916	2134	2377

EVFELT03BC - Felt Shelf Liner for Cube Pedestals

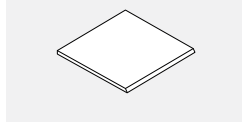

- Felt shelf liner can be added to any closed back shelf.
- Front edge is cut at 45 degree.

PRODUCT CODE	PRICE	SIZE/ H	INCHES W	INCHES D	WEIGHT LBS	VOL FT ³
EVFTFELT03BC	22	12	12	0.38	0.1	0.03

EVSSP12BBFM • Cube Mobile Pedestal, Two Open Boxes, One File Box and Accessory Tray

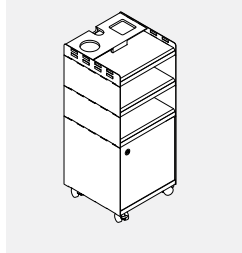

- Mobile pedestal with two open boxes in the middle, one file box at the bottom and a top accessory tray.
- File box interior dimensions: 11 7/8" h x 11 13/16" w x 10 7/16" d.
- Includes four locking casters, PET felt accessory tray, chrome wire divider and optional lock
- File door lock, if specified is located on the top right corner for the right pedestal and top left corner for the left pedestal.
- Bottom, middle and top shelves, front door and back are made of 3/4" low pressure laminate.
- Sides are made of powder coated metal.
- Ships knocked-down.

PRODUCT CODE	PRICE	SIZE/ H	INCHES W	INCHES D	WEIGHT LBS	VOL FT ³
Without Lock						
EVSSP12BBFMR	568	28	12	12	35	2.33
EVSSP12BBFML	568	28	12	12	35	2.33
With Lock						
EVSSP12BBFMKR	582	28	12	12	35	2.33
EVSSP12BBFMKL	582	28	12	12	35	2.33

EVSSP12BFMR • Cube Mobile Pedestal, One Open Box, One File Box and Accessory Tray

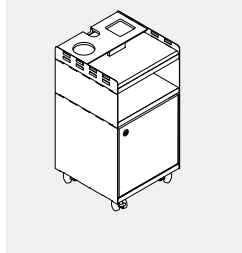

- Mobile pedestal with one open box in the middle, one file box at the bottom and a top accessory tray.
- File box interior dimensions: 11 7/8" h x 11 13/16" w x 10 7/16" d.
- Includes four locking casters, PET felt accessory tray, chrome wire divider and optional lock
- File door lock, if specified is located on the top right corner for the right pedestal and top left corner for the left pedestal.
- Bottom, middle and top shelves, front door and back are made of 3/4" low pressure laminate.
- Sides are made of powder coated metal.
- Ships knocked-down.

PRODUCT CODE	PRICE	SIZE/ H	INCHES W	INCHES D	WEIGHT LBS	VOL FT ³
Without Lock						
EVSSP12BFMR	447	22	12	12	28	1.83
EVSSP12BFML	447	22	12	12	28	1.83
With Lock						
EVSSP12BFMKR	461	22	12	12	28	1.83
EVSSP12BFMKL	461	22	12	12	28	1.83

EVSSP12SFM • Cube Mobile Pedestal, One Closed Storage Box, One File Box and Accessory Tray

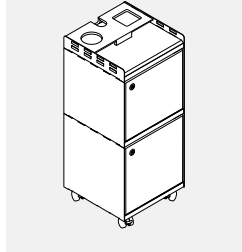

- Mobile pedestal with one closed storage box at the top, one file box at the bottom and a top accessory tray.
- File box interior dimensions: 11 7/8" h x 11 13/16" w x 10 7/16" d.
- Closed storage box interior dimensions: 10 1/2" h x 11 13/16" w x 10 7/16" d.
- Includes four locking casters, PET felt accessory tray, chrome wire divider and optional lock
- Door locks, if specified are located on the top right corner for the right pedestal and top left corner for the left pedestal of each box.
- Bottom, middle and top shelves, front door and back are made of 3/4" low pressure laminate.
- Sides are made of powder coated metal.
- Ships knocked-down.

PRODUCT CODE	PRICE	SIZE/ H	INCHES W	INCHES D	WEIGHT LBS	VOL FT ³
Without Lock						
EVSSP12SFMR	568	28	12	12	35	2.33
EVSSP12SFML	568	28	12	12	35	2.33
With Lock						
EVSSP12SFMKR	582	28	12	12	35	2.33
EVSSP12SFMKL	582	28	12	12	35	2.33

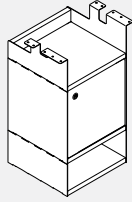
EVSSPH12BFB • Cube Hanging Pedestal, One File Box and Two Open Boxes

- Hanging pedestal with one file box in the middle and two open boxes, one at the top and one at the bottom.
- Attaches to the underside of a worksurface with supplied screws.
- File box interior dimensions: 11 7/8" h x 11 13/16" w x 10 7/16" d.
- Includes chrome wire divider and optional lock.
- Metal wire divider is chrome and sits 3 7/16" from either side and is interchangeable.
- File door lock, if specified is located on the top right corner for the right pedestal and top left corner for the left pedestal.
- Bottom, middle and top shelves, front door and back are made of 3/4" low pressure laminate.
- Sides are made of powder coated metal.
- Ships knocked-down.

PRODUCT CODE	PRICE	SIZE/ INCHES			WEIGHT VOL	
		H	W	D	LBS	FT ³
Without Lock						
EVSSPH12BFBR	431	24	12	12	26	2.33
EVSSPH12BFBL	431	24	12	12	26	2.33
With Lock						
EVSSPH12BFBKR	444	24	12	12	26	2.33
EVSSPH12BFBKL	444	24	12	12	26	2.33

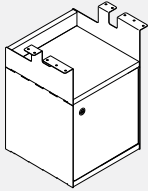
EVSSPH12BF • Cube Hanging Pedestal, One File Box

- Hanging pedestal with one file box at the bottom and one open box at the top.
- Attaches to the underside of a worksurface with supplied screws.
- File box interior dimensions: 11 7/8" h x 11 13/16" w x 10 7/16" d.
- Includes chrome wire divider and optional lock.
- Metal wire divider is chrome and sits 3 7/16" from either side and is interchangeable.
- File door lock, if specified is located on the top right corner for the right pedestal and top left corner for the left pedestal.
- Bottom, middle and top shelves, front door and back are made of 3/4" low pressure laminate.
- Sides are made of powder coated metal.
- Ships knocked-down.

PRODUCT CODE	PRICE	SIZE/ INCHES			WEIGHT VOL	
		H	W	D	LBS	FT ³
Without Lock						
EVSSPH12BFBR	324	18.5	12	12	20	1.83
EVSSPH12BFBL	324	18.5	12	12	20	1.83
With Lock						
EVSSPH12BFKR	337	18.5	12	12	20	1.83
EVSSPH12BFKL	337	18.5	12	12	20	1.83

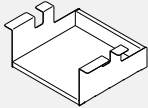
EVSSPH12B • Cube Hanging Pedestal Box

- Hanging pedestal open box.
- Attaches to the underside of a worksurface with supplied screws to create an open box.
- Bottom, middle and top shelves, front door and back are made of 3/4" low pressure laminate.
- Sides are made of powder coated metal.
- Ships knocked-down.

PRODUCT CODE	PRICE	SIZE/ INCHES			WEIGHT VOL	
		H	W	D	LBS	FT ³
EVSSPH12B	132	6	12	12	6	0.96

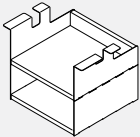
EVSSPH12BB • Cube Hanging Pedestal, Two Open Boxes

- Hanging pedestal with two open boxes.
- Attaches to the underside of a worksurface with supplied screws.
- Bottom, middle and top shelves, front door and back are made of 3/4" low pressure laminate.
- Sides are made of powder coated metal.
- Ships knocked-down.

PRODUCT CODE	PRICE	SIZE/ INCHES			WEIGHT VOL	
		H	W	D	LBS	FT ³
EVSSPH12BB	244	11.5	12	12	12	1.42

EVT • Lateral File Tops

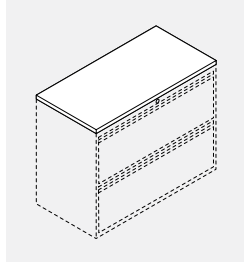

- Made of 1" or 1/16" thick particle board with laminate finish and edged in 3.0 mm edge banding.

PRODUCT CODE	PRICE LP	HP	SIZE/ INCHES			WEIGHT VOL	
			H	W	D	LBS	FT ³
EVT1830	147	207	1.0625	30	18	18.00	0.70
EVT1836	172	232	1.0625	36	18	22.00	0.82
EVT1842	201	309	1.0625	42	18	26.00	0.92
EVT1860	278	472	1.0625	60	18	37.00	1.27
EVT1872	330	534	1.0625	72	18	44.00	1.50
EVT1884	450	607	1.0625	84	18	52.00	1.85
EVT1890	487	662	1.0625	90	18	56.00	1.85
EVT18108	606	828	1.0625	108	18	67.00	2.20

EVLP50BF18xxP • Prime Box File Lateral

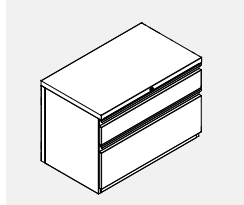

- One and a half height lateral filing cabinet.
- Fixed front drawers, top box drawer front 4.8" bottom file drawer front 13.6" (interior 12.5").
- Locking.
- Side to side hanging bars included.
- To add counterweight (W2 option), add \$410 list.

PRODUCT CODE	PRICE	SIZE/INCHES			WEIGHT LBS	VOL FT ³
		H	W	D		
EVLP50BF1830P	1268	20.98	30	18.06	119.96	8.0
EVLP50BF1836P	1320	20.98	36	18.06	129.86	9.5
EVLP50BF1842P	1364	20.98	42	18.06	165.45	11.1

EVLF20G18xxP • Prime 2 High Lateral File

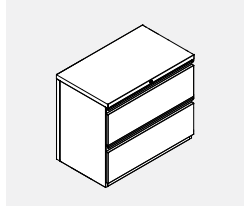

- Two high lateral filing cabinet.
- Fixed front file drawers, top drawer front 11.2" (interior 10.6") bottom drawer front 13.6" (interior 12.5").
- Locking.
- Side to side hanging bars included.
- To add counterweight (W2 option), add \$200 list.

PRODUCT CODE	PRICE	SIZE/INCHES			WEIGHT LBS	VOL FT ³
		H	W	D		
EVLF20G1830P	1268	28	30	18	98.7	10.5
EVLF20G1836P	1327	28	36	18	114.4	12.5
EVLF20G1842P	1399	28	42	18	129.4	14.5

EVLF30G18xxP • Prime 3 High Lateral File

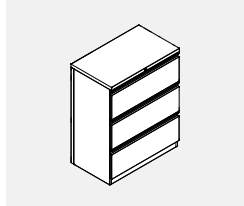

- Three high lateral filing cabinet.
- Fixed front file drawers, top & middle drawer front 11.2" (interior 10.6") bottom drawer front 13.6" (interior 12.5").
- Locking.
- Side to side hanging bars included.
- Will not line up with 42" high panels.
- To add counterweight (W2 option), add \$200 list.

PRODUCT CODE	PRICE	SIZE/INCHES			WEIGHT LBS	VOL FT ³
		H	W	D		
EVLF30G1830P	1662	39.2	30	18	127.9	14.5
EVLF30G1836P	1749	39.2	36	18	147.6	17.2
EVLF30G1842P	1849	39.2	42	18	167.5	20.0

EVLF40H18xxP • Prime 4 High RFFF Lateral File

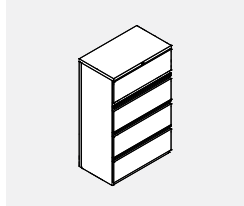

- Four high receding top door and remaining fixed front lateral filing cabinet.
- Top opening receding door + roll out shelf 14.4" front, accepts binder height; fixed front drawers second and third drawers 11.2" (interior 10.6") bottom drawer front 13.6" (interior 12.5").
- Locking.
- Side to side hanging bars included.
- To add counterweight (W2 option), add \$200 list.

PRODUCT CODE	PRICE	SIZE/INCHES			WEIGHT LBS	VOL FT ³
		H	W	D		
EVLF40H1830P	2112	53.6	30	18	171.9	19.6
EVLF40H1836P	2226	53.6	36	18	198.2	23.3
EVLF40H1842P	2352	53.6	42	18	225.3	27.0

EVLF50P18xxP • Prime 5 High RFFF Lateral File

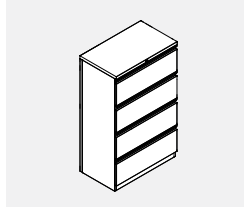

- Five high receding top door and remaining fixed front lateral filing cabinet.
- 13.6" (interior 12.5").
- Locking.
- Side to side hanging bars included.
- Top opening receding door + Roll out shelf 14.4" front, accepts binder height; fixed front drawers below - second and third 11.2" (interior 10.6") bottom drawer front
- To add counterweight (W2 option), add \$200 list.

PRODUCT CODE	PRICE	SIZE/INCHES			WEIGHT LBS	VOL FT ³
		H	W	D		
EVLF50P1830P	2751	65.6	30	18	208.9	23.9
EVLF50P1836P	2896	65.6	36	18	239.9	28.4
EVLF50P1842P	3061	65.6	42	18	272.7	32.9

EVSC21G18xxP • Prime 2 High Storage Cabinet

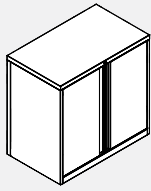

- Two high storage cabinet.
- One adjustable shelf + fixed bottom shelf.
- Locking.

PRODUCT CODE	PRICE	SIZE/INCHES			WEIGHT LBS	VOL FT ³
		H	W	D		
EVSC21G1830P	1040	28	30	18	75.08	10.5
EVSC21G1836P	1161	28	36	18	86.48	12.5
EVSC21G1842P	1262	28	42	18	95.78	14.5

EVSC31G18xxP • Prime 3 High Storage Cabinet

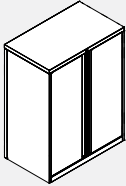

- Three high storage cabinet.
- Two adjustable shelves + fixed bottom shelf.
- Will not line up to 42" high panels.
- Locking.

PRODUCT CODE	PRICE	SIZE/INCHES			WEIGHT LBS	VOL FT ³
		H	W	D		
EVSC31G1830P	1297	39.2	30	18	96.69	14.5
EVSC31G1836P	1459	39.2	36	18	111.59	17.2
EVSC31G1842P	1612	39.2	42	18	124.49	20.0

EVSC41H18xxP • Prime 4 High Storage Cabinet

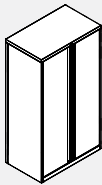

- Four high storage cabinet.
- Three adjustable shelves + fixed bottom shelf.
- Locking.

PRODUCT CODE	PRICE	SIZE/INCHES			WEIGHT LBS	VOL FT ³
		H	W	D		
EVSC41H1830P	1551	53.6	30	18	120.17	19.6
EVSC41H1836P	1734	53.6	36	18	138.27	23.3
EVSC41H1842P	1920	53.6	42	18	154.37	27.0

EVSC51C18xxP • Prime 5 High Storage Cabinet

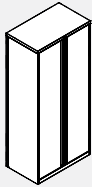

- Five high storage cabinet.
- Four adjustable shelves + fixed bottom shelf.
- Locking.

PRODUCT CODE	PRICE	SIZE/INCHES			WEIGHT LBS	VOL FT ³
		H	W	D		
EVSC51C1830P	1751	65.6	30	18	138.5	23.9
EVSC51C1836P	1961	65.6	36	18	160.4	28.4
EVSC51C1842P	2176	65.6	42	18	180.4	32.9

EVSLFxx24BCPL • Prime Tower, Left Wardrobe, Half Height Door, Box Box File Drawers

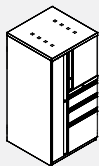

"4G" Tower Shown

- Left wardrobe tower with half height door and box box file drawers.
- Wardrobe section includes top shelf and coat bar.
- Hinged door compartment of 50"h and 54"h includes one adjustable shelf; 66"h includes two adjustable open shelves.
- Wardrobe section includes top perforations for ventilation.
- Three locks included - wardrobe door, hinged door shelving compartment and drawers.
- To add counterweight (W2 option), add \$105 list.

PRODUCT CODE	PRICE	SIZE/INCHES			WEIGHT LBS	VOL FT ³
		H	W	D		
EVSLF4G24BCPL	2822	49.6	24	24	176.71	19.23
EVSLF4H24BCPL	2836	53.6	24	24	181.63	19.83
EVSLF5024BCPL	2968	65.6	24	24	204.52	25.25

EVSLFxx24BCPR • Prime Tower, Right Wardrobe, Half Height Door, Box Box File Drawers

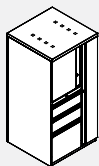

"4G" Tower Shown

- Right wardrobe tower with half height door and box box file drawers.
- Wardrobe section includes top shelf and coat bar.
- Hinged door compartment of 50"h and 54"h includes one adjustable shelf; 66"h includes two adjustable open shelves.
- Wardrobe section includes top perforations for ventilation.
- Three locks included - wardrobe door, hinged door shelving compartment and drawers.
- To add counterweight (W2 option), add \$105 list.

PRODUCT CODE	PRICE	SIZE/INCHES			WEIGHT LBS	VOL FT ³
		H	W	D		
EVSLF4G24BCPR	2822	49.6	24	24	176.71	19.23
EVSLF4H24BCPR	2836	53.6	24	24	181.63	19.83
EVSLF5024BCPR	2968	65.6	24	24	204.52	25.25

EVSLFxx24FCPL • Prime Tower, Left Wardrobe, Half Height Door, File File Drawers

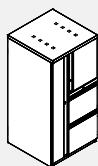

*4G' Tower Shown

- Left wardrobe tower with half height door and file file drawers.
- Wardrobe section includes top shelf and coat bar.
- Hinged door compartment of 50" h and 54" h includes one adjustable shelf; 66" h includes two adjustable open shelves.
- Wardrobe section includes top perforations for ventilation.
- Three locks included - wardrobe door, hinged door shelving compartment and drawers.
- To add counterweight (W2 option), add \$105 list.

PRODUCT CODE	PRICE	SIZE/INCHES			WEIGHT LBS	VOL FT ³
		H	W	D		
EVSLF4G24FCPL	2822	49.6	24	24	181.05	19.23
EVSLF4H24FCPL	2836	53.6	24	24	186.43	19.83
EVSLF5024FCPL	2968	65.6	24	24	231.53	25.25

EVSLFxx24FCPR • Prime Tower, Right Wardrobe, Half Height Door, File File Drawers

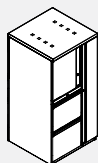

*4G' Tower Shown

- Right wardrobe tower with half height door and file file drawers.
- Wardrobe section includes top shelf and coat bar.
- Hinged door compartment of 50" h and 54" h includes one adjustable shelf; 66" h includes two adjustable open shelves.
- Wardrobe section includes top perforations for ventilation.
- Three locks included - wardrobe door, hinged door shelving compartment and drawers.
- To add counterweight (W2 option), add \$105 list.

PRODUCT CODE	PRICE	SIZE/INCHES			WEIGHT LBS	VOL FT ³
		H	W	D		
EVSLF4G24FCPR	2822	49.6	24	24	181.05	19.23
EVSLF4H24FCPR	2836	53.6	24	24	186.43	19.83
EVSLF5024FCPR	2968	65.6	24	24	231.53	25.25

EVSLSxx2424BOPL • Prime Tower, Left Wardrobe, Side Open Shelf, Box Box File Drawers

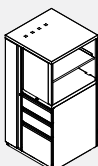

*4G' Tower Shown

- Left wardrobe tower with side open shelving and box box file drawers.
- Wardrobe section includes top shelf and coat bar.
- 50" h and 54" h include open side shelf with one adjustable shelf; 66" h includes open side shelf with two adjustable shelves.
- Wardrobe section includes top perforations for ventilation.
- Two locks included - wardrobe door and drawers.
- To add counterweight (W2 option), add \$105 list.

PRODUCT CODE	PRICE	SIZE/INCHES			WEIGHT LBS	VOL FT ³
		H	W	D		
EVSLS4G2424BOPL	3117	49.6	24	24	186.18	19.23
EVSLS4H2424BOPL	3135	53.6	24	24	186.91	19.83
EVSLS502424BOPL	3131	65.6	24	24	236.34	25.25

EVSLSxx2424BOPR • Prime Tower, Right Wardrobe, Side Open Shelf, Box Box File Drawers

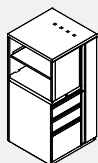

*4G' Tower Shown

- Right wardrobe tower with side open shelving and box box file drawers.
- Wardrobe section includes top shelf and coat bar.
- 50" h and 54" h include open side shelf with one adjustable shelf; 66" h includes open side shelf with two adjustable shelves.
- Wardrobe section includes top perforations for ventilation.
- Two locks included - wardrobe door and drawers.
- To add counterweight (W2 option), add \$105 list.

PRODUCT CODE	PRICE	SIZE/INCHES			WEIGHT LBS	VOL FT ³
		H	W	D		
EVSLS4G2424BOPR	3117	49.6	24	24	186.18	19.23
EVSLS4H2424BOPR	3135	53.6	24	24	186.91	19.83
EVSLS502424BOPR	3131	65.6	24	24	236.34	25.25

EVSLSxx2424FOPL • Prime Tower, Left Wardrobe, Side Open Shelf, File File Drawers

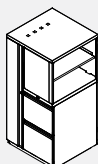

*4G' Tower Shown

- Left wardrobe tower with side open shelving and file file drawers.
- Wardrobe section includes top shelf and coat bar.
- 50" h and 54" h include open side shelf with one adjustable shelf; 66" h includes open side shelf with two adjustable shelves.
- Wardrobe section includes top perforations for ventilation.
- Two locks included - wardrobe door and drawers.
- To add counterweight (W2 option), add \$105 list.

PRODUCT CODE	PRICE	SIZE/INCHES			WEIGHT LBS	VOL FT ³
		H	W	D		
EVSLS4G2424FOPL	3117	49.6	24	24	179.54	19.23
EVSLS4H2424FOPL	3135	53.6	24	24	180.26	19.83
EVSLS502424FOPL	3131	65.6	24	24	232.55	25.25

EVSLSxx2424FOPR • Prime Tower, Right Wardrobe, Side Open Shelf, File File Drawers

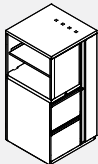

*4G' Tower Shown

- Right wardrobe tower with side open shelving and file file drawers.
- Wardrobe section includes top shelf and coat bar.
- 50" h and 54" h include open side shelf with one adjustable shelf; 66" h includes open side shelf with two adjustable shelves.
- Wardrobe section includes top perforations for ventilation.
- Two locks included - wardrobe door and drawers.
- To add counterweight (W2 option), add \$105 list.

PRODUCT CODE	PRICE	SIZE/INCHES			WEIGHT LBS	VOL FT ³
		H	W	D		
EVSLS4G2424FOPR	3117	49.6	24	24	179.54	19.23
EVSLS4H2424FOPR	3135	53.6	24	24	180.26	19.83
EVSLS502424FOPR	3131	65.6	24	24	232.55	25.25

EVWC51C18xxP • Prime Wardrobe

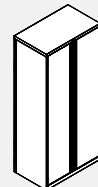

- Wardrobe cabinet.
- 30" W includes full width shelf and side to side coat rod.
- 36" and 42" W are split with shelving on left side, wardrobe on the other.

PRODUCT CODE	PRICE	SIZE/INCHES			WEIGHT LBS	VOL FT ³
		H	W	D		
EVWC51C1830P	1789	65.6	30	18	125.26	23.85
EVWC51C1836P	1998	65.6	36	18	164.97	28.40
EVWC51C1842P	2198	65.6	42	18	180.59	32.94

EVCC31G18xxP • Prime Three High Combination Cabinet

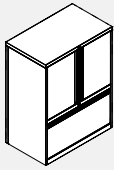

- Multi stor cabinet including hinged door upper section with one adjustable shelf; one fixed front file drawers below.
- Will not line up to 42" high panels.
- Locking.
- To add counterweight (W2 option), add \$200 list.

PRODUCT CODE	PRICE	SIZE/INCHES			WEIGHT LBS	VOL FT ³
		H	W	D		
EVCC31G1830P	2227	39.2	30	18	117.3	14.5
EVCC31G1836P	2426	39.2	36	18	135.5	17.2
EVCC31G1842P	2635	39.2	42	18	152.5	20.0

EVCC41G18xxP • Prime Four High Combination Cabinet

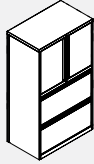

- Multi stor cabinet including hinged door upper section with one adjustable shelf; two fixed front file drawers below, lines up to 50" high panels.
- Locking.
- To add counterweight (W2 option), add \$200 list.

PRODUCT CODE	PRICE	SIZE/INCHES			WEIGHT LBS	VOL FT ³
		H	W	D		
EVCC41G1830P	2665	49.6	30	18	149.96	18.2
EVCC41G1836P	2853	49.6	36	18	172.96	21.6
EVCC41G1842P	3072	49.6	42	18	195.36	25.1

EVCC41H18xxP • Prime Four High Combination Cabinet

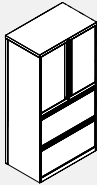

- Multi stor cabinet including hinged door upper section with one adjustable shelf; two fixed front file drawers below, lines up to 54" high panels.
- Locking.
- To add counterweight (W2 option), add \$200 list.

PRODUCT CODE	PRICE	SIZE/INCHES			WEIGHT LBS	VOL FT ³
		H	W	D		
EVCC41H1830P	2796	53.6	30	18	154.54	19.6
EVCC41H1836P	2992	53.6	36	18	178.54	23.3
EVCC41H1842P	3225	53.6	42	18	202.04	27.0

EVCC31C18xxP • Prime Five High Combination Cabinet



- Multi stor cabinet including hinged door upper section with one adjustable shelf; three fixed front file drawers below.
- Locking.
- To add counterweight (W2 option), add \$200 list.

PRODUCT CODE	PRICE	SIZE/INCHES			WEIGHT LBS	VOL FT ³
		H	W	D		
EVCC51C1830P	3083	65.6	30	18	188.5	23.9
EVCC51C1836P	3344	65.6	36	18	216.9	28.4
EVCC51C1842P	3581	65.6	42	18	245.5	32.9

EVLFA0718 • Prime Front to Back File Bars

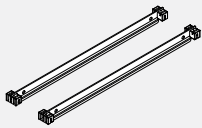

- Package of two, grey finish.

PRODUCT CODE	PRICE	SIZE/INCHES			WEIGHT LBS	VOL FT ³
		H	W	D		
EVLFA0718	28	1	17.3	1	1	0.04

EVLFS • Prime Hanging File Bars

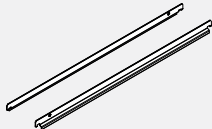

- Package of two, grey finish.

PRODUCT CODE	PRICE	SIZE/INCHES			WEIGHT LBS	VOL FT ³
		H	W	D		
EVLFA01	48	1.3	27.5	0.5	2	0.03
EVLFA02	48	1.3	33.5	0.5	2.4	0.04
EVLFA03	48	1.3	39.5	0.5	2.8	0.05

EVLFA1018 • Prime Plate Dividers

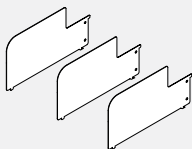

- Package of three, grey finish.

PRODUCT CODE	PRICE	SIZE/INCHES			WEIGHT LBS	VOL FT ³
		H	W	D		
EVLFA1018	61	7.25	13.5	0.2	4	0.07

EVLFA2418 • Prime Half Height Plate Dividers

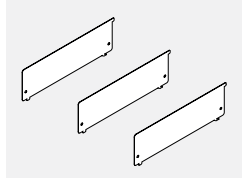

- Package of three, grey finish.

PRODUCT CODE	PRICE	SIZE/INCHES			WEIGHT LBS	VOL FT ³
		H	W	D		
EVLFA2418	45	3.95	13.5	0.2	2.2	0.04

EVLFA2018 • Prime EDP Adapters

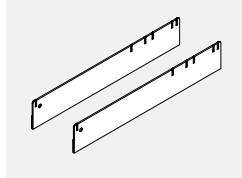

PRODUCT CODE	PRICE	SIZE/INCHES			WEIGHT LBS	VOL FT ³
		H	W	D		
EVLFA2018	51	2.6	16.5	0.15	2.5	0.02

EVK • Keys and Replacement Lock Core

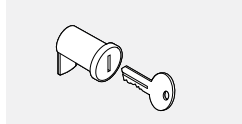

- Set of Extra Keys.
- Replacement Lock and Key.

PRODUCT CODE	PRICE	SIZE/INCHES			WEIGHT LBS	VOL FT ³
		H	W	D		
EVKY -EXTRA KEY	14	1.75	0.75	0.2	0.2	0.01
EVKC -LOCK & KEY	41	2	1	0.5	0.4	0.01

EVSA • Prime Extra Cabinet Shelves

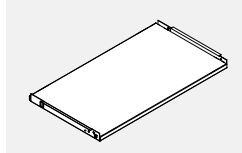

- Shelf, non-slotted.

PRODUCT CODE	PRICE	SIZE/INCHES			WEIGHT LBS	VOL FT ³
		H	W	D		
Shelf, non-slotted.						
EVSA11830	141	0.8	28.4	16	7.2	0.4
EVSA11836	147	0.8	34.4	16	8.4	0.5
EVSA11842	155	0.8	40.4	16	9.5	0.6

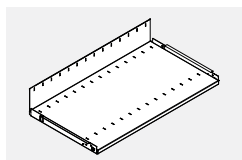

- Shelf, slotted.

PRODUCT CODE	PRICE	SIZE/INCHES			WEIGHT LBS	VOL FT ³
		H	W	D		
Shelf, slotted.						
EVSA21830	154	5.25	28.4	16	8.2	1.8
EVSA21836	160	5.25	34.4	16	9.6	2.2
EVSA21842	176	5.25	40.4	16	10.8	2.6

EVHPB6 - Worksurface Supporting 9300 Pedestal Bracket

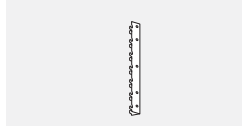

- Attaches to back edge of a pedestal and connects pedestal to panel connector.

PRODUCT CODE	PRICE	SIZE/H	INCHES		WEIGHT LBS	VOL FT ³
			W	D		
EVHPB6	28	13.5	1	1	0.5	0.5

EVHPB5 - Worksurface Supporting Pedestal Bracket and Filler For Prime

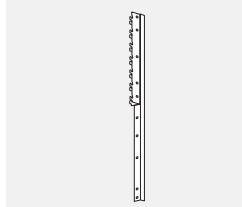

- Attaches to back edge of a pedestal and connects pedestal to panel connector.

PRODUCT CODE	PRICE	SIZE/H	INCHES		WEIGHT LBS	VOL FT ³
			W	D		
EVHPB5	28	28	1	2	0.5	0.5

EVSCRGD-P • Double Wall Cabinet

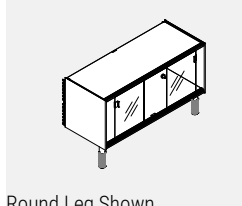

Round Leg Shown

- Unit shown with "R" round leg, for "S" square leg, please replace the "R" in the code with an "S" eg. EVSxC"R"to EVSxC"S".
- Panel Supported (Brackets Included)
- Wood top not included
- Available in standard paint finishes.
- Tracks for sliding door available in Tungsten only.
- Available in tempered frosted glass option only.

PRODUCT CODE	PRICE	SIZE/H	INCHES		WEIGHT LBS	VOL FT ³
			W	D		
EVSCRGD1330P	769	21	30	14.7	53.00	5.36
EVSCRGD1336P	811	21	36	14.7	54.00	6.43
EVSCRGD1342P	870	21	42	14.7	56.00	7.50
EVSCRGD1348P	927	21	48	14.7	58.00	8.58
EVSCRGD1354P	983	21	54	14.7	60.00	9.65
EVSCRGD1360P	1027	21	60	14.7	62.00	10.72

EVSCRGD-F • Free Standing Double Wall Cabinet

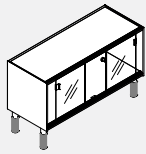

Round Leg Shown

- Unit shown with "R" round leg, for "S" square leg, please replace the "R" in the code with an "S" eg. EVSxC"R" to EVSxC"S".
- Free Standing with Back Wall
- Wood top not included
- Available in standard paint finishes.
- Tracks for sliding door available in Tungsten only.
- Available in tempered frosted glass option only.

PRODUCT CODE	PRICE	SIZE/ INCHES			WEIGHT VOL	
		H	W	D	LBS	FT ³
EVSCRGD1330F	893	21	30	14.7	53.00	5.36
EVSCRGD1336F	939	21	36	14.7	54.00	6.43
EVSCRGD1342F	1005	21	42	14.7	56.00	7.50
EVSCRGD1348F	1067	21	48	14.7	58.00	8.58
EVSCRGD1354F	1133	21	54	14.7	60.00	9.65
EVSCRGD1360F	1181	21	60	14.7	62.00	10.72

EVSDCRGD • Back to Back Double Wall Cabinet

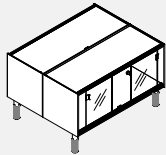

Round Leg Shown

- Unit shown with "R" round leg, for "S" square leg, please replace the "R" in the code with an "S" eg. EVSxC"R" to EVSxC"S".
- Back to Back Free Standing (back wall included)
- Wood top not included
- Available in standard paint finishes.
- Tracks for sliding door available in Tungsten only.
- Available in tempered frosted glass option only.

PRODUCT CODE	PRICE	SIZE/ INCHES			WEIGHT VOL	
		H	W	D	LBS	FT ³
EVSDCRGD1330	1565	21	30	29.4	106.00	10.72
EVSDCRGD1336	1653	21	36	29.4	108.00	12.86
EVSDCRGD1342	1775	21	42	29.4	112.00	15.01
EVSDCRGD1348	1861	21	48	29.4	116.00	17.15
EVSDCRGD1354	2019	21	54	29.4	120.00	19.29
EVSDCRGD1360	2110	21	60	29.4	124.00	21.44

EVSCRGD-P • Panel Supported Wall Cabinet

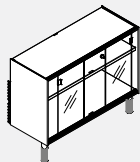

Round Leg Shown

- Unit shown with "R" round leg, for "S" square leg, please replace the "R" in the code with an "S" eg. EVSxC"R" to EVSxC"S".
- Panel supported (brackets included)
- Wood top not included
- Available in standard paint finishes.
- Tracks for sliding door available in Tungsten only.
- Available in tempered frosted glass option only.

PRODUCT CODE	PRICE	SIZE/ INCHES			WEIGHT VOL	
		H	W	D	LBS	FT ³
EVSCRGD2230P	1014	28	30	14.7	63.00	7.15
EVSCRGD2236P	1065	28	36	14.7	64.00	8.58
EVSCRGD2242P	1130	28	42	14.7	66.00	10.00
EVSCRGD2248P	1188	28	48	14.7	68.00	11.43
EVSCRGD2254P	1258	28	54	14.7	70.00	12.86
EVSCRGD2260P	1313	28	60	14.7	72.00	14.29

EVSCRGD-F • Free Standing Double wall Cabinet

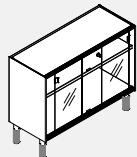

Round Leg Shown

- Unit shown with "R" round leg, for "S" square leg, please replace the "R" in the code with an "S" eg. EVSxC"R" to EVSxC"S".
- Panel supported (brackets included)
- Wood top not included
- Available in standard paint finishes.
- Tracks for sliding door available in Tungsten only.
- Available in tempered frosted glass option only.

PRODUCT CODE	PRICE	SIZE/ INCHES			WEIGHT VOL	
		H	W	D	LBS	FT ³
EVSCRGD2230F	1139	28	30	14.7	63.00	7.15
EVSCRGD2236F	1188	28	36	14.7	64.00	8.58
EVSCRGD2242F	1272	28	42	14.7	66.00	10.00
EVSCRGD2248F	1341	28	48	14.7	68.00	11.43
EVSCRGD2254F	1416	28	54	14.7	70.00	12.86
EVSCRGD2260F	1473	28	60	14.7	72.00	14.29

EVSDCRGD • Back to Back Double wall Cabinet

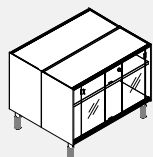

- Unit shown with "R" round leg, for "S" square leg, please replace the "R" in the code with an "S" eg. EVSxC"R" to EVSxC"S".
- Back to Back Free Standing (Back wall included)
- Wood top not included
- Available in standard paint finishes.
- Tracks for sliding door available in Tungsten only.
- Available in tempered frosted glass option only.

PRODUCT CODE	PRICE	SIZE/ INCHES			WEIGHT VOL	
		H	W	D	LBS	FT ³
EVSDCRGD2230	2055	28	30	29.4	126.00	14.29
EVSDCRGD2236	2153	28	36	29.4	128.00	17.15
EVSDCRGD2242	2300	28	42	29.4	132.00	20.01
EVSDCRGD2248	2433	28	48	29.4	136.00	22.87
EVSDCRGD2254	2584	28	54	29.4	140.00	25.73
EVSDCRGD2260	2677	28	60	29.4	144.00	28.58

EVSCRND-P • Double Wall Cabinet

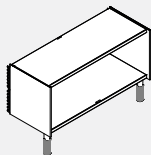

- Unit shown with "R" round leg, for "S" square leg, please replace the "R" in the code with an "S" eg. EVSxC"R" to EVSxC"S".
- Panel supported (brackets included)
- Wood top not included
- Available in standard paint finishes.

PRODUCT CODE	PRICE	SIZE/ INCHES			WEIGHT VOL	
		H	W	D	LBS	FT ³
EVSCRND1330P	576	21	30	14.7	51.00	5.36
EVSCRND1336P	597	21	36	14.7	52.00	6.43
EVSCRND1342P	614	21	42	14.7	54.00	7.50
EVSCRND1348P	646	21	48	14.7	56.00	8.58
EVSCRND1354P	664	21	54	14.7	58.00	9.65
EVSCRND1360P	681	21	60	14.7	60.00	10.72

EVSCRND-F • Free Standing Double Wall Cabinet

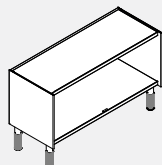

- Unit shown with "R" round leg, for "S" square leg, please replace the "R" in the code with an "S" eg. EVSxC"R" to EVSxC"S".
- Wood top not included, includes back wall.
- Available in standard paint finishes.

PRODUCT CODE	PRICE	SIZE/ INCHES			WEIGHT VOL	
		H	W	D	LBS	FT ³
EVSCRND1330F	700	21	30	14.7	51.00	5.36
EVSCRND1336F	726	21	36	14.7	52.00	6.43
EVSCRND1342F	747	21	42	14.7	54.00	7.50
EVSCRND1348F	788	21	48	14.7	56.00	8.58
EVSCRND1354F	811	21	54	14.7	58.00	9.65
EVSCRND1360F	837	21	60	14.7	60.00	10.72

EVT • Double Wall Cabinet Top

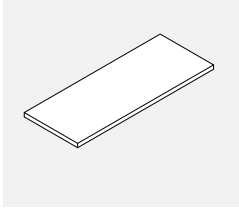

- Laminate top for double wall cabinet.

PRODUCT CODE	PRICE		SIZE/	INCHES		WEIGHT VOL	
	LP	HP	W	D	LBS	FT ³	
EVT1430	106	141	30	14.5	11.33	0.25	
EVT1436	120	163	36	14.5	13.59	0.30	
EVT1442	136	186	42	14.5	15.86	0.35	
EVT1448	155	205	48	14.5	18.13	0.40	
EVT1454	167	220	54	14.5	20.39	0.45	
EVT1460	188	251	60	14.5	22.66	0.50	

EVT • Back to Back Double Wall Cabinet Top

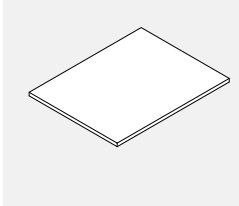

- Laminate top for double wall cabinet.

PRODUCT CODE	PRICE		SIZE/	INCHES		WEIGHT VOL	
	LP	HP	W	D	LBS	FT ³	
EVT2930	198	217	30	29.4	22.97	0.51	
EVT2936	234	252	36	29.4	27.56	0.61	
EVT2942	331	355	42	29.4	32.16	0.71	
EVT2948	350	377	48	29.4	36.75	0.82	
EVT2954	383	409	54	29.4	41.34	0.92	
EVT2960	408	439	60	29.4	45.94	1.02	

EVWSRL01 • Worksurface round Support Leg

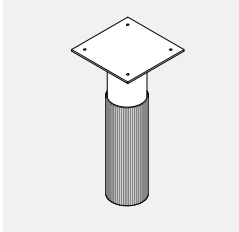

- Provides supports when worksurface overhangs 21”h Double Wall Storage or 1.5H 1200 Series Cabinet Storage must have File Top.
- Must be used to support the worksurface in conjunction with panel mounted hardware.
- Contains a levelling glide and PVC sleeve.
- 1.5 diameter round tube.
- Available in standard paint finishes.
- Available in BLK (Black) only

PRODUCT CODE	PRICE	SIZE/	INCHES		WEIGHT VOL	
		H	W	D	LBS	FT ³
EVWSRL01	45	4.5	3	3	1.00	0.03

EVWSSL01 • Worksurface Square Support Leg

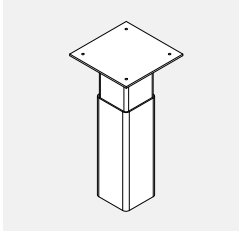

- Provides supports when worksurface overhangs 21”h Double Wall Storage or 1.5H 1200 Series Cabinet Storage must have File Top.
- Must be used to support the worksurface in conjunction with panel mounted hardware.
- Contains a levelling glide and PVC sleeve.
- 1.5” x 1.5” square tube.
- Available in standard paint finishes.
- Available in BLK (Black) only

PRODUCT CODE	PRICE	SIZE/	INCHES		WEIGHT VOL	
		H	W	D	LBS	FT ³
EVWSSL01	45	4.5	3	3	1.00	0.03

EVECC • Vertical Wire Channel

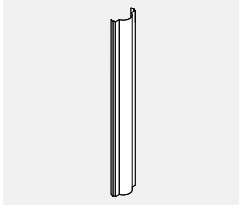

- **PVC extrusion attaches to panel vertical to provide enclosure for a power or light cord.**
- Available in 16” and 32” lengths, six per package.
- Can be cut to required lengths on site.
- Panel frame finish

PRODUCT CODE	PRICE	SIZE/
		H
Straight Run		
EVECC121	29	21
EVECC136	36	36
Corner		
EVECC221	29	21
EVECC236	36	36

EVALB • Load Bar

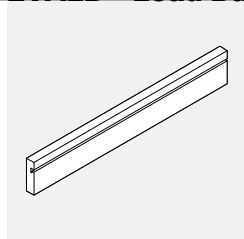

- Enables accessory items to be hung from a panel or wall.
- Includes end caps and mounting brackets.

PRODUCT CODE	PRICE	SIZE/ INCHES		
		H	W	D
EVALB24	129	2.25	24	1
EVALB30	142	2.25	30	1
EVALB36	156	2.25	36	1
EVALB42	182	2.25	42	1
EVALB48	207	2.25	48	1
EVALB54	227	2.25	54	1
EVALB60	240	2.25	60	1

EVALB2 • Ganging Load Bar - Top

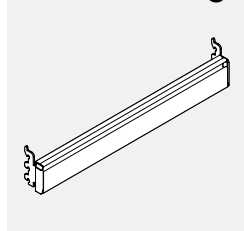

- Enables accessory items to be hung from a panel or wall
- Includes end caps and mounting brackets.
- Can connect to EVALB2-2 and/or EVALB2-3 Load Bars to create a multi-level bar or "Slat Wall" or can be used on its own.

PRODUCT CODE	PRICE	SIZE/ INCHES		
		H	W	D
EVALB224	101	2.25	24	1
EVALB230	109	2.25	30	1
EVALB236	113	2.25	36	1
EVALB242	120	2.25	42	1
EVALB248	127	2.25	48	1
EVALB254	130	2.25	54	1
EVALB260	135	2.25	60	1

EVALB22 • Ganging Load Bar - Middle

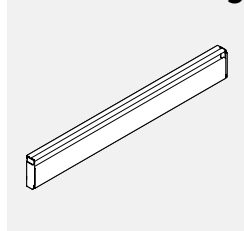

- Enables accessory items to be hung from a panel or wall.
- Includes end caps and is to be used in conjunction with the Ganging Load Bar-Top (EVALB) mounting brackets NOT included.
- Can connect to EVALB2 and/or EVALB2-3 Load Bars to create a multi-level bar or "Slat Wall".
- Wall". Multiples of EVALB2-2 can be joined one below the other to create the "Slat Wall".
- Must be used on conjunction with an EVALB2 or a combination of EVALB2 and EVALB2-3.

PRODUCT CODE	PRICE	SIZE/ INCHES		
		H	W	D
EVALB2-224	67	2.25	24	1
EVALB2-230	75	2.25	30	1
EVALB2-236	79	2.25	36	1
EVALB2-242	87	2.25	42	1
EVALB2-248	91	2.25	48	1
EVALB2-254	99	2.25	54	1
EVALB2-260	103	2.25	60	1

EVALB23 • Ganging Load Bar - Bottom

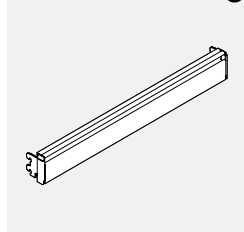

- Enables accessory items to be hung from a panel or wall.
- Includes end caps and mounting brackets.
- Must connect to EVALB2 and/or EVALB2-3 Load Bars to create a multi-level bar or "Slat Wall".
- Must be used on conjunction with an EVALB2 or a combination of EVALB2 and EVALB2-2.

PRODUCT CODE	PRICE	SIZE/ INCHES		
		H	W	D
EVALB2-324	99	2.25	24	1
EVALB2-330	103	2.25	30	1
EVALB2-336	109	2.25	36	1
EVALB2-342	113	2.25	42	1
EVALB2-348	122	2.25	48	1
EVALB2-354	128	2.25	54	1
EVALB2-360	132	2.25	60	1

EVACH01 • Coat Hook

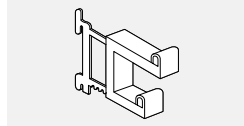

- Panel mounted coat hook.**
- Panel frame finish
 - Not available in Fog (FOG)
 - Not available in Metal Paper Accessory Colours

PRODUCT CODE	PRICE	SIZE/ INCHES			WEIGHT VOL	
		H	W	D	LBS	FT ³
EVACH01	67	3	0.75	3	0.2	0.001

EVACH02 • Panel Coat Hook

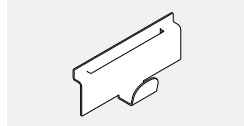

- Panel mounted coat hook.**
- Installed at panel top in groove between module and top trim.
 - Available in standard and premium paint colors.
 - Priced per six piece package.

PRODUCT CODE	PRICE	SIZE/ INCHES			WEIGHT VOL	
		H	W	D	LBS	FT ³
EVACH02	89	1	2.5	0.625	0.8	0.01

CPN01 • Name Plate

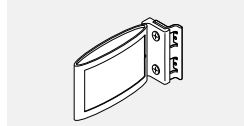

- Name plate can be set either as a single-sided (parallel to panel surface) or double-sided (perpendicular to panel surface - for aisle applications, displaying name on both sides).
- Injection molded frame and die-cast base with black rubberized finish. Steel bracket and fasteners included.
- Includes two slide-in name cards.

PRODUCT CODE	PRICE	SIZE/ INCHES			WEIGHT VOL	
		H	W	D	LBS	FT ³
CPNP01	67	3.3	5.3	1.25	0.3	0.013

EVANP02 • Name Plate

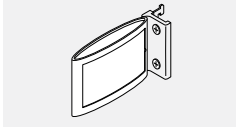

- Name plate attaches to 1" increment slots of Evolve. It can be set either as a single-sided (parallel to panel surface) or double-sided (perpendicular to panel surface - for aisle applications, displaying name on both sides).
- Injection molded frame and die-cast base with **black rubberized finish**. Steel bracket and fasteners included
- Includes two slide-in name cards.

PRODUCT CODE	PRICE	SIZE/ INCHES			WEIGHT VOL	
		H	W	D	LBS	FT ³
EVANP02	86	3.3	5.3	1.25	0.3	0.013

EVATB • Fabric Tackboard

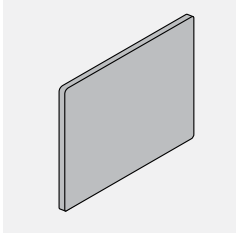

- To provide a tackable surface for notes and memos in a work area. Panel mounted.**
- Includes set of 4 mounting brackets.
 - Class "A" Fire Rated Fabric.

PRODUCT CODE	PRICE		SIZE/ INCHES			WEIGHT VOL	
	GR1	GR2	H	W	D	LBS	FT ³
EVATB1730	253	266	17	30	0.25	3	0.416
EVATB1736	289	303	17	36	0.25	4	0.500
EVATB1742	330	343	17	42	0.25	4	0.583
EVATB1748	367	385	17	48	0.25	5	0.666
EVATB1754	407	428	17	54	0.25	5	0.750
EVATB1760	447	469	17	60	0.25	6	0.833
EVATB2130	253	262	21	30	0.25	3	0.416
EVATB2136	289	298	21	36	0.25	4	0.500
EVATB2142	330	341	21	42	0.25	4	0.583
EVATB2148	367	381	21	48	0.25	5	0.666
EVATB2154	407	426	21	54	0.25	5	0.750
EVATB2160	447	468	21	60	0.25	6	0.833
EVATB2430	253	263	24	30	0.25	3	0.416
EVATB2436	289	303	24	36	0.25	4	0.500
EVATB2442	342	367	24	42	0.25	4	0.583
EVATB2448	383	407	24	48	0.25	5	0.666
EVATB2454	428	494	24	52	0.25	5	0.750
EVATB2460	447	468	24	60	0.25	6	0.833

EVHTVM • TV Mount

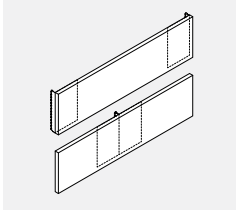

- Laminate panel with two mounting brackets to be installed on Evolve panels.
- TV Mount can be installed on panel of equal width or both brackets can be attached in middle for installing on single connector.
- TV frame not included, TV frame to be ordered separately.
- Note: TV frame must be securely attach to laminate panel. Care should be taken to attach TV frame using correct fasteners.
- Failure to do so may result in collapse of unit and subsequent possible injury.

PRODUCT CODE	PRICE	SIZE/ INCHES			WEIGHT VOL	
		H	W	D	LBS	FT ³
EVHTVM24	168	11	24	1.0	14.00	0.46
EVHTVM30	184	11	30	1.0	17.00	0.52
EVHTVM36	198	11	36	1.0	19.00	0.60
EVHTVM42	213	11	42	1.0	22.00	0.68

EVPMP42 • Privacy Mesh Divider

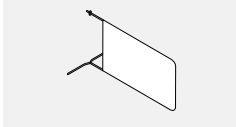

- **Divider attaches to connector.**
- Available with Visionknit mesh only.
- Current available (others available upon request)
 - GRY Grey
 - BOR Burnt Orange
- Wire frame upholstered in Visionknit mesh.
- Visionknit mesh easy to replace.
- Wire frame painted in standard paint finishes.
- For each mesh colour ordered, minimum order must be 25 pcs.
- If mesh colour ordered is less than 25 pcs, there will be upcharge fee \$132 net per each mesh colour.
- Note: Divider can be only used with 42"h. segmented panels (24" bottom and 12" top module configuration only).
- Divider attaches to top 12" module.

PRODUCT CODE	PRICE	SIZE/ INCHES			WEIGHT VOL	
		H	W	D	LBS	FT ³
EVPMP42	152	12	24	0.250	5	0.416

EVAWB • Write Board

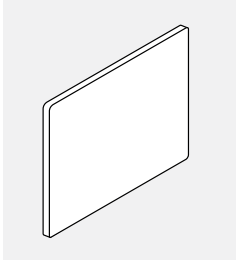

- **To provide a writing surface in a work area. Panel mounted.**
- Includes set of 4 mounting brackets.
- Black trim only

PRODUCT CODE	PRICE	SIZE/ INCHES			WEIGHT VOL	
		H	W	D	LBS	FT ³
EVAWB2130	284	21	30	3	0.416	
EVAWB2136	323	21	36	4	0.500	
EVAWB2142	361	21	42	4	0.588	
EVAWB2148	420	21	48	5	0.833	
EVAWB2430	284	24	30	3	0.416	
EVAWB2436	323	24	36	4	0.500	
EVAWB2442	361	24	42	4	0.588	
EVAWB2448	420	24	48	5	0.833	

EVAMT • Marker Tray

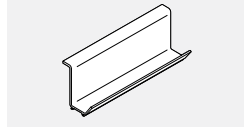

- Provides a tray for storage of markers, erasers. etc.
- Attaches to the bottom of the White Marker Board.

PRODUCT CODE	PRICE	SIZE/ INCHES	WEIGHT LBS	VOL FT ³
EVAMT12	15	12	0.5	0.01

EVSOFD • Overhead Divider

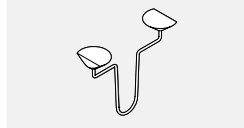

- Attaches to EVSOF12 or EVSOF13 Overhead top shelf inside the overhead.
- Provides a rigid division for books and binders.
- Sold per pair.

PRODUCT CODE	PRICE	SIZE/ H	INCHES W	WEIGHT LBS	VOL FT ³
EVSOFD01	56	10	0.1875	0.8	0.02

EVAOMFD • Dry Erase Marker Board

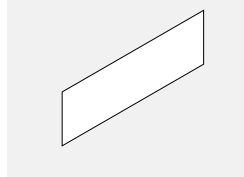

- Adheres magnetically to the door fo a flipper door overhead.

PRODUCT CODE	PRICE	SIZE/ H	INCHES W	D	WEIGHT LBS	VOL FT ³
EVAOMFD24	220	14.4	22.8	0.05		
EVAOMFD30	253	14.4	28.8	0.05		
EVAOMFD36	290	14.4	34.8	0.05		
EVAOMFD42	331	14.4	40.8	0.05		
EVAOMFD48	362	14.4	46.8	0.05		
EVAOMFD54	380	14.4	52.8	0.05		
EVAOMFD60	410	14.4	58.8	0.05		

EVAOMBW • Dry Erase Marker Board

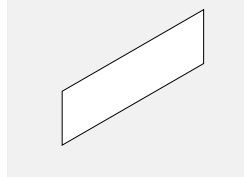

- Adheres magnetically to the back wall of the AODA Overhead.

PRODUCT CODE	PRICE	SIZE/ H	INCHES W	D	WEIGHT LBS	VOL FT ³
EVAOMBW30	253	14.4	29.2	0.05		
EVAOMBW36	290	14.4	35.5	0.05		
EVAOMBW42	331	14.4	41.2	0.05		
EVAOMBW48	362	14.4	47.2	0.05		
EVAOMBW54	380	14.4	53.2	0.05		
EVAOMBW60	410	14.4	59.2	0.05		

EVED50 • Duo Module

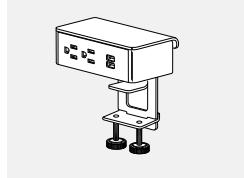

- The duo power module is completely integrated with a mounting clamp to attach to the edge of a worksurface.
- Provides two outlets and two 2.1 amp USB ports.
- White face plate, outlets and bracket; 72" long three-prong black cord.

PRODUCT CODE	PRICE	SIZE/ H	INCHES W	D	WEIGHT LBS	VOL FT ³
EVED50	615	1.8	5.5	3.2	2.50	0.14

EVED50AC • Duo Module with A+C

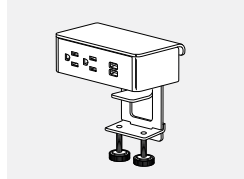

- The Duo power module is completely integrated with a mounting clamp to attach to the edge of a worksurface.
- Provides two 15 Amp 120 Volt AC Receptacles; 2.4 amp USB-A port and 60 watt USB-C power delivery port.
- 10' long three-prong cord.
- Available in W - White or B - Black as indicated by last letter of model number.

PRODUIT CODE	PRIX	TAILLE/ H	POUCES L	P	POIDS LB	VOLUME PI ³
EVED50ACW	695	3	5.5	3.2	3	0.2
EVED50ACB	695	3	5.5	3.2	3	0.2

EVEDU51 • Duo Under Module

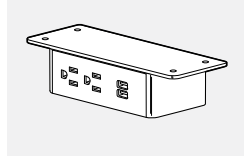

- The duo under power module comes with a thin flush mounting bracket to attach to the underside of a work surface or above work surface shelves.
- Provides two outlets and two 2.1 amp USB ports.
- White face plate, outlets and brackets; 72" long three-prong black cord.

PRODUCT CODE	PRICE	SIZE/ H	INCHES W	D	WEIGHT LBS	VOL FT ³
EVEDU51	537	1.8	5.5	2.8	2.5	0.14

EVEDU51AC • Duo Under Module

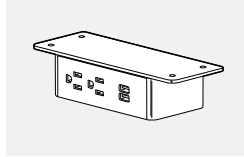

- The Duo under power module comes with a thin flush mounting bracket to attach to the underside of a work surface or above work surface shelves.
- Provides two 15 Amp 120 Volt AC Receptacles; 2.4 amp USB-A port and 60 watt USB-C power delivery port.
- 10' long three-prong cord.
- Available in W - White or B - Black as indicated by last letter of model number.

PRODUCT CODE	PRICE	TAILLE/ POUCES			POIDS VOLUME	
		H	L	P	LB	PI ³
EVEDU51ACW	695	1.8	5.5	2.8	3	0.2
EVEDU51ACB	695	1.8	5.5	2.8	3	0.2

EVEDB52 • Duo Bezel Module

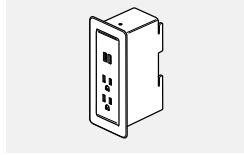

- The duo bezel power module is embedded and flush-mounted in a piece of furniture or a work surface.
- Provides two outlets and two 2.1 amp USB ports.
- White face plate, outlets and bezel; 72" long three-prong black cord.
- Contact your Customer Service Representative for surface applications.

PRODUCT CODE	PRICE	SIZE/ INCHES			WEIGHT VOL	
		H	W	D	LBS	FT ³
EVEDB52	576	4	6.5	3.2	2.5	0.14

EVETP53 • Trio Plus Module

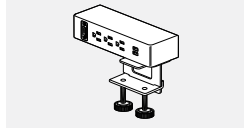

- The trio plus power module is completely integrated with a mounting clamp to attach to the edge of a work surface or above work surface shelves.
- Provides three outlets and two 2.1 amp USB ports and an adapter kit containing blank cover, HDMI, RJ45 or VGA adapter brackets. Note: HDMI, RJ45 and VGA connectors are not included.
- White face plate, outlets, adapters and brackets; 72" long three-prong black cord.

PRODUCT CODE	PRICE	SIZE/ INCHES			WEIGHT VOL	
		H	W	D	LBS	FT ³
EVETP53	693	1.8	8	3.2	2.5	0.14

EVETPB55 • Trio Plus Bezel Module

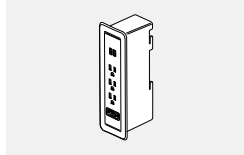

- The trio plus bezel power module is embedded and flush-mounted in a piece of furniture or a work surface.
- Provides three outlets and two 2.1 amp USB ports and an adapter kit containing blank cover, HDMI, RJ45 or VGA adapter brackets. Note: HDMI, RJ45 and VGA connectors are not included.
- White face plate, outlets, adapters and bezel; 72" long three-prong black cord.
- Contact your Customer Service Representative for surface applications.

PRODUCT CODE	PRICE	SIZE/ INCHES			WEIGHT VOL	
		H	W	D	LBS	FT ³
EVETPB55	662	4	9	3.2	2.5	0.14

EVMA1 • Single Clamp Mount Monitor Arm

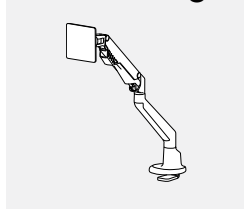

- Finger touch dynamic height adjustment, 12" height range. 4.4 to 19.8 lbs. per monitor loading capacity; accepts screen size 17"-30".
- Maximum monitor width of 34".
- Maximum of 20.5" extension from rear of desk to back of monitor, folds to 4.5".
- Tilt, pan and landscape to portrait rotation; quick release VESA plate, 180 degree lock out.
- Clamp mount and grommet mount options included, accommodates 0.5" to 2" thick tops.
- Accepts mini slide arm GAMS.
- Available in TUN - Tungsten only.

PRODUCT CODE	PRICE	SIZE/ INCHES			WEIGHT VOL	
		H	W	D	LBS	FT ³
EVMA1	460	21		5.5	6.6	0.4

EVMA2 • Double Clamp Mount Monitor Arm

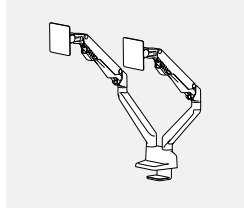

- Finger touch dynamic height adjustment, 12" height range. 4.4 to 19.8 lbs. per monitor loading capacity; accepts screen size 17"-30".
- Maximum monitor width of 34".
- Maximum of 20.5" extension from rear of desk to back of monitor, folds to 4.5".
- Tilt, pan and landscape to portrait rotation; quick release VESA plate, 180 degree lock out.
- Clamp mount and grommet mount options included, accommodates 0.5" to 2" thick tops.
- Accepts mini slide arm GAMS.
- Available in TUN - Tungsten only.

PRODUCT CODE	PRICE	SIZE/ INCHES			WEIGHT VOL	
		H	W	D	LBS	FT ³
EVMA2	807	21		5.5	12.8	1

EVAMS • Mini Slide Monitor Arm

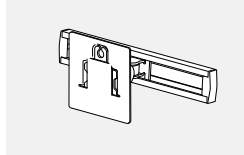

- Works with GAMA1 and GAMA2 monitor arms.
- 9" slide, loading capacity 13.2lbs.
- Quick release VESA plate.
- Available in TUN - Tungsten only.

PRODUCT CODE	PRICE	SIZE/ INCHES			WEIGHT VOL	
		H	W	D	LBS	FT ³
EVAMS	160	4.5	11	6	3.3	0.3

EVELEDVS • LED Single Arm Lamp

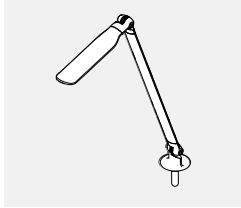

- 7 System watts, 18-fractional LEDs.
- 3500K 250 lumens, 84CRI.
- Soft touch - instant on, fade to off.
- Infinite dimming 100% down to 15%, last state memory.
- Standard 10 hours turn off (ATO).
- 50,000 hour life LEDs.
- 15 watt, 24 volt wall transformer, 6' cord.
- White (WHT)or Black (BLK) - Must specify colour choice.

PRODUCT CODE	PRICE	SIZE/ INCHES			WEIGHT VOL	
		H	W	D	LBS	FT ³
EVELEDVS	616	8	7	33	7.3	0.98
With occupancy sensor						
EVELEDVSO	920	10	9	35	8.3	1.51

- UL, CUL and CSA compliant, ETL Listed.
- Base not included.

EVELEDVD • LED Double Arm Lamp

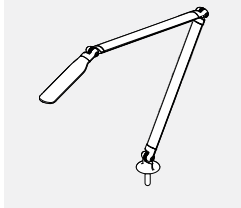

- 7 System watts, 18-fractional LEDs.
- 3500K 250 lumens, 84CRI.
- Double arm articulation with 20" base to head reaches.
- Soft touch - instant on, fade to off.
- Infinite dimming 100% down to 15%, last state memory.
- Standard 10 hours turn off (ATO).
- 50,000 hour life LEDs.
- 15 watt, 24 volt wall transformer, 6' cord.
- White (WHT)or Black (BLK) - Must specify colour choice.

PRODUCT CODE	PRICE	SIZE/ INCHES			WEIGHT VOL	
		H	W	D	LBS	FT ³
EVELEDVD	633	8	7	33	7.6	1.02
With occupancy sensor						
EVELEDVDO	931	10	9	35	8.6	1.57

- UL, CUL and CSA compliant, ETL Listed.
- Base not included.

EVELEDRS • LED Single Arm Lamp

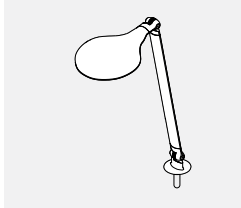

- 7 System watts, 18-fractional LEDs.
- 3500K 250 lumens, 84CRI.
- Soft touch - instant on, fade to off.
- Infinite dimming 100% down to 15%, last state memory.
- Standard 10 hours turn off (ATO).
- 50,000 hour life LEDs.
- 15 watt, 24 volt wall transformer, 6' cord.
- White (WHT)or Black (BLK) - Must specify colour choice.

PRODUCT CODE	PRICE	SIZE/ INCHES			WEIGHT VOL	
		H	W	D	LBS	FT ³
EVELEDRS	616	8	7	33	7.3	0.98
With occupancy sensor						
EVELEDRSO	920	10	9	35	8.3	1.51

- UL, CUL and CSA compliant, ETL Listed.
- Base not included.

EVELEDRD • LED Double Arm Lamp

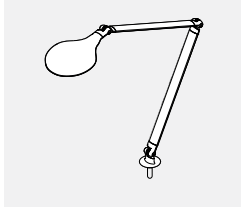

- 7 System watts, 18-fractional LEDs.
- 3500K 250 lumens, 84CRI.
- Double arm articulation with 20" base to head reaches.
- Soft touch - instant on, fade to off.
- Infinite dimming 100% down to 15%, last state memory.
- Standard 10 hours turn off (ATO).
- 50,000 hour life LEDs.
- 15 watt, 24volt wall transformer, 6' cord.
- White (WHT)or Black (BLK) - Must specify colour choice.

PRODUCT CODE	PRICE	SIZE/ INCHES			WEIGHT VOL	
		H	W	D	LBS	FT ³
EVELEDRD	633	8	7	33	7.6	1.02
With occupancy sensor						
EVELEDRDO	931	10	9	35	8.6	1.57

- UL, CUL and CSA compliant, ETL Listed.
- Base not included.

Lamp Mounting Options

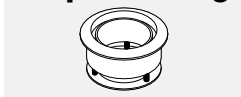

Grommet Mount

PRODUCT CODE	PRICE	SIZE/ INCHES	WEIGHT VOL
		H W D	LBS FT ³
EVELEDASM	155	3 6 6	3 0.06



Worksurface Mount

PRODUCT CODE	PRICE	SIZE/ INCHES	WEIGHT VOL
		H W D	LBS FT ³
EVELEDACM	155	3 6 6	2 0.04

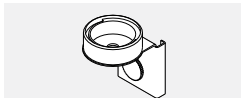

Slatwall Mount

PRODUCT CODE	PRICE	SIZE/ INCHES	WEIGHT VOL
		H W D	LBS FT ³
EVELEDASW	155	3 6 6	3 0.06



Panel Mount

PRODUCT CODE	PRICE	SIZE/ INCHES	WEIGHT VOL
		H W D	LBS FT ³
EVELEDAPM	155	3 6 6	3 0.06

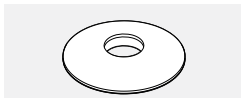

Weighted Base

PRODUCT CODE	PRICE	SIZE/ INCHES	WEIGHT VOL
		H W D	LBS FT ³
EVELEDAFS	173	4 12 12	6 0.50

EVABB01 • Binder Bin

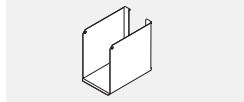

- Load bar/accessory rail mounted metal binder bin.
- Panel frame finish

PRODUCT CODE	PRICE	SIZE/ H	INCHES W	D	WEIGHT LBS	VOL FT ³
EVABB01	56	9	5.75	9.25	1.85	0.21

EVAFS01 • Flip Sorter

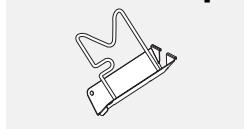

- Load bar/accessory rail mounted metal flip sorter. Comes with nickel plated wire.
- Panel frame finish

PRODUCT CODE	PRICE	SIZE/ H	INCHES W	D	WEIGHT LBS	VOL FT ³
EVAFS01	39	9	3	9	0.6	0.14

EVASS01 • Slant Sorter



Right hand Shown

- Load bar/accessory rail mounted metal slant sorter.
- Panel frame finish

PRODUCT CODE	PRICE	SIZE/ H	INCHES W	D	WEIGHT LBS	VOL FT ³
EVASS01R	34	9.25	2.75	9	1	0.28
EVASS01L	34	9.25	2.75	9	1	0.28

EVALT01 • Letter Tray

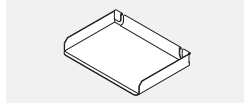

- Load bar/accessory rail mounted metal letter tray.
- Panel frame finish

PRODUCT CODE	PRICE	SIZE/ H	INCHES W	D	WEIGHT LBS	VOL FT ³
EVALT01	42	1.75	12	8.75	0.5	0.15

EVALT02 • Legal Tray

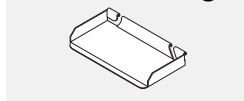

- Load bar/accessory rail mounted metal legal tray.
- Panel frame finish

PRODUCT CODE	PRICE	SIZE/ H	INCHES W	D	WEIGHT LBS	VOL FT ³
EVALT02	56	1.75	14.7	8.75	0.5	0.15

EVAMB01 • Media Bin

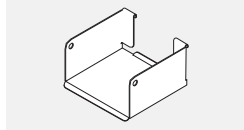

- Load bar/accessory rail mounted.
- Panel frame finish

PRODUCT CODE	PRICE	SIZE/ H	INCHES W	D	WEIGHT LBS	VOL FT ³
EVAMB01	42	3	5.75	5.25	0.8	0.05

EVAUT01 • Utility Tray

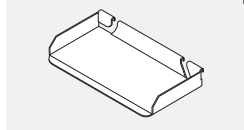

- Load bar/accessory rail mounted metal utility tray.
- Panel frame finish

PRODUCT CODE	PRICE	SIZE/ H	INCHES W	D	WEIGHT LBS	VOL FT ³
EVAUT01	29	1	7.5	3.75	0.5	0.02

EVAPP01 • Mail Box

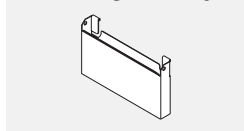

- Load bar/accessory rail mounted.
- Panel frame finish

PRODUCT CODE	PRICE	SIZE/ H	INCHES W	D	WEIGHT LBS	VOL FT ³
EVAPP01	70	7	12	1.75	2	0.25

EVATH01 • Telephone Holder

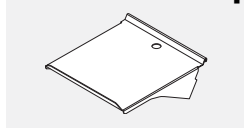

- Load bar/rail mounted telephone holder.
- Panel frame finish

PRODUCT CODE	PRICE	SIZE/ H	INCHES W	D	WEIGHT LBS	VOL FT ³
EVATH01	66	2	8	10	2	0.26

EVPFD-WS • Worksurface Felt Divider

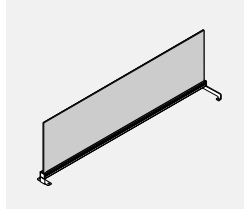

- Privacy felt divider integrated into an aluminum top trim.
- Attaches on top of a worksurface to add privacy or divide space.
- Must be used at connector location.
- Includes aluminum trim with channel, felt tile and brackets.
- 9 mm felt material is tackable and comes in 18 different colors. Please specify felt finish.
- Aluminum extrusion and brackets available in standard paint finishes.
- Felt tile and attachment hardware to ship separately.

PRODUCT CODE	PRICE	SIZE/ H	INCHES W	D	WEIGHT LBS	VOL FT ³
EVPFD1818WS	153	18	18	1	2.26	0.75
EVPFD1824WS	172	18	24	1	2.77	0.94
EVPFD1830WS	193	18	30	1	3.29	1.13
EVPFD1836WS	210	18	36	1	3.8	1.31

Why Softpod?

Softpod is where flexibility meets focus - bringing a new work style option to the Global family of products. This sleek privacy pod is a cozy, secluded space dedicated to focus. Its multi-segmented dividers and hexagon shape offer flexibility for both privacy and space planning.

Divider:

- PET Felt / aluminum composition
- Channel edge allows for add-on privacy

PET Felt features:

- Tackable acoustic material
- Soft form capability

Electrical:

- Simple interconnect / direct plug-in or
- Hard wire formats

Storage:

- Solution based

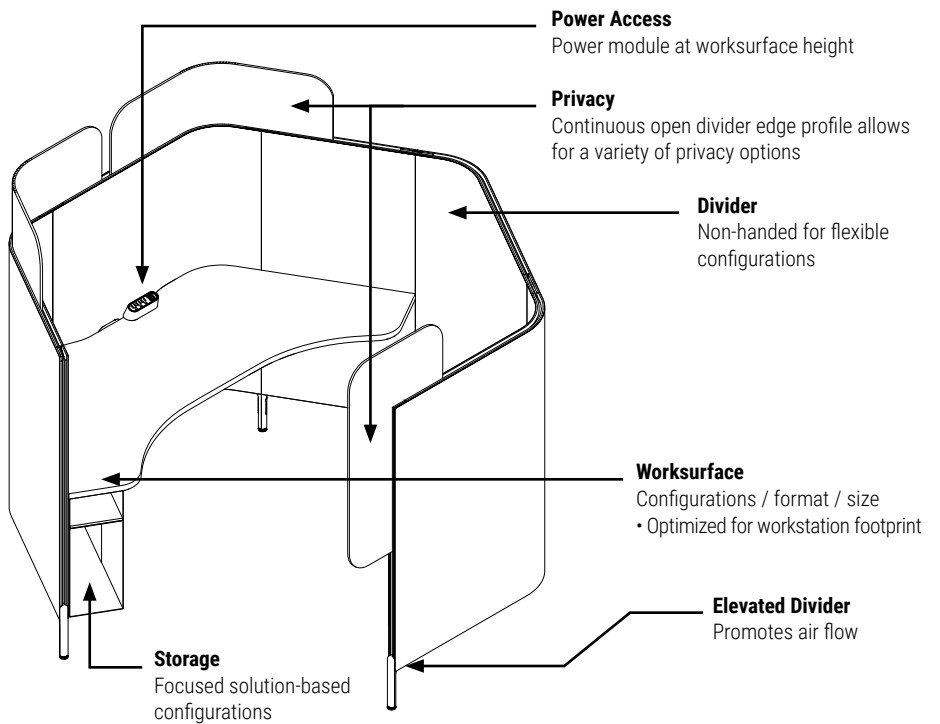

Statement Of Line

Softpods

HX3P5472SW
Softpod with 3 Dividers and Worksurface

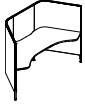

HX4P5472SW
Softpod with 4 Dividers and Worksurface



HX4P5472R/LW
Softpod with 4 Dividers and Wrap Around Worksurface

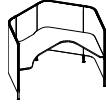

HX5P5472SW
Softpod with 5 Dividers and Worksurface

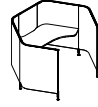

HX5P5472WW
Softpod with 5 Dividers and Wrap Around Worksurface

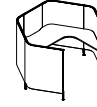

HXP5430
Single J-divider



Extensions

HXPAEFE
End PET Felt Extension Divider Add-on



HXPACFE
Corner PET Felt Extension Divider Add-on

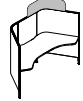

HXPATCFE
Top Corner PET Felt Extension Divider Add-on



Electrical

BRED50
Duo Module



BRETP53
Trio Plus Module



HXEUWC
Under Worksurface/ Edge USB Charger



GAADG
Access Door Module



GAADCT
Access Door Module with Cable Tray

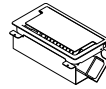

GMDSA10
ModPower Starter Mounted Unit

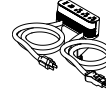

GMDCA3
ModPower Middle Mounted Unit

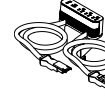

GMDEA3
ModPower End Mounted Unit

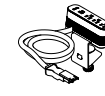

GMDSF10
ModPower In Surface Starter Unit



GMDCF3
ModPower In Surface Middle Unit



GMDEF3
ModPower In Surface End Unit

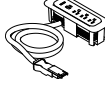

GMDCLIPS
ModPower Management Clips



GMDJ36BK
ModPower Interconnecting Jumper



GMDPC22W
Slim Desktop Power Module, 2 Duplex



GMDPC32W
Slim Desktop Power Module, 3 Duplex



HXEPK
Station 2-Circuit Power Kit



HXECS
Cable Shroud



HXEPPJ
Station to Station Jumper



HXECS
Ceiling Feed



HXEBF
Base Feed

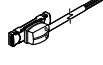

HXECP
Ceiling Feed Pole

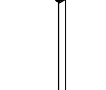

HXEPGK
Divider Grommet Kit



HXEPGCS
Divider Grommet Connector / Spacer

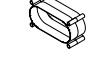

Accessories

BLVELEDVS
LED Single Arm Lamp



BLVELEDVD
LED Double Arm Lamp



BLVELEDRS
LED Single Arm Lamp

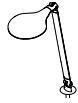

BLVELEDRD
LED Double Arm Lamp



BLVELEDASC
Lamp Mounting Options



BLVELEDAFS
Lamp Mounting Options



HXAHS
Hanging Shelf



HXAHSWB
Hanging Shelf with Dry Erase Board



HXARWS
Rear Wall Shelf



HXACHS
Coat/Bag Hook for Dividers



HXACHT
Coat/Bag Hook for Dividers Edge



HXABH
Under Surface Bag Hook



HXNP
Name Plate



Storage

HXSCSO
Under Worksurface Casual Storage Unit



L2PO
Pantry Storage

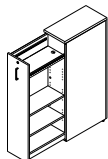

Footprint

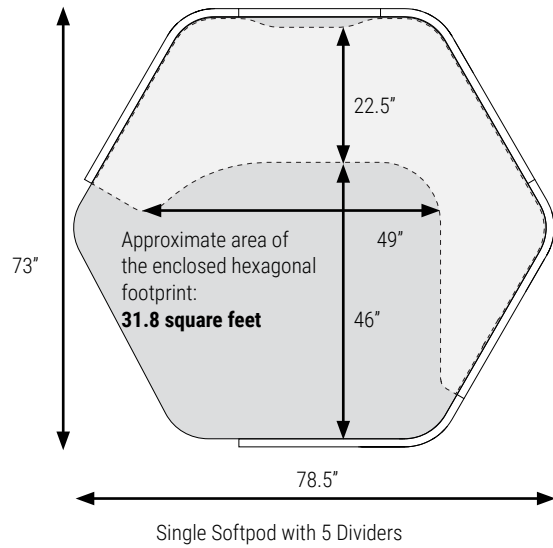
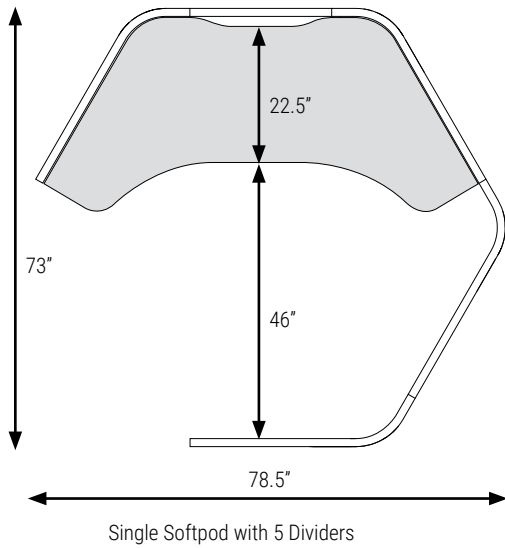
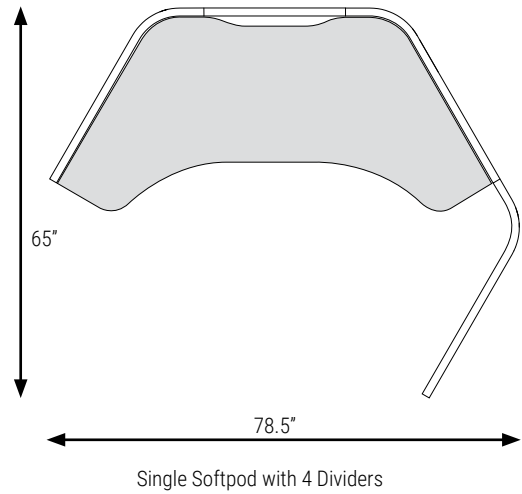
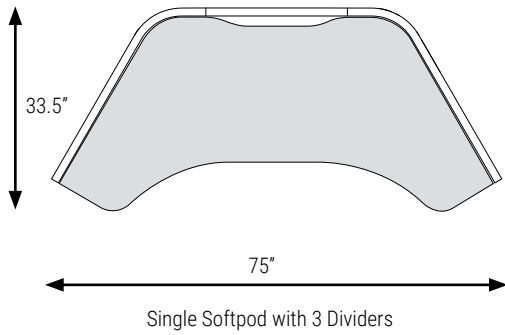

Off Grid Planning

The flexible format of Softpod offers a variety of planning options and encourages both on and off grid layouts. From a single or cluster of Softpods this versatile system adapts to your needs.

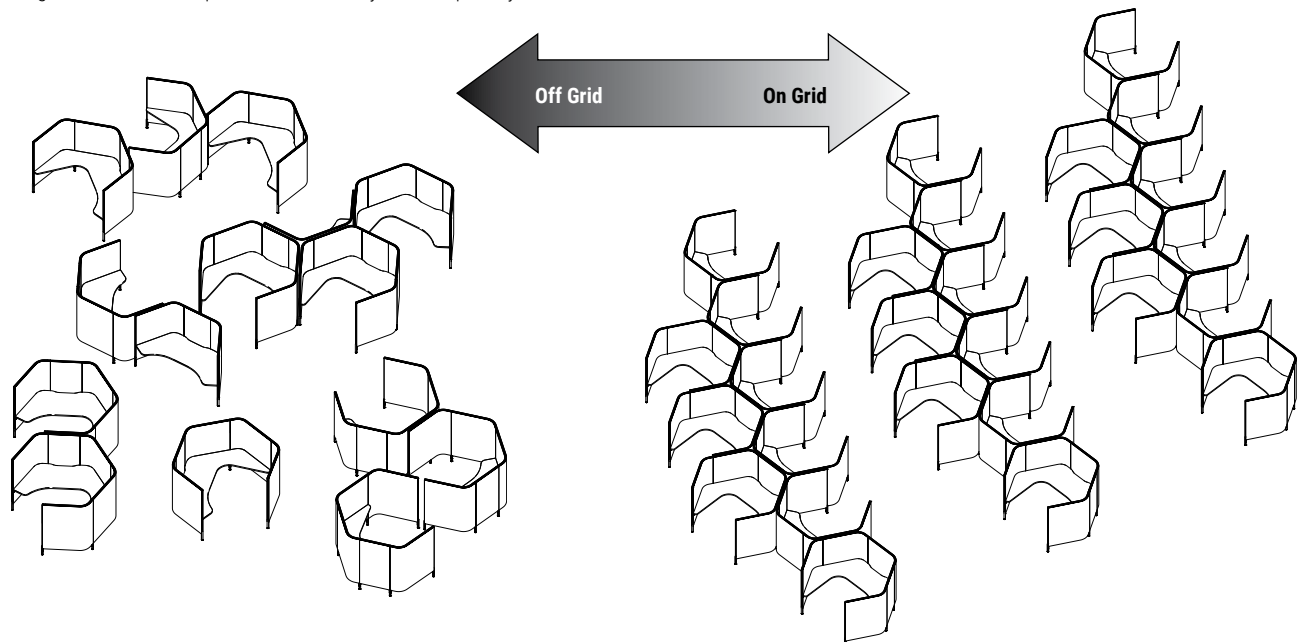

Off Grid Planning

Agile

The freestanding, single Softpod can flex to support any number of employees in a hybrid work environment. The pods can be easily reconfigured and adjusted as needs change. Its small kit of parts and thoughtfully designed features make it easy to specify and keep inventory counts low. Easy to specify and keep inventory counts low.

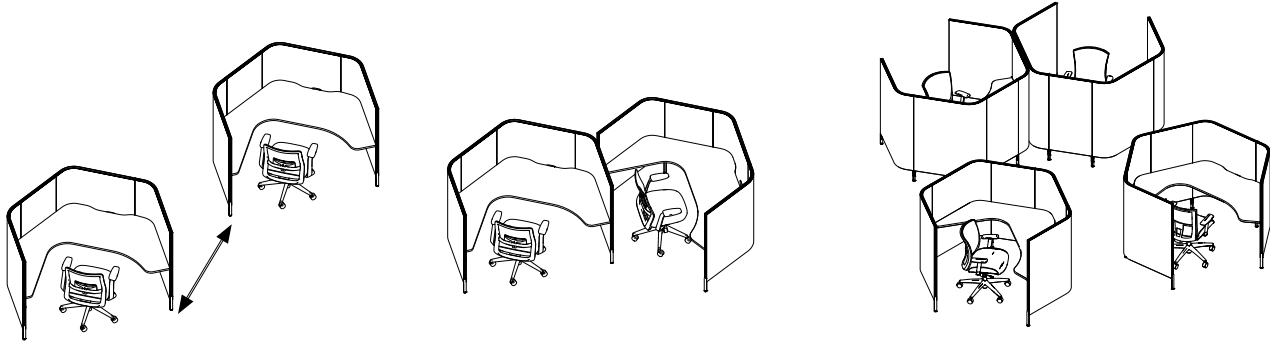

Scalable

The adaptable dividers give the ability to address the level of privacy needed on a station by station basis.

Softpod PRIVACY

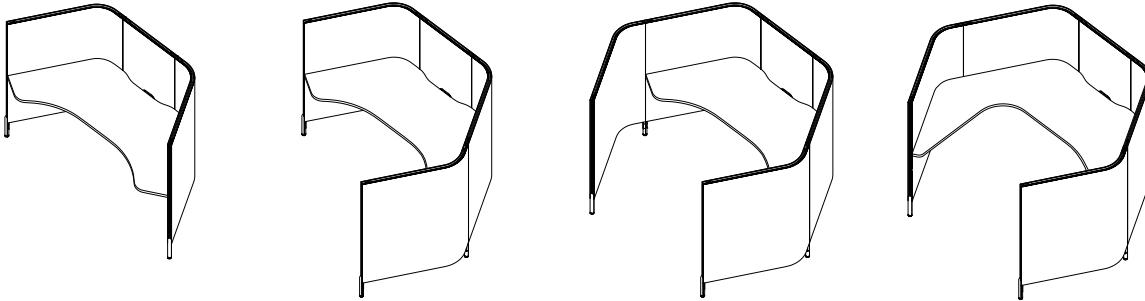

Extensions - PRIVACY

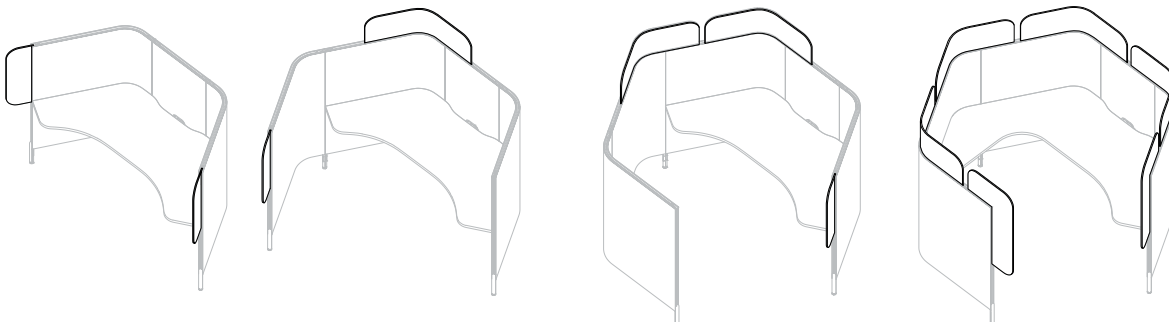

Quick Specification

Softpod's small and complete kits allows for quick and efficient movement of product from time of specification to installation.

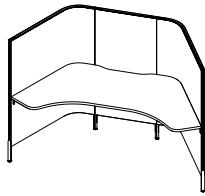

Single Pod with 3 Dividers

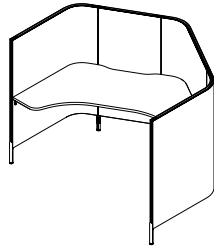

Single Pod with 4 Dividers

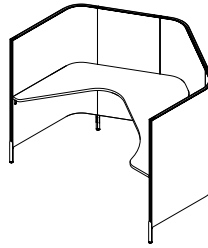

Single Pod with 4 Dividers and Wrap Around Surface

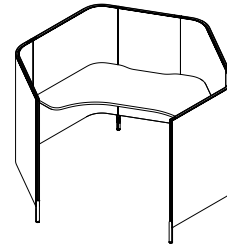

Single Pod with 5 Dividers

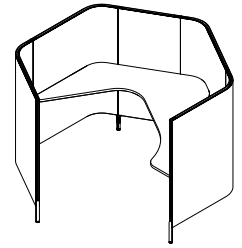

Single Pod with 5 Dividers and Wrap Around Surface

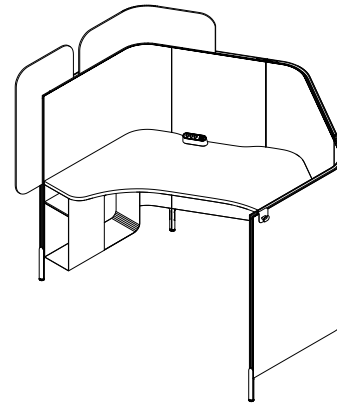
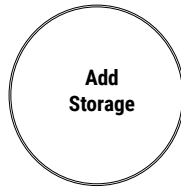
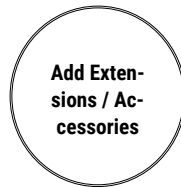
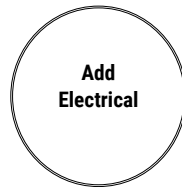

Power Connections

Plug In

Simple casual wire - Direct plug-in or hard wired.

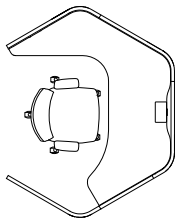

Daisy Chain Interconnect System

Plug-in power supply and interlinked, pre-determined, universal modules. If specified, one module is shipped with the station and interconnected on site.

Integrating additional station (C) requires disconnecting A from B and plugging in the C on site.

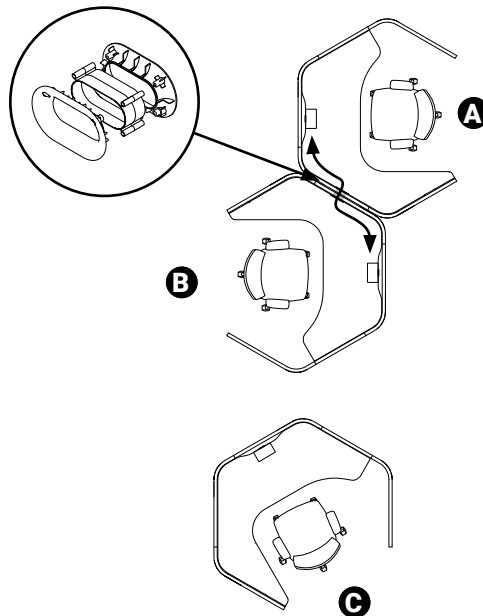

Dual Circuit Power

Outlets mounted below worksurfaces.

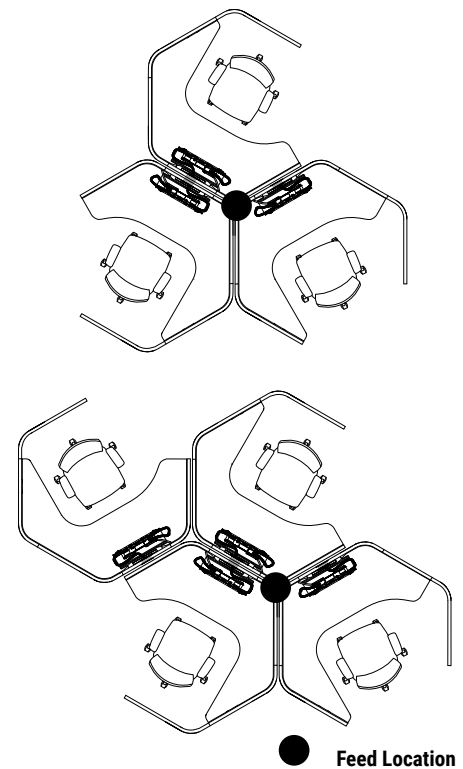

Space Planning

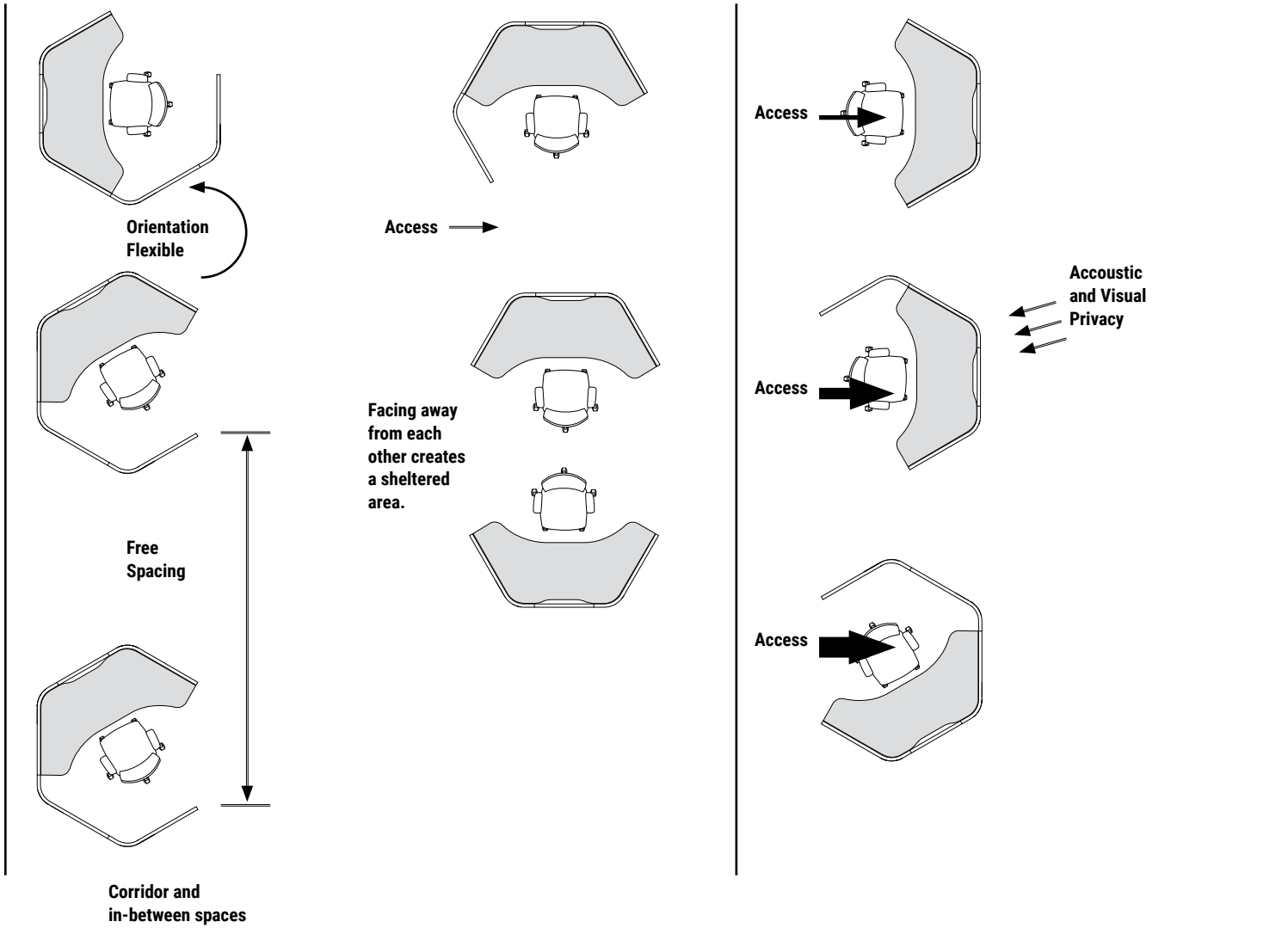

Pod Formats

Align units in cluster plan
Option unit type & orientation

(A) Worksurfaces must have opposing alignment

Flat and curved dividers are non-handed and symmetrical. The addition of the legs determines if the j-dividers becomes LEFT handed or RIGHT handed. Any j-divider can be configured and re-configured LEFT or RIGHT.

Maximum 4 unit cluster per 2 circuits

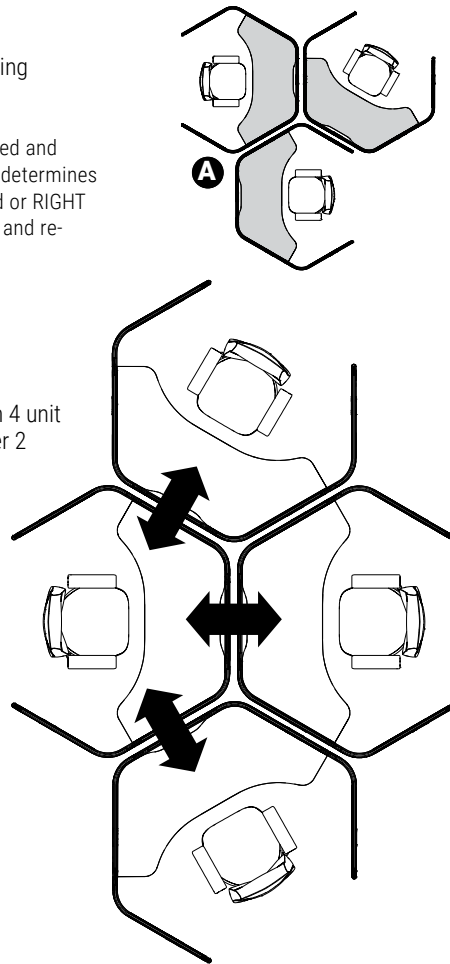

Power/ data is delivered through divider via grommet

Grommet tethers units together

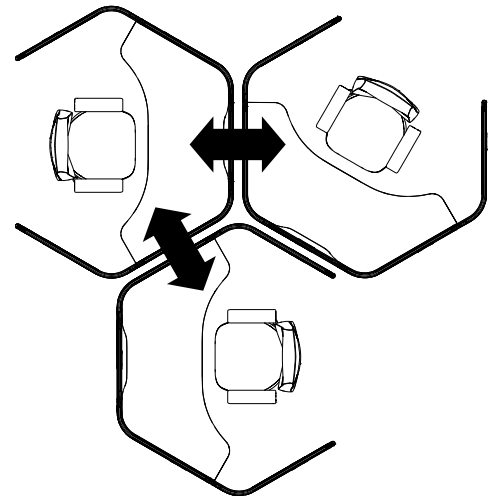

Planning for Single Softpod with 3 Dividers

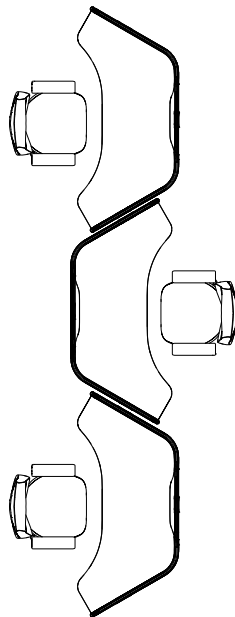
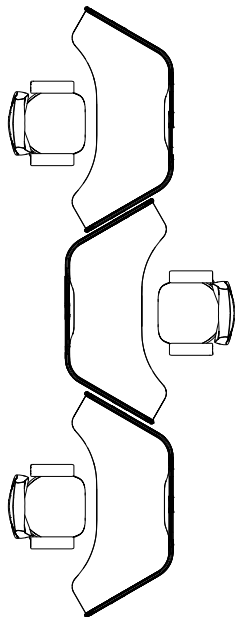

Touchdown

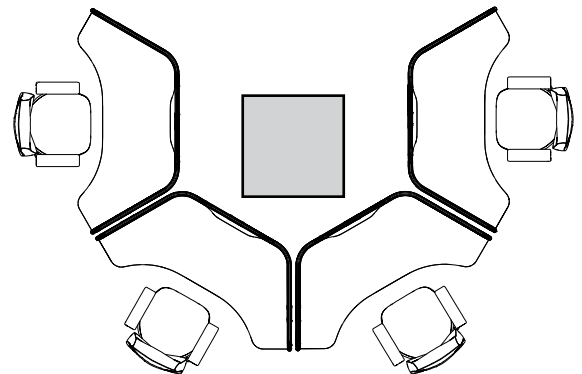

Around Column

Planning for Single Softpod with 4 Dividers

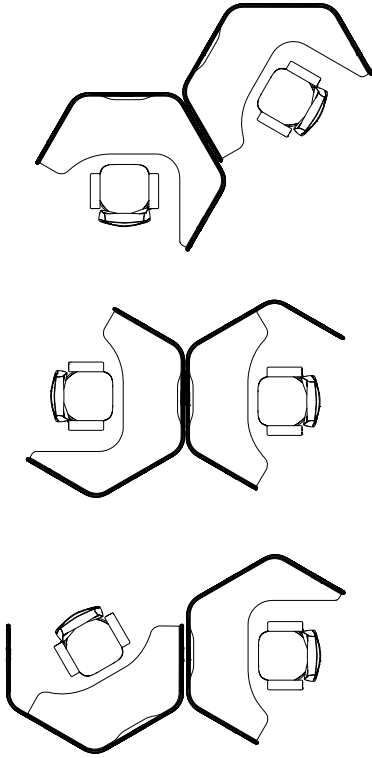

Cluster of 2 Softpods

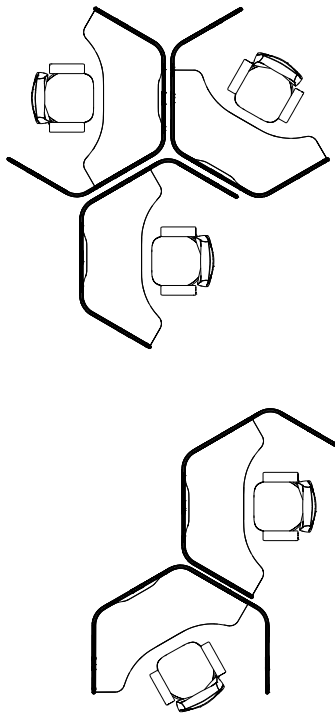

Cluster of 3 Softpods

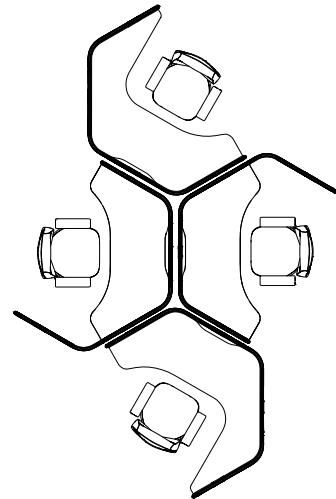

Cluster of 4 Softpods

Planning for Single Softpod with 5 Dividers - Center

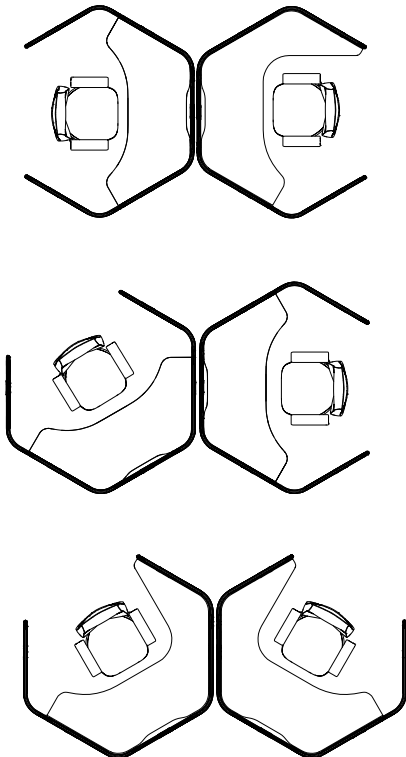

Cluster of 2 Softpods

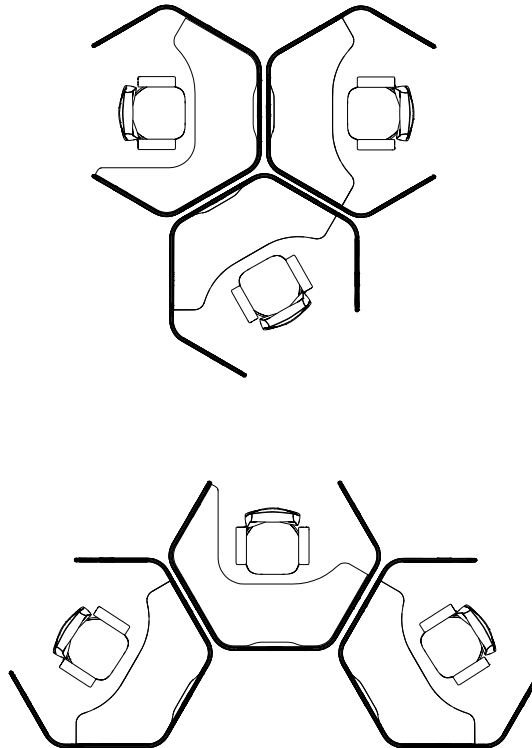

Cluster of 3 Softpods

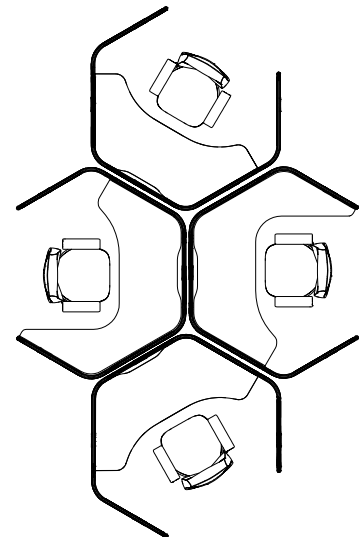

Cluster of 4 Softpods

Planning for Single Softpod with 5 Dividers Left/Right

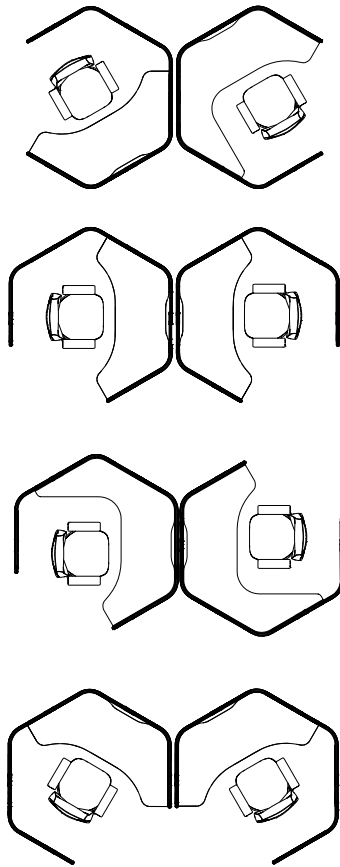

Cluster of 2 Softpods

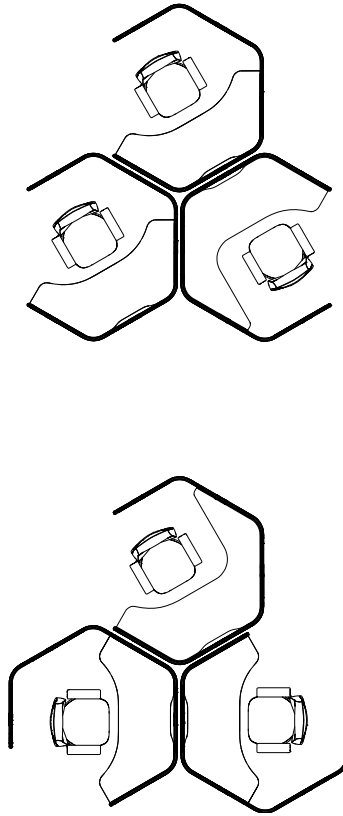

Cluster of 3 Softpods

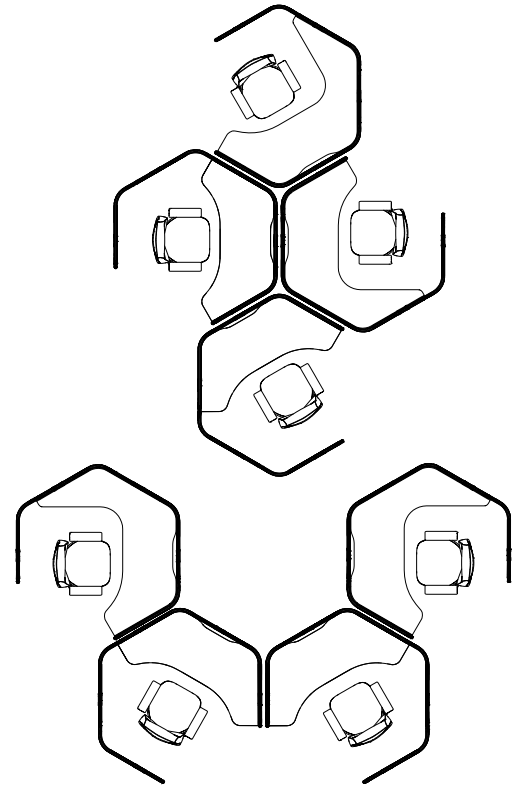

Cluster of 4 Softpods

Privacy Extensions

Flexible privacy extensions can be added to any Softpod workstation to adjust the level of privacy based on the user's needs.

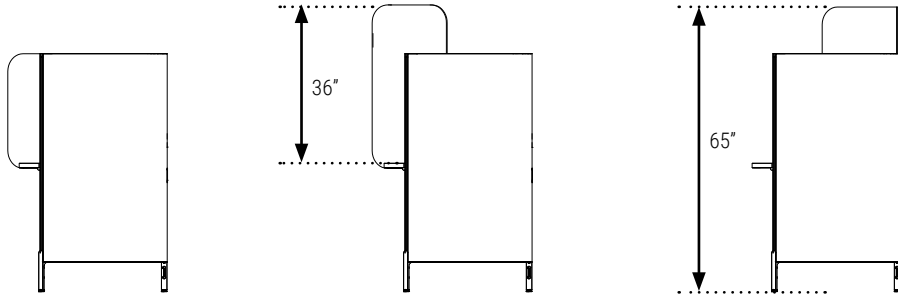
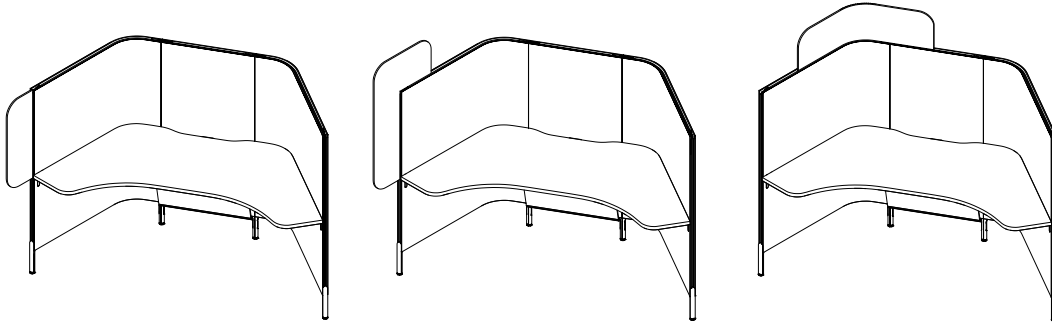

End PET Felt Extension Divider Add-on
 Height: 25.5"
 Depth: 9mm
 Width: 9.5"
 PET Felt
 - solid



Top Corner PET Felt Extension Divider Add-on
 Height: 37"
 Depth: 9mm
 Width: 19.5"
 PET Felt
 - solid
 - perforated



Corner PET Felt Extension Divider Add-on
 Height: 11.5"
 Depth: 9mm
 Width: 38.5"
 PET Felt
 - solid
 - perforated

Privacy Extensions

PET Felt - Solid

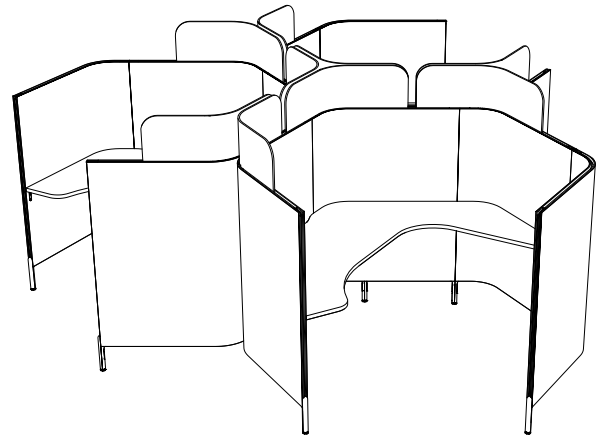
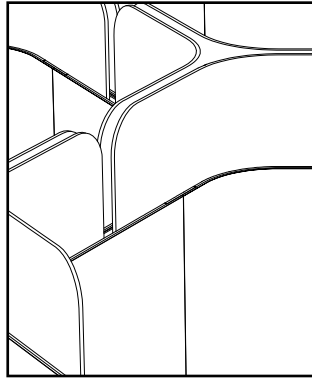

PET Felt - Perforated

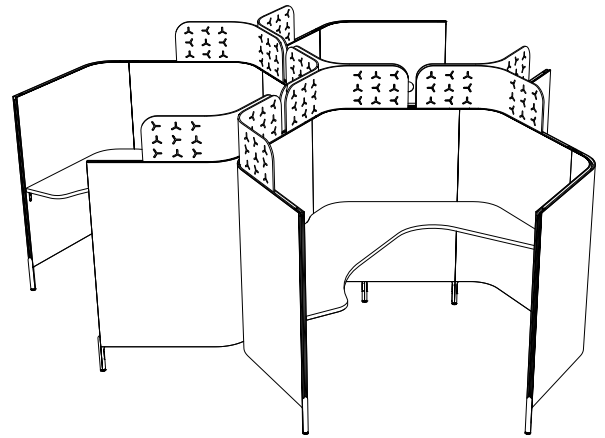
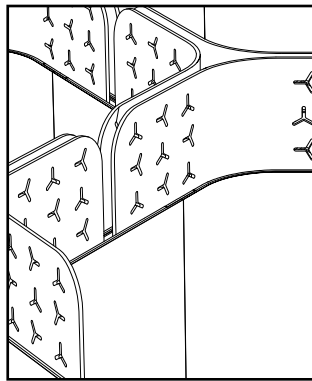

PET Felt Colour Programming

PET Felt finishes may be the same or different for the interior and exterior of the Softpod. Only one finish may be applied to either the interior or exterior of each divider within each Softpod. Extensions may be in any single PET Felt colour to compliment or contrast. Due to variation in the color of felt, we recommend a contrasting or complimentary colour.

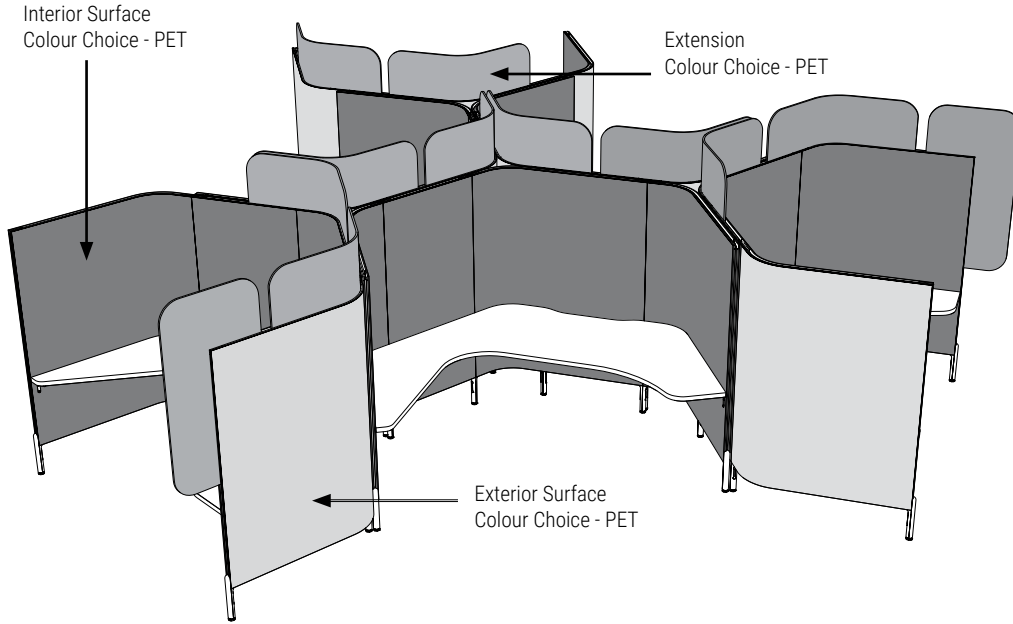

Worksurface Dimensions and Grain Direction

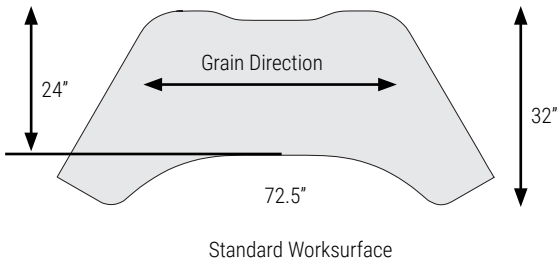

- A single worksurface to be used within Softpod dividers.
- The surface is non handed with pre-determined mounting points.
- Choose from either standard LP - low pressure laminate or HP - high pressure laminate, with PVC edge.

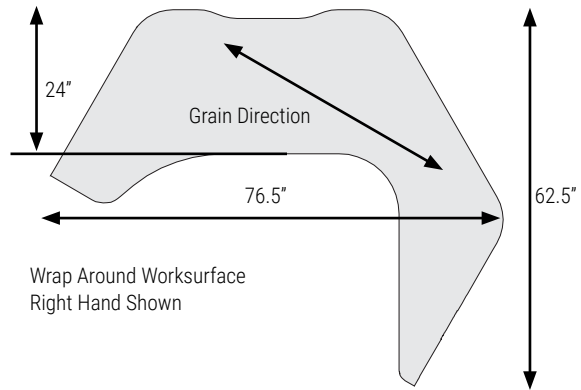

- A single wrap around worksurface to be used within Softpod dividers.
- The surface is handed L -left or R -right with pre-determined mounting points.
- Compatible only with 4 or 5 divider station configurations.
- Choose from either standard LP - low pressure laminate or HP - high pressure laminate, with PVC edge.

Grommet Location

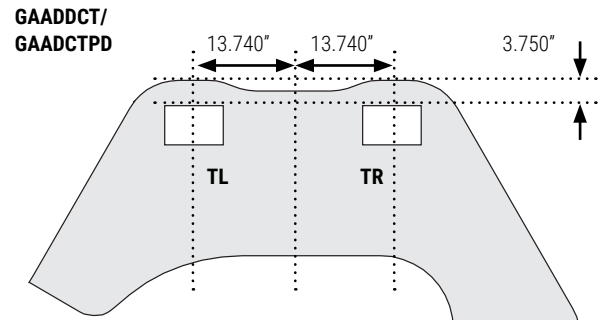
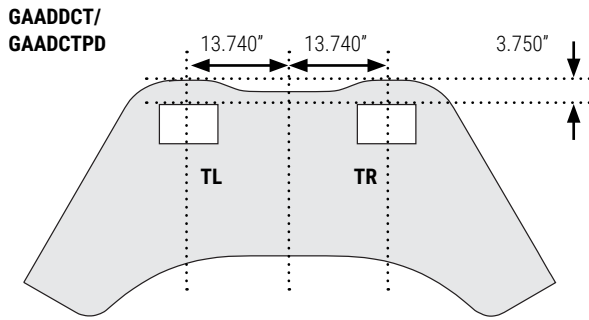

Right Hand Shown

- Grommet cutout option for GAADS series and Mod Power. TR -top right or TL -top left. Grommets must be ordered separately.
- GAAD grommet is not available in combination with HXECS (Cable Shroud) and HXEPK (2 Circuit Power Kit).

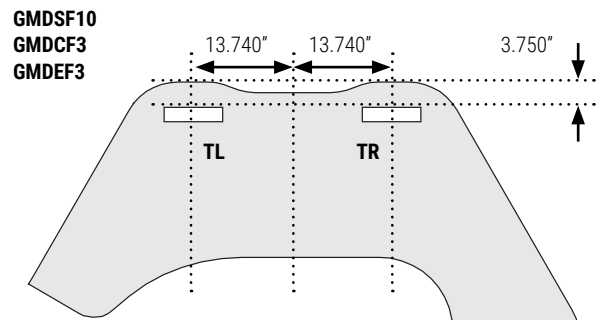
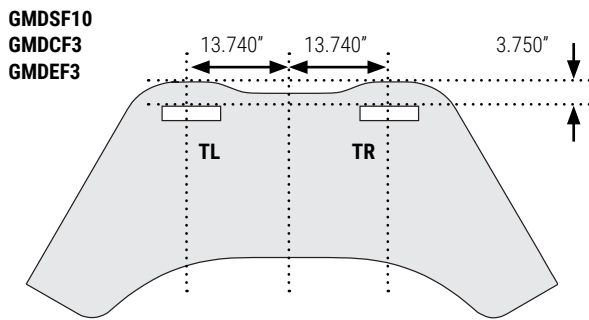
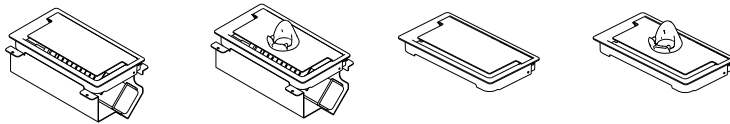

Right Hand Shown

- Grommet cutout option for GAADS series and Mod Power. TR -top right or TL -top left. Grommets must be ordered separately.
- GAAD grommet is not available in combination with HXECS (Cable Shroud) and HXEPK (2 Circuit Power Kit).

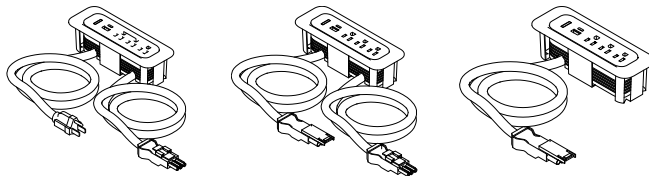

Electrical

Power and data lines can enter Softpod via floor, ceiling, or through grommet in the divider. The grommet opening is built-into every Softpod divider at a specific location, but it is covered by an on-site removable PET plug.

A grommet on a single Softpod can also facilitate cable access to a wall outlet.

Grommets installed on specific dividers facilitate passage of wires through Softpod dividers into adjacent Softpods.

Orientation of worksurfaces plays important role when planning Softpod cluster layouts with the need to pass cables between individual Softpods as the cables are best hidden underneath.

Worksurfaces must have opposing alignment.

Align units in cluster plan option unit type & orientation.

(A) Worksurfaces must have opposing alignment.

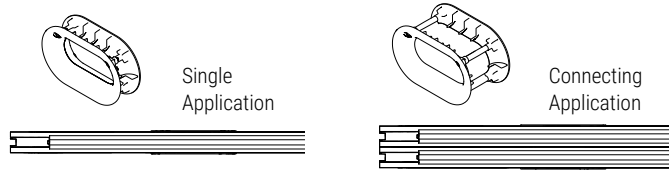
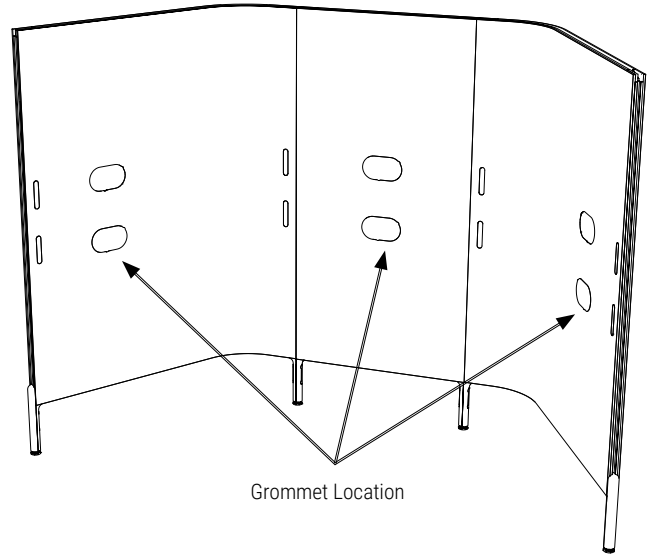
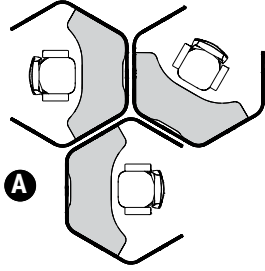

Ceiling pole attaches to the divider grommet under worksurface.

Location of the Ceiling pole on the inside of the Softpod is determined by the contoured recess at the back of worksurface.

White dots below indicate possible ceiling feed pole location within the Pod (must be at the same location as worksurface contoured recess).

Grey dots indicate possible Ceiling fee pole location outside of the POD (because cables pass through the divider grommets and under the worksurface).

Black arrows indicate possible power and data cable passage between Softpods (because cables pass through the divider grommet under the worksurface, through the second divider grommet and into the adjacent Softpod, under worksurface).

In either case, the cables enter or exit the Softpod through the divider grommet.

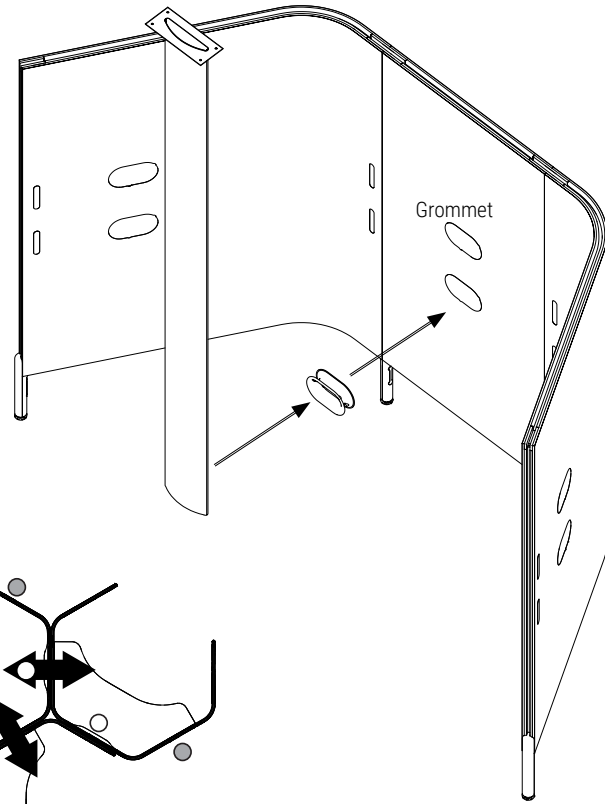

Recommended Maximum 4 unit cluster per 2 circuits.

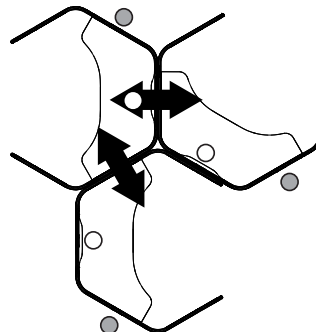
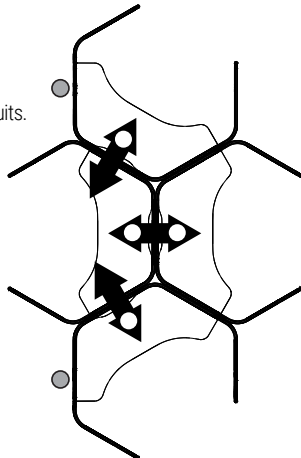

● Ceiling Feed Pole Location

Electrical Options

Direct Plug In

- Direct or floor monument outlet plug-in.

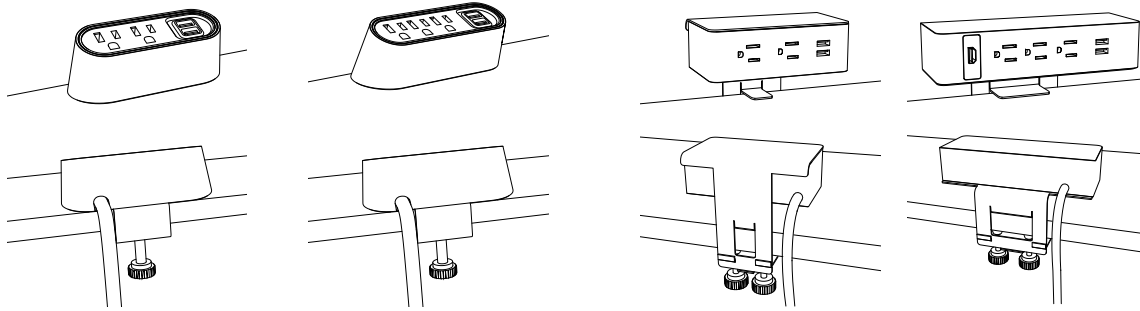

Grommet Application

- In surface.

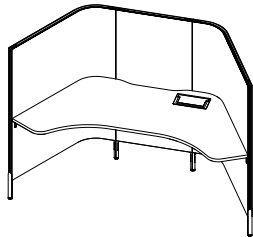

Grommet Application

- In surface Daisy Chain.

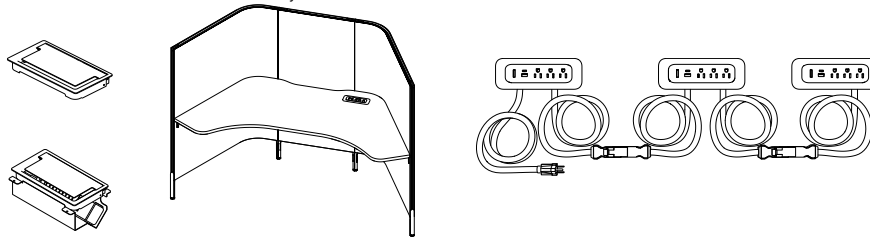

Daisy Chain Interconnect System

- Direct or floor monument outlet plug-in.

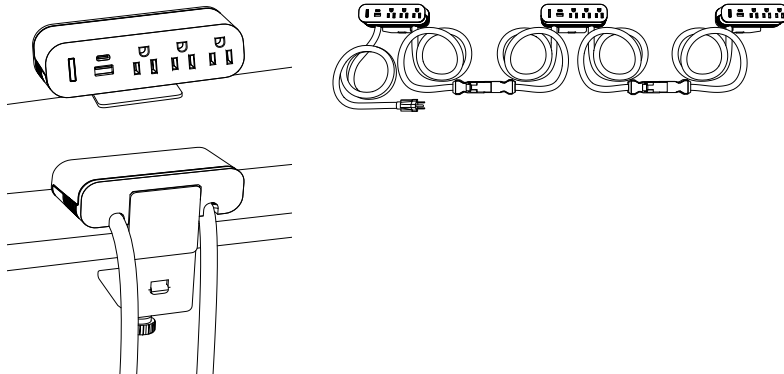

Dual Circuit Power

- Hardwired

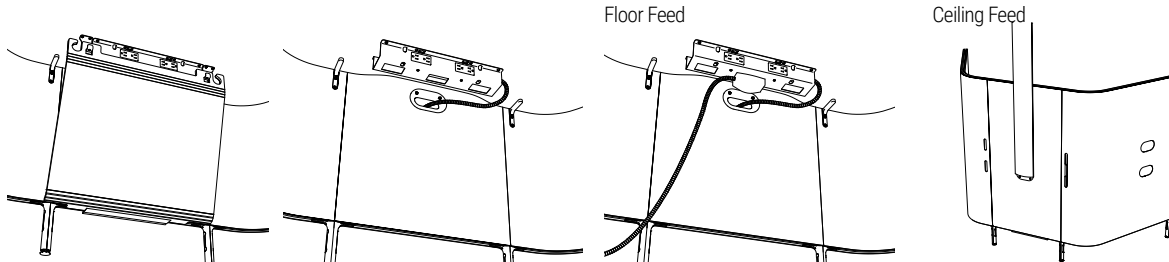

Electrical

2 Circuit, 4 Wire Power Distribution

The 2-circuit, 4-wire electrical components are housed in a metal trough, mounted under worksurface, immediately adjacent to the worksurface contoured recess.

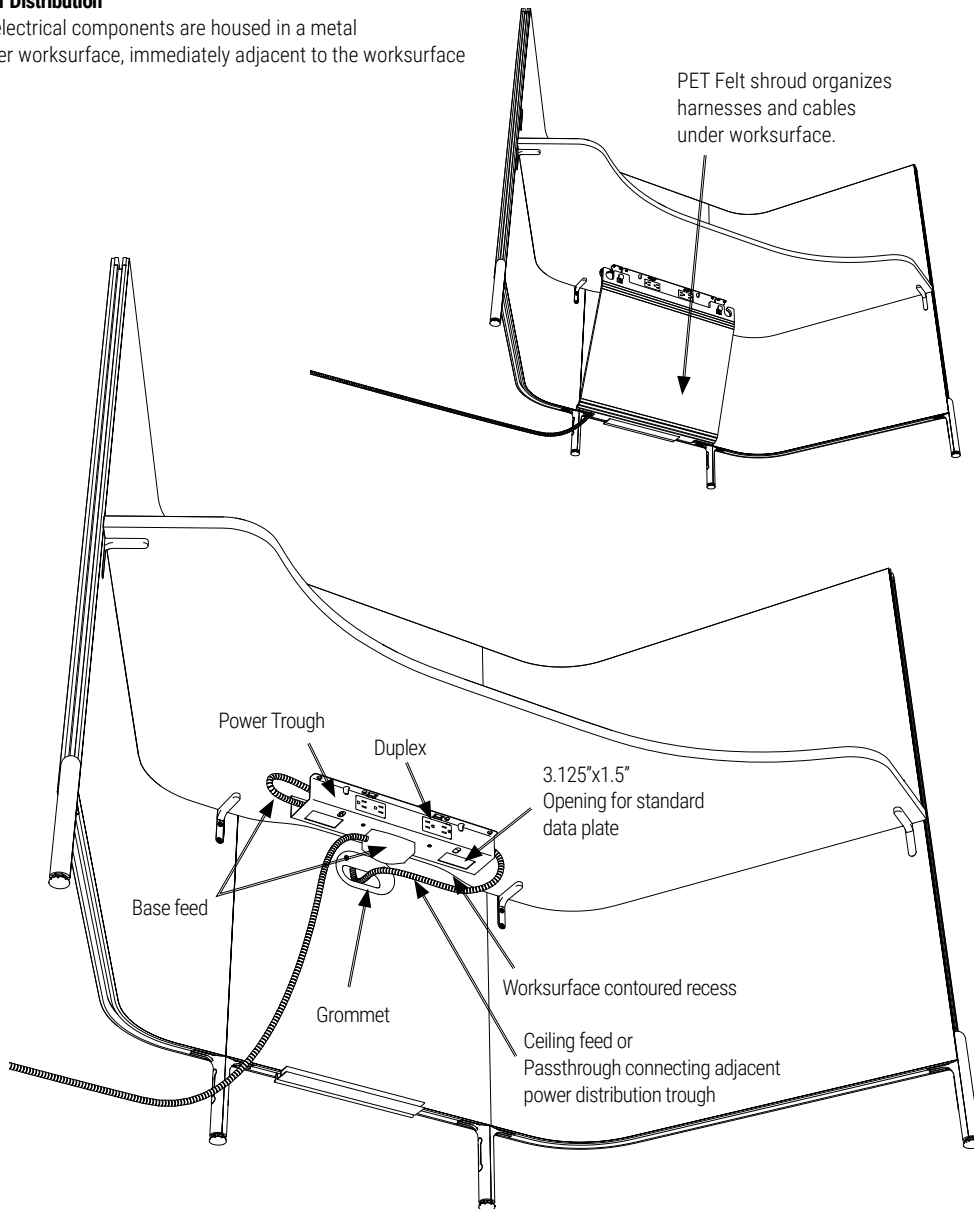

Storage

Hook

For hanging small items like earphones.

Shelf

PET Felt liner with rear hole to direct power cords for charging.

Rear Access

Tuck valuable items out of sight

Bag Drop

Area for storing personal items.

Pantry Storage

Multifunction, customizable storage

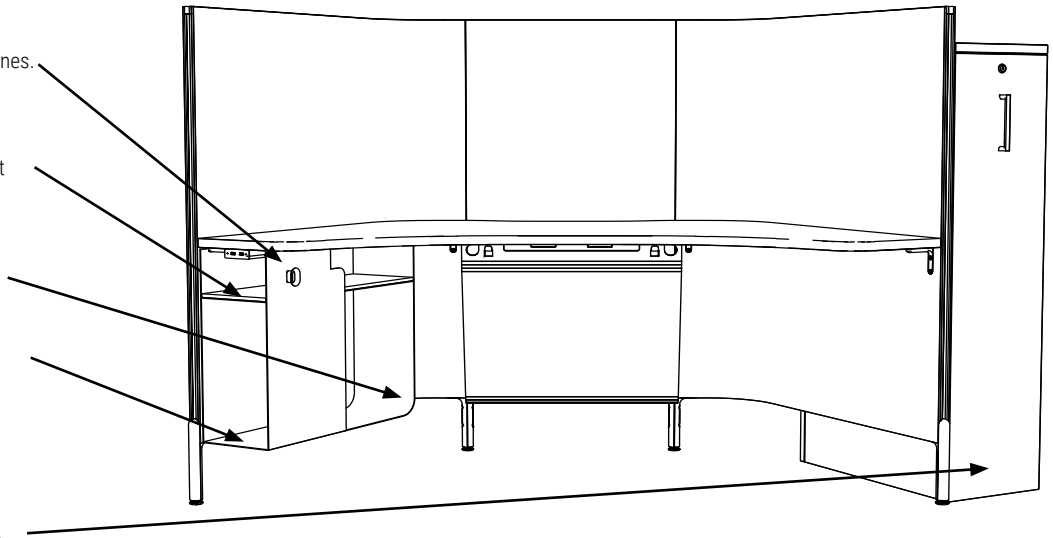

Accessories

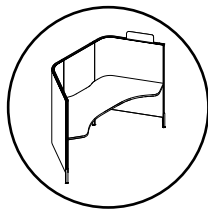
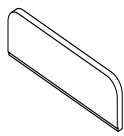

HXNP

Name Plate

Height: 3.5"

Depth: 0.5"

Width: 11"

- Two sided white dry erase surface.

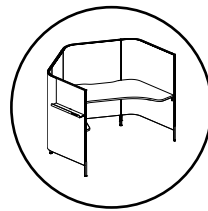
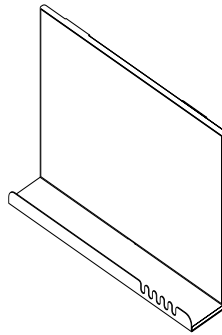

HXAHS

Hanging Shelf

Height: 16"

Depth: 3"

Width: 23.5"

- Optional dry erase board available

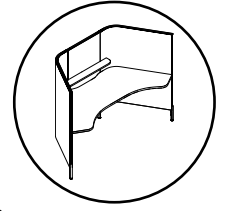
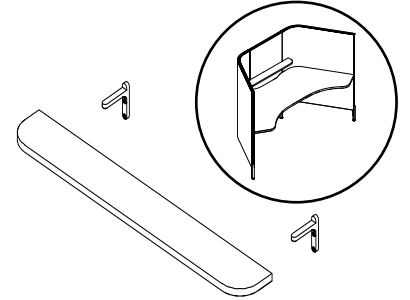

HXARWS

Rear Wall Shelf

Height: 3/4"

Depth: 4.5"

Width: 32.5"

- Laminate

NOTE : Not compatible with Ceiling Feed Pole or any monitor mounts.

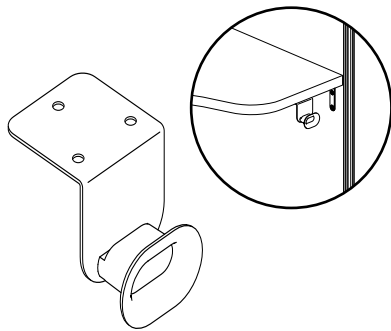

HXABH

Under Surface Bag Hook

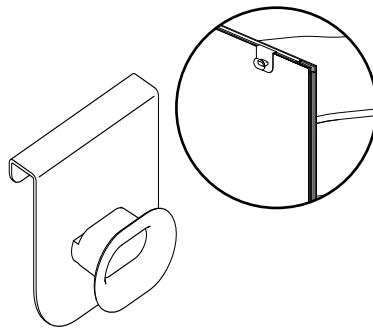

HXACHT

Coat, Bag Hook for horizontal divider edge

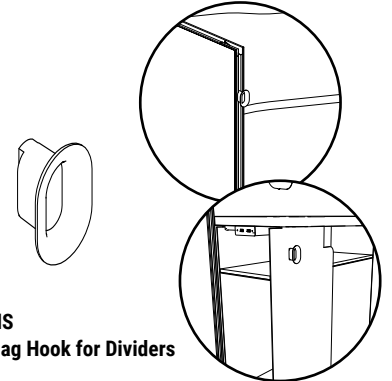

HXACHS

Coat, Bag Hook for Dividers

HX3P5472SW • Softpod with 3 Dividers and Worksurface

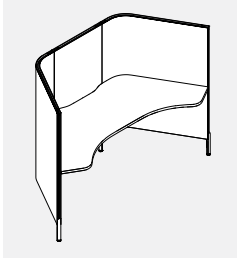

- Complete 3 divider pod consisting of one straight back divider, two side j-dividers and one standard worksurface.
- Installed pod measures 54”h from the floor, 25” from top of surface and has a clearance of 6 3/8” at floor level.
- Dividers are surfaced with tackable PET Felt. Please choose any standard PET Felt color. Interior PET Felt color may be different than the outer.
- The divider perimeter reveal trim accepts privacy extensions and is made of polypropylene available only in CHR - Charcoal.
- Surface choice of LP - low pressure or HP - high pressure laminate with PVC edge. Please choose any standard laminate and PVC edge.
- Metal legs are powder coated paint. Please choose CHR - Charcoal or DWT - Designer White.
- Complete pod includes all connecting hardware, tubular legs and supporting brackets.
- Extensions, electrical, storage and accessories are specified separately.

PRODUCT CODE	PRICE		SIZE/INCHES			WEIGHT	VOL
	LP	HP	H	W	D	LBS	FT ³
HX3P5472SW	2910	3293	54	72	30	141	22.92

HX4P5472SW • Softpod with 4 Dividers and Worksurface



- Complete 4 divider pod consisting of one straight back divider, three side j-dividers and one standard worksurface.
- Installed pod measures 54”h from the floor, 25” from top of surface and has a clearance of 6 3/8” at floor level.
- Dividers are surfaced with tackable PET Felt. Please choose any standard PET Felt color. Interior PET Felt color may be different than the outer.
- The divider perimeter reveal trim accepts privacy extensions and is made of polypropylene available only in CHR - Charcoal.
- Surface choice of LP - low pressure or HP - high pressure laminate with PVC edge. Please choose any standard laminate and PVC edge.
- Metal legs are powder coated paint. Please choose CHR - Charcoal or DWT - Designer White.
- Complete pod includes all connecting hardware, tubular legs and supporting brackets.
- Wing divider can be installed left or right.
- Extensions, electrical, storage and accessories are specified separately.

PRODUCT CODE	PRICE		SIZE/INCHES			WEIGHT	VOL
	LP	HP	H	W	D	LBS	FT ³
HX4P5472SW	3654	4036	54	72	65	170	25.41

HX4P5472R/LW • Softpod with 4 Dividers and Wrap Around Worksurface



Right Hand Shown

- Complete 4 divider pod consisting of one straight back divider, three side j-dividers and one standard wrap around worksurface.
- Installed pod measures 54”h from the floor, 25” from top of surface and has a clearance of 6 3/8” at floor level.
- Dividers are surfaced with tackable PET Felt. Please choose any standard PET Felt color. Interior PET Felt color may be different than the outer.
- The divider perimeter reveal trim accepts privacy extensions and is made of polypropylene available only in CHR - Charcoal.
- Surface choice of LP - low pressure or HP - high pressure laminate with PVC edge. Please choose any standard laminate and PVC edge.
- Metal legs are powder coated paint. Please choose CHR - Charcoal or DWT - Designer White.
- Complete pod includes all connecting hardware, tubular legs and supporting brackets.
- Extensions, electrical, storage and accessories are specified separately.

PRODUCT CODE	PRICE		SIZE/INCHES			WEIGHT	VOL
	LP	HP	H	W	D	LBS	FT ³
HX4P5472RW	3977	4516	54	72	65	185	25.41
HX4P5472LW	3977	4516	54	72	65	185	25.41

HX5P5472SW • Softpod with 5 Dividers and Worksurface

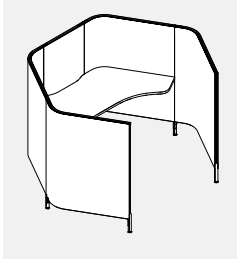

- Complete 5 divider pod consisting of one straight back divider, four side j-dividers and one standard worksurface.
- Installed pod measures 54”h from the floor, 25” from top of surface and has a clearance of 6 3/8” at floor level.
- Dividers are surfaced with tackable PET Felt. Please choose any standard PET Felt color. Interior PET Felt color may be different than the outer.
- The divider perimeter reveal trim accepts privacy extensions and is made of polypropylene available only in CHR - Charcoal.
- Surface choice of LP - low pressure or HP - high pressure laminate with PVC edge. Please choose any standard laminate and PVC edge.
- Metal legs are powder coated paint. Please choose CHR - Charcoal or DWT - Designer White.
- Complete pod includes all connecting hardware, tubular legs and supporting brackets.
- Wing dividers can be installed both on left or right side or one on each side.
- Extensions, electrical, storage and accessories are specified separately.

PRODUCT CODE	PRICE		SIZE/INCHES			WEIGHT	VOL
	LP	HP	H	W	D	LBS	FT ³
HX5P5472SW	4462	4845	54	72	65	198	25.41

HX5P5472WW • Softpod with 5 Dividers and Wrap Around Worksurface

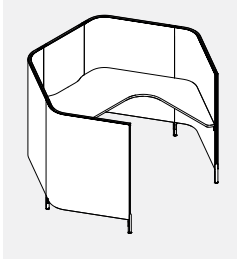

Right Hand Shown

- Complete 5 divider pod consisting of one straight back divider, four side j-dividers and one standard wrap around worksurface.
- Installed pod measures 54”h from the floor, 25” from top of surface and has a clearance of 6 3/8” at floor level.
- Dividers are surfaced with tackable PET Felt. Please choose any standard PET Felt color. Interior PET Felt color may be different than the outer.
- The divider perimeter reveal trim accepts privacy extensions and is made of polypropylene available only in CHR - Charcoal.
- Surface choice of LP - low pressure or HP - high pressure laminate with PVC edge. Please choose any standard laminate and PVC edge.
- Metal legs are powder coated paint. Please choose CHR - Charcoal or DWT - Designer White.
- Complete pod includes all connecting hardware, tubular legs and supporting brackets.
- Extra wing divider can be installed on left or right side.
- Extensions, electrical, storage and accessories are specified separately.

PRODUCT CODE	PRICE		SIZE/INCHES			WEIGHT	VOL
	LP	HP	H	W	D	LBS	FT ³
HX5P5472RW	4739	5277	54	72	65	213.36	25.41
HX5P5472LW	4739	5277	54	72	65	213.36	25.41

HXP5430 • Single J-divider

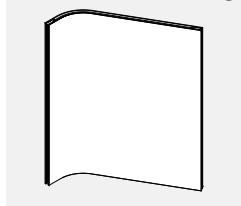

- A single divider is curved; non-handed symmetrical along the horizontal axis.
- J-dividers are surfaced with tackable PET Felt. Please choose any standard PET Felt color. Interior PET Felt color may be different than the outer.
- Installed pod measures 54”h from the floor, 25” from top of surface and has a clearance of 6 3/8” at floor level.
- The divider perimeter reveal trim accepts privacy extensions and is made of polypropylene available only in CHR - Charcoal.
- J-divider comes complete with top connector kit, shared leg kit and trim.
- If a Single J-divider is ordered as an add-on to a previous order, the PET Felt finish may or may not match based on dyelot and fading.
- Single J-divider is not intended to be used alone without a complete kit including a work surface due to stability and connectivity constraints.

PRODUCT CODE	PRICE GR1	SIZE/INCHES			WEIGHT LBS	VOL FT ³
		H	W	D		
HXP5430AP	833	54	30	6	28.3	16.17

HXPAEFE • End PET Felt Extension Divider Add-on

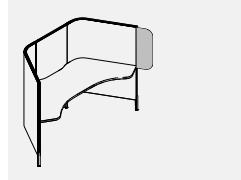

- Designed to add 8.7” of additional privacy at the end of the divider.
- Fits into the base divider perimeter reveal and placement is user oriented.
- PET Felt divider surface is tackable. Choose from standard PET finishes.
- NOTE : Not available with a perforated pattern.

PRODUCT CODE	PRICE	SIZE/INCHES			WEIGHT LBS	VOL FT ³
		H	W	D		
HXPAEFE	40	25.4	9.3	0.35	0.63	0.05

HXPACFE • Corner PET Felt Extension Divider Add-on

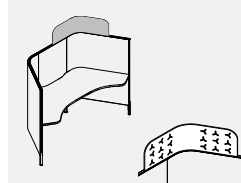

- Designed to add 11.1” of additional privacy at the top corner of the divider.
- Fits into the base divider perimeter reveal and placement is user oriented.
- Installed station with Corner PET Felt Extension Divider Add-on installed measures 65” from floor, 36” from top of worksurface.
- PET Felt divider surface is tackable. Choose from standard PET finishes.
- Perforated pattern option available, shown with “P” at the end of the code.

PRODUCT CODE	PRICE	SIZE/INCHES			WEIGHT LBS	VOL FT ³
		H	W	D		
HXPACFE	71	11.687	38.3	0.35	1.16	0.09
HXPACFEP	142	11.687	38.3	0.35	1.16	0.09

HXPATCFE • Top Corner PET Felt Extension Divider Add-on

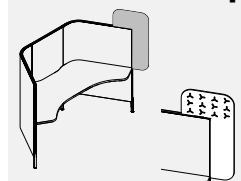

- Designed to add 8.7” of additional privacy to the top of the divider and 11.1” at the end of the divider.
- Fits into the base divider perimeter reveal and placement is user oriented.
- Installed station with Corner PET Felt Extension Divider Add-on installed measures 65” from floor, 36” from top of worksurface.
- PET Felt divider surface is tackable. Choose from standard PET finishes.
- Perforated pattern option available, shown with “P” at the end of the code.

PRODUCT CODE	PRICE	SIZE/INCHES			WEIGHT LBS	VOL FT ³
		H	W	D		
HXPATCFE	77	37.1”	19.5	0.35	1.25	0.15
HXPATCFEP	154	37.1”	19.5	0.35	1.25	0.15

GMDPC22W • Slim Desktop Power Module, 2 Simplex

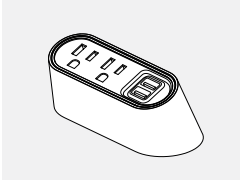

- Desktop power center with two 15A tamper resistant power receptacles, one USB-A and one USB-C (provides 3.1A); 10' power cord.
- Includes three mounting options (i) a screw-in mounting plate for forward facing outlets; or (ii) an under surface mount bracket; or (iii) a clamp mounting kit for 0.5-1.5" thick surfaces.
- Gloss white body with grey face.

PRODUCT CODE	PRICE	SIZE/INCHES			WEIGHT LBS	VOL FT ³
		H	W	D		
GMDPC22W	494	2.25	4.88	2.25	2.5	0.5

GMDPC32W • Slim Desktop Power Module, 3 Simplex

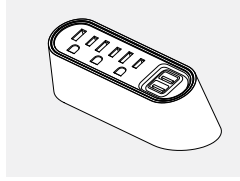

- Desktop power center with three 15A tamper resistant power receptacles, one USB-A and one USB-C (provides 3.1A); 10' power cord.
- Includes three mounting options (i) a screw-in mounting plate for forward facing outlets; or (ii) an under surface mount bracket; or (iii) a clamp mounting kit for 0.5-1.5" thick surfaces.
- Gloss white body with grey face.

PRODUCT CODE	PRICE	SIZE/INCHES			WEIGHT LBS	VOL FT ³
		H	W	D		
GMDPC32W	645	2.25	6.00	2.25	2.6	0.5

BRED50 • Duo Module, 2 Simplex

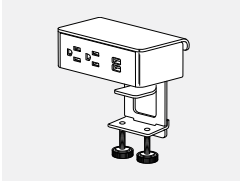

- The duo power module is completely integrated with a mounting clamp to attach to the edge of a worksurface.
- Provides two outlets and two 2.1 amp USB ports.
- White face plate, outlets and bracket; 72" long three-prong cord.

PRODUCT CODE	PRICE	SIZE/INCHES			WEIGHT LBS	VOL FT ³
		H	W	D		
BRED50	615	1.8	5.5	3.2	2.5	0.14

BRETP53 • Trio Plus Module, 3 Simplex

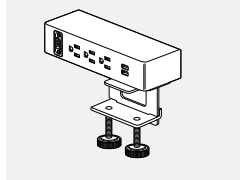

- The trio plus power module is completely integrated with a mounting clamp to attach to the edge of a work surface or above worksurface shelves.
- Provides three outlets and two 2.1 amp USB ports and an adapter kit containing blank cover, HDMI, RJ45 or VGA adapter brackets.
- Note: HDMI, RJ45 and VGA connectors are not included.
- White face plate, outlets, adapters and brackets; 72" long three-prong cord.

PRODUCT CODE	PRICE	SIZE/INCHES			WEIGHT LBS	VOL FT ³
		H	W	D		
BRETP53	693	1.8	8	3.2	2.5	0.14

HXEUWC • Under Worksurface/ Edge USB Charger

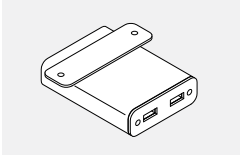

- Under surface table mounted module - dual USB (A&C) charging ports.
- Consists of one 15 watt USB C charging outlet and one 2.1 amp USB A charging outlet.
- Unit has white housing, white powder coated mounting bracket and white electrical cord.

PRODUCT CODE	PRICE	SIZE/INCHES			WEIGHT LBS	VOL FT ³
		H	W	D		
HXEUWC	367	1	3	4	0.31	0.01

GAADG • Access Door Module

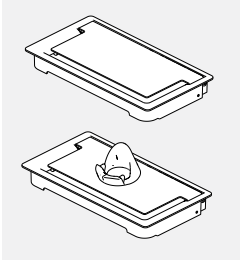

- Soft close door is set back from edge to allow for cable pass thru.
- Available in all standard divider frame finishes.
- GAADGDH includes device holder for most mobilephones or tablets. Holder is only available in white.
- FreeFit can only accommodate one grommet per worksurface.

PRODUCT CODE	PRICE	SIZE/INCHES			WEIGHT LBS	VOL FT ³
		H	D	W		
GAADG	58	1.08	5.54	10.09	2	0.04
GAADGDH	63	1.08	5.54	10.09	2	0.04

GAADCT • Access Door Module with Cable Tray

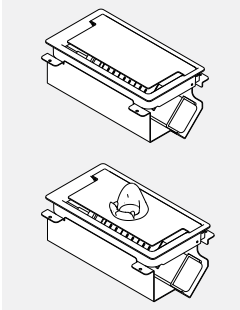

- Soft close door is set back from edge to allow for cable pass thru when closed.
- Cable tray comes one standard telcom knock out and a platform to mount a powerbar.
- Sides are open for easy access.
- Available in all standard divider frame finishes.
- GAADCTDH includes device holder for most mobile phones or tablets. Holder is only available in white.
- FreeFit can only accommodate one grommet per worksurface

PRODUCT CODE	PRICE	SIZE/INCHES			WEIGHT LBS	VOL FT ³
		H	D	W		
GAADCT	92	5.07	5.54	10.09	4	0.19
GAADCTDH	100	5.07	5.54	10.09	4	0.19

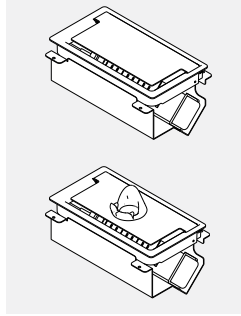
GAADCTPD • Access Door Module with Cable Tray and Power Bar

- Access door module with cable tray and power bar.
- Powerbar with 3 simplex and 2 USB, CSA Certified.
- Soft close door is set back from edge to allow for cable pass thru when closed.
- Cable tray comes one standard telcom knock out and a platform to mount a powerbar.
- Sides are open for easy access.
- Housing Paint Finish - TBD
- GAADCTPDDH includes device holder for most mobile phones or tablets.
- Holder is only available in white.
- One grommet per worksurface.

PRODUCT CODE	PRICE	SIZE/INCHES			WEIGHT LBS	VOL FT ³
		H	D	W		
GAADCTPD	202	6.96	5.54	10.09	4	0.20
GAADCTPDDH	206	6.96	5.54	10.09	4	0.20

ModPower Daisy Chain Solution

- Adds flexible power and USB charging to work surfaces.
- Connects up to four units with a single corded infeed with NEMA plug.
- ModPower units are sold separately.
- Begin the run with a starter unit which includes a coded infeed. Add additional middle or end units as required.
- Middle and end units are equipped with connecting cables.
- In-surface modules require table top cut-outs for mounting. Please specify TR - Top Right and/or TL - Top Left.

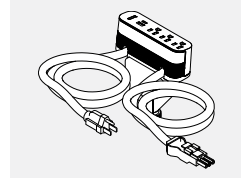
GMDSA10 • ModPower Starter Mounted Unit

- ModPower starter unit includes one 10' cord with a NEMA plug and one 3' connector cord.
- Unit equipped with three 15A tamper resistant receptacles, one USB-A and one USB-C charging ports and a circuit breaker.
- Includes edge clamp and 3 other mounting methods; and 4 cable management cord clips.
- MG at the end of the code indicates a magnesium finish, while WH is a white finish.

PRODUCT CODE	PRICE	H	W	D	WEIGHT LBS	VOL FT ³
GMDSA10WH	806	6.13	1.75	2.5	4.33	1.0

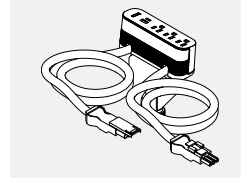
GMDCA3 • ModPower Middle Mounted Unit

- ModPower middle unit includes two 3' connector cords.
- Unit equipped with three 15A rated 12A tamper resistant receptacles, one USB-A and one USB-C charging ports and a circuit breaker.
- Includes edge clamp and 3 other mounting methods; and 4 cable management cord clips.
- MG at the end of the code indicates a magnesium finish, while WH is a white finish.

PRODUCT CODE	PRICE	H	W	D	WEIGHT LBS	VOL FT ³
GMDCA3WH	763	6.13	1.75	2.5	3.33	1.0

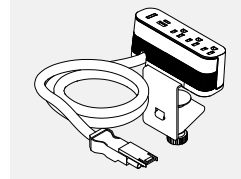
GMDEA3 • ModPower End Mounted Unit

- ModPower end unit includes one 3' connector cord.
- Unit equipped with three 15A rated 12A tamper resistant receptacles, one USB-A and one USB-C charging ports and a circuit breaker.
- Includes edge clamp and 3 other mounting methods; and 2 cable management cord clips.
- MG at the end of the code indicates a magnesium finish, while WH is a white finish.

PRODUCT CODE	PRICE	H	W	D	WEIGHT LBS	VOL FT ³
GMDEA3WH	675	6.13	1.75	2.5	2.75	1.0

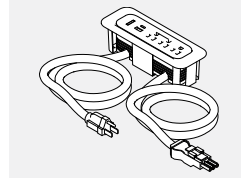
GMDSF10 • ModPower In Surface Starter Unit

- ModPower starter unit includes one 10' cord with a NEMA plug and one 3' connector cord.
- Unit equipped with three 15A tamper resistant receptacles, one USB-A and one USB-C charging ports and a circuit breaker.
- 4 cable management cord clips included.
- MG at the end of the code indicates a magnesium finish, while WH is a white finish.

PRODUCT CODE	PRICE	H	W	D	WEIGHT LBS	VOL FT ³
GMDSF10WH	597	2.63	7.63	2.63	3.44	1.0

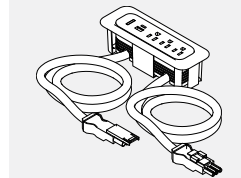
GMDCF3 • ModPower In Surface Middle Unit

- ModPower middle unit includes two 3' connector cords.
- Unit equipped with three 15A rated 12A tamper resistant receptacles, one USB-A and one USB-C charging ports and a circuit breaker.
- 4 cable management cord clips included.
- MG at the end of the code indicates a magnesium finish, while WH is a white finish.

PRODUCT CODE	PRICE	H	W	D	WEIGHT LBS	VOL FT ³
GMDCF3WH	562	2.63	7.63	2.63	2.44	1.0

GMDEF3 • ModPower In Surface End Unit

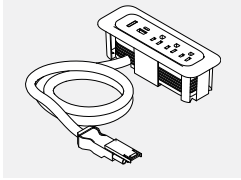

- ModPower end unit includes one 3' connector cord.
- Unit equipped with three 15A rated 12A tamper resistant receptacles, one USB-A and one USB-C charging ports and a circuit breaker.
- 2 cable management cord clips included.
- MG at the end of the code indicates a magnesium finish, while WH is a white finish.

PRODUCT CODE	PRICE	SIZE/INCHES			WEIGHT		VOL FT ³
		H	W	D	LBS		
GMDEF3MG	494	2.63	7.63	2.63	1.85	1.0	
GMDEF3WH	494	2.63	7.63	2.63	1.85	1.0	

GMDCLIPS • ModPower Management Clips

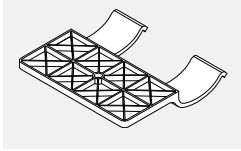

- Includes 10 clips.

PRODUCT CODE	PRICE	SIZE/INCHES			WEIGHT		VOL FT ³
		H	W	D	LBS		
GMDCLIPS	131	2.6	2.5	0.6	0.3	0.2	

GMDJ36BK • ModPower Interconnecting Jumper

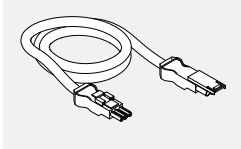

- ModPower interconnecting jumper cord to add an additional 3 feet of cord length between ModPower units.
- Package of 2, each 3 feet with male & female connector.

PRODUCT CODE	PRICE	SIZE/INCHES			WEIGHT		VOL FT ³
		H	W	D	LBS		
GMDJ36BK	422	36			1.38	0.9	

HXEPK • Station 2-Circuit Power Kit

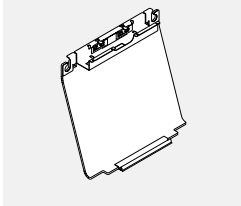

- Station 2-Circuit Power Kit consists of two duplexes, trough, cable shroud and divider grommet.
- Accommodates up to two standard data plates (plates not included).
- Accommodates center mount single or dual screen monitor arm.
- Facilitates 2-circuit power delivery.
- Facilitates interconnection of two stations. Please specify Station to Station Jumper.
- Specify duplex circuit #1, #2 or combination #1+2.
- Ceiling or base feed not included, please specify separately.
- Trough is powder coated metal in CHR - Charcoal.
- Includes all connecting hardware, supporting brackets and through divider grommet.
- PET Felt finish, please chose from any standard PET Felt.

PRODUCT CODE	PRICE	SIZE/INCHES			WEIGHT		VOL FT ³
		H	W	D	LBS		
HXEPK11	311	20.85	23.5	9.73	3.92	2.76	
HXEPK12	311	20.85	23.5	9.73	3.92	2.76	
HXEPK22	311	20.85	23.5	9.73	3.92	2.76	

HXECS • Cable Shroud

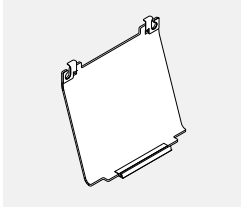

- Cable shroud secures to the bottom of worksurface and clips to the bottom of straight section of any divider.
- Includes all connecting hardware.
- PET Felt finish, please chose from any standard PET Felt.

PRODUCT CODE	PRICE	SIZE/INCHES			WEIGHT		VOL FT ³
		H	W	D	LBS		
HXECS	76	1	22	8	1.62	2.87	

HXEPPJ • Station to Station Jumper

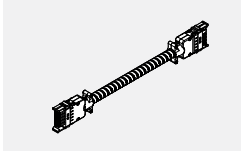

- Station to station jumper.
- Facilitates interconnection of two stations (through divider grommet, under the worksurface).

PRODUCT CODE	PRICE	SIZE/INCHES			WEIGHT		VOL FT ³
		H	W	D	LBS		
HXEPPJ	120	2	60	2	5	0.13	

HXEBF • Base Feed

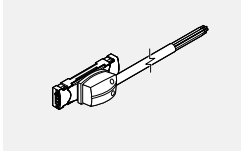

- Base feed provides single power entry from floor into 2-Circuit Power Kit under worksurface.
- 6' long liquid tight whip; ready to be hardwired to building power supply.

PRODUCT CODE	PRICE	SIZE/INCHES			WEIGHT		VOL FT ³
		H	W	D	LBS		
HXEBF	263	2	72	2	5.6	0.06	

HXECEF • Ceiling Feed

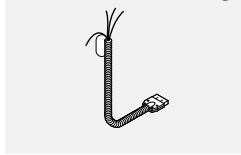

- Ceiling feed plugs into left or right duplex mounted within the 2-Circuit Power Kit.
- 10' long metal conduit, ready to be hardwired to building power supply.
- Strain relief fitting provided; junction box is not included.
- To be used with HXECFP - Ceiling Feed Pole

PRODUCT CODE	PRICE	SIZE/INCHES			WEIGHT LBS	VOL FT ³
		H	W	D		
HXECEF	178	2	144	2	5.6	0.06

HXECFP • Ceiling Feed Pole

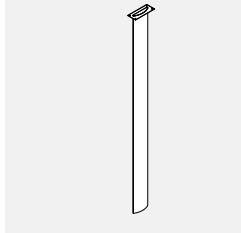

- Ceiling Feed Pole manages power and data cables between ceiling and worksurface.
- Aluminum extrusion with PVC cover secures to the divider grommet and passes below worksurface through the worksurface contoured recess.
- Mounting hardware and ceiling bezel included.
- Hardware for securing the pole above ceiling tile is not included.
- Please specify standard paint finish.
- PVC colour CHR - Charcoal.
- Ceiling Feed HXECEF must be ordered separately.

PRODUCT CODE	PRICE	SIZE/INCHES			WEIGHT LBS	VOL FT ³
		H	W	D		
HXECFP	150	116	6	1.5	5.49	0.38

HXEPGK • Divider Grommet Kit

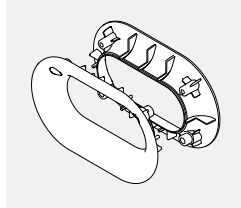

- Divider Grommet Kit facilitates passage of wires through any Softpod divider.
- Can be located either below or above the worksurface.
- Installed on site; no need to order special dividers.
- Powder coated die-cast aluminum divider grommet - specify CHR - Charcoal or WHT (OR DWT)

PRODUCT CODE	PRICE	SIZE/INCHES			WEIGHT LBS	VOL FT ³
		H	W	D		
HXEPGK	29	3.25	5.5	2.75	0.27	0.02

HXEPGCS • Divider Grommet Connector / Spacer

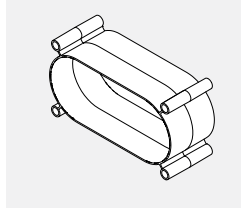

- Divider Grommet Spacer converts any Divider Grommet Kit into a connector.
- Clamps two dividers together through the divider grommet opening.
- Can be located above or below the worksurface at pre-determined locations.
- Specify with the Divider Grommet Kit or use with the Divider Grommet Kit included in the Station 2-Circuit Power Kit.
- Made of injection molded ABS in CHR - Charcoal.
- For Dual Pod connection, only 1 HXEPGK is needed.

PRODUCT CODE	PRICE	SIZE/INCHES			WEIGHT LBS	VOL FT ³
		H	W	D		
HXEPGCS	13	3.25	5.5	2.75	0.04	0.01

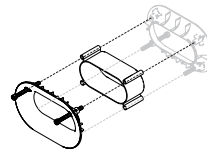

HXSCSO • Under Worksurface Casual Storage Unit

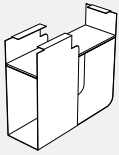

- Open storage with shelf; extension at the back provides side compartment.
- Sheet metal construction with PET liner; 24" deep
- Secured to the bottom of worksurface.
- Choose from standard PET and panel frame finishes.
- Order coat hook HXACHS, attaches to either left or right side of storage unit (sold separately).

PRODUCT CODE	PRICE	SIZE / INCHES				WEIGHT		VOL FT ³
		H	W	D	LBS			
HXSCSO	327	21	8	24	20.18	4.22		

L2PO • Pantry Storage

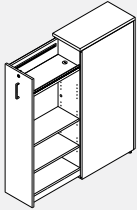

Left Hand Shown

- The pull out cabinet serves as a multifunction, customizable storage unit that both defines space and enhances privacy in an open plan environment.
- Can be used in conjunction with Licence, Bridges, FreeFit and Boulevard.
- Internal organization consists of two fixed shelves top and bottom. The two middle shelves are adjustable. Two accessory rails are standard and will accept GC metal accessories
- Interior cabinet shelves and back are standard in Designer White. Cabinet shell, drawer and top can be specified in any standard laminate.
- L2PO-NL/R does not fit binders.
- Only available with FA handle.

PRODUCT CODE	PRICE LP	B	W	SIZE / INCHES				WEIGHT		VOL FT ³
				H (LP/B)	H (W)	W	D	LBS		
L2PO1224H54NL	1642	1659	1690	53.56	54	12	24	138	9	
L2PO1230H54NL	1720	1740	1760	53.56	54	12	30	153	11	
L2PO1236H54NL	1799	1823	1849	53.56	54	12	36	167	14	
L2PO1824H54NL	1904	1928	1970	53.56	54	18	24	166	14	
L2PO1830H54NL	1989	2020	2069	53.56	54	18	30	182	17	
L2PO1836H54NL	2075	2110	2168	53.56	54	18	36	197	20	
L2PO1224H54NR	1642	1659	1690	53.56	54	12	24	138	9	
L2PO1230H54NR	1720	1740	1760	53.56	54	12	30	153	11	
L2PO1236H54NR	1799	1823	1849	53.56	54	12	36	167	14	
L2PO1824H54NR	1904	1928	1970	53.56	54	18	24	166	14	
L2PO1830H54NR	1989	2020	2069	53.56	54	18	30	182	17	
L2PO1836H54NR	2075	2110	2168	53.56	54	18	36	197	20	

Finish

While the Pantry Storage cabinet walls, top and pull-out drawer front door and back panel finish can be specified, the internal cabinet back and adjustable shelves are standard white. Please specify the cabinet top and pull-out drawer front finish.

Options

- Dual USB outlet kit - please add "USB" at the end of the code. Add \$377 to the list price
- When you specify dual USB outlet the top shelf will come with grey PET Felt surface and grommet which allows for cable passage from the USB outlet (located below the top shelf). A two-prong power cord exits the cabinet through the floor at the back.
- Dry-erase marker board - Choose "DE" option. Please add \$266 to the list price. If specified the Dry-erase marker laminate will be applied to the external surface of the pull-out drawer side wall.

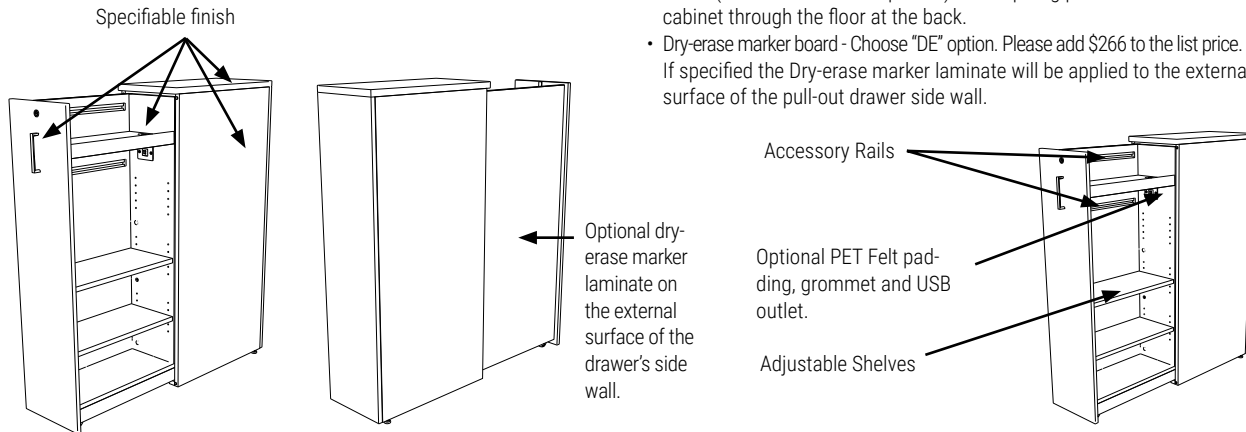

Integrated Accessory rails

Two accessory rails (each 18.25" long) are provided to further enhance customization with Global Contract metal accessories.

Upper Accessory Rail:

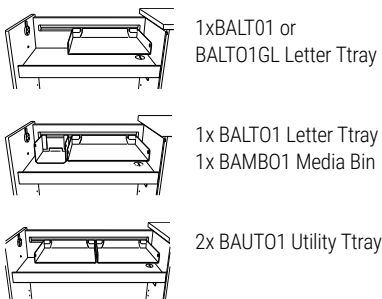

Lower Accessory Rail:

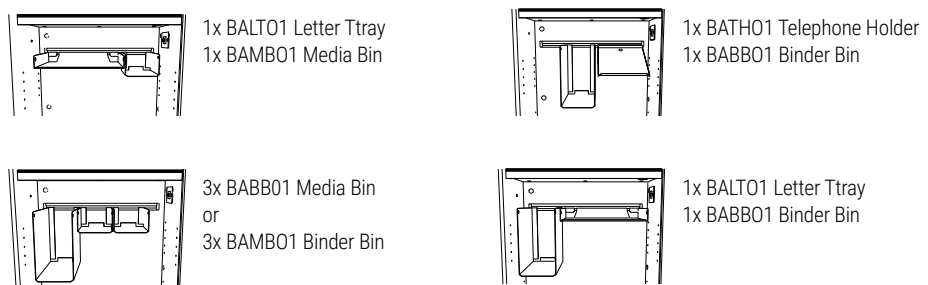

L2PW • Wardrobe Pantry Storage

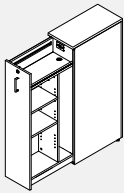

Left Hand Shown

- The pull out cabinet serves as a multifunction, customizable storage unit that both defines space and enhances privacy in an open plan environment.
- Can be used in conjunction with Licence,, FreeFit and Boulevard.
- Internal organization consists of one fixed shelf at the top. The two middle shelves are adjustable. Wardrobe includes coat hook.
- Interior cabinet shelves and back are standard in Designer White. Cabinet shell, drawer and top can be specified in any standard laminate.
- L2PW-NL/R does not fit binders.
- Only available with FA handle.

Finish

While the Pantry Storage cabinet walls, top and pull-out drawer front door and back panel finish can be specified, the internal cabinet back and adjustable shelves are standard white. Please specify the cabinet top and pull-out drawer front finish.

Options

- Dual USB outlet kit - please add "USB" at the end of the code. Add \$512 to the list price
- When you specify dual USB outlet the top shelf will come with grey felt surface and grommet which allows for cable passage from the USB outlet (located below the top shelf). A two-prong power cord exits the cabinet through the floor at the back.
- Dry-erase marker board - Choose "DE" option. Please add \$361 to the list price. If specified the Dry-erase marker laminate will be applied to the external surface of the pull-out drawer side wall.

PRODUCT CODE	PRICE		SIZE/INCHES				WEIGHT		VOL FT³
	LP	B	W	H (LP/B)	H (W)	W	D	LBS	
L2PW1224H42NL	1631	1649	1684	41.56	42	12	24	128	7
L2PW1230H42NL	1706	1728	1769	41.56	42	12	30	143	9
L2PW1236H42NL	1779	1806	1855	41.56	42	12	36	157	11
L2PW1824H42NL	1889	1917	1963	41.56	42	18	24	156	11
L2PW1830H42NL	1972	2006	2062	41.56	42	18	30	172	13
L2PW1836H42NL	2054	2095	2160	41.56	42	18	36	187	16
L2PW1224NL	1778	1794	1825	49.56	50	12	24	133	8
L2PW1230NL	1856	1888	1914	49.56	50	12	30	148	10
L2PW1236NL	1935	1981	2004	49.56	50	12	36	162	15
L2PW1824NL	2078	2110	2143	49.56	50	18	24	161	12
L2PW1830NL	2162	2215	2243	49.56	50	18	30	177	15
L2PW1836NL	2248	2318	2342	49.56	50	18	36	192	18
L2PW1224H54NL	1812	1829	1860	53.56	54	12	24	138	9
L2PW1230H54NL	1890	1910	1930	53.56	54	12	30	153	11
L2PW1236H54NL	1969	1993	2019	53.56	54	12	36	167	14
L2PW1824H54NL	2118	2142	2184	53.56	54	18	24	166	14
L2PW1830H54NL	2203	2234	2283	53.56	54	18	30	182	17
L2PW1836H54NL	2289	2324	2382	53.56	54	18	36	197	20
L2PW1224H42NR	1493	1511	1546	41.56	42	12	24	128	7
L2PW1230H42NR	1706	1728	1769	41.56	42	12	30	143	9
L2PW1236H42NR	1779	1806	1855	41.56	42	12	36	157	11
L2PW1824H42NR	1854	1882	1928	41.56	42	18	24	156	11
L2PW1830H42NR	1972	2006	2062	41.56	42	18	30	172	13
L2PW1836H42NR	2054	2095	2160	41.56	42	18	36	187	16
L2PW1224NR	1778	1794	1825	49.56	50	12	24	133	8
L2PW1230NR	1856	1888	1914	49.56	50	12	30	148	10
L2PW1236NR	1935	1981	2004	49.56	50	12	36	162	15
L2PW1824NR	2078	2110	2143	49.56	50	18	24	161	12
L2PW1830NR	2162	2215	2243	49.56	50	18	30	177	15
L2PW1836NR	2248	2318	2342	49.56	50	18	36	192	18
L2PW1224H54NR	1812	1829	1860	53.56	54	12	24	138	9
L2PW1230H54NR	1890	1910	1930	53.56	54	12	30	153	11
L2PW1236H54NR	1969	1993	2019	53.56	54	12	36	167	14
L2PW1824H54NR	2118	2142	2184	53.56	54	18	24	166	14
L2PW1830H54NR	2203	2234	2283	53.56	54	18	30	182	17
L2PW1836H54NR	2289	2324	2382	53.56	54	18	36	197	20

Specifiable finish

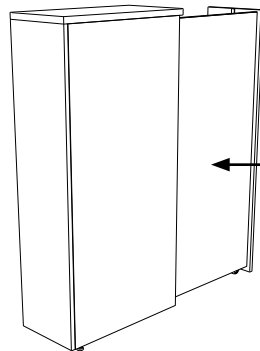
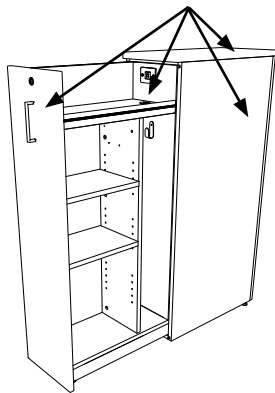

Optional dry-erase marker laminate on the external surface of the drawer's side wall.

Optional felt padding, grommet and USB outlet.

Coathook

Adjustable Shelves

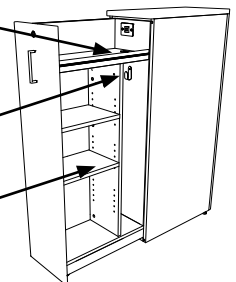

BLVELEDVS • LED Single Arm Lamp

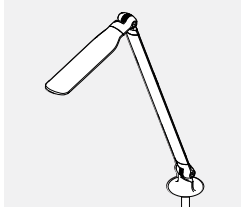

- **7 System watts, 18-fractional LEDs.**
- 3500K 250 lumens, 84 CRI.
- Soft touch - instant on, fade to off.
- Infinite dimming 100% down to 15%, last state memory.
- Standard 10 hours turn off (ATO).
- 50,000 hour life LEDs.
- 15 watt, 24 volt wall transformer, 6' cord.
- White (WHT) Silver (SIL) or Black (BLK) - Must specify colour choice.
- UL, CUL and CSA compliant, ETL Listed.
- Base not included.

PRODUCT CODE	PRICE	SIZE/ H	INCHES W	D	WEIGHT LBS	VOL FT ³
BLVELEDVS	616				3	0.93
With Occupancy Sensor						
BLVELEDVSO	920				3	0.93

BLVELEDVD • LED Double Arm Lamp

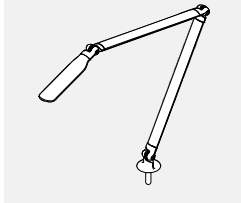

- **7 System watts, 18-fractional LEDs.**
- 3500K 250 lumens, 84 CRI.
- Double arm articulation with 20" base to head reaches.
- Soft touch - instant on, fade to off.
- Infinite dimming 100% down to 15%, last state memory.
- Standard 10 hours turn off (ATO).
- 50,000 hour life LEDs.
- 15 watt, 24 volt wall transformer, 6' cord.
- White (WHT) Silver (SIL) or Black (BLK) - Must specify colour choice.
- UL, CUL and CSA compliant, ETL Listed.
- Base not included.

PRODUCT CODE	PRICE	SIZE/ H	INCHES W	D	WEIGHT LBS	VOL FT ³
BLVELEDVD	646				3	0.93
With Occupancy Sensor						
BLVELEDVDO	931				3	0.93

BLVELEDRS • LED Single Arm Lamp

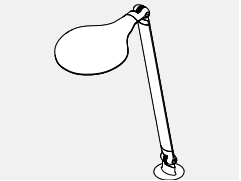

- **7 System watts, 18-fractional LEDs.**
- 3500K 250 lumens, 84 CRI.
- Soft touch - instant on, fade to off.
- Infinite dimming 100% down to 15%, last state memory.
- Standard 10 hours turn off (ATO).
- 50,000 hour life LEDs.
- 15 watt, 24 volt wall transformer, 6' cord.
- White (WHT) Silver (SIL) or Black (BLK) - Must specify colour choice.
- UL, CUL and CSA compliant, ETL Listed.
- Base not included.

PRODUCT CODE	PRICE	SIZE/ H	INCHES W	D	WEIGHT LBS	VOL FT ³
BLVELEDRS	616				3	0.93
With Occupancy Sensor						
BLVELEDRSO	920				3	0.93

BLVELEDRD • LED Double Arm Lamp

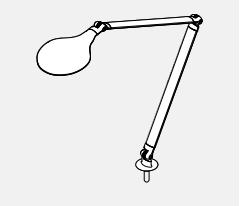

- **7 System watts, 18-fractional LEDs.**
- 3500K 250 lumens, 84 CRI.
- Double arm articulation with 20" base to head reaches.
- Soft touch - instant on, fade to off.
- Infinite dimming 100% down to 15%, last state memory.
- Standard 10 hours turn off (ATO).
- 50,000 hour life LEDs.
- 15 watt, 24 volt wall transformer, 6' cord.
- White (WHT) Silver (SIL) or Black (BLK) - Must specify colour choice.
- UL, CUL and CSA compliant, ETL Listed.
- Base not included.

PRODUCT CODE	PRICE	SIZE/ H	INCHES W	D	WEIGHT LBS	VOL FT ³
BLVELEDRD	633				3	0.93
With Occupancy Sensor						
BLVELEDRDO	931				3	0.93

Lamp Mounting Options

- White (WHT) Silver (SIL) or Black (BLK) - Must specify colour choice.

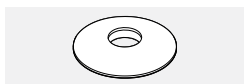

Worksurface Clamp Mount

PRODUCT CODE	PRICE	SIZE/ H	INCHES W	D	WEIGHT LBS	VOL FT ³
BLVELEDASCM	155				1	0.05

Freestanding Base

PRODUCT CODE	PRICE	SIZE/ H	INCHES W	D	WEIGHT LBS	VOL FT ³
BLVELEDAFS	173				3	0.5

HXAHS • Hanging Shelf

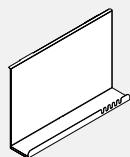

- Hanging Shelf for personal item storage.
- Suspended from the divider's top reveal.
- Installed board measures 16" from top; 9" from top of worksurface.
- Painted metal, choose from standard panel frame finishes.
- Choose a PET Felt finish for the tray insert.

PRODUCT CODE	PRICE			WEIGHT LBS	VOL FT ³	
	H	W	D			
HXAHS	104	16	23.5	3	8.8	1.91

HXAHSWB • Hanging Shelf with Dry Erase Board

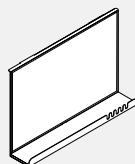

- Hanging shelf with, dry-erase marker surface.
- Suspended from the divider's top reveal.
- Installed board measures 16" from top; 9" from top of worksurface.
- White surface, painted metal frame; choose from standard panel frame finishes.
- Choose a PET Felt finish for the tray insert.

PRODUCT CODE	PRICE			WEIGHT LBS	VOL FT ³	
	H	W	D			
HXAHSWB	398	16	23.5	3	9.57	1.91

HXARWS • Rear Wall Shelf



- Rear wall laminate shelf.
- Made of 3/4" LP- low pressure or HP - high pressure; non-handed, with pre-determined mounting points.
- 2.5" front radii.
- Choose from standard laminate finishes, PVC edge.
- NOTE: Not compatible with Ceiling Feed Pole or any monitor mounts.

PRODUCT CODE	PRICE			WEIGHT LBS	VOL FT ³	
	LP	HP	H			W
HXARWS	106	135	0.75	32.25	4.5	1.13

HXACHS • Coat/Bag Hook for Dividers

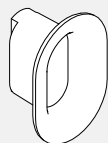

- Coat/Bag Hook can be installed anywhere along the divider perimeter reveal or either side of the Under Surface Casual Storage Unit.
- Made of die-cast aluminum, specify any standard metal paint finish.
- Choose a PET Felt finish for the plug insert.

PRODUCT CODE	PRICE			WEIGHT LBS	VOL FT ³	
	H	W	D			
HXACHS	30	2	1.25	0.75	0.05	0.01

HXACHT • Coat/Bag Hook for Dividers Edge

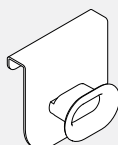

- Coat/Bag Hook can be installed anywhere along the divider perimeter reveal or either or both sides of any divider.
- Made of die-cast aluminum with steel brackets, specify any standard metal paint finish.
- Choose a PET Felt finish for the plug insert.

PRODUCT CODE	PRICE			WEIGHT LBS	VOL FT ³	
	H	W	D			
HXACHT	35	2	1.25	0.75	0.23	0.01

HXABH • Under Surface Bag Hook

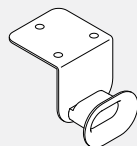

- Under Surface Bag Hook can be secured to the bottom of worksurface.
- Made of die-cast aluminum with steel brackets, specify any standard metal paint finish.
- Choose a PET Felt finish for the plug insert.

PRODUCT CODE	PRICE			WEIGHT LBS	VOL FT ³	
	H	W	D			
HXABH	33	2	1.25	0.75	0.18	0.01

HXNP • Name Plate

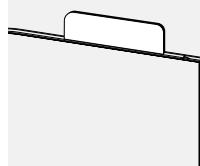

- Name Plate sits inside the divider top reveal.
- Two-sided white dry erase surface laminated to 1/2" PET Felt.

PRODUCT CODE	PRICE			WEIGHT LBS	VOL FT ³
	H	W	D		
HXNP	60	3.625	10.75	0.5	0.01

GCPPVACH • Universal Polypropylene Divider Panels - H Configuration

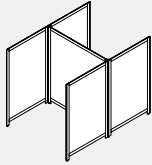

• **Universal Polypropylene Divider Panels dividing space with flexibility.**

- Lightweight and easy to clean partitions.
- Minimal footprint for storage.
- Fluted solid white polypropylene screens surrounded by a 1/2" by 2/5" powder coated aluminum frame in DWT - Designer White or TUN - Tungsten
- Charcoal soft touch radius end trim.
- 7" panel opening at panel bottom for easy cleaning and cable pass-thru.
- Includes all connecting hardware and 1" levelling glide.
- Stations are 60" wide by 42" deep by 66" high.
- Planning stations are preconfigured in a back-to-back H with ability to add stations with a T configuration.

PRODUCT CODE	PRICE	SIZE/INCHES			WEIGHT		VOL FT ³
		H	W	D	LBS		
GCPPVACH666085	1888	66	60	85	90		18.74

GCPPVACT • Universal Polypropylene Divider Panels - T Configuration

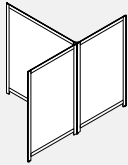

• **Universal Polypropylene Divider Panels dividing space with flexibility.**

- Lightweight and easy to clean partitions.
- Minimal footprint for storage.
- Fluted solid white polypropylene screens surrounded by a 1/2" by 2/5" powder coated aluminum frame in DWT - Designer White or TUN - Tungsten
- Charcoal soft touch radius end trim.
- 7" panel opening at panel bottom for easy cleaning and cable pass-thru.
- Includes all connecting hardware and 1" levelling glide.
- Stations are 60" wide by 42" deep by 66" high.
- Planning stations are preconfigured in a back-to-back H with ability to add stations with a T configuration.

PRODUCT CODE	PRICE	SIZE/INCHES			WEIGHT		VOL FT ³
		H	W	D	LBS		
GCPPVACT666085	1202	66	60	85	73		11.82

GCPPVACU • Universal Polypropylene Divider Panels - U Configuration

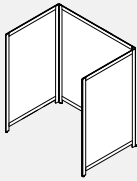

• **Universal Polypropylene Divider Panels dividing space with flexibility.**

- Lightweight and easy to clean partitions.
- Minimal footprint for storage.
- Fluted solid white polypropylene screens surrounded by a 1/2" by 2/5" powder coated aluminum frame in DWT - Designer White or TUN - Tungsten
- Charcoal soft touch radius end trim.
- 7" panel opening at panel bottom for easy cleaning and cable pass-thru.
- Includes all connecting hardware and 1" levelling glide.
- Stations are 60" wide by 42" deep by 66" high.
- Planning stations are preconfigured in a back-to-back U with ability to add stations with an L configuration.

PRODUCT CODE	PRICE	SIZE/INCHES			WEIGHT		VOL FT ³
		H	W	D	LBS		
GCPPVACU666043	1205	66	60	43	73		11.82

GCPPVACL • Universal Polypropylene Divider Panels - L Configuration

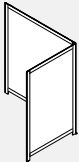

• **Universal Polypropylene Divider Panels dividing space with flexibility.**

- Lightweight and easy to clean partitions.
- Minimal footprint for storage.
- Fluted solid white polypropylene screens surrounded by a 1/2" by 2/5" powder coated aluminum frame in DWT - Designer White or TUN - Tungsten
- Charcoal soft touch radius end trim.
- 7" panel opening at panel bottom for easy cleaning and cable pass-thru.
- Includes all connecting hardware and 1" levelling glide.
- Stations are 60" wide by 42" deep by 66" high.
- Planning stations are preconfigured in a back-to-back U with ability to add stations with an L configuration.

PRODUCT CODE	PRICE	SIZE/INCHES			WEIGHT		VOL FT ³
		H	W	D	LBS		
GCPPVACL666043	859	66	60	43	58		8.36

GCUPFSP • Freestanding Divider Polycarbonate Screen With Flat Feet

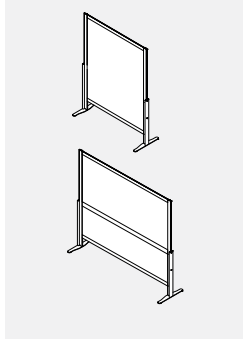

- Provides privacy and room separation.
- Lightweight and easy to clean and move.
- Consists of a powder coated aluminum frame, translucent fluted polycarbonate and steel flat feet.
- Option for 54", 60 and 72" high.
- 72" high by 60" wide divider has a crossbar in the middle.
- Please choose any standard paint finish for frame and feet.

PRODUCT CODE	PRICE	SIZE / INCHES			WEIGHT LBS	VOL FT ³
		H	W	D		
GCUPFSP5424	471	51.75	24	20	15.96	14.38
GCUPFSP5430	518	51.75	30	20	17.96	17.97
GCUPFSP5436	560	51.75	36	20	19.96	21.56
GCUPFSP5442	607	51.75	42	20	21.96	25.16
GCUPFSP5448	614	51.75	48	20	20.96	28.75
GCUPFSP5460	741	51.75	60	20	22.96	35.94
GCUPFSP6024	482	57.75	24	20	17.96	16.04
GCUPFSP6030	527	57.75	30	20	19.96	20.05
GCUPFSP6036	570	57.75	36	20	21.96	24.06
GCUPFSP6042	616	57.75	42	20	23.96	28.07
GCUPFSP6048	625	57.75	48	20	25.96	32.08
GCUPFSP6060	752	57.75	60	20	27.96	40.10
GCUPFSP7230	608	69.75	30	20	21.96	24.22
GCUPFSP7236	663	69.75	36	20	23.96	29.06
GCUPFSP7242	737	69.75	42	20	25.96	33.91
GCUPFSP7248	744	69.75	48	20	27.96	38.75
GCUPFSP7260	858	69.75	60	20	29.96	48.44

GCUPMSP • Freestanding Divider Polycarbonate Screen With Casters

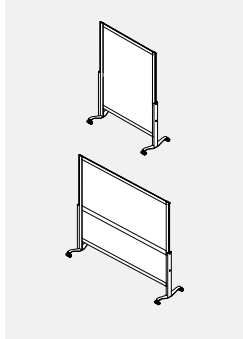

- Provides privacy and room separation.
- Lightweight and easy to clean and move.
- Consists of a powder coated aluminum frame, translucent fluted polycarbonate and steel feet with casters.
- Option for 54", 60 and 72" high.
- 72" high by 60" wide divider has a crossbar in the middle.
- Please choose any standard paint finish for frame and feet.

PRODUCT CODE	PRICE	SIZE / INCHES			WEIGHT LBS	VOL FT ³
		H	W	D		
GCUPMSP5424	697	52.05	24	20	17.13	14.46
GCUPMSP5430	744	52.05	30	20	19.13	18.07
GCUPMSP5436	726	52.05	36	20	21.13	21.69
GCUPMSP5442	771	52.05	42	20	23.13	25.30
GCUPMSP5448	778	52.05	48	20	22.13	28.92
GCUPMSP5460	895	52.05	60	20	24.13	36.15
GCUPMSP6024	655	58.05	24	20	19.13	16.13
GCUPMSP6030	697	58.05	30	20	21.13	20.16
GCUPMSP6036	737	58.05	36	20	23.13	24.19
GCUPMSP6042	780	58.05	42	20	25.13	28.22
GCUPMSP6048	788	58.05	48	20	27.13	32.25
GCUPMSP6060	905	58.05	60	20	29.13	40.31
GCUPMSP7230	891	70.05	30	20	23.13	24.32
GCUPMSP7236	833	70.05	36	20	25.13	29.19
GCUPMSP7242	890	70.05	42	20	27.13	34.05
GCUPMSP7248	898	70.05	48	20	29.13	38.92
GCUPMSP7260	1003	70.05	60	20	31.13	48.65

GCUPSHP • Shared Divider Polycarbonate Screen

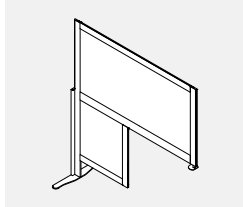

- Provides privacy and divides space for workstations.
- Divider stands on the floor and sits on the worksurface.
- Has no mechanical connection to any surface.
- Lightweight and easy to clean and move.
- Consists of a powder coated aluminum frame, translucent fluted polycarbonate and steel flat foot.
- Option for 54" and 60" high.
- Extends 24" from the worksurface.
- Sits 24" or 30" above worksurface.
- Please choose any standard paint finish for frame and feet.

PRODUCT CODE	PRICE	SIZE / INCHES			WEIGHT LBS	VOL FT ³
		H	W	D		
GCUPSHP5448	484	53.57	48	20	13.45	29.76
GCUPSHP5454	506	53.57	54	20	15.45	33.48
GCUPSHP6048	525	59.57	48	20	17.45	33.09
GCUPSHP6054	551	59.57	54	20	19.45	37.23

GCUPFSF • Freestanding Divider Felt Screen With Flat Feet

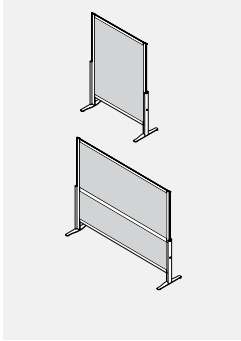

- Provides privacy and room separation.
- Lightweight and easy to clean and move.
- Consists of a powder coated aluminum frame, felt and steel flat feet.
- Option for 54", 60 and 72" high.
- 72" high by 60" wide divider has a crossbar in the middle.
- Please choose any standard paint finish for frame and feet.

PRODUCT CODE	PRICE	SIZE/INCHES			WEIGHT LBS	VOL FT ³
		H	W	D		
GCUPFSF5424	422	51.75	24	20	19.58	14.38
GCUPFSF5430	446	51.75	30	20	20.32	17.97
GCUPFSF5436	454	51.75	36	20	21.06	21.56
GCUPFSF5442	477	51.75	42	20	21.8	25.16
GCUPFSF5448	485	51.75	48	20	22.54	28.75
GCUPFSF5460	596	51.75	60	20	24.03	35.94
GCUPFSF6024	431	57.75	24	20	20.38	16.04
GCUPFSF6030	457	57.75	30	20	21.11	20.05
GCUPFSF6036	464	57.75	36	20	21.84	24.06
GCUPFSF6042	492	57.75	42	20	22.57	28.07
GCUPFSF6048	495	57.75	48	20	23.3	32.08
GCUPFSF6060	605	57.75	60	20	24.87	40.10
GCUPFSF7230	507	69.75	30	20	22.42	24.22
GCUPFSF7236	515	69.75	36	20	23.24	29.06
GCUPFSF7242	603	69.75	42	20	24.06	33.91
GCUPFSF7248	611	69.75	48	20	24.88	38.75
GCUPFSF7260	762	69.75	60	20	29.79	48.44

GCUPMSF • Freestanding Felt Divider Screen With Casters

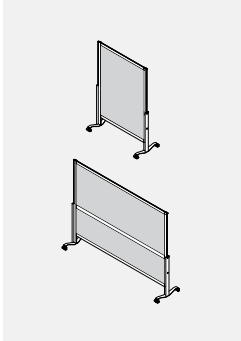

- Provides privacy and room separation.
- Lightweight and easy to clean and move.
- Consists of a powder coated aluminum frame, felt and steel feet with casters.
- Option for 54", 60 and 72" high.
- 72" high by 60" wide divider has a crossbar in the middle.
- Please choose any standard paint finish for frame and feet.

PRODUCT CODE	PRICE	SIZE/INCHES			WEIGHT LBS	VOL FT ³
		H	W	D		
GCUPMSF5424	600	52.05	24	20	20.76	14.46
GCUPMSF5430	622	52.05	30	20	21.5	18.07
GCUPMSF5436	629	52.05	36	20	22.24	21.69
GCUPMSF5442	651	52.05	42	20	22.98	25.30
GCUPMSF5448	658	52.05	48	20	23.72	28.92
GCUPMSF5460	761	52.05	60	20	25.21	36.15
GCUPMSF6024	609	58.05	24	20	21.47	16.13
GCUPMSF6030	631	58.05	30	20	22.23	20.16
GCUPMSF6036	638	58.05	36	20	22.99	24.19
GCUPMSF6042	660	58.05	42	20	23.75	28.22
GCUPMSF6048	668	58.05	48	20	24.51	32.25
GCUPMSF6060	769	58.05	60	20	26.05	40.31
GCUPMSF7230	679	70.05	30	20	23.6	24.32
GCUPMSF7236	688	70.05	36	20	24.42	29.19
GCUPMSF7242	767	70.05	42	20	25.24	34.05
GCUPMSF7248	774	70.05	48	20	26.06	38.92
GCUPMSF7260	915	70.05	60	20	30.97	48.65

GCUPSHF • Shared Divider Felt Screen

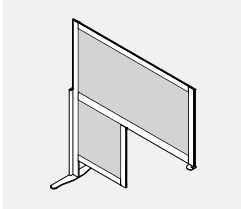

- Provides privacy and divides space for workstations.
- Divider stands on the floor and sits on the worksurface.
- Has no mechanical connection to any surface.
- Lightweight and easy to clean and move.
- Consists of a powder coated aluminum frame, translucent fluted polycarbonate and steel flat foot.
- Option for 54" and 60" high.
- Extends 24" from the worksurface.
- Sits 24" or 30" above worksurface.
- Please choose any standard paint finish for frame and feet.

PRODUCT CODE	PRICE	SIZE/INCHES			WEIGHT LBS	VOL FT ³
		H	W	D		
GCUPSHF5448	399	53.57	48	20	18.06	29.76
GCUPSHF5454	455	53.57	54	20	18.8	33.48
GCUPSHF6048	425	59.57	48	20	18.84	33.09
GCUPSHF6054	561	59.57	54	20	19.6	37.23

GCUPFSG • Freestanding Divider Glass Screen with Flat Feet

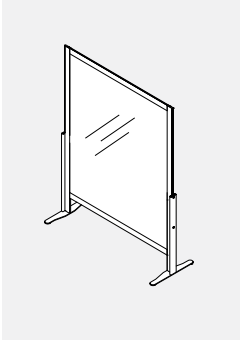

- Provides privacy and room separation.
- Lightweight and easy to clean and move.
- Consists of an aluminum frame, clear glass screen and steel flat feet.
- Please choose any standard panel frame paint finish from Global Contract for all metal parts.
- Option for 54" / 60" high.
- Upcharge for frosted (FRST) glass is 20%.

PRODUCT CODE	PRICE	SIZE/INCHES			WEIGHT LBS	VOL FT ³
		H	W	D		
GCUPFSG5424	553	51.75	24	20	30.83	14.38
GCUPFSG5430	601	51.75	30	20	34.95	17.97
GCUPFSG5436	649	51.75	36	20	39.07	21.56
GCUPFSG5442	696	51.75	42	20	43.19	25.16
GCUPFSG5448	744	51.75	48	20	47.31	28.75
GCUPFSG5460	839	51.75	60	20	55.56	35.94
GCUPFSG6024	586	57.75	24	20	33.11	16.04
GCUPFSG6030	638	57.75	30	20	37.74	20.05
GCUPFSG6036	691	57.75	36	20	42.36	24.06
GCUPFSG6042	743	57.75	42	20	46.99	28.07
GCUPFSG6048	796	57.75	48	20	51.61	32.08
GCUPFSG6060	901	57.75	60	20	60.86	40.10

GCUPMSG • Freestanding Divider Glass Screen with Casters

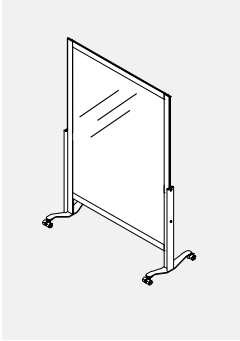

- Provides privacy and room separation.
- Lightweight and easy to clean and move.
- Consists of an aluminum frame, clear glass screen and steel flat feet.
- Please choose any standard panel frame paint finish from Global Contract for all metal parts.
- Option for 54" / 60" high.
- Upcharge for frosted (FRST) glass is 20%.

PRODUCT CODE	PRICE	SIZE/INCHES			WEIGHT LBS	VOL FT ³
		H	W	D		
GCUPMSG5424	793	52.05	24	20	31.99	14.46
GCUPMSG5430	840	52.05	30	20	36.11	18.07
GCUPMSG5436	888	52.05	36	20	40.24	21.69
GCUPMSG5442	935	52.05	42	20	44.36	25.30
GCUPMSG5448	983	52.05	48	20	48.48	28.92
GCUPMSG5460	1078	52.05	60	20	56.72	36.15
GCUPMSG6024	825	58.05	24	20	34.28	16.13
GCUPMSG6030	878	58.05	30	20	38.9	20.16
GCUPMSG6036	930	58.05	36	20	43.53	24.19
GCUPMSG6042	982	58.05	42	20	48.15	28.22
GCUPMSG6048	1034	58.05	48	20	52.78	32.25
GCUPMSG6060	1140	58.05	60	20	62.03	40.31

GCUPSHG • Shared Divider Glass Screen

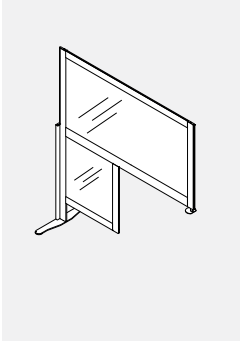

- Provides privacy and divides space for workstations.
- Divider stands on the floor and sits on the work surface.
- Has no mechanical connection to any surface.
- Lightweight and easy to clean and move.
- Consists of a powder coated aluminum frame, clear glass screen and steel flat foot.
- Option for 54" / 60" high.
- Extends 24" from the work surface.
- Sits 24" or 30" above work surface.
- Please choose any standard paint finish for frame and feet.
- Upcharge for frosted (FRST) glass is 20%.

PRODUCT CODE	PRICE	SIZE/INCHES			WEIGHT LBS	VOL FT ³
		H	W	D		
GCUPSHG5448	611	53.57	48	20	36.17	29.76
GCUPSHG5454	638	53.57	54	20	38.51	33.48
GCUPSHG6048	660	59.57	48	20	40.52	33.09
GCUPSHG6054	693	59.57	54	20	43.36	37.23

Bridges Feature List

Our desire was to develop an environment for collaborative teamwork which would facilitate connection, or bridging, of people and ideas. A set of components which would even serve as a catalyst - inviting team members out of their cocooned comfort zones and encouraging them to engage, to co-create.

- Flexible building components:**
- single tables (freestanding or mobile)
 - training rooms
 - boardrooms
 - library
 - 1 person general and private office
 - 2 person work station
 - 3-person work station
 - 4-person work station
 - 6+ -person work station
 - Storage spine-based work station
 - Panel based work station

Easy to customize / reconfigure to fit specific requirements. From the facility manager's perspective, all work stations can be standardized to form a linear worksurface and power/data services, and their respective function, or purpose, can be governed by the type, quantity and placement of adjacent components like dividers, storage cabinets, shelves and accessories. These adjacent components can be easily reconfigured with minimal down time - without having to invite electrical and IT crew.

Compatible with various environments clean, simple, elegant design language with finishes suggesting comfortable, even domestic flavour. Wide range of finished various environments. From understated to some combinations, like anodized aluminum and white that give a hint of subtle sophistication.

Choice of two functionally and visually differentiated leg supports on casters or levelers: - height-adjustable round legs - fixed height rectangular legs with optional anodized aluminum finish

Various power/data delivery levels to choose from: - wire basket to organize cable excess under worksurface and storage - table leg integrated vertical cable manager - worksurface edge-mounted power/data units (easy to reconfigure, plug into wall/ floor outlets) - single and double below worksurface power/data trough (desk top, floor standing computers and office equipment) - worksurface access door (access to below worksurface power outlets and data terminals) - above worksurface power/data trough (laptop / tablet / phone immediate access) - storage integrated power/data unit - horizontal cable management under storage units with optional wire basket - raised storage units for uninterrupted access to panel based floor raceway

Interconnected storage units can form a spine (space division, storage, cable management and worksurface support). Storage leg can be configured to act as a ganging bracket.

Panel integrated storage units can be connected and provide support to panel partitions (space division, storage, cable management, panel power/data delivery access and worksurface support). Panel integrated Bridges leg provides support to panel mounted worksurfaces.

Bridges Collaborative Seating collection consists of seating, privacy screens, tables, tablets and power. It is a versatile modular furniture series which can be configured into many space planning scenarios including corner, in-line, open concept, traditional reception as well as secluded seating with high privacy partitions.

Worksurfaces

- Worksurfaces are available in (HP) high pressure laminate and (LP) low pressure laminate.
- Veneer tops available, please contact your Customer Service Representative.
- HP laminate tops are 1 1/16" thick laminate particle board and have a flat 3 mm edge profile on all sides.
- LP laminate tops are 1" thick melamine particle board and have a flat 3 mm edge profile on all side.

Tables

- All single sliding rail tables are standard with casters.
- All multiple linear workstations are standard with levelers.
- Tops square for flush surface-to-surface abutment and to accept desk mounted accessories.
- Worksurfaces provided with pilot holes for alignment purposes.

Worksurface Edge Profiles:

HP/LP edge: 

CODES: The price list uses a numbering system with meaningful alphanumeric characters to create a simple-to-understand product number. This makes specifying the product much easier and more accurate.

SPECIFICATION EXAMPLE OF A BRIDGES WORKSURFACE

PRODUCT CODE: BRTWS2472HP MR71T CHR
 BRT = Bridges
 WS = Type of Worksurface
 2472 = Size: Depth x Width
 HP = Finish
 MR71T = High Pressure Laminate
 CHR = PVC Edging

How To Specify:

- Specify Bridges product code in appropriate top material.
- Specify top colour - ie. Laminate colour MR71T (Studio White Matrix).
- Specify PVC edge colour - ie. CHR (Charcoal).

30" WIDE UNITS Storage Capacity Chart

SIDE TO SIDE

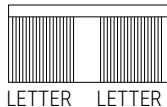

SIDE TO SIDE LETTER/FRONT TO BACK LEGAL

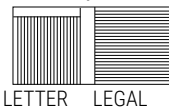

36" & 42" WIDE UNITS Storage Capacity Chart

SIDE TO SIDE LETTER

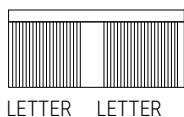

FRONT TO BACK LEGAL

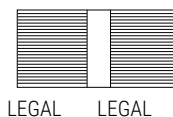

SIDE TO SIDE LETTER/FRONT TO BACK LEGAL

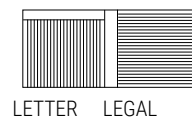

GRAIN DIRECTION CHART

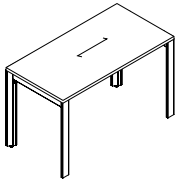

BRTS1P-L

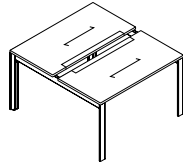

BRTBAR2PA-L

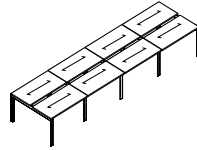

BRTBAR8PA-L

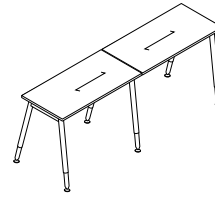

BRTS2P-LR

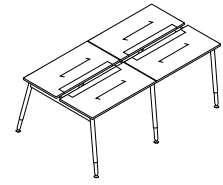

BRTBAR4PA-LR

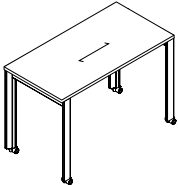

BRTS1P-C

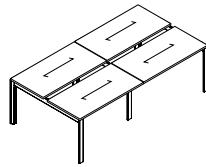

BRTBAR4P-L

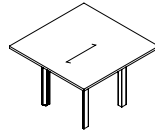

BRTSQ

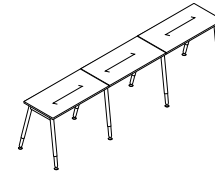

BRTS3P-LR

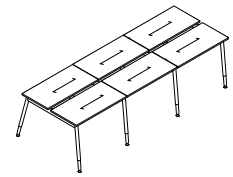

BRTBAR6P-LR

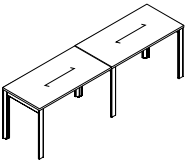

BRTS2P-L

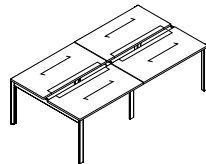

BRTBAR4PA-L

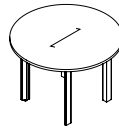

BRTR

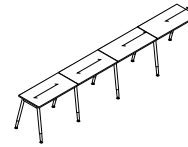

BRTS4P-LR

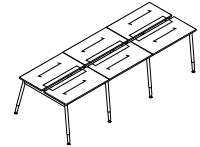

BRTBAR6PA-LR

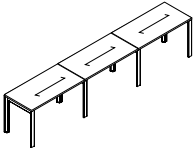

BRTS3P-L

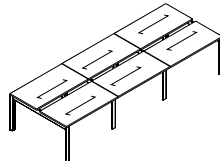

BRTBAR6P-L

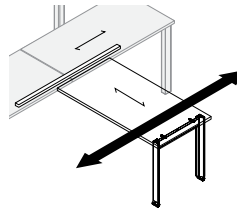

BRTSLDT72C

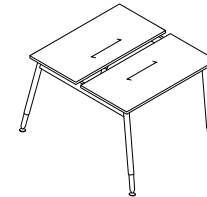

BRTBAR2P-LR

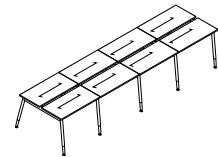

BRTBAR8P-LR

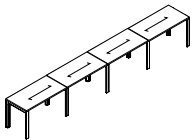

BRTS4P-L

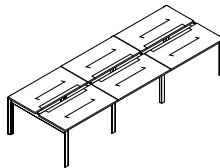

BRTBAR6PA-L

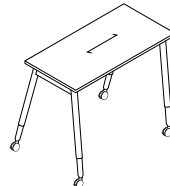

BRTS1P-CR

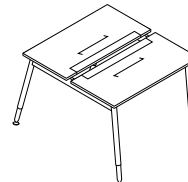

BRTBAR2PA-LR

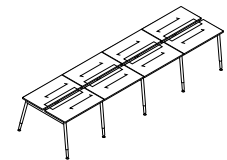

BRTBAR8PA-LR

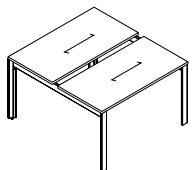

BRTBAR2P-L

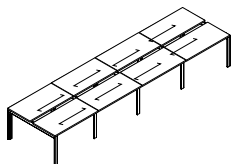

BRTBAR8P-L

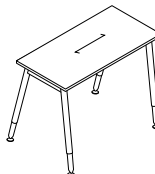

BRTS1P-LR



BRTBAR4P-LR

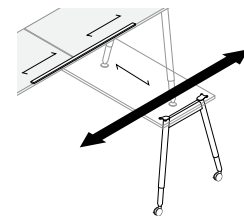

BRTSLDT72CR

GRAIN DIRECTION CHART

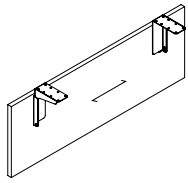

BRTMPS

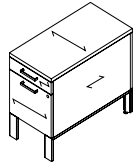

BRT25BF-L

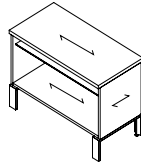

BRT25LO-L

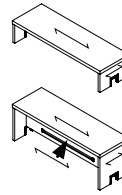

BRTBTS

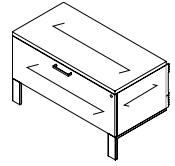

BRTPSL

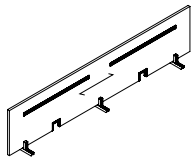

BRTLPPD

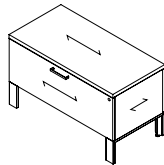

BRT21F-L

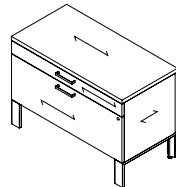

BRT25LBF-L

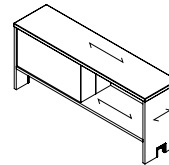

BRTBAS048

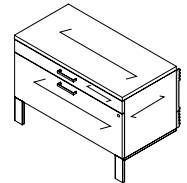

BRTPLBF

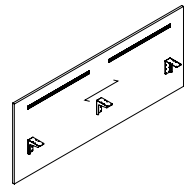

BRTLPPD

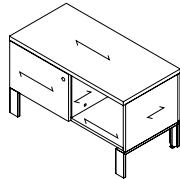

BRT21LS-L

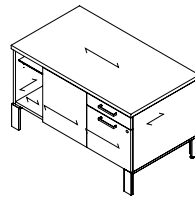

BRT25LBF042L

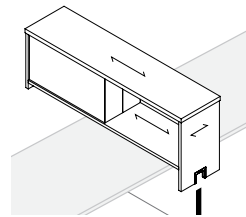

BRTSDS48



BRTCS45BBFF

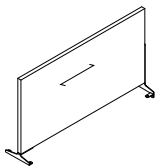

BRTLPPD

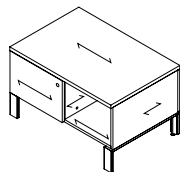

BRT21LSS-L

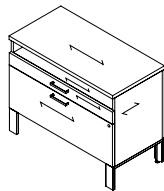

BRT29LOBF-L

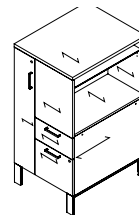

BRTTW50

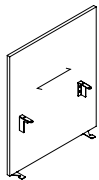

BRTLPPD

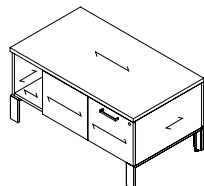

BRT21LS042L

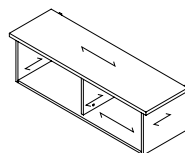

BRTTES

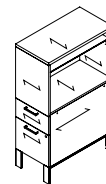

BRTT50

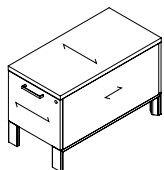

BRT21BF

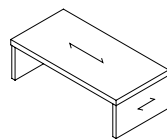

BRTSTS

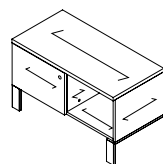

BRTPSLS

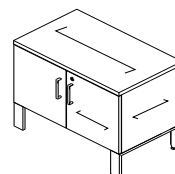

BRT25L2D

Technical Information - Rectangular Leg

Support Leg and Frame

Single and shared worksurface support.

Bridges Rectangular legs are available with:

- Locking casters (BRTLCS)
- Levelers (BRTLVS)
- Casters and Levelers not retrofitable.

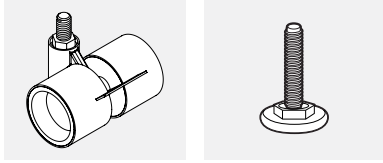

NOTES:

- Levelers have a 2" height range, with 5/16-18 thread.
- Levelers are available in black only.
- 45mm high casters with 8mm thread, available in White Body/Grey Tire combination only.
- Leg frame is available in our (9) standard paint and anodized aluminum finish.
- Paint finish is durable environmentally friendly epoxy powder coating.

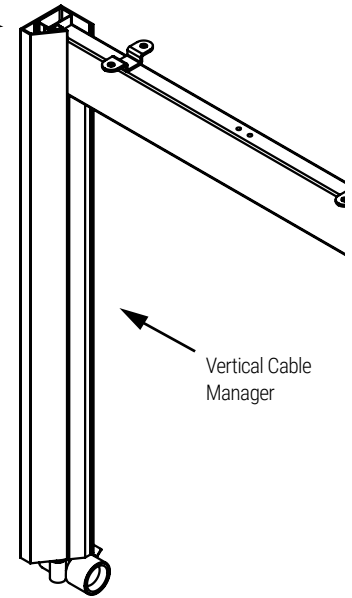

Technical Information - Round Leg

Support Leg and Frame

- Tubular steel legs are adjustable in 1" increments.

Single and shared worksurface support.

Height adjustment allows the user to easily set the height of a table.

Legs have a height adjustment range of 24" - 32" in 1" increments with levelers and 27" - 35" with casters.

Bridges Round legs are available with:

- Locking casters (BRTLCR)
- Levelers (BRTLVR)
- Casters and levelers are retrofitable on site.



NOTES:

- Levelers have a 1" height range, with 3/8-16 thread.
- Levelers are available in Chrome only.
- Casters available in Tungsten/Black combination only.
- Casters are 3" diameter with an overall height of 3 3/4", with 3/8-16 thread.
- Inner leg is available in Chrome only.
- Leg frame is available in our (9) standard paint finishes.
- Paint finish is durable environmentally friendly epoxy powder coating.

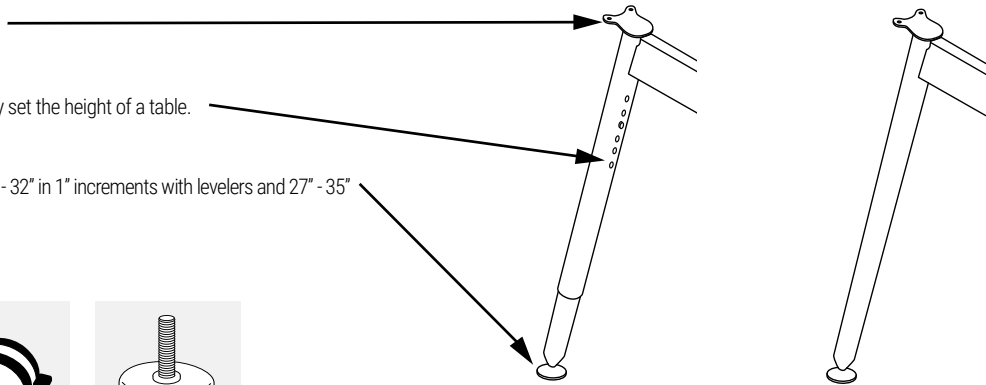

Height Adjustable Leg

Fixed Leg

Technical Information - Handle Options

Optional handle to provide a softer and slimmer alternative to standard Bridges2 storage handles. Radiused corners and edges. Can be retrofitted on site as the drilling hole drawer front pattern remains unchanged.

Finish matches anodized aluminum.

- Centre to centre hole pattern for Bridges 2 handles is 128 mm.

Standard Handle

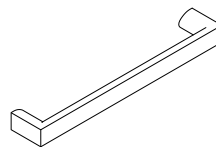

BRH1 - Anodized aluminum
BRH1B - Black

Optional Handle

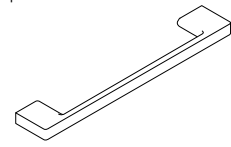

BRH2 - Anodized aluminum

BRTS1P-L • Rectangular Legs - Single Line 1 Person Pod (Levelers)

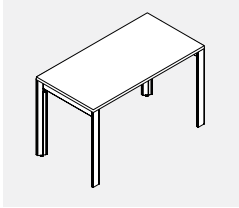

- **Single Line Table Assemblies consist of one worksurface, two leg assemblies and one horizontal structural beam.**
- Finish option, please choose from:
 - 1) anodized aluminum vertical legs with powder coated steel horizontal structural members.
Anodized aluminum leg upcharge of \$110 for this configuration.
 - 2) powder coated aluminum vertical legs and steel horizontal structural members. Choose from standard metal finishes.
- Worksurface available in HP and LP. For wood veneer tops, please contact your Customer Service Representative.

PRODUCT CODE	PRICE		SIZE/ INCHES			WEIGHT VOL	
	LP	HP	H	W	D	LBS	FT ³
BRTS1P2436L	982	1038	29	36	24	45	4.00
BRTS1P2442L	1043	1111	29	42	24	48	4.10
BRTS1P2448L	1093	1174	29	48	24	51	4.20
BRTS1P2451L	1123	1209	29	50.5	24	54	4.30
BRTS1P2454L	1154	1249	29	54	24	57	4.40
BRTS1P2460L	1197	1301	29	60	24	60	4.48
BRTS1P2463L	1207	1317	29	62.5	24	63	4.57
BRTS1P2466L	1221	1328	29	66	24	66	4.65
BRTS1P2472L	1232	1356	29	72	24	69	4.73
BRTS1P2478L	1279	1395	29	78	24	72	4.82
BRTS1P2484L	1316	1441	29	84	24	75	4.92
BRTS1P3036L	1057	1120	29	36	30	54	4.20
BRTS1P3042L	1146	1233	29	42	30	57	4.30
BRTS1P3048L	1169	1262	29	48	30	60	4.41
BRTS1P3051L	1191	1287	29	50.5	30	63	4.50
BRTS1P3054L	1217	1304	29	54	30	66	4.60
BRTS1P3060L	1242	1353	29	60	30	69	4.73
BRTS1P3063L	1254	1366	29	62.5	30	72	4.80
BRTS1P3066L	1263	1381	29	66	30	75	4.90
BRTS1P3072L	1293	1416	29	72	30	78	5.01
BRTS1P3078L	1327	1452	29	78	30	81	5.10
BRTS1P3084L	1381	1516	29	84	30	84	5.20

BRTS1P-C • Rectangular Legs - Single Line 1 Person Pod (Casters)

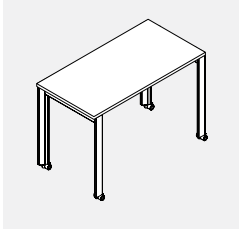

- **Single Line Table Assemblies consist of one worksurface, two leg assemblies and one horizontal structural beam.**
- 40mm white locking casters with grey tires; steel horizontal beams, aluminum legs.
- Finish options, please choose from:
 - 1) anodized aluminum vertical legs with powder coated steel horizontal structural members.
Anodized aluminum leg upcharge of \$110 for this configuration.
 - 2) powder coated aluminum vertical legs and steel horizontal structural members. Choose from standard metal finishes.
- Worksurface available in HP and LP. For wood veneer tops, please contact your Customer Service Representative.

PRODUCT CODE	PRICE		SIZE/ INCHES			WEIGHT VOL	
	LP	HP	H	W	D	LBS	FT ³
BRTS1P2436C	1047	1104	29	36	24	45	4.00
BRTS1P2442C	1109	1175	29	42	24	48	4.10
BRTS1P2448C	1159	1238	29	48	24	51	4.20
BRTS1P2451C	1189	1277	29	50.5	24	54	4.30
BRTS1P2454C	1221	1312	29	54	24	57	4.40
BRTS1P2460C	1261	1366	29	60	24	60	4.48
BRTS1P2463C	1272	1383	29	62.5	24	63	4.57
BRTS1P2466C	1285	1393	29	66	24	66	4.65
BRTS1P2472C	1305	1421	29	72	24	69	4.73
BRTS1P2478C	1342	1460	29	78	24	72	4.82
BRTS1P2484C	1381	1505	29	84	24	75	4.92
BRTS1P3036C	1122	1187	29	36	30	54	4.20
BRTS1P3042C	1209	1299	29	42	30	57	4.30
BRTS1P3048C	1233	1327	29	48	30	60	4.41
BRTS1P3051C	1256	1351	29	50.5	30	63	4.50
BRTS1P3054C	1280	1368	29	54	30	66	4.60
BRTS1P3060C	1309	1417	29	60	30	69	4.73
BRTS1P3063C	1318	1431	29	62.5	30	72	4.90
BRTS1P3066C	1328	1444	29	66	30	75	4.90
BRTS1P3072C	1357	1464	29	72	30	78	5.01
BRTS1P3078C	1392	1516	29	78	30	81	5.10
BRTS1P3084C	1455	1581	29	84	30	84	5.20

BRTS2P-L • Rectangular Legs - Single Line 2 Person Pod (Levelers)

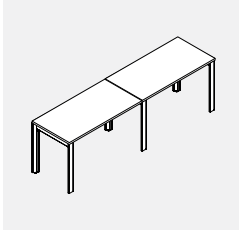

- **Single Line, 2-person workstation consists of two worksurfaces, three leg assemblies and 2 horizontal structural beams.**
- One leg can be shared by 2 adjoining worksurfaces.
- Finish options, please choose from:
 - 1) anodized aluminum vertical legs with powder coated steel horizontal structural members.
Anodized aluminum leg upcharge of \$164 for this configuration.
 - 2) powder coated aluminum vertical legs and steel horizontal structural members. Choose from standard metal finishes.
- Worksurface available in HP and LP. For wood veneer tops, please contact your Customer Service Representative.

PRODUCT CODE	PRICE		SIZE/ INCHES			WEIGHT VOL	
	LP	HP	H	W	D	LBS	FT ³
BRTS2P2448L	1863	2027	29	96	24	95	6.21
BRTS2P2454L	1987	2169	29	108	24	104	6.45
BRTS2P2460L	2068	2283	29	120	24	113	6.71
BRTS2P2466L	2115	2334	29	132	24	122	6.95
BRTS2P2472L	2158	2391	29	144	24	131	7.13
BRTS2P2478L	2231	2468	29	156	24	140	7.27
BRTS2P2484L	2309	2558	29	168	24	149	7.41
BRTS2P3048L	2001	2186	29	96	30	113	6.57
BRTS2P3054L	2086	2269	29	108	30	122	6.85
BRTS2P3060L	2147	2365	29	120	30	131	7.13
BRTS2P3066L	2190	2422	29	132	30	140	7.41
BRTS2P3072L	2264	2510	29	144	30	155	7.69
BRTS2P3078L	2314	2562	29	156	30	164	7.97
BRTS2P3084L	2422	2693	29	168	30	173	8.25

BRTS3P-L • Rectangular Legs - Single Line 3 Person Pod (Levelers)

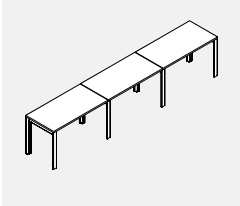

- **Single Line, 3-person workstation consists of 3 worksurfaces, 4 leg assemblies and 3 horizontal structural beams.**
- Finish options, please choose from:
 - 1) anodized aluminum vertical legs with powder coated steel horizontal structural members. Anodized aluminum leg upcharge of \$217 for this configuration.
 - 2) powder coated aluminum vertical legs and steel horizontal structural members. Choose from standard metal finishes.
- Worksurface available in HP and LP. For wood veneer tops, please contact your Customer Service Representative.

PRODUCT CODE	PRICE		SIZE/INCHES			WEIGHT VOL	
	LP	HP	H	W	D	LBS	FT ³
BRTS3P2448L	2632	2879	29	144	24	138	8.47
BRTS3P2454L	2816	3093	29	162	24	152	8.68
BRTS3P2460L	2945	3249	29	180	24	165	8.89
BRTS3P2466L	3011	3340	29	198	24	179	9.11
BRTS3P2472L	3077	3424	29	216	24	192	9.32
BRTS3P2478L	3186	3543	29	234	24	206	9.53
BRTS3P2484L	3298	3678	29	252	24	219	9.74
BRTS3P3048L	2833	3106	29	144	30	161	9.01
BRTS3P3054L	2958	3232	29	162	30	178	9.44
BRTS3P3060L	3050	3379	29	180	30	195	9.87
BRTS3P3066L	3113	3461	29	198	30	212	10.30
BRTS3P3072L	3204	3570	29	216	30	229	10.72
BRTS3P3078L	3300	3676	29	234	30	246	11.16
BRTS3P3084L	3461	3869	29	252	30	263	11.59

BRTS4P-L • Rectangular Legs - Single Line 4 Person Pod (Levelers)

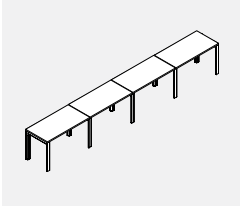

- **Single Line, 4-person workstation consists of 4 worksurfaces, 5 leg assemblies and 4 horizontal structural beams.**
- Finish options, please choose from:
 - 1) anodized aluminum vertical legs with powder coated steel horizontal structural members. Anodized aluminum leg upcharge of \$271 for this configuration.
 - 2) powder coated aluminum vertical legs and steel horizontal structural members. Choose from standard metal finishes.
- Worksurface available in HP and LP. For wood veneer tops, please contact your Customer Service Representative.

PRODUCT CODE	PRICE		SIZE/INCHES			WEIGHT VOL	
	LP	HP	H	W	D	LBS	FT ³
BRTS4P2448L	3400	3730	29	192	24	180	10.73
BRTS4P2454L	3649	4015	29	216	24	199	11.22
BRTS4P2460L	3815	4241	29	240	24	217	11.71
BRTS4P2466L	3905	4344	29	264	24	236	12.20
BRTS4P2472L	4021	4490	29	288	24	254	12.69
BRTS4P2478L	4137	4617	29	312	24	273	13.18
BRTS4P2484L	4292	4797	29	336	24	291	13.67
BRTS4P3048L	3663	4032	29	192	30	213	11.45
BRTS4P3054L	3831	4200	29	216	30	235	12.02
BRTS4P3060L	3955	4392	29	240	30	257	12.59
BRTS4P3066L	4037	4506	29	264	30	279	13.16
BRTS4P3072L	4159	4645	29	288	30	301	13.73
BRTS4P3078L	4290	4787	29	312	30	323	14.30
BRTS4P3084L	4506	5044	29	336	30	345	14.87

BRTBAR2P-L • Rectangular Legs - Back 2 Back 2 Person Pod (Levelers)

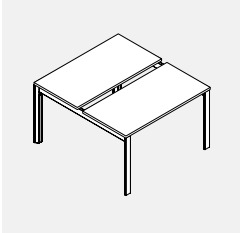

- **Back 2 Back, 2-person workstation consists of 2 worksurfaces, 2 Back 2 Back leg assemblies and 2 horizontal structural beams.**
- Finish options, please choose from:
 - 1) anodized aluminum vertical legs with powder coated steel horizontal structural members. Anodized aluminum leg upcharge of \$110 for this configuration.
 - 2) powder coated aluminum vertical legs and steel horizontal structural members. Choose from standard metal finishes.
- Worksurface available in HP and LP. For wood veneer tops, please contact your Customer Service Representative.

PRODUCT CODE	PRICE		SIZE/INCHES			WEIGHT VOL	
	LP	HP	H	W	D	LBS	FT ³
BRTBAR2P2460L	1939	2154	29	60	50.5	110	8.56
BRTBAR2P2466L	1987	2203	29	66	50.5	119	8.76
BRTBAR2P2472L	2030	2262	29	72	50.5	128	9.02
BRTBAR2P2478L	2101	2341	29	78	50.5	137	9.20
BRTBAR2P2484L	2179	2429	29	84	50.5	146	9.40
BRTBAR2P3060L	1968	2190	29	60	62.5	130	9.00
BRTBAR2P3066L	2011	2245	29	66	62.5	141	9.25
BRTBAR2P3072L	2076	2314	29	72	62.5	152	9.54
BRTBAR2P3078L	2145	2387	29	78	62.5	163	9.80
BRTBAR2P3084L	2245	2515	29	84	62.5	174	10.4

BRTBAR2PA-L • Rectangular Legs - Back 2 Back 2 Person Pod (Levelers) with Access Door

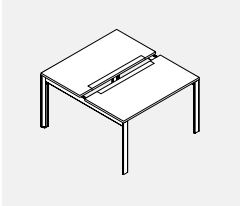

- **Back 2 Back, 2-person workstation consists of 2 worksurfaces, 2 Back 2 Back leg assemblies and 2 horizontal structural beams.**
- Finish options, please choose from:
 - 1) anodized aluminum vertical legs with powder coated steel horizontal structural members. Anodized aluminum leg upcharge of \$110 for this configuration.
 - 2) powder coated aluminum vertical legs and steel horizontal structural members. Choose from standard metal finishes.
- Anodized aluminum worksurface door provides access to power / data through below worksurface.
- Worksurface with access doors cannot be combined with above worksurface power trough.
- Worksurface available in HP and LP.

PRODUCT CODE	PRICE		SIZE/INCHES			WEIGHT VOL	
	LP	HP	H	W	D	LBS	FT ³
BRTBAR2PA2460L	2019	2323	29	60	50.5	110	8.56
BRTBAR2PA2466L	2097	2435	29	66	50.5	119	8.76
BRTBAR2PA2472L	2179	2567	29	72	50.5	128	9.02
BRTBAR2PA3060L	2179	2567	29	60	62.5	130	9.00
BRTBAR2PA3066L	2292	2710	29	66	62.5	141	9.25
BRTBAR2PA3072L	2372	2841	29	72	62.5	152	9.54

BRTBAR2PDA-L • Rectangular Legs - Back 2 Back 2 Person Pod (Levelers) with Access Doors

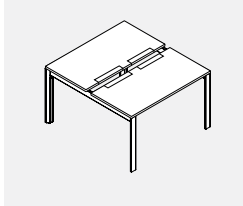

• **Back 2 Back, 2-person workstation consists of 2 worksurfaces, 2 Back 2 Back leg assemblies and 2 horizontal structural beams.**

- These tables feature dual access doors providing a central connection point for monitor lifts.
- Finish options, please choose from:
 - 1) anodized aluminum vertical legs with powder coated steel horizontal structural members. Anodized aluminum leg upcharge of \$110 for this configuration.
 - 2) powder coated aluminum vertical legs and steel horizontal structural members. Choose from standard metal finishes.

- Anodized aluminum worksurface door provides access to power / data through below worksurface.
- Worksurface with access doors cannot be combined with above worksurface power trough.
- Worksurface available in HP and LP.

PRODUCT CODE	PRICE		SIZE/INCHES			WEIGHT		VOL FT ³
	LP	HP	H	W	D	LBS		
BRTBAR2PDA2460L	2179	2511	29	60	50.5	110	8.56	
BRTBAR2PDA2466L	2264	2632	29	66	50.5	119	8.76	
BRTBAR2PDA2472L	2352	2772	29	72	50.5	128	9.02	
BRTBAR2PDA2478L	2404	2842	29	78	50.5	137	9.20	
BRTBAR2PDA2484L	2476	2961	29	84	50.5	146	9.40	
BRTBAR2PDA3060L	2352	2772	29	60	62.5	130	9.00	
BRTBAR2PDA3066L	2476	2927	29	66	62.5	141	9.25	
BRTBAR2PDA3072L	2563	3067	29	72	62.5	152	9.54	
BRTBAR2PDA3078L	2615	3172	29	78	62.5	163	9.80	
BRTBAR2PDA3084L	2702	3295	29	84	62.5	174	10.4	

BRTBAR4P-L • Rectangular Legs - Back 2 Back 4 Person Pod (Levelers)

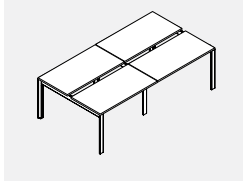

• **Back 2 Back, 4-person workstation consists of 4 worksurfaces, 2 Back 2 Back outer leg assemblies, 1 Back 2 Back narrow leg assembly and 4 horizontal structural beams.**

- Finish options, please choose from:
 - 1) anodized aluminum vertical legs with powder coated steel horizontal structural members. Anodized aluminum leg upcharge of \$164 for this configuration.
 - 2) powder coated aluminum vertical legs and steel horizontal structural members. Choose from standard metal finishes.

- Worksurface available in HP and LP. For wood veneer tops, please contact your Customer Service Representative.

PRODUCT CODE	PRICE		SIZE/INCHES			WEIGHT		VOL FT ³
	LP	HP	H	W	D	LBS		
BRTBAR4P2460L	3428	3853	29	120	50.5	208	13.82	
BRTBAR4P2466L	3518	3958	29	132	50.5	224	14.28	
BRTBAR4P2472L	3608	4073	29	144	50.5	240	14.74	
BRTBAR4P2478L	3751	4227	29	156	50.5	256	15.20	
BRTBAR4P2484L	3905	4409	29	168	50.5	272	15.66	
BRTBAR4P3060L	3518	3958	29	120	62.5	253	14.70	
BRTBAR4P3066L	3603	4068	29	132	62.5	273	15.24	
BRTBAR4P3072L	3724	4209	29	144	62.5	293	15.78	
BRTBAR4P3078L	3853	4352	29	156	62.5	313	16.32	
BRTBAR4P3084L	4068	4608	29	168	62.5	333	16.86	

BRTBAR4PA-L • Rectangular Legs - Back 2 Back 4 Person Pod (Levelers) with Access Door

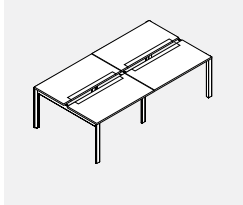

• **Back 2 Back, 4-person workstation consists of 4 worksurfaces, 2 Back 2 Back outer leg assemblies, 1 Back 2 Back narrow leg assembly and 4 horizontal structural beams**

- Finish options, please choose from:
 - 1) anodized aluminum vertical legs with powder coated steel horizontal structural members. Anodized aluminum leg upcharge of \$164 for this configuration.

- 2) powder coated aluminum vertical legs and steel horizontal structural members. Choose from standard metal finishes.
- Anodized aluminum worksurface door provides access to power / data through below worksurface.
- Worksurface with access doors cannot be combined with above worksurface power trough.
- Worksurface available in HP and LP.

PRODUCT CODE	PRICE		SIZE/INCHES			WEIGHT		VOL FT ³
	LP	HP	H	W	D	LBS		
BRTBAR4PA2460L	3584	4197	29	120	50.5	208	13.82	
BRTBAR4PA2466L	3743	4422	29	132	50.5	224	14.28	
BRTBAR4PA2472L	3905	4681	29	144	50.5	240	14.74	
BRTBAR4PA3060L	3873	4648	29	120	62.5	253	14.70	
BRTBAR4PA3066L	4098	4939	29	132	62.5	273	15.24	
BRTBAR4PA3072L	4261	5196	29	144	62.5	293	15.78	

BRTBAR4PDA-L • Rectangular Legs - Back 2 Back 4 Person Pod (Levelers) with Access Doors

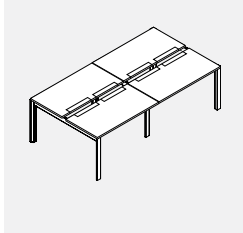

• **Back 2 Back, 4-person workstation consists of 4 worksurfaces, 2 Back 2 Back outer leg assemblies, 1 Back 2 Back narrow leg assembly and 4 horizontal structural beams**

- These tables feature dual access doors providing a central connection point for monitor lifts.
- Finish options, please choose from:
 - 1) anodized aluminum vertical legs with powder coated steel horizontal structural members. Anodized aluminum leg upcharge of \$164 for this configuration.

- 2) powder coated aluminum vertical legs and steel horizontal structural members. Choose from standard metal finishes.
- Anodized aluminum worksurface door provides access to power / data through below worksurface.
- Worksurface with access doors cannot be combined with above worksurface power trough.
- Worksurface available in HP and LP.

PRODUCT CODE	PRICE		SIZE/INCHES			WEIGHT		VOL FT ³
	LP	HP	H	W	D	LBS		
BRTBAR4PDA2460L	3869	4532	29	120	50.5	208	13.82	
BRTBAR4PDA2466L	4045	4774	29	132	50.5	224	14.28	
BRTBAR4PDA2472L	4216	5055	29	144	50.5	240	14.74	
BRTBAR4PDA2478L	4323	5192	29	156	50.5	256	15.20	
BRTBAR4PDA2484L	4459	5438	29	168	50.5	272	15.66	
BRTBAR4PDA3060L	4183	5018	29	120	62.5	253	14.70	
BRTBAR4PDA3066L	4426	5334	29	132	62.5	273	15.24	
BRTBAR4PDA3072L	4602	5612	29	144	62.5	293	15.78	
BRTBAR4PDA3078L	4707	5821	29	156	62.5	313	16.32	
BRTBAR4PDA3084L	4880	6064	29	168	62.5	333	16.86	

BRTBAR6P-L • Rectangular Legs - Back 2 Back 6 Person Pod (Levelers)

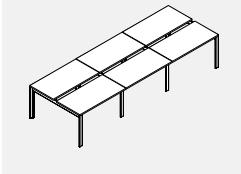

- **Back 2 Back, 6-person workstation consists of 6 worksurfaces, 2 Back 2 Back outer leg assemblies, 2 Back 2 Back narrow leg assemblies and 6 horizontal structural beams.**
- Finish options, please choose from:
 - 1) anodized aluminum vertical legs with powder coated steel horizontal structural members. Anodized aluminum leg upcharge of \$217 for this configuration.
 - 2) powder coated aluminum vertical legs and steel horizontal structural members. Choose from standard metal finishes.
- Worksurface available in HP and LP. For wood veneer tops, please contact your Customer Service Representative.

PRODUCT CODE	PRICE		SIZE/INCHES			WEIGHT		VOL FT ³
	LP	HP	H	W	D	LBS		
BRTBAR6P2460L	4883	5523	29	180	50.5	308	19.76	
BRTBAR6P2466L	5051	5710	29	198	50.5	329	20.54	
BRTBAR6P2472L	5187	5883	29	216	50.5	359	21.32	
BRTBAR6P2478L	5400	6116	29	234	50.5	409	22.10	
BRTBAR6P2484L	5632	6387	29	252	50.5	434	22.88	
BRTBAR6P3060L	5003	5660	29	180	62.5	369	21.08	
BRTBAR6P3066L	5160	5860	29	198	62.5	400	21.97	
BRTBAR6P3072L	5346	6072	29	216	62.5	431	22.86	
BRTBAR6P3078L	5540	6283	29	234	62.5	462	23.75	
BRTBAR6P3084L	5860	6672	29	252	62.5	493	24.53	

BRTBAR6PA-L • Rectangular Legs - Back 2 Back 6 Person Pod (Levelers) with Access Door

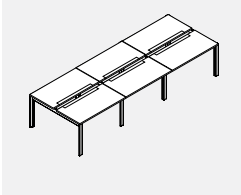

- **Back 2 Back, 6-person workstation consists of 6 worksurfaces, 2 Back 2 Back outer leg assemblies, 2 Back 2 Back narrow leg assemblies and 6 horizontal structural beams.**
- Finish options, please choose from
 - 1) anodized aluminum vertical legs with powder coated steel horizontal structural members. Anodized aluminum leg upcharge of \$217 for this configuration.
 - 2) powder coated aluminum vertical legs and steel horizontal structural members. Choose from standard metal finishes.
- Anodized aluminum worksurface door provides access to power / data through below worksurface.
- Worksurface with access doors cannot be combined with above worksurface power trough.
- Worksurface available in HP and LP.

PRODUCT CODE	PRICE		SIZE/INCHES			WEIGHT		VOL FT ³
	LP	HP	H	W	D	LBS		
BRTBAR6PA2460L	5116	6035	29	180	50.5	308	19.76	
BRTBAR6PA2466L	5388	6408	29	198	50.5	329	20.54	
BRTBAR6PA2472L	5632	6795	29	216	50.5	359	21.32	
BRTBAR6PA3060L	5536	6698	29	180	62.5	369	21.08	
BRTBAR6PA3066L	5907	7165	29	198	62.5	400	21.97	
BRTBAR6PA3072L	6149	7554	29	216	62.5	431	22.86	

BRTBAR6PDA-L • Rectangular Legs - Back 2 Back 6 Person Pod (Levelers) with Access Doors

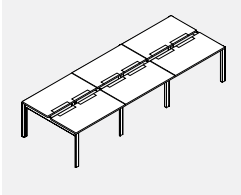

- **Back 2 Back, 6-person workstation consists of 6 worksurfaces, 2 Back 2 Back outer leg assemblies, 2 Back 2 Back narrow leg assemblies and 6 horizontal structural beams.**
- These tables feature dual access doors providing a central connection point for monitor lifts.
- Finish options, please choose from
 - 1) anodized aluminum vertical legs with powder coated steel horizontal structural members. Anodized aluminum leg upcharge of \$217 for this configuration.
 - 2) powder coated aluminum vertical legs and steel horizontal structural members. Choose from standard metal finishes.
- Anodized aluminum worksurface door provides access to power / data through below worksurface.
- Worksurface with access doors cannot be combined with above worksurface power trough.
- Worksurface available in HP and LP.

PRODUCT CODE	PRICE		SIZE/INCHES			WEIGHT		VOL FT ³
	LP	HP	H	W	D	LBS		
BRTBAR6PDA2460L	5525	6519	29	180	50.5	308	19.76	
BRTBAR6PDA2466L	5821	6871	29	198	50.5	329	20.54	
BRTBAR6PDA2472L	6083	7339	29	216	50.5	359	21.32	
BRTBAR6PDA2478L	6240	7548	29	234	50.5	409	22.10	
BRTBAR6PDA2484L	6448	7911	29	252	50.5	434	22.88	
BRTBAR6PDA3060L	5977	7234	29	180	62.5	369	21.08	
BRTBAR6PDA3066L	6379	7739	29	198	62.5	400	21.97	
BRTBAR6PDA3072L	6641	8158	29	216	62.5	431	22.86	
BRTBAR6PDA3078L	6798	8470	29	234	62.5	462	23.75	
BRTBAR6PDA3084L	7060	8837	29	252	62.5	493	24.53	

BRTBAR8P-L • Rectangular Legs - Back 2 Back 8 Person Pod (Levelers)

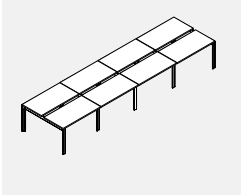

- **Back 2 Back, 8-person workstation consists of 8 worksurfaces, 2 Back 2 Back outer leg assemblies, 3 Back 2 Back narrow leg assemblies and 8 horizontal structural beams.**
- Finish options, please choose from:
 - 1) anodized aluminum vertical legs with powder coated steel horizontal structural members. Anodized aluminum leg upcharge of \$271 for this configuration.
 - 2) powder coated aluminum vertical legs and steel horizontal structural members. Choose from standard metal finishes.
- Worksurface available in HP and LP. For wood veneer tops, please contact your Customer Service Representative.

PRODUCT CODE	PRICE		SIZE/INCHES			WEIGHT		VOL FT ³
	LP	HP	H	W	D	LBS		
BRTBAR8P2460L	6435	7288	29	240	50.5	412	24.42	
BRTBAR8P2466L	6584	7464	29	264	50.5	448	25.30	
BRTBAR8P2472L	6766	7695	29	288	50.5	484	26.30	
BRTBAR8P2478L	7048	8003	29	312	50.5	520	27.30	
BRTBAR8P2484L	7358	8364	29	336	50.5	556	28.30	
BRTBAR8P3060L	6551	7431	29	240	62.5	492	26.18	
BRTBAR8P3066L	6719	7647	29	264	62.5	536	27.28	
BRTBAR8P3072L	6966	7934	29	288	62.5	581	28.38	
BRTBAR8P3078L	7224	8219	29	312	62.5	625	29.48	
BRTBAR8P3084L	7647	8733	29	336	62.5	669	30.58	

BRTBAR8PA-L • Rectangular Legs - Back 2 Back 8 Person Pod (Levelers) with Access Door

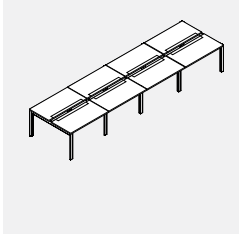

- Back 2 Back, 8-person workstation consists of 8 worksurfaces, 2 Back 2 Back outer leg assemblies, 3 Back 2 Back narrow leg assemblies and 8 horizontal structural beams.

- Finish options, please choose from:

- 1) anodized aluminum vertical legs with powder coated steel horizontal structural members. Anodized aluminum leg upcharge of \$271 for this configuration.
- 2) powder coated aluminum vertical legs and steel horizontal structural members. Choose from standard metal finishes.
- Anodized aluminum worksurface door provides access to power / data through below worksurface.
- Worksurface with access doors cannot be combined with above worksurface power trough.
- Worksurface available in HP and LP.

PRODUCT CODE	PRICE		SIZE/INCHES				WEIGHT VOL	
	LP	HP	H	W	D	LBS	FT³	
BRTBAR8PA2460L	6744	7971	29	240	50.5	412	24.42	
BRTBAR8PA2466L	7035	8392	29	264	50.5	448	25.30	
BRTBAR8PA2472L	7358	8908	29	288	50.5	484	26.30	
BRTBAR8PA3060L	7261	8811	29	240	62.5	492	26.18	
BRTBAR8PA3066L	7714	9393	29	264	62.5	536	27.28	
BRTBAR8PA3072L	8037	9906	29	288	62.5	581	28.38	

BRTBAR8PDA-L • Rectangular Legs - Back 2 Back 8 Person Pod (Levelers) with Access Doors

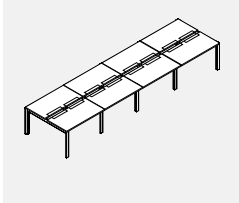

- Back 2 Back, 8-person workstation consists of 8 worksurfaces, 2 Back 2 Back outer leg assemblies, 3 Back 2 Back narrow leg assemblies and 8 horizontal structural beams.

- These tables feature dual access doors providing a central connection point for monitor lifts.

- Finish options, please choose from:

- 1) anodized aluminum vertical legs with powder coated steel horizontal structural members. Anodized aluminum leg upcharge of \$271 for this configuration.
- 2) powder coated aluminum vertical legs and steel horizontal structural members. Choose from standard metal finishes.
- Anodized aluminum worksurface door provides access to power / data through below worksurface.
- Worksurface with access doors cannot be combined with above worksurface power trough.
- Worksurface available in HP and LP.

PRODUCT CODE	PRICE		SIZE/INCHES				WEIGHT VOL	
	LP	HP	H	W	D	LBS	FT³	
BRTBAR8PDA2460L	7284	8609	29	240	50.5	412	24.42	
BRTBAR8PDA2466L	7599	9064	29	264	50.5	448	25.30	
BRTBAR8PDA2472L	7949	9622	29	288	50.5	484	26.30	
BRTBAR8PDA2478L	8158	9898	29	312	50.5	520	27.30	
BRTBAR8PDA2484L	8436	10388	29	336	50.5	556	28.30	
BRTBAR8PDA3060L	7842	9517	29	240	62.5	492	26.18	
BRTBAR8PDA3066L	8333	10145	29	264	62.5	536	27.28	
BRTBAR8PDA3072L	8677	10701	29	288	62.5	581	28.38	
BRTBAR8PDA3078L	8888	11120	29	312	62.5	625	29.48	
BRTBAR8PDA3084L	9238	11440	29	336	62.5	669	30.58	

BRT36P-C • Rectangular Legs - 36" High Single Table (Casters)

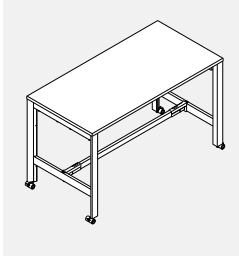

- Single table assembly consists of one work-surface, two H leg assemblies and all required beams.

- 24" deep tables have three (3) beams at the top, and one bottom beam.

- 30" and 36" deep tables have four (4) beams at the top, and one bottom beam.

- 40mm white locking casters with grey tires.

- Finish option, please choose from:

- 1) anodized aluminum vertical legs with powder coated steel horizontal structural members. Anodized aluminum leg upcharge of \$110 for this configuration.
- 2) powder coated aluminum vertical legs with steel horizontal structural members. Choose from standard metal finishes.
- Worksurface available in LP and HP.

PRODUCT CODE	PRICE		SIZE/INCHES				WEIGHT VOL	
	LP	HP	H	W	D	LBS	FT³	
BRT36P2436C	1891	1943	36	36	24	68.5	4.55	
BRT36P2442C	1950	2017	36	42	24	76.0	4.76	
BRT36P2448C	2025	2107	36	48	24	81.5	4.98	
BRT36P2454C	2130	2222	36	54	24	88.0	5.19	
BRT36P2460C	2198	2305	36	60	24	94.6	5.41	
BRT36P2466C	2248	2357	36	66	24	101.1	5.62	
BRT36P2472C	2295	2410	36	72	24	107.6	5.83	
BRT36P2478C	2354	2475	36	78	24	114.1	6.13	
BRT36P2484C	2413	2540	36	84	24	120.6	6.42	
BRT36P3036C	2178	2239	36	36	30	83.9	5.00	
BRT36P3042C	2273	2361	36	42	30	91.0	5.26	
BRT36P3048C	2330	2422	36	48	30	99.2	5.53	
BRT36P3054C	2432	2526	36	54	30	107.3	5.79	
BRT36P3060C	2498	2608	36	60	30	115.5	6.06	
BRT36P3066C	2552	2668	36	66	30	123.6	6.32	
BRT36P3072C	2617	2736	36	72	30	131.8	6.59	
BRT36P3078C	2682	2807	36	78	30	139.9	6.95	
BRT36P3084C	2761	2897	36	84	30	148.1	7.32	
BRT36P3642C	2464	2549	36	42	36	99.9	6.56	
BRT36P3648C	2552	2644	36	48	36	109.0	6.87	
BRT36P3654C	2670	2778	36	54	36	118.2	7.18	
BRT36P3660C	2758	2873	36	60	36	126.3	7.48	
BRT36P3666C	2844	2972	36	66	36	135.5	7.79	
BRT36P3672C	2927	3065	36	72	36	144.6	8.10	
BRT36P3678C	3012	3160	36	78	36	152.8	8.50	
BRT36P3684C	3092	3252	36	84	36	161.9	8.91	

BRT36P-L • Rectangular Legs - 36" High Single Table (Levelers)

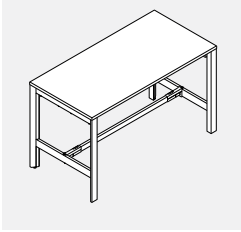

- Single table assembly consists of one work-surface, two H leg assemblies and all required beams.
- 24" deep tables have three (3) beams at the top, and one bottom beam.
- 30" and 36" deep tables have four (4) beams at the top, and one bottom beam.
- Finish option, please choose from:
 - 1) anodized aluminum vertical legs with powder coated steel horizontal structural members. Anodized aluminum leg upcharge of \$110 for this configuration
 - 2) powder coated aluminum vertical legs with steel horizontal structural members Choose from standard metal finishes
- Worksurface available in LP and HP.

PRODUCT CODE	PRICE		SIZE/INCHES				WEIGHT LBS	VOL FT ³
	LP	HP	H	W	D			
BRT36P2436L	1813	1863	36	36	24	68.0	4.55	
BRT36P2442L	1872	1939	36	42	24	75.5	4.76	
BRT36P2448L	1947	2028	36	48	24	81.0	4.98	
BRT36P2454L	2053	2145	36	54	24	87.6	5.19	
BRT36P2460L	2120	2225	36	60	24	94.1	5.41	
BRT36P2466L	2169	2279	36	66	24	100.6	5.62	
BRT36P2472L	2218	2333	36	72	24	107.1	5.83	
BRT36P2478L	2277	2397	36	78	24	113.6	6.13	
BRT36P2484L	2335	2462	36	84	24	120.2	6.42	
BRT36P3036L	2098	2162	36	36	30	83.4	5.00	
BRT36P3042L	2195	2283	36	42	30	90.5	5.26	
BRT36P3048L	2252	2344	36	48	30	98.7	5.53	
BRT36P3054L	2354	2448	36	54	30	106.8	5.79	
BRT36P3060L	2421	2529	36	60	30	115.0	6.06	
BRT36P3066L	2474	2591	36	66	30	123.1	6.32	
BRT36P3072L	2538	2658	36	72	30	131.3	6.59	
BRT36P3078L	2603	2728	36	78	30	139.4	6.95	
BRT36P3084L	2683	2820	36	84	30	147.6	7.32	
BRT36P3642L	2387	2471	36	42	36	99.4	6.56	
BRT36P3648L	2474	2566	36	48	36	108.5	6.87	
BRT36P3654L	2592	2697	36	54	36	117.7	7.18	
BRT36P3660L	2680	2794	36	60	36	125.8	7.48	
BRT36P3666L	2764	2893	36	66	36	135.0	7.79	
BRT36P3672L	2849	2988	36	72	36	144.1	8.10	
BRT36P3678L	2933	3083	36	78	36	152.3	8.50	
BRT36P3684L	3014	3174	36	84	36	161.4	8.91	

BRT36A-L • Rectangular Legs - 36" High Add-On (Levelers)

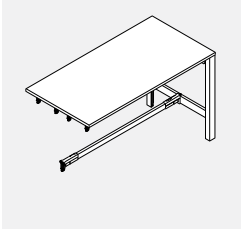

- Single table assembly consists of one work-surface, one H leg assembly and all required beams.
- 24" deep tables have three (3) beams at the top, and one bottom beam.
- 30" and 36" deep tables have four (4) beams at the top, and one bottom beam.
- Finish option, please choose from:
 - 1) anodized aluminum vertical legs with powder coated steel horizontal structural members. Anodized aluminum leg upcharge of \$55 for this configuration
 - 2) powder coated aluminum vertical legs with steel horizontal structural members Choose from standard metal finishes
- Worksurface available in LP and HP.

PRODUCT CODE	PRICE		SIZE/INCHES				WEIGHT LBS	VOL FT ³
	LP	HP	H	W	D			
BRT36A2436L	1366	1418	36	36	24	54.2	2.87	
BRT36A2442L	1427	1494	36	42	24	61.7	3.08	
BRT36A2448L	1500	1583	36	48	24	67.2	3.30	
BRT36A2454L	1606	1697	36	54	24	73.7	3.51	
BRT36A2460L	1673	1781	36	60	24	80.2	3.73	
BRT36A2466L	1724	1833	36	66	24	86.8	3.94	
BRT36A2472L	1771	1887	36	72	24	93.3	4.15	
BRT36A2478L	1830	1950	36	78	24	99.8	4.45	
BRT36A2484L	1890	2016	36	84	24	106.3	4.74	
BRT36A3036L	1624	1687	36	36	30	67.5	3.24	
BRT36A3042L	1720	1807	36	42	30	74.7	3.50	
BRT36A3048L	1777	1867	36	48	30	82.8	3.77	
BRT36A3054L	1879	1970	36	54	30	91.0	4.03	
BRT36A3060L	1945	2054	36	60	30	99.1	4.30	
BRT36A3066L	1999	2115	36	66	30	107.3	4.56	
BRT36A3072L	2064	2182	36	72	30	115.4	4.83	
BRT36A3078L	2129	2254	36	78	30	123.6	5.19	
BRT36A3084L	2209	2345	36	84	30	131.7	5.56	
BRT36A3642L	1845	1927	36	42	36	81.6	4.30	
BRT36A3648L	1929	2025	36	48	36	90.8	4.61	
BRT36A3654L	2050	2155	36	54	36	99.9	4.92	
BRT36A3660L	2136	2254	36	60	36	108.1	5.22	
BRT36A3666L	2222	2350	36	66	36	117.2	5.53	
BRT36A3672L	2308	2446	36	72	36	126.4	5.84	
BRT36A3678L	2390	2540	36	78	36	134.5	6.24	
BRT36A3684L	2472	2630	36	84	36	143.7	6.65	

BRT42P-C • Rectangular Legs - 42" High Pod (Casters)

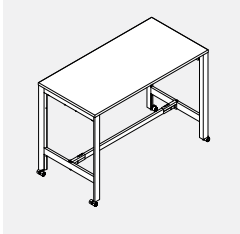

- Single table assembly consists of one work-surface, two H leg assemblies and all required beams.
- 24" deep tables have three (3) beams at the top, and one bottom beam.
- 30" and 36" deep tables have four (4) beams at the top, and one bottom beam.
- 40mm white locking casters with grey tires
- Finish option, please choose from:
 - 1) anodized aluminum vertical legs with powder coated steel horizontal structural members. Anodized aluminum leg upcharge of \$110 for this configuration
 - 2) powder coated aluminum vertical legs with steel horizontal structural members. Choose from standard metal finishes
- Worksurface available in LP and HP.

PRODUCT CODE	PRICE		SIZE / INCHES			WEIGHT LBS	VOL FT ³
	LP	HP	H	W	D		
BRT42P2436C	1935	1987	42	36	24	70.4	5.11
BRT42P2442C	1995	2063	42	42	24	77.9	5.32
BRT42P2448C	2068	2152	42	48	24	83.4	5.54
BRT42P2454C	2175	2266	42	54	24	89.9	5.75
BRT42P2460C	2243	2349	42	60	24	96.5	5.97
BRT42P2466C	2292	2400	42	66	24	103.0	6.18
BRT42P2472C	2339	2454	42	72	24	109.5	6.39
BRT42P2478C	2399	2518	42	78	24	116.0	6.69
BRT42P2484C	2457	2586	42	84	24	122.5	6.98
BRT42P3036C	2222	2285	42	36	30	85.8	5.60
BRT42P3042C	2318	2404	42	42	30	92.9	5.86
BRT42P3048C	2375	2465	42	48	30	101.1	6.13
BRT42P3054C	2477	2569	42	54	30	109.2	6.39
BRT42P3060C	2543	2652	42	60	30	117.4	6.66
BRT42P3066C	2595	2714	42	66	30	125.5	6.92
BRT42P3072C	2660	2782	42	72	30	133.7	7.19
BRT42P3078C	2727	2850	42	78	30	141.8	7.55
BRT42P3084C	2807	2945	42	84	30	150.0	7.92
BRT42P3642C	2510	2593	42	42	36	101.8	7.34
BRT42P3648C	2595	2688	42	48	36	110.9	7.65
BRT42P3654C	2715	2820	42	54	36	120.1	7.96
BRT42P3660C	2803	2918	42	60	36	128.2	8.26
BRT42P3666C	2888	3015	42	66	36	137.4	8.57
BRT42P3672C	2973	3111	42	72	36	146.5	8.88
BRT42P3678C	3056	3205	42	78	36	154.7	9.28
BRT42P3684C	3138	3295	42	84	36	163.8	9.69

BRT42P-L • Rectangular Legs - 42" High Pod (Levelers)

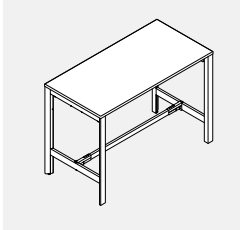

- Single table assembly consists of one work-surface, two H leg assemblies and all required beams.
- 24" deep tables have three (3) beams at the top, and one bottom beam.
- 30" and 36" deep tables have four (4) beams at the top, and one bottom beam.
- Finish option, please choose from:
 - 1) anodized aluminum vertical legs with powder coated steel horizontal structural members. Anodized aluminum leg upcharge of \$110 for this configuration
 - 2) powder coated aluminum vertical legs with steel horizontal structural members. Choose from standard metal finishes
- Worksurface available in LP and HP.

PRODUCT CODE	PRICE		SIZE / INCHES			WEIGHT LBS	VOL FT ³
	LP	HP	H	W	D		
BRT42P2436L	1858	1906	42	36	24	69.94	5.11
BRT42P2442L	1917	1983	42	42	24	77.46	5.32
BRT42P2448L	1990	2071	42	48	24	82.98	5.54
BRT42P2454L	2096	2190	42	54	24	89.50	5.75
BRT42P2460L	2166	2270	42	60	24	96.02	5.97
BRT42P2466L	2213	2322	42	66	24	102.54	6.18
BRT42P2472L	2261	2377	42	72	24	109.06	6.39
BRT42P2478L	2321	2442	42	78	24	115.58	6.69
BRT42P2484L	2379	2507	42	84	24	122.10	6.98
BRT42P3036L	2145	2207	42	36	30	85.33	5.60
BRT42P3042L	2237	2325	42	42	30	92.48	5.86
BRT42P3048L	2296	2388	42	48	30	100.63	6.13
BRT42P3054L	2399	2490	42	54	30	108.78	6.39
BRT42P3060L	2464	2574	42	60	30	116.93	6.66
BRT42P3066L	2517	2635	42	66	30	125.08	6.92
BRT42P3072L	2583	2703	42	72	30	133.23	7.19
BRT42P3078L	2650	2772	42	78	30	141.38	7.55
BRT42P3084L	2728	2864	42	84	30	149.53	7.92
BRT42P3642L	2430	2515	42	42	36	101.34	7.34
BRT42P3648L	2517	2613	42	48	36	110.49	7.65
BRT42P3654L	2637	2742	42	54	36	119.64	7.96
BRT42P3660L	2724	2841	42	60	36	127.79	8.26
BRT42P3666L	2809	2936	42	66	36	136.94	8.57
BRT42P3672L	2894	3033	42	72	36	146.09	8.88
BRT42P3678L	2978	3126	42	78	36	154.24	9.28
BRT42P3684L	3059	3216	42	84	36	163.39	9.69

BRT42A-L • Rectangular Legs - 42" High Add-On (Levelers)

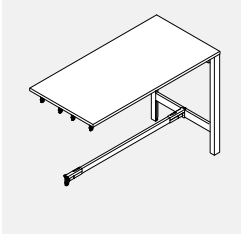

- **Single table assembly consists of one work-surface, one H leg assembly and all required beams.**
- 24" deep tables have three (3) beams at the top, and one bottom beam.
- 30" and 36" deep tables have four (4) beams at the top, and one bottom beam.
- Finish option, please choose from:
 - 1) anodized aluminum vertical legs with powder coated steel horizontal structural members. Anodized aluminum leg upcharge of \$55 for this configuration
 - 2) powder coated aluminum vertical legs with steel horizontal structural members. Choose from standard metal finishes
- Worksurface available in LP and HP.

PRODUCT CODE	PRICE		SIZE/INCHES			WEIGHT LBS	VOL FT ³
	LP	HP	H	W	D		
BRT42A2436L	1389	1440	42	36	24	55.15	3.15
BRT42A2442L	1450	1516	42	42	24	62.67	3.36
BRT42A2448L	1522	1605	42	48	24	68.19	3.58
BRT42A2454L	1628	1722	42	54	24	74.71	3.79
BRT42A2460L	1696	1802	42	60	24	81.23	4.01
BRT42A2466L	1747	1855	42	66	24	87.75	4.22
BRT42A2472L	1792	1906	42	72	24	94.27	4.43
BRT42A2478L	1852	1973	42	78	24	100.79	4.73
BRT42A2484L	1913	2038	42	84	24	107.31	5.02
BRT42A3036L	1647	1708	42	36	30	68.52	3.54
BRT42A3042L	1739	1829	42	42	30	75.67	3.80
BRT42A3048L	1799	1891	42	48	30	83.82	4.07
BRT42A3054L	1901	1993	42	54	30	91.97	4.33
BRT42A3060L	1967	2076	42	60	30	100.12	4.60
BRT42A3066L	2020	2136	42	66	30	108.27	4.86
BRT42A3072L	2086	2206	42	72	30	116.42	5.13
BRT42A3078L	2152	2276	42	78	30	124.57	5.49
BRT42A3084L	2231	2366	42	84	30	132.72	5.86
BRT42A3642L	1866	1950	42	42	36	82.60	4.69
BRT42A3648L	1954	2046	42	48	36	91.75	5.00
BRT42A3654L	2070	2178	42	54	36	100.90	5.31
BRT42A3660L	2158	2276	42	60	36	109.05	5.61
BRT42A3666L	2245	2372	42	66	36	118.20	5.92
BRT42A3672L	2330	2467	42	72	36	127.35	6.23
BRT42A3678L	2413	2562	42	78	36	135.50	6.63
BRT42A3684L	2493	2653	42	84	36	144.65	7.04

BRTSQ • Rectangular Legs - Meeting Table - Rectangular

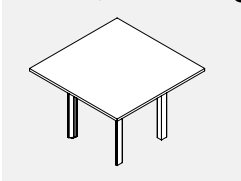

- **Rectangular meeting tables; levelers or casters**
- LP or HP tops, 3mm edging.
- Anodized aluminum leg upcharge of \$110 for this configuration.
- Includes top, legs and beam.
- L = Levelers
- C = Casters
- Worksurface available in HP and LP. For wood veneer tops, please contact your Customer Service Representative.

PRODUCT CODE	PRICE		SIZE/INCHES			WEIGHT LBS	VOL FT ³
	LP	HP	H	W	D		
BRTSQ42L	1221	1349	29	42	42	85	4.20
BRTSQ42C	1285	1414	29	42	42	85	4.20

BRTR • Rectangular Legs - Meeting Table - Round

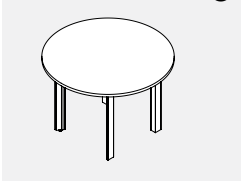

- **Round meeting tables; levelers or casters**
- LP or HP tops, 3mm edging.
- Anodized aluminum leg upcharge of \$110 for this configuration.
- Includes top, legs and beam.
- L = Levelers
- C = Casters
- Worksurface available in HP and LP. For wood veneer tops, please contact your Customer Service Representative.

PRODUCT CODE	PRICE		SIZE/INCHES			WEIGHT LBS	VOL FT ³
	LP	HP	H	W	D		
BRTR42L	1221	1349	29	42	42	65	3.90
BRTR42C	1285	1414	29	42	42	65	3.90

BRTSLDT72C • Rectangular Legs - Rail Sliding Table Kit

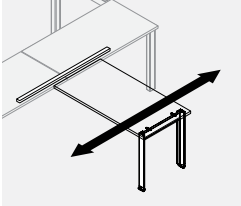

- **Includes leg, leg support, sliding bracket hardware, 72" rail and hardware to secure table. Worksurface not included.**
- 40mm dia. locking casters with 8mm thread, white body and grey tires.
- Legs included are for 24" deep worksurfaces.
- Anodized aluminum leg upcharge of \$55 for this configuration.
- Maximum length of the sliding table surface is 48".

PRODUCT CODE	PRICE	SIZE/INCHES			WEIGHT LBS	VOL FT ³
		H	W	D		
BRTSLDT72C	646	29	48	72	28.5	2.40

BRTS1P-LR • Round Legs Single Line 1 Person Pod (Levelers)

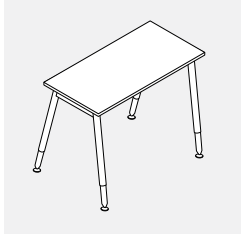

- Single Line Table Assemblies consist of one worksurface, two leg assemblies and one horizontal structural beam.
- Worksurface available in HP and LP. For wood veneer tops, please contact your Customer Service Representative.

PRODUCT CODE	PRICE		SIZE/INCHES			WEIGHT VOL	
	LP	HP	H	W	D	LBS	FT ³
BRTS1P2436LR	1048	1084	29	36	24	45	4.00
BRTS1P2442LR	1084	1135	29	42	24	48	4.10
BRTS1P2448LR	1133	1217	29	48	24	51	4.20
BRTS1P2451LR	1163	1232	29	50.5	24	54	4.30
BRTS1P2454LR	1207	1286	29	54	24	57	4.40
BRTS1P2460LR	1233	1342	29	60	24	60	4.48
BRTS1P2463LR	1250	1355	29	62.5	24	63	4.57
BRTS1P2466LR	1258	1366	29	66	24	66	4.65
BRTS1P2472LR	1282	1395	29	72	24	69	4.73
BRTS1P2478LR	1316	1433	29	78	24	72	4.82
BRTS1P2484LR	1354	1481	29	84	24	75	4.92
BRTS1P3036LR	1019	1080	29	36	30	45	4.00
BRTS1P3042LR	1136	1225	29	42	30	48	4.10
BRTS1P3048LR	1162	1253	29	48	30	51	4.20
BRTS1P3051LR	1198	1291	29	50.5	30	54	4.30
BRTS1P3054LR	1221	1312	29	54	30	57	4.40
BRTS1P3060LR	1251	1343	29	60	30	60	4.48
BRTS1P3063LR	1261	1374	29	62.5	30	63	4.57
BRTS1P3066LR	1268	1387	29	66	30	66	4.65
BRTS1P3072LR	1300	1406	29	72	30	69	4.73
BRTS1P3078LR	1332	1456	29	78	30	72	4.82
BRTS1P3084LR	1387	1522	29	84	30	75	4.92

BRTS1P-CR • Round Legs Single Line 1 Person Pod (Casters)



- Single Line Table Assemblies consist of one worksurface, two leg assemblies and one horizontal structural beam.
- Worksurface available in HP and LP. For wood veneer tops, please contact your Customer Service Representative.

PRODUCT CODE	PRICE		SIZE/INCHES			WEIGHT VOL	
	LP	HP	H	W	D	LBS	FT ³
BRTS1P2436CR	1124	1162	29	36	24	45	4.00
BRTS1P2442CR	1162	1210	29	42	24	48	4.10
BRTS1P2448CR	1207	1290	29	48	24	51	4.20
BRTS1P2451CR	1238	1312	29	50.5	24	54	4.30
BRTS1P2454CR	1287	1363	29	54	24	57	4.40
BRTS1P2460CR	1313	1418	29	60	24	60	4.48
BRTS1P2463CR	1326	1432	29	62.5	24	63	4.57
BRTS1P2466CR	1334	1444	29	66	24	66	4.65
BRTS1P2472CR	1356	1473	29	72	24	69	4.73
BRTS1P2478CR	1393	1514	29	78	24	72	4.82
BRTS1P2484CR	1431	1558	29	84	24	75	4.92
BRTS1P3036CR	1095	1159	29	36	30	45	4.00
BRTS1P3042CR	1217	1301	29	42	30	48	4.10
BRTS1P3048CR	1236	1329	29	48	30	51	4.20
BRTS1P3051CR	1277	1370	29	50.5	30	54	4.30
BRTS1P3054CR	1294	1388	29	54	30	57	4.40
BRTS1P3060CR	1327	1420	29	60	30	60	4.48
BRTS1P3063CR	1338	1452	29	62.5	30	63	4.57
BRTS1P3066CR	1349	1464	29	66	30	66	4.65
BRTS1P3072CR	1383	1483	29	72	30	69	4.73
BRTS1P3078CR	1412	1535	29	78	30	72	4.82
BRTS1P3084CR	1464	1599	29	84	30	75	4.92

BRTS2P-LR • Round Legs Single Line 2 Person Pod (Levelers)



- Single Line Table Assemblies consists of 2 worksurfaces, 3 leg assemblies and 2 horizontal structural beams.
- Worksurface available in HP and LP. For wood veneer tops, please contact your Customer Service Representative.

PRODUCT CODE	PRICE		SIZE/INCHES			WEIGHT VOL	
	LP	HP	H	W	D	LBS	FT ³
BRTS2P2448LR	1923	2086	29	96	24	95	6.21
BRTS2P2454LR	2043	2225	29	108	24	104	6.45
BRTS2P2460LR	2127	2341	29	120	24	113	6.71
BRTS2P2466LR	2179	2391	29	132	24	122	6.95
BRTS2P2472LR	2219	2451	29	144	24	131	7.13
BRTS2P2478LR	2287	2527	29	156	24	140	7.27
BRTS2P2484LR	2378	2617	29	168	24	149	7.41
BRTS2P3048LR	2011	2195	29	96	30	113	6.57
BRTS2P3054LR	2094	2280	29	108	30	122	6.85
BRTS2P3060LR	2156	2376	29	120	30	131	7.13
BRTS2P3066LR	2198	2429	29	132	30	140	7.41
BRTS2P3072LR	2259	2501	29	144	30	155	7.69
BRTS2P3078LR	2323	2574	29	156	30	164	7.97
BRTS2P3084LR	2429	2702	29	168	30	173	8.25

BRTS3P-LR • Round Legs Single Line 3 Person Pod (Levelers)



- Single Line, 3-person workstation consists of 3 worksurfaces, 4 leg assemblies and 3 horizontal structural beams.
- Worksurface available in HP and LP. For wood veneer tops, please contact your Customer Service Representative.

PRODUCT CODE	PRICE		SIZE/INCHES			WEIGHT VOL	
	LP	HP	H	W	D	LBS	FT ³
BRTS3P2448LR	2709	2957	29	144	24	138	8.47
BRTS3P2454LR	2894	3168	29	162	24	152	8.68
BRTS3P2460LR	3020	3340	29	180	24	165	8.89
BRTS3P2466LR	3087	3418	29	198	24	179	9.11
BRTS3P2472LR	3156	3506	29	216	24	192	9.32
BRTS3P2478LR	3259	3621	29	234	24	206	9.53
BRTS3P2484LR	3378	3754	29	252	24	219	9.74
BRTS3P3048LR	2846	3123	29	144	30	161	9.01
BRTS3P3054LR	2973	3249	29	162	30	178	9.44
BRTS3P3060LR	3064	3392	29	180	30	195	9.87
BRTS3P3066LR	3126	3476	29	198	30	212	10.30
BRTS3P3072LR	3219	3582	29	216	30	229	10.72
BRTS3P3078LR	3315	3687	29	234	30	246	11.16
BRTS3P3084LR	3476	3881	29	252	30	263	11.59

BRTS4P-LR • Round Legs Single Line 4 Person Pod (Levelers)

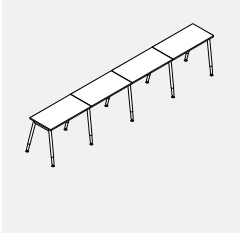

- Single Line, 4-person workstation consists of 4 worksurfaces, 5 leg assemblies and 3 horizontal structural beams.
- Worksurface available in HP and LP. For wood veneer tops, please contact your Customer Service Representative.

PRODUCT CODE	PRICE		SIZE/INCHES			WEIGHT VOL	
	LP	HP	H	W	D	LBS	FT ³
BRTS4P2448LR	3460	3828	29	192	24	180	10.73
BRTS4P2454LR	3743	4111	29	216	24	199	11.22
BRTS4P2460LR	3898	4338	29	240	24	217	11.71
BRTS4P2466LR	4004	4443	29	264	24	236	12.20
BRTS4P2472LR	4093	4556	29	288	24	254	12.69
BRTS4P2478LR	4236	4711	29	312	24	273	13.18
BRTS4P2484LR	4389	4893	29	336	24	291	13.67
BRTS4P3048LR	3680	4047	29	192	30	213	11.45
BRTS4P3054LR	3846	4215	29	216	30	235	12.02
BRTS4P3060LR	3970	4409	29	240	30	257	12.59
BRTS4P3066LR	4055	4518	29	264	30	279	13.16
BRTS4P3072LR	4177	4660	29	288	30	301	13.73
BRTS4P3078LR	4304	4803	29	312	30	323	14.30
BRTS4P3084LR	4518	5063	29	336	30	345	14.87

BRTBAR2P-LR • Round Legs Back 2 Back 2 Person Pod (Levelers)

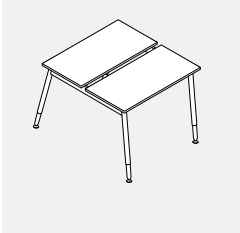

- Back 2 Back, 2-person workstation consists of 2 worksurfaces, 2 Back 2 Back leg assemblies and 2 horizontal structural beams.
- Worksurface available in HP and LP. For wood veneer tops, please contact your Customer Service Representative.

PRODUCT CODE	PRICE		SIZE/INCHES			WEIGHT VOL	
	LP	HP	H	W	D	LBS	FT ³
BRTBAR2P2460LR	1991	2203	29	60	50.5	110	8.56
BRTBAR2P2466LR	2037	2256	29	66	50.5	119	8.76
BRTBAR2P2472LR	2083	2314	29	72	50.5	128	9.02
BRTBAR2P2478LR	2154	2391	29	78	50.5	137	9.20
BRTBAR2P2484LR	2215	2464	29	84	50.5	146	9.40
BRTBAR2P3060LR	1851	2239	29	60	62.5	130	9.00
BRTBAR2P3066LR	2063	2295	29	66	62.5	141	9.25
BRTBAR2P3072LR	2124	2358	29	72	62.5	152	9.54
BRTBAR2P3078LR	2190	2435	29	78	62.5	163	9.80
BRTBAR2P3084LR	2295	2567	29	84	62.5	174	10.4

BRTBAR2PA-LR • Round Legs Back 2 Back 2 Person Pod with Access Door (Levelers)

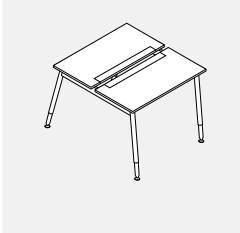

- Back 2 Back, 2-person workstation consists of 2 worksurfaces, 2 Back 2 Back leg assemblies and 2 horizontal structural beams.
- Anodized aluminum worksurface door provides access to power / data through below worksurface.
- Worksurface with access doors cannot be combined with above worksurface power trough.
- Worksurface available in HP and LP.

PRODUCT CODE	PRICE		SIZE/INCHES			WEIGHT VOL	
	LP	HP	H	W	D	LBS	FT ³
BRTBAR2PA2460LR	2068	2376	29	60	50.5	110	8.56
BRTBAR2PA2466LR	2149	2488	29	66	50.5	119	8.76
BRTBAR2PA2472LR	2231	2617	29	72	50.5	128	9.02
BRTBAR2PA3060LR	2198	2586	29	60	62.5	130	9.00
BRTBAR2PA3066LR	2312	2730	29	66	62.5	141	9.25
BRTBAR2PA3072LR	2391	2861	29	72	62.5	152	9.54

BRTBAR2PDA-LR • Round Legs Back 2 Back 2 Person Pod with Access Door (Levelers)

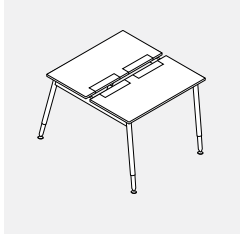

- Back 2 Back, 2-person workstation consists of 2 worksurfaces, 2 Back 2 Back leg assemblies and 2 horizontal structural beams.
- These tables feature dual access doors providing a central connection point for monitor lifts.
- Anodized aluminum worksurface door provides access to power / data through below worksurface.
- Worksurface with access doors cannot be combined with above worksurface power trough.
- Worksurface available in HP and LP.

PRODUCT CODE	PRICE		SIZE/INCHES			WEIGHT VOL	
	LP	HP	H	W	D	LBS	FT ³
BRTBAR2PDA2460LR	2234	2567	29	60	50.5	110	8.56
BRTBAR2PDA2466LR	2322	2687	29	66	50.5	119	8.76
BRTBAR2PDA2472LR	2408	2826	29	72	50.5	128	9.02
BRTBAR2PDA2478LR	2462	2896	29	78	50.5	137	9.20
BRTBAR2PDA2484LR	2514	3002	29	84	50.5	146	9.40
BRTBAR2PDA3060LR	2372	2792	29	60	62.5	130	9.00
BRTBAR2PDA3066LR	2496	2950	29	66	62.5	141	9.25
BRTBAR2PDA3072LR	2582	3090	29	72	62.5	152	9.54
BRTBAR2PDA3078LR	2637	3193	29	78	62.5	163	9.80
BRTBAR2PDA3084LR	2723	3315	29	84	62.5	174	10.4

BRTBAR4P-LR • Round Legs Back 2 Back 4 Person Pod (Levelers)

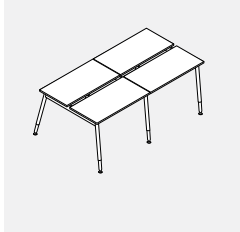

- Back 2 Back, 4-person workstation consists of 4 worksurfaces, 3 Back 2 Back leg assemblies and 4 horizontal structural beams.
- Worksurface available in HP and LP. For wood veneer tops, please contact your Customer Service Representative.

PRODUCT CODE	PRICE		SIZE/INCHES			WEIGHT VOL	
	LP	HP	H	W	D	LBS	FT ³
BRTBAR4P2460LR	3539	3962	29	120	50.5	208	13.82
BRTBAR4P2466LR	3627	4068	29	132	50.5	224	14.28
BRTBAR4P2472LR	3717	4183	29	144	50.5	240	14.74
BRTBAR4P2478LR	3862	4338	29	156	50.5	256	15.20
BRTBAR4P2484LR	4015	4518	29	168	50.5	272	15.66
BRTBAR4P3060LR	3627	4068	29	120	62.5	253	14.70
BRTBAR4P3066LR	3649	4111	29	132	62.5	273	15.24
BRTBAR4P3072LR	3803	4286	29	144	62.5	293	15.78
BRTBAR4P3078LR	3930	4428	29	156	62.5	313	16.32
BRTBAR4P3084LR	4145	4685	29	168	62.5	333	16.86

BRTBAR4PA-LR • Round Legs Back 2 Back 4 Person Pod with Access Door (Levelers)

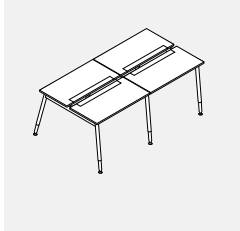

- Back 2 Back, 4-person workstation consists of 4 worksurfaces, 3 Back 2 Back leg assemblies and 4 horizontal structural beams.
- Anodized aluminum worksurface door provides access to power / data through below worksurface.
- Worksurface with access doors cannot be combined with above worksurface power trough.
- Worksurface available in HP and LP.

PRODUCT CODE	PRICE		SIZE/INCHES			WEIGHT VOL	
	LP	HP	H	W	D	LBS	FT ³
BRTBAR4PA2460LR	3691	4304	29	120	50.5	208	13.82
BRTBAR4PA2466LR	3926	4604	29	132	50.5	224	14.28
BRTBAR4PA2472LR	4015	4789	29	144	50.5	240	14.74
BRTBAR4PA3060LR	3983	4759	29	120	62.5	253	14.70
BRTBAR4PA3066LR	4241	5015	29	132	62.5	273	15.24
BRTBAR4PA3072LR	4338	5273	29	144	62.5	293	15.78

BRTBAR4PDA-LR • Round Legs Back 2 Back 4 Person Pod with Access Door (Levelers)



- Back 2 Back, 4-person workstation consists of 4 worksurfaces, 3 Back 2 Back leg assemblies and 4 horizontal structural beams.
- These tables feature dual access doors providing a central connection point for monitor lifts.
- Anodized aluminum worksurface door provides access to power / data through below worksurface.
- Worksurface with access doors cannot be combined with above worksurface power trough.
- Worksurface available in HP and LP.

PRODUCT CODE	PRICE		SIZE/INCHES			WEIGHT VOL	
	LP	HP	H	W	D	LBS	FT ³
BRTBAR4PDA2460LR	3986	4649	29	120	50.5	208	13.82
BRTBAR4PDA2466LR	4239	4973	29	132	50.5	224	14.28
BRTBAR4PDA2472LR	4337	5172	29	144	50.5	240	14.74
BRTBAR4PDA2478LR	4440	5312	29	156	50.5	256	15.20
BRTBAR4PDA2484LR	4579	5555	29	168	50.5	272	15.66
BRTBAR4PDA3060LR	4301	5139	29	120	62.5	253	14.70
BRTBAR4PDA3066LR	4579	5415	29	132	62.5	273	15.24
BRTBAR4PDA3072LR	4684	5695	29	144	62.5	293	15.78
BRTBAR4PDA3078LR	4789	5906	29	156	62.5	313	16.32
BRTBAR4PDA3084LR	4963	6148	29	168	62.5	333	16.86

BRTBAR6P-LR • Round Legs Back 2 Back 6 Person Pod (Levelers)

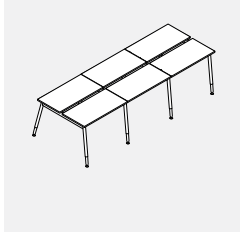

- Back 2 Back, 6-person workstation consists of 6 worksurfaces, 4 Back 2 Back leg assemblies and 6 horizontal structural beams.
- Worksurface available in HP and LP. For wood veneer tops, please contact your Customer Service Representative.

PRODUCT CODE	PRICE		SIZE/INCHES			WEIGHT VOL	
	LP	HP	H	W	D	LBS	FT ³
BRTBAR6P2460LR	5083	5734	29	180	50.5	308	19.76
BRTBAR6P2466LR	5218	5877	29	198	50.5	329	20.54
BRTBAR6P2472LR	5354	6052	29	216	50.5	359	21.32
BRTBAR6P2478LR	5568	6283	29	234	50.5	409	22.10
BRTBAR6P2484LR	5800	6554	29	252	50.5	434	22.88
BRTBAR6P3060LR	5170	5830	29	180	62.5	369	21.08
BRTBAR6P3066LR	5297	5995	29	198	62.5	400	21.97
BRTBAR6P3072LR	5480	6206	29	216	62.5	431	22.86
BRTBAR6P3078LR	5676	6419	29	234	62.5	462	23.75
BRTBAR6P3084LR	6002	6807	29	252	62.5	493	24.53

BRTBAR6PA-LR • Round Legs Back 2 Back 6 Person Pod with Access Door (Levelers)



- **Back 2 Back, 6-person workstation consists of 6 worksurfaces, 4 Back 2 Back leg assemblies and 6 horizontal structural beams.**
- Anodized aluminum worksurface door provides access to power / data through below worksurface.
- Worksurface with access doors cannot be combined with above worksurface power trough.
- Worksurface available in HP and LP.

PRODUCT CODE	PRICE		SIZE/INCHES			WEIGHT VOL	
	LP	HP	H	W	D	LBS	FT ³
BRTBAR6PA2460LR	5317	6237	29	180	50.5	308	19.76
BRTBAR6PA2466LR	5556	6576	29	198	50.5	329	20.54
BRTBAR6PA2472LR	5800	6964	29	216	50.5	359	21.32
BRTBAR6PA3060LR	5705	6865	29	180	62.5	369	21.08
BRTBAR6PA3066LR	6041	7301	29	198	62.5	400	21.97
BRTBAR6PA3072LR	6283	7688	29	216	62.5	431	22.86

BRTBAR6PDA-LR • Round Legs Back 2 Back 6 Person Pod with Access Door (Levelers)



- **Back 2 Back, 6-person workstation consists of 6 worksurfaces, 4 Back 2 Back leg assemblies and 6 horizontal structural beams.**
- These tables feature dual access doors providing a central connection point for monitor lifts.
- Anodized aluminum worksurface door provides access to power / data through below worksurface.
- Worksurface with access doors cannot be combined with above worksurface power trough.
- Worksurface available in HP and LP.

PRODUCT CODE	PRICE		SIZE/INCHES			WEIGHT VOL	
	LP	HP	H	W	D	LBS	FT ³
BRTBAR6PDA2460LR	5742	6735	29	180	50.5	308	19.76
BRTBAR6PDA2466LR	6001	7102	29	198	50.5	329	20.54
BRTBAR6PDA2472LR	6266	7520	29	216	50.5	359	21.32
BRTBAR6PDA2478LR	6419	7726	29	234	50.5	409	22.10
BRTBAR6PDA2484LR	6632	8093	29	252	50.5	434	22.88
BRTBAR6PDA3060LR	6160	7413	29	180	62.5	369	21.08
BRTBAR6PDA3066LR	6524	7886	29	198	62.5	400	21.97
BRTBAR6PDA3072LR	6787	8302	29	216	62.5	431	22.86
BRTBAR6PDA3078LR	6943	8615	29	234	62.5	462	23.75
BRTBAR6PDA3084LR	7203	8984	29	252	62.5	493	24.53

BRTBAR8P-LR • Round Legs Back 2 Back 8 Person Pod (Levelers)

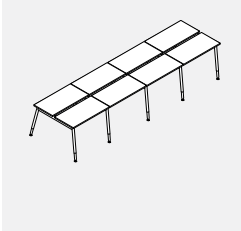

- **Back 2 Back, 8-person workstation consists of 8 worksurfaces, 5 Back 2 Back leg assemblies and 8 horizontal structural beams.**
- Worksurface available in HP and LP. For wood veneer tops, please contact your Customer Service Representative.

PRODUCT CODE	PRICE		SIZE/INCHES			WEIGHT VOL	
	LP	HP	H	W	D	LBS	FT ³
BRTBAR8P2460LR	6629	7481	29	240	50.5	412	24.42
BRTBAR8P2466LR	6811	7688	29	264	50.5	448	25.30
BRTBAR8P2472LR	6992	7921	29	288	50.5	484	26.30
BRTBAR8P2478LR	7275	8230	29	312	50.5	520	27.30
BRTBAR8P2484LR	7598	8592	29	336	50.5	556	28.30
BRTBAR8P3060LR	6744	7622	29	240	62.5	492	26.18
BRTBAR8P3066LR	6914	7842	29	264	62.5	536	27.28
BRTBAR8P3072LR	7160	8128	29	288	62.5	581	28.38
BRTBAR8P3078LR	7415	8412	29	312	62.5	625	29.48
BRTBAR8P3084LR	7842	8927	29	336	62.5	669	30.58

BRTBAR8PA-LR • Round Legs Back 2 Back 8 Person Pod with Access Door (Levelers)



- **Back 2 Back, 8-person workstation consists of 8 worksurfaces, 5 Back 2 Back leg assemblies and 8 horizontal structural beams.**
- Anodized aluminum worksurface door provides access to power / data through below worksurface.
- Worksurface with access doors cannot be combined with above worksurface power trough.
- Worksurface available in HP and LP.

PRODUCT CODE	PRICE		SIZE/INCHES			WEIGHT VOL	
	LP	HP	H	W	D	LBS	FT ³
BRTBAR8PA2460LR	6940	8166	29	240	50.5	412	24.42
BRTBAR8PA2466LR	7261	8616	29	264	50.5	448	25.30
BRTBAR8PA2472LR	7585	9134	29	288	50.5	484	26.30
BRTBAR8PA3060LR	7456	9005	29	240	62.5	492	26.18
BRTBAR8PA3066LR	7907	9585	29	264	62.5	536	27.28
BRTBAR8PA3072LR	8230	10101	29	288	62.5	581	28.38

BRTBAR8PDA-LR • Round Legs Back 2 Back 8 Person Pod with Access Door (Levelers)



- **Back 2 Back, 8-person workstation consists of 8 worksurfaces, 5 Back 2 Back leg assemblies and 8 horizontal structural beams.**
- These tables feature dual access doors providing a central connection point for monitor lifts.
- Anodized aluminum worksurface door provides access to power / data through below worksurface.
- Worksurface with access doors cannot be combined with above worksurface power trough.
- Worksurface available in HP and LP.

PRODUCT CODE	PRICE		SIZE/INCHES			WEIGHT VOL	
	LP	HP	H	W	D	LBS	FT ³
BRTBAR8PDA2460LR	7494	8819	29	240	50.5	412	24.42
BRTBAR8PDA2466LR	7842	9307	29	264	50.5	448	25.30
BRTBAR8PDA2472LR	8193	9865	29	288	50.5	484	26.30
BRTBAR8PDA2478LR	8400	10145	29	312	50.5	520	27.30
BRTBAR8PDA2484LR	8677	10630	29	336	50.5	556	28.30
BRTBAR8PDA3060LR	8053	9725	29	240	62.5	492	26.18
BRTBAR8PDA3066LR	8540	10353	29	264	62.5	536	27.28
BRTBAR8PDA3072LR	8888	10911	29	288	62.5	581	28.38
BRTBAR8PDA3078LR	9097	11328	29	312	62.5	625	29.48
BRTBAR8PDA3084LR	9447	11817	29	336	62.5	669	30.58

BRTSLDT72CR • Sliding Table Kit (Round Legs)



- **Includes leg, leg support, sliding bracket hardware, 72" rail and hardware to secure table. Worksurface not included.**
- Maximum length of the Sliding Table surface is 48".
- Locking casters are 3" diameter as standard.

PRODUCT CODE	PRICE	SIZE/INCHES			WEIGHT VOL	
		H	W	D	LBS	FT ³
BRTSLDT72CR	646	29	48	72	28.5	2.40

BRTSL-C • Single Leg Assembly (Casters)

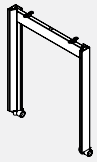

- Two Single Leg Assemblies form the structure of the Bridges series Single Table.
- 40mm white locking casters with grey tires; steel frame, aluminum legs.
- Anodized aluminum leg upcharge \$55.
- Please specify paint finish for support.

PRODUCT CODE	PRICE	SIZE/INCHES			WEIGHT VOL	
		H	W	D	LBS	FT ³
BRTSL24C	426	28	2.5	24	8	1.34
BRTSL30C	443	28	2.5	30	8	1.41
BRTSL36C	462	28	2.5	36	8	1.81

BRTSL-L • Single Leg Assembly (Levelers)

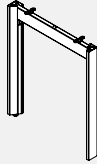

- Two Single Leg Assemblies form the structure of the Bridges series Single Line Tables.
- One leg can be shared by 2 adjoining worksurfaces.
- Leveling glides, steel frame, aluminum legs.
- Anodized aluminum leg upcharge \$55.
- Please specify paint finish for support.
- Please specify 2 beams when using BRTSL36L.

PRODUCT CODE	PRICE	SIZE/INCHES			WEIGHT VOL	
		H	W	D	LBS	FT ³
BRTSL24L	387	28	2.5	24	8	1.34
BRTSL30L	405	28	2.5	30	8	1.34
BRTSL36L	422	28	2.5	36	9	1.50

BRTBA-L • Back 2 Back Leg Assembly (Levelers)

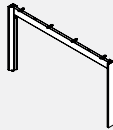

- Two Back 2 Back Leg Assemblies form the structure of the Bridges series Back 2 Back Tables.
- One double leg can be shared by 4 adjoining worksurfaces.
- Leveling, steel frame, aluminum legs.
- Anodized aluminum leg upcharge \$55.
- Please specify paint finish for support.

PRODUCT CODE	PRICE	SIZE/INCHES			WEIGHT VOL	
		H	W	D	LBS	FT ³
BRTBA34L	387	28	2.5	34	10	2.47
BRTBA51L	420	28	2.5	50.5	12	2.96
BRTBA63L	437	28	2.5	62.5	13	3.21

BRTHL-C • Single "H" Leg Assembly (Casters)

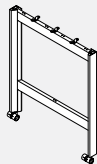

- Two Single Leg Assemblies form the structure of the Bridges series Single Line Tables.
- Leveling glides, steel frame, aluminum legs.
- Anodized aluminum leg upcharge \$55.
- Please specify paint finish for support.
- Note:
 - 24" deep tables must have three (3) beams at the top, and one beam (BRTBB-C "Bottom Table Beam") at the bottom.
 - 30" and 36" deep tables must have four (4) beams at the top, and one beam (BRTBB-C "Bottom Table Beam") at the bottom.

PRODUCT CODE	PRICE	SIZE/INCHES			WEIGHT VOL	
		H	W	D	LBS	FT ³
BRTHL3624C	485	35	2.5	24	14	1.68
BRTHL3630C	513	35	2.5	30	16	1.76
BRTHL3636C	583	35	2.5	36	18	2.26
BRTHL4224C	507	41	2.5	24	15	1.96
BRTHL4230C	536	41	2.5	30	17	2.06
BRTHL4236C	604	41	2.5	36	19	2.65

BRTHL-L • Single "H" Leg Assembly (Levelers)

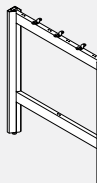

- Two Single Leg Assemblies form the structure of the Bridges series Single Line Tables.
- One leg can be shared by 2 adjoining worksurfaces.
- Leveling glides, steel frame, aluminum legs.
- Anodized aluminum leg upcharge \$55.
- Please specify paint finish for support.
- Note:
 - 24" deep tables must have three (3) beams at the top, and one beam (BRTBB-C "Bottom Table Beam") at the bottom.
 - 30" and 36" deep tables must have four (4) beams at the top, and one beam (BRTBB-C "Bottom Table Beam") at the bottom.

PRODUCT CODE	PRICE	SIZE/INCHES			WEIGHT VOL	
		H	W	D	LBS	FT ³
BRTHL3624L	446	35	2.5	24	14	1.68
BRTHL3630L	474	35	2.5	30	16	1.76
BRTHL3636L	541	35	2.5	36	18	2.26
BRTHL4224L	469	41	2.5	24	15	1.96
BRTHL4230L	498	41	2.5	30	17	2.06
BRTHL4236L	564	41	2.5	36	19	2.65

BRTDLSHS34 • 34" Leg Shroud

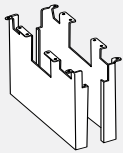

- A two part steel enclosure creates 5" deep and 30" wide cable management cavity between 34" rectangular table legs.
- Hides floor power feeds as well as data/communication cables rising from floor monuments to the underside of Bridges II tables.
- Secures to BRTBA34L rectangular leg and to underside of worksurfaces.
- Specify paint finish.

PRODUCT CODE	PRICE	SIZE/INCHES			WEIGHT VOL	
		H	W	D	LBS	FT ³
BRTDLSHS34	438	28	30	5	62	5.25

BRTSLL • Single Loop Leg

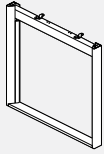

- Two Single Leg Assemblies form the structure of the Bridges series Single Line Tables.
- One leg can be shared by 2 adjoining worksurfaces.
- Leveling glides, steel frame, aluminum legs.
- Anodized aluminum leg upcharge \$55.
- Please specify paint finish for support.
- Please specify two beams when using BRTSLL36L

PRODUCT CODE	PRICE	SIZE/INCHES			WEIGHT VOL	
		H	W	D	LBS	FT ³
BRTSLL24L	447	28	2.5	24	11.00	1.01
BRTSLL30L	466	28	2.5	30	13.75	1.26
BRTSLL36L	494	28	2.5	36	16.50	1.51

BRTBALL • Back 2 Back Loop Leg

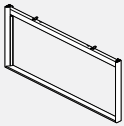

- Two Back 2 Back Leg Assemblies form the structure of the Bridges series Back 2 Back Tables.
- One double leg can be shared by 4 adjoining worksurfaces.
- Leveling glides, steel frame, aluminum legs.
- Anodized aluminum leg upcharge \$55.
- Please specify paint finish for support.

PRODUCT CODE	PRICE	SIZE/INCHES			WEIGHT VOL	
		H	W	D	LBS	FT ³
BRTBALL51L	512	28	2.5	50.5	23.14	2.12
BRTBALL63L	535	28	2.5	62.5	28.64	2.62

BRT • 120° Corner Leg Kit

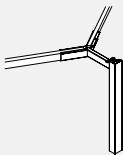

- One 120° corner leg kit combined with two single or double Leg Assemblies and support beams form the structure of the Bridges series 120° Tables.
- 120° corner leg kit includes one corner leg and adjacent, telescopic beams to support BRTWAC120 or BRTWAC120A 120° worksurfaces. Telescopic horizontal beams allow single or double Leg Assemblies to be positioned either under the worksurface (end of a run) or to be shared by adjoining worksurfaces. Levelers, steel frame, aluminum legs.
- Anodized aluminum leg upcharge \$30.
- Please specify paint finish for support.

PRODUCT CODE	PRICE	SIZE/INCHES			WEIGHT VOL	
		H	W	D	LBS	FT ³
BRT120L42	741	28	2.5	34	6.6	2.80

BRTHLEG • Boulevard Leg Assembly

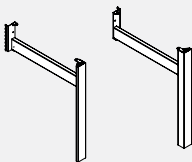

- Boulevard Leg Assembly attaches to a Boulevard panel for applications which require functionality of Boulevard panels with an open environment of Bridges tables.
- One leg with horizontal member connecting to 1" increment slots in panel's vertical frame member. Provides support to panel and panel-connected worksurface at the end of a run; design coordinated with Bridges freestanding tables.
- Supports 24" and 30" deep worksurfaces. By adding 2 BHBF01 flat brackets and 1 BHBC02 corner bracket, a single leg can then support the adjoining worksurface. Leveling glide is standard. No worksurface supporting beams, use panel cantilevers and storage for worksurface support. One aluminum leg with steel structure - specify Left or Right and 24" or 30" deep for corresponding worksurface depths. Panel bracket, dislodgment clip and worksurface hardware included.
- Anodized aluminum leg upcharge \$30.
- Please specify paint finish for support.

PRODUCT CODE	PRICE	SIZE/INCHES			WEIGHT VOL	
		H	W	D	LBS	FT ³
BRTHLEG24LL	308	28	2.5	24	9	1.25
BRTHLEG24RL	308	28	2.5	24	9	1.25
BRTHLEG30LL	323	28	2.5	30	11	1.45
BRTHLEG30RL	323	28	2.5	30	11	1.45

BRTLVS • Leveler for Rectangular Leg Table



- 5/16" thread with black base; leveler has 2" adjustment range.
- Casters and levelers on Rectangular legs cannot be interchanged on site.

PRODUCT CODE	PRICE	SIZE/INCHES			WEIGHT VOL	
		H	W	D	LBS	FT ³
BRTLVS	9	2.5	1	1	0.025	0.001

BRTLCS • Locking Caster for Rectangular Leg Tables

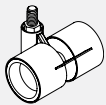

- Locking Caster for Rectangular Table
- 40mm dia. locking caster with 8mm thread; white body, light grey tires.
- Casters and levelers on rectangular legs cannot be interchanged on site.

PRODUCT CODE	PRICE	SIZE/INCHES			WEIGHT VOL	
		H	W	D	LBS	FT ³
BRTLCS	26	2.5	2.7	2.6	0.055	0.008

BRTSL • Single Leg Assembly

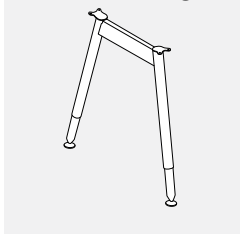

- Two Single Leg Assemblies combined with a Single Beam form the supporting structure of the Bridges series Single Line Tables.
- One leg can be shared by 2 adjoining worksurfaces.
- Leveling glides are standard. Locking casters are available on single tables. Specify 2 casters (BRTLCL) at an upcharge of \$22 each.

PRODUCT CODE	PRICE	SIZE/INCHES			WEIGHT VOL	
		H	W	D	LBS	FT ³
BRTSL	342	28	3	24	8	1.25

BRTFSL • Fixed Height Single Leg Assembly



- Two Single Leg Assemblies combined with a Single Beam form the supporting structure of the Bridges series Single Line Tables.
- One leg can be shared by 2 adjoining worksurfaces.

PRODUCT CODE	PRICE	SIZE/INCHES			WEIGHT VOL	
		H	W	D	LBS	FT ³
BRTFSL	294	28	2.5	24	5	0.97

BRTDL • Back 2 Back Leg Assembly



- Two Back 2 Back Leg Assemblies combined with 2 Single Beams form the supporting structure of the Bridges series Back 2 Back tables.
- One leg can be shared by 2 adjoining worksurfaces.
- Leveling glides are standard.

PRODUCT CODE	PRICE	SIZE/INCHES			WEIGHT VOL	
		H	W	D	LBS	FT ³
BRTDL	446	28	3	50	12	2.81

BRTFDL • Fixed Height Back 2 Back Leg Assembly

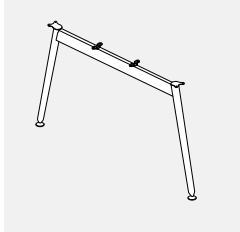

- Two Back 2 Back Leg Assemblies combined with 2 Single Beams form the supporting structure of the Bridges series Back 2 Back tables.
- One leg can be shared by 2 adjoining worksurfaces.
- Leveling glides are standard.

PRODUCT CODE	PRICE	SIZE/INCHES			WEIGHT VOL	
		H	W	D	LBS	FT ³
BRTFDL	399	28	2.5	50	8	2.03

BRTBL • Boulevard Leg Assembly

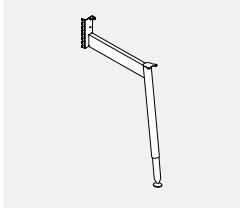

- Boulevard Leg Assembly attaches to a Boulevard panel for applications which require functionality of Boulevard panels with an open environment of Bridge 2 tables.
- Panel bracket secures the leg to the panel in 1" increments, within a 24" to 32" height range.
- Panel mounting bracket is reversible for non-handed applications.
- Supports 24" and 30" deep worksurfaces. By adding 2 BHBF01 flat brackets and 1 BHBC02 corner bracket, a single leg can then support the adjoining worksurface. Leveling glide is standard. No worksurface supporting beams, use panel cantilevers and storage for worksurface support. Panel bracket, dislodgment clip and worksurface hardware included.
- Leveling glide is standard.

PRODUCT CODE	PRICE	SIZE/INCHES			WEIGHT VOL	
		H	W	D	LBS	FT ³
BRTBL	328	28	3	24	12	1.25

BRTCRL • 120° Corner Leg Kit

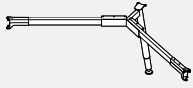

- Provides support for worksurfaces connected at 120° Degree.
- Single leg and beam assembly for 120° worksurface planning.
- Works with BRTWAC120 or BRTWAC120A worksurfaces.
- For a single table application two BRTSL (single legs) must be added.
- To join to a Back 2 Back table application, leg assembly will join to existing pod.
- Note: When joining to an existing table, the beam extends to reach the shared leg.

PRODUCT CODE	PRICE	SIZE / INCHES			WEIGHT VOL	
		H	W	D	LBS	FT ³
BRTCRL42	686	28	18	16	15	1.50

BRTFCRL • 120° Fixed Height Corner Leg Kit

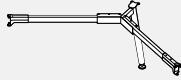

- Provides support for worksurfaces connected at 120° Degree, supported by fixed height legs.
- Single leg and beam assembly for 120° worksurface planning.
- Works with BRTWAC120 or BRTWAC120A worksurfaces.
- For a single table application two BRTFSL (single legs) must be added.
- To join to a Back 2 Back table application, leg assembly will join to existing pod.
- Note: When joining to an existing table, the beam extends to reach the shared leg.

PRODUCT CODE	PRICE	SIZE / INCHES			WEIGHT VOL	
		H	W	D	LBS	FT ³
BRTFCRL42	639	28	18	16	13	1.50

BRTLVR • Levelers for Tables

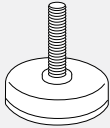

- Provides an option to casters.
- Leveler is 2 1/8" diameter.
- 1 1/2" long, 3/8" - 16 threaded stem provides 1" height adjustment range.
- Field retrofittable on round leg.

PRODUCT CODE	PRICE	SIZE / INCHES			WEIGHT VOL	
		H	W	D	LBS	FT ³
BRTLVR	9	2	2.125	2.125	0.2	0.002

BRTLCL • Locking Casters for Round Leg Tables

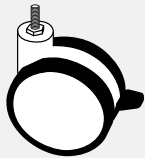

- Provides an option to levelers.
- Caster is 3" diameter wheel and 3/8" - 16 threaded stem.
- Overall height is 3 3/4".
- Field retrofittable on round leg.

PRODUCT CODE	PRICE	SIZE / INCHES			WEIGHT VOL	
		H	W	D	LBS	FT ³
BRTLCL	26	3.75	3	1.5	0.3	0.002

BRTSL • Round Table Leg Assembly

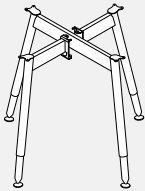

- Four leg assembly.
- Leveling glides are standard. Locking casters are available. Specify 4 casters (BRTLCL) at an upcharge of \$17 each.
- Maximum table diameter is 42".
- Includes all connecting hardware.

PRODUCT CODE	PRICE	SIZE / INCHES			WEIGHT VOL	
		H	W	D	LBS	FT ³
BRTSL	705	28	24	24	16	2.33

Beam Applications

Bridges II table legs are connected with supporting beams. Unless there is one beam for a single line of tables while two beams connect Back 2 Back table structures. Adjustable clamps at either end of the beam can be adjusted to accommodate the following applications in both single table as well as Back 2 Back table configurations.

STANDARD TABLE BEAM

Single table beam application bridges two legs to form support for a single table, or two Back 2 Back work surfaces.

Adjustable clamps at either end of the beam are pushed all the way in to allow both table legs to be tucked under the work surface.

End of run table beam application supports one table leg assembly tucked under work surface (one adjustable clamp pushed all the way in), while the other table leg assembly can be shared between two adjacent work surfaces (adjustable clamp pulled out to extend the beam).

Interconnecting table beam application supports both table leg assemblies extended to support adjacent work surfaces on either side. Both adjustable clamps pulled out to extend the beam at either end.

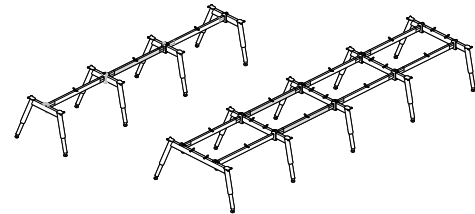
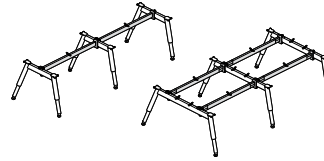
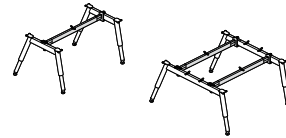

TELESCOPIC TABLE RETURN BEAM

Supports a return connected perpendicularly to a 24" or 30" deep primary work surface. The Telescopic beam is connected to a single or Back 2 Back leg on one side and to any work surface-supporting beam on the opposite side. Telescopic beam clamp allows the table leg to be tucked under worksurface or shared between two adjacent worksurfaces.

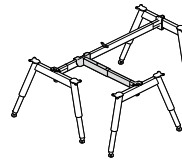

TABLE TO TABLE TELESCOPIC BRIDGE BEAM

Supports a 36" to 84" wide top connected perpendicularly between two freestanding tables. Adjustable brackets on both sides of the beam connect off module to the perpendicular standard beam and can be adjusted to accommodate 24" and 30" deep primary worksurfaces.

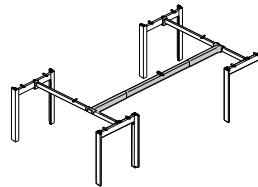
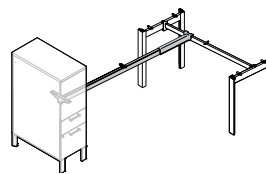

TABLE TO STORAGE TELESCOPIC RETURN BEAM

Supports a return connected perpendicularly to a 24" or 30" deep primary work surface on one end and a storage cabinet on the other. This allows the return worksurface to be layered otop of storage without the need for an additional leg assembly.



STORAGE TABLE BEAM

The Storage beam is connected to a single or Back 2 Back leg on one side and to the work surface on the opposite side - thus saving one leg (assembly work surface is connected to storage units with included storage brackets). Storage table beam's flexibility allows for a single table application (with the table leg tucked in under the work surface) as well as for a double table installation (two adjacent tables supported by a shared leg in the middle and two storage cabinets at the opposite ends).

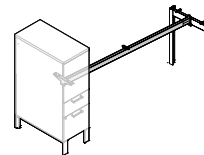

STORAGE TABLE BEAM ADAPTER

Connects to Storage table beam. This assembly allows a work surface to be supported by a leg on one side and a spine (formed by interconnected storage cabinets) on the opposite side.

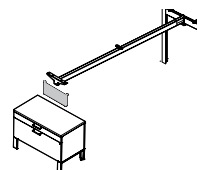

BRTSB-C • Standard Table Beam

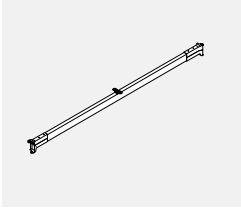

- **Standard table beam bridges two legs to form support for a single table, or two Back 2 Back work surfaces. Adjustable clamps at either end of the beam accommodate Standard table beam, end of run and interconnecting table beam applications. Adjustable brackets ship attached to the beam.**
- Specify Single Table Beam size corresponding nominally to the worksurface length. Includes all hardware necessary to connect to legs. Powder coated steel beam and aluminum cast clamps.
- Specify metal finish.
- Distance between bottom of beam and floor of standard height application is 25 3/8".

PRODUCT CODE	PRICE	SIZE/INCHES			WEIGHT VOL	
		H	W	D	LBS	FT ³
BRTSB15C	147	2	10	1	1.28	0.01
BRTSB24C	187	2	19	1	2.03	0.01
BRTSB30C	189	2	25	1	2.70	0.02
BRTSB36C	191	2	31	1	3.31	0.03
BRTSB42C	194	2	37	1	3.59	0.04
BRTSB48C	202	2	43	1	4.60	0.05
BRTSB51C	211	2	45.5	1	4.81	0.05
BRTSB54C	218	2	49	1	4.86	0.06
BRTSB60C	227	2	55	1	5.45	0.07
BRTSB63C	231	2	57.5	1	5.72	0.08
BRTSB66C	233	2	61	1	6.09	0.08
BRTSB72C	242	2	67	1	6.74	0.09
BRTSB78C	252	2	73	1	7.38	0.12
BRTSB84C	257	2	79	1	8.02	0.15

BRTBB-C • Bottom Table Beam

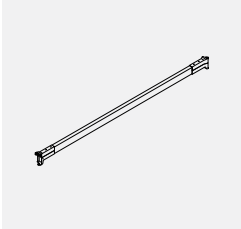

- **Bottom table beam connects to the lower cross beam on the 36" and 42" high "H" leg to create the footrest.**
- One beam required for each table
- Cannot be used as a substitute for the standard table beam.
- Specify the bottom table beam that corresponds to the worksurface length. Includes all hardware necessary to connect to "H" leg. Powder coated steel beam and aluminum cast clamps.
- Specify metal finish

PRODUCT CODE	PRICE	SIZE/INCHES			WEIGHT VOL	
		H	W	D	LBS	FT ³
BRTBB36C	191	2	31	1	3.31	0.03
BRTBB42C	194	2	37	1	3.59	0.04
BRTBB48C	202	2	43	1	4.60	0.05
BRTBB54C	218	2	49	1	4.86	0.06
BRTBB60C	227	2	55	1	5.45	0.07
BRTBB66C	233	2	61	1	6.09	0.08
BRTBB72C	242	2	67	1	6.74	0.09
BRTBB78C	252	2	73	1	7.38	0.12
BRTBB84C	257	2	79	1	8.02	0.15

BRTTB-C • Telescopic Table Return Beam

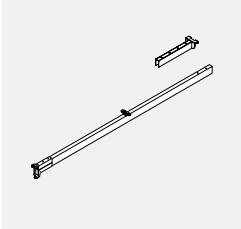

- **Provides support for a worksurface connected perpendicularly to a run of primary tables.**
- Can be adjusted to accommodate 24" and 30" deep primary worksurfaces.
- Adjustable clamp secures the beam to a Leg assembly on one side, while the other side of the beam connects off-module, to the perpendicular Standard Beam.
- The adjustable clamp can also be extended to allow for the leg to be tucked in under the work surface or to be shared by two adjacent work surfaces.
- Includes all hardware necessary to connect to legs.
- Powder coated steel and die-cast aluminum clamp.
- Distance between bottom of beam and floor of standard height application is 25 3/8".

PRODUCT CODE	PRICE	SIZE/INCHES			WEIGHT VOL	
		H	W	D	LBS	FT ³
BRTTB36C	298	2	48.5	1	5.19	0.05
BRTTB42C	315	2	54.5	1	5.83	0.06
BRTTB48C	331	2	60.5	1	6.74	0.07
BRTTB54C	345	2	66.5	1	7.11	0.07
BRTTB60C	362	2	72.5	1	7.75	0.08
BRTTB66C	372	2	78.5	1	8.40	0.09
BRTTB72C	380	2	84.5	1	9.04	0.09
BRTTB78C	387	2	90.5	1	9.68	0.12
BRTTB84C	396	2	96.5	1	10.32	0.15

BRTSTB-C • Storage Table Beam



- **Storage Table Beam allows a worksurface to be supported by a leg on one side and storage tower(s) on the opposite side. The Storage beam is connected to a single or Back 2 Back leg on one side and to the worksurface on the opposite side - thus saving one leg assembly. The flexible arrangement of such a leg/beam/clamp assembly allows the leg to be tucked in under the work surface or to be shared by two adjacent work surfaces.**
- Also, applies to multiple, Back 2 Back Assemblies.
- Specify Storage table beam size corresponding nominally to the worksurface length. Includes all hardware necessary to connect to legs.
- Powder coated steel.
- Distance between bottom of beam and floor of standard height application is 25 3/8".

PRODUCT CODE	PRICE	SIZE/INCHES			WEIGHT VOL	
		H	W	D	LBS	FT ³
BRTSTB36C	202	2	32.75	1	3.50	0.03
BRTSTB42C	211	2	38.75	1	4.16	0.04
BRTSTB48C	213	2	44.75	1	4.78	0.05
BRTSTB54C	227	2	50.75	1	5.43	0.05
BRTSTB60C	242	2	54.75	1	5.85	0.06
BRTSTB66C	257	2	62.75	1	6.74	0.07
BRTSTB72C	267	2	68.75	1	7.35	0.08
BRTSTB78C	275	2	74.75	1	7.99	0.08
BRTSTB84C	283	2	80.75	1	8.64	0.09

BRT2TTB • Table to Table Telescopic Bridge Beam



- Provides support for a worksurface connected between two primary tables.
- Can be adjusted to accommodate 24" and 30" deep primary worksurfaces.
- Adjustable brackets on both sides of the beam connect off-module to the perpendicular standard beam.
- Includes all hardware necessary to connect to legs.
- Power coated steel. Please specify colour.

PRODUCT CODE	PRICE	SIZE / INCHES			WEIGHT VOL	
		H	W	D	LBS	FT ³
BRT2TTB36	321	2.52	61.3	3.41	8.7	3.5
BRT2TTB42	328	2.52	67.3	3.41	9.3	3.8
BRT2TTB48	333	2.52	73.3	3.41	9.9	4.2
BRT2TTB54	340	2.52	79.3	3.41	10.5	4.6
BRT2TTB60	344	2.52	85.3	3.41	11.1	4.9
BRT2TTB66	353	2.52	91.3	3.41	11.7	5.3
BRT2TTB72	359	2.52	97.3	3.41	12.3	5.6
BRT2TTB78	364	2.52	103.3	3.41	12.9	6.0
BRT2TTB84	371	2.52	109.3	3.41	13.5	6.4

BRT2STTB • Table to Storage Telescopic Return Beam

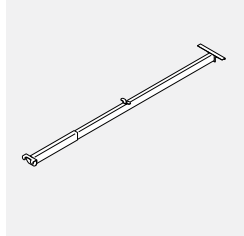

- Provides support for a return connected a primary work surface on one end and a storage cabinet on the other.
- Can be adjusted to accommodate 24" and 30" deep primary worksurfaces.
- Adjustable clamp secures the beam to a Storage Tower on one side, while the other side of the beam connects off-module, to the perpendicular Standard Beam.
- Includes all hardware necessary to connect to legs.
- Power coated steel. Please specify colour.

PRODUCT CODE	PRICE	SIZE / INCHES			WEIGHT VOL	
		H	W	D	LBS	FT ³
BRT2STTB36	232	2.52	61.3	3.41	8.7	3.5
BRT2STTB42	239	2.52	67.3	3.41	9.3	3.8
BRT2STTB48	244	2.52	73.3	3.41	9.9	4.2
BRT2STTB54	252	2.52	79.3	3.41	10.5	4.6
BRT2STTB60	257	2.52	85.3	3.41	11.1	4.9
BRT2STTB66	263	2.52	91.3	3.41	11.7	5.3
BRT2STTB72	270	2.52	97.3	3.41	12.3	5.6
BRT2STTB78	276	2.52	103.3	3.41	12.9	6.0
BRT2STTB84	281	2.52	109.3	3.41	13.5	6.4

BRTSA • Storage Table Beam Adapter

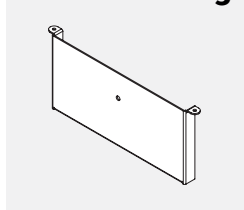

- Storage table beam adapter allows a worksurface to be supported by a leg on one side and storage spine on the opposite side. A typical Storage spine is formed by series of interconnected 21" or 25" high storage cabinets of corresponding depth.
- The Storage beam is connected to a single or Back 2 Back leg on one side and to the worksurface on the opposite side - thus saving one leg assembly.
- The 21" or 25" adapters provide structural support - acting as supports between top of the storage cabinet spine and the bottom of perpendicular worksurfaces.
- The flexible leg/beam/adapter assembly arrangement allows the leg to be tucked in under the worksurface or to be shared by two adjacent worksurfaces. Included hardware connect the adapter to the worksurface and to the Spine storage beam adapter tower.
- Note: Specify Storage Beam nominally 18" shorter than worksurfaces for storage spine support application.
- Specify Storage Spine Adapter BRTSA21 (21") or BRTSA25 adapter (25") - depending on the height of Bridges storage units forming the spine.
- Includes all hardware necessary to connect the adapter to the beam, worksurface and storage spine.

PRODUCT CODE	PRICE	SIZE / INCHES			WEIGHT VOL	
		H	W	D	LBS	FT ³
BRTSA21	97	6.5	15.2	1	2.15	0.05
BRTSA25	81	2.75	15.2	1	4.3	0.02

BRTLSC • Leg Support Cantilever

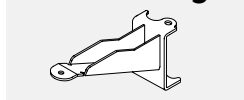

- Provides stability for leg supports.

PRODUCT CODE	PRICE	SIZE / INCHES			WEIGHT VOL	
		H	W	D	LBS	FT ³
BRTLSC	120	3.5	7	2	0.5	0.007

BRTESBBIN • Elevated Shelf Binder Bin

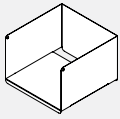

- **Elevated Shelf Binder Bin.**
- Frame finish.
- Not compatible with 16" Deep shared Overhead with Sliding Doors.
- Handy companion to 12" deep BRTBTS Shared Elevated Table Shelves. The bin rests on top surface, provides better utilization of vertical space, binder/book manager, enhanced sense of privacy as well as magnetic board on the opposite side.

PRODUCT CODE	PRICE	SIZE/INCHES			WEIGHT VOL	
		H	W	D	LBS	FT ³
BRTESBBIN	147	8	12	12	6	0.66

BRTHB • Hanging Bracket

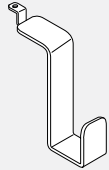

- **A formed steel bracket hooks over Bridges2 table leg. Can be secured either on the inner or outer side of the leg.**
- Frame Finish.

PRODUCT CODE	PRICE	SIZE/INCHES			WEIGHT VOL	
		H	W	D	LBS	FT ³
BRTHB	24	3.5	1.5	3.3	0.2	0.01

BRTWB • Whiteboard

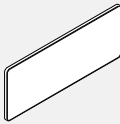

- **White dry-erase marker board surface on white powder coated steel backer.**
- Fits 16" tall Bridges 2 dividers and single-sided shelves. White dry-erase surface attaches magnetically to the steel backer, when removed the backer can be used as a magnetic board.

PRODUCT CODE	PRICE	SIZE/INCHES			WEIGHT VOL	
		H	W	D	LBS	FT ³
BRTWB0924	201	8.5	24	0.5	1	0.56

BRTTB • Tackboard

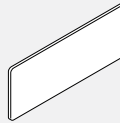

- **Grey tackboard surface on white powder coated steel backer.**
- Fits 16" tall Bridges 2 dividers and single sided shelves.

PRODUCT CODE	PRICE	SIZE/INCHES			WEIGHT VOL	
		H	W	D	LBS	FT ³
BRTTB0924	201	8.5	24	0.5	1	0.56

BRTTEGF • Table End Gap Filler

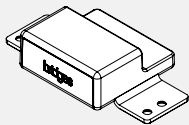

- **Injection molded block fills the gap finishing the end of Back 2 Back table assemblies. Secures to the bottom of two Back 2 Back worksurfaces.**
- Injection molded resin, white.

PRODUCT CODE	PRICE	SIZE/INCHES			WEIGHT VOL	
		H	W	D	LBS	FT ³
BRTTEGF	9	1.1	2.5	4.5	0.025	0.006

BRTWS • Rectangular Worksurface Top

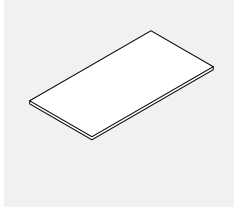

- **Worksurfaces are available in high pressure laminate (HP 1 1/16" thick) and low pressure laminate (LP 1" thick) with a flat 3 mm edge profile on all sides.**
- Worksurfaces provided with pilot holes for alignment purposes.
- Worksurface available in HP and LP.

PRODUCT CODE	PRICE		SIZE/INCHES			WEIGHT VOL	
	LP	HP	H	W	D	LBS	FT ³
BRTWS2436	156	207	1	36	24	23	0.71
BRTWS2442	205	272	1	42	24	28	0.90
BRTWS2448	245	329	1	48	24	31	1.06
BRTWS2454	290	383	1	54	24	35	1.20
BRTWS2460	326	430	1	60	24	39	1.30
BRTWS2466	340	449	1	66	24	43	1.41
BRTWS2472	355	470	1	72	24	47	1.54
BRTWS2478	381	501	1	78	24	51	1.70
BRTWS2484	410	537	1	84	24	55	1.80
BRTWS3036	194	256	1	36	30	30	1.06
BRTWS3042	275	362	1	42	30	34	1.12
BRTWS3048	290	383	1	48	30	39	1.41
BRTWS3054	317	408	1	54	30	44	1.44
BRTWS3060	340	449	1	60	30	49	1.77
BRTWS3066	353	469	1	66	30	54	1.80
BRTWS3072	374	495	1	72	30	59	2.00
BRTWS3078	398	524	1	78	30	64	2.10
BRTWS3084	443	579	1	84	30	69	2.24
BRTWS3642	333	418	1	42	36	39	2.63
BRTWS3648	378	471	1	48	36	45	3.00
BRTWS3654	420	526	1	54	36	51	3.38
BRTWS3660	466	583	1	60	36	56	3.75
BRTWS3666	508	637	1	66	36	62	4.13
BRTWS3672	552	691	1	72	36	68	4.50
BRTWS3678	594	743	1	78	36	73	4.88
BRTWS3684	639	800	1	84	36	79	5.25

BRTWSA • Rectangular Worksurface Top with Access Door

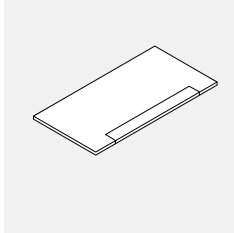

- **Tables Worksurfaces are available in high pressure laminate (HP: 1 1/16" thick), low pressure laminate (LP: 1" thick), 3 mm edging on all sides.**
- Worksurfaces provided with pilot holes for easier alignment purposes.
- Worksurfaces 42" through 72" have one access door.
- 3.5" deep anodized aluminum door provides access to power / data trough below worksurface.
- Access door is offset 13.5" from either side of worksurface.
- Worksurfaces with access doors cannot be combined with Above Worksurface Power Troughs.
- Worksurface available in HP and LP.

PRODUCT CODE	PRICE		SIZE/INCHES			WEIGHT VOL	
	LP	HP	H	W	D	LBS	FT ³
BRTWSA2442	257	372	1	42	24	23	0.71
BRTWSA2448	290	420	1	48	24	28	0.90
BRTWSA2454	323	469	1	54	24	31	1.06
BRTWSA2460	362	519	1	60	24	35	1.20
BRTWSA2466	396	564	1	66	24	39	1.30
BRTWSA2472	428	620	1	72	24	43	1.41
BRTWSA3042	308	443	1	42	30	30	1.06
BRTWSA3048	345	501	1	48	30	34	1.12
BRTWSA3054	387	564	1	54	30	39	1.41
BRTWSA3060	428	620	1	60	30	44	1.44
BRTWSA3066	476	686	1	66	30	49	1.77
BRTWSA3072	508	741	1	72	30	54	1.80
BRTWSA3642	366	498	1	42	36	39	2.63
BRTWSA3648	436	590	1	48	36	45	3.00
BRTWSA3654	493	681	1	54	36	51	3.38
BRTWSA3660	553	754	1	60	36	56	3.75
BRTWSA3666	636	854	1	66	36	62	4.13
BRTWSA3672	688	936	1	72	36	68	4.50

BRTWSAA • Rectangular Worksurface Top with 2 16" Access Doors

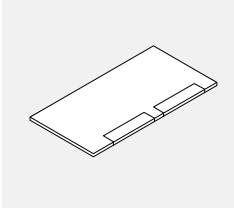

- **Tables Worksurfaces are available in high pressure laminate (HP: 1 1/16" thick), low pressure laminate (LP: 1" thick), 3 mm edging on all sides.**
- Worksurfaces provided with pilot holes for easier alignment purposes.
- 3.5" deep anodized aluminum door provides access to power / data trough below worksurface.
- Access door is offset 10" (60" worksurfaces) and 13.5" (worksurfaces 66" and wider) from either side of worksurface.
- Worksurfaces with access doors cannot be combined with Above Worksurface Power Troughs.
- Dimension between doors is 8" for 60" and 66" long surfaces, 14" for 72", 20" for 78" and 26" for 84".
- Worksurface available in HP and LP. F
- Worksurfaces should not be used with Table Mounted Dividers BRPX3P21.

PRODUCT CODE	PRICE		SIZE/INCHES			WEIGHT VOL	
	LP	HP	H	W	D	LBS	FT ³
BRTWSAA2460	393	558	1	60	24	35	1.20
BRTWSAA2466	428	612	1	66	24	39	1.30
BRTWSAA2472	462	672	1	72	24	43	1.41
BRTWSAA2478	466	677	1	78	24	47	1.54
BRTWSAA2484	493	730	1	84	24	51	1.70
BRTWSAA3060	462	672	1	60	30	44	1.44
BRTWSAA3066	518	740	1	66	30	49	1.77
BRTWSAA3072	547	802	1	72	30	54	1.80
BRTWSAA3078	551	821	1	78	30	59	2.00
BRTWSAA3084	585	871	1	84	30	64	2.10
BRTWSAA3660	521	726	1	60	36	56	3.75
BRTWSAA3666	604	829	1	66	36	62	4.13
BRTWSAA3672	650	920	1	72	36	68	4.50
BRTWSAA3678	675	954	1	78	36	73	4.88
BRTWSAA3684	741	1041	1	84	36	79	5.25

BRTWAC120 • 120° Table Top

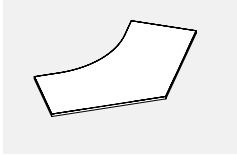

- 5-sided worksurface can be used for a single, freestanding table, can form a pod of two or three tables, or can be combined with rectangular worksurfaces to create larger workstations.

- Worksurfaces provided with pilot holes for alignment purposes.
- Worksurface available in HP and LP.

PRODUCT CODE	PRICE		SIZE/INCHES			WEIGHT VOL	
	LP	HP	H	W	D	LBS	FT ³
BRTWAC120424224	735	974	1	42	24	31	1.06
BRTWAC120424230	800	1042	1	42	30	39	1.41

BRTWAC120A • 120° Table Top with Access Door

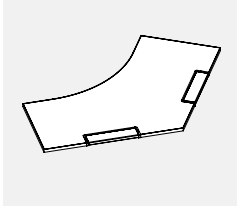

- 5-sided worksurface can be used for a single, freestanding table, can form a pod of two or three tables, or can be combined with rectangular worksurfaces to create larger workstations.

- 3.5" deep anodized aluminum door provides access to power / data trough below worksurface.
- 120° Worksurface as above with Worksurface access door - anodized aluminum worksurface access door provides access to power / data trough below worksurface.
- Worksurface with access doors cannot be combined with above worksurface power trough.
- Access door is offset 13.5" from either side of worksurface.
- Worksurface available in HP and LP.

PRODUCT CODE	PRICE		SIZE/INCHES			WEIGHT VOL	
	LP	HP	H	W	D	LBS	FT ³
BRTWAC120A424224	781	1041	1	42	24	31	1.06
BRTWAC120A424230	843	1169	1	42	30	39	1.41

BRTMTR • Round Meeting Table Top

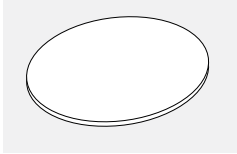

- **Round top**
- Worksurfaces provided with pilot holes for alignment purposes.
- Worksurface available in HP and LP.

PRODUCT CODE	PRICE		SIZE/INCHES			WEIGHT VOL	
	LP	HP	H	W	D	LBS	FT ³
BRTMTR42	387	484	1	42	42	40	1.76

BRTWS • Meeting Table Top

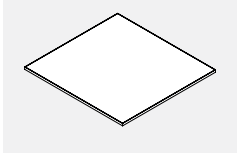

- **Can create convenient, flexible extension of the Back 2 Back Bridges table assembly.**
- Worksurfaces provided with pilot holes for alignment purposes.
- Meeting table top. 50.5" long side matches 24" deep, Back 2 Back Bridges table assembly
- Meeting table tops 62.5 long side matches 30" deep, Back 2 Back Bridges table assemblies.
- Worksurface available in HP and LP.

PRODUCT CODE	PRICE		SIZE/INCHES			WEIGHT VOL	
	LP	HP	H	W	D	LBS	FT ³
BRTWS2451	290	383	1	50.5	24	31	1.06
BRTWS3051	303	398	1	50.5	30	37	1.41
BRTWS3651	451	526	1	50.5	36	43	1.71
BRTWS4251	499	634	1	50.5	42	48	1.93
BRTWS4851	569	715	1	50.5	48	52	2.07
BRTWS5151	608	748	1	50.5	50.5	55	2.12
BRTWS5451	658	839	1	50.5	54	59	2.19
BRTWS6051	748	934	1	50.5	60	63	2.26
BRTWS2463	332	441	1	62.5	24	39	1.41
BRTWS3063	344	459	1	62.5	30	49	1.77
BRTWS3663	507	637	1	62.5	36	53	1.94
BRTWS4263	608	763	1	62.5	42	57	2.07
BRTWS4863	730	914	1	62.5	48	61	2.13
BRTWS5463	824	1026	1	62.5	54	63	2.21
BRTWS6063	915	1140	1	62.5	60	67	2.34

BRTWS-SCP • Display Wall Table Top with Scoop

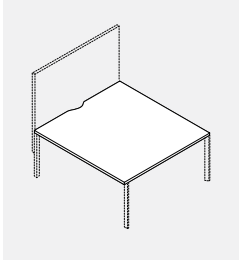

- Display wall mounts to the end of Bridges Back 2 Back table assembly supported by rectangular legs. As opposed to two separate Back 2 Back work surfaces, the Display Wall table top provides one continuous, uninterrupted surface with a scoop cutout next to the Display Wall (the scoop facilitates cable passage from below the table).

PRODUCT CODE	PRICE		SIZE/INCHES			WEIGHT		VOL FT ³
	LP	HP	H	W	D	LBS		
BRTWS4851SCP	569	715	1	50.5	48	60	1.40	
BRTWS5451SCP	658	839	1	50.5	54	68	1.58	
BRTWS6051SCP	748	934	1	50.5	60	75	1.75	
BRTWS4863SCP	730	914	1	62.5	48	75	1.74	
BRTWS5463SCP	824	1026	1	62.5	54	84	1.95	
BRTWS6063SCP	915	1140	1	62.5	60	93	2.17	

- Worksurfaces provided with pilot holes for alignment purposes.
- Table top. 50.5" long side matches 24" deep, Back 2 Back Bridges table assembly
- Meeting table tops 62.5 long side matches 30" deep, Back 2 Back Bridges table assemblies.
- Worksurface available in HP and LP.

BRTTVFT • Display Wall: Monitor Facing Double Work Station

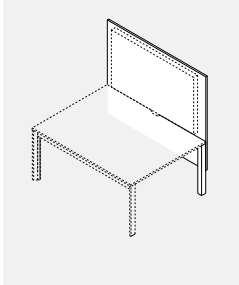

- Display wall mounts to the end of bridges Back 2 Back table assembly supported by bridges rectangular legs.

PRODUCT CODE	PRICE		SIZE/INCHES			WEIGHT		VOL FT ³
	LP	HP	H	W	D	LBS		
BRTTVFT51	1384	1845	52	50.5	4	62.00	6.08	
BRTTVFT63	1460	1999	52	62.5	4	74.00	7.52	

- Display faces the double work station - facilitates seated presentation area.
- Includes laminate board, TV/display brackets (black), mounting hardware, vertical cable manager (black). Slim (22mm) bracket capable of supporting displays/TVs up to 50" (resp. 62") wide, up to 80lbs. When installed, top of the 52" x 50.5" (resp. 62.5") wide board reaches 65.5" high.
- 1" LP or HP laminate board with 3mm edging. Different HP laminate finishes expand product functionality. For instance: white dryerase marker board laminate can be specified on "non-display" board surface. Specify laminate finish, HP laminate position (Display side, non-display side) and edging.
- Note: Included vertical cable manager passes through the gap between two Back 2 Back work surfaces. Should you need one continuous, uninterrupted surface specify Display Wall table top with a scoop (listed in the Work surface section of bridges Price List).
- Display wall mounts to the end of Bridges Back 2 Back table assembly supported by rectangular legs or Back 2 Back table structure with BRTWS-SCP Display Wall Table Top with scoop. As opposed to two separate Back 2 Back work surfaces, the BRTWS-SCP Display Wall Table Top provides one continuous, uninterrupted surface with a scoop cutout next to the display wall (the scoop facilitates cable passage from below the table top).
- Please add \$422 for white, dry erase on 51" wide Display Wall and \$576 for 63" wide.

BRTTVBK • Display Wall: Monitor Facing Back of Double Work Station

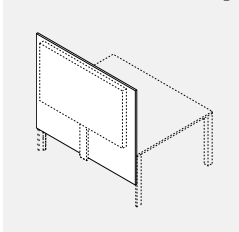

- Display wall support board mounts to end of bridges Back 2 Back table assembly supported by bridges rectangular legs. Display faces back of the double work station - facilitates standing or seated presentation area (combine with collaborative seating).

PRODUCT CODE	PRICE		SIZE/INCHES			WEIGHT		VOL FT ³
	LP	HP	H	W	D	LBS		
BRTTVBK51	1384	1845	52	50.5	4	62.00	6.08	
BRTTVBK63	1460	1999	52	62.5	4	74.00	7.52	

- Includes laminate board, TV/display brackets (black), mounting hardware, vertical cable manager (black). Slim (22mm) bracket capable of supporting displays/TVs up to 50" (resp. 62") wide, up to 80lbs.
- When installed, top of the 52" x 50.5" (resp. 62.5") wide board reaches 65.5" high.
- 1" LP or HP laminate board with 3mm edging. Different HP laminate finished expand product functionality. For instance: white dry-erase marker board laminate can be specified on "non-display" board surface. Specify laminate finish, HP laminate position (Display side, non-display side) and edging.
- Display wall mounts to the end of Bridges Back 2 Back table assembly supported by rectangular legs or Back 2 Back table structure with BRTWS-SCP Display Wall Table Top with scoop. As opposed to two separate Back 2 Back work surfaces, the BRTWS-SCP Display Wall Table Top provides one continuous, uninterrupted surface with a scoop cutout next to the display wall (the scoop facilitates cable passage from below the table top).
- Please add \$422 for white, dry erase on 51" wide Display Wall and \$576 for 63" wide.

Power delivery / cable management

At the basic level, table and floor based office equipment is serviced by a wall or floor power supply. As the operation grows, there might be a need to organize excessive cable clutter.

Cable Basket (1) connects to the underside of worksurfaces with steel brackets and cables are simply dropped and coiled into them.

Cable Snake(2) installed in proximity of floor monument to manage vertical cable clutter.

Table clamped, single circuit Desk Top Power Data Modules (3) deliver services to desk height, while tapping into wall or floor power supply. Again, the excessive cables can be managed with Cable Baskets.

Ceiling pole BRTCPP (4) manages power and data cables between ceiling and above or below worksurface power troughs.

Above and Below Worksurface Power/Data Troughs (5) can be installed between Back 2 Back tables for extended below and above desk height power/data distribution. - 8 wire, 4-circuit system.

Single Sided Power/Data Troughs (6) can be installed to the underside of a single table.

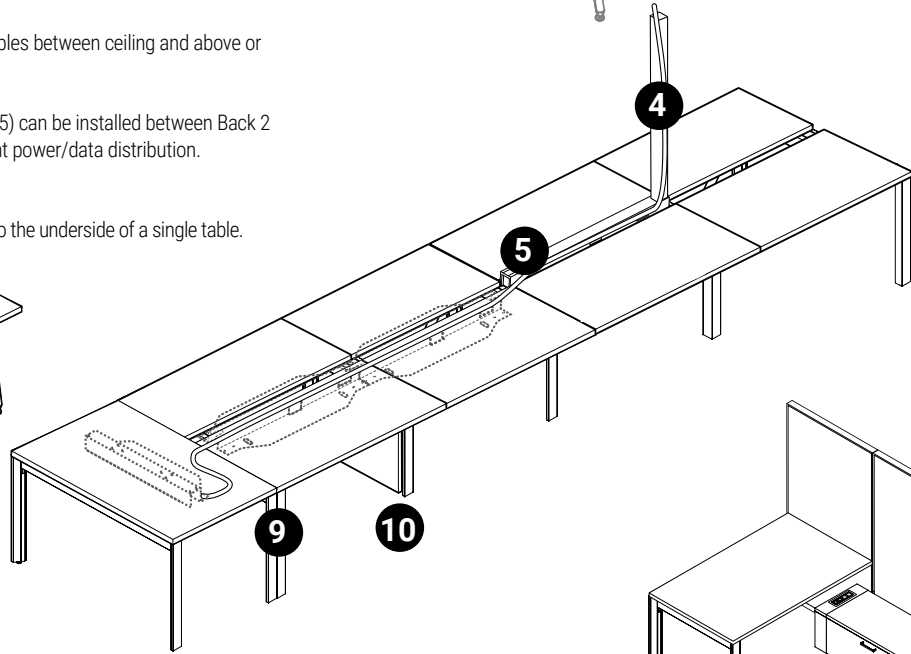
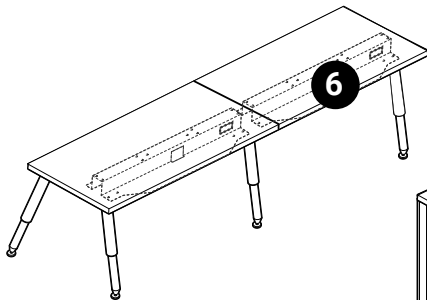
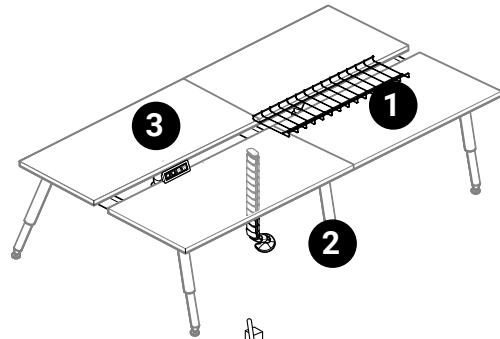

Elevated storage units provide access to floor raceway power duplexes and data terminals (7). 1" gap between panels and storage allow for easy passage of cables.

Some storage units can be connected to panel vertical slots and those allow to open and access panel floor raceway.

Storage power/data box BRTVCM (8) attaches to storage units and provides access to one duplex/data terminal on top storage surface. Integrated single circuit module can be plugged to floor monument under the storage, to a wall outlet or to a panel floor raceway duplex receptacle.

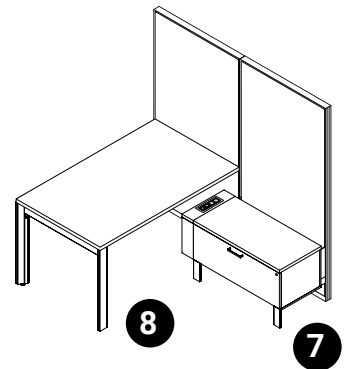

NOTE: Specify BRTHH58 (9) to distribute power from double sided, Back 2 Back below worksurface power trough to a single sided, below work surface power trough at the end of a table run.

Leg shroud (10) attaches to 34" wide legs and manages power floor feed as well as data cables from floor monument.

Electrical system

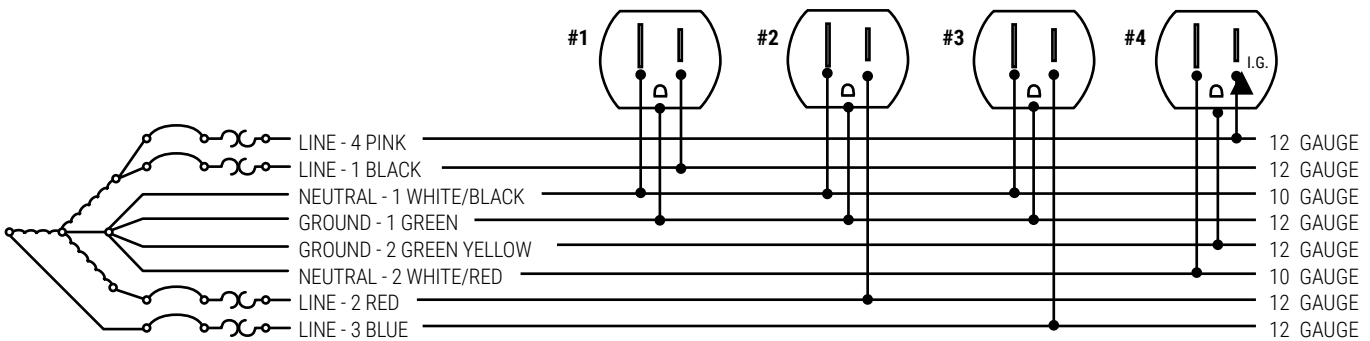

An 8-wire, 4-circuits, 3+1 electrical systems complies with UL 1286

8 Wires	4 Circuits	Receptacles
4 Lines (12ga.)	3 Utility Circuit	Duplex - Up to 6 duplex receptacles per circuit
2 Neutrals	1 Isolated Circuit	
2 Grounds (12ga.)		

Specifications
120 VAC system rated at 20A (15 CSA)

BRED50 • Duo Module



- The duo power module is completely integrated with a mounting clamp to attach to the edge of a worksurface.
- Provides two outlets and two 2.1 amp USB ports.
- White face plate, outlets and bracket; 72" long three-prong cord.

PRODUCT CODE	PRICE	SIZE/ INCHES			WEIGHT VOL	
		H	W	D	LBS	FT ³
BRED50	615	1.8	5.5	3.2	2.50	0.14

BRED50AC • Duo Module with A+C



- The Duo power module is completely integrated with a mounting clamp to attach to the edge of a worksurface.
- 10' long three-prong cord.
- Provides two 15 Amp 120 Volt AC Receptacles; 2.4 amp USB-A port and 60 watt USB-C power delivery port.
- Available in W - White or B - Black as indicated by last letter of model number.

PRODUCT CODE	PRICE	SIZE/ INCHES			WEIGHT VOL	
		H	W	D	LBS	FT ³
BRED50ACW	695	3	5.5	3.2	3	0.2
BRED50ACB	695	3	5.5	3.2	3	0.2

BREDU51 • Duo Under Module

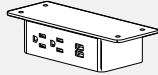

- The duo under power module comes with a thin flush mounting bracket to attach to the underside of a work surface or above work surface shelves.
- Provides two outlets and two 2.1 amp USB ports.
- White face plate, outlets and brackets; 72" long three-prong cord.

PRODUCT CODE	PRICE	SIZE/ INCHES			WEIGHT VOL	
		H	W	D	LBS	FT ³
BREDU51	537	1.8	5.5	2.8	2.5	0.14

BREDU51AC • Duo Under Module with A+C

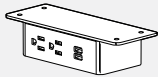

- The Duo under power module comes with a thin flush mounting bracket to attach to the underside of a work surface or above work surface shelves.
- 10' long three-prong cord.
- Provides two 15 Amp 120 Volt AC Receptacles; 2.4 amp USB-A port and 60 watt USB-C power delivery port.
- Available in W - White or B - Black as indicated by last letter of model number.

PRODUCT CODE	PRICE	SIZE/ INCHES			WEIGHT VOL	
		H	W	D	LBS	FT ³
BREDU51ACW	695	1.8	5.5	2.8	3	0.2
BREDU51ACB	695	1.8	5.5	2.8	3	0.2

BREDB52 • Duo Bezel Module



- The duo bezel power module is embedded and flush-mounted in a piece of furniture or a work surface.
- Provides two outlets and two 2.1 amp USB ports.
- White face plate, outlets and bezel; 72" long three-prong cord.
- Note: Will not work on W thick worksurfaces, please contact your Customer Service Representative for specific surface applications.

PRODUCT CODE	PRICE	SIZE/ INCHES			WEIGHT VOL	
		H	W	D	LBS	FT ³
BREDB52	576	4	6.5	3.2	2.5	0.14

BRETP53 • Trio Plus Module

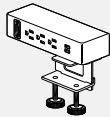

- The trio plus power module is completely integrated with a mounting clamp to attach to the edge of a work surface or above work surface shelves.
- Provides three outlets and two 2.1 amp USB ports and an adapter kit containing blank cover, HDMI, RJ45 or VGA adapter brackets. Note: HDMI, RJ45 and VGA connectors are not included.
- White face plate, outlets, adapters and brackets; 72" long three-prong cord.

PRODUCT CODE	PRICE	SIZE/ INCHES			WEIGHT VOL	
		H	W	D	LBS	FT ³
BRETP53	693	1.8	8	3.2	2.5	0.14

BRETPB55 • Trio Plus Bezel Module



- The trio plus bezel power module is embedded and flush-mounted in a piece of furniture or a work surface.
- Provides three outlets and two 2.1 amp USB ports and an adapter kit containing blank cover, HDMI, RJ45 or VGA adapter brackets. Note: HDMI, RJ45 and VGA connectors are not included.
- White face plate, outlets, adapters and bezel; 72" long three-prong cord.
- Will not work on W thick worksurfaces, please contact your Customer Service Representative for specific surface applications.

PRODUCT CODE	PRICE	SIZE/ INCHES			WEIGHT VOL	
		H	W	D	LBS	FT ³
BRETPB55	662	4	9	3.2	2.5	0.14

BRTPD5 • Data/Comm Spacer

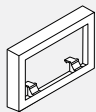

- Data/comm plate spacer extends the depth behind data/comm jacks by 0.6" in order to accommodate larger data/comm cable bending radius.
- Black finish.
- "W" indicates White, "S" indicates Silver.

PRODUCT CODE	PRICE	SIZE/ INCHES			WEIGHT VOL	
		H	W	D	LBS	FT ³
BRTPD5	45	2.04	4.75	0.6	0.1	0.01
BRTPD5W	45	2.04	4.75	0.6	0.1	0.01
BRTPD5S	45	2.04	4.75	0.6	0.1	0.01

BRACS • Cable Snake



- Flexible cable management trough.
- Two pathways within the snake, one for data/communication and one for routing power cables.
- Clear (CLR) available only.

PRODUCT CODE	PRICE	SIZE/ INCHES			WEIGHT VOL	
		H	W	D	LBS	FT ³
BRACS	123	30	8	2	3	0.19
BRACSH	207	49	8	2	5	0.27

BRTCM • Wire Manager



- Replacement wire manager can be added to Bridges. Wire manager neatly organizes and stores electrical and communication cables.
- Two lengths, 46" for tops 60" and under, 58" for tops 72".

PRODUCT CODE	PRICE	SIZE/ INCHES			WEIGHT VOL	
		H	W	D	LBS	FT ³
BRTCM43	47	3	5	46	8	0.67
BRTCM55	58	3	5	58	9	0.85

ModPower Power Solution

- Power solutions for flexible spaces. Connect up to four units (in Canada)/six units in the USA from a single infeed with NEMA plug to deliver power and charging ports to the table top. In-surface modules and clamp on modules available.
- Easy to install; code compliant that allows users to optimize any space providing convenient power access. Perfect for training areas, meeting rooms, in-office workstations and more. Units feature tamper-resistant receptacles as well as both USB-A and USB-C charging ports.
- Easy to use connectors that are touch-safe with added latch to prevent unintended separation. Easy push together to connect, and simple press down on latch to disconnect.
- Maximum overall length not to exceed 48.5 feet per infeed. UL listed to UL962A SD, the standard for furniture power distribution units for portable/moveable work space tables.
- Certified to CSA standard C22.2 No. 203-16.

- Will work with Licence, Terina and Bridges Products.
- Surface mounted module ships with a clamp mount that will accommodate any material 1/2" to 1-1/2" thick; additional brackets are also included for screw in mounting options that can accommodate vertical or horizontal positions.

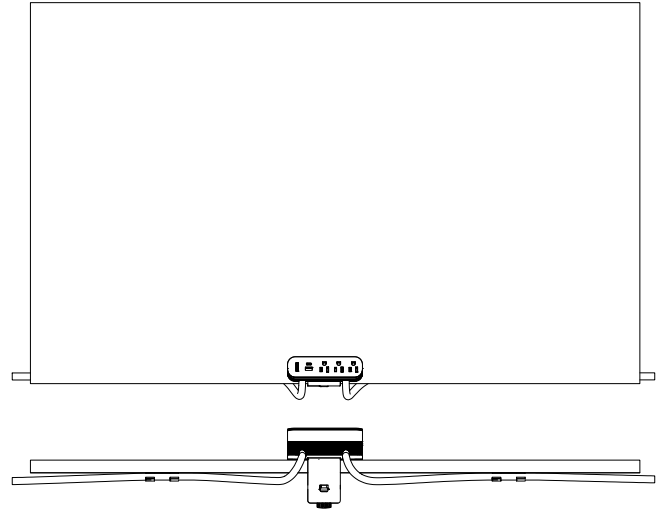
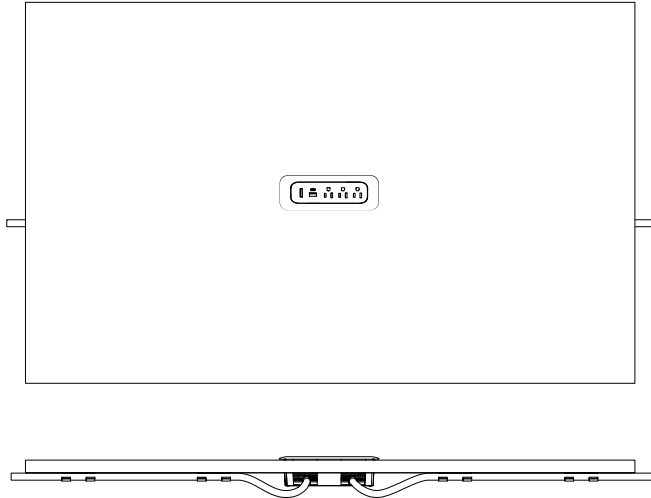
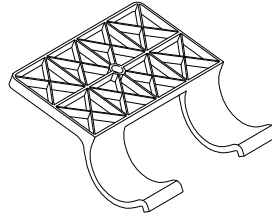

GMDSF10 • ModPower In Surface Starter Unit

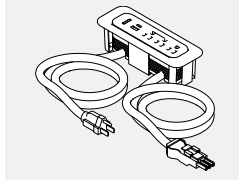

- ModPower starter unit includes one 10' cord with a NEMA plug and one 3' connector cord.
- Unit equipped with three 15A tamper resistant receptacles, one USB-A and one USB-C charging ports and a circuit breaker.
- 4 cable management cord clips included.
- MG at the end of the code indicates a magnesium finish, while WH is a white finish.

PRODUCT CODE	PRICE	DIMENSIONS			WEIGHT		VOL FT ³
		H	W	D	LBS		
GMDSF10MG	597	2.63	7.63	2.63	3.44	1.0	
GMDSF10WH	597	2.63	7.63	2.63	3.44	1.0	

GMDCF3 • ModPower In Surface Middle Unit

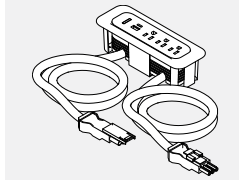

- ModPower middle unit includes two 3' connector cords.
- Unit equipped with three 15A rated 12A tamper resistant receptacles, one USB-A and one USB-C charging ports and a circuit breaker.
- 4 cable management cord clips included.
- MG at the end of the code indicates a magnesium finish, while WH is a white finish.

PRODUCT CODE	PRICE	DIMENSIONS			WEIGHT		VOL FT ³
		H	W	D	LBS		
GMDCF3MG	562	2.63	7.63	2.63	2.44	1.0	
GMDCF3WH	562	2.63	7.63	2.63	2.44	1.0	

GMDEF3 • ModPower In Surface End Unit

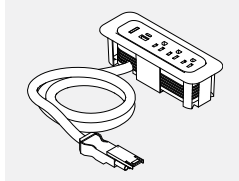

- ModPower end unit includes one 3' connector cord.
- Unit equipped with three 15A rated 12A tamper resistant receptacles, one USB-A and one USB-C charging ports and a circuit breaker.
- 2 cable management cord clips included.
- MG at the end of the code indicates a magnesium finish, while WH is a white finish.

PRODUCT CODE	PRICE	DIMENSIONS			WEIGHT		VOL FT ³
		H	W	D	LBS		
GMDEF3MG	494	2.63	7.63	2.63	1.85	1.0	
GMDEF3WH	494	2.63	7.63	2.63	1.85	1.0	

GMDSA10 • ModPower Starter Mounted Unit

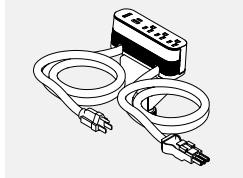

- ModPower starter unit includes one 10' cord with a NEMA plug and one 3' connector cord.
- Unit equipped with three 15A tamper resistant receptacles, one USB-A and one USB-C charging ports and a circuit breaker.
- Includes edge clamp and 3 other mounting methods; and 4 cable management cord clips.
- MG at the end of the code indicates a magnesium finish, while WH is a white finish.

PRODUCT CODE	PRICE	DIMENSIONS			WEIGHT		VOL FT ³
		H	W	D	LBS		
GMDSA10MG	631	2.5	6.13	1.75	4.33	1.0	
GMDSA10WH	631	2.5	6.13	1.75	4.33	1.0	

GMDCA3 • ModPower Middle Mounted Unit

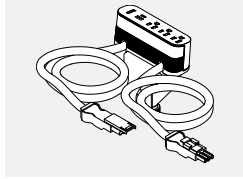

- ModPower middle unit includes two 3' connector cords.
- Unit equipped with three 15A rated 12A tamper resistant receptacles, one USB-A and one USB-C charging ports and a circuit breaker.
- Includes edge clamp and 3 other mounting methods; and 4 cable management cord clips.
- MG at the end of the code indicates a magnesium finish, while WH is a white finish.

PRODUCT CODE	PRICE	DIMENSIONS			WEIGHT		VOL FT ³
		H	W	D	LBS		
GMDCA3MG	597	2.5	6.13	1.75	3.33	1.0	
GMDCA3WH	597	2.5	6.13	1.75	3.33	1.0	

GMDEA3 • ModPower End Mounted Unit

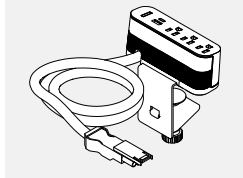

- ModPower end unit includes one 3' connector cord.
- Unit equipped with three 15A rated 12A tamper resistant receptacles, one USB-A and one USB-C charging ports and a circuit breaker.
- Includes edge clamp and 3 other mounting methods; and 2 cable management cord clips.
- MG at the end of the code indicates a magnesium finish, while WH is a white finish.

PRODUCT CODE	PRICE	DIMENSIONS			WEIGHT		VOL FT ³
		H	W	D	LBS		
GMDEA3MG	528	2.5	6.13	1.75	2.75	1.0	
GMDEA3WH	528	2.5	6.13	1.75	2.75	1.0	

GMDCLIPS • ModPower Management Clips

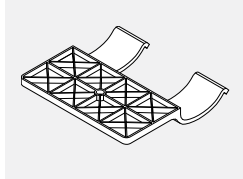

- Includes 10 clips.

PRODUCT CODE	PRICE	DIMENSIONS			WEIGHT		VOL FT ³
		H	W	D	LBS		
GMDCLIPS	102	0.6	2.6	2.5	0.3	0.2	

GMDJ36BK • ModPower Interconnecting Jumper

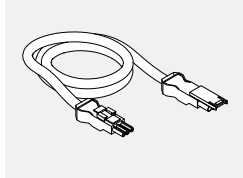

- ModPower interconnecting jumper cord to add an additional 3 feet of cord length between ModPower units.
- Package of 2, each 3 feet with male & female connector.

PRODUCT CODE	PRICE	DIMENSIONS			WEIGHT		VOL FT ³
		H	W	D	LBS		
GMDJ36BK	329		36		1.38	0.9	

BRTETA-KIT • Above Worksurface Power Trough

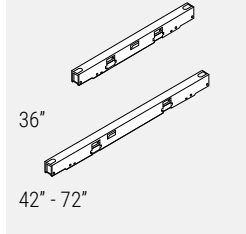

• **Above Worksurface Power Trough Kit Facilitates power distribution and data/communication cable management.**

- Formed steel trough is secured between Back 2 Back stations. Not suitable for single table assemblies.
- Power Trough Kits 36-72 consist of one double sided steel trough, Power Distribution Housing, mounting brackets and one charcoal grey extruded Data/Communication cable manager.
- Power Trough Kits 78 and 84 consist of two double sided steel troughs (BRTETA78KIT = BRTETA36 above KIT + BRTETA42KIT + Jumper. BRTETA84KIT = BRTETA42KIT + BRTETA42KIT + Jumper), two Power Distribution Housings, mounting brackets and two charcoal grey extruded Data/Communication cable managers.
- Specify Duplex receptacles separately. 36" trough can house one duplex per side and 42-72" trough can house two duplexes per side, 78" trough can house three duplexes and 84" trough can house four duplexes per side. Specify Jumpers between tables separately.
- Ceiling feed entry through slots at either end; base feed entry at either end.
- Each trough provides two openings 1.37" x 2.68" (one per side) for data/communication terminal plates. A single terminal plate (not supplied) can accommodate up to 4 data/communication plates.
- Data/comm plate spacer BRTPDSS available to accommodate larger cable-to-terminal bending radius
- Each trough provides two openings 1.37" x 2.68" (one per side) for data/communication terminal plates. A single terminal plate (not supplied) can accommodate up to 4 data/communication terminals (jacks).
- Painted finish.
- Specify above worksurface power trough end cap BRTETEC to finish open ends of the power trough.
- Each trough includes one black (BRTPDSS) data/comm spacer extending the depth behind the data/comm jacks by 0.6". White (BRTPDSSW) and Silver (BRTPDSSS) are also available as an option. Additional spacers may be purchased individually for \$45 list, see BRTPDSS.

PRODUCT CODE	PRICE	SIZE/INCHES			WEIGHT VOL	
		H	W	D	LBS	FT ³
BRTETA36KIT	485	3.5	35.9	2.5	4.06	0.18
BRTETA42KIT	525	3.5	41.9	2.5	4.73	0.21
BRTETA48KIT	557	3.5	47.9	2.5	5.41	0.24
BRTETA54KIT	589	3.5	53.9	2.5	6.09	0.27
BRTETA60KIT	607	3.5	59.9	2.5	6.77	0.30
BRTETA66KIT	652	3.5	65.9	2.5	7.45	0.33
BRTETA72KIT	663	3.5	71.9	2.5	8.12	0.36
BRTETA78KIT	1008	3.5	78	2.5	8.81	0.39
BRTETA84KIT	1051	3.5	84	2.5	9.49	0.42

BRTTEST-KIT • Back 2 Back Storage Tower Gap Filler Kit

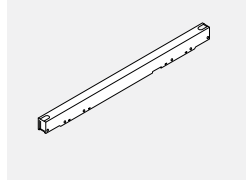

• **Consists of a formed sheet metal cover and four brackets which allow the cover to be mounted at either above worksurface power trough level or below work surface power trough level.**

- Versatile brackets secure the cover trough at corners, to the bottom of Back 2 Back work surface supported by either shared 51 or 63 legs or storage beam and storage towers.
- Note: the Back 2 Back storage tower gap filler is not compatible with single, freestanding tables.
- The BRTTEST15kit covers the gap between two Back 2 Back BRTT5024x or BRTT5030x storage towers.
- The BRTTEST30kit covers the gap between two pairs of Back 2 Back BRTT5024x or BRTT5030x storage towers.
- The BRTTEST24kit covers the gap between two Back 2 Back BRTTW5024x or BRTTW5030x storage towers.
- The BRTTEST48kit covers the gap between two pairs of Back 2 Back BRTTW5024x or BRTTW5030x storage towers.
- A corresponding harness is included.

PRODUCT CODE	PRICE	SIZE/INCHES			WEIGHT VOL	
		H	W	D	LBS	FT ³
BRTTEST15KIT	428	3.5	2.5	15.5	2	0.078
BRTTEST30KIT	495	3.5	2.5	31	3.5	0.157
BRTTEST24KIT	464	3.5	2.5	24	2.5	0.122
BRTTEST48KIT	547	3.5	2.5	48	4	0.243

BRTETEC • Above Worksurface Power Trough End Cap

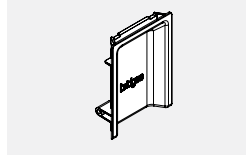

• **Covers the ends of the worksurface power trough.**

- Specify two per linear trough assembly.
- Finish white

PRODUCT CODE	PRICE	SIZE/INCHES			WEIGHT VOL	
		H	W	D	LBS	FT ³
BRTETEC	9	3.1	2.25	0.5	0.1	0.002

BRTVCM • Vertical Cable Manager

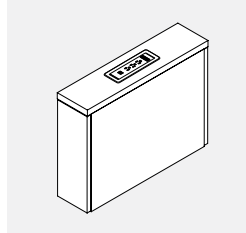

- 6" wide vertical channel which can be secured to an end or in-between 21" or 25" high storage units of corresponding depth.
- Facilitates power / data transfer from a floor monument under storage cabinets or from a panel base raceway to top of storage units.
- The units can join other 18" or 24" deep storage units to form a storage spine.
- Floor clearance allows for access to panel floor raceway duplex outlets.
- Removable top with a Below Worksurface Power/Data Module provides easy access.
- Optional Cable Basket suspends off storage unit's bottoms and manages cables along the horizontal plane. 3/4" LP chassis, fronts and back (specify LP finish), 1" top (specify LP or HP finish); unfinished cut-out edges. Universal connecting hardware included.
- Flush-mounted Trio Plus Bezel Module (BRETPE55) included
- Provides three outlets and two 2.1 amp USB ports and an adapter kit containing blank cover, HDMI, RJ45 or VGA adapter brackets. Note: HDMI, RJ45 and VGA connectors are not included.

PRODUCT CODE	PRICE		SIZE/INCHES			WEIGHT VOL	
	LP	HP	H	W	D	LBS	FT ³
BRTVCM2118	903	920	21	6	18	14	1.31
BRTVCM2518	920	935	25	6	18	17	1.56
BRTVCM2124	953	969	21	6	24	17	1.75
BRTVCM2524	969	985	25	6	24	22	2.08

BRTETB-SKIT • Below Worksurface Single Power/Data Trough

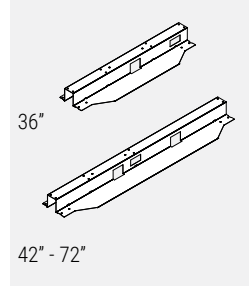

• **Below Worksurface Single Power Trough Kit Facilitates power distribution and data/communication cable management.**

- Formed steel trough is secured below a single table work-surface; outlets are facing the rear worksurface edge.
- Not suitable for Back 2 Back tables
- Power Trough Kits 36-72 consist of one single sided steel trough, Power Distribution Housing, mounting brackets and one charcoal grey extruded Data/Communi-cation cable manager.
- Power Trough Kits 78 and 84 consist of two single sided steel troughs (BRTERB78KIT = BRTETB36KIT + BRTETB42KIT + Jumper. BRTETB84KIT = BRTETB42KIT + BRTETB42KIT + Jumper), two Power Distribution Housings, mounting brackets and two charcoal grey extruded Data/Communication cable managers.
- Specify Duplex receptacles separately. 36" trough can house one duplex, 42-72" trough can house two duplexes, 78" through can house three duplexes and 84" trough can house four duplexes per side.
- Specify Jumpers between tables separately.
- Base feed entry at either end; no ceiling feed.
- Each trough provides one opening 1.37" x 2.68" for terminal plate (not supplied). One terminal plate can accommodate up to 4 data/communi-cation terminals (jacks).
- Each trough includes one black (BRTPDS) data/comm spacer extending the depth behind the data/comm jacks by 0.6". White (BRTPDSW) and Silver (BRTPDSS) are also available as an option. Additional spacers may be purchased individually for \$45 list, see BRTPDS.
- Painted finish.
- Note: Please specify BRTETB36SKIT Single Trough Kit for 120° Degree Tables BRTWAC120

PRODUCT CODE	PRICE	SIZE/INCHES			WEIGHT VOL	
		H	W	D	LBS	FT ³
BRTETB36SKIT	428	2.5	30.34	8.5	4.5	0.59
BRTETB42SKIT	469	2.5	36.34	8.5	5.3	0.61
BRTETB48SKIT	508	2.5	42.34	8.5	6.2	0.71
BRTETB54SKIT	532	2.5	48.34	8.5	7.1	0.81
BRTETB60SKIT	541	2.5	54.34	8.5	8.0	0.91
BRTETB66SKIT	564	2.5	60.34	8.5	8.9	1.01
BRTETB72SKIT	583	2.5	66.34	8.5	9.8	1.11
BRTETB78SKIT	895	2.5	72.34	8.5	11.0	1.21
BRTETB84SKIT	935	2.5	78.34	8.5	12.0	1.31

BRTETB-DKIT • Below Worksurface Double Power/Data Trough

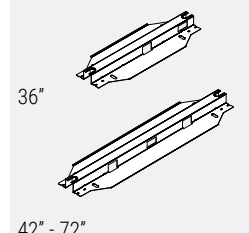

• **Below Worksurface Double Power Trough Kit Facili-tates power distribution and data/communication cable management.**

- Formed steel trough is secured below worksurfaces, between Back 2 Back stations, supported by Back 2 Back Legs.
- Not suitable for single table assemblies.
- Power Trough Kits 36-72 consist of one double sided steel trough, Power Distribution Housing, mounting brackets and one charcoal grey extruded Data/Communi-cation cable manager.
- Power Trough Kits 78 and 84 consist of two double sided steel troughs (BRTETB78KIT = BRTETB36KIT + BRTETB42KIT + Jumper. BRTETB84KIT = BRTETB42KIT + BRTETB42KIT + Jumper), two Power Distribution Housings, mounting brackets and two charcoal grey extruded Data/Communication cable managers.
- Specify Duplex receptacles separately. 36" trough can house one duplex per side, 42-72" trough can house two duplexes, 78" trough can house three duplexes and 84"trough can house four duplexes per side.
- Specify Jumpers between tables separately.
- Ceiling feed entry through slots at either end; base feed entry at either end.
- Each trough provides two openings 1.37" x 2.68"(one per side) for data/communication terminal plates (not supplied).
- Painted finish.
- Each trough includes one black (BRTPDS) data/comm spacer extending the depth behind the data/comm jacks by 0.6". White (BRTPDSW) and Silver (BRTPDSS) are also available as an option. Additional spacers may be purchased individually for \$45 list, see BRTPDS.

PRODUCT CODE	PRICE	SIZE/INCHES			WEIGHT VOL	
		H	W	D	LBS	FT ³
BRTETB36DKIT	589	2.5	30.3	11.6	3.8	0.37
BRTETB42DKIT	607	2.5	36.3	11.6	4.5	0.44
BRTETB48DKIT	633	2.5	42.3	11.6	5.3	0.52
BRTETB54DKIT	646	2.5	48.3	11.6	6.0	0.59
BRTETB60DKIT	663	2.5	54.3	11.6	6.8	0.66
BRTETB66DKIT	686	2.5	60.3	11.6	7.5	0.74
BRTETB72DKIT	702	2.5	66.3	11.6	8.3	0.81
BRTETB78DKIT	1196	2.5	72.3	11.6	9.0	0.88
BRTETB84DKIT	1209	2.5	78.3	11.6	9.8	0.96

BRTCF • Bridges Ceiling Feed

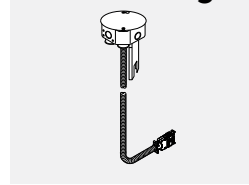

• **Ceiling feed provides a single power entry from ceiling, through Ceiling pole into Power Trough, into Power Distribution Housing.**

- An 8-wire (4-circuit) metal conduit harness with included metal junction box for hard wiring to the building power supply above ceiling tile.
- Must be hard wired to the building power supply by a licensed electrician.
- Ceiling Pole not included.

PRODUCT CODE	PRICE	SIZE/INCHES			WEIGHT VOL	
		H	W	D	LBS	FT ³
BRTCF120	409	120	6	6	5	2
BRTCF144	455	144	6	6	6	3

BRTBF • Bridges Base Feed

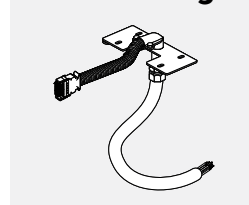

• **Provides single power entry from floor or wall located building power supply.**

- Connects to Power Distribution Housing.
- Must be hard wired to the building power supply by a licensed electrician.

PRODUCT CODE	PRICE	SIZE/INCHES			WEIGHT VOL	
		H	W	D	LBS	FT ³
BRTBF	449	4	72	6	4	2
BRTBF120	641	4	120	6	6	2
BRTBF144	691	4	144	6	8	2

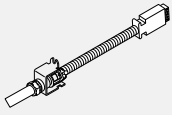
BRTDIVPBF • Bridges Divider Panel Base Feed

- Provides single power entry from floor or wall located building power supply.
- Connects to Power Distribution Housing.
- Must be hard wired to the building power supply by a licensed electrician.

PRODUCT CODE	PRICE	SIZE/INCHES			WEIGHT VOL	
		H	W	D	LBS	FT ³
BRTDIVPBF	430	4	72	6	4	2

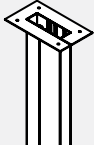
BRTCPP • Bridges Ceiling Pole

- Ceiling pole brings ceiling feed conduit and data cables from the ceiling down to Power troughs at desk height. Accommodates 10' ceiling heights.
- A two part construction allows power/data conduit lay-in.
- Includes mounting hardware and ceiling bezel.
- Painted finish.

PRODUCT CODE	PRICE	SIZE/INCHES			WEIGHT VOL	
		H	W	D	LBS	FT ³
BRTCPP	242	99	4.75	1.5	13	0.48

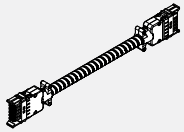
BRTHH • Housing to Housing Harness

- Distributes power between Power Distribution Housings.
- Specify BRTHH58 to distribute power from double sided, Back 2 Back below the worksurface power trough to a single sided, below work surface power trough at the end of a table run.
(Please see Power Delivery page at the beginning of electrical section (item #9)).

PRODUCT CODE	PRICE	SIZE/INCHES			WEIGHT VOL	
		H	W	D	LBS	FT ³
BRTHH28	145	2	28	0.5	1.0	1.17
BRTHH44	173	2	44.5	0.5	1.5	1.17
BRTHH52	183	2	52.5	0.5	2.0	1.17
BRTHH58	189	2	58.5	0.5	2.2	1.17
BRTHH76	212	2	76.5	0.5	2.8	1.17

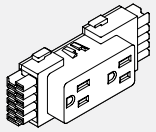
BRT8D • Duplex Receptacles

- Snaps into Power Distribution Housing.
- Up to 6 duplex receptacles per circuit.
- D1 = Circuit #1 (utility circuit)
- D2 = Circuit #2 (utility circuit)
- D3 = Circuit #3 (utility circuit)
- DA - Circuit #A (dedicated circuit)
- XW identifies white colour plastic, all others in standard black.

PRODUCT CODE	PRICE	SIZE/INCHES			WEIGHT VOL	
		H	W	D	LBS	FT ³
BRT8D1	32	2	4.625	1.25	0.10	0.01
BRT8D2	32	2	4.625	1.25	0.10	0.01
BRT8D3	32	2	4.625	1.25	0.10	0.01
BRT8DA	32	2	4.625	1.25	0.10	0.01
BRT8DXW1	47	2	4.625	1.25	0.10	0.01
BRT8DXW2	47	2	4.625	1.25	0.10	0.01
BRT8DXW3	47	2	4.625	1.25	0.10	0.01
BRT8DXWA	47	2	4.625	1.25	0.10	0.01

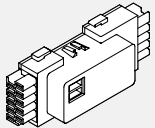
BE8D • USB Receptacles

- Snaps into Power Distribution Housing.
- USB charging module provides convenient charging power access through dual ports on face of receptacles.
- Two USB ports.
- 2 amp output, considered as circuit #1.

PRODUCT CODE	PRICE	SIZE/INCHES			WEIGHT VOL	
		H	W	D	LBS	FT ³
BRT8DU1-W	216	2	4.625	1.25	0.10	0.01
BRT8DU1-B	216	2	4.625	1.25	0.10	0.01

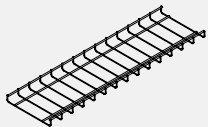
BRTCB • Power/Data Cable Basket

- Shallow, 8" wide basket manages cable excess. If suspended below Back 2 Back worksurfaces, it facilitates the simplest way of electrifying a workstation. The equipment can be plugged directly to a wall or floor monument outlets and the Cable Basket serves to manage cords and cables. It can be easily unclipped from steel brackets (included) to rearrange cable connections from below the worksurface.
- The same steel brackets can suspend the Cable Basket below storage cabinet's bottom where it keeps the cords and cables off the floor and manages them under storage cabinets along the horizontal plane - between panel base raceway outlets, floor monuments and Storage Vertical Cable Manager, for example.
- Tall storage cabinet's legs provide easy access to the Cable Basket where it can be easily unclipped from steel brackets (included) to rearrange cable connections.
- Note: wide Cable Baskets can span under several storage cabinets. As a general rule - specify Cable Basket min. 8" shorter than the storage cabinet spine assembly.
- Steel wire construction, black finish baskets; black steel hanging brackets, fasteners.
- BRTCB76KIT contains 2 pieces BRTCB34.

PRODUCT CODE	PRICE	SIZE/INCHES			WEIGHT VOL	
		H	W	D	LBS	FT ³
BRTCB8	78	1	8	8	0.36	0.03
BRTCB16	86	1	16	8	0.73	0.07
BRTCB22	90	1	22	8	1.01	0.10
BRTCB28	97	1	28	8	1.20	0.13
BRTCB34	111	1	34	8	1.56	0.15
BRTCB40	114	1	40	8	1.80	0.18
BRTCB46	123	1	46	8	2.16	0.21
BRTCB52	129	1	52	8	2.39	0.24
BRTCB58	140	1	58	8	2.66	0.26
BRTCB64	142	1	64	8	2.94	0.29
BRTCB70	154	1	70	8	3.22	0.34
BRTCB76KIT	212	1	34	8	1.56	0.15

BRPBS • Starter Beam

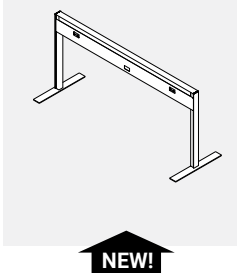

- Bridges Power Beam divides space, delineates territory, provides power and data to adjacent work spaces.
- Starter Beam can serve as a single, standalone unit or the beginning of a longer run of interconnected beams.
- 30" to 72" wide beams feature knockouts for two electrical duplex and one communication face place on each side while 24" wide beams accommodate one electrical duplex and one communication face place on each side.
- The leg expands by approximately 4" in height to compensate for uneven floors and allow for accurate levelling. Feet depth is 24".
- Starter Beam consist of the horizontal channel, raceway covers, two legs, two 24" deep feet, two vertical end trims and corresponding end trim capture strips.
- Specify standard Flat Top Trim (BRPBTC), Glass and Top Trim Kit (BRPBEG) or PET Felt and Top Trim Kit (BRPBEF) separately.
- Specify electrical components separately.
- Specify standard metal paint finish.

PRODUCT CODE	PRICE	SIZE/INCHES			WEIGHT LBS	VOL FT³
		H	W	D		
BRPBS1824	406	18	24	24	20.23	6.00
BRPBS1830	431	18	30	24	21.83	7.50
BRPBS1836	450	18	36	24	23.14	9.00
BRPBS1842	471	18	42	24	24.46	10.50
BRPBS1848	496	18	48	24	25.77	12.00
BRPBS1854	517	18	54	24	27.08	13.50
BRPBS1860	538	18	60	24	28.39	15.00
BRPBS1866	562	18	66	24	29.7	16.50
BRPBS1872	595	18	72	24	31.01	18.00
BRPBS2624	432	26	24	24	21.24	8.67
BRPBS2630	457	26	30	24	22.84	10.83
BRPBS2636	476	26	36	24	24.15	13.00
BRPBS2642	497	26	42	24	25.47	15.17
BRPBS2648	523	26	48	24	26.77	17.33
BRPBS2654	544	26	54	24	28.09	19.50
BRPBS2660	564	26	60	24	29.4	21.67
BRPBS2666	588	26	66	24	30.7	23.83
BRPBS2672	621	26	72	24	32.02	26.00
BRPBS3424	455	34	24	24	22.25	11.33
BRPBS3430	489	34	30	24	23.85	14.17
BRPBS3436	508	34	36	24	25.16	17.00
BRPBS3442	529	34	42	24	26.47	19.83
BRPBS3448	554	34	48	24	27.78	22.67
BRPBS3454	575	34	54	24	29.09	25.50
BRPBS3460	596	34	60	24	30.4	28.33
BRPBS3466	617	34	66	24	31.71	31.17
BRPBS3472	656	34	72	24	33.02	34.00

BRPBA • Add-on Beam



- Bridges Power Beam divides space, delineates territory, provides power and data to adjacent work spaces.
- Add-on Beam connects to the Starter Beam and serves to extend the run of Bridges Power Beams as desired.
- 30" to 72" wide beams feature knockouts for two electrical duplex and one communication face place on each side while 24" wide beams accommodate one electrical duplex and one communication face place on each side.
- Add-on Beam consist of the horizontal channel, raceway covers, two legs, one foot and a pair of beam-to-beam connecting capture strips.
- The leg expands by approximately 4" in height to compensate for uneven floors and allow for accurate levelling. Feet depth is 24".
- Specify standard Flat Top Trim (BRPBTC), Glass and Top Trim Kit (BRPBEG) or PET Felt and Top Trim Kit (BRPBEF) separately.
- Specify electrical components separately.
- Specify standard metal paint finish.

PRODUCT CODE	PRICE	SIZE/INCHES			WEIGHT LBS	VOL FT³
		H	W	D		
BRPBA1824	298	18	24	24	14.46	6.00
BRPBA1830	323	18	30	24	16.06	7.50
BRPBA1836	342	18	36	24	17.37	9.00
BRPBA1842	363	18	42	24	18.68	10.50
BRPBA1848	389	18	48	24	19.99	12.00
BRPBA1854	410	18	54	24	21.31	13.50
BRPBA1860	430	18	60	24	22.62	15.00
BRPBA1866	451	18	66	24	23.92	16.50
BRPBA1872	487	18	72	24	25.24	18.00
BRPBA2624	325	26	24	24	15.5	8.67
BRPBA2630	350	26	30	24	17.11	10.83
BRPBA2636	369	26	36	24	18.42	13.00
BRPBA2642	389	26	42	24	19.73	15.17
BRPBA2648	415	26	48	24	21.04	17.33
BRPBA2654	436	26	54	24	22.35	19.50
BRPBA2660	456	26	60	24	23.66	21.67
BRPBA2666	477	26	66	24	24.97	23.83
BRPBA2672	513	26	72	24	26.28	26.00
BRPBA3424	356	34	24	24	16.55	11.33
BRPBA3430	381	34	30	24	18.15	14.17
BRPBA3436	400	34	36	24	19.46	17.00
BRPBA3442	421	34	42	24	20.77	19.83
BRPBA3448	447	34	48	24	22.08	22.67
BRPBA3454	468	34	54	24	23.4	25.50
BRPBA3460	488	34	60	24	24.71	28.33
BRPBA3466	509	34	66	24	26.01	31.17
BRPBA3472	545	34	72	24	27.33	34.00

BRPBTC • Flat Top Trim

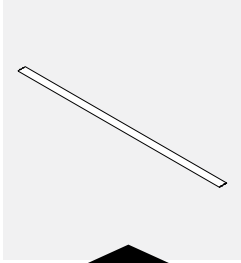

NEW!

- Flat Top Trim attaches on top of Bridges Power Beams to add privacy or divide space.
- Flat top trim is made of an aluminum extrusion.
- Specify standard metal paint finish.

PRODUCT CODE	PRICE	SIZE/INCHES			WEIGHT LBS	VOL FT ³
		H	W	D		
BRPBTC24	10	0.2	24	2.61	0.24	0.01
BRPBTC30	13	0.2	30	2.61	0.61	0.01
BRPBTC36	15	0.2	36	2.61	0.73	0.01
BRPBTC42	17	0.2	42	2.61	0.85	0.01
BRPBTC48	20	0.2	48	2.61	0.97	0.01
BRPBTC54	23	0.2	54	2.61	1.1	0.02
BRPBTC60	23	0.2	60	2.61	1.22	0.02
BRPBTC66	26	0.2	66	2.61	1.34	0.02
BRPBTC72	30	0.2	72	2.61	1.47	0.02

BRPBEG • Embedded Glass and Top Trim Kit

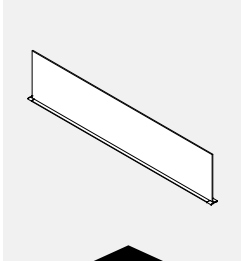

NEW!

- Embedded Glass and Top Trim Kit attaches on top of beams to add privacy or divide space.
- Embedded Glass Top Trim Kit consist of the extruded aluminum channel, die-cast channel end covers, glass partition, gasket and hardware required to secure the trim to the beam's horizontal channel.
- Specify standard metal paint finish.
- Clear tempered glass is standard.

PRODUCT CODE	PRICE CLR	FRST	SIZE/INCHES			WEIGHT LBS	VOL FT ³
			H	W	D		
BRPBEG0824	125	207	8	24	2.61	9.42	0.29
BRPBEG0830	133	214	8	30	2.61	11.79	0.36
BRPBEG0836	140	222	8	36	2.61	14.15	0.44
BRPBEG0842	148	230	8	42	2.61	16.52	0.51
BRPBEG0848	163	254	8	48	2.61	18.88	0.58
BRPBEG0854	181	283	8	54	2.61	19.52	0.65
BRPBEG0860	198	311	8	60	2.61	20.58	0.73
BRPBEG0866	215	340	8	66	2.61	21.55	0.80
BRPBEG0872	238	374	8	72	2.61	23.62	0.87
BRPBEG1624	130	212	16	24	2.61	9.891	0.58
BRPBEG1630	160	256	16	30	2.61	12.37	0.73
BRPBEG1636	179	302	16	36	2.61	14.85	0.87
BRPBEG1642	204	347	16	42	2.61	17.346	1.02
BRPBEG1648	229	392	16	48	2.61	19.824	1.16
BRPBEG1654	253	413	16	54	2.61	21.25	1.31
BRPBEG1660	278	482	16	60	2.61	23.62	1.45
BRPBEG1666	303	527	16	66	2.61	25.98	1.60
BRPBEG1672	333	578	16	72	2.61	28.35	1.74

BRPBEF • Embedded PET Felt and Top Trim Kit

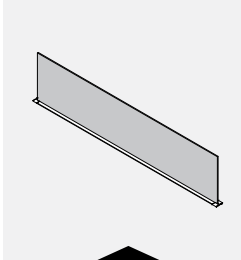

NEW!

- Embedded PET Felt and Top Trim Kit attaches on top of beams to add privacy or divide space.
- - Embedded PET Felt Top Trim Kit consist of the extruded aluminum channel, die-cast channel end covers, PET felt partition and hardware required to secure the trim to the beams horizontal channel.
- Specify standard metal paint finish.
- 9mm PET felt material is tackable Please specify standard finish.

PRODUCT CODE	PRICE	SIZE/INCHES			WEIGHT LBS	VOL FT ³
		H	W	D		
BRPBEF0824	61	8	24	2.61	1.32	0.29
BRPBEF0830	64	8	30	2.61	1.65	0.36
BRPBEF0836	85	8	36	2.61	1.99	0.44
BRPBEF0842	89	8	42	2.61	2.32	0.51
BRPBEF0848	160	8	48	2.61	2.65	0.58
BRPBEF0854	164	8	54	2.61	2.98	0.65
BRPBEF0860	167	8	60	2.61	3.32	0.73
BRPBEF0866	171	8	66	2.61	3.65	0.80
BRPBEF0872	180	8	72	2.61	3.98	0.87
BRPBEF1624	61	16	24	2.61	1.83	0.58
BRPBEF1630	64	16	30	2.61	2.3	0.73
BRPBEF1636	85	16	36	2.61	2.76	0.87
BRPBEF1642	89	16	42	2.61	3.22	1.02
BRPBEF1648	160	16	48	2.61	3.68	1.16
BRPBEF1654	164	16	54	2.61	4.14	1.31
BRPBEF1660	167	16	60	2.61	4.61	1.45
BRPBEF1666	171	16	66	2.61	5.07	1.60
BRPBEF1672	180	16	72	2.61	5.53	1.74

BRPBEFP • Embedded Perforated PET Felt and Top Trim Kit

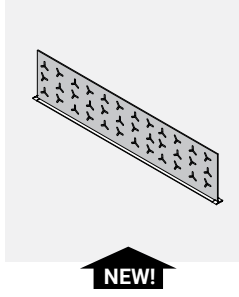

NEW!

- Embedded Perforated PET Felt and Top Trim Kit attaches on top of beams to add privacy or divide space.
- Embedded Perforated PET Felt Top Trim Kit consist of the extruded aluminum channel, die-cast channel end covers, perforated PET felt partition and hardware required to secure the trim to the beams horizontal channel.
- Specify standard metal paint finish.
- 9mm PET felt material is tackable. Please specify standard finish.

PRODUCT CODE	PRICE	SIZE/INCHES			WEIGHT LBS	VOL FT ³
		H	W	D		
BRPBEFP0824	122	8	24	2.61	1.32	0.29
BRPBEFP0830	129	8	30	2.61	1.65	0.36
BRPBEFP0836	170	8	36	2.61	1.99	0.44
BRPBEFP0842	177	8	42	2.61	2.32	0.51
BRPBEFP0848	320	8	48	2.61	2.65	0.58
BRPBEFP0854	327	8	54	2.61	2.98	0.65
BRPBEFP0860	335	8	60	2.61	3.32	0.73
BRPBEFP0866	342	8	66	2.61	3.65	0.80
BRPBEFP0872	360	8	72	2.61	3.98	0.87
BRPBEFP1624	122	16	24	2.61	1.83	0.58
BRPBEFP1630	129	16	30	2.61	2.3	0.73
BRPBEFP1636	170	16	36	2.61	2.76	0.87
BRPBEFP1642	177	16	42	2.61	3.22	1.02
BRPBEFP1648	320	16	48	2.61	3.68	1.16
BRPBEFP1654	327	16	54	2.61	4.14	1.31
BRPBEFP1660	335	16	60	2.61	4.61	1.45
BRPBEFP1666	342	16	66	2.61	5.07	1.60
BRPBEFP1672	360	16	72	2.61	5.53	1.74

BPX3OP • Over Panel Frame

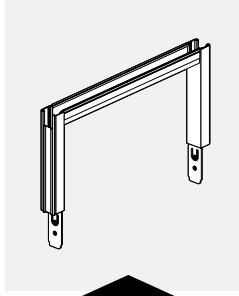

NEW!

- Attaches to the top of any Boulevard System 3 panel to create a floor-to-ceiling wall.
- Any tile can be attached to either side to enclose the frame.
- Two non-slotted uprights at either end slide into vertical extrusions on the base.
- Shipped without horizontal and vertical trim, specify separately.
- Openings in horizontal channels allow for vertical cable passage from top lay-in channel and behind the cover tiles
- Over Panel Frames 18" and 24" wide are not punched for vertical wire channel.
- Boulevard System 3 Over Panel is not compatible with Boulevard 1 panels.

PRODUCT CODE	PRICE	SIZE/ INCHES			WEIGHT LBS	VOL FT ³
		H	W	D		
BPX3OP0824	99	8	24	2.61	4	0.43
BPX3OP0830	106	8	30	2.61	4	0.65
BPX3OP0836	114	8	36	2.61	4	0.71
BPX3OP0842	127	8	42	2.61	5	0.87
BPX3OP0848	134	8	48	2.61	5	0.93
BPX3OP0854	142	8	54	2.61	6	1.04
BPX3OP0860	151	8	60	2.61	6	1.20
BPX3OP0866	168	8	66	2.61	7	1.31
BPX3OP0872	186	8	72	2.61	8	1.42
BPX3OP1624	99	16	24	2.61	5	0.73
BPX3OP1630	106	16	30	2.61	5	1.09
BPX3OP1636	114	16	36	2.61	5	1.18
BPX3OP1642	127	16	42	2.61	6	1.45
BPX3OP1648	134	16	48	2.61	6	1.55
BPX3OP1654	142	16	54	2.61	7	1.73
BPX3OP1660	151	16	60	2.61	7	2.00
BPX3OP1666	168	16	66	2.61	9	2.16
BPX3OP1672	186	16	72	2.61	10	2.37

BP3FT • Removeable Face Tile - Fabric or Laminate

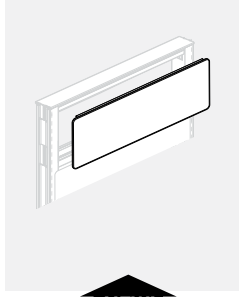

NEW!

- Attaches to any opening in a Pass-Thru Panel.
- Tile clips included.
- Easily interchangeable on site.
- Specify two tiles per over panel opening of corresponding width. Tiles can be combined. For example, Fabric Tile on one side and Accessory Tile on the opposite side of the same panel.
- OPT* = Laminate or Whiteboard.

PRODUCT CODE	PRICE			SIZE/ INCHES			WEIGHT VOL	
	GR1	GR2	OPT*	H	W	D	LBS	FT ³
BP3FT0824	94	103	110	8	24	0.25	1	0.16
BP3FT0830	103	114	130	8	30	0.25	2	0.20
BP3FT0836	127	140	154	8	36	0.25	2	0.25
BP3FT0842	135	147	164	8	42	0.25	2	0.29
BP3FT0848	141	154	168	8	48	0.25	3	0.33
BP3FT0854	149	164	176	8	54	0.25	3	0.37
BP3FT0860	154	167	182	8	60	0.25	4	0.41
BP3FT0866	175	232	296	8	66	0.25	4	0.46
BP3FT0872	226	298	373	8	72	0.25	4	0.50
BP3FT1624	106	112	120	16	24	0.25	2	0.33
BP3FT1630	113	128	142	16	30	0.25	3	0.41
BP3FT1636	140	152	167	16	36	0.25	3	0.50
BP3FT1642	149	164	176	16	42	0.25	3	0.58
BP3FT1648	156	169	186	16	48	0.25	4	0.66
BP3FT1654	165	176	193	16	54	0.25	4	0.75
BP3FT1660	182	240	199	16	60	0.25	5	0.83
BP3FT1666	199	256	319	16	66	0.25	5	0.92
BP3FT1672	246	326	408	16	72	0.25	6	1.00

BP3AT • Removable Face Tile - Accessory

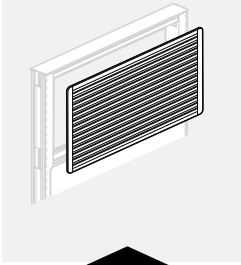

NEW!

- Attaches to any opening in an Over Panel Frame.
- Provides support for accessories.
- Easily interchangeable on site.
- Two tile clips included.
- Specify two tiles per over panel opening of corresponding width. Tiles can be combined. For example, Fabric Tile on one side and Accessory Tile on the opposite side of the same panel.
- Accessory Tile cannot be installed opposite an electrical tile.

PRODUCT CODE	PRICE	SIZE/ INCHES			WEIGHT VOL	
		H	W	D	LBS	FT ³
BP3AT0824	112	08	24	0.25	2.3	0.16
BP3AT0830	123	08	30	0.25	2.9	0.20
BP3AT0836	145	08	36	0.25	3.5	0.25
BP3AT0842	175	08	42	0.25	4.1	0.29
BP3AT0848	205	08	48	0.25	4.7	0.33
BP3AT0854	220	08	54	0.25	5.3	0.37
BP3AT0860	251	08	60	0.25	5.9	0.41
BP3AT0866	271	08	66	0.25	6.5	0.45
BP3AT0872	294	08	72	0.25	7.0	0.50
BP3AT1624	134	16	24	0.25	4.7	0.33
BP3AT1630	143	16	30	0.25	5.7	0.41
BP3AT1636	173	16	36	0.25	7.0	0.50
BP3AT1642	205	16	42	0.25	8.2	0.58
BP3AT1648	238	16	48	0.25	9.4	0.66
BP3AT1654	257	16	54	0.25	10.6	0.75
BP3AT1660	295	16	60	0.25	11.9	0.83
BP3AT1666	326	16	66	0.25	13.0	0.91
BP3AT1672	355	16	72	0.25	14.0	1.00

BP3GT • Removable Face Tile - Glazed

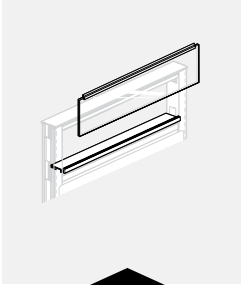

NEW!

- Attaches to any opening in a Pass-Thru Panel.
- 8" or 16" high glazing provides visual accessibility and light transfer.
- Easily interchangeable on site.
- Specify one Glazed Tile for over panel opening of corresponding width.
- Clear tempered glass standard.

PRODUCT CODE	PRICE	FRST/SMK	SIZE/ INCHES			WEIGHT VOL	
			H	W	D	LBS	FT ³
BP3GT0824	112	134	8	24	2.61	3.1	0.16
BP3GT0830	123	147	8	30	2.61	3.9	0.20
BP3GT0836	144	173	8	36	2.61	4.7	0.25
BP3GT0842	168	202	8	42	2.61	5.5	0.29
BP3GT0848	194	231	8	48	2.61	6.3	0.33
BP3GT0854	218	262	8	54	2.61	7.1	0.37
BP3GT0860	242	292	8	60	2.61	7.8	0.41
BP3GT0866	268	321	8	66	2.61	8.6	0.46
BP3GT0872	292	352	8	72	2.61	9.4	0.50
BP3GT1624	121	145	16	24	2.61	5.8	0.33
BP3GT1630	140	167	16	30	2.61	7.2	0.41
BP3GT1636	169	204	16	36	2.61	8.7	0.50
BP3GT1642	198	238	16	42	2.61	10.2	0.58
BP3GT1648	228	272	16	48	2.61	11.6	0.66
BP3GT1654	256	308	16	54	2.61	13.1	0.75
BP3GT1660	286	342	16	60	2.61	14.6	0.83
BP3GT1666	315	361	16	66	2.61	16.0	0.91
BP3GT1672	342	394	16	72	2.61	17.5	1.00

BRP3PS • 90 Degree Post

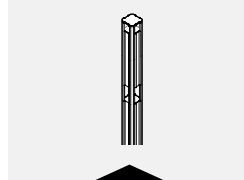

NEW!

- Post facilitates splitting of the beam run into up to 4 directions at 90 angle.
- Post kit consist of the extruded aluminum post and four pairs of capture strip connectors.
- Post Vertical Trim must be specified in accordance to your post 2-way, 3-way or 4-way configuration.
- Specify painted metal finish colour.

PRODUCT CODE	PRICE	SIZE/INCHES			WEIGHT LBS	VOL FT ³
		H	W	D		
BRP3PS018	65	18	2.61	2.61	3.00	0.12
BRP3PS026	93	26	2.61	2.61	3.60	0.13
BRP3PS034	122	34	2.61	2.61	4.00	0.14

BRP3PS • 60 Degree Post

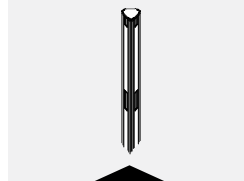

NEW!

- Post facilitates splitting of the beam run into up to 3 directions at 120 angle.
- Post kit consist of the extruded aluminum post and three pairs of capture strip connectors.
- Post Vertical Trim must be specified in accordance to your post 2-way, 3-way or 4-way configuration.
- Specify painted metal finish colour.

PRODUCT CODE	PRICE	SIZE/INCHES			WEIGHT LBS	VOL FT ³
		H	W	D		
BRP3PS60018	65	18	2.61	2.61	3.00	0.12
BRP3PS60026	93	26	2.61	2.61	3.60	0.13
BRP3PS60034	122	34	2.61	2.61	4.00	0.14

BRP3PS • 45 Degree Post

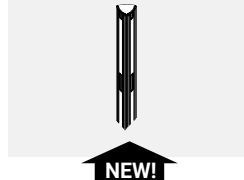

NEW!

- Post facilitates two beams at 45 angle.
- Post kit consist of the extruded aluminum post and four pairs of capture strip connectors.
- Post Vertical Trim must be specified in accordance to your post 2-way, 3-way or 4-way configuration.
- Specify painted metal finish colour.

PRODUCT CODE	PRICE	SIZE/INCHES			WEIGHT LBS	VOL FT ³
		H	W	D		
BRP3PS45018	65	18	2.61	2.61	3.00	0.12
BRP3PS45026	93	26	2.61	2.61	3.60	0.13
BRP3PS45034	122	34	2.61	2.61	4.00	0.14

BRPVTRF • End Trim

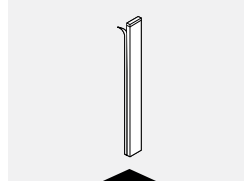

NEW!

- Attaches to Post
- Consist of the extruded aluminum trim and one pair of capture strip connectors.
- Post Vertical Trim must be specified in accordance to your post 2-way, 3-way or 4-way configuration.
- Specify painted metal finish colour.

PRODUCT CODE	PRICE	SIZE/INCHES			WEIGHT LBS	VOL FT ³
		H	W	D		
BRPVTRF18	22	18	2.61	2.61	0.50	0.01
BRPVTRF26	29	26	2.61	2.61	0.72	0.02
BRPVTRF34	37	34	2.61	2.61	0.94	0.03
BRPVTRF42	45	42	2.61	2.61	1.16	0.04
BRPVTRF50	54	50	2.61	2.61	1.38	0.05

BA3VTEF • Overpanel End Trim

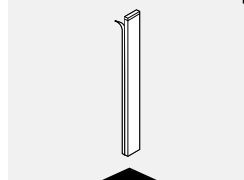

NEW!

- Attaches to sides of Overpanel Extension frame.
- Overpanel Extension Vertical Trim consist of the extruded aluminum trim, die-cast corner and a pair capture strip connectors.
- Overpanel Extension Vertical Trim must be specified because Overpanel Extensions may not necessarily continue in full length, and single, strategically positioned Overpane Extensions will therefore require their own vertical trims in corresponding locations.
- Specify metal finish colour

PRODUCT CODE	PRICE	SIZE/INCHES			WEIGHT LBS	VOL FT ³
		H	W	D		
BA3VTEF8	11	8	2.61	0.125	0.20	0.01
BA3VTEF16	23	16	2.61	0.125	0.50	0.03

BRPRB • Round Disk Base for Post

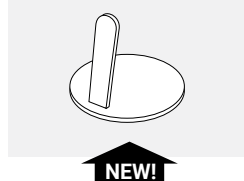

NEW!

- Attached to the bottom of BRP3PS Post to provide stability at an intersection.
- Round metal plate is 1/4" thick.
- Specify painted metal finish colour.

PRODUCT CODE	PRICE	SIZE/INCHES			WEIGHT LBS	VOL FT ³
		H	W	D		
BRPRB	235	6.5	7.5	7.5	3.67	0.01

BEPE • Post Extension

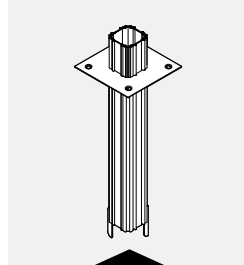

NEW!

- **Lightweight aluminum pole to be used to bring power and/or data/communication cables from ceiling to a beam through a post.**
- Attaches to ceiling and post.
- Includes connectors, ceiling trim plate and screws.
- Post extension will accept:
 - 75 cables 5.6mm (0.220") dia. data cables
 - 60 cables 5.6mm (0.220") dia. data cables with 1 power feed
 - 45 cables 5.6mm (0.220") dia. data cables with 2 power feeds.
- Ceiling bezel is white only.
- Specify metal finish colour

PRODUCT CODE	PRICE	SIZE/INCHES			WEIGHT LBS	VOL FT ³
		H	W	D		
BEPE81	171	81	2.61	2.61	9	0.43

B3LEP-NC • End of Run Gallery Panel in a T configuration, No Connectors for Additional Gallery Panels

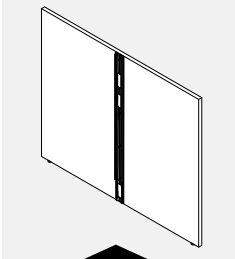

NEW!

- Provides floor standing support while enclosing the end of a panel run on two sides.
- Attaches to the end of a Bridges Power Beam with capture strips to form a T configuration.
- Connection is on the interior face center.
- Includes all attachment hardware and glides.
- Total height is inclusive of panel glides extended to their full height.
- 51" wide gallery panel accommodates two 24" deep surfaces while the 63" wide accommodates two 30" deep surfaces and 75" wide two 36" deep surfaces.
- Please specify LP laminate finish and PVC edge finish.
- If a wood grain laminate is chosen, grain direction run horizontally.
- Edged in PVC on three exposed edges and self edged on bottom.

PRODUCT CODE	PRICE LP	SIZE/INCHES			WEIGHT LBS	VOL FT ³
		H	W	D		
B3LEP4227NC	404	42	26.5	1	29.49	0.64
B3LEP4251NC	634	42	51	1	55.17	1.24
B3LEP4263NC	710	42	63	1	68.01	1.53
B3LEP4275NC	790	42	75	1	80.86	1.82
B3LEP5027NC	471	50	26.5	1	35.25	0.77
B3LEP5051NC	736	50	51	1	65.92	1.48
B3LEP5063NC	829	50	63	1	81.27	1.82
B3LEP5075NC	936	50	75	1	96.62	2.17
B3LEP5427NC	471	54	26.5	1	38.12	0.83
B3LEP5451NC	758	54	51	1	71.3	1.59
B3LEP5463NC	854	54	63	1	87.9	1.97
B3LEP5475NC	965	54	75	1	104.49	2.34

B3LSEPL-NC • Left End of Run Single Gallery Panel in L Configuration, No Connectors for Additional Gallery Panels

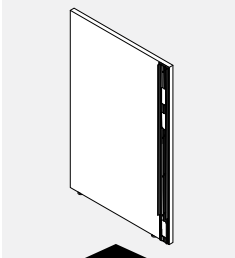

NEW!

- Provides floor standing support while enclosing the end of a panel run on one side.
- Attaches to the end of a Bridges Power Beam with capture strips to form an L configuration.
- Connection is on interior face near it's right end.
- Includes all attachment hardware and glides.
- Total height is inclusive of panel glides extended to their full height.
- 27" wide gallery panel accommodates a 24" deep surface while the 33" wide accommodates a 30" deep surface and 39" wide a 36" deep surface.
- Please specify LP laminate finish and PVC edge finish.
- If a wood grain laminate is chosen, grain direction run horizontally.
- Edged in PVC on three exposed edges and self edged on bottom.

PRODUCT CODE	PRICE LP	SIZE/INCHES			WEIGHT LBS	VOL FT ³
		H	W	D		
B3LSEPL4215NC	332	42	14.25	1	16.64	0.35
B3LSEPL4227NC	483	42	27	1	29.47	0.66
B3LSEPL4233NC	521	42	33	1	35.89	0.80
B3LSEPL4239NC	548	42	39	1	42.32	0.95
B3LSEPL5015NC	378	50	14.25	1	19.9	0.41
B3LSEPL5027NC	549	50	27	1	35.23	0.78
B3LSEPL5033NC	595	50	33	1	42.9	0.95
B3LSEPL5039NC	637	50	39	1	50.57	1.13
B3LSEPL5415NC	378	54	14.25	1	21.52	0.45
B3LSEPL5427NC	565	54	27	1	38.1	0.84
B3LSEPL5433NC	614	54	33	1	46.4	1.03
B3LSEPL5439NC	657	54	39	1	54.7	1.22

B3LSEPR-NC • Right End of Run Single Gallery Panel in L Configuration, No Connectors for Additional Gallery Panels

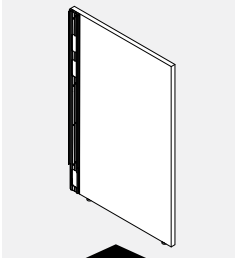

NEW!

- Provides floor standing support while enclosing the end of a panel run on one side.
- Attaches to the end of a Bridges Power Beam with capture strips to form an L configuration.
- Connection is on interior face near it's right end.
- - Includes all attachment hardware and glides.
- Total height is inclusive of panel glides extended to their full height.
- 27" wide gallery panel accommodates a 24" deep surface while the 33" wide accommodates a 30" deep surface and 39" wide a 36" deep surface.
- Please specify LP laminate finish and PVC edge finish.
- If a wood grain laminate is chosen, grain direction run horizontally.
- Edged in PVC on three exposed edges and self edged on bottom.

PRODUCT CODE	PRICE LP	SIZE/INCHES			WEIGHT LBS	VOL FT ³
		H	W	D		
B3LSEPR4215NC	332	42	14.25	1	16.64	0.35
B3LSEPR4227NC	483	42	27	1	29.47	0.66
B3LSEPR4233NC	521	42	33	1	35.89	0.80
B3LSEPR4239NC	548	42	39	1	42.32	0.95
B3LSEPR5015NC	378	50	14.25	1	19.9	0.41
B3LSEPR5027NC	549	50	27	1	35.23	0.78
B3LSEPR5033NC	595	50	33	1	42.9	0.95
B3LSEPR5039NC	637	50	39	1	50.57	1.13
B3LSEPR5415NC	378	54	14.25	1	21.52	0.45
B3LSEPR5427NC	565	54	27	1	38.1	0.84
B3LSEPR5433NC	614	54	33	1	46.4	1.03
B3LSEPR5439NC	657	54	39	1	54.7	1.22

B3LEP • End of Run Gallery Panel in a T configuration, with Connectors for Additional Gallery Panels

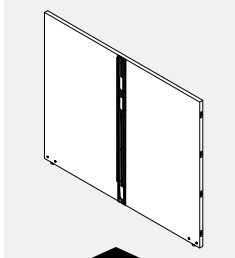

NEW!

- Provides floor standing support while enclosing the end of a panel run.
- Attaches to the end of a Bridges Power Beam with capture strips to form a T configuration.
- Connections at both ends as well as on the middle of interior face.
- The end connections are to connect other Gallery Panels.
- The side right is compatible with right hand Gallery Panels (B3LX-PRxxxx and B3LXPRxxxxNC, B3L2PRxxxx and B3L3PRxxxx) only.
- The left side is compatible with left hand Gallery Panels (B3LX-PLxxxx and B3LXPLxxxxNC, B3L2PLxxxx and B3L3PLxxxx) only.
- The middle interior face connections are for Boulevard panels.
- Includes all attachment hardware and glides.
- Total height is inclusive of panel glides extended to their full height.
- 51" wide gallery panel accomodates two 24" deep surface while the 63" wide accomodates two 30" deep surfaces and 75" wide two 36" deep surfaces.
- Please specify LP laminate finish and PVC edge finish.
- If a wood grain laminate is chosen, grain direction run horizontally.
- Gallery panel is edged in PVC on exposed top edge only and self edged on the three other edges.

PRODUCT CODE	PRICE LP	SIZE/INCHES			WEIGHT LBS	VOL FT ³
		H	W	D		
B3LEP4251	648	42	51	1	55.25	1.24
B3LEP4263	723	42	63	1	68.1	1.53
B3LEP4275	804	42	75	1	80.95	1.82
B3LEP5051	750	50	51	1	66.01	1.48
B3LEP5063	843	50	63	1	81.36	1.82
B3LEP5075	950	50	75	1	96.71	2.17
B3LEP5451	772	54	51	1	71.38	1.59
B3LEP5463	868	54	63	1	87.98	1.97
B3LEP5475	979	54	75	1	104.58	2.34

B3LSEPL • Left End of Run Single Gallery Panel in L Configuration, with Connectors for Additional Gallery Panels

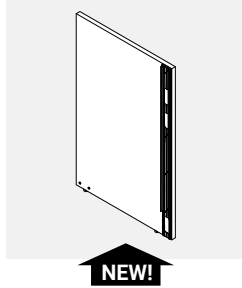

NEW!

- Provides floor standing support while enclosing the end of a panel run.
- Attaches at the end of a Bridges Power Beam with capture strips to form an L configuration.
- Connection to the Boulevard panel is on interior face near its right end.
- Connections for a Gallery Panel are on the left edge.
- Compatible with left hand Gallery Panels (B3LXPLxxxx and B3LXPLxxxxNC, B3L2PLxxxx and B3L3PLxxxx) only.
- Includes all attachment hardware and glides.
- Total height is inclusive of panel glides extended to their full height.
- 27" wide gallery panel accomodates a 24" deep surface while the 33" wide accomodates a 30" deep surface and 39" wide a 36" deep surface.
- Please specify LP laminate finish and PVC edge finish.
- If a wood grain laminate is chosen, grain direction run horizontally.
- Edged in PVC on two exposed edges, self edged on connecting to gallery panel edge and the bottom.

PRODUCT CODE	PRICE LP	SIZE /INCHES			WEIGHT LBS	VOL FT³
		H	W	D		
B3LSEPL4227	490	42	27	1	29.51	0.66
B3LSEPL4233	528	42	33	1	35.94	0.80
B3LSEPL4239	554	42	39	1	42.36	0.95
B3LSEPL5027	556	50	27	1	35.27	0.78
B3LSEPL5033	603	50	33	1	42.94	0.95
B3LSEPL5039	645	50	39	1	50.62	1.13
B3LSEPL5427	572	54	27	1	38.14	0.84
B3LSEPL5433	620	54	33	1	46.44	1.03
B3LSEPL5439	663	54	39	1	54.74	1.22

B3LSEPR • Right End of Run Single Gallery Panel in L Configuration, with Connectors for additional Gallery Panels

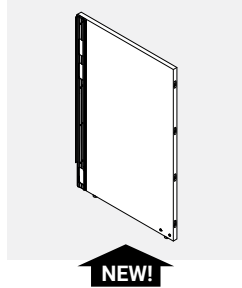

NEW!

- Provides floor standing support while enclosing the end of a panel run.
- Attaches at the end of a Bridges Power Beam with capture strips to form an L configuration.
- Connection to the Boulevard panel is on interior face near its left end.
- Connections for a Gallery Panel are on the right edge.
- Compatible with right hand Gallery Panels (B3LXPRxxxx and B3LXPRxxxxNC, B3L2PRxxxx and B3L3PRxxxx) only.
- Includes all attachment hardware and glides.
- Total height is inclusive of panel glides extended to their full height.
- 27" wide gallery panel accomodates a 24" deep surface while the 33" wide accomodates a 30" deep surface and 39" wide a 36" deep surface.
- Please specify LP laminate finish and PVC edge finish.
- If a wood grain laminate is chosen, grain direction run horizontally.
- Edged in PVC on two exposed edges, self edged on connecting to gallery panel edge and the bottom.

PRODUCT CODE	PRICE LP	SIZE /INCHES			WEIGHT LBS	VOL FT³
		H	W	D		
B3LSEPR4227	490	42	27	1	29.51	0.66
B3LSEPR4233	528	42	33	1	35.94	0.80
B3LSEPR4239	554	42	39	1	42.36	0.95
B3LSEPR5027	556	50	27	1	35.27	0.78
B3LSEPR5033	603	50	33	1	42.94	0.95
B3LSEPR5039	645	50	39	1	50.62	1.13
B3LSEPR5427	572	54	27	1	38.14	0.84
B3LSEPR5433	620	54	33	1	46.44	1.03
B3LSEPR5439	663	54	39	1	54.74	1.22

B3LXPL • Left Gallery Panel Extension, with Connectors for Additional Gallery Panels

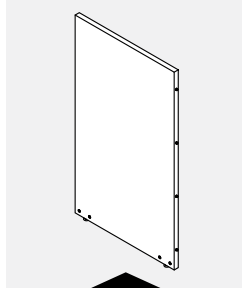

NEW!

- Provides floor standing support while extending the Gallery Panels runs.
- Attaches to the left edge of a Gallery Panel by the pin connectors to allow for additional Gallery Panels to be added on the left side.
- Pin connectors on the right edge and modular connectors on the left edge of the interior face.
- The right side is compatible with Gallery Panels (B3LEPxxx, B3LSEPL, B3LMPxxx, B3LSMP and B3LXPLxxx) only.
- The left side is compatible with left hand Gallery Panels (B3LXPLxxxx and B3LXPLxxxxNC, B3L2PLxxxx and B3L3PLxxxx) only.
- Includes all attachment hardware and glides.
- Total height is inclusive of panel glides extended to their full height.
- Please specify LP laminate finish and PVC edge finish.
- If a wood grain laminate is chosen, grain direction run horizontally.
- Edged in PVC on exposed top edge only and self edges on the three other.
- Edged in PVC on two exposed edges, self edged on connecting to gallery panel edge and the bottom.

PRODUCT CODE	PRICE LP	SIZE /INCHES			WEIGHT LBS	VOL FT³
		H	W	D		
B3LXPL4224	252	42	24	1	25.83	0.58
B3LXPL4230	290	42	30	1	32.26	0.73
B3LXPL4236	328	42	36	1	38.68	0.88
B3LXPL4242	365	42	42	1	45.11	1.02
B3LXPL4248	403	42	48	1	51.53	1.17
B3LXPL5024	300	50	24	1	30.83	0.69
B3LXPL5030	347	50	30	1	38.51	0.87
B3LXPL5036	394	50	36	1	46.18	1.04
B3LXPL5042	440	50	42	1	53.86	1.22
B3LXPL5048	487	50	48	1	61.53	1.39
B3LXPL5424	310	54	24	1	33.34	0.75
B3LXPL5430	358	54	30	1	41.64	0.94
B3LXPL5436	405	54	36	1	49.94	1.13
B3LXPL5442	452	54	42	1	58.24	1.31
B3LXPL5448	503	54	48	1	66.54	1.50

B3LXPR • Right Gallery Panel Extension, with Connectors for Additional Gallery Panels

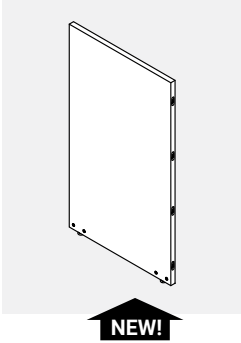

- Provides floor standing support while extending the Gallery Panels run.
- Attaches to the right edge of a Gallery Panel by the pin connectors to allow for additional Gallery Panels to be added on the right side.
- Pin connectors on the right edge and modular connectors on the left edge of the interior face.
- The right side is compatible with right hand Gallery Panels (B3LXPRxxxx and B3LXPRxxxxNC, B3L2PRxxxx and B3L3PRxxxx) only.
- The left side is compatible with Gallery Panels (B3LEPxxx, B3LSEPRxxx, B3LMPxxx and B3LXPRxxx) only.
- Includes all attachment hardware and glides.
- Total height is inclusive of panel glides extended to their full height.
- Please specify LP laminate finish and PVC edge finish.
- If a wood grain laminate is chosen, grain direction run horizontally.
- Edged in PVC on exposed top edge only and self edges on the three other.

PRODUCT CODE	PRICE LP	SIZE /INCHES			WEIGHT LBS	VOL FT³
		H	W	D		
B3LXPR4224	252	42	24	1	25.83	0.58
B3LXPR4230	290	42	30	1	32.26	0.73
B3LXPR4236	328	42	36	1	38.68	0.88
B3LXPR4242	365	42	42	1	45.11	1.02
B3LXPR4248	403	42	48	1	51.53	1.17
B3LXPR5024	300	50	24	1	30.83	0.69
B3LXPR5030	347	50	30	1	38.51	0.87
B3LXPR5036	394	50	36	1	46.18	1.04
B3LXPR5042	440	50	42	1	53.86	1.22
B3LXPR5048	487	50	48	1	61.53	1.39
B3LXPR5424	310	54	24	1	33.34	0.75
B3LXPR5430	358	54	30	1	41.64	0.94
B3LXPR5436	405	54	36	1	49.94	1.13
B3LXPR5442	452	54	42	1	58.24	1.31
B3LXPR5448	503	54	48	1	66.54	1.50

B3LXPL-NC • Left Gallery Panel Extension, No Connectors for Additional Gallery Panels

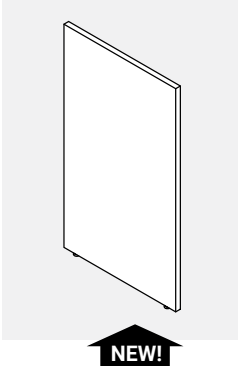

- Provides floor standing support while enclosing the end of a Gallery Panel left run.
- Attached to the left edge of a Gallery Panel by the pin connectors to finish the run.
- Pin connectors are on the right edge of the interior face.
- Compatible with gallery panels (B3LEPxxxx, B3LSEPLxxxx, B3LMPxxxx, B3LSMPxxxx and B3LXPLxxxx) only.
- Includes all attachment hardware and glides.
- Total height is inclusive of panel glides extended to their full height.
- Please specify LP laminate finish and PVC edge finish.
- If a wood grain laminate is chosen, grain direction run horizontally.
- Edged in PVC on two exposed edges, self edged on connecting to gallery panel edge and the bottom.

PRODUCT CODE	PRICE LP	SIZE /INCHES			WEIGHT LBS	VOL FT³
		H	W	D		
B3LXPL4212NC	138	42	12	1	12.95	0.29
B3LXPL4224NC	245	42	24	1	25.8	0.58
B3LXPL4230NC	283	42	30	1	32.22	0.73
B3LXPL4236NC	320	42	36	1	38.65	0.88
B3LXPL4242NC	359	42	42	1	45.07	1.02
B3LXPL4248NC	396	42	48	1	51.5	1.17
B3LXPL5012NC	172	50	12	1	15.45	0.35
B3LXPL5024NC	294	50	24	1	30.8	0.69
B3LXPL5030NC	340	50	30	1	38.47	0.87
B3LXPL5036NC	386	50	36	1	46.15	1.04
B3LXPL5042NC	435	50	42	1	53.82	1.22
B3LXPL5048NC	481	50	48	1	61.5	1.39
B3LXPL5412NC	172	54	12	1	16.7	0.38
B3LXPL5424NC	303	54	24	1	33.3	0.75
B3LXPL5430NC	351	54	30	1	41.6	0.94
B3LXPL5436NC	398	54	36	1	49.9	1.13
B3LXPL5442NC	447	54	42	1	58.2	1.31
B3LXPL5448NC	494	54	48	1	66.5	1.50

B3LXPR-NC • Right Gallery Panel Extension, No Connectors for Additional Gallery Panels

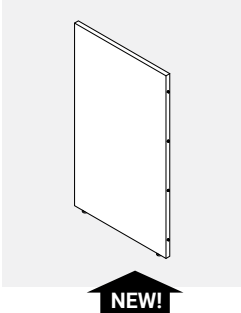

- Provides floor standing support while enclosing the end of a Gallery Panel right run.
- Attached to the right edge of a Gallery Panel by the pin connectors to finish the run.
- Pin connectors are on the left edge of the interior face.
- Compatible with gallery panels (B3LEPxxxx, B3LSEPRxxxx, B3LMPxxxx and B3LXPRxxxx) only.
- Includes all attachment hardware and glides.
- Total height is inclusive of panel glides extended to their full height.
- Please specify LP laminate finish and PVC edge finish.
- If a wood grain laminate is chosen, grain direction run horizontally.
- Edged in PVC on two exposed edges, self edged on connecting to gallery panel edge and the bottom.

PRODUCT CODE	PRICE LP	SIZE /INCHES			WEIGHT LBS	VOL FT³
		H	W	D		
B3LXPR4212NC	138	42	12	1	12.95	0.29
B3LXPR4224NC	245	42	24	1	25.8	0.58
B3LXPR4230NC	283	42	30	1	32.22	0.73
B3LXPR4236NC	320	42	36	1	38.65	0.88
B3LXPR4242NC	359	42	42	1	45.07	1.02
B3LXPR4248NC	396	42	48	1	51.5	1.17
B3LXPR5012NC	172	50	12	1	15.45	0.35
B3LXPR5024NC	294	50	24	1	30.8	0.69
B3LXPR5030NC	340	50	30	1	38.47	0.87
B3LXPR5036NC	386	50	36	1	46.15	1.04
B3LXPR5042NC	435	50	42	1	53.82	1.22
B3LXPR5048NC	481	50	48	1	61.5	1.39
B3LXPR5412NC	172	54	12	1	16.7	0.38
B3LXPR5424NC	303	54	24	1	33.3	0.75
B3LXPR5430NC	351	54	30	1	41.6	0.94
B3LXPR5436NC	398	54	36	1	49.9	1.13
B3LXPR5442NC	447	54	42	1	58.2	1.31
B3LXPR5448NC	494	54	48	1	66.5	1.50

B3L2PR • Right Gallery Panel End of Run Return

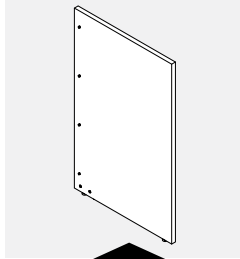

NEW!

- Provides floor standing support while enclosing the end of a Gallery Panel run.
- Attaches at the Gallery Panel right edge with connectors to form an L configuration.
- Connections to Gallery Panel are on the interior face near it's left end.
- Compatible with Gallery Panels (B3LEPxxxx, B3LSEPRxxxx, B3LMPxxxx and B3LXPRxxxx) only.
- Includes all attachment hardware and glides.
- Total height is inclusive of panel glides extended to their full height.
- 25" wide gallery panel accomodates a 24" deep surface while the 31" wide accomodates a 30" deep surface and 37" wide a 36" deep surface.
- Please specify LP laminate finish and PVC edge finish.
- If a wood grain laminate is chosen, grain direction run horizontally.
- Edged in PVC on three exposed edges and self edged on the bottom edge.

PRODUCT CODE	PRICE LP	SIZE /INCHES			WEIGHT LBS	VOL FT ³
		H	W	D		
B3L2PR4213	149	42	13	1	14.02	0.32
B3L2PR4225	283	42	25	1	26.87	0.61
B3L2PR4231	320	42	31	1	33.29	0.75
B3L2PR4237	347	42	37	1	39.72	0.90
B3L2PR5013	186	50	13	1	16.73	0.38
B3L2PR5025	340	50	25	1	32.08	0.72
B3L2PR5031	386	50	31	1	39.75	0.90
B3L2PR5037	428	50	37	1	47.43	1.07
B3L2PR5413	186	54	13	1	18.08	0.41
B3L2PR5425	351	54	25	1	34.68	0.78
B3L2PR5431	398	54	31	1	42.98	0.97
B3L2PR5437	441	54	37	1	51.28	1.16

B3L2PL • Left Gallery Panel End of Run Return

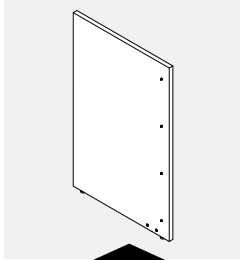

NEW!

- Provides floor standing support while enclosing the end of a gallery panel run.
- Attaches at the Gallery Panel left edge with connectors to form an L configuration.
- Connections to Gallery Panel are on the interior face near it's right end.
- Compatible with Gallery Panels (B3LEPxxxx, B3LSEPLxxxx, B3LMPxxxx, B3LSMPxxxx and B3LXPLxxxx) only.
- Includes all attachment hardware and glides.
- Total height is inclusive of panel glides extended to their full height.
- 25" wide gallery panel accomodates a 24" deep surface while the 31" wide accomodates a 30" deep surface and 37" wide a 36" deep surface.
- Please specify LP laminate finish and PVC edge finish.
- If a wood grain laminate is chosen, grain direction run horizontally.
- Edged in PVC on three exposed edges and self edged on the bottom edge.

PRODUCT CODE	PRICE LP	SIZE /INCHES			WEIGHT LBS	VOL FT ³
		H	W	D		
B3L2PL4213	149	42	13	1	14.02	0.32
B3L2PL4225	283	42	25	1	26.87	0.61
B3L2PL4231	320	42	31	1	33.29	0.75
B3L2PL4237	347	42	37	1	39.72	0.90
B3L2PL5013	186	50	13	1	16.73	0.38
B3L2PL5025	340	50	25	1	32.08	0.72
B3L2PL5031	386	50	31	1	39.75	0.90
B3L2PL5037	428	50	37	1	47.43	1.07
B3L2PL5413	186	54	13	1	18.08	0.41
B3L2PL5425	351	54	25	1	34.68	0.78
B3L2PL5431	398	54	31	1	42.98	0.97
B3L2PL5437	441	54	37	1	51.28	1.16

B3L3PL • Left Gallery Panel End of Run 3-Way Return

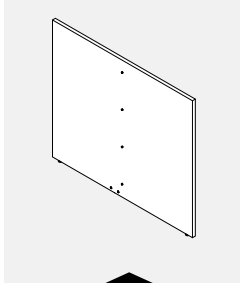

NEW!

- Provides floor standing support while enclosing the end of a Gallery Panel run.
- Attaches to the Gallery Panel left edge with connectors to form an T configuration.
- Connections to Gallery Panel are on the interior face in the middle.
- Compatible with Gallery Panels (B3LEPxxxx, B3LSEPLxxxx, B3LMPxxxx, B3LSMPxxxx and B3LXPLxxxx) only.
- Includes all attachment hardware and glides.
- Total height is inclusive of panel glides extended to their full height.
- 49" wide gallery panel accomodates two 24" deep surfaces while the 61" wide accomodates two 30" deep surface and 73" wide two 36" deep surface.
- Please specify LP laminate finish and PVC edge finish.
- If a wood grain laminate is chosen, grain direction run horizontally.
- Edged in PVC on three exposed edges and self edged on the bottom edge.

PRODUCT CODE	PRICE LP	SIZE /INCHES			WEIGHT LBS	VOL FT ³
		H	W	D		
B3L3PL4225	222	42	25	1	26.87	0.61
B3L3PL4249	384	42	49	1	52.57	1.19
B3L3PL4261	509	42	61	1	65.41	1.48
B3L3PL4273	591	42	73	1	78.26	1.77
B3L3PL5025	278	50	25	1	32.08	0.72
B3L3PL5049	527	50	49	1	62.77	1.42
B3L3PL5061	620	50	61	1	78.12	1.77
B3L3PL5073	727	50	73	1	93.47	2.11
B3L3PL5425	278	54	25	1	34.68	0.78
B3L3PL5449	543	54	49	1	67.88	1.53
B3L3PL5461	639	54	61	1	84.48	1.91
B3L3PL5473	750	54	73	1	101.08	2.28

B3L3PR • Right Gallery Panel End of Run 3-Way Return

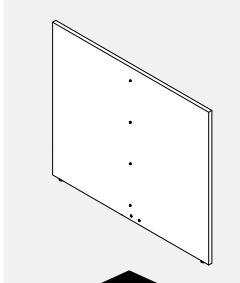

NEW!

- Provides floor standing support while enclosing the end of a Gallery Panel run.
- Attaches to the Gallery Panel right edge with connectors to form an T configuration.
- Connections to Gallery Panel are on the interior face in the middle.
- Compatible with gallery panels (B3LEPxxxx, B3LSEPRxxxx, B3LMPxxxx and B3LXPRxxxx) only.
- Includes all attachment hardware and glides.
- Total height is inclusive of panel glides extended to their full height.
- 49" wide gallery panel accomodates two 24" deep surfaces while the 61" wide accomodates two 30" deep surface and 73" wide two 36" deep surface.
- Please specify LP laminate finish and PVC edge finish.
- If a wood grain laminate is chosen, grain direction run horizontally.
- Edged in PVC on three exposed edges and self edged on the bottom edge.

PRODUCT CODE	PRICE LP	SIZE /INCHES			WEIGHT LBS	VOL FT ³
		H	W	D		
B3L3PR4225	222	42	25	1	26.87	0.61
B3L3PR4249	384	42	49	1	52.57	1.19
B3L3PR4261	509	42	61	1	65.41	1.48
B3L3PR4273	591	42	73	1	78.26	1.77
B3L3PR5025	278	50	25	1	32.08	0.72
B3L3PR5049	527	50	49	1	62.77	1.42
B3L3PR5061	620	50	61	1	78.12	1.77
B3L3PR5073	727	50	73	1	93.47	2.11
B3L3PR5425	278	54	25	1	34.68	0.78
B3L3PR5449	543	54	49	1	67.88	1.53
B3L3PR5461	639	54	61	1	84.48	1.91
B3L3PR5473	750	54	73	1	101.08	2.28

B3HLPBB01 • Gallery Panel Bottom Inline Bracket

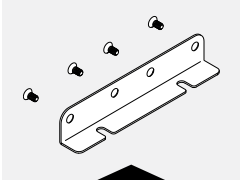

NEW!

- Gallery Panel Bottom Inline Bracket connects two Gallery Panels at the bottom with screws.
- Available in standard paint colors.

PRODUCT CODE	PRICE	SIZE /INCHES			WEIGHT		VOL FT ³
		H	W	D	LBS		
B3HLPBB01	34	7	1.5	8	1	0.5	

B3HLPCB01 • Gallery Panel Corner Bracket

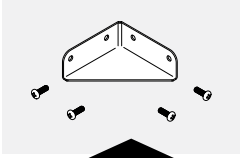

NEW!

- Gallery Panel Corner Bottom bracket connects two Gallery Panels at 90 degrees.
- Available in standard paint colors.

PRODUCT CODE	PRICE	SIZE /INCHES			WEIGHT		VOL FT ³
		H	W	D	LBS		
B3HLPCB01	33	7	1.5	4	4	0.5	

B3PMP-GI-W • Privacy Glass for 1" Laminate Panels

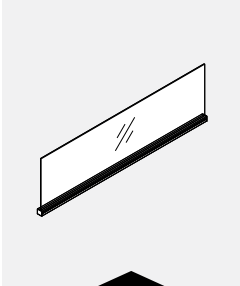

NEW!

- Privacy glass integrated with aluminum top trim.
- Attaches on top of gallery panels to add privacy or divide space.
- Includes aluminum trim with channel, end caps and glass tile.
- Top rail may also be used to hang accessories.
- Glass and attachment hardware ship separately.
- Please specify standard paint finish for the channel.
- Standard in clear (CLR) or frosted (FRST).

PRODUCT CODE	PRICE	FRST	SIZE /INCHES			WEIGHT		VOL FT ³
			H	W	D	LBS		
B3PMP24GI8W	195	244	8	24	1	4.84	0.11	
B3PMP30GI8W	213	268	8	30	1	6.06	0.14	
B3PMP38GI8W	228	283	8	36	1	7.28	0.17	
B3PMP42GI8W	244	304	8	42	1	8.5	0.19	
B3PMP48GI8W	254	317	8	48	1	9.72	0.22	
B3PMP24GI16W	195	244	16	24	1	8.92	0.22	
B3PMP30GI16W	213	268	16	30	1	11.17	0.28	
B3PMP36GI16W	228	283	16	36	1	13.43	0.33	
B3PMP42GI16W	244	304	16	42	1	15.68	0.39	
B3PMP48GI16W	254	317	16	48	1	17.92	0.44	

B3PFD-W • Felt divider for 1" Laminate Panels

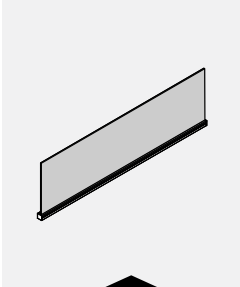

NEW!

- Privacy felt integrated with aluminum top trim.
- Attaches on top of gallery panels to add privacy or divide space.
- Includes aluminum trim with channel, end caps and felt tile.
- Top rail may also be used to hang accessories.
- Felt and attachment hardware ship separately.
- Please specify standard paint finish for the channel.
- Please specify standard felt finish.

PRODUCT CODE	PRICE	SIZE /INCHES			WEIGHT		VOL FT ³
		H	W	D	LBS		
B3PFD0824W	70		8	24	1	1.32	0.11
B3PFD0830W	85		8	30	1	1.65	0.14
B3PFD0836W	99		8	36	1	1.99	0.17
B3PFD0842W	111		8	42	1	2.32	0.19
B3PFD0848W	165		8	48	1	2.65	0.22
B3PFD0854W	178		8	54	1	2.98	0.25
B3PFD0860W	193		8	60	1	3.32	0.28
B3PFD0866W	204		8	66	1	3.65	0.31
B3PFD0872W	231		8	72	1	3.98	0.33
B3PFD1624W	81		16	24	1	1.83	0.22
B3PFD1630W	95		16	30	1	2.3	0.28
B3PFD1636W	113		16	36	1	2.76	0.33
B3PFD1642W	126		16	42	1	3.22	0.39
B3PFD1648W	187		16	48	1	3.68	0.44
B3PFD1654W	204		16	54	1	4.14	0.50
B3PFD1660W	219		16	60	1	4.61	0.56
B3PFD1666W	231		16	66	1	5.07	0.61
B3PFD1672W	263		16	72	1	5.53	0.67

BE8CI-1 • "I" Connector



NEW!

- Connects two Pass Thru Cables.
- Inline coupler used to connect two BE8CPxxHH Pass-Thru Cables.

PRODUCT CODE	PRICE	SIZE/ INCHES			WEIGHT VOL	
		H	W	D	LBS	FT ³
BE8CI1	77	1.5	1.5	4.625	0.06	0.03

BE8D • Duplex Receptacles

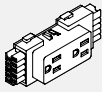

NEW!

- Snaps into Power Distribution Housing.
- Up to 6 duplex receptacles per circuit.
- BE8D1 = Circuit #1 (utility circuit)
- BE8D2 = Circuit #2 (utility circuit)
- BE8D3 = Circuit #3 (utility circuit)
- BE8DA - Circuit #A (dedicated circuit)

PRODUCT CODE	PRICE	SIZE/ INCHES			WEIGHT VOL	
		H	W	D	LBS	FT ³
BE8D1	32	2	4.625	1.25	0.10	0.01
BE8D2	32	2	4.625	1.25	0.10	0.01
BE8D3	32	2	4.625	1.25	0.10	0.01
BE8DA	32	2	4.625	1.25	0.10	0.01

BE8D • USB Receptacles

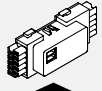

NEW!

- Snaps into Power Distribution Housing.
- USB charging module provides convenient charging power access through dual ports on face of receptacles.
- Two USB ports.
- 2 amp output, considered as circuit #1.

PRODUCT CODE	PRICE	SIZE/ INCHES			WEIGHT VOL	
		H	W	D	LBS	FT ³
BE8DU1-B	216	2	4.625	1.25	0.10	0.01
BE8DU1-W	216	2	4.625	1.25	0.10	0.01

BE83D • Power Distribution Housing Kit - Beam Raceway

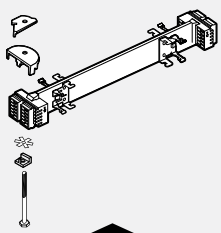

NEW!

- Provides two duplex receptacles per panel side for all panel widths above 24" wide.
- Power Distribution Housing is specified per panel size. eg. BE83D36 is for use with a 36" panel.
- 24" wide panel allows for only one (1) duplex receptacle per panel side.

PRODUCT CODE	PRICE	SIZE/ INCHES			WEIGHT VOL	
		H	L	D	LBS	FT ³
BE83D24	180	2	9.25	2.61	0.83	1.17
BE83D30	189	2	15.25	2.61	1.28	1.17
BE83D36	200	2	21.25	2.61	1.62	1.65
BE83D42	205	2	27.25	2.61	2.00	2.00
BE83D48	216	2	33.25	2.61	2.32	2.54
BE83D54	220	2	39.25	2.61	2.66	3.20
BE83D60	221	2	45.25	2.61	3.04	3.20
BE83D66	282	2	51.25	2.61	3.49	3.25
BE83D72	310	2	57.25	2.61	3.76	3.30

BE8JC • Jumper Cable

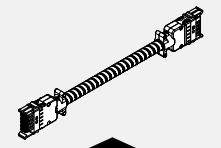

NEW!

- Electrically connects two Power Distribution Housings.
- The BE8JC16 electrically connects two powered panels positioned side by side.
- The BE8JC20 electrically connects two powered panels separated by a post.
- Wires are concealed in a flexible metal conduit.
- Cannot go through a Boulevard 1 post in a corner application. (Please use the Jumper Cable Mesh)

PRODUCT CODE	PRICE	SIZE/ INCHES			WEIGHT VOL	
		H	L	D	LBS	FT ³
BE8JC16	145	2	16.75	0.5	0.66	1.17
BE8JC20	147	2	20.75	0.5	0.78	1.17

BE8JM19 • Jumper Cable Mesh

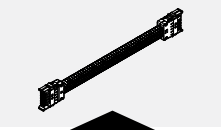

NEW!

- Electrically connects two Power Distribution Housings in Boulevard 1 panels that are separated by a post in a corner application.
- BE8JM19 - Wires are covered with a durable nylon mesh.
- BE8JMS19 - Wires are concealed in a flexible metal shroud and covered with a durable nylon mesh.
- Used in System 3 Panels at tile position passing through post at corner application.

PRODUCT CODE	PRICE	SIZE/ INCHES			WEIGHT VOL	
		H	L	D	LBS	FT ³
BE8JM19	147	2	19	0.5	0.75	1.17
BE8JMS19	167	2	19	0.5	0.75	1.17

BE8CP-HH • Housing-to-Housing Pass-Thru Cable

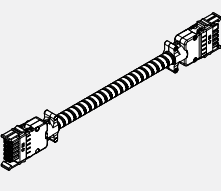

NEW!

- Electrically connects two Power Distribution Housings in panels separated by one or more non-powered panels.
- Wires are concealed in a flexible metal conduit.
- **NOTE** : In Boulevard 1 and or System 3 tile position applications, the Housing-to-Housing Pass-Thru Cables can only be used in a straight run.

PRODUCT CODE	PRICE	SIZE/ INCHES			WEIGHT VOL	
		H	L	D	LBS	FT ³
BE8CP40HH	146	2	40.5	0.5	1.44	1.17
BE8CP46HH	152	2	46.5	0.5	1.71	1.17
BE8CP52HH	161	2	52.5	0.5	1.95	1.17
BE8CP58HH	167	2	58.5	0.5	2.21	1.17
BE8CP64HH	173	2	64.5	0.5	2.37	1.17
BE8CP70HH	178	2	70.5	0.5	2.6	1.17
BE8CP76HH	185	2	76.5	0.5	2.81	1.17
BE8CP82HH	194	2	82.5	0.5	3.03	1.17
BE8CP88HH	201	2	88.5	0.5	3.05	1.17
BE8CP94HH	205	2	94.5	0.5	3.30	1.17
BE8CP100HH	212	2	100.5	0.5	3.47	1.17
BE8CP106HH	220	2	106.5	0.5	3.87	1.17
BE8CP118HH	233	2	118.5	0.5	4.08	1.17
BE8CP130HH	244	2	130.5	0.5	4.73	1.17
BE8CP142HH	256	2	142.5	0.5	4.99	1.17

BE8CP-HJ • Housing-to-Jumper Pass-Thru Cable

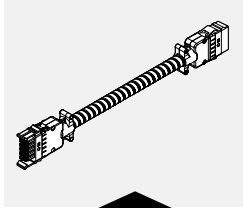

NEW!

- Electrically connects a Power Distribution Housing to a Housing connection of a harness.
- Wires are concealed in a flexible metal conduit.
- **NOTE** : In both Boulevard 1 and System 3 Tile Position applications, the Housing-to-Jumper Pass-Thru Cables can only be used in a straight run.

PRODUCT CODE	PRICE	SIZE/ INCHES			WEIGHT VOL	
		H	L	D	LBS	FT ³
BE8CP24HJ	113	2	24	0.5	0.9	1.17
BE8CP30HJ	119	2	30	0.5	1.3	1.17
BE8CP36HJ	124	2	36	0.5	1.44	1.17
BE8CP42HJ	154	2	42	0.5	1.71	1.17
BE8CP48HJ	161	2	48	0.5	1.95	1.17
BE8CP54HJ	171	2	54	0.5	2.21	1.17
BE8CP60HJ	178	2	60	0.5	2.37	1.17
BE8CP72HJ	185	2	72	0.5	2.81	1.17
BE8CP84HJ	200	2	84	0.5	3.05	1.17
BE8CP96HJ	212	2	96	0.5	3.3	1.17
BE8CP108HJ	221	2	108	0.5	3.87	1.17
BE8CP120HJ	234	2	120	0.5	4.08	1.17
BE8CP144HJ	266	2	144	0.5	4.59	1.17

BRBPEFH • Base Feed and Housing for powerBeam

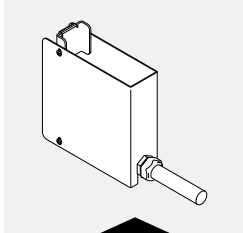

NEW!

- Floorfeed housing and harness for Bridges Power Beam applications. Specify xx18 baseFEED for 18" high power-BEAMS. xx26 baseFEED for 26" Bridges Power Beam, etc.
- Attaches to inner side of the powerBEAM leg
- Base feed kit consist of two mounting brackets, steel shroud and base feed harness with 72" long liquid-tight conduit hardwired to building power supply.
- **NOTE**: on-site drilling required to secure mounting brackets to the inside of the beam vertical leg
- Post Vertical Trim must be specified in accordance to your post 2-way, 3-way or 4-way configuration.
- Specify metal finish colour

PRODUCT CODE	PRICE	SIZE/ INCHES			WEIGHT VOL	
		H	L	D	LBS	FT ³
BRBPEFH18	524	6.9	6	2.5	2.70	0.06
BRBPEFH26	559	16.9	6	2.5	5.41	0.15
BRBPEFH34	585	22.9	6	2.5	7.03	0.20

BE8CF-1 • Ceiling Feed - Single

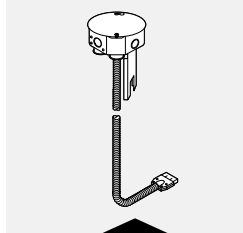

NEW!

- Provides single power entry from ceiling, through post and into raceway channel.
- Power entry cable penetrates 8" into a panel and plugs into either a Power Distribution Housing or BE8CPxxHJ Pass-Thru Harness.
- Specify Post Extension separately.
- Must be hard wired to power source by a licensed electrician.

PRODUCT CODE	PRICE	SIZE/ INCHES			WEIGHT VOL	
		H	L	D	LBS	FT ³
BE8CF1201	321	6	120	6	5.24	2
BE8CF1441	435	6	144	6	5.96	2

BE8CF-2 • Ceiling Feed - Double

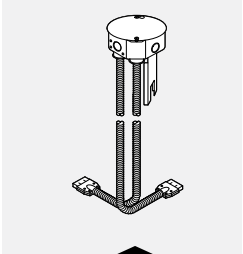

NEW!

- Provides dual power entry from ceiling, through post and into raceway channel.
- Power entry cable penetrates 8" into a panel and plugs into either a Power Distribution Housing or a BE8CPxxHJ Pass-Thru Harness.
- Use 1) In middle of run to distribute power in two directions.
2) At beginning of run where second Ceiling Feed harness is connected to BE8CPxxHJ and distributes power underneath Power Distribution Housing to pick-up second circuit grouping in long panel run.
- Specify Post Extension separately.
- Must be hard wired to power source by a licensed electrician.

PRODUCT CODE	PRICE	SIZE/ INCHES			WEIGHT VOL	
		H	L	D	LBS	FT ³
BE8CF1202	564	6	120	3	5.24	2
BE8CF1442	637	6	144	3	5.96	2

BRTWMS • Wire Manager Kit



NEW!

- Provides wire management from under the Freefit worksurface to the Power Beam.
- The bracket can be aligned anywhere on the Power Beam.
- Kit includes a neoprene wire manager sock, bracket and screws.
- Please specify bracket paint finish.

PRODUCT CODE	PRICE	SIZE/ INCHES			WEIGHT VOL	
		H	L	D	LBS	FT ³
BRTWMS	102	1.25	42	5.25	1.87	0.4

Applications

Combining **Bridges tables with BRPX3P table mounted dividers** increases power, data capacity, offers optional, integrated desk-height power/data access and enhances sense of privacy with fabric covered panel tiles. Optional Accessory tiles support paper-organizing accessories.

Non-powered BRPX3P dividers combined with BRTETB power troughs. The troughs in this instance provide power/data distribution and access, while the BRPX3P dividers enhance sense of privacy and, with accessory tiles in place, provide support for bridges paper accessories.

Notice that the dividers combined with power troughs do not distribute any power.

Specify quantity and finish of BRA3VTRF22 vertical aluminum flat end trim at either end.

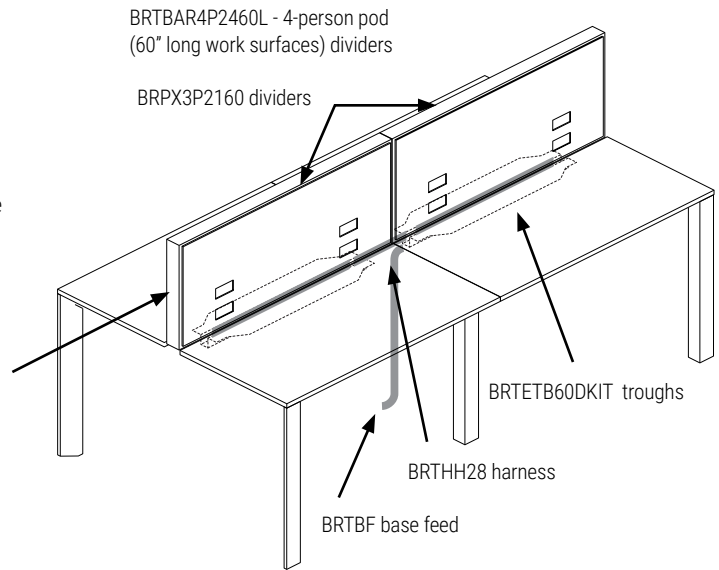

BRPX3P dividers with built-in 8-wire, 4-circuit power distribution system and data.

The BRPX3P dividers provide power/data distribution, desk-height access, while enhancing sense of privacy. When specified, accessory tiles can provide support for Bridges paper accessories.

Note: **Powered BRPX3P dividers cannot be combined with BRTETB power troughs on freestanding Bridges tables.** They both require separate, dedicated base feed, and BRPX3P Divider's base feed would physically interfere with the BRTETB below work surface trough.

BRPX3P dividers and BRTETB below work surface troughs can only be combined if the **power to the BRPX3P dividers is fed horizontally from adjacent Boulevard System 3 panels** (thus preventing base feed's interfering with the troughs). BRTETB below work surface troughs remain powered by BRTDIVPBF base feed.

BRTBAR4P2460L - 4-person pod (60" long work surfaces) dividers

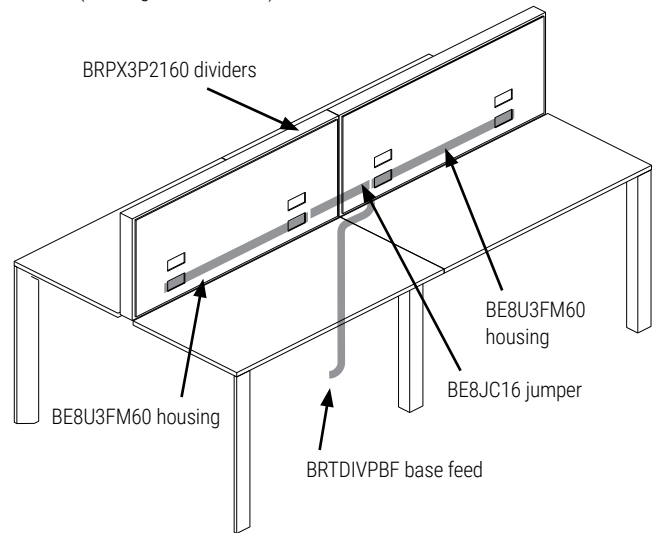

Under certain conditions **powered BRPX3P dividers can be combined with BRTETB power troughs.** Thus, in addition to enhanced privacy and support for accessories, the BRPX3P/BRTETB electrified combo provides double layered power distribution system (each with 8 wires and 4 circuits) for customers with high power demands. Note that each layer needs its own power supply source base feed power supply.

Note: BRPX3P dividers and BRTETB below work surface troughs can only be combined if the **power to the BRPX3P dividers is fed horizontally from adjacent Boulevard System 3 panels.**

BRPX3P Divider's base feed will physically interfere with the BRTETB below work surface trough. BRTETB below work surface troughs remain powered by BRTDIVPBF base feed. Bridges BRTBF base feed and BRTDIVPBF divider base feed are dedicated, non-interchangeable components.

BRTBAR4P2460L - 4-person pod 60" long work surfaces dividers power troughs

BE8JC16, BE8JC20 or BE8CPHH Pass-through

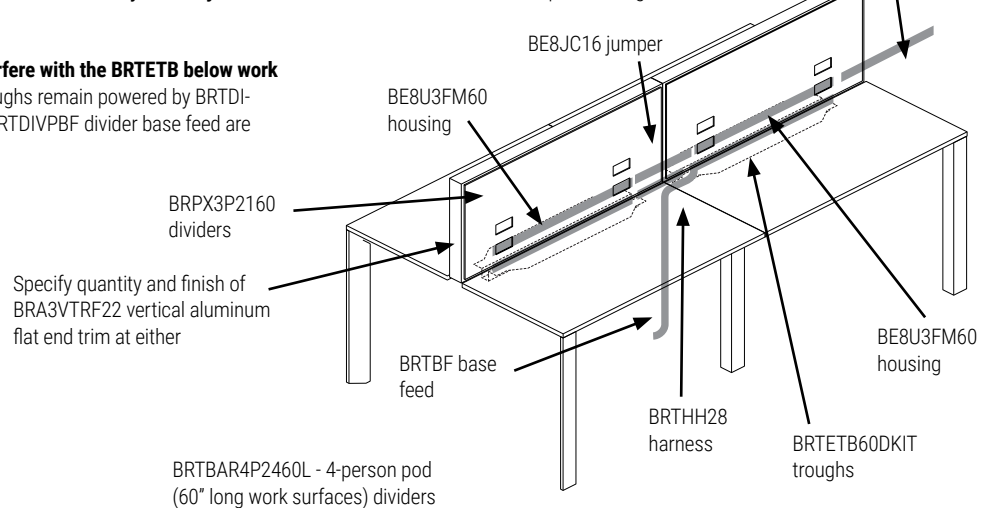

Specify quantity and finish of BRA3VTRF22 vertical aluminum flat end trim at either

Applications

Bridges table mounted BRPX3P dividers offers can be combined with Boulevard System 3 panels. Table mounted BRPX3P dividers will match in height 50" high Boulevard System 3 floor standing panel.

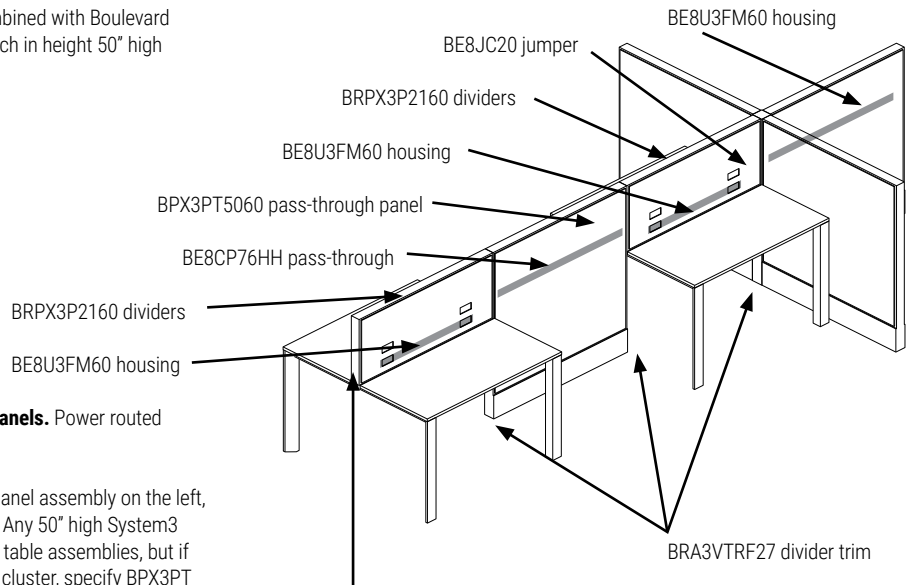

BRPX3P dividers combined with BOULEVARD System3 panels. Power routed through System 3 panels.

This example illustrates power routed from the System 3 panel assembly on the left, through the post and into table mounted BRPX3P dividers. Any 50" high System3 panel can be connected between two independent bridges table assemblies, but if you intend to route power/ data into the next bridges table cluster, specify BPX3PT Pass-through panel so that the cables could cross horizontally into the next table mounted BRPX3P divider on the right.

Specify quantity and finish of BRA3VTRF27 Bridges Divider trims which cover System 3 panel vertical face below Bridges table mounted BRPX3P dividers.

Specify quantity and finish of BRA3VTRF22 Vertical Aluminum Flat End Trim at either end.

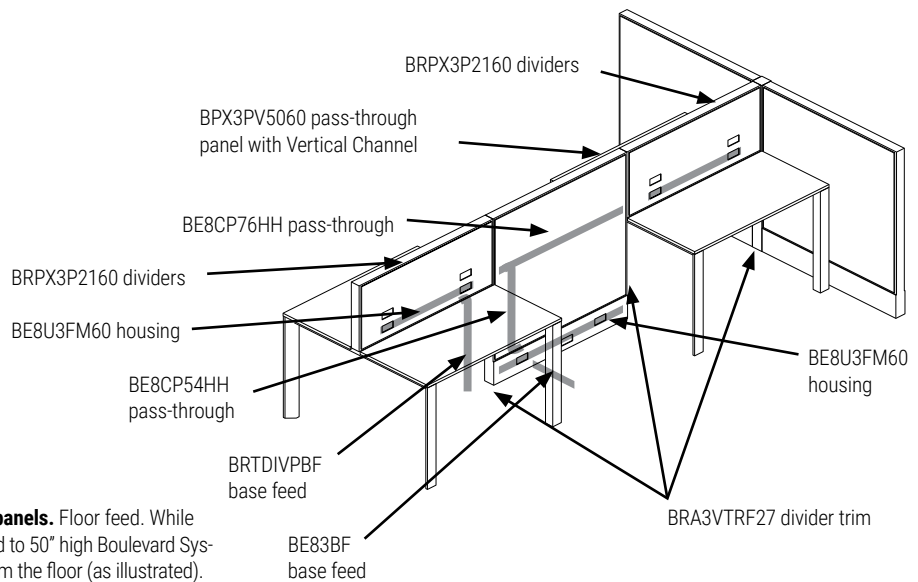

BRPX3P dividers combined with BOULEVARD System 3 panels. Floor feed. While table mounted BRPX3P dividers can be physically connected to 50" high Boulevard System 3 floor standing panels, power/data could be routed from the floor (as illustrated). There are two ways of facilitating floor feed. 1: Power could enter through the bottom of table mounted BRPX3P divider, into BE8U3FM60 housing and then continues through BPX3PT5060 or BPX3PV5060 pass-through panel into adjacent BRPX3P divider. 2: BE83BF base feed supplies BE8U3FM60 housing within BPX3PV5060 pass-through panel (with integrated vertical channel). BE8CP54HH Pass-through harness then feeds BE8U3FM60 housing within the table mounted BRPX3P divider on the right. BE8CP76HH Pass-through harness then continues through BPX3PV5060 pass-through panel into adjacent BRPX3P divider.

Note: These two examples are for illustration purposes only as **two power feeds must not be connected to one power distribution system!**

Applications

BRPX3MA25 and BRPXGMA25 Boulevard System 3 dividers facilitate seamless transition from panel-based office to open environment.

BRPX3MA25 and BRPXGMA25 panels combined with BOULEVARD System 3.
Power routed through System 3 panels.

The first 50" high panel is furnished with face mount power through its integrated vertical channel.

Any equipment placed on top of the 25" storage cabinets can be plugged into the floor raceway (cables rising through the gap between the panels and the cabinet).

Specify quantity and finish of BRA3VTSF25 bridges-BLVD step down end trims.

BRPXGMA25 panel

BRPXGMA25 panel

The pair of work surface-mounted BRED50 Duo Modules on the right (plugged into the floor raceway) provide easy access to power at desk height.

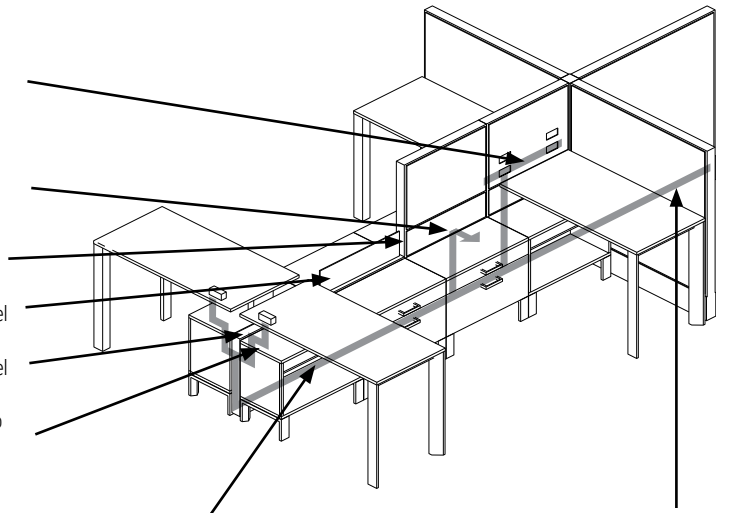

Specify quantity and finish of BRA3VTRF25 vertical aluminum flat end trim at the end.

This example illustrates power routed at the floor level from the System 3 panel assembly on the left into BRPX3MA25 and BRPXGMA25 panels.

Combination of **25" high Bridges storage cabinets with BRPX3S storage mounted dividers** forms storage-based linear spine capable of delivering 8-wire, 4-circuit power distribution along the spine.

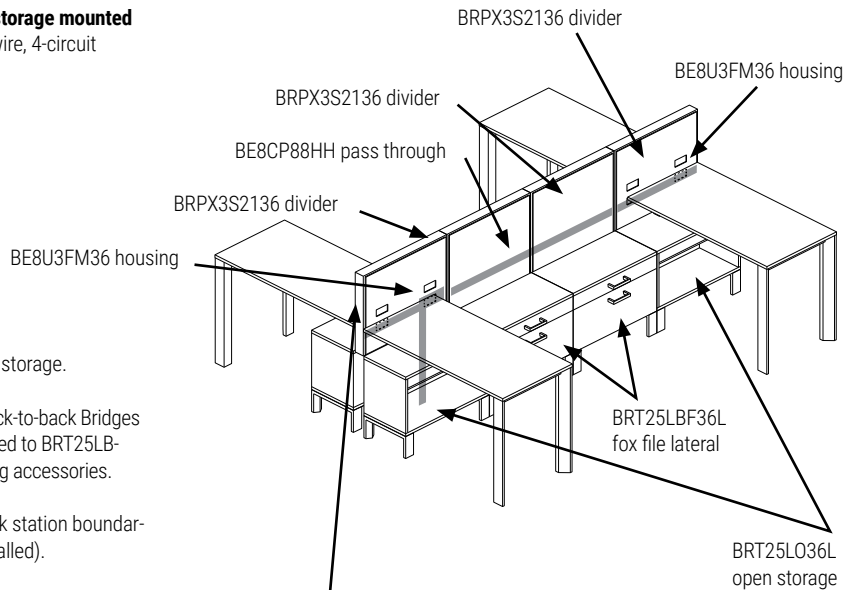

BRPX3S storage mounted dividers combined with Bridges 25" high storage.

BRPX3S dividers are secured to a storage-based spine formed by back-to-back Bridges storage cabinets of corresponding width (BRPX3S2136 divider secured to BRT25LBF36L, for instance). Optional Accessory tiles support paper-organizing accessories.

Storage mounted dividers reach 46" above the floor to suggest work station boundaries as well as to support paper organizers (with accessory tile installed).

Power enters the spine from the bottom, in-between the back-to-back storage cabinets and is then routed horizontally between the dividers.

Note: This assembly was conceived as a stand-alone application - **not compatible with floor standing Boulevard System 3 panels.**

Specify quantity and finish of BRA3VTRF22 Vertical Aluminum Flat End Trim at either end.

Applications

Note: BRPX3S storage mounted dividers combined with Bridges 25" high storage was conceived as a standalone application. **It is not compatible with floor standing Boulevard System 3 panels.**

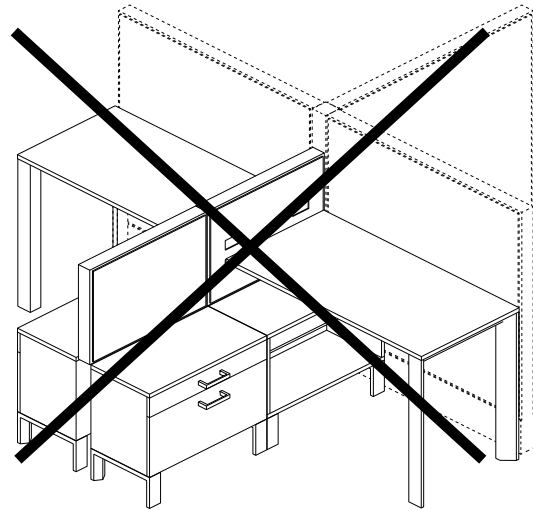

BRPX3MA25 • 25" High System 3 Panel

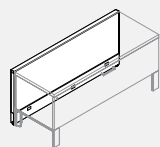

PRODUCT CODE	PRICE			SIZE/INCHES			WEIGHT VOL		
	GR1	GR2	OPT	H	W	D	LBS	FT ³	
BRPX3MA2530	439	461	481	25	30	2.5	5.00	1.09	
BRPX3MA2536	477	521	547	25	36	2.5	6.00	1.30	
BRPX3MA2542	521	561	589	25	42	2.5	7.00	1.52	

- 25" high System3 panel facilitates seamless transition from a panel-based, enclosed office to an open one. It can be connected to a cluster of panels on one side and continue with power / data spine distribution into collaborative areas.
- 25" high System3 panel also enables creation of a storage-based spine with full 8-wire, 4-circuit power and data capacity.

BRPX3GMA25 • 25" High System 3 Panel

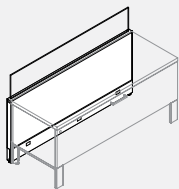

PRODUCT CODE	PRICE			SIZE/INCHES			WEIGHT VOL		
	GR1	GR2	OPT	H	W	D	LBS	FT ³	
BRPX3GMA2530	860	882	926	25	30	2.5	5.00	1.09	
BRPX3GMA2536	904	945	993	25	36	2.5	6.00	1.30	
BRPX3GMA2542	958	999	1051	25	42	2.5	7.00	1.52	

- 25" high System3 panel facilitates seamless transition from a panel-based, enclosed office to an open one. It can be connected to a cluster of panels on one side and continue with power / data spine distribution into collaborative areas.
- 25" high System3 panel also enables creation of a storage-based spine with full 8-wire, 4-circuit power and data capacity.
- B3 panel Top trim option provided with embedded, frame-less glass pane rising 8" above the top of the panel. For instance, when installed on 42" high B3 panel, overall height will be 50" high.
- There is 1.25" gap between two adjacent glass panes.
- Glass shipped separately, Allen key to set the glass pane plumb is provided with each panel.
- 5mm tempered glass, acid etched on one side or clear.
- Square corners on glass.
- Integrated adjustable brackets and extruded aluminum trim.
- Cannot be retrofit on-site.

BRPX3P21 • Table Mounted Open Frame Divider

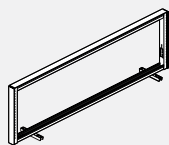

PRODUCT CODE	PRICE	SIZE/INCHES			WEIGHT VOL		
		H	W	D	LBS	FT ³	
BRPX3P2130	166	22	30	2.5	5.40	0.95	
BRPX3P2136	173	22	36	2.5	6.50	1.15	
BRPX3P2142	178	22	42	2.5	7.50	1.34	
BRPX3P2148	188	22	48	2.5	8.60	1.53	
BRPX3P2154	195	22	54	2.5	9.70	1.72	
BRPX3P2160	202	22	60	2.5	10.80	1.91	
BRPX3P2166	207	22	66	2.5	11.90	2.10	
BRPX3P2172	215	22	72	2.5	13.00	2.29	

- Aluminum panel frame designed to be secured between two back-2-back bridges work surfaces. When installed, the height of the panel matches the height of 50" high System3 panel. Note: individual panels can be interconnected with 'Capture strips'. The bridges panel is physically compatible with System 3 and can be interconnected using System 3 'Capture strips'.
- Intended to distribute 8-wire / 4-circuit power and data along table-based spine, enhance seated privacy, acoustics and support paper / task accessories. Not suitable for panel mounted Monitor arms. Divider is not slotted.
- Table mounting brackets and capture strips included (individual in-line panels can be interconnected with Capture strips). Specify power distribution harness, duplexes and tiles. End trims not included.
- Tile options: full fabric, full fabric with power/data openings, partial accessory/fabric tile and partial accessory / fabric with power/data openings.
- NOTE: The panel mounts only parallel, between back-2-back work surface. Perpendicular mounting brackets are not available.
- NOTE: Table Mounted Dividers with tiles should not be used with worksurfaces with access doors, BRTWSA & BRTWSAA.

Application

BRPX3S • Storage Mounted B3 Divider

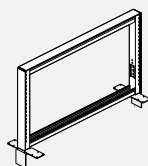

PRODUCT CODE	PRICE	SIZE/INCHES			WEIGHT VOL		
		H	W	D	LBS	FT ³	
BRPX3S2130	166	22	30	2.5	5.40	0.95	
BRPX3S2136	173	22	36	2.5	6.50	1.15	
BRPX3S2142	178	22	42	2.5	7.50	1.34	

- Aluminum panel frame designed to be secured between two back-2-back bridges 21" or 25" high lateral storage units. When installed, top of the panel reaches 42" or 46". Note: individual panels can be interconnected with 'Capture strips'. The bridges panel is physically compatible with System 3 and can be interconnected using System 3 'Capture strips'.
- Intended to distribute 8-wire / 4-circuit power and data along storage-based spine, enhance seated privacy, acoustics and support Paper / task accessories. Not suitable for panel mounted monitor arms. Divider is not slotted.
- Storage mounting brackets and capture strips included (individual in-line panels can be interconnected with capture strips)
- Specify power distribution harness, duplexes and tiles. End trims not included.
- Tile options: full fabric, full fabric with power/data openings, partial accessory/fabric tile and partial accessory fabric with power/data openings.
- NOTE: The panel mounts only parallel, between Back-2-back storage units. Perpendicular mounting brackets are not available.
- Horizontal cable management will not work between storage to table dividers or to panels.
- Cable management must be between dividers on storage only.

Application

BRPX3FT21 • B3 Bridges Divider Tile

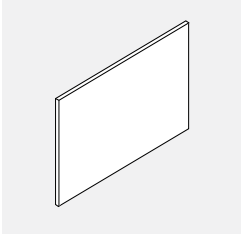

- Full fabric tile. Aluminum frame, fabric stretched around frame's perimeter.

PRODUCT CODE	PRICE			SIZE/INCHES			WEIGHT VOL	
	GR1	GR2	OPT	H	W	D	LBS	FT³
BRPX3FT2130	80	87	92	22	30	1	2.70	0.38
BRPX3FT2136	87	92	101	22	36	1	3.25	0.46
BRPX3FT2142	99	106	113	22	42	1	3.80	0.53
BRPX3FT2148	109	118	128	22	48	1	4.32	0.61
BRPX3FT2154	120	129	140	22	54	1	4.86	0.69
BRPX3FT2160	130	141	152	22	60	1	5.40	0.76
BRPX3FT2166	142	152	166	22	66	1	5.94	0.84
BRPX3FT2172	152	166	177	22	72	1	6.48	0.92

BRPX3NET21 • B3 Bridges Fabric Electrical Tile

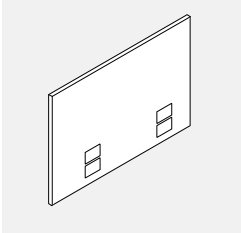

- Full fabric tile with openings for power and data. Aluminum frame, fabric stretched around frame's perimeter.
- Includes one data opening blank cover. Specify power distribution module, duplexes.
- Jumpers and power feed harnesses separately.

PRODUCT CODE	PRICE			SIZE/INCHES			WEIGHT VOL	
	GR1	GR2	OPT	H	W	D	LBS	FT³
BRPX3NET2130	151	164	175	22	30	1	2.70	0.38
BRPX3NET2136	154	167	178	22	36	1	3.25	0.46
BRPX3NET2142	157	171	186	22	42	1	3.80	0.53
BRPX3NET2148	164	174	189	22	48	1	4.32	0.61
BRPX3NET2154	166	177	194	22	54	1	4.86	0.69
BRPX3NET2160	169	184	198	22	60	1	5.40	0.76
BRPX3NET2166	173	188	202	22	66	1	5.94	0.84
BRPX3NET2172	176	193	206	22	72	1	6.48	0.92

BRPX3ATF21 • B3 Bridges Accessory Fabric Tile

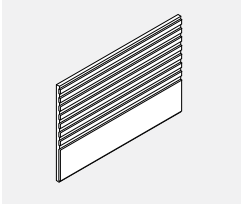

- Partial accessory/fabric tile. The kit consists of a 12" high accessory tile with horizontal slats and an 8" high fabric tile (fabric stretched over aluminum frame).

PRODUCT CODE	PRICE			SIZE/INCHES			WEIGHT VOL	
	GR1	GR2	OPT	H	W	D	LBS	FT³
BRPX3ATF2130	252	271	294	22	30	1	6.84	0.38
BRPX3ATF2136	260	283	304	22	36	1	8.20	0.46
BRPX3ATF2142	272	294	317	22	42	1	9.57	0.53
BRPX3ATF2148	283	304	330	22	48	1	10.94	0.61
BRPX3ATF2154	294	317	341	22	54	1	12.31	0.69
BRPX3ATF2160	303	329	355	22	60	1	13.68	0.76
BRPX3ATF2166	314	339	366	22	66	1	15.04	0.84
BRPX3ATF2172	323	352	378	22	72	1	16.40	0.92

BRPX3ATE21 • B3 Bridges Accessory Electrical Tile

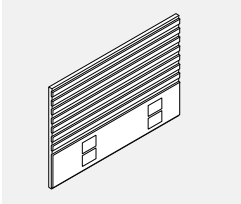

- Partial accessory/fabric power and data tile. The kit consists of a 12" high accessory tile with horizontal slats and an 8" high fabric tile (fabric stretched over aluminum frame).
- Power/data openings in the partial fabric tile section, cover includes one data opening blank cover.
- Specify power distribution module, Duplexes, Jumpers and Power feed harnesses separately.

PRODUCT CODE	PRICE			SIZE/INCHES			WEIGHT VOL	
	GR1	GR2	OPT	H	W	D	LBS	FT³
BRPX3ATE2130	276	298	323	22	30	1	7.00	0.38
BRPX3ATE2136	289	311	337	22	36	1	8.40	0.46
BRPX3ATE2142	300	323	352	22	42	1	9.80	0.53
BRPX3ATE2148	311	337	362	22	48	1	11.10	0.61
BRPX3ATE2154	323	350	377	22	54	1	12.50	0.69
BRPX3ATE2160	333	361	389	22	60	1	13.90	0.76
BRPX3ATE2166	344	373	405	22	66	1	15.20	0.84
BRPX3ATE2172	358	386	418	22	72	1	16.60	0.92

BRA3VTRF22 • B3 Bridges Divider Trim

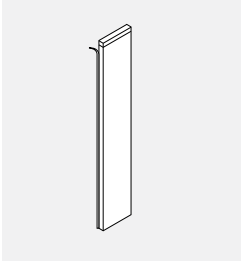

- For use with Bridges/System3 Panel/Storage Dividers.
- Table mounted BRPX3P End Trim.
- 25" Boulevard Panel Vertical trim.
- System3 step down panel trim - covers panel's vertical from the bottom of table mounted BRPX3P to the bottom of the adjacent System3 panel.
- System3 step down panel trim - covers panel's vertical from top of BRPXGMA25 panel to top of adjacent BPX3-34" high System3 panel.
- System3 step down panel trim - covers panel's vertical from top of BRPXGMA25 panel on top of adjacent BPX3-42" high System3 panel.
- System3 step down panel trim - covers panel's vertical from top of BRPXGMA25 panel to top of adjacent BPX3-50" high System3 panel.

PRODUCT CODE	PRICE	SIZE/INCHES			WEIGHT VOL	
		H	W	D	LBS	FT³
BRA3VTRF22	28	22	2.61	0.125	0.045	
BRA3VTRF25	33	25	2.61	0.125	0.045	
BRA3VTRF27	40	27	2.61	0.125	0.05	
BRA3VTRF34	45	34	2.61	0.125	0.06	
BRA3VTRF38	52	38	2.61	0.125	0.07	
BRA3VTSF09	20	9	2.61	0.125	0.02	
BRA3VTSF17	23	17	2.61	0.125	0.03	
BRA3VTSF25	33	25	2.61	0.125	0.05	

BRTAGDD • Glass Table Mounted Dividers

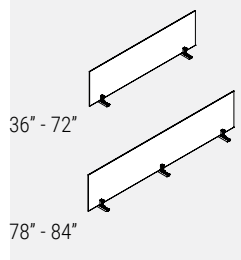

- **Parallel divider, Back 2 Back tables, glass**
- Secures between two Back 2 Back tables; provides privacy, divides space.
- Installed divider measures 15.7" from the top of the worksurface.
- 36" -72" dividers include 2 support brackets; 78" and 84" dividers include 3 support brackets.
- Tempered glass, acid etched finish on one side (similar to frosted), painted support brackets.

PRODUCT CODE	PRICE	SIZE/INCHES			WEIGHT VOL	
		H	W	D	LBS	FT ³
BRTAGDD36	362	16	33	0.25	12	0.07
BRTAGDD42	405	16	39	0.25	14	0.09
BRTAGDD48	437	16	45	0.25	16	0.10
BRTAGDD54	476	16	51	0.25	18	0.11
BRTAGDD60	501	16	57	0.25	21	0.13
BRTAGDD66	541	16	63	0.25	23	0.14
BRTAGDD72	583	16	69	0.25	25	0.16
BRTAGDD78	677	16	75	0.25	27	0.17
BRTAGDD84	718	16	81	0.25	29	0.18

BRTAGDS • Glass Table Mounted Parallel Divider

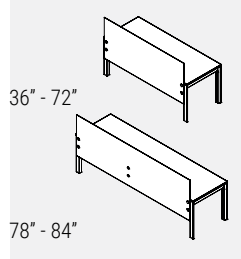

- **Secures to the rear edge of a single table; provides privacy, divides space while not obstructing available light.**
- 36"-72" dividers include 2 mounting brackets; 78" and 84" dividers include 3 mounting brackets.
- Tempered glass, acid etched on one side (similar to frosted), satin chrome disc fasteners and powder coated steel support brackets.
- Installed divider reaches 15.7 up and 15" down from the top of the worksurface.
- Not recommended for use on tables using 42" high legs.

PRODUCT CODE	PRICE	SIZE/INCHES			WEIGHT VOL	
		H	W	D	LBS	FT ³
BRTAGDS36	686	30.7	33	0.250	23	0.150
BRTAGDS42	751	30.7	39	0.250	27	0.175
BRTAGDS48	816	30.7	45	0.250	31	0.200
BRTAGDS54	881	30.7	51	0.250	35	0.225
BRTAGDS60	944	30.7	57	0.250	39	0.250
BRTAGDS66	1008	30.7	63	0.250	43	0.275
BRTAGDS72	1074	30.7	69	0.250	47	0.300
BRTAGDS78	1285	30.7	75	0.250	51	0.325
BRTAGDS84	1349	30.7	81	0.250	55	0.350

BRTAGED • Glass Perpendicular End of Run Divider

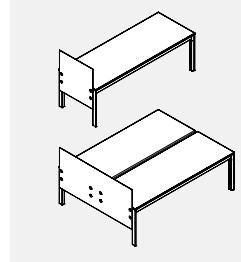

- **Secures to the perpendicular edge of a single or double Back 2 Back table; provides privacy, divides space while not obstructing available light.**
- Installed divider reaches 15.7 up and 15" down from the top of the worksurface.
- 1/2" radius front top corner of 24" and 30" deep glass dividers. 51" and 63" glass dividers for Back 2 Back tables have both top corners 1/2" radius.
- 24" and 30" dividers include 2 mounting brackets.
- 51" and 63" dividers include 4 mounting brackets.
- Tempered glass, acid etched on one side (similar to frosted), satin chrome disc fasteners and powder coated steel support brackets.
- Note: Outside of glass is etched and inside is smooth for left (BRTAGEDL) and right (BRTAGED-R).

PRODUCT CODE	PRICE	SIZE/INCHES			WEIGHT VOL	
		H	W	D	LBS	FT ³
BRTAGED24L	652	30.7	25.4	0.250	23	0.150
BRTAGED24R	652	30.7	25.4	0.250	23	0.150
BRTAGED30L	718	30.7	31.4	0.250	27	0.175
BRTAGED30R	718	30.7	31.4	0.250	27	0.175
BRTAGED51	1285	30.7	50.5	0.250	31	0.200
BRTAGED63	1414	30.7	62.5	0.250	35	0.225

BRTAGPPD-M • Shared Glass Perpendicular Side to Side Divider - Middle

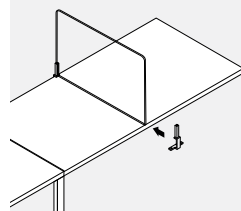

- **Provides privacy, divides space.**
- 24M and 30M kits are designed to be installed on tables with recessed legs (round legs, 34" rectangular legs).
- 24M and 30M kits consist of a rear and front bracket (powder coated steel), tempered glass with rounded top corners (acid etched on one side), bracket-fitting gaskets and mounting screws securing the brackets to the underside of the worksurface.
- Over the seam application would be installed with the wide bracket at the front (thus bypassing the shared leg) and "middle of the work surface" application would be installed with the wide bracket at the back and the narrow at the front".

PRODUCT CODE	PRICE	SIZE/INCHES			WEIGHT VOL	
		H	W	D	LBS	FT ³
BRTAGPPD24M	484	16	24	0.250	9	0.055
BRTAGPPD30M	503	16	30	0.250	11.25	0.069

BRTAGPPD-MQ • Shared Glass Perpendicular Side to Side Divider - Middle - Square Corners

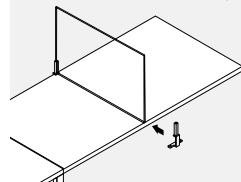

- **Provides privacy, divides space.**
- 24M and 30M kits are designed to be installed on tables with recessed legs (round legs, 34" rectangular legs).
- 24M and 30M kits consist of a rear and front bracket (powder coated steel), tempered glass with rounded top corners (acid etched on one side), bracket-fitting gaskets and mounting screws securing the brackets to the underside of the worksurface.
- Over the seam application would be installed with the wide bracket at the front (thus bypassing the shared leg) and "middle of the work surface" application would be installed with the wide bracket at the back and the narrow at the front".

PRODUCT CODE	PRICE	SIZE/INCHES			WEIGHT VOL	
		H	W	D	LBS	FT ³
BRTAGPPD24MQ	409	16	24	0.250	9	0.055
BRTAGPPD30MQ	430	16	30	0.250	11.25	0.069

BRTAGPPD-S • Shared Glass Perpendicular Side to Side Divider - Seam

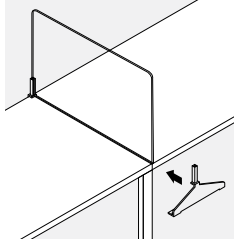

- Provides privacy, divides space.
- 24S and 30S kits are designed to be installed in the middle or over a seam of two adjacent work surfaces supported by a shared, full depth RECTANGULAR leg.
- 24S and 30S kits consist of a rear and front bracket (powder coated steel), tempered glass with rounded top corners (acid etched on one side), bracket-fitting gaskets and mounting screws securing the brackets to the underside of the worksurface.
- Note: Cannot be installed over two, side-by-side rectangular legs. Only one shared or recessed leg.

PRODUCT CODE	PRICE	SIZE/INCHES			WEIGHT VOL	
		H	W	D	LBS	FT ³
BRTAGPPD24S	484	16	24	0.250	9	0.055
BRTAGPPD30S	503	16	30	0.250	11.25	0.069

BRTAGPPD-SQ • Shared Glass Perpendicular Side to Side Divider - Seam - Square Corners

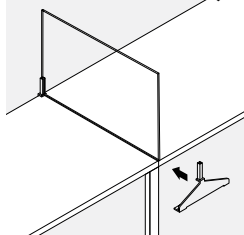

- Provides privacy, divides space.
- 24S and 30S kits are designed to be installed in the middle or over a seam of two adjacent work surfaces supported by a shared, full depth RECTANGULAR leg.
- 24S and 30S kits consist of a rear and front bracket (powder coated steel), tempered glass with rounded top corners (acid etched on one side), bracket-fitting gaskets and mounting screws securing the brackets to the underside of the worksurface. Note: Cannot be installed over two, side-by-side rectangular legs. Only one shared or recessed leg.

PRODUCT CODE	PRICE	SIZE/INCHES			WEIGHT VOL	
		H	W	D	LBS	FT ³
BRTAGPPD24SQ	409	16	24	0.250	9	0.055
BRTAGPPD30SQ	430	16	30	0.250	11.25	0.069

BRTAGMPS • Glass Modesty Panel

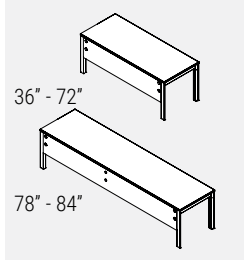

- Secures to the rear edge of a single table, between table legs; provides privacy. Installed divider reaches 15" below the worksurface.
- 36"-72" modesty panels include 2 mounting brackets.
- 78"-84" modesty panels include 3 mounting brackets.
- Tempered glass, acid etched on one side (similar to frosted), satin chrome disc fasteners and powder coated steel support brackets.

PRODUCT CODE	PRICE	SIZE/INCHES			WEIGHT VOL	
		H	W	D	LBS	FT ³
BRTAGMPS36	476	13.25	29.75	0.25	9	0.05
BRTAGMPS42	507	13.25	35.75	0.25	11	0.06
BRTAGMPS48	541	13.25	41.75	0.25	13	0.08
BRTAGMPS54	574	13.25	47.75	0.25	15	0.09
BRTAGMPS60	607	13.25	53.75	0.25	17	0.10
BRTAGMPS66	638	13.25	59.75	0.25	19	0.11
BRTAGMPS72	671	13.25	65.75	0.25	20	0.12
BRTAGMPS78	847	13.25	71.75	0.25	22	0.13
BRTAGMPS84	881	13.25	77.75	0.25	24	0.14

BRTAFDD • Back 2 Back Parallel Felt Divider

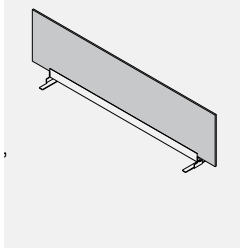

- **Secures to the underside of the worksurface.**
- 9mm felt material is tackable and comes in 18 different colours. Please specify colour.
- Installed divider measures 15.7" high from the top of the worksurface.
- Please choose standard metal finish for extrusion and brackets.
- Upcharge of \$96 for anodized extrusion option.

PRODUCT CODE	PRICE	SIZE/INCHES			WEIGHT VOL	
		H	W	D	LBS	FT ³
BRTAFDD36	198	16.88	33	7.5	2.8	0.41
BRTAFDD42	222	16.88	39	7.5	3.2	0.48
BRTAFDD48	252	16.88	45	7.5	3.7	0.55
BRTAFDD54	355	16.88	51	7.5	4.1	0.63
BRTAFDD60	377	16.88	57	7.5	4.6	0.70
BRTAFDD66	398	16.88	63	7.5	5.0	0.77
BRTAFDD72	420	16.88	69	7.5	5.4	0.85
BRTAFDD78	441	16.88	75	7.5	5.9	0.92
BRTAFDD84	463	16.88	81	7.5	6.3	1.00

BRTAFPPD-M • Perpendicular Side to Side Off Module Felt Divider

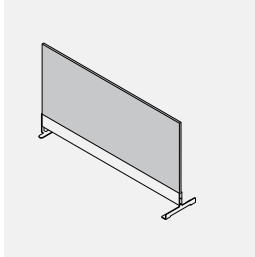

- **1 wide bracket at the back and 1 narrow bracket at the front secure the divider off module to worksurface edges.**
- 9mm felt material is tackable and comes in 18 different colours. Please specify colour.
- Installed divider measures 15.7" high from the top of the worksurface.
- Please choose standard metal finish for extrusion and brackets.
- Upcharge of \$96 for anodized extrusion option.

PRODUCT CODE	PRICE	SIZE/INCHES			WEIGHT VOL	
		H	W	D	LBS	FT ³
BRTAFPPD24M	166	16.85	24.24	6.5	2.1	0.22
BRTAFPPD30M	189	16.85	30.24	6.5	2.6	0.27

BRTAFPPD-S • Perpendicular Side to Side Felt Divider

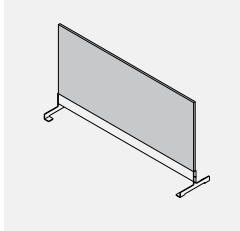

- **2 wide bracket secure the divider off module and over the seam of 2 adjacent worksurface.**
- 9mm felt material is tackable and comes in 18 different colours. Please specify colour.
- Installed divider measures 15.7" high from the top of the worksurface.
- Please choose standard metal finish for extrusion and brackets.
- Upcharge of \$96 for anodized extrusion option.

PRODUCT CODE	PRICE	SIZE/INCHES			WEIGHT VOL	
		H	W	D	LBS	FT ³
BRTAFPPD24S	171	16.85	24.24	6.5	2.3	0.22
BRTAFPPD30S	193	16.85	30.24	6.5	2.7	0.27
BRTAFPPD51S	347	16.85	50.81	6.5	4.2	0.46
BRTAFPPD63S	393	16.85	62.81	6.5	5.1	0.57

BRTAFDSN • Felt Divider and Modesty Panel Kit

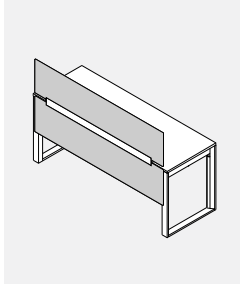

- **Felt divider and modesty panel kit secures to the rear bottom of a single Bridges table and provides privacy above and below the worksurface.**
- 9 mm felt material is tackable and comes in a wide range of colours.
- Installed, the divider measures 15.7 high from the top of the worksurface and 15" high below the top of the worksurface.
- Kit includes two felt dividers, support extrusion and left and right brackets.
- Please choose the finish of the felt and the metal finish for the extrusion and brackets.

PRODUCT CODE	PRICE	SIZE/INCHES			WEIGHT VOL	
		H	W	D	LBS	FT ³
BRTAFDSN48	484	30.68	45	4.05	5.19	38.83
BRTAFDSN54	585	30.68	51	4.05	5.87	44.01
BRTAFDSN60	624	30.68	57	4.05	6.54	49.18
BRTAFDSN66	652	30.68	63	4.05	7.21	54.36
BRTAFDSN72	748	30.68	69	4.05	7.89	59.54
BRTAFDSN78	788	30.68	72	4.05	8.57	62.13
BRTAFDSN84	826	30.68	78	4.05	9.24	67.30

BRTAFEDN • Felt End Divider and Modesty Panel Kit

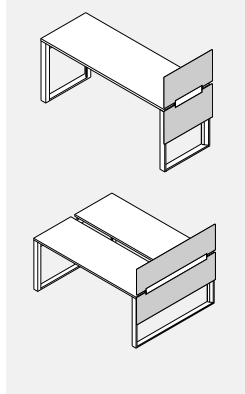

- Felt divider and modesty panel kit secures to the side bottom of a single or back to back Bridges table and provides privacy above and below the worksurface.
- 9 mm felt material is tackable and comes in a wide range of colours.
- Installed, the divider measures 15.7 high from the top of the worksurface and 15" high below the top of the worksurface.
- Kit includes two felt dividers, support extrusion and left and right brackets.
- Please choose the finish of the felt and the metal finish for the extrusion and brackets.

PRODUCT CODE	PRICE	SIZE/ INCHES			WEIGHT VOL	
		H	W	D	LBS	FT ³
BRTAFEDN24	294	30.68	25.46	4.05	3.3	21.97
BRTAFEDN30	331	30.68	31.46	4.05	3.98	27.15
BRTAFEDN51	607	30.68	50.56	4.05	6.22	43.63
BRTAFEDN63	692	30.68	62.56	4.05	7.57	53.98

BRTAFMPSN • Felt Modesty Panel

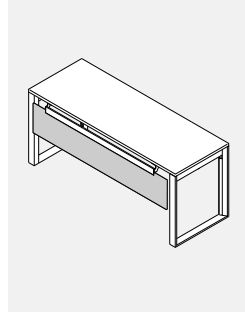

- Felt modesty panel secures to the rear bottom of a single Bridges table and provides privacy below the worksurface.
- 9 mm felt material is tackable and comes in a wide range of colours.
- Installed, the divider measures 15" high below the top of the worksurface.
- Kit includes felt modesty, support extrusion and left and right brackets.
- Please choose the finish of the felt and the metal finish for the extrusion and brackets.

PRODUCT CODE	PRICE	SIZE/ INCHES			WEIGHT VOL	
		H	W	D	LBS	FT ³
BRTAFMPSN48	196	13.82	41.76	4.17	3.31	16.71
BRTAFMPSN54	268	13.82	47.76	4.17	3.72	19.11
BRTAFMPSN60	281	13.82	53.76	4.17	4.13	21.51
BRTAFMPSN66	298	13.82	59.76	4.17	4.54	23.92
BRTAFMPSN72	317	13.82	65.76	4.17	4.95	26.32
BRTAFMPSN78	333	13.82	71.76	4.17	5.36	28.72
BRTAFMPSN84	353	13.82	77.76	4.17	5.77	31.12

Single Table Or Single Table Row Application:

Perpendicular laminate side to side divider
BRTLPPD: flush with the front WS edge. Can be installed off-module to the front and back edge of work surface, regardless of type of leg support - supporting brackets can straddle over shared leg."

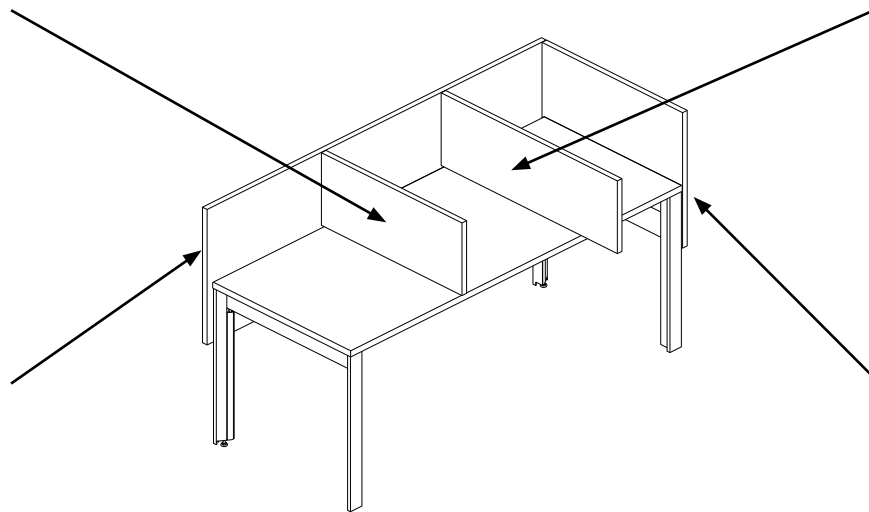

Extended Perpendicular Laminate side to side divider
BRTLPE The extended version protrudes by 6" beyond the front WS edge for added privacy. Can be installed off-module to the front and back edge of work surface, regardless of type of leg support - supporting brackets can straddle over shared leg."

Parallel laminate table mounted divider
BRTLPPDS for single table or single table row: recessed 1.3" at both ends; mounted to the table with 0.9" gap at the back.

Laminate perpendicular end of run divider
BRTLPE 24, 30 for single table or single table run: flush at the front WS edge; extended back flush with BRTLPPDS divider."

Back-To-Back And Back 2 Back Table Row Application:

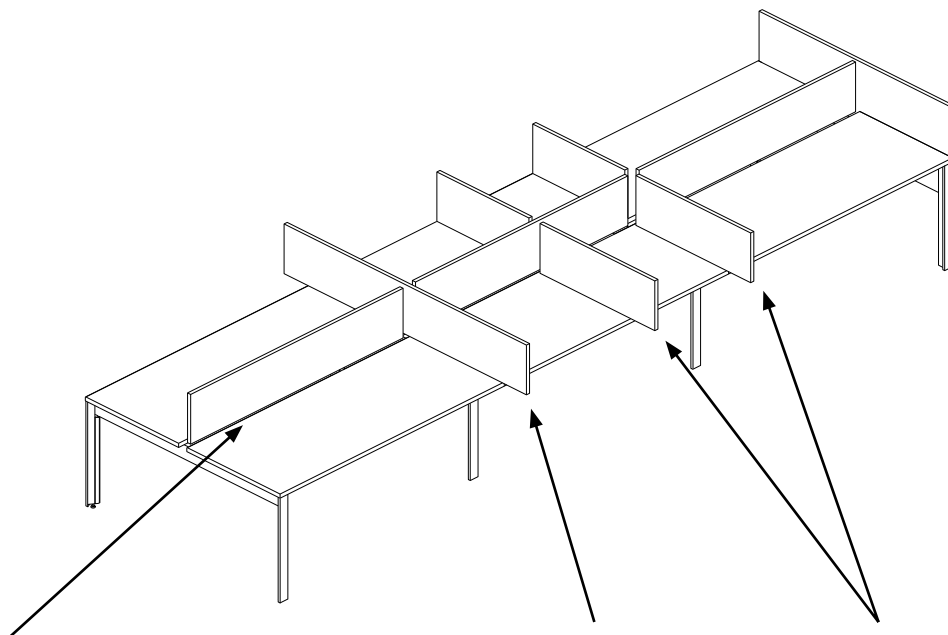

Parallel laminate table mounted divider
BRTLPPD: recessed 1.3" at both ends; mounted between two back-to-back work surfaces."

Extended perpendicular laminate side to side double divider BRTLPPDSE: this one piece divider spans beyond both back-2-back work surfaces: installs on-module, between two BRTLPPD dividers and is secured to the front edge of both work surfaces, regardless of type of leg support - supporting brackets can straddle over shared leg." Protrudes 6" beyond the front

Extended perpendicular laminate side to side divider BRTLPE. The extended version protrudes by 6" beyond the front WS edge for added privacy. Can be installed off-module or on module to the front and back edge of work surface, regardless of type of leg support - supporting brackets can straddle over shared leg." Shown above in On-module and Off-module application.

BRTLPESE • Perpendicular Laminate Side to Side Divider - Extended

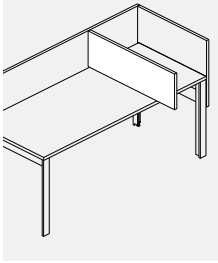

- Provides privacy, divides spaces.
- Protrudes by 6" beyond the front worksurface edge for added privacy.
- Specify BRTLPESE30 for 24" deep work surfaces and BRTLPESE36 for 30" deep work surfaces.
- Secures off-module or on-module to the front and back edge of work surface, regardless of type of leg support - supporting brackets can straddle over shared leg.
- Includes powder coated steel support brackets. 3/4 LP PVC edge boards, please specify laminate and 3mm PVC edge on order.

PRODUCT CODE	PRICE	SIZE/INCHES			WEIGHT VOL	
		H	W	D	LBS	FT ³
BRTLPESE30	215	16	30	0.75	9.00	0.21
BRTLPESE36	245	16	36	0.75	11.00	0.25

BRTLPESE • Perpendicular Laminate Side to Side Double Divider - Extended

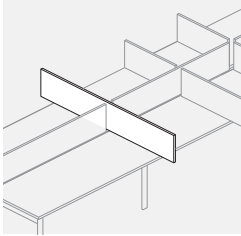

- Provides privacy, divides space. Protrudes 6" beyond the front worksurface edges on either side for added privacy.
- Specify BRTLPESE63 for 24" deep back 2 back work surfaces and BRTLPESE75 for 30" deep back 2 back work surfaces.
- Installs on-module, between two BRTLPESE dividers. It is secured to the front edge of both work surfaces, regardless of type of leg support - supporting brackets can straddle over shared leg.
- NOTE: Can only be installed on-module, between two BRTLPESE dividers.
- Includes powder coated steel support brackets. 3/4 LP PVC edge boards, please specify laminate and 3mm PVC edge on order.

PRODUCT CODE	PRICE	SIZE/INCHES			WEIGHT VOL	
		H	W	D	LBS	FT ³
BRTLPESE63	399	16	63	0.75	18.00	0.44
BRTLPESE75	446	16	75	0.75	22.00	0.52

BRTLPESE • Laminate Table Mounted Dividers

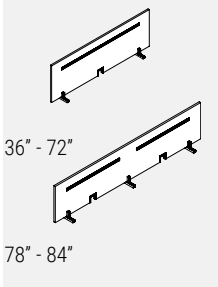

- Parallel divider, Back 2 Back tables, LP
- Secures between two Back 2 Back tables; provides privacy, divides space.
- Installed divider measures 15.7" from the top of the worksurface.
- 78" and 84" dividers include 3 support brackets and two pass-through grommets.
- Integrated anodized aluminum accessory rail, white cut out and rail trims; painted support brackets.
- 3/4" LP PVC edged boards, please specify laminate & 3mm PVC edge on order.

PRODUCT CODE	PRICE	SIZE/INCHES			WEIGHT VOL	
		H	W	D	LBS	FT ³
BRTLPESE36	283	16	33	0.75	10	0.22
BRTLPESE42	309	16	39	0.75	12	0.27
BRTLPESE48	337	16	45	0.75	14	0.31
BRTLPESE54	355	16	51	0.75	15	0.35
BRTLPESE60	372	16	57	0.75	17	0.39
BRTLPESE66	389	16	63	0.75	19	0.43
BRTLPESE72	417	16	69	0.75	21	0.47
BRTLPESE78	523	16	75	0.75	23	0.52
BRTLPESE84	539	16	81	0.75	24	0.56

BRTLPESE • High Laminate Table Mounted Divider

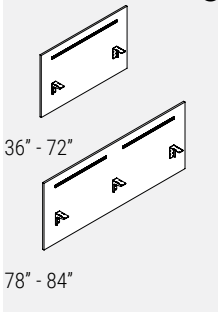

- Parallel divider, single tables, LP
- Accessory rail is installed on one side only.
- Secures to the back of a single table; provides privacy, divides space.
- Installed divider reaches 15.7 up and 15" down from the top of the worksurface.
- 36" - 72" dividers include 2 support brackets; 78" and 84" dividers include 3 support brackets.
- Integrated anodized aluminum accessory rail, white cut out and rail trims; powder coat brackets.
- Integrated modesty panel.
- 3/4" LP PVC edged boards, please specify laminate & 3mm PVC edge on order.
- Not recommended for use on tables using 42" high legs.

PRODUCT CODE	PRICE	SIZE/INCHES			WEIGHT VOL	
		H	W	D	LBS	FT ³
BRTLPESE36	398	30.7	33	0.75	22	0.50
BRTLPESE42	486	30.7	39	0.75	25	0.56
BRTLPESE48	523	30.7	45	0.75	29	0.66
BRTLPESE54	550	30.7	51	0.75	32	0.75
BRTLPESE60	592	30.7	57	0.75	36	0.83
BRTLPESE66	626	30.7	63	0.75	40	0.91
BRTLPESE72	663	30.7	69	0.75	43	1.00
BRTLPESE78	813	30.7	75	0.75	47	1.08
BRTLPESE84	849	30.7	81	0.75	50	1.16

BRTLPPD • High Perpendicular Laminate Side to Side Divider

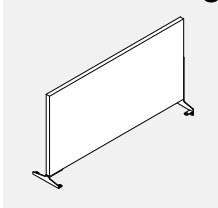

- Perpendicular side-to-side divider, 3/4" LP PVC edged board, please specify laminate & 3mm PVC edge finish.
- Includes powder coated steel support brackets.
- Provides privacy, divides space; secures off-module or on-module to the front and back edge of worksurface, regardless of type of leg support - supporting brackets can straddle over shared leg.
- Installed divider measures 15.7" from the top of the worksurface.

PRODUCT CODE	PRICE	SIZE/INCHES			WEIGHT VOL	
		H	W	D	LBS	FT ³
BRTLPPD24	195	16	24	0.75	7	0.16
BRTLPPD30	212	16	30	0.75	9	0.20

BRTLPEP • Laminate Perpendicular End of a Run Divider

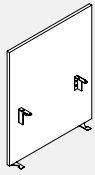

- Secures to the side edge of a table/tables; provides privacy, divides space, LP.
- Installed divider reaches 15.7" up and 15" down from the top of the worksurface.
- Includes powder coated steel support brackets for rectangular legs only.
- Integrated modesty panel.
- 3/4" LP self edged boards, please specify laminate & 3mm PVC edge on order.

PRODUCT CODE	PRICE	SIZE/INCHES			WEIGHT VOL	
		H	W	D	LBS	FT ³
BRTLPEP24	310	30.7	24	0.75	7	0.16
BRTLPEP30	337	30.7	30	0.75	9	0.20
BRTLPEP51	530	30.7	50.5	0.75	15	0.35
BRTLPEP63	603	30.7	62.5	0.75	19	0.43

BRTPEG • Laminate Gable for Rectangular Leg

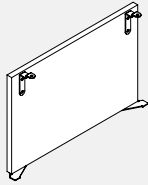

- Perpendicular end of a run gable, LP
- Secures to the side edge of a table/tables and rectangular legs; provides privacy, divides space.
- Includes powder coated steel support brackets.
- 3/4" LP self edged boards.
- 3 Gable heights available:
 - BRTPEG24, 30, 51 and 63 measure 15" below worksurface.
 - BRTPEGH21 lines up with the bottom of storage cabinets.
 - BRTPEGH27 reaches down 1" from the floor.
- Note: BRTPEGH27 will not fit on BRTSLLL Loop Leg.

PRODUCT CODE	PRICE	SIZE/INCHES			WEIGHT VOL	
		H	W	D	LBS	FT ³
BRTPEG24	202	14	24	0.75	6	0.14
BRTPEG24H21	231	20.5	24	0.75	9	0.21
BRTPEG24H27	270	26.5	24	0.75	12	0.26
BRTPEG30	218	14	30	0.75	8	0.18
BRTPEG30H21	245	20.5	30	0.75	12	0.26
BRTPEG30H27	284	26.5	30	0.75	15	0.33
BRTPEG51	356	14	50.5	0.75	13	0.30
BRTPEG51H21	422	20.5	50.5	0.75	20	0.43
BRTPEG51H27	493	26.5	50.5	0.75	26	0.56
BRTPEG63	387	14	62.5	0.75	16	0.38
BRTPEG63H21	455	20.5	62.5	0.75	25	0.53
BRTPEG63H27	524	26.5	62.5	0.75	32	0.69

BRTMPS • Laminate Modesty Panel

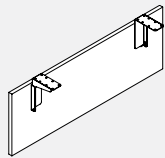

- Parallel modesty panel, single tables, LP
- Secures to the back edge of a table; provides privacy, divides space.
- Installed divider reaches 15" below worksurface.
- Includes powder coated steel support brackets.
- 3/4" LP self edged boards.
- Flip down for easy access to underside of worksurface.
- Note: actual size of modesty is different than the nominal code.

PRODUCT CODE	PRICE	SIZE/INCHES			WEIGHT VOL	
		H	W	D	LBS	FT ³
BRTMPS36	345	14	30.5	0.75	9	0.21
BRTMPS42	362	14	36.5	0.75	11	0.25
BRTMPS48	380	14	42.5	0.75	13	0.29
BRTMPS54	396	14	48.5	0.75	14	0.32
BRTMPS60	410	14	54.5	0.75	16	0.36
BRTMPS66	428	14	60.5	0.75	17	0.40
BRTMPS72	443	14	66.5	0.75	19	0.43
BRTMPS78	461	14	72.5	0.75	20	0.47
BRTMPS84	476	14	78.5	0.75	22	0.51

BRLBST • Single Rail Accessory Rail

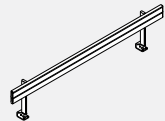

- Table mounted accessory rail
- Compatible with standard accessories.
- Includes end caps and mounting hardware.
- Please specify paint finish.

PRODUCT CODE	PRICE	SIZE/INCHES			WEIGHT VOL	
		H	W	D	LBS	FT ³
BRLBST36	288	13.5	33	2.95	5.90	0.26
BRLBST42	301	13.5	39	2.95	6.44	0.30
BRLBST48	311	13.5	45	2.95	6.98	0.35
BRLBST54	323	13.5	51	2.95	7.52	0.39
BRLBST60	332	13.5	57	2.95	8.07	0.43
BRLBST66	342	13.5	63	2.95	8.61	0.48
BRLBST72	355	13.5	69	2.95	9.15	0.52
BRLBST78	365	13.5	75	2.95	9.69	0.56
BRLBST84	377	13.5	81	2.95	10.24	0.61

BRLBB2B • Back 2 Back Accessory Rail

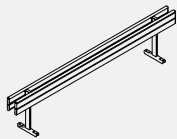

- Double sided accessory rail mounts between worksurfaces on back 2 back assembly
- Compatible with standard accessories.
- Includes end caps and mounting hardware.
- Please specify paint finish.

PRODUCT CODE	PRICE	SIZE/INCHES			WEIGHT VOL	
		H	W	D	LBS	FT ³
BRLBB2B36	444	13.5	33	7.50	9.02	0.32
BRLBB2B42	472	13.5	39	7.50	10.10	0.37
BRLBB2B48	495	13.5	45	7.50	11.19	0.42
BRLBB2B54	519	13.5	51	7.50	12.27	0.48
BRLBB2B60	534	13.5	57	7.50	13.36	0.53
BRLBB2B66	557	13.5	63	7.50	14.44	0.58
BRLBB2B72	578	13.5	69	7.50	15.52	0.63
BRLBB2B78	601	13.5	75	7.50	16.61	0.69
BRLBB2B84	624	13.5	81	7.50	17.69	0.74

Single Table Or Single Table Row Application; 16" and 30" high dividers

Table Mounted Framed Divider for single table or single table row; recessed 1.5" at both ends, mounted to the table with 0.6" gap at the back.
 BRTMFD/BRTMLD 36" (33" actual) - 66" (63" actual) dividers have 2 mounting brackets.
 BRTMFD/BRTMLD 72" (69" actual) - 84" (81" actual) dividers have 3 mounting brackets.

Perpendicular Single Table End of Run Framed Divider;
 BREFD/BRELD 24" (21" actual for 24" deep work surfaces),
 BREFD/BRELD 30" (27" actual for 30" deep work surfaces),
 BREFD/BRELD 36" (33" actual for 36" deep work surfaces),

Two brackets secure the divider to the side edge of work surface. Flush with rear edge, 3" recessed from front work surface edge.

Perpendicular Shared Framed Divider;
 BRSFD/BRSLD 24" (21" actual for 24" deep work surfaces),
 BRSFD/BRSLD 30" (27" actual for 30" deep work surfaces),
 BRSFD/BRSLD 36" (33" actual for 36" deep work surfaces),

Single bracket secures the divider to the rear edge of work surface; Can be mounted off-module or over the seam of two adjacent work surfaces. Flush with the rear edge, 3" recessed from front work surface edge.

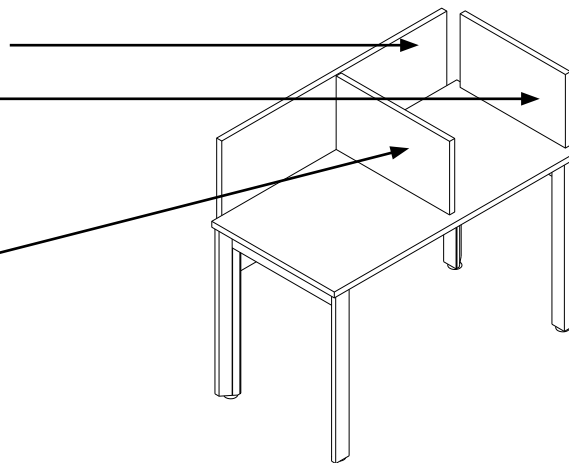

Back 2 Back Table Application; 16" dividers

Perpendicular Back 2 Back Parallel Framed Divider secured between two back-to-back tables; recessed 1.5" at both ends; 0.6" gap between the divider and work surfaces.
 BRPFD/BRPLD 36" (33" actual) - 66" (63" actual) dividers have 2 mounting brackets.
 BRPFD/BRPLD 72" (69" actual) - 84" (81" actual) dividers have 3 mounting brackets.

Perpendicular Shared Frame Back 2 Back Framed Divider;
 BRSDFD/BRSDLD 51" (45" actual for 24" deep back-to-back work surfaces)
 BRSDFD/BRSDLD 63" (57" actual for 30" deep back-to-back work surfaces).
 One bracket secures the divider through the gap between work surfaces; two brackets locate top of the divider between two adjacent Parallel dividers.
 NOTE: cannot be used on its own without the two Parallel dividers.
 3" recessed from front work surface edges.

Perpendicular Back 2 Back End of Run Framed Divider;
 BREDFD/BREDLD 51" (45" actual for 24" deep back-to-back work surfaces)
 BREDFD/BREDLD 63" (57" actual for 30" deep back-to-back work surfaces).
 Three brackets secure the divider to both side edges of work surfaces.
 3" recessed from front work surface edges.

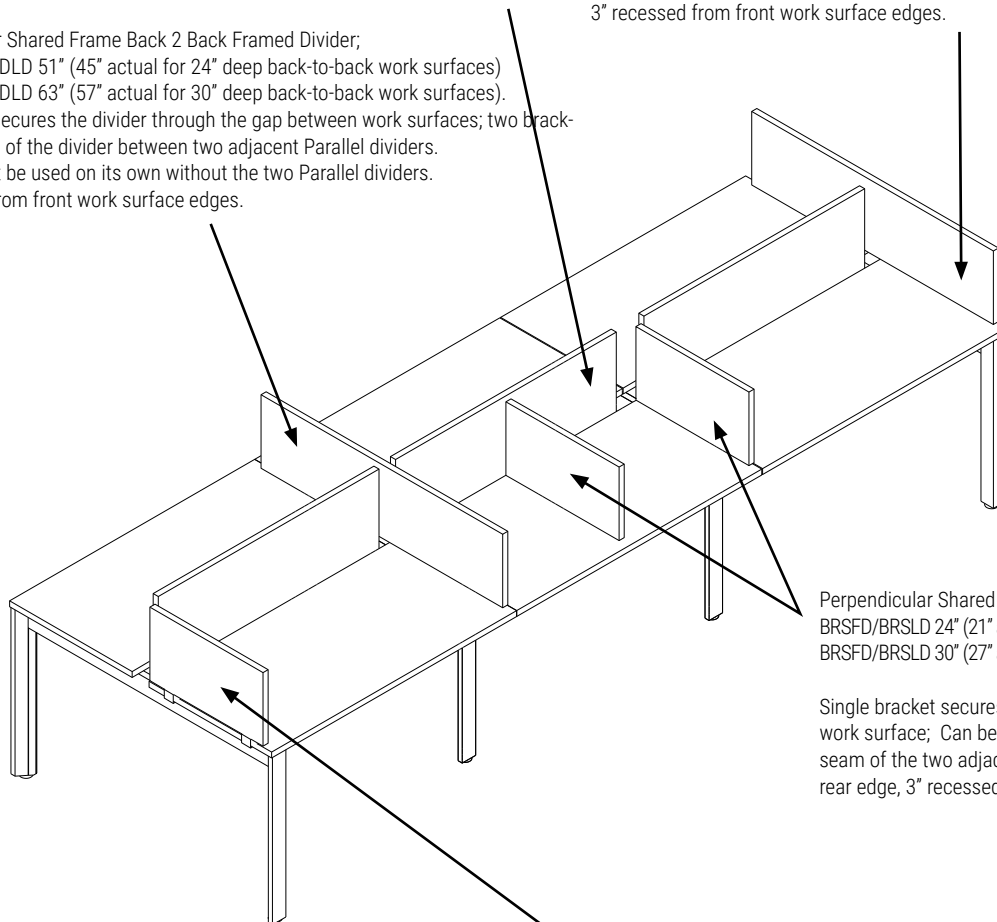

Perpendicular Shared Framed Divider;
 BRSFD/BRSLD 24" (21" actual for 24" deep work surfaces).
 BRSFD/BRSLD 30" (27" actual for 30" deep work surfaces).

Single bracket secures the divider to the rear edge of work surface; Can be mounted off-module or over the seam of the two adjacent work surfaces. Flush with the rear edge, 3" recessed from front work surfaces edge.

Perpendicular Single Table End of Run Framed Divider;
 BREFD/BRELD 24" (21" actual for 24" deep work surfaces).
 BREFD/BRELD 30" (27" actual for 30" deep work surfaces).

Two brackets secure the divider to the side edge of work surface. Flush with the rear edge, 3" recessed from front work surface edge.

Note: Do not use framed dividers with glass dividers. Connection hardware will not fit.

BRPFD/BRPLD • Back 2 Back Parallel Framed Dividers

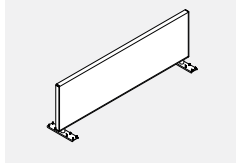

- **Secures to the underside of the worksurface**
- Divider frame and connecting hardware is painted, please choose from standard metal paint finishes.
- Fabric divider is tackable and always railroaded.
- Divider infill can be specified in fabric, low pressure laminate (LP), high pressure laminate (HP), dry erase whiteboard (DE) or dry erase magnetic whiteboard (DM).
- Installed divider measures 15.7" from top of worksurface.
- 36" to 54" dividers include 2 support brackets. 60" to 84" dividers include 3 support brackets.
- Note 60" - 84" dividers require 3 support brackets and cannot be used with worksurfaces that have a single access door

PRODUCT CODE	PRICE		SIZE/INCHES			WEIGHT VOL	
	GR1	GR2	H	W	D	LBS	FT ³
BRPFD36	341	375	16	33	1.25	13	0.92
BRPFD42	352	384	16	39	1.25	15	1.08
BRPFD48	404	443	16	45	1.25	17	1.25
BRPFD54	421	469	16	51	1.25	19	1.42
BRPFD60	508	557	16	57	1.25	22	1.58
BRPFD66	535	590	16	63	1.25	23	1.75
BRPFD72	552	613	16	69	1.25	25	1.92
BRPFD78	561	624	16	75	1.25	27	2.08
BRPFD84	587	656	16	81	1.25	28	2.25

PRODUCT CODE	PRICE				SIZE/INCHES			LP/HP/DE	MAG	VOL
	LP	HP	DE	DM	H	W	D	LBS	LBS	FT ³
BRPLD36	251	326	424	710	16	33	1.25	17	20	0.92
BRPLD42	265	347	459	785	16	39	1.25	19	23	1.08
BRPLD48	297	404	527	903	16	45	1.25	21	26	1.25
BRPLD54	347	486	860	1608	16	51	1.25	24	29	1.42
BRPLD60	418	574	908	1659	16	57	1.25	26	32	1.58
BRPLD66	431	626	916	1760	16	63	1.25	30	37	1.75
BRPLD72	446	630	971	1774	16	69	1.25	33	40	1.92
BRPLD78	451	659	978	1790	16	75	1.25	35	43	2.08
BRPLD84	461	691	987	1803	16	81	1.25	37	46	2.25

BREFD/BRELD • Perpendicular Single Table End of Run Framed Dividers

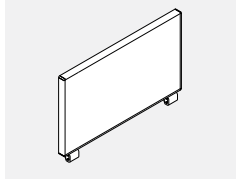

- **Connects to the perpendicular end of a single or Back 2 Back table.**
- Divider frame and connecting hardware is painted, please choose from standard metal paint finishes.
- Fabric divider is tackable and always railroaded. Divider infill can be specified in fabric, low pressure laminate (LP), high pressure laminate (HP), dry erase whiteboard (DE) or dry erase magnetic whiteboard (DM) user side only.
- Installed divider measures 15.7" from top of worksurface.
- Divider comes with 2 support brackets.
- When dry erase magnetic whiteboard (DM) is specified it is applied user side ONLY and dry erase whiteboard (DE) is applied on the opposite side.
- Two brackets secure the divider to the side edge of work surface. Flush with the rear edge, 3" recessed from front work surface edge.

PRODUCT CODE	PRICE		SIZE/INCHES			WEIGHT VOL	
	GR1	GR2	H	W	D	LBS	FT ³
BREFD24	263	292	16	21	1.25	9	0.58
BREFD30	272	300	16	27	1.25	11	0.75
BREFD36	297	332	16	33	1.25	12	0.92

PRODUCT CODE	PRICE				SIZE/INCHES			LP/HP/DE	MAG	VOL
	LP	HP	DE	DM	H	W	D	LBS	LBS	FT ³
BRELD24	188	242	305	367	16	21	1.25	12	14	0.58
BRELD30	208	277	340	418	16	27	1.25	14	17	0.75
BRELD36	215	293	389	486	16	33	1.25	16	20	0.92

BRSFD/BRSLD • Perpendicular Shared Framed Dividers

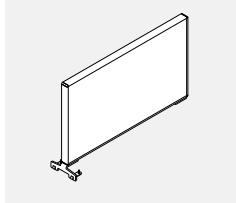

- **Connects anywhere along and between worksurfaces to divide space and create privacy.**
- Divider is fastened under the worksurface flush to the back of the table and recessed 3" from the front edge on the user side.
- Divider frame and connecting hardware is painted, please choose from standard metal paint finishes.
- Fabric divider is tackable and always railroaded. Divider infill can be specified in fabric, low pressure laminate (LP), high pressure laminate (HP), dry erase whiteboard (DE) or dry erase magnetic whiteboard (DM).
- Installed divider measures 15.7" from top of worksurface.
- Divider comes with a support bracket at the back and a spacer plate with double sided adhesive at the front.

PRODUCT CODE	PRICE		SIZE/INCHES			WEIGHT VOL	
	GR1	GR2	H	W	D	LBS	FT ³
BRSFD24	254	281	16	21	1.25	9	0.58
BRSFD30	263	292	16	27	1.25	11	0.75
BRSFD36	290	322	16	33	1.25	12	0.92

PRODUCT CODE	PRICE				SIZE/INCHES			LP/HP/DE	MAG	VOL
	LP	HP	DE	DM	H	W	D	LBS	LBS	FT ³
BRSLD24	188	237	297	486	16	21	1.25	12	14	0.58
BRSLD30	202	271	333	603	16	27	1.25	14	17	0.75
BRSLD36	215	293	389	667	16	33	1.25	16	20	0.92

BREDFD/BREDLD • Perpendicular Back 2 Back End of Run Framed Dividers

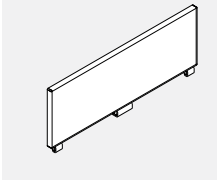

- **Connects to the end of run on Back 2 Back tables to create privacy.**
- Divider is fastened under the worksurface and recessed 3" from the user edge on the either side.
- Divider frame and connecting hardware is painted, please choose from standard metal paint finishes.
- Fabric divider is tackable and always railroaded.
- Divider infill can be specified in fabric, low pressure laminate (LP), high pressure laminate (HP), dry erase whiteboard (DE) or dry erase magnetic whiteboard (DM) user side only.
- Installed divider measures 15.7" from top of worksurface.
- Divider comes with 1 large and 2 small support brackets.
- When dry erase magnetic whiteboard (DM) is specified it is applied user side ONLY and dry erase whiteboard (DE) is applied on the opposite side

PRODUCT CODE	PRICE		SIZE/ INCHES			WEIGHT		VOL FT ³
	GR1	GR2	H	W	D	LBS		
BREDFD51	410	454	16	45	1.25	18	1.25	
BREDFD63	464	512	16	57	1.25	21	1.58	

PRODUCT CODE	PRICE		SIZE/ INCHES				LP/HP/DE		MAG LBS	VOL FT ³
	LP	HP	DE	DM	H	W	D			
BREDLD51	305	408	541	659	16	45	1.25	21	26	1.25
BREDLD63	375	535	875	1119	16	57	1.25	26	32	1.58

BRSDFD/BRSDL D • Perpendicular Back 2 Back Shared Framed Dividers

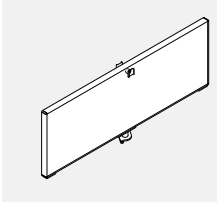

- **Connects between parallel framed dividers for Back 2 Back tables to divide space and create privacy.**
- Divider is fastened under the worksurface and recessed 3" from the user edge on the either side.
- Divider frame and connecting hardware is painted, please choose from standard metal paint finishes.
- Fabric divider is tackable and always railroaded.
- Divider infill can be specified in fabric, low pressure laminate (LP), high pressure laminate (HP), dry erase whiteboard (DE) or dry erase magnetic whiteboard (DM).
- Installed divider measures 15.7" from top of worksurface.
- Divider comes with one center support bracket, two spacer plates with adhesive and two top spacer clamps.

PRODUCT CODE	PRICE		SIZE/ INCHES			WEIGHT		VOL FT ³
	GR1	GR2	H	W	D	LBS		
BRSDFD51	385	426	16	45	1.25	17	1.25	
BRSDFD63	438	486	16	57	1.25	20	1.58	

PRODUCT CODE	PRICE		SIZE/ INCHES				LP/HP/DE		MAG LBS	VOL FT ³
	LP	HP	DE	DM	H	W	D			
BRSDL51	293	396	521	894	16	45	1.25	21	26	1.25
BRSDL63	361	513	853	1603	16	57	1.25	26	32	1.58

NOTE: cannot be used on its own without the two Parallel dividers.

BRTMFD/BRTMLD • Table Mounted Framed Dividers

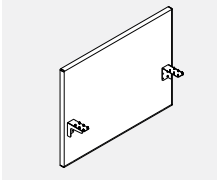

- **Parallel divider for single tables.**
- Divider frame and connecting hardware is painted, please choose from standard metal paint finishes.
- Fabric divider is tackable and always railroaded.
- Divider infill can be specified in fabric, low pressure laminate (LP), high pressure laminate (HP), dry erase whiteboard (DE) or dry erase magnetic whiteboard (DM) user side only.
- Fastens to the underside of the worksurface
- 0.6 gap between worksurface and divider allows for cable pass thru.
- Installed divider reaches 15.7" up and 15" down from the top of the worksurface.
- 36" to 66" dividers include 2 support brackets. 72" to 84" dividers include 3 support brackets.
- When dry erase magnetic whiteboard (DM) is specified it is applied user side ONLY and dry erase whiteboard (DE) is applied on the opposite side.
- LAMINATE NOTE: 72" to 84" dividers require 3 support brackets and cannot be used with worksurfaces that have a single access door.
- FABRIC NOTE: 60" to 84" dividers require 3 support brackets and cannot be used with worksurfaces that have a single access door.

PRODUCT CODE	PRICE		SIZE/ INCHES			WEIGHT		VOL FT ³
	GR1	GR2	H	W	D	LBS		
BRTMFD36	307	340	30	33	1.25	20	1.90	
BRTMFD42	367	403	30	39	1.25	22	2.03	
BRTMFD48	410	454	30	45	1.25	25	2.34	
BRTMFD54	457	505	30	51	1.25	27	2.66	
BRTMFD60	518	565	30	57	1.25	30	2.97	
BRTMFD66	587	641	30	63	1.25	33	3.28	
BRTMFD72	604	667	30	69	1.25	37	3.59	
BRTMFD78	630	692	30	75	1.25	40	3.91	
BRTMFD84	674	743	30	81	1.25	43	4.22	

PRODUCT CODE	PRICE		SIZE/ INCHES				LP/HP/DE		MAG LBS	VOL FT ³
	LP	HP	DE	DM	H	W	D			
BRTMLD36	365	510	741	1184	30	33	1.25	30	38	1.90
BRTMLD42	380	526	1069	1434	30	39	1.25	34	42	2.03
BRTMLD48	395	540	1075	1527	30	45	1.25	38	48	2.34
BRTMLD54	408	556	2060	2794	30	51	1.25	43	54	2.66
BRTMLD60	431	576	2185	2958	30	57	1.25	48	60	2.97
BRTMLD66	446	653	2191	2973	30	63	1.25	52	66	3.28
BRTMLD72	468	673	2206	2988	30	69	1.25	57	71	3.59
BRTMLD78	928	1236	2220	3001	30	75	1.25	61	77	3.91
BRTMLD84	943	1250	2234	3016	30	81	1.25	66	83	4.22

BRTADP-H24 • Back 2 Back Polycarbonate Divider Screen Kit, 24" high

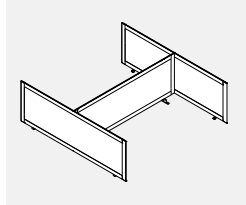

- Provides privacy in an open plan environment.
- Lightweight and easy to clean table mounted partitions.
- Consists of a powder coated aluminum frame, translucent fluted polycarbonate and all hardware to connect. Brackets are painted steel.
- Side dividers extend 6.25" from the front edge of each surface.
- Center divider sits over the gap between the worksurface allowing for the passage of cables to the trough. The gap for each side is approximately 1".
- BRTADP51-H24 are for 24" deep surfaces and BRTADP63-H24 are for 30" deep surfaces.
- Width and depth are nominal sizes representing the sizes of the Bridges configuration. Allow for 1/4" overhang at sides and 6 1/4" at front.
- Please choose any standard paint finish for frame and hardware. End trim cap is available only in CHR - charcoal.

PRODUCT CODE	PRICE	SIZE/INCHES			WEIGHT LBS	VOL FT ³
		H	W	D		
BRTADP5136H24	1070	24.63	36	50.50	33.00	6.31
BRTADP5142H24	1092	24.63	42	50.50	34.50	7.36
BRTADP5148H24	1114	24.63	48	50.50	36.00	8.42
BRTADP5154H24	1136	24.63	54	50.50	37.50	9.47
BRTADP5160H24	1159	24.63	60	50.50	39.00	10.52
BRTADP5166H24	1183	24.63	66	50.50	40.50	11.57
BRTADP5172H24	1202	24.63	72	50.50	42.00	12.63
BRTADP5178H24	1225	24.63	78	50.50	43.50	13.68
BRTADP5184H24	1249	24.63	84	50.50	45.00	14.73
BRTADP6336H24	1158	24.63	36	62.50	46.50	7.81
BRTADP6342H24	1179	24.63	42	62.50	48.00	9.11
BRTADP6348H24	1201	24.63	48	62.50	49.50	10.42
BRTADP6354H24	1224	24.63	54	62.50	51.00	11.72
BRTADP6360H24	1246	24.63	60	62.50	52.50	13.02
BRTADP6366H24	1267	24.63	66	62.50	54.00	14.32
BRTADP6372H24	1290	24.63	72	62.50	55.50	15.63
BRTADP6378H24	1313	24.63	78	62.50	57.00	16.93
BRTADP6384H24	1335	24.63	84	62.50	58.50	18.23

BRTADP-H30 • Back 2 Back Polycarbonate Divider Screen Kit, 30" high

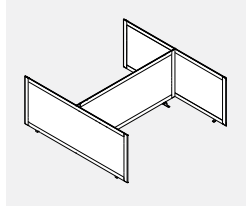

- Provides privacy in an open plan environment.
- Lightweight and easy to clean table mounted partitions.
- Consists of a powder coated aluminum frame, translucent fluted polycarbonate and all hardware to connect. Brackets are painted steel.
- Side dividers extend 6.25" from the front edge of each surface.
- Center divider sits over the gap between the worksurface allowing for the passage of cables to the trough. The gap for each side is approximately 1".
- BRTADP51-H24 are for 24" deep surfaces and BRTADP63-H24 are for 30" deep surfaces.
- Width and depth are nominal sizes representing the sizes of the Bridges configuration. Allow for 1/4" overhang at sides and 6 1/4" at front.
- Please choose any standard paint finish for frame and hardware. End trim cap is available only in CHR - charcoal.

PRODUCT CODE	PRICE	SIZE/INCHES			WEIGHT LBS	VOL FT ³
		H	W	D		
BRTADP5136H30	1187	30.63	36	50.50	35.50	6.31
BRTADP5142H30	1212	30.63	42	50.50	37.00	7.36
BRTADP5148H30	1238	30.63	48	50.50	38.50	8.42
BRTADP5154H30	1264	30.63	54	50.50	40.00	9.47
BRTADP5160H30	1289	30.63	60	50.50	41.50	10.52
BRTADP5166H30	1316	30.63	66	50.50	43.00	11.57
BRTADP5172H30	1341	30.63	72	50.50	44.50	12.63
BRTADP5178H30	1366	30.63	78	50.50	46.00	13.68
BRTADP5184H30	1393	30.63	84	50.50	47.50	14.73
BRTADP6336H30	1332	30.63	36	62.50	49.00	7.81
BRTADP6342H30	1357	30.63	42	62.50	50.50	9.11
BRTADP6348H30	1386	30.63	48	62.50	52.00	10.42
BRTADP6354H30	1409	30.63	54	62.50	53.50	11.72
BRTADP6360H30	1437	30.63	60	62.50	55.00	13.02
BRTADP6366H30	1462	30.63	66	62.50	56.50	14.32
BRTADP6372H30	1488	30.63	72	62.50	58.00	15.63
BRTADP6378H30	1515	30.63	78	62.50	59.50	16.93
BRTADP6384H30	1539	30.63	84	62.50	61.00	18.23

BRTADPE-H24 - Back 2 Back Polycarbonate Divider Screen Kit, 24" high

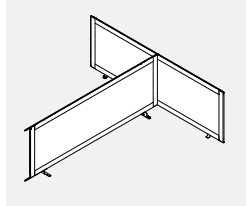

- Provides an extension for privacy in an open plan environment. Intended to always connect to Back 2 Back Divider Screen Kit
- Lightweight and easy to clean table mounted partitions.
- Consists of a powder coated aluminum frame, translucent fluted polycarbonate and all hardware to connect. Brackets are painted steel.
- Side dividers extend 6.25" from the front edge of each surface.
- Center divider sits over the gap between the worksurface allowing for the passage of cables to the trough. The gap for each side is approximately 1".
- BRTADPE51-H24 are for 24" deep surfaces and BRTADPE63-H24 are for 30" deep surfaces.
- Width and depth are nominal sizes representing the sizes of the Bridges configuration. Allow for 1/4" overhang at sides and 6 1/4" at front.
- Please choose any standard paint finish for frame and hardware. End trim cap is available only in CHR - charcoal.
- Can be used as left or right connection.

PRODUCT CODE	PRICE	SIZE/INCHES			WEIGHT LBS	VOL FT ³
		H	W	D		
BRTADPE5136H24	725	24.63	36	50.50	26.35	6.31
BRTADPE5142H24	745	24.63	42	50.50	27.85	7.36
BRTADPE5148H24	768	24.63	48	50.50	29.35	8.42
BRTADPE5154H24	792	24.63	54	50.50	30.85	9.47
BRTADPE5160H24	815	24.63	60	50.50	32.35	10.52
BRTADPE5166H24	837	24.63	66	50.50	33.85	11.57
BRTADPE5172H24	859	24.63	72	50.50	35.35	12.63
BRTADPE5178H24	881	24.63	78	50.50	36.85	13.68
BRTADPE5184H24	903	24.63	84	50.50	38.35	14.73
BRTADPE6336H24	767	24.63	36	62.50	39.85	7.81
BRTADPE6342H24	790	24.63	42	62.50	41.35	9.11
BRTADPE6348H24	813	24.63	48	62.50	42.85	10.42
BRTADPE6354H24	835	24.63	54	62.50	44.35	11.72
BRTADPE6360H24	858	24.63	60	62.50	45.85	13.02
BRTADPE6366H24	881	24.63	66	62.50	47.35	14.32
BRTADPE6372H24	902	24.63	72	62.50	48.85	15.63
BRTADPE6378H24	924	24.63	78	62.50	50.35	16.93
BRTADPE6384H24	947	24.63	84	62.50	51.85	18.23

BRTADPE-H30 • Back 2 Back Polycarbonate Divider Screen Kit, 30" high

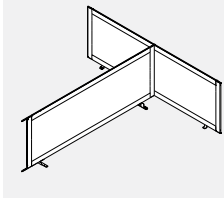

- Provides an extension for privacy in an open plan environment. Intended to always connect to Back 2 Back Divider Screen Kit
- Lightweight and easy to clean table mounted partitions.
- Consists of a powder coated aluminum frame, translucent fluted polycarbonate and all hardware to connect. Brackets are painted steel.
- Side dividers extend 6.25" from the front edge of each surface.
- Center divider sits over the gap between the worksurface allowing for the passage of cables to the trough. The gap for each side is approximately 1".
- BRTADPE51-H24 are for 24" deep surfaces and BRTADPE63-H24 are for 30" deep surfaces.
- Width and depth are nominal sizes representing the sizes of the Bridges configuration. Allow for 1/4" overhang at sides and 6 1/4" at front.
- Please choose any standard paint finish for frame and hardware. End trim cap is available only in CHR - charcoal.
- Can be used as left or right connection.

PRODUCT CODE	PRICE	SIZE/INCHES			WEIGHT LBS	VOL FT ³
		H	W	D		
BRTADPE5136H30	796	30.63	36	50.50	28.85	6.31
BRTADPE5142H30	824	30.63	42	50.50	30.35	7.36
BRTADPE5148H30	849	30.63	48	50.50	31.85	8.42
BRTADPE5154H30	875	30.63	54	50.50	33.35	9.47
BRTADPE5160H30	901	30.63	60	50.50	34.85	10.52
BRTADPE5166H30	926	30.63	66	50.50	36.35	11.57
BRTADPE5172H30	953	30.63	72	50.50	37.85	12.63
BRTADPE5178H30	977	30.63	78	50.50	39.35	13.68
BRTADPE5184H30	1003	30.63	84	50.50	40.85	14.73
BRTADPE6336H30	847	30.63	36	62.50	42.35	7.81
BRTADPE6342H30	872	30.63	42	62.50	43.85	9.11
BRTADPE6348H30	899	30.63	48	62.50	45.35	10.42
BRTADPE6354H30	924	30.63	54	62.50	46.85	11.72
BRTADPE6360H30	952	30.63	60	62.50	48.35	13.02
BRTADPE6366H30	975	30.63	66	62.50	49.85	14.32
BRTADPE6372H30	1003	30.63	72	62.50	51.35	15.63
BRTADPE6378H30	1029	30.63	78	62.50	52.85	16.93
BRTADPE6384H30	1054	30.63	84	62.50	54.35	18.23

BRTADP-H24 • Single Table Polycarbonate Divider Screen Kit, 24" high

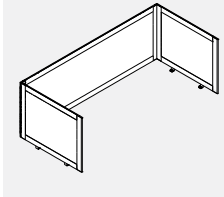

- Provides privacy in an open plan environment.
- Lightweight and easy to clean table mounted partitions.
- Consists of a powder coated aluminum frame, translucent fluted polycarbonate and all hardware to connect. Brackets are painted steel.
- Side dividers extend 6.25" from the front edge of each surface.
- Back divider extends over the back edge of the worksurface by 1 1/2" allowing for the passage of cables to the trough.
- BRTADP24-H24 are for 24" deep surfaces and BRTADP30-H24 are for 30" deep surfaces.
- Width and depth are nominal sizes representing the sizes of the Bridges configuration. Allow for 1/4" overhang at the sides, 1 1/2" at the back and 6 1/4" at the front.
- Please choose any standard paint finish for frame and hardware. End trim cap is available only in CHR - charcoal.

PRODUCT CODE	PRICE	SIZE/INCHES			WEIGHT LBS	VOL FT ³
		H	W	D		
BRTADP2436H24	738	24.63	36	31.75	26.55	3.97
BRTADP2442H24	761	24.63	42	31.75	28.10	4.63
BRTADP2448H24	783	24.63	48	31.75	29.65	5.29
BRTADP2454H24	805	24.63	54	31.75	31.20	5.95
BRTADP2460H24	828	24.63	60	31.75	32.75	6.61
BRTADP2466H24	850	24.63	66	31.75	34.30	7.28
BRTADP2472H24	871	24.63	72	31.75	35.85	7.94
BRTADP2478H24	894	24.63	78	31.75	37.40	8.60
BRTADP2484H24	919	24.63	84	31.75	38.95	9.26
BRTADP3036H24	792	24.63	36	37.75	40.50	4.72
BRTADP3042H24	815	24.63	42	37.75	42.05	5.51
BRTADP3048H24	837	24.63	48	37.75	43.60	6.29
BRTADP3054H24	859	24.63	54	37.75	45.15	7.08
BRTADP3060H24	881	24.63	60	37.75	46.70	7.87
BRTADP3066H24	903	24.63	66	37.75	48.25	8.65
BRTADP3072H24	926	24.63	72	37.75	49.80	9.44
BRTADP3078H24	948	24.63	78	37.75	51.35	10.22
BRTADP3084H24	970	24.63	84	37.75	52.90	11.01

BRTADP-H30 • Single Table Polycarbonate Divider Screen Kit, 30" high

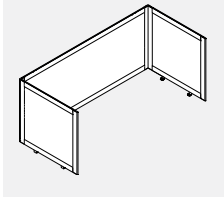

- Provides privacy in an open plan environment.
- Lightweight and easy to clean table mounted partitions.
- Consists of a powder coated aluminum frame, translucent fluted polycarbonate and all hardware to connect. Brackets are painted steel.
- Side dividers extend 6.25" from the front edge of each surface.
- Back divider extends over the back edge of the worksurface by 1 1/2" allowing for the passage of cables to the trough.
- BRTADP24-H24 are for 24" deep surfaces and BRTADP30-H24 are for 30" deep surfaces.
- Width and depth are nominal sizes representing the sizes of the Bridges configuration. Allow for 1/4" overhang at the sides, 1 1/2" at the back and 6 1/4" at the front.
- Please choose any standard paint finish for frame and hardware. End trim cap is available only in CHR - charcoal.

PRODUCT CODE	PRICE	SIZE/INCHES			WEIGHT LBS	VOL FT ³
		H	W	D		
BRTADP2436H30	828	30.63	36	31.75	28.85	3.97
BRTADP2442H30	856	30.63	42	31.75	30.35	4.63
BRTADP2448H30	881	30.63	48	31.75	31.85	5.29
BRTADP2454H30	905	30.63	54	31.75	33.35	5.95
BRTADP2460H30	932	30.63	60	31.75	34.85	6.61
BRTADP2466H30	957	30.63	66	31.75	36.35	7.28
BRTADP2472H30	985	30.63	72	31.75	37.85	7.94
BRTADP2478H30	1009	30.63	78	31.75	39.35	8.60
BRTADP2484H30	1034	30.63	84	31.75	40.85	9.26
BRTADP3036H30	879	30.63	36	37.75	42.35	4.72
BRTADP3042H30	905	30.63	42	37.75	43.85	5.51
BRTADP3048H30	931	30.63	48	37.75	45.35	6.29
BRTADP3054H30	956	30.63	54	37.75	46.85	7.08
BRTADP3060H30	983	30.63	60	37.75	48.35	7.87
BRTADP3066H30	1008	30.63	66	37.75	49.85	8.65
BRTADP3072H30	1033	30.63	72	37.75	51.35	9.44
BRTADP3078H30	1059	30.63	78	37.75	52.85	10.22
BRTADP3084H30	1085	30.63	84	37.75	54.35	11.01

BRTADPE-H24 • Single Table Polycarbonate Divider Screen Extension Kit, 24" high

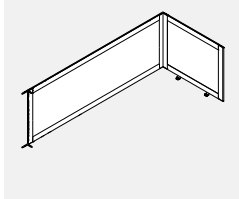

- Provides an extension for privacy in an open plan environment. Intended to always connect to Single Table Divider Screen Kit

- Lightweight and easy to clean table mounted partitions.
- Can be used as left or right connection.
- Consists of a powder coated aluminum frame, translucent fluted polycarbonate and all hardware to connect. Brackets are painted steel.
- Side dividers extend 6.25" from the front edge of each surface.
- Back divider extends over the back edge of the worksurface by 1 1/2" allowing for the passage of cables to the trough.
- BRTADPE24-H24 are for 24" deep surfaces and BRTADPE30-H24 are for 30" deep surfaces.
- Width and depth are nominal sizes representing the sizes of the Bridges configuration. Allow for 1/4" overhang at the sides, 1 1/2" at the back and 6 1/4" at the front.
- Please choose any standard paint finish for frame and hardware. End trim cap is available only in CHR - charcoal.
- Can be used as left or right connection.

PRODUCT CODE	PRICE	SIZE/INCHES			WEIGHT LBS	VOL FT ³
		H	W	D		
BRTADPE2436H24	553	24.63	36	31.75	21.05	3.97
BRTADPE2442H24	608	24.63	42	31.75	22.60	4.63
BRTADPE2448H24	630	24.63	48	31.75	24.15	5.29
BRTADPE2454H24	652	24.63	54	31.75	25.70	5.95
BRTADPE2460H24	674	24.63	60	31.75	27.25	6.61
BRTADPE2466H24	697	24.63	66	31.75	28.80	7.28
BRTADPE2472H24	719	24.63	72	31.75	30.35	7.94
BRTADPE2478H24	741	24.63	78	31.75	31.90	8.60
BRTADPE2484H24	763	24.63	84	31.75	33.45	9.26
BRTADPE3036H24	575	24.63	36	37.75	35.00	4.72
BRTADPE3042H24	629	24.63	42	37.75	36.55	5.51
BRTADPE3048H24	652	24.63	48	37.75	38.10	6.29
BRTADPE3054H24	674	24.63	54	37.75	39.65	7.08
BRTADPE3060H24	697	24.63	60	37.75	41.20	7.87
BRTADPE3066H24	718	24.63	66	37.75	42.75	8.65
BRTADPE3072H24	740	24.63	72	37.75	44.30	9.44
BRTADPE3078H24	763	24.63	78	37.75	45.85	10.22
BRTADPE3084H24	787	24.63	84	37.75	47.40	11.01

BRTADPE-H30 • Single Table Polycarbonate Divider Screen Extension Kit, 30" high

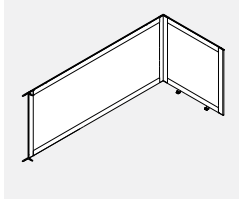

- Provides an extension for privacy in an open plan environment. Intended to always connect to Single Table Divider Screen Kit

- Lightweight and easy to clean table mounted partitions.
- Can be used as left or right connection.
- Consists of a powder coated aluminum frame, translucent fluted polycarbonate and all hardware to connect. Brackets are painted steel.
- Side dividers extend 6.25" from the front edge of each surface.
- Back divider extends over the back edge of the worksurface by 1 1/2" allowing for the passage of cables to the trough.
- BRTADPE24-H24 are for 24" deep surfaces and BRTADPE30-H24 are for 30" deep surfaces.
- Width and depth are nominal sizes representing the sizes of the Bridges configuration. Allow for 1/4" overhang at the sides, 1 1/2" at the back and 6 1/4" at the front.
- Please choose any standard paint finish for frame and hardware. End trim cap is available only in CHR - charcoal.
- Can be used as left or right connection.

PRODUCT CODE	PRICE	SIZE/INCHES			WEIGHT LBS	VOL FT ³
		H	W	D		
BRTADPE2436H30	609	30.63	36	31.75	22.85	3.97
BRTADPE2442H30	667	30.63	42	31.75	24.40	4.63
BRTADPE2448H30	692	30.63	48	31.75	25.95	5.29
BRTADPE2454H30	717	30.63	54	31.75	27.50	5.95
BRTADPE2460H30	743	30.63	60	31.75	29.05	6.61
BRTADPE2466H30	768	30.63	66	31.75	30.60	7.28
BRTADPE2472H30	794	30.63	72	31.75	32.15	7.94
BRTADPE2478H30	821	30.63	78	31.75	33.70	8.60
BRTADPE2484H30	845	30.63	84	31.75	35.25	9.26
BRTADPE3036H30	635	30.63	36	37.75	36.80	4.72
BRTADPE3042H30	692	30.63	42	37.75	38.35	5.51
BRTADPE3048H30	717	30.63	48	37.75	39.90	6.29
BRTADPE3054H30	741	30.63	54	37.75	41.45	7.08
BRTADPE3060H30	768	30.63	60	37.75	43.00	7.87
BRTADPE3066H30	794	30.63	66	37.75	44.55	8.65
BRTADPE3072H30	820	30.63	72	37.75	46.10	9.44
BRTADPE3078H30	845	30.63	78	37.75	47.65	10.22
BRTADPE3084H30	870	30.63	84	37.75	49.20	11.01

BRTADG-H24 • Back 2 Back Glass Divider Screen Kit, 24" high

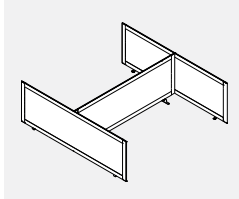

- Provides privacy in an open plan environment.

- Easy to clean table mounted partitions.
- Consists of a powder coated aluminum frame, 4mm clear (CLR) glass and all hardware to connect. Brackets are painted steel.
- Side dividers extend 6.25" from the front edge of each surface.
- Center divider sits over the gap between the worksurface allowing for the passage of cables to the trough. The gap for each side is approximately 1".
- BRTADG51-H24 are for 24" deep surfaces and BRTADG63-H24 are for 30" deep surfaces.
- Width and depth are nominal sizes representing the sizes of the Bridges configuration. Allow for 1/4" overhang at sides and 6 1/4" at front.
- Please choose any standard paint finish for frame and hardware. End trim cap is available only in CHR - charcoal.
- Upcharge for frosted (FRST) glass is 20%

PRODUCT CODE	PRICE	SIZE/INCHES			WEIGHT LBS	VOL FT ³
		H	W	D		
BRTADG5136H24	1389	24.60	36	50.50	33.00	6.31
BRTADG5142H24	1421	24.60	42	50.50	34.50	7.36
BRTADG5148H24	1454	24.60	48	50.50	36.00	8.42
BRTADG5154H24	1488	24.60	54	50.50	37.50	9.47
BRTADG5160H24	1519	24.60	60	50.50	39.00	10.52
BRTADG5166H24	1553	24.60	66	50.50	40.50	11.57
BRTADG5172H24	1585	24.60	72	50.50	42.00	12.63
BRTADG5178H24	1618	24.60	78	50.50	43.50	13.68
BRTADG5184H24	1650	24.60	84	50.50	45.00	14.73
BRTADG6336H24	1519	24.60	36	62.50	46.50	7.81
BRTADG6342H24	1552	24.60	42	62.50	48.00	9.11
BRTADG6348H24	1584	24.60	48	62.50	49.50	10.42
BRTADG6354H24	1617	24.60	54	62.50	51.00	11.72
BRTADG6360H24	1649	24.60	60	62.50	52.50	13.02
BRTADG6366H24	1683	24.60	66	62.50	54.00	14.32
BRTADG6372H24	1714	24.60	72	62.50	55.50	15.63
BRTADG6378H24	1748	24.60	78	62.50	57.00	16.93
BRTADG6384H24	1781	24.60	84	62.50	58.50	18.23

BRTADG-H30 • Back 2 Back Glass Divider Screen Kit, 30" high

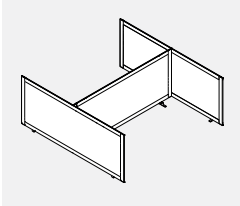

- Provides privacy in an open plan environment.
- Easy to clean table mounted partitions.
- Consists of a powder coated aluminum frame, 4mm clear (CLR) glass and all hardware to connect. Brackets are painted steel.
- Side dividers extend 6.25" from the front edge of each surface.
- Center divider sits over the gap between the worksurface allowing for the passage of cables to the trough. The gap for each side is approximately 1".
- BRTADG51-H30 are for 24" deep surfaces and BRTADG63-H30 are for 30" deep surfaces.
- Width and depth are nominal sizes representing the sizes of the Bridges configuration. Allow for 1/4" overhang at sides and 6 1/4" at front.
- Please choose any standard paint finish for frame and hardware. End trim cap is available only in CHR - charcoal.
- Upcharge for frosted (FRST) glass is 20%.

PRODUCT CODE	PRICE	SIZE/INCHES			WEIGHT LBS	VOL FT ³
		H	W	D		
BRTADG5136H30	1467	30.60	36	50.50	35.50	6.31
BRTADG5142H30	1502	30.60	42	50.50	37.00	7.36
BRTADG5148H30	1535	30.60	48	50.50	38.50	8.42
BRTADG5154H30	1568	30.60	54	50.50	40.00	9.47
BRTADG5160H30	1603	30.60	60	50.50	41.50	10.52
BRTADG5166H30	1635	30.60	66	50.50	43.00	11.57
BRTADG5172H30	1656	30.60	72	50.50	44.50	12.63
BRTADG5178H30	1703	30.60	78	50.50	46.00	13.68
BRTADG5184H30	1736	30.60	84	50.50	47.50	14.73
BRTADG6336H30	1647	30.60	36	62.50	49.00	7.81
BRTADG6342H30	1682	30.60	42	62.50	50.50	9.11
BRTADG6348H30	1714	30.60	48	62.50	52.00	10.42
BRTADG6354H30	1749	30.60	54	62.50	53.50	11.72
BRTADG6360H30	1782	30.60	60	62.50	55.00	13.02
BRTADG6366H30	1815	30.60	66	62.50	56.50	14.32
BRTADG6372H30	1835	30.60	72	62.50	58.00	15.63
BRTADG6378H30	1883	30.60	78	62.50	59.50	16.93
BRTADG6384H30	1917	30.60	84	62.50	61.00	18.23

BRTADG-H24 • Back 2 Back Glass Divider Screen Extension Kit, 24" high

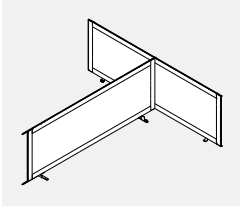

- Provides privacy in an open plan environment.
- Easy to clean table mounted partitions.
- Consists of a powder coated aluminum frame, 4mm clear (CLR) glass and all hardware to connect. Brackets are painted steel.
- Side dividers extend 6.25" from the front edge of each surface.
- Center divider sits over the gap between the worksurface allowing for the passage of cables to the trough. The gap for each side is approximately 1".
- BRTADG51-H30 are for 24" deep surfaces and BRTADG63-H30 are for 30" deep surfaces.
- Width and depth are nominal sizes representing the sizes of the Bridges configuration. Allow for 1/4" overhang at sides and 6 1/4" at front.
- Please choose any standard paint finish for frame and hardware. End trim cap is available only in CHR - charcoal.
- Upcharge for frosted (FRST) glass is 20%.
- Can be used as left or right connection.

PRODUCT CODE	PRICE	SIZE/INCHES			WEIGHT LBS	VOL FT ³
		H	W	D		
BRTADGE5136H24	916	24.60	36	50.50	26.35	6.31
BRTADGE5142H24	949	24.60	42	50.50	27.85	7.36
BRTADGE5148H24	982	24.60	48	50.50	29.35	8.42
BRTADGE5154H24	1015	24.60	54	50.50	30.85	9.47
BRTADGE5160H24	1047	24.60	60	50.50	32.35	10.52
BRTADGE5166H24	1080	24.60	66	50.50	33.85	11.57
BRTADGE5172H24	1113	24.60	72	50.50	35.35	12.63
BRTADGE5178H24	1144	24.60	78	50.50	36.85	13.68
BRTADGE5184H24	1177	24.60	84	50.50	38.35	14.73
BRTADGE6336H24	982	24.60	36	62.50	39.85	7.81
BRTADGE6342H24	1013	24.60	42	62.50	41.35	9.11
BRTADGE6348H24	1047	24.60	48	62.50	42.85	10.42
BRTADGE6354H24	1077	24.60	54	62.50	44.35	11.72
BRTADGE6360H24	1111	24.60	60	62.50	45.85	13.02
BRTADGE6366H24	1144	24.60	66	62.50	47.35	14.32
BRTADGE6372H24	1176	24.60	72	62.50	48.85	15.63
BRTADGE6378H24	1209	24.60	78	62.50	50.35	16.93
BRTADGE6384H24	1242	24.60	84	62.50	51.85	18.23

BRTADG-H30 • Back 2 Back Glass Divider Screen Extension Kit, 30" high

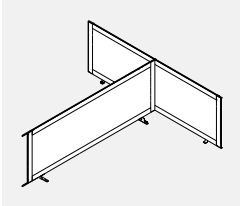

- Provides an extension for privacy in an open plan environment. Intended to always connect to Back 2 Back Divider Screen Kit
- Easy to clean table mounted partitions.
- Consists of a powder coated aluminum frame, 4mm clear (CLR) glass and all hardware to connect. Brackets are painted steel.
- Side dividers extend 6.25" from the front edge of each surface.
- Center divider sits over the gap between the worksurface allowing for the passage of cables to the trough. The gap for each side is approximately 1".
- BRTADGE51-H30 are for 24" deep surfaces and BRTADGE63-H30 are for 30" deep surfaces.
- Width and depth are nominal sizes representing the sizes of the Bridges configuration. Allow for 1/4" overhang at sides and 6 1/4" at front.
- Please choose any standard paint finish for frame and hardware. End trim cap is available only in CHR - charcoal.
- Upcharge for frosted (FRST) glass is 20%.
- Can be used as left or right connection.

PRODUCT CODE	PRICE	SIZE/INCHES			WEIGHT LBS	VOL FT ³
		H	W	D		
BRTADGE5136H30	966	30.60	36	50.50	28.85	6.31
BRTADGE5142H30	999	30.60	42	50.50	30.35	7.36
BRTADGE5148H30	1033	30.60	48	50.50	31.85	8.42
BRTADGE5154H30	1067	30.60	54	50.50	33.35	9.47
BRTADGE5160H30	1100	30.60	60	50.50	34.85	10.52
BRTADGE5166H30	1134	30.60	66	50.50	36.35	11.57
BRTADGE5172H30	1154	30.60	72	50.50	37.85	12.63
BRTADGE5178H30	1201	30.60	78	50.50	39.35	13.68
BRTADGE5184H30	1235	30.60	84	50.50	40.85	14.73
BRTADGE6336H30	1032	30.60	36	62.50	42.35	7.81
BRTADGE6342H30	1067	30.60	42	62.50	43.85	9.11
BRTADGE6348H30	1099	30.60	48	62.50	45.35	10.42
BRTADGE6354H30	1133	30.60	54	62.50	46.85	11.72
BRTADGE6360H30	1166	30.60	60	62.50	48.35	13.02
BRTADGE6366H30	1200	30.60	66	62.50	49.85	14.32
BRTADGE6372H30	1221	30.60	72	62.50	51.35	15.63
BRTADGE6378H30	1267	30.60	78	62.50	52.85	16.93
BRTADGE6384H30	1301	30.60	84	62.50	54.35	18.23

BRTADG-H24 • Single Table Glass Divider Screen Kit, 24" high

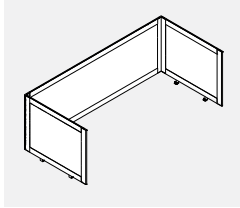

- Provides privacy in an open plan environment.
- Easy to clean table mounted partitions.
- Consists of a powder coated aluminum frame, 4mm clear (CLR) glass and all hardware to connect. Brackets are painted steel.
- Side dividers extend 6.25" from the front edge of each surface.
- Back divider extends over the back edge of the worksurface by 1 1/2" allowing for the passage of cables to the trough.
- BRTADG24-H24 are for 24" deep surfaces and BRTADG30-H24 are for 30" deep surfaces.
- Width and depth are nominal sizes representing the sizes of the Bridges configuration. Allow for 1/4" overhang at the sides, 1 1/2" at the back and 6 1/4" at the front.
- Please choose any standard paint finish for frame and hardware. End trim cap is available only in CHR - charcoal.
- Upcharge for frosted (FRST) glass is 20%.

PRODUCT CODE	PRICE	SIZE/INCHES			WEIGHT LBS	VOL FT ³
		H	W	D		
BRTADG2436H24	1003	24.60	36	31.50	26.55	3.94
BRTADG2442H24	1035	24.60	42	31.50	28.10	4.59
BRTADG2448H24	1068	24.60	48	31.50	29.65	5.25
BRTADG2454H24	1100	24.60	54	31.50	31.20	5.91
BRTADG2460H24	1134	24.60	60	31.50	32.75	6.56
BRTADG2466H24	1165	24.60	66	31.50	34.30	7.22
BRTADG2472H24	1199	24.60	72	31.50	35.85	7.88
BRTADG2478H24	1230	24.60	78	31.50	37.40	8.53
BRTADG2484H24	1264	24.60	84	31.50	38.95	9.19
BRTADG3036H24	1064	24.60	36	37.75	40.50	4.72
BRTADG3042H24	1097	24.60	42	37.75	42.05	5.51
BRTADG3048H24	1131	24.60	48	37.75	43.60	6.29
BRTADG3054H24	1163	24.60	54	37.75	45.15	7.08
BRTADG3060H24	1196	24.60	60	37.75	46.70	7.87
BRTADG3066H24	1228	24.60	66	37.75	48.25	8.65
BRTADG3072H24	1261	24.60	72	37.75	49.80	9.44
BRTADG3078H24	1293	24.60	78	37.75	51.35	10.22
BRTADG3084H24	1327	24.60	84	37.75	52.90	11.01

BRTADG-H30 • Single Table Glass Divider Screen Kit, 30" high

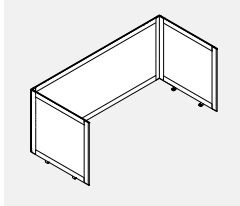

- Provides privacy in an open plan environment.
- Easy to clean table mounted partitions.
- Consists of a powder coated aluminum frame, 4mm clear (CLR) glass and all hardware to connect. Brackets are painted steel.
- Side dividers extend 6.25" from the front edge of each surface.
- Back divider extends over the back edge of the worksurface by 1 1/2" allowing for the passage of cables to the trough.
- BRTADG24-H30 are for 24" deep surfaces and BRTADG30-H30 are for 30" deep surfaces.
- Width and depth are nominal sizes representing the sizes of the Bridges configuration. Allow for 1/4" overhang at the sides, 1 1/2" at the back and 6 1/4" at the front.
- Please choose any standard paint finish for frame and hardware. End trim cap is available only in CHR - charcoal.
- Upcharge for frosted (FRST) glass is 20%.

PRODUCT CODE	PRICE	SIZE/INCHES			WEIGHT LBS	VOL FT ³
		H	W	D		
BRTADG2436H30	1042	30.60	36	31.50	28.85	3.94
BRTADG2442H30	1076	30.60	42	31.50	30.40	4.59
BRTADG2448H30	1110	30.60	48	31.50	31.95	5.25
BRTADG2454H30	1144	30.60	54	31.50	33.50	5.91
BRTADG2460H30	1177	30.60	60	31.50	35.05	6.56
BRTADG2466H30	1212	30.60	66	31.50	36.60	7.22
BRTADG2472H30	1230	30.60	72	31.50	38.15	7.88
BRTADG2478H30	1279	30.60	78	31.50	39.70	8.53
BRTADG2484H30	1313	30.60	84	31.50	41.25	9.19
BRTADG3036H30	1110	30.60	36	37.75	42.80	4.72
BRTADG3042H30	1143	30.60	42	37.75	44.35	5.51
BRTADG3048H30	1176	30.60	48	37.75	45.90	6.29
BRTADG3054H30	1210	30.60	54	37.75	47.45	7.08
BRTADG3060H30	1243	30.60	60	37.75	49.00	7.87
BRTADG3066H30	1279	30.60	66	37.75	50.55	8.65
BRTADG3072H30	1297	30.60	72	37.75	52.10	9.44
BRTADG3078H30	1345	30.60	78	37.75	53.65	10.22
BRTADG3084H30	1379	30.60	84	37.75	55.20	11.01

BRTADGE-H24 • Single Table Glass Divider Screen Extension Kit, 24" high

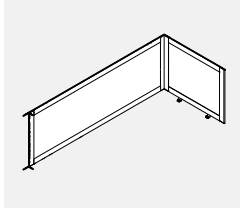

- Provides an extension for privacy in an open plan environment. Intended to always connect to Single Table Divider Screen Kit
- Lightweight and easy to clean table mounted partitions.
- Consists of a powder coated aluminum frame, 4mm clear (CLR) glass and all hardware to connect. Brackets are painted steel.
- Side dividers extend 6.25" from the front edge of each surface.
- Back divider extends over the back edge of the worksurface by 1 1/2" allowing for the passage of cables to the trough.
- BRTADGE24-H24 are for 24" deep surfaces and BRTADGE30-H24 are for 30" deep surfaces.
- Width and depth are nominal sizes representing the sizes of the Bridges configuration. Allow for 1/4" overhang at the sides, 1 1/2" at the back and 6 1/4" at the front.
- Please choose any standard paint finish for frame and hardware. End trim cap is available only in CHR - charcoal.
- Upcharge for frosted (FRST) glass is 20%.
- Can be used as left or right connection.

PRODUCT CODE	PRICE	SIZE/INCHES			WEIGHT LBS	VOL FT ³
		H	W	D		
BRTADGE2436H24	716	24.60	36	31.50	21.05	3.94
BRTADGE2442H24	781	24.60	42	31.50	22.60	4.59
BRTADGE2448H24	815	24.60	48	31.50	24.15	5.25
BRTADGE2454H24	845	24.60	54	31.50	25.70	5.91
BRTADGE2460H24	879	24.60	60	31.50	27.25	6.56
BRTADGE2466H24	910	24.60	66	31.50	28.80	7.22
BRTADGE2472H24	944	24.60	72	31.50	30.35	7.88
BRTADGE2478H24	975	24.60	78	31.50	31.90	8.53
BRTADGE2484H24	1009	24.60	84	31.50	33.45	9.19
BRTADGE3036H24	754	24.60	36	37.75	35.00	4.72
BRTADGE3042H24	817	24.60	42	37.75	36.55	5.51
BRTADGE3048H24	850	24.60	48	37.75	38.10	6.29
BRTADGE3054H24	883	24.60	54	37.75	39.65	7.08
BRTADGE3060H24	915	24.60	60	37.75	41.20	7.87
BRTADGE3066H24	948	24.60	66	37.75	42.75	8.65
BRTADGE3072H24	982	24.60	72	37.75	44.30	9.44
BRTADGE3078H24	1013	24.60	78	37.75	45.85	10.22
BRTADGE3084H24	1047	24.60	84	37.75	47.40	11.01

BRTADGE-H30 • Single Table Glass Divider Screen Extension Kit, 30" high

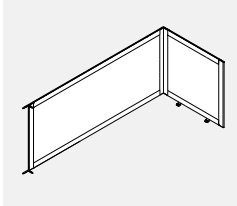

- Provides an extension for privacy in an open plan environment. Intended to always connect to Single Table Divider Screen Kit

- Easy to clean table mounted partitions.
- Consists of a powder coated aluminum frame, 4mm clear (CLR) glass and all hardware to connect. Brackets are painted steel.
- Side dividers extend 6.25" from the front edge of each surface.
- Back divider extends over the back edge of the worksurface by 1 1/2" allowing for the passage of cables to the trough.
- BRTADGE24-H30 are for 24" deep surfaces and BRTADGE30-H30 are for 30" deep surfaces.
- Width and depth are nominal sizes representing the sizes of the Bridges configuration. Allow for 1/4" overhang at the sides, 1 1/2" at the back and 6 1/4" at the front.
- Please choose any standard paint finish for frame and hardware. End trim cap is available only in CHR - charcoal.
- Upcharge for frosted (FRST) glass is 20%.
- Can be used as left or right connection.

PRODUCT CODE	PRICE	SIZE/INCHES			WEIGHT LBS	VOL FT ³
		H	W	D		
BRTADGE2436H30	752	30.60	36	31.50	22.85	3.94
BRTADGE2442H30	818	30.60	42	31.50	24.40	4.59
BRTADGE2448H30	851	30.60	48	31.50	25.95	5.25
BRTADGE2454H30	886	30.60	54	31.50	27.50	5.91
BRTADGE2460H30	920	30.60	60	31.50	29.05	6.56
BRTADGE2466H30	953	30.60	66	31.50	30.60	7.22
BRTADGE2472H30	971	30.60	72	31.50	32.15	7.88
BRTADGE2478H30	1020	30.60	78	31.50	33.70	8.53
BRTADGE2484H30	1055	30.60	84	31.50	35.25	9.19
BRTADGE3036H30	785	30.60	36	37.75	36.80	4.72
BRTADGE3042H30	851	30.60	42	37.75	38.35	5.51
BRTADGE3048H30	884	30.60	48	37.75	39.90	6.29
BRTADGE3054H30	920	30.60	54	37.75	41.45	7.08
BRTADGE3060H30	953	30.60	60	37.75	43.00	7.87
BRTADGE3066H30	986	30.60	66	37.75	44.55	8.65
BRTADGE3072H30	1005	30.60	72	37.75	46.10	9.44
BRTADGE3078H30	1054	30.60	78	37.75	47.65	10.22
BRTADGE3084H30	1088	30.60	84	37.75	49.20	11.01

BRTADF-H24 • Back 2 Back Felt Divider Screen Kit, 24" high

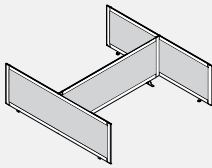

- Provides privacy in an open plan environment.
- Consists of a powder coated aluminum frame, 9mm felt and all hardware to connect. Brackets are painted steel.
- Side dividers extend 6.25" from the front edge of each surface.
- Center divider sits over the gap between the worksurface allowing for the passage of • cables to the trough. The gap for each side is approximately 1".
- BRTADF51-H24 are for 24" deep surfaces and BRTADF63-H24 are for 30" deep surfaces.
- Width and depth are nominal sizes representing the sizes of the Bridges configuration. Allow for 1/4" overhang at sides and 6 1/4" at front.
- Please choose any standard paint finish for frame and hardware. End trim cap is available only in CHR - charcoal.
- 9mm felt material is tackable and comes in a variety of colors.

PRODUCT CODE	PRICE	SIZE/INCHES			WEIGHT LBS	VOL FT ³
		H	W	D		
BRTADF5136H24	890	24.60	36	50.50	28.00	6.31
BRTADF5142H24	905	24.60	42	50.50	29.50	7.36
BRTADF5148H24	923	24.60	48	50.50	31.00	8.42
BRTADF5154H24	936	24.60	54	50.50	32.50	9.47
BRTADF5160H24	957	24.60	60	50.50	34.00	10.52
BRTADF5166H24	974	24.60	66	50.50	35.50	11.57
BRTADF5172H24	992	24.60	72	50.50	37.00	12.63
BRTADF5178H24	1010	24.60	78	50.50	38.50	13.68
BRTADF5184H24	1043	24.60	84	50.50	40.00	14.73
BRTADF6336H24	957	24.60	36	62.50	41.50	7.81
BRTADF6342H24	974	24.60	42	62.50	43.00	9.11
BRTADF6348H24	992	24.60	48	62.50	44.50	10.42
BRTADF6354H24	1009	24.60	54	62.50	46.00	11.72
BRTADF6360H24	1026	24.60	60	62.50	47.50	13.02
BRTADF6366H24	1043	24.60	66	62.50	49.00	14.32
BRTADF6372H24	1060	24.60	72	62.50	50.50	15.63
BRTADF6378H24	1077	24.60	78	62.50	52.00	16.93
BRTADF6384H24	1111	24.60	84	62.50	53.50	18.23

BRTADF-H30 • Back 2 Back Felt Divider Screen Kit, 30" high

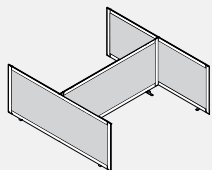

- Provides privacy in an open plan environment.
- Consists of a powder coated aluminum frame, 9mm felt and all hardware to connect. Brackets are painted steel.
- Side dividers extend 6.25" from the front edge of each surface.
- Center divider sits over the gap between the worksurface allowing for the passage of • cables to the trough. The gap for each side is approximately 1".
- BRTADF51-H30 are for 24" deep surfaces and BRTADF63-H30 are for 30" deep surfaces.
- Width and depth are nominal sizes representing the sizes of the Bridges configuration. Allow for 1/4" overhang at sides and 6 1/4" at front.
- Please choose any standard paint finish for frame and hardware. End trim cap is available only in CHR - charcoal.
- 9mm felt material is tackable and comes in a variety of colors.

PRODUCT CODE	PRICE	SIZE/INCHES			WEIGHT LBS	VOL FT ³
		H	W	D		
BRTADF5136H30	890	30.60	36	50.50	30.50	6.31
BRTADF5142H30	905	30.60	42	50.50	32.00	7.36
BRTADF5148H30	923	30.60	48	50.50	33.50	8.42
BRTADF5154H30	936	30.60	54	50.50	35.00	9.47
BRTADF5160H30	957	30.60	60	50.50	36.50	10.52
BRTADF5166H30	974	30.60	66	50.50	38.00	11.57
BRTADF5172H30	992	30.60	72	50.50	39.50	12.63
BRTADF5178H30	1010	30.60	78	50.50	41.00	13.68
BRTADF5184H30	1043	30.60	84	50.50	42.50	14.73
BRTADF6336H30	957	30.60	36	62.50	44.00	7.81
BRTADF6342H30	974	30.60	42	62.50	45.50	9.11
BRTADF6348H30	992	30.60	48	62.50	47.00	10.42
BRTADF6354H30	1009	30.60	54	62.50	48.50	11.72
BRTADF6360H30	1026	30.60	60	62.50	50.00	13.02
BRTADF6366H30	1043	30.60	66	62.50	51.50	14.32
BRTADF6372H30	1060	30.60	72	62.50	53.00	15.63
BRTADF6378H30	1077	30.60	78	62.50	54.50	16.93
BRTADF6384H30	1111	30.60	84	62.50	56.00	18.23

BRTADFE-H24 • Back 2 Back Felt Divider Screen Extension Kit, 24" high

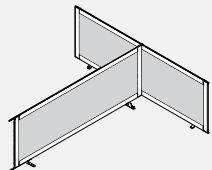

- Provides an extension for privacy in an open plan environment. Intended to always connect to Back 2 Back Divider Screen Kit.
- Consists of a powder coated aluminum frame, 9mm felt and all hardware to connect. Brackets are painted steel.
- Side dividers extend 6.25" from the front edge of each surface.
- Center divider sits over the gap between the worksurface allowing for the passage of • cables to the trough. The gap for each side is approximately 1".
- BRTADFE51-H24 are for 24" deep surfaces and BRTADFE63-H24 are for 30" deep surfaces.
- Width and depth are nominal sizes representing the sizes of the Bridges configuration. Allow for 1/4" overhang at sides and 6 1/4" at front.
- Please choose any standard paint finish for frame and hardware. End trim cap is available only in CHR - charcoal.
- 9mm felt material is tackable and comes in a variety of colors.
- Can be used as left or right connection.

PRODUCT CODE	PRICE	SIZE/INCHES			WEIGHT LBS	VOL FT ³
		H	W	D		
BRTADFE5136H24	605	24.60	36	50.50	23.35	6.31
BRTADFE5142H24	624	24.60	42	50.50	24.85	7.36
BRTADFE5148H24	639	24.60	48	50.50	26.35	8.42
BRTADFE5154H24	658	24.60	54	50.50	27.85	9.47
BRTADFE5160H24	674	24.60	60	50.50	29.35	10.52
BRTADFE5166H24	692	24.60	66	50.50	30.85	11.57
BRTADFE5172H24	710	24.60	72	50.50	32.35	12.63
BRTADFE5178H24	726	24.60	78	50.50	33.85	13.68
BRTADFE5184H24	761	24.60	84	50.50	35.35	14.73
BRTADFE6336H24	638	24.60	36	62.50	36.85	7.81
BRTADFE6342H24	656	24.60	42	62.50	38.35	9.11
BRTADFE6348H24	673	24.60	48	62.50	39.85	10.42
BRTADFE6354H24	691	24.60	54	62.50	41.35	11.72
BRTADFE6360H24	706	24.60	60	62.50	42.85	13.02
BRTADFE6366H24	725	24.60	66	62.50	44.35	14.32
BRTADFE6372H24	741	24.60	72	62.50	45.85	15.63
BRTADFE6378H24	760	24.60	78	62.50	47.35	16.93
BRTADFE6384H24	794	24.60	84	62.50	48.85	18.23

BRTADFE-H30 • Back 2 Back Felt Divider Screen Extension Kit, 30" high

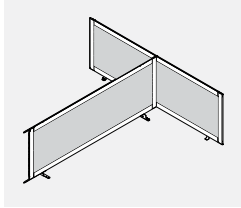

- Provides an extension for privacy in an open plan environment. Intended to always connect to Back 2 Back Divider Screen Kit.

- Consists of a powder coated aluminum frame, 9mm felt and all hardware to connect. Brackets are painted steel.
- Side dividers extend 6.25" from the front edge of each surface.
- Center divider sits over the gap between the worksurface allowing for the passage of • cables to the trough. The gap for each side is approximately 1".
- BRTADFE51-H30 are for 24" deep surfaces and BRTADFE63-H30 are for 30" deep surfaces.
- Width and depth are nominal sizes representing the sizes of the Bridges configuration. Allow for 1/4" overhang at sides and 6 1/4" at front.
- Please choose any standard paint finish for frame and hardware. End trim cap is available only in CHR - charcoal.
- 9mm felt material is tackable and comes in a variety of colors.
- Can be used as left or right connection.

PRODUCT CODE	PRICE	SIZE/INCHES			WEIGHT LBS	VOL FT³
		H	W	D		
BRTADFE5136H30	605	30.60	36	50.50	25.85	6.31
BRTADFE5142H30	624	30.60	42	50.50	27.35	7.36
BRTADFE5148H30	639	30.60	48	50.50	28.85	7.42
BRTADFE5154H30	658	30.60	54	50.50	30.35	9.47
BRTADFE5160H30	674	30.60	60	50.50	31.85	10.52
BRTADFE5166H30	692	30.60	66	50.50	33.35	11.57
BRTADFE5172H30	710	30.60	72	50.50	34.85	12.63
BRTADFE5178H30	726	30.60	78	50.50	36.35	13.68
BRTADFE5184H30	761	30.60	84	50.50	37.85	14.73
BRTADFE6336H30	638	30.60	36	62.50	39.35	7.81
BRTADFE6342H30	656	30.60	42	62.50	40.85	9.11
BRTADFE6348H30	673	30.60	48	62.50	42.35	10.42
BRTADFE6354H30	691	30.60	54	62.50	43.85	11.72
BRTADFE6360H30	706	30.60	60	62.50	45.35	13.02
BRTADFE6366H30	725	30.60	66	62.50	46.85	14.32
BRTADFE6372H30	741	30.60	72	62.50	48.35	15.63
BRTADFE6378H30	760	30.60	78	62.50	49.85	16.93
BRTADFE6384H30	794	30.60	84	62.50	51.35	18.23

BRTADF-H24 • Single Table Divider Felt Screen Kit, 24" high

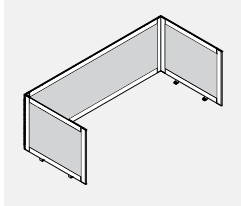

- Provides privacy in an open plan environment.

- Consists of a powder coated aluminum frame, 9mm felt and all hardware to connect. Brackets are painted steel.
- Side dividers extend 6.237" from the front edge of each surface.
- Back divider extends over the back edge of the worksurface by 1 1/2" allowing for the passage of cables to the trough.
- BRTADF24-H24 are for 24" deep surfaces and BRTADF30-H24 are for 30" deep surfaces.
- Width and depth are nominal sizes representing the sizes of the FreeFit Table. Allow for 1/4" overhang at the sides, 1 1/2" at the back and 6.237" at the front.
- Please choose any standard paint finish for frame and hardware. End trim cap is available only in CHR - charcoal.
- 9mm felt material is tackable and comes in a variety of colors.

PRODUCT CODE	PRICE	SIZE/INCHES			WEIGHT LBS	VOL FT³
		H	W	D		
BRTADF2436H24	647	24.60	36	31.50	22.55	3.94
BRTADF2442H24	663	24.60	42	31.50	24.10	4.59
BRTADF2448H24	681	24.60	48	31.50	25.65	5.25
BRTADF2454H24	699	24.60	54	31.50	27.20	5.91
BRTADF2460H24	716	24.60	60	31.50	28.75	6.56
BRTADF2466H24	733	24.60	66	31.50	30.30	7.22
BRTADF2472H24	751	24.60	72	31.50	31.85	7.88
BRTADF2478H24	767	24.60	78	31.50	33.40	8.53
BRTADF2484H24	802	24.60	84	31.50	34.95	9.19
BRTADF3036H24	669	24.60	36	37.75	36.50	4.72
BRTADF3042H24	688	24.60	42	37.75	38.05	5.51
BRTADF3048H24	703	24.60	48	37.75	39.60	6.29
BRTADF3054H24	722	24.60	54	37.75	41.15	7.08
BRTADF3060H24	738	24.60	60	37.75	41.70	7.87
BRTADF3066H24	756	24.60	66	37.75	44.25	8.65
BRTADF3072H24	773	24.60	72	37.75	45.80	9.44
BRTADF3078H24	790	24.60	78	37.75	47.35	10.22
BRTADF3084H24	825	24.60	84	37.75	48.90	11.01

BRTADF-H30 • Single Table Divider Felt Screen Kit, 30" high

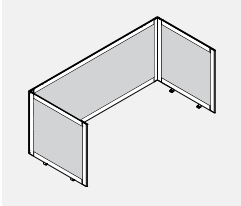

- Provides privacy in an open plan environment.

- Consists of a powder coated aluminum frame, 9mm felt and all hardware to connect. Brackets are painted steel.
- Side dividers extend 6.237" from the front edge of each surface.
- Back divider extends over the back edge of the worksurface by 1 1/2" allowing for the passage of cables to the trough.
- BRTADF24-H30 are for 24" deep surfaces and BRTADF30-H30 are for 30" deep surfaces.
- Width and depth are nominal sizes representing the sizes of the FreeFit Table. Allow for 1/4" overhang at the sides, 1 1/2" at the back and 6.237" at the front.
- Please choose any standard paint finish for frame and hardware. End trim cap is available only in CHR - charcoal.
- 9mm felt material is tackable and comes in a variety of colors.

PRODUCT CODE	PRICE	SIZE/INCHES			WEIGHT LBS	VOL FT³
		H	W	D		
BRTADF2436H30	647	30.60	36	31.50	24.85	3.94
BRTADF2442H30	663	30.60	42	31.50	26.40	4.59
BRTADF2448H30	681	30.60	48	31.50	27.95	5.25
BRTADF2454H30	699	30.60	54	31.50	29.50	5.91
BRTADF2460H30	716	30.60	60	31.50	31.05	6.56
BRTADF2466H30	733	30.60	66	31.50	32.60	7.22
BRTADF2472H30	751	30.60	72	31.50	34.14	7.88
BRTADF2478H30	767	30.60	78	31.50	34.70	8.53
BRTADF2484H30	802	30.60	84	31.50	37.25	9.19
BRTADF3036H30	669	30.60	36	37.75	38.80	4.72
BRTADF3042H30	688	30.60	42	37.75	40.35	5.51
BRTADF3048H30	703	30.60	48	37.75	41.90	6.29
BRTADF3054H30	722	30.60	54	37.75	43.45	7.08
BRTADF3060H30	738	30.60	60	37.75	45.00	7.87
BRTADF3066H30	756	30.60	66	37.75	46.55	8.65
BRTADF3072H30	773	30.60	72	37.75	48.10	9.44
BRTADF3078H30	790	30.60	78	37.75	49.65	10.22
BRTADF3084H30	825	30.60	84	37.75	51.20	11.01

BRTADFE-H24 • Single Table Felt Divider Screen Extension Kit, 24" high

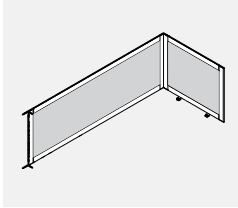

- Provides an extension for privacy in an open plan environment. Intended to always connect to Single Table Divider Screen Kit
- Consists of a powder coated aluminum frame, 9mm felt and all hardware to connect. Brackets are painted steel.
- Side dividers extend 6.237" from the front edge of each surface.
- Back divider extends over the back edge of the worksurface by 1 1/2" allowing for the passage of cables to the trough.
- BRTADFE24-H24 are for 24" deep surfaces and BRTADFE30-H24 are for 30" deep surfaces.
- Width and depth are nominal sizes representing the sizes of the FreeFit Table. Allow for 1/4" overhang at the sides, 1 1/2" at the back and 6.237" at the front.
- Please choose any standard paint finish for frame and hardware. End trim cap is available only in CHR - charcoal.
- 9mm felt material is tackable and comes in a variety of colors.
- Can be used as left or right connection.

PRODUCT CODE	PRICE	SIZE/INCHES			WEIGHT LBS	VOL FT ³
		H	W	D		
BRTADFE2436H24	488	24.60	36	31.50	18.55	3.94
BRTADFE2442H24	536	24.60	42	31.50	20.10	4.59
BRTADFE2448H24	553	24.60	48	31.50	21.65	5.25
BRTADFE2454H24	571	24.60	54	31.50	23.20	5.91
BRTADFE2460H24	589	24.60	60	31.50	24.75	6.56
BRTADFE2466H24	605	24.60	66	31.50	26.30	7.22
BRTADFE2472H24	624	24.60	72	31.50	27.85	7.88
BRTADFE2478H24	639	24.60	78	31.50	29.40	8.53
BRTADFE2484H24	674	24.60	84	31.50	30.95	9.19
BRTADFE3036H24	507	24.60	36	37.75	32.50	4.72
BRTADFE3042H24	556	24.60	42	37.75	34.05	5.51
BRTADFE3048H24	572	24.60	48	37.75	35.60	6.29
BRTADFE3054H24	590	24.60	54	37.75	37.15	7.08
BRTADFE3060H24	607	24.60	60	37.75	38.70	7.87
BRTADFE3066H24	625	24.60	66	37.75	40.25	8.65
BRTADFE3072H24	640	24.60	72	37.75	41.80	9.44
BRTADFE3078H24	659	24.60	78	37.75	43.35	10.22
BRTADFE3084H24	693	24.60	84	37.75	44.90	11.01

BRTADFE-H30 • Single Table Felt Divider Screen Extension Kit, 30" high

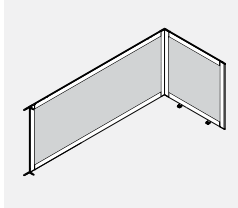

- Provides an extension for privacy in an open plan environment. Intended to always connect to Single Table Divider Screen Kit
- Consists of a powder coated aluminum frame, 9mm felt and all hardware to connect. Brackets are painted steel.
- Side dividers extend 6.237" from the front edge of each surface.
- Back divider extends over the back edge of the worksurface by 1 1/2" allowing for the passage of cables to the trough.
- BRTADFE24-H30 are for 24" deep surfaces and BRTADFE30-H30 are for 30" deep surfaces.
- Width and depth are nominal sizes representing the sizes of the FreeFit Table. Allow for 1/4" overhang at the sides, 1 1/2" at the back and 6.237" at the front.
- Please choose any standard paint finish for frame and hardware. End trim cap is available only in CHR - charcoal.
- 9mm felt material is tackable and comes in a variety of colors.
- Can be used as left or right connection.

PRODUCT CODE	PRICE	SIZE/INCHES			WEIGHT LBS	VOL FT ³
		H	W	D		
BRTADFE2436H30	488	30.60	36	31.50	20.35	3.94
BRTADFE2442H30	536	30.60	42	31.50	21.90	4.59
BRTADFE2448H30	553	30.60	48	31.50	23.45	5.25
BRTADFE2454H30	571	30.60	54	31.50	25.00	5.91
BRTADFE2460H30	589	30.60	60	31.50	26.55	6.56
BRTADFE2466H30	605	30.60	66	31.50	28.10	7.22
BRTADFE2472H30	624	30.60	72	31.50	29.65	7.88
BRTADFE2478H30	639	30.60	78	31.50	31.20	8.53
BRTADFE2484H30	674	30.60	84	31.50	32.75	9.19
BRTADFE3036H30	507	30.60	36	37.75	34.30	4.72
BRTADFE3042H30	556	30.60	42	37.75	35.85	5.51
BRTADFE3048H30	572	30.60	48	37.75	37.40	6.29
BRTADFE3054H30	590	30.60	54	37.75	38.95	7.08
BRTADFE3060H30	607	30.60	60	37.75	40.50	7.87
BRTADFE3066H30	625	30.60	66	37.75	42.05	8.65
BRTADFE3072H30	640	30.60	72	37.75	43.60	9.44
BRTADFE3078H30	659	30.60	78	37.75	45.15	10.22
BRTADFE3084H30	693	30.60	84	37.75	46.70	11.01

BRTADPCPP4 • Back 2 Back Ceiling Feed Pole Kit

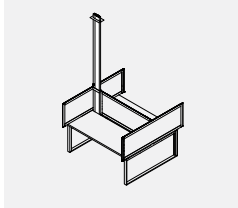

- Ceiling pole brings ceiling feed conduit and data cables from the ceiling to Power Troughs at desk height.
- To be used in conjunction with BRTCF - Bridges Ceiling Feed.
- A two part construction allows for power/data conduit lay-in.
- Includes mounting hardware and ceiling bezel, painted finish.
- Please specify the center divider 6" shorter when using the Ceiling Feed Pole Kit.

PRODUCT CODE	PRICE	SIZE/INCHES			WEIGHT LBS	VOL FT ³
		H	W	D		
BRTADPCPP	275	99	4.75	1.50	13.00	0.48

BRTMKIT • Screen Middle Kit

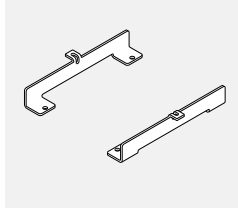

- Kit to be used with Bridges Screen Divider when the End Table Shelf is used.
- During installation, remove the end cap brackets and install the BRTMKIT instead.

PRODUCT CODE	PRICE	SIZE/INCHES			WEIGHT LBS	VOL FT ³
		H	W	D		
BRTMKIT	24	2	2	2	0.50	0.01

Storage Assembly

For a complete storage assembly, one must specify a top, a chassis and legs.

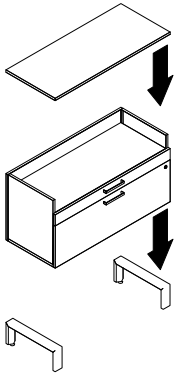

- 1 - BRT29LOBF-U
- 1 - BRTWU
- 2 - BRT-LEGL

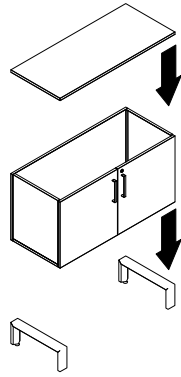

- 1 - BRT29L2D-U
- 1 - BRTWU
- 2 - BRT-LEGL

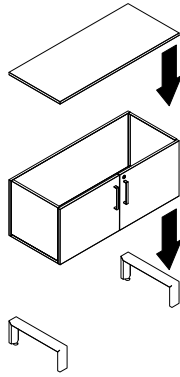

- 1 - BRT25L2D-U
- 1 - BRTWU
- 2 - BRT-LEGL

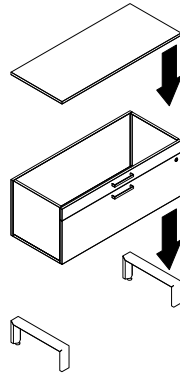

- 1 - BRT25LBF-U
- 1 - BRTWU
- 2 - BRT-LEGL

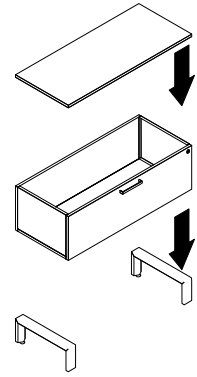

- 1 - BRT21F-U
- 1 - BRTWU
- 2 - BRT-LEGL

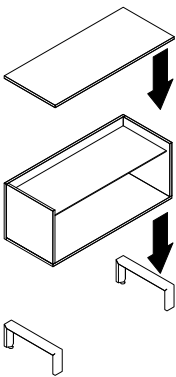
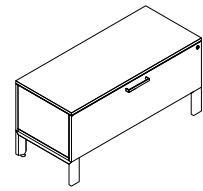
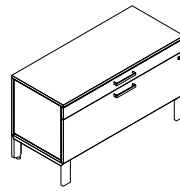
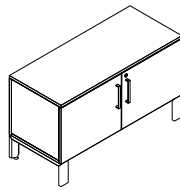
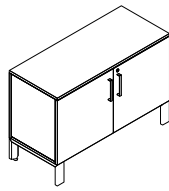
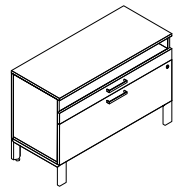

- 1 - BRT25LO-U
- 1 - BRTWU
- 2 - BRT-LEGL

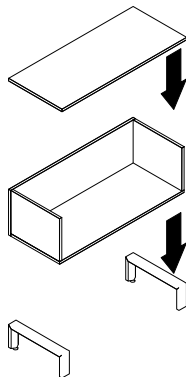

- 1 - BRT21LO-U
- 1 - BRTWU
- 2 - BRTLEGL

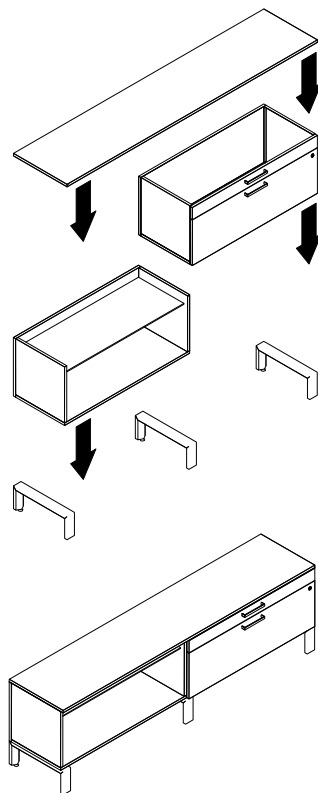

- For larger assemblies, legs may be shared.
- 1 - BRT25LO-U
 - 1 - BRT25LBF-U
 - 1 - BRTWU - ensuring the width of the surface equal the combined width of both storage chassis
 - 3 - BRT-LEGL

BRT21BF • 21" File Pedestal

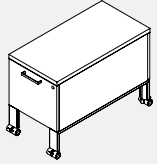
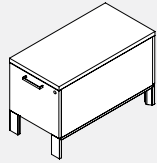

Fits below Bridges tables

- Can join with other 21" high storage units of corresponding depth to form a spine or slides out on casters to serve as an additional worksurface.
- Floor clearance allows for access to panel floor raceway duplex outlets; units on levelers accommodate installation of an optional Cable Basket to manage cords and data cables under storage spine.
- One file drawer (holds letter, legal and A4 suspended file folders except 18" pedestals).
- Optional Cable Basket suspends off storage unit's bottom and manages cables along the horizontal plane. (NO CASTER models only)
- Fits under table beams even with optional seat cushion.
- LP chassis and drawer fronts (specify LP finish) 1" top (specify LP or HP finish); metal handles, powder coated aluminum or anodized aluminum legs specify 5/16x2" levelers or 40mm white/grey, locking casters.
- Anodized aluminum leg upcharge \$55.
- Optional e-lock available in the vertical position. Please specify V-Vertical and add \$224 list.

PRODUCT CODE	PRICE		SIZE/INCHES			WEIGHT VOL	
	LP	HP	H	W	D	LBS	FT ³
Levelers							
BRT21BF18L	710	760	21	15.5	18	58	3.39
BRT21BF24L	825	870	21	15.5	24	64	4.52
BRT21BF30L	903	969	21	15.5	30	72	5.65
Casters							
BRT21BF18C	710	760	21	15.5	18	58	3.39
BRT21BF24C	825	870	21	15.5	24	64	4.52
BRT21BF30C	903	969	21	15.5	30	72	5.65

BRT25BF-L • 25" Box/File Pedestal

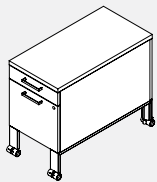
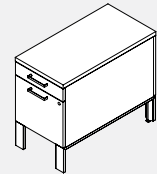

Fits below Bridges tables

- Can join with other 25" high storage units of corresponding depth to form a spine or slides out on casters to serve as an additional worksurface.
- Floor clearance allows for access to panel floor raceway duplex outlets; units on levelers accommodate installation of an optional Cable Basket to manage cords and data cables under storage spine.
- One box drawer, one file drawer (holds letter, legal and A4 suspended file folders except 18" pedestals).
- Optional Cable Basket suspends off storage unit's bottom and manages cables along the horizontal plane. (NO CASTER models only)
- Fits under 30" worksurface table beams as is.
- LP chassis and drawer fronts (specify LP finish) 1" top (specify LP or HP finish); metal handles, powder coated aluminum or anodized aluminum legs specify 5/16x2" levelers or 40mm white/grey, locking casters
- Anodized aluminum leg upcharge \$55.
- Pedestal with cushion will not fit under beam.
- Black injection moulded pencil tray included.
- 25" high Bridges storage should not be used under Back 2 Back Bridges table applications using Below Worksurface Trough. Storage will not fit under the trough.
- Optional e-lock available in the vertical position. Please specify V-Vertical and add \$224 list.

PRODUCT CODE	PRICE		SIZE/INCHES			WEIGHT VOL	
	LP	HP	H	W	D	LBS	FT ³
Levelers							
BRT25BF18L	806	857	25	15.5	18	69	3.89
BRT25BF24L	935	986	25	15.5	24	74	5.02
BRT25BF30L	1019	1082	25	15.5	30	82	6.15
Casters							
BRT25BF18C	870	921	25	15.5	18	69	3.89
BRT25BF24C	1000	1051	25	15.5	24	74	5.02
BRT25BF30C	1082	1146	25	15.5	30	82	6.15

BRT21LS-L/R • 21" Sliding Door Storage

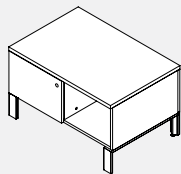

Right Open Shown

Fits below Bridges tables

- Can join with other 21" high storage units to form a spine.
- Can serve as an additional worksurface or an ad-hoc guest seating with optional cushion.
- Floor clearance allows for access to panel floor raceway duplex outlets and for installation of an optional Cable Basket to manage cords and data cables under storage spine.
- Storage compartment internal height: 12.36"
- Sliding door locks on left side.
- Optional 15.5"x18" cushion.
- Optional Cable Basket suspends off storage unit's bottom and manages cables along the horizontal plane.
- LP chassis and sliding door (specify LP finish), 1" top (specify LP or HP finish); metal handles, powder coated aluminum or anodized aluminum legs.
- Anodized aluminum leg upcharge \$55.

PRODUCT CODE	PRICE		SIZE/INCHES			WEIGHT VOL	
	LP	HP	H	W	D	LBS	FT ³
Left							
BRT21LS30L	774	839	21	30	18	53	6.56
BRT21LS36L	857	921	21	36	18	60	7.87
BRT21LS42L	935	1000	21	42	18	67	9.18
Right							
BRT21LS30R	774	839	21	30	18	53	6.56
BRT21LS36R	857	921	21	36	18	60	7.87
BRT21LS42R	935	1000	21	42	18	67	9.18

BRT21LSS-L/R • 21" Shared Sliding Door Storage

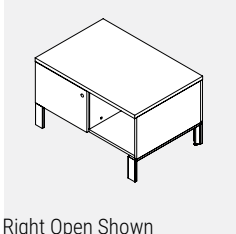

Right Open Shown

- Shared units offer two 11" deep storage compartments on either side - positioned usually beside Bridges table assembly, between two adjacent workstations.
- The units can join with other 21" high, 24" deep storage units to form a storage spine or to serve as an additional return worksurface or an ad-hoc guest seating with optional cushion.
- Floor clearance allows for installation of an optional Cable Basket to manage cords and data cables under storage spine. Storage compartment internal height: 12.36". Sliding door locks on left side.
- Optional 15.5"x18" cushion.
- Optional Cable Basket suspends off storage unit's bottom and manages cables along the horizontal plane.
- LP chassis and sliding door (specify LP finish) 1" top (specify LP or HP finish); metal handles, powder coated aluminum or anodized aluminum legs.
- Anodized aluminum leg upcharge \$55.

PRODUCT CODE	PRICE		SIZE/INCHES			WEIGHT VOL	
	LP	HP	H	W	D	LBS	FT ³
Left							
BRT21LSS30L	1082	1146	21	30	24	69	8.75
BRT21LSS36L	1177	1260	21	36	24	78	10.50
BRT21LSS42L	1277	1373	21	42	24	87	12.25
Right							
BRT21LSS30R	1082	1146	21	30	24	69	8.75
BRT21LSS36R	1177	1260	21	36	24	78	10.50
BRT21LSS42R	1277	1373	21	42	24	87	12.25

BRT21LSO42L • 21" Shared File/Open Storage

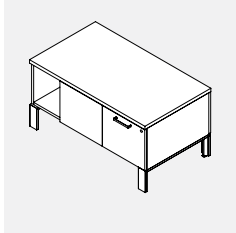

- Shared units offer storage compartments on either side - positioned usually between two adjacent Bridges workstations.
- The units can join with other 21" high, 24" deep storage units to form a storage spine or to serve as an additional return worksurface or an ad-hoc guest seating with optional cushion.
- Floor clearance allows for installation of an optional Cable Basket to manage cords and data cables under storage spine.
- One lockable file drawer, one open compartment per side. Storage compartment internal height without height adjustable shelf: 12.360"
- Optional 15.5" x 18" cushion. Optional Cable Basket suspends off storage unit's bottom manages cables along the horizontal plane.
- LP chassis drawer fronts (specify LP finish) 1" top (specify LP or HP finish); metal handles, powder coated aluminum or anodized aluminum legs.
- Anodized aluminum leg upcharge \$55.
- 25" high Bridges storage should not be used under Back 2 Back Bridges table applications using Below Worksurface Trough. Storage will not fit under the trough.
- Optional e-lock available in the vertical position. Please specify V-Vertical and add \$224 list.

PRODUCT CODE	PRICE		SIZE/INCHES			WEIGHT VOL	
	LP	HP	H	W	D	LBS	FT ³
BRT21LSO42L	1453	1566	21	42	24	124	14.0

BRT25LBF042L • 25" Shared Storage

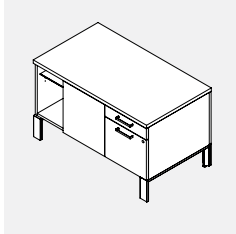

- Shared units offer storage compartments on either side.
- Positioned usually between two adjacent Bridges workstations. The units can join with other 25" high, 24" deep storage units to form a storage spine or to serve as an additional return worksurface.
- Floor clearance allows for installation of an optional Cable Basket to manage cords and data cables under storage spine.
- One lockable file drawer, one box drawer, one open compartment with adjustable shelf per side. Storage compartment internal height without height adjustable shelf: 16.08". Optional 15.5" x 18" cushion.
- Optional Cable Basket suspends off storage unit's bottom and manages cables along the horizontal plane.
- LP chassis and drawer fronts (specify LP finish) 1" top (specify LP or HP finish); metal handles, powder coated aluminum or anodized aluminum legs.
- Anodized aluminum leg upcharge \$55.
- Black injection moulded pencil tray included.
- 25" high Bridges storage should not be used under Back 2 Back Bridges table applications using Below Worksurface Trough. Storage will not fit under the trough.
- Optional e-lock available in the vertical position. Please specify V-Vertical and add \$224 list.

PRODUCT CODE	PRICE		SIZE/INCHES			WEIGHT VOL	
	LP	HP	H	W	D	LBS	FT ³
BRT25LBF042L	1823	1923	25	42	24	154	16.66

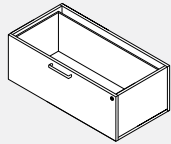
BRT21F-U • 21" High Lateral File Drawer, No Top

- **Fits below Bridges tables.**

- Can join with other 21" high storage units to form a spine.
- Floor clearance allows for access to panel floor raceway duplex outlets and for installation of an optional Cable Basket to manage cords and data cables under storage spine.
- One file drawer, top and legs to be ordered separately.
- LP chassis and drawer front (specify LP finish); metal handles.
- Optional Cable Basket suspends off storage unit's bottom and manages cables along the horizontal plane.
- Optional e-lock available in the vertical position. Please specify V-Vertical and add \$224 list.

PRODUCT CODE	PRICE LP	SIZE/INCHES			WEIGHT VOL	
		H	W	D	LBS	FT ³
BRT21F3018U	763	13	30	18	47	4.06
BRT21F3618U	843	13	36	18	51	4.88
BRT21F4218U	978	13	42	18	56	5.69
BRT21F3024U	781	13	30	24	51	5.42
BRT21F3624U	869	13	36	24	55	6.50
BRT21F4224U	1024	13	42	24	60	7.58

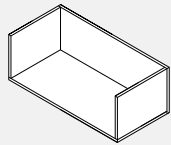
BRT21LO-U • 21" High Open Storage, No Top

- **An open storage unit with no top.**

- Positioned usually beside Bridges table assembly or between two adjacent workstations.
- Can join with other 21" high storage units to form a spine.
- Floor clearance allows for access to panel floor raceway duplex outlets and for installation of an optional Cable Basket to manage cords and data cables under storage spine.
- One box opening, top and legs to be ordered separately.
- LP chassis (specify LP finish).
- Optional Cable Basket suspends off storage unit's bottom and manages cables along the horizontal plane.
- Unit ships knocked down.

PRODUCT CODE	PRICE LP	SIZE/INCHES			WEIGHT VOL	
		H	W	D	LBS	FT ³
BRT21LO3018U	240	13	30	18	25	4.06
BRT21LO3618U	358	13	36	18	29	4.88
BRT21LO4218U	387	13	42	18	32	5.69
BRT21LO3024U	251	13	30	24	29	5.42
BRT21LO3624U	371	13	36	24	33	6.50
BRT21LO4224U	403	13	42	24	36	7.58

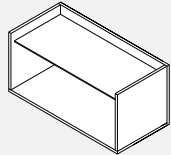
BRT25LO-U • 25" High Open Storage with Glass Shelf, No Top

- **An open storage unit with glass shelf and no top.**

- Positioned usually beside Bridges table assembly or between two adjacent workstations.
- Can join with other 25" high storage units to form a spine.
- Floor clearance allows for access to panel floor raceway duplex outlets and for installation of an optional Cable Basket to manage cords and data cables under storage spine.
- One box opening with glass shelf, top and legs to be ordered separately.
- LP chassis (specify LP finish).
- Optional Cable Basket suspends off storage unit's bottom and manages cables along the horizontal plane.
- 25" high Bridges storage should not be used under Back 2 Back Bridges table applications using Below Worksurface Trough. Storage will not fit under the trough.
- Unit ships knocked down.

PRODUCT CODE	PRICE LP	SIZE/INCHES			WEIGHT VOL	
		H	W	D	LBS	FT ³
BRT25LO3018U	355	17	30	18	40	5.31
BRT25LO3618U	486	17	36	18	46	6.38
BRT25LO4218U	503	17	42	18	52	7.44
BRT25LO3024U	380	17	30	24	44	7.08
BRT25LO3624U	506	17	36	24	50	8.50
BRT25LO4224U	528	17	42	24	56	9.92

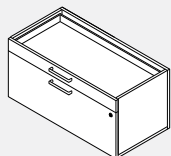
BRT25LBF-U • 25" High Box File Lateral, No Top

- **A box / file storage unit.**

- Positioned usually beside Bridges table assembly or between two adjacent workstations.
- Can join with other 25" high storage units to form a spine.
- Floor clearance allows for access to panel floor raceway duplex outlets and for installation of an optional Cable Basket to manage cords and data cables under storage spine.
- One lockable file drawer, one box drawer, top and legs to be ordered separately.
- LP chassis and drawer fronts (specify LP finish); metal handles.
- Black injection moulded pencil tray included (can be secured inside the drawer anywhere along the perimeter wall).
- 25" high Bridges storage should not be used under Back 2 Back Bridges table applications using Below Worksurface Trough. Storage will not fit under the trough.
- Optional Cable Basket suspends off storage unit's bottom and manages cables along the horizontal plane.
- Optional e-lock available in the vertical position. Please specify V-Vertical and add \$224 list.

PRODUCT CODE	PRICE LP	SIZE/INCHES			WEIGHT VOL	
		H	W	D	LBS	FT ³
BRT25LBF3018U	915	17	30	18	58	5.31
BRT25LBF3618U	1062	17	36	18	79	6.38
BRT25LBF4218U	1133	17	42	18	68	7.44
BRT25LBF3024U	952	17	30	24	62	7.08
BRT25LBF3624U	1104	17	36	24	83	8.50
BRT25LBF4224U	1177	17	42	24	72	9.92

BRT25L2D-U • 25" High Storage Cabinet, No Top

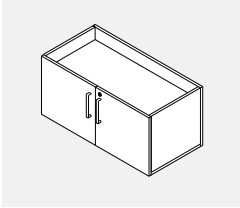

- **A 2 door storage unit.**
- Positioned usually beside Bridges table assembly, between two adjacent workstations.
- The units are level with Bridges tops, can join other 29" high storage units to form a credenza.
- Floor clearance allows for access to panel floor raceway duplex outlets and for installation of an optional Cable Basket to manage cords and data cables under storage spine.
- Two lockable doors, glass shelf included. Top and legs to be ordered separately.
- Storage compartment internal height is 20.5".
- LP chassis and drawer fronts (specify LP finish); metal handles.
- Optional Cable Basket suspends off storage unit's bottom and manages cables along the horizontal plane.
- Optional e-lock available in the horizontal position for the storage cabinet. Please specify HR - Horizontal Right or HL Horizontal Left and add \$224 list.
- Unit ships knocked down.

PRODUCT CODE	PRICE LP	SIZE / INCHES			WEIGHT VOL	
		H	W	D	LBS	FT ³
BRT25L2D3018U	675	17	30	18	39	5.31
BRT25L2D3618U	727	17	36	18	45	6.38
BRT25L2D4218U	757	17	42	18	54	7.44
BRT25L2D3024U	788	17	30	24	43	7.08
BRT25L2D3624U	859	17	36	24	49	8.50
BRT25L2D4224U	893	17	42	24	58	9.92

BRT29L2D-U • 29" High Storage Cabinet, No Top

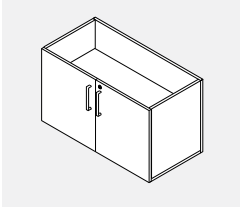

- **A 2 door storage unit.**
- Positioned usually beside Bridges table assembly, between two adjacent workstations.
- The units are level with Bridges tops, can join other 29" high storage units to form a credenza.
- Floor clearance allows for access to panel floor raceway duplex outlets and for installation of an optional Cable Basket to manage cords and data cables under storage spine.
- Two lockable doors, glass shelf included. Top and legs to be ordered separately.
- Storage compartment internal height is 20.5".
- LP chassis and drawer fronts (specify LP finish); metal handles.
- Optional Cable Basket suspends off storage unit's bottom and manages cables along the horizontal plane.
- Optional e-lock available in the horizontal position for the storage cabinet. Please specify HR - Horizontal Right or HL Horizontal Left and add \$224 list.
- Unit ships knocked down.

PRODUCT CODE	PRICE LP	SIZE / INCHES			WEIGHT VOL	
		H	W	D	LBS	FT ³
BRT29L2D3018U	773	21	30	18	49	6.56
BRT29L2D3618U	806	21	36	18	55	7.88
BRT29L2D4218U	842	21	42	18	64	9.19
BRT29L2D3024U	908	21	30	24	53	8.75
BRT29L2D3624U	948	21	36	24	59	10.50
BRT29L2D4224U	969	21	42	24	68	12.25

BRT29LOBF-U • 29" High Box File Open Storage, No Top

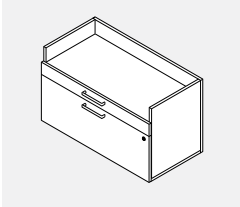

- **Box/file/shelf unit.**
- Positioned usually beside Bridges table assembly, between two adjacent workstations.
- The units are level with Bridges tops, can join other 29" high storage units to form a credenza.
- Floor clearance allows for access to panel floor raceway duplex outlets and for installation of an optional Cable Basket to manage cords and data cables under storage spine.
- One lockable file drawer, one box drawer, one open compartment. Top and legs to be ordered separately.
- Storage compartment internal height: 3.9"
- Black injection moulded pencil tray included (can be secured inside the drawer anywhere along the perimeter wall).
- LP chassis and drawer fronts (specify LP finish); metal handles.
- Optional Cable Basket suspends off storage unit's bottom and manages cables along the horizontal plane.
- Optional e-lock available in the vertical position. Please specify V-Vertical and add \$224 list.

PRODUCT CODE	PRICE LP	SIZE / INCHES			WEIGHT VOL	
		H	W	D	LBS	FT ³
BRT29LOBF3018U	1077	21	30	18	70	6.56
BRT29LOBF3618U	1217	21	36	18	78	7.88
BRT29LOBF4218U	1335	21	42	18	86	9.19
BRT29LOBF3024U	1121	21	30	24	74	8.75
BRT29LOBF3624U	1264	21	36	24	82	10.50
BRT29LOBF4224U	1389	21	42	24	90	12.25

BRT-LEGL • Bridges Leg for Modular Storage

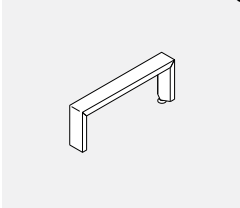

- **Two single legs form the structure of the Bridges series modular storage.**
- A single can be used at the each end of modular storage units or can be used to support where two modular units meet.
- Leveling glides, steel frame, aluminum legs.
- Please specify paint or anodized finish.
- Anodized aluminum leg upcharge \$55.

PRODUCT CODE	PRICE	SIZE / INCHES			WEIGHT VOL	
		H	W	D	LBS	FT ³
BRT18LEGL	48	8	2.5	18	8	1.34
BRT24LEGL	56	8	2.5	24	8	1.34

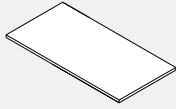
BRTWU • Bridges Worksurface for Modular Storage

- Worksurfaces are available in high pressure laminate (HP 1 1/16" thick) and low pressure laminate (LP 1" thick) with a flat 3 mm edge profile on all sides.
- Worksurfaces provided with pilot holes for alignment purposes.
- Worksurfaces can be used for each modular unit or can span two to three units.

PRODUCT CODE	PRICE		SIZE/INCHES			WEIGHT VOL	
	LP	HP	H	W	D	LBS	FT ³
BRTWU1830	134	178	1	30	18	15	0.50
BRTWU1836	154	204	1	36	18	18	0.59
BRTWU1842	202	270	1	42	18	21	0.68
BRTWU1860	319	410	1	60	18	29	0.97
BRTWU1866	334	439	1	66	18	32	1.10
BRTWU1872	352	464	1	72	18	35	1.20
BRTWU1878	369	488	1	78	18	38	1.30
BRTWU1884	405	530	1	84	18	41	1.40
BRTWU1890	421	551	1	90	18	44	1.50
BRTWU1896	437	573	1	96	18	47	1.60
BRTWU2430	141	184	1	30	24	20	0.65
BRTWU2436	156	207	1	36	24	24	0.78
BRTWU2442	205	272	1	42	24	28	0.90
BRTWU2460	326	430	1	60	24	39	1.30
BRTWU2466	340	449	1	66	24	43	1.41
BRTWU2472	355	470	1	72	24	47	1.54
BRTWU2478	381	501	1	78	24	51	1.70
BRTWU2484	410	537	1	84	24	55	1.80
BRTWU2490	428	561	1	90	24	59	1.90
BRTWU2496	444	583	1	96	24	63	2.00

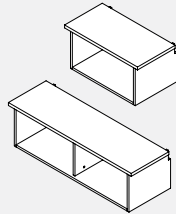
BRTTES • Table Mounted End Shelf

- Single or double open shelf / extended worksurface.
- Secured to the end of single or Back 2 Back Bridges table; supported by rectangular legs, all mounting hardware included.
- Storage compartment internal height: 13.25"
- LP chassis (specify LP finish) 1" top (specify LP or HP finish).
- NOTE: not compatible with round legs.
- 25" high Bridges storage should not be used under Back 2 Back Bridges table applications using Below Worksurface Trough. Storage will not fit under the trough.

PRODUCT CODE	PRICE		SIZE/INCHES			WEIGHT VOL	
	LP	HP	H	W	D	LBS	FT ³
BRTTES24	596	646	15	24	15.5	29	3.22
BRTTES30	652	710	15	30	15.5	34	4.03
BRTTES51	1082	1188	15	50.5	15.5	57	6.79
BRTTES63	1188	1323	15	62.5	15.5	68	8.4

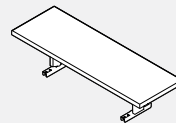
BRTCMS • Centre Mount Shelf

- Open, shared Centre mount shelf 'floats' 6.750" above the gap formed by two back-to-back work surfaces. 12" deep x 30" or 36" laminate shelf surface accepts BRTESBBIN Elevated Shelf Binder Bin - The 30" wide shelf accommodates two, while 36" shelf accommodates up to three BRTESBBIN bins. Shelves overhang the support structure by 6" on either side.
- Aluminum / die cast structure attaches to the underside of both work surfaces.
- Note: Not compatible with BRTETA Above Work Surface Power Trough and Work Surfaces with Access Doors.
- Specify high pressure laminate shelf (HP 1 1/16" thick) or low pressure laminate shelf (LP 1" thick).
- Specify support structure metal finish.
- Anodized support structure finish up charge \$55.

PRODUCT CODE	PRICE		SIZE/INCHES			WEIGHT VOL	
	LP	HP	H	W	D	LBS	FT ³
BRTCMS30	215	245	6.75	30	12	12.60	1.41
BRTCMS36	308	339	6.75	36	12	15.20	1.69

BRTSTS • Single Sided Elevated Table Shelf

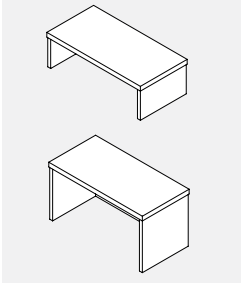

- **Single sided elevated shelf.**
- Secured perpendicularly to the single or Back 2 Back Bridges tables. Integrated anodized aluminum accessory rail. White cut out and accessory rail trims.
- Optional Elevated Shelf Binder Bin rests on top surface - better utilization of vertical space, enhanced sense of privacy.
- Three heights available:
- 8" high provides additional storage space without obstructing view; reaches 16" module height when combined with 8" high Binder Shelf. Internal height 6.6".
- 13" high lines up with 42" floor-standing panels.
- 16" high lines up with top of 16" table dividers (15.8"). Specify 12" narrower Shared Elevated Shelf immediately adjacent to the perpendicular elevated shelf. Internal height 14.6".
- NOTE: In order to prevent interference ensure that the Shared Elevated Shelves immediately adjacent to the perpendicular elevated shelf which are of equal or bigger height are specified 12" narrower than the supporting worksurface.
- Optional Elevated Shelf Binder Bin (BRTESBBIN) rests on top surface - better utilization of vertical space, enhanced sense of privacy.
- See Accessory compatibility chart.

PRODUCT CODE	PRICE		SIZE/INCHES			WEIGHT VOL	
	LP	HP	H	W	D	LBS	FT ³
BRTSTS0824	211	275	8	24	12	14	1.33
BRTSTS0830	242	308	8	30	12	16	1.66
BRTSTS0851	387	485	8	50.5	12	25	2.80
BRTSTS0863	437	583	8	62.5	12	28	3.47
BRTSTS1324	227	290	13	24	12	18	2.16
BRTSTS1330	257	323	13	30	12	21	2.70
BRTSTS1351	387	485	13	50.5	12	32	4.55
BRTSTS1363	451	583	13	62.5	12	38	5.64
BRTSTS1624	257	323	16	24	12	19	2.66
BRTSTS1630	308	372	16	30	12	29	3.33
BRTSTS1651	451	564	16	50.5	12	33	5.61
BRTSTS1663	519	663	16	62.5	12	39	6.94

BRTBTS • Shared Elevated Table Shelf

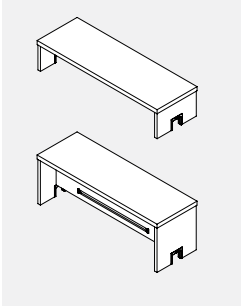

- **Shared, Back 2 Back elevated shelf; rests on Back 2 Back Bridges tables.**
- Cut-outs in both supporting side gables allow placement over Above Worksurface Power/data troughs. Integrated anodized aluminum accessory rail. White cut out and accessory rail trims.
- Three heights available:
- 8" high provides additional storage space without obstructing view; reaches 16" module height when combined with 8" high Binder Shelf. Internal height 6.6".
- 13" high lines up with 42" floor-standing panels.
- 16" high lines up with top of 16" table dividers (15.8"). Specify 12" narrower Shared Elevated Shelf immediately adjacent to the perpendicular elevated shelf. Internal height 14.6".
- NOTE: In order to prevent interference ensure that the Shared Elevated Shelves immediately adjacent to the perpendicular elevated shelf which are of equal or bigger height are specified 12" narrower than the supporting worksurface.
- Optional Elevated Shelf Binder Bin (BRTESBBIN) rests on top surface - better utilization of vertical space, binder/book manager, enhanced sense of privacy, magnetic board on the opposite side.
- LP chassis (specify LP finish); 1" top (specify LP or HP finish).

PRODUCT CODE	PRICE		SIZE/INCHES			WEIGHT VOL	
	LP	HP	H	W	D	LBS	FT ³
BRTBTS0836	323	387	8	36	12	16	2.00
BRTBTS0842	356	420	8	42	12	19	2.33
BRTBTS0848	387	485	8	48	12	21	2.66
BRTBTS0854	405	519	8	54	12	23	3.00
BRTBTS0860	451	583	8	60	12	26	3.33
BRTBTS0866	485	633	8	66	12	28	3.66
BRTBTS0872	519	663	8	72	12	30	4.00
BRTBTS0878	550	710	8	78	12	32	4.33
BRTBTS0884	583	760	8	84	12	35	4.66
BRTBTS1336	387	469	13	36	12	22	3.25
BRTBTS1342	437	519	13	42	12	25	3.79
BRTBTS1348	469	583	13	48	12	28	4.33
BRTBTS1354	519	633	13	54	12	30	4.87
BRTBTS1360	564	677	13	60	12	33	5.86
BRTBTS1366	550	741	13	66	12	36	6.45
BRTBTS1372	646	806	13	72	12	39	6.50
BRTBTS1378	696	857	13	78	12	42	7.04
BRTBTS1384	741	921	13	84	12	44	7.58
BRTBTS1636	405	469	16	36	12	25	4.00
BRTBTS1642	451	550	16	42	12	28	4.66
BRTBTS1648	501	596	16	48	12	31	5.33
BRTBTS1654	532	663	16	54	12	34	6.00
BRTBTS1660	583	710	16	60	12	38	6.66
BRTBTS1666	633	760	16	66	12	41	7.33
BRTBTS1672	677	825	16	72	12	44	8.00
BRTBTS1678	710	870	16	78	12	47	8.66
BRTBTS1684	760	935	16	84	12	50	9.33

BRTBASO48 • Table Supported Shared Overhead

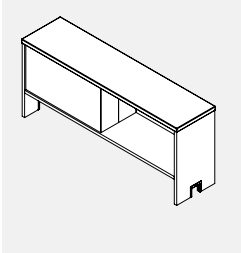

- **One compartment per side; white magnetic back wall; lines up with 50" high floor standing storage.**
- Integrated anodized aluminum accessory rail below the shelves.
- Fits over the gap between two parallel Back 2 Back Bridges tables.
- Fits over above worksurface power/data trough.
- Storage compartment internal height: 12.25".
- Optional Elevated Shelf Binder Bin rests on top surface - better utilization of vertical space, enhanced sense of privacy.
- LP chassis (specify LP finish), white powder-coated steel central partition and backs; 1" top (specify LP or HP finish).

PRODUCT CODE	PRICE		SIZE/INCHES			WEIGHT VOL	
	LP	HP	H	W	D	LBS	FT ³
BRTBASO48	646	741	21	48	12	54	7.00

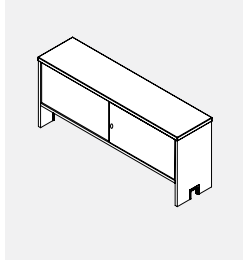
BRTBASL • Shared Elevated Overhead with Sliding Laminate Doors

- **Two compartments facing in opposite direction can be locked with sliding laminate doors. Storage compartment internal height: 12.25**
- Shared elevated overhead fits over the gap between two parallel Bridges Back 2 Back tables.
- Integrated anodized aluminum accessory rail below the storage compartments. Fits over Above Worksurface Power/Data Troughs.
- NOTE: In order to prevent duplex outlet and work surface access door interference, please specify overhead of the same width as the width of the supporting worksurface.

To prevent interference with ceiling feed pole please specify overhead 6" shorter in order width corresponding with the length of the supporting work surface. Elevated Shelf Binder Bins DO NOT work with this overhead. Bottom accessory rail accepts BALT01 Letter Tray, BAMBO1 Media Bin, BAUT01 Utility Tray and BVATH01 Telephone holder.
LP chassis (specify LP finish); 1" top (specify LP or HP finish), satin lock.

PRODUCT CODE	PRICE		SIZE/INCHES			WEIGHT VOL	
	LP	HP	H	W	D	LBS	FT ³
BRTBASL36	1836	1956	21	36	16	23.5	6.56
BRTBASL42	1964	2113	21	42	16	27.5	7.65
BRTBASL48	2066	2242	21	48	16	31.4	8.75
BRTBASL54	2222	2405	21	54	16	35.3	9.84
BRTBASL60	2344	2537	21	60	16	39.3	10.93
BRTBASL66	2646	2868	21	66	16	43.2	12.03
BRTBASL72	2785	3035	21	72	16	47.1	13.12
BRTBASL78	2932	3200	21	78	16	51.0	14.21
BRTBASL84	2970	3340	21	84	16	55.0	15.31

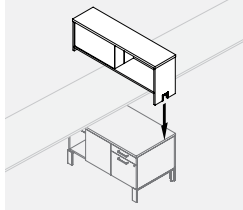
BRTSDS48 • 45" High Shared Storage Divider

- **Divides side-2-side workstations; two shared open shelves**

- One compartment per side; white magnetic back wall. Rests on top of shared 25" box/file/open and Back 2 Back worksurface.
- Top of the unit is 15.7" from the top of the worksurface.
- Storage compartment internal height: 12.8".
- Optional Elevated Shelf Binder Bin (BRTSEBBIN) rests on top surface - better utilization of vertical space, enhanced sense of privacy.
- LP chassis (specify LP finish), white powder-coated steel central partition and backs; 1" top (specify LP or HP finish).

PRODUCT CODE	PRICE		SIZE/INCHES			WEIGHT VOL	
	LP	HP	H	W	D	LBS	FT ³
BRTSDS48	519	613	16	48	12	54	5.33

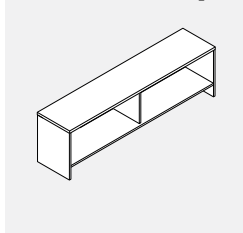
BRT21HO • Open Single Sided Storage

- **Table supported single sided open storage**
- Storage compartment internal height: 14"
- LP chassis (specify LP finish); 1" top (specify LP or HP finish).
- NOTE: Cannot be used in conjunction with above worksurface power trough.
- In order to prevent duplex outlet and work surface access door interference, please specify overhead of the same width as the width of the supporting worksurface.
- To prevent interference with ceiling feed pole please specify overhead 6" shorter width corresponding with the length of the supporting work surface.

PRODUCT CODE	PRICE		SIZE/INCHES			WEIGHT VOL	
	LP	HP	H	W	D	LBS	FT ³
BRT21HO3616	811	919	21	36	16	81	9
BRT21HO4216	871	997	21	42	16	96	10.5
BRT21HO4816	930	1070	21	48	16	100	12
BRT21HO5416	987	1146	21	54	16	124	13.5
BRT21HO6016	1054	1229	21	60	16	134	15
BRT21HO6616	1120	1315	21	66	16	144	16.5
BRT21HO7216	1162	1383	21	72	16	152	18
BRT21HO7816	1250	1480	21	78	16	161	19.5
BRT21HO8416	1300	1546	21	84	16	168	21

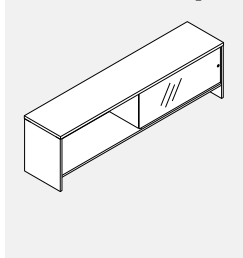
BRT21GS • Open Single Sided Storage with One Sliding Glass Door

- **Table supported single sided open storage, single sliding glass door with recessed pull**
- Storage compartment internal height: 14"
- LP chassis (specify LP finish); 1" top (specify LP or HP finish).
- Not locking.
- Glass is clear.
- NOTE: Cannot be used in conjunction with above worksurface power trough.
- In order to prevent duplex outlet and work surface access door interference, please specify overhead of the same width as the width of the supporting worksurface.
- To prevent interference with ceiling feed pole please specify overhead 6" shorter width corresponding with the length of the supporting work surface.

PRODUCT CODE	PRICE		SIZE/INCHES			WEIGHT VOL	
	LP	HP	H	W	D	LBS	FT ³
BRT21GS3616	1279	1386	21	36	16	87	9
BRT21GS4216	1343	1467	21	42	16	103	10.5
BRT21GS4816	1400	1541	21	48	16	108	12
BRT21GS5416	1671	1830	21	54	16	133	13.5
BRT21GS6016	1736	1915	21	60	16	144	15
BRT21GS6616	1821	2016	21	66	16	155	16.5
BRT21GS7216	1880	2092	21	72	16	164	18
BRT21GS7816	1981	2210	21	78	16	174	19.5
BRT21GS8416	2039	2287	21	84	16	181	21

BRT21LS • Open Single Sided Storage with One Sliding Laminate Door

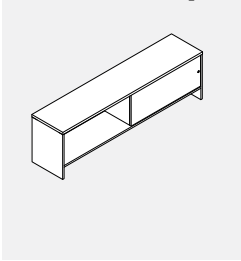

- **Table supported single sided open storage, single sliding laminate door with recessed pull**
- Storage compartment internal height: 14"
- LP chassis (specify LP finish); 1" top (specify LP or HP finish).
- Not locking.
- NOTE: Cannot be used in conjunction with above worksurface power trough.
- In order to prevent duplex outlet and work surface access door interference, please specify overhead of the same width as the width of the supporting worksurface.
- To prevent interference with ceiling feed pole please specify overhead 6" shorter width corresponding with the length of the supporting work surface.

PRODUCT CODE	PRICE		SIZE/INCHES			WEIGHT VOL	
	LP	HP	H	W	D	LBS	FT ³
BRT21LS3616	1241	1392	21	36	16	94	9
BRT21LS4216	1302	1478	21	42	16	111	10.5
BRT21LS4816	1360	1559	21	48	16	117	12
BRT21LS5416	1417	1642	21	54	16	143	13.5
BRT21LS6016	1639	1890	21	60	16	155	15
BRT21LS6616	1707	1981	21	66	16	167	16.5
BRT21LS7216	1757	2056	21	72	16	177	18
BRT21LS7816	1836	2160	21	78	16	188	19.5
BRT21LS8416	1887	2234	21	84	16	198	21

BRT21HDO • Open Double Sided Storage

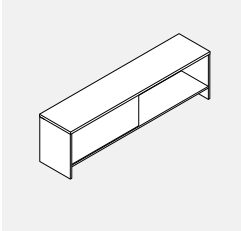

- **Table supported double sided open storage.**
- Fits over the gap between two parallel Bridges Back 2 Back tables.
- Storage compartment internal height: 14"
- LP chassis (specify LP finish); 1" top (specify LP or HP finish)
- NOTE: Cannot be used in conjunction with above worksurface power trough
- In order to prevent duplex outlet and work surface access door interference, please specify overhead of the same width as the width of the supporting worksurface.
- To prevent interference with ceiling feed pole please specify overhead 6" shorter width corresponding with the length of the supporting work surface.

PRODUCT CODE	PRICE		SIZE/INCHES			WEIGHT VOL	
	LP	HP	H	W	D	LBS	FT ³
BRT21HDO3616	842	948	21	36	16	81	9
BRT21HDO4216	890	1013	21	42	16	96	10.5
BRT21HDO4816	931	1074	21	48	16	100	12
BRT21HDO5416	1004	1163	21	54	16	124	13.5
BRT21HDO6016	1056	1230	21	60	16	134	15
BRT21HDO6616	1136	1330	21	66	16	144	16.5
BRT21HDO7216	1173	1386	21	72	16	152	18
BRT21HDO7816	1265	1496	21	78	16	161	19.5
BRT21HDO8416	1301	1549	21	84	16	168	21

BRT21GDS • Double Sided Storage with Sliding Glass Door

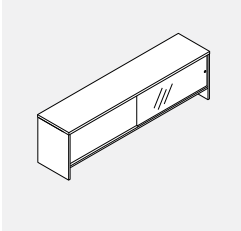

- **Table supported double sided storage with sliding glass doors and recessed pull.**
- Fits over the gap between two parallel Bridges Back 2 Back tables.
- Storage compartment internal height: 14"
- LP chassis (specify LP finish); 1" top (specify LP or HP finish).
- Not Locking
- NOTE: Cannot be used in conjunction with above worksurface power trough
- In order to prevent duplex outlet and work surface access door interference, please specify overhead of the same width as the width of the supporting worksurface.
- To prevent interference with ceiling feed pole please specify overhead 6" shorter width corresponding with the length of the supporting work surface.

PRODUCT CODE	PRICE		SIZE/INCHES			WEIGHT VOL	
	LP	HP	H	W	D	LBS	FT ³
BRT21GDS3616	1661	1766	21	36	16	94	9
BRT21GDS4216	1737	1862	21	42	16	111	10.5
BRT21GDS4816	1778	1918	21	48	16	117	12
BRT21GDS5416	2298	2457	21	54	16	143	13.5
BRT21GDS6016	2341	2517	21	60	16	155	15
BRT21GDS6616	2497	2692	21	66	16	167	16.5
BRT21GDS7216	2552	2762	21	72	16	177	18
BRT21GDS7816	2655	2884	21	78	16	188	19.5
BRT21GDS8416	2826	3075	21	84	16	196	21

BRT21LDS • Double sided Storage with Sliding Laminate Door

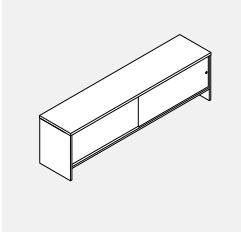

- **Table supported double sided storage with sliding laminate doors and recessed pull.**
- Fits over the gap between two parallel Bridges Back 2 Back tables.
- Storage compartment internal height: 14"
- LP chassis (specify LP finish); 1" top (specify LP or HP finish).
- Not Locking
- NOTE: Cannot be used in conjunction with above worksurface power trough
- In order to prevent duplex outlet and work surface access door interference, please specify overhead of the same width as the width of the supporting worksurface.
- To prevent interference with ceiling feed pole please specify overhead 6" shorter width corresponding with the length of the supporting work surface.

PRODUCT CODE	PRICE		SIZE/INCHES			WEIGHT VOL	
	LP	HP	H	W	D	LBS	FT ³
BRT21LDS3616	1631	1736	21	36	16	106	9
BRT21LDS4216	1734	1859	21	42	16	126	10.5
BRT21LDS4816	1771	1913	21	48	16	134	12
BRT21LDS5416	2212	2371	21	54	16	162	13.5
BRT21LDS6016	2252	2428	21	60	16	176	15
BRT21LDS6616	2401	2596	21	66	16	190	16.5
BRT21LDS7216	2438	2651	21	72	16	203	18
BRT21LDS7816	2530	2759	21	78	16	216	19.5
BRT21LDS8416	2682	2928	21	84	16	227	21

BRTTW50-L/R • Storage Tower with Coat Storage

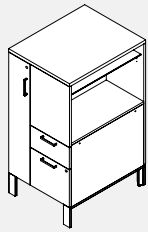

Left Shown

PRODUCT CODE	PRICE		SIZE/INCHES				WEIGHT VOL	
	LP	HP	H	W	D	LBS	FT ³	
BRTTW5024L	1759	1872	50	24	24	142	16.66	
BRTTW5024R	1759	1872	50	24	24	142	16.66	
BRTTW5030L	1955	2066	50	24	30	163	20.83	
BRTTW5030R	1955	2066	50	24	30	163	20.83	

- Provides storage and privacy at the end of a table
- Box+file drawers; open compartment with adjustable shelf (50" high); coat storage with hinged door.
- Specify Left or Right handed.
- Capable of supporting worksurface on one side (built-in threaded inserts to secure dedicated worksurface supporting beam).
- Open side storage compartment internal height: 19.6".
- Optional Cable Basket suspends off storage unit's bottom and manages cables along the horizontal plane.
- LP chassis (specify LP finish), 1" top (specify LP or HP finish); metal handles; powder coated aluminum or anodized aluminum legs (specify paint finish).
- Anodized aluminum leg upcharge \$55.
- Black injection moulded pencil tray included.
- Optional e-lock available in the vertical position for the box, file drawer. Please specify V-Vertical and add \$224 list.
- Optional e-lock available in the horizontal position for the wardrobe. Please specify HR-Horizontal Right or HL-Horizontal Left and add \$224 list.

BRTTW66-L/R • Storage Tower with Coat Storage

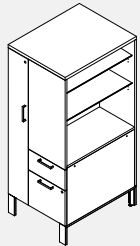

Left Shown

PRODUCT CODE	PRICE		SIZE/INCHES				WEIGHT VOL	
	LP	HP	H	W	D	LBS	FT ³	
BRTTW6624L	2287	2433	66	24	24	170	22	
BRTTW6624R	2287	2433	66	24	24	170	22	
BRTTW6630L	2540	2684	66	24	30	195	27.5	
BRTTW6630R	2540	2684	66	24	30	195	27.5	

- Provides storage and privacy at the end of a table
- Box+file drawers; open compartment (66" high); coat storage with hinged door and 2 shelves.
- Specify Left or Right handed.
- Capable of supporting worksurface on one side (built-in threaded inserts to secure dedicated worksurface supporting beam).
- Open side storage compartment internal height: 35.6".
- Optional Cable Basket suspends off storage unit's bottom and manages cables along the horizontal plane.
- LP chassis (specify LP finish), 1" top (specify LP or HP finish); metal handles; powder coated aluminum or anodized aluminum legs (specify paint finish).
- Anodized aluminum leg upcharge \$55.
- Black injection moulded pencil tray included.
- Optional e-lock available in the vertical position for the box, file drawer. Please specify V-Vertical and add \$224 list.
- Optional e-lock available in the horizontal position for the wardrobe. Please specify HR-Horizontal Right or HL-Horizontal Left and add \$224 list.

BRTT50-L/R • 50" High Storage Tower

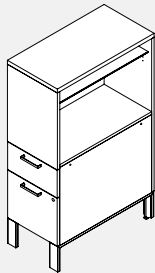

Left Shown

PRODUCT CODE	PRICE		SIZE/INCHES				WEIGHT VOL	
	LP	HP	H	W	D	LBS	FT ³	
BRTT5024L	1309	1388	50	15.5	24	88	10.76	
BRTT5024R	1309	1388	50	15.5	24	88	10.76	
BRTT5030L	1438	1533	50	15.5	30	101	13.45	
BRTT5030R	1438	1533	50	15.5	30	101	13.45	

- Provides storage and privacy at the end of a table
- Box+file drawers; open compartment with adjustable glass shelf.
- Specify Left or Right handed.
- Capable of supporting worksurface on one side (built-in threaded inserts to secure dedicated worksurface supporting beam).
- Open side storage compartment internal height: 19.6".
- Optional Cable Basket suspends off storage unit's bottoms and manages cables along the horizontal plane.
- LP chassis (specify LP finish), 1" top (specify LP or HP finish); metal handles; powder coated aluminum or anodized aluminum legs (specify paint finish).
- Anodized aluminum leg upcharge \$55.
- Black injection moulded pencil tray included.
- Optional e-lock available in the vertical position. Please specify V-Vertical and add \$224 list.

BRTT66-L/R • 66" High Storage Tower

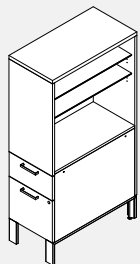

Left Shown

PRODUCT CODE	PRICE		SIZE/INCHES				WEIGHT VOL	
	LP	HP	H	W	D	LBS	FT ³	
BRTT6624L	1700	1805	66	15.5	24	106	12.91	
BRTT6624R	1700	1805	66	15.5	24	106	12.91	
BRTT6630L	1869	1995	66	15.5	30	121	16.14	
BRTT6630R	1869	1995	66	15.5	30	121	16.14	

- Provides storage and privacy at the end of a table
- Box+file drawers; open compartment with 2 adjustable glass shelf.
- Specify Left or Right handed.
- Capable of supporting worksurface on one side (built-in threaded inserts to secure dedicated worksurface supporting beam).
- Open side storage compartment internal height: 35.6".
- Optional Cable Basket suspends off storage unit's bottoms and manages cables along the horizontal plane.
- LP chassis (specify LP finish), 1" top (specify LP or HP finish); metal handles; powder coated aluminum or anodized aluminum legs (specify paint finish).
- Anodized aluminum leg upcharge \$55.
- Black injection moulded pencil tray included.
- Optional e-lock available in the vertical position. Please specify V-Vertical and add \$224 list.

BRTTW2D50-L/R - 50" High Two Door Storage Tower

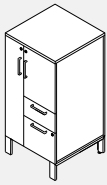

Left Shown

- Provides storage and privacy at the end of a table
- Box+file drawers; closed compartment with one adjustable laminate shelf and hinged door; coat storage with hinged door.
- Specify Left or Right handed.
- Closed side storage compartment internal height: 20.3"
- Optional Cable Basket suspends off storage unit's bottoms and manages cables along the horizontal plane.
- LP chassis (specify LP finish), 1" top (specify LP or HP finish); metal handles; powder coated aluminum or anodized aluminum legs (specify paint finish).
- Anodized aluminum leg upcharge \$55.
- Black injection moulded pencil tray included.
- Optional e-lock available in the vertical position for the box, file drawer. Please specify V-Vertical and add \$224 list.
- Optional e-lock available in the horizontal position for the wardrobe. Please specify HR-Horizontal Right or HL-Horizontal Left and add \$224 list.
- Optional e-lock available in the horizontal position for the closed compartment. Please specify HR-Horizontal Right or HL-Horizontal Left and add \$224 list.

PRODUCT CODE	PRICE		SIZE/INCHES			WEIGHT VOL	
	LP	HP	H	W	D	LBS	FT ³
BRTTW2D5018L	1628	1715	50	24	18	121	12.50
BRTTW2D5018R	1628	1715	50	24	18	121	12.50
BRTTW2D5024L	1826	1938	50	24	24	142	16.67
BRTTW2D5024R	1826	1938	50	24	24	142	16.67
BRTTW2D5030L	2021	2132	50	24	30	163	20.83
BRTTW2D5030R	2021	2132	50	24	30	163	20.83

BRTTW2D66-L/R - 66" High Two Door Storage Tower

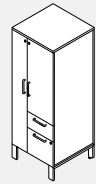

Left Shown

- Provides storage and privacy at the end of a table
- Box+file drawers; closed compartment with two adjustable laminate shelves and hinged door; coat storage with hinged door.
- Specify Left or Right handed.
- Closed side storage compartment internal height: 36.3"
- Anodized aluminum leg upcharge \$55.
- Optional Cable Basket suspends off storage unit's bottoms and manages cables along the horizontal plane.
- LP chassis (specify LP finish), 1" top (specify LP or HP finish); metal handles; powder coated aluminum or anodized aluminum legs (specify paint finish).
- Black injection moulded pencil tray included.
- Optional e-lock available in the vertical position for the box, file drawer. Please specify V-Vertical and add \$224 list.
- Optional e-lock available in the horizontal position for the wardrobe. Please specify HR-Horizontal Right or HL-Horizontal Left and add \$224 list.
- Optional e-lock available in the horizontal position for the closed compartment. Please specify HR-Horizontal Right or HL-Horizontal Left and add \$224 list.

PRODUCT CODE	PRICE		SIZE/INCHES			WEIGHT VOL	
	LP	HP	H	W	D	LBS	FT ³
BRTTW2D6618L	2082	2188	66	24	18	145	16.50
BRTTW2D6618R	2082	2188	66	24	18	145	16.50
BRTTW2D6624L	2354	2499	66	24	24	170	22.00
BRTTW2D6624R	2354	2499	66	24	24	170	22.00
BRTTW2D6630L	2607	2751	66	24	30	195	27.50
BRTTW2D6630R	2607	2751	66	24	30	195	27.50

BRTT1D50-L/R - 50" High Hinged Door Storage Tower

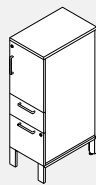

Right Shown

- Provides storage and privacy at the end of a table
- Box+file drawers; closed compartment with one adjustable laminate shelf and hinged door.
- Specify Left or Right handed.
- Closed side storage compartment internal height: 20.3"
- Optional Cable Basket suspends off storage unit's bottoms and manages cables along the horizontal plane.
- LP chassis (specify LP finish), 1" top (specify LP or HP finish); metal handles; powder coated aluminum or anodized aluminum legs (specify paint finish).
- Anodized aluminum leg upcharge \$55.
- Black injection moulded pencil tray included.
- Optional e-lock available in the vertical position for the box, file drawer. Please specify V-Vertical and add \$224 list.
- Optional e-lock available in the horizontal position for the closed compartment. Please specify HR-Horizontal Right or HL-Horizontal Left and add \$224 list.

PRODUCT CODE	PRICE		SIZE/INCHES			WEIGHT VOL	
	LP	HP	H	W	D	LBS	FT ³
BRTT1D5018L	1199	1260	50	15.5	18	110	8.07
BRTT1D5018R	1199	1260	50	15.5	18	110	8.07
BRTT1D5024L	1375	1454	50	15.5	24	131	10.76
BRTT1D5024R	1375	1454	50	15.5	24	131	10.76
BRTT1D5030L	1504	1599	50	15.5	30	152	13.45
BRTT1D5030R	1504	1599	50	15.5	30	152	13.45

BRTT1D66-L/R - 66" High Hinged Door Storage Tower

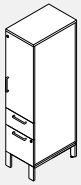

Right Shown

- Provides storage and privacy at the end of a table
- Box+file drawers; closed compartment with two adjustable laminate shelves and hinged door.
- Specify Left or Right handed.
- Closed side storage compartment internal height: 36.3"
- Optional Cable Basket suspends off storage unit's bottoms and manages cables along the horizontal plane.
- LP chassis (specify LP finish), 1" top (specify LP or HP finish); metal handles; powder coated aluminum or anodized aluminum legs (specify paint finish).
- Anodized aluminum leg upcharge \$55.
- Black injection moulded pencil tray included.
- Optional e-lock available in the vertical position for the box, file drawer. Please specify V-Vertical and add \$224 list.
- Optional e-lock available in the horizontal position for the closed compartment. Please specify HR-Horizontal Right or HL-Horizontal Left and add \$224 list.

PRODUCT CODE	PRICE		SIZE/INCHES			WEIGHT VOL	
	LP	HP	H	W	D	LBS	FT ³
BRTT1D6618L	1533	1620	66	15.5	18	134	10.66
BRTT1D6618R	1533	1620	66	15.5	18	134	10.66
BRTT1D6624L	1766	1872	66	15.5	24	159	14.21
BRTT1D6624R	1766	1872	66	15.5	24	159	14.21
BRTT1D6630L	1936	2063	66	15.5	30	184	17.76
BRTT1D6630R	1936	2063	66	15.5	30	184	17.76

BRTW1D-L/R - Hinged Door Wardrobe Tower

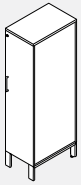

Right Shown

- Provides wardrobe and privacy at the end of a table.
- Specify Left or Right handed.
- Optional Cable Basket suspends off storage unit's bottoms and manages cables along the horizontal plane.
- LP chassis (specify LP finish), 1" top (specify LP or HP finish); metal handles; powder coated aluminum or anodized aluminum legs (specify paint finish).
- Anodized aluminum leg upcharge \$55.
- Optional e-lock available in the horizontal position for the wardrobe. Please specify HR-Horizontal Right or HL-Horizontal Left and add \$224 list.
- 18" unit has coat hooks, 24" and 30" units have a coat rod.

PRODUCT CODE	PRICE		SIZE/INCHES			WEIGHT VOL	
	LP	HP	H	W	D	LBS	FT ³
BRTW1D5018L	924	983	50	15.5	18	105	8.07
BRTW1D5018R	924	983	50	15.5	18	105	8.07
BRTW1D5024L	1047	1123	50	15.5	24	126	10.76
BRTW1D5024R	1047	1123	50	15.5	24	126	10.76
BRTW1D5030L	1174	1271	50	15.5	30	147	13.45
BRTW1D5030R	1174	1271	50	15.5	30	147	13.45
BRTW1D6618L	1169	1228	66	15.5	18	129	10.66
BRTW1D6618R	1169	1228	66	15.5	18	129	10.66
BRTW1D6624L	1323	1399	66	15.5	24	154	14.21
BRTW1D6624R	1323	1399	66	15.5	24	154	14.21
BRTW1D6630L	1481	1575	66	15.5	30	179	17.76
BRTW1D6630R	1481	1575	66	15.5	30	179	17.76

BRTCS45BBFF • Cantilever Storage Open Box, Box, File, Open, File

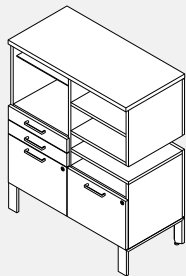

Left Shown

- Provides storage and privacy anywhere along the length of the bench.
- The middle opening of the cabinet allows the upper portion to cantilever above the worksurface
- Two locking file drawers.
- Two pencil drawers not locking.
- Open compartment with adjustable glass shelf, internal dimension of 15.9"
- Three fixed open compartments two above worksurfaces (6.7" interior dimension), one below (3.7" interior dimension)
- Specify Left or Right handed.
- Optional Cable Basket suspends off storage unit's bottoms and manages cables along the horizontal plane.
- LP chassis (specify LP finish), 1" top (specify LP or HP finish); metal handles; powder coated aluminum or anodized aluminum legs (specify paint finish).
- Anodized aluminum leg upcharge \$55.
- Optional e-lock available in the vertical position. Please specify V-Vertical and add \$224 list each.
- Cantilever storage requires two e-locks.

PRODUCT CODE	PRICE		SIZE/INCHES			WEIGHT VOL	
	LP	HP	H	W	D	LBS	FT ³
BRTCS45BBFFL	1978	2079	45	36	18	256	24
BRTCS45BBFFR	1978	2079	45	36	18	256	24

BRTCS45FFF0 • Cantilever Storage Open, File, Open, File, Open

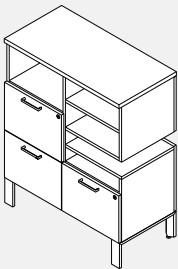

Left Shown

- Provides storage and privacy anywhere along the length of the bench.
- The middle opening of the cabinet allows the upper portion to cantilever above the worksurface
- Three locking file drawers with two locks.
- Open compartment (10.3" interior dimension)
- Three fixed open compartments two above worksurface (6.7" interior dimension), one below (3.7" interior dimension).
- Specify Left or Right handed.
- Optional Cable Basket suspends off storage unit's bottoms and manages cables along the horizontal plane.
- LP chassis (specify LP finish), 1" top (specify LP or HP finish); metal handles; powder coated aluminum or anodized aluminum legs (specify paint finish).
- Anodized aluminum leg upcharge \$55.
- Optional e-lock available in the vertical position. Please specify V-Vertical and add \$224 list each.
- Cantilever storage requires two e-locks.

PRODUCT CODE	PRICE		SIZE/INCHES			WEIGHT VOL	
	LP	HP	H	W	D	LBS	FT ³
BRTCS45FFFOL	2026	2124	45	36	18	256	24
BRTCS45FFFOR	2026	2124	45	36	18	256	24

BRTCS45BBF00 • Cantilever Storage Open, Box, Box, File, Open



Left Shown

- Provides storage and privacy anywhere along the length of the bench.
- The middle opening of the cabinet allows the upper portion to cantilever above the worksurface
- Locking file drawer.
- Two pencil drawers not locking.
- Open compartment (10.3" interior dimension) with adjustable glass shelf.
- Four fixed open compartments two above worksurface (6.7" interior dimension), two below (lower 12.2" interior dimension and upper 3.3" interior dimension)
- Specify Left or Right handed.
- Optional Cable Basket suspends off storage unit's bottoms and manages cables along the horizontal plane.
- LP chassis (specify LP finish), 1" top (specify LP or HP finish); metal handles; powder coated aluminum or anodized aluminum legs (specify paint finish).
- Anodized aluminum leg upcharge \$55.
- Optional e-lock available in the vertical position. Please specify V-Vertical and add \$224 list each.
- Cantilever storage requires one e-lock.

PRODUCT CODE	PRICE		SIZE/INCHES				WEIGHT VOL	
	LP	HP	H	W	D	LBS	FT ³	
BRTCS45BBFOOL	1933	2032	45	36	18	256	24	
BRTCS45BBFOOR	1933	2032	45	36	18	256	24	

BRTDS2B2F • Pier Storage unit Box/File, Box/File

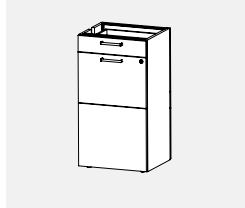

- Supports SideXSide divider with Box File on opposite sides for SideXSide application.
- Two lockable file drawers, two box drawers.
- Black injection moulded pencil tray included (can be secured inside the drawer anywhere along the perimeter wall).
- Optional e-lock available in the vertical position. Please specify V-Vertical and add \$446 list.

PRODUCT CODE	PRICE	SIZE/ INCHES			WEIGHT VOL	
		H	W	D	LBS	FT ³
BRTDS2B2F	1271	36	18	16	85	14

BRTDSOP • Pier Storage unit Open with Two glass adjustable shelves

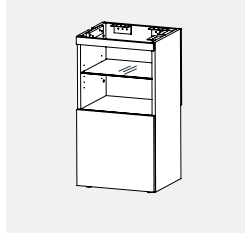

- Supports SideXSide divider with Box File on opposite sides for SideXSide application.
- Storage compartment internal height without height adjustable shelf: 15"

PRODUCT CODE	PRICE	SIZE/ INCHES			WEIGHT VOL	
		H	W	D	LBS	FT ³
BRTDSOP	843	36	18	16	75	14

BRTDS2D • Pier Storage unit Hinged Door with Two glass adjustable shelves

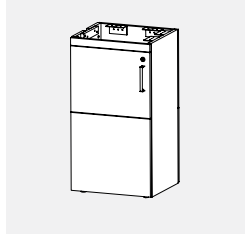

- Supports SideXSide divider with hinged lockable door on opposite sides for SideXSide application.
- Storage compartment internal height without height adjustable shelf: 15"
- Optional e-lock available in the vertical position. Please specify HL HR- Horizontal Left and Right add \$446 list.

PRODUCT CODE	PRICE	SIZE/ INCHES			WEIGHT VOL	
		H	W	D	LBS	FT ³
BRTDS2D	1135	36	18	16	79	14

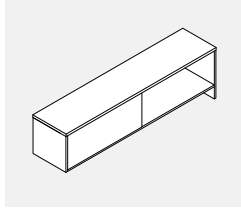
BRT21PHDO • SideXSide Storage - Open Double Sided

- Pier and Table supported SideXSide double sided open storage.
- Divides space and provides storage anywhere along bench or table.
- Storage compartment internal height: 14".
- LP chassis (specify LP finish); 1" top (specify LP or HP finish).

PRODUCT CODE	PRICE		SIZE/INCHES			WEIGHT VOL	
	LP	HP	H	W	D	LBS	FT ³
BRT21PHDO4216	733	858	21	42	16	96	10.5
BRT21PHDO4816	781	923	21	48	16	100	12
BRT21PHDO5416	857	1015	21	54	16	124	13.5
BRT21PHDO6016	903	1081	21	60	16	134	15
BRT21PHDO6616	980	1174	21	66	16	144	16.5
BRT21PHDO7216	1033	1246	21	72	16	152	18

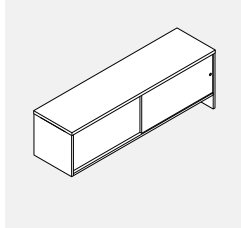
BRT21PLDS • SideXSide Storage - Sliding Laminate Double Sided

- Pier and Table supported SideXSide double sided storage with sliding laminate doors and recessed pull.
- Divides space and provides storage anywhere along bench or table.
- Storage compartment internal height: 14".
- LP chassis (specify LP finish); 1" top (specify LP or HP finish).
- Not Locking

PRODUCT CODE	PRICE		SIZE/INCHES			WEIGHT VOL	
	LP	HP	H	W	D	LBS	FT ³
BRT21PLDS4216	1703	1828	21	42	16	126	11
BRT21PLDS4816	1738	1880	21	48	16	134	12
BRT21PLDS5416	2181	2341	21	54	16	162	14
BRT21PLDS6016	2221	2398	21	60	16	176	15
BRT21PLDS6616	2371	2566	21	66	16	190	17
BRT21PLDS7216	2408	2619	21	72	16	203	18

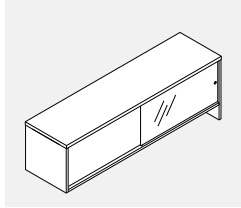
BRT21PGDS • SideXSide Storage - Sliding Glass Double Sided

- Pier and Table supported SideXSide double sided storage with sliding glass doors and recessed pull.
- Divides space and provides storage anywhere along bench or table.
- Storage compartment internal height: 14".
- LP chassis (specify LP finish); 1" top (specify LP or HP finish).

PRODUCT CODE	PRICE		SIZE/INCHES			WEIGHT VOL	
	LP	HP	H	W	D	LBS	FT ³
BRT21PGDS4216	1722	1843	21	42	16	110	10.5
BRT21PGDS4816	1758	1899	21	48	16	116	12
BRT21PGDS5416	2281	2441	21	54	16	141	13.5
BRT21PGDS6016	2322	2498	21	60	16	153	15
BRT21PGDS6616	2477	2671	21	66	16	165	16.5
BRT21PGDS7216	2532	2745	21	72	16	175	18

Panel supporting laterals

- Provide storage and panel support. Full access to Boulevard System 3 bottom raceway cover and power/data outlets. Feet support the front of the unit while a set of brackets (included) secures the unit to Boulevard panels.
- Panel mounting brackets leave 1" deep space between the storage and the panel allowing for easy cable passage behind the storage. Note: that the brackets bring the total depth to 19" (18" deep storage units) from the panel and 24" (23" deep storage units).
- Optional Cable Basket suspends off storage unit's bottom and manages cables along the horizontal plane.
- LP chassis (specify LP finish); 1" top (specify LP or HP finish); metal handles; powder coated aluminum or anodized aluminum legs (specify finish).

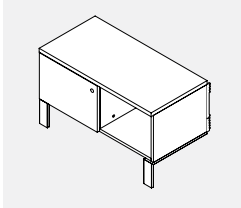
BRTPSLS • Panel Supporting Lateral Sliding Door

- Fits below Bridges tables, can join with other 21" high, 18" and 23" deep storage units along the panel. Can serve as an additional worksurface or an ad-hoc guest seating with optional cushion.
- Storage compartment internal height: 12.36".
- Sliding door locks on left side.
- Anodized aluminum leg upcharge \$55.

PRODUCT CODE	PRICE		SIZE/INCHES			WEIGHT VOL	
	LP	HP	H	W	D	LBS	FT ³
BRTPSLS30	986	1051	21	30	19	53	6.56
BRTPSLS36	1064	1132	21	36	19	60	7.87
BRTPSLS42	1146	1209	21	42	19	67	9.18
BRTPSLS2330	1313	1399	21	30	24	61	8.39
BRTPSLS2336	1420	1505	21	36	24	70	10.06
BRTPSLS2342	1528	1616	21	42	24	79	11.74

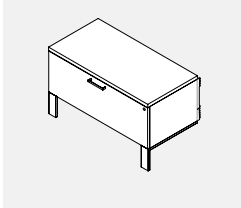
BRTPSL • Panel Supporting Lateral File Drawer

- Fits below Bridges tables, can join with other 21" high, 18" and 23" deep storage units along the panel. Can serve as an additional worksurface or an ad-hoc guest seating with optional cushion.
- One file drawer (holds letter, legal and A4 suspended file folders).
- Anodized aluminum leg upcharge \$55.
- Optional e-lock available in the vertical position. Please specify V-Vertical and add \$224 list.

PRODUCT CODE	PRICE		SIZE/INCHES			WEIGHT VOL	
	LP	HP	H	W	D	LBS	FT ³
BRTPSL30	1019	1033	21	30	19	77	6.56
BRTPSL36	1114	1177	21	36	19	84	7.87
BRTPSL42	1227	1290	21	42	19	92	9.18
BRTPSL2330	1355	1376	21	30	24	86	8.39
BRTPSL2336	1484	1570	21	36	24	95	10.06
BRTPSL2342	1642	1723	21	42	24	104	11.74

BRTP25LO-L • Panel Supporting Open Storage

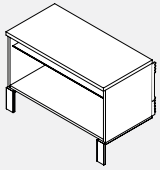

- Fits below Bridges tables, can join with other 25" high, 18" and 23" deep storage units along the panel. Can serve as an additional worksurface or an ad-hoc guest seating with optional cushion.
- Open compartment with glass adjustable shelf. Storage compartment internal height without height adjustable shelf: 15.8"
- Anodized aluminum leg upcharge \$55.

PRODUCT CODE	PRICE		SIZE/INCHES			WEIGHT VOL	
	LP	HP	H	W	D	LBS	FT ³
BRTP25LO30L	564	677	25	30	19	49	7.81
BRTP25LO36L	710	774	25	36	19	55	9.37
BRTP25LO42L	774	857	25	42	19	62	10.93
BRTP25LO2330L	755	903	25	30	24	59	10.42
BRTP25LO2336L	947	1033	25	36	24	66	12.50
BRTP25LO2342L	1033	1140	25	42	24	72	14.58

BRTPLBF • Panel Supporting Lateral Box/File

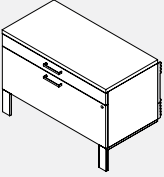

- Fits below Bridges tables, can join with other 25" high, 18" and 23" deep storage units along the panel.
- One lockable file drawer (holds letter, legal and A4 suspended file folders), one box drawer.
- Anodized aluminum leg upcharge \$55.
- Black injection moulded pencil tray included (can be secured inside the drawer anywhere along the perimeter wall).
- Optional e-lock available in the vertical position. Please specify V-Vertical and add \$224 list.

PRODUCT CODE	PRICE		SIZE/INCHES			WEIGHT VOL	
	LP	HP	H	W	D	LBS	FT ³
BRTPLBF30	1098	1163	25	30	19	88	7.81
BRTPLBF36	1260	1323	25	36	19	96	9.37
BRTPLBF42	1373	1453	25	42	19	104	10.93
BRTPLBF2330	1540	1616	25	30	24	98	10.42
BRTPLBF2336	1680	1763	25	36	24	107	12.50
BRTPLBF2342	1830	1936	25	42	24	116	14.58

BRTP25L2D • Panel Supporting Lateral w/hinged doors

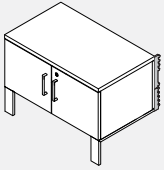

- Fits below Bridges tables, can join with other 25" high, 18" or 23" deep storage units along the panel.
- Can serve as an additional worksurface or an ad-hoc guest seating with optional cushion.
- Two lockable doors
- LP chassis and door fronts (specify LP finish)
- 1" top (specify LP or HP finish); metal handles, powder coated aluminum or anodized aluminum legs. Anodized aluminum leg upcharge \$55.

PRODUCT CODE	PRICE		SIZE/INCHES			WEIGHT VOL	
	LP	HP	H	W	D	LBS	FT ³
BRTP25L2D30	870	955	25	30	19	69	7.81
BRTP25L2D36	941	1038	25	36	19	78	9.38
BRTP25L2D42	987	1102	25	42	19	90	10.94
BRTP25L2D3024	997	1109	25	30	24	75	10.42
BRTP25L2D3624	1081	1214	25	36	24	84	12.50
BRTP25L2D4224	1162	1279	25	42	24	96	14.58

BRTC • Cushion

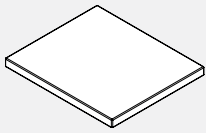

- Optional seat cushion may be added to any storage component.

PRODUCT CODE	SIZE/ INCHES			WEIGHT VOL	
	H	W	D	LBS	FT ³
BRTC	1.25	15.5	18	1	0.41

PRODUCT CODE	PRICE										
	GR1	GR2	GR3	GR4	GR5	GR6	GR7	GR8	GR9	GR10	GR20
BRTC	187	220	245	278	329	373	420	464	509	560	
BRTC	625	718	806	898	1099	1299	1502	1702	1902	2126	

Bridges Collaborative Seating

Bridges collaborative seating collection consists of seating, privacy screens, tables, tablets and power. It is a versatile modular furniture series which can be configured into many space planning scenarios including corner, in-line, open concept, traditional reception as well as secluded seating with high privacy partitions.

Furniture pieces can be used as stand alone items or can be mechanically linked together to form a variety of seating configurations.

Seat and backrest can be integrated with Bridges tables, as well as Boulevard panels.

Corner tables and in-line 6" table modules double as power delivery centers.

Dedicated seat backrests feature dual USB charging port.

Some Inline 6" table modules are furnished with grommets to support tablets.

Legs are available in standard Bridges metal painted finishes and anodized aluminum finish.

Bridges Collaborative Seating upholstery features a single stitch, thick white thread around the edges. The white, wide stitch along with crisp corners are part of its distinctive personality. In order to achieve crisp edges and to minimize "pillow" effect caused by taut fabric, the upholstery material has been applied deliberately loose, which may, over time, produce puckering of the upholstery surface material. This can be easily corrected by stretching the fabric by hand or during vacuuming.

In order to efficiently utilize fabric yield all 60" seats and backs feature a seam in the middle. The double stitch seam is sewn with a thin thread, closely matching the upholstery material in colour.

Some complicated fabric patterns prevent pattern matching and will be upholstered without the seam at the discretion of the factory.

Should you require no middle seam by cutting into the roll, please specify "NO SEAM" at time of your order.

• COM yardage is an estimate only. More accurate yardage will be dependent on the width of the fabric and on the repeat pattern.

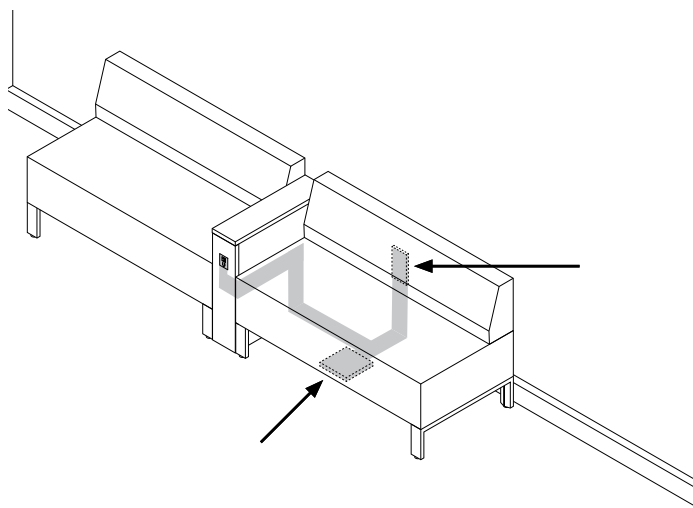
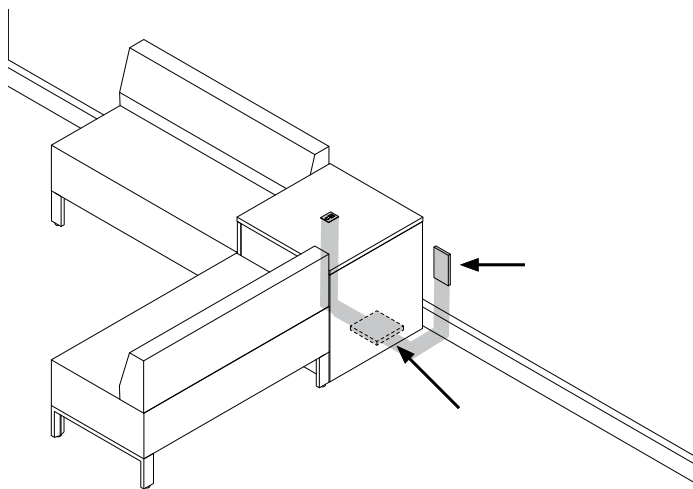
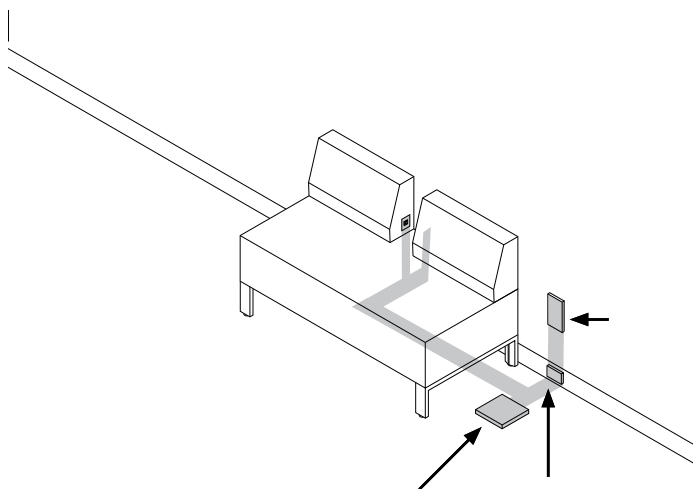

BRTST24-F • Low Table

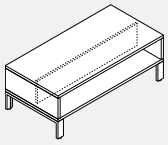

- **Freestanding 17" high tables.**
- Central partition divides space under top surface into two 11" deep compartments. All LP chassis w/ HP or LP top (3mm edging). Bridges storage aluminum leg.
- Specify chassis and top finish, specify metal leg finish. Add \$55 for anodized aluminum leg finish.
- To convert to mobile, please add \$36 list and an "M" at the end of the product code.

PRODUCT CODE	PRICE		SIZE/INCHES			WEIGHT	VOL
	LP	HP	H	W	D	LBS	FT ³
BRTST2424F	462	537	17	24	24	40.7	5.67
BRTST2448F	652	845	17	48	24	69.0	11.33
BRTST2460F	730	999	17	60	24	83.6	14.17

BRTSE-NB • Lounge Seat

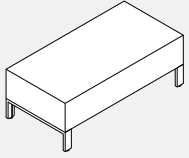

- **Fully upholstered armless lounge seat with metal base.**
- Seats can be freestanding or linked with optional interlocking bracket kit.
- Specify seating fabric and leg finish.
- Add \$55 for anodized aluminum leg finish.

PRODUCT CODE	SIZE/INCHES			WEIGHT	VOL	YRDS
	H	W	D	LBS	FT ³	(COM)
BRTSE24NB	17	24	24	22.7	5.57	1.25
BRTSE48NB	17	48	24	36.9	11.33	2.00
BRTSE60NB	17	60	24	47.0	14.17	2.50

PRODUCT CODE	PRICE										
	GR1	GR2	GR3	GR4	GR5	GR6	GR7	GR8	GR9	GR10	
BRTSE24NB	652	697	732	774	839	899	958	1015	1076	1140	
BRTSE48NB	1191	1262	1317	1386	1488	1584	1681	1767	1867	1969	
BRTSE60NB	1378	1467	1537	1621	1750	1871	1990	2101	2224	2352	
GRADE	GR11	GR12	GR13	GR14	GR15	GR16	GR17	GR18	GR19	GR20	
BRTSE24NB	1224	1343	1460	1580	1840	2101	2364	2626	2886	3175	
BRTSE48NB	2105	2295	2484	2670	3092	3508	3928	4348	4764	5225	
BRTSE60NB	2522	2759	2992	3227	3754	4275	4802	5324	5845	6421	

BRTSE-B • Lounge Seat with Backrest

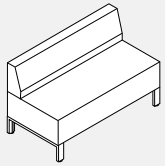

- **Fully upholstered armless lounge seat with full backrest and metal base.**
- Backrests are permanently secured to the seats and cannot be reconfigured on site.
- Seats can be freestanding or linked with optional interlocking bracket kit.
- Specify seating fabric and leg finish.
- Add \$55 for anodized aluminum leg finish.

PRODUCT CODE	SIZE/INCHES			WEIGHT	VOL	YRDS
	H	W	D	LBS	FT ³	(COM)
BRTSE2424B		24	24	33.0	9.57	2.25
BRTSE4848B		48	24	55.5	19.33	3.50
BRTSE6060B		60	24	70.0	24.17	4.50

PRODUCT CODE	PRICE										
	GR1	GR2	GR3	GR4	GR5	GR6	GR7	GR8	GR9	GR10	
BRTSE2424B	1030	1109	1170	1249	1364	1471	1581	1680	1790	1904	
BRTSE4848B	1901	2025	2123	2242	2421	2589	2758	2911	3086	3266	
BRTSE6060B	2203	2363	2488	2641	2870	3089	3307	3505	3727	3958	
GRADE	GR11	GR12	GR13	GR14	GR15	GR16	GR17	GR18	GR19	GR20	
BRTSE2424B	2056	2273	2484	2694	3167	3633	4109	4579	5046	5568	
BRTSE4848B	3502	3835	4160	4489	5229	5953	6692	7426	8153	8962	
BRTSE6060B	4261	4687	5110	5531	6479	7414	8363	9306	10241	11283	

BRTSE-BL/R • Lounge Seat, Single 24" Offset Backrest

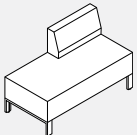

Right Hand Shown

- **Fully upholstered armless lounge seat with one backrest and metal base.**
- Specify backrest as either Left or Right side. Backrests are permanently secured to the bench and cannot be reconfigured on site.
- Seats can be freestanding or linked with optional interlocking bracket kit.
- Specify seating fabric and leg finish.
- Add \$55 for anodized aluminum leg finish.

PRODUCT CODE	SIZE/INCHES			WEIGHT	VOL	YRDS
	H	W	D	LBS	FT ³	(COM)
BRTSE2448BL	48	24	24	46.10	19.33	3.00
BRTSE2448BR	48	24	24	46.10	19.33	3.00

PRODUCT CODE	PRICE										
	GR1	GR2	GR3	GR4	GR5	GR6	GR7	GR8	GR9	GR10	
BRTSE2448BL	1568	1672	1757	1858	2012	2156	2301	2432	2582	2735	
BRTSE2448BR	1568	1672	1757	1858	2012	2156	2301	2432	2582	2735	
GRADE	GR11	GR12	GR13	GR14	GR15	GR16	GR17	GR18	GR19	GR20	
BRTSE2448BL	2936	3224	3506	3785	4417	5041	5675	6302	6926	7619	
BRTSE2448BR	2936	3224	3506	3785	4417	5041	5675	6302	6926	7619	

BRTSE-BODL/R • Lounge Seat, Two 24" Offset Backrest

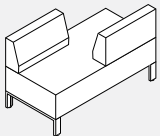

Left Hand Shown

- **Fully upholstered armless lounge seat with two offset backrests and metal base.**
- Specify either Left or Right backrest configuration. Backrests are permanently secured to the bench and cannot be reconfigured on site.
- Seats can be freestanding or linked with optional interlocking bracket kit.
- Specify seating fabric and leg finish.
- Add \$55 for anodized aluminum leg finish.

PRODUCT CODE	SIZE/INCHES			WEIGHT	VOL	YRDS
	H	W	D	LBS	FT ³	(COM)
BRTSE2448BODL	29	48	24	46.10	19.33	4.00
BRTSE2448BODR	29	48	24	46.10	19.33	4.00

PRODUCT CODE	PRICE										
	GR1	GR2	GR3	GR4	GR5	GR6	GR7	GR8	GR9	GR10	
BRTSE2448BODL	1944	2085	2196	2331	2536	2728	2922	3098	3296	3502	
BRTSE2448BODR	1944	2085	2196	2331	2536	2728	2922	3098	3296	3502	
GRADE	GR11	GR12	GR13	GR14	GR15	GR16	GR17	GR18	GR19	GR20	
BRTSE2448BODL	3771	4151	4527	4901	5743	6576	7417	8256	9087	10011	
BRTSE2448BODR	3771	4151	4527	4901	5743	6576	7417	8256	9087	10011	

BRTSE-EBL/R • Lounge Seat, Single 21" Wide Backrest with USB

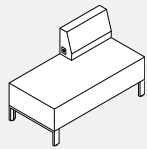

Right Hand Shown

- Fully upholstered armless lounge seat with one backrest and metal base.

- 21" wide backrest come with embedded dual USB port in its side. Note: the side mounted power/USB outlets always point to the centre of the seat. Each USB outlet offers 2 amps. AC/DC transformer plugs into the wall or floor monument (approximately 4' long cable available from the bottom of the seat). Transformer power consumption: 0.68 amps.

- Specify either Left or Right backrest configuration. Backrests are permanently secured to the bench and cannot be reconfigured on site.
- Seats can be freestanding or linked with optional interlocking bracket kit.

	PRODUCT CODE	PRICE									
		GR1	GR2	GR3	GR4	GR5	GR6	GR7	GR8	GR9	GR10
• White USB outlets.	BRTSE2148EBL	1816	1923	2005	2107	2259	2404	2550	2682	2831	2984
• Specify seating fabric and leg finish.	BRTSE2148EBR	1816	1923	2005	2107	2259	2404	2550	2682	2831	2984
• Add \$55 for anodized aluminum leg finish.	BRTSE2148EBL	3187	3474	3753	4035	4666	5290	5921	6549	7173	7867
	BRTSE2148EBR	3187	3474	3753	4035	4666	5290	5921	6549	7173	7867

PRODUCT CODE	SIZE/INCHES			WEIGHT LBS	VOL FT ³	YRDS (COM)
	H	W	D			
BRTSE2148EBL	29	48	24	46.10	19.33	3.00
BRTSE2148EBR	29	48	24	46.10	19.33	3.00

BRTSE-E2B • Lounge Seat, two 21" Wide Backrests with USB

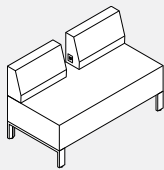

- Fully upholstered armless lounge seat with two backrests, each with dual USB outlet and metal base.

- Both 21" wide backrests come with embedded dual USB port in its side. Note: the side mounted power/USB outlets always point to the centre of the seat. Each USB outlet offers 2 amps. AC/DC transformer plugs into the wall or floor monument (about 52" long cable available from the bottom of the seat). Transformer power consumption: 0.68 amps.

- Backrests are permanently secured to the bench and cannot be reconfigured on site.
- Seats can be freestanding or linked with optional interlocking bracket kit.

- Specify seating fabric and leg finish.
- USB outlets are white.

	PRODUCT CODE	PRICE									
		GR1	GR2	GR3	GR4	GR5	GR6	GR7	GR8	GR9	GR10
• Add \$55 for anodized aluminum leg finish.	BRTSE2148E2B	2442	2582	2694	2828	3034	3226	3420	3595	3794	3997
	BRTSE2148E2B	4268	4649	5024	5399	6241	7073	7915	8754	9584	10509

PRODUCT CODE	SIZE/INCHES			WEIGHT LBS	VOL FT ³	YRDS (COM)
	H	W	D			
BRTSE2148E2B	29	48	24	57.00	19.33	4.00

BRTSE-EBODL/R • Lounge Seat Two USB backrests Offset

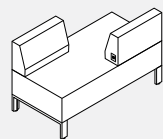

Left Hand Shown

- Fully upholstered armless lounge seat with two offset backrests, each with dual USB outlet and metal base.

- Both 21" wide backrests come with embedded dual USB port in its side.

- Note: the side mounted power/USB outlets always point to the centre of the seat. Each USB outlet offers 2 amps. AC/DC transformer plugs into the wall or floor monument (about 52" long cable available from the bottom of the seat). Transformer power consumption: 0.68 amps.

- Backrests are permanently secured to the bench and cannot be reconfigured on site.
- Seats can be freestanding or linked with optional interlocking bracket kit.

	PRODUCT CODE	PRICE									
		GR1	GR2	GR3	GR4	GR5	GR6	GR7	GR8	GR9	GR10
• Specify seating fabric and leg finish.	BRTSE2148EBODL	2442	2582	2694	2828	3034	3226	3420	3595	3794	3997
• USB outlets are white.	BRTSE2148EBODR	2442	2582	2694	2828	3034	3226	3420	3595	3794	3997
• Add \$55 for anodized aluminum leg finish.	BRTSE2148EBODL	4268	4649	5024	5399	6241	7073	7915	8754	9584	10509
	BRTSE2148EBODR	4268	4649	5024	5399	6241	7073	7915	8754	9584	10509

PRODUCT CODE	SIZE/INCHES			WEIGHT LBS	VOL FT ³	YRDS (COM)
	H	W	D			
BRTSE2148EBODL	29	48	24	57.00	19.33	4.00
BRTSE2148EBODR	29	48	24	57.00	19.33	4.00

BRTSE-EBL/R • Single Seat, Single 21" Wide Backrest with USB

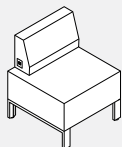

Right Hand Shown

- Fully upholstered armless lounge seat with one backrests, with dual USB outlet and metal base.

- 21" wide backrest come with embedded dual USB port in its side.

- Note: Each USB outlet offers 2 amps. AC/DC transformer plugs into the wall or floor monument (about 52" long cable available from the bottom of the seat). Transformer power consumption: 0.68 amps.

- Backrests are permanently secured to the bench and cannot be reconfigured on site.
- Seats can be freestanding or linked with optional interlocking bracket kit.

	PRODUCT CODE	PRICE									
		GR1	GR2	GR3	GR4	GR5	GR6	GR7	GR8	GR9	GR10
• Specify seating fabric and leg finish.	BRTSE2124EBL	1279	1356	1420	1496	1612	1722	1828	1927	2039	2155
• USB outlets are white.	BRTSE2124EBR	1279	1356	1420	1496	1612	1722	1828	1927	2039	2155
• Add \$55 for anodized aluminum leg finish.	BRTSE2124EBL	2306	2519	2730	2945	3418	3883	4356	4828	5297	5818
	BRTSE2124EBR	2306	2519	2730	2945	3418	3883	4356	4828	5297	5818

PRODUCT CODE	SIZE/INCHES			WEIGHT LBS	VOL FT ³	YRDS (COM)
	H	W	D			
BRTSE2124EBL	29	24	24	33.00	9.67	2.25
BRTSE2124EBR	29	24	24	33.00	9.67	2.25

BRTSPI • Boulevard Integrated Lounge Seat

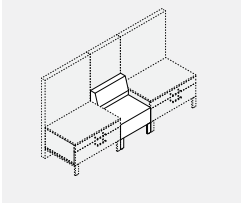

- Fully upholstered armless lounge seat with full width backrest and special metal legs.
- The single backrest is permanently secured to the bench and cannot be reconfigured on site.
- The seat brackets connect on-module to panel's vertical slots; **On-module applications only**. The seat width must be equal to panel width. The seat is **NOT** capable of supporting the panel.
- Seats and storage units can be interconnected with shared leg. Special leg support allows access to panel raceway cavity under the seat as well as access to panel-distributed duplex outlets.
- Backrests are permanently secured to the bench and cannot be reconfigured on site.

PRODUCT CODE	SIZE/INCHES			WEIGHT LBS	VOL FT ³	YRDS (COM)
	H	W	D			
BRTSPI2424	29	24	24	33.00	9.67	2.25
BRTSPI4848	29	48	24	55.50	19.33	3.50
BRTSPI6060	29	60	24	69.00	24.17	4.50

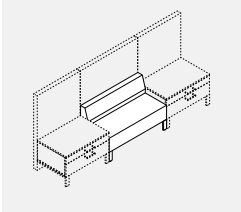

PRODUCT CODE	GRADE	PRICE									
		GR1	GR2	GR3	GR4	GR5	GR6	GR7	GR8	GR9	GR10
BRTSPI2424		1030	1109	1170	1249	1364	1471	1581	1680	1790	1904
BRTSPI4848		1901	2025	2123	2242	2421	2589	2758	2911	3086	3266
BRTSPI6060		2203	2363	2488	2641	2870	3089	3307	3505	3727	3958
PRODUCT CODE	GRADE	GR11	GR12	GR13	GR14	GR15	GR16	GR17	GR18	GR19	GR20
BRTSPI2424		2056	2273	2484	2694	3167	3633	4109	4579	5046	5568
BRTSPI4848		3502	3835	4160	4489	5229	5953	6692	7426	8153	8962
BRTSPI6060		4261	4687	5110	5531	6479	7414	8363	9306	10241	11283

BRTSPI-L/R • Boulevard integrated Single Seat with USB

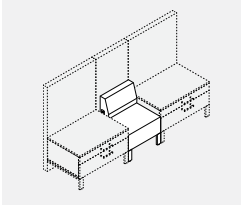

Right Hand Shown

- Fully upholstered armless lounge seat with 21" wide backrest with dual USB outlets and special metal legs.
- The single backrest is permanently secured to the bench and cannot be reconfigured on site.
- The seat brackets connect on-module to panel's vertical slots; **On-module applications only**. The seat width must be equal to panel width. The seat is **NOT** capable of supporting the panel.
- Seats and storage units can be interconnected with shared leg. Special leg support allows access to panel raceway cavity under the seat as well as access to panel-distributed duplex outlets.
- Note: Each USB outlet offers 2 amps. AC/DC transformer plugs into the wall or floor monument (about 52" long cable available from the bottom of the seat). Transformer power consumption:0.68 amps.
- Panels and storage units not included.

PRODUCT CODE	SIZE/INCHES			WEIGHT LBS	VOL FT ³	YRDS (COM)
	H	W	D			
BRTSPI2124L	29	24	24	33.00	9.67	2.25
BRTSPI2124R	29	24	24	55.50	19.33	2.25

PRODUCT CODE	GRADE	PRICE									
		GR1	GR2	GR3	GR4	GR5	GR6	GR7	GR8	GR9	GR10
BRTSPI2124L		1279	1356	1420	1496	1612	1722	1828	1927	2039	2155
BRTSPI2124R		1279	1356	1420	1496	1612	1722	1828	1927	2039	2155
PRODUCT CODE	GRADE	GR11	GR12	GR13	GR14	GR15	GR16	GR17	GR18	GR19	GR20
BRTSPI2124L		2306	2519	2730	2945	3418	3883	4356	4828	5297	5818
BRTSPI2124R		2306	2519	2730	2945	3418	3883	4356	4828	5297	5818

BRTSPI-B2 • Boulevard integrated Lounge Seat Two 21" Backrests with USB

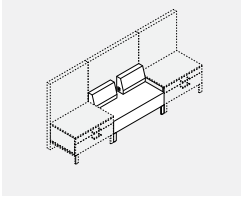

- Fully upholstered armless lounge seat with 21" wide backrest with dual USB outlets and special metal legs.
- The single backrest is permanently secured to the bench and cannot be reconfigured on site.
- The seat brackets connect on-module to panel's vertical slots; **On-module applications only**. The seat width must be equal to panel width. The seat is **NOT** capable of supporting the panel.
- Seats and storage units can be interconnected with shared leg. Special leg support allows access to panel raceway cavity under the seat as well as access to panel-distributed duplex outlets.
- Note: Each USB outlet offers 2 amps. AC/DC transformer plugs into the wall or floor monument (about 52" long cable available from the bottom of the seat). Transformer power consumption:0.68 amps.
- Panels and storage units not included.

PRODUCT CODE	SIZE/INCHES			WEIGHT LBS	VOL FT ³	YRDS (COM)
	H	W	D			
BRTSPI2148B2	29	48	24	33.00	9.67	4.00

PRODUCT CODE	GRADE	PRICE									
		GR1	GR2	GR3	GR4	GR5	GR6	GR7	GR8	GR9	GR10
BRTSPI2148B2		2442	2582	2694	2828	3034	3226	3420	3595	3794	3997
PRODUCT CODE	GRADE	GR11	GR12	GR13	GR14	GR15	GR16	GR17	GR18	GR19	GR20
BRTSPI2148B2		4268	4649	5024	5399	6241	7073	7915	8754	9584	10509

BRTSINT-S • Bridges Integrated Lounge Seat Single Sided

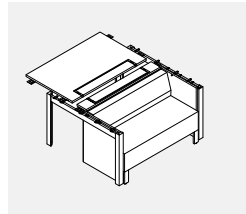
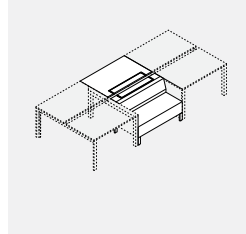

- Fully upholstered armless lounge seat with full width backrest and metal legs
- Integrated into Bridges 62.5" deep Back 2 Back linear table assembly.
- The Single-sided kit consists of 24"x48" or 24"x60" seat, full width back, three-sided below work surface enclosure, 6" deep work surface module with access door, 30"x48" or 30"x60" wide work surface with access door and supporting hardware.
- **Note: Only compatible with Back 2 Back 30" deep work surfaces (62.5" total depth) supported by Bridges rectangular legs.**
- **Connecting Back 2 Back table beams, legs and worksurface need to be specified separately.**
- Not compatible with Bridges round legs, 24" deep work surfaces; not compatible with single line table assemblies 24" and 30" deep. The kit cannot be used at the end of a table run, nor can it be used as a standalone, freestanding configuration. It must always be supported by Back 2 Back Bridges table assemblies on either side.
- Note: the seat module accommodates continuation of power and data distribution services below work surfaces (specify Below Work surface Power Troughs and power components separately).
- The 6" deep work surface module with access door provides access to Below Work Surface Power Trough.
- Backrests are permanently secured to the bench and cannot be reconfigured on site.
- Tables not included.
- Specify seating fabric and leg finish. Add \$55 for anodized aluminum leg finish

PRODUCT CODE	SIZE/INCHES			WEIGHT LBS	VOL FT ³	YRDS (COM)
	H	W	D			
BRTSINT48S	29	48	24	126.00	19.33	3.50
BRTSINT60S	29	60	24	155.00	24.17	4.50

PRODUCT CODE	PRICE										
	GRADE	GR1	GR2	GR3	GR4	GR5	GR6	GR7	GR8	GR9	GR10
BRTSINT48SLP	4164	4237	4291	4358	4459	4558	4655	4743	4841	4943	
BRTSINT60SLP	4353	4441	4511	4596	4722	4847	4965	5075	5200	5328	
BRTSINT48SHP	4386	4455	4511	4578	4682	4776	4875	4963	5063	5165	
BRTSINT60SHP	4573	4660	4732	4816	4942	5066	5184	5295	5418	5548	
GRADE	GR11	GR12	GR13	GR14	GR15	GR16	GR17	GR18	GR19	GR20	
BRTSINT48SLP	5080	5270	5456	5643	6065	6480	6904	7323	7737	8199	
BRTSINT60SLP	5498	5734	5969	6202	6729	7249	7776	8300	8819	9396	
BRTSINT48SHP	5299	5489	5677	5863	6284	6701	7123	7542	7956	8421	
BRTSINT60SHP	5716	5952	6186	6420	6947	7468	7995	8520	9038	9617	

BRTSINT-D • Bridges Integrated Lounge Double Sided

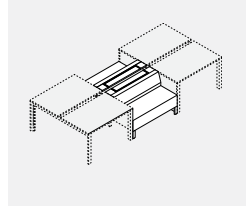

- Fully upholstered armless lounge bench with backrests and metal legs integrated into Bridges 62.5" deep Back 2 Back linear table assembly.
- The Double-sided kit consists of two 24"x48" or 24"x60" seats, full width backs, three-sided below work surface enclosures, 6" deep work surface modules with access doors and supporting hardware.
- Note: Only compatible with Back 2 Back 30" deep work surfaces (62.5" total depth) supported by Bridges rectangular legs. Not compatible with Bridges round legs, 24" deep work surfaces; not compatible with single line table assemblies 24" and 30" deep.
- The kit cannot be used at the end of a table run nor as a standalone, freestanding configuration. It must always be supported by Back 2 Back Bridges table assemblies on either side.
- Note: the seat module accommodates continuation of power and data distribution services below work surfaces (specify Below Work Surface Power Troughs and power components separately).
- The 6" deep work surface module with access door provides access to Below Work Surface Power Trough.
- Backrests are permanently secured to the bench and cannot be reconfigured on site.
- Tables not included.
- Specify seating fabric, LP laminate finish (enclosure), work surface and leg finish.
- Specify seating fabric and leg finish. Add \$55 for anodized aluminum leg finish.

PRODUCT CODE	SIZE/INCHES			WEIGHT LBS	VOL FT ³	YRDS (COM)
	H	W	D			
BRTSINT48D	29	48	24	182.00	19.33	3.50
BRTSINT60D	29	60	24	220.00	24.17	4.50

PRODUCT CODE	PRICE										
	GRADE	GR1	GR2	GR3	GR4	GR5	GR6	GR7	GR8	GR9	GR10
BRTSINT48DLP	5121	5365	5564	5799	6156	6497	6832	7139	7490	7849	
BRTSINT60DLP	5727	6041	6294	6599	7059	7494	7928	8323	8771	9232	
BRTSINT48DHP	5339	5586	5782	6019	6377	6714	7051	7360	7707	8067	
BRTSINT60DHP	5946	6263	6514	6818	7278	7714	8146	8542	8989	9453	
GRADE	GR11	GR12	GR13	GR14	GR15	GR16	GR17	GR18	GR19	GR20	
BRTSINT48DLP	8319	8985	9639	10296	11771	13225	14702	16168	17623	19241	
BRTSINT60DLP	9838	10694	11538	12381	14277	16148	18044	19930	21801	23883	
BRTSINT48DHP	8539	9203	9859	10515	11990	13444	14922	16389	17844	19461	
BRTSINT60DHP	10060	10913	11757	12599	14497	16367	18264	20149	22020	24100	

BRTPP-L1 • Seat Partitions

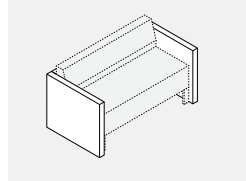

- Fully upholstered, 2.5" thick, 3-part, low level partition kit wraps around 24" or 48" bridges seat.
- The seat front is recessed by 2.5". The kit is secured to seats on-site (brackets connecting seat legs to the inner side of the partition are included).
- Upholsterd kits consist of 2" hollow core boards, 1/4 foam, fabric, levelers and connecting hardware. Specify panel fabric finish.
- Note: Seats and backrests are not included.

PRODUCT CODE	PRICE		SIZE/INCHES			WEIGHT LBS	VOL FT ³	YRDS (COM)
	GR1	GR2	H	W	D			
BRTPP2424L1	1098	1207	25	29	28.7	32.00	12.04	2.50
BRTPP2448L1	1464	1616	25	53	28.7	41.00	22.01	3.25

BRTPP-L2 • Seat Privacy Partitions

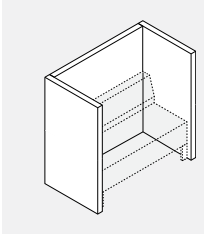

- Fully upholstered, 2.5" thick, 3-part, Two tier partition kit wraps around 24" or 48" bridges seat. The 50" high assembly provides seated visual privacy.
- 2.5" thick, upholstered partitions improve acoustic privacy for focused time away from the team or for a quiet phone call. Recessed seat extends the partition at the front by 2.5" for enhanced sense of privacy.
- The kit is secured to seats on-site (brackets connecting seat legs to the inner side of the partition are included).
- Upholstered kits consist of 2" hollow core boards, 1/4" foam, fabric, levelers and connecting hardware. Specify panel fabric finish.
- Note: Seats and backrests are not included.

PRODUCT CODE	PRICE		SIZE/INCHES			WEIGHT LBS	VOL FT ³	YRDS (COM)
	GR1	GR2	H	W	D			
BRTPP2424L2	1610	1830	50	29	28.7	38.00	24.08	5.00
BRTPP2448L2	2123	2343	50	53	28.7	48.00	44.01	6.50

BRTS-B • Square Table Block

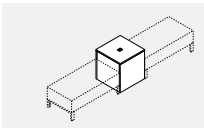
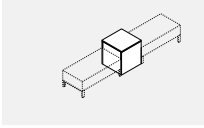

- Freestanding 25" high, 24" square table block serves as a visual anchor whenever bridges seat needs to turn corner, or split into two, three or four directions.
- BRTS2424BP can be positioned directly over a floor monument, which will supply power to the top-mounted Power module. This option includes 24"x24" block chassis and flush-mounted Duo power module included (two outlets and two 2.1 amp USB ports, white face plate, outlets and bezel, 72" long three prong black cord).
- The square table block can function as a self-supporting, freestanding unit or it can be secured permanently to adjacent Bridges seats with optional interconnecting brackets listed below.
- Specify LP laminate chassis, 1" LP or HP laminate surface.
- 2 Square Table Ganging Brackets Kits included.
- Powered Square Table Block has optional side panel grommet as needed. Please specify GRMTRS for right side and GRMTLS for left side.

PRODUCT CODE	PRICE		SIZE/INCHES			WEIGHT LBS	VOL FT ³
	LP	HP	H	W	D		
BRTS2424B	512	586	25	24	24	57.00	8.33
BRTS2424BP	1025	1098	25	24	24	59.30	8.33

BRTSTBG • Square Table Block Ganging Bracket Kit

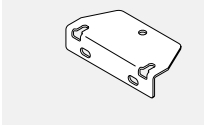

- Two Square Table Block Ganging Brackets connect seat legs permanently to the side of the 24" square table block on site. The kit employs machine screws connecting legs to seats and ships with wood screws which provide permanent connection the the Square Table Block.
- Includes 2 brackets and screws; Black powdercoat finish.

PRODUCT CODE	PRICE	SIZE/ INCHES			WEIGHT LBS	VOL FT ³
		H	W	D		
BRTSTBG	36	1.1	5	2.4	0.50	0.01

BRTSTSB • Ganging Bracket Kit

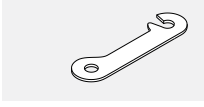

- Two ganging brackets connect seat temporarily to adjacent in-line seat or 24" deep bridges storage.
- Black powder coat finish.

PRODUCT CODE	PRICE	SIZE/ H	INCHES		WEIGHT LBS	VOL FT ³
			W	D		
BRTSTSB	17	.1	6	1.3	0.3	0.00

BRTS-Bx • Inline 6" Block

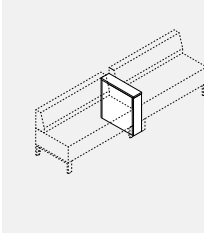

- Multifunctional In-line 6" table block divides seating areas, serves as a utility surface, can support tablet arms, lamps and double as a power delivery centre.
- It is permanently secured between two Bridges seats and cannot be placed at the end of a run. Two Square Table Block Ganging Brackets BRTSTBG connect seat legs permanently to the side of the in-line table block on site. The included kit employs machine screws connecting legs to seats and ships with wood screws which provide permanent connection the the Inline 6" Block. Black powder coat finish.
- The chassis is available without Power Module, with one Power Module or with two vertically embedded Power Modules.
- Vertical-panel flush-mounted Duo module provides two outlets and two 2.1 amp USB ports; 72" cord exits through the bottom and plugs into a floor monument under seats, white face plate and bezel.
- BRTS2406BT and BRTS2406BPT include 9.5" x 14.5" swivel tablet.
- Specify LP laminate chassis, 1" LP or HP laminate surface. If top is specified in LP the tablet will be manufactured in LP as well. If top is specified in HP the tablet will be manufactured in HP.
- 2 Square Table Ganging Bracket Kits included.

PRODUCT CODE	PRICE		SIZE/INCHES			WEIGHT LBS	VOL FT ³
	LP	HP	H	W	D		
BRTS2406B	439	474	25	6	24	21.00	2.08
BRTS2406BP	953	988	25	6	24	23.30	2.08
BRTS2406B2P	1464	1500	25	6	24	24.30	2.08
BRTS2406BT	842	879	25	6	24	25.60	2.08
BRTS2406BPT	1354	1392	25	6	24	24.30	2.08

BRTS2406B

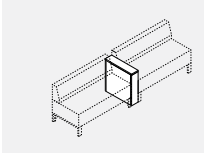

Inline table (without power module and swivel arm).

BRTS2406BP

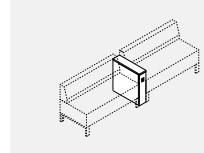

Inline table with front power module

BRTS2406B2P

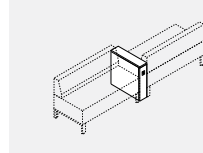

Inline table with front and rear power module.

BRTS2406BT

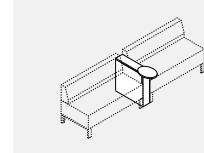

Inline table with swivel tablet arm.

BRTS2406BPT

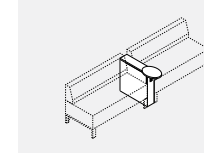

Inline table with front power module and swivel tablet arm.

LICENCE 2 SPECIFICATIONS

- Greenguard certified (www.greenguard.org)
- Carb compliant
- Level3™ certified (www.levelcertified.org)
- Tested to meet or exceed ANSI/BIFMA X5.9.2004 , ANSI/BIFMA X5.5.2008 and CAN/CGSB 44-227-2008
- Plant is ISO 9001:2015 (Quality) certified
- Plant is ISO 14001: 2015 (Environmental) certified
- Plant is OHSAS 18001:2007 (Health and Safety) certified
- 100% made in Canada
- Lifetime Warranty
- Over 6500 standard components
- Custom units available in 5 weeks lead time
- Over 24 standard laminate finishes available
- Edge colour can be specified - select from 20 colours and patterns
- Desk shells and rectangular returns non handed
- Panel end style with top over side panel design
- Tops available in 1" thick Low Pressure Laminate
- Tops available in 1-1/16" or 1-7/16" thick High Pressure Laminate
- Tops available in one edge style: Boulevard (S)
- Surfaces constructed of 45lb. density particleboard substructure with high performance thermally fused laminate or optional high pressure laminate
- Chassis constructed from 45lb. density particleboard substructure with thermally fused laminate
- 3mm edges surround all tops, end panels, drawers and door fronts
- Laminate full modesty and 10" partial modesty available as standard
- Anodized Aluminum framed frosted glazed doors available, no handles included.
- Box drawers mounted on full extension premium ball bearing slides
- File drawers mounted on premium full extension progressive ball bearing slides
- File drawers accommodate letter and/or legal hanging files (see file drawer capacity page G.2)
- Locks are standard on all units. Available in black or silver finish
- All lateral files feature a drawer interlocking mechanism
- Desk drawers open with pulls as standard
- Drawer bottoms are routed into the drawer sides
- Drawer fronts are edged on all four sides with matching 3mm edge
- All drawers locking as standard
- Key alike available
- Pedestals available in 15-1/2" width and 18, 20, 23, 24, 29, 30, 36 depth, include one pencil tray
- All mobile pedestals have option for a counterweight
- Storage modules feature levellers 5/16" x 1" easily accessible from outside the unit. All others feature 5/16" x 2" levellers.
- Monopost legs available in 3 different options, 2.5" or 3" square, 3" round and 6" round
- 6 handle options
- Storage modules available in 4 heights 29", 50", 65.8", 72.8"
- Lateral modules available in 3 widths 30", 36", 42"
- Rectangular grommets are standard and can be specified in a variety of locations as standard (see Grommet Location page A.10)
- Several Power Grommets style and configurations available.
- Drawers/Door fronts are available in a different finish than that of the chassis. Please specify option. Note that the kick plate will match the drawer front finish unless otherwise noted.

FREESTANDING - TECHNICAL INFORMATION

Worksurfaces

- Worksurfaces are offered in LP (1"), B (1 1/16") or W (1 7/16").
- All worksurfaces are drilled to accept connectors in a desk configuration.
- Worksurfaces are available in the following shapes: rectangular, bow, wedge and swerve.

Worksurface Edge trim

- Available in 1 1/16" ("B" thickness), 1 7/16" ("W" thickness) or 1" ("LP" thickness).
- Wood grain PVC edge trim, available in Boulevard (S) edge "B" and "W" thickness only.

Edge Options

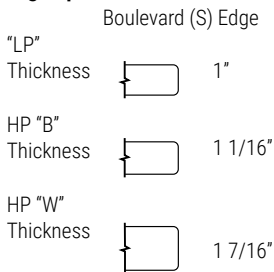

Hardware

All attachment hardware is included.

Modesty Panels

- Available in full panel 27 5/8" high or half panel ("H" option) 10" high.
- Modesty panels are flush mounted with 24", 30" and 36" deep end gables.
- Modesty panels are available recessed for 30" and 36" deep end gables.
- All recessed modesty panels are inset 6" from the edge.
- Only flush modesty panels are used for extended shell and bridge.
- Only full modesty panels are used for "L2D" desks: Rectangular, Bow, and Wedge worksurfaces.
- All exposed edges are edge banded.

Panel and Gables

- The term "end gable" or "narrow gable" is used to configure a shell, single pedestal or return.
- The term "end panel" or "narrow panel" is used to configure a table desk with shaped worksurfaces such as "D", "P", or profiles.
- All end gables are interchangeable for left or right hand use.

- End gables 24", 30" and 36" deep are drilled to accept full or half modesty panels that are flush mounted.
- End gables 30" and 36" are used for full or half modesty panels that are recessed.
- All panels and end gables are 1" thick and 27 5/8" high.
- All panels and end gables are finished in low pressure laminate.
- End gables are used in shells and single pedestal desks.
- Narrow end gables are used in shells, single pedestal desks, "T", or "L" bases.
- Narrow panels are routed to accept modular connectors for "T" or "L" applications.
- All panels and gables are predrilled to accept levelers at the bottom and connectors at the top.
- All panels or gables are 3mm edge banded at the exposed edge .
- All narrow gables are routed at the top to allow cables to pass through and come with a connecting flat bracket.
- All bottom edges are edge banded.

Handles

- Handles are offered in 4 styles.
- Options are as follows:
 - BB = Bow Matte Black
 - BC = Bow Matte Chrome
 - UB = "U"Dull Black
 - UC = "U"Dull Chrome
 - FA = Flat Aluminum
 - RN = Round Nickel

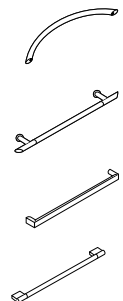

- Span dimension between drilling locations is 192mm.
- e-lock

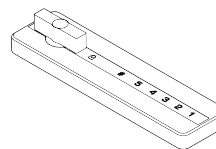

WOOD GRAIN (WG) LAMINATE DIRECTION

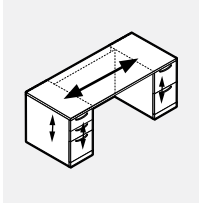

Double Pedestal Desks

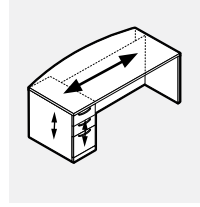

Single Pedestal Desks

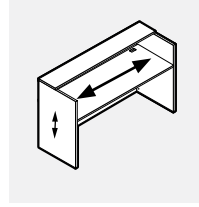

Reception Desks

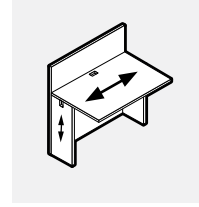

Surround Bridges

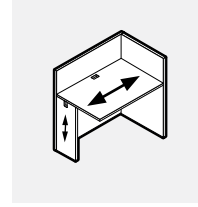

Right Hand Surround Bridges

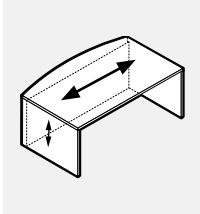

Shells

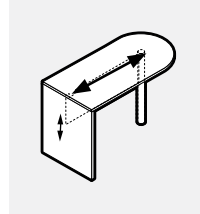

"D" Shaped Tables

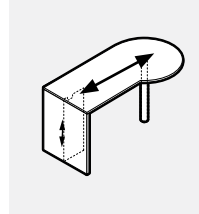

"P" Shaped Tables

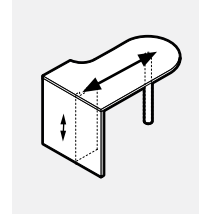

Profile Corner Round Tables

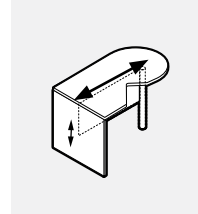

Profile Corner Cut Tables

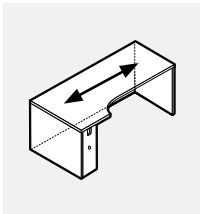

Profile Corner Desks

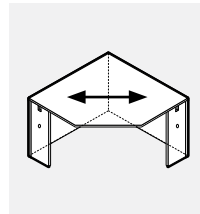

All Corner Desks 42" and Smaller

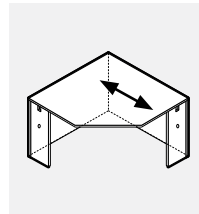

All Corner Desks Larger than 42"

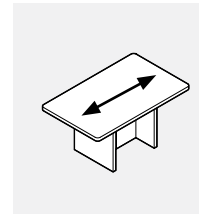

Occasional Tables

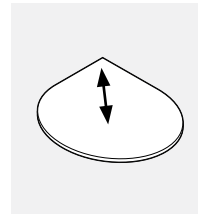

Teardrop Table Tops

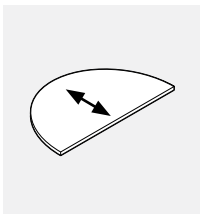

Half Moon Table Tops

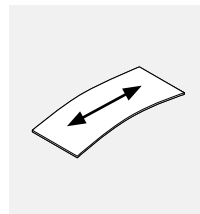

All Other Table Tops

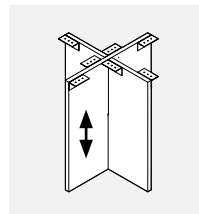

Bases

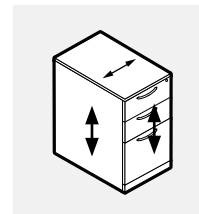

All Pedestals

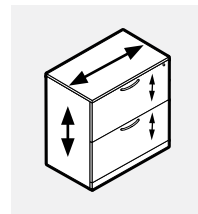

All Laterals

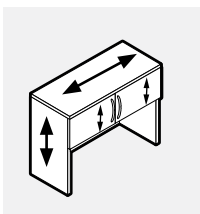

All Hinged Door Hutches

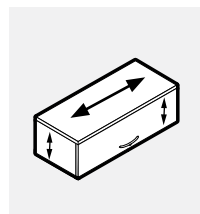

All Flip-Up Door Overheads

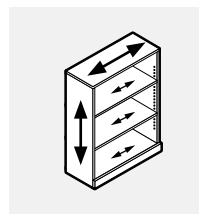

All Bookcases

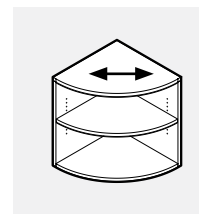

All Corner Bookcases

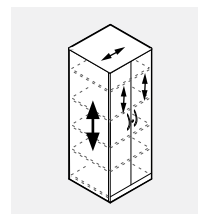

All Towers

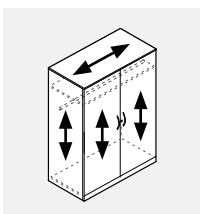

All Cabinets

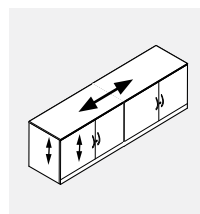

All Credenzas

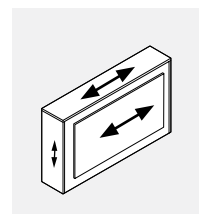

Gallery Desk

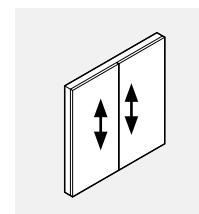

Visual Board

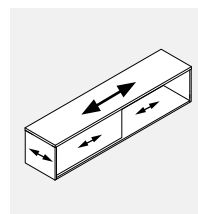

Overhead Divider Storage

GROMMET LOCATION

Notes

- All worksurfaces are standard with rectangular grommets # BG5.
- Worksurfaces 54" wide and under are standard with 1 grommet.
- Worksurfaces over 54" wide are standard with 2 grommets.
- Grommet location must be specified at time of order or it will default to "no grommet" option.

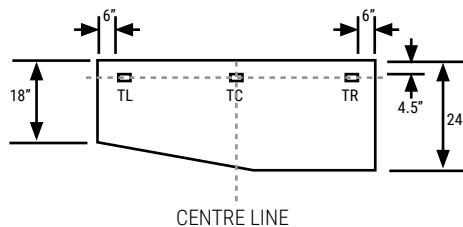
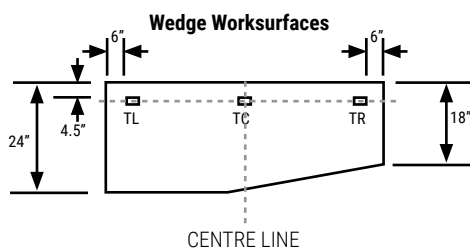
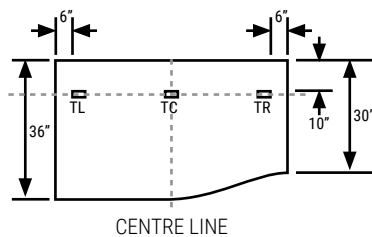
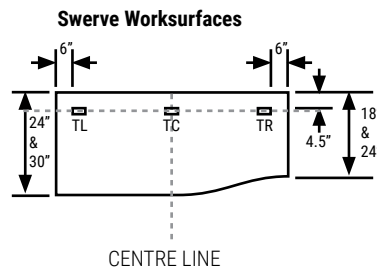
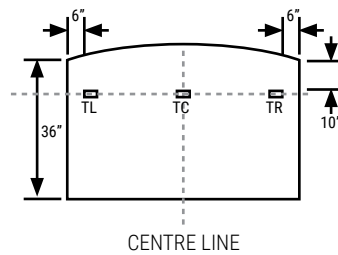
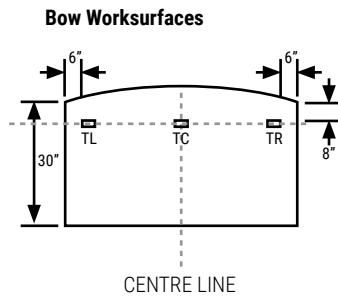
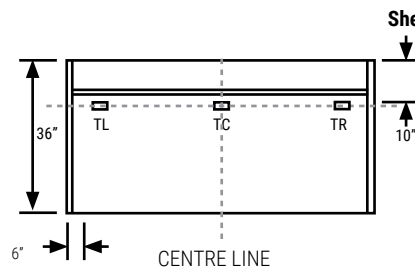
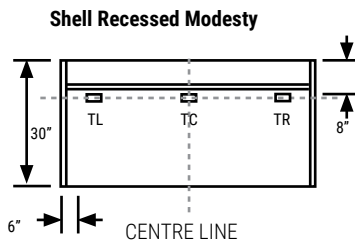
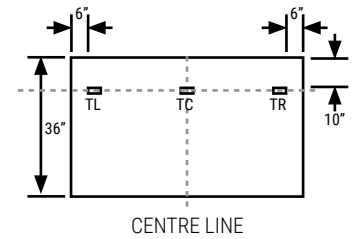
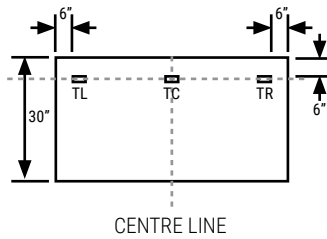
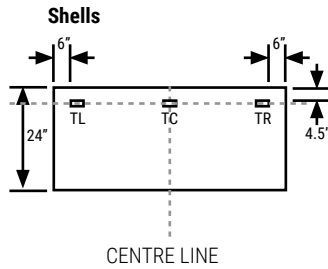
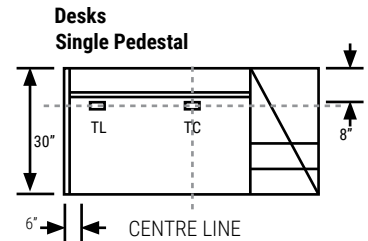
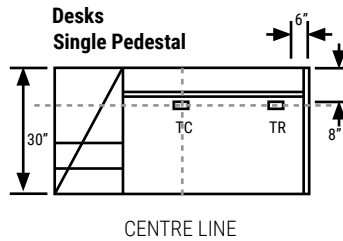
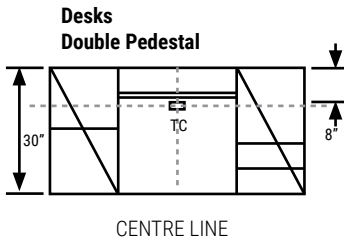

GROMMET LOCATION

"P" Shaped Tables "L2T"

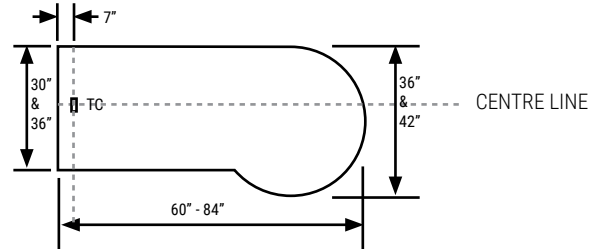
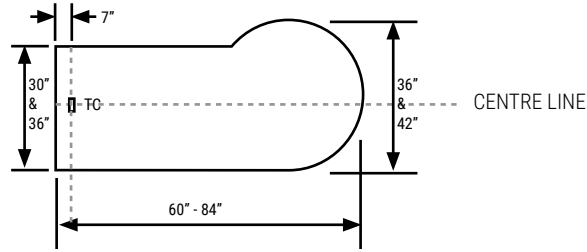

Extended "D" - L2TED

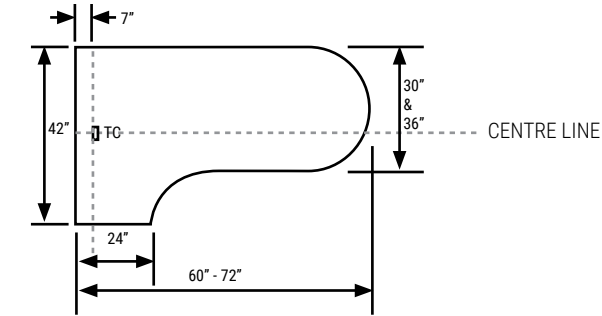

"D" Shaped Tables

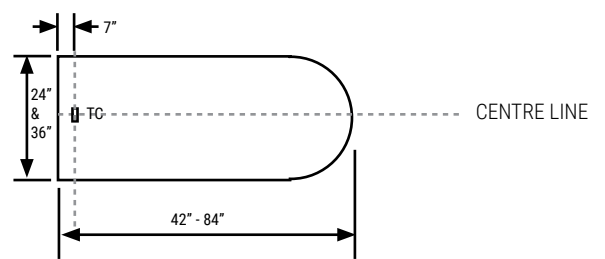

Extended Corner "L2EC"

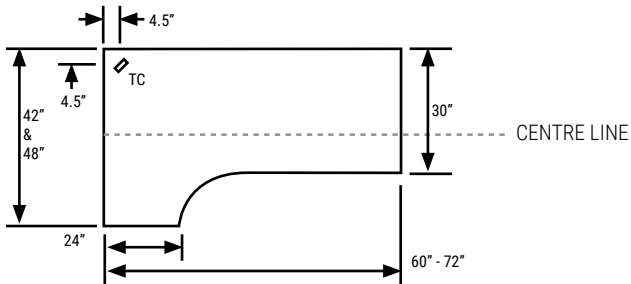

Extended "D" Cut Out "L2TEDCO"

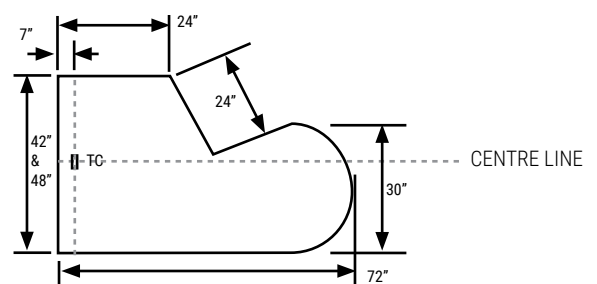

Extended Corner Recessed Modesty

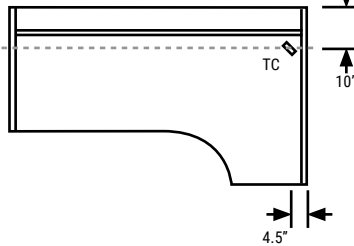

Wedge Shell Recessed Modesty

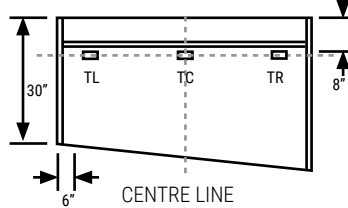

Corner Worksurfaces - 1 Piece

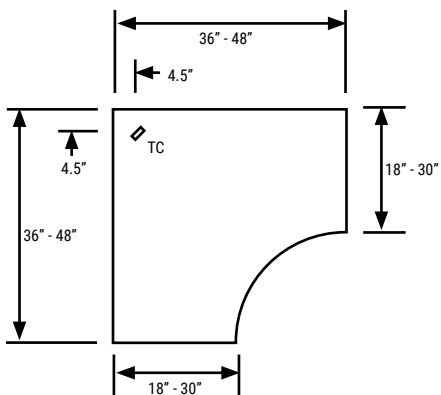

Split Corner Worksurfaces - 2 Piece

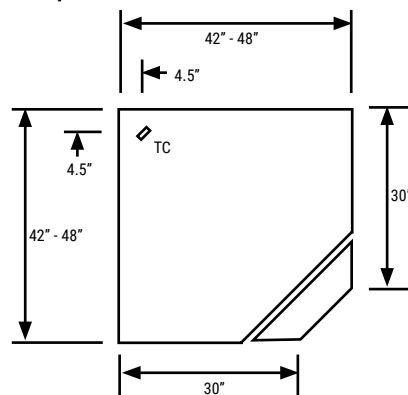

GROMMET LOCATION

Hockey Shaped Tables "L2TH"



Floating Tops "L2F"

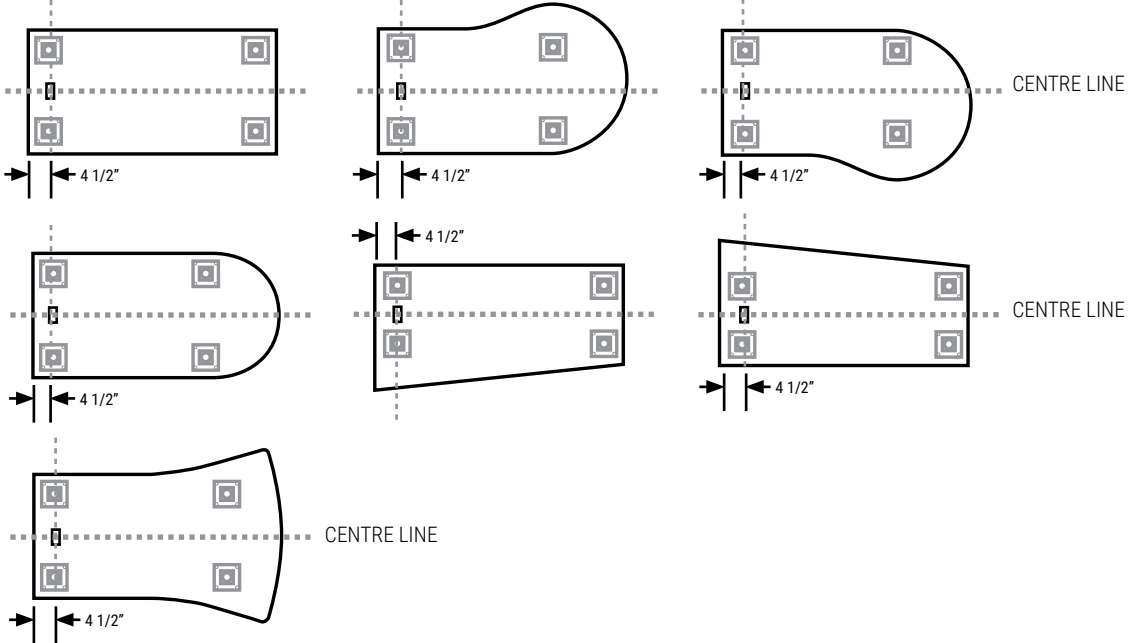

Runoff Tops "L2TC"

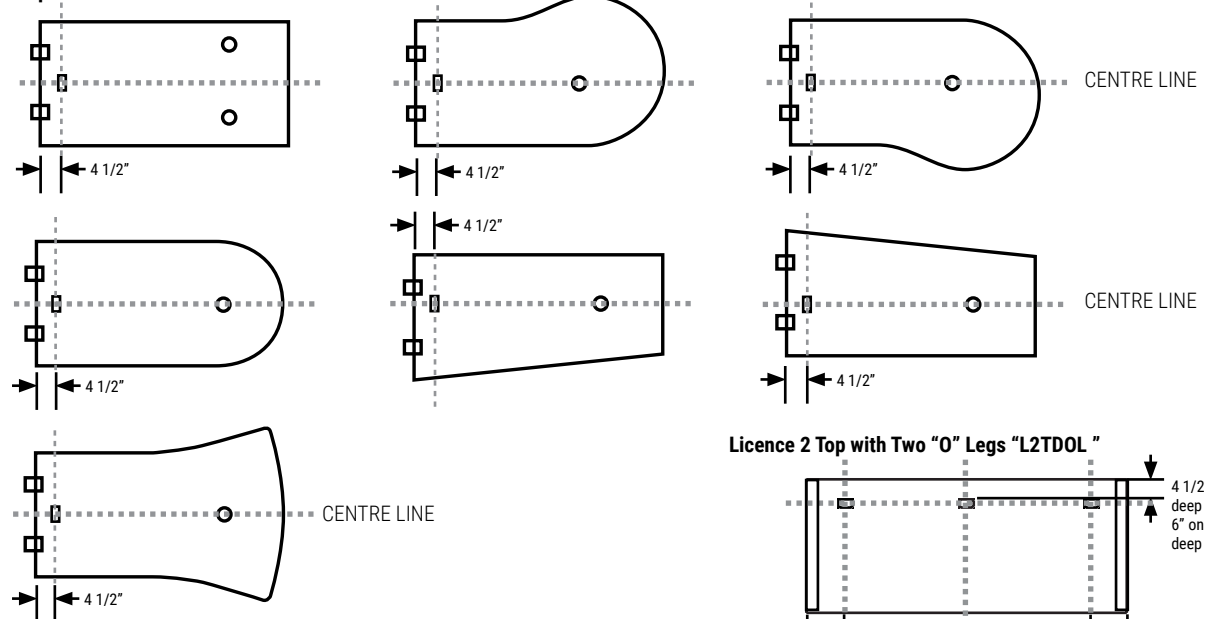

Licence 2 Top with Two "O" Legs "L2TDOL"

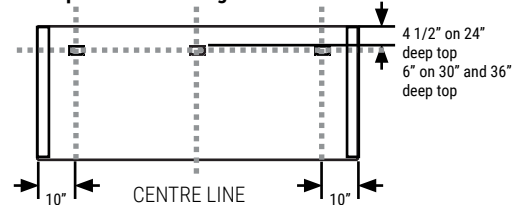

Floating Tops "L2FFL"

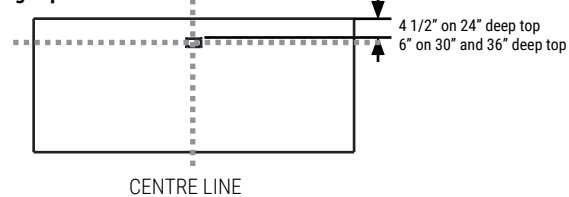

Technical Information

Double Pedestal Desk/ Single Pedestal Desk

- All desks are Shipped knocked down (KD).
- Pedestals are shipped assembled
- Pedestals are LP all over
- Non Interlocking mechanism Pedestals
- Half modesty available on all Double Pedestal Desks, specify 'H' Before size eg. L2DRH3060FB
- Half modesty available on Single Pedestal Desks, specify "H" before size eg. L2DRH-3060BR
- All desks have modesty recessed 6"

Executive Return Desk

- All desks are Shipped knocked down (KD).
- This typed of desk must be connected at open end to adjoining worksurface with flat brackets.
- Half modesty available on all Single Pedestal Returns, specify "H" before size eg. L2RH2036FL

Single Pedestal Returns

- All desks are Shipped knocked down (KD).
- This type of desk must be connected at open end to adjoining worksurface with flat brackets.

DESKS • GUIDELINES FOR ORDERING PRODUCT

CODES: The price list uses a numbering system with meaningful alphanumeric characters to create a simple-to-understand product number. This makes specifying the product much easier and more accurate.

SPECIFICATION EXAMPLE OF A DESK UNIT

PRODUCT CODE: L2DR3060FB
 L2 = New Licence
 D = Desk
 R = Rectangular
 3060 = Size: Depth x Width
 FB = PED FF LEFT / PED BBF RIGHT

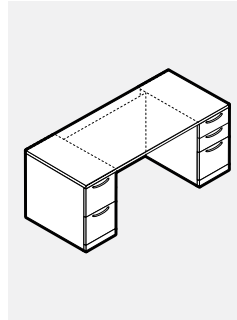

OPTIONS:
 Top: LP - LP (Low Pressure Laminate) Thickness 1"
 HP B - B Thickness 1 1/16"
 HP W - W Thickness 1 7/16"

Top Finish Laminate: Choose Colour

Top PVC Edging: Choose Colour

Chassis Laminate: Choose Colour

Chassis PVC Edging: Choose Colour

Handle Style: **BC - Bow Matte Chrome (DEFAULT)**
 BB - Bow Matt Black
 UB - "U" Dull Black
 UC - "U" Dull Chrome
 FA - Flat Aluminum
 RN - Round Nickel

Grommet Location: **N - No grommet (DEFAULT)**
 Double Pedestal desk: TC - Top Centre Only

 Single Right Pedestal Desk: TC - Top Centre
 TL - Top Left

 Single Left Pedestal Desk: TC - Top Centre
 TR - Top Right

L2 • Keys

PRODUCT CODE	PRICE	SIZE/ INCHES		WEIGHT	VOL
		H	W D		
Master key:					
L2MK	29				
Extra key for existing cabinet:					
L2EK	12				
Core key:					
L2CK	14				
Core & Key:					
L2LOCKKEY	31				

- Additional key (specify at time of order).
- Please choose black or silver.

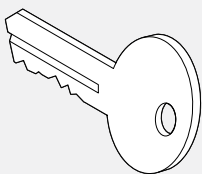

L2DR-FB • Double Pedestal Desk, FF Left, BBF Right, Recessed Modesty

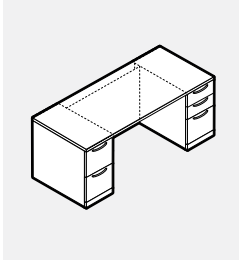

• Optional e-lock available for each pedestal in the vertical position. Please specify V-Vertical and add \$224 list for each.

PRODUCT CODE	FINISH LP	B	W	SIZE/INCHES			D	WEIGHT LBS	VOL FT ³
				H (LP/B)	H (W)	W			
L2DR3060FB	2290	2426	2550	29	29.5	60	30	224	24
L2DR3066FB	2333	2482	2617	29	29.5	66	30	234	25
L2DR3072FB	2376	2538	2684	29	29.5	72	30	244	25
L2DR3078FB	2420	2593	2752	29	29.5	78	30	272	26
L2DR3084FB	2463	2653	2822	29	29.5	84	30	299	26
L2DR3672FB	2497	2693	2861	29	29.5	72	36	272	26
L2DR3678FB	2544	2756	2935	29	29.5	78	36	299	28
L2DR3684FB	2593	2820	3014	29	29.5	84	36	327	28

L2DR-BF • Double Pedestal Desk, FF Right, BBF Left, Recessed Modesty

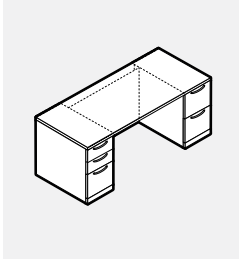

• Optional e-lock available for each pedestal in the vertical position. Please specify V-Vertical and add \$224 list for each.

PRODUCT CODE	FINISH LP	B	W	SIZE/INCHES			D	WEIGHT LBS	VOL FT ³
				H (LP/B)	H (W)	W			
L2DR3060BF	2290	2426	2550	29	29.5	60	30	224	24
L2DR3066BF	2333	2482	2617	29	29.5	66	30	234	25
L2DR3072BF	2376	2538	2684	29	29.5	72	30	244	25
L2DR3078BF	2420	2593	2752	29	29.5	78	30	272	26
L2DR3084BF	2463	2653	2822	29	29.5	84	30	299	26
L2DR3672BF	2497	2693	2861	29	29.5	72	36	272	26
L2DR3678BF	2544	2756	2935	29	29.5	78	36	299	28
L2DR3684BF	2593	2820	3014	29	29.5	84	36	327	28

L2DRH-FB • Double Pedestal Desk, FF Left, BBF Right Recessed Half Modesty

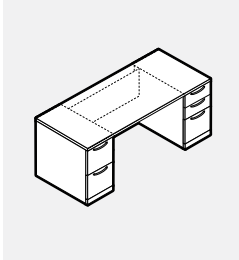

• Optional e-lock available for each pedestal in the vertical position. Please specify V-Vertical and add \$224 list for each.

PRODUCT CODE	FINISH LP	B	W	SIZE/INCHES			D	WEIGHT LBS	VOL FT ³
				H (LP/B)	H (W)	W			
L2DRH3060FB	2234	2369	2496	29	29.5	60	30	224	24
L2DRH3066FB	2269	2420	2553	29	29.5	66	30	234	25
L2DRH3072FB	2301	2462	2611	29	29.5	72	30	244	25
L2DRH3078FB	2334	2510	2668	29	29.5	78	30	272	26
L2DRH3084FB	2368	2556	2728	29	29.5	84	30	299	26
L2DRH3672FB	2423	2617	2785	29	29.5	72	36	272	26
L2DRH3678FB	2460	2670	2849	29	29.5	78	36	299	28
L2DRH3684FB	2498	2726	2919	29	29.5	84	36	327	28

L2DRH-BF • Double Pedestal Desk, BBF Left, FF Right Recessed Half Modesty

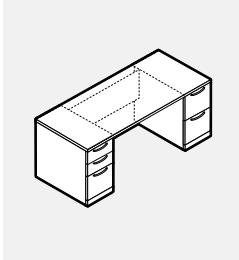

• Optional e-lock available for each pedestal in the vertical position. Please specify V-Vertical and add \$224 list for each.

PRODUCT CODE	FINISH LP	B	W	SIZE/INCHES			D	WEIGHT LBS	VOL FT ³
				H (LP/B)	H (W)	W			
L2DRH3060BF	2234	2369	2496	29	29.5	60	30	224	24
L2DRH3066BF	2269	2420	2553	29	29.5	66	30	234	25
L2DRH3072BF	2301	2462	2611	29	29.5	72	30	244	25
L2DRH3078BF	2334	2510	2668	29	29.5	78	30	272	26
L2DRH3084BF	2368	2556	2728	29	29.5	84	30	299	26
L2DRH3672BF	2423	2617	2785	29	29.5	72	36	272	26
L2DRH3678BF	2460	2670	2849	29	29.5	78	36	299	28
L2DRH3684BF	2498	2726	2919	29	29.5	84	36	327	28

L2DB-FB • Bowfront Double Pedestal Desk, FF Left, BBF Right, Recessed Modesty

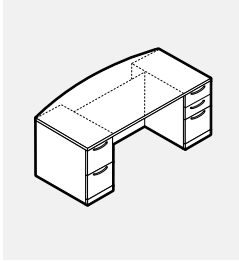

• Optional e-lock available for each pedestal in the vertical position. Please specify V-Vertical and add \$224 list for each.

PRODUCT CODE	FINISH LP	B	W	SIZE/INCHES			D	WEIGHT LBS	VOL FT ³
				H (LP/B)	H (W)	W			
L2DB3060FB	2344	2507	2646	29	29.5	60	36	374	25
L2DB3066FB	2390	2569	2721	29	29.5	66	36	383	26
L2DB3072FB	2435	2631	2795	29	29.5	72	36	395	26
L2DB3078FB	2485	2694	2869	29	29.5	78	36	422	28
L2DB3084FB	2534	2760	2948	29	29.5	84	36	450	28
L2DB3672FB	2558	2785	2970	29	29.5	72	42	422	28
L2DB3678FB	2611	2855	3051	29	29.5	78	42	450	29
L2DB3684FB	2664	2927	3138	29	29.5	84	42	477	29

L2DB-BF • Bowfront Double Pedestal Desk, FF Right, BBF Left, Recessed Modesty

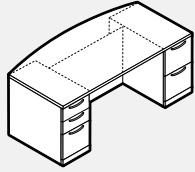

• Optional e-lock available for each pedestal in the vertical position. Please specify V-Vertical and add \$224 list for each.

PRODUCT CODE	FINISH LP	B	W	SIZE / INCHES				WEIGHT LBS	VOL FT ³
				H(LP/B)	H(W)	W	D		
L2DB3060BF	2344	2507	2646	29	29.5	60	36	374	25
L2DB3066BF	2390	2569	2721	29	29.5	66	36	383	26
L2DB3072BF	2435	2631	2795	29	29.5	72	36	395	26
L2DB3078BF	2485	2694	2869	29	29.5	78	36	422	28
L2DB3084BF	2534	2760	2948	29	29.5	84	36	450	28
L2DB3672BF	2558	2785	2970	29	29.5	72	42	422	28
L2DB3678BF	2611	2855	3051	29	29.5	78	42	450	29
L2DB3684BF	2664	2927	3138	29	29.5	84	42	477	29

L2DBH-FB • Bowfront Double Pedestal Desk, FF Left, BBF Right Recessed Half Modesty

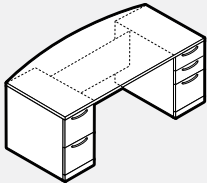

• Optional e-lock available for each pedestal in the vertical position. Please specify V-Vertical and add \$224 list for each.

PRODUCT CODE	FINISH LP	B	W	SIZE / INCHES				WEIGHT LBS	VOL FT ³
				H(LP/B)	H(W)	W	D		
L2DBH3060FB	2290	2452	2592	29	29.5	60	36	374	25
L2DBH3066FB	2324	2507	2655	29	29.5	66	36	383	26
L2DBH3072FB	2363	2555	2721	29	29.5	72	36	395	26
L2DBH3078FB	2398	2611	2784	29	29.5	78	36	422	28
L2DBH3084FB	2438	2665	2850	29	29.5	84	36	450	28
L2DBH3672FB	2485	2710	2894	29	29.5	72	42	422	28
L2DBH3678FB	2525	2770	2966	29	29.5	78	42	450	29
L2DBH3684FB	2570	2833	3042	29	29.5	84	42	477	29

L2DBH-BF • Bowfront Double Pedestal Desk, BBF Left, FF Right Recessed Half Modesty

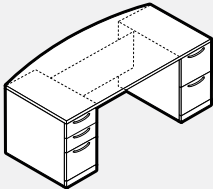

• Optional e-lock available for each pedestal in the vertical position. Please specify V-Vertical and add \$224 list for each.

PRODUCT CODE	FINISH LP	B	W	SIZE / INCHES				WEIGHT LBS	VOL FT ³
				H(LP/B)	H(W)	W	D		
L2DBH3060BF	2290	2452	2592	29	29.5	60	36	374	25
L2DBH3066BF	2324	2507	2655	29	29.5	66	36	383	26
L2DBH3072BF	2363	2555	2721	29	29.5	72	36	395	26
L2DBH3078BF	2398	2611	2784	29	29.5	78	36	422	28
L2DBH3084BF	2438	2665	2850	29	29.5	84	36	450	28
L2DBH3672BF	2485	2710	2894	29	29.5	72	42	422	28
L2DBH3678BF	2525	2770	2966	29	29.5	78	42	450	29
L2DBH3684BF	2570	2833	3042	29	29.5	84	42	477	29

L2DR-BR • Single Pedestal Desk, BBF Right, Recessed Modesty

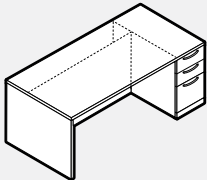

• Optional e-lock available for the pedestal in the vertical position. Please specify V-Vertical and add \$224 list.

PRODUCT CODE	FINISH LP	B	W	SIZE / INCHES				WEIGHT LBS	VOL FT ³
				H(LP/B)	H(W)	W	D		
L2DR3060BR	1590	1724	1849	29	29.5	60	30	224	14
L2DR3066BR	1632	1781	1916	29	29.5	66	30	234	15
L2DR3072BR	1674	1837	1983	29	29.5	72	30	244	15
L2DR3078BR	1711	1885	2045	29	29.5	78	30	272	17
L2DR3084BR	1763	1955	2123	29	29.5	84	30	299	17
L2DR3672BR	1782	1975	2145	29	29.5	72	36	272	17
L2DR3678BR	1821	2031	2215	29	29.5	78	36	299	18
L2DR3684BR	1878	2103	2298	29	29.5	84	36	327	18

L2DR-BL • Single Pedestal Desk, BBF Left, Recessed Modesty

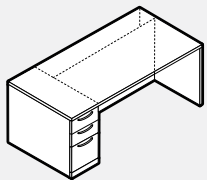

• Optional e-lock available for the pedestal in the vertical position. Please specify V-Vertical and add \$224 list.

PRODUCT CODE	FINISH LP	B	W	SIZE / INCHES				WEIGHT LBS	VOL FT ³
				H(LP/B)	H(W)	W	D		
L2DR3060BL	1590	1724	1849	29	29.5	60	30	224	14
L2DR3066BL	1632	1781	1916	29	29.5	66	30	234	15
L2DR3072BL	1674	1837	1983	29	29.5	72	30	244	15
L2DR3078BL	1711	1885	2045	29	29.5	78	30	272	17
L2DR3084BL	1763	1955	2123	29	29.5	84	30	299	17
L2DR3672BL	1782	1975	2145	29	29.5	72	36	272	17
L2DR3678BL	1821	2031	2215	29	29.5	78	36	299	18
L2DR3684BL	1878	2103	2298	29	29.5	84	36	327	18

L2DRH-BR • Single Pedestal Desk, BBF Right Recessed Half Modesty

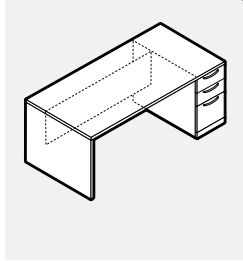

• Optional e-lock available for the pedestal in the vertical position. Please specify V-Vertical and add \$224 list.

PRODUCT CODE	FINISH LP	B	W	SIZE/INCHES			D	WEIGHT LBS	VOL FT ³
				H(LP/B)	H(W)	W			
L2DRH3060BR	1485	1620	1748	29	29.5	60	30	224	14
L2DRH3066BR	1518	1668	1803	29	29.5	66	30	234	15
L2DRH3072BR	1552	1713	1862	29	29.5	72	30	244	15
L2DRH3078BR	1584	1759	1916	29	29.5	78	30	272	17
L2DRH3084BR	1619	1808	1978	29	29.5	84	30	299	17
L2DRH3672BR	1658	1851	2022	29	29.5	72	36	272	17
L2DRH3678BR	1695	1903	2086	29	29.5	78	36	299	18
L2DRH3684BR	1733	1961	2155	29	29.5	84	36	327	18

L2DRH-BL • Single Pedestal Desk, BBF Left Recessed Half Modesty

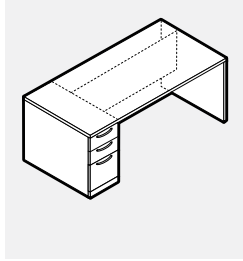

• Optional e-lock available for the pedestal in the vertical position. Please specify V-Vertical and add \$224 list.

PRODUCT CODE	FINISH LP	B	W	SIZE/INCHES			D	WEIGHT LBS	VOL FT ³
				H(LP/B)	H(W)	W			
L2DRH3060BL	1485	1620	1748	29	29.5	60	30	224	14
L2DRH3066BL	1518	1668	1803	29	29.5	66	30	234	15
L2DRH3072BL	1552	1713	1862	29	29.5	72	30	244	15
L2DRH3078BL	1584	1759	1916	29	29.5	78	30	272	17
L2DRH3084BL	1619	1808	1978	29	29.5	84	30	299	17
L2DRH3672BL	1658	1851	2022	29	29.5	72	36	272	17
L2DRH3678BL	1695	1903	2086	29	29.5	78	36	299	18
L2DRH3684BL	1733	1961	2155	29	29.5	84	36	327	18

L2DB-BR • Bowfront Single Pedestal Desk, BBF Right, Recessed Modesty

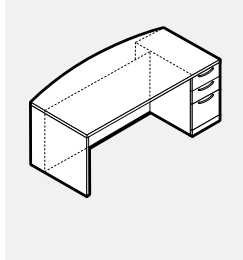

• Optional e-lock available for the pedestal in the vertical position. Please specify V-Vertical and add \$224 list.

PRODUCT CODE	FINISH LP	B	W	SIZE/INCHES			D	WEIGHT LBS	VOL FT ³
				H(LP/B)	H(W)	W			
L2DB3060BR	1642	1805	1945	29	29.5	60	36	264	14
L2DB3066BR	1690	1867	2022	29	29.5	66	36	274	15
L2DB3072BR	1736	1929	2094	29	29.5	72	36	286	15
L2DB3078BR	1778	1988	2162	29	29.5	78	36	314	17
L2DB3084BR	1835	2059	2248	29	29.5	84	36	338	17
L2DB3672BR	1843	2068	2254	29	29.5	72	42	310	17
L2DB3678BR	1890	2133	2330	29	29.5	78	42	338	18
L2DB3684BR	1948	2213	2422	29	29.5	84	42	362	18

L2DB-BL • Bowfront Single Pedestal Desk, BBF Left, Recessed Modesty

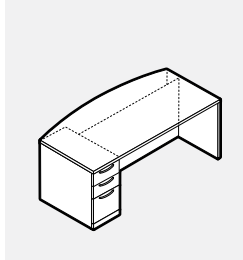

• Optional e-lock available for the pedestal in the vertical position. Please specify V-Vertical and add \$224 list.

PRODUCT CODE	FINISH LP	B	W	SIZE/INCHES			D	WEIGHT LBS	VOL FT ³
				H(LP/B)	H(W)	W			
L2DB3060BL	1642	1805	1945	29	29.5	60	36	264	14
L2DB3066BL	1690	1867	2022	29	29.5	66	36	274	15
L2DB3072BL	1736	1929	2094	29	29.5	72	36	286	15
L2DB3078BL	1778	1988	2162	29	29.5	78	36	314	17
L2DB3084BL	1835	2059	2248	29	29.5	84	36	338	17
L2DB3672BL	1843	2068	2254	29	29.5	72	42	310	17
L2DB3678BL	1890	2133	2330	29	29.5	78	42	338	18
L2DB3684BL	1948	2213	2422	29	29.5	84	42	362	18

L2DBH-BR • Bowfront Single Pedestal Desk, BBF Right Recessed Half Modesty

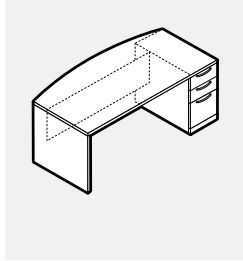

• Optional e-lock available for the pedestal in the vertical position. Please specify V-Vertical and add \$224 list.

PRODUCT CODE	FINISH LP	B	W	SIZE/INCHES			D	WEIGHT LBS	VOL FT ³
				H(LP/B)	H(W)	W			
L2DBH3060BR	1540	1701	1840	29	29.5	60	36	264	14
L2DBH3066BR	1575	1753	1904	29	29.5	66	36	274	15
L2DBH3072BR	1612	1807	1969	29	29.5	72	36	286	15
L2DBH3078BR	1648	1861	2032	29	29.5	78	36	314	17
L2DBH3084BR	1689	1915	2101	29	29.5	84	36	338	17
L2DBH3672BR	1720	1945	2129	29	29.5	72	42	310	17
L2DBH3678BR	1759	2003	2200	29	29.5	78	42	338	18
L2DBH3684BR	1803	2067	2279	29	29.5	84	42	362	18

L2DBH-BL • Bowfront Single Pedestal Desk, BBF Left Recessed Half Modesty

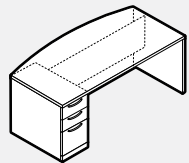

- Optional e-lock available for the pedestal in the vertical position. Please specify V-Vertical and add \$224 list.

PRODUCT CODE	FINISH			SIZE / INCHES				WEIGHT LBS	VOL FT ³
	LP	B	W	H (LP/B)	H (W)	W	D		
L2DBH3060BL	1540	1701	1840	29	29.5	60	36	264	14
L2DBH3066BL	1575	1753	1904	29	29.5	66	36	274	15
L2DBH3072BL	1612	1807	1969	29	29.5	72	36	286	15
L2DBH3078BL	1648	1861	2032	29	29.5	78	36	314	17
L2DBH3084BL	1689	1915	2101	29	29.5	84	36	338	17
L2DBH3672BL	1720	1945	2129	29	29.5	72	42	310	17
L2DBH3678BL	1759	2003	2200	29	29.5	78	42	338	18
L2DBH3684BL	1803	2067	2279	29	29.5	84	42	362	18

L2DRA-FB • Double Desk, FF Left BBF Right Recessed, Glazed Full Modesty

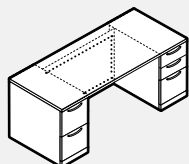

- Modesty is aluminum framed.
- Glazing is frosted acrylic.
- Optional e-lock available for each pedestal in the vertical position. Please specify V-Vertical and add \$224 list for each.

PRODUCT CODE	FINISH			SIZE / INCHES				WEIGHT LBS	VOL FT ³
	LP	B	W	H (LP/B)	H (W)	W	D		
L2DRA3060FB	2714	2846	2967	29.06	29.5	60	30	204	22
L2DRA3066FB	2797	2945	3076	29.06	29.5	66	30	213	23
L2DRA3072FB	2882	3039	3183	29.06	29.5	72	30	222	23
L2DRA3078FB	2962	3138	3290	29.06	29.5	78	30	247	24
L2DRA3084FB	3051	3237	3403	29.06	29.5	84	30	272	24
L2DRA3672FB	3001	3190	3355	29.06	29.5	72	36	247	24
L2DRA3678FB	3087	3293	3473	29.06	29.5	78	36	272	25
L2DRA3684FB	3180	3400	3590	29.06	29.5	84	36	297	25

L2DRA-BF • Double Desk, FF Right BBF Left Recessed, Glazed Full Modesty

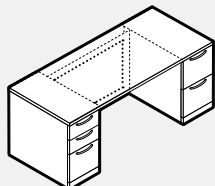

- Modesty is aluminum framed.
- Glazing is frosted acrylic.
- Optional e-lock available for each pedestal in the vertical position. Please specify V-Vertical and add \$224 list for each.

PRODUCT CODE	FINISH			SIZE / INCHES				WEIGHT LBS	VOL FT ³
	LP	B	W	H (LP/B)	H (W)	W	D		
L2DRA3060BF	2714	2846	2967	29.06	29.5	60	30	204	22
L2DRA3066BF	2797	2945	3076	29.06	29.5	66	30	213	23
L2DRA3072BF	2882	3039	3183	29.06	29.5	72	30	222	23
L2DRA3078BF	2962	3138	3290	29.06	29.5	78	30	247	24
L2DRA3084BF	3051	3237	3403	29.06	29.5	84	30	272	24
L2DRA3672BF	3001	3190	3355	29.06	29.5	72	36	247	24
L2DRA3678BF	3087	3293	3473	29.06	29.5	78	36	272	25
L2DRA3684BF	3180	3400	3590	29.06	29.5	84	36	297	25

L2DBA-FB • Bowfront Double Desk, FF Left BBF Right Recessed, Glazed Full Modesty

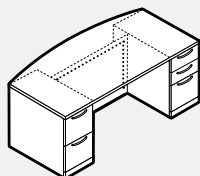

- Modesty is aluminum framed.
- Glazing is frosted acrylic.
- Optional e-lock available for each pedestal in the vertical position. Please specify V-Vertical and add \$224 list for each.

PRODUCT CODE	FINISH			SIZE / INCHES				WEIGHT LBS	VOL FT ³
	LP	B	W	H (LP/B)	H (W)	W	D		
L2DBA3060FB	2764	2924	3061	29.06	29.5	60	36	340	23
L2DBA3066FB	2851	3027	3175	29.06	29.5	66	36	348	24
L2DBA3072FB	2945	3130	3290	29.06	29.5	72	36	359	24
L2DBA3078FB	3031	3232	3406	29.06	29.5	78	36	384	25
L2DBA3084FB	3122	3342	3523	29.06	29.5	84	36	409	25
L2DBA3672FB	3061	3282	3460	29.06	29.5	72	42	384	25
L2DBA3678FB	3153	3392	3584	29.06	29.5	78	42	409	26
L2DBA3684FB	3249	3507	3711	29.06	29.5	84	42	434	26

L2DBA-BF • Bowfront Double Desk, FF Right BBF Left Recessed, Glazed Full Modesty

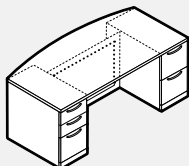

- Modesty is aluminum framed.
- Glazing is frosted acrylic.
- Optional e-lock available for each pedestal in the vertical position. Please specify V-Vertical and add \$224 list for each.

PRODUCT CODE	FINISH			SIZE / INCHES				WEIGHT LBS	VOL FT ³
	LP	B	W	H (LP/B)	H (W)	W	D		
L2DBA3060BF	2764	2924	3061	29.06	29.5	60	36	340	23
L2DBA3066BF	2851	3027	3175	29.06	29.5	66	36	348	24
L2DBA3072BF	2945	3130	3290	29.06	29.5	72	36	359	24
L2DBA3078BF	3031	3232	3406	29.06	29.5	78	36	384	25
L2DBA3084BF	3122	3342	3523	29.06	29.5	84	36	409	25
L2DBA3672BF	3061	3282	3460	29.06	29.5	72	42	384	25
L2DBA3678BF	3153	3392	3584	29.06	29.5	78	42	409	26
L2DBA3684BF	3249	3507	3711	29.06	29.5	84	42	434	26

L2DRAH-FB • Double Pedestal Desk, FF Left BBF Right Recessed, Half Glazed Modesty

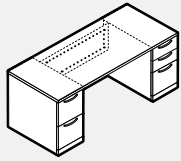

- Modesty is aluminum framed.
- Glazing is frosted acrylic.
- Optional e-lock available for each pedestal in the vertical position. Please specify V-Vertical and add \$224 list for each.

PRODUCT CODE	FINISH LP	B	W	SIZE/INCHES		W	D	WEIGHT LBS	VOL FT ³
				H(LP/B)	H(W)				
L2DRAH3060FB	2569	2701	2823	29.06	29.5	60	30	204	22
L2DRAH3066FB	2638	2783	2917	29.06	29.5	66	30	213	23
L2DRAH3072FB	2697	2856	3001	29.06	29.5	72	30	222	23
L2DRAH3078FB	2759	2928	3084	29.06	29.5	78	30	247	24
L2DRAH3084FB	2823	3010	3174	29.06	29.5	84	30	272	24
L2DRAH3672FB	2818	3009	3170	29.06	29.5	72	36	247	24
L2DRAH3678FB	2882	3087	3265	29.06	29.5	78	36	272	25
L2DRAH3684FB	2950	3170	3359	29.06	29.5	84	36	297	25

L2DRAH-BF • Double Pedestal Desk, BBF Left FF Right Recessed, Half Glazed Modesty

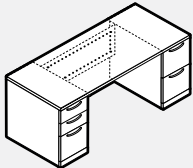

- Modesty is aluminum framed.
- Glazing is frosted acrylic.
- Optional e-lock available for each pedestal in the vertical position. Please specify V-Vertical and add \$224 list for each.

PRODUCT CODE	FINISH LP	B	W	SIZE/INCHES		W	D	WEIGHT LBS	VOL FT ³
				H(LP/B)	H(W)				
L2DRAH3060BF	2569	2701	2823	29.06	29.5	60	30	204	22
L2DRAH3066BF	2638	2783	2917	29.06	29.5	66	30	213	23
L2DRAH3072BF	2697	2856	3001	29.06	29.5	72	30	222	23
L2DRAH3078BF	2759	2928	3084	29.06	29.5	78	30	247	24
L2DRAH3084BF	2823	3010	3174	29.06	29.5	84	30	272	24
L2DRAH3672BF	2818	3009	3170	29.06	29.5	72	36	247	24
L2DRAH3678BF	2882	3087	3265	29.06	29.5	78	36	272	25
L2DRAH3684BF	2950	3170	3359	29.06	29.5	84	36	297	25

L2DBAH-FB • Bowfront Double Desk, FF Left BBF Right Recessed, Half Glazed Modesty

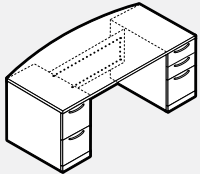

- Modesty is aluminum framed.
- Glazing is frosted acrylic.
- Optional e-lock available for each pedestal in the vertical position. Please specify V-Vertical and add \$224 list for each.

PRODUCT CODE	FINISH LP	B	W	SIZE/INCHES		W	D	WEIGHT LBS	VOL FT ³
				H(LP/B)	H(W)				
L2DBAH3060FB	2620	2780	2917	29.06	29.5	60	36	340	23
L2DBAH3066FB	2694	2867	3015	29.06	29.5	66	36	348	24
L2DBAH3072FB	2758	2949	3106	29.06	29.5	72	36	359	24
L2DBAH3078FB	2822	3027	3200	29.06	29.5	78	36	384	25
L2DBAH3084FB	2892	3113	3295	29.06	29.5	84	36	409	25
L2DBAH3672FB	2877	3099	3278	29.06	29.5	72	42	384	25
L2DBAH3678FB	2948	3187	3377	29.06	29.5	78	42	409	26
L2DBAH3684FB	3016	3277	3480	29.06	29.5	84	42	434	26

L2DBAH-BF • Bowfront Double Desk, BBF Left FF Right Recessed, Half Glazed Modesty

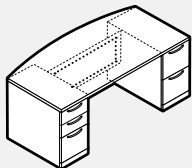

- Modesty is aluminum framed.
- Glazing is frosted acrylic.
- Optional e-lock available for each pedestal in the vertical position. Please specify V-Vertical and add \$224 list for each.

PRODUCT CODE	FINISH LP	B	W	SIZE/INCHES		W	D	WEIGHT LBS	VOL FT ³
				H(LP/B)	H(W)				
L2DBAH3060BF	2620	2780	2917	29.06	29.5	60	36	340	23
L2DBAH3066BF	2694	2867	3015	29.06	29.5	66	36	348	24
L2DBAH3072BF	2758	2949	3106	29.06	29.5	72	36	359	24
L2DBAH3078BF	2822	3027	3200	29.06	29.5	78	36	384	25
L2DBAH3084BF	2892	3113	3295	29.06	29.5	84	36	409	25
L2DBAH3672BF	2877	3099	3278	29.06	29.5	72	42	384	25
L2DBAH3678BF	2948	3187	3377	29.06	29.5	78	42	409	26
L2DBAH3684BF	3016	3277	3480	29.06	29.5	84	42	434	26

L2ER-FL • Executive Return with FF Pedestal Left

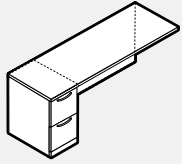

• Optional e-lock available for the pedestal in the vertical position. Please specify V-Vertical and add \$224 list.

PRODUCT CODE	FINISH LP	B	W	SIZE / INCHES				WEIGHT LBS	VOL FT ³
				H(LP/B)	H(W)	W	D		
L2ER2036FL	1135	1199	1264	29	29.5	36	20	151	12
L2ER2042FL	1174	1252	1327	29	29.5	42	20	172	12
L2ER2048FL	1220	1301	1388	29	29.5	48	20	179	12
L2ER2054FL	1258	1354	1448	29	29.5	54	20	184	13
L2ER2436FL	1179	1249	1317	29	29.5	36	24	151	12
L2ER2442FL	1223	1300	1381	29	29.5	42	24	172	12
L2ER2448FL	1264	1354	1442	29	29.5	48	24	179	13
L2ER2454FL	1309	1409	1505	29	29.5	54	24	184	13

L2ER-FR • Executive Return with FF Pedestal Right

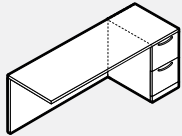

• Optional e-lock available for the pedestal in the vertical position. Please specify V-Vertical and add \$224 list.

PRODUCT CODE	FINISH LP	B	W	SIZE / INCHES				WEIGHT LBS	VOL FT ³
				H(LP/B)	H(W)	W	D		
L2ER2036FR	1135	1199	1264	29	29.5	36	20	151	12
L2ER2042FR	1174	1252	1327	29	29.5	42	20	172	12
L2ER2048FR	1220	1301	1388	29	29.5	48	20	179	12
L2ER2054FR	1258	1354	1448	29	29.5	54	20	184	13
L2ER2436FR	1179	1249	1317	29	29.5	36	24	151	12
L2ER2442FR	1223	1300	1381	29	29.5	42	24	172	12
L2ER2448FR	1264	1354	1442	29	29.5	48	24	179	13
L2ER2454FR	1309	1409	1505	29	29.5	54	24	184	13

L2ERH-FL • Executive Return with FF Pedestal Left and Half Modesty

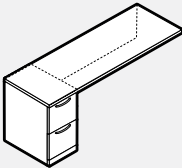

• Optional e-lock available for the pedestal in the vertical position. Please specify V-Vertical and add \$224 list.

PRODUCT CODE	FINISH LP	B	W	SIZE / INCHES				WEIGHT LBS	VOL FT ³
				H(LP/B)	H(W)	W	D		
L2ERH2036FL	1084	1148	1218	29	29.5	36	20	151	12
L2ERH2042FL	1114	1190	1264	29	29.5	42	20	172	12
L2ERH2048FL	1141	1229	1315	29	29.5	48	20	179	12
L2ERH2054FL	1170	1266	1363	29	29.5	54	20	184	13
L2ERH2436FL	1126	1196	1263	29	29.5	36	24	151	12
L2ERH2442FL	1159	1235	1316	29	29.5	42	24	172	12
L2ERH2448FL	1189	1280	1366	29	29.5	48	24	179	13
L2ERH2454FL	1221	1320	1417	29	29.5	54	24	184	13

L2ERH-FR • Executive Return with FF Pedestal Right and Half Modesty

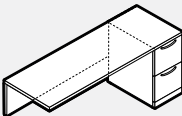

• Optional e-lock available for the pedestal in the vertical position. Please specify V-Vertical and add \$224 list.

PRODUCT CODE	FINISH LP	B	W	SIZE / INCHES				WEIGHT LBS	VOL FT ³
				H(LP/B)	H(W)	W	D		
L2ERH2036FR	1084	1148	1218	29	29.5	36	20	151	12
L2ERH2042FR	1114	1190	1264	29	29.5	42	20	172	12
L2ERH2048FR	1141	1229	1315	29	29.5	48	20	179	12
L2ERH2054FR	1170	1266	1363	29	29.5	54	20	184	13
L2ERH2436FR	1126	1196	1263	29	29.5	36	24	151	12
L2ERH2442FR	1159	1235	1316	29	29.5	42	24	172	12
L2ERH2448FR	1189	1280	1366	29	29.5	48	24	179	13
L2ERH2454FR	1221	1320	1417	29	29.5	54	24	184	13

L2ER-BL • Executive Return with BBF Pedestal Left

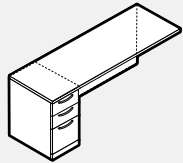

• Optional e-lock available for the pedestal in the vertical position. Please specify V-Vertical and add \$224 list.

PRODUCT CODE	FINISH LP	B	W	SIZE/INCHES				WEIGHT LBS	VOL FT ³
				H(LP/B)	H(W)	W	D		
L2ER2036BL	1196	1260	1327	29	29.5	36	20	151	12
L2ER2042BL	1235	1313	1388	29	29.5	42	20	172	12
L2ER2048BL	1279	1364	1448	29	29.5	48	20	179	12
L2ER2054BL	1318	1416	1509	29	29.5	54	20	184	13
L2ER2436BL	1242	1312	1381	29	29.5	36	24	151	12
L2ER2442BL	1286	1364	1442	29	29.5	42	24	172	12
L2ER2448BL	1328	1418	1505	29	29.5	48	24	179	13
L2ER2454BL	1373	1472	1569	29	29.5	54	24	184	13

L2ER-BR • Executive Return with BBF Pedestal Right

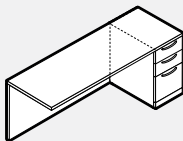

• Optional e-lock available for the pedestal in the vertical position. Please specify V-Vertical and add \$224 list.

PRODUCT CODE	FINISH LP	B	W	SIZE/INCHES				WEIGHT LBS	VOL FT ³
				H(LP/B)	H(W)	W	D		
L2ER2036BR	1196	1260	1327	29	29.5	36	20	151	12
L2ER2042BR	1235	1313	1388	29	29.5	42	20	172	12
L2ER2048BR	1279	1364	1448	29	29.5	48	20	179	12
L2ER2054BR	1318	1416	1509	29	29.5	54	20	184	13
L2ER2436BR	1242	1312	1381	29	29.5	36	24	151	12
L2ER2442BR	1286	1364	1442	29	29.5	42	24	172	12
L2ER2448BR	1328	1418	1505	29	29.5	48	24	179	13
L2ER2454BR	1373	1472	1569	29	29.5	54	24	184	13

L2ERH-BL • Executive Return with BBF Pedestal Left and Half Modesty

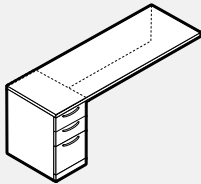

• Optional e-lock available for the pedestal in the vertical position. Please specify V-Vertical and add \$224 list.

PRODUCT CODE	FINISH LP	B	W	SIZE/INCHES				WEIGHT LBS	VOL FT ³
				H(LP/B)	H(W)	W	D		
L2ERH2036BL	1143	1207	1279	29	29.5	36	20	151	12
L2ERH2042BL	1173	1251	1326	29	29.5	42	20	172	12
L2ERH2048BL	1202	1289	1375	29	29.5	48	20	179	12
L2ERH2054BL	1232	1329	1423	29	29.5	54	20	184	13
L2ERH2436BL	1190	1258	1327	29	29.5	36	24	151	12
L2ERH2442BL	1222	1299	1378	29	29.5	42	24	172	12
L2ERH2448BL	1252	1342	1430	29	29.5	48	24	179	13
L2ERH2454BL	1284	1384	1481	29	29.5	54	24	184	13

L2ERH-BR • Executive Return with BBF Pedestal Right and Half Modesty

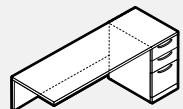

• Optional e-lock available for the pedestal in the vertical position. Please specify V-Vertical and add \$224 list.

PRODUCT CODE	FINISH LP	B	W	SIZE/INCHES				WEIGHT LBS	VOL FT ³
				H(LP/B)	H(W)	W	D		
L2ERH2036BR	1143	1207	1279	29	29.5	36	20	151	12
L2ERH2042BR	1173	1251	1326	29	29.5	42	20	172	12
L2ERH2048BR	1202	1289	1375	29	29.5	48	20	179	12
L2ERH2054BR	1232	1329	1423	29	29.5	54	20	184	13
L2ERH2436BR	1190	1258	1327	29	29.5	36	24	151	12
L2ERH2442BR	1222	1299	1378	29	29.5	42	24	172	12
L2ERH2448BR	1252	1342	1430	29	29.5	48	24	179	13
L2ERH2454BR	1284	1384	1481	29	29.5	54	24	184	13

Technical Information

Technical Information

Reception Desk:

- All desks are shipped KD.
- Centre desk reception transaction top is available in "LP", "B" or "W" thickness to match the thickness and profile of worksurface edge.
- All other exposed edges are banded with 3mm PVC.
- Center unit is freestanding and can be connected on one or both sides with a return or bridge.
- **Bridge unit is connected to the centre unit to extend the return on either side. This unit must be connected on both ends and nonhanded.**
- Left or right hand unit is designed to extend the centre unit. This unit must be connected on one end.
- **Can be used as a freestanding unit or connected with surrounding bridge or corner surround.**
- **Comes with transaction top.**

DESKS • GUIDELINES FOR ORDERING PRODUCT

CODES: The price list uses a numbering system with meaningful alphanumeric characters to create a simple-to-understand product number. This makes specifying the product much easier and more accurate.

SPECIFICATION EXAMPLE OF A GALLERY RECEPTION DESK UNIT

PRODUCT CODE: L2GR66
 L2 = New Licence
 G = Gallery
 R = Reception
 66 = Size: Width

OPTIONS:
 Top: LP - LP (Low Pressure Laminate) Thickness 1"
 HP B - B Thickness 1 1/16"
 HP W - W Thickness 1 7/16"

Top Finish Laminate: Choose Colour

Top PVC Edging: Choose Colour

Chassis Laminate: Choose Colour

Chassis PVC Edging: Choose Colour

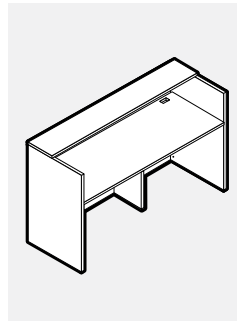

L2GR • Gallery Reception Desk

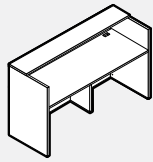

- Two grommets installed TL/TR.

PRODUCT CODE	FINISH LP	SIZE/INCHES			H(LP/B)	H(W)	W	D	WEIGHT LBS	VOL FT ³
		B	W	D						
L2GR66	1313	1647	1834	42.315	42.750	66	25	149	15	
L2GR72	1381	1745	1943	42.315	42.750	72	25	163	17	
L2GR78	1447	1837	2055	42.315	42.750	78	25	166	18	
L2GR84	1515	1932	2166	42.315	42.750	84	25	171	20	
L2GR96	1648	2123	2389	42.315	42.750	96	25	178	23	

L2GB • Gallery Bridge

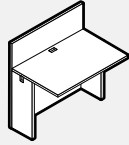

- One grommet installed TC.

PRODUCT CODE	FINISH LP	SIZE/INCHES			H(LP/B)	H(W)	W	D	WEIGHT LBS	VOL FT ³
		B	W	D						
L2GB42	585	716	778	41.315	41.315	42	25	79	10	
L2GB48	639	788	859	41.315	41.315	48	25	86	12	
L2GB54	693	859	938	41.315	41.315	54	25	95	13	
L2GB60	744	928	1020	41.315	41.315	60	25	101	14	

L2GR-L • Gallery Left Return

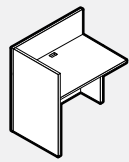

- One grommet installed TC.

PRODUCT CODE	FINISH LP	SIZE/INCHES			H(LP/B)	H(W)	W	D	WEIGHT LBS	VOL FT ³
		B	W	D						
L2GR36L	652	773	829	41.315	41.315	36	25	90	9	
L2GR42L	705	843	910	41.315	41.315	42	25	97	11	
L2GR48L	762	915	992	41.315	41.315	48	25	106	13	
L2GR54L	816	987	1071	41.315	41.315	54	25	119	14	
L2GR60L	868	1057	1151	866	901	60	25	132	16	

L2GR-R • Gallery Right Return

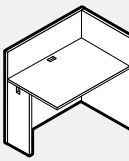

- One grommet installed TC.

PRODUCT CODE	FINISH LP	SIZE/INCHES			H(LP/B)	H(W)	W	D	WEIGHT LBS	VOL FT ³
		B	W	D						
L2GR36R	652	773	829	41.315	41.315	36	25	90	9	
L2GR42R	705	843	910	41.315	41.315	42	25	97	11	
L2GR48R	762	915	992	41.315	41.315	48	25	106	13	
L2GR54R	816	987	1071	41.315	41.315	54	25	119	14	
L2GR60R	868	1057	1151	866	901	60	25	132	16	

L2GD • Gallery Desk Decorative Panel

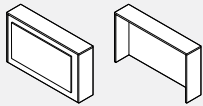

Front Back

- To be used in conjunction with a 66", 72" or 84" rectangular desk shell.
- Decorative Panel is high pressure laminate.

PRODUCT CODE	FINISH LP	SIZE/INCHES			H(LP/B)	H(W)	W	D	WEIGHT LBS	VOL FT ³
		B	W	D						
L2GD66	1618	1757	1906	42.315	42.750	68.25	12	99	20	
L2GD72	1837	1999	2171	42.315	42.750	74.25	12	113	22	
L2GD84	1970	2149	2344	42.315	42.750	86.25	12	117	25	

L2GDP • Gallery Desk with Pigeon Holes and Decorative Panel

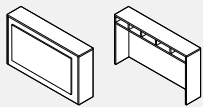

Front Back

- To be used in conjunction with a 66", 72" or 84" rectangular desk shell.
- Decorative Panel is high pressure laminate.

PRODUCT CODE	FINISH LP	SIZE/INCHES			H(LP/B)	H(W)	W	D	WEIGHT LBS	VOL FT ³
		B	W	D						
L2GDP66	1682	1863	2016	42.315	42.750	68.25	12	99	20	
L2GDP72	1906	2119	2298	42.315	42.750	74.25	12	113	22	
L2GDP84	2055	2287	2488	42.315	42.750	86.25	12	117	25	

L2GRKIT • Reception Kit Gallery

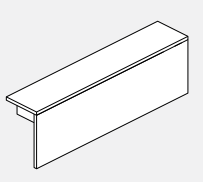

- Unit to be placed on L2DR or L2CRS Desk Shell

PRODUCT CODE	FINISH LP	SIZE/INCHES			H(LP/B)	H(W)	W	D	WEIGHT LBS	VOL FT ³
		B	W	D						
L2GRKIT36H36	406	429	446	18.37	18.75	36	12	68	1.50	
L2GRKIT42H36	443	471	492	18.37	18.75	42	12	79	1.75	
L2GRKIT48H36	481	518	535	18.37	18.75	48	12	90	2.00	
L2GRKIT54H36	521	557	583	18.37	18.75	54	12	101	2.25	
L2GRKIT60H36	558	601	626	18.37	18.75	60	12	113	2.50	
L2GRKIT36H42	449	494	509	24.37	24.75	36	12	68	1.50	
L2GRKIT42H42	495	547	564	24.37	24.75	42	12	79	1.75	
L2GRKIT48H42	539	596	620	24.37	24.75	48	12	90	2.00	
L2GRKIT54H42	586	650	674	24.37	24.75	54	12	101	2.25	
L2GRKIT60H42	633	702	730	24.37	24.75	60	12	113	2.50	

Technical Information

- All Desks and connecting shells are Shipped knocked down (KD).
- All connecting units must be connected to an adjoining worksurface where there is either no end gable or a narrow gable with flat brackets.
- Gables & partial gables are interchangeable.
- All bottom edges are edge banded.
- Each shell allows for grommet (BG5) to be specified at no upcharge. Please see general information (Section A) for location.

DESKS • GUIDELINES FOR ORDERING PRODUCT

CODES: The price list uses a numbering system with meaningful alphanumeric characters to create a simple-to-understand product number. This makes specifying the product much easier and more accurate.

SPECIFICATION EXAMPLE OF A DESK UNIT

PRODUCT CODE: L2DR3060
 L2 = New Licence
 D = Desk
 R = Rectangular
 3060 = Size: Depth x Width

OPTIONS:
 Top: LP - LP (Low Pressure Laminate) Thickness 1"
 HP B - B Thickness 1 1/16"
 HP W - W Thickness 1 7/16"

Top Finish Laminate: Choose Colour
 Top PVC Edging: Choose Colour
 Chassis Laminate: Choose Colour
 Chassis PVC Edging: Choose Colour

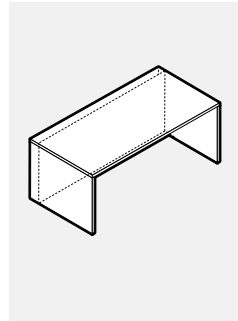

SPECIFICATION EXAMPLE OF A CONNECTING RETURN UNIT

PRODUCT CODE: L2RCH2030R
 L2 = New Licence
 R = Return
 C = Connecting
 H = Half Back Panel
 2030 = Size: Depth x Width
 R = Connecting on Right

OPTIONS:
 Top: LP - LP (Low Pressure Laminate) Thickness 1"
 HP B - B Thickness 1 1/16"
 HP W - W Thickness 1 7/16"

Top Finish Laminate: Choose Colour
 Top PVC Edging: Choose Colour
 Chassis Laminate: Choose Colour
 Chassis PVC Edging: Choose Colour

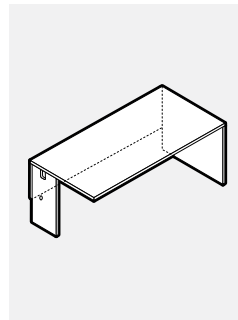

L2DR • Rectangular Desk, Recessed Modesty

• All recessed modesties are inset 6" from the visitor edge.

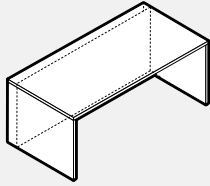

PRODUCT CODE	FINISH			SIZE/INCHES				WEIGHT LBS	VOL FT ³
	LP	B	W	H(LP/B)	H(W)	W	D		
L2DR3060	853	1041	1169	29	29.5	60	30	136	6
L2DR3066	898	1102	1247	29	29.5	66	30	145	7
L2DR3072	943	1165	1317	29	29.5	72	30	155	7
L2DR3078	988	1227	1389	29	29.5	78	30	175	9
L2DR3084	1038	1293	1471	29	29.5	84	30	185	10
L2DR3660	949	1170	1320	29	29.5	60	36	155	7
L2DR3666	999	1239	1401	29	29.5	66	36	165	9
L2DR3672	1051	1312	1484	29	29.5	72	36	176	9
L2DR3678	1098	1381	1568	29	29.5	78	36	197	11
L2DR3684	1153	1455	1654	29	29.5	84	36	208	12

L2DB • Bowfront Desk, Recessed Modesty

• All recessed modesties are inset 6" from the visitor edge.

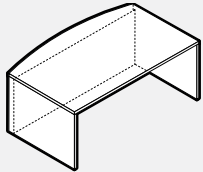

PRODUCT CODE	FINISH			SIZE/INCHES				WEIGHT LBS	VOL FT ³
	LP	B	W	H(LP/B)	H(W)	W	D		
L2DB3060	909	1132	1286	29	29.5	60	36	155	7
L2DB3066	958	1199	1366	29	29.5	66	36	165	9
L2DB3072	1007	1266	1451	29	29.5	72	36	176	9
L2DB3078	1057	1338	1531	29	29.5	78	36	197	11
L2DB3084	1111	1415	1620	29	29.5	84	36	208	12
L2DB3660	1007	1261	1433	29	29.5	60	42	155	7
L2DB3666	1060	1338	1527	29	29.5	66	42	165	9
L2DB3672	1114	1415	1618	29	29.5	72	42	176	9
L2DB3678	1166	1493	1707	29	29.5	78	42	197	11
L2DB3684	1227	1573	1807	29	29.5	84	42	208	12

L2CRS • Credenza Shell, Full End Gables on Both Sides and Flush Back

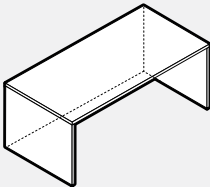

PRODUCT CODE	FINISH			SIZE/INCHES				WEIGHT LBS	VOL FT ³
	LP	B	W	H(LP/B)	H(W)	W	D		
L2CRS2024	503	575	625	29	29.5	24	20	68	3
L2CRS2030	546	633	691	29	29.5	30	20	77	3
L2CRS2036	586	681	756	29	29.5	36	20	87	3
L2CRS2042	625	737	820	29	29.5	42	20	94	3
L2CRS2048	668	793	884	29	29.5	48	20	102	4
L2CRS2054	705	847	948	29	29.5	54	20	109	4
L2CRS2060	756	909	1021	29	29.5	60	20	118	4
L2CRS2066	799	965	1085	29	29.5	66	20	127	6
L2CRS2072	838	1020	1148	29	29.5	72	20	135	6
L2CRS2078	879	1074	1217	29	29.5	78	20	151	7
L2CRS2084	926	1135	1286	29	29.5	84	20	160	8
L2CRS2424	524	596	651	29	29.5	24	24	68	3
L2CRS2430	565	652	718	29	29.5	30	24	77	3
L2CRS2436	609	710	787	29	29.5	36	24	87	3
L2CRS2442	650	768	853	29	29.5	42	24	94	3
L2CRS2448	696	826	921	29	29.5	48	24	102	4
L2CRS2454	736	882	987	29	29.5	54	24	109	4
L2CRS2460	787	945	1062	29	29.5	60	24	118	4
L2CRS2466	828	1003	1131	29	29.5	66	24	127	6
L2CRS2472	870	1058	1197	29	29.5	72	24	135	6
L2CRS2478	914	1118	1262	29	29.5	78	24	151	7
L2CRS2484	963	1179	1335	29	29.5	84	24	160	8
L2CRS3030	620	724	796	29	29.5	30	30	90	3
L2CRS3036	667	787	869	29	29.5	36	30	99	3
L2CRS3042	710	847	943	29	29.5	42	30	109	4
L2CRS3048	756	909	1019	29	29.5	48	30	119	4
L2CRS3054	801	971	1089	29	29.5	54	30	127	6
L2CRS3060	853	1041	1169	29	29.5	60	30	136	6
L2CRS3066	898	1102	1247	29	29.5	66	30	145	7
L2CRS3072	943	1165	1317	29	29.5	72	30	155	7
L2CRS3078	988	1227	1389	29	29.5	78	30	175	9
L2CRS3084	1038	1293	1471	29	29.5	84	30	185	10

L2CRSH • Credenza Shell, Flush Back, Cut Out Modesty, Full End Gables on Both Sides

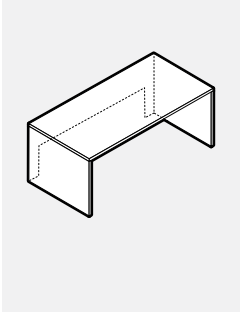

PRODUCT CODE	FINISH LP	B	W	SIZE / INCHES			WEIGHT LBS	VOL FT ³	
				H (LP/B)	H (W)	D			
L2CRSH2030	546	633	691	29	29.5	30	20	77	3
L2CRSH2036	586	681	756	29	29.5	36	20	87	3
L2CRSH2042	625	737	820	29	29.5	42	20	94	3
L2CRSH2048	668	793	884	29	29.5	48	20	102	4
L2CRSH2054	705	847	948	29	29.5	54	20	109	4
L2CRSH2060	756	909	1021	29	29.5	60	20	118	4
L2CRSH2066	799	965	1085	29	29.5	66	20	127	6
L2CRSH2072	838	1020	1148	29	29.5	72	20	135	6
L2CRSH2078	879	1074	1217	29	29.5	78	20	151	7
L2CRSH2084	926	1135	1286	29	29.5	84	20	160	8
L2CRSH2430	565	652	718	29	29.5	30	24	77	3
L2CRSH2436	609	710	787	29	29.5	36	24	87	3
L2CRSH2442	650	768	853	29	29.5	42	24	94	3
L2CRSH2448	696	826	921	29	29.5	48	24	102	4
L2CRSH2454	736	882	987	29	29.5	54	24	109	4
L2CRSH2460	787	945	1062	29	29.5	60	24	118	4
L2CRSH2466	828	1003	1131	29	29.5	66	24	127	6
L2CRSH2472	870	1058	1197	29	29.5	72	24	135	6
L2CRSH2478	914	1118	1262	29	29.5	78	24	151	7
L2CRSH2484	963	1179	1335	29	29.5	84	24	160	8
L2CRSH3030	620	724	796	29	29.5	30	30	90	3
L2CRSH3036	667	787	869	29	29.5	36	30	99	3
L2CRSH3042	710	847	943	29	29.5	42	30	109	4
L2CRSH3048	756	909	1019	29	29.5	48	30	119	4
L2CRSH3054	801	971	1089	29	29.5	54	30	127	6
L2CRSH3060	853	1041	1169	29	29.5	60	30	139	6
L2CRSH3066	898	1102	1247	29	29.5	66	30	145	7
L2CRSH3072	943	1165	1317	29	29.5	72	30	155	7
L2CRSH3078	963	1227	1389	29	29.5	78	30	175	9
L2CRSH3084	1038	1293	1471	29	29.5	84	30	185	10

L2RC-R • Return, Connecting Right, Full Gable on Right and Narrow Gable on Left

• Units are non-handed. They can be configured as either lefts or rights.

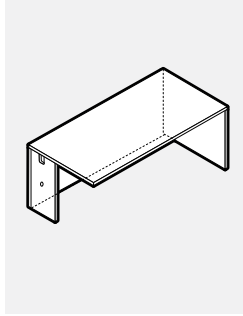

PRODUCT CODE	FINISH			SIZE / INCHES				WEIGHT LBS	VOL FT ³
	LP	B	W	H (LP/B)	H (W)	W	D		
L2RC2024R	472	545	592	29	29.5	24	20	64	3
L2RC2030R	519	601	663	29	29.5	30	20	69	3
L2RC2036R	560	656	730	29	29.5	36	20	79	3
L2RC2042R	605	715	796	29	29.5	42	20	86	3
L2RC2048R	647	771	865	29	29.5	48	20	95	4
L2RC2054R	691	829	931	29	29.5	54	20	102	4
L2RC2060R	744	899	1010	29	29.5	60	20	110	4
L2RC2066R	792	957	1077	29	29.5	66	20	119	6
L2RC2072R	838	1020	1148	29	29.5	72	20	128	6
L2RC2078R	882	1076	1220	29	29.5	78	20	143	7
L2RC2084R	926	1134	1286	29	29.5	84	20	152	8
L2RC2424R	492	562	617	29	29.5	24	24	64	3
L2RC2430R	537	622	688	29	29.5	30	24	69	3
L2RC2436R	584	681	760	29	29.5	36	24	79	3
L2RC2442R	626	741	828	29	29.5	42	24	86	3
L2RC2448R	673	802	899	29	29.5	48	24	95	4
L2RC2454R	718	865	969	29	29.5	54	24	102	4
L2RC2460R	777	935	1052	29	29.5	60	24	110	4
L2RC2466R	821	996	1122	29	29.5	66	24	119	6
L2RC2472R	870	1058	1197	29	29.5	72	24	128	6
L2RC2478R	916	1119	1264	29	29.5	78	24	143	7
L2RC2484R	963	1179	1335	29	29.5	84	24	152	8
L2RC3030R	586	686	761	29	29.5	30	30	83	3
L2RC3036R	635	752	837	29	29.5	36	30	91	3
L2RC3042R	679	817	911	29	29.5	42	30	101	4
L2RC3048R	729	882	988	29	29.5	48	30	111	4
L2RC3054R	777	945	1063	29	29.5	54	30	119	6
L2RC3060R	837	1024	1154	29	29.5	60	30	129	6
L2RC3066R	884	1088	1229	29	29.5	66	30	138	7
L2RC3072R	935	1159	1310	29	29.5	72	30	147	7
L2RC3078R	983	1223	1464	29	29.5	78	30	167	9
L2RC3084R	1032	1287	1544	29	29.5	84	30	177	10
L2RC3660R	903	1124	1271	29	29.5	60	36	145	7
L2RC3666R	957	1198	1356	29	29.5	66	36	157	9
L2RC3672R	1011	1272	1447	29	29.5	72	36	169	9
L2RC3678R	1063	1345	1531	29	29.5	78	36	190	11
L2RC3684R	1115	1417	1618	29	29.5	84	36	201	12

L2RCH-R • Half Modesty Return, Connecting Right, Full Gable on Right and Narrow Gable on Left

• Units are non-handed. They can be configured as either lefts or rights.

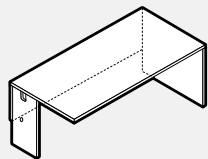

PRODUCT CODE	FINISH LP	B	W	SIZE / INCHES			WEIGHT LBS	VOL FT ³	
				H (LP/B)	H (W)	D			
L2RCH2024R	420	486	539	29	29.5	24	20	55	3
L2RCH2030R	450	530	591	29	29.5	30	20	57	3
L2RCH2036R	484	576	647	29	29.5	36	20	65	3
L2RCH2042R	513	619	702	29	29.5	42	20	69	3
L2RCH2048R	546	667	756	29	29.5	48	20	76	4
L2RCH2054R	576	706	809	29	29.5	54	20	81	4
L2RCH2060R	617	767	879	29	29.5	60	20	86	4
L2RCH2066R	650	809	931	29	29.5	66	20	92	6
L2RCH2072R	684	859	991	29	29.5	72	20	99	6
L2RCH2078R	715	903	1043	29	29.5	78	20	112	7
L2RCH2084R	748	947	1099	29	29.5	84	20	119	8
L2RCH2424R	437	505	560	29	29.5	24	24	56	3
L2RCH2430R	469	552	616	29	29.5	30	24	57	3
L2RCH2436R	502	601	673	29	29.5	36	24	65	3
L2RCH2442R	534	642	730	29	29.5	42	24	69	3
L2RCH2448R	565	691	787	29	29.5	48	24	76	4
L2RCH2454R	601	737	842	29	29.5	54	24	81	4
L2RCH2460R	642	799	911	29	29.5	60	24	86	4
L2RCH2466R	675	842	969	29	29.5	66	24	92	6
L2RCH2472R	712	893	1031	29	29.5	72	24	99	6
L2RCH2478R	743	941	1086	29	29.5	78	24	112	7
L2RCH2484R	777	987	1141	29	29.5	84	24	119	8
L2RCH3030R	521	617	691	29	29.5	30	30	77	3
L2RCH3036R	556	671	755	29	29.5	36	30	83	3
L2RCH3042R	590	722	817	29	29.5	42	30	87	4
L2RCH3048R	625	773	882	29	29.5	48	30	92	4
L2RCH3054R	663	826	944	29	29.5	54	30	98	6
L2RCH3060R	706	890	1021	29	29.5	60	30	105	6
L2RCH3066R	743	943	1084	29	29.5	66	30	111	7
L2RCH3072R	782	997	1148	29	29.5	72	30	119	7
L2RCH3078R	818	1051	1282	29	29.5	78	30	136	9
L2RCH3084R	854	1101	1348	29	29.5	84	30	144	10
L2RCH3660R	777	992	1139	29	29.5	60	36	123	7
L2RCH3666R	817	1052	1209	29	29.5	66	36	129	9
L2RCH3672R	859	1114	1287	29	29.5	72	36	141	9
L2RCH3678R	899	1170	1357	29	29.5	78	36	154	11
L2RCH3684R	938	1181	1430	29	29.5	84	36	162	12

L2RC-L • Return, Connecting Left, Full Gable on Left and Narrow Gable on Right

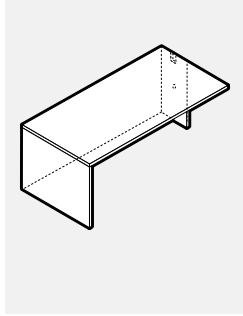

• Units are non-handed. They can be configured as either lefts or rights.

PRODUCT CODE	FINISH			SIZE / INCHES				WEIGHT LBS	VOL FT ³
	LP	B	W	H (LP/B)	H (W)	W	D		
L2RC2024L	472	545	592	29	29.5	24	20	64	3
L2RC2030L	519	601	663	29	29.5	30	20	69	3
L2RC2036L	560	656	730	29	29.5	36	20	79	3
L2RC2042L	605	715	796	29	29.5	42	20	86	3
L2RC2048L	647	771	865	29	29.5	48	20	95	4
L2RC2054L	691	829	931	29	29.5	54	20	102	4
L2RC2060L	744	899	1010	29	29.5	60	20	110	4
L2RC2066L	792	957	1077	29	29.5	66	20	119	6
L2RC2072L	838	1020	1148	29	29.5	72	20	128	6
L2RC2078L	882	1076	1220	29	29.5	78	20	143	7
L2RC2084L	926	1134	1286	29	29.5	84	20	152	8
L2RC2424L	492	562	617	29	29.5	24	24	64	3
L2RC2430L	537	622	688	29	29.5	30	24	69	3
L2RC2436L	584	681	760	29	29.5	36	24	79	3
L2RC2442L	626	741	828	29	29.5	42	24	86	3
L2RC2448L	673	802	899	29	29.5	48	24	95	4
L2RC2454L	718	865	969	29	29.5	54	24	102	4
L2RC2460L	777	935	1052	29	29.5	60	24	110	4
L2RC2466L	821	996	1122	29	29.5	66	24	119	6
L2RC2472L	870	1058	1197	29	29.5	72	24	128	6
L2RC2478L	916	1119	1264	29	29.5	78	24	143	7
L2RC2484L	963	1179	1335	29	29.5	84	24	152	8
L2RC3030L	586	686	761	29	29.5	30	30	83	3
L2RC3036L	635	752	837	29	29.5	36	30	91	3
L2RC3042L	679	817	911	29	29.5	42	30	101	4
L2RC3048L	729	882	988	29	29.5	48	30	111	4
L2RC3054L	777	945	1063	29	29.5	54	30	119	6
L2RC3060L	837	1024	1154	29	29.5	60	30	129	6
L2RC3066L	884	1088	1229	29	29.5	66	30	138	7
L2RC3072L	935	1159	1310	29	29.5	72	30	147	7
L2RC3078L	983	1223	1464	29	29.5	78	30	167	9
L2RC3084L	1032	1287	1544	29	29.5	84	30	177	10
L2RC3660L	903	1124	1271	29	29.5	60	36	145	7
L2RC3666L	957	1198	1356	29	29.5	66	36	157	9
L2RC3672L	1011	1272	1447	29	29.5	72	36	169	9
L2RC3678L	1063	1345	1531	29	29.5	78	36	190	11
L2RC3684L	1115	1417	1618	29	29.5	84	36	201	12

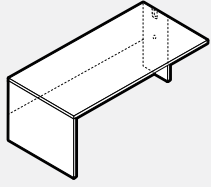
L2RCH-L • Half Modesty Return, Connecting Left, Full Gable on Left and Narrow Gable on Right

- Units are non-handed. They can be configured as either lefts or rights.

PRODUCT CODE	FINISH			SIZE / INCHES				WEIGHT		VOL FT ³
	LP	B	W	H (LP/B)	H (W)	W	D	LBS		
L2RCH2024L	420	486	539	29	29.5	24	20	55	3	
L2RCH2030L	450	530	591	29	29.5	30	20	57	3	
L2RCH2036L	484	576	647	29	29.5	36	20	65	3	
L2RCH2042L	513	619	702	29	29.5	42	20	69	3	
L2RCH2048L	546	667	756	29	29.5	48	20	76	4	
L2RCH2054L	576	706	809	29	29.5	54	20	81	4	
L2RCH2060L	617	767	879	29	29.5	60	20	86	4	
L2RCH2066L	650	809	931	29	29.5	66	20	92	5	
L2RCH2072L	684	859	991	29	29.5	72	20	99	5	
L2RCH2078L	715	903	1043	29	29.5	78	20	112	6	
L2RCH2084L	748	947	1099	29	29.5	84	20	119	7	
L2RCH2424L	437	505	560	29	29.5	24	24	56	3	
L2RCH2430L	469	552	616	29	29.5	30	24	57	3	
L2RCH2436L	502	601	673	29	29.5	36	24	65	3	
L2RCH2442L	534	642	730	29	29.5	42	24	69	3	
L2RCH2448L	565	691	787	29	29.5	48	24	76	4	
L2RCH2454L	601	737	842	29	29.5	54	24	81	4	
L2RCH2460L	642	799	911	29	29.5	60	24	86	4	
L2RCH2466L	675	842	969	29	29.5	66	24	92	5	
L2RCH2472L	712	893	1031	29	29.5	72	24	99	5	
L2RCH2478L	743	941	1086	29	29.5	78	24	112	6	
L2RCH2484L	777	987	1141	29	29.5	84	24	119	7	
L2RCH3030L	521	617	691	29	29.5	30	30	77	3	
L2RCH3036L	556	671	755	29	29.5	36	30	83	3	
L2RCH3042L	590	722	817	29	29.5	42	30	87	4	
L2RCH3048L	625	773	882	29	29.5	48	30	92	4	
L2RCH3054L	663	826	944	29	29.5	54	30	98	5	
L2RCH3060L	706	890	1021	29	29.5	60	30	105	5	
L2RCH3066L	743	943	1084	29	29.5	66	30	111	6	
L2RCH3072L	782	997	1148	29	29.5	72	30	119	6	
L2RCH3078L	818	1051	1282	29	29.5	78	30	136	8	
L2RCH3084L	854	1101	1348	29	29.5	84	30	144	9	
L2RCH3660L	777	992	1139	29	29.5	60	36	123	6	
L2RCH3666L	817	1052	1209	29	29.5	66	36	129	8	
L2RCH3672L	859	1114	1287	29	29.5	72	36	141	8	
L2RCH3678L	899	1170	1357	29	29.5	78	36	154	10	
L2RCH3684L	938	1181	1430	29	29.5	84	36	162	11	

L2RC-C • Return, Connecting Narrow Gables on Both Sides

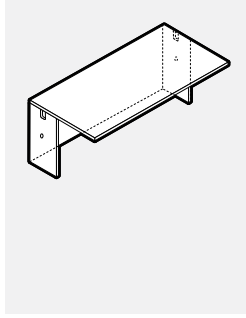

PRODUCT CODE	FINISH			SIZE / INCHES				WEIGHT LBS	VOL FT ³
	LP	B	W	H (LP/B)	H (W)	W	D		
L2RC2024C	420	488	539	29	29.5	24	20	56	3
L2RC2030C	463	524	584	29	29.5	30	20	62	3
L2RC2036C	507	576	647	29	29.5	36	20	72	3
L2RC2042C	551	634	710	29	29.5	42	20	78	3
L2RC2048C	592	686	774	29	29.5	48	20	87	4
L2RC2054C	638	739	838	29	29.5	54	20	95	4
L2RC2060C	696	806	914	29	29.5	60	20	102	4
L2RC2066C	737	860	977	29	29.5	66	20	111	6
L2RC2072C	785	919	1047	29	29.5	72	20	120	6
L2RC2078C	828	972	1109	29	29.5	78	20	135	7
L2RC2084C	870	1029	1173	29	29.5	84	20	144	8
L2RC2424C	438	507	560	29	29.5	24	24	56	3
L2RC2430C	484	546	608	29	29.5	30	24	62	3
L2RC2436C	527	603	673	29	29.5	36	24	72	3
L2RC2442C	574	656	739	29	29.5	42	24	78	3
L2RC2448C	617	713	805	29	29.5	48	24	87	4
L2RC2454C	666	769	870	29	29.5	54	24	95	4
L2RC2460C	722	839	949	29	29.5	60	24	102	4
L2RC2466C	767	895	1019	29	29.5	66	24	111	6
L2RC2472C	817	956	1088	29	29.5	72	24	120	6
L2RC2478C	862	1011	1154	29	29.5	78	24	135	7
L2RC2484C	908	1069	1222	29	29.5	84	24	144	8
L2RC3030C	541	639	712	29	29.5	30	30	75	3
L2RC3036C	587	703	788	29	29.5	36	30	84	3
L2RC3042C	636	768	866	29	29.5	42	30	94	4
L2RC3048C	681	796	899	29	29.5	48	30	103	4
L2RC3054C	732	858	970	29	29.5	54	30	116	6
L2RC3060C	792	931	1056	29	29.5	60	30	121	6
L2RC3066C	839	992	1126	29	29.5	66	30	130	7
L2RC3072C	891	1057	1201	29	29.5	72	30	140	7
L2RC3078C	938	1119	1277	29	29.5	78	30	160	9
L2RC3084C	987	1177	1349	29	29.5	84	30	169	10

L2RCH-C • Half Modesty Return, Connecting Narrow Gables on Both Sides

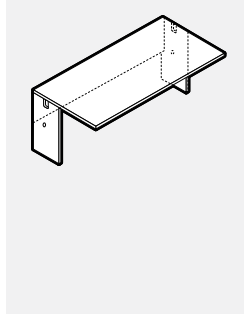

PRODUCT CODE	FINISH			SIZE/INCHES				WEIGHT LBS	VOL FT ³
	LP	B	W	H (LP/B)	H (W)	W	D		
L2RCH2024C	366	430	485	29	29.5	24	20	46	3
L2RCH2030C	398	476	537	29	29.5	30	20	50	3
L2RCH2036C	429	523	591	29	29.5	36	20	57	3
L2RCH2042C	461	564	647	29	29.5	42	20	62	3
L2RCH2048C	493	611	701	29	29.5	48	20	68	4
L2RCH2054C	507	652	756	29	29.5	54	20	74	4
L2RCH2060C	551	712	825	29	29.5	60	20	78	4
L2RCH2066C	584	756	877	29	29.5	66	20	85	6
L2RCH2072C	616	803	934	29	29.5	72	20	91	6
L2RCH2078C	647	849	991	29	29.5	78	20	105	7
L2RCH2084C	678	893	1043	29	29.5	84	20	111	8
L2RCH2424C	383	449	503	29	29.5	24	24	46	3
L2RCH2430C	417	495	560	29	29.5	30	24	50	3
L2RCH2436C	447	541	616	29	29.5	36	24	57	3
L2RCH2442C	480	587	673	29	29.5	42	24	62	3
L2RCH2448C	512	636	730	29	29.5	48	24	68	4
L2RCH2454C	527	679	787	29	29.5	54	24	74	4
L2RCH2460C	574	739	857	29	29.5	60	24	78	4
L2RCH2466C	607	787	911	29	29.5	66	24	85	6
L2RCH2472C	640	837	971	29	29.5	72	24	91	6
L2RCH2478C	673	883	1029	29	29.5	78	24	105	7
L2RCH2484C	704	928	1085	29	29.5	84	24	111	8
L2RCH3030C	473	573	642	29	29.5	30	30	72	3
L2RCH3036C	509	620	704	29	29.5	36	30	80	3
L2RCH3042C	546	673	768	29	29.5	42	30	85	4
L2RCH3048C	583	727	832	29	29.5	48	30	90	4
L2RCH3054C	616	778	895	29	29.5	54	30	95	6
L2RCH3060C	666	842	971	29	29.5	60	30	97	6
L2RCH3066C	700	894	1035	29	29.5	66	30	103	7
L2RCH3072C	737	949	1102	29	29.5	72	30	111	7
L2RCH3078C	773	1003	1165	29	29.5	78	30	129	9
L2RCH3084C	807	1055	1228	29	29.5	84	30	136	10

L2RCS • Return Connecting Swerve Left

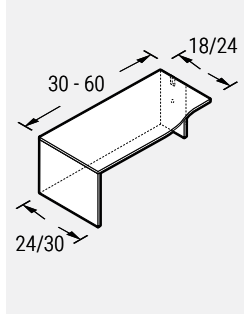

PRODUCT CODE	FINISH			SIZE/INCHES				WEIGHT LBS	VOL FT ³
	LP	B	W	H (LP/B)	H (W)	W	D		
L2RCS243018	569	652	761	29	29.5	30	24	70	2
L2RCS243618	612	712	828	29	29.5	36	24	79	3
L2RCS244218	653	769	895	29	29.5	42	24	88	3
L2RCS244818	700	827	963	29	29.5	48	24	97	4
L2RCS245418	741	884	1031	29	29.5	54	24	106	4
L2RCS246018	800	955	1110	29	29.5	60	24	114	4
L2RCS303024	619	724	839	29	29.5	30	30	81	3
L2RCS303624	668	788	915	29	29.5	36	30	91	3
L2RCS304224	715	853	992	29	29.5	42	30	109	4
L2RCS304824	763	916	1069	29	29.5	48	30	119	4
L2RCS305424	809	982	1143	29	29.5	54	30	127	6
L2RCS306024	859	1048	1222	29	29.5	60	30	136	6

L2RCS • Return Connecting Swerve Right

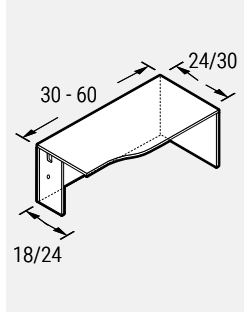

PRODUCT CODE	FINISH			SIZE/INCHES				WEIGHT LBS	VOL FT ³
	LP	B	W	H (LP/B)	H (W)	W	D		
L2RCS183024	569	652	761	29	29.9	30	24	70	2
L2RCS183624	612	712	828	29	29.5	36	24	79	3
L2RCS184224	653	769	895	29	29.5	42	24	88	3
L2RCS184824	700	827	963	29	29.5	48	24	97	4
L2RCS185424	741	884	1031	29	29.5	54	24	106	4
L2RCS186024	800	955	1110	29	29.5	60	24	114	4
L2RCS243030	619	724	839	29	29.5	30	30	81	3
L2RCS243630	668	788	915	29	29.5	36	30	91	3
L2RCS244230	715	853	992	29	29.5	42	30	109	4
L2RCS244830	763	916	1069	29	29.5	48	30	119	4
L2RCS245430	809	982	1143	29	29.5	54	30	127	6
L2RCS246030	859	1048	1222	29	29.5	60	30	136	6

L2RCSH • Return Connecting Swerve Left with Half Modesty Panel

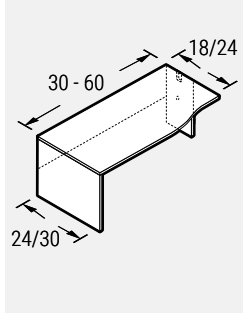

PRODUCT CODE	FINISH LP	B	W	SIZE/INCHES			D	WEIGHT LBS	VOL FT ³
				H(LP/B)	H(W)	W			
L2RCSH243018	503	586	693	29	29.5	30	24	61	2
L2RCSH243618	534	633	744	29	29.5	36	24	65	3
L2RCSH244218	564	674	801	29	29.5	42	24	72	3
L2RCSH244818	596	719	857	29	29.5	48	24	77	4
L2RCSH245418	626	763	909	29	29.5	54	24	84	4
L2RCSH246018	672	821	975	29	29.5	60	24	90	4
L2RCSH303024	553	652	771	29	29.5	30	30	78	3
L2RCSH303624	589	704	835	29	29.5	36	30	88	3
L2RCSH304224	624	757	898	29	29.5	42	30	105	4
L2RCSH304824	660	809	959	29	29.5	48	30	114	4
L2RCSH305424	697	862	1024	29	29.5	54	30	121	5
L2RCSH306024	732	914	1086	29	29.5	60	30	130	5

L2RCSH • Return Connecting Swerve Right with Half Modesty Panel

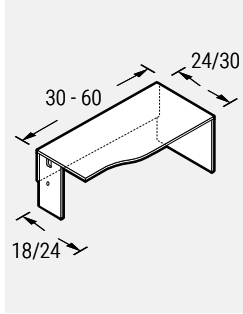

PRODUCT CODE	FINISH LP	B	W	SIZE/INCHES			D	WEIGHT LBS	VOL FT ³
				H(LP/B)	H(W)	W			
L2RCSH183024	503	586	693	29	29.5	30	24	61	2
L2RCSH183624	534	633	744	29	29.5	36	24	65	3
L2RCSH184224	564	674	801	29	29.5	42	24	72	3
L2RCSH184824	596	719	857	29	29.5	48	24	77	4
L2RCSH185424	626	763	909	29	29.5	54	24	84	4
L2RCSH186024	672	821	975	29	29.5	60	24	90	4
L2RCSH243030	553	652	771	29	29.5	30	30	78	3
L2RCSH243630	589	704	835	29	29.5	36	30	88	3
L2RCSH244230	624	757	898	29	29.5	42	30	105	4
L2RCSH244830	660	809	959	29	29.5	48	30	114	4
L2RCSH245430	697	862	1024	29	29.5	54	30	121	6
L2RCSH246030	732	914	1086	29	29.5	60	30	130	6

L2RCW • Return Connecting Wedge Left

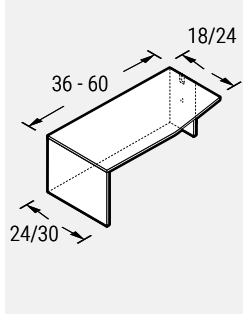

PRODUCT CODE	FINISH LP	B	W	SIZE/INCHES			D	WEIGHT LBS	VOL FT ³
				H(LP/B)	H(W)	W			
L2RCW243018	569	652	761	29	29.5	30	24	70	2
L2RCW243618	612	712	828	29	29.5	36	24	79	3
L2RCW244218	653	769	895	29	29.5	42	24	88	3
L2RCW244818	700	827	963	29	29.5	48	24	97	4
L2RCW245418	741	884	1031	29	29.5	54	24	106	4
L2RCW246018	800	955	1110	29	29.5	60	24	114	4
L2RCW303024	619	724	839	29	29.5	30	30	81	3
L2RCW303624	668	788	915	29	29.5	36	30	91	3
L2RCW304224	715	853	992	29	29.5	42	30	109	4
L2RCW304824	763	916	1069	29	29.5	48	30	119	4
L2RCW305424	809	982	1143	29	29.5	54	30	127	6
L2RCW306024	859	1048	1222	29	29.5	60	30	136	6

L2RCW • Return Connecting Wedge Right

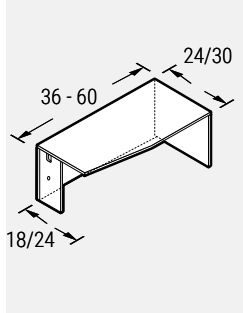

PRODUCT CODE	FINISH LP	B	W	SIZE/INCHES			D	WEIGHT LBS	VOL FT ³
				H(LP/B)	H(W)	W			
L2RCW183024	569	652	761	29	29.5	30	24	70	2
L2RCW183624	612	712	828	29	29.5	36	24	79	3
L2RCW184224	653	769	895	29	29.5	42	24	88	3
L2RCW184824	700	827	963	29	29.5	48	24	97	4
L2RCW185424	741	884	1031	29	29.5	54	24	106	4
L2RCW186024	800	955	1110	29	29.5	60	24	114	4
L2RCW243030	619	724	839	29	29.5	30	30	81	3
L2RCW243630	668	788	915	29	29.5	36	30	91	3
L2RCW244230	715	853	992	29	29.5	42	30	109	4
L2RCW244830	763	916	1069	29	29.5	48	30	119	4
L2RCW245430	809	982	1143	29	29.5	54	30	127	6
L2RCW246030	859	1048	1222	29	29.5	60	30	136	6

L2RCWH • Return Connecting Wedge Left with Half Modesty

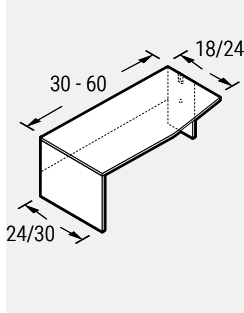

PRODUCT CODE	FINISH LP	B	W	SIZE/INCHES				WEIGHT LBS	VOL FT ³
				H (LP/B)	H (W)	W	D		
L2RCWH243018	503	586	693	29	29.5	30	24	61	2
L2RCWH243618	534	633	744	29	29.5	36	24	65	3
L2RCWH244218	564	674	801	29	29.5	42	24	72	3
L2RCWH244818	596	719	857	29	29.5	48	24	77	4
L2RCWH245418	626	763	909	29	29.5	54	24	84	4
L2RCWH246018	672	821	975	29	29.5	60	24	90	4
L2RCWH303024	553	652	771	29	29.5	30	30	78	3
L2RCWH303624	589	704	835	29	29.5	36	30	88	3
L2RCWH304224	624	757	898	29	29.5	42	30	105	4
L2RCWH304824	660	809	959	29	29.5	48	30	114	4
L2RCWH305424	697	862	1024	29	29.5	54	30	121	6
L2RCWH306024	732	914	1086	29	29.5	60	30	130	6

L2RCWH • Return Connecting Wedge Right with Half Modesty

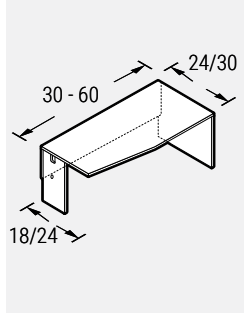

PRODUCT CODE	FINISH LP	B	W	SIZE/INCHES				WEIGHT LBS	VOL FT ³
				H (LP/B)	H (W)	W	D		
L2RCWH183024	503	586	693	29	29.5	30	24	61	2
L2RCWH183624	534	633	744	29	29.5	36	24	65	3
L2RCWH184224	564	674	801	29	29.5	42	24	72	3
L2RCWH184824	596	719	857	29	29.5	48	24	77	4
L2RCWH185424	626	763	909	29	29.5	54	24	84	4
L2RCWH186024	672	821	975	29	29.5	60	24	90	4
L2RCWH243030	553	652	771	29	29.5	30	30	78	3
L2RCWH243630	589	704	835	29	29.5	36	30	88	3
L2RCWH244230	624	757	898	29	29.5	42	30	105	4
L2RCWH244830	660	809	959	29	29.5	48	30	114	4
L2RCWH245430	697	862	1024	29	29.5	54	30	121	6
L2RCWH246030	732	914	1086	29	29.5	60	30	130	6

L2ER-L • Executive Return Left

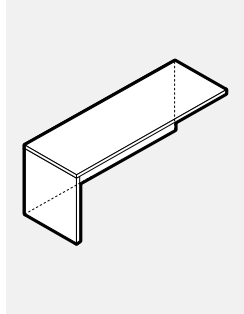

• Units are non-handed. They can be configured as either lefts or rights.

PRODUCT CODE	FINISH LP	B	W	SIZE/INCHES				WEIGHT LBS	VOL FT ³
				H (LP/B)	H (W)	W	D		
L2ER2024L	378	442	493	29	29.5	24	20	25	3
L2ER2030L	421	501	560	29	29.5	30	20	29	3
L2ER2036L	469	561	637	29	29.5	36	20	32	3
L2ER2042L	520	625	706	29	29.5	42	20	35	3
L2ER2048L	561	681	777	29	29.5	48	20	37	4
L2ER2054L	607	740	843	29	29.5	54	20	40	4
L2ER2060L	663	809	926	29	29.5	60	20	44	4
L2ER2066L	704	868	992	29	29.5	66	20	46	6
L2ER2072L	750	927	1062	29	29.5	72	20	50	6
L2ER2424L	393	461	512	29	29.5	24	24	25	3
L2ER2430L	438	521	583	29	29.5	30	24	29	3
L2ER2436L	488	585	663	29	29.5	36	24	32	3
L2ER2442L	539	650	737	29	29.5	42	24	35	3
L2ER2448L	585	710	806	29	29.5	48	24	37	4
L2ER2454L	633	769	879	29	29.5	54	24	40	4
L2ER2460L	688	842	959	29	29.5	60	24	44	4
L2ER2466L	733	903	1032	29	29.5	66	24	46	6
L2ER2472L	778	965	1106	29	29.5	72	24	50	6

L2ERH-L • Executive Return Left, Half Modesty

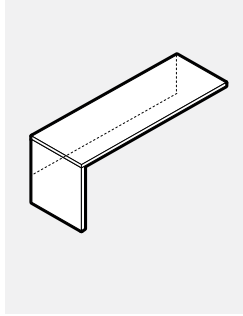

• Units are non-handed. They can be configured as either lefts or rights.

PRODUCT CODE	FINISH			SIZE/INCHES				WEIGHT LBS	VOL FT ³
	LP	B	W	H (LP/B)	H(W)	W	D		
L2ERH2024L	326	387	438	29	29.5	24	20	25	3
L2ERH2030L	356	430	492	29	29.5	30	20	29	3
L2ERH2036L	397	486	560	29	29.5	36	20	32	3
L2ERH2042L	428	530	615	29	29.5	42	20	35	3
L2ERH2048L	459	576	671	29	29.5	48	20	37	4
L2ERH2054L	492	619	724	29	29.5	54	20	40	4
L2ERH2060L	534	677	792	29	29.5	60	20	44	4
L2ERH2066L	564	722	843	29	29.5	66	20	46	6
L2ERH2072L	594	767	902	29	29.5	72	20	50	6
L2ERH2424L	337	400	457	29	29.5	24	24	25	3
L2ERH2430L	369	449	509	29	29.5	30	24	29	3
L2ERH2436L	413	505	584	29	29.5	36	24	32	3
L2ERH2442L	446	552	639	29	29.5	42	24	35	3
L2ERH2448L	477	601	697	29	29.5	48	24	37	4
L2ERH2454L	509	646	752	29	29.5	54	24	40	4
L2ERH2460L	556	703	821	29	29.5	60	24	44	4
L2ERH2466L	587	751	879	29	29.5	66	24	46	6
L2ERH2472L	619	799	941	29	29.5	72	24	50	6

L2ER-R • Executive Return Right

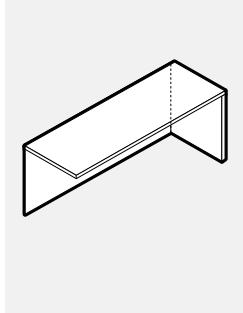

• Units are non-handed. They can be configured as either lefts or rights.

PRODUCT CODE	FINISH			SIZE/INCHES				WEIGHT LBS	VOL FT ³
	LP	B	W	H (LP/B)	H(W)	W	D		
L2ER2024R	378	442	493	29	29.5	24	20	55	3
L2ER2030R	421	501	560	29	29.5	30	20	63	3
L2ER2036R	469	561	637	29	29.5	36	20	70	3
L2ER2042R	520	625	706	29	29.5	42	20	77	3
L2ER2048R	561	681	777	29	29.5	48	20	87	4
L2ER2054R	607	740	843	29	29.5	54	20	92	4
L2ER2060R	663	809	926	29	29.5	60	20	102	4
L2ER2066R	704	868	992	29	29.5	66	20	110	6
L2ER2072R	750	927	1062	29	29.5	72	20	119	6
L2ER2424R	393	461	512	29	29.5	24	24	55	3
L2ER2430R	438	521	583	29	29.5	30	24	63	3
L2ER2436R	488	585	663	29	29.5	36	24	70	3
L2ER2442R	539	650	737	29	29.5	42	24	77	3
L2ER2448R	585	710	806	29	29.5	48	24	87	4
L2ER2454R	633	769	879	29	29.5	54	24	92	4
L2ER2460R	688	842	959	29	29.5	60	24	102	4
L2ER2466R	733	903	1032	29	29.5	66	24	110	6
L2ER2472R	778	965	1106	29	29.5	72	24	119	6

L2ERH-R • Executive Return Right, Half Modesty

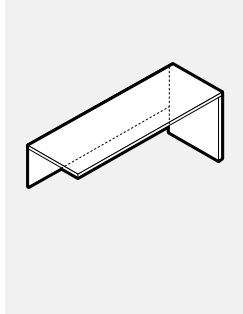

• Units are non-handed. They can be configured as either lefts or rights.

PRODUCT CODE	FINISH			SIZE/INCHES				WEIGHT LBS	VOL FT ³
	LP	B	W	H (LP/B)	H(W)	W	D		
L2ERH2024R	326	387	438	29	29.5	24	20	45	3
L2ERH2030R	356	430	492	29	29.5	30	20	53	3
L2ERH2036R	397	486	560	29	29.5	36	20	62	3
L2ERH2042R	428	530	615	29	29.5	42	20	67	3
L2ERH2048R	459	576	671	29	29.5	48	20	77	4
L2ERH2054R	492	619	724	29	29.5	54	20	83	4
L2ERH2060R	534	677	792	29	29.5	60	20	94	4
L2ERH2066R	564	722	843	29	29.5	66	20	101	6
L2ERH2072R	594	767	902	29	29.5	72	20	110	6
L2ERH2424R	337	400	457	29	29.5	24	24	45	3
L2ERH2430R	369	449	509	29	29.5	30	24	53	3
L2ERH2436R	413	505	584	29	29.5	36	24	62	3
L2ERH2442R	446	552	639	29	29.5	42	24	67	3
L2ERH2448R	477	601	697	29	29.5	48	24	77	4
L2ERH2454R	509	646	752	29	29.5	54	24	83	4
L2ERH2460R	556	703	821	29	29.5	60	24	94	4
L2ERH2466R	587	751	879	29	29.5	66	24	101	6
L2ERH2472R	619	799	941	29	29.5	72	24	110	6

L2B • Bridge with Flush Mounted Modesty

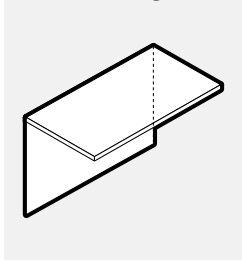

PRODUCT CODE	FINISH			SIZE / INCHES				WEIGHT		VOL FT ³
	LP	B	W	H (LP/B)	H (W)	W	D	LBS		
L2B2024	259	318	372	29	29.5	24	20	39	2	
L2B2030	303	377	439	29	29.5	30	20	42	3	
L2B2036	352	439	512	29	29.5	36	20	68	3	
L2B2042	394	495	579	29	29.5	42	20	77	3	
L2B2048	438	553	647	29	29.5	48	20	86	4	
L2B2054	481	612	715	29	29.5	54	20	94	4	
L2B2424	270	331	386	29	29.5	24	24	39	2	
L2B2430	315	392	458	29	29.5	30	24	44	3	
L2B2436	364	457	532	29	29.5	36	24	68	3	
L2B2442	409	519	605	29	29.5	42	24	77	3	
L2B2448	457	576	673	29	29.5	48	24	86	4	
L2B2454	501	637	741	29	29.5	54	24	94	4	

L2BH • Bridge with Flush Mounted Half Modesty

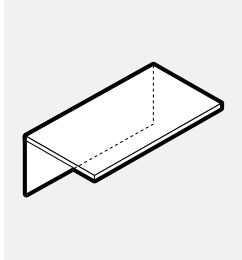

PRODUCT CODE	FINISH			SIZE / INCHES				WEIGHT		VOL FT ³
	LP	B	W	H (LP/B)	H (W)	W	D	LBS		
L2BH2024	206	263	317	29	29.5	24	20	36	2	
L2BH2030	238	309	369	29	29.5	30	20	36	2	
L2BH2036	272	358	430	29	29.5	36	20	54	3	
L2BH2042	303	400	486	29	29.5	42	20	61	3	
L2BH2048	334	446	539	29	29.5	48	20	66	4	
L2BH2054	366	492	592	29	29.5	54	20	72	4	
L2BH2424	215	275	329	29	29.5	24	24	36	2	
L2BH2430	246	319	385	29	29.5	30	24	42	3	
L2BH2436	284	372	449	29	29.5	36	24	54	3	
L2BH2442	317	419	505	29	29.5	42	24	61	3	
L2BH2448	350	463	561	29	29.5	48	24	66	4	
L2BH2454	381	509	617	29	29.5	54	24	72	4	

L2EC-R • Extended Corner Desk with 10" End Panel on Left, Full Modesty & Full Gable on Right

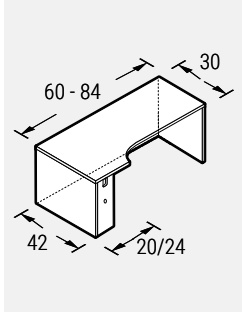

PRODUCT CODE	FINISH			SIZE / INCHES				WEIGHT		VOL FT ³
	LP	B	W	H (LP/B)	H (W)	W	D	LBS		
For 20" Return Connection										
L2EC20426030R	1077	1334	1516	29	29.5	60	42	187	8	
L2EC20426630R	1133	1414	1607	29	29.5	66	42	209	9	
L2EC20427230R	1187	1488	1697	29	29.5	72	42	231	10	
L2EC20427830R	1236	1566	1788	29	29.5	78	42	253	11	
L2EC20428430R	1290	1641	1879	29	29.5	84	42	275	12	
For 24" Return Connection										
L2EC24426030R	1077	1334	1516	29	29.5	60	42	187	8	
L2EC24426630R	1133	1414	1607	29	29.5	66	42	209	9	
L2EC24427230R	1187	1488	1697	29	29.5	72	42	231	10	
L2EC24427830R	1236	1566	1788	29	29.5	78	42	253	11	
L2EC24428430R	1290	1641	1879	29	29.5	84	42	275	12	

L2EC-L • Extended Corner Desk with 10" End Panel on Right, Full Modesty & Full Gable on Left

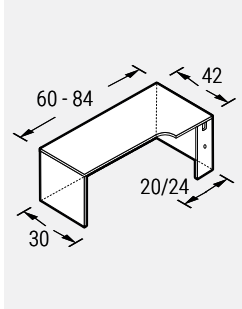

PRODUCT CODE	FINISH			SIZE / INCHES				WEIGHT		VOL FT ³
	LP	B	W	H (LP/B)	H (W)	W	D	LBS		
For 20" Return Connection										
L2EC30604220L	1077	1334	1516	29	29.5	60	42	187	8	
L2EC30664220L	1133	1414	1607	29	29.5	66	42	209	9	
L2EC30724220L	1187	1488	1697	29	29.5	72	42	231	10	
L2EC30784220L	1236	1566	1788	29	29.5	78	42	253	11	
L2EC30844220L	1290	1641	1879	29	29.5	84	42	275	12	
For 24" Return Connection										
L2EC30604224L	1077	1334	1516	29	29.5	60	42	187	8	
L2EC30664224L	1133	1414	1607	29	29.5	66	42	209	9	
L2EC30724224L	1187	1488	1697	29	29.5	72	42	231	10	
L2EC30784224L	1236	1566	1788	29	29.5	78	42	253	11	
L2EC30844224L	1290	1641	1879	29	29.5	84	42	275	12	

L2EC-R • Extended Corner Desk with 10" End Panel on Left, Full Modesty & Full Gable on Right

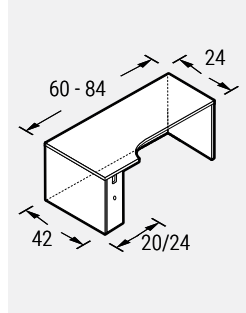

PRODUCT CODE	FINISH LP	B	W	SIZE/INCHES				WEIGHT LBS	VOL FT ³
				H(LP/B)	H(W)	W	D		
For 20" Return Connection									
L2EC20426024R	1056	1313	1494	29	29.5	60	42	187	8
L2EC20426624R	1109	1389	1584	29	29.5	66	42	209	9
L2EC20427224R	1163	1465	1674	29	29.5	72	42	231	10
L2EC20427824R	1218	1542	1764	29	29.5	78	42	253	11
L2EC20428424R	1266	1619	1858	29	29.5	84	42	275	12
For 24" Return Connection									
L2EC24426024R	1056	1313	1494	29	29.5	60	42	187	8
L2EC24426624R	1109	1389	1584	29	29.5	66	42	209	9
L2EC24427224R	1163	1465	1674	29	29.5	72	42	231	10
L2EC24427824R	1218	1542	1764	29	29.5	78	42	253	11
L2EC24428424R	1266	1619	1858	29	29.5	84	42	275	12

L2EC-L • Extended Corner Desk with 10" End Panel on Left, Full Modesty & Full Gable on Right

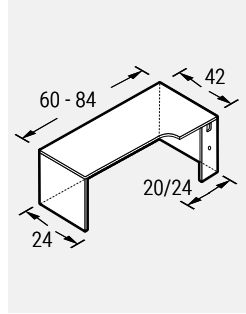

PRODUCT CODE	FINISH LP	B	W	SIZE/INCHES				WEIGHT LBS	VOL FT ³
				H(LP/B)	H(W)	W	D		
For 20" Return Connection									
L2EC24604220L	1056	1313	1494	29	29.5	60	42	187	8
L2EC24664220L	1109	1389	1584	29	29.5	66	42	209	9
L2EC24724220L	1163	1465	1674	29	29.5	72	42	231	10
L2EC24784220L	1218	1542	1764	29	29.5	78	42	253	11
L2EC24844220L	1266	1619	1858	29	29.5	84	42	275	12
For 24" Return Connection									
L2EC24604224L	1056	1313	1494	29	29.5	60	42	187	8
L2EC24664224L	1109	1389	1584	29	29.5	66	42	209	9
L2EC24724224L	1163	1465	1674	29	29.5	72	42	231	10
L2EC24784224L	1218	1542	1764	29	29.5	78	42	253	11
L2EC24844224L	1266	1619	1858	29	29.5	84	42	275	12

L2DEC-R • Extended Corner Desk with 10" End Panel on Left, Full Modesty and Full Gable Right

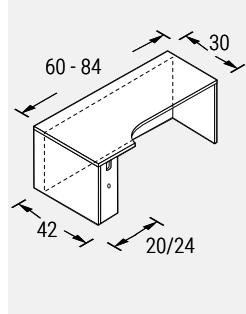

• All recessed modesties are inset 6" from the visitor edge.

PRODUCT CODE	FINISH LP	B	W	SIZE/INCHES				WEIGHT LBS	VOL FT ³
				H(LP/B)	H(W)	W	D		
For 20" Connection									
L2DEC20426030R	1077	1334	1516	29	29.5	60	42	187	8
L2DEC20426630R	1133	1414	1607	29	29.5	66	42	209	9
L2DEC20427230R	1187	1488	1697	29	29.5	72	42	231	10
L2DEC20427830R	1236	1566	1788	29	29.5	78	42	253	11
L2DEC20428430R	1290	1641	1879	29	29.5	84	42	275	12
For 24" Connection									
L2DEC24426030R	1077	1334	1516	29	29.5	60	42	187	8
L2DEC24426630R	1133	1414	1607	29	29.5	66	42	209	9
L2DEC24427230R	1187	1488	1697	29	29.5	72	42	231	10
L2DEC24427830R	1236	1566	1788	29	29.5	78	42	253	11
L2DEC24428430R	1290	1641	1879	29	29.5	84	42	275	12

L2DEC-L • Extended Corner Desk with 10" End Panel on Right, Full Modesty and Full Gable Left

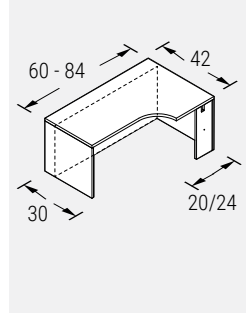

• All recessed modesties are inset 6" from the visitor edge.

PRODUCT CODE	FINISH LP	B	W	SIZE/INCHES				WEIGHT LBS	VOL FT ³
				H(LP/B)	H(W)	W	D		
For 20" Connection									
L2DEC30604220L	1077	1334	1516	29	29.5	60	42	187	8
L2DEC30664220L	1133	1414	1607	29	29.5	66	42	209	9
L2DEC30724220L	1187	1488	1697	29	29.5	72	42	231	10
L2DEC30784220L	1236	1566	1788	29	29.5	78	42	253	11
L2DEC30844220L	1290	1641	1879	29	29.5	84	42	275	12
For 24" Connection									
L2DEC30604224L	1077	1334	1516	29	29.5	60	42	187	8
L2DEC30664224L	1133	1414	1607	29	29.5	66	42	209	9
L2DEC30724224L	1187	1488	1697	29	29.5	72	42	231	10
L2DEC30784224L	1236	1566	1788	29	29.5	78	42	253	11
L2DEC30844224L	1290	1641	1879	29	29.5	84	42	275	12

L2DEC-R • Extended Corner Desk with 10" End Panel on Left, Full Modesty and Full Gable Right

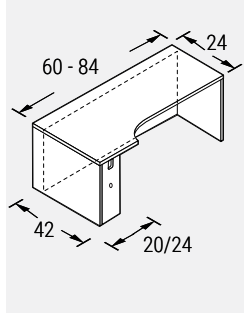

• All recessed modesties are inset 6" from the visitor edge.

PRODUCT CODE	FINISH			SIZE/INCHES				WEIGHT LBS	VOL FT ³
	LP	B	W	H(LP/B)	H(W)	W	D		
For 20" Connection									
L2DEC20426024R	1056	1313	1494	29	29.5	60	42	187	8
L2DEC20426624R	1109	1389	1584	29	29.5	66	42	209	9
L2DEC20427224R	1163	1465	1674	29	29.5	72	42	231	10
L2DEC20427824R	1218	1542	1764	29	29.5	78	42	253	11
L2DEC20428424R	1266	1619	1858	29	29.5	84	42	275	12
For 24" Connection									
L2DEC24426024R	1056	1313	1494	29	29.5	60	42	187	8
L2DEC24426624R	1109	1389	1584	29	29.5	66	42	209	9
L2DEC24427224R	1163	1465	1674	29	29.5	72	42	231	10
L2DEC24427824R	1218	1542	1764	29	29.5	78	42	253	11
L2DEC24428424R	1266	1619	1858	29	29.5	84	42	275	12

L2DEC-L • Extended Corner Desk with 10" End Panel on Right, Full Modesty and Full Gable Left

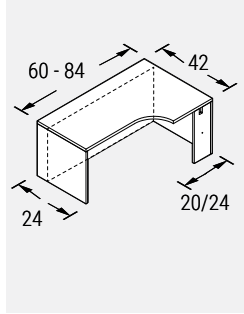

• All recessed modesties are inset 6" from the visitor edge.

PRODUCT CODE	FINISH			SIZE/INCHES				WEIGHT LBS	VOL FT ³
	LP	B	W	H(LP/B)	H(W)	W	D		
For 20" Connection									
L2DEC24604220L	1056	1313	1494	29	29.5	60	42	187	8
L2DEC24664220L	1109	1389	1584	29	29.5	66	42	209	9
L2DEC24724220L	1163	1465	1674	29	29.5	72	42	231	10
L2DEC24784220L	1218	1542	1764	29	29.5	78	42	253	11
L2DEC24844220L	1266	1619	1858	29	29.5	84	42	275	12
For 24" Connection									
L2DEC24604224L	1056	1313	1494	29	29.5	60	42	187	8
L2DEC24664224L	1109	1389	1584	29	29.5	66	42	209	9
L2DEC24724224L	1163	1465	1674	29	29.5	72	42	231	10
L2DEC24784224L	1218	1542	1764	29	29.5	78	42	253	11
L2DEC24844224L	1266	1619	1858	29	29.5	84	42	275	12

L2CS • Corner with Straight Front, Full Back Panel & Narrow End Gables

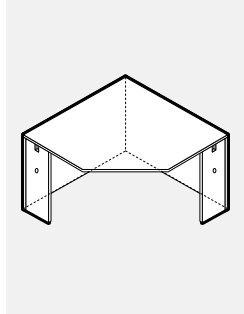

• For grain direction on surfaces larger than 42", please see grain direction chart at beginning of the Price List

PRODUCT CODE	FINISH			SIZE/INCHES				WEIGHT LBS	VOL FT ³
	LP	B	W	H(LP/B)	H(W)	W	D		
L2CS183618	862	1063	1329	29	29.5	36	36	79	3
L2CS183620	884	1089	1364	29	29.5	36	36	84	3
L2CS183624	884	1089	1364	29	29.5	36	36	84	3
L2CS203618	884	1089	1364	29	29.5	36	36	84	3
L2CS203620	921	1148	1480	29	29.5	36	36	88	3
L2CS203624	942	1174	1514	29	29.5	36	36	88	3
L2CS243618	884	1089	1364	29	29.5	36	36	84	3
L2CS243620	942	1174	1514	29	29.5	36	36	88	3
L2CS243624	942	1174	1514	29	29.5	36	36	88	3
L2CS184218	944	1168	1452	29	29.5	42	42	87	4
L2CS184220	970	1198	1488	29	29.5	42	42	92	4
L2CS184224	970	1198	1488	29	29.5	42	42	92	4
L2CS204218	970	1198	1488	29	29.5	42	42	92	4
L2CS204220	970	1198	1488	29	29.5	42	42	97	4
L2CS204224	994	1227	1570	29	29.5	42	42	97	4
L2CS244218	970	1198	1488	29	29.5	42	42	92	4
L2CS244220	994	1227	1570	29	29.5	42	42	97	4
L2CS244224	994	1227	1570	29	29.5	42	42	97	4
L2CS184818	1000	1225	1507	29	29.5	48	48	97	6
L2CS184820	1026	1254	1544	29	29.5	48	48	101	6
L2CS184824	1026	1254	1544	29	29.5	48	48	101	6
L2CS204818	1026	1254	1544	29	29.5	48	48	101	6
L2CS204820	1026	1254	1544	29	29.5	48	48	107	6
L2CS204824	1052	1285	1626	29	29.5	48	48	107	6
L2CS244818	1026	1254	1544	29	29.5	48	48	101	6
L2CS244820	1052	1285	1626	29	29.5	48	48	107	6
L2CS244824	1052	1285	1626	29	29.5	48	48	107	6

L2CSH • Corner with Straight Front, Cut Out Back Panel & Narrow End Gables

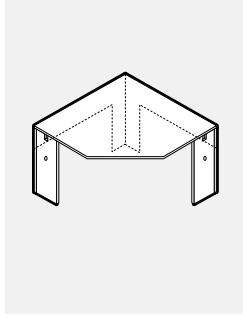

• For grain direction on surfaces larger than 42", please see grain direction chart at beginning of the Price List

PRODUCT CODE	FINISH LP	B	W	SIZE/INCHES			D	WEIGHT LBS	VOL FT ³
				H(LP/B)	H(W)	W			
L2CSH183618	891	1093	1357	29	29.5	36	36	51	3
L2CSH183620	915	1120	1394	29	29.5	36	36	55	3
L2CSH183624	915	1120	1394	29	29.5	36	36	55	3
L2CSH203618	915	1120	1394	29	29.5	36	36	55	3
L2CSH203620	949	1177	1509	29	29.5	36	36	59	3
L2CSH203624	971	1203	1542	29	29.5	36	36	59	3
L2CSH243618	915	1120	1394	29	29.5	36	36	55	3
L2CSH243620	971	1203	1542	29	29.5	36	36	59	3
L2CSH243624	971	1203	1542	29	29.5	36	36	59	3
L2CSH184218	977	1201	1484	29	29.5	42	42	57	4
L2CSH184220	1004	1230	1524	29	29.5	42	42	63	4
L2CSH184224	1004	1230	1524	29	29.5	42	42	63	4
L2CSH204218	1004	1230	1524	29	29.5	42	42	63	4
L2CSH204220	1004	1230	1524	29	29.5	42	42	68	4
L2CSH204224	1029	1262	1606	29	29.5	42	42	68	4
L2CSH244218	1004	1230	1524	29	29.5	42	42	63	4
L2CSH244220	1029	1262	1606	29	29.5	42	42	68	4
L2CSH244224	1029	1262	1606	29	29.5	42	42	68	4
L2CSH184818	1034	1260	1541	29	29.5	48	48	65	6
L2CSH184820	1060	1288	1581	29	29.5	48	48	70	6
L2CSH184824	1060	1288	1581	29	29.5	48	48	70	6
L2CSH204818	1060	1288	1581	29	29.5	48	48	70	6
L2CSH204820	1060	1288	1581	29	29.5	48	48	76	6
L2CSH204824	1085	1318	1663	29	29.5	48	48	76	6
L2CSH244818	1060	1288	1581	29	29.5	48	48	70	6
L2CSH244820	1085	1318	1663	29	29.5	48	48	76	6
L2CSH244824	1085	1318	1663	29	29.5	48	48	76	6

L2CC • Corner with Curved Front, Full Back Panel & Narrow End Gables

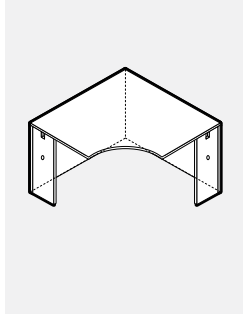

• For grain direction on surfaces larger than 42", please see grain direction chart at beginning of the Price List

PRODUCT CODE	FINISH LP	B	W	SIZE/INCHES			D	WEIGHT LBS	VOL FT ³
				H(LP/B)	H(W)	W			
L2CC183618	872	1082	1355	29	29.5	36	36	79	3
L2CC183620	898	1109	1392	29	29.5	36	36	84	3
L2CC183624	898	1109	1392	29	29.5	36	36	84	3
L2CC203618	898	1109	1392	29	29.5	36	36	84	3
L2CC203620	934	1169	1509	29	29.5	36	36	88	3
L2CC203624	956	1197	1542	29	29.5	36	36	88	3
L2CC243618	898	1109	1392	29	29.5	36	36	84	3
L2CC243620	956	1197	1542	29	29.5	36	36	88	3
L2CC243624	956	1197	1542	29	29.5	36	36	88	3
L2CC184218	958	1189	1481	29	29.5	42	42	87	4
L2CC184220	983	1221	1518	29	29.5	42	42	92	4
L2CC184224	983	1221	1518	29	29.5	42	42	92	4
L2CC204218	983	1221	1518	29	29.5	42	42	92	4
L2CC204220	983	1221	1518	29	29.5	42	42	97	4
L2CC204224	1008	1251	1604	29	29.5	42	42	97	4
L2CC244218	983	1221	1518	29	29.5	42	42	92	4
L2CC244220	1008	1251	1604	29	29.5	42	42	97	4
L2CC244224	1008	1251	1604	29	29.5	42	42	97	4
L2CC184818	1015	1247	1537	29	29.5	48	48	97	6
L2CC184820	1038	1277	1575	29	29.5	48	48	101	6
L2CC184824	1038	1277	1575	29	29.5	48	48	101	6
L2CC204818	1038	1277	1575	29	29.5	48	48	101	6
L2CC204820	1038	1277	1575	29	29.5	48	48	107	6
L2CC204824	1064	1305	1660	29	29.5	48	48	107	6
L2CC244818	1038	1277	1575	29	29.5	48	48	101	6
L2CC244820	1064	1305	1660	29	29.5	48	48	107	6
L2CC244824	1064	1305	1660	29	29.5	48	48	107	6

L2CCH • Corner with Curved Front, Cut Out Back Panel & Narrow End Gables

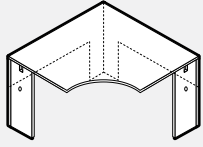

• For grain direction on surfaces larger than 42", please see grain direction chart at beginning of the Price List

PRODUCT CODE	FINISH LP	B	W	SIZE / INCHES				WEIGHT		VOL FT ³
				H (LP/B)	H (W)	W	D	LBS		
L2CCH183618	903	1110	1482	29	29.5	36	36	51	3	
L2CCH183620	928	1139	1485	29	29.5	36	36	55	3	
L2CCH183624	928	1139	1485	29	29.5	36	36	55	3	
L2CCH203618	928	1139	1485	29	29.5	36	36	55	3	
L2CCH203620	965	1199	1608	29	29.5	36	36	59	3	
L2CCH203624	987	1227	1608	29	29.5	36	36	59	3	
L2CCH243618	928	1139	1485	29	29.5	36	36	55	3	
L2CCH243620	987	1227	1608	29	29.5	36	36	59	3	
L2CCH243624	987	1227	1608	29	29.5	36	36	59	3	
L2CCH184218	993	1223	1515	29	29.5	42	42	57	4	
L2CCH184220	1020	1253	1554	29	29.5	42	42	63	4	
L2CCH184224	1020	1253	1554	29	29.5	42	42	63	4	
L2CCH204218	1020	1253	1554	29	29.5	42	42	63	4	
L2CCH204220	1020	1253	1554	29	29.5	42	42	68	4	
L2CCH204224	1042	1285	1637	29	29.5	42	42	68	4	
L2CCH244218	1020	1253	1554	29	29.5	42	42	63	4	
L2CCH244220	1042	1285	1637	29	29.5	42	42	68	4	
L2CCH244224	1042	1285	1637	29	29.5	42	42	68	4	
L2CCH184818	1051	1280	1570	29	29.5	48	48	65	6	
L2CCH184820	1075	1310	1608	29	29.5	48	48	70	6	
L2CCH184824	1075	1310	1608	29	29.5	48	48	70	6	
L2CCH204818	1075	1310	1608	29	29.5	48	48	70	6	
L2CCH204820	1075	1310	1608	29	29.5	48	48	76	6	
L2CCH204824	1099	1341	1693	29	29.5	48	48	76	6	
L2CCH244818	1075	1310	1608	29	29.5	48	48	70	6	
L2CCH244820	1099	1341	1693	29	29.5	48	48	76	6	
L2CCH244824	1099	1341	1693	29	29.5	48	48	76	6	

L2CK • Split Corner Desk w/Curved Front Keyboard, Full Back Panel & Narrow End Gables

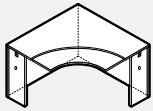

• For grain direction on surfaces larger than 42", please see grain direction chart at beginning of the Price List

PRODUCT CODE	FINISH LP	B	W	SIZE / INCHES				WEIGHT		VOL FT ³
				H (LP/B)	H (W)	W	D	LBS		
L2CK244224	1717	2014	2389	29	29.5	42	42	97	4	
L2CK244824	1773	2069	2448	29	29.5	48	48	107	6	

L2CHK • Split Corner Desk w/Curved Front Keyboard, Cut Out Back Panel & Narrow End Gables

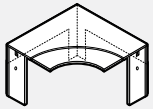

• For grain direction on surfaces larger than 42", please see grain direction chart at beginning of the Price List

PRODUCT CODE	FINISH LP	B	W	SIZE / INCHES				WEIGHT		VOL FT ³
				H (LP/B)	H (W)	W	D	LBS		
L2CHK244224	1750	2030	2405	29	29.5	42	42	68	4	
L2CHK244824	1807	2088	2462	29	29.5	48	48	76	6	

Technical Information

- All Shaped tables are Shipped knocked down (KD).
- Monoleg or square leg ships in a separate box.
- All Units must be connected to an adjoining unit with flat brackets.
- For 24" deep returns that connect to an adjoining unit with included flat brackets.
- For 24" deep returns that connect to the corner units, the narrow panel is 10" and for 30" deep returns, the narrow panel is 14".
- All bottom edges are edge banded.
- Monolegs are drilled to accept shoulder screws to attach to the modesty.
- Modesty are offered 10" high only.
- Top plate with cut-out for 3" monoleg will accept modesty panel 1" thick.
- 8 x 8" plate is attached to surface with #10 3/4 wood screws, included.
- 1" height adjustment range.

TABLES • GUIDELINES FOR ORDERING PRODUCT

CODES: The price list uses a numbering system with meaningful alphanumeric characters to create a simple-to-understand product number. This makes specifying the product much easier and more accurate.

SPECIFICATION EXAMPLE OF A SHAPED TABLE

PRODUCT CODE:

L2TDH3060
 L2 = New Licence
 T = Table
 D = D Shape Worksurface
 H = Half Modesty (10"High)
 3060 = Size: Depth x Width

OPTIONS:

Top: LP - LPL (Low Pressure Laminate) Thickness 1"
 HP B - B Thickness 1 1/16"
 HP W - W Thickness 1 7/16"

Leg Option: L2BHML03 (DEFAULT) Round Monoleg
 L2LSQ3X3 - Square Leg

Top Finish Laminate: Choose Colour

Top PVC Edging: Choose Colour

Chassis Laminate: Choose Colour

Chassis PVC Edging: Choose Colour

Metal Leg Finish: Choose Colour

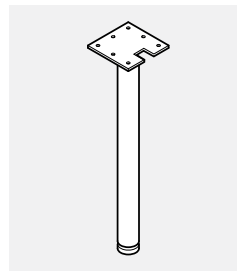

L2BHML03

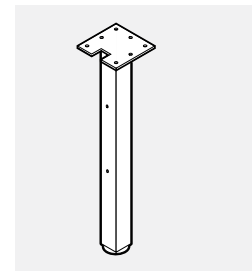

L2LSQ3X3

L2TD • D-Shaped Top with T-Base & Leg

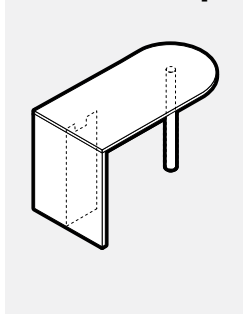

• Add \$118 to list price for chrome leg option.

PRODUCT CODE	FINISH			SIZE/INCHES				WEIGHT LBS	VOL FT ³
	LP	B	W	H (LP/B)	H (W)	W	D		
L2TD2442	760	877	965	29	29.5	42	24	64	3
L2TD2448	779	910	1007	29	29.5	48	24	68	3
L2TD2454	802	945	1054	29	29.5	54	24	72	3
L2TD2460	825	982	1098	29	29.5	60	24	76	4
L2TD2466	845	1015	1140	29	29.5	66	24	79	4
L2TD2472	867	1052	1188	29	29.5	72	24	84	4
L2TD2478	890	1085	1229	29	29.5	78	24	87	6
L2TD2484	910	1120	1277	29	29.5	84	24	91	6
L2TD3054	870	1047	1169	29	29.5	54	30	97	4
L2TD3060	898	1088	1224	29	29.5	60	30	107	7
L2TD3066	926	1132	1279	29	29.5	66	30	117	8
L2TD3072	949	1170	1329	29	29.5	72	30	127	9
L2TD3078	975	1217	1384	29	29.5	78	30	136	9
L2TD3084	1003	1256	1438	29	29.5	84	30	146	10
L2TD3654	935	1139	1282	29	29.5	54	36	107	4
L2TD3660	967	1190	1343	29	29.5	60	36	111	10
L2TD3666	996	1238	1406	29	29.5	66	36	116	9
L2TD3672	1026	1288	1467	29	29.5	72	36	153	10
L2TD3678	1057	1338	1529	29	29.5	78	36	165	11
L2TD3684	1086	1387	1591	29	29.5	84	36	176	12

L2TDH • D-Shaped Top with Half Modesty & Leg

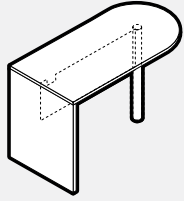

• Add \$118 to list price for chrome leg option.

PRODUCT CODE	FINISH LP	B	W	SIZE / INCHES				WEIGHT LBS	VOL FT ³
				H(LP/B)	H(W)	W	D		
L2TDH2442	741	860	947	29	29.5	42	24	63	3
L2TDH2448	774	904	1000	29	29.5	48	24	69	3
L2TDH2454	805	948	1056	29	29.5	54	24	75	3
L2TDH2460	837	994	1110	29	29.5	60	24	81	4
L2TDH2466	868	1036	1164	29	29.5	66	24	87	4
L2TDH2472	899	1084	1221	29	29.5	72	24	94	4
L2TDH2478	930	1126	1272	29	29.5	78	24	99	6
L2TDH2484	959	1170	1327	29	29.5	84	24	106	6
L2TDH3054	871	1047	1169	29	29.5	54	30	95	4
L2TDH3060	908	1098	1232	29	29.5	60	30	102	7
L2TDH3066	943	1151	1294	29	29.5	66	30	112	8
L2TDH3072	977	1201	1357	29	29.5	72	30	122	9
L2TDH3078	1013	1254	1421	29	29.5	78	30	132	9
L2TDH3084	1051	1305	1485	29	29.5	84	30	142	10
L2TDH3654	935	1140	1284	29	29.5	54	36	145	4
L2TDH3660	975	1199	1353	29	29.5	60	36	151	10
L2TDH3666	1005	1251	1416	29	29.5	66	36	154	9
L2TDH3672	1047	1309	1485	29	29.5	72	36	156	10
L2TDH3678	1085	1366	1559	29	29.5	78	36	161	11
L2TDH3684	1124	1427	1632	29	29.5	84	36	172	12

L2TR • Rectangular Top with T-Base & Mono Leg

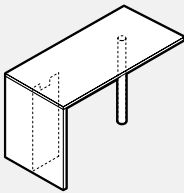

• Add \$118 to list price for chrome leg option.

PRODUCT CODE	FINISH LP	B	W	SIZE / INCHES				WEIGHT LBS	VOL FT ³
				H(LP/B)	H(W)	W	D		
L2TR2442	760	877	965	29	29.5	42	24	64	3
L2TR2448	779	910	1007	29	29.5	48	24	68	3
L2TR2454	802	945	1054	29	29.5	54	24	72	3
L2TR2460	825	982	1098	29	29.5	60	24	76	4
L2TR2466	845	1015	1140	29	29.5	66	24	79	4
L2TR2472	867	1052	1188	29	29.5	72	24	84	4
L2TR2478	890	1085	1229	29	29.5	78	24	87	6
L2TR2484	910	1120	1277	29	29.5	84	24	91	6
L2TR3054	870	1047	1169	29	29.5	54	30	97	4
L2TR3060	898	1088	1224	29	29.5	60	30	107	7
L2TR3066	926	1132	1279	29	29.5	66	30	112	8
L2TR3072	949	1170	1329	29	29.5	72	30	127	9
L2TR3078	975	1217	1384	29	29.5	78	30	136	9
L2TR3084	1003	1256	1438	29	29.5	84	30	146	10
L2TR3654	935	1139	1282	29	29.5	54	36	107	4
L2TR3660	967	1190	1343	29	29.5	60	36	111	7
L2TR3666	996	1238	1406	29	29.5	66	36	116	8
L2TR3672	1026	1288	1467	29	29.5	72	36	153	9
L2TR3678	1057	1338	1529	29	29.5	78	36	165	9
L2TR3684	1086	1387	1591	29	29.5	84	36	176	10

L2TRH • Rectangular Top with Half Modesty & Mono Leg

• Add \$118 to list price for chrome leg option.

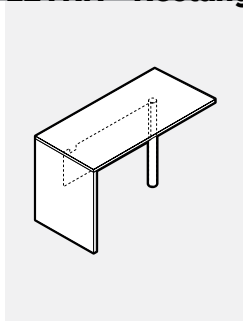

PRODUCT CODE	FINISH LP	B	W	SIZE/INCHES			D	WEIGHT LBS	VOL FT ³
				H(LP/B)	H(W)	W			
L2TRH2442	741	860	947	29	29.5	42	24	63	3
L2TRH2448	774	904	1010	29	29.5	48	24	69	3
L2TRH2454	805	948	1056	29	29.5	54	24	75	3
L2TRH2460	837	994	1110	29	29.5	60	24	81	4
L2TRH2466	868	1036	1164	29	29.5	66	24	87	4
L2TRH2472	899	1084	1221	29	29.5	72	24	94	4
L2TRH2478	930	1126	1272	29	29.5	78	24	99	6
L2TRH2484	959	1170	1327	29	29.5	84	24	100	6
L2TRH3054	871	1047	1169	29	29.5	54	30	95	4
L2TRH3060	908	1098	1232	29	29.5	60	30	102	7
L2TRH3066	943	1151	1294	29	29.5	66	30	112	8
L2TRH3072	977	1201	1357	29	29.5	72	30	132	9
L2TRH3078	1013	1254	1421	29	29.5	78	30	142	9
L2TRH3084	1051	1305	1485	29	29.5	84	30	145	10
L2TRH3654	935	1140	1284	29	29.5	54	36	145	4
L2TRH3660	975	1199	1353	29	29.5	60	36	151	7
L2TRH3666	1005	1251	1416	29	29.5	66	36	154	8
L2TRH3672	1047	1309	1485	29	29.5	72	36	156	9
L2TRH3678	1085	1366	1559	29	29.5	78	36	161	9
L2TRH3684	1124	1427	1632	29	29.5	84	36	172	10

L2TA • Axe Shaped Top with T-Base & Leg

• Add \$118 to list price for chrome leg option.

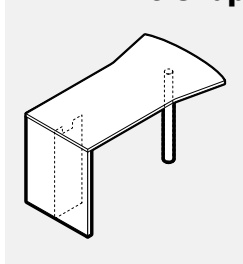

PRODUCT CODE	FINISH LP	B	W	SIZE/INCHES			D	WEIGHT LBS	VOL FT ³
				H(LP/B)	H(W)	W			
L2TA3060	996	1252	1427	29	29.50	60	42	131	10
L2TA3066	1032	1309	1497	29	29.50	66	42	140	11
L2TA3072	1064	1364	1569	29	29.50	72	42	149	12
L2TA3078	1099	1420	1639	29	29.50	78	42	157	12
L2TA3084	1134	1476	1711	29	29.50	84	42	166	13
L2TA3672	1140	1481	1706	29	29.50	72	48	153	13
L2TA3678	1179	1544	1786	29	29.50	78	48	163	14
L2TA3684	1221	1607	1866	29	29.50	84	48	173	15

L2TAH • Axe Shaped Top with Half Modesty & Leg

• Add \$118 to list price for chrome leg option.

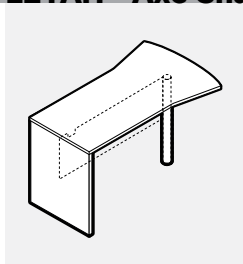

PRODUCT CODE	FINISH LP	B	W	SIZE/INCHES			D	WEIGHT LBS	VOL FT ³
				H(LP/B)	H(W)	W			
L2TAH3060	1005	1261	1438	29	29.50	60	42	127	10
L2TAH3066	1051	1327	1517	29	29.50	66	42	135	11
L2TAH3072	1093	1393	1598	29	29.50	72	42	144	12
L2TAH3078	1136	1460	1680	29	29.50	78	42	153	12
L2TAH3084	1179	1527	1759	29	29.50	84	42	162	13
L2TAH3672	1162	1498	1725	29	29.50	72	48	149	13
L2TAH3678	1207	1573	1815	29	29.50	78	48	158	14
L2TAH3684	1256	1648	1903	29	29.50	84	48	168	15

L2TP-L • P-Shaped Top Left with T-Base & Leg

• Add \$118 to list price for chrome leg option.

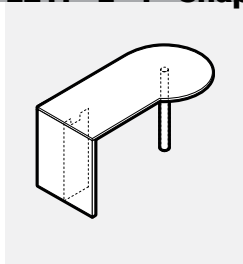

PRODUCT CODE	FINISH LP	B	W	SIZE/INCHES			D	WEIGHT LBS	VOL FT ³
				H(LP/B)	H(W)	W			
L2TP3060L	948	1170	1329	29	29.50	60	36	121	9
L2TP3066L	978	1223	1392	29	29.50	66	36	135	9
L2TP3072L	1010	1268	1454	29	29.50	72	36	150	10
L2TP3078L	1038	1320	1516	29	29.50	78	36	164	11
L2TP3084L	1070	1370	1580	29	29.50	84	36	178	12
L2TP3672L	1086	1387	1591	29	29.50	72	42	188	12
L2TP3678L	1122	1442	1663	29	29.50	78	42	202	12
L2TP3684L	1158	1502	1733	29	29.50	84	42	217	13

L2TP-R • P-Shaped Top Right with T-Base & Leg

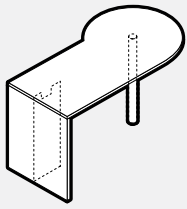

• Add \$118 to list price for chrome leg option.

PRODUCT CODE	FINISH LP	B	W	SIZE / INCHES				WEIGHT		VOL FT ³
				H (LP/B)	H (W)	W	D	LBS		
L2TP3060R	948	1170	1329	29	29.50	60	36	121	9	
L2TP3066R	978	1223	1392	29	29.50	66	36	135	9	
L2TP3072R	1010	1268	1454	29	29.50	72	36	150	10	
L2TP3078R	1038	1320	1516	29	29.50	78	36	164	11	
L2TP3084R	1070	1370	1580	29	29.50	84	36	178	12	
L2TP3672R	1086	1387	1591	29	29.50	72	42	188	12	
L2TP3678R	1122	1442	1663	29	29.50	78	42	202	12	
L2TP3684R	1158	1502	1733	29	29.50	84	42	217	13	

L2TPH-L • P-Shaped Top Left with Half Modesty & Leg

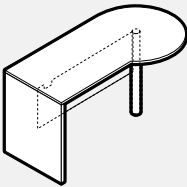

• Add \$118 to list price for chrome leg option.

PRODUCT CODE	FINISH LP	B	W	SIZE / INCHES				WEIGHT		VOL FT ³
				H (LP/B)	H (W)	W	D	LBS		
L2TPH3060L	958	1181	1338	29	29.50	60	36	117	9	
L2TPH3066L	997	1238	1412	29	29.50	66	36	131	9	
L2TPH3072L	1036	1299	1482	29	29.50	72	36	145	10	
L2TPH3078L	1076	1357	1555	29	29.50	78	36	160	11	
L2TPH3084L	1118	1417	1626	29	29.50	84	36	174	12	
L2TPH3672L	1104	1406	1608	29	29.50	72	42	184	12	
L2TPH3678L	1147	1472	1692	29	29.50	78	42	198	12	
L2TPH3684L	1191	1539	1773	29	29.50	84	42	212	13	

L2TPH-R • P-Shaped Top Right with Half Modesty & Leg

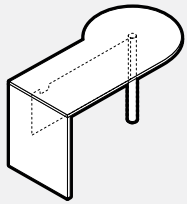

• Add \$118 to list price for chrome leg option.

PRODUCT CODE	FINISH LP	B	W	SIZE / INCHES				WEIGHT		VOL FT ³
				H (LP/B)	H (W)	W	D	LBS		
L2TPH3060R	958	1181	1338	29	29.50	60	36	117	9	
L2TPH3066R	997	1238	1412	29	29.50	66	36	131	9	
L2TPH3072R	1036	1299	1482	29	29.50	72	36	145	10	
L2TPH3078R	1076	1357	1555	29	29.50	78	36	160	11	
L2TPH3084R	1118	1417	1626	29	29.50	84	36	174	12	
L2TPH3672R	1104	1406	1608	29	29.50	72	42	184	12	
L2TPH3678R	1147	1472	1692	29	29.50	78	42	198	12	
L2TPH3684R	1191	1539	1773	29	29.50	84	42	212	13	

L2TH-L • Hockey Shaped Top Left with T-Base & Leg

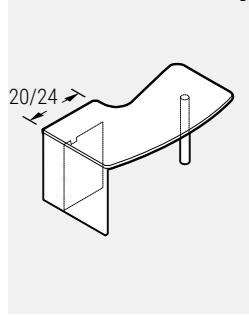

• Add \$118 to list price for chrome leg option.

PRODUCT CODE	FINISH LP	B	W	SIZE/INCHES			D	WEIGHT LBS	VOL FT ³
				H(LP/B)	H(W)	W			
For 20" Return Connection									
L2TH203060L	988	1218	1388	29	29.50	60	36	121	9
L2TH203066L	1020	1264	1452	29	29.50	66	36	135	9
L2TH203072L	1051	1316	1515	29	29.50	72	36	150	10
L2TH203078L	1080	1365	1580	29	29.50	78	36	164	11
L2TH203084L	1110	1417	1641	29	29.50	84	36	178	12
L2TH203660L	1057	1318	1511	29	29.50	60	42	188	10
L2TH203666L	1093	1376	1584	29	29.50	66	42	202	11
L2TH203672L	1131	1433	1656	29	29.50	72	42	217	12
L2TH203678L	1164	1494	1728	29	29.50	78	42	220	12
L2TH203684L	1198	1552	1802	29	29.50	84	42	237	13
For 24" Return Connection									
L2TH3060L	988	1218	1388	29	29.50	60	36	121	9
L2TH3066L	1020	1264	1452	29	29.50	66	36	135	9
L2TH3072L	1051	1316	1515	29	29.50	72	36	150	10
L2TH3078L	1080	1365	1580	29	29.50	78	36	164	11
L2TH3084L	1110	1417	1641	29	29.50	84	36	178	12
L2TH3660L	1057	1318	1511	29	29.50	60	42	188	10
L2TH3666L	1093	1376	1584	29	29.50	66	42	202	11
L2TH3672L	1131	1433	1656	29	29.50	72	42	217	12
L2TH3678L	1164	1494	1728	29	29.50	78	42	220	12
L2TH3684L	1198	1552	1802	29	29.50	84	42	237	13

L2TH-R • Hockey Shaped Top Right with T-Base & Leg

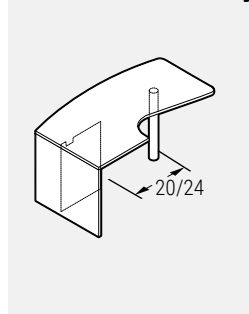

• Add \$118 to list price for chrome leg option.

PRODUCT CODE	FINISH LP	B	W	SIZE/INCHES			D	WEIGHT LBS	VOL FT ³
				H(LP/B)	H(W)	W			
For 20" Return Connection									
L2TH203060R	988	1218	1388	29	29.50	60	36	121	9
L2TH203066R	1020	1264	1452	29	29.50	66	36	135	9
L2TH203072R	1051	1316	1515	29	29.50	72	36	150	10
L2TH203078R	1080	1365	1580	29	29.50	78	36	164	11
L2TH203084R	1110	1417	1641	29	29.50	84	36	178	12
L2TH203660R	1057	1318	1511	29	29.50	60	42	188	10
L2TH203666R	1093	1376	1584	29	29.50	66	42	202	11
L2TH203672R	1131	1433	1656	29	29.50	72	42	217	12
L2TH203678R	1164	1494	1728	29	29.50	78	42	220	12
L2TH203684R	1198	1552	1802	29	29.50	84	42	237	13
For 24" Return Connection									
L2TH3060R	988	1218	1388	29	29.50	60	36	121	9
L2TH3066R	1020	1264	1452	29	29.50	66	36	135	9
L2TH3072R	1051	1316	1515	29	29.50	72	36	150	10
L2TH3078R	1080	1365	1580	29	29.50	78	36	164	11
L2TH3084R	1110	1417	1641	29	29.50	84	36	178	12
L2TH3660R	1057	1318	1511	29	29.50	60	42	188	10
L2TH3666R	1093	1376	1584	29	29.50	66	42	202	11
L2TH3672R	1131	1433	1656	29	29.50	72	42	217	12
L2TH3678R	1164	1494	1728	29	29.50	78	42	220	12
L2TH3684R	1198	1552	1802	29	29.50	84	42	237	13

L2THH-L • Hockey Shaped Top Left with Half Modesty & Leg

• Add \$118 to list price for chrome leg option.

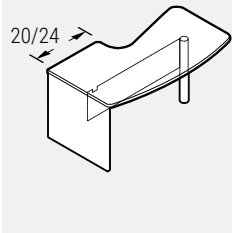

PRODUCT CODE	FINISH LP	B	W	SIZE / INCHES				WEIGHT LBS	VOL FT ³
				H (LP/B)	H (W)	W	D		
For 20" Return Connection									
L2THH203060L	997	1225	1396	29	29.50	60	36	117	9
L2THH203066L	1036	1286	1472	29	29.50	66	36	131	9
L2THH203072L	1077	1348	1544	29	29.50	72	36	145	10
L2THH203078L	1119	1406	1619	29	29.50	78	36	160	11
L2THH203084L	1161	1467	1692	29	29.50	84	36	174	12
L2THH203660L	1058	1318	1511	29	29.50	60	42	184	10
L2THH203666L	1102	1387	1592	29	29.50	66	42	198	11
L2THH203672L	1147	1454	1674	29	29.50	72	42	212	12
L2THH203678L	1195	1522	1759	29	29.50	78	42	220	12
L2THH203684L	1235	1591	1840	29	29.50	84	42	237	13
For 24" Return Connection									
L2THH3060L	997	1225	1396	29	29.50	60	36	117	9
L2THH3066L	1036	1286	1472	29	29.50	66	36	131	9
L2THH3072L	1077	1348	1544	29	29.50	72	36	145	10
L2THH3078L	1119	1406	1619	29	29.50	78	36	160	11
L2THH3084L	1161	1467	1692	29	29.50	84	36	174	12
L2THH3660L	1058	1318	1511	29	29.50	60	42	184	10
L2THH3666L	1102	1387	1592	29	29.50	66	42	198	11
L2THH3672L	1147	1454	1674	29	29.50	72	42	212	12
L2THH3678L	1195	1522	1759	29	29.50	78	42	220	12
L2THH3684L	1235	1591	1840	29	29.50	84	42	237	13

L2THH-R • Hockey Shaped Top Right with Half Modesty & Leg

• Add \$118 to list price for chrome leg option.

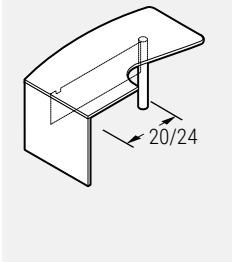

PRODUCT CODE	FINISH LP	B	W	SIZE / INCHES				WEIGHT LBS	VOL FT ³
				H (LP/B)	H (W)	W	D		
For 20" Return Connection									
L2THH203060R	997	1225	1396	29	29.50	60	36	117	9
L2THH203066R	1036	1286	1472	29	29.50	66	36	131	9
L2THH203072R	1077	1348	1544	29	29.50	72	36	145	10
L2THH203078R	1119	1406	1619	29	29.50	78	36	160	11
L2THH203084R	1161	1467	1692	29	29.50	84	36	174	12
L2THH203660R	1058	1318	1511	29	29.50	60	42	184	10
L2THH203666R	1102	1387	1592	29	29.50	66	42	198	11
L2THH203672R	1147	1454	1674	29	29.50	72	42	212	12
L2THH203678R	1195	1522	1759	29	29.50	78	42	220	12
L2THH203684R	1235	1591	1840	29	29.50	84	42	237	13
For 24" Return Connection									
L2THH3060R	997	1225	1396	29	29.50	60	36	117	9
L2THH3066R	1036	1286	1472	29	29.50	66	36	131	9
L2THH3072R	1077	1348	1544	29	29.50	72	36	145	10
L2THH3078R	1119	1406	1619	29	29.50	78	36	160	11
L2THH3084R	1161	1467	1692	29	29.50	84	36	174	12
L2THH3660R	1058	1318	1511	29	29.50	60	42	184	10
L2THH3666R	1102	1387	1592	29	29.50	66	42	198	11
L2THH3672R	1147	1454	1674	29	29.50	72	42	212	12
L2THH3678R	1195	1522	1759	29	29.50	78	42	220	12
L2THH3684R	1235	1591	1840	29	29.50	84	42	237	13

L2TEDH-L • Extended “D” with Half Modesty & Leg

• Add \$118 to list price for chrome leg option.

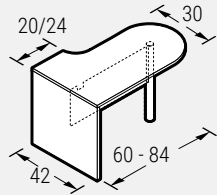

PRODUCT CODE	FINISH LP	B	W	SIZE/INCHES			D	WEIGHT LBS	VOL FT ³
				H(LP/B)	H(W)	W			
For 20" Return Connection									
L2TEDH603020L	1082	1288	1475	29	29.50	60	42	110	8
L2TEDH663020L	1126	1353	1555	29	29.50	66	42	121	9
L2TEDH723020L	1170	1418	1635	29	29.50	72	42	132	10
L2TEDH783020L	1220	1484	1715	29	29.50	78	42	143	11
L2TEDH843020L	1261	1552	1794	29	29.50	84	42	154	12
For 24" Return Connection									
L2TEDH603024L	1082	1288	1475	29	29.50	60	42	110	8
L2TEDH663024L	1126	1353	1555	29	29.50	66	42	121	9
L2TEDH723024L	1170	1418	1635	29	29.50	72	42	132	10
L2TEDH783024L	1220	1484	1715	29	29.50	78	42	143	11
L2TEDH843024L	1261	1552	1794	29	29.50	84	42	154	12

L2TED-L • Extended “D” with T-Base & Leg

• Add \$118 to list price for chrome leg option.

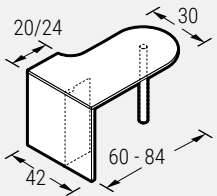

PRODUCT CODE	FINISH LP	B	W	SIZE/INCHES			D	WEIGHT LBS	VOL FT ³
				H(LP/B)	H(W)	W			
For 20" Return Connection									
L2TED603020L	1070	1263	1448	29	29.50	60	42	110	8
L2TED663020L	1106	1318	1517	29	29.50	66	42	121	9
L2TED723020L	1140	1375	1587	29	29.50	72	42	132	10
L2TED783020L	1175	1430	1658	29	29.50	78	42	143	11
L2TED843020L	1210	1484	1727	29	29.50	84	42	154	12
For 24" Return Connection									
L2TED603024L	1070	1263	1448	29	29.50	60	42	110	8
L2TED663024L	1106	1318	1517	29	29.50	66	42	121	9
L2TED723024L	1140	1375	1587	29	29.50	72	42	132	10
L2TED783024L	1175	1430	1658	29	29.50	78	42	143	11
L2TED843024L	1210	1484	1727	29	29.50	84	42	154	12

L2TEDH-R • Extended “D” with Half Modesty & Leg

• Add \$118 to list price for chrome leg option.

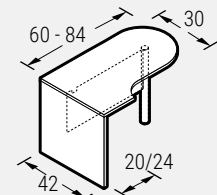

PRODUCT CODE	FINISH LP	B	W	SIZE/INCHES			D	WEIGHT LBS	VOL FT ³
				H(LP/B)	H(W)	W			
For 20" Return Connection									
L2TEDH603020R	1082	1288	1475	29	29.50	60	42	110	8
L2TEDH663020R	1126	1353	1555	29	29.50	66	42	121	9
L2TEDH723020R	1170	1418	1635	29	29.50	72	42	132	10
L2TEDH783020R	1220	1484	1715	29	29.50	78	42	143	11
L2TEDH843020R	1261	1552	1794	29	29.50	84	42	154	12
For 24" Return Connection									
L2TEDH603024R	1082	1288	1475	29	29.50	60	42	110	8
L2TEDH663024R	1126	1353	1555	29	29.50	66	42	121	9
L2TEDH723024R	1170	1418	1635	29	29.50	72	42	132	10
L2TEDH783024R	1220	1484	1715	29	29.50	78	42	143	11
L2TEDH843024R	1261	1552	1794	29	29.50	84	42	154	12

L2TED-R • Extended “D” with T-Base & Leg

• Add \$118 to list price for chrome leg option.

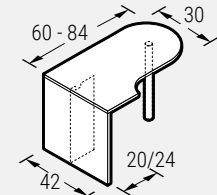

PRODUCT CODE	FINISH LP	B	W	SIZE/INCHES			D	WEIGHT LBS	VOL FT ³
				H(LP/B)	H(W)	W			
For 20" Return Connection									
L2TED603020R	1070	1263	1448	29	29.50	60	42	110	8
L2TED663020R	1106	1318	1517	29	29.50	66	42	121	9
L2TED723020R	1140	1375	1587	29	29.50	72	42	132	10
L2TED783020R	1175	1430	1658	29	29.50	78	42	143	11
L2TED843020R	1210	1484	1727	29	29.50	84	42	154	12
For 24" Return Connection									
L2TED603024R	1070	1263	1448	29	29.50	60	42	110	8
L2TED663024R	1106	1318	1517	29	29.50	66	42	121	9
L2TED723024R	1140	1375	1587	29	29.50	72	42	132	10
L2TED783024R	1175	1430	1658	29	29.50	78	42	143	11
L2TED843024R	1210	1484	1727	29	29.50	84	42	154	12

L2TROL • Licence 2 Top with “O” Leg and T base

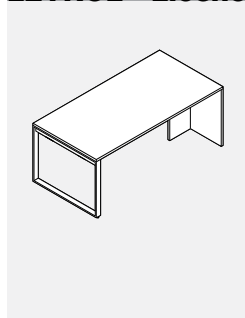

- Includes worksurface, loop leg and laminate T base.
- BG5 grommet please specify TC only.
- Loop leg is painted please specify standard paint colour.

PRODUCT CODE	FINISH				W	WEIGHT		VOL FT ³
	LP	B	W	D		LBS		
L2TROL2442	889	953	1041	24	42	138	5	
L2TROL2448	927	1005	1086	24	48	153	5	
L2TROL2454	969	1057	1132	24	54	168	6	
L2TROL2460	1003	1102	1176	24	60	183	6	
L2TROL2466	1016	1121	1221	24	66	198	6	
L2TROL2472	1031	1140	1266	24	72	213	7	
L2TROL2478	1056	1169	1307	24	78	228	7	
L2TROL2484	1085	1205	1351	24	84	243	7	
L2TROL3042	1041	1124	1200	30	42	168	7	
L2TROL3048	1056	1143	1210	30	48	187	7	
L2TROL3054	1081	1168	1307	30	54	206	8	
L2TROL3060	1102	1207	1363	30	60	225	8	
L2TROL3066	1114	1225	1417	30	66	243	8	
L2TROL3072	1136	1251	1470	30	72	262	9	
L2TROL3078	1159	1277	1522	30	78	281	9	
L2TROL3084	1201	1331	1579	30	84	300	10	
L2TROL3642	1143	1223	1351	36	42	200	7	
L2TROL3648	1186	1274	1418	36	48	222	8	
L2TROL3654	1225	1327	1484	36	54	245	8	
L2TROL3660	1268	1378	1554	36	60	267	9	
L2TROL3666	1310	1431	1620	36	66	290	9	
L2TROL3672	1351	1482	1687	36	72	312	10	
L2TROL3678	1392	1533	1753	36	78	335	10	
L2TROL3684	1433	1586	1821	36	84	357	11	

L2TCROL • Licence 2 Return with “O” Leg

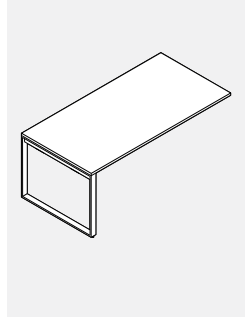

- Includes worksurface, loop leg and connecting brackets and connecting flat brackets
- HAT channel is standard on all tops except 42 and 48 wide
- BG5 grommet please specify TL,TC,TR
- Loop leg is painted please specify standard paint colour
- Worksurface supporting pedestals and laterals will not fit due to the metal channel under the surface.

PRODUCT CODE	FINISH				W	WEIGHT		VOL FT ³
	LP	B	W	D		LBS		
L2TCROL2442	662	726	816	24	42	110	4	
L2TCROL2448	701	779	860	24	48	125	5	
L2TCROL2454	804	892	967	24	54	140	5	
L2TCROL2460	845	947	1021	24	60	155	5	
L2TCROL2466	868	972	1071	24	66	170	6	
L2TCROL2472	891	1000	1126	24	72	185	6	
L2TCROL2478	924	1037	1176	24	78	200	6	
L2TCROL2484	959	1082	1227	24	84	215	7	
L2TCROL3042	790	872	949	30	42	137	6	
L2TCROL3048	804	892	959	30	48	156	6	
L2TCROL3054	891	978	1119	30	54	175	7	
L2TCROL3060	922	1026	1181	30	60	194	7	
L2TCROL3066	942	1054	1243	30	66	212	8	
L2TCROL3072	971	1086	1305	30	72	231	8	
L2TCROL3078	1003	1121	1366	30	78	250	8	
L2TCROL3084	1054	1183	1428	30	84	269	9	
L2TCROL3642	892	971	1099	36	42	164	7	
L2TCROL3648	934	1024	1166	36	48	186	7	
L2TCROL3654	1035	1136	1294	36	54	209	8	
L2TCROL3660	1088	1198	1371	36	60	231	8	
L2TCROL3666	1137	1260	1448	36	66	254	9	
L2TCROL3672	1187	1317	1522	36	72	276	9	
L2TCROL3678	1235	1376	1597	36	78	299	10	
L2TCROL3684	1286	1438	1671	36	84	321	10	

L2TDOL • Licence 2 Top with Two "O" Legs

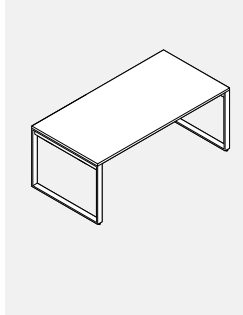

- Includes worksurface, 2 loop legs
- HAT channel is standard on all tops except 42 and 48 wide
- BG5 grommet please specify TL,TC,TR
- Loop leg is painted please specify standard paint colour
- Worksurface supporting pedestals and laterals will not fit due to the metal channel under the surface.

PRODUCT CODE	FINISH					WEIGHT		VOL FT ³
	LP	B	W	D	W	LBS		
L2TDOL2442	1055	1119	1207	24	42	115	6	
L2TDOL2448	1093	1170	1252	24	48	130	7	
L2TDOL2454	1197	1285	1357	24	54	145	7	
L2TDOL2460	1238	1338	1414	24	60	160	7	
L2TDOL2466	1261	1365	1464	24	66	175	8	
L2TDOL2472	1284	1393	1520	24	72	190	8	
L2TDOL2478	1316	1430	1568	24	78	205	8	
L2TDOL2484	1353	1473	1619	24	84	220	9	
L2TDOL3042	1243	1328	1401	30	42	143	9	
L2TDOL3048	1258	1345	1415	30	48	162	9	
L2TDOL3054	1343	1431	1570	30	54	181	10	
L2TDOL3060	1374	1480	1634	30	60	200	10	
L2TDOL3066	1394	1505	1696	30	66	218	11	
L2TDOL3072	1426	1539	1758	30	72	237	11	
L2TDOL3078	1455	1573	1819	30	78	256	11	
L2TDOL3084	1505	1635	1880	30	84	275	12	
L2TDOL3642	1392	1471	1598	36	42	170	10	
L2TDOL3648	1432	1522	1667	36	48	192	10	
L2TDOL3654	1535	1635	1794	36	54	215	11	
L2TDOL3660	1586	1696	1871	36	60	237	11	
L2TDOL3666	1637	1758	1947	36	66	260	12	
L2TDOL3672	1685	1816	2022	36	72	282	12	
L2TDOL3678	1734	1877	2096	36	78	305	13	
L2TDOL3684	1785	1936	2170	36	84	327	13	

Technical Information

- All units must be connected to an adjoining unit with flat brackets included.
 - Grommet option for Runoff tables are "TC" only.
- NOTE: All Runoff tables includes HAT CHANNEL support.

OPTIONS:

- Top: LP - LPL (Low Pressure Laminate) Thickness 1"
 HP B - B Thickness 1 1/16"
 HP W - W Thickness 1 7/16"
- Leg Option: BHML03 (DEFAULT) Round Monoleg
 LLSQ3X3H28 - Square Leg
- Top Finish Laminate: Choose Colour
- Top PVC Edging: Choose Colour
- Metal Leg Finish: Choose Colour

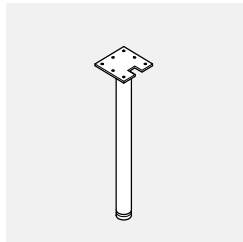

BHML03

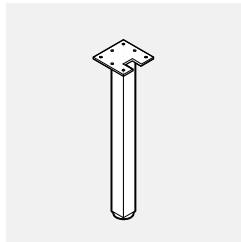

LLSQ3X3H28

L2TCD • "D" Shaped Runoff with Leg

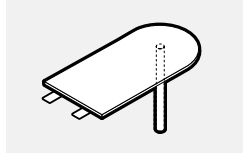

- Add \$118 to list price for chrome leg option.

PRODUCT CODE	FINISH			SIZE/INCHES				WEIGHT		VOL FT ³
	LP	B	W	H (LP/B)	H (W)	W	D	LBS		
L2TCD3060	713	895	947	29	29.5	60	30	97	4	
L2TCD3066	757	956	1021	29	29.5	66	30	106	6	
L2TCD3660	777	992	1069	29	29.5	60	36	97	4	
L2TCD3666	811	1047	1133	29	29.5	66	36	106	6	

L2TCR1L • Rectangular Shaped Runoff

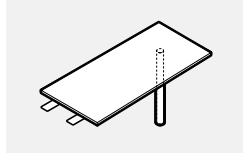

- Add \$118 to list price for chrome leg option.

PRODUCT CODE	FINISH			SIZE/INCHES				WEIGHT		VOL FT ³
	LP	B	W	H (LP/B)	H (W)	W	D	LBS		
L2TCR1L3060	690	862	919	29	29.5	60	30	97	4	
L2TCR1L3066	718	908	969	29	29.5	66	30	106	6	
L2TCR1L3660	736	942	1013	29	29.5	60	36	97	4	
L2TCR1L3666	769	993	1074	29	29.5	66	36	106	6	

L2TCA1L • Axe Shaped Runoff

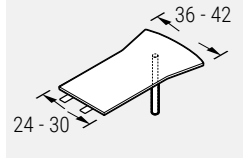

- Add \$118 to list price for chrome leg option.

PRODUCT CODE	FINISH			SIZE/INCHES				WEIGHT		VOL FT ³
	LP	B	W	H (LP/B)	H (W)	W	D	LBS		
L2TCA1L2460	739	944	1022	29	29.5	60	36	119	4	
L2TCA1L2466	773	996	1081	29	29.5	66	36	130	6	
L2TCA1L3060	785	1020	1114	29	29.5	60	42	119	4	
L2TCA1L3066	824	1077	1181	29	29.5	66	42	130	6	

L2TCP • "P" Shaped Runoff with Leg

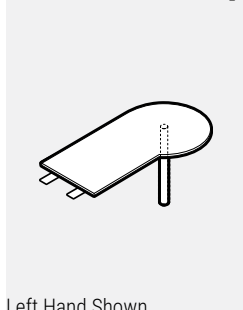

- Add \$118 to list price for chrome leg option.

PRODUCT CODE	FINISH			SIZE/INCHES				WEIGHT		VOL FT ³
	LP	B	W	H (LP/B)	H (W)	W	D	LBS		
Right										
L2TCP3060R	774	988	1069	29	29.5	60	36	119	4	
L2TCP3066R	809	1043	1133	29	29.5	66	36	130	6	
L2TCP3660R	826	1071	1169	29	29.5	60	42	119	4	
L2TCP3666R	866	1134	1239	29	29.5	66	42	130	6	
Left										
L2TCP3060L	774	988	1069	29	29.5	60	36	119	4	
L2TCP3066L	809	1043	1133	29	29.5	66	36	130	6	
L2TCP3660L	826	1071	1169	29	29.5	60	42	119	4	
L2TCP3666L	866	1134	1239	29	29.5	66	42	130	6	

Left Hand Shown

L2TCW • Wedge Shaped Runoff with Leg

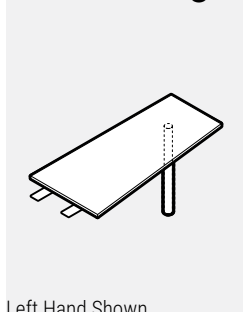

- Add \$118 to list price for chrome leg option.

PRODUCT CODE	FINISH			SIZE/INCHES				WEIGHT		VOL FT ³
	LP	B	W	H (LP/B)	H (W)	W	D	LBS		
Right										
L2TCW3060R	733	915	982	29	29.5	60	30	119	4	
L2TCW3066R	765	965	1034	29	29.5	66	30	130	6	
L2TCW3660R	785	999	1084	29	29.5	60	36	119	4	
L2TCW3666R	820	1055	1143	29	29.5	66	36	130	6	
Left										
L2TCW3060L	733	915	982	29	29.5	60	30	119	4	
L2TCW3066L	765	965	1034	29	29.5	66	30	130	6	
L2TCW3660L	785	999	1084	29	29.5	60	36	119	4	
L2TCW3666L	820	1055	1143	29	29.5	66	36	130	6	

Left Hand Shown

Floating Tops

- Monolegs and Support channel ships in a separate box.
- Floating tops are not pre-drilled to accept monolegs or spacers.
- Grommet locations (TC only) must be specified at the time of order or it will default to "No Grommet" option.
- Floating top must be placed on top of 1H credenza or 1H lateral open.
- Grommet Option **TC** only
- All Floating tables include HAT CHANNEL support.

LLSQ3X3 • "Spacer" Leg

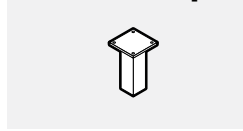

PRODUCT CODE	PRICE	CHROME OPT	SIZE/INCHES			WEIGHT LBS	VOL FT ³
			H	W	D		
LLSQ3X3	135	230	8	3	3	4	0.09

LLSQ3X3H28 • Square Leg

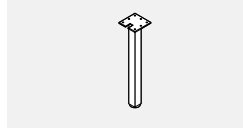

PRODUCT CODE	PRICE	CHROME OPT	SIZE/INCHES			WEIGHT LBS	VOL FT ³
			H	W	D		
LLSQ3X3H28	255	338	28	3	3	4	0.17

L2FD • Floating "D" Shaped with Legs and Spacers

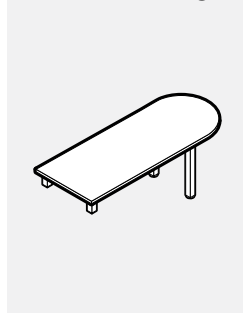

- Add \$469 to list price for chrome leg option.

PRODUCT CODE	FINISH			SIZE/INCHES				WEIGHT LBS	VOL FT ³
	LP	B	W	H(LP/B)	H(W)	W	D		
L2FD3060	941	1133	1151	29	29.5	60	30	53	7
L2FD3066	971	1179	1201	29	29.5	66	30	57	7
L2FD3072	1003	1227	1254	29	29.5	72	30	62	8
L2FD3078	1036	1282	1305	29	29.5	78	30	64	8
L2FD3084	1082	1341	1355	29	29.5	84	30	68	9
L2FD3660	987	1235	1328	29	29.5	60	36	57	8
L2FD3666	1022	1291	1393	29	29.5	66	36	63	8
L2FD3672	1057	1350	1455	29	29.5	72	36	68	9
L2FD3678	1098	1412	1520	29	29.5	78	36	70	9
L2FD3684	1143	1480	1585	29	29.5	84	36	75	10

L2FR • Floating Rectangular Shaped with Legs and Spacers

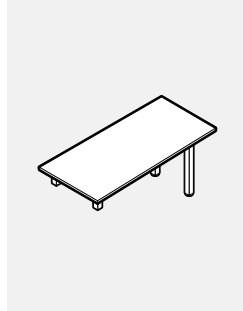

- Add \$469 to list price for chrome leg option.

PRODUCT CODE	FINISH			SIZE/INCHES				WEIGHT LBS	VOL FT ³
	LP	B	W	H(LP/B)	H(W)	W	D		
L2FR2460	890	1051	1076	29	29.5	60	24	51	6
L2FR2466	916	1092	1120	29	29.5	66	24	55	6
L2FR2472	945	1133	1164	29	29.5	72	24	59	7
L2FR2478	975	1175	1205	29	29.5	78	24	62	7
L2FR2484	1015	1228	1252	29	29.5	84	24	66	8
L2FR3060	935	1131	1173	29	29.5	60	30	53	7
L2FR3066	969	1175	1225	29	29.5	66	30	57	7
L2FR3072	1000	1225	1280	29	29.5	72	30	62	8
L2FR3078	1035	1279	1329	29	29.5	78	30	64	8
L2FR3084	1077	1335	1383	29	29.5	84	30	68	9
L2FR3660	983	1205	1297	29	29.5	60	36	57	8
L2FR3666	1020	1262	1357	29	29.5	66	36	63	8
L2FR3672	1056	1318	1421	29	29.5	72	36	68	9
L2FR3678	1095	1376	1484	29	29.5	78	36	70	9
L2FR3684	1141	1444	1548	29	29.5	84	36	75	10

L2FA • Floating Axe Shaped with Legs and Spacers

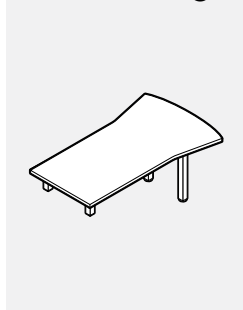

- Add \$469 to list price for chrome leg option.

PRODUCT CODE	FINISH			SIZE/INCHES				WEIGHT LBS	VOL FT ³
	LP	B	W	H(LP/B)	H(W)	W	D		
L2FA3060	1036	1293	1378	29	29.5	60	42	77	8
L2FA3066	1077	1356	1448	29	29.5	66	42	81	8
L2FA3072	1119	1420	1518	29	29.5	72	42	84	9
L2FA3078	1163	1485	1587	29	29.5	78	42	88	9
L2FA3084	1217	1560	1658	29	29.5	84	42	95	10
L2FA3660	1106	1394	1507	29	29.5	60	48	83	9
L2FA3666	1148	1464	1586	29	29.5	66	48	88	9
L2FA3672	1196	1535	1667	29	29.5	72	48	90	10
L2FA3678	1239	1608	1746	29	29.5	78	48	95	11
L2FA3684	1297	1690	1821	29	29.5	84	48	101	11

L2FP • Floating “P” Shaped with Legs and Spacers

• Add \$469 to list price for chrome leg option.

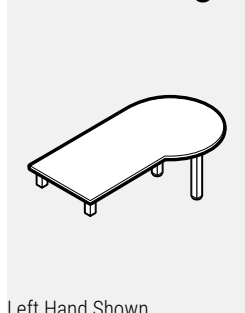

Left Hand Shown

PRODUCT CODE	FINISH LP	B	W	SIZE/INCHES				WEIGHT LBS	VOL FT ³
				H(LP/B)	H(W)	W	D		
Right									
L2FP3060R	1004	1228	1301	29	29.5	60	36	66	8
L2FP3066R	1038	1286	1364	29	29.5	66	36	70	8
L2FP3072R	1076	1341	1426	29	29.5	72	36	75	9
L2FP3078R	1115	1399	1484	29	29.5	78	36	77	9
L2FP3084R	1163	1467	1546	29	29.5	84	36	81	10
L2FP3660R	1055	1312	1401	29	29.5	60	42	70	9
L2FP3666R	1093	1374	1472	29	29.5	66	42	76	9
L2FP3672R	1134	1438	1542	29	29.5	72	42	81	10
L2FP3678R	1177	1503	1612	29	29.5	78	42	84	11
L2FP3684R	1228	1579	1684	29	29.5	84	42	88	11
Left									
L2FP3060L	1004	1228	1301	29	29.5	60	36	66	8
L2FP3066L	1038	1286	1364	29	29.5	66	36	70	8
L2FP3072L	1076	1341	1426	29	29.5	72	36	75	9
L2FP3078L	1115	1399	1484	29	29.5	78	36	77	9
L2FP3084L	1163	1467	1546	29	29.5	84	36	81	10
L2FP3660L	1055	1312	1401	29	29.5	60	42	70	9
L2FP3666L	1093	1374	1472	29	29.5	66	42	76	9
L2FP3672L	1134	1438	1542	29	29.5	72	42	81	10
L2FP3678L	1177	1503	1612	29	29.5	78	42	84	11
L2FP3684L	1228	1579	1684	29	29.5	84	42	88	11

L2FW • Floating Wedge Shaped with Legs and Spacers

• Add \$469 to list price for chrome leg option.

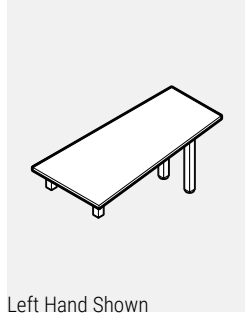

Left Hand Shown

PRODUCT CODE	FINISH LP	B	W	SIZE/INCHES				WEIGHT LBS	VOL FT ³
				H(LP/B)	H(W)	W	D		
Right									
L2FW3060R	941	1133	1175	29	29.5	60	30	53	7
L2FW3066R	971	1179	1229	29	29.5	66	30	57	7
L2FW3072R	1003	1227	1284	29	29.5	72	30	62	8
L2FW3078R	1036	1282	1334	29	29.5	78	30	64	8
L2FW3084R	1082	1341	1387	29	29.5	84	30	68	9
L2FW3660R	983	1205	1268	29	29.5	60	36	57	8
L2FW3666R	1020	1262	1329	29	29.5	66	36	63	8
L2FW3672R	1056	1318	1392	29	29.5	72	36	68	9
L2FW3678R	1095	1376	1453	29	29.5	78	36	70	9
L2FW3684R	1141	1444	1515	29	29.5	84	36	75	10
Left									
L2FW3060L	941	1133	1175	29	29.5	60	30	53	7
L2FW3066L	971	1179	1229	29	29.5	66	30	57	7
L2FW3072L	1003	1227	1284	29	29.5	72	30	62	8
L2FW3078L	1036	1282	1334	29	29.5	78	30	64	8
L2FW3084L	1082	1341	1387	29	29.5	84	30	68	9
L2FW3660L	983	1205	1268	29	29.5	60	36	57	8
L2FW3666L	1020	1262	1329	29	29.5	66	36	63	8
L2FW3672L	1056	1318	1392	29	29.5	72	36	68	9
L2FW3678L	1095	1376	1453	29	29.5	78	36	70	9
L2FW3684L	1141	1444	1515	29	29.5	84	36	75	10

L2FBR • Floating top Rectangular with Legs / SPACERS SOLD SEPARATELY

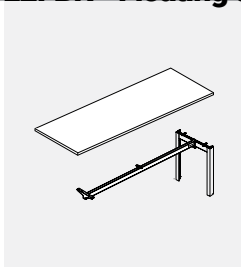

- Anodized aluminum leg upcharge \$55.
- Due to beam location, grommet is only available as a special request, please contact your customer service representative.
- Worksurface supporting pedestals and laterals will not fit due to the metal channel under the surface.

PRODUCT CODE	FINISH LP	B	W	SIZE / INCHES			D	WEIGHT LBS	VOL FT ³
				H (LP/B)	H (W)	W			
L2FBR2466	828	953	1052	1	1.44	66	24	51	6
L2FBR2472	854	987	1095	1	1.44	72	24	55	6
L2FBR2478	888	1032	1147	1	1.44	78	24	59	7
L2FBR2484	926	1081	1203	1	1.44	84	24	62	7
L2FBR3066	895	1049	1166	1	1.44	66	30	53	8
L2FBR3072	924	1092	1220	1	1.44	72	30	57	8
L2FBR3078	963	1141	1280	1	1.44	78	30	62	9
L2FBR3084	1004	1199	1345	1	1.44	84	30	64	9

L2SPBOX • Laminate Spacers with Glass Shelf

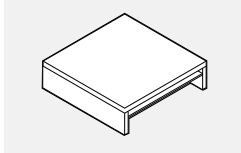

- Glazing is clear.

PRODUCT CODE	PRICE LP	SIZE / INCHES			WEIGHT LBS	VOL FT ³
		H	W	D		
L2SPBOX1620	547	8	16	20	15	1
L2SPBOX1626	612	8	16	26	18	2
L2SPBOX1634	696	8	16	34	22	5

L2FFL • Licence Floating Tops with "O" Leg

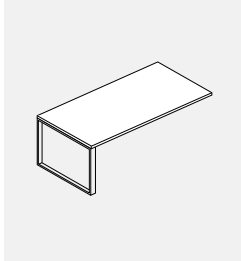

- Kit includes a worksurface, "O" leg and channel.
- Option for grommet - BG5, TC only.
- Painted loop leg, please specify standard paint colour.
- Worksurface supporting pedestals and laterals will not fit due to the metal channel under the surface.

PRODUCT CODE	FINISH LP	B	W	SIZE / INCHES			D	WEIGHT LBS	VOL FT ³
				H (LP/B)	H (W)	W			
L2FFL2466	805	910	1009	1	1.44	66	24	55	6
L2FFL2472	826	935	1062	1	1.44	72	24	59	7
L2FFL2478	857	970	1104	1	1.44	78	24	62	7
L2FFL2484	892	1013	1158	1	1.44	84	24	66	8
L2FFL3066	879	991	1181	1	1.44	66	30	57	7
L2FFL3072	906	1021	1239	1	1.44	72	30	62	8
L2FFL3078	934	1054	1299	1	1.44	78	30	64	8
L2FFL3084	985	1114	1360	1	1.44	84	30	68	9
L2FFL3666	1075	1197	1386	1	1.44	66	36	63	8
L2FFL3672	1121	1252	1455	1	1.44	72	36	68	9
L2FFL3678	1166	1309	1529	1	1.44	78	36	70	9
L2FFL3684	1218	1368	1604	1	1.44	84	36	75	10

L2HGAMP • Hanging Aluminum Framed Frosted Glazing Modesty

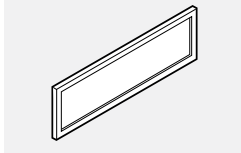

- Framed is anodize aluminum.
- Glazing is frosted acrylic.
- Hanging brackets are included.

PRODUCT CODE	PRICE	SIZE / INCHES			WEIGHT LBS	VOL FT ³
		H	W	D		
L2HGAMP36	490	14	35.50	0.75	12	1
L2HGAMP42	526	14	41.50	0.75	13	1
L2HGAMP48	562	14	47.50	0.75	14	1
L2HGAMP54	601	14	53.50	0.75	16	1

L2HGMP • Hanging Laminate Modesty

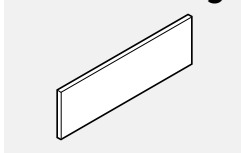

- Hanging brackets are included.

PRODUCT CODE	PRICE LP	SIZE / INCHES			WEIGHT LBS	VOL FT ³
		H	W	D		
L2HGMP36	286	14	36	0.75	9	1
L2HGMP42	294	14	42	0.75	11	1
L2HGMP48	305	14	48	0.75	13	1
L2HGMP54	311	14	54	0.75	14	1

General Notes

Pedestals

Pedestals are shipped assembled.

- Pedestals are offered in three types of applications: Worksurface Supporting, Freestanding, and Mobile.
- Pedestal front width is 15-1/2" with a deep size variation 18" 23" 24" 29" 30" 36"
- If specifying a pedestal for a desk or credenza, please ensure you specify next depth lower ie. 23" deep pedestal for a 24" deep credenza or desk.
- Worksurface supporting Pedestals are 28"high
- Freestanding pedestals come with the choice of "LP", "B" for 29"high or "W" thickness top for 29.5"high
- Pedestals Freestanding are on adjustable levelers
- Mobile pedestals come with a top with the choice of "LP", "B" for 29"high or "W" thickness top for 29.5"high and have front locking casters to support the pedestal.
- Pencil tray included in the top box drawer of each pedestal.
- Box drawers mounted on full extension ball bearing slides
- File drawers mounted on full extension ball bearing slides
- All file drawers come with adjustable rails for legal or letter size hanging folders. See File Drawer Capacity chart page G2.
- Pull out shelf for CPU and printer units can support 75 lbs. per shelf and has telescopic extension.
- CPU and printer units have ventilation grommet on back panel.
- Interior clearance of printer shelf is 11".
- Printer pedestals have 2 pull out shelves and the back panel has four round grommets.
- CPU pedestals have 1 pull out shelf and the back panel has two round grommets.
- Both CPU and printer units must be installed under a worksurface to prevent tipping.
- All pedestals with a door, include 1 adjustable shelf.
- Cases and fronts are finished in low pressure laminate.
- Specify thickness of the top to match the thickness of the worksurface.
- Locks are standard on all units. Available in black or silver finish. The lock will match the handle finish.

Hutches and Overheads

Hutches and overheads are shipped assembled.

- Hutches and overheads are offered in "LP" and "W" thickness with three option heights. See Storage Technical Info page G3.
- Specify thickness of hutch or overhead top to match the thickness of the worksurface.
- Cases and fronts are finished in low pressure laminate.
- Hutches and overheads with hinged doors (laminate or aluminum), flip up fronts have no handle option.
- Hutches with pigeon holes come with touch latch mechanism.
- Hutches and overheads with sliding laminate doors have standard handle options
- Hutches and overheads with sliding glass doors are offered with recessed handle only. The recessed handle is in chrome finish
- Hutches and wall mounted overheads are offered in 4 styles: Open storage, Hinged doors - laminate or anodized aluminum frame doors with the option for glazing: frosted or clear, sliding doors are laminate or glass doors and flip-up doors.
- Once installed, the bottom of the flip-up door overhead will not line up with the bottom of the open or hinged door overhead.
- Wall mounted storage cabinets must be securely attached to wall studs.
- Panel mounted overheads include attachment brackets for Boulevard panels.
- Back panels on hutches comes with a center round grommet for wire access.
- Top on hutch and overhead storage cabinets with flip-up doors is 3/4" thick Low Pressure Laminate. Doors slides on top of the unit.
- Inside dimension for hutches and wall mounted units with flip-up doors is 13 1/4" high x 14 1/2" deep
- Inside dimension for hutches and wall mounted with hinged doors is 12 3/4" high x 15 1/4" deep
- Inside dimension for open hutches and wall mounted is 12 3/4" high x 15 1/4" deep
- Inside dimension for hutches and wall mounted with sliding doors is 12-3/4"high x 13" deep
- Use double sided tape to attach hutches to worksurface.
- Locks are standard on all units. Available in black or silver finish. The lock will match the handle finish.
- Recommended to be installed against and fixed to a wall using appropriate hardware (not included).

Credenzas

Credenzas are shipped assembled.

- Credenza model # L2CR2H2H or L2CR1H1H must be ordered with counterweights to avoid tipping.
- Credenza come with the choice of "LP", "B" or "W" thickness top
- Credenzas are offered with the choice of "LP", "B" for 20"h. or 29"high and "W" thickness top for 20.5"h or 29.5"high
- Credenza come with hinged doors, laminate or anodized aluminum frame doors with the option for glazing: frosted or clear
- Locks are standard on all units. Available in black or silver finish. The lock will match the handle finish.

Bookcases

Bookcases are Shipped knocked down (KD).

- Available in 30" or 36" widths and 12.685" and 16.685"depths dimension at base-board with range in height from 29" to 72" with 12" clearance between shelves.
- Bottom shelf is fixed and all other shelves are adjustable.
- Specify thickness of the top to match the thickness and profile of the worksurface.
- Tops are offered "LP" or "B" or "W".
- Up to 42"h, Bookcases are offered in "LP", "B", "W".
- 54"h. and up are offered in "LP" and "W".
- Recommended to be installed against and fixed to a wall using appropriate hardware (not included).

Laterals

Laterals are shipped assembled.

- Laterals are available in three widths, 30" 36", 42" with a height variation of 28" to 54" and a depth of 20" and 24".
- Tops are offered LP, B or W
- Worksurface supporting units do not come with a top.
- Up to 42"h, laterals are offered in "LP", "B", "W".
- 54"h and up are offered in "LP" and "W".
- Cases and fronts are finished in low pressure laminate.
- Laterals with hinged doors, laminate or anodized aluminum frame doors with the option for glazing: frosted or clear
- Lateral files are offered in 2 types of applications: Worksurface Supporting and Freestanding.
- All lateral files feature a drawer interlocking mechanism
- Up to 42"h, Laterals are offered in "LP", "B", "W".
- 54"h, and up are offered in "LP" and "W".
- All file drawer come with adjustable rails for legal or letter size hanging folders.
- Counterweights must be specified in a lateral configurations except worksurface supporting.
- "C" combo lateral have a pencil drawer included in the box drawer. The penciltray is parallel with the depth of the drawer.
- In "C" combo lateral, only one side can be locked.
- All laterals with a door, include 1 adjustable shelf.
- File drawers mounted on full extension ball bearing slides
- Locks are standard on all units. Available in black or silver finish. The lock will match the handle finish.

Towers and cabinets

Towers and cabinets are shipped assembled.

- Towers offered 24"w and cabinets 30"w and 36"w are offered in "LP" and "W".
- Cases are finished in low pressure laminate.
- Towers or cabinets are offered with hinged doors, laminate or anodized aluminum frame with the option for glazing: frosted or clear
- Towers or cabinets with anodized aluminum doors are offered without handles. Touch latch mechanism is included.
- Storage tower with the cupboard above FF or BBF and wardrobe will lock only the wardrobe and drawers.
- Storage tower with the wardrobe include a coat rod.
- Locks are standard on all units. Available in black or silver finish. The lock will match the handle finish.
- Counterweights must be specified for units 20" deep by 60" to 72" high with 2H2D or 2H/Open, please order 2 x LACWB for each unit.

LATERAL FILE DRAWERS

Lateral File Drawer:

36W & 42W

Legal Filing - front to back

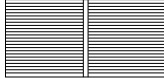

- Drawer file with plastic rail
- 30"W Size 9.44"H x 25.75"W x 16"L
- 36"W Size 9.44"H x 31.75"W x 16"L
- 42"W Size 9.44"H x 37.75"W x 16"L

Lateral File Drawer:

36W & 42W

Legal Filing - side to side

Letter Filing - front to back

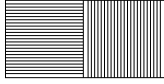
**Lateral File Drawer:**

30W, 36W & 42W

Letter Filing - front to back

**Lateral File Drawer:**

36W & 42W

Letter & Legal Filing - front to back

**Lateral File Drawer:**

30W, 36W & 42W

Legal Filing - side to side

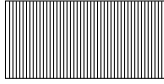

PEDESTAL DRAWERS

Box Drawer:

15.5W

Legal Filing - side to side



- 18"D Drawer Box Size 3.93"H x 13"W x 16"L
- 20.23.24.29.30.36"D Drawer Box Size 3.93"H x 13"W x 20"L

File Drawer:

15.5W

Letter Filing - front to back



- 18"D Drawer File with plastic rail Size 9.4"H x 13"W x 16"L
- 20"D and up Drawer File with plastic rail Size 9.4"H x 13"W x 20"L

File Drawer:

15.5W

Legal Filing - side to side



- 18"D Drawer File with plastic rail Size 9.4"H x 13"W x 16"L
- 20"D and up Drawer File with plastic rail Size 9.4"H x 13"W x 20"L

COMBO LATERAL FILE DRAWERS

- For 30" wide units: Drawer width is 11 3/4" and can accommodate only side to side legal or letter filing.
- For 36" wide units: Drawer width is 14 3/4" and can accommodate only side to side legal or letter filing.

STORAGE TECHNICAL INFORMATION

**1" LPL TOP
LP HUTCH
LP DESK 29H
LP CABINET**

**1-1/16" HPL TOP
LP HUTCH
B TOP DESK 29H
LP CABINET**

**1-7/16" HPL TOP
W TOP HUTCH
W TOP DESK 29.5H
W CABINET**

**NO TACKBOARD
LTB
50" High**

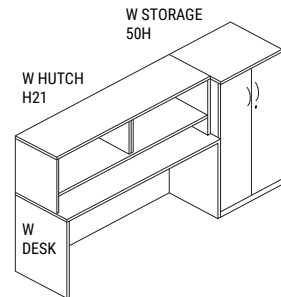
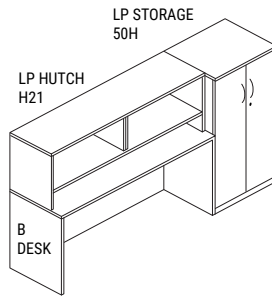
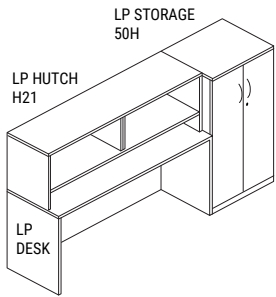

**TACKBOARD
LTB21
66" High**

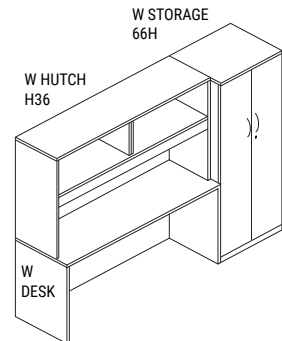
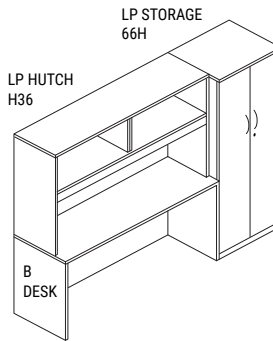
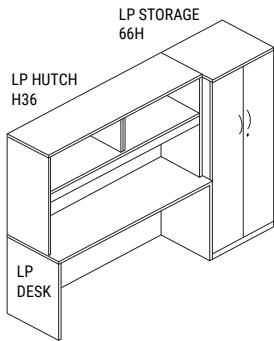

**TACKBOARD
LTB27
72" High**

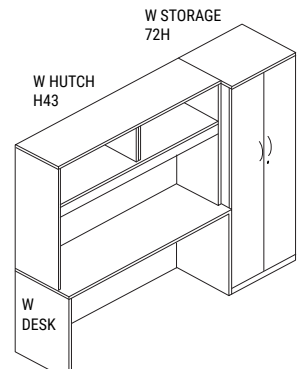
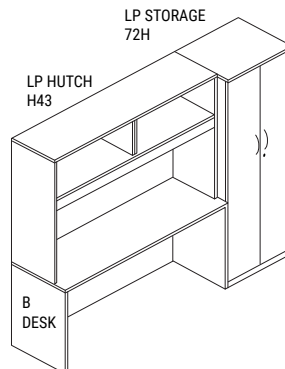
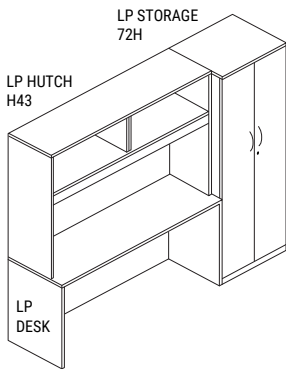

STACK ON TWO HEIGHT CABINET IS TO BE PLACED ON 1H CRENZNA

**50" High
Only**

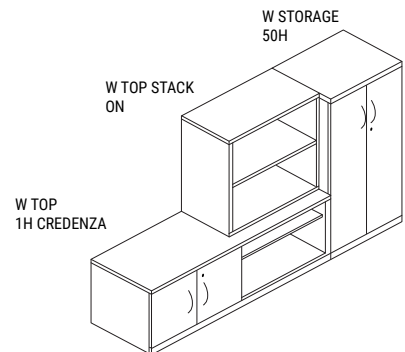
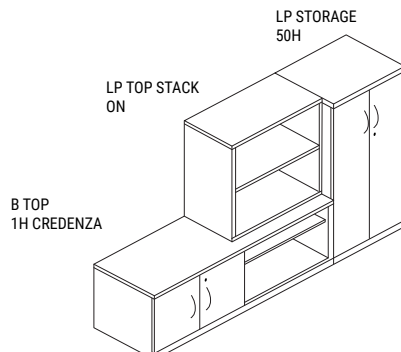
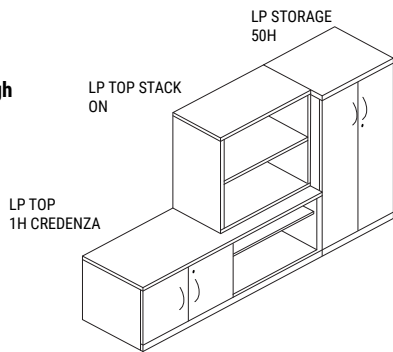

L2PBBF • Worksurface Supporting Box, Box, File Pedestal

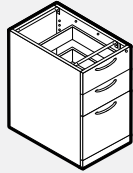

- One lock included.
- Optional e-lock available in the vertical position. Please specify V - Vertical and add \$224 list.
- Counter weight must be ordered separately.

PRODUCT CODE	PRICE LP	SIZE/INCHES			WEIGHT LBS	VOL FT ³
		H	W	D		
L2PBBF18	821	28	15.5	18	94	8
L2PBBF20	895	28	15.5	20	94	8
L2PBBF23	909	28	15.5	23	94	8
L2PBBF24	909	28	15.5	24	99	10
L2PBBF29	943	28	15.5	29	105	10
L2PBBF30	943	28	15.5	30	110	10
L2PBBF36	991	28	15.5	36	116	11

L2PFF • Worksurface Supporting File, File Pedestal

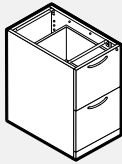

- One lock included.
- Optional e-lock available in the vertical position. Please specify V - Vertical and add \$224 list.

PRODUCT CODE	PRICE LP	SIZE/INCHES			WEIGHT LBS	VOL FT ³
		H	W	D		
L2PFF18	748	28	15.5	18	94	8
L2PFF20	837	28	15.5	20	94	8
L2PFF23	847	28	15.5	23	94	8
L2PFF24	847	28	15.5	24	99	8
L2PFF29	891	28	15.5	29	105	10
L2PFF30	891	28	15.5	30	110	10
L2PFF36	927	28	15.5	36	116	11

L2P1D • Worksurface Supporting 1 Door Pedestal

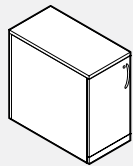

- Includes one adjustable shelf.
- One lock included.
- Optional e-lock available in the horizontal position. Please specify HL - Horizontal Left and add \$204 list.

PRODUCT CODE	PRICE LP	SIZE/INCHES			WEIGHT LBS	VOL FT ³
		H	W	D		
L2P1D18	626	28	15.5	18	66	8
L2P1D20	675	28	15.5	20	74	8
L2P1D23	693	28	15.5	23	74	8
L2P1D24	693	28	15.5	24	75	10
L2P1D29	761	28	15.5	29	84	10
L2P1D30	761	28	15.5	30	85	10

L2PBBF-F • Freestanding Box, Box, File Pedestal

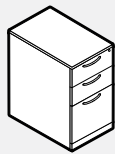

- One lock included.
- Optional e-lock available in the vertical position. Please specify V - Vertical and add \$224 list.
- Counter weight must be ordered separately.

PRODUCT CODE	FINISH LP	B	W	SIZE/INCHES				WEIGHT LBS	VOL FT ³
				H (LP/B)	H (W)	W	D		
L2PBBF20F	972	1000	1038	29	29.5	15.5	20	94	8
L2PBBF24F	987	1015	1055	29	29.5	15.5	24	99	8
L2PBBF30F	1029	1062	1106	29	29.5	15.5	30	105	10
L2PBBF36F	1077	1120	1168	29	29.5	15.5	36	116	11

L2PFF-F • Freestanding File, File Pedestal

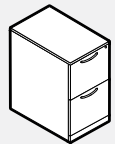

- One lock included.
- Optional e-lock available in the vertical position. Please specify V - Vertical and add \$224 list.
- Counter weight must be ordered separately.

PRODUCT CODE	FINISH LP	B	W	SIZE/INCHES				WEIGHT LBS	VOL FT ³
				H (LP/B)	H (W)	W	D		
L2PFF20F	882	909	972	29	29.5	15.5	20	99	8
L2PFF24F	894	923	988	29	29.5	15.5	24	99	8
L2PFF30F	969	1003	1043	29	29.5	15.5	30	110	10
L2PFF36F	1054	1095	1109	29	29.5	15.5	36	116	11

L2P1D-F • Freestanding 1 Door Pedestal

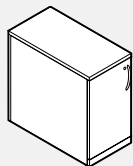

- Includes one adjustable shelf.
- One lock included.
- Optional e-lock available in the horizontal position. Please specify HL - Horizontal Left and add \$224 list.
- Counter weight must be ordered separately.

PRODUCT CODE	FINISH LP	B	W	SIZE/INCHES				WEIGHT LBS	VOL FT ³
				H (LP/B)	H (W)	W	D		
L2P1D20F	752	803	839	29	29.5	15.5	20	78	8
L2P1D24F	763	816	851	29	29.5	15.5	24	98	8
L2P1D30F	839	903	945	29	29.5	15.5	30	103	10
L2P1D36F	921	997	1047	29	29.5	15.5	36	110	11

L2PBBF-MIT • Mobile Box, Box, File Pedestal to fit under Worksurface



- One lock included.
- Optional e-lock available in the vertical position. Please specify V - Vertical and add \$224 list.
- Counter weight must be ordered separately.
- 18" deep mobile pedestal has a fifth caster at center bottom.

PRODUCT CODE	PRICE LP	SIZE/INCHES			WEIGHT LBS	VOL FT ³
		H	W	D		
L2PBBF18MIT	1187	28	15.5	18	99	8
L2PBBF23MIT	1254	28	15.5	23	105	8
L2PBBF29MIT	1316	28	15.5	29	110	10

L2PBBF-M • Mobile Box, Box, File Pedestal with Standard Top

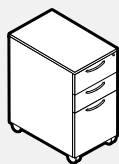

- One lock included.
- Optional e-lock available in the vertical position. Please specify V - Vertical and add \$224 list.
- Counter weight must be ordered separately.
- 20" deep mobile pedestal has a fifth caster at center bottom.

PRODUCT CODE	FINISH LP	B	W	SIZE / INCHES				WEIGHT LBS	VOL FT ³
				H (LP/B)	H (W)	W	D		
L2PBBF20M	1280	1287	1348	29	29.5	15.5	20	99	8
L2PBBF24M	1299	1309	1366	29	29.5	15.5	24	99	8
L2PBBF30M	1327	1356	1400	29	29.5	15.5	30	105	10
L2PBBF36M	1381	1417	1458	29	29.5	15.5	36	110	11

L2PFF-MIT • Mobile File, File Pedestal to fit under Worksurface



- One lock included.
- Optional e-lock available in the vertical position. Please specify V - Vertical and add \$224 list.
- Counter weight must be ordered separately.
- 18" deep mobile pedestal has a fifth caster at center bottom.

PRODUCT CODE	PRICE LP	SIZE / INCHES				WEIGHT LBS	VOL FT ³
		H	W	D			
L2PFF18MIT	1011	28	15.5	18	99	8	
L2PFF23MIT	1076	28	15.5	23	105	8	
L2PFF29MIT	1133	28	15.5	29	110	10	

L2PFF-M • Mobile File, File Pedestal with Standard Top

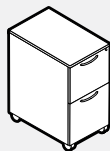

- One lock included.
- Optional e-lock available in the vertical position. Please specify V - Vertical and add \$224 list.
- Counter weight must be ordered separately.
- 20" deep mobile pedestal has a fifth caster at center bottom.

PRODUCT CODE	FINISH LP	B	W	SIZE / INCHES				WEIGHT LBS	VOL FT ³
				H (LP/B)	H (W)	W	D		
L2PFF20M	1084	1109	1141	29	29.5	15.5	20	99	8
L2PFF24M	1099	1126	1162	29	29.5	15.5	24	99	8
L2PFF30M	1139	1169	1230	29	29.5	15.5	30	105	10
L2PFF36M	1198	1233	1280	29	29.5	15.5	36	110	11

L2PBF-M • Mobile Box, File Pedestal with Standard Top

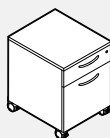

- One lock included.
- Optional e-lock available in the vertical position. Please specify V - Vertical and add \$224 list.
- Counter weight must be ordered separately.
- 20" deep mobile pedestal has a fifth caster at center bottom.

PRODUCT CODE	FINISH LP	B	W	SIZE / INCHES				WEIGHT LBS	VOL FT ³
				H (LP/B)	H (W)	W	D		
L2PBF20M	944	972	1026	22.69	23.15	15.5	20	78	7
L2PBF24M	957	987	1038	22.69	23.15	15.5	24	80	7
L2PBF30M	991	1025	1064	22.69	23.15	15.5	30	90	9

L2PBF-MIT • Mobile Box, File Pedestal with Inset Top



- One lock included.
- Optional e-lock available in the vertical position. Please specify V - Vertical and add \$224 list.
- Counter weight must be ordered separately.
- 18" deep mobile pedestal has a fifth caster at center bottom.

PRODUCT CODE	PRICE LP	SIZE / INCHES				WEIGHT LBS	VOL FT ³
		H	W	D			
L2PBF18MIT	884	22	15.5	18	99	8	
L2PBF23MIT	941	22	15.5	23	99	8	
L2PBF24MIT	941	22	15.5	24	105	8	
L2PBF29MIT	994	22	15.5	29	105	8	
L2PBF30MIT	994	22	15.5	30	110	10	

L2PU • Printer Unit with 2 Pull Out Shelves

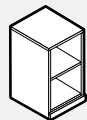

PRODUCT CODE	PRICE LP	SIZE / INCHES				WEIGHT LBS	VOL FT ³
		H (LP/B)	W	D			
L2PU18	904	28	22	18	83	8	
L2PU22	986	28	22	22	88	9	
L2PU24	1029	28	22	24	94	10	

L2L2H • Worksurface Supporting File, File Lateral for 18" deep and 22" deep units

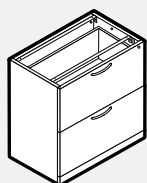

- One lock included.
- Optional e-lock available in the vertical position. Please specify V - Vertical and add \$224 list.

PRODUCT CODE	PRICE LP	SIZE / INCHES				WEIGHT LBS	VOL FT ³
		H (LP/B)	W	D			
L2L2H1830	1205	28	30	18	189	12	
L2L2H1836	1285	28	36	18	209	14	
L2L2H1842	1334	28	42	18	216	20	
L2L2H2230	1238	28	30	22	189	12	
L2L2H2236	1320	28	36	22	209	14	
L2L2H2242	1414	28	42	22	216	20	

L2L2D • Worksurface Supporting 2 Door Storage Lateral with 1 Adjustable Shelf

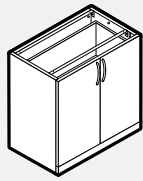

- One lock included.
- Optional e-lock available in the horizontal position. Please specify HR - Horizontal Right and add \$224 list.

PRODUCT CODE	PRICE LP	SIZE / INCHES			WEIGHT LBS	VOL FT ³
		H (LP/B)	W	D		
L2L2D1830	842	28	30	18	171	12
L2L2D1836	889	28	36	18	178	14
L2L2D1842	974	28	42	18	180	20
L2L2D2230	910	28	30	22	171	12
L2L2D2236	935	28	36	22	178	14
L2L2D2242	1077	28	42	22	180	20

L2L2AD • Worksurface Supporting 2 Aluminum Door Storage Lateral with 1 Adjustable Shelf

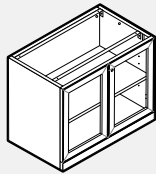

- One lock included.
- E-lock not available for aluminum framed glass doors.

PRODUCT CODE	PRICE LP	SIZE / INCHES			WEIGHT LBS	VOL FT ³
		H (LP/B)	W	D		
L2L2AD1830	1432	28	30	18	165	12
L2L2AD1836	1535	28	36	18	172	14
L2L2AD1842	1676	28	42	18	174	20
L2L2AD2230	1500	28	30	22	165	12
L2L2AD2236	1584	28	36	22	172	14
L2L2AD2242	1781	28	42	22	174	20

L2LCR • Worksurface Supporting Lateral File Combo

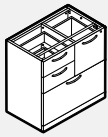

- One lock included.
- Optional e-lock available in the vertical position. Please specify V - Vertical and add \$224 list.

PRODUCT CODE	PRICE LP	SIZE / INCHES			WEIGHT LBS	VOL FT ³
		H (LP/B)	W	D		
L2LCR1830	1480	28	30	18	204	12
L2LCR1836	1727	28	36	18	215	14
L2LCR2230	1722	28	30	22	204	12
L2LCR2236	1808	28	36	22	215	14

L2LCL • Worksurface Supporting Lateral File Combo

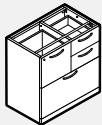

- One lock included.
- E-lock not available.

PRODUCT CODE	PRICE LP	SIZE / INCHES			WEIGHT LBS	VOL FT ³
		H (LP/B)	W	D		
L2LCL1830	1480	28	30	18	204	12
L2LCL1836	1727	28	36	18	215	14
L2LCL2230	1722	28	30	22	204	12
L2LCL2236	1808	28	36	22	215	14

L2LCR • Lateral File Combo with Top

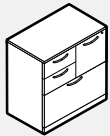

- One lock included.
- Optional e-lock available in the vertical position. Please specify V - Vertical and add \$224 list.

PRODUCT CODE	FINISH LP	B	W	SIZE / INCHES				WEIGHT LBS	VOL FT ³
				H (LP/B)	H (W)	W	D		
L2LCR2030	1827	1869	1916	29	29.5	30	20	204	12
L2LCR2036	1915	1940	2039	29	29.5	36	20	215	14
L2LCR2430	1900	1943	1995	29	29.5	30	24	204	12
L2LCR2436	1991	2020	2123	29	29.5	36	24	215	14

L2LCL • Lateral File Combo with Top

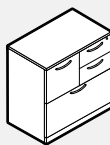

- One lock included.
- E-lock not available.

PRODUCT CODE	FINISH LP	B	W	SIZE / INCHES				WEIGHT LBS	VOL FT ³
				H (LP/B)	H (W)	W	D		
L2LCL2030	1827	1869	1916	29	29.5	30	20	204	12
L2LCL2036	1915	1940	2039	29	29.5	36	20	215	14
L2LCL2430	1900	1943	1995	29	29.5	30	24	204	12
L2LCL2436	1991	2020	2123	29	29.5	36	24	215	14

L2LO • Freestanding 1 High Open Unit

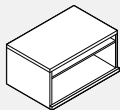

PRODUCT CODE	FINISH LP	B	W	SIZE / INCHES				WEIGHT LBS	VOL FT ³
				H (LP/B)	H (W)	W	D		
L2LO2030	651	740	803	19.94	20.4	30	20	75	11
L2LO2036	773	881	915	19.94	20.4	36	20	86	13
L2LO2430	677	769	837	19.94	20.4	30	24	75	11
L2LO2436	805	915	954	19.94	20.4	36	24	86	13

L2L2D-H20 • Freestanding 2 Doors, 1 High Unit

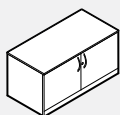

- One lock included.
- Includes one adjustable shelf.
- Optional e-lock available in the horizontal position. Please specify HR - Horizontal Right and add \$224 list.

PRODUCT CODE	FINISH LP	B	W	SIZE / INCHES				WEIGHT LBS	VOL FT ³
				H (LP/B)	H (W)	W	D		
L2L2D2030H20	894	972	1022	19.94	20.4	30	20	95	11
L2L2D2036H20	972	1067	1122	19.94	20.4	36	20	106	13
L2L2D2430H20	931	1011	1063	19.94	20.4	30	24	95	11
L2L2D2436H20	1011	1109	1166	19.94	20.4	36	24	106	13

L2L2AD • Freestanding 2 Aluminum Doors, 1 High

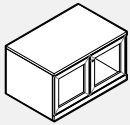

- One lock included.
- Includes one adjustable shelf.
- E-lock not available for aluminum framed glass doors.

PRODUCT CODE	FINISH LP	B	W	SIZE / INCHES				WEIGHT LBS	VOL FT ³
				H (LP/B)	H (W)	W	D		
L2L2AD2030H20	1370	1448	1497	19.5	20	30	20	86	10
L2L2AD2036H20	1488	1582	1637	19.5	20	36	20	96	12
L2L2AD2430H20	1406	1485	1539	19.5	20	30	24	86	10
L2L2AD2436H20	1527	1623	1682	19.5	20	36	24	96	12

L2L2D • Freestanding 2 Doors, 2 High Unit

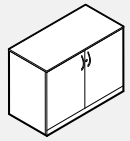

- One lock included.
- Includes one adjustable shelf.
- Optional e-lock available in the horizontal position. Please specify HR - Horizontal Right and add \$224 list.

PRODUCT CODE	FINISH LP	B	W	SIZE / INCHES				WEIGHT LBS	VOL FT ³
				H (LP/B)	H (W)	W	D		
L2L2D2030	987	1096	1124	29	29.5	30	20	171	12
L2L2D2036	1088	1181	1236	29	29.5	36	20	178	14
L2L2D2042	1220	1327	1388	29	29.5	42	20	208	20
L2L2D2430	1025	1140	1169	29	29.5	30	24	171	12
L2L2D2436	1133	1229	1287	29	29.5	36	24	178	14
L2L2D2442	1264	1378	1444	29	29.5	42	24	208	20

L2L2AD • Freestanding 2 Aluminum Doors, 2 High Unit

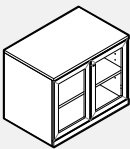

- One lock included.
- Includes one adjustable shelf.
- E-lock not available for aluminum framed glass doors.

PRODUCT CODE	FINISH LP	B	W	SIZE / INCHES				WEIGHT LBS	VOL FT ³
				H (LP/B)	H (W)	W	D		
L2L2AD2030	1579	1687	1717	29	29.5	30	20	165	12
L2L2AD2036	1734	1830	1884	29	29.5	36	20	172	14
L2L2AD2042	1920	2028	2090	29	29.5	42	20	174	20
L2L2AD2430	1617	1730	1759	29	29.5	30	24	165	12
L2L2AD2436	1779	1877	1933	29	29.5	36	24	172	14
L2L2AD2442	1967	2082	2147	29	29.5	42	24	174	20

L2L1H • Freestanding 1 High Lateral

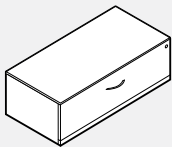

- One lock included.
- Optional e-lock available in the vertical position. Please specify V - Vertical and add \$224 list.

PRODUCT CODE	FINISH LP	B	W	SIZE / INCHES				WEIGHT LBS	VOL FT ³
				H (LP/B)	H (W)	W	D		
L2L1H2030	890	938	971	19.94	20.4	30	20	105	11
L2L1H2036	949	1008	1062	19.94	20.4	36	20	114	13
L2L1H2042	1029	1095	1158	19.94	20.4	42	20	133	15
L2L1H2430	926	974	1010	19.94	20.4	30	24	105	11
L2L1H2436	991	1051	1104	19.94	20.4	36	24	114	13
L2L1H2442	1069	1137	1200	19.94	20.4	42	24	133	15

L2LBFH20 • Freestanding Box File Lateral

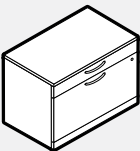

- One lock included.
- Optional e-lock available in the vertical position. Please specify V - Vertical and add \$224 list.

PRODUCT CODE	FINISH LP	B	W	SIZE / INCHES				WEIGHT LBS	VOL FT ³
				H (LP/B)	H (W)	W	D		
L2LBF2030H20	1201	1233	1298	19.94	20	30	20	108	11
L2LBF2036H20	1293	1330	1405	19.94	20	36	20	117	13
L2LBF2042H20	1377	1419	1504	19.94	20	42	20	136	15
L2LBF2430H20	1245	1277	1342	19.94	20	30	24	108	11
L2LBF2436H20	1337	1374	1449	19.94	20	36	24	117	13
L2LBF2442H20	1421	1463	1548	19.94	20	42	24	136	15

L2L2H • Freestanding 2 High Lateral

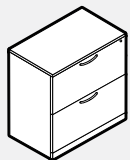

- One lock included.
- Optional e-lock available in the vertical position. Please specify V - Vertical and add \$224 list.

PRODUCT CODE	FINISH LP	B	W	SIZE / INCHES				WEIGHT LBS	VOL FT ³
				H (LP/B)	H (W)	W	D		
L2L2H2030	1348	1393	1442	29	29.5	30	20	189	12
L2L2H2036	1441	1496	1552	29	29.5	36	20	209	14
L2L2H2042	1549	1616	1669	29	29.5	42	20	242	20
L2L2H2430	1400	1448	1502	29	29.5	30	24	189	12
L2L2H2436	1497	1557	1612	29	29.5	36	24	209	14
L2L2H2442	1610	1680	1736	29	29.5	42	24	242	20

L2L3H • Freestanding 3 High Lateral

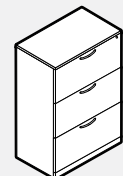

- One lock included.
- Optional e-lock available in the vertical position. Please specify V - Vertical and add \$224 list.

PRODUCT CODE	FINISH LP	B	W	SIZE / INCHES				WEIGHT LBS	VOL FT ³
				H (LP/B)	H (W)	W	D		
L2L3H2030	1838	1884	1935	41.75	42.18	30	20	252	18
L2L3H2036	1980	2034	2047	41.75	42.18	36	20	264	21
L2L3H2430	1913	1960	2012	41.75	42.18	30	24	252	18
L2L3H2436	2059	2118	2130	41.75	42.18	36	24	264	21

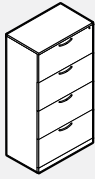
L2L4H • Freestanding 4 High Lateral

- One lock included.
- Optional e-lock available in the vertical position. Please specify V - Vertical and add \$224 list.

PRODUCT CODE	FINISH		SIZE/INCHES				WEIGHT		VOL FT ³
	LP	W	H(LP/B)	H(W)	W	D	LBS		
L2L4H2030	2377	2476	54.5	54.94	30	20	315	23	
L2L4H2036	2496	2641	54.5	54.94	36	20	336	28	
L2L4H2430	2471	2574	54.5	54.94	30	24	315	23	
L2L4H2436	2595	2745	54.5	54.94	36	24	336	28	

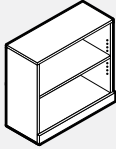
L2B2H • Bookcase 1 Adjustable Shelf

- Shipped knocked down (KD).

PRODUCT CODE	FINISH			SIZE/INCHES				WEIGHT		VOL FT ³
	LP	B	W	H(LP/B)	H(W)	W	D	LBS		
L2B2H3012	526	575	619	29	29.5	30	12	95	8	
L2B2H3612	611	669	727	29	29.5	36	12	106	9	
L2B2H30	626	699	769	29	29.5	30	17	95	11	
L2B2H36	725	781	839	29	29.5	36	17	106	13	

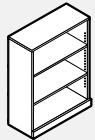
L2B3H • Bookcase 2 Adjustable Shelves

- Shipped knocked down (KD).

PRODUCT CODE	FINISH			SIZE/INCHES				WEIGHT		VOL FT ³
	LP	B	W	H(LP/B)	H(W)	W	D	LBS		
L2B3H3012	673	722	752	41.75	42.18	30	12	160	9	
L2B3H3612	739	811	849	41.75	42.18	36	12	171	12	
L2B3H30	838	908	967	41.75	42.18	30	17	160	15	
L2B3H36	944	1026	1084	41.75	42.18	36	17	171	18	

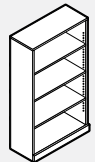
L2B4H • Bookcase 3 Adjustable Shelves

- Shipped knocked down (KD).

PRODUCT CODE	FINISH		SIZE/INCHES				WEIGHT		VOL FT ³
	LP	W	H(LP/B)	H(W)	W	D	LBS		
L2B4H3012	803	915	54.5	54.94	30	12	178	13	
L2B4H3612	902	1031	54.5	54.94	36	12	189	15	
L2B4H30	1024	1140	54.5	54.94	30	17	178	19	
L2B4H36	1119	1227	54.5	54.94	36	17	189	22	

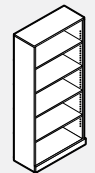
L2B5H • Bookcase 4 Adjustable Shelves

- Shipped knocked down (KD).

PRODUCT CODE	FINISH		SIZE/INCHES				WEIGHT		VOL FT ³
	LP	W	H(LP/B)	H(W)	W	D	LBS		
L2B5H3012	969	1032	65.81	66.25	30	12	193	15	
L2B5H3612	1057	1189	65.81	66.25	36	12	204	19	
L2B5H30	1147	1239	65.81	66.25	30	17	193	23	
L2B5H36	1285	1421	65.81	66.25	36	17	204	28	

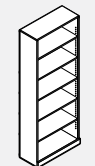
L2B6H • Bookcase 5 Adjustable Shelves

- Shipped knocked down (KD).

PRODUCT CODE	FINISH		SIZE/INCHES				WEIGHT		VOL FT ³
	LP	W	H(LP/B)	H(W)	W	D	LBS		
L2B6H3012	1043	1154	72.81	73.24	30	12	237	17	
L2B6H3612	1169	1300	72.81	73.24	36	12	248	20	
L2B6H30	1175	1297	72.81	73.24	30	17	242	25	
L2B6H36	1406	1608	72.81	73.24	36	17	253	30	

L2BC • Corner Bookcase 20”D x 20”W /24”D x 24”W

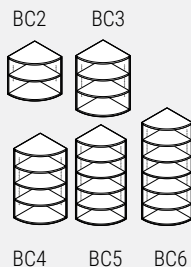

- Shipped knocked down (KD).

PRODUCT CODE	FINISH LP	FINISH B	FINISH W	SIZE/INCHES				WEIGHT LBS	VOL FT³
				H(LP/B)	H(W)	W	D		
L2BC2H20	847	994	1031	29.00	29.50	20	20	90	11
L2BC2H24	882	1034	1070	29.00	29.50	24	24	90	11
L2BC3H20	1074	1222	1261	41.75	42.18	20	20	125	15
L2BC3H24	1118	1266	1312	41.75	42.18	24	24	125	15
L2BC4H20	1301	-	1494	54.50	54.94	20	20	158	20
L2BC4H24	1354	-	1554	54.50	54.94	24	24	158	20
L2BC5H20	1529	-	1725	65.81	66.25	20	20	188	24
L2BC5H24	1591	-	1794	65.81	66.25	24	24	188	24
L2BC6H20	1720	-	1927	72.81	73.24	20	20	218	26
L2BC6H24	1788	-	2002	72.81	73.24	24	24	218	26

L2TW2D-D • Storage Tower with 2 Doors and 4 Adjustable Shelves

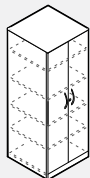

- 50” High Tower comes with 3 adjustable shelves.
- One lock on right door included.
- Optional e-lock available in the horizontal position. Please specify HR - Horizontal Right and add \$224 list.

PRODUCT CODE	FINISH LP	FINISH W	FINISH D	SIZE/INCHES				WEIGHT LBS	VOL FT³
				H(LP/B)	H(W)	W	D		
L2TW2D50H20D	1480	1586	20	49.56	50.00	24	20	211	22
L2TW2D66H20D	1635	1782	20	65.81	66.25	24	20	268	24
L2TW2D72H20D	1706	1847	20	72.81	73.24	24	20	283	26
L2TW2D50H24D	1535	1648	24	49.56	50.00	24	24	211	22
L2TW2D66H24D	1697	1850	24	65.81	66.25	24	24	268	24
L2TW2D72H24D	1773	1916	24	72.81	73.24	24	24	283	26

L2TW2DCS-D • Storage Tower with 2 Doors, Coat Rod and Hat Shelf

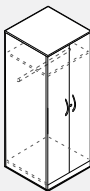

- 50” High Tower comes with one shelf.
- One lock on right door included.
- Optional e-lock available in the horizontal position. Please specify HR - Horizontal Right and add \$224 list.

PRODUCT CODE	FINISH LP	FINISH W	FINISH D	SIZE/INCHES				WEIGHT LBS	VOL FT³
				H(LP/B)	H(W)	W	D		
L2TW2DCS50H20D	1322	1475	20	49.56	50.00	24	20	178	22
L2TW2DCS66H20D	1496	1606	20	65.81	66.25	24	20	268	24
L2TW2DCS72H20D	1560	1670	20	72.81	73.24	24	20	284	26
L2TW2DCS50H24D	1374	1531	24	49.56	50.00	24	24	178	22
L2TW2DCS66H24D	1555	1668	24	65.81	66.25	24	24	268	24
L2TW2DCS72H24D	1621	1733	24	72.81	73.24	24	24	284	26

L2TW2H2D-D • Storage Tower with a 3 High Cupboard over a 2 High Lateral

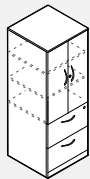

- 50” High Tower comes with one adjustable shelf.
- Two locks included.
- Optional e-lock available in the vertical position for the file drawers. Please specify V - Vertical and add \$224 list.
- Optional e-lock available in the horizontal position for the upper storage cabinet. Please specify HR- Horizontal Right and add \$224 list.

PRODUCT CODE	FINISH LP	FINISH W	FINISH D	SIZE/INCHES				WEIGHT LBS	VOL FT³
				H(LP/B)	H(W)	W	D		
L2TW2H2D50H20D	2001	2043	20	49.56	50.00	24	20	222	22
L2TW2H2D66H20D	2223	2259	20	65.81	66.25	24	20	279	24
L2TW2H2D72H20D	2287	2448	20	72.81	73.24	24	20	295	26
L2TW2H2D50H24D	2083	2126	24	49.56	50.00	24	24	222	22
L2TW2H2D66H24D	2314	2349	24	65.81	66.25	24	24	279	24
L2TW2H2D72H24D	2379	2543	24	72.81	73.24	24	24	295	26

L2TW3H2D-D • Storage Tower with a 2 High Cupboard over a 3 High Lateral

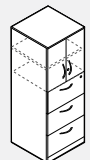

- Two locks included.
- Optional e-lock available in the vertical position for the file drawers. Please specify V - Vertical and add \$224 list.
- Optional e-lock available in the horizontal position for the upper storage cabinet. Please specify HR- Horizontal Right and add \$224 list.

PRODUCT CODE	FINISH LP	FINISH W	FINISH D	SIZE/INCHES				WEIGHT LBS	VOL FT³
				H(LP/B)	H(W)	W	D		
L2TW3H2D66H20D	2452	2558	20	65.81	66.25	24	20	296	24
L2TW3H2D72H20D	2526	2603	20	72.81	73.24	24	20	311	26
L2TW3H2D66H24D	2550	2660	24	65.81	66.25	24	24	296	24
L2TW3H2D72H24D	2625	2708	24	72.81	73.24	24	24	311	26

L2TW4H2D-D • Tower with a 2 Door Storage Cabinet over a 4 High Lateral

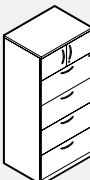

- Two locks included.
- Lock on cupboard is not available for UB, UC or RN handles.
- Optional e-lock available in the vertical position for the file drawers. Please specify V - Vertical and add \$224 list.
- Optional e-lock available in the horizontal position for the upper storage cabinet. Please specify HR- Horizontal Right and add \$224 list.

PRODUCT CODE	FINISH LP	FINISH W	FINISH D	SIZE/INCHES				WEIGHT LBS	VOL FT³
				H(LP/B)	H(W)	W	D		
L2TW4H2D66H20D	2784	2894	20	65.81	66.25	24	20	307	24
L2TW4H2D72H20D	2872	2908	20	72.81	73.24	24	20	322	26
L2TW4H2D66H24D	2895	3011	24	65.81	66.25	24	24	307	24
L2TW4H2D72H24D	2989	3023	24	72.81	73.24	24	24	322	26

L2TWBBF2DL • Storage Tower with a 3 High Cupboard, BBF Drawers and Wardrobe



Right Hand Shown

- Storage compartment includes 1 adjustable shelves for 50" h. unit and 2 adjustable shelves for 66" h. and 72" h. units
- Two locks included.
- Optional e-lock available in the vertical position for the box, box, file drawers. Please specify V - Vertical and add \$224 list.
- Optional e-lock available in the horizontal position for the wardrobe. Please specify HR - Horizontal Right or HL - Horizontal Left and add \$224 list.

PRODUCT CODE	FINISH		SIZE / INCHES				WEIGHT LBS	VOL FT ³
	LP	W	H (LP/B)	H (W)	W	D		
Left								
L2TWBBF2DL50H20D	2047	2199	49.56	50.00	24	20	288	20
L2TWBBF2DL66H20D	2280	2385	65.81	66.25	24	20	348	22
L2TWBBF2DL72H20D	2363	2467	72.81	73.25	24	20	378	24
L2TWBBF2DL50H24D	2129	2286	49.5	50.00	24	24	288	20
L2TWBBF2DL66H24D	2369	2481	65.81	66.25	24	24	348	22
L2TWBBF2DL72H24D	2455	2567	72.81	73.25	24	24	378	24
Right								
L2TWBBF2DR50H20D	2047	2199	49.56	50.00	24	20	288	20
L2TWBBF2DR66H20D	2280	2385	65.81	66.25	24	20	348	22
L2TWBBF2DR72H20D	2363	2467	72.81	73.25	24	20	378	24
L2TWBBF2DR50H24D	2129	2286	49.5	50.00	24	24	288	20
L2TWBBF2DR66H24D	2369	2481	65.81	66.25	24	24	348	22
L2TWBBF2DR72H24D	2455	2567	72.81	73.25	24	24	378	24

L2TW2F2D-D • Storage Tower with a 3 High Cupboard, FF Drawers and Wardrobe

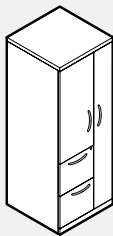

Right Hand Shown

- Wardrobe has a coat rod.
- Two locks included.
- Optional e-lock available in the vertical position for the file drawers. Please specify V - Vertical and add \$224 list.
- Optional e-lock available in the horizontal position for the wardrobe. Please specify HR - Horizontal Right or HL - Horizontal Left and add \$224 list.

PRODUCT CODE	FINISH		SIZE / INCHES				WEIGHT LBS	VOL FT ³
	LP	W	H (LP/B)	H (W)	W	D		
Left								
L2TW2F2DL50H20D	1925	2079	49.56	50.00	24	20	222	22
L2TW2F2DL66H20D	2156	2261	65.81	66.25	24	20	279	24
L2TW2F2DL72H20D	2239	2345	72.81	73.24	24	20	295	26
L2TW2F2DL50H24D	2001	2158	49.56	50.00	24	24	222	22
L2TW2F2DL66H24D	2245	2351	65.81	66.25	24	24	279	24
L2TW2F2DL72H24D	2331	2438	72.81	73.24	24	24	295	26
Right								
L2TW2F2DR50H20D	1925	2079	49.56	50.00	24	20	222	22
L2TW2F2DR66H20D	2156	2261	65.81	66.25	24	20	279	24
L2TW2F2DR72H20D	2239	2345	72.81	73.24	24	20	295	26
L2TW2F2DR50H24D	2001	2158	49.56	50.00	24	24	222	22
L2TW2F2DR66H24D	2245	2351	65.81	66.25	24	24	279	24
L2TW2F2DR72H24D	2331	2438	72.81	73.24	24	24	295	26

L2TW3F2D-D • Storage Tower with a 2 High Cupboard, FFF Drawers and Wardrobe

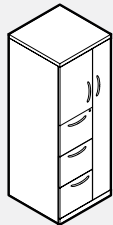

Right Hand Shown

- Two locks included.
- Optional e-lock available in the vertical position for the file drawers. Please specify V - Vertical and add \$224 list.
- Optional e-lock available in the horizontal position for the wardrobe. Please specify HR - Horizontal Right or HL - Horizontal Left and add \$224 list.

PRODUCT CODE	FINISH		SIZE / INCHES				WEIGHT LBS	VOL FT ³
	LP	W	H (LP/B)	H (W)	W	D		
Left								
L2TW3F2DL66H20D	2281	2394	65.81	66.25	24	20	296	24
L2TW3F2DL72H20D	2364	2453	72.81	73.24	24	20	311	26
L2TW3F2DL66H24D	2372	2489	65.81	66.25	24	24	296	24
L2TW3F2DL72H24D	2460	2552	72.81	73.24	24	24	311	26
Right								
L2TW3F2DR66H20D	2281	2394	65.81	66.25	24	20	296	24
L2TW3F2DR72H20D	2364	2453	72.81	73.24	24	20	311	26
L2TW3F2DR66H24D	2372	2489	65.81	66.25	24	24	296	24
L2TW3F2DR72H24D	2460	2552	72.81	73.24	24	24	311	26

L2TWBBFDO • Storage Tower with 3 High Side Open Cupboard, BBF Drawers and Wardrobe

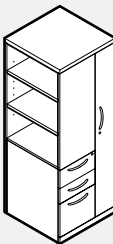

Right Hand Shown

- Open bookcase compartment includes 1 adjustable shelves for 50" h unit and 2 adjustable shelves for 66" h and 72" h units
- Two locks included.
- Optional e-lock available in the vertical position for the box, box, file drawers. Please specify V - Vertical and add \$224 list.
- Optional e-lock available in the horizontal position for the wardrobe. Please specify HR - Horizontal Right or HL - Horizontal Left and add \$224 list.

PRODUCT CODE	FINISH		SIZE / INCHES				WEIGHT LBS	VOL FT ³
	LP	W	H (LP/B)	H (W)	W	D		
Left								
L2TWBBFDOL50H20D	1903	2024	49.50	50.00	24	20	285	20
L2TWBBFDOL66H20D	2107	2175	65.81	66.25	24	20	345	22
L2TWBBFDOL72H20D	2177	2242	72.81	73.25	24	20	375	24
L2TWBBFDOL50H24D	1981	2103	49.50	50.00	24	24	285	20
L2TWBBFDOL66H24D	2191	2262	65.81	66.25	24	24	345	22
L2TWBBFDOL72H24D	2263	2331	72.81	73.25	24	24	375	24
Right								
L2TWBBFDOR50H20D	1903	2024	49.50	50.00	24	20	285	20
L2TWBBFDOR66H20D	2107	2175	65.81	66.25	24	20	345	22
L2TWBBFDOR72H20D	2177	2242	72.81	73.25	24	20	375	24
L2TWBBFDOR50H24D	1981	2103	49.50	50.00	24	24	285	20
L2TWBBFDOR66H24D	2191	2262	65.81	66.25	24	24	345	22
L2TWBBFDOR72H24D	2263	2331	72.81	73.25	24	24	375	24

L2TW2FDO-D • Storage Tower with a 3 High Side Open Cupboard, FF Drawers and Wardrobe

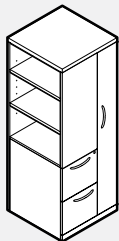

Right Hand Shown

- 50" High Tower comes with one adjustable shelf.
- Two locks included.
- Optional e-lock available in the vertical position for the file drawers. Please specify V - Vertical and add \$224 list.
- Optional e-lock available in the horizontal position for the wardrobe. Please specify HR - Horizontal Right or HL - Horizontal Left and add \$224 list.

PRODUCT CODE	FINISH		SIZE/INCHES				WEIGHT LBS	VOL FT ³
	LP	W	H(LP/B)	H(W)	W	D		
Left								
L2TW2FDOL50H20D	1782	1900	49.56	50.00	24	20	211	22
L2TW2FDOL66H20D	1983	2053	65.81	66.25	24	20	268	24
L2TW2FDOL72H20D	2054	2118	72.81	73.24	24	20	284	26
L2TW2FDOL50H24D	1851	1975	49.56	50.00	24	24	211	22
L2TW2FDOL66H24D	2063	2133	65.81	66.25	24	24	268	24
L2TW2FDOL72H24D	2134	2202	72.81	73.24	24	24	284	26
Right								
L2TW2FDOR50H20D	1782	1900	49.56	50.00	24	20	211	22
L2TW2FDOR66H20D	1983	2053	65.81	66.25	24	20	268	24
L2TW2FDOR72H20D	2054	2118	72.81	73.24	24	20	284	26
L2TW2FDOR50H24D	1851	1975	49.56	50.00	24	24	211	22
L2TW2FDOR66H24D	2063	2133	65.81	66.25	24	24	268	24
L2TW2FDOR72H24D	2134	2202	72.81	73.24	24	24	284	26

L2TW3FDO-D • Storage Tower with a 2 High Side Open Cupboard, FFF Drawers and Wardrobe

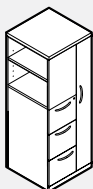

Right Hand Shown

- Two locks included.
- Optional e-lock available in the vertical position for the file drawers. Please specify V - Vertical and add \$224 list.
- Optional e-lock available in the horizontal position for the wardrobe. Please specify HR - Horizontal Right or HL - Horizontal Left and add \$224 list.

PRODUCT CODE	FINISH		SIZE/INCHES				WEIGHT LBS	VOL FT ³
	LP	W	H(LP/B)	H(W)	W	D		
Left								
L2TW3FDOL66H20D	2143	2248	65.81	66.25	24	20	285	24
L2TW3FDOL72H20D	2277	2292	72.81	73.24	24	20	300	26
L2TW3FDOL66H24D	2225	2335	65.81	66.25	24	24	285	24
L2TW3FDOL72H24D	2365	2383	72.81	73.24	24	24	300	26
Right								
L2TW3FDOR66H20D	2143	2248	65.81	66.25	24	20	285	24
L2TW3FDOR72H20D	2277	2292	72.81	73.24	24	20	300	26
L2TW3FDOR66H24D	2225	2335	65.81	66.25	24	24	285	24
L2TW3FDOR72H24D	2365	2383	72.81	73.24	24	24	300	26

L2TWA2DCS • Storage Tower with 2 Aluminum Doors, Coat Rod and Hat Shelf

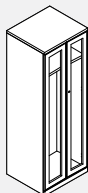

- 50" High Tower comes with 1 shelf above hang rod.
- One lock included.
- E-locks not available for aluminum framed glass doors.

PRODUCT CODE	FINISH		SIZE/INCHES				WEIGHT LBS	VOL FT ³
	LP	W	H(LP/B)	H(W)	W	D		
L2TWA2DCS50H20D	2136	2290	49.56	50.00	24	20	162	20
L2TWA2DCS66H20D	2490	2602	65.81	66.25	24	20	244	22
L2TWA2DCS72H20D	2624	2734	72.81	73.25	24	20	258	24
L2TWA2DCS50H24D	2190	2345	49.56	50.00	24	24	162	20
L2TWA2DCS66H24D	2550	2664	65.81	66.25	24	24	244	22
L2TWA2DCS72H24D	2684	2797	72.81	73.25	24	24	258	24

L2TWA2D • Storage Tower with 2 Aluminum Doors and 4 Adjustable Shelves

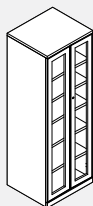

- 50" High Tower comes with 3 adjustable shelves.
- One lock included.
- E-locks not available for aluminum framed glass doors.

PRODUCT CODE	FINISH		SIZE/INCHES				WEIGHT LBS	VOL FT ³
	LP	W	H(LP/B)	H(W)	W	D		
L2TWA2D50H20D	2294	2400	49.56	50.00	24	20	192	20
L2TWA2D66H20D	2631	2779	65.81	66.25	24	20	244	22
L2TWA2D72H20D	2769	2910	72.81	73.25	24	20	257	24
L2TWA2D50H24D	2349	2462	49.56	50.00	24	24	192	20
L2TWA2D66H24D	2695	2847	65.81	66.25	24	24	244	22
L2TWA2D72H24D	2835	2981	72.81	73.25	24	24	257	24

L2TWA2H2D • Storage Tower with a 3 High Cupboard over a 2 High Lateral

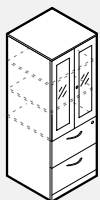

- 50" High Tower comes with 1 adjustable shelf.
- Lock is on the upper drawer.
- Two locks included.
- Optional e-lock available in the vertical position. Please specify V - Vertical and add \$224 list.
- E-locks not available for aluminum framed glass doors.

PRODUCT CODE	FINISH		SIZE/INCHES				WEIGHT LBS	VOL FT ³
	LP	W	H(LP/B)	H(W)	W	D		
L2TWA2H2D50H20D	2499	2543	49.56	50.00	24	20	202	20
L2TWA2H2D66H20D	2902	2938	65.81	66.25	24	20	254	22
L2TWA2H2D72H20D	3036	3192	72.81	73.25	24	20	258	24
L2TWA2H2D50H24D	2582	2625	49.56	50.00	24	24	202	20
L2TWA2H2D66H24D	2992	3031	65.81	66.25	24	24	254	22
L2TWA2H2D72H24D	3127	3289	72.81	73.25	24	24	258	24

L2TWA3H2D • Storage Tower with a 2 High Cupboard with Aluminum Doors over a 3 High Lateral

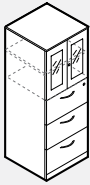

- Lock is on the upper drawer.
- Two locks included.
- Optional e-lock available in the vertical position. Please specify V - Vertical and add \$224 list.
- E-locks not available for aluminum framed glass doors.

PRODUCT CODE	FINISH		SIZE/INCHES				WEIGHT		VOL FT ³
	LP	W	H (LP/B)	H (W)	W	D	LBS		
L2TWA3H2D66H20D	2988	3097	65.81	66.25	24	20	269	22	
L2TWA3H2D72H20D	3128	3208	72.81	73.25	24	20	283	24	
L2TWA3H2D66H24D	3086	3196	65.81	66.25	24	24	269	22	
L2TWA3H2D72H24D	3229	3313	72.81	73.25	24	24	283	24	

L2TWA4H2D • Storage Tower with Cupboard with Aluminum Doors over a 4 High Lateral

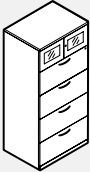

- Lock is on the upper drawer.
- Two locks included.
- Optional e-lock available in the vertical position. Please specify V - Vertical and add \$224 list.
- E-locks not available for aluminum framed glass doors.

PRODUCT CODE	FINISH		SIZE/INCHES				WEIGHT		VOL FT ³
	LP	W	H (LP/B)	H (W)	W	D	LBS		
L2TWA4H2D66H20D	3123	3231	65.81	66.25	24	20	279	22	
L2TWA4H2D72H20D	3289	3324	72.81	73.25	24	20	293	24	
L2TWA4H2D66H24D	3232	3347	65.81	66.25	24	24	293	22	
L2TWA4H2D72H24D	3406	3442	72.81	73.25	24	24	293	24	

L2TWA2F2D • Storage Tower with a 3 High Cupboard, FF Drawers and Wardrobe

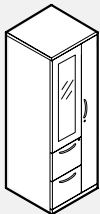

Right Hand Shown

- Storage compartment includes 1 adjustable shelves for 50" unit and 2 adjustable shelves for 66" and 72" units
- Two locks included.
- Optional e-lock available in the vertical position for the file drawers. Please specify V - Vertical and add \$224 list.
- Optional e-lock available in the horizontal position for the wardrobe. Please specify HR - Horizontal Right or HL - Horizontal Left and add \$224 list.
- E-locks not available for aluminum framed glass doors.

PRODUCT CODE	FINISH		SIZE/INCHES				WEIGHT		VOL FT ³
	LP	W	H (LP/B)	H (W)	W	D	LBS		
L2TWA2F2DR50H20D	2177	2330	49.56	50.00	24	20	219	20	
L2TWA2F2DR66H20D	2516	2620	65.81	66.25	24	20	276	22	
L2TWA2F2DR72H20D	2640	2745	72.81	73.25	24	20	292	24	
L2TWA2F2DR50H24D	2254	2410	49.56	50.00	24	24	219	20	
L2TWA2F2DR66H24D	2603	2710	65.81	66.25	24	24	276	22	
L2TWA2F2DR72H24D	2729	2839	72.81	73.25	24	24	292	24	
L2TWA2F2DL50H20D	2177	2330	49.56	50.00	24	20	219	20	
L2TWA2F2DL66H20D	2516	2620	65.81	66.25	24	20	276	22	
L2TWA2F2DL72H20D	2640	2745	72.81	73.25	24	20	292	24	
L2TWA2F2DL50H24D	2254	2410	49.56	50.00	24	24	219	20	
L2TWA2F2DL66H24D	2603	2710	65.81	66.25	24	24	276	22	
L2TWA2F2DL72H24D	2729	2839	72.81	73.25	24	24	292	24	

L2TWABBF2D • Storage Tower with a 3 High Cupboard, BBF Drawers and Wardrobe

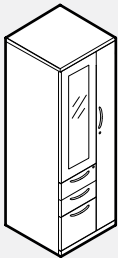

Right Hand Shown

- Storage compartment includes 1 adjustable shelves for 50" unit and 2 adjustable shelves for 66" and 72" units
- Two locks included.
- Optional e-lock available in the vertical position for the box, box, file drawers. Please specify V - Vertical and add \$224 list.
- Optional e-lock available in the horizontal position for the wardrobe. Please specify HR - Horizontal Right or HL - Horizontal Left and add \$224 list.
- E-locks not available for aluminum framed glass doors.

PRODUCT CODE	FINISH		SIZE/INCHES				WEIGHT		VOL FT ³
	LP	W	H (LP/B)	H (W)	W	D	LBS		
L2TWABBF2DL50H20D	2300	2452	49.56	50.00	24	20	288	20	
L2TWABBF2DL66H20D	2640	2743	65.81	66.25	24	20	348	22	
L2TWABBF2DL72H20D	2761	2868	72.81	73.25	24	20	378	24	
L2TWABBF2DL50H24D	2376	2534	49.56	50.00	24	24	288	20	
L2TWABBF2DL66H24D	2727	2834	65.81	66.25	24	24	348	22	
L2TWABBF2DL72H24D	2851	2960	72.81	73.25	24	24	378	24	
L2TWABBF2DR50H20D	2300	2452	49.56	50.00	24	20	288	20	
L2TWABBF2DR66H20D	2640	2743	65.81	66.25	24	20	348	22	
L2TWABBF2DR72H20D	2761	2868	72.81	73.25	24	20	378	24	
L2TWABBF2DR50H24D	2376	2534	49.56	50.00	24	24	288	20	
L2TWABBF2DR66H24D	2727	2834	65.81	66.25	24	24	348	22	
L2TWABBF2DR72H24D	2851	2960	72.81	73.25	24	24	378	24	

L2TW3F2D-D • Storage Tower with a 2 High Cupboard, FFF Drawers and Wardrobe

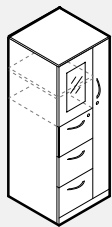

- Lock is on the upper drawer.
- Storage compartment includes 1 adjustable shelf.
- Two locks included.
- Optional e-lock available in the vertical position for the file drawers. Please specify V - Vertical and add \$224 list.
- Optional e-lock available in the horizontal position for the wardrobe. Please specify HR - Horizontal Right or HL - Horizontal Left and add \$224 list.
- E-locks not available for aluminum framed glass doors.

PRODUCT CODE	FINISH		SIZE/INCHES				WEIGHT		VOL FT ³
	LP	W	H (LP/B)	H (W)	W	D	LBS		
L2TWA3F2DR66H20D	2577	2692	65.81	66.25	24	20	340	22	
L2TWA3F2DR72H20D	2697	2786	72.81	73.25	24	20	370	24	
L2TWA3F2DR66H24D	2670	2786	65.81	66.25	24	24	340	22	
L2TWA3F2DR72H24D	2792	2886	72.81	73.25	24	24	370	24	
L2TWA3F2DL66H20D	2577	2692	65.81	66.25	24	20	340	22	
L2TWA3F2DL72H20D	2697	2786	72.81	73.25	24	20	370	24	
L2TWA3F2DL66H24D	2670	2786	65.81	66.25	24	24	340	22	
L2TWA3F2DL72H24D	2792	2886	72.81	73.25	24	24	370	24	

L2CB • Storage Cabinet with 2 Doors and 4 Adjustable Shelves

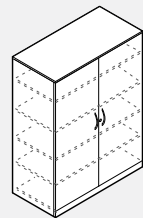

- 50"h. cabinet comes with 3 adjustable shelves.
- 66"h. and 72"h. Cabinet comes with 4 adjustable shelves.
- One lock included.
- Optional e-lock available in the horizontal position. Please specify HR - Horizontal Right and add \$224 list.

PRODUCT CODE	FINISH		SIZE/INCHES				WEIGHT		VOL FT ³
	LP	W	H (LP/B)	H (W)	W	D	LBS		
L2CB20302D50H	1684	1821	49.56	50.00	30	20	245	21	
L2CB20362D50H	1803	1964	49.56	50.00	36	20	281	25	
L2CB20302D66H	1913	2047	65.81	66.25	30	20	310	28	
L2CB20362D66H	2056	2213	65.81	66.25	36	20	354	33	
L2CB20302D72H	1988	2120	72.81	73.24	30	20	327	30	
L2CB20362D72H	2133	2287	72.81	73.24	36	20	372	36	
L2CB24302D50H	1751	1896	49.56	50.00	30	24	245	25	
L2CB24362D50H	1874	2041	49.56	50.00	36	24	281	30	
L2CB24302D66H	1990	2130	65.81	66.25	30	24	310	33	
L2CB24362D66H	2138	2301	65.81	66.25	36	24	354	39	
L2CB24302D72H	2067	2206	72.81	73.24	30	24	327	36	
L2CB24362D72H	2220	2379	72.81	73.24	36	24	372	43	

L2CB • Storage Cabinet with 2 Doors Coat Rod and 1 Fixed Shelf

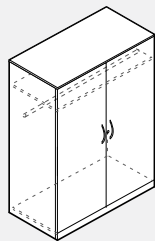

- One lock included.
- Optional e-lock available in the horizontal position. Please specify HR - Horizontal Right and add \$224 list.

PRODUCT CODE	FINISH		SIZE/INCHES				WEIGHT		VOL FT ³
	LP	W	H (LP/B)	H (W)	W	D	LBS		
L2CB20302DCS50H	1540	1668	49.56	50.00	30	20	204	21	
L2CB20362DCS50H	1625	1781	49.56	50.00	36	20	231	25	
L2CB20302DCS66H	1689	1849	65.81	66.25	30	20	249	28	
L2CB20362DCS66H	1778	1933	65.81	66.25	36	20	281	33	
L2CB20302DCS72H	1761	2025	72.81	73.24	30	20	265	30	
L2CB20362DCS72H	1858	2014	72.81	73.24	36	20	298	36	
L2CB24302DCS50H	1601	1734	49.56	50.00	30	24	204	25	
L2CB24362DCS50H	1690	1850	49.56	50.00	36	24	231	30	
L2CB24302DCS66H	1756	1925	65.81	66.25	30	24	249	33	
L2CB24362DCS66H	1848	2009	65.81	66.25	36	24	281	39	
L2CB24302DCS72H	1835	2103	72.81	73.24	30	24	265	36	
L2CB24362DCS72H	1932	2094	72.81	73.24	36	24	298	43	

L2CB • Storage Cabinet with 3 High Cupboard, 2 Adjustable Shelves over a 2 High Lateral

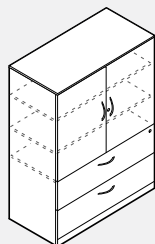

- 50"h. cabinet comes with one adjustable shelf.
- 66" and 72" Cabinet comes with 2 adjustable shelves.
- Two locks included.
- Optional e-lock available for the file drawers vertical position. Please specify V - Vertical and add \$224 list.
- Optional e-lock available in the horizontal position for upper storage cabinet. Please specify HR - Horizontal Right and add \$224 list.

PRODUCT CODE	FINISH		SIZE/INCHES				WEIGHT		VOL FT ³
	LP	W	H (LP/B)	H (W)	W	D	LBS		
L2CB20302H2D50H	2190	2312	49.56	50.00	30	20	256	21	
L2CB20362H2D50H	2324	2435	49.56	50.00	36	20	292	25	
L2CB20302H2D66H	2451	2575	65.81	66.25	30	20	321	28	
L2CB20362H2D66H	2611	2756	65.81	66.25	36	20	365	33	
L2CB20302H2D72H	2527	2652	72.81	73.24	30	20	338	30	
L2CB20362H2D72H	2665	2790	72.81	73.24	36	20	383	36	
L2CB24302H2D50H	2277	2401	49.56	50.00	30	24	256	25	
L2CB24362H2D50H	2421	2534	49.56	50.00	36	24	292	30	
L2CB24302H2D66H	2549	2677	65.81	66.25	30	24	321	33	
L2CB24362H2D66H	2715	2867	65.81	66.25	36	24	365	39	
L2CB24302H2D72H	2629	2757	72.81	73.24	30	24	338	36	
L2CB24362H2D72H	2770	2902	72.81	73.24	36	24	383	43	

L2CB • Storage Cabinet with a 2 High Cupboard, 1 Adjustable Shelf over a 3 High Lateral

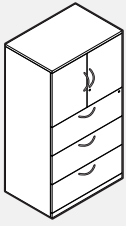

- One lock on right door.
- Two locks included.
- Optional e-lock available for the file drawers vertical position. Please specify V - Vertical and add \$224 list.
- Optional e-lock available in the horizontal position for upper storage cabinet. Please specify HR - Horizontal Right and add \$224 list.

PRODUCT CODE	FINISH		SIZE/INCHES				WEIGHT		VOL FT ³
	LP	W	H (LP/B)	H (W)	W	D	LBS		
L2CB20303H2D66H	2569	2694	65.81	66.25	30	20	337	28	
L2CB20363H2D66H	2729	2877	65.81	66.25	36	20	381	33	
L2CB20303H2D72H	2670	2795	72.81	73.25	30	20	354	30	
L2CB20363H2D72H	2830	2982	72.81	73.25	36	20	399	36	
L2CB24303H2D66H	2671	2800	65.81	66.25	30	24	337	28	
L2CB24363H2D66H	2839	2991	65.81	66.25	36	24	381	33	
L2CB24303H2D72H	2779	2907	72.81	73.25	30	24	354	30	
L2CB24363H2D72H	2946	3101	72.81	73.25	36	24	399	36	

L2CB • Storage Cabinet with a 2 Door Storage Cupboard above a 4 High Lateral

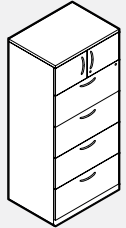

- Two locks included.
- Lock on cupboard is not available for UB, UC or RN handles.
- Optional e-lock available for the file drawers vertical position. Please specify V - Vertical and add \$224 list.
- Optional e-lock available in the horizontal position for upper storage cabinet. Please specify HR - Horizontal Right and add \$224 list.

PRODUCT CODE	FINISH		SIZE/INCHES				WEIGHT		VOL FT ³
	LP	W	H (LP/B)	H (W)	W	D	LBS		
L2CB20304H2D66H	2957	3106	65.81	66.25	30	20	343	28	
L2CB20364H2D66H	3189	3345	65.81	66.25	36	20	387	33	
L2CB20304H2D72H	3035	3165	72.81	73.24	30	20	360	30	
L2CB20364H2D72H	3222	3375	72.81	73.24	36	20	405	36	
L2CB24304H2D66H	3076	3231	65.81	66.25	30	24	278	33	
L2CB24364H2D66H	3317	3479	65.81	66.25	36	24	314	39	
L2CB24304H2D72H	3156	3291	72.81	73.24	30	24	343	36	
L2CB24364H2D72H	3348	3510	72.81	73.24	36	24	387	43	

L2CB • Storage Cabinet with Open Bookcase and 2 Adjustable Shelves & 2 Door Cupboard

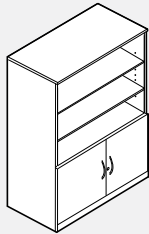

- 50" h. cabinet comes with one adjustable shelf.
- 66" h. and 72" h. Cabinet comes with 2 adjustable Shelves.
- One lock included.
- Optional e-lock available in the horizontal position. Please specify HR - Horizontal Right and add \$224 list.

PRODUCT CODE	FINISH		SIZE/INCHES				WEIGHT		VOL FT ³
	LP	W	H (LP/B)	H (W)	W	D	LBS		
L2CB20302D050H	1414	1601	49.56	50.00	30	20	212	21	
L2CB20362D050H	1509	1773	49.56	50.00	36	20	248	25	
L2CB20302D066H	1585	1823	65.81	66.25	30	20	277	28	
L2CB20362D066H	1944	2068	65.81	66.25	36	20	321	33	
L2CB20302D072H	1638	1898	72.81	73.24	30	20	294	30	
L2CB20362D072H	1786	2145	72.81	73.24	36	20	339	36	
L2CB24302D050H	1483	1681	49.56	50.00	30	24	212	25	
L2CB24362D050H	1585	1862	49.56	50.00	36	24	248	30	
L2CB24302D066H	1664	1915	65.81	66.25	30	24	277	33	
L2CB24362D066H	1795	2171	65.81	66.25	36	24	321	39	
L2CB24302D072H	1720	1990	72.81	73.24	30	24	294	36	
L2CB24362D072H	1874	2254	72.81	73.24	36	24	339	43	

L2CB • Storage Cabinet with Open Bookcase and 2 Adjustable Shelves over a 2 High Lateral

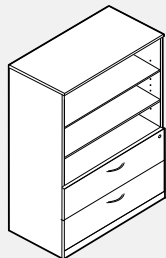

- 50" h. cabinet comes with one adjustable shelf.
- 66" h. and 72" h. Cabinet comes with 2 adjustable Shelves.
- One lock included.
- Optional e-lock available in the vertical position. Please specify V - Vertical and add \$224 list.

PRODUCT CODE	FINISH		SIZE/INCHES				WEIGHT		VOL FT ³
	LP	W	H (LP/B)	H (W)	W	D	LBS		
L2CB20302H050H	1706	1833	49.56	50.00	30	20	226	21	
L2CB20362H050H	1791	1925	49.56	50.00	36	20	261	25	
L2CB20302H066H	1879	2003	65.81	66.25	30	20	290	28	
L2CB20362H066H	2031	2113	65.81	66.25	36	20	334	33	
L2CB20302H072H	1955	1989	72.81	73.24	30	20	307	30	
L2CB20362H072H	2085	2165	72.81	73.24	36	20	352	36	
L2CB24302H050H	1789	1924	49.56	50.00	30	24	226	25	
L2CB24362H050H	1879	2022	49.56	50.00	36	24	261	30	
L2CB24302H066H	1973	2103	65.81	66.25	30	24	290	33	
L2CB24362H066H	2133	2219	65.81	66.25	36	24	334	39	
L2CB24302H072H	2052	2089	72.81	73.24	30	24	307	36	
L2CB24362H072H	2190	2273	72.81	73.24	36	24	352	43	

L2CBA • Storage Cabinet with 2 Doors and 4 Adjustable Shelves

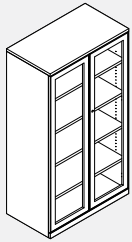

- One lock included.
- Door frame is anodized aluminum.
- Glazing is frosted acrylic.
- Doors standard with no handles.
- E-locks not available for aluminum framed glass doors.

PRODUCT CODE	FINISH LP	W	SIZE / INCHES				D	WEIGHT LBS	VOL FT ³
			H (LP/B)	H (W)	W	D			
L2CBA20302D50H	2594	2731	49.56	50.00	30	20	235	21	
L2CBA20362D50H	2809	2973	49.56	50.00	36	20	281	25	
L2CBA20302D66H	3031	3165	65.81	66.25	30	20	300	28	
L2CBA20362D66H	3296	3454	65.81	66.25	36	20	344	33	
L2CBA20302D72H	3183	3317	72.81	73.25	30	20	317	30	
L2CBA20362D72H	3461	3617	72.81	73.25	36	20	362	36	
L2CBA24302D50H	2663	2807	49.56	50.00	30	24	235	21	
L2CBA24362D50H	2882	3047	49.56	50.00	36	24	281	25	
L2CBA24302D66H	3106	3249	65.81	66.25	30	24	300	28	
L2CBA24362D66H	3378	3541	65.81	66.25	36	24	344	33	
L2CBA24302D72H	3263	3400	72.81	73.25	30	24	317	30	
L2CBA24362D72H	3546	3710	72.81	73.25	36	24	362	36	

L2CBA • Storage Cabinet with 2 Doors, Coat Rod and 1 Adjustable Shelf

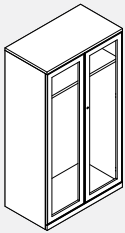

- One lock included.
- Door frame is anodized aluminum.
- Glazing is frosted acrylic.
- Doors standard with no handles.
- E-locks not available for aluminum framed glass doors.

PRODUCT CODE	FINISH LP	W	SIZE / INCHES				D	WEIGHT LBS	VOL FT ³
			H (LP/B)	H (W)	W	D			
L2CBA20302DCS50H	2452	2580	49.56	50.00	30	20	195	21	
L2CBA20362DCS50H	2631	2786	49.56	50.00	36	20	221	25	
L2CBA20302DCS66H	2806	2966	65.81	66.25	30	20	239	28	
L2CBA20362DCS66H	3016	3174	65.81	66.25	36	20	271	33	
L2CBA20302DCS72H	2958	3221	72.81	73.25	30	20	255	30	
L2CBA20362DCS72H	3187	3342	72.81	73.25	36	20	288	36	
L2CBA24302DCS50H	2514	2646	49.56	50.00	30	24	195	21	
L2CBA24362DCS50H	2696	2858	49.56	50.00	36	24	221	25	
L2CBA24302DCS66H	2872	3042	65.81	66.25	30	24	239	28	
L2CBA24362DCS66H	3087	3251	65.81	66.25	36	24	271	33	
L2CBA24302DCS72H	3031	3298	72.81	73.25	30	24	255	30	
L2CBA24362DCS72H	3258	3422	72.81	73.25	36	24	288	36	

L2CBA • Storage Cabinet with 3 High Cupboard, 2 Adjustable Shelves over a 2 High Lateral

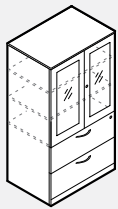

- Cabinet 2h2d.
- One lock on right door.
- One lock on upper drawer.
- Door frame is anodized aluminum with lock(s).
- Glazing is frosted acrylic.
- Doors standard with no handles.
- Two locks included.
- Optional e-lock available in the vertical position. Please specify V-Vertical and add \$224 list.
- E-locks not available for aluminum framed glass doors.

PRODUCT CODE	FINISH LP	W	SIZE / INCHES				D	WEIGHT LBS	VOL FT ³
			H (LP/B)	H (W)	W	D			
L2CBA20302H2D50H	2740	2862	49.56	50.00	30	20	233	19	
L2CBA20362H2D50H	2925	3038	49.56	50.00	36	20	265	22	
L2CBA20302H2D66H	3207	3330	65.81	66.25	30	20	292	25	
L2CBA20362H2D66H	3444	3588	65.81	66.25	36	20	332	29	
L2CBA20302H2D72H	3359	3484	72.81	73.25	30	20	307	27	
L2CBA20362H2D72H	3585	3710	72.81	73.25	36	20	348	32	
L2CBA24302H2D50H	2826	2952	49.56	50.00	30	24	233	22	
L2CBA24362H2D50H	3017	3132	49.56	50.00	36	24	265	27	
L2CBA24302H2D66H	3307	3433	65.81	66.25	30	24	292	29	
L2CBA24362H2D66H	3546	3698	65.81	66.25	36	24	332	35	
L2CBA24302H2D72H	3461	3589	72.81	73.25	30	24	307	32	
L2CBA24362H2D72H	3689	3821	72.81	73.25	36	24	348	38	

L2CBA • Storage Cabinet with 2 High Cupboard, 1 Adjustable Shelves over a 3 High Lateral

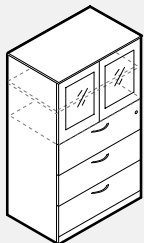

- Cabinet 3h2d.
- One lock on right door.
- One lock on upper drawer.
- Door frame is anodized aluminum with lock(s).
- Glazing is frosted acrylic.
- Doors standard with no handles.
- Two locks included.
- Optional e-lock available in the vertical position. Please specify V-Vertical and add \$224 list.
- E-locks not available for aluminum framed glass doors.

PRODUCT CODE	FINISH LP	W	SIZE / INCHES				D	WEIGHT LBS	VOL FT ³
			H (LP/B)	H (W)	W	D			
L2CBA20303H2D66H	3160	3285	65.81	66.25	30	20	337	28	
L2CBA20363H2D66H	3377	3523	65.81	66.25	36	20	381	33	
L2CBA20303H2D72H	3341	3463	72.81	73.25	30	20	354	30	
L2CBA20363H2D72H	3564	3716	72.81	73.25	36	20	399	36	
L2CBA24303H2D66H	3263	3392	65.81	66.25	30	24	337	28	
L2CBA24363H2D66H	3485	3639	65.81	66.25	36	24	381	33	
L2CBA24303H2D72H	3446	3575	72.81	73.25	30	24	354	30	
L2CBA24363H2D72H	3678	3838	72.81	73.25	36	24	399	36	

L2CBA • Storage Cabinet with 2 Aluminum Door Storage Cupboard above a 4 high Lateral

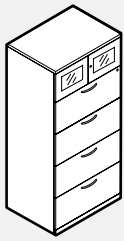

- Two locks included.
- Door frame is anodized aluminum.
- Glazing is frosted acrylic.
- Doors standard with no handles.
- One lock on right door.
- One lock on upper drawer.
- Optional e-lock available in the vertical position. Please specify V - Vertical and add \$224 list.
- E-locks not available for aluminum framed glass doors.

PRODUCT CODE	FINISH		SIZE/INCHES				WEIGHT VOL	
	LP	W	H (LP/B)	H (W)	W	D	LBS	FT ³
L2CBA20304H2D66H	3362	3512	65.81	66.25	30	20	343	28
L2CBA20364H2D66H	3696	3852	65.81	66.25	36	20	387	33
L2CBA20304H2D72H	3524	3655	72.81	73.25	30	20	360	30
L2CBA20364H2D72H	3755	3909	72.81	73.25	36	20	345	36
L2CBA24304H2D66H	3482	3637	65.81	66.25	30	24	343	28
L2CBA24364H2D66H	3824	3985	65.81	66.25	36	24	387	33
L2CBA24304H2D72H	3649	3783	72.81	73.25	30	24	360	30
L2CBA24364H2D72H	3883	4046	72.81	73.25	36	24	345	36

L2HH • Hutch with Hinged Doors

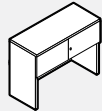

30" - 42" units

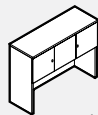

48" units

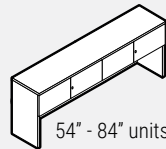

54" - 84" units

- 30" - 42" units come with one lock.
- 48" - 84" units come with two locks.
- Optional e-lock available in the horizontal position. Please specify HR - Horizontal Right and add \$224 list.
- Hutches 48" or longer require two e-locks.

PRODUCT CODE	FINISH		SIZE/INCHES				WEIGHT VOL	
	LP	W	H (LP/B)	W	D	LBS	FT ³	
L2HH30H36	851	954	36.81	30	16	138	17	
L2HH36H36	899	1015	36.81	36	16	145	18	
L2HH42H36	974	1119	36.81	42	16	163	19	
L2HH48H36	1230	1381	36.81	48	16	180	22	
L2HH54H36	1456	1608	36.81	54	16	208	26	
L2HH60H36	1488	1676	36.81	60	16	216	29	
L2HH66H36	1568	1779	36.81	66	16	233	30	
L2HH72H36	1610	1836	36.81	72	16	251	32	
L2HH78H36	1702	1988	36.81	78	16	264	46	
L2HH84H36	1751	2012	36.81	84	16	277	50	
L2HH30H43	915	1008	43.81	30	16	158	19	
L2HH36H43	945	1062	43.81	36	16	166	20	
L2HH42H43	1043	1197	43.81	42	16	175	22	
L2HH48H43	1286	1432	43.81	48	16	191	24	
L2HH54H43	1495	1669	43.81	54	16	209	31	
L2HH60H43	1548	1736	43.81	60	16	227	32	
L2HH66H43	1632	1843	43.81	66	16	249	33	
L2HH72H43	1708	1936	43.81	72	16	259	36	
L2HH78H43	1773	2056	43.81	78	16	272	48	
L2HH84H43	1819	2089	43.81	84	16	285	53	

L2HH-A • Hutch with Aluminum Hinged Doors

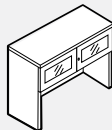

30" - 42" units

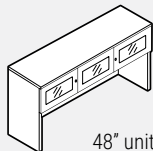

48" units

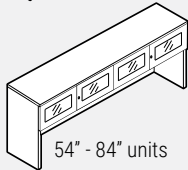

54" - 84" units

- 30" - 42" units come with one lock.
- 48" - 84" units come with two locks.
- Door frame is anodized aluminum.
- Glazing is frosted acrylic.
- Doors standard with no handles.
- E-locks not available for aluminum framed glass doors.

PRODUCT CODE	FINISH		SIZE/INCHES				WEIGHT VOL	
	LP	W	H (LP/B)	W	D	LBS	FT ³	
L2HH30H36A	1351	1451	36.81	30	16	138	17	
L2HH36H36A	1430	1546	36.81	36	16	145	18	
L2HH42H36A	1522	1635	36.81	42	16	163	19	
L2HH48H36A	1997	2145	36.81	48	16	180	22	
L2HH54H36A	2432	2586	36.81	54	16	208	26	
L2HH60H36A	2496	2684	36.81	60	16	216	29	
L2HH66H36A	2587	2614	36.81	66	16	233	30	
L2HH72H36A	2655	2881	36.81	72	16	251	32	
L2HH78H36A	2749	3035	36.81	78	16	264	46	
L2HH84H36A	2826	3101	36.81	84	16	277	50	
L2HH30H43A	1415	1509	43.81	30	16	158	19	
L2HH36H43A	1480	1594	43.81	36	16	166	20	
L2HH42H43A	1591	1748	43.81	42	16	175	22	
L2HH48H43A	2052	2198	43.81	48	16	191	24	
L2HH54H43A	2490	2646	43.81	54	16	209	31	
L2HH60H43A	2556	2747	43.81	60	16	227	32	
L2HH66H43A	2651	2769	43.81	66	16	249	33	
L2HH72H43A	2760	2989	43.81	72	16	259	36	
L2HH78H43A	2819	3102	43.81	78	16	272	48	
L2HH84H43A	2900	3167	43.81	84	16	285	53	

L2HO • Open Hutch

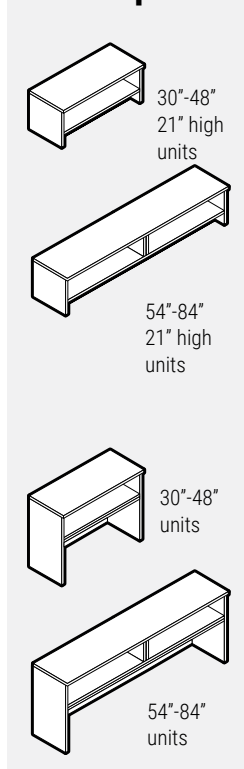

PRODUCT CODE	FINISH LP	W	SIZE/INCHES			WEIGHT LBS	VOL FT ³
			H(LP/B)	W	D		
L2HO30H21	472	579	20.56	30	16	73	11
L2HO36H21	518	605	20.56	36	16	81	13
L2HO42H21	575	727	20.56	42	16	96	15
L2HO48H21	639	799	20.56	48	16	100	18
L2HO54H21	769	931	20.56	54	16	124	20
L2HO60H21	796	997	20.56	60	16	134	22
L2HO66H21	849	1075	20.56	66	16	144	24
L2HO72H21	882	1122	20.56	72	16	152	26
L2HO78H21	932	1170	20.56	78	16	161	29
L2HO84H21	977	1262	20.56	84	16	169	31
L2HO30H36	576	681	36.81	30	16	91	18
L2HO36H36	626	751	36.81	36	16	109	19
L2HO42H36	691	842	36.81	42	16	127	22
L2HO48H36	799	956	36.81	48	16	131	24
L2HO54H36	903	1064	36.81	54	16	145	29
L2HO60H36	935	1137	36.81	60	16	138	31
L2HO66H36	996	1225	36.81	66	16	142	33
L2HO72H36	1041	1284	36.81	72	16	149	36
L2HO78H36	1096	1399	36.81	78	16	154	46
L2HO84H36	1153	1431	36.81	84	16	158	50
L2HO30H43	642	681	43.81	30	16	99	22
L2HO36H43	677	751	43.81	36	16	108	26
L2HO42H43	801	842	43.81	42	16	122	31
L2HO48H43	854	956	43.81	48	16	127	35
L2HO54H43	972	1064	43.81	54	16	151	40
L2HO60H43	1063	1137	43.81	60	16	161	44
L2HO66H43	1126	1225	43.81	66	16	171	48
L2HO72H43	1209	1284	43.81	72	16	178	53
L2HO78H43	1233	1399	43.81	78	16	187	57
L2HO84H43	1293	1431	43.81	84	16	196	62

L2HF • Hutch with Flip Up Doors

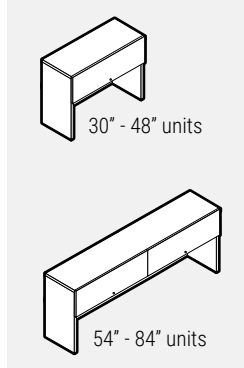

- 30" - 48" units come with one lock.
- 54" - 84" units come with two locks.
- Optional e-lock available in the horizontal position. Please specify HR - Horizontal Right and add \$224 list.
- Hutches 48" or longer require two e-locks.

PRODUCT CODE	FINISH LP	W	SIZE/INCHES			WEIGHT LBS	VOL FT ³
			H(LP/B)	W	D		
L2HF30H36	857	890	36.81	30	16	142	18
L2HF36H36	914	949	36.81	36	16	146	19
L2HF42H36	983	1022	36.81	42	16	158	22
L2HF48H36	988	1029	36.81	48	16	180	24
L2HF54H36	1483	1541	36.81	54	16	182	29
L2HF60H36	1573	1637	36.81	60	16	220	31
L2HF66H36	1647	1713	36.81	66	16	253	33
L2HF72H36	1696	1764	36.81	72	16	259	36
L2HF78H36	1774	1845	36.81	78	16	264	46
L2HF84H36	1839	1913	36.81	84	16	275	50
L2HF30H43	943	978	43.81	30	16	150	22
L2HF36H43	948	988	43.81	36	16	154	26
L2HF42H43	1021	1060	43.81	42	16	166	31
L2HF48H43	1093	1136	43.81	48	16	188	35
L2HF54H43	1498	1559	43.81	54	16	194	40
L2HF60H43	1619	1684	43.81	60	16	232	44
L2HF66H43	1702	1772	43.81	66	16	265	48
L2HF72H43	1749	1816	43.81	72	16	271	53
L2HF78H43	1878	1956	43.81	78	16	276	57
L2HF84H43	1948	2026	43.81	84	16	287	62

L2HHP • Hutch with Laminate Doors and Pigeon Holes

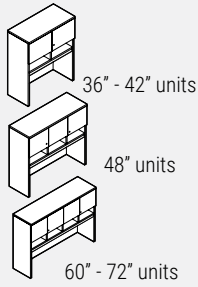

- For tackboards, please use LTB21xx.
- 36" - 42" units come with one lock.
- 48" - 72" units come with two locks.
- Optional e-lock available in the horizontal position. Please specify HR - Horizontal Right or HL - Horizontal Left for the 48" wide unit and add \$224 list.
- Hutches 48" or longer require two e-locks.

PRODUCT CODE	FINISH		SIZE/INCHES			WEIGHT		VOL FT ³
	LP	W	H (LP/B)	W	D	LBS		
L2HHP36	1092	1203	43.81	36	16	145	17	
L2HHP42	1159	1289	43.81	42	16	163	19	
L2HHP48	1561	1715	43.81	48	16	180	22	
L2HHP60	1890	2068	43.81	60	16	216	26	
L2HHP66	1949	2169	43.81	66	16	233	30	
L2HHP72	2030	2254	43.81	72	16	251	32	

L2HHP-A • Hutch with Aluminum Hinged Doors and Pigeon Holes

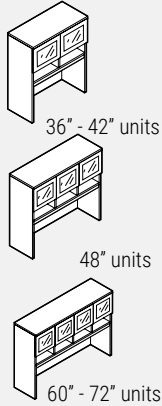

- For tackboards, please use LTB21xx.
- 36" - 42" units come with one lock.
- 48" - 72" units come with two locks.
- Door frame is anodized aluminum.
- Glazing is frosted acrylic.
- Doors standard with no handles.
- E-locks not available for aluminum framed glass doors.

PRODUCT CODE	FINISH		SIZE/INCHES			WEIGHT		VOL FT ³
	LP	W	H (LP/B)	W	D	LBS		
L2HHP36A	1531	1646	43.81	36	16.8	132	15	
L2HHP42A	1670	1803	43.81	42	16.8	148	17	
L2HHP48A	2239	2391	43.81	48	16.8	164	20	
L2HHP60A	2768	2949	43.81	60	16.8	196	24	
L2HHP66A	2864	3084	43.81	66	16.8	212	27	
L2HHP72A	2983	3207	43.81	72	16.8	228	29	

L2HSD • Hutch with Sliding Laminate Doors

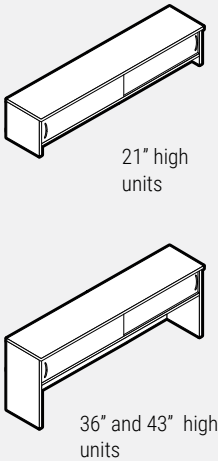

- One lock included.

PRODUCT CODE	FINISH		SIZE/INCHES			WEIGHT		VOL FT ³
	LP	W	H (LP/B)	W	D	LBS		
L2HSD48H21	1062	1225	20.56	48	16	122	18	
L2HSD54H21	1165	1349	20.56	54	16	146	20	
L2HSD60H21	1205	1409	20.56	60	16	156	22	
L2HSD66H21	1285	1509	20.56	66	16	166	24	
L2HSD72H21	1322	1540	20.56	72	16	174	26	
L2HSD78H21	1387	1671	20.56	78	16	183	29	
L2HSD84H21	1428	1708	20.56	84	16	191	31	
L2HSD48H36	1316	1484	36.81	48	16	141	24	
L2HSD54H36	1454	1621	36.81	54	16	165	29	
L2HSD60H36	1488	1697	36.81	60	16	175	31	
L2HSD66H36	1579	1813	36.81	66	16	185	33	
L2HSD72H36	1619	1850	36.81	72	16	193	36	
L2HSD78H36	1706	2026	36.81	78	16	201	46	
L2HSD84H36	1745	2055	36.81	84	16	210	50	
L2HSD48H43	1394	1562	43.81	48	16	149	35	
L2HSD54H43	1540	1700	43.81	54	16	173	40	
L2HSD60H43	1581	1789	43.81	60	16	183	44	
L2HSD66H43	1672	1905	43.81	66	16	193	48	
L2HSD72H43	1763	1997	43.81	72	16	200	53	
L2HSD78H43	1812	2127	43.81	78	16	209	57	
L2HSD84H43	1869	2158	43.81	84	16	218	62	

L2HGSD • Hutch with Sliding Glass Doors

- One lock included.
- Glass is frosted tempered.

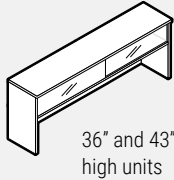
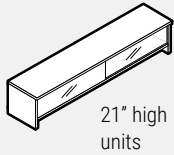

PRODUCT CODE	FINISH LP	SIZE/INCHES				D	WEIGHT LBS	VOL FT ³
		W	H (LP/B)	W	D			
L2HGSD48H21	2281	2451	20.56	48	16	139	18	
L2HGSD54H21	2404	2593	20.56	54	16	163	20	
L2HGSD60H21	2452	2660	20.56	60	16	184	22	
L2HGSD66H21	2543	2779	20.56	66	16	194	24	
L2HGSD72H21	2602	2850	20.56	72	16	201	26	
L2HGSD78H21	2698	2991	20.56	78	16	210	29	
L2HGSD84H21	2764	3055	20.56	84	16	219	31	
L2HGSD48H36	2424	2593	36.81	48	16	157	24	
L2HGSD54H36	2576	2743	36.81	54	16	182	29	
L2HGSD60H36	2614	2822	36.81	60	16	202	31	
L2HGSD66H36	2714	2949	36.81	66	16	212	33	
L2HGSD72H36	2779	3050	36.81	72	16	220	36	
L2HGSD78H36	2890	3204	36.81	78	16	229	46	
L2HGSD84H36	2966	3256	36.81	84	16	238	50	
L2HGSD48H43	2481	2721	43.81	48	16	165	35	
L2HGSD54H43	2614	2875	43.81	54	16	189	40	
L2HGSD60H43	2675	2957	43.81	60	16	210	44	
L2HGSD66H43	2779	3050	43.81	66	16	220	48	
L2HGSD72H43	2850	3192	43.81	72	16	228	53	
L2HGSD78H43	2960	3328	43.81	78	16	237	57	
L2HGSD84H43	3042	3403	43.81	84	16	245	62	

L2DSH • Double Sided Hutch with Laminate Doors

- Two locks included.

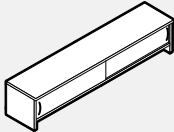

PRODUCT CODE	FINISH LP	SIZE/INCHES				D	WEIGHT LBS	VOL FT ³
		W	H (LP/B)	W	D			
L2DSH60H21	1268	1472	20.56	60	16	156	22	
L2DSH66H21	1350	1575	20.56	66	16	166	24	
L2DSH72H21	1392	1585	20.56	72	16	201	26	
L2DSH78H21	1464	1748	20.56	78	16	210	29	
L2DSH84H21	1509	1786	20.56	84	16	219	31	

LTB27 • Tackboards for 43" High Hutches

- Provides a tackable surface for notes and memos.
- Velcro for installation is included.
- Tackboards for hutches are 3" shorter than the overall size of the hutch.

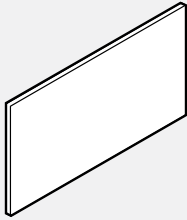

PRODUCT CODE	FABRIC		SIZE/INCHES				WEIGHT LBS	VOL FT ³
	GR1	GR2	H	W	D			
LTB2727	298	315	27	27	1	7	0.46	
LTB2733	323	344	27	33	1	7	0.57	
LTB2739	352	378	27	39	1	7	0.67	
LTB2745	399	428	27	45	1	8	0.78	
LTB2751	459	486	27	51	1	8	0.88	
LTB2757	512	539	27	57	1	9	0.98	
LTB2763	564	592	27	63	1	9	1.09	
LTB2769	620	652	27	69	1	10	1.19	
LTB2775	696	730	27	75	1	10	1.30	
LTB2781	777	811	27	81	1	11	1.40	

LTB21 • Tackboards for 36" High Hutches

- Provides a tackable surface for notes and memos.
- Velcro for installation is included.
- Tackboards for hutches are 3" shorter than the overall size of the hutch.

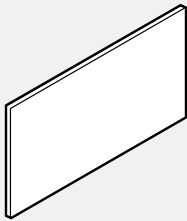

PRODUCT CODE	FABRIC		SIZE/INCHES				WEIGHT LBS	VOL FT ³
	GR1	GR2	H	W	D			
LTB2127	233	252	21	27	1	4	0.38	
LTB2133	253	273	21	33	1	4	0.42	
LTB2139	275	303	21	39	1	4	0.49	
LTB2145	314	341	21	45	1	5	0.56	
LTB2151	359	372	21	51	1	5	0.63	
LTB2157	399	428	21	57	1	6	0.69	
LTB2163	442	474	21	63	1	6	0.76	
LTB2169	486	513	21	69	1	7	0.83	
LTB2175	545	572	21	75	1	7	0.89	
LTB2181	608	636	21	81	1	8	0.96	

L2HC • Corner Curved Bookcase

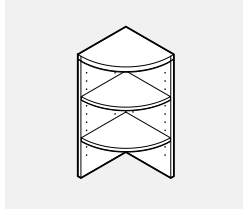

- Shipped knocked down (KD).

PRODUCT CODE	FINISH		SIZE/INCHES			WEIGHT		VOL FT ³
	LP	W	H (LP/B)	W	D	LBS		
L2HC1637	617	712	36.81	16.87	16.87	57	7	
L2HC1644	656	752	43.81	16.87	16.87	63	8	

L2HBK • Open Hutch Bookcase

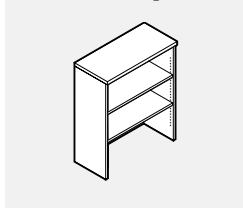

- Shipped knocked down (KD).

PRODUCT CODE	FINISH		SIZE/INCHES			WEIGHT		VOL FT ³
	LP	W	H (LP/B)	W	D	LBS		
L2HBK303	724	845	36.81	30	16.875	109	12	
L2HBK363	782	928	36.81	36	16.875	123	14	
L2HBK304	793	915	43.81	30	16.875	119	13	
L2HBK364	837	982	43.81	36	16.875	135	17	

L2WHO • Wall Mounted Open Storage

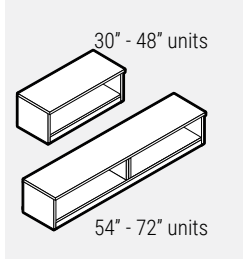

PRODUCT CODE	FINISH		SIZE/INCHES				WEIGHT		VOL FT ³
	LP	W	H (LP/B)	H (W)	W	D	LBS		
L2WHO30	520	617	16.75	17.18	30	16	69	7	
L2WHO36	553	696	16.75	17.18	36	16	78	8	
L2WHO42	639	777	16.75	17.18	42	16	87	9	
L2WHO48	678	831	16.75	17.18	48	16	97	10	
L2WHO54	733	924	16.75	17.18	54	16	106	11	
L2WHO60	915	1032	16.75	17.18	60	16	117	12	
L2WHO66	959	1064	16.75	17.18	66	16	125	13	
L2WHO72	1003	1170	16.75	17.18	72	16	139	14	

L2WHH • Wall Mounted Hinged Door

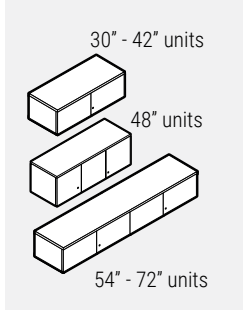

- 30" - 42" units come with one lock.
- 48" - 72" units come with two locks.
- Optional e-lock available in the horizontal position. Please specify HR - Horizontal Right or HL - Horizontal Left for the 48" wide unit and add \$224 list.
- Hutches 48" or longer require two e-locks.

PRODUCT CODE	FINISH		SIZE/INCHES				WEIGHT		VOL FT ³
	LP	W	H (LP/B)	H (W)	W	D	LBS		
L2WHH30	701	777	16.75	17.18	30	16	120	7	
L2WHH36	752	842	16.75	17.18	36	16	139	8	
L2WHH42	821	932	16.75	17.18	42	16	143	9	
L2WHH48	1029	1148	16.75	17.18	48	16	145	10	
L2WHH54	1220	1354	16.75	17.18	54	16	155	11	
L2WHH60	1262	1368	16.75	17.18	60	16	165	12	
L2WHH66	1320	1444	16.75	17.18	66	16	175	13	
L2WHH72	1376	1559	16.75	17.18	72	16	187	14	

L2WHF • Wall Mounted Flip-up Door

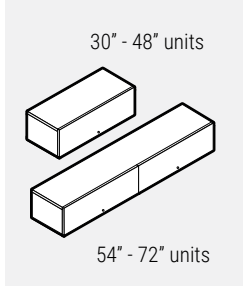

- 30" - 48" units come with one lock.
- 54" - 72" units come with two locks.
- Optional e-lock available in the horizontal position. Please specify HR - Horizontal Right or HL - Horizontal Left add \$224 list.
- Hutches 54" or longer require two e-locks.

PRODUCT CODE	FINISH		SIZE/INCHES				WEIGHT		VOL FT ³
	LP	W	H (LP/B)	H (W)	W	D	LBS		
L2WHF30	782		17.63	17.63	30	16	94	7	
L2WHF36	829		17.63	17.63	36	16	103	8	
L2WHF42	903		17.63	17.63	42	16	113	9	
L2WHF48	948		17.63	17.63	48	16	123	10	
L2WHF54	1399		17.63	17.63	54	16	130	11	
L2WHF60	1441		17.63	17.63	60	16	141	12	
L2WHF66	1527		17.63	17.63	66	16	151	13	
L2WHF72	1566		17.63	17.63	72	16	163	14	

L2WHH • Wall Mounted Unit with Aluminum Doors

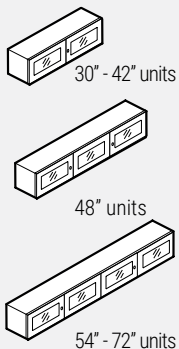

- Horizontal wall rails included.
- 30" - 42" units come with one lock.
- 48" - 72" units come with two locks.
- Door frame is anodized aluminum.
- Glazing is frosted acrylic.
- Doors standard with no handles.
- E-locks not available for aluminum framed glass doors.

PRODUCT CODE	FINISH LP	W	SIZE/INCHES				WEIGHT		VOL FT ³
			H (LP/B)	H (W)	W	D	LBS		
L2WHH30A	1166	1241	16.75	17.19	30	16	109	6	
L2WHH36A	1258	1349	16.75	17.19	36	16	126	7	
L2WHH42A	1366	1480	16.75	17.19	42	16	130	8	
L2WHH48A	1748	1867	16.75	17.19	48	16	132	9	
L2WHH54A	2110	2246	16.75	17.19	54	16	141	10	
L2WHH60A	2193	2300	16.75	17.19	60	16	150	11	
L2WHH66A	2279	2401	16.75	17.19	66	16	159	12	
L2WHH72A	2389	2570	16.75	17.19	72	16	170	13	

L2WSD • Wall Mounted Unit with Sliding Laminate Doors

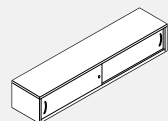

- Wall mounting horizontal rails included.
- One lock included.

PRODUCT CODE	FINISH LP	W	SIZE/INCHES				WEIGHT		VOL FT ³
			H (LP/B)	H (W)	W	D	LBS		
L2WSD36	1024	1151	16.75	17.19	36	16	128	7	
L2WSD42	1118	1266	16.75	17.19	42	16	130	8	
L2WSD48	1159	1309	16.75	17.19	48	16	132	9	
L2WSD54	1284	1464	16.75	17.19	54	16	141	10	
L2WSD60	1339	1539	16.75	17.19	60	16	150	11	
L2WSD66	1430	1661	16.75	17.19	66	16	159	12	
L2WSD72	1471	1717	16.75	17.19	72	16	170	13	

L2WGSD • Wall Mounted Unit with Sliding Glass Doors

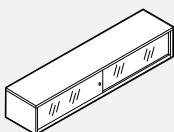

- Wall mounting horizontal rails included.
- Standard recessed chrome pull.
- Lock is included and must be installed at time of manufacturing, please specify key number.
- Frosted tempered glass.

PRODUCT CODE	FINISH LP	W	SIZE/INCHES				WEIGHT		VOL FT ³
			H (LP/B)	H (W)	W	D	LBS		
L2WGSD36	1902	2206	16.75	17.19	36	16	128	7	
L2WGSD42	2223	2378	16.75	17.19	42	16	130	8	
L2WGSD48	2279	2448	16.75	17.19	48	16	132	9	
L2WGSD54	2383	2570	16.75	17.19	54	16	141	10	
L2WGSD60	2446	2652	16.75	17.19	60	16	150	11	
L2WGSD66	2549	2785	16.75	17.19	66	16	159	12	
L2WGSD72	2646	2896	16.75	17.19	72	16	170	13	

LTB20 • Tackboards for Wall Mounted Units

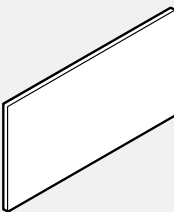

- Please specify wall rails BHV01 and BHV02 separately, see Boulevard Price List.
- Provides a tackable surface for notes and memos.
- Mounting brackets for installation included.
- Tackboards for Wall Mounted Unit. Wall Rails (BHV01 and BHV02) must be ordered separately.
- For tackboards longer than 60", please include an additional BHV01 at the centre.

PRODUCT CODE	FABRIC		SIZE/INCHES				WEIGHT		VOL FT ³
	GR1	GR2	H	W	D	LBS			
LTB2030	233	256	19.5	30	1	4	0.38		
LTB2036	253	276	19.5	36	1	4	0.42		
LTB2042	275	289	19.5	42	1	4	0.49		
LTB2048	314	329	19.5	48	1	5	0.56		
LTB2054	359	369	19.5	54	1	5	0.63		
LTB2060	399	420	19.5	60	1	6	0.69		
LTB2066	442	469	19.5	66	1	6	0.76		
LTB2072	486	513	19.5	72	1	7	0.83		
LTB2078	545	578	19.5	78	1	7	0.89		
LTB2084	608	650	19.5	84	1	8	0.96		

BHV • Component Wall Adapter - Single and Double

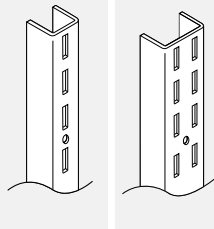

- **Used to attach system components to fixed wall.**
- Panel frame finish.
- The vertical wall adapter is a "U" shaped channel with a vertical row of slots with 1" centers.
- The double Component Wall Adapter has a double row of slots with 1" centers.
- Comes in 60" length only.
- Care should be taken to mount adapters only to wall studs using correct fasteners.
- Does not include mounting hardware. Mounting hardware selection to be based on wall material.
- Failure to do this may result in collapse of the unit and subsequent possible personal injury.
- Sold in pairs.

PRODUCT CODE	PRICE	SIZE/INCHES			WEIGHT		VOL FT ³
		H	W	D	LBS		
BHV01	99	60	0.75	0.5	4	0.009	
BHV02	114	60	1.50	0.5	5	0.026	

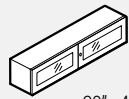
L2PHH • Boulevard Panel Mounted Unit with Aluminum Doors

30" - 42" units

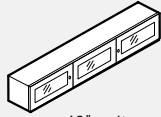

48" unit

- 30" - 42" units comes with one lock
- 48" Unit comes with two locks.
- Door frame is anodized aluminum.
- Glazing is frosted acrylic.
- Doors standard with no handles.
- E-locks not available for aluminum framed glass doors.

PRODUCT CODE	FINISH LP	W	SIZE/INCHES				WEIGHT		VOL FT ³
			H (LP/B)	H (W)	W	D	LBS		
L2PHH30A	1300	1430	16.75	17.19	30	14.75	111	6	
L2PHH36A	1384	1539	16.75	17.19	36	14.75	128	7	
L2PHH42A	1484	1662	16.75	17.19	42	14.75	132	8	
L2PHH48A	1850	2091	16.75	17.19	48	14.75	134	9	

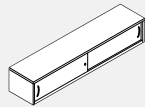
L2PSD • Boulevard Panel Mounted Unit with Sliding Laminate Doors

- Hardware included to mount the unit on the panel.
- One lock included.

PRODUCT CODE	FINISH LP	W	SIZE/INCHES				WEIGHT		VOL FT ³
			H (LP/B)	H (W)	W	D	LBS		
L2PSD36	1080	1201	16.75	17.19	36	14.75	123	7	
L2PSD42	1153	1304	16.75	17.19	42	14.75	132	8	
L2PSD48	1179	1330	16.75	17.19	48	14.75	141	9	

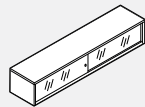
L2PGSD • Boulevard Panel Mounted Unit with Sliding Glass Doors

- Hardware included to mount the unit on the panel.
- One lock included.
- Standard recessed chrome pull.

PRODUCT CODE	FINISH LP	W	SIZE/INCHES				WEIGHT		VOL FT ³
			H (LP/B)	H (W)	W	D	LBS		
L2PGSD36	2171	2294	16.75	17.19	36	14.75	123	7	
L2PGSD42	2261	2418	16.75	17.19	42	14.75	132	8	
L2PGSD48	2302	2468	16.75	17.19	48	14.75	141	9	

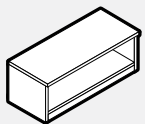
L2PHO • Boulevard Panel Mounted Unit Open Overhead

- Hardware included to mount the unit on the panel.

PRODUCT CODE	FINISH LP	W	SIZE/INCHES				WEIGHT		VOL FT ³
			H (LP/B)	H (W)	W	D	LBS		
L2PHO30	541	622	16.75	17.18	30	14.75	72	7	
L2PHO36	575	702	16.75	17.18	36	14.75	80	8	
L2PHO42	590	761	16.75	17.18	42	14.75	89	9	
L2PHO48	624	827	16.75	17.18	48	14.75	99	10	

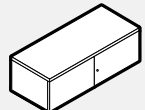
L2PHH • Boulevard Panel Mounted Hinged Door Overhead

30" - 42" units

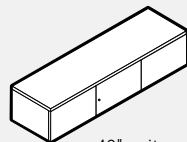

48" unit

- Hardware included to mount the unit on the panel.
- One lock included.
- Optional e-lock available in the horizontal position. Please specify HR - Horizontal Right or HL - Horizontal Left for the 48" wide unit and add \$224 list.
- Hatches 48" or longer require two e-locks.

PRODUCT CODE	FINISH LP	W	SIZE/INCHES				WEIGHT		VOL FT ³
			H (LP/B)	H (W)	W	D	LBS		
L2PHH30	835	965	16.75	17.18	30	14.75	122	7	
L2PHH36	879	1033	16.75	17.18	36	14.75	141	8	
L2PHH42	941	1115	16.75	17.18	42	14.75	145	9	
L2PHH48	1134	1374	16.75	17.18	48	14.75	147	10	

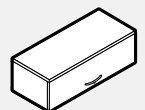
L2PHF • Boulevard Panel Mounted Flip-up Door Overhead

- Hardware included to mount the unit on the panel.
- One lock included.
- Optional e-lock available in the horizontal position. Please specify HR - Horizontal Right and add \$224 list.

PRODUCT CODE	FINISH LP	SIZE/INCHES			WEIGHT		VOL FT ³
		H (LP)	W	D	LBS		
L2PHF30	851	17.63	30	16	94	7	
L2PHF36	893	17.63	36	16	103	8	
L2PHF42	943	17.63	42	16	113	9	
L2PHF48	993	17.63	48	16	123	10	

L2SOHD • Stack On 2H Cabinet with Hinged Doors & Adjustable Shelf for 1H Storage

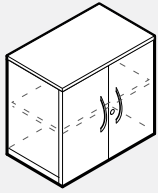

- One lock included.
- Optional e-lock available in the horizontal position. Please specify HR - Horizontal Right and add \$224 list.

PRODUCT CODE	FINISH LP	W	SIZE/INCHES				WEIGHT LBS	VOL FT ³
			H(LP)	H(W)	W	D		
one door								
L2SOHDL15	626	697	29.63	29.63	15	16	95	7
L2SOHDR15	626	697	29.63	29.63	15	16	95	7
L2SOHDL18	642	713	29.63	29.63	18	16	99	9
L2SOHDR18	642	713	29.63	29.63	18	16	99	9
double door								
L2SOHD30	901	1007	29.63	29.63	30	16	171	11
L2SOHD36	1004	1134	29.63	29.63	36	16	178	13

L2SOALD • Stack On 2H Cabinet with Aluminum Hinged Doors & Adjustable Shelf for 1H Storage

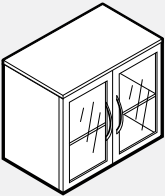

- No lock available for the one door units, one lock included for the double door units.
- Door frame is anodized aluminum.
- Glazing is frosted acrylic.
- Doors standard with no handles.
- E-locks not available for aluminum framed glass doors.

PRODUCT CODE	FINISH LP	W	SIZE/INCHES				WEIGHT LBS	VOL FT ³
			H(LP)	H(W)	W	D		
one door								
L2SOALDL15	1043	1111	29.63	29.63	15	16	88	7
L2SOALDR15	1043	1111	29.63	29.63	15	16	88	7
L2SOALDL18	1089	1159	29.63	29.63	18	16	94	9
L2SOALDR18	1089	1159	29.63	29.63	18	16	94	9
double door								
L2SOALD30	1764	1872	29.63	29.63	30	16	164	11
L2SOALD36	1913	2038	29.63	29.63	36	16	172	13

L2S00 • Stack On 2H Cabinet with Adjustable Shelf for 1H Storage

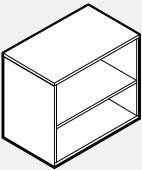

PRODUCT CODE	FINISH LP	W	SIZE/INCHES				WEIGHT LBS	VOL FT ³
			H(LP)	H(W)	W	D		
L2S0015	459	532	29.63	29.63	15	16	61	7
L2S0018	470	546	29.63	29.63	18	16	72	8
L2S0030	604	719	29.63	29.63	30	16	88	14
L2S0036	704	845	29.63	29.63	36	16	94	19

L2SOSD • Stack On 2H Cabinet with Sliding Door, Divider & Adjustable Shelves for 1H Storage

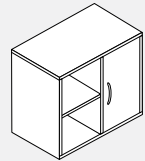

- Includes one sliding door.
- Lock not included.

PRODUCT CODE	FINISH LP	W	SIZE/INCHES				WEIGHT LBS	VOL FT ³
			H(LP)	H(W)	W	D		
L2SOSD30	924	1031	29.63	29.63	30	16	116	14
L2SOSD36	1086	1218	29.63	29.63	36	16	121	19

L2SOGSD • Stack On 2H Cabinet with Sliding Glass Doors & Adjustable Shelf for 1H Storage

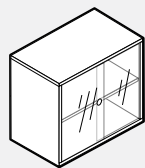

- One lock included.
- Standard recessed chrome pull.
- Glass is frosted tempered.

PRODUCT CODE	FINISH LP	W	SIZE/INCHES				WEIGHT LBS	VOL FT ³
			H(LP)	H(W)	W	D		
L2SOGSD30	2175	2269	29.63	29.63	30	16	116	14
L2SOGSD36	2379	2493	29.63	29.63	36	16	121	19

L2CR1H1H • Credenza, 1 High File / File

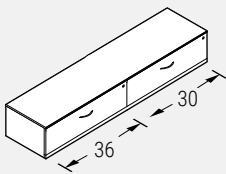

- Two locks included.
- Optional e-lock available in the vertical position. Please specify V - Vertical and add \$224 list.
- Hutches 48" or longer require two e-locks.

PRODUCT CODE	FINISH LP	B	W	SIZE/INCHES				WEIGHT LBS	VOL FT ³
				H(LP/B)	H(W)	W	D		
L2CR1H1H2060	1664	1750	1788	19.94	20.5	60	20	189	22
L2CR1H1H2066	1745	1837	1877	19.94	20.5	66	20	209	24
L2CR1H1H2072	1769	1872	1916	19.94	20.5	72	20	246	26
L2CR1H1H2460	1730	1819	1862	19.94	20.5	60	24	189	22
L2CR1H1H2466	1813	1906	1955	19.94	20.5	66	24	209	24
L2CR1H1H2472	1839	1948	1993	19.94	20.5	72	24	246	26

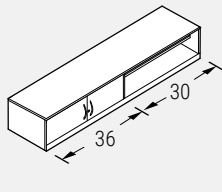
L2CR2D0 • Credenza, 1 High 2 Doors / Open Shelf

- One lock included.
- One height adjustable shelf included.
- Optional e-lock available in the horizontal position. Please specify HR - Horizontal Right and add \$224 list.

PRODUCT CODE	FINISH LP	B	W	SIZE/INCHES				D	WEIGHT LBS	VOL FT ³
				H(LP/B)	H(W)	W	D			
L2CR2D02060	1426	1582	1668	19.94	20.5	60	20	169	22	
L2CR2D02066	1488	1661	1752	19.94	20.5	66	20	180	24	
L2CR2D02072	1554	1745	1845	19.94	20.5	72	20	191	26	
L2CR2D02460	1482	1646	1733	19.94	20.5	60	24	169	22	
L2CR2D02466	1548	1727	1823	19.94	20.5	66	24	180	24	
L2CR2D02472	1617	1812	1918	19.94	20.5	72	24	191	26	

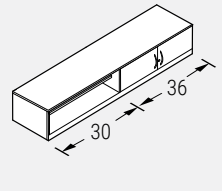
L2CRO2D • Credenza, 1 High Open Shelf / 2 Doors

- One lock included.
- One height adjustable shelf included.
- Optional e-lock available in the horizontal position. Please specify HR - Horizontal Right and add \$224 list.

PRODUCT CODE	FINISH LP	B	W	SIZE/INCHES				D	WEIGHT LBS	VOL FT ³
				H(LP/B)	H(W)	W	D			
L2CRO2D2060	1426	1582	1668	19.94	20.5	60	20	169	22	
L2CRO2D2066	1488	1661	1752	19.94	20.5	66	20	180	24	
L2CRO2D2072	1554	1745	1845	19.94	20.5	72	20	191	26	
L2CRO2D2460	1482	1646	1733	19.94	20.5	60	24	169	22	
L2CRO2D2466	1548	1727	1823	19.94	20.5	66	24	180	24	
L2CRO2D2472	1617	1812	1918	19.94	20.5	72	24	191	26	

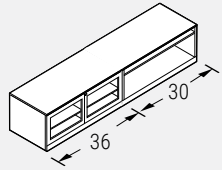
L2CR2ADO • Credenza, 2 Aluminum Doors / 1 High Open Shelf

- One lock included.
- One height adjustable shelf included.
- Door frame is anodized aluminum.
- Glazing is frosted acrylic.
- Doors standard with no handles.

PRODUCT CODE	FINISH LP	B	W	SIZE/INCHES				D	WEIGHT LBS	VOL FT ³
				H(LP/B)	H(W)	W	D			
L2CR2ADO2060	1900	2056	2144	19.94	20.5	60	20	154	20	
L2CR2ADO2066	2002	2175	2266	19.94	20.5	66	20	164	22	
L2CR2ADO2072	2067	2256	2361	19.94	20.5	72	20	174	24	
L2CR2ADO2460	1957	2119	2209	19.94	20.5	60	24	154	20	
L2CR2ADO2466	2063	2243	2339	19.94	20.5	66	24	164	22	
L2CR2ADO2472	2130	2324	2430	19.94	20.5	72	24	174	24	

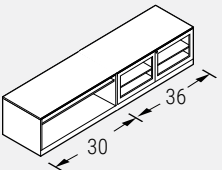
L2CRO2AD • Credenza, 1 High Open Shelf / 2 Aluminum Doors

- One lock included.
- One height adjustable shelf included.
- Door frame is anodized aluminum.
- Glazing is frosted acrylic.
- Doors standard with no handles.

PRODUCT CODE	FINISH LP	B	W	SIZE/INCHES				D	WEIGHT LBS	VOL FT ³
				H(LP/B)	H(W)	W	D			
L2CRO2AD2060	1900	2056	2144	19.94	20.5	60	20	154	20	
L2CRO2AD2066	2002	2175	2266	19.94	20.5	66	20	164	22	
L2CRO2AD2072	2067	2256	2361	19.94	20.5	72	20	174	24	
L2CRO2AD2460	1957	2119	2209	19.94	20.5	60	24	154	20	
L2CRO2AD2466	2063	2243	2339	19.94	20.5	66	24	164	22	
L2CRO2AD2472	2130	2324	2430	19.94	20.5	72	24	174	24	

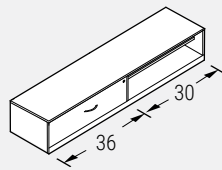
L2CR1HO • Credenza, 1 High File / Open Shelf

- One lock included.
- One height adjustable shelf included.
- Optional e-lock available in the vertical position. Please specify V - Vertical and add \$224 list.

PRODUCT CODE	FINISH LP	B	W	SIZE/INCHES				D	WEIGHT LBS	VOL FT ³
				H(LP/B)	H(W)	W	D			
L2CR1HO2060	1448	1575	1667	19.94	20.5	60	20	179	22	
L2CR1HO2066	1509	1647	1756	19.94	20.5	66	20	189	24	
L2CR1HO2072	1619	1772	1858	19.94	20.5	72	20	200	26	
L2CR1HO2460	1505	1638	1731	19.94	20.5	60	24	179	22	
L2CR1HO2466	1569	1711	1824	19.94	20.5	66	24	189	24	
L2CR1HO2472	1684	1840	1932	19.94	20.5	72	24	200	26	

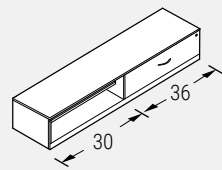
L2CRO1H • Credenza, Open Shelf / 1 High File

- One lock included.
- One height adjustable shelf included.
- Optional e-lock available in the vertical position. Please specify V - Vertical and add \$224 list.

PRODUCT CODE	FINISH LP	B	W	SIZE/INCHES				D	WEIGHT LBS	VOL FT ³
				H(LP/B)	H(W)	W	D			
L2CRO1H2060	1448	1575	1667	19.94	20.5	60	20	179	22	
L2CRO1H2066	1509	1647	1756	19.94	20.5	66	20	189	24	
L2CRO1H2072	1619	1772	1858	19.94	20.5	72	20	200	26	
L2CRO1H2460	1505	1638	1731	19.94	20.5	60	24	179	22	
L2CRO1H2466	1569	1711	1824	19.94	20.5	66	24	189	24	
L2CRO1H2472	1684	1840	1932	19.94	20.5	72	24	200	26	

L2CR01H • Credenza, 1 High File / 2 Door

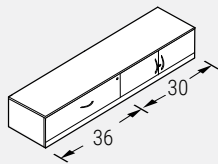

- Two locks included.
- Optional e-lock available in the vertical position for the file drawer. Please specify V - Vertical and add \$224 list.
- Optional e-lock available in the horizontal position. Please specify HR - Horizontal Right and add \$224 list.

PRODUCT CODE	FINISH			SIZE/INCHES				WEIGHT		VOL FT ³
	LP	B	W	H(LP/B)	H(W)	W	D	LBS		
L2CR1H2D2060	1761	1850	1970	19.94	20.5	60	20	199	22	
L2CR1H2D2066	1779	1880	2129	19.94	20.5	66	20	209	24	
L2CR1H2D2072	1890	2080	2181	19.94	20.5	72	20	220	26	
L2CR1H2D2460	1834	1926	2053	19.94	20.5	60	24	199	22	
L2CR1H2D2466	1849	1958	2215	19.94	20.5	66	24	209	24	
L2CR1H2D2472	1962	2162	2266	19.94	20.5	72	24	220	26	

L2CR2D1H • Credenza, 2 Door / 1 High File

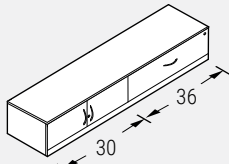

- Two locks included.
- Optional e-lock available in the vertical position for the file drawer. Please specify V - Vertical and add \$224 list.
- Optional e-lock available in the horizontal position. Please specify HR - Horizontal Right and add \$224 list.

PRODUCT CODE	FINISH			SIZE/INCHES				WEIGHT		VOL FT ³
	LP	B	W	H(LP/B)	H(W)	W	D	LBS		
L2CR2D1H2060	1761	1850	1970	19.94	20.5	60	20	199	22	
L2CR2D1H2066	1779	1880	2129	19.94	20.5	66	20	209	24	
L2CR2D1H2072	1890	2080	2181	19.94	20.5	72	20	220	26	
L2CR2D1H2460	1834	1926	2053	19.94	20.5	60	24	199	22	
L2CR2D1H2466	1849	1958	2215	19.94	20.5	66	24	209	24	
L2CR2D1H2472	1962	2162	2266	19.94	20.5	72	24	220	26	

L2CR1H2AD • Credenza, 1 High File / 2 Aluminum Door

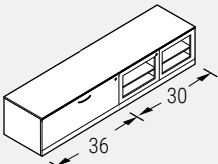

- Two locks included.
- One height adjustable shelf included.
- Door frame is anodized aluminum.
- Glazing is frosted acrylic.
- Doors standard with no handles.
- Optional e-lock available in the vertical position. Please specify V - Vertical and add \$224 list.
- E-locks not available for aluminum framed glass doors.

PRODUCT CODE	FINISH			SIZE/INCHES				WEIGHT		VOL FT ³
	LP	B	W	H(LP/B)	H(W)	W	D	LBS		
L2CR1H2AD2060	2236	2324	2449	19.94	20.5	60	20	181	20	
L2CR1H2AD2066	2294	2397	2643	19.94	20.5	66	20	190	22	
L2CR1H2AD2072	2402	2593	2696	19.94	20.5	72	20	200	24	
L2CR1H2AD2460	2308	2400	2527	19.94	20.5	60	24	181	20	
L2CR1H2AD2466	2364	2472	2729	19.94	20.5	66	24	190	22	
L2CR1H2AD2472	2478	2677	2783	19.94	20.5	72	24	200	24	

L2CR2AD1H • Credenza, 2 Aluminum Door / 1 High File

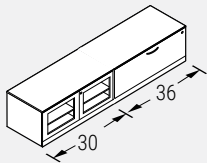

- Two locks included.
- One height adjustable shelf included.
- Door frame is anodized aluminum.
- Glazing is frosted acrylic.
- Doors standard with no handles.
- Optional e-lock available in the vertical position. Please specify V - Vertical and add \$224 list.
- E-locks not available for aluminum framed glass doors.

PRODUCT CODE	FINISH			SIZE/INCHES				WEIGHT		VOL FT ³
	LP	B	W	H(LP/B)	H(W)	W	D	LBS		
L2CR2AD1H2060	2236	2324	2449	19.94	20.5	60	20	181	20	
L2CR2AD1H2066	2294	2397	2643	19.94	20.5	66	20	190	22	
L2CR2AD1H2072	2402	2593	2696	19.94	20.5	72	20	200	24	
L2CR2AD1H2460	2308	2400	2527	19.94	20.5	60	24	181	20	
L2CR2AD1H2466	2364	2472	2729	19.94	20.5	66	24	190	22	
L2CR2AD1H2472	2478	2677	2783	19.94	20.5	72	24	200	24	

L2DSCR1H • Double Sided 1H Credenza Lateral

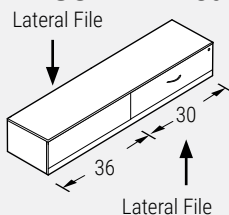

- Two locks included.
- Optional e-lock available in the vertical position. Please specify V - Vertical and add \$224 list.
- Credenzas require two e-locks.

PRODUCT CODE	FINISH			SIZE/INCHES				WEIGHT		VOL FT ³
	LP	B	W	H(LP/B)	H(W)	W	D	LBS		
L2DSCR1H2060	1961	2056	2124	19.94	20.5	60	20	196	22	
L2DSCR1H2066	2024	2127	2215	19.94	20.5	66	20	206	24	
L2DSCR1H2072	2085	2198	2305	19.94	20.5	72	20	217	26	
L2DSCR1H2460	2039	2138	2209	19.94	20.5	60	24	196	22	
L2DSCR1H2466	2102	2213	2302	19.94	20.5	66	24	206	24	
L2DSCR1H2472	2168	2285	2397	19.94	20.5	72	24	217	26	

L2CRBFBF • Credenza, BF / BF

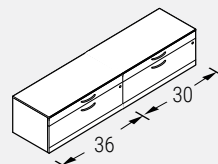

- Two locks included.
- Optional e-lock available in the vertical position. Please specify V - Vertical and add \$224 list.
- Credenzas require two e-locks.

PRODUCT CODE	FINISH			SIZE/INCHES				WEIGHT		VOL FT ³
	LP	B	W	H(LP/B)	H(W)	W	D	LBS		
L2CRBFBF2060	2225	2312	2349	19.94	20.5	60	20	218	20	
L2CRBFBF2066	2314	2409	2451	19.94	20.5	66	20	228	22	
L2CRBFBF2072	2352	2455	2499	19.94	20.5	72	20	239	24	
L2CRBFBF2460	2294	2383	2424	19.94	20.5	60	24	218	20	
L2CRBFBF2466	2387	2484	2527	19.94	20.5	66	24	228	22	
L2CRBFBF2472	2424	2530	2577	19.94	20.5	72	24	239	24	

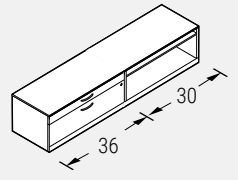
L2CRBFO • Credenza, BF / Open

- One lock included.
- One height adjustable shelf included.
- Optional e-lock available in the vertical position. Please specify V - Vertical and add \$224 list.

PRODUCT CODE	FINISH LP	B	W	SIZE/INCHES				D	WEIGHT LBS	VOL FT ³
				H(LP/B)	H(W)	W	D			
L2CRBFO2060	1728	1856	1948	19.94	20.5	60	20	202	20	
L2CRBFO2066	1802	1938	2047	19.94	20.5	66	20	220	22	
L2CRBFO2072	1912	2063	2149	19.94	20.5	72	20	254	24	
L2CRBFO2460	1799	1929	2026	19.94	20.5	60	24	202	20	
L2CRBFO2466	1873	2016	2129	19.94	20.5	66	24	220	22	
L2CRBFO2472	1988	2146	2235	19.94	20.5	72	24	254	24	

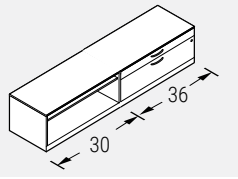
L2CROBF • Credenza, Open / BF

- One lock included.
- One height adjustable shelf included.
- Optional e-lock available in the vertical position. Please specify V - Vertical and add \$224 list.

PRODUCT CODE	FINISH LP	B	W	SIZE/INCHES				D	WEIGHT LBS	VOL FT ³
				H(LP/B)	H(W)	W	D			
L2CROBF2060	1728	1856	1948	19.94	20.5	60	20	202	20	
L2CROBF2066	1802	1938	2047	19.94	20.5	66	20	220	22	
L2CROBF2072	1912	2063	2149	19.94	20.5	72	20	254	24	
L2CROBF2460	1799	1929	2026	19.94	20.5	60	24	202	20	
L2CROBF2466	1873	2016	2129	19.94	20.5	66	24	220	22	
L2CROBF2472	1988	2146	2235	19.94	20.5	72	24	254	24	

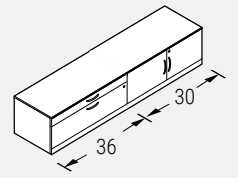
L2CRBF • Credenza, Box File / 2 Doors

- Two locks included.
- One height adjustable shelf included.
- Optional e-lock available in the vertical position for the file drawer. Please specify V - Vertical and add \$224 list.
- Optional e-lock available in the horizontal position. Please specify HR - Horizontal Right and add \$224 list.

PRODUCT CODE	FINISH LP	B	W	SIZE/INCHES				D	WEIGHT LBS	VOL FT ³
				H(LP/B)	H(W)	W	D			
L2CRBF2D2060	2045	2131	2254	19.94	20.5	60	20	214	20	
L2CRBF2D2066	2069	2173	2422	19.94	20.5	66	20	224	22	
L2CRBF2D2072	2181	2369	2472	19.94	20.5	72	20	235	24	
L2CRBF2D2460	2126	2218	2344	19.94	20.5	60	24	214	20	
L2CRBF2D2466	2154	2261	2517	19.94	20.5	66	24	224	22	
L2CRBF2D2472	2269	2464	2571	19.94	20.5	72	24	235	24	

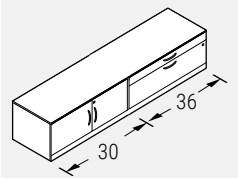
L2CR2DBF • Credenza, 2 Doors / Box File

- Two locks included.
- One height adjustable shelf included.
- Optional e-lock available in the vertical position for the file drawer. Please specify V - Vertical and add \$224 list.
- Optional e-lock available in the horizontal position. Please specify HR - Horizontal Right and add \$224 list.

PRODUCT CODE	FINISH LP	B	W	SIZE/INCHES				D	WEIGHT LBS	VOL FT ³
				H(LP/B)	H(W)	W	D			
L2CR2DBF2060	2045	2131	2254	19.94	20.5	60	20	214	20	
L2CR2DBF2066	2069	2173	2422	19.94	20.5	66	20	224	22	
L2CR2DBF2072	2181	2369	2472	19.94	20.5	72	20	235	24	
L2CR2DBF2460	2126	2218	2344	19.94	20.5	60	24	214	20	
L2CR2DBF2466	2154	2261	2517	19.94	20.5	66	24	224	22	
L2CR2DBF2472	2269	2464	2571	19.94	20.5	72	24	235	24	

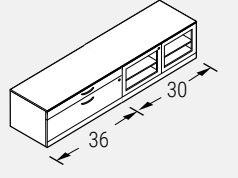
L2CRBF2AD • Credenza, Box File / 2 Aluminum Door

- Two locks included.
- One height adjustable shelf included.
- Door frame is anodized aluminum.
- Glazing is frosted acrylic.
- Doors standard with no handles.
- Optional e-lock available in the vertical position. Please specify V - Vertical and add \$224 list.
- E-locks not available for aluminum framed glass doors.

PRODUCT CODE	FINISH LP	B	W	SIZE/INCHES				D	WEIGHT LBS	VOL FT ³
				H(LP/B)	H(W)	W	D			
L2CRBF2AD2060	2518	2608	2728	19.94	20.5	60	20	214	20	
L2CRBF2AD2066	2586	2687	2935	19.94	20.5	66	20	224	22	
L2CRBF2AD2072	2696	2886	2988	19.94	20.5	72	20	235	24	
L2CRBF2AD2460	2618	2709	2836	19.94	20.5	60	24	214	20	
L2CRBF2AD2466	2692	2795	3054	19.94	20.5	66	24	224	22	
L2CRBF2AD2472	2804	3001	3106	19.94	20.5	72	24	235	24	

L2CR2ADBF • Credenza, 2 Aluminum Doors, Box File

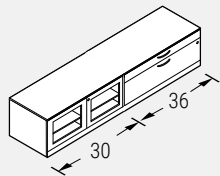

- Two locks included.
- One height adjustable shelf included.
- Door frame is anodized aluminum.
- Glazing is frosted acrylic.
- Doors standard with no handles.
- Optional e-lock available in the vertical position. Please specify V - Vertical and add \$224 list.
- E-locks not available for aluminum framed glass doors.

PRODUCT CODE	FINISH			SIZE / INCHES				WEIGHT		VOL FT ³
	LP	B	W	H (LP/B)	H (W)	W	D	LBS		
L2CR2ADBF2060	2518	2608	2728	19.94	20.5	60	20	214	20	
L2CR2ADBF2066	2586	2687	2935	19.94	20.5	66	20	224	22	
L2CR2ADBF2072	2696	2886	2988	19.94	20.5	72	20	235	24	
L2CR2ADBF2460	2618	2709	2836	19.94	20.5	60	24	214	20	
L2CR2ADBF2466	2692	2795	3054	19.94	20.5	66	24	224	22	
L2CR2ADBF2472	2804	3001	3106	19.94	20.5	72	24	235	24	

L2CR2H2D • Credenza, 2 High File / 2 Door

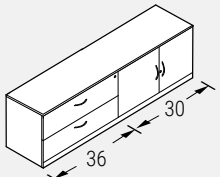

- Two locks included.
- Optional e-lock available in the vertical position for the file drawer. Please specify V - Vertical and add \$224 list.
- Optional e-lock available in the horizontal position. Please specify HR - Horizontal Right and add \$224 list.

PRODUCT CODE	FINISH			SIZE / INCHES				WEIGHT		VOL FT ³
	LP	B	W	H (LP/B)	H (W)	W	D	LBS		
L2CR2H2D2060	2296	2453	2529	29	29.5	60	20	363	24	
L2CR2H2D2066	2390	2555	2640	29	29.5	66	20	374	26	
L2CR2H2D2072	2490	2642	2752	29	29.5	72	20	396	30	
L2CR2H2D2460	2388	2552	2632	29	29.5	60	24	363	24	
L2CR2H2D2466	2486	2657	2745	29	29.5	66	24	374	26	
L2CR2H2D2472	2592	2747	2862	29	29.5	72	24	396	30	

L2CR2D2H • Credenza, 2 Door / 2 High File

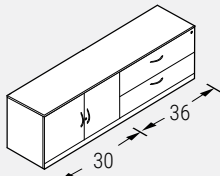

- Two locks included.
- Optional e-lock available in the vertical position for the file drawer. Please specify V - Vertical and add \$224 list.
- Optional e-lock available in the horizontal position. Please specify HR - Horizontal Right and add \$224 list.

PRODUCT CODE	FINISH			SIZE / INCHES				WEIGHT		VOL FT ³
	LP	B	W	H (LP/B)	H (W)	W	D	LBS		
L2CR2D2H2060	2296	2453	2529	29	29.5	60	20	363	24	
L2CR2D2H2066	2390	2555	2640	29	29.5	66	20	374	26	
L2CR2D2H2072	2490	2642	2752	29	29.5	72	20	396	30	
L2CR2D2H2460	2388	2552	2632	29	29.5	60	24	363	24	
L2CR2D2H2466	2486	2657	2745	29	29.5	66	24	374	26	
L2CR2D2H2472	2592	2747	2862	29	29.5	72	24	396	30	

L2CR2H2H • Credenza, 2 High File / File

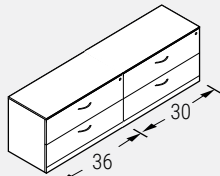

- Two locks included.
- Optional e-lock available in the vertical position. Please specify V - Vertical and add \$224 list.
- Credenzas require two e-locks.

PRODUCT CODE	FINISH			SIZE / INCHES				WEIGHT		VOL FT ³
	LP	B	W	H (LP/B)	H (W)	W	D	LBS		
L2CR2H2H2060	2664	2756	2855	29	29.5	60	20	385	24	
L2CR2H2H2066	2757	2860	2961	29	29.5	66	20	407	26	
L2CR2H2H2072	2849	2960	3072	29	29.5	72	20	418	30	
L2CR2H2H2460	2769	2864	2970	29	29.5	60	24	385	24	
L2CR2H2H2466	2867	2974	3079	29	29.5	66	24	407	26	
L2CR2H2H2472	2962	3079	3193	29	29.5	72	24	418	30	

L2CR2D2D • Credenza, 2 High 4 Doors

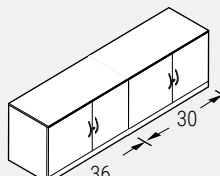

- Two locks included.
- Optional e-lock available in the horizontal position. Please specify HR - Horizontal Right and add \$224 list.
- Credenzas require two e-locks.

PRODUCT CODE	FINISH			SIZE / INCHES				WEIGHT		VOL FT ³
	LP	B	W	H (LP/B)	H (W)	W	D	LBS		
L2CR2D2D2060	1935	2156	2215	29	29.5	60	20	341	24	
L2CR2D2D2066	2037	2242	2324	29	29.5	66	20	352	26	
L2CR2D2D2072	2140	2328	2438	29	29.5	72	20	363	30	
L2CR2D2D2460	2012	2245	2301	29	29.5	60	24	341	24	
L2CR2D2D2466	2119	2333	2421	29	29.5	66	24	352	26	
L2CR2D2D2472	2224	2422	2537	29	29.5	72	24	363	30	

L2CR4AD • Credenza, 2 High 4 Aluminum Doors

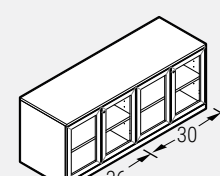

- Two locks included.
- Door frame is anodized aluminum.
- Glazing is frosted acrylic.
- Doors standard with no handles.
- E-lock not available for aluminum framed glass doors.

PRODUCT CODE	FINISH			SIZE / INCHES				WEIGHT		VOL FT ³
	LP	B	W	H (LP/B)	H (W)	W	D	LBS		
L2CR4AD2060	3116	3340	3397	29	29.5	60	20	336	24	
L2CR4AD2066	3329	3533	3620	29	29.5	66	20	347	26	
L2CR4AD2072	3544	3730	3843	29	29.5	72	20	358	30	
L2CR4AD2460	3193	3424	3483	29	29.5	60	24	336	24	
L2CR4AD2466	3412	3625	3713	29	29.5	66	24	347	26	
L2CR4AD2472	3629	3825	3941	29	29.5	72	24	358	30	

LPSTC/LLSTC • Pedestal/Lateral Seat Cushion

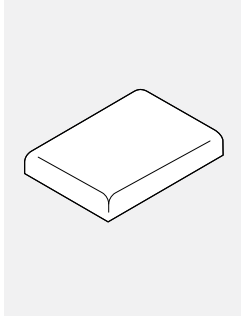

PRODUCT CODE	YRDS	SIZE/ INCHES			WEIGHT VOL	
		H	W	D	LBS	FT ³
LPSTC1518	0.75	2	15.5	18	2	0.34
LPSTC1520	0.75	2	15.5	20	2	0.40
LPSTC1523	0.75	2	15.5	23	3	0.44
LPSTC1524	0.75	2	15.5	24	3	0.46
LPSTC1529	1.00	2	15.5	29	3	0.55
LPSTC1530	1.00	2	15.5	30	3	0.24
LLSTC2030	1.00	2	20	30	5	0.76
LLSTC2036	1.25	2	20	36	6	0.91
LLSTC2230	1.00	2	22	30	6	0.84
LLSTC2236	1.25	2	22	36	7	1.01
LLSTC2430	1.00	2	24	30	6	0.91
LLSTC2436	1.25	2	24	36	7	1.10

PRODUCT CODE	PRICE																			
	GR1	GR2	GR3	GR4	GR5	GR6	GR7	GR8	GR9	GR10	GR11	GR12	GR13	GR14	GR15	GR16	GR17	GR18	GR19	GR20
LPSTC1518	196	226	245	272	314	353	389	422	463	503	557	633	703	779	944	1109	1274	1439	1604	1785
LPSTC1520	202	230	253	278	319	358	396	429	469	508	562	637	710	785	949	1114	1280	1444	1608	1790
LPSTC1523	206	233	256	283	323	361	399	435	472	513	565	640	715	789	955	1119	1285	1451	1613	1794
LPSTC1524	212	240	262	289	330	367	406	439	477	521	573	647	722	795	959	1123	1289	1455	1619	1801
LPSTC1529	259	296	326	360	414	466	518	562	613	668	737	839	936	1034	1256	1473	1696	1916	2134	2377
LPSTC1530	266	301	331	366	420	471	523	567	619	673	743	844	943	1041	1262	1481	1702	1923	2140	2383
LLSTC2030	281	318	345	383	437	488	536	585	636	691	760	860	958	1057	1279	1496	1720	1938	2156	2399
LLSTC2036	333	380	417	461	527	590	653	712	778	844	932	1057	1179	1304	1581	1852	2130	2402	2677	2981
LLSTC2230	286	322	353	386	441	493	541	589	639	694	763	866	965	1060	1284	1500	1724	1943	2160	2402
LLSTC2236	340	385	421	466	532	595	661	718	783	851	938	1062	1187	1309	1585	1860	2135	2409	2683	2987
LLSTC2430	289	326	355	389	443	495	546	591	641	697	767	868	967	1063	1286	1503	1726	1945	2165	2405
LLSTC2436	344	392	428	471	537	603	667	724	789	857	944	1069	1191	1315	1591	1865	2143	2417	2688	2991

LACWB • Counterweight Balance for use in Licence Storage Units

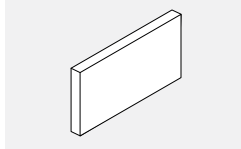

PRODUCT CODE	PRICE	SIZE/INCHES			WEIGHT LBS	VOL FT ³
		H	W	D		
LACWB	92	0.5	11.62	11.62	10	0.07

BHTP01 • Bracket to connect Licence Towers to Boulevard Panels

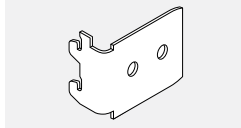

• Panel Frame Finish

PRODUCT CODE	PRICE	SIZE/ INCHES			WEIGHT VOL	
		H	W	D	LBS	FT ³
BHTP01	64	2	2.5	1	2	0.05

L2PO • Pantry Storage

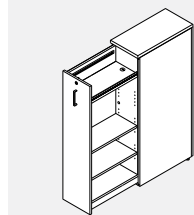

Left Hand Shown

- The pull out cabinet serves as a multifunction, customizable storage unit that both defines space and enhances privacy in an open plan environment.
- Can be used in conjunction with Licence, Bridges, FreeFit and Boulevard.
- Internal organization consists of two fixed shelves top and bottom. The two middle shelves are adjustable. Two accessory rails are standard and will accept GC metal accessories
- Interior cabinet shelves and back are standard in Designer White. Cabinet shell, drawer and top can be specified in any standard laminate.
- L2PO-NL/R does not fit binders.
- Only available with FA handle.

Finish

While the Pantry Storage cabinet walls, top and pull-out drawer front door and back panel finish can be specified, the internal cabinet back and adjustable shelves are standard white. Please specify the cabinet top and pull-out drawer front finish.

Options

- Dual USB outlet kit - please add "USB" at the end of the code. Add \$377 to the list price
- When you specify dual USB outlet the top shelf will come with grey felt surface and grommet which allows for cable passage from the USB outlet (located below the top shelf). A two-prong power cord exits the cabinet through the floor at the back.
- Dry-erase marker board - Choose "DE" option. Please add \$266 to the list price. If specified the Dry-erase marker laminate will be applied to the external surface of the pull-out drawer side wall.

PRODUCT CODE	PRICE LP	SIZE/INCHES			H(LP/B)	H(W)	W	D	WEIGHT LBS	VOL FT ³
		B	W	H(LP/B)						
L2PO1224H42NL	1493	1511	1546	41.56	42	12	24	128	7	
L2PO1230H42NL	1568	1590	1631	41.56	42	12	30	143	9	
L2PO1236H42NL	1641	1668	1717	41.56	42	12	36	157	11	
L2PO1824H42NL	1716	1744	1790	41.56	42	18	24	156	11	
L2PO1830H42NL	1799	1833	1889	41.56	42	18	30	172	13	
L2PO1836H42NL	1881	1922	1987	41.56	42	18	36	187	16	
L2PO1224NL	1624	1640	1671	49.56	50	12	24	133	8	
L2PO1230NL	1702	1734	1760	49.56	50	12	30	148	10	
L2PO1236NL	1781	1827	1850	49.56	50	12	36	162	15	
L2PO1824NL	1885	1917	1950	49.56	50	18	24	161	12	
L2PO1830NL	1969	2022	2050	49.56	50	18	30	177	15	
L2PO1836NL	2055	2125	2149	49.56	50	18	36	192	18	
L2PO1224H54NL	1642	1659	1690	53.56	54	12	24	138	9	
L2PO1230H54NL	1720	1740	1760	53.56	54	12	30	153	11	
L2PO1236H54NL	1799	1823	1849	53.56	54	12	36	167	14	
L2PO1824H54NL	1904	1928	1970	53.56	54	18	24	166	14	
L2PO1830H54NL	1989	2020	2069	53.56	54	18	30	182	17	
L2PO1836H54NL	2075	2110	2168	53.56	54	18	36	197	20	
L2PO1224H42NR	1493	1511	1546	41.56	42	12	24	128	7	
L2PO1230H42NR	1568	1590	1631	41.56	42	12	30	143	9	
L2PO1236H42NR	1641	1668	1717	41.56	42	12	36	157	11	
L2PO1824H42NR	1716	1744	1790	41.56	42	18	24	156	11	
L2PO1830H42NR	1799	1833	1889	41.56	42	18	30	172	13	
L2PO1836H42NR	1881	1922	1987	41.56	42	18	36	187	16	
L2PO1224NR	1624	1640	1671	49.56	50	12	24	133	8	
L2PO1230NR	1702	1734	1760	49.56	50	12	30	148	10	
L2PO1236NR	1781	1827	1850	49.56	50	12	36	162	15	
L2PO1824NR	1885	1917	1950	49.56	50	18	24	161	12	
L2PO1830NR	1969	2022	2050	49.56	50	18	30	177	15	
L2PO1836NR	2055	2125	2149	49.56	50	18	36	192	18	
L2PO1224H54NR	1642	1659	1690	53.56	54	12	24	138	9	
L2PO1230H54NR	1720	1740	1760	53.56	54	12	30	153	11	
L2PO1236H54NR	1799	1823	1849	53.56	54	12	36	167	14	
L2PO1824H54NR	1904	1928	1970	53.56	54	18	24	166	14	
L2PO1830H54NR	1989	2020	2069	53.56	54	18	30	182	17	
L2PO1836H54NR	2075	2110	2168	53.56	54	18	36	197	20	

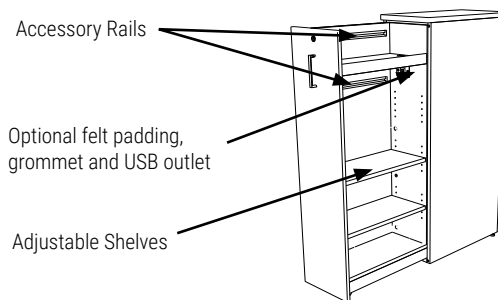
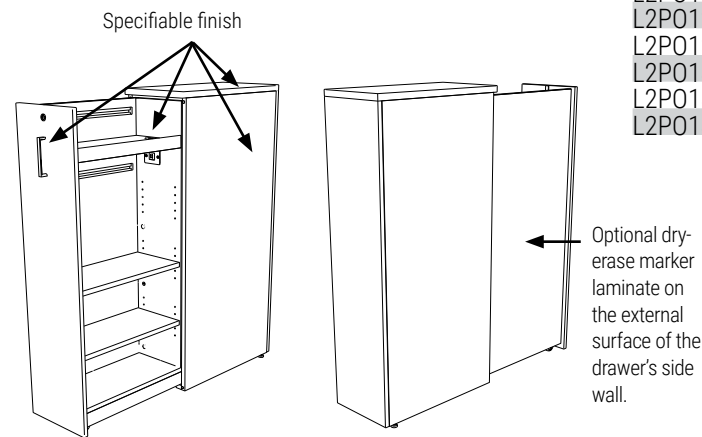

Integrated Accessory rails

Two accessory rails (each 18.25" long) are provided to further enhance customization with Global Contract metal accessories.

Upper Accessory Rail:

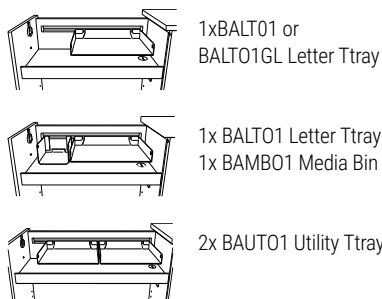

Lower Accessory Rail:

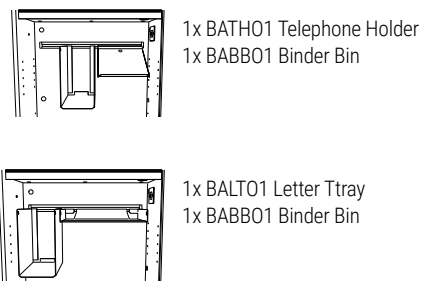
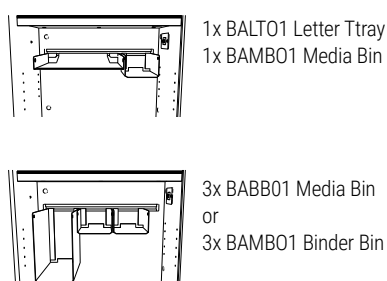

L2PW • Wardrobe Pantry Storage

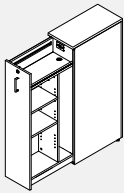

Left Hand Shown

- The pull out cabinet serves as a multifunction, customizable storage unit that both defines space and enhances privacy in an open plan environment.
- Can be used in conjunction with Licence,, FreeFit and Boulevard.
- Internal organization consists of one fixed shelf at the top. The two middle shelves are adjustable. Wardrobe includes coat hook.
- Interior cabinet shelves and back are standard in Designer White. Cabinet shell, drawer and top can be specified in any standard laminate.
- L2PW-NL/R does not fit binders.
- Only available with FA handle.

Finish

While the Pantry Storage cabinet walls, top and pull-out drawer front door and back panel finish can be specified, the internal cabinet back and adjustable shelves are standard white. Please specify the cabinet top and pull-out drawer front finish.

Options

- Dual USB outlet kit - please add "USB" at the end of the code. Add \$512 to the list price
- When you specify dual USB outlet the top shelf will come with grey felt surface and grommet which allows for cable passage from the USB outlet (located below the top shelf). A two-prong power cord exits the cabinet through the floor at the back.
- Dry-erase marker board - Choose "DE" option. Please add \$361 to the list price. If specified the Dry-erase marker laminate will be applied to the external surface of the pull-out drawer side wall.

PRODUCT CODE	PRICE			SIZE/INCHES				WEIGHT		VOL FT ³
	LP	B	W	H (LP/B)	H (W)	W	D	LBS		
L2PW1224H42NL	1631	1649	1684	41.56	42	12	24	128	7	
L2PW1230H42NL	1706	1728	1769	41.56	42	12	30	143	9	
L2PW1236H42NL	1779	1806	1855	41.56	42	12	36	157	11	
L2PW1824H42NL	1889	1917	1963	41.56	42	18	24	156	11	
L2PW1830H42NL	1972	2006	2062	41.56	42	18	30	172	13	
L2PW1836H42NL	2054	2095	2160	41.56	42	18	36	187	16	
L2PW1224NL	1778	1794	1825	49.56	50	12	24	133	8	
L2PW1230NL	1856	1888	1914	49.56	50	12	30	148	10	
L2PW1236NL	1935	1981	2004	49.56	50	12	36	162	15	
L2PW1824NL	2078	2110	2143	49.56	50	18	24	161	12	
L2PW1830NL	2162	2215	2243	49.56	50	18	30	177	15	
L2PW1836NL	2248	2318	2342	49.56	50	18	36	192	18	
L2PW1224H54NL	1812	1829	1860	53.56	54	12	24	138	9	
L2PW1230H54NL	1890	1910	1930	53.56	54	12	30	153	11	
L2PW1236H54NL	1969	1993	2019	53.56	54	12	36	167	14	
L2PW1824H54NL	2118	2142	2184	53.56	54	18	24	166	14	
L2PW1830H54NL	2203	2234	2283	53.56	54	18	30	182	17	
L2PW1836H54NL	2289	2324	2382	53.56	54	18	36	197	20	
L2PW1224H42NR	1493	1511	1546	41.56	42	12	24	128	7	
L2PW1230H42NR	1706	1728	1769	41.56	42	12	30	143	9	
L2PW1236H42NR	1779	1806	1855	41.56	42	12	36	157	11	
L2PW1824H42NR	1854	1882	1928	41.56	42	18	24	156	11	
L2PW1830H42NR	1972	2006	2062	41.56	42	18	30	172	13	
L2PW1836H42NR	2054	2095	2160	41.56	42	18	36	187	16	
L2PW1224NR	1778	1794	1825	49.56	50	12	24	133	8	
L2PW1230NR	1856	1888	1914	49.56	50	12	30	148	10	
L2PW1236NR	1935	1981	2004	49.56	50	12	36	162	15	
L2PW1824NR	2078	2110	2143	49.56	50	18	24	161	12	
L2PW1830NR	2162	2215	2243	49.56	50	18	30	177	15	
L2PW1836NR	2248	2318	2342	49.56	50	18	36	192	18	
L2PW1224H54NR	1812	1829	1860	53.56	54	12	24	138	9	
L2PW1230H54NR	1890	1910	1930	53.56	54	12	30	153	11	
L2PW1236H54NR	1969	1993	2019	53.56	54	12	36	167	14	
L2PW1824H54NR	2118	2142	2184	53.56	54	18	24	166	14	
L2PW1830H54NR	2203	2234	2283	53.56	54	18	30	182	17	
L2PW1836H54NR	2289	2324	2382	53.56	54	18	36	197	20	

Specifiable finish

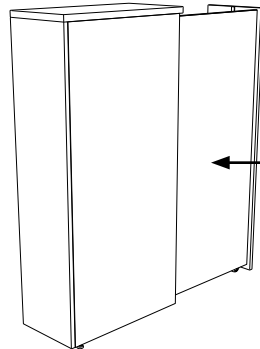
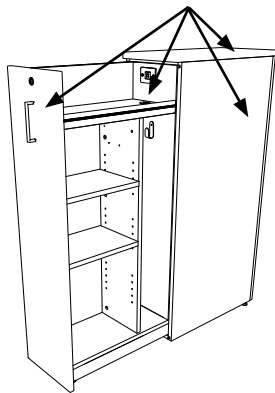

Optional dry-erase marker laminate on the external surface of the drawer's side wall.

Optional felt padding, grommet and USB outlet

Coathook

Adjustable Shelves

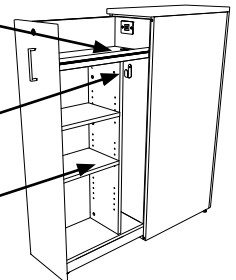

L2CT • Collaboration Tables with Integrated Wire Management

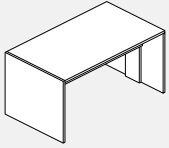

- Units Shipped knocked down (KD)
- Footrest to be ordered seperately.
- Add "FR" to the end of the code for a footrail and add \$1,890 to the list price.
- Foot rail kit will include a quantity of two 2" diameter rails and 4 flanges.
- "W" thick (1 7/16") top and gables.
- Low pressure modesty panel.

Standard Grommet Location:

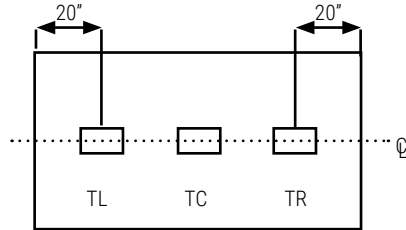

Please see Accessories Section for power grommets.

Half Modesty at 15" high.

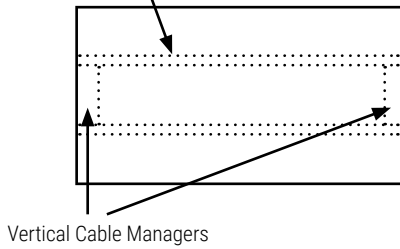

PRODUCT CODE	FINISH "W"	H(W)	W	D	WEIGHT LBS	VOL FT ³
L2CT3060H29	1690	29.5	60	30	171	13
L2CT3066H29	1761	29.5	66	30	180	14
L2CT3072H29	1836	29.5	72	30	189	15
L2CT3078H29	1905	29.5	78	30	198	16
L2CT3084H29	1981	29.5	84	30	207	18
L2CT3096H29	2126	29.5	96	30	216	20
L2CT3060H36	1791	36	60	30	176	19
L2CT3066H36	1866	36	66	30	185	21
L2CT3072H36	1938	36	72	30	194	23
L2CT3078H36	2011	36	78	30	203	24
L2CT3084H36	2085	36	84	30	212	26
L2CT3096H36	2231	36	96	30	221	30
L2CT3060H42	1936	42	60	30	181	25
L2CT3066H42	2011	42	66	30	190	28
L2CT3072H42	2083	42	72	30	199	30
L2CT3078H42	2156	42	78	30	208	33
L2CT3084H42	2230	42	84	30	217	35
L2CT3096H42	2375	42	96	30	226	40
L2CT3660H29	1896	29.5	60	36	180	15
L2CT3666H29	1978	29.5	66	36	189	17
L2CT3672H29	2058	29.5	72	36	198	18
L2CT3678H29	2140	29.5	78	36	207	20
L2CT3684H29	2220	29.5	84	36	216	21
L2CT3696H29	2383	29.5	96	36	225	24
L2CT3660H36	2020	36	60	36	185	23
L2CT3666H36	2098	36	66	36	194	25
L2CT3672H36	2181	36	72	36	203	27
L2CT3678H36	2262	36	78	36	212	29
L2CT3684H36	2344	36	84	36	221	32
L2CT3696H36	2507	36	96	36	230	36
L2CT3660H42	2185	42	60	36	190	30
L2CT3666H42	2264	42	66	36	199	33
L2CT3672H42	2346	42	72	36	208	36
L2CT3678H42	2427	42	78	36	217	39
L2CT3684H42	2510	42	84	36	226	42
L2CT3696H42	2671	42	96	36	235	48
L2CT4260H29	2102	29.5	60	42	189	18
L2CT4266H29	2192	29.5	66	42	198	19
L2CT4272H29	2281	29.5	72	42	207	21
L2CT4278H29	2369	29.5	78	42	216	23
L2CT4284H29	2460	29.5	84	42	225	25
L2CT4296H29	2638	29.5	96	42	234	28
L2CT4260H36	2246	36	60	42	194	26
L2CT4266H36	2335	36	66	42	203	29
L2CT4272H36	2424	36	72	42	212	32
L2CT4278H36	2514	36	78	42	221	34
L2CT4284H36	2603	36	84	42	230	37
L2CT4296H36	2783	36	96	42	239	42
L2CT4260H42	2430	42	60	42	199	35
L2CT4266H42	2519	42	66	42	208	39
L2CT4272H42	2611	42	72	42	217	42
L2CT4278H42	2698	42	78	42	226	46
L2CT4284H42	2787	42	84	42	235	49
L2CT4296H42	2966	42	96	42	244	56

L2CTV • Collaboration Tables with Media Wall Integrated Wire Management

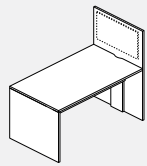

- Units Shipped knocked down (KD)
- Footrest to be ordered separately.
- Add "FR" to the end of the code for a foot rail and add \$1,890 to the list price.
- Foot rail kit will include a quantity of two 2" diameter rails and 4 flanges.
- Unit includes TV/Display bracket & mounting hardware.
- "W" thick (1 7/16") top and gables.
- Low pressure modesty panel.

Standard Grommet Location:

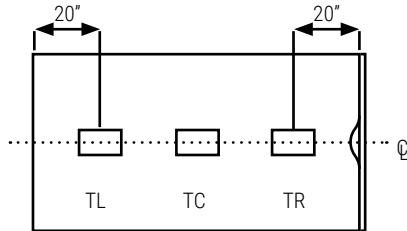

Please see Accessories Section for power grommets.

Half Modesty at 15" high.

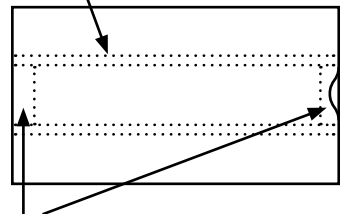

Vertical Cable Managers

PRODUCT CODE	FINISH "W"	H(W)	W	D	WEIGHT LBS	VOL FT ³
L2CTV4260H29H66	3110	29.5	60	42	192	18
L2CTV4266H29H66	3199	29.5	66	42	201	19
L2CTV4272H29H66	3288	29.5	72	42	210	21
L2CTV4278H29H66	3377	29.5	78	42	219	23
L2CTV4284H29H66	3464	29.5	84	42	228	25
L2CTV4296H29H66	3648	29.5	96	42	237	28
L2CTV4860H29H66	3377	29.5	60	48	198	20
L2CTV4866H29H66	3475	29.5	66	48	207	22
L2CTV4872H29H66	3572	29.5	72	48	216	24
L2CTV4878H29H66	3669	29.5	78	48	225	26
L2CTV4884H29H66	3769	29.5	84	48	234	28
L2CTV4896H29H66	3960	29.5	96	48	243	32
L2CTV4260H36H72	3253	36	60	42	197	26
L2CTV4266H36H72	3343	36	66	42	206	29
L2CTV4272H36H72	3432	36	72	42	215	32
L2CTV4278H36H72	3521	36	78	42	224	34
L2CTV4284H36H72	3609	36	84	42	233	37
L2CTV4296H36H72	3788	36	96	42	242	42
L2CTV4860H36H72	3540	36	60	48	203	30
L2CTV4866H36H72	3637	36	66	48	212	33
L2CTV4872H36H72	3737	36	72	48	221	36
L2CTV4878H36H72	3835	36	78	48	230	39
L2CTV4884H36H72	3929	36	84	48	239	42
L2CTV4896H36H72	3632	36	96	48	248	48
L2CTV4260H42H72	3367	42	60	42	202	35
L2CTV4266H42H72	3455	42	66	42	211	39
L2CTV4272H42H72	3544	42	72	42	220	42
L2CTV4278H42H72	3666	42	78	42	229	46
L2CTV4284H42H72	3724	42	84	42	238	49
L2CTV4296H42H72	3934	42	96	42	247	56
L2CTV4860H42H72	3663	42	60	48	208	40
L2CTV4866H42H72	3760	42	66	48	217	44
L2CTV4872H42H72	3859	42	72	48	226	48
L2CTV4878H42H72	3956	42	78	48	235	52
L2CTV4884H42H72	4055	42	84	48	244	56
L2CTV4896H42H72	4248	42	96	48	253	64

Technical Information - Tables

Tables

- All table surfaces are High Pressure Laminate in "B" or "W" thickness.
- All tables have "T" mold edge band, unless otherwise indicated.
- Tables up to and including 96" long are manufactured in one piece, 120" to 192" long are manufactured in two pieces and over 216" are manufactured in three pieces. If wood grain laminate is chosen, the wood grain pattern will not line up.
- Tables in 2 or 3 pieces will have the joining edge finished with PVC edge (0.5mm), hardware will be shipped for assembly.
- Grommet locations must be specified at the time of order or it will default to "no grommet" option.
- Power modules and grommets are not included, they must be specified separately.
- Positions for drop in power and data grommets are intended for use on tops with the following bases: LR, LSQ, LDRUM, TELRS, TELRR, TELBS, TELBR. For any other base, please consult Customer Service Representative.
- Tables are not pre-drilled to accept legs or bases.
- "LTR" Rectangular shape tables with edge B and W have a 1" radius at each corner.
- For table tops with square corners, please add "NR" at the end of the product code, no upcharge required. The "NR" option is available only with the B and W edge profiles.
- "LBT" Boat shape tables are 6" narrower at the ends. The nominal size is identified at the centre.
- "LBTB" Boat shape tables with bow ends are 12" narrower at the ends. The nominal size is identified at the centre.
- Trapezoid tables can be used in several combinations.
- Power modules and grommets are not included, they must be specified separately.

Bases

- Available in variety of materials metal, high pressure laminate or low pressure laminate, please refer to specific base in price list
- "LR" Rectangular and "LSQ" square bases come standard with removable access door and cut out on the bottom of the base for pass-thru cables.
- "TELRS / TELBS" square and "TELRR / TELBR" rectangular bases come standard with cut out on the bottom of the base for pass-thru cables. Hinged access doors are optional and must be specified with an "HD" at the end of the code. There will be an upcharge of \$122 to the list price.
- Drum bases are finished in high pressure only and comes with a full bottom and notch at the top. Sand bag included. Access door is not an option.
- Drum, rectangular and square bases are shipped assembled.

Folding Legs

- Legs are folded by pressing the lever. Once folded, the legs are held securely by the interlocking springs.
- Includes adjustable levelers offering 12mm (1/2") of adjustment.
- Minimum special sizing for tables is 54" in length and 25" in depth.
- Sold per pair.

Flip Top Training Tables

- "GFT" Rectangular Flip tables with edge B and W edge have straight corners.

Visual Board

- Unit offered in high pressure laminate (B) comes with 2 high pressure laminate doors
- Cork board included on one inside door.
- Unit closes with a touch latch mechanism, but no lock option.
- "MG" indicates a magnetic white board.

Tables • Guidelines For Ordering Product

CODES: The price list uses a numbering system with meaningful alphanumeric characters to create a simple-to-understand product number. This makes specifying the product much easier and more accurate.

SPECIFICATION EXAMPLE OF A TABLE UNIT

PRODUCT CODE: LTS2424
 L = Licence
 T = Table
 S = Square
 2424 = Size: Depth x Width

Edge Options:

"B" Edges

HP (B) 1.062" Thickness

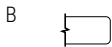

"W" Edges

HP (W) 1.437" Thickness



Base Specification Guide (See Installation Manual For Examples).

- Tables up to 96" in length require 2 T bases
- Tables 108" to 144" in length require 3 T bases
- Tables 156" to 192" in length require 4 T bases
- Tables 216" to 240" in length require 6 T bases

FLAT BAR 3 PRONG "TTF"

BASE SPREAD	TOP WIDTH
18"	24W
22"	30W
24"	36W
30"	42W
36"	48W
36"	54W

LLT/LLTT W/BULLNOSE ENDS

BASE SPREAD	TOP WIDTH
18"	24W
26"	30W
26"	36W
30"	42W
36"	48W
36"	54W
42"	60W

TTF/TT FLAT BAR "T"

BASE SPREAD	TOP WIDTH
18"	24W
22"	30W
24"	36W
30"	42W
36"	48W
36"	54W

LD DRUM

BASE SPREAD	ROUND TOP SIZE
18" dia	30" dia
18" dia	36" dia
24" dia	42" dia
24" dia	48" dia
30" dia	54" dia
30" dia	60" dia

LSQ, TELRS & TELBS SQUARE

BASE SPREAD	TOP SIZE
18"	30x30
18"	36x36
24"	42x42
24"	48x48
30"	54x54
30"	60x60

LCT CROSS BASE

BASE SPREAD	TOP SIZE
18"	24x24
24"	30x30
24"	36x36
30"	42x42
30"	48x48
36"	54x54
42"	60x60

- 1 Piece Tables up to 96" in length require 2 bases
- Tables 108" to 192" in length require 3 bases
- Tables 216" to 240" in length require 4 bases

LR, LSQ, TELRS, TELRR, TELBS, TELBR

BASE SPREAD	TOP WIDTH
18"	30
18"	36
24"	42
24"	48
30"	54
30"	60

LLEBA

BASE SPREAD	TOP WIDTH
18"	30
18"	36
24"	42
30"	48
36"	54
36"	60

TRUMPET 28H

BASE SPREAD	TOP SIZE
18"	24x24
24"	30x30
24"	36x36
30"	42x42
30"	48x48

FLAT SQUARE

BASE SPREAD	TOP SIZE
18"	24x24
18"	30x30
23"	36x36
23"	42x42
30"	48x48

FLAT DISC 28H

BASE SPREAD	TOP SIZE
18"	24x24
18"	30x30
24"	36x36
30"	42x42
30"	48x48
36"	54x54

FLATBAR X

BASE SPREAD	TOP SIZE
18"	24x24
18"	30x30
24"	36x36
24"	42x42
30"	48x48
36"	54x54

TRUMPET 40.5H

BASE SPREAD	TOP SIZE
18"	24x24
24"	30x30
24"	36x36

FLAT SQUARE 40.5H

BASE SPREAD	TOP SIZE
18"	24x24
23"	30x30

FLAT DISC 40.5H

BASE SPREAD	TOP SIZE
18"	24x24
22"	30x30
24"	36x36

FLATBAR X 40.5H

BASE SPREAD	TOP SIZE
18"	24x24
22"	30x30

LL4S W/BULLNOSE ENDS

BASE SPREAD	TOP SIZE
18"	24x24
26"	30x30
26"	36x36
26"	42x42
30"	48x48
36"	54x54

LHC HAT CHANNEL

LHC40 For Table 54" Wide
 LHC46 For Table 60" Wide
 LHC52 For Table 66" Wide
 LHC58 For Table 72" Wide
 LHC64 For Table 78" Wide
 LHC70 For Table 84" Wide

LL4S W/BULLNOSE ENDS 40.5H

BASE SPREAD	TOP SIZE
26"	30x30
30"	36x36
36"	42x42

Tops with post legs must be specified with HAT Channels for structural reinforcement.

Grommet Cut Dimensions (inches)

BG5

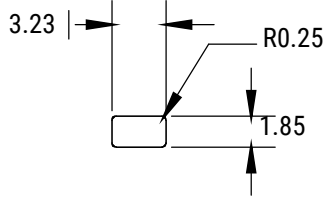
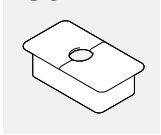

MSPDM

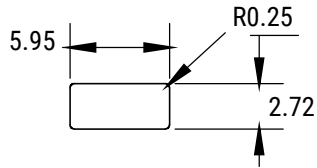
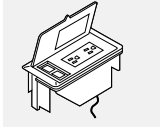

GAAD

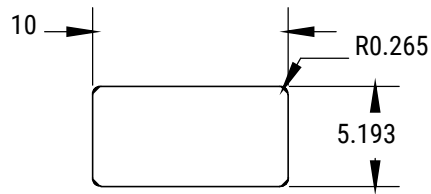
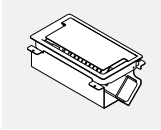

GCRTMCS4xx

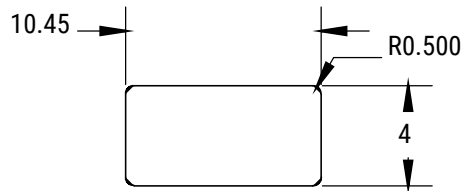
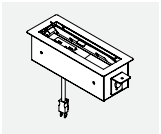

GCRTMCS6xx

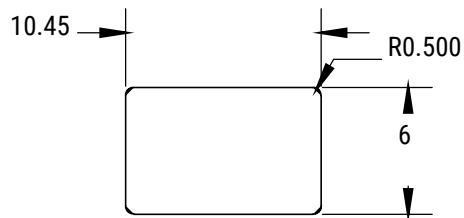
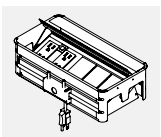
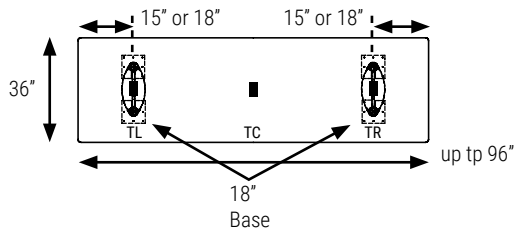

Table Dimension Chart & Grommet Location

LELBA - Elliptical Base

For One Piece Top

LELBA BASE SPREAD	TOP WIDTH
18"	30
18"	36
24"	42
30"	48
36"	54
36"	60



*15" for table widths between 60" and 72" and 18" for table widths between 78" and 96"

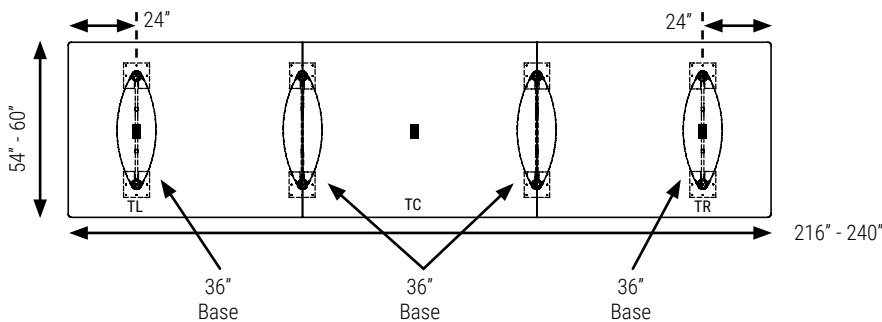
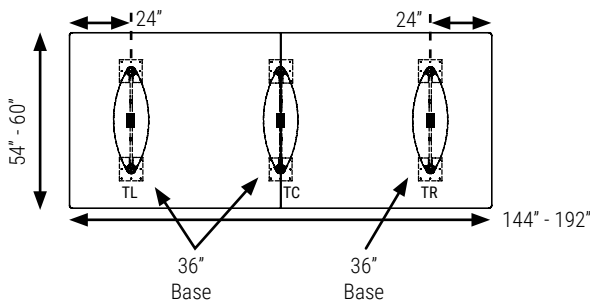
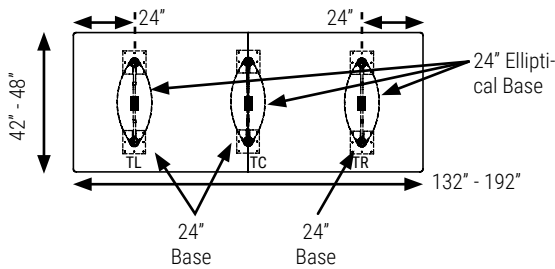
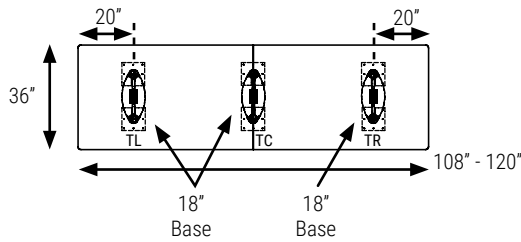

Note: Grommet orientation is perpendicular to the length of table.

Table Dimension Chart & Grommet Location

LR - Rectangular Base

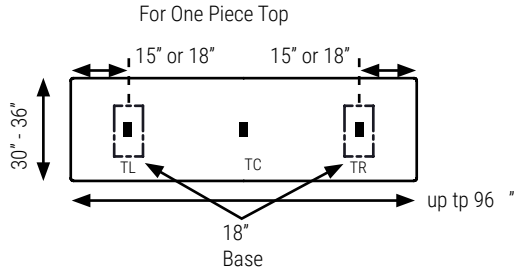

*15" for table widths between 60" and 72" and 18" for table widths between 78" and 96"

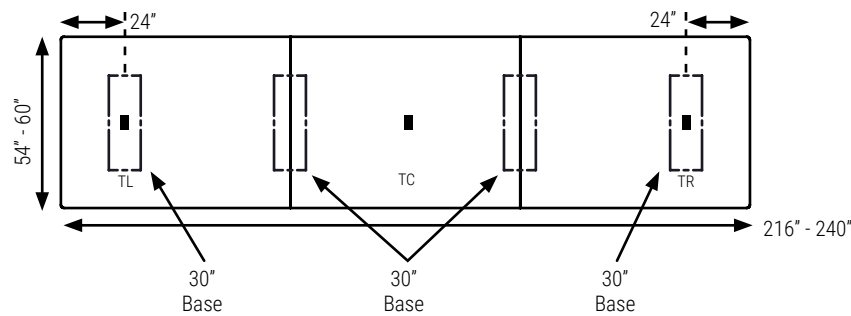
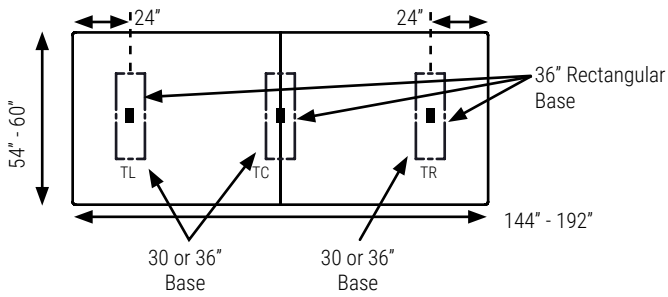
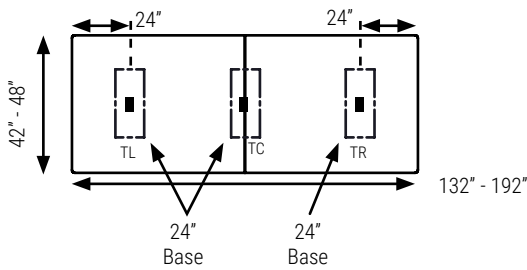
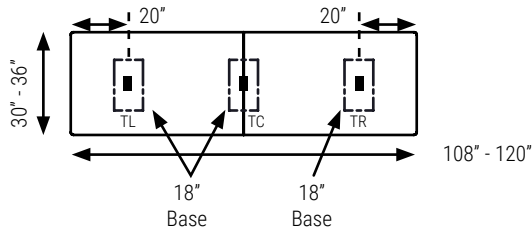

Note: Grommet orientation is perpendicular to the length of table.

Table Dimension Chart & Grommet Location

For One Piece Top

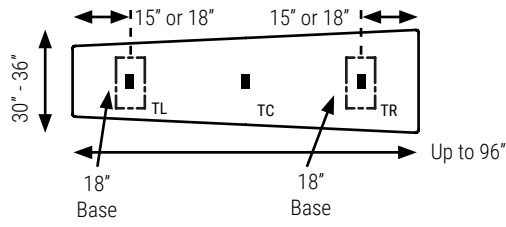

*15" for table widths between 60" and 72" and 18" for table widths between 78" and 96"

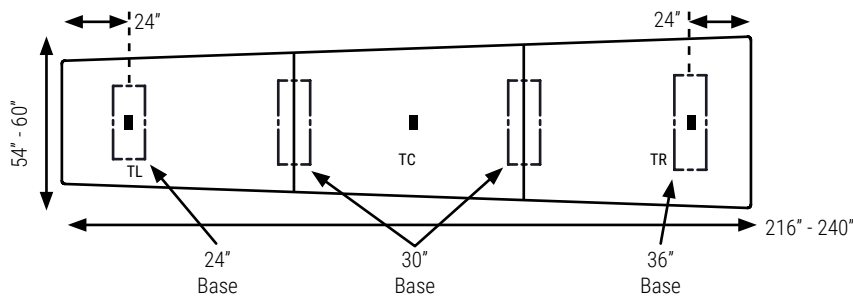
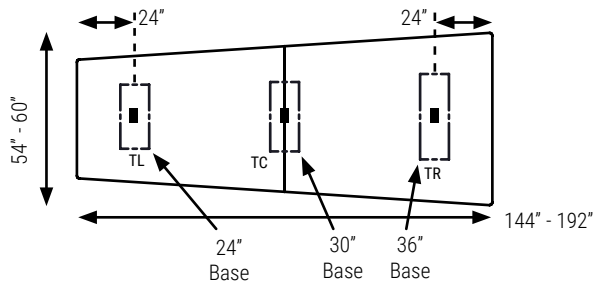
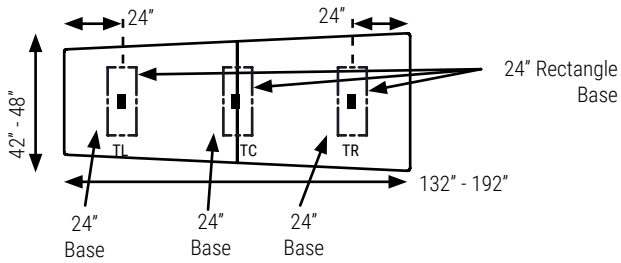
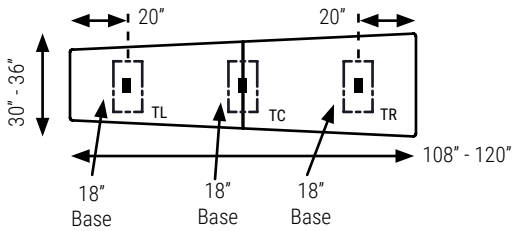

Note: Grommet orientation is perpendicular to the length of table.

Table Dimension Chart & Grommet Location

LELBA - Elliptical Base

For One Piece Top

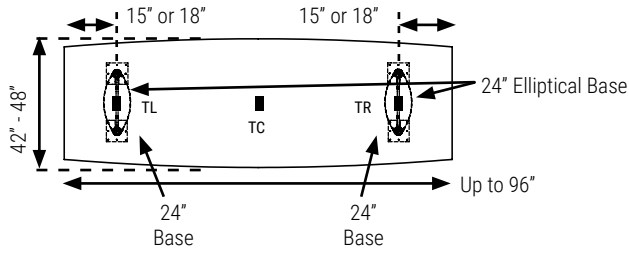

*15\"/>

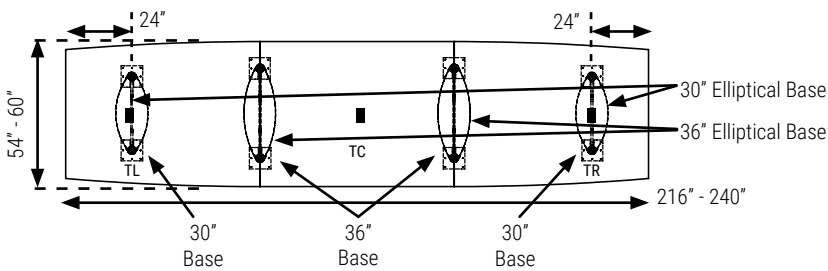
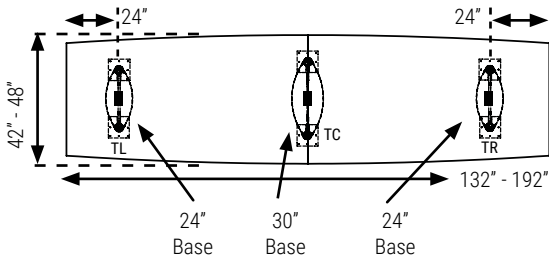
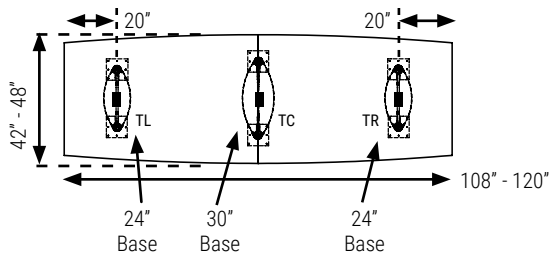

Note: Grommet orientation is perpendicular to the length of table.

Table Dimension Chart & Grommet Location

LELBA - Rectangular Base

For One Piece Top

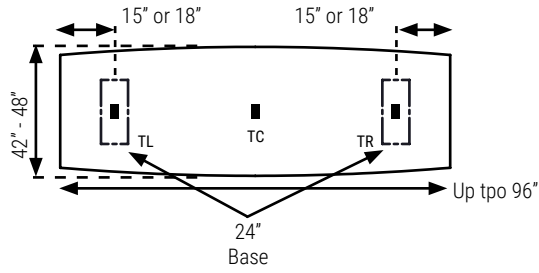

*15" for table widths between 60" and 72" and 18" for table widths between 78" and 96"

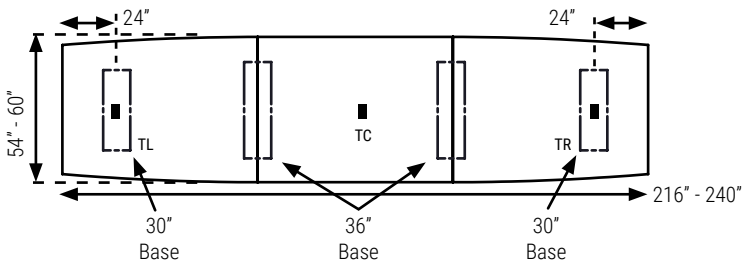
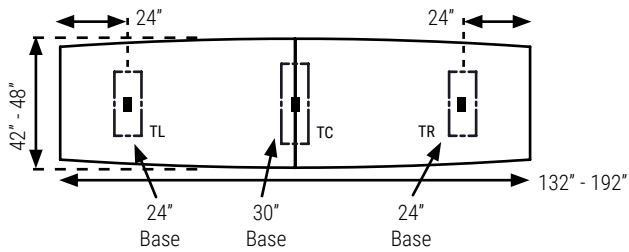
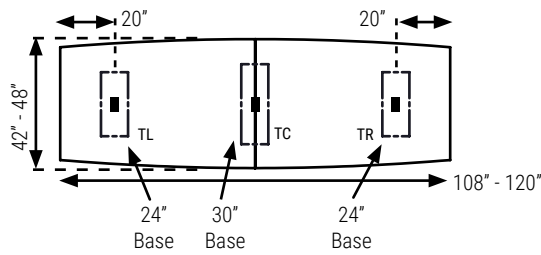

Note: Grommet orientation is perpendicular to the length of table.

Table Dimension Chart & Grommet Location

LR - Elliptical Base

For One Piece Top

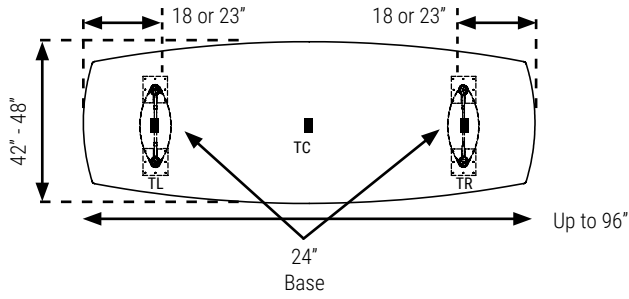

*18" for table widths between 60" and 72" and 23" for table widths between 78" and 96"

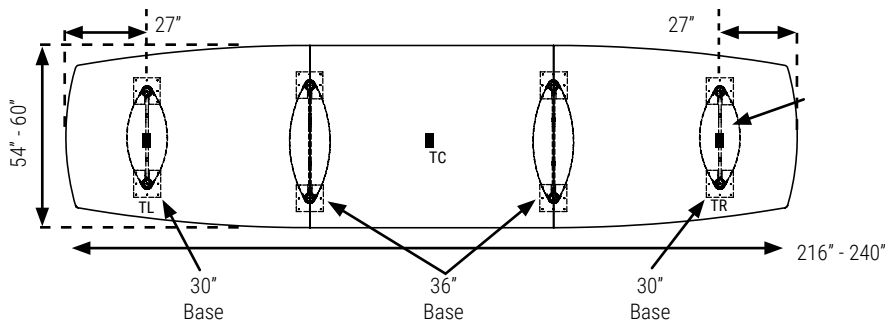
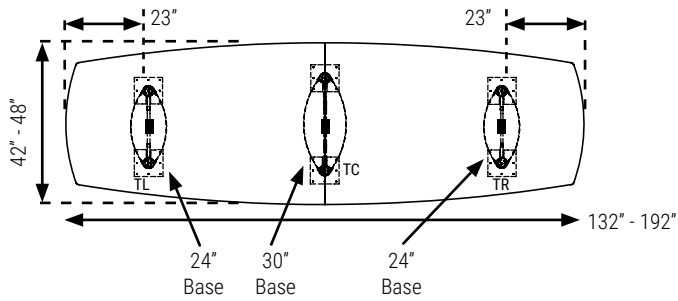
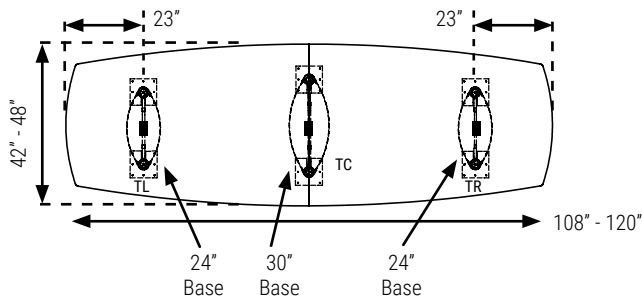

Note: Grommet orientation is perpendicular to the length of table.

Table Dimension Chart

LR - Rectangular Base

For One Piece Top

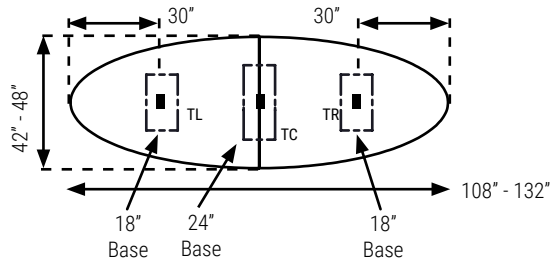
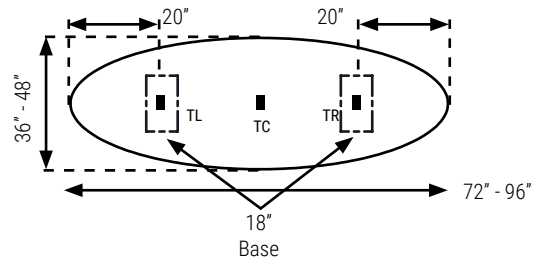

*15" for table widths between 60" and 72" and 18" for table widths between 78" and 96"

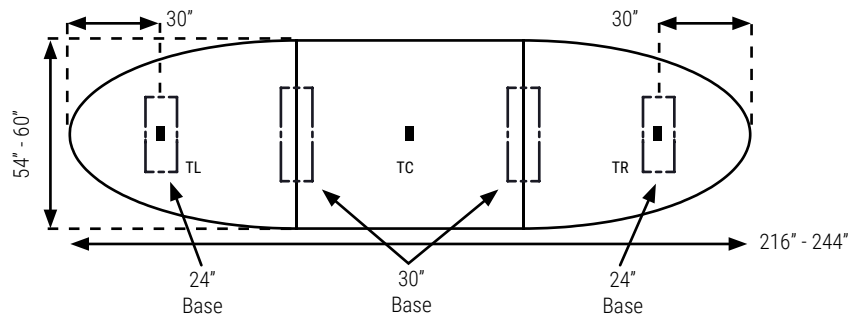
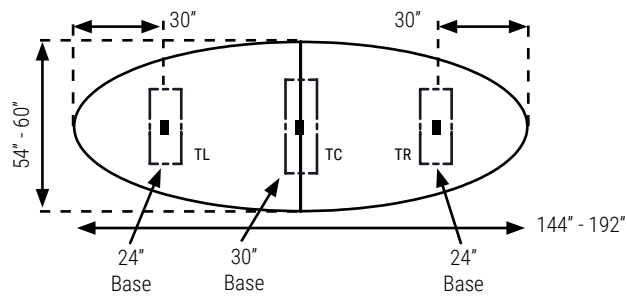

Note: Grommet orientation is perpendicular to the length of table.

Table Dimension Chart

LR - Rectangular Base

For One Piece Top

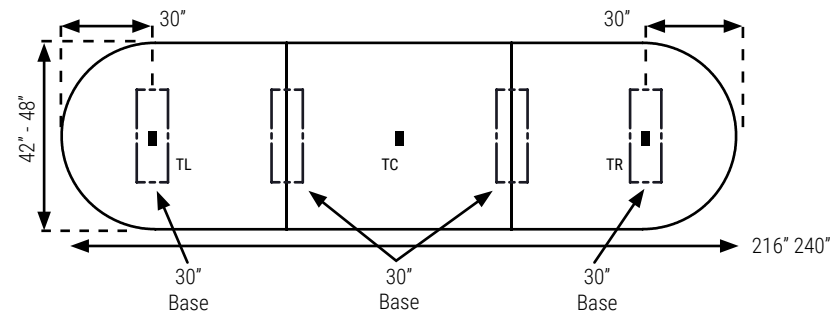
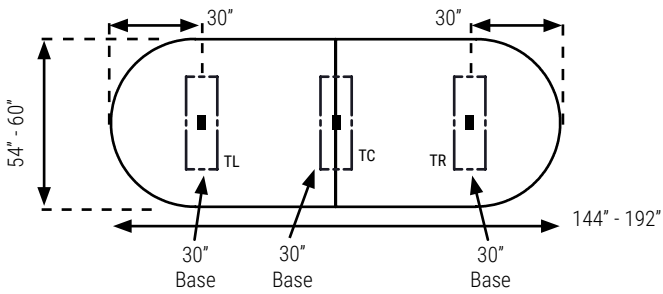
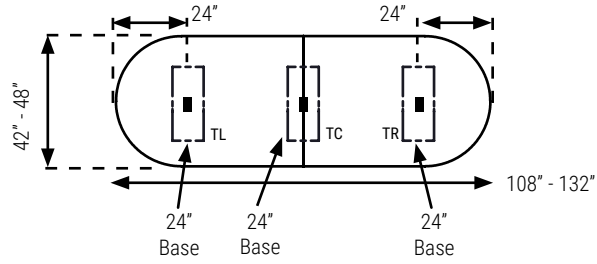
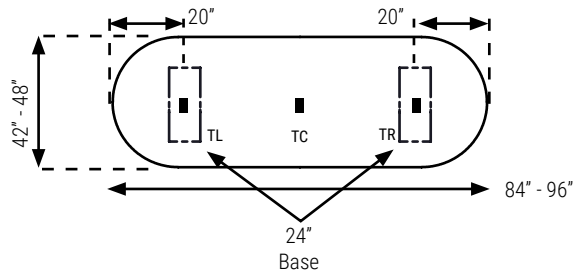

Note: Grommet orientation is perpendicular to the length of table.

LTS • Square Table Top

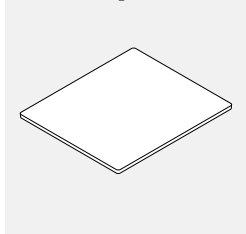

• Tops with Band W thickness have 1" radius corners.

PRODUCT CODE	EDGE		SIZE / INCHES				WEIGHT LBS	VOL FT ³
	B	W	H (B)	H (W)	W	D		
LTS2424	173	252	1	1.5	24	24	29	3
LTS3030	218	361	1	1.5	30	30	32	3
LTS3636	315	462	1	1.5	36	36	46	4
LTS4242	469	608	1	1.5	42	42	57	6
LTS4848	603	769	1	1.5	48	48	75	7
LTS5454	748	955	1	1.5	54	54	86	10
LTS6060	910	1159	1	1.5	60	60	99	12

L-DIA • Circle Table Top

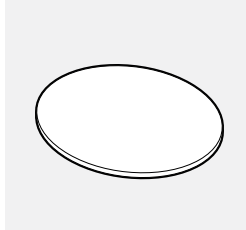

PRODUCT CODE	EDGE		SIZE / INCHES				WEIGHT LBS	VOL FT ³
	B	W	H (B)	H (W)	W	D		
L24DIA	177	257	1	1.5	24 dia	24 dia	29	3
L30DIA	226	373	1	1.5	30	30	32	3
L36DIA	323	473	1	1.5	36	36	46	4
L42DIA	484	624	1	1.5	42	42	57	6
L48DIA	617	795	1	1.5	48	48	75	7
L54DIA	769	983	1	1.5	54	54	86	10
L60DIA	938	1195	1	1.5	60	60	99	12

LTR • Rectangle Table Top

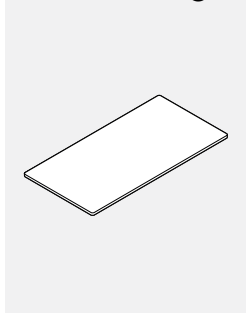

• Tops with B and W thickness have 1" radius corners.

PRODUCT CODE	EDGE		SIZE / INCHES				WEIGHT LBS	VOL FT ³
	B	W	H (B)	H (W)	W	D		
LTR2430	184	278	1	1.5	30	24	26	2
LTR2436	207	321	1	1.5	36	24	31	2
LTR2442	272	366	1	1.5	42	24	33	3
LTR2448	329	413	1	1.5	48	24	35	3
LTR2454	383	461	1	1.5	54	24	40	3
LTR2460	430	507	1	1.5	60	24	42	4
LTR2466	449	553	1	1.5	66	24	47	4
LTR2472	470	604	1	1.5	72	24	53	4
LTR3036	256	386	1	1.5	36	30	31	2
LTR3042	362	442	1	1.5	42	30	35	2
LTR3048	383	498	1	1.5	48	30	40	3
LTR3054	408	556	1	1.5	54	30	44	3
LTR3060	449	612	1	1.5	60	30	48	3
LTR3066	469	669	1	1.5	66	30	53	3
LTR3072	495	725	1	1.5	72	30	57	3
LTR3078	524	781	1	1.5	78	30	59	4
LTR3084	579	838	1	1.5	84	30	62	4
LTR3096	672	949	1	1.5	96	30	66	4
LTR3642	418	552	1	1.5	42	36	42	2
LTR3648	471	622	1	1.5	48	36	46	2
LTR3654	526	693	1	1.5	54	36	51	2
LTR3660	583	763	1	1.5	60	36	57	3
LTR3666	637	835	1	1.5	66	36	63	3
LTR3672	691	903	1	1.5	72	36	68	3
LTR3678	743	974	1	1.5	78	36	72	3
LTR3684	800	1047	1	1.5	84	36	74	4
LTR3696	909	1188	1	1.5	96	36	79	4
LTR4248	564	713	1	1.5	48	42	57	3
LTR4254	634	795	1	1.5	54	42	59	3
LTR4260	699	872	1	1.5	60	42	62	3
LTR4266	763	956	1	1.5	66	42	68	3
LTR4272	828	1035	1	1.5	72	42	73	3
LTR4278	894	1118	1	1.5	78	42	76	3
LTR4284	959	1198	1	1.5	84	42	78	3
LTR4296	1092	1357	1	1.5	96	42	92	4
LTR4854	715	894	1	1.5	54	48	62	3
LTR4860	789	987	1	1.5	60	48	66	3
LTR4866	865	1076	1	1.5	66	48	73	3
LTR4872	938	1166	1	1.5	72	48	79	3
LTR4878	1011	1260	1	1.5	78	48	84	3
LTR4884	1086	1350	1	1.5	84	48	88	4
LTR4896	1233	1531	1	1.5	96	48	110	4

LTR • Rectangle Table Top 2 Piece

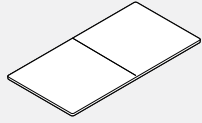

- Tables larger than 192" long are manufactured in 3 pieces.
- Tops with B and W thickness have 1" radius corners.

PRODUCT CODE	EDGE		SIZE/INCHES				WEIGHT LBS	VOL FT ³
	B	W	H(B)	H(W)	W	D		
LTR36108	1166	1374	1	1.5	108	36	105	4
LTR36120	1286	1516	1	1.5	120	36	114	4
LTR42108	1330	1566	1	1.5	108	42	108	6
LTR42120	1464	1722	1	1.5	120	42	123	6
LTR48108	1485	1745	1	1.5	108	48	110	6
LTR48120	1641	1926	1	1.5	120	48	132	7
LTR48132	1789	2098	1	1.5	132	48	143	7
LTR48144	1815	2131	1	1.5	144	48	158	8
LTR48156	2088	2450	1	1.5	156	48	167	8
LTR48168	2234	2620	1	1.5	168	48	176	9
LTR48180	2509	2936	1	1.5	180	48	189	10
LTR48192	2534	2970	1	1.5	192	48	201	10
LTR54144	2202	2569	1	1.5	144	54	169	10
LTR54168	2534	2956	1	1.5	168	54	187	10
LTR54192	2867	3343	1	1.5	192	54	212	13
LTR54216	3196	3729	1	1.5	216	54	234	18
LTR54240	3530	4118	1	1.5	240	54	259	20
LTR60144	2417	2811	1	1.5	144	60	180	11
LTR60168	2781	3237	1	1.5	168	60	198	13
LTR60192	3148	3663	1	1.5	192	60	223	18
LTR60216	3512	4090	1	1.5	216	60	245	22
LTR60240	3880	4516	1	1.5	240	60	270	24

LTRB • Rectangle Table Top with Bow Ends

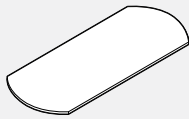

PRODUCT CODE	EDGE		SIZE/INCHES				WEIGHT LBS	VOL FT ³
	B	W	H(B)	H(W)	W	D		
LTRB4284	991	1232	1	1.5	84	42	78	3
LTRB4296	1124	1399	1	1.5	96	42	92	4
LTRB4884	1119	1389	1	1.5	84	48	88	4
LTRB4896	1271	1579	1	1.5	96	48	110	4

LTRB • Rectangle Table Top with Bow Ends 2 Piece

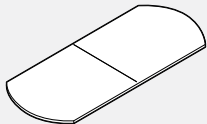

- Tables larger than 192" long are manufactured in 3 pieces.

PRODUCT CODE	EDGE		SIZE/INCHES				WEIGHT LBS	VOL FT ³
	B	W	H(B)	H(W)	W	D		
LTRB42108	1373	1612	1	1.5	108	42	108	6
LTRB42120	1507	1773	1	1.5	120	42	123	6
LTRB48108	1531	1792	1	1.5	108	48	110	6
LTRB48120	1690	1983	1	1.5	120	48	132	7
LTRB48132	1843	2162	1	1.5	132	48	143	7
LTRB48144	1871	2196	1	1.5	144	48	158	8
LTRB48156	2149	2519	1	1.5	156	48	167	8
LTRB48168	2302	2701	1	1.5	168	48	176	9
LTRB48180	2582	3025	1	1.5	180	48	189	10
LTRB48192	2611	3061	1	1.5	192	48	201	10
LTRB54144	2269	2643	1	1.5	144	54	169	10
LTRB54168	2613	3043	1	1.5	168	54	187	10
LTRB54192	2951	3444	1	1.5	192	54	212	13
LTRB54216	3293	3841	1	1.5	216	54	234	18
LTRB54240	3636	4239	1	1.5	240	54	259	20
LTRB60144	2487	2895	1	1.5	144	60	180	11
LTRB60168	2864	3333	1	1.5	168	60	198	13
LTRB60192	3242	3774	1	1.5	192	60	223	18
LTRB60216	3620	4213	1	1.5	216	60	245	22
LTRB60240	3995	4650	1	1.5	240	60	270	24

LRT • Racetrack Table Top



PRODUCT CODE	EDGE		SIZE/INCHES				WEIGHT LBS	VOL FT ³
	B	W	H(B)	H(W)	W	D		
LRT4284	991	1232	1	1.5	84	42	78	3
LRT4296	1124	1399	1	1.5	96	42	92	4
LRT4884	1119	1389	1	1.5	84	48	88	4
LRT4896	1271	1579	1	1.5	96	48	110	4

LRT • Racetrack Table Top 2 Piece

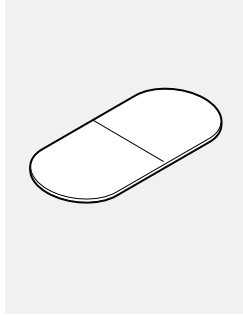

• Tables larger than 192" long are manufactured in 3 pieces.

PRODUCT CODE	EDGE		SIZE / INCHES				WEIGHT LBS	VOL FT ³
	B	W	H(B)	H(W)	W	D		
LRT42108	1373	1612	1	1.5	108	42	108	6
LRT42120	1507	1773	1	1.5	120	42	123	6
LRT48108	1531	1792	1	1.5	108	48	110	6
LRT48120	1690	1983	1	1.5	120	48	132	7
LRT48132	1843	2162	1	1.5	132	48	143	7
LRT48144	1871	2196	1	1.5	144	48	158	8
LRT48156	2149	2519	1	1.5	156	48	167	8
LRT48168	2302	2701	1	1.5	168	48	176	9
LRT48180	2582	3025	1	1.5	180	48	189	10
LRT48192	2611	3061	1	1.5	192	48	201	10
LRT54144	2269	2643	1	1.5	144	54	169	10
LRT54168	2613	3043	1	1.5	168	54	187	10
LRT54192	2951	3444	1	1.5	192	54	204	10
LRT54216	3293	3841	1	1.5	216	54	226	11
LRT54240	3636	4239	1	1.5	240	54	253	11
LRT60144	2487	2895	1	1.5	144	60	180	11
LRT60168	2864	3333	1	1.5	168	60	198	13
LRT60192	3242	3774	1	1.5	192	60	223	18
LRT60216	3620	4213	1	1.5	216	60	245	22
LRT60240	3995	4650	1	1.5	240	60	270	24

LO • Oval Table Top

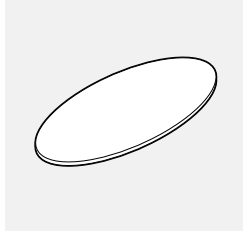

PRODUCT CODE	EDGE		SIZE / INCHES				WEIGHT LBS	VOL FT ³
	B	W	H(B)	H(W)	W	D		
LO3672	710	931	1	1.5	72	36	68	3
LO3684	825	1076	1	1.5	84	36	74	3
LO3696	935	1223	1	1.5	96	36	79	3
LO4284	991	1232	1	1.5	84	42	78	3
LO4296	1124	1399	1	1.5	96	42	92	4
LO4884	1119	1389	1	1.5	84	48	88	4
LO4896	1271	1579	1	1.5	96	48	110	4

LBT • Boat Table Top

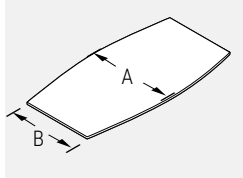

A	B
42	36
48	42

PRODUCT CODE	EDGE		SIZE / INCHES				WEIGHT LBS	VOL FT ³
	B	W	H(B)	H(W)	W	D		
LBT4284	991	1232	1	1.5	84	42	78	3
LBT4296	1124	1399	1	1.5	96	42	92	4
LBT4884	1119	1389	1	1.5	84	48	99	4
LBT4896	1271	1579	1	1.5	96	48	110	4

LBT • Boat Table Top 2 Piece

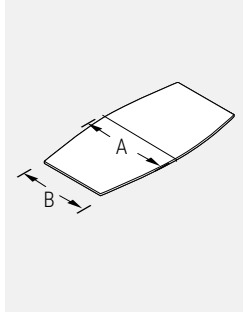

• Tables larger than 192" long are manufactured in 3 pieces.
• 6" narrower at the ends.

A	B
42	36
48	42
54	48
60	54

PRODUCT CODE	EDGE		SIZE / INCHES				WEIGHT LBS	VOL FT ³
	B	W	H(B)	H(W)	W	D		
LBT42108	1373	1612	1	1.5	108	42	108	6
LBT42120	1507	1773	1	1.5	120	42	123	6
LBT48108	1531	1792	1	1.5	108	48	110	6
LBT48120	1690	1983	1	1.5	120	48	132	7
LBT48132	1843	2162	1	1.5	132	48	143	7
LBT48144	1871	2196	1	1.5	144	48	158	8
LBT48156	2149	2519	1	1.5	156	48	167	8
LBT48168	2302	2701	1	1.5	168	48	176	9
LBT48180	2582	3025	1	1.5	180	48	189	10
LBT48192	2611	3061	1	1.5	192	48	201	10
LBT54144	2269	2643	1	1.5	144	54	169	10
LBT54168	2613	3043	1	1.5	168	54	187	10
LBT54192	2951	3444	1	1.5	192	54	212	13
LBT54216	3293	3841	1	1.5	216	54	234	18
LBT54240	3636	4239	1	1.5	240	54	259	20
LBT60144	2487	2895	1	1.5	144	60	180	11
LBT60168	2864	3333	1	1.5	168	60	198	13
LBT60192	3242	3774	1	1.5	192	60	223	18
LBT60216	3620	4213	1	1.5	216	60	245	22
LBT60240	3995	4650	1	1.5	240	60	270	24

LBTB • Boat Table Top with Bow Ends

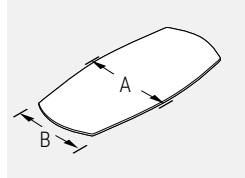

A	B
42	30
48	36

PRODUCT CODE	EDGE		SIZE/INCHES				WEIGHT LBS	VOL FT ³
	B	W	H(B)	H(W)	W	D		
LBTB4284	991	1232	1	1.5	84	42	78	3
LBTB4296	1124	1399	1	1.5	96	42	92	4
LBTB4884	1119	1389	1	1.5	84	48	88	4
LBTB4896	1271	1579	1	1.5	96	48	110	4

LBTB • Boat Table Top with Bow Ends 2 Piece

• Tables larger than 192" long are manufactured in 3 pieces.

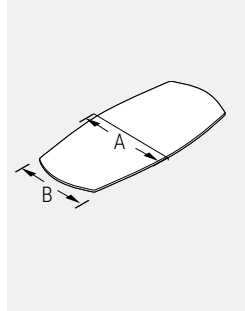

A	B
60	48
54	42
48	36
42	30

PRODUCT CODE	EDGE		SIZE/INCHES				WEIGHT LBS	VOL FT ³
	B	W	H(B)	H(W)	W	D		
LBTB42108	1373	1612	1	1.5	108	42	108	6
LBTB42120	1507	1773	1	1.5	120	42	123	6
LBTB48108	1531	1792	1	1.5	108	48	110	6
LBTB48120	1690	1983	1	1.5	120	48	132	7
LBTB48132	1843	2162	1	1.5	132	48	143	7
LBTB48144	1871	2196	1	1.5	144	48	158	8
LBTB48156	2149	2519	1	1.5	156	48	167	8
LBTB48168	2302	2701	1	1.5	168	48	176	9
LBTB48180	2582	3025	1	1.5	180	48	189	10
LBTB48192	2611	3061	1	1.5	192	48	204	11
LBTB54144	2269	2643	1	1.5	144	54	176	9
LBTB54168	2613	3043	1	1.5	168	54	187	10
LBTB54192	2951	3444	1	1.5	192	54	212	13
LBTB54216	3293	3841	1	1.5	216	54	234	18
LBTB54240	3636	4239	1	1.5	240	54	259	20
LBTB60144	2487	2895	1	1.5	144	60	180	11
LBTB60168	2864	3333	1	1.5	168	60	198	13
LBTB60192	3242	3774	1	1.5	192	60	223	18
LBTB60216	3620	4213	1	1.5	216	60	245	22
LBTB60240	3995	4650	1	1.5	240	60	270	24

LTW • Wedge Table Top

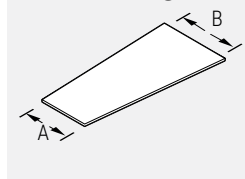

A	B
36	48

PRODUCT CODE	EDGE		SIZE/INCHES				WEIGHT LBS	VOL FT ³
	B	W	H(B)	H(W)	W	D		
LTW4896	1271	1579	1	1.5	96	48	110	4

LTW • Wedge Table Top 2 Piece

• Tables larger than 192" long are manufactured in 3 pieces.

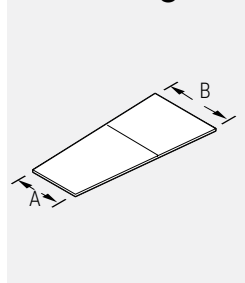

A	B
48	60
42	54
36	48

PRODUCT CODE	EDGE		SIZE/INCHES				WEIGHT LBS	VOL FT ³
	B	W	H(B)	H(W)	W	D		
LTW48108	1531	1792	1	1.5	108	48	110	6
LTW48120	1690	1983	1	1.5	120	48	132	7
LTW48132	1843	2162	1	1.5	132	48	143	7
LTW48144	1871	2196	1	1.5	144	48	158	8
LTW48156	2149	2519	1	1.5	156	48	167	8
LTW48168	2302	2701	1	1.5	168	48	176	9
LTW48180	2582	3025	1	1.5	180	48	189	10
LTW48192	2611	3061	1	1.5	192	48	201	10
LTW54144	2269	2643	1	1.5	144	54	169	10
LTW54168	2613	3043	1	1.5	168	54	187	10
LTW54192	2951	3444	1	1.5	192	54	212	13
LTW54216	3293	3841	1	1.5	216	54	234	18
LTW54240	3636	4239	1	1.5	240	54	259	20
LTW60144	2487	2895	1	1.5	144	60	180	11
LTW60168	2864	3333	1	1.5	168	60	198	13
LTW60192	3242	3774	1	1.5	192	60	223	18
LTW60216	3620	4213	1	1.5	216	60	245	22
LTW60240	3995	4650	1	1.5	240	60	270	24

LTW _ _ - first dash is A and second dash is the length, B is not included in code.

LTWB • Wedge Table Top with Bow Ends

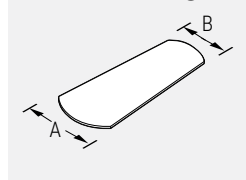

A	B
48	36

PRODUCT CODE	EDGE		H(B)	H(W)	W	D	WEIGHT LBS	VOL FT ³
	B	W						
LTWB4896	1271	1579	1	1.5	96	48	110	4

LTWB • Wedge Table Top with Bow Ends 2 Piece

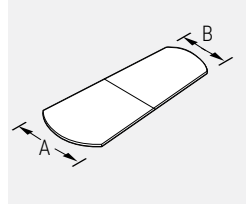

• Tables larger than 192" long are manufactured in 3 pieces.

A	B
48	36
54	42
60	48

PRODUCT CODE	EDGE		H(B)	H(W)	W	D	WEIGHT LBS	VOL FT ³
	B	W						
LTWB48108	1531	1792	1	1.5	108	48	110	6
LTWB48120	1690	1983	1	1.5	120	48	132	7
LTWB48132	1843	2162	1	1.5	132	48	143	7
LTWB48144	1871	2196	1	1.5	144	48	158	8
LTWB48156	2149	2519	1	1.5	156	48	167	8
LTWB48168	2302	2701	1	1.5	168	48	176	9
LTWB48180	2582	3025	1	1.5	180	48	189	10
LTWB48192	2611	3061	1	1.5	192	48	198	11
LTWB54144	2269	2643	1	1.5	144	54	178	9
LTWB54168	2613	3043	1	1.5	168	54	187	10
LTWB54192	2951	3444	1	1.5	192	54	212	13
LTWB54216	3293	3841	1	1.5	216	54	234	18
LTWB54240	3636	4239	1	1.5	240	54	259	20
LTWB60144	2487	2895	1	1.5	144	60	180	11
LTWB60168	2864	3333	1	1.5	168	60	198	13
LTWB60192	3242	3774	1	1.5	192	60	223	18
LTWB60216	3620	4213	1	1.5	216	60	245	22
LTWB60240	3995	4650	1	1.5	240	60	270	24

LHM • Halfmoon Table Top

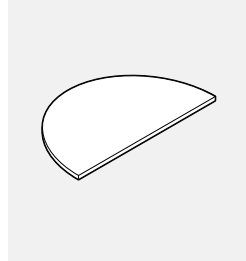

PRODUCT CODE	EDGE		H(B)	H(W)	W	D	WEIGHT LBS	VOL FT ³
	B	W						
LHM2424	177	257	1	1.5	24	24	29	3
LHM2448	337	426	1	1.5	48	24	35	3
LHM2460	443	524	1	1.5	60	24	42	4
LHM2472	485	619	1	1.5	72	24	53	6
LHM3030	226	373	1	1.5	30	30	32	3
LHM3048	394	513	1	1.5	48	30	40	4
LHM3060	462	633	1	1.5	60	30	48	6
LHM3072	509	748	1	1.5	72	30	57	7

LTZ • Trapezoid Table Top

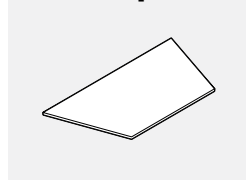

PRODUCT CODE	EDGE		H(B)	H(W)	W	D	WEIGHT LBS	VOL FT ³
	B	W						
LTZ2460	443	524	1	1.5	60	24	42	4
LTZ2472	485	619	1	1.5	72	24	53	6
LTZ3060	462	633	1	1.5	60	30	48	6
LTZ3072	509	748	1	1.5	72	30	57	7

LW • Wave Table Top

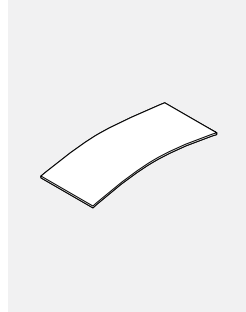

PRODUCT CODE	EDGE		H(B)	H(W)	W	D	WEIGHT LBS	VOL FT ³
	B	W						
LW2448	337	426	1	1.5	48	24	35	3
LW2460	443	524	1	1.5	60	24	42	4
LW2466	462	573	1	1.5	66	24	47	6
LW2472	485	619	1	1.5	72	24	53	6
LW3060	462	633	1	1.5	60	30	48	6
LW3066	484	688	1	1.5	66	30	53	7
LW3072	509	748	1	1.5	72	30	64	8
LW3660	596	787	1	1.5	60	36	53	7
LW3666	652	859	1	1.5	66	36	63	8
LW3672	710	931	1	1.5	72	36	68	9

LCT • Cross Base for Table Tops

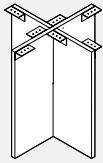

PRODUCT CODE	PRICE	SIZE/INCHES			WEIGHT		VOL FT ³
		H	W	D	LBS		
LCT18	469	28	18	18	29	6	
LCT24	469	28	24	24	39	4	
LCT30	526	28	30	30	48	6	
LCT36	604	28	36	36	57	8	
LCT42	677	28	42	42	62	9	

LR • Rectangular Base for Table Tops

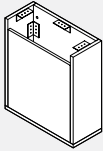

- Short side panel is removable for full wire access.

PRODUCT CODE	PRICE	SIZE/INCHES			WEIGHT		VOL FT ³
		H	W	D	LBS		
LR18	406	28	18	10	39	3	
LR24	459	28	24	10	46	4	
LR30	507	28	30	10	54	6	
LR36	565	28	36	10	66	8	
LR42	650	28	42	10	83	9	

LSQ • Square Base for Table Tops

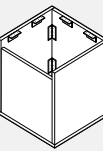

- Short side panel is removable for full wire access.

PRODUCT CODE	PRICE	SIZE/INCHES			WEIGHT		VOL FT ³
		H	W	D	LBS		
LSQ18	509	28	18	18	50	7	
LSQ24	624	28	24	24	66	11	
LSQ30	744	28	30	30	83	17	

LDRUM • Drum Base for Table Tops

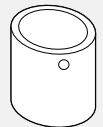

- Drum bases are finished in high pressure only and come with a full bottom.
- A 2" hole at the top to run the cables from the floor to the table top.
- Sand bag included.
- Access door is not an option.

PRODUCT CODE	PRICE	SIZE/INCHES			WEIGHT		VOL FT ³
		H	W	D	LBS		
LDRUM18	826	28	18	18	32	8	
LDRUM24	881	28	24	24	43	11	
LDRUM30	903	28	30	30	54	14	

LV • "V" Base for Table Tops

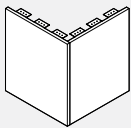

PRODUCT CODE	PRICE	SIZE/INCHES			WEIGHT		VOL FT ³
		H	W	D	LBS		
LV1818	271	28	18	18	29	3	
LV2424	310	28	24	24	39	4	
LV3030	364	28	30	30	48	6	

LELBA • Elliptical Base with Aluminum Extrusion

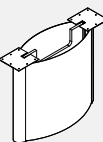

- Laminate side panels are removable for full wire access.
- Standard in metal paint finishes.
- Optional anodized aluminum finish available, please add \$50 list.

PRODUCT CODE	PRICE	SIZE/INCHES			WEIGHT		VOL FT ³
		H	W	D	LBS		
LELBA18	1151	28	18	9	33	2	
LELBA24	1225	28	24	10	44	2	
LELBA30	1374	28	30	12	55	4	
LELBA36	1526	28	36	13	66	7	
LELBA42	1674	28	42	14	77	9	

TELRR • Rectangular Panel Base with Anodized Aluminum Radius Corner Detail

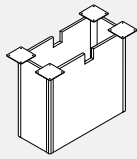

Single hinged access door is optional. Add "HD" to the end of the code. Add \$122 to list price.

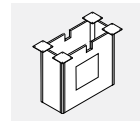

PRODUCT CODE	PRICE	SIZE/INCHES			WEIGHT LBS	VOL FT ³
		H	W	D		
TELRR18	688	28	18	12	66	7
TELRR24	727	28	24	12	72	9
TELRR30	767	28	30	12	105	11
TELRR36	806	28	36	12	129	13
TELRR42	845	28	42	12	129	15

TELBR • Rectangular Base with Rectangular Anodized Aluminum Corner Detail

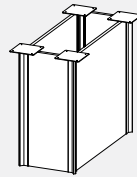

Single hinged access door is optional. Add "HD" to the end of the code. Add \$122 to list price.

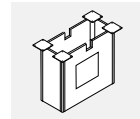

PRODUCT CODE	PRICE	SIZE/INCHES			WEIGHT LBS	VOL FT ³
		H	W	D		
TELBR18	710	28	18	12	66	7
TELBR24	751	28	24	12	72	9
TELBR30	789	28	30	12	105	11
TELBR36	829	28	36	12	129	13
TELBR42	869	28	42	12	129	15

TELRS • Square Panel Base with Anodized Aluminum Radius Corner Detail

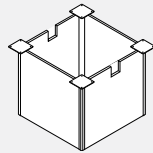

Single hinged access door is optional. Add "HD" to the end of the code. Add \$122 to list price.

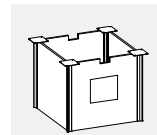

PRODUCT CODE	PRICE	SIZE/INCHES			WEIGHT LBS	VOL FT ³
		H	W	D		
TELRS18	737	28	18	18	77	7
TELRS24	813	28	24	24	83	9
TELRS30	890	28	30	30	117	20
TELRS36	967	28	36	36	140	24
TELRS42	1042	28	42	42	140	24

TELBS • Square Base with Rectangular Anodized Aluminum End Detail

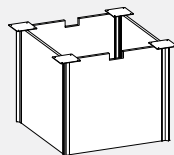

Single hinged access door is optional. Add "HD" to the end of the code. Add \$122 to list price.

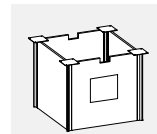

PRODUCT CODE	PRICE	SIZE/INCHES			WEIGHT LBS	VOL FT ³
		H	W	D		
TELBS18	761	28	18	18	77	7
TELBS24	851	28	24	24	83	9
TELBS30	945	28	30	30	117	20
TELBS36	1051	28	36	36	140	24
TELBS42	1159	28	42	42	140	24

TRUM • Trumpet Column Base

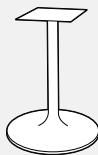

PRODUCT CODE	PRICE		SIZE/INCHES			WEIGHT LBS	VOL FT ³
	PAINTED	CHROME	H	W	D		
TRUM18	430	562	28	18	18	15	9
TRUM24	493	624	28	24	24	18	13
TRUM30	800	931	28	30	30	20	15
TRUM18BH	635	765	40.5	18	18	26	18
TRUM24BH	726	858	40.5	24	24	29	15

TTFD • Flat Disk Column Base

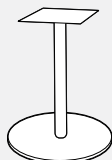

PRODUCT CODE	PRICE		SIZE/INCHES			WEIGHT LBS	VOL FT ³
	PAINTED	CHROME	H	W	D		
TTFD18	768	915	28	18	18	50	9
TTFD22	829	975	28	22	22	55	13
TTFD24	891	1036	28	24	24	66	14
TTFD30	1294	1356	28	30	30	88	15
TTFD36	1723	1867	28	36	36	110	15
TTFD18BH	942	1088	40.5	18	18	72	11
TTFD22BH	1003	1148	40.5	22	22	77	15
TTFD24BH	1063	1209	40.5	24	24	110	17

TTSQ • Flat Square Column Base

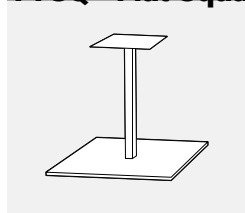

Plate size: (18"-30" 11"x11"), (36" 14"x14")
 Column size: (18"-24" 2.1/2"), (30"-36" 3")

PRODUCT CODE	PRICE		SIZE/INCHES			WEIGHT		VOL FT ³
	PAINTED	CHROME	H	W	D	LBS		
TTSQ18	1076	1207	28	18	18	50	9	
TTSQ23	1199	1330	28	23	23	61	13	
TTSQ30	1537	1669	28	30	30	88	15	
TTSQ18BH	1250	1381	40.5	18	18	72	11	
TTSQ23BH	1371	1503	40.5	23	23	83	15	

TTFLTX • Flat Bar "X" Column Base



Plate size: (18"-30" 11"x11"), (36" 14"x14")
 Column size: (18"-24" 2.1/2"), (30"-36" 3")

PRODUCT CODE	PRICE		SIZE/INCHES			WEIGHT		VOL FT ³
	PAINTED	CHROME	H	W	D	LBS		
TTFLTX18	1137	1342	28	18	18	15	9	
TTFLTX22	1153	1357	28	22	22	17	11	
TTFLTX24	1168	1373	28	24	24	18	13	
TTFLTX30	1199	1374	28	30	30	20	15	
TTFLTX36	1229	1433	28	36	36	22	24	
TTFLTX18BH	1310	1516	40.5	18	18	26	11	
TTFLTX22BH	1326	1529	40.5	22	22	28	13	
TTFLTX24BH	1371	1579	40.5	24	24	29	15	

TTFLT • Flat Bar "T" Column Base

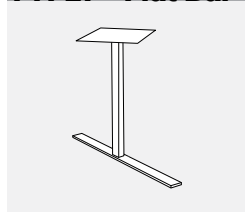

Plate size: (18"-30" 11"x11"), (36" 14"x14")
 Column size: (18"-24" 2.1/2"), (30"-36" 3")

PRODUCT CODE	PRICE		SIZE/INCHES			WEIGHT		VOL FT ³
	PAINTED	CHROME	H	W	D	LBS		
TTFLT18	860	1007	28		18	9	2	
TTFLT22	877	1024	28		22	10	2	
TTFLT24	891	1036	28		24	11	3	
TTFLT30	923	1069	28		30	13	3	
TTFLT36	954	1099	28		36	15	3	

TTFL3P • Flat Bar 3 Prong Column Base



Plate size: (18"-30" 11"x11"), (36" 14"x14")
 Column size: (18"-24" 2.1/2"), (30"-36" 3")

PRODUCT CODE	PRICE		SIZE/INCHES			WEIGHT		VOL FT ³
	PAINTED	CHROME	H	W	D	LBS		
TTFL3P18	1076	1282	28		18	11	7	
TTFL3P22	1092	1297	28		22	12	13	
TTFL3P24	1107	1312	28		24	13	15	
TTFL3P30	1137	1342	28		30	15	15	
TTFL3P36	1153	1357	28		36	18	24	

LL4S • 4 Star Table Leg with Bullnose End

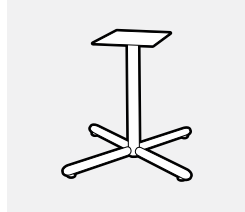

- Leg Plate is 11"x11" for 26" and 30" spread and 14"x14" for 36" spread.
- For the caster option specify "CS" at the end of the code with a \$77 upcharge

PRODUCT CODE	PRICE		SIZE/INCHES			WEIGHT		VOL FT ³
	PAINTED	CHROME	H	W	D	LBS		
LL4S18	437	553	28	18	18	15	7	
LL4S26	519	635	28	26	26	18	15	
LL4S30	552	669	28	30	30	20	15	
LL4S36	607	724	28	36	36	22	24	

LL4S-42 • Bistro Leg with Bullnose End



- Leg Plate is 11"x11" for 26" and 30" spread.

PRODUCT CODE	PRICE		SIZE/INCHES			WEIGHT		VOL FT ³
	PAINTED	CHROME	H	W	D	LBS		
LL4S2642	592	710	40.5	26	26	22	18	
LL4S3042	633	750	40.5	30	30	24	23	
LL4S3642	691	806	40.5	36	36	26	28	

LLT • "T" Table Leg with Bullnose End

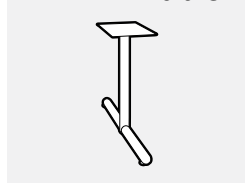

- Leg Plate is 11"x11"
- For the caster option specify "CS" at the end of the code with a \$37 upcharge

PRODUCT CODE	PRICE		SIZE/INCHES			WEIGHT		VOL FT ³
	PAINTED	CHROME	H	W	D	LBS		
LLT18	268	385	28	18	6	9	2	
LLT26	284	400	28	26	6	11	3	
LLT30	295	410	28	30	6	13	3	
LLT36	546	662	28	36	6	15	3	

LLTT • “TT” Table Leg with Bullnose End



- Leg Plate is 11”x 24”
- For the caster option specify “CS” at the end of the code with a \$37 upcharge

PRODUCT CODE	PRICE		SIZE / INCHES			WEIGHT		VOL FT ³
	PAINTED	CHROME	H	W	D	LBS		
LLTT18	447	594	28	18	6	13	2	
LLTT26	471	617	28	26	6	20	3	
LLTT30	485	633	28	30	6	24	3	
LLTT36	699	844	28	36	6	26	3	
LLTT42	817	965	28	42	6	31	4	

LLSQ • Square Post Leg

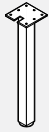

- 2.5” x 2.5” square tubular leg provides support for worksurfaces.
- Top plate welded to leg.
- 8” x 8” plate attached with #10 3/4” wood screws included.
- 1” height adjustment range.

PRODUCT CODE	PRICE		SIZE / INCHES			WEIGHT		VOL FT ³
	PAINTED	CHROME	H	W	D	LBS		
LLSQ25X25H28	218	334	28	2.5	2.5	9	0.17	

LATBL • Tapered Leg



- Tapered leg provides support for worksurfaces.
- Top plate welded to leg.
- 8” x 8” plate attached with #10 3/4” wood screws included.
- 1” height adjustment range.
- Bottom of leg tube is a 1” diameter and top is 2 3/8” diameter.

PRODUCT CODE	PRICE		SIZE / INCHES			WEIGHT		VOL FT ³
	PAINTED	CHROME	H	W	D	LBS		
LATBL28	177	301	28	3	3	9	0.17	

BHML • Monoleg



- 3” diameter Monoleg provides support for worksurfaces.
- Top plate welded to leg.
- 8” x 8” plate attached with #10 3/4” wood screws included.
- 1” height adjustment range.

PRODUCT CODE	PRICE		SIZE / INCHES			WEIGHT		VOL FT ³
	PAINTED	CHROME	H	W	D	LBS		
BHML03	188	304	28	3	3	9	0.17	

L2BHML • Monoleg

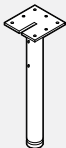

- 3” diameter Monoleg provides support for worksurfaces.
- Cut-out top plate welded to leg. Cut-out accepts 3/4” modesty panel.
- 8” x 8” plate attached with #10 3/4” wood screws included.
- 1” height adjustment range.

PRODUCT CODE	PRICE		SIZE / INCHES			WEIGHT		VOL FT ³
	PAINTED	CHROME	H	W	D	LBS		
L2BHML03	188	304	28	3	3	9	0.17	

LBHML06 • 6” Monoleg



- 6” diameter Monoleg provides support for worksurfaces.
- Top plate welded to leg flush.
- 8” x 8” plate attached with #10 3/4” wood screws, included.
- 1” height adjustment range.
- Leg is offset flush to edge.

PRODUCT CODE	PRICE		SIZE / INCHES			WEIGHT		VOL FT ³
	PAINTED	CHROME	H	W	D	LBS		
LBHML06	362	508	28	6	6	9	0.17	

FOLDLEG • Folding Leg



- Sold as a set of two.
- Available in only in (SIL) Silver or (BLK) Black.

PRODUCT CODE	PRICE		SIZE / INCHES			WEIGHT		VOL FT ³
	PAINTED	CHROME	H	W	D	LBS		
FOLDLEG	418		28	24.625	3	11	7	

LHC • HAT Channel for Conference Tables

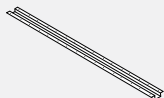

- See chart on page H.2

PRODUCT CODE	PRICE		SIZE / INCHES			WEIGHT		VOL FT ³
	PAINTED	CHROME	H	W	D	LBS		
LHC40	56		1.4	40	5	4	0.20	
LHC46	62		1.4	46	5	6	0.22	
LHC52	66		1.4	52	5	7	0.25	
LHC58	76		1.4	58	5	8	0.28	
LHC64	85		1.4	64	5	9	0.31	
LHC70	91		1.4	70	5	10	0.33	

LVB • Visual Board

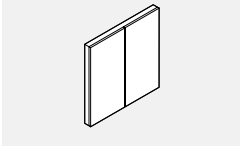

• See page H.1 for technical information.

PRODUCT CODE	FINISH		SIZE / INCHES			WEIGHT		VOL FT ³
	LP/B	HP/B	H (LP/B)	W	D	LBS		
LVB48	1533	1697	48	48	8	154	10	
LVB48MG	2385	2629	48	48	8	154	10	

MSPDM • 1 Duplex, 2 Data

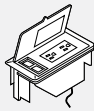

- Includes one duplex and 2 data jacks (both RJ45, Cat 6)
- Black plastic

PRODUCT CODE	PRICE	DIMENSIONS			WEIGHT		VOL FT ³
		H	W	D	LBS		
MSPDM	276	2.75	6.5	3.5	2	0.1	

ModPower Power Solution

- Power solutions for flexible spaces. Connect up to four units (in Canada)/six units in the USA from a single infeed with NEMA plug to deliver power and charging ports to the table top. In-surface modules and clamp on modules available.
- Easy to install; code compliant that allows users to optimize any space providing convenient power access. Perfect for training areas, meeting rooms, in-office workstations and more. Units feature tamper-resistant receptacles as well as both USB-A and USB-C charging ports.
- Easy to use connectors that are touch-safe with added latch to prevent unintended separation. Easy push together to connect, and simple press down on latch to disconnect.
- Maximum overall length not to exceed 48.5 feet per infeed. UL listed to UL962A SD, the standard for furniture power distribution units for portable/moveable work space tables.
- Certified to CSA standard C22.2 No. 203-16.
- Will work with Licence, Terina and Bridges Products.
- Surface mounted module ships with a clamp mount that will accommodate any material 1/2" to 1-1/2" thick; additional brackets are also included for screw in mounting options that can accommodate vertical or horizontal positions.
- Modules can be integrated into surfaces but the surface must be specified as a special.

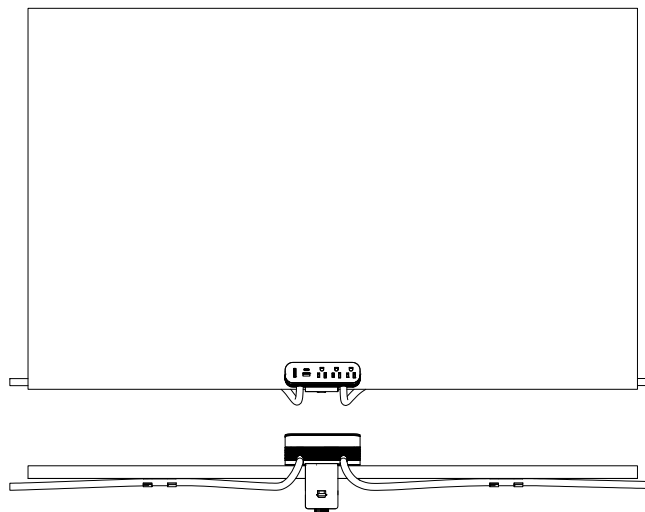
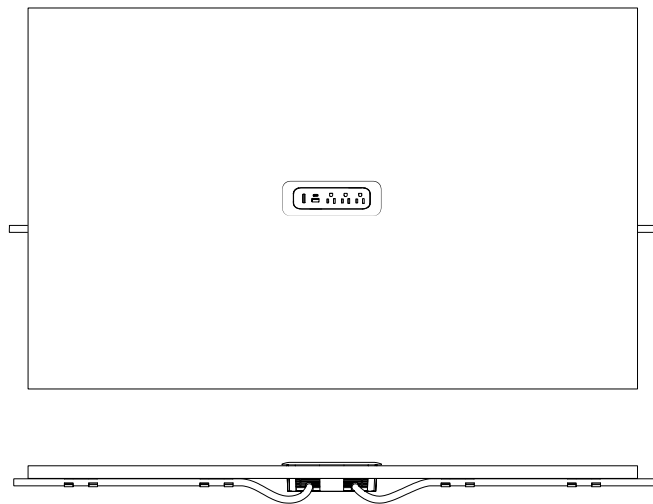
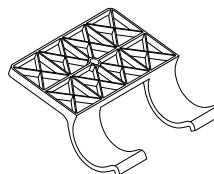

GMDSF10 • ModPower In Surface Starter Unit

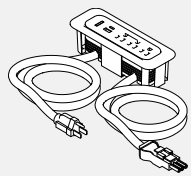

- ModPower starter unit includes one 10' cord with a NEMA plug and one 3' connector cord.
- Unit equipped with three 15A tamper resistant receptacles, one USB-A and one USB-C charging ports and a circuit breaker.
- 4 cable management cord clips included.
- MG at the end of the code indicates a magnesium finish, while WH is a white finish.

PRODUCT CODE	PRICE	DIMENSIONS			WEIGHT		VOL FT ³
		H	W	D	LBS		
GMDSF10MG	597	7.63	2.75	2.63	3.44	1.0	
GMDSF10WH	597	7.63	2.75	2.63	3.44	1.0	

GMDCF3 • ModPower In Surface Middle Unit

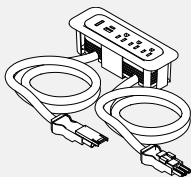

- ModPower middle unit includes two 3' connector cords.
- Unit equipped with three 15A rated 12A tamper resistant receptacles, one USB-A and one USB-C charging ports and a circuit breaker.
- 4 cable management cord clips included.
- MG at the end of the code indicates a magnesium finish, while WH is a white finish.

PRODUCT CODE	PRICE	DIMENSIONS			WEIGHT		VOL FT ³
		H	W	D	LBS		
GMDCF3MG	562	7.63	2.75	2.63	2.44	1.0	
GMDCF3WH	562	7.63	2.75	2.63	2.44	1.0	

GMDEF3 • ModPower In Surface End Unit

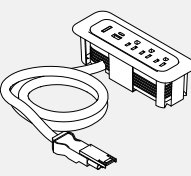

- ModPower end unit includes one 3' connector cord.
- Unit equipped with three 15A rated 12A tamper resistant receptacles, one USB-A and one USB-C charging ports and a circuit breaker.
- 2 cable management cord clips included.
- MG at the end of the code indicates a magnesium finish, while WH is a white finish.

PRODUCT CODE	PRICE	DIMENSIONS			WEIGHT		VOL FT ³
		H	W	D	LBS		
GMDEF3MG	494	7.63	2.75	2.63	1.85	1.0	
GMDEF3WH	494	7.63	2.75	2.63	1.85	1.0	

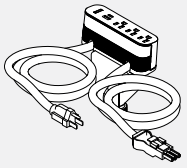
GMDSA10 • ModPower Starter Mounted Unit

- ModPower starter unit includes one 10' cord with a NEMA plug and one 3' connector cord.
- Unit equipped with three 15A tamper resistant receptacles, one USB-A and one USB-C charging ports and a circuit breaker.
- Includes edge clamp and 3 other mounting methods; and 4 cable management cord clips.
- MG at the end of the code indicates a magnesium finish, while WH is a white finish.

PRODUCT CODE	PRICE	H	W	D	WEIGHT	
					LBS	FT ³
GMDSA10MG	631	6.13	1.75	2.5	4.33	1.0
GMDSA10WH	631	6.13	1.75	2.5	4.33	1.0

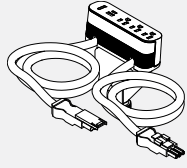
GMDCA3 • ModPower Middle Mounted Unit

- ModPower middle unit includes two 3' connector cords.
- Unit equipped with three 15A rated 12A tamper resistant receptacles, one USB-A and one USB-C charging ports and a circuit breaker.
- Includes edge clamp and 3 other mounting methods; and 4 cable management cord clips.
- MG at the end of the code indicates a magnesium finish, while WH is a white finish.

PRODUCT CODE	PRICE	H	W	D	WEIGHT	
					LBS	FT ³
GMDCA3MG	597	6.13	1.75	2.5	3.33	1.0
GMDCA3WH	597	6.13	1.75	2.5	3.33	1.0

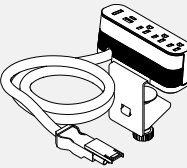
GMDEA3 • ModPower End Mounted Unit

- ModPower end unit includes one 3' connector cord.
- Unit equipped with three 15A rated 12A tamper resistant receptacles, one USB-A and one USB-C charging ports and a circuit breaker.
- Includes edge clamp and 3 other mounting methods; and 2 cable management cord clips.
- MG at the end of the code indicates a magnesium finish, while WH is a white finish.

PRODUCT CODE	PRICE	H	W	D	WEIGHT	
					LBS	FT ³
GMDEA3MG	528	6.13	1.75	2.5	2.75	1.0
GMDEA3WH	528	6.13	1.75	2.5	2.75	1.0

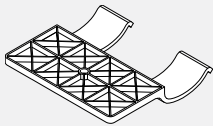
GMDCLIPS • ModPower Management Clips

- Includes 10 clips.

PRODUCT CODE	PRICE	H	W	D	WEIGHT	
					LBS	FT ³
GMDCLIPS	102	2.6	2.5	0.6	0.3	0.2

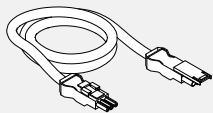
GMDJ36BK • ModPower Interconnecting Jumper

- ModPower interconnecting jumper cord to add an additional 3 feet of cord length between ModPower units.
- Package of 2, each 3 feet with male & female connector.

PRODUCT CODE	PRICE	H	W	D	WEIGHT	
					LBS	FT ³
GMDJ36BK	329	36			1.38	0.9

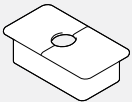
BG5 • Rectangular Grommet

- Option
(BLK) Black Plastic
(GRY) Grey Plastic
(WHT) White Plastic

PRODUCT CODE	PRICE	H	W	D	WEIGHT	
					LBS	FT ³
BG5	35		3.5	2		

Telecom Plates



PRODUCT
CODE
Black telecom plate with 2 RJ45 cat 6 data
ABLBB 245



Black telecom plate with 3 RJ45 cat 6 data
ABLBBB 361



Black telecom plate with 4 RJ45 cat 6 data
ABLBBBB 476

GCRTMCS401 • Recessed Power Block, 1 Duplex, 1 Data Knock-outs, 1 Power Duplex

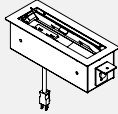

- Single sided recessed power block with 1 regular duplex and 1 data knock-out on top, 1 power duplex on bottom.
- 10 ft power cord with straight plug.
- Telecom plates ordered separately.
- Available in Black - B, Tungsten - T or Designer White - W as indicated by last letter of model number; duplexes always grey.
- Not approved for daisy-chain applications.

PRODUCT CODE	PRICE	H	W	D	WEIGHT LBS	VOL FT ³
GCRTMCS401B	578	10.78	4.22	4.86	4.3	0.51
GCRTMCS401T	578	10.78	4.22	4.86	4.3	0.51
GCRTMCS401W	578	10.78	4.22	4.86	4.3	0.51

GCRTMCS421 • Recessed Power Block, 1 Power including USB A+C, 1 Data Knock-outs, 1 Power Duplex

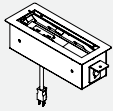

- Single sided recessed power block with 1 power and USB A+C duplex and 1 data knock-out on top, 1 power duplex on bottom.
- USB Type A port charges maximum 2.4 amps at 5V and Type C port charges maximum 3 amps at 5V.
- 10 ft power cord with straight plug.
- Telecom plates ordered separately.
- Available in Black - B, Tungsten - T or Designer White - W as indicated by last letter of model number; duplexes always grey.
- Not approved for daisy-chain applications.

PRODUCT CODE	PRICE	H	W	D	WEIGHT LBS	VOL FT ³
GCRTMCS421B	759	10.78	4.22	4.86	4.3	0.51
GCRTMCS421T	759	10.78	4.22	4.86	4.3	0.51
GCRTMCS421W	759	10.78	4.22	4.86	4.3	0.51

GCRTMCS602 • Recessed Power Block, 2 Duplex, 2 Data Knock-outs, 1 Power Duplex

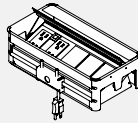

- Double sided recessed power block with 2 regular duplex and 2 data knock-outs on top, 1 power duplex on bottom.
- 10 ft power cord with straight plug.
- Telecom plates ordered separately.
- Available in Black - B, Tungsten - T or Designer White - W as indicated by last letter of model number; duplexes always grey.
- Not approved for daisy-chain applications.

PRODUCT CODE	PRICE	H	W	D	WEIGHT LBS	VOL FT ³
GCRTMCD602B	660	10.78	6.22	4.86	5.9	0.51
GCRTMCD602T	660	10.78	6.22	4.86	5.9	0.51
GCRTMCD602W	660	10.78	6.22	4.86	5.9	0.51

GCRTMCS602 • Recessed Power Block, 2 Duplex, 2 Data Knock-outs, 1 Power Duplex

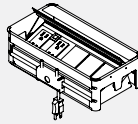

- Double sided recessed power block with 1 regular duplex, 1 power and USB A+C and 2 data knock-outs on top, 1 power duplex on bottom.
- USB Type A port charges maximum 2.4 amps at 5V and Type C port charges maximum 3 amps at 5V.
- 10 ft power cord with straight plug.
- Telecom plates ordered separately.
- Available in Black - B, Tungsten - T or Designer White - W as indicated by last letter of model number; duplexes always grey.
- Not approved for daisy-chain applications.

PRODUCT CODE	PRICE	H	W	D	WEIGHT LBS	VOL FT ³
GCRTMCD622B	831	10.78	6.22	4.86	6.1	0.51
GCRTMCD622T	831	10.78	6.22	4.86	6.1	0.51
GCRTMCD622W	831	10.78	6.22	4.86	6.1	0.51

GCRTMCS622 • Recessed Power Block, 2 Power including USB A+C, 2 Data Knock-outs, 1 Power Duplex

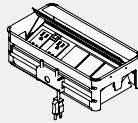

- Double sided recessed power block with 2 power and USB A+C and 2 data knock-outs on top, 1 power duplex on bottom.
- USB Type A port charges maximum 2.4 amps at 5V and Type C port charges maximum 3 amps at 5V.
- 10 ft power cord with straight plug.
- Telecom plates ordered separately.
- Available in Black - B, Tungsten - T or Designer White - W as indicated by last letter of model number; duplexes always grey.
- Not approved for daisy-chain applications.

PRODUCT CODE	PRICE	H	W	D	WEIGHT LBS	VOL FT ³
GCRTMCD642B	1001	10.78	6.22	4.86	6.3	0.51
GCRTMCD642T	1001	10.78	6.22	4.86	6.3	0.51
GCRTMCD642W	1001	10.78	6.22	4.86	6.3	0.51

Terina Tables

Terina™ is a multi-purpose table that allows you to quickly adapt your space to suit your needs. The simple flip-top mechanism is designed for single-handed operation. Tables nest in an upright position to minimize storage space.

Worksurfaces

Laminate surfaces (B) are 1-1/16" thick tops constructed of 45lb. density particle board with high pressure laminate and finished on the underside of the surface with a kraft paper backing. Veneer (V) surfaces are 1-3/16" thick tops constructed of 45 lb. density particle board and are balanced on the underside with veneer (unfinished). Worksurfaces are pre-drilled for alignment of the Terina base.

Base

Tables feature an aluminum leg, cross beam and die-cast foot. Legs and cross beam are available in all standard panel frame painted finishes. Die-cast foot is always in polished aluminum finish. Foot span is 36". Stacking depth of 9".

Casters

Casters are standard on all tables. 2-3/8" dual wheel casters with manual lock. Full 360° swivel. Suggested for carpeted surfaces. Available in grey only.

Ganging Plates

Ganging plates are available for ganging adjoining tables together. Ganging plates are black epoxy coated steel plates with two thumbscrews.

Wire Management

Wire management option is a snap-in channel that fits on the interior of the leg or on the understand of the flip-top cross beam.

Modesty Panels

10" Modesty panel affixes to the top and base, articulating when it folds down. available in all standard LP laminate and veneer finishes.

GFT-R • Rectangular Flip Top Training Table

- B and V edge tops have square corners



PRODUCT CODE	PRICE					WEIGHT LBS	VOL FT ³
	B	V	H	W	D		
GFT2448R	1177	1921	29	48	24	48	6
GFT2454R	1225	2062	29	54	24	53	6
GFT2460R	1274	2091	29	60	24	55	7
GFT2466R	1292	2130	29	66	24	61	7
GFT2472R	1310	2165	29	72	24	66	7
GFT3048R	1225	1965	29	48	30	53	6
GFT3054R	1252	2117	29	54	30	55	6
GFT3060R	1292	2154	29	60	30	61	7
GFT3066R	1308	2238	29	66	30	66	7
GFT3072R	1337	2316	29	72	30	68	7

GFT-M • Folding Modesty Panel

- Includes hardware to connect to Terina Tables.
- Woodgrain modesty panels over 60" will have the woodgrain run horizontally, whereas others will run vertically.
- Due to location of the modesty panel, only MSPDM and GMDSF10 grommets can be used on Terina tables with modesty panels.

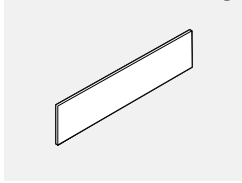

PRODUCT CODE	PRICE					WEIGHT LBS	VOL FT ³
	LP	V	H	W	D		
GFT48M	290	484	10	46	0.75	11	1
GFT54M	302	543	10	52	0.75	13	1
GFT60M	314	601	10	58	0.75	15	1
GFT66M	324	656	10	64	0.75	18	2
GFT72M	339	714	10	70	0.75	20	2

GFTCM • Wire Manager

- Set of four
- Each piece is 10" long



PRODUCT CODE	PRICE				WEIGHT LBS	VOL FT ³
	H	W	D			
GFTCM04BLK	36	2	10	2	1	1

GFCNGFP • Ganging Flush Plate

- Please specify application so that inserts may be added to surface.

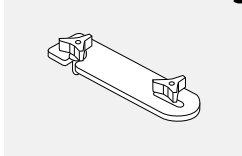

PRODUCT CODE	PRICE			WEIGHT LBS	VOL FT ³
	H	W	D		
GFCNGFP	36	2.5	5	0.1	0.01

Technical Information - Vice Versa Tables

Tables

- All worksurfaces have threaded inserts for metal-to-metal connection of support hardware.
- 60" and 72" tables come standard with wire manager.
- HP tops are 1 1/16" thick laminate particle board.

HP Top with T-Mould Edge

- Rectangular mobile table made of 1 1/16" thick particle board with High Pressure laminate finish. HP tops have 3.5mm PVC edge.

Viceversa Leg

- Universal mounting plate can be used to gang 2 tables simply by rotating 45° to span 2 table tops without metal skirts.
- Table legs have a wire management channel that neatly organizes electrical and communication cables running from the worksurfaces to the floor.
- The channel is covered by a clear PVC snap-on cover.
- The Viceversa leg features a push button height adjustment mechanism. This mechanism allows the user to easily set the height of a table.

Legs have a height range of 23.5" – 30.5" in 1" increments for levelers and 25"-33" with casters.

Viceversa legs are available with:

- Levelers
- Locking casters.

NOTES:

- Levelers have a 0.5" height range.
- Levelers available in Charcoal Grey only.
- Casters available in grey with black only.
- Legs are available in our (6) standard finishes.
- Finish is durable environmentally friendly paint.

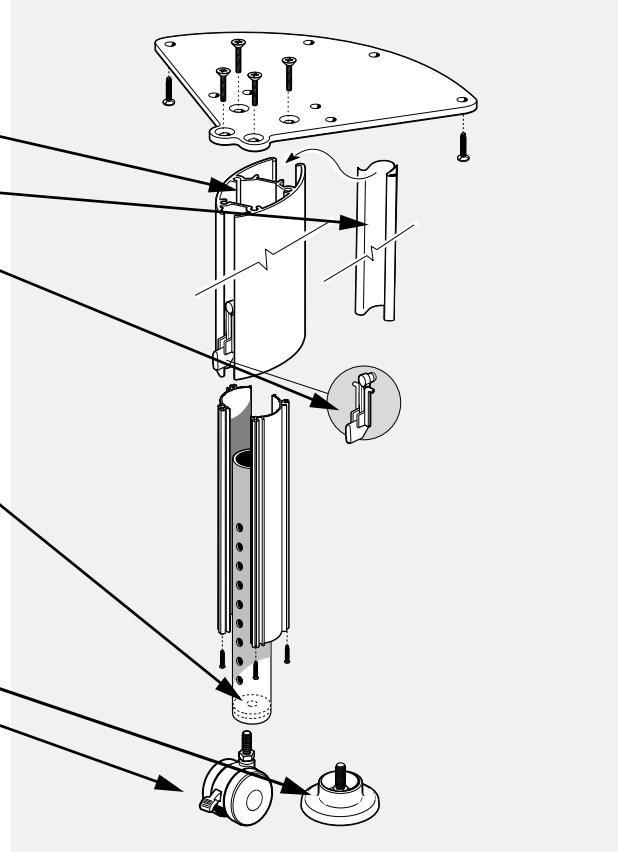

VVRT • Rectangular Tables with 4 Legs

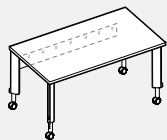

- **Tables are designed to work individually or as a group. They can be moved to meet the changing needs of an individual or group.**
- Tables come standard with 4 locking casters. Optional levelers available, please specify.
- 6" metal skirt provides strength and stability.
- Modesty Panel, Pong Panel or 6" metal skirt cannot be used on tables with 2 legs or shared tables.

PRODUCT CODE	PRICE HP	SIZE/ INCHES			WEIGHT VOL	
		H	D	W	LBS	FT ³
VVRT2448HP4	900	26-32	24	48	63	7.11
VVRT2460HP4	989	26-32	24	60	71	7.36
VVRT2472HP4	1036	26-32	24	72	78	7.62
VVRT3060HP4	1081	26-32	30	60	80	7.69
VVRT3072HP4	1124	26-32	30	72	90	8.01

VVS • Square Tables with 4 Legs

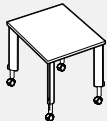

- **Square tables are designed to work individually or as a grouping. They can be moved to meet the changing needs of an individual or group.**
- Tables come standard with 4 locking casters. Optional levelers available, please specify.

PRODUCT CODE	PRICE HP	SIZE/ INCHES			WEIGHT VOL	
		H	D	W	LBS	FT ³
VVS30HP4	989	26-32	30	30	71	7.2
VVS36HP4	1036	26-32	36	36	76	7.6
VVS42HP4	1081	26-32	42	42	82	8.0
VVS48HP4	1173	26-32	48	48	88	8.4

VVR • Round Tables with 4 Legs



- **Round tables are designed to work individually or as a group. They can be moved to meet the changing needs of an individual or group.**
- Tables come standard with 4 locking casters. Optional levelers available, please specify.

PRODUCT CODE	PRICE HP	SIZE/ INCHES			WEIGHT VOL	
		H	D	W	LBS	FT ³
VVR30HP4	947	26-32	30	30	57	6.8
VVR36HP4	989	26-32	36	36	64	7
VVR42HP4	1036	26-32	42	42	71	7.2
VVR48HP4	1124	26-32	48	48	79	7.6

Technical Information - Tables

Common

- Tables up to and including 96" long are manufactured in one piece, 108" to 168" long are manufactured in two pieces and over 192" are manufactured in three pieces. If wood grain laminate or wood veneer is chosen, the wood grain may not line up for any tables longer than 10 feet.
- Tables in 2 or 3 pieces will have the joining edge finished, hardware will be shipped for assembly.
- Grommet locations must be specified at the time of order or it will default to "no grommet" option.
- Tables are pre-drilled with factory installed inserts for easy metal to metal base connection.

Edge Options B & W

- "LKD" Rectangular shape tables with edge B and W have 1" radius at each corner. For tables with square corners, please add "NR" at the end of the product code, no upcharge required.
- The "NR" option is available only with the B and W edge profiles.

- All table surfaces are High Pressure Laminate in "B" (1 1/16") or "W" (1 7/16") thickness.

Edge Options KL/FV/KV

- LKD" Rectangular shape tables have 90 degree corners. There is no radius corner option.
- All table surfaces are 1 3/16" thickness.
- KL is a high pressure laminate top with 3mm perimeter PVC edging with a 2" undercut knife profile.
- FV is a veneer top with a flat 3mm perimeter hardwood edge.
- KV is a veneer top with 3mm perimeter hardwood edge with a 2" undercut knife profile.

Tables • Guidelines For Ordering Product

CODES: The price list uses a numbering system with meaningful alphanumeric characters to create a simple-to-understand product number. This makes specifying the product much easier and more accurate.

SPECIFICATION EXAMPLE OF A TABLE UNIT

PRODUCT CODE: LKD3636
 L = Licence
 KD = Kadin Tables
 3636 = Size: Depth x Width

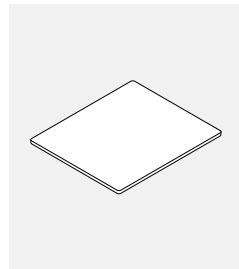

Edge Options:

"B" Edges

Laminate surface with PVC edge

HP (B) 1.062" Thickness

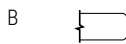

"W" Edges

Laminate surface with PVC edge

HP (W) 1.437" Thickness

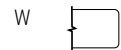

"KL" Edges

Laminate surface with PVC edge

HP (KL) 1.187" Thickness

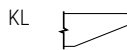

"FV" Edges

Veneer surface with Hardwood edge

(FV) 1.187" Thickness

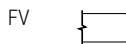

"KV" Edges

Veneer surface with Hardwood edge

(KV) 1.187" Thickness

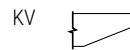

LKD Grommet locations

Square Table (TC Grommet Only)

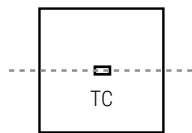

- LKD3636 accepts BG5.
- LKD4242, LKD4848, LKD5454 and LKD6060 accept all grommets and modules.

Round Table (TC Grommet Only)

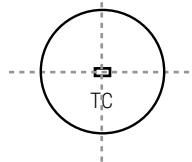

- LKD36DIA accepts BG5.
- LKD42DIA, LKD48DIA, LKD54DIA and LKD60DIA accept BG5 and MSPDM.

Rectangular Table

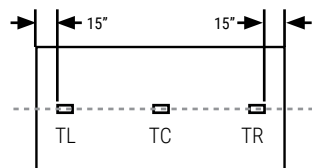

TC GROMMET ONLY

- LKD3648
- LKD3654
- LKD4248
- LKD4254
- LKD4854

ONE GROMMET CHOICE ONLY - TL,TC OR TR

- LKD3660, LKD3666, LKD3672
- LKD4260, LKD4266, LKD4272

(Accept BG5, MSPDM, GCRTMCS401, GCRTMCS421)

UP TO 3 GROMMETS IN TL,TC AND/OR TR

- LKD3678, LKD3684, LKD3696
- LKD4278, LKD4284, LKD4296
- LKD4878, LKD4884, LKD4896

Rectangular Table, 2 Piece Top

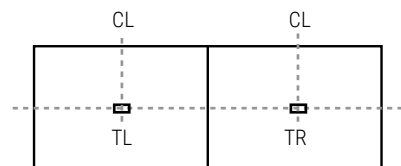

UP TO 2 GROMMETS IN TL, AND/OR TR

- LKD

All sizes

Rectangular Table, 3 Piece Top

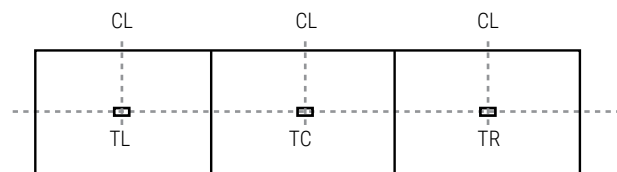

UP TO 3 GROMMETS IN TL,TC AND/OR TR

- LKD

All sizes

Note: Grommet orientation follows the length of table.

ModPower Power Solution

- Power solutions for flexible spaces. Connect up to four units (in Canada)/six units in the USA from a single infeed with NEMA plug to deliver power and charging ports to the table top. In-surface modules and clamp on modules available.
- Easy to install; code compliant that allows users to optimize any space providing convenient power access. Perfect for training areas, meeting rooms, in-office workstations and more. Units feature tamper-resistant receptacles as well as both USB-A and USB-C charging ports.
- Easy to use connectors that are touch-safe with added latch to prevent unintended separation. Easy push together to connect, and simple press down on latch to disconnect.
- Maximum overall length not to exceed 48.5 feet per infeed. UL listed to UL962A SD, the standard for furniture power distribution units for portable/moveable work space tables.
- Certified to CSA standard C22.2 No. 203-16.

- Will work with Licence, Terina and Bridges Products.
- Surface mounted module ships with a clamp mount that will accommodate any material 1/2" to 1-1/2" thick; additional brackets are also included for screw in mounting options that can accommodate vertical or horizontal positions.
- Modules can be integrated into surfaces but the surface must be specified as a special.

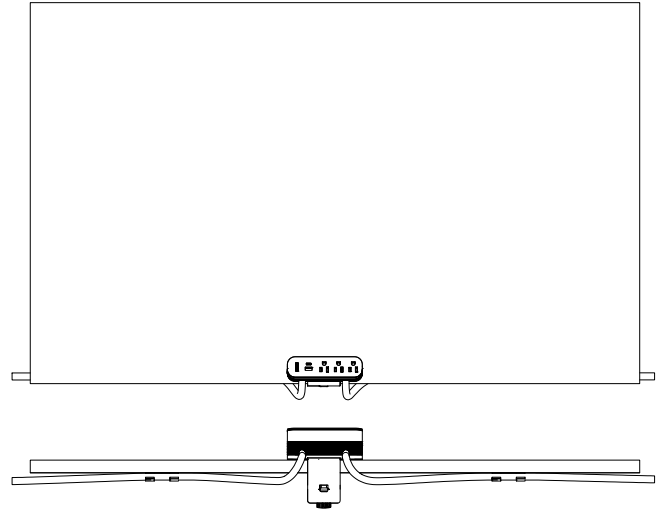
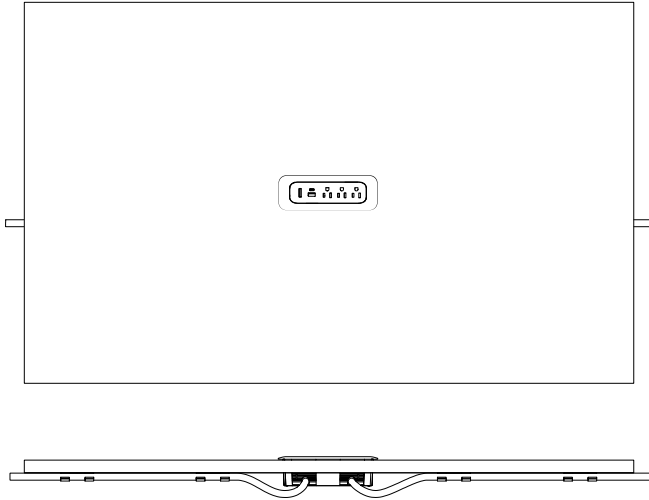
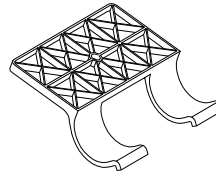

GMDSF10 • ModPower In Surface Starter Unit

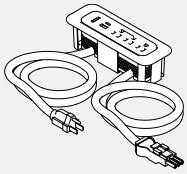

- ModPower starter unit includes one 10' cord with a NEMA plug and one 3' connector cord.
- Unit equipped with three 15A tamper resistant receptacles, one USB-A and one USB-C charging ports and a circuit breaker.
- 4 cable management cord clips included.
- MG at the end of the code indicates a magnesium finish, while WH is a white finish.

PRODUCT CODE	PRICE	PRICE			WEIGHT LBS	VOL FT ³
		H	W	D		
GMDSF10MG	597	2.63	7.63	2.63	3.44	1.0
GMDSF10WH	597	2.63	7.63	2.63	3.44	1.0

GMDCF3 • ModPower In Surface Middle Unit

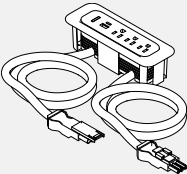

- ModPower middle unit includes two 3' connector cords.
- Unit equipped with three 15A rated 12A tamper resistant receptacles, one USB-A and one USB-C charging ports and a circuit breaker.
- 4 cable management cord clips included.
- MG at the end of the code indicates a magnesium finish, while WH is a white finish.

PRODUCT CODE	PRICE	PRICE			WEIGHT LBS	VOL FT ³
		H	W	D		
GMDCF3MG	562	2.63	7.63	2.63	2.44	1.0
GMDCF3WH	562	2.63	7.63	2.63	2.44	1.0

GMDEF3 • ModPower In Surface End Unit

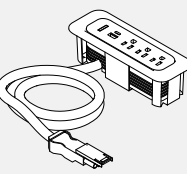

- ModPower end unit includes one 3' connector cord.
- Unit equipped with three 15A rated 12A tamper resistant receptacles, one USB-A and one USB-C charging ports and a circuit breaker.
- 2 cable management cord clips included.
- MG at the end of the code indicates a magnesium finish, while WH is a white finish.

PRODUCT CODE	PRICE	PRICE			WEIGHT LBS	VOL FT ³
		H	W	D		
GMDEF3MG	494	2.63	7.63	2.63	1.85	1.0
GMDEF3WH	494	2.63	7.63	2.63	1.85	1.0

GMDSA10 • ModPower Starter Mounted Unit

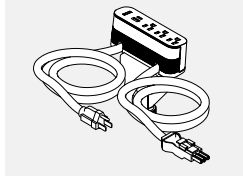

- ModPower starter unit includes one 10' cord with a NEMA plug and one 3' connector cord.
- Unit equipped with three 15A tamper resistant receptacles, one USB-A and one USB-C charging ports and a circuit breaker.
- Includes edge clamp and 3 other mounting methods; and 4 cable management cord clips.
- MG at the end of the code indicates a magnesium finish, while WH is a white finish.

PRODUCT CODE	PRICE	DIMENSIONS			WEIGHT		VOL	
		H	W	D	LBS	FT ³		
GMDSA10MG	631	2.5	6.13	1.75	4.33	1.0		
GMDSA10WH	631	2.5	6.13	1.75	4.33	1.0		

GMDCA3 • ModPower Middle Mounted Unit

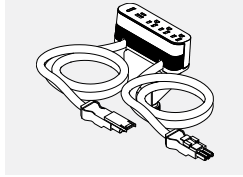

- ModPower middle unit includes two 3' connector cords.
- Unit equipped with three 15A rated 12A tamper resistant receptacles, one USB-A and one USB-C charging ports and a circuit breaker.
- Includes edge clamp and 3 other mounting methods; and 4 cable management cord clips.
- MG at the end of the code indicates a magnesium finish, while WH is a white finish.

PRODUCT CODE	PRICE	DIMENSIONS			WEIGHT		VOL	
		H	W	D	LBS	FT ³		
GMDCA3MG	597	2.5	6.13	1.75	3.33	1.0		
GMDCA3WH	597	2.5	6.13	1.75	3.33	1.0		

GMDEA3 • ModPower End Mounted Unit

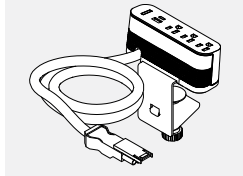

- ModPower end unit includes one 3' connector cord.
- Unit equipped with three 15A rated 12A tamper resistant receptacles, one USB-A and one USB-C charging ports and a circuit breaker.
- Includes edge clamp and 3 other mounting methods; and 2 cable management cord clips.
- MG at the end of the code indicates a magnesium finish, while WH is a white finish.

PRODUCT CODE	PRICE	DIMENSIONS			WEIGHT		VOL	
		H	W	D	LBS	FT ³		
GMDEA3MG	528	2.5	6.13	1.75	2.75	1.0		
GMDEA3WH	528	2.5	6.13	1.75	2.75	1.0		

GMDCLIPS • ModPower Management Clips

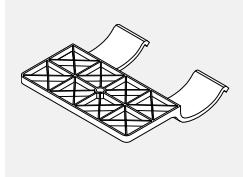

- Includes 10 clips.

PRODUCT CODE	PRICE	DIMENSIONS			WEIGHT		VOL	
		H	W	D	LBS	FT ³		
GMDCLIPS	102	0.6	2.6	2.5	0.3	0.2		

GMDJ36BK • ModPower Interconnecting Jumper

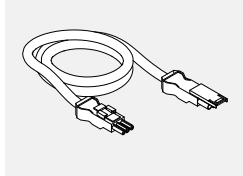

- ModPower interconnecting jumper cord to add an additional 3 feet of cord length between ModPower units.
- Package of 2, each 3 feet with male & female connector.

PRODUCT CODE	PRICE	DIMENSIONS			WEIGHT		VOL	
		H	W	D	LBS	FT ³		
GMDJ36BK	329		36		1.38	0.9		

LKD • Square Table

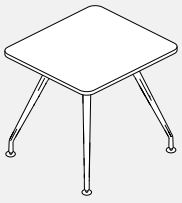

- Leg finish option, chrome or paint.
- Beam finish, paint only.

PRODUCT CODE	PRICE					SIZE / INCHES				WEIGHT		VOL FT ³
	B	W	KL	FV	KV	H(B)	H(W)	W	D	LBS		
LKD3636	1158	1300	1443	1645	1702	29	29.5	36	36	73	4	
LKD4242	1323	1459	1685	1960	2039	29	29.5	42	42	86	4	
LKD4848	1553	1717	1960	2320	2424	29	29.5	48	48	107	5	
LKD5454	1712	1911	2357	2812	2944	29	29.5	54	54	120	5	
LKD6060	1886	2123	2702	3262	3427	29	29.5	60	60	135	6	

LKD • Round Table

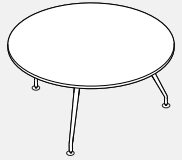

- Leg finish option, chrome or paint.
- Beam finish, paint only.

PRODUCT CODE	PRICE					SIZE / INCHES				WEIGHT		VOL FT ³
	B	W	KL	FV	KV	H(B)	H(W)	W	D	LBS		
LKD36DIA	934	1079	1224	1477	1548	29	29.5	36	36	66	3	
LKD42DIA	1098	1235	1518	1859	1956	29	29.5	42	42	78	3	
LKD48DIA	1305	1476	1847	2291	2422	29	29.5	48	48	99	4	
LKD54DIA	1463	1667	2271	2832	2996	29	29.5	54	54	111	4	
LKD60DIA	1635	1882	2685	3387	3584	29	29.5	60	60	126	5	

LKD4 • Round Table with 4 Legs



- Leg finish option, chrome or paint.
- Beam finish, paint only.

PRODUCT CODE	PRICE					SIZE / INCHES				WEIGHT		VOL FT ³
	B	W	KL	FV	KV	H(B)	H(W)	W	D	LBS		
LKD436DIA	1158	1300	1363	1613	1686	29	29.5	36	36	66	3	
LKD442DIA	1323	1459	1663	2006	2101	29	29.5	42	42	78	3	
LKD448DIA	1553	1717	2021	2465	2598	29	29.5	48	48	99	4	
LKD454DIA	1712	1911	2405	2968	3129	29	29.5	54	54	111	4	
LKD460DIA	1886	2123	2836	3537	3735	29	29.5	60	60	126	5	

LKD • Rectangular Table

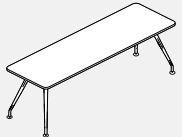

- Leg finish option, chrome or paint.
- Beam finish, paint only.

PRODUCT CODE	PRICE					SIZE / INCHES				WEIGHT		VOL FT ³
	B	W	KL	FV	KV	H(B)	H(W)	W	D	LBS		
LKD3648	1370	1514	1667	1938	2015	29	29.5	48	36	75	4	
LKD3654	1429	1589	1823	2125	2214	29	29.5	54	36	81	4	
LKD3660	1491	1667	1933	2273	2370	29	29.5	60	36	88	5	
LKD3666	1553	1746	2047	2419	2525	29	29.5	66	36	95	5	
LKD3672	1612	1821	2157	2562	2681	29	29.5	72	36	101	5	
LKD3678	1673	1895	2268	2708	2839	29	29.5	78	36	105	5	
LKD3684	1736	1973	2382	2854	2991	29	29.5	84	36	108	5	
LKD3696	1858	2126	2604	3146	3301	29	29.5	96	36	115	6	
LKD4248	1468	1610	1815	2128	2221	29	29.5	48	42	87	4	
LKD4254	1540	1696	1985	2339	2443	29	29.5	54	42	90	5	
LKD4260	1611	1783	2115	2507	2624	29	29.5	60	42	94	5	
LKD4266	1685	1870	2245	2679	2803	29	29.5	66	42	101	5	
LKD4272	1755	1955	2373	2846	2984	29	29.5	72	42	106	5	
LKD4278	1829	2042	2502	3014	3163	29	29.5	78	42	110	6	
LKD4284	1898	2128	2631	3185	3343	29	29.5	84	42	113	6	
LKD4296	2043	2301	2890	3520	3703	29	29.5	96	42	129	6	
LKD4854	1671	1845	2150	2556	2671	29	29.5	54	48	94	5	
LKD4860	1751	1943	2296	2745	2876	29	29.5	60	48	99	5	
LKD4866	1832	2037	2442	2936	3079	29	29.5	66	48	107	6	
LKD4872	1913	2133	2587	3128	3285	29	29.5	72	48	114	6	
LKD4878	1992	2230	2736	3321	3491	29	29.5	78	48	120	6	
LKD4884	2074	2326	2881	3511	3695	29	29.5	84	48	125	6	
LKD4896	2233	2519	3175	3896	4103	29	29.5	96	48	149	7	

LKD • Rectangular Table, 2 Piece Top

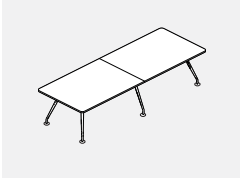

- Leg finish option, chrome or paint.
- Beam finish, paint only.

PRODUCT CODE	PRICE					SIZE / INCHES				WEIGHT		VOL FT ³
	B	W	KL	FV	KV	H (B)	H (W)	W	D	LBS		
LKD36108	2557	2756	3280	3887	4062	29	29.5	108	36	154	7	
LKD36120	2686	2908	3503	4180	4375	29	29.5	120	36	164	8	
LKD42108	2727	2953	3603	4310	4516	29	29.5	108	42	124	8	
LKD42120	2873	3120	3862	4648	4876	29	29.5	120	42	141	9	
LKD48108	2932	3177	3925	4735	4969	29	29.5	108	48	127	9	
LKD48120	3098	3373	4220	5117	5380	29	29.5	120	48	151	9	
LKD48132	3258	3556	4511	5501	5789	29	29.5	132	48	164	10	
LKD48144	3300	3605	4804	5883	6198	29	29.5	144	48	181	10	
LKD48156	3580	3927	5096	6266	6606	29	29.5	156	48	191	11	
LKD48168	3740	4111	5390	6650	7014	29	29.5	168	48	206	11	
LKD48180	4020	4433	5684	7033	7422	29	29.5	180	48	220	12	
LKD54144	3687	4039	5274	6489	6841	29	29.5	144	54	193	11	
LKD54168	4040	4448	5929	7344	7758	29	29.5	168	54	214	12	
LKD60144	3903	4288	5699	7049	7442	29	29.5	144	60	206	12	
LKD60168	4291	4732	6424	7998	8455	29	29.5	168	60	227	13	

LKD • Rectangular Table, 3 Piece Top



- Leg finish option, chrome or paint.
- Beam finish, paint only.

PRODUCT CODE	PRICE					SIZE / INCHES				WEIGHT		VOL FT ³
	B	W	KL	FV	KV	H (B)	H (W)	W	D	LBS		
LKD48192	4521	4941	6431	7872	8290	29	29.5	192	48	279	14	
LKD54192	4859	5318	7044	8662	9134	29	29.5	192	54	288	15	
LKD54216	5212	5725	7700	9519	10048	29	29.5	216	54	270	16	
LKD54240	5565	6133	8353	10376	10965	29	29.5	240	54	298	17	
LKD60192	5146	5645	7612	9411	9935	29	29.5	192	60	257	16	
LKD60216	5533	6089	8337	10360	10948	29	29.5	216	60	283	17	
LKD60240	5919	6533	9059	11308	11960	29	29.5	240	60	311	18	

Guideline for Ordering Product

CODES: The price list uses a numbering system with meaningful alphanumeric characters to create a simple-to-understand product number. This makes specifying the product much easier and more accurate.

SPECIFICATION EXAMPLE OF A HEIGHT ADJUSTABLE TABLE

Ordered as components, please order:

1, BASE

PRODUCT CODE:

FT - FreeFit
5 - Standard Range Legs
2 - Leg Quantity
SF - Small Frame
24 - Depth
CL - C-leg Style
S - Standard Controller

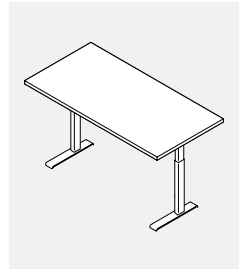

OPTIONS:

Frame Style: 5 - Standard Range Frame 27.5" to 47"
6 - Extended Range Frame 22.5" to 48.5"

Leg Quantity: 1 - 1 Leg for return Kit
2 - 2 Leg table Kit
3 - 3 Leg Table Kit
4 - 4 Leg Table Kit

Frame Size: SF - Small Frame, for 42" to 60" wide Tables
LF - Large Frame, for 66" to 84" wide Tables

Worksurface Depth: 24 - For 23" deep worksurfaces
30 - For 29" and 35" deep worksurfaces

Leg Style: CL - C Shaped Table Leg
TL - T Shaped Table Leg

Controller Style: S - Standard Controller
D - Display Controller

Base Finish: BLK - Black
DWT - Designer White
TUN - Tungsten
The following finishes are available for minimum orders of 72 legs for special projects. For customer who request the finishes below, and do not meet the 72 legs threshold, a 30% surcharge will apply to the base and an extended lead time of 6 weeks.

BZD - Blizzard	SIL - Silver
CHR - Charcoal	FOG - Steel
NEV - Nevada	TPE - Taupe
SDT - Stonedust	

2, TOP

PRODUCT CODE:

FTWR2436

Top: LP = LP (Low Pressure Laminate) Thickness 1"
HP = HP (High Pressure Laminate) Thickness 1 1/16"

Top Finish Laminate: Choose Colour

Top PVC Edging: Choose Colour

3, ACCESSORIES

PRODUCT CODE:

FTAEC12

Base Finish: BLK - Black
DWT - Designer White
TUN - Tungsten
The following finishes are available for minimum orders of 72 legs for special projects. For customer who request the finishes below, and do not meet the 72 legs threshold, a 30% surcharge will apply to the base and an extended lead time of 6 weeks.

BZD - Blizzard	SIL - Silver
CHR - Charcoal	FOG - Steel
NEV - Nevada	TPE - Taupe
SDT - Stonedust	

Height Adjustable Tables • Product Map

C-Leg Base

Standard and Extended Range

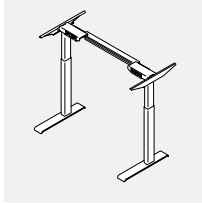

90 Degree Retrofit Kit with C-Leg

Standard and Extended Range



Single Frame

Standard and Extended Range

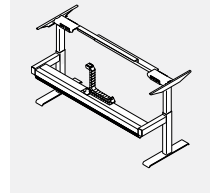

T-Leg Base

Standard and Extended Range

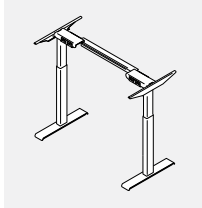

90 Degree Retrofit Kit with T-Leg

Standard and Extended Range



Single End of Run Frame

Standard and Extended Range

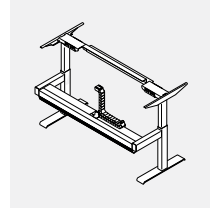

90 Degree Table Base, Equal Sides

Standard and Extended Range

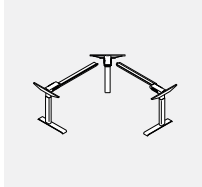

120 Degree Table Base

Standard and Extended Range

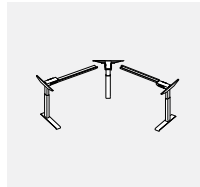

Media Table Frame

Standard and Extended Range

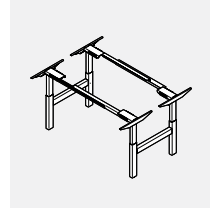

90 Degree Table Base, Unequal Sides

Standard and Extended Range

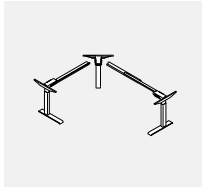

Back to Back Frame

Standard and Extended Range

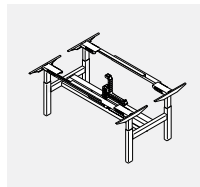

FREEFIT GROMMET LOCATION

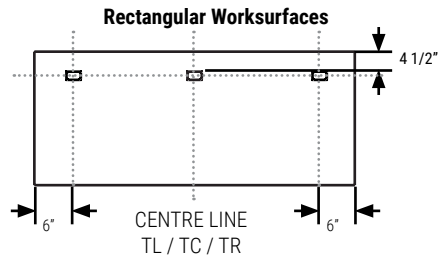
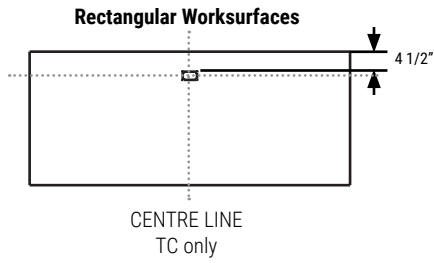

120° Corner Table Top

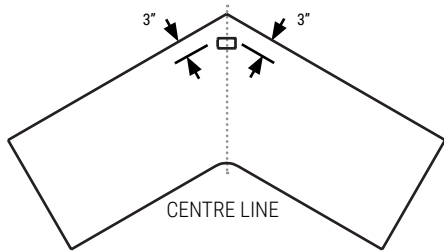

90° Extended Corner Worksurface

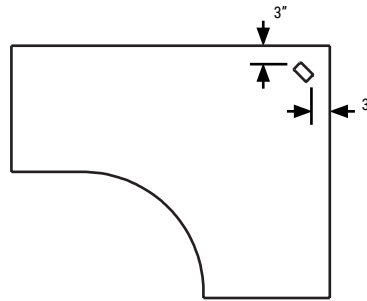

For FTWR worksurfaces 64" and larger, TL/TR, TL/TC and TC/TR are also available.

GAADxx Grommets Rectangular Worksurface TL

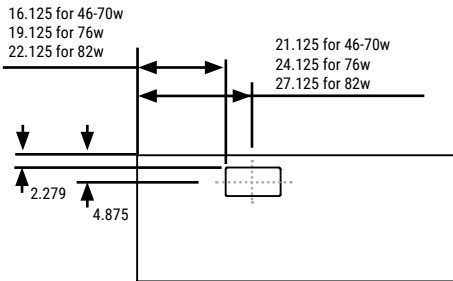

GAADxx Grommets Rectangular Worksurface TR

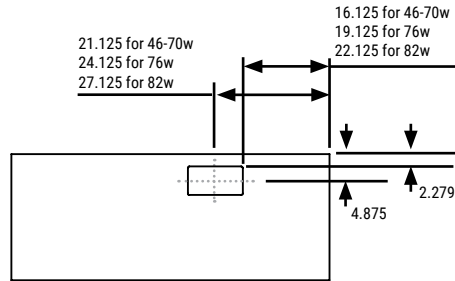

For Back to Back Tables and Freestanding Tables only. Not available for return table tops.

Media Table Tops

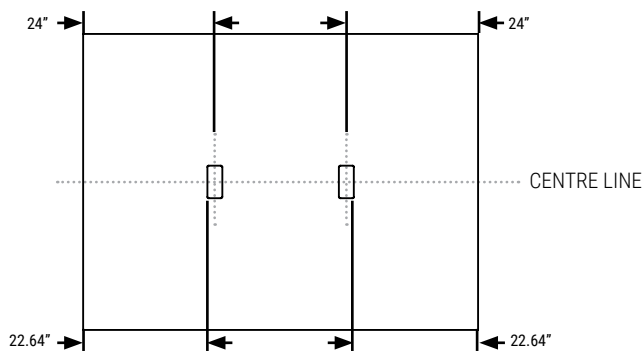

General Specification

FEATURES

- Table frames feature 80 X 50 mm rectangular outer leg with the large tube attached to the foot.
- Open base design with ample room for chair and user's legs.
- Flat foot design includes adjustable (10mm) glides.
- All table frames include expandable width upper crossbars to create a variety of size tables.
- Tables have no lower crossbars.
- All table frames are easy to assemble with few parts.
- Tables are designed so that the paint will never mar on the leg during operation.
- Steel construction of the leg assembly tubing, feet and upper structure assemblies.
- Powder coat finishes for bases standard in (DWT) Designer White, (BLK) Black and (TUN) Tungsten.
- All standard Global Contract laminate finishes are available.
- Sizes of tops are "nominal". Unless otherwise stated, actual depth is 1" less and actual width is 2" less than "nominal" size.
- Additional Finishes available minimum quantity of 72 legs (36 - 2 leg tables, 24 - 3 leg tables or 18 B2B Tables) Blizzard, Charcoal, Nevada, Silver, Steel, Stonedust, and Taupe
- All bases lift 350 lbs on two leg tables.
- All bases operate at 1.5" per second.
- Standard Range Frame adjusts from 27.5" to 47" including the worksurface.
- Extended Range Frame adjusts from 22.5" to 48.5" including the worksurface.
- Tops are warrantied for lifetime and bases are warranted for 7 years.

CERTIFICATIONS

Products are fully compliant with ANSI/BIFMA X5.5 – 2014, CAN/CGSB-44.227 - 2017; EN 60335-1 and UL962

All Global Contract Extended Range tables meet the BIFMA G1-2013 Ergonomic Guideline for "recommended adjustment range".

EXTENDED RANGE COLUMNS

The 3-part construction ensures a short installation dimension combined with a long stroke length making the Extended Range Column the optimum choice no matter the height of the person using it. The middle profile of the column moves synchronously so the profiles are always in the same height optimising the desk design and the stability.

- Compact design where guide and actuator functions are an integrated unit
- Reinforced column and optimised motor housing design for extra strength and stability
- Max. thrust 1200 N per column (12 mm spindle pitch)
- Max. speed 38 mm/s unloaded
- Installation dimension: 560 mm 518 mm (BIFMA)
- Stroke length: 650 mm 665 mm (BIFMA)
- Dimensions column: 50 x 80 mm (outer profile), 43.5 x 73.5 mm (middle profile) and 37 x 67 mm (inner profile)
- Low noise level
- No visible gliding pads

STANDARD RANGE COLUMNS

The 2-part lifting column is a perfect choice for a wide range of different desk applications in the office.

- Compact design where guide and actuator functions are an integrated unit
- Reinforced column and optimised motor housing design for extra strength and stability
- Max. load 800 N per column
- Max. speed: 38 mm/s unloaded
- Standard installation dimension 645 mm
- Standard stroke length 500 mm
- Dimensions column: 50 x 80 mm (outer profile) and 43.5 x 73.5 mm (inner profile)
- Dimension motor housing: 177 x 97 x 46 mm
- Low noise level
- No visible gliding pads

FOOT

Freefit offers two foot styles either a "T" or "C".

The feet are available in two different lengths (560 mm and 710 mm). The foot offers a recessed connection for the column and connects from the bottom with 4 bolts. Adjustable glides are standard

DESK MOUNT FRAME

- Can be specified in two lengths Short Frame (SF) for tables 42" – 60" in length. Long Frames (LF) for tables 66"- 84" in length
 - All metal parts Black
 - Cantilever length: 550 mm
 - Central or off-centre placement of columns (T-desk and C-desk)
- Includes all connecting hardware

CONTROL BOX

Two leg tables come standard with a 200 W Control Box

- Mains voltage 230 VAC, 50 Hz, or 120 VAC, 60 Hz
- Ultra-compact; length 210 mm length
- Lightweight control box; weight only approx. 400 g

Three Leg Tables come standard with a 300 W Control Box

- can be connected up to 4 columns
- Mains voltage 100-240 VAC, 50-60 Hz (universal)
- Ultra-compact; length 265 mm length
- Lightweight control box; weight only approx. 500 g

Common features for the (200 W and 300 W):

- Ultra-low; height only 38 mm
- Environment: Operation Storage
- Ambient temperature: 5 to 40 °C -10 to +50 °C
- Relative humidity: 20 to 80 % at 30 °C 20 to 80 % at 30 °C
- Atmospheric pressure: 700 to 1060 hPa 700 to 1060 hPa
- Compact high-power SMPS (Switch Mode Power Supply)
- Colour: black
- Protection against overload (EOP), by individual current limitation
- The control box is designed with a soft start/stop function
- Autodetection of the number and type of columns connected
- Cable grooves at the bottom to optimise cable management
- White plugs for easy recognition when mounting/dismounting
- PVC-Free™
- Low standby power consumption – only 0.1 W.
- Exchangeable standard mains cable

STANDARD UP/DOWN CONTROLLER

Features Bluetooth® connection, two favourite positions and a reminder via an LED to remind the users to use their desk. The Controller is activated by tilting the desk panel in the same direction as the desk is intended to drive. Via pulsating green and orange lights, the LED reminds the users to change positions. Using the integrated Bluetooth® and downloading the Desk Control™ App the user can also be reminded via notifications on computers and smart devices.

- Colour: Black
- Black cable with RJ45 modular plug, 1700 mm straight
- PVC-Free™
- Featuring ZERO™: Very low power consumption in standby mode
- Approved according to EN 60335-1
- Approved according to UL962

NOTE: All grommets must be specified separately.

DISPLAY UP/DOWN CONTROLLER

Features Bluetooth® connection, four favourite positions, a display to guide the users and a reminder via a light strip to remind the users to use their desks. The Controller is activated by tilting the desk panel in the same direction as the desk is intended to drive. The Display Controller features a modern discreet design with a glossy surface and an integrated display to ensure a clean and minimalist design. The display provides guidance to the users when operating the desk. Via pulsating green and orange lights, the light strip reminds the users to change positions. Using the integrated Bluetooth® and downloading the Desk Control™ App the users can also be reminded via notifications on smart devices.

- Colour: Black
- Black cable with RJ45 modular plug, 1700 mm straight
- PVC-Free™
- Featuring ZERO™: Very low power consumption in standby mode
- Approved according to EN 60335-1
- Approved according to UL962

ANTI COLLISION SENSOR

Features enhanced Anti-Collision protection which can limit material damage to a desk or an object if a collision occurs during driving of the desk. The sensor is a compact plug-in adapter based on gyroscope-technology, and it detects even little tilting of the desk when the desk is driving up or down. Upon detected tilting, the system stops and drives in the opposite direction to avoid collision and damage to the desk or the object. The sensor can detect both hard and soft obstacles. The Anti-Collision Sensor is standard on all desks.

- Reacts to angle changes bigger than 0.7° per second
- Just plug it in – no mounting required
- ZEROTM Power capable
- PVC-Free

BATTERY BOX

A high-performance lithium-Ion battery with a capacity of 2.15 Ah. On a full charge the table can cycle from 35 to 45 stroke lengths based upon the range of column selected and load on the table.

- Compact unit for easy handling and installation
- Battery alarm (audio) when charging is needed
- Battery charging indicator (LED light bars) indicating the capacity level
- Thermal switch protection, overcurrent protection
- Colour: black
- Battery capacity: 2.15 Ah / 52 Wh
- Nominal voltage: 24 V DC
- Discharge current: 9 A (max)
- Maximum charging voltage: 40 V DC
- Charging current: 0.5 A
- Weight: 600 g

USAGE

- Ambient temperature: 5 to 40 °C
- Storage temperature: 0 to 45 °C
- Approved according to:
- EN 62133 (Battery safety testing)
- UL 1642 (Lithium cells, standard test)
- UN 38.3 (transportation of Lithium batteries)
- UL 2054 (Household and commercial batteries)
- EN 60335-1 with CBH Advanced

FT52-CL • Standard Range Base with C-Legs

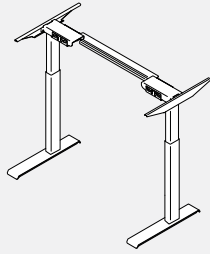

- Kit includes one beam, two cantilevers, two standard range columns and two C styled feet.
- BF indicates a smaller frame for 30" to 36" tables.
- SF indicates small frame for 42" to 60" tables.
- LF indicates large frame: 66" to 84" tables.
- For 23" deep worksurfaces, use 24" CL leg.
- For 29" and 35" deep worksurface, use 30" CL leg.
- For enhanced collision detection an Anti Collision Desk Sensor included with every base.
- For Standard Up/Down Controller add (S) at the end of the code. For Display Controller, please add at "D" at the end of the product code and \$78 to the list price.
- Specify paint finish: BLK-Black, DWT-Designer White, TUN-Tungsten.

PRODUCT CODE	PRICE	HEIGHT MIN/MAX	WIDTH MIN/MAX	DEPTH MIN/MAX	WEIGHT LBS	VOL FT ³
FT52BF24CL	1778	27.5" - 47"	30" - 36"	24" - 24"	56.12	2.3
FT52BF30CL	1791	27.5" - 47"	30" - 36"	30" - 30"	56.12	2.3
FT52SF24CL	1806	27.5" - 47"	42" - 60"	24" - 24"	56.12	2.3
FT52SF30CL	1821	27.5" - 47"	42" - 60"	30" - 36"	56.12	2.3
FT52LF24CL	1815	27.5" - 47"	66" - 84"	24" - 24"	59.3	2.3
FT52LF30CL	1827	27.5" - 47"	66" - 84"	30" - 36"	59.3	2.3

FT52-TL • Standard Range Base with T-Legs

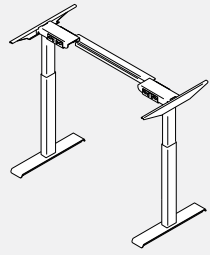

- Kit includes one beam, two cantilevers, two standard range columns and two T styled feet.
- BF indicates a smaller frame for 30" to 36" tables.
- SF indicates small frame for 42" to 60" tables.
- LF indicates large frame: 66" to 84" tables.
- For 23" deep worksurfaces, use 24" TL leg.
- For 29" deep worksurface, use 30" TL leg.
- For enhanced collision detection an Anti Collision Desk Sensor included with every base.
- For Standard Up/Down Controller add (S) at the end of the code. For Display Controller, please add at "D" at the end of the product code and \$78 to the list price.
- Specify paint finish: BLK-Black, DWT-Designer White, TUN-Tungsten.

PRODUCT CODE	PRICE	HEIGHT MIN/MAX	WIDTH MIN/MAX	DEPTH MIN/MAX	WEIGHT LBS	VOL FT ³
FT52BF24TL	1734	27.5" - 47"	30" - 36"	24" - 24"	56.12	2.3
FT52BF30TL	1748	27.5" - 47"	30" - 36"	30" - 30"	56.12	2.3
FT52SF24TL	1763	27.5" - 47"	42" - 60"	24" - 24"	56.12	2.3
FT52SF30TL	1778	27.5" - 47"	42" - 60"	30" - 36"	56.12	2.3
FT52LF24TL	1769	27.5" - 47"	66" - 84"	24" - 24"	59.3	2.3
FT52LF30TL	1784	27.5" - 47"	66" - 84"	30" - 36"	59.3	2.3

FT62-CL • Extended Range Base with C-Legs

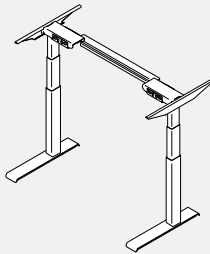

- Kit includes one beam, two cantilevers, two extended range columns and two C styled feet.
- BF indicates a smaller frame for 30" to 36" tables.
- SF indicates small frame for 42" to 60" tables. LF indicates large frame: 66" to 84" tables.
- For 23" deep worksurfaces, use 24" CL leg.
- For 29" and 35" deep worksurface, use 30" CL leg.
- For enhanced collision detection an Anti Collision Desk Sensor included with every base.
- For Standard Up/Down Controller add (S) at the end of the code. For Display Controller, please add at "D" at the end of the product code and \$78 to the list price.
- Specify paint finish: BLK-Black, DWT-Designer White, TUN-Tungsten.

PRODUCT CODE	PRICE	HEIGHT MIN/MAX	WIDTH MIN/MAX	DEPTH MIN/MAX	WEIGHT LBS	VOL FT ³
FT62BF24CL	1896	22.5" - 48.5"	30" - 36"	24" - 24"	56.12	2.3
FT62BF30CL	1911	22.5" - 48.5"	30" - 36"	30" - 30"	56.12	2.3
FT62SF24CL	1927	22.5" - 48.5"	42" - 60"	24" - 24"	59.3	2.3
FT62SF30CL	1941	22.5" - 48.5"	42" - 60"	30" - 36"	59.3	2.3
FT62LF24CL	1932	22.5" - 48.5"	66" - 84"	24" - 24"	64.7	2.3
FT62LF30CL	1947	22.5" - 48.5"	66" - 84"	30" - 36"	64.7	2.3

FT62-TL • Extended Range Base with T-Legs

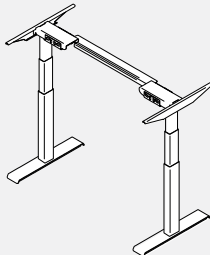

- Kit includes one beam, two cantilevers, two extended range columns and two T styled feet.
- BF indicates a smaller frame for 30" to 36" tables.
- SF indicates small frame for 42" to 60" tables.
- LF indicates large frame: 66" to 84" tables.
- For 23" deep worksurfaces, use 24" TL leg.
- For 29" deep worksurface, use 30" TL leg.
- For enhanced collision detection an Anti Collision Desk Sensor included with every base.
- For Standard Up/Down Controller add (S) at the end of the code. For Display Controller, please add at "D" at the end of the product code and \$78 to the list price.
- Specify paint finish: BLK-Black, DWT-Designer White, TUN-Tungsten.

PRODUCT CODE	PRICE	HEIGHT MIN/MAX	WIDTH MIN/MAX	DEPTH MIN/MAX	WEIGHT LBS	VOL FT ³
FT62BF24TL	1854	22.5" - 48.5"	30" - 36"	24" - 24"	56.12	2.3
FT62BF30TL	1868	22.5" - 48.5"	30" - 36"	30" - 30"	56.12	2.3
FT62SF24TL	1884	22.5" - 48.5"	42" - 60"	24" - 24"	59.3	2.3
FT62SF30TL	1895	22.5" - 48.5"	42" - 60"	30" - 36"	59.3	2.3
FT62LF24TL	1890	22.5" - 48.5"	66" - 84"	24" - 24"	64.7	2.3
FT62LF30TL	1905	22.5" - 48.5"	66" - 84"	30" - 36"	64.7	2.3

• LP = Thermally Fused Laminate, HP = High Pressure Laminate.

FT539F-CL • Standard Range 90 Degree Table Base, Equal Sides

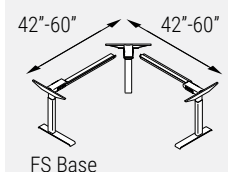

FS Base

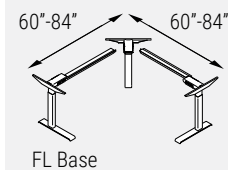

FL Base

- Kit includes two equal length beams, three cantilevers, one standard range corner column, two standard range columns and two C styled feet.

- FS indicates small base for 54" to 60" sided tables.

- FL indicates large base for 66" to 84" sided tables.

- For 23" deep worksurfaces, use 24" CL leg.

- For 29" and 35" deep worksurface, use 30" CL leg.

- For enhanced collision detection an Anti Collision Desk Sensor included with every base.

- For Standard Up/Down Controller add (S) at the end of the code. For Display Controller, please add at "D" at the end of the product code and \$78 to the list price.

- Specify paint finish: BLK-Black, DWT-Designer White, TUN-Tungsten.

PRODUCT CODE	PRICE	HEIGHT MIN/MAX	WIDTH MIN/MAX	DEPTH MIN/MAX	WEIGHT LBS	VOL FT ³
FT539FS24CL	2629	27.5" - 47"	42" - 60"	42" - 60"	79.1	4.7
FT539FS30CL	2644	27.5" - 47"	42" - 60"	42" - 60"	79.1	4.7
FT539FL24CL	2678	27.5" - 47"	66" - 84"	66" - 84"	59.3	4.7
FT539FL30CL	2690	27.5" - 47"	66" - 84"	66" - 84"	59.3	4.7

FT539FSL-CL • Standard Range 90 Degree Table Base, Unequal Sides

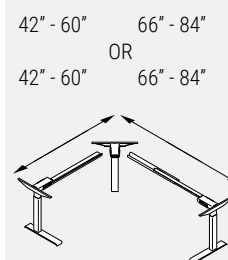

- Kit includes two beams (one small and one large), three cantilevers, one standard range corner column, two standard range columns and two C styled feet.

- For 23" deep worksurfaces, use 24" CL leg.

- For 29" and 35" deep worksurface, use 30" CL leg.

- For enhanced collision detection an Anti Collision Desk Sensor included with every base.

- For Standard Up/Down Controller add (S) at the end of the code. For Display Controller, please add at "D" at the end of the product code and \$78 to the list price.

- Specify paint finish: BLK-Black, DWT-Designer White, TUN-Tungsten.

PRODUCT CODE	PRICE	HEIGHT MIN/MAX	WIDTH MIN/MAX	DEPTH MIN/MAX	WEIGHT LBS	VOL FT ³
FT539FSL24CL	2652	27.5" - 47"	42" - 60"	66" - 84"	85.4	4.7
FT539FSL30CL	2666	27.5" - 47"	42" - 60"	66" - 84"	85.4	4.7

FT639F-CL • Extended Range 90 Degree Table Base, Equal Sides

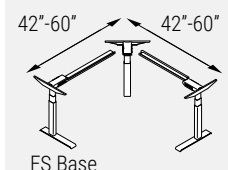

FS Base

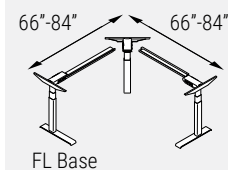

FL Base

- Kit includes two equal length beams, three cantilevers, one extended range corner column, two extended range columns and two C styled feet.

- FS indicates small base for 54" to 60" sided tables.

- FL indicates large base for 66" to 84" sided tables.

- For 23" deep worksurfaces, use 24" CL leg.

- For 29" and 35" deep worksurface, use 30" CL leg.

- For enhanced collision detection an Anti Collision Desk Sensor included with every base.

- For Standard Up/Down Controller add (S) at the end of the code. For Display Controller, please add at "D" at the end of the product code and \$78 to the list price.

- Specify paint finish: BLK-Black, DWT-Designer White, TUN-Tungsten.

PRODUCT CODE	PRICE	HEIGHT MIN/MAX	WIDTH MIN/MAX	DEPTH MIN/MAX	WEIGHT LBS	VOL FT ³
FT639FS24CL	2808	22.5" - 48.5"	42" - 60"	42" - 60"	76.5	4.7
FT639FS30CL	2822	22.5" - 48.5"	42" - 60"	42" - 60"	76.5	4.7
FT639FL24CL	2855	22.5" - 48.5"	66" - 84"	66" - 84"	82.7	4.7
FT639FL30CL	2869	22.5" - 48.5"	66" - 84"	66" - 84"	82.7	4.7

FT639FSL-CL • Extended Range 90 Degree Table Base, Unequal Sides

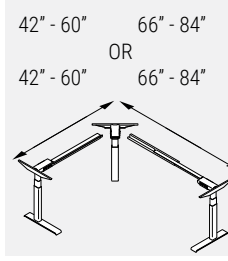

- Kit includes two beams (one small and one large), three cantilevers, one extended range corner column, two extended range columns and two C styled feet.

- For 23" deep worksurfaces, use 24" CL leg.

- For 29" and 35" deep worksurface, use 30" CL leg.

- For enhanced collision detection an Anti Collision Desk Sensor included with every base.

- For Standard Up/Down Controller add (S) at the end of the code. For Display Controller, please add at "D" at the end of the product code and \$78 to the list price.

- Specify paint finish: BLK-Black, DWT-Designer White, TUN-Tungsten.

PRODUCT CODE	PRICE	HEIGHT MIN/MAX	WIDTH MIN/MAX	DEPTH MIN/MAX	WEIGHT LBS	VOL FT ³
FT639FSL24CL	2832	22.5" - 48.5"	42" - 60"	48" - 84"	85.4	4.7
FT639FSL30CL	2845	22.5" - 48.5"	42" - 60"	48" - 84"	85.4	4.7

FT51-R-CL • Standard Range 90 Degree Table Retrofit Kit with with C-Leg

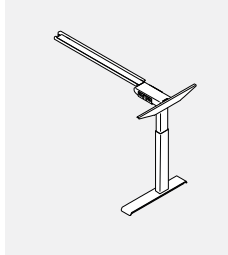

- Kit includes one beam, one cantilever, one standard range column and one C styled foot.

- SR indicates short returns.

- LR indicates long returns.

- For 23" deep worksurfaces, use 24" CL leg.

- For 29" and 35" deep worksurface, use 30" CL leg.

- Specify paint finish: BLK-Black, DWT-Designer White, TUN-Tungsten.

PRODUCT CODE	PRICE	HEIGHT MIN/MAX	WIDTH MIN/MAX	DEPTH MIN/MAX	WEIGHT LBS	VOL FT ³
FT51SR24CL	1195	27.5" - 47"	24" - 48"	24" - 24"	24.9	4.7
FT51LR24CL	1219	27.5" - 47"	54" - 72"	24" - 24"	26.9	4.7
FT51SR30CL	1203	27.5" - 47"	24" - 48"	30" - 36"	24.9	4.7
FT51LR30CL	1225	27.5" - 47"	54" - 72"	30" - 36"	26.9	4.7

FT51-R-TL • Standard Range 90 Degree Table Retrofit Kit with with T-Leg

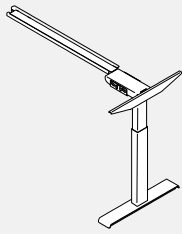

- Kit includes one beam, one cantilever, one standard range column and one T styled foot.
- SR indicates short returns.
- LR indicates long returns.
- For 23" deep worksurfaces, use 24" TL leg.
- For 29" and 35" deep worksurface, use 30" TL leg.
- Specify paint finish: BLK-Black, DWT-Designer White, TUN-Tungsten.

PRODUCT CODE	PRICE	HEIGHT MIN/MAX	WIDTH MIN/MAX	DEPTH MIN/MAX	WEIGHT LBS	VOL FT ³
FT51SR24TL	1176	27.5" - 47"	24" - 48"	24" - 24"	24.9	2.3
FT51LR24TL	1197	27.5" - 47"	54" - 72"	24" - 24"	26.9	2.3
FT51SR30TL	1181	27.5" - 47"	24" - 48"	30" - 36"	24.9	2.3
FT51LR30TL	1204	27.5" - 47"	54" - 72"	30" - 36"	26.9	2.3

FT61-R-CL • Extended Range 90 Degree Table Retrofit Kit with with C-Leg

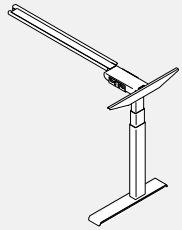

- Kit includes one beam, one cantilever, one extended range column and one C styled foot.
- SR indicates short returns.
- LR indicates long returns.
- For 23" deep worksurfaces, use 24" CL leg.
- For 29" and 35" deep worksurface, use 30" CL leg.
- Specify paint finish: BLK-Black, DWT-Designer White, TUN-Tungsten.

PRODUCT CODE	PRICE	HEIGHT MIN/MAX	WIDTH MIN/MAX	DEPTH MIN/MAX	WEIGHT LBS	VOL FT ³
FT61SR24CL	1255	22.5" - 48.5"	24" - 48"	24" - 24"	27.6	4.7
FT61LR24CL	1279	22.5" - 48.5"	54" - 72"	24" - 24"	30.7	4.7
FT61SR30CL	1262	22.5" - 48.5"	24" - 48"	30" - 36"	27.6	4.7
FT61LR30CL	1286	22.5" - 48.5"	54" - 72"	30" - 36"	30.7	4.7

FT61-R-TL • Extended Range 90 Degree Table Retrofit Kit with with T-Leg

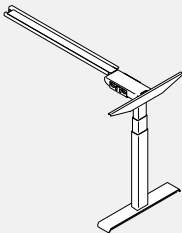

- Kit includes one beam, one cantilever, one extended range column and one T styled foot.
- SR indicates short returns.
- LR indicates long returns.
- For 23" deep worksurfaces, use 24" TL leg.
- For 29" and 35" deep worksurface, use 30" TL leg.
- Specify paint finish: BLK-Black, DWT-Designer White, TUN-Tungsten.

PRODUCT CODE	PRICE	HEIGHT MIN/MAX	WIDTH MIN/MAX	DEPTH MIN/MAX	WEIGHT LBS	VOL FT ³
FT61SR24TL	1234	22.5" - 48.5"	24" - 48"	24" - 24"	27.6	2.3
FT61LR24TL	1257	22.5" - 48.5"	54" - 72"	24" - 24"	30.7	2.3
FT61SR30TL	1241	22.5" - 48.5"	24" - 48"	30" - 36"	27.6	2.3
FT61LR30TL	1265	22.5" - 48.5"	54" - 72"	30" - 36"	30.7	2.3

FT531F-CL • Standard Range 120 Degree Table Base, Equal Sides

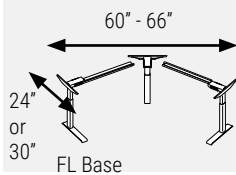
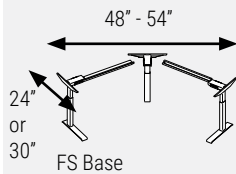

- Kit includes two beams, three cantilevers, one standard range corner column, two standard range columns and two C styled feet.
- FS indicates small base for 48" to 54" sided tables.
- FL indicates large base for 60" to 66" sided tables.
- For 23" deep worksurfaces, use 24" CL leg.
- For 29" and 35" deep worksurface, use 30" CL leg.
- For enhanced collision detection an Anti Collision Desk Sensor included with every base.
- For Standard Up/Down Controller add (S) at the end of the code. For Display Controller, please add at "D" at the end of the product code and \$78 to the list price.
- Specify paint finish: BLK-Black, DWT-Designer White, TUN-Tungsten.

PRODUCT CODE	PRICE	HEIGHT MIN/MAX	WIDTH MIN/MAX	DEPTH MIN/MAX	WEIGHT LBS	VOL FT ³
FT531FS24CL	2629	27.5" - 47"	48" - 54"	48" - 54"	59.7	4.7
FT531FS30CL	2644	27.5" - 47"	48" - 54"	48" - 54"	59.7	4.7
FT531FL24CL	2678	27.5" - 47"	60" - 66"	60" - 66"	59.7	4.7
FT531FL30CL	2690	27.5" - 47"	60" - 66"	60" - 66"	59.7	4.7

FT631F-CL • Extended Range 120 Degree Table Base, Equal Sides

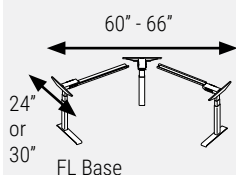
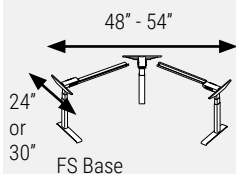

- Kit includes two beams, three cantilevers, one extended range corner column, two extended range columns and two C styled feet.
- FS indicates small base for 48" to 54" sided tables.
- FL indicates large base for 60" to 66" sided tables.
- For 23" deep worksurfaces, use 24" CL leg.
- For 29" and 35" deep worksurface, use 30" CL leg.
- For enhanced collision detection an Anti Collision Desk Sensor included with every base.
- For Standard Up/Down Controller add (S) at the end of the code. For Display Controller, please add at "D" at the end of the product code and \$78 to the list price.
- Specify paint finish: BLK-Black, DWT-Designer White, TUN-Tungsten.

PRODUCT CODE	PRICE	HEIGHT MIN/MAX	WIDTH MIN/MAX	DEPTH MIN/MAX	WEIGHT LBS	VOL FT ³
FT631FS24CL	2808	22.5" - 48.5"	48" - 54"	48" - 54"	59.7	4.7
FT631FS30CL	2822	22.5" - 48.5"	48" - 54"	48" - 54"	59.7	4.7
FT631FL24CL	2855	22.5" - 48.5"	60" - 66"	60" - 66"	59.7	4.7
FT631FL30CL	2869	22.5" - 48.5"	60" - 66"	60" - 66"	59.7	4.7

FT5B2B • Back to Back Standard Range Base

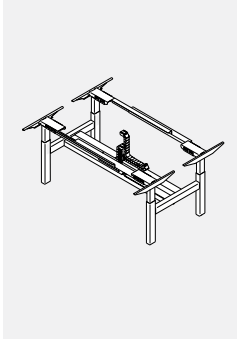

- Kit includes two beams, four cantilevers, four standard range columns and one power trough assembly with two energy chains.
- For 50.5 depth, use two x 23" deep worksurfaces.
- For 62.5" depth, use two x 29" deep worksurfaces.
- 30" or larger depth worksurfaces cannot be used with Back to Back bases.
- Duplex receptacles are not included, please specify separately.
- For enhanced collision detection an Anti Collision Desk Sensor included with every base.
- For Standard Up/Down Controller add (S) at the end of the code. For Display Controller, please add at "D" at the end of the product code and \$165 to the list price.
- Specify paint finish: BLK-Black, DWT-Designer White, TUN-Tungsten.

PRODUCT CODE	PRICE	HEIGHT MIN/MAX	WIDTH MIN/MAX	DEPTH MIN/MAX	WEIGHT LBS	VOL FT ³
FT5B2B48	4977	27.5" - 47"	48" - 48"	50.5" - 62.5"	129	4.7
FT5B2B54	5014	27.5" - 47"	54" - 54"	50.5" - 62.5"	129	4.7
FT5B2B60	5066	27.5" - 47"	60" - 60"	50.5" - 62.5"	129	4.7
FT5B2B66	5104	27.5" - 47"	66" - 66"	50.5" - 62.5"	129	4.7
FT5B2B72	5117	27.5" - 47"	72" - 84"	50.5" - 62.5"	129	4.7

FT6B2B • Back to Back Extended Range Base

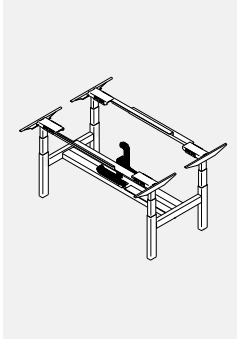

- Kit includes two beams, four cantilevers, four extended range columns and one power trough assembly with two energy chains.
- For 50.5 depth, use two x 23" deep worksurfaces.
- For 62.5" depth, use two x 29" deep worksurfaces.
- 30" or larger depth worksurfaces cannot be used with Back to Back bases.
- Duplex receptacles are not included, please specify separately.
- For enhanced collision detection an Anti Collision Desk Sensor included with every base.
- For Standard Up/Down Controller add (S) at the end of the code. For Display Controller, please add at "D" at the end of the product code and \$165 to the list price.
- Specify paint finish: BLK-Black, DWT-Designer White, TUN-Tungsten.

PRODUCT CODE	PRICE	HEIGHT MIN/MAX	WIDTH MIN/MAX	DEPTH MIN/MAX	WEIGHT LBS	VOL FT ³
FT6B2B48	5204	22.5" - 48.5"	48" - 48"	50.5" - 62.5"	129	4.7
FT6B2B54	5241	22.5" - 48.5"	54" - 54"	50.5" - 62.5"	129	4.7
FT6B2B60	5294	22.5" - 48.5"	60" - 60"	50.5" - 62.5"	129	4.7
FT6B2B66	5331	22.5" - 48.5"	66" - 66"	50.5" - 62.5"	129	4.7
FT6B2B72	5343	22.5" - 48.5"	72" - 84"	50.5" - 62.5"	129	4.7

FT5SGL-T • Standard Range Single Frame

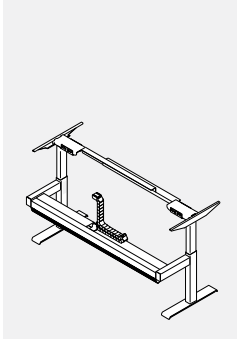

- Kit includes one beam, two cantilevers, two standard range columns, two T styled feet and one power trough assembly with one energy chains.
- For T24 leg, use 23" deep worksurfaces.
- For T30 leg, use 29" deep worksurfaces.
- 30" or larger depth worksurfaces cannot be used with Back to Back bases.
- Duplex receptacles are not included, please specify separately.
- For enhanced collision detection an Anti Collision Desk Sensor included with every base.
- For Standard Up/Down Controller add (S) at the end of the code. For Display Controller, please add at "D" at the end of the product code and \$78 to the list price.
- Specify paint finish: BLK-Black, DWT-Designer White, TUN-Tungsten.

PRODUCT CODE	PRICE	HEIGHT MIN/MAX	WIDTH MIN/MAX	DEPTH MIN/MAX	WEIGHT LBS	VOL FT ³
FT5SGL48T24	2915	27.5" - 47"	48" - 48"	24" - 24"	75	2.3
FT5SGL54T24	2949	27.5" - 47"	54" - 54"	24" - 24"	75	2.3
FT5SGL60T24	2988	27.5" - 47"	60" - 60"	24" - 24"	75	2.3
FT5SGL66T24	3017	27.5" - 47"	66" - 66"	24" - 24"	75	2.3
FT5SGL72T24	3042	27.5" - 47"	72" - 84"	24" - 24"	75	2.3
FT5SGL48T30	2930	27.5" - 47"	48" - 48"	30" - 30"	75	2.3
FT5SGL54T30	2964	27.5" - 47"	54" - 54"	30" - 30"	75	2.3
FT5SGL60T30	3003	27.5" - 47"	60" - 60"	30" - 30"	75	2.3
FT5SGL66T30	3033	27.5" - 47"	66" - 66"	30" - 30"	75	2.3
FT5SGL72T30	3057	27.5" - 47"	72" - 84"	30" - 30"	75	2.3

FT6SGL-T • Extended Range Single Frame

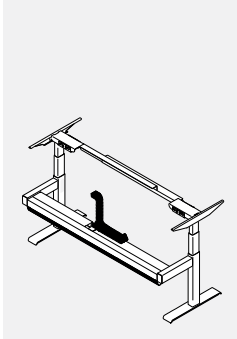

- Kit includes one beam, two cantilevers, two extended range columns, two T styled feet and one power trough assembly with one energy chains.
- For T24 leg, use 23" deep worksurfaces.
- For T30 leg, use 29" deep worksurfaces.
- 30" or larger depth worksurfaces cannot be used with Back to Back bases.
- Duplex receptacles are not included, please specify separately.
- For enhanced collision detection an Anti Collision Desk Sensor included with every base.
- For Standard Up/Down Controller add (S) at the end of the code. For Display Controller, please add at "D" at the end of the product code and \$78 to the list price.
- Specify paint finish: BLK-Black, DWT-Designer White, TUN-Tungsten.

PRODUCT CODE	PRICE	HEIGHT MIN/MAX	WIDTH MIN/MAX	DEPTH MIN/MAX	WEIGHT LBS	VOL FT ³
FT6SGL48T24	3029	22.5" - 48.5"	48" - 48"	24" - 24"	75	2.3
FT6SGL54T24	3063	22.5" - 48.5"	54" - 54"	24" - 24"	75	2.3
FT6SGL60T24	3103	22.5" - 48.5"	60" - 60"	24" - 24"	75	2.3
FT6SGL66T24	3132	22.5" - 48.5"	66" - 66"	24" - 24"	75	2.3
FT6SGL72T24	3157	22.5" - 48.5"	72" - 84"	24" - 24"	75	2.3
FT6SGL48T30	3043	22.5" - 48.5"	48" - 48"	30" - 30"	75	2.3
FT6SGL54T30	3076	22.5" - 48.5"	54" - 54"	30" - 30"	75	2.3
FT6SGL60T30	3115	22.5" - 48.5"	60" - 60"	30" - 30"	75	2.3
FT6SGL66T30	3146	22.5" - 48.5"	66" - 66"	30" - 30"	75	2.3
FT6SGL72T30	3170	22.5" - 48.5"	72" - 84"	30" - 30"	75	2.3

FT5SGL-T • Standard Range End of Run Single Frame

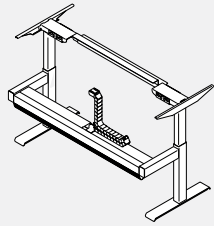

- Kit includes one beam, two cantilevers, two standard range columns, two T styled feet and one power trough assembly with one energy chains.
- For T24 leg, use 23" deep worksurfaces.
- For T30 leg, use 29" deep worksurfaces.
- 30" or larger depth worksurfaces cannot be used with Back to Back bases.
- Duplex receptacles are not included, please specify separately.
- For enhanced collision detection an Anti Collision Desk Sensor included with every base.
- For Standard Up/Down Controller add (S) at the end of the code. For Display Controller, please add at "D" at the end of the product code and \$78 to the list price.
- Specify paint finish: BLK-Black, DWT-Designer White, TUN-Tungsten.

PRODUCT CODE	PRICE	HEIGHT MIN/MAX	WIDTH MIN/MAX	DEPTH MIN/MAX	WEIGHT LBS	VOL FT ³
FT5SGL51T24	3178	27.5" - 47"	51" - 62"	24" - 24"	75	2.3
FT5SGL51T30	3194	27.5" - 47"	51" - 62"	30" - 30"	75	2.3

FT6SGL-T • Extended Range End of Run Single Frame

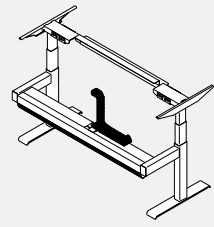

- Kit includes one beam, two cantilevers, two extended range columns, two T styled feet and one power trough assembly with one energy chains.
- For T24 leg, use 23" deep worksurfaces.
- For T30 leg, use 29" deep worksurfaces.
- 30" or larger depth worksurfaces cannot be used with Back to Back bases.
- Duplex receptacles are not included, please specify separately.
- For enhanced collision detection an Anti Collision Desk Sensor included with every base.
- For Standard Up/Down Controller add (S) at the end of the code. For Display Controller, please add at "D" at the end of the product code and \$78 to the list price.
- Specify paint finish: BLK-Black, DWT-Designer White, TUN-Tungsten.

PRODUCT CODE	PRICE	HEIGHT MIN/MAX	WIDTH MIN/MAX	DEPTH MIN/MAX	WEIGHT LBS	VOL FT ³
FT6SGL51T24	3293	22.5" - 48.5"	51" - 62"	24" - 24"	75	2.3
FT6SGL51T30	3306	22.5" - 48.5"	51" - 62"	30" - 30"	75	2.3

FTM5B2B-F • Standard Range Media Table Base

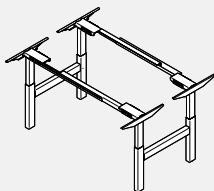

- Kit includes two beams, four cantilevers, four standard range columns and two controllers.
- SF indicates small base for 60" sided tables.
- LF indicates large base for 66" to 96" sided tables.
- Duplex receptacles are not included, please specify separately.
- For enhanced collision detection an Anti Collision Desk Sensor included with every base.
- For Standard Up/Down Controller add (S) at the end of the code. For Display Controller, please add at "D" at the end of the product code and \$165 to the list price.
- Specify paint finish: BLK-Black, DWT-Designer White, TUN-Tungsten.

PRODUCT CODE	PRICE	HEIGHT MIN/MAX	WIDTH MIN/MAX	DEPTH MIN/MAX	WEIGHT LBS	VOL FT ³
FTM5B2BSF	4067	27.5" - 47"	60" - 60"	54" - 60"	129	4.7
FTM5B2BLF	4081	27.5" - 47"	66" - 96"	54" - 60"	129	4.7

FTM6B2B-F • Extended Range Media Table Base

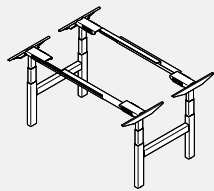

- Kit includes two beams, four cantilevers, four extended range columns and two controllers.
- SF indicates small base for 60" sided tables.
- LF indicates large base for 66" to 96" sided tables.
- Duplex receptacles are not included, please specify separately.
- For enhanced collision detection an Anti Collision Desk Sensor included with every base.
- For Standard Up/Down Controller add (S) at the end of the code. For Display Controller, please add at "D" at the end of the product code and \$165 to the list price.
- Specify paint finish: BLK-Black, DWT-Designer White, TUN-Tungsten.

PRODUCT CODE	PRICE	HEIGHT MIN/MAX	WIDTH MIN/MAX	DEPTH MIN/MAX	WEIGHT LBS	VOL FT ³
FTM6B2BSF	4294	22.5" - 48.5"	60" - 60"	54" - 60"	129	4.7
FTM6B2BLF	4308	22.5" - 48.5"	66" - 96"	54" - 60"	129	4.7

FTWR - Rectangular Worksurface

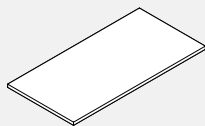

- Rectangular worksurfaces are non-handed and can be interchanged on site.
- Specify laminate finish and PVC edge finish.
- Grommet option for surfaces less than 64" is TC - Top Center only.
- Specification:
- For 23" deep worksurfaces, use FT52(S/L)F24CL/TL standard range or FT62(S/L)F24CL/TL extended range base.
- For 29" deep worksurfaces, use FT52(S/L)F30CL/TL standard range or FT62(S/L)F30CL/TL extended range base.
- For 35" deep worksurfaces, use FT5(S/L)F30CL/TL standard range or FT6(S/L)F30CL/TL extended range base.
- The 35" deep worksurfaces cannot be used with Back to Back Bases.
- For Back to Back bases, please use the following chart:
 FTW(23/29)46, FT(5/6)B2B48
 FTW(23/29)52, FT(5/6)B2B54
 FTW(23/29)58, FT(5/6)B2B60
 FTW(23/29)64, FT(5/6)B2B66
 FTW(23/29)72, FT(5/6)B2B72
 FTW(23/29)76, FT(5/6)B2B72
 FTW(23/29)82, FT(5/6)B2B72

PRODUCT CODE	PRICE LP	HP	SIZE/INCHES			WEIGHT LBS	VOL FT ³
			H	W	D		
FTWR2328	149	191	1	28	23	20	1.16
FTWR2334	165	215	1	34	23	24	1.40
FTWR2340	212	279	1	40	23	28	1.64
FTWR2346	245	329	1	46	23	31	1.84
FTWR2352	290	383	1	52	23	36	2.08
FTWR2358	326	430	1	58	23	40	2.32
FTWR2364	340	449	1	64	23	44	2.56
FTWR2370	355	470	1	70	23	48	3.80
FTWR2376	381	501	1	76	23	52	3.03
FTWR2382	410	537	1	82	23	56	3.27
FTWR2928	173	227	1	28	29	25	1.46
FTWR2934	202	265	1	34	29	30	1.76
FTWR2940	283	371	1	40	29	35	2.06
FTWR2946	290	383	1	46	29	40	2.32
FTWR2952	317	408	1	52	29	45	2.62
FTWR2958	340	449	1	58	29	50	2.92
FTWR2964	353	469	1	64	29	55	3.22
FTWR2970	374	495	1	70	29	60	3.52
FTWR2976	398	524	1	76	29	65	3.83
FTWR2982	443	579	1	82	29	71	4.13
FTWR3528	178	234	1	28	35	30	2.00
FTWR3534	210	275	1	34	35	35	2.00
FTWR3540	295	385	1	40	35	40	2.50
FTWR3546	378	471	1	46	35	48	2.80
FTWR3552	420	526	1	52	35	54	3.16
FTWR3558	466	583	1	58	35	60	3.52
FTWR3564	508	637	1	64	35	67	3.89
FTWR3570	552	691	1	70	35	73	4.25
FTWR3576	594	743	1	76	35	79	4.62
FTWR3582	639	800	1	82	35	85	4.98

FTWRR - Rectangular Return Worksurface

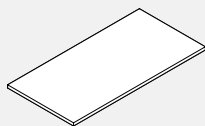

- Rectangular return worksurfaces are non-handed and can be interchanged on site.
- Specify laminate finish and PVC edge finish.
- Includes two flat brackets for connection.
- Specification:
- For 23" deep worksurfaces, use FT51SR24CL/TL standard range or FT61SR24CL/TL extended range base.
- For 29" deep worksurfaces, use FT51SR30CL/TL standard range or FT61SR30CL/TL extended range base.

PRODUCT CODE	PRICE LP	HP	SIZE/INCHES			WEIGHT LBS	VOL FT ³
			H	W	D		
FTWRR2329	149	191	1	29	23	20	1.16
FTWRR2335	165	215	1	35	23	24	1.40
FTWRR2341	212	279	1	41	23	28	1.64
FTWRR2347	254	336	1	47	23	32	1.88
FTWRR2353	297	392	1	53	23	36	2.12
FTWRR2359	333	438	1	59	23	40	2.36
FTWRR2929	173	227	1	29	29	25	1.46
FTWRR2935	202	265	1	35	29	30	1.76
FTWRR2941	283	371	1	41	29	35	2.06
FTWRR2947	297	392	1	47	29	40	2.36
FTWRR2953	323	418	1	53	29	46	2.67
FTWRR2959	347	458	1	59	29	51	2.97

FTWR - Rectangular End of Run Worksurface

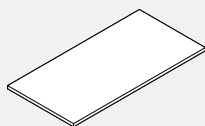

- Rectangular end of run worksurfaces are non-handed and can be interchanged on site.
- Specify laminate finish and PVC edge finish.
- Specification:
- For 23" deep worksurfaces, use FT52(S/F)L24CL/TL standard range or FT62(S/F)L24CL/TL extended range base.
- For 29" deep worksurfaces, use FT52(S/F)L30CL/TL standard range or FT62(S/F)L30CL/TL extended range base.
- For Back to Back bases, please use the following chart:
 FTWR(23/29)51, FT(5/6)B2B60
 FTWR(23/29)62, FT(5/6)B2B66

PRODUCT CODE	PRICE LP	HP	SIZE/INCHES			WEIGHT LBS	VOL FT ³
			H	W	D		
FTWR2351	326	430	1	51	23	40	2.02
FTWR2362	340	449	1	62	23	44	2.5
FTWR2951	340	449	1	51	29	50	2.54
FTWR2962	353	528	1	62	29	55	3.15

• LP = Thermally Fused Laminate, HP = High Pressure Laminate.

FTWCC - 90 Degree Corner Worksurface

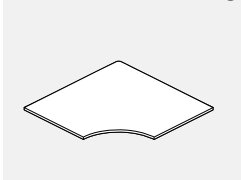

- 90 Corner Worksurface.
- Specify laminate finish and PVC edge finish.
- Specification:
- For tables that connect with 23" deep work-surfaces, use FT539FS24CL standard range or FT539FS24CL extended range base.
- For table that connect with 29" deep work-surfaces, use FT539FS30CL standard range or FT639FS30CL extended range base.

PRODUCT CODE	FINISH		SIZE / INCHES				WEIGHT LBS	VOL FT ³
	LP	HP	H	W	D			
FTWCC234023	549	603	1	40	40	70	1.50	
FTWCC234623	565	620	1	46	46	75	2.00	
FTWCC235223	647	712	1	52	52	80	4.69	
FTWCC235823	828	910	1	58	58	100	5.84	
FTWCC294029	549	603	1	40	40	70	1.50	
FTWCC294629	549	603	1	46	46	75	3.67	
FTWCC295229	647	712	1	52	52	80	4.69	
FTWCC295829	828	910	1	58	58	100	5.84	

FTWEC - Left Extended 90 Degree Corner Worksurface

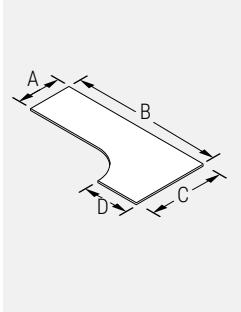

- Left Extended 90 Degree Corner Worksurface.
- Specify laminate finish and PVC edge finish.
- Specification:
- For tables that connect with 23" deep (A and D) work-surfaces, use FT539F(S/L)24CL standard range or FT639F(S/L)24CL extended range base.
- For table that connect with 29" deep (A and D) work-surfaces, use FT539F(S/L)30CL standard range or FT639F(S/L)30CL extended range base.

PRODUCT CODE	FINISH		SIZE / INCHES				WEIGHT LBS	VOL FT ³
	LP	HP	H	W	D			
FTWEC23584023	741	927	1	58	40	115	2.55	
FTWEC23644023	824	1030	1	64	40	127	2.81	
FTWEC23704023	901	1128	1	70	40	138	3.07	
FTWEC23764023	963	1200	1	76	40	150	3.34	
FTWEC23824023	1020	1275	1	82	40	162	3.60	
FTWEC23584623	763	955	1	58	46	115	2.55	
FTWEC23644623	849	1060	1	64	46	127	2.81	
FTWEC23704623	928	1162	1	70	46	138	3.07	
FTWEC23764623	991	1236	1	76	46	150	3.34	
FTWEC23824623	1051	1313	1	82	46	162	3.60	
FTWEC23585223	787	985	1	58	52	130	2.88	
FTWEC23645223	872	1093	1	64	52	143	3.18	
FTWEC23705223	956	1197	1	70	52	156	3.48	
FTWEC23765223	1020	1273	1	76	52	170	3.77	
FTWEC23825223	1082	1353	1	82	52	183	4.07	
FTWEC23645823	901	1125	1	64	58	160	3.54	
FTWEC23705823	986	1232	1	70	58	174	3.88	
FTWEC23765823	1051	1312	1	76	58	189	4.21	
FTWEC23825823	1114	1394	1	82	58	204	4.54	
FTWEC29584029	771	965	1	58	40	115	2.55	
FTWEC29644029	858	1071	1	64	40	127	2.81	
FTWEC29704029	936	1173	1	70	40	138	3.07	
FTWEC29764029	1000	1247	1	76	40	150	3.34	
FTWEC29824029	1060	1327	1	82	40	162	3.60	
FTWEC29584629	794	993	1	58	46	115	2.55	
FTWEC29644629	883	1102	1	64	46	127	2.81	
FTWEC29704629	966	1208	1	70	46	138	3.07	
FTWEC29764629	1031	1286	1	76	46	150	3.34	
FTWEC29824629	1093	1366	1	82	46	162	3.6	
FTWEC29585229	818	1024	1	58	52	130	2.88	
FTWEC29645229	908	1136	1	64	52	143	3.18	
FTWEC29705229	994	1243	1	70	52	156	3.48	
FTWEC29765229	1060	1324	1	76	52	170	3.77	
FTWEC29825229	1125	1407	1	82	52	183	4.07	
FTWEC29645829	935	1170	1	64	58	160	3.54	
FTWEC29705829	1025	1282	1	70	58	174	3.88	
FTWEC29765829	1093	1365	1	76	58	189	4.21	
FTWEC29825829	1159	1451	1	82	58	204	4.54	

NOTE: FTWEC

A	B	C	D
DEPTH	LENGTH	WIDTH	DEPTH

• LP = Thermally Fused Laminate, HP = High Pressure Laminate.

FTWEC • Right Extended 90 Degree Corner Worksurface

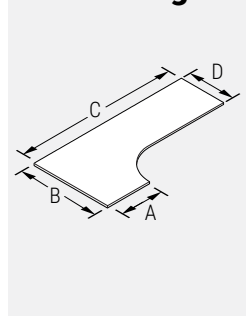

- Right Extended 90 Degree Corner Worksurface.
- Specify laminate finish and PVC edge finish.
- Specification:
- For tables that connect with 23" deep (A and D) worksurfaces, use FT539F(S/L)24CL standard range or FT639F(S/L)24CL extended range base.
- For table that connect with 29" deep (A and D) worksurfaces, use FT539F(S/L)30CL standard range or FT639F(S/L)30CL extended range base.

NOTE: FTWEC

A	B	C	D
DEPTH	WIDTH	LENGTH	DEPTH

PRODUCT CODE	FINISH		SIZE / INCHES			WEIGHT LBS	VOL FT ³
	LP	HP	H	W	D		
FTWEC23405823	741	927	1	58	40	115	2.55
FTWEC23406423	824	1030	1	64	40	127	2.81
FTWEC23407023	901	1128	1	70	40	138	3.07
FTWEC23407623	963	1200	1	76	40	150	3.34
FTWEC23408223	1020	1275	1	82	40	162	3.60
FTWEC23465823	763	955	1	58	46	115	2.55
FTWEC23466423	849	1060	1	64	46	127	2.81
FTWEC23467023	928	1162	1	70	46	138	3.07
FTWEC23467623	991	1236	1	76	46	150	3.34
FTWEC23468223	1051	1313	1	82	46	162	3.6
FTWEC23525823	787	985	1	58	52	130	2.88
FTWEC23526423	872	1093	1	64	52	143	3.18
FTWEC23527023	956	1197	1	70	52	156	3.48
FTWEC23527623	1020	1273	1	76	52	170	3.77
FTWEC23528223	1082	1353	1	82	52	183	4.07
FTWEC23586423	901	1125	1	64	58	160	3.54
FTWEC23587023	986	1232	1	70	58	174	3.88
FTWEC23587623	1051	1312	1	76	58	189	4.21
FTWEC23588223	1114	1394	1	82	58	204	4.54
FTWEC29405829	771	965	1	58	40	115	2.55
FTWEC29406429	858	1071	1	64	40	127	2.81
FTWEC29407029	936	1173	1	70	40	138	3.07
FTWEC29407629	1000	1247	1	76	40	150	3.34
FTWEC29408229	1060	1327	1	82	40	162	3.60
FTWEC29465829	794	993	1	58	46	115	2.55
FTWEC29466429	883	1102	1	64	46	127	2.81
FTWEC29467029	966	1208	1	70	46	138	3.07
FTWEC29467629	1031	1286	1	76	46	150	3.34
FTWEC29468229	1093	1366	1	82	46	162	3.6
FTWEC29525829	818	1024	1	58	52	130	2.88
FTWEC29526429	908	1136	1	64	52	143	3.18
FTWEC29527029	994	1243	1	70	52	156	3.48
FTWEC29527629	1060	1324	1	76	52	170	3.77
FTWEC29528229	1125	1407	1	82	52	183	4.07
FTWEC29586429	935	1170	1	64	58	160	3.54
FTWEC29587029	1025	1282	1	70	58	174	3.88
FTWEC29587629	1093	1365	1	76	58	189	4.21
FTWEC29588229	1159	1451	1	82	58	204	4.54

FTWRE • Rectangular Extension Return Worksurface

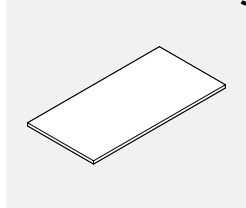

- **Worksurfaces to be used only with Extended 90 Degree Corner Worksurfaces.**
- Rectangular Extension Return Worksurface.
- Specify laminate finish and PVC edge finish.
- Includes 2 flat brackets for connection.
- Specification:
- FTWRE23 to be used with FTWEC23xxxx23.
- FTWRE29 to be used with FTWEC29xxxx29.

PRODUCT CODE	FINISH		SIZE / INCHES			WEIGHT LBS	VOL FT ³
	LP	HP	H	W	D		
FTWRE2324	136	180	1	24	23	16	0.96
FTWRE2330	149	191	1	30	23	20	1.20
FTWRE2336	165	215	1	36	23	25	1.44
FTWRE2924	163	209	1	24	29	21	1.21
FTWRE2930	173	227	1	30	29	26	1.51
FTWRE2936	202	265	1	36	29	31	1.81

FTWTC • 120 Degree Corner Worksurface

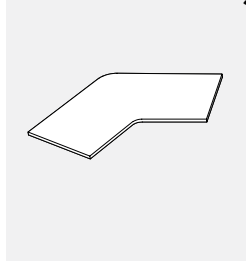

- 120 Degree Corner Worksurface.
- Specify laminate finish and PVC edge finish.
- Specification:
- For tables that connect with 23" deep (A and C) worksurfaces, use FT531F(S/L)24CL standard range or FT531F(S/L)24CL extended range base.
- For table that connect with 29" deep (A and C) worksurfaces, use FT531F(S/L)30CL standard range or FT631F(S/L)30CL extended range.

PRODUCT CODE	FINISH		SIZE / INCHES			WEIGHT LBS	VOL FT ³
	LP	HP	H	W	D		
FTWTC234623	773	1077	1	46	23	165	3.67
FTWTC235223	773	1077	1	52	23	211	4.69
FTWTC235823	1389	1961	1	58	23	263	5.84
FTWTC236423	1389	1961	1	64	23	320	7.11
FTWTC294629	773	1077	1	46	29	165	3.67
FTWTC295229	773	1077	1	52	29	211	4.69
FTWTC295829	1389	1961	1	58	29	263	5.84
FTWTC296429	1389	1961	1	64	29	320	7.10

• LP = Thermally Fused Laminate, HP = High Pressure Laminate.

FTWMR • Media Table Top

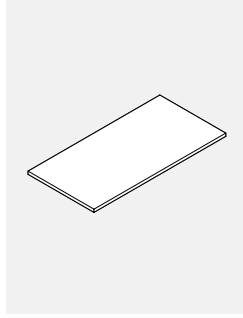

- Media Table Top.
- Specify laminate finish and PVC edge finish.
- Specification:
- For tables FTWMR5a460 and 6060, use FTM5B2BSF standard range or FTM6B2BSF extended range base.
- For all other tables, use FTM5B2BLF standard range or FTM6B2BLF extended range base.

PRODUCT CODE	FINISH LP	HP	SIZE / INCHES			WEIGHT LBS	VOL FT ³
			H	W	D		
FTWMR5460	557	769	1	60	54	96	5.63
FTWMR5466	607	842	1	66	54	106	6.19
FTWMR5472	658	915	1	72	54	115	6.75
FTWMR5478	706	987	1	78	54	125	7.31
FTWMR5484	758	1058	1	84	54	135	7.88
FTWMR5490	807	1131	1	90	54	144	8.44
FTWMR5496	859	1201	1	96	54	154	9.00
FTWMR6060	611	850	1	60	60	107	6.25
FTWMR6066	667	930	1	66	60	118	6.88
FTWMR6072	723	1009	1	72	60	128	7.50
FTWMR6078	778	1088	1	78	60	139	8.13
FTWMR6084	833	1166	1	84	60	150	8.75
FTWMR6090	890	1247	1	90	60	160	9.38
FTWMR6096	944	1327	1	96	60	171	10.00

FTMT5145 • TV Mount

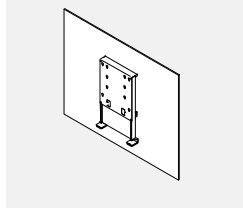

- TV Mount for FreeFit Media Tables.
- Includes the TV/Display bracket and mounting hardware.
- Maximum TV size is 50".
- Back panel is made of PET Felt.

PRODUCT CODE	FINISH LP	SIZE / INCHES			WEIGHT LBS	VOL FT ³
		H	W	D		
FTMT5145	616	40.5	51	4	16.82	4.8

FTB-L • Laminate Leg Shroud for C-Leg, Left

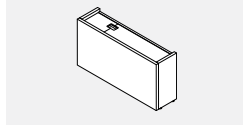

- Laminate shroud for a FreeFit C-Leg on the left side.
- Includes a felt liner at the top.
- Short side panel is removable to access interior.
- Please specify low pressure laminate, PVC edge and felt finishes.

PRODUCT CODE	FINISH LP	SIZE / INCHES			WEIGHT LBS	VOL FT ³
		H	W	D		
FTB23L	495	18	23	9	47	2
FTB29L	518	18	29	9	55	3
FTB35L	540	18	35	9	67	3

FTB-R • Laminate Leg Shroud for C-Leg, Right

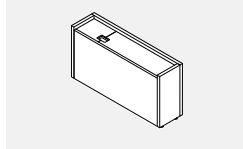

- Laminate housing to cover a FreeFit C-Leg on the right side.
- Includes a felt liner at the top.
- Short side panel is removable to access interior.
- Please specify low pressure laminate, PVC edge and felt finishes.

PRODUCT CODE	FINISH LP	SIZE / INCHES			WEIGHT LBS	VOL FT ³
		H	W	D		
FTB23R	495	18	23	9	47	2
FTB29R	518	18	29	9	55	3
FTB35R	540	18	35	9	67	3

FTB • Laminate Housing for T-Leg

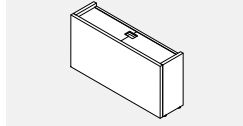

- Laminate housing to cover a FreeFit T-Leg.
- Includes a felt liner at the top.
- Short side panel is removable to access interior.
- Please specify low pressure laminate, PVC edge and felt finishes.

PRODUCT CODE	FINISH LP	SIZE / INCHES			WEIGHT LBS	VOL FT ³
		H	W	D		
FTB23	495	18	23	9	47	2
FTB29	518	18	29	9	55	3
FTB35	540	18	35	9	67	3

FTB • Laminate Leg Shroud for Media Bases

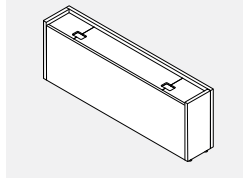

- Includes a felt liner at the top.
- Side panel is removable to access the interior.
- Please specify low pressure laminate, PVC edging and felt finish.

PRODUCT CODE	FINISH LP	SIZE / INCHES			WEIGHT LBS	VOL FT ³
		H	W	D		
FTB54	779	18	54	9	110	5
FTB60	903	18	60	9	134	6

• LP = Thermally Fused Laminate, HP = High Pressure Laminate.

FTCRBFO • Credenza, BF / Open

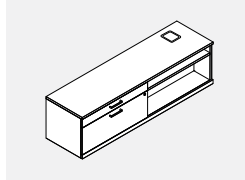

- Credenza storage with grommet to accommodate a FreeFit C leg base.
- Recommended for use with the standard range bases only.
- One lock included
- One adjustable Shelf
- Select any standard Licence2 handle
- Optional E-lock available in the vertical position. Please specify V - Vertical and add \$224.00 list.
- Grommet available only in BLK - Black

PRODUCT CODE	FINISH LP	B	W	SIZE / INCHES			WEIGHT		VOL FT ³
				H(LP/B)	H(W)	W	D	LBS	
FTCRBFO2060	1856	2032	2104	19.94	20.5	60	20	202	20
FTCRBFO2066	1912	2103	2182	19.94	20.5	66	20	220	22
FTCRBFO2072	2012	2219	2305	19.94	20.5	72	20	254	24
FTCRBFO2460	1929	2112	2188	19.94	20.5	60	24	202	20
FTCRBFO2466	1989	2188	2270	19.94	20.5	66	24	220	22
FTCRBFO2472	2092	2308	2397	19.94	20.5	72	24	254	24

FTCROBF • Credenza, Open / BF

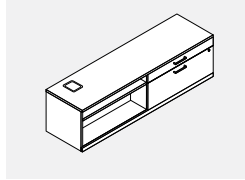

- Credenza storage with grommet to accommodate a FreeFit C leg base.
- Recommended for use with the standard range bases only.
- One lock included
- One adjustable Shelf
- Select any standard Licence2 handle
- Optional E-lock available in the vertical position. Please specify V - Vertical and add \$224.00 list.
- Grommet available only in BLK - Black

PRODUCT CODE	FINISH LP	B	W	SIZE / INCHES			WEIGHT		VOL FT ³
				H(LP/B)	H(W)	W	D	LBS	
FTCROBF2060	1856	2032	2104	19.94	20.5	60	20	202	20
FTCROBF2066	1912	2103	2182	19.94	20.5	66	20	220	22
FTCROBF2072	2012	2219	2305	19.94	20.5	72	20	254	24
FTCROBF2460	1929	2112	2188	19.94	20.5	60	24	202	20
FTCROBF2466	1989	2188	2270	19.94	20.5	66	24	220	22
FTCROBF2472	2092	2308	2397	19.94	20.5	72	24	254	24

FTCRBFO-T • Credenza, BF / Open

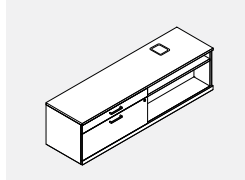

- Credenza storage with grommet to accommodate a FreeFit T-leg base.
- Recommended for use with the standard range bases only.
- One lock included
- One adjustable Shelf
- Select any standard Licence2 handle
- Optional E-lock available in the vertical position. Please specify V - Vertical and add \$224.00 list.
- Grommet available only in BLK - Black

PRODUCT CODE	FINISH LP	B	W	SIZE / INCHES			WEIGHT		VOL FT ³
				H(LP/B)	H(W)	W	D	LBS	
FTCRBFO2060T	1856	2032	2104	19.94	20.5	60	20	202	20
FTCRBFO2066T	1912	2103	2182	19.94	20.5	66	20	220	22
FTCRBFO2072T	2012	2219	2305	19.94	20.5	72	20	254	24
FTCRBFO2460T	1929	2112	2188	19.94	20.5	60	24	202	20
FTCRBFO2466T	1989	2188	2270	19.94	20.5	66	24	220	22
FTCRBFO2472T	2092	2308	2397	19.94	20.5	72	24	254	24

FTCROBF-T • Credenza, Open / BF

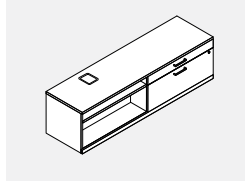

- Credenza storage with grommet to accommodate a FreeFit T-leg base.
- Recommended for use with the standard range bases only.
- One lock included
- One adjustable Shelf
- Select any standard Licence2 handle
- Optional E-lock available in the vertical position. Please specify V - Vertical and add \$224.00 list.
- Grommet available only in BLK - Black

PRODUCT CODE	FINISH LP	B	W	SIZE / INCHES			WEIGHT		VOL FT ³
				H(LP/B)	H(W)	W	D	LBS	
FTCROBF2060T	1856	2032	2104	19.94	20.5	60	20	202	20
FTCROBF2066T	1912	2103	2182	19.94	20.5	66	20	220	22
FTCROBF2072T	2012	2219	2305	19.94	20.5	72	20	254	24
FTCROBF2460T	1929	2112	2188	19.94	20.5	60	24	202	20
FTCROBF2466T	1989	2188	2270	19.94	20.5	66	24	220	22
FTCROBF2472T	2092	2308	2397	19.94	20.5	72	24	254	24

• LP = Thermally Fused Laminate, HP = High Pressure Laminate.

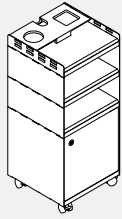
FTSSP12BBFM • Cube Mobile Pedestal, Two Open Boxes, One File Box and Accessory Tray

- Mobile pedestal with two open boxes in the middle, one file box at the bottom and a top accessory tray.
- File box interior dimensions: 11 7/8" h x 11 13/16" w x 10 7/16" d.
- Includes four locking casters, PET felt accessory tray, chrome wire divider and optional lock
- File door lock, if specified is located on the top right corner for the right pedestal and top left corner for the left pedestal.
- Bottom, middle and top shelves, front door and back are made of 3/4" low pressure laminate.
- Sides are made of powder coated metal.
- Ships knocked-down.

PRODUCT CODE	PRICE	SIZE/ INCHES			WEIGHT VOL	
		H	W	D	LBS	FT ³
Without Lock						
FTSSP12BBFMR	568	28	12	12	35	2.33
FTSSP12BBFML	568	28	12	12	35	2.33
With Lock						
FTSSP12BBFMKR	582	28	12	12	35	2.33
FTSSP12BBFMKL	582	28	12	12	35	2.33

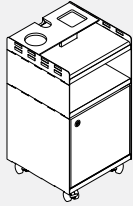
FTSSP12BFMR • Cube Mobile Pedestal, One Open Box, One File Box and Accessory Tray

- Mobile pedestal with one open box in the middle, one file box at the bottom and a top accessory tray.
- File box interior dimensions: 11 7/8" h x 11 13/16" w x 10 7/16" d.
- Includes four locking casters, PET felt accessory tray, chrome wire divider and optional lock
- File door lock, if specified is located on the top right corner for the right pedestal and top left corner for the left pedestal.
- Bottom, middle and top shelves, front door and back are made of 3/4" low pressure laminate.
- Sides are made of powder coated metal.
- Ships knocked-down.

PRODUCT CODE	PRICE	SIZE/ INCHES			WEIGHT VOL	
		H	W	D	LBS	FT ³
Without Lock						
FTSSP12BFMR	447	22	12	12	28	1.83
FTSSP12BFML	447	22	12	12	28	1.83
With Lock						
FTSSP12BFMKR	461	22	12	12	28	1.83
FTSSP12BFMKL	461	22	12	12	28	1.83

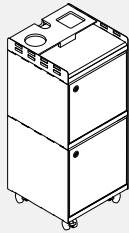
FTSSP12SFM • Cube Mobile Pedestal, One Closed Storage Box, One File Box and Accessory Tray

- Mobile pedestal with one closed storage box at the top, one file box at the bottom and a top accessory tray.
- File box interior dimensions: 11 7/8" h x 11 13/16" w x 10 7/16" d.
- Closed storage box interior dimensions: 10 1/2" h x 11 13/16" w x 10 7/16" d.
- Includes four locking casters, PET felt accessory tray, chrome wire divider and optional lock
- Door locks, if specified are located on the top right corner for the right pedestal and top left corner for the left pedestal of each box.
- Bottom, middle and top shelves, front door and back are made of 3/4" low pressure laminate.
- Sides are made of powder coated metal.
- Ships knocked-down.

PRODUCT CODE	PRICE	SIZE/ INCHES			WEIGHT VOL	
		H	W	D	LBS	FT ³
Without Lock						
FTSSP12SFMR	568	28	12	12	35	2.33
FTSSP12SFML	568	28	12	12	35	2.33
With Lock						
FTSSP12SFMKR	582	28	12	12	35	2.33
FTSSP12SFMKL	582	28	12	12	35	2.33

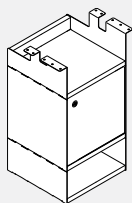
FTSSPH12BFB • Cube Hanging Pedestal, One File Box and Two Open Boxes

- Hanging pedestal with one file box in the middle and two open boxes, one at the top and one at the bottom.
- Attaches to the underside of a worksurface with supplied screws.
- File box interior dimensions: 11 7/8" h x 11 13/16" w x 10 7/16" d.
- Includes chrome wire divider and optional lock.
- Metal wire divider is chrome and sits 3 7/16" from either side and is interchangeable.
- File door lock, if specified is located on the top right corner for the right pedestal and top left corner for the left pedestal.
- Bottom, middle and top shelves, front door and back are made of 3/4" low pressure laminate.
- Sides are made of powder coated metal.
- Ships knocked-down.

PRODUCT CODE	PRICE	SIZE/ H	INCHES			WEIGHT LBS	VOL FT ³
			W	D			
Without Lock							
FTSSPH12BFBR	431	24	12	12	26	2.33	
FTSSPH12BFBL	431	24	12	12	26	2.33	
With Lock							
FTSSPH12BFBKR	444	24	12	12	26	2.33	
FTSSPH12BFBKL	444	24	12	12	26	2.33	

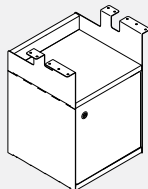
FTSSPH12BF • Cube Hanging Pedestal, One File Box

- Hanging pedestal with one file box at the bottom and one open box at the top.
- Attaches to the underside of a worksurface with supplied screws.
- File box interior dimensions: 11 7/8" h x 11 13/16" w x 10 7/16" d.
- Includes chrome wire divider and optional lock.
- Metal wire divider is chrome and sits 3 7/16" from either side and is interchangeable.
- File door lock, if specified is located on the top right corner for the right pedestal and top left corner for the left pedestal.
- Bottom, middle and top shelves, front door and back are made of 3/4" low pressure laminate.
- Sides are made of powder coated metal.
- Ships knocked-down.

PRODUCT CODE	PRICE	SIZE/ H	INCHES			WEIGHT LBS	VOL FT ³
			W	D			
Without Lock							
FTSSPH12BFR	324	18.5	12	12	20	1.83	
FTSSPH12BFL	324	18.5	12	12	20	1.83	
With Lock							
FTSSPH12BFKR	337	18.5	12	12	20	1.83	
FTSSPH12BFKL	337	18.5	12	12	20	1.83	

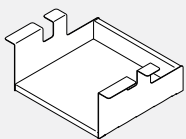
FTSSPH12B • Cube Hanging Pedestal Box

- Hanging pedestal open box.
- Attaches to the underside of a worksurface with supplied screws to create an open box.
- Bottom, middle and top shelves, front door and back are made of 3/4" low pressure laminate.
- Sides are made of powder coated metal.
- Ships knocked-down.

PRODUCT CODE	PRICE	SIZE/ H	INCHES			WEIGHT LBS	VOL FT ³
			W	D			
FTSSPH12B	132	6	12	12	6	0.96	

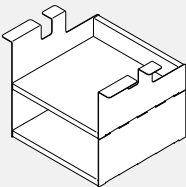
FTSSPH12BB • Cube Hanging Pedestal, Two Open Boxes

- Hanging pedestal with two open boxes.
- Attaches to the underside of a worksurface with supplied screws.
- Bottom, middle and top shelves, front door and back are made of 3/4" low pressure laminate.
- Sides are made of powder coated metal.
- Ships knocked-down.

PRODUCT CODE	PRICE	SIZE/ H	INCHES			WEIGHT LBS	VOL FT ³
			W	D			
FTSSPH12BB	244	11.5	12	12	12	1.42	

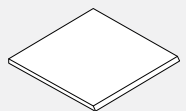
FTFELT03BC • Felt Shelf Liner for Cube Pedestals

- Felt shelf liner can be added to any closed back shelf.
- Front edge is cut at 45 degree.

PRODUCT CODE	PRICE	SIZE/ H	INCHES			WEIGHT LBS	VOL FT ³
			W	D			
FTFELT03BC	22	12	12	0.38	0.1	0.03	

BRT8D • Duplex Receptacles

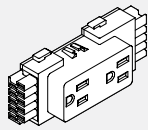

- Snaps into Power Distribution Housing.
- Up to 6 duplex receptacles per circuit.
- xxxD1 = Circuit #1 (utility circuit)
- xxxD2 = Circuit #2 (utility circuit)
- xxxD3 = Circuit #3 (utility circuit)
- xxxDA - Circuit #A (dedicated circuit)
- XW identifies white colour plastic, all others in standard black.

PRODUCT CODE	PRICE	SIZE/ INCHES			WEIGHT VOL	
		H	W	D	LBS	FT ³
BRT8D1	32	2	4.625	1.25	0.10	0.01
BRT8D2	32	2	4.625	1.25	0.10	0.01
BRT8D3	32	2	4.625	1.25	0.10	0.01
BRT8DA	32	2	4.625	1.25	0.10	0.01
BRT8DXW1	47	2	4.625	1.25	0.10	0.01
BRT8DXW2	47	2	4.625	1.25	0.10	0.01
BRT8DXW3	47	2	4.625	1.25	0.10	0.01
BRT8DXWA	47	2	4.625	1.25	0.10	0.01

GAADG • Access Door Module

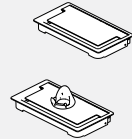

- Soft close door is set back from edge to allow for cable pass thru.
- Available in all standard panel frame finishes.
- GAADGDH includes device holder for most mobile phones or tablets. Holder is only available in white.
- FreeFit can only accommodate one grommet per worksurface.

PRODUCT CODE	PRICE	SIZE/INCHES			WEIGHT LBS	VOL FT ³
		H	D	W		
GAADG	58	1.08	5.54	10.09	2	0.04
GAADGDH	63	1.08	5.54	10.09	2	0.04

GAADCT • Access Door Module with Cable Tray

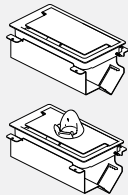

- Soft close door is set back from edge to allow for cable pass thru when closed.
- Cable tray comes one standard telcom knock out and a platform to mount a powerbar.
- Sides are open for easy access.
- Available in all standard panel frame finishes.
- GAADCTDH includes device holder for most mobile phones or tablets. Holder is only available in white.
- FreeFit can only accommodate one grommet per worksurface.

PRODUCT CODE	PRICE	SIZE/INCHES			WEIGHT LBS	VOL FT ³
		H	D	W		
GAADCT	92	5.07	5.54	10.09	4	0.19
GAADCTDH	100	5.07	5.54	10.09	4	0.19

GAADCTPD • Access Door Module with Cable Tray and Power Bar

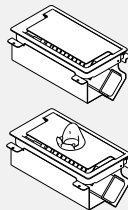

- Powerbar with 3 simplex and 2 USB, CSA Certified.
- Soft close door is set back from edge to allow for cable pass thru when closed.
- Cable tray comes one standard telcom knock out and a platform to mount a powerbar.
- Sides are open for easy access.
- Available in all standard panel frame finishes.
- GAADCTPDDH includes device holder for most mobile phones or tablets. Holder is only available in white.
- FreeFit can only accommodate one grommet per worksurface.

PRODUCT CODE	PRICE	SIZE/INCHES			WEIGHT LBS	VOL FT ³
		H	D	W		
GAADCTPD	202	6.96	5.54	10.09	4	0.20
GAADCTPDDH	206	6.96	5.54	10.09	4	0.20

BWAEGC00158GC • Power Bar with USB

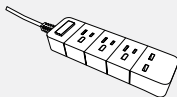

- Power Bar with 3 receptacles + 2 USB and power switch.
- Standard with 6' cord.
- Rating 15A, 125V, AC 60Hz, 1875W.
- USB output 5V, 2.6A (max.)
- White case, white cord.

PRODUCT CODE	PRICE	SIZE/ INCHES			WEIGHT VOL	
		H	W	D	LBS	FT ³
BWAEGC00158GC	99	1.3	2.3	1	1	0.02

BG5 • Rectangular Grommet

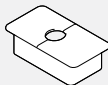

- Option (BLK) Black Plastic (GRY) Grey Plastic (WHT) White Plastic

PRODUCT CODE	PRICE	SIZE/ INCHES			WEIGHT VOL	
		H	W	D	LBS	FT ³
BG5	35		3.5	2		

MSPDM • 1 Duplex, 1 Data



- Includes two simplex, one data and one phone connector.
- Black plastic

PRODUCT CODE	PRICE	SIZE/ INCHES			WEIGHT VOL	
		H	W	D	LBS	FT ³
MSPDM	276	2.75	6.5	3.5	2	0.1

BWAEFC • Ceiling Feed Post

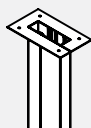

- Ceiling pole brings ceiling feed conduit and data cables from the ceiling down to Power troughs height. Accommodates 9'-3" ceiling heights.
- A two part construction allows power/data conduit lay-in.
- Includes mounting hardware and ceiling bezel.
- Painted finish.

PRODUCT CODE	PRICE	SIZE/INCHES			WEIGHT LBS	VOL FT ³
		H	D	W		
BWAEFC	303	99.32	2.5	4.74	13	0.48

BWAECFH • Ceiling Feed Harness



- Ceiling feed provides a single power entry from ceiling, through Ceiling pole into Power Trough, into Power Distribution Housing.
- An 8-wire (4-circuit) metal conduit harness with included metal junction box for hard wiring to the building power supply above ceiling tile.
- Must be hard wired to the building power supply by a licensed electrician.
- Ceiling Pole not included.

PRODUCT CODE	PRICE	SIZE/INCHES			WEIGHT LBS	VOL FT ³
		H	D	W		
BWAECFH120	373	120	6	6.00	5.00	2
BWAECFH144	417	144	6	6.00	6.00	3

FTAEC • Table to Table Connector

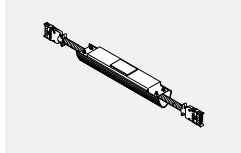

- Connects Freefit back2back legs and trough provide power data/communication pass thru
- Connector kit consist of formed steel housing, mounting brackets,
- Housing to housing harness and one charcoal grey extruded Data/Communication cable manager
- For table to table up to 72" w (with no storage in between tables), use FTAETTC12.
- For table to table 78" w (when no storage in between), use FTAETTC18.
- For table to table 84" w (when no storage in between), use FTAETTC24.
- For table to table up to 72" w with a Pantry Storage is in between, use FTAETTC24.

PRODUCT CODE	PRICE	SIZE/INCHES			WEIGHT LBS	VOL FT ³
		H	D	W		
FTAEC12	259	3	16	2.3	6.00	0.12
FTAEC18	278	3	22	2.3	8.00	0.15
FTAEC24	294	3	28	2.3	9.00	0.18
FTAEC30	310	3	34	2.3	10.60	0.22
FTAEC36	324	3	40	2.3	12.00	0.24
FTAEC42	348	3	46	2.3	11.60	0.28
FTAEC48	372	3	52	2.3	14.00	0.30

FTABRC • Table to Bridges Connector

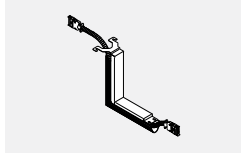

- Connects FreeFit back2back benching to Bridges 29H table with below surface power trough.
- Please specify paint colour on bracket. Wire manager is always charcoal.

PRODUCT CODE	PRICE	SIZE/INCHES			WEIGHT LBS	VOL FT ³
		H	D	W		
FTABRC	219	13	13	2.3	2.4	0.28

FTACCL • Leg Wire Manager

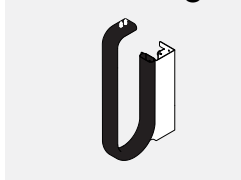

- Provides wire management from under FreeFit worksurface, down the leg and to the floor.
- Can only be used for FreeFit Regular and Media tables. Not for use on FreeFit Back to Back tables.
- Kit includes wire manager housing, magnets, screws and cable chain.
- Magnetically fastens to the Freefit leg and cable chain is screwed to work surface.
- Please specify housing paint finish.

PRODUCT CODE	PRICE	SIZE/INCHES			WEIGHT LBS	VOL FT ³
		H	D	W		
FTACCL	388	16	3.2	2	0.06	0.06

FTAEFF • Floor Feed

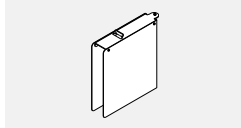

- Floor feed housing for FreeFit benching applications only
- Liquitite whip 72"
- Must be hard wired to power source by a licenced technican
- Please choose paint colour for housing.

PRODUCT CODE	PRICE	SIZE/INCHES			WEIGHT LBS	VOL FT ³
		H	D	W		
FTAEFF	574	10.8	8.75	2	7	0.23

FFTCB • Under Worksurface Cable Basket

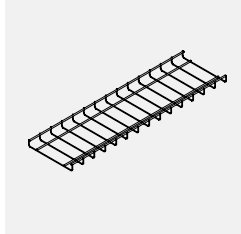

- Shallow 8" wide basket manages cable excess.
- It can be easily unclipped from steel brackets (included) to rearrange cable connections from below work surface.
- As a general rule- specify cable basket 30" shorter that the Freefit work surface.
- Steel wire construction, black painted finish, black steel hanging brackets and fasteners.

PRODUCT CODE	PRICE	SIZE/ H	INCHES		WEIGHT LBS	VOL FT ³
			W	D		
FFTCB36	78	1	8	8	0.36	0.03
FFTCB48	86	1	16	8	0.73	0.07
FFTCB54	90	1	22	8	1.01	0.10
FFTCB60	97	1	28	8	1.20	0.13
FFTCB66	111	1	34	8	1.56	0.15
FFTCB72	114	1	40	8	1.80	0.18
FFTCB78	123	1	46	8	2.16	0.21
FFTCB84	129	1	52	8	2.39	0.24

BRACS • Cable Snake



- **Flexible cable management trough.**
- Two pathways within the snake, one for data/communication and one for routing power cables.
- Clear (CLR) available only.

PRODUCT CODE	PRICE	SIZE/ H	INCHES		WEIGHT LBS	VOL FT ³
			W	D		
BRACS	123	30	8	2	3	0.19
BRACSH	207	49	8	2	5	0.27

FTBATT • Battery and Charger

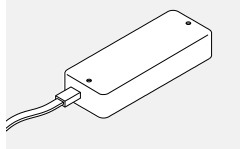

- Battery Pak with charging cable mounts to the underside of the worksurface
- Features LED bars indicating capacity level and audio alarm when it needs to be charged.
- On a full charge the table can cycle from 35 to 45 stroke lengths based upon the range of column selected and load on the table.

PRODUCT CODE	PRICE	SIZE/INCHES			WEIGHT		VOL FT ³
		H	D	W	LBS		
FTBATT	859	1.5	8	3	1.54	0.02	

FTACDS • Anti Collision Desk Sensor USB Plug

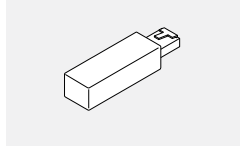

- Provides enhanced anti-collision detection.
- Plugs directly into leg column.
- Only one USB plug required for table assembly.
- This is a replacement part. The sensor ships stand with every table.

PRODUCT CODE	PRICE	SIZE/INCHES			WEIGHT		VOL FT ³
		H	D	W	LBS		
FTACDS	72	0.5	2.36	0.6	0.01	0.01	

FTDPG1C • Display + Bluetooth + Reminder Controller

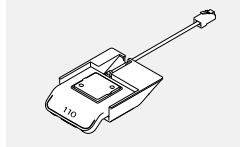

- Up/down drive with 4 memory positions.
- LED Light strip reminder, table height display.
- Bluetooth enabled connects to Desk Control App.

PRODUCT CODE	PRICE	SIZE/INCHES			WEIGHT		VOL FT ³
		H	D	W	LBS		
FTDPG1C	166	1	3	4.3	0.4	0.01	

FTDPG1M • Memory + Bluetooth + Diode Reminder Controller

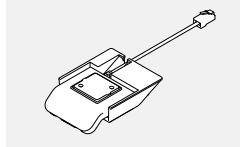

- Up/down drive with 2 memory positions.
- Bluetooth enabled connects to Desk Control App.
- This is a replacement part. Every base comes standard with a controller.

PRODUCT CODE	PRICE	SIZE/INCHES			WEIGHT		VOL FT ³
		H	D	W	LBS		
FTDPG1M	66	1	3	4.3	0.4	0.01	

FTCD2DUSB • Desk2Device USB Charger

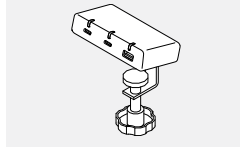

- Charge virtually any USB device directly from your FreeFit desk. Reduce cable clutter and get better power access.
- The charger is powered directly by the control box of a FreeFit table, no additional power outlet is required.
- Features one USB Type-A port (output 7.5w), two USB Type-C ports (output 50w if one port is used, 25w if both are used).
- Housing is white in color and the mounts are in black.
- Can be mounted on top of the table surface or underneath the surface (horizontal or slightly tilted).
- Includes two different mounts and a rubber (silicone) pad to secure placement on a smooth desk surface.
- Low standby power consumption of only 0.1w.
- LED diodes indicate either charging or that an active device is connected.
- PVC-Free (TM).

PRODUCT CODE	PRICE	SIZE/INCHES			WEIGHT		VOL FT ³
		H	D	W	LBS		
FTCD2DUSB	422	0.85	3.77	1.96	0.187	0.004	

FreeFit • Single Table; 21' high dividers

- FreeFit table mounted dividers for single table or single table row; recessed 6.5" at both ends (for example - 72" (70" actual) FreeFit table mounted divider measures 57").
- The centre of all dividers is always mounted 2.250" from work surface's rear edge. Please note the gap between the divider and the work surface therefore varies, depending on the divider thickness (1.250" framed dividers. 0.750" frame-less LP and 0.250" frame-less glass).
- 48" (33" actual) - 66" (51" actual) dividers have 2 mounting brackets.
- 72" (57" actual) dividers have 3 mounting brackets.

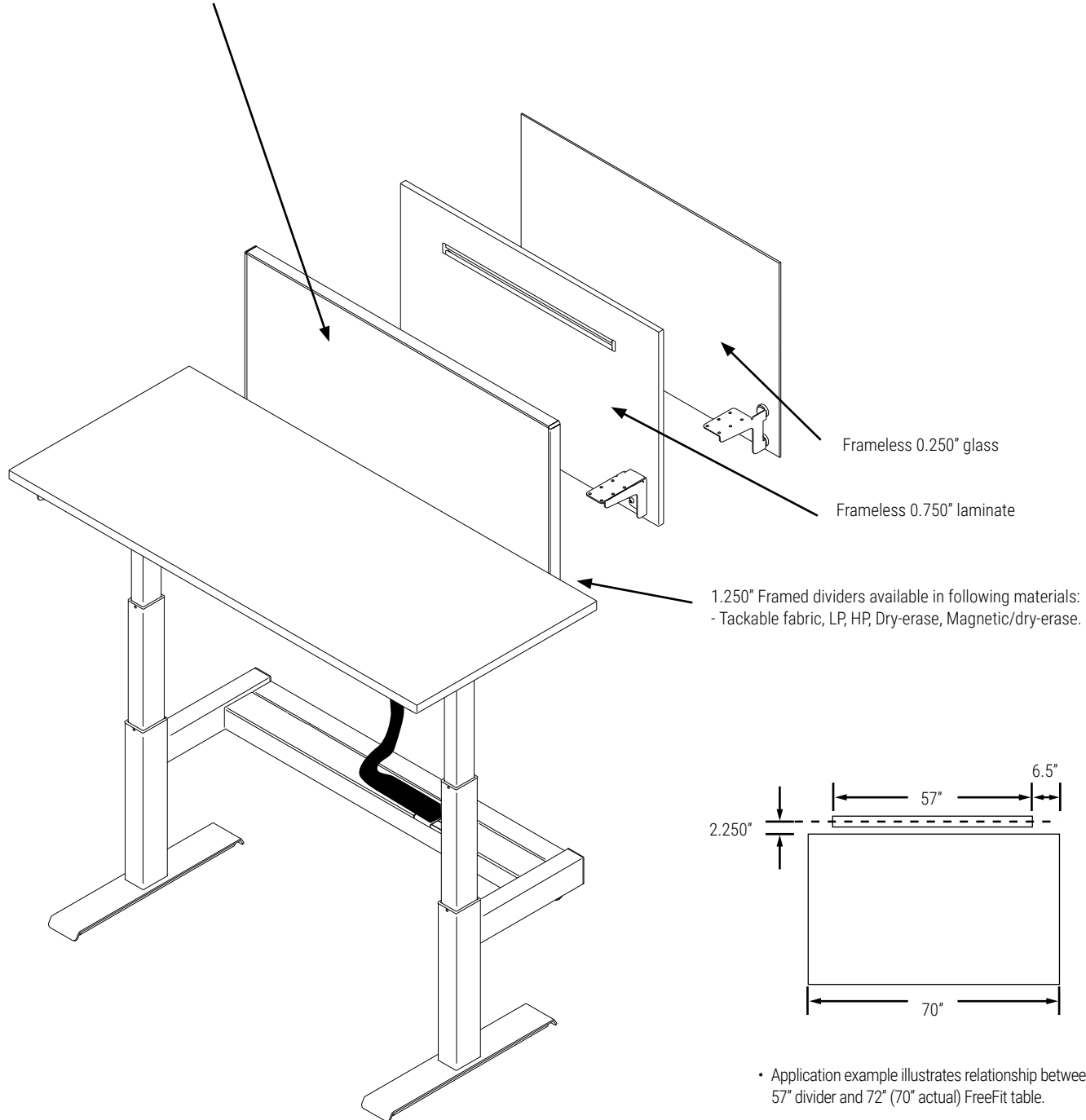

- Application example illustrates relationship between 57" divider and 72" (70" actual) FreeFit table.
- Example Order:
 BWATMFD72
 (actual dimension of 57") for
 BWA2D3072A8
 (actual dimension of 70").

FreeFit • Back 2 Back Table; 37" high dividers

FreeFit Back 2 Back stationary dividers; stationary, shared, secured to table structure; recessed 6.5" at both ends (for example - 72" (70" actual) FreeFit table mounted divider measures 57").

The centre of all dividers is always mounted 2.250" from work surface's rear edge. Please note the gap between the divider and the worksurface therefore varies, depending on the divider thickness (1.250" Framed dividers, 0.750" frame-less LP and 0.250" frame-less glass).

- 48" (33" actual) divider for 48" (46" actual) table
- 54" (39" actual) divider for 54" (52" actual) table
- 60" (45" actual) divider for 60" (58" actual) table
- 66" (51" actual) divider for 66" (64" actual) table
- 72" (57" actual) divider for 72" (70" actual) table

- Framed dividers (Tackable fabric, LP, HP, Dryerase, Magnetic/dry-erase.
- Frameless LP
- Frameless glass

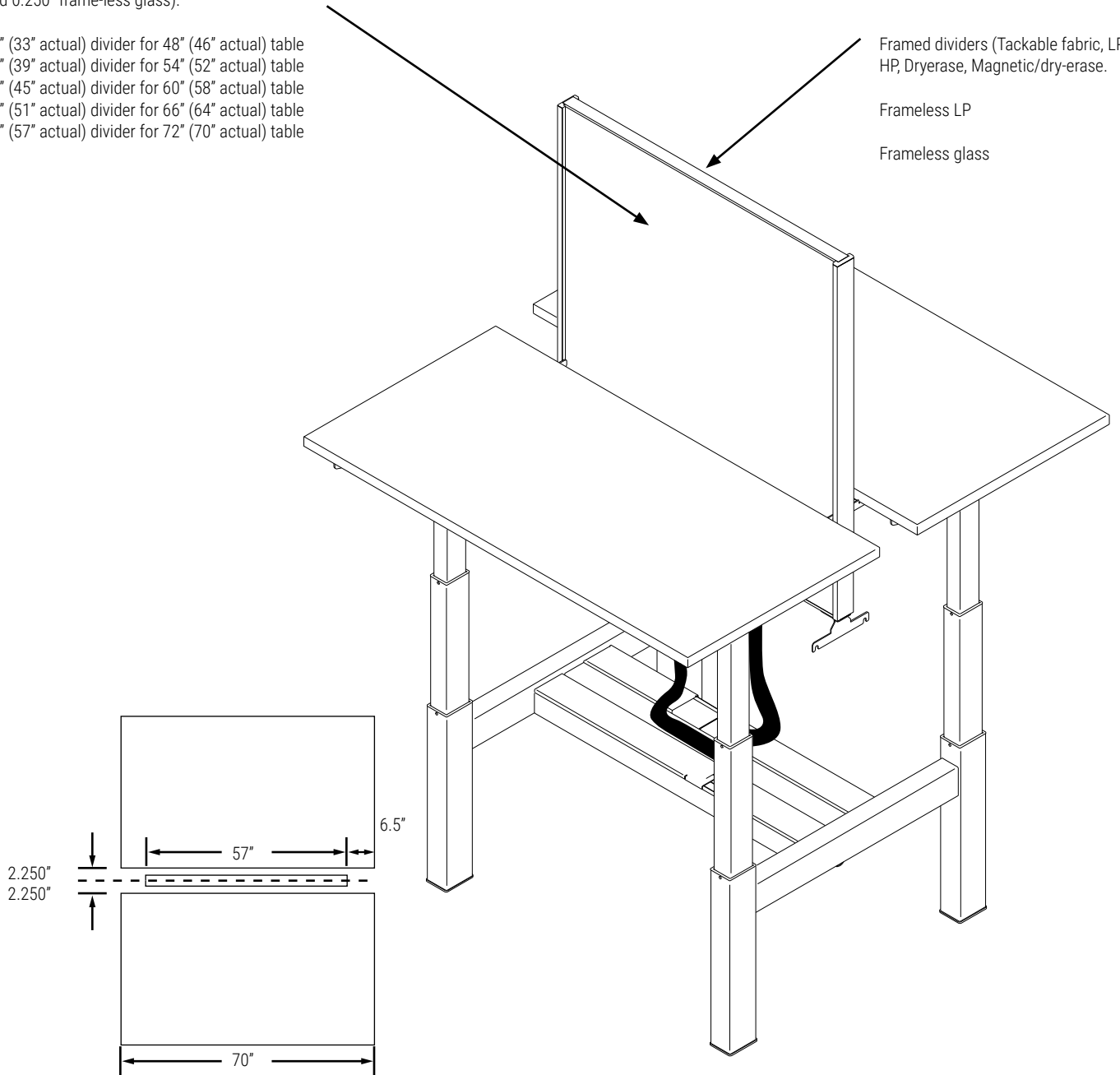

Application example illustrates relationship between 57" shared divider and 72" (70" actual) FreeFit Back 2 Back table.

- Example Order:
 BWASFD72
 (actual dimension of 57") for
 BWA2D6072A8
 (actual dimension of 70").

BWATMFD/BWATMLD • Table Mounted Framed Dividers

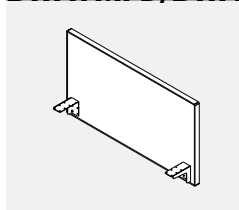

- **Connects parallel on Freefit single and back 2 back tables.**
- Divider frame and connecting hardware is painted, please choose from standard metal paint finishes.
- Fabric divider is tackable.
- Divider infill can be specified in fabric, low pressure laminate (LP), high pressure laminate (HP), dry erase whiteboard (DE) or dry erase magnetic whiteboard (DM) user side only.
- Fastens to the underside of the worksurface
- 1.625" gap between worksurface and divider allows for cable pass thru
- Installed divider measures 15.7" from top of worksurface and 5.75" below the worksurface.
- 48" to 66" dividers include 2 support brackets. 72" divider includes 3 support brackets.

TACKABLE FABRIC

PRODUCT CODE	PRICE		SIZE/ INCHES			WEIGHT LBS	VOL FT ³
	GR1	GR2	H	W	D		
BWATMFD48	323	359	21.5	33	1.25	16	1.23
BWATMFD54	347	381	21.5	39	1.25	18	1.46
BWATMFD60	377	419	21.5	45	1.25	20	1.68
BWATMFD66	421	469	21.5	51	1.25	22	1.90
BWATMFD72	464	512	21.5	57	1.25	26	2.13

LAMINATE

PRODUCT CODE	PRICE					SIZE/ INCHES			WEIGHT LBS	VOL FT ³
	LP	HP	DE	DM	H	W	D			
BWATMLD48	202	320	480	626	21.5	33	1.25	35	1.23	
BWATMLD54	230	381	574	763	21.5	39	1.25	39	1.46	
BWATMLD60	271	431	636	840	21.5	45	1.25	44	1.68	
BWATMLD66	311	535	1075	1442	21.5	51	1.25	48	1.90	
BWATMLD72	340	563	1097	1463	21.5	57	1.25	52	2.13	

- When dry erase magnetic whiteboard (DM) is specified it is applied user side ONLY and dry erase whiteboard (DE) is applied on the opposite side

BWASFD/BWASLD • Stationary Framed Dividers

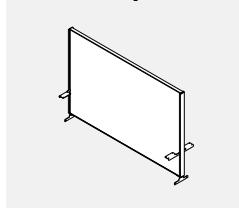

- **Provides a stationary framed divider between back 2 back height adjustable tables**
- Divider frame and connecting hardware is painted, please choose from standard metal paint finishes.
- Fabric divider is tackable.
- Divider infill can be specified in fabric, low pressure laminate (LP), high pressure laminate (HP), dry erase whiteboard (DE) or dry erase magnetic whiteboard (DM).
- Divider is anchored to the base and captured between two aluminum upright tracks. The uprights have sliding brackets that connect the worksurfaces to the divider providing continuous support as it travels up and down.
- 1.625" gap between worksurface and divider allows for cable pass thru
- Installed divider measures 54" from floor.

TACKABLE FABRIC

PRODUCT CODE	PRICE		SIZE/ INCHES			WEIGHT LBS	VOL FT ³
	GR1	GR2	H	W	D		
BWASFD48	641	675	37.2	33	2	25	2.13
BWASFD54	658	691	37.2	39	2	28	2.52
BWASFD60	672	713	37.2	45	2	31	2.91
BWASFD66	711	758	37.2	51	2	34	3.29
BWASFD72	921	968	37.2	57	2	37	3.68

LAMINATE

PRODUCT CODE	PRICE					SIZE/ INCHES			WEIGHT LBS	VOL FT ³
	LP	HP	DE	DM	H	W	D			
BWASLD48	556	860	1250	2375	37.2	33	2	58	2.13	
BWASLD54	598	928	1329	2512	37.2	39	2	66	2.52	
BWASLD60	613	943	1343	2527	37.2	45	2	73	2.91	
BWASLD66	646	1013	2239	4488	37.2	51	2	81	3.29	
BWASLD72	840	1388	2375	4740	37.2	57	2	88	3.68	

BWATMLLD • Table Mounted Laminate Dividers

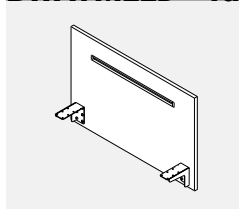

- **Connects parallel on Freefit single and back 2 back tables.**
- Laminate divider with integrated accessory rail, installed one side only.
- Integrated anodized aluminum accessory rail, white cut out and rail trims; white powder coat brackets.
- 3/4" LP PVC edged boards, please specify laminate & 3mm PVC edge.
- Fastens to the underside of the worksurface.
- 1.88 gap between worksurface and divider allows for cable pass thru.
- Installed divider measures 15.7" from top of worksurface and 5.75" below the worksurface.
- 48" to 66" dividers include 2 support brackets. 72" divider includes 3 support brackets.

LAMINATE

PRODUCT CODE	PRICE	SIZE/ INCHES			WEIGHT LBS	VOL FT ³
		H	W	D		
BWATMLLD48	242	21.5	33	0.75	16	1.23
BWATMLLD54	257	21.5	39	0.75	19	1.46
BWATMLLD60	272	21.5	45	0.75	21	1.68
BWATMLLD66	404	21.5	51	0.75	24	1.90
BWATMLLD72	418	21.5	57	0.75	27	2.13

BWASLLD • Stationary Laminate Dividers

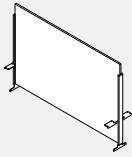

- Provides a stationary laminate divider between back 2 back height adjustable tables
- Divider uprights and connecting hardware is painted, please choose from standard metal paint finishes.
- Please specify laminate (LP) finish.
- Divider is anchored to the base and captured between two aluminum upright tracks. The uprights have sliding brackets that connect the worksurfaces to the divider providing continuous support as it travels up and down.
- 1.88" gap between worksurface and divider allows for cable pass thru.
- Installed divider measures 54" from floor.

LAMINATE PRODUCT CODE	PRICE	SIZE/ INCHES			WEIGHT LBS	VOL FT ³
		H	W	D		
BWASLLD48	493	37.2	33	2	28	2.13
BWASLLD54	507	37.2	39	2	33	2.52
BWASLLD60	523	37.2	45	2	37	2.91
BWASLLD66	792	37.2	51	2	41	3.29
BWASLLD72	805	37.2	57	2	46	3.68

BWATMGD • Table Mounted Glass Dividers

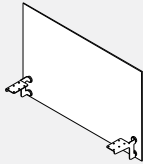

- Frameless glass divider connects parallel on single and back 2 back tables.
- Tempered glass, acid etched on one side (similar to frosted), satin chrome disc fasteners and powder coated steel support brackets.
- Fastens to the underside of the worksurface.
- 2.13 gap between worksurface and divider allows for cable pass thru.
- Installed divider measures 15.7" from top of worksurface and 4.75" below the worksurface.
- 54" to 66" dividers include 2 support brackets. 72" divider includes 3 support brackets.
- 1/2" radius on all four corners.

GLASS PRODUCT CODE	PRICE	SIZE/ INCHES			WEIGHT LBS	VOL FT ³
		H	W	D		
BWATMGD48	521	21.5	33	0.25	16	1.23
BWATMGD54	561	21.5	39	0.25	19	1.46
BWATMGD60	601	21.5	45	0.25	22	1.68
BWATMGD66	637	21.5	51	0.25	24	1.90
BWATMGD72	677	21.5	57	0.25	28	2.13

BWASGD • Stationary Glass Dividers

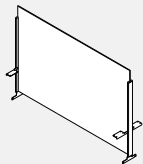

- Provides a stationary glass divider between back 2 back height adjustable tables.
- Tempered glass, acid etched on one side (similar to frosted), satin chrome disc fasteners and white powdercoated steel support brackets.
- Divider is anchored to the base and captured between two aluminum upright tracks. The uprights have sliding brackets that connect the worksurfaces to the divider providing continuous support as it travels up and down.
- 2.13 gap between worksurface and divider allows for cable pass thru.
- 1/2" radius on top two corners.

GLASS PRODUCT CODE	PRICE	SIZE/ INCHES			WEIGHT LBS	VOL FT ³
		H	W	D		
BWASGD48	462	37.2	33	2	30	2.13
BWASGD54	526	37.2	39	2	34	2.52
BWASGD60	596	37.2	45	2	39	2.91
BWASGD66	660	37.2	51	2	43	3.29
BWASGD72	725	37.2	57	2	48	3.68

BWAFWR • Felt Wrap Around Divider for FreeFit Table

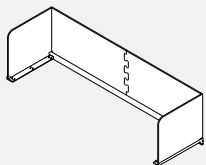

Single

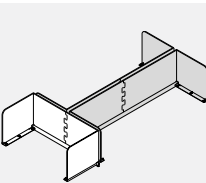

End of Run

- Wraps around FreeFit table to provide privacy.
- 9mm Felt material is tackable and comes in 18 different colours. Please specify colour.
- Installed divider measures 15.7" high from top of the work-surface.
- Please choose standard metal finish for extrusion and brackets.
- Upcharge of \$83 for anodized extrusion option.
- Divider extends by 1.5" at the back.
- For sizes 2346, 2351 and 2352, the felt will be manufactured in one pieces, while all others will be manufactured in two pieces as shown.
- Note: Cannot use ceiling feed option with this divider.

PRODUCT CODE	PRICE	SIZE/ INCHES			WEIGHT LBS	VOL FT ³
		H	W	D		
BWAFWR2346	381	18.24	46.84	18.46	26.58	1.07
BWAFWR2352	404	18.24	52.84	18.46	28.40	1.21
BWAFWR2358	425	18.24	58.84	18.46	30.22	1.34
BWAFWR2364	563	18.24	64.84	18.46	32.02	0.74
BWAFWR2370	600	18.24	70.84	18.46	33.84	0.81
BWAFWR2946	431	18.24	46.84	24.46	30.74	1.07
BWAFWR2952	570	18.24	52.84	24.46	32.55	0.60
BWAFWR2958	607	18.24	58.84	24.46	34.37	0.67
BWAFWR2964	642	18.24	64.84	24.46	36.19	0.74
BWAFWR2970	683	18.24	70.84	24.46	38.00	0.81
End of Run						
BWAFWR2351	386	18.24	51.34	27.94	27.94	1.05
BWAFWR2951	569	18.24	51.34	32.09	32.09	0.62
BWAFWR2363	562	18.24	63.34	31.57	31.57	1.50
BWAFWR2963	641	18.24	63.34	35.73	35.73	0.87

BWAFPN • Parallel Felt Divider

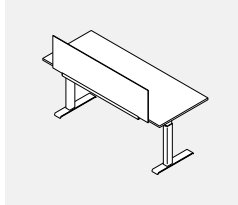

- Felt divider connects parallel on a single or Back to Back FreeFit table.
- 9 mm felt material is tackable and comes in a wide range of colours.
- Installed, the divider measures 15.7" high from the top of the worksurface.
- Kit includes felt divider, support extrusion and left and right brackets.
- Please choose the finish of the felt and the metal finish for the extrusion and brackets.

PRODUCT CODE	PRICE	SIZE/INCHES			WEIGHT LBS	VOL FT ³
		H	W	D		
BWAFPN36	132	18.24	21	5.86	2.21	1.30
BWAFPN42	148	18.24	27	5.86	2.77	1.67
BWAFPN48	202	18.24	33	5.86	2.82	2.04
BWAFPN54	227	18.24	39	5.86	3.29	2.41
BWAFPN60	256	18.24	45	5.86	3.75	2.78
BWAFPN66	361	18.24	51	5.86	4.22	3.15
BWAFPN72	385	18.24	57	5.86	4.69	3.53

BWAFMPSN • Modesty Felt Divider

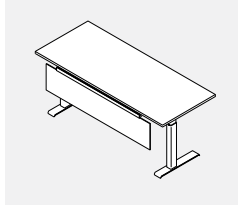

- Felt modesty panel secures to the rear bottom of a regular FreeFit table and provides privacy below the worksurface.
- 9 mm felt material is tackable and comes in a wide range of colours.
- Installed, the divider measures 15" high below the top of the worksurface.
- Kit includes felt modesty, support extrusion and left and right brackets.
- Please choose the finish of the felt and the metal finish for the extrusion and brackets.

PRODUCT CODE	PRICE	SIZE/INCHES			WEIGHT LBS	VOL FT ³
		H	W	D		
BWAFMPSN36	124	13.94	21	4.17	1.84	0.71
BWAFMPSN42	135	13.94	27	4.17	2.32	0.91
BWAFMPSN48	189	13.94	33	4.17	2.44	1.11
BWAFMPSN54	211	13.94	39	4.17	2.86	1.31
BWAFMPSN60	239	13.94	45	4.17	3.27	1.51
BWAFMPSN66	337	13.94	51	4.17	3.68	1.72
BWAFMPSN72	359	13.94	57	4.17	4.09	1.92

BWAFPDN • Parallel Above & Below Felt Divider

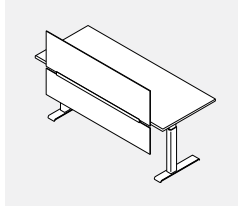

- Felt divider and modesty panel kit secures to the rear bottom of a regular FreeFit table and provides privacy above and below the worksurface.
- 9 mm felt material is tackable and comes in a wide range of colours.
- Installed, the divider measures 15.7 high from the top of the work-surface and 15" high below the top of the worksurface.
- Kit includes two felt dividers, support extrusion and left and right brackets.
- Please choose the finish of the felt and the metal finish for the extrusion and brackets.

PRODUCT CODE	PRICE	SIZE/INCHES			WEIGHT LBS	VOL FT ³
		H	W	D		
BWAFPDN36	195	30.68	21	5.86	2.79	2.18
BWAFPDN42	213	30.68	27	5.86	3.56	2.81
BWAFPDN48	303	30.68	33	5.86	3.82	3.43
BWAFPDN54	336	30.68	39	5.86	4.5	4.06
BWAFPDN60	393	30.68	45	5.86	5.17	4.68
BWAFPDN66	600	30.68	51	5.86	5.85	5.31
BWAFPDN72	637	30.68	57	5.86	6.53	5.93

BWAFFC • Corner Wrap Felt Divider

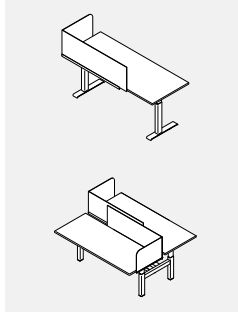

- Felt Corner Wrap secures to the side and rear bottom of a FreeFit table, wraps around one side and provides limited privacy.
- 9 mm felt material is tackable and comes in a wide range of colours.
- Installed, the divider measures 15.7 high from the top of the worksurface..
- Kit includes felt dividers, support extrusion and large and small handed brackets.
- Please choose the finish of the felt and the metal finish for the extrusion and brackets.

PRODUCT CODE	PRICE	SIZE/INCHES			WEIGHT LBS	VOL FT ³
		H	W	D		
BWAFFC2432L	275	18.24	32.46	18.52	4.99	6.35
BWAFFC2432R	275	18.24	32.46	18.52	4.99	6.35
BWAFFC2438L	314	18.24	38.46	18.52	5.46	7.52
BWAFFC2438R	314	18.24	38.46	18.52	5.46	7.52
BWAFFC2448L	337	18.24	47.46	18.52	6.16	9.28
BWAFFC2448R	337	18.24	47.46	18.52	6.16	9.28
BWAFFC3032L	310	18.24	32.46	24.52	5.72	8.40
BWAFFC3032R	310	18.24	32.46	24.52	5.72	8.40
BWAFFC3038L	333	18.24	38.46	24.52	6.19	9.95
BWAFFC3038R	333	18.24	38.46	24.52	6.19	9.95
BWAFFC3048L	358	18.24	47.46	24.52	6.89	12.28
BWAFFC3048R	358	18.24	47.46	24.52	6.89	12.28

FFTDH-H24 • Height Adjustable Table Polycarbonate Divider Screen Kit, 24" high

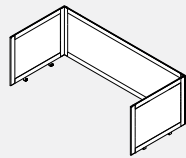

- Provides privacy in an open plan environment.
- Lightweight and easy to clean table mounted partitions.
- Consists of a powder coated aluminum frame, translucent fluted polycarbonate and all hardware to connect. Brackets are painted steel.
- Side dividers extend 6.237" from the front edge of each surface.
- Back divider extends over the back edge of the worksurface by 1 1/2" allowing for the passage of cables to the trough.
- FFTDP24xxH24 are for 23" deep surfaces and FFTD-P30xxH24 are for 29" deep surfaces.
- Width and depth are nominal sizes representing the sizes of the FreeFit Table. Allow for 1/4" overhang at the sides, 1 1/2" at the back and 6.237" at the front.
- Please choose any standard paint finish for frame and hardware. End trim cap is available only in CHR - charcoal.

PRODUCT CODE	PRICE	SIZE/ INCHES			WEIGHT LBS	VOL FT ³
		H	W	D		
FFTDH2436H24	738	24.63	34	31.75	26.55	3.94
FFTDH2442H24	761	24.63	40	31.75	28.10	4.59
FFTDH2448H24	783	24.63	46	31.75	29.65	5.25
FFTDH2454H24	805	24.63	42	31.75	31.20	5.91
FFTDH2460H24	828	24.63	58	31.75	32.75	6.56
FFTDH2466H24	850	24.63	60	31.75	34.30	7.22
FFTDH2472H24	871	24.63	70	31.75	35.85	7.88
FFTDH2478H24	894	24.63	76	31.75	37.40	8.53
FFTDH2484H24	919	24.63	82	31.75	38.95	9.19
FFTDH3036H24	792	24.63	34	37.75	40.50	4.72
FFTDH3042H24	815	24.63	40	37.75	42.05	5.51
FFTDH3048H24	837	24.63	46	37.75	43.60	6.29
FFTDH3054H24	859	24.63	42	37.75	45.15	7.08
FFTDH3060H24	881	24.63	58	37.75	46.70	7.87
FFTDH3066H24	903	24.63	60	37.75	48.25	8.65
FFTDH3072H24	926	24.63	70	37.75	49.80	9.44
FFTDH3078H24	948	24.63	76	37.75	51.35	10.22
FFTDH3084H24	970	24.63	82	37.75	52.90	11.01

FFTDH-H30 • Height Adjustable Table Polycarbonate Divider Screen Kit, 30" high

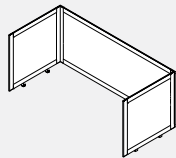

- Provides privacy in an open plan environment.
- Lightweight and easy to clean table mounted partitions.
- Consists of a powder coated aluminum frame, translucent fluted polycarbonate and all hardware to connect. Brackets are painted steel.
- Side dividers extend 6.237" from the front edge of each surface.
- Back divider extends over the back edge of the worksurface by 1 1/2" allowing for the passage of cables to the trough.
- FFTDP24xxH24 are for 23" deep surfaces and FFTD-P30xxH24 are for 29" deep surfaces.
- Width and depth are nominal sizes representing the sizes of the FreeFit Table. Allow for 1/4" overhang at the sides, 1 1/2" at the back and 6.237" at the front.
- Please choose any standard paint finish for frame and hardware. End trim cap is available only in CHR - charcoal.

PRODUCT CODE	PRICE	SIZE/ INCHES			WEIGHT LBS	VOL FT ³
		H	W	D		
FFTDH3036H30	828	30.63	34	31.75	26.55	3.94
FFTDH3042H30	856	30.63	40	31.75	28.10	4.59
FFTDH3048H30	881	30.63	46	31.75	29.65	5.25
FFTDH3054H30	905	30.63	42	31.75	31.20	5.91
FFTDH3060H30	932	30.63	58	31.75	32.75	6.56
FFTDH3066H30	957	30.63	60	31.75	34.30	7.22
FFTDH3072H30	985	30.63	70	31.75	35.85	7.88
FFTDH3078H30	1009	30.63	76	31.75	37.40	8.53
FFTDH3084H30	1034	30.63	82	31.75	38.95	9.19
FFTDH3036H30	879	30.63	34	37.75	40.50	4.72
FFTDH3042H30	905	30.63	40	37.75	42.05	5.51
FFTDH3048H30	931	30.63	46	37.75	43.60	6.29
FFTDH3054H30	956	30.63	42	37.75	45.15	7.08
FFTDH3060H30	983	30.63	58	37.75	46.70	7.87
FFTDH3066H30	1008	30.63	60	37.75	48.25	8.65
FFTDH3072H30	1033	30.63	70	37.75	49.80	9.44
FFTDH3078H30	1059	30.63	76	37.75	51.35	10.22
FFTDH3084H30	1085	30.63	82	37.75	52.90	11.01

FFTDG-H24 • Height Adjustable Table Glass Divider Screen Kit, 24" high

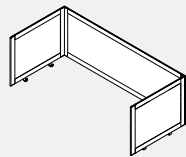

- Provides privacy in an open plan environment.
- Easy to clean table mounted partitions.
- Consists of a powder coated aluminum frame, 4mm clear (CLR) glass and all hardware to connect. Brackets are painted steel.
- Side dividers extend 6.237" from the front edge of each surface.
- Back divider extends over the back edge of the worksurface by 1 1/2" allowing for the passage of cables to the trough.
- FFTDG24xxH24 are for 23" deep surfaces and FFTD-DG30xxH24 are for 29" deep surfaces.
- Width and depth are nominal sizes representing the sizes of the FreeFit Table. Allow for 1/4" overhang at the sides, 1 1/2" at the back and 6.237" at the front.
- Please choose any standard paint finish for frame and hardware. End trim cap is available only in CHR - charcoal.
- Upcharge for frosted (FRST) glass is 20%.

PRODUCT CODE	PRICE	SIZE/ INCHES			WEIGHT LBS	VOL FT ³
		H	W	D		
FFTDG2436H24	994	24.60	34	31.50	26.55	3.94
FFTDG2442H24	1029	24.60	40	31.50	28.10	4.59
FFTDG2448H24	1059	24.60	46	31.50	29.65	5.25
FFTDG2454H24	1093	24.60	42	31.50	31.20	5.91
FFTDG2460H24	1125	24.60	58	31.50	32.75	6.56
FFTDG2466H24	1158	24.60	60	31.50	34.30	7.22
FFTDG2472H24	1190	24.60	70	31.50	35.85	7.88
FFTDG2478H24	1223	24.60	76	31.50	37.40	8.53
FFTDG2484H24	1256	24.60	82	31.50	38.95	9.19
FFTDG3036H24	1057	24.60	34	37.75	40.50	4.72
FFTDG3042H24	1089	24.60	40	37.75	42.05	5.51
FFTDG3048H24	1122	24.60	46	37.75	43.60	6.29
FFTDG3054H24	1156	24.60	42	37.75	45.15	7.08
FFTDG3060H24	1187	24.60	58	37.75	46.70	7.87
FFTDG3066H24	1221	24.60	60	37.75	48.25	8.65
FFTDG3072H24	1253	24.60	70	37.75	49.80	9.44
FFTDG3078H24	1286	24.60	76	37.75	51.35	10.22
FFTDG3084H24	1318	24.60	82	37.75	52.90	11.01

FFTDG-H30 • Height Adjustable Table Glass Divider Screen Kit, 30" high

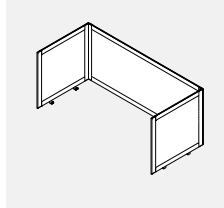

- Provides privacy in an open plan environment.
- Easy to clean table mounted partitions.
- Consists of a powder coated aluminum frame, 4mm clear (CLR) glass and all hardware to connect. Brackets are painted steel.
- Side dividers extend 6.237" from the front edge of each surface.
- Back divider extends over the back edge of the worksurface by 1 1/2" allowing for the passage of cables to the trough.
- FTFDG24xxH30 are for 23" deep surfaces and FTFDG30xxH30 are for 29" deep surfaces.
- Width and depth are nominal sizes representing the sizes of the FreeFit Table. Allow for 1/4" overhang at the sides, 1 1/2" at the back and 6.237" at the front.
- Please choose any standard paint finish for frame and hardware. End trim cap is available only in CHR - charcoal.
- Upcharge for frosted (FRST) glass is 20%.

PRODUCT CODE	PRICE	SIZE/ INCHES			WEIGHT		VOL FT ³
		H	W	D	LBS		
FFTDG2436H30	1042	30.60	34	31.50	28.85	3.94	
FFTDG2442H30	1075	30.60	40	31.50	30.40	4.59	
FFTDG2448H30	1110	30.60	46	31.50	31.95	5.25	
FFTDG2454H30	1143	30.60	42	31.50	33.50	5.91	
FFTDG2460H30	1176	30.60	58	31.50	35.05	6.56	
FFTDG2466H30	1210	30.60	60	31.50	36.60	7.22	
FFTDG2472H30	1230	30.60	70	31.50	38.15	7.88	
FFTDG2478H30	1279	30.60	76	31.50	39.70	8.53	
FFTDG2484H30	1312	30.60	82	31.50	41.25	9.19	
FFTDG3036H30	1109	30.60	34	37.75	42.80	4.72	
FFTDG3042H30	1141	30.60	40	37.75	44.35	5.51	
FFTDG3048H30	1176	30.60	46	37.75	45.90	6.29	
FFTDG3054H30	1209	30.60	42	37.75	47.45	7.08	
FFTDG3060H30	1242	30.60	58	37.75	49.00	7.87	
FFTDG3066H30	1277	30.60	60	37.75	50.55	8.65	
FFTDG3072H30	1297	30.60	70	37.75	52.10	9.44	
FFTDG3078H30	1345	30.60	76	37.75	53.65	10.22	
FFTDG3084H30	1378	30.60	82	37.75	55.20	11.01	

FFTDF-H24 • Height Adjustable Table Felt Divider Screen Kit, 24" high

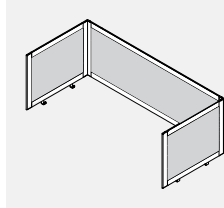

- Provides privacy in an open plan environment.
- Consists of a powder coated aluminum frame, 9mm felt and all hardware to connect. Brackets are painted steel.
- Side dividers extend 6.237" from the front edge of each surface.
- Back divider extends over the back edge of the worksurface by 1 1/2" allowing for the passage of cables to the trough.
- FFTDF24xxH24 are for 23" deep surfaces and FFTDF30xxH24 are for 29" deep surfaces.
- Width and depth are nominal sizes representing the sizes of the FreeFit Table. Allow for 1/4" overhang at the sides, 1 1/2" at the back and 6.237" at the front.
- Please choose any standard paint finish for frame and hardware. Select also a felt finish. End trim cap is available only in CHR - charcoal.
- 9mm felt material is tackable and comes in a variety of colors.

PRODUCT CODE	PRICE	SIZE/INCHES			WEIGHT		VOL FT ³
		H	W	D	LBS		
FFTDF2436H24	647	24.60	34	31.50	22.55	3.94	
FFTDF2442H24	663	24.60	40	31.50	24.10	4.59	
FFTDF2448H24	681	24.60	46	31.50	25.65	5.25	
FFTDF2454H24	699	24.60	42	31.50	27.20	5.91	
FFTDF2460H24	716	24.60	58	31.50	28.75	6.56	
FFTDF2466H24	735	24.60	60	31.50	30.30	7.22	
FFTDF2472H24	751	24.60	70	31.50	31.85	7.80	
FFTDF2478H24	767	24.60	76	31.50	33.40	8.53	
FFTDF2484H24	802	24.60	82	31.50	34.95	9.19	
FFTDF3036H24	669	24.60	34	37.75	36.50	4.72	
FFTDF3042H24	688	24.60	40	37.75	38.05	5.51	
FFTDF3048H24	703	24.60	46	37.75	39.60	6.29	
FFTDF3054H24	722	24.60	42	37.75	41.15	7.08	
FFTDF3060H24	738	24.60	58	37.75	41.70	7.87	
FFTDF3066H24	756	24.60	60	37.75	44.25	8.65	
FFTDF3072H24	773	24.60	70	37.75	45.80	9.44	
FFTDF3078H24	790	24.60	76	37.75	47.35	10.22	
FFTDF3084H24	825	24.60	82	37.75	48.90	11.01	

FFTDF-H30 • Height Adjustable Table Felt Divider Screen Kit, 30" high

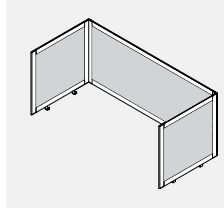

- Provides privacy in an open plan environment.
- Consists of a powder coated aluminum frame, 9mm felt and all hardware to connect. Brackets are painted steel.
- Side dividers extend 6.237" from the front edge of each surface.
- Back divider extends over the back edge of the worksurface by 1 1/2" allowing for the passage of cables to the trough.
- FFTDF24xxH30 are for 23" deep surfaces and FFTDF30xxH30 are for 29" deep surfaces.
- Width and depth are nominal sizes representing the sizes of the FreeFit Table. Allow for 1/4" overhang at the sides, 1 1/2" at the back and 6.237" at the front.
- Please choose any standard paint finish for frame and hardware. Select also a felt finish. End trim cap is available only in CHR - charcoal.
- 9mm felt material is tackable and comes in a variety of colors.

PRODUCT CODE	PRICE	SIZE/INCHES			WEIGHT		VOL FT ³
		H	W	D	LBS		
FFTDF2436H30	641	30.60	34	31.50	24.85	3.94	
FFTDF2442H30	659	30.60	40	31.50	26.40	4.59	
FFTDF2448H30	674	30.60	46	31.50	27.95	5.25	
FFTDF2454H30	691	30.60	42	31.50	29.50	5.91	
FFTDF2460H30	705	30.60	58	31.50	31.05	6.56	
FFTDF2466H30	723	30.60	60	31.50	32.60	7.22	
FFTDF2472H30	738	30.60	70	31.50	34.15	7.88	
FFTDF2478H30	755	30.60	76	31.50	35.70	8.53	
FFTDF2484H30	793	30.60	82	31.50	37.25	9.19	
FFTDF3036H30	673	30.60	34	37.75	38.80	4.72	
FFTDF3042H30	690	30.60	40	37.75	40.35	5.51	
FFTDF3048H30	704	30.60	46	37.75	41.90	6.29	
FFTDF3054H30	722	30.60	42	37.75	43.45	7.08	
FFTDF3060H30	738	30.60	58	37.75	45.00	7.87	
FFTDF3066H30	755	30.60	60	37.75	46.55	8.65	
FFTDF3072H30	769	30.60	70	37.75	48.10	9.44	
FFTDF3078H30	787	30.60	76	37.75	49.65	10.22	
FFTDF3084H30	824	30.60	82	37.75	51.20	11.01	

FTATB • Boulevard Connector Kit

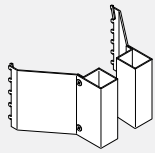

- FreeFit to Boulevard kit secures FreeFit height adjustable freestanding tables to parallel Boulevard panels.
- It provides panel/table alignment, preventing moving parts from rubbing against panel vertical surfaces and maintains 1" clearance around table surface perimeter.
- Standard metal finishes.
- All hardware included.
- Sold as a pair.
- Note: - Kit connects to C style base only.

PRODUCT CODE	PRICE	SIZE/ INCHES			WEIGHT VOL	
		H	W	D	LBS	FT ³
FTATB	140	10	6.5	10	7.00	0.50

FTAEG • Back to Back End Gable

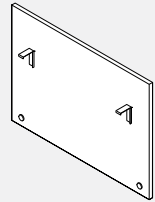

- Optional Back to Back Freefit End Gable is intended to be installed at the end of Freefit Back to Back table run.
- Made out of 3/4" PL Laminate, it enhances Freefit table assembly aesthetics by reducing number of visible elements below work surface.
- Two heights available.
- The End Gable connects to Freefit H-frame crossbar; compatible with Floor Feed.
- Please specify LP finish.
- Please specify paint finish for the brackets.

PRODUCT CODE	PRICE	SIZE/INCHES			WEIGHT LBS	VOL FT ³
		H	D	W		
FTAEG18H	311	18	30	0.75	10.00	0.24
FTAEG22H	337	23	30	0.75	13.00	0.30

FTACPU • CPU Holder

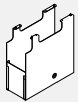

- Accepts tower CPU's with a width range from 7.6" to 2.25" and a maximum height of 18"
- Durable sheet metal construction
- Please specify paint finish.

PRODUCT CODE	PRICE	SIZE/INCHES			WEIGHT LBS	VOL FT ³
		H	D	W		
FTACPU	281	21	21	8	3.57	2.04

BRTLCS • Locking Caster for Rectangular Leg Tables



- Locking Caster for Rectangular Table.
- 40mm dia. locking caster with 8mm thread; white-body, light grey tires.

PRODUCT CODE	PRICE	SIZE/INCHES			WEIGHT LBS	VOL FT ³
		H	D	W		
BRTLCS	26	2.5	2.7	2.6	0.06	0.01

FTFOOT-TL • T-foot

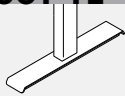

- Replacement single "T" foot.
- Includes attachment hardware.

PRODUCT CODE	PRICE	SIZE/INCHES			WEIGHT LBS	VOL FT ³
		H	D	W		
FTFOOT24TL	83	1.16	23	3	4.4	0.25
FTFOOT30TL	89	1.16	29	3	4.85	0.31

FTFOOT-CL • C-foot

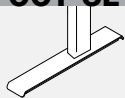

- Replacement single "C" foot.
- Includes attachment hardware.

PRODUCT CODE	PRICE	SIZE/INCHES			WEIGHT LBS	VOL FT ³
		H	D	W		
FTFOOT24CL	107	1.16	23	3	4.4	0.25
FTFOOT30CL	116	1.16	29	3	4.85	0.31

FTSETGLIDE • Set of Glides



- Replacement Glides a set of two with 1/2" adjustment

PRODUCT CODE	PRICE	SIZE/INCHES			WEIGHT LBS	VOL FT ³
		H	D	W		
FTSETGLIDE	12	1	1.5	1.5	0.06	0.01

BRLBST • Single Table Accessory Rail

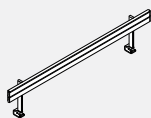

- **Table mounted accessory rail.**
- Compatible with standard Bins, Trays and Sorters.
- Includes end caps and mounting hardware.
- Please specify paint finish
- To ensure proper connection and clearance on tables 46" wide and up, choose accessory rail 13" smaller than the actual table width (70" wide table gets 57" wide rail).
- Tables 40" wide and smaller use 33" wide accessory rail.

PRODUCT CODE	PRICE	SIZE/ INCHES			WEIGHT VOL	
		H	W	D	LBS	FT ³
BRLBST36	288	16	33	2.95	5.9	0.26
BRLBST42	301	16	39	2.95	6.44	0.30
BRLBST48	311	16	45	2.95	6.98	0.35
BRLBST54	323	16	51	2.95	7.52	0.39
BRLBST60	332	16	57	2.95	8.07	0.43
BRLBST66	342	16	63	2.95	8.61	0.48
BRLBST72	355	16	69	2.95	9.15	0.52
BRLBST78	365	16	75	2.95	9.69	0.56
BRLBST84	377	16	81	2.95	10.24	0.61

PRIVA NOTES

GENERAL INFORMATION

- Priva™ acoustic pods provide a place for personal privacy, focus and online collaboration, away from the commotion of the open office.
- Integrated ventilation (55 cubic feet per minute) and low-voltage LED lighting are motion-sensor activated to reduce energy consumption while providing a comfortable environment for short or longer stays.
- The tempered glass entrance door, in combination with an optional glass back panel, reduces the sense of confinement.

CONSTRUCTION

- Assembles in less than 90 minutes. Once complete, simply plug in and get to work!
- Priva has been tested and complies with all BIFMA mechanical tests.
- Exterior is clad in 3/4" thermally fused laminate with a 10mm tempered glass door and glass (POD1G, POD2G, POD3G) or laminate back panel (POD1L).
- Exterior corner details are made of extruded aluminum
- Internal frame is comprised of 14 gauge steel beams
- Interior is clad in PET (recommended for greater acoustic properties)
- Laminate interior is optional.
- Pod ceiling is Designer White laminate
- Interior carpet flooring is comprised of eco-friendly Nylon fiber, solution dyed with a polypropylene backing.
- Laminate touch-down shelf is standard in Designer White (DWT) laminate.

DIMENSIONS

- Door: 32"w x 88"h
- Shelf: 24"w x 8"d x 40"h

Exterior Laminate Finishes

Absolute Acajou	ACJ
Asian Night	ASN
Black	BLK
Brushed Cobalt	BRC
Clear Maple	CMB
Dark Espresso	DES
Designer White	DWT
Noce Biondo	NBL
Noce Grigio	NGL
Noce Leggero	NEL
Noce Medio	NML
Storm Grey	SOG
Walnut Heights	WHE
White Chocolate	WHC
Winter Cherry	WCR

Exterior Frame Finishes

Black	BLK
Charcoal	CHR
Designer White	DWT
Tungsten	TUN

Hardware Finishes (Handle + Hinge)

Black	BK
Silver	SI

Interior Finishes - Select Laminate or PET

PET

Graphite	GPH
Pewter	PWT
Mist	MTS

Laminate

Black	BLK
Designer White	DWT
Storm Grey	SOG

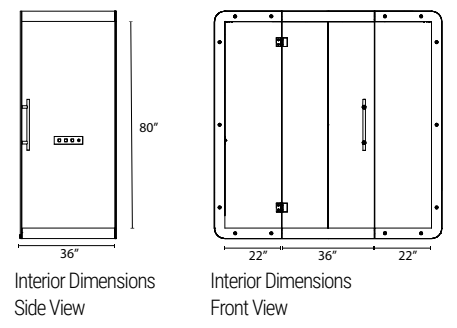
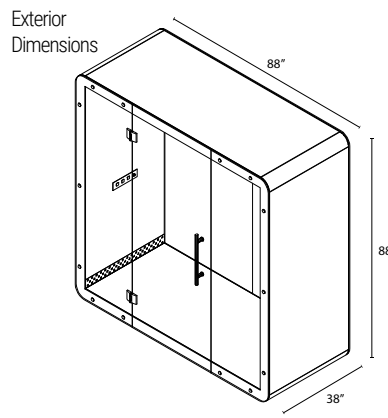
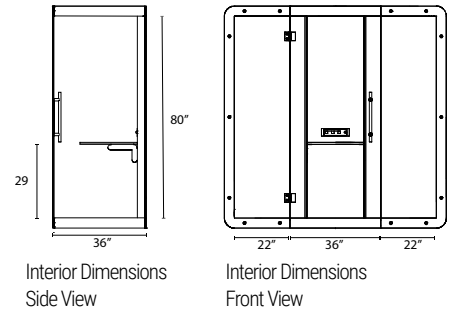
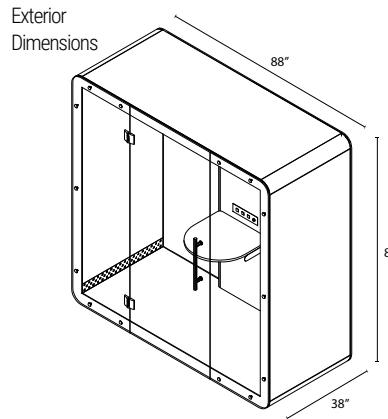
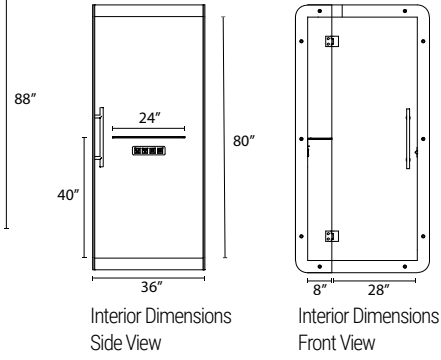
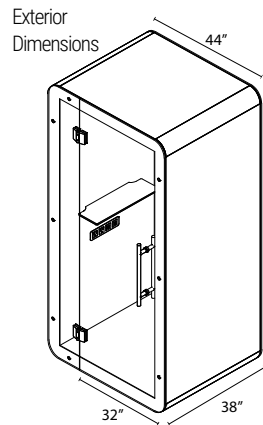
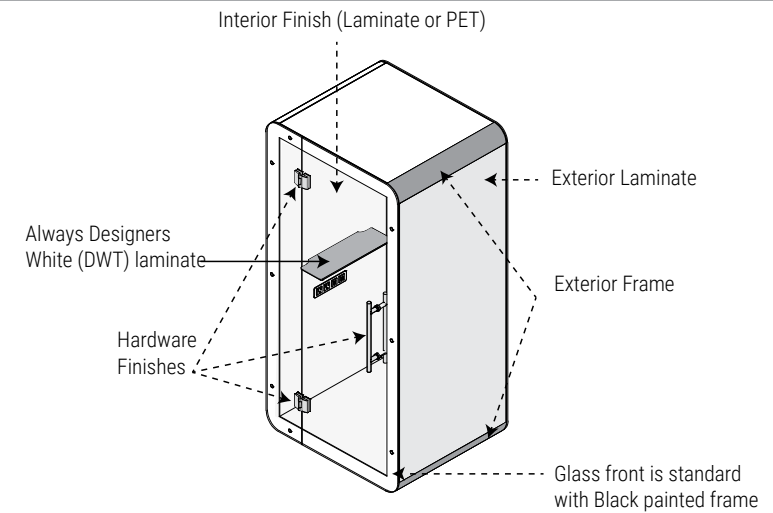

POD1G • Single User Pod - Glass Back Panel

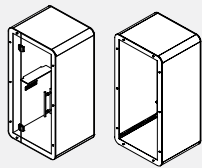

Front View/Rear View

- Acoustic Pod includes laminate exterior with aluminum frame. PET interior provides acoustic privacy.
- Laminate interior optional for easy cleaning. Door is 10mm tempered glass with a glass back panel.
- Power + Connectivity: 2 AC outlets and 2 charging USB-A ports coupled with an occupancy sensor controlling two 12V DC fans and an LED light circuit, ensuring comfort in even the smallest of enclosed spaces, while keeping power consumption at a minimum.
- Acoustic Ratings: NIC-36, STI .07
- Airflow Specifications: CFM 55

PRODUCT CODE	PRICE	SIZE/INCHES			WEIGHT LBS	VOL FT ³
		H	W	D		
POD1G	23502	88	44	38	800	85

POD1L • Single User Pod - Laminate Back Panel

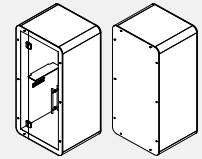

Front View/Rear View

- Acoustic Pod includes laminate exterior with aluminum frame. PET interior provides acoustic privacy.
- Laminate interior optional for easy cleaning. Door is 10mm tempered glass with a laminate back panel.
- Power + Connectivity: 2 AC outlets and 2 charging USB-A ports coupled with an occupancy sensor controlling two 12V DC fans and an LED light circuit, ensuring comfort in even the smallest of enclosed spaces, while keeping power consumption at a minimum.
- Acoustic Ratings: NIC-36, STI .07
- Airflow Specifications: CFM 55

PRODUCT CODE	PRICE	SIZE/INCHES			WEIGHT LBS	VOL FT ³
		H	W	D		
POD1L	23502	88	44	38	800	85

POD2G • Two Person Meeting Pod - Glass/Laminate Back Panel

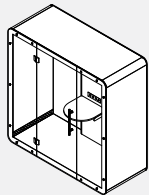

- Acoustic Meeting Pod includes laminate exterior with aluminum frame. PET interior provides acoustic privacy.
- Includes D-Shaped Table 22.75" w x 22.75" d x 1" thick.
- Table can be installed at 26h, 28h or 30h
- Door is 10mm tempered glass
- Interior dimensions: 80" w x 36" d x 80" h
- Power + Connectivity: 2 AC outlets, USB-C and USB-A ports coupled with an occupancy sensor controlling two 12V DC fans and two LED lights, ensuring comfort in even the smallest of enclosed spaces, while keeping power consumption at a minimum.
- Acoustic Ratings: NIC-36, STI .07
- Airflow Specifications: CFM 55

PRODUCT CODE	PRICE	SIZE/INCHES			WEIGHT LBS	VOL FT ³
		H	W	D		
POD2G	42293	88	88	38	1200	170

POD3G • Office Pod - Glass Back Panel

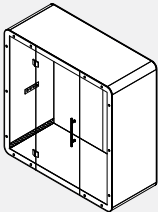

- Acoustic Office Pod includes laminate exterior with aluminum frame. PET interior provides acoustic privacy.
- Full tempered glass back
- Can accommodate a single task chair and small desk 36w x 24d (sold separately)
- Door is 10mm tempered glass
- Interior dimensions: 80" w x 36" d x 80" h
- Power + Connectivity: 2 AC outlets, USB-C and USB-A ports coupled with an occupancy sensor controlling two 12V DC fans and two LED lights, ensuring comfort in even the smallest of enclosed spaces, while keeping power consumption at a minimum.
- Acoustic Ratings: NIC-36, STI .07
- Airflow Specifications: CFM 55

PRODUCT CODE	PRICE	SIZE/INCHES			WEIGHT LBS	VOL FT ³
		H	W	D		
POD3G	39184	88	88	38	1200	170

GCBMSG • Board Mounted Wellness Screen

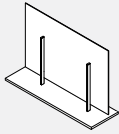

- Surface mounted wellness screen provides a physical divider.
- Choose LP (low pressure laminate colour).
- Acrylic glazing is clear and support rails are painted DWT Designer White.
- Kit includes all hardware to assemble and place on top of a surface.
- Actual height of the acrylic is 31.5", screws will allow acrylic to be installed at any height along the vertical rails to allow a 1/2" to 10" gap.

PRODUCT CODE	PRICE	SIZE/ INCHES			WEIGHT VOL	
		H	W	D	LBS	FT ³
GCBMSG3636LP	441	36	36	12	28.45	2.92
GCBMSG3648LP	567	36	48	12	34.17	3.98

GCAMSG • Wellness Screen only, for use with existing worksurface or transaction top

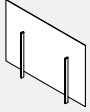

- Surface mounted wellness screen provides a physical divider.
- Acrylic glazing is clear and support rails are painted DWT Designer White.
- Kit includes all hardware to install on an existing surface.
- Actual height of the acrylic is 31.5", screws will allow acrylic to be installed at any height along the vertical rails to allow a 1/2" to 10" gap.

PRODUCT CODE	PRICE	SIZE/ INCHES			WEIGHT VOL	
		H	W	D	LBS	FT ³
GCAMSG3636LP	323	36	36	2	20.2	2.92
GCAMSG3648LP	422	36	48	2	22.8	3.98

GCBRMSG • Wellness Screen with surface mounting bracket, for use with existing worksurface or transaction topface or transaction top

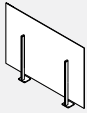

- Surface mounted wellness screen provides a physical divider.
- Acrylic glazing is clear and support rails are painted DWT Designer White.
- Kit includes all hardware to install on an existing surface.
- Actual height of the acrylic is 31.5", screws will allow acrylic to be installed at any height along the vertical rails to allow 1/2" to 10" gap.

PRODUCT CODE	PRICE	SIZE/ INCHES			WEIGHT VOL	
		H	W	D	LBS	FT ³
GCBRMSG3636LP	397	36	36	5	20.2	2.92
GCBRMSG3648LP	495	36	48	5	22.8	3.98

GCTCSG • Wellness Screen with clamp mount bracket, for use with existing worksurface or transaction top

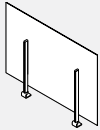

- Surface mounted wellness screen provides a physical divider.
- Acrylic glazing is clear and support rails are painted DWT Designer White.
- Kit includes all hardware to install on an existing surface.
- Actual height of the acrylic is 31.5", screws will allow acrylic to be installed at any height along the vertical rails to allow 1/2" to 10" gap.
- LP code indicated dividers will fit on 1" thick surfaces, where the W code will fit on 1 1/2" thick surfaces.

PRODUCT CODE	PRICE	SIZE/ INCHES			WEIGHT VOL	
		H	W	D	LBS	FT ³
GCTCSG3636LP	397	36	36	3	20.2	2.92
GCTCSG3648LP	495	36	48	3	22.8	3.98
GCTCSG3636W	407	36	36	3	20.2	2.92
GCTCSG3648W	506	36	48	3	22.8	3.98

GCFS - Trifold Wellness Screen

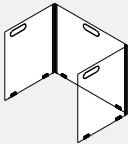

- Surface supported trifold wellness screen provides a physical divider.
- Light-weight and fold-able for easy transport or storage.
- Acrylic glazing is 3mm with clear finish.
- Includes support feet and integrated handles.
- Code with "-1" suffix is a single unit individually packed.
- Code with "-5" suffix is a bundle of 5 units, bulk packed.
- Carrying weight for the GCFSGS1618 is 4 lbs and for the GCFSGA1923 is 5 lbs.

PRODUCT CODE	PRICE	SIZE/ INCHES			WEIGHT VOL	
		H	W	D	LBS	FT ³
GCFSGS1618-1	322	15.75	18	15	5.15	0.97
GCFSGS1618-5	1547	15.75	18	15	25.75	4.86
GCFSGA1923-1	372	19	23	15.75	7.30	0.67
GCFSGA1923-5	1792	19	23	15.8	36.50	3.37

L2AFD • Aluminum Framed Wellness Screen

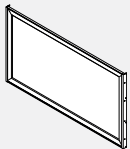

- Aluminum Framed Wellness Screen to fit between two vertical surfaces.
- Acrylic glazing is clear and support rails are painted DWT Designer White.
- Kit includes two brackets and all hardware to install between two surfaces.
- Custom size widths are available, please price out at next size up and tag the width needed ie. L2AFD42, tag:*40 wide.

PRODUCT CODE	PRICE	SIZE/ INCHES			WEIGHT VOL	
		H	W	D	LBS	FT ³
L2AFD36	637	33	36	0.8	15	0.6
L2AFD42	703	33	42	0.8	17	0.7
L2AFD48	768	33	48	0.8	19	0.8
L2AFD54	837	33	54	0.8	21	0.9
L2AFD60	903	33	60	0.8	23	1.0
L2AFD66	969	33	66	0.8	25	1.1
L2AFD72	1035	33	72	0.8	27	1.2

L2RSB • Screening Booth

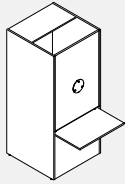

- Screening Booth is ideal for hospitals, clinics, reception areas or anywhere a safe self-contained environment is required.
- Screening Booth has a protected speaker hold, a paper space above the work surface, a interior and exterior worksurface.
- The gap between the work surface and glazed frame can be changed during assembly from 1.5" to 4" based on the direction of the screen.
- Booth available in DWTLP - Designer White only.
- Can be closed or connected with Diet Lamine Panels.
- Ships knocked down.

PRODUCT CODE	PRICE LP	SIZE/INCHES			WEIGHT		VOL FT ³
		H	W	D	LBS		
L2RSB	2356	82	36	36	238.81	61.50	

L2SBCF • Screening Booth Ceiling Feed Pole

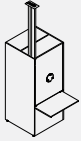

- Screening Booth Ceiling Pole can be used to bring power and/or data from the ceiling to the Booth.
- Aluminum extrusion comes in powder coated paint finish, DWT - Designer White or TUN - Tungsten.
- Kit includes aluminum extrusions, spacer, trim kit and double-sided adhesive tape.
- Maximum ceiling height of 108".

PRODUCT CODE	PRICE	SIZE/INCHES			WEIGHT		VOL FT ³
		H	W	D	LBS		
L2SBCF	132	76.5	4.5	1.5	8.69	0.29	

Global offices in Canada

Head Office

560 Supertest Road
Toronto, Ontario
M3J 2M6
T (416) 650-6500

Toronto Sales Office

1350 Flint Road
Toronto, Ontario
M3J 2J7
T (416) 661-3660

Moncton

268 Coverdale Road
Riverview, New Brunswick
E1B 3J2
T (506) 858-8383

Showrooms

Calgary

237 8 Avenue SE, Suite 302
Calgary, Alberta
T2G 5C3
T (403) 250-7770

Montreal

1010 Sainte-Catherine Street West
Mezzanine 2
Montreal, Quebec
H3B 1E7T
T (514) 866-4331

Ottawa

251 Laurier Avenue West, Suite 400
Ottawa, Ontario
K1P 5J6
T (613) 234-2881
Please call ahead to book an appointment.

Edmonton

10158 103 Street NW, Suite 201
Edmonton, Alberta
T5J 0X6
T (780) 444-8922

Toronto

1350 Flint Road
Toronto, Ontario
M3J 2J7
T (416) 661-3660

Vancouver

675 West Hastings Street, Suite 1000
Vancouver, British Columbia
V6B 1N2
T (604) 432-1701

Halifax

1061 Marginal Road, Suite 120
Halifax, Nova Scotia
B3H 4P7
T (902) 422-7434

Toronto - The Blueprint

(MetroCentre)
200 Wellington Street West, Suite 1602
Toronto, Ontario
M5V 3C7

Winnipeg

111 Lombard Avenue, Suite 220
Winnipeg, Manitoba
R3B 0T4
T (204) 925-3350

