

Systems

Effective April 2025 Canada

PRICE LIST
systems
panel + deskking



General Information

Table of Contents	2
Terms and Conditions	3
Lifetime Warranty	6
Finishes	7
Key Alike Form	10

Boulevard

Product Overview	11
Value Added Benefits	13
Woodgrain Chart	14
Boulevard 1 Technical Information	15
Boulevard 1 Panels	16
- Guidelines for Ordering Product	
Boulevard 1 Graphic Panels	17
Boulevard 1 Panels	19
Boulevard 1 Connectors and Trims	31
Boulevard System 3 Panel	38
System/Technical Information	
Boulevard System 3 Panels	39
-Guidelines for Ordering Product	
Boulevard System 3 Graphic Panels	40
Boulevard System 3 Panels	42
Boulevard System 3 Connectors and Trims	53
Boulevard Gallery Panels	56
Electrical	62
Worksurfaces	70
Worksurface Hardware	80
Storage	84

Diet

Diet Panel System/Technical Information	95
Panels	96
Panel Connectors	103
Electrical	109
Linking Panels	110
Linking Panel Connectors	112
Worksurfaces and Hardware	113
Storage	114

Compile

Product Overview	115
Panels	117
Gallery Panels	157
Connectors	161
Electrical	167
Worksurfaces	169
Worksurface Hardware	175
Storage	178

Accessories

Keyboard Trays and Mechanisms	181
Computer Support	184
Monitor Arms	185
Lights	187
Grommets/Power Modules/Bars	189
Paper Management	192

Evolve

Product Overview	197
Value Added Benefits	200
Woodgrain Chart	201
Graphic Panels	202
Panels	204
Panel Connectors and Trims	235
No Raceway Panels	247
No Raceway Panel Connectors	252
Freestanding Panels	256
Acoustic Grid	261
Electrical	263
Power Beam	268
Worksurface	289
Worksurface Hardware	302
Laminate Gallery Panels	305
Storage	317
Accessories	330

Priva Pods

Product Overview	336
Pods	337

Soft Pod

Introduction	338
Planning and Application	342
Softpods and Extensions	362
Electrical	367
Storage	371
Accessories	373

Universal Panels

Universal Divider Panels	375
Freestanding Dividers Polycarbonate	376
Freestanding Dividers Felt	377
Freestanding Dividers Glass	378

Bridges

Product Overview	379
Woodgrain Chart	380
Leg/Handle Details	382
Rectangular Leg Packages	383
Round Leg Packages	391
Rectangular Leg Components	395
Round Leg Components	397
Beams	399
Worksurfaces	403
Display Wall	405
Power	406
Bridges Power Beam	413
Gallery Panels	418
Dividers	424
Storage	448
Collaborative Seating	461

Collaborative Spaces

Statement Of Line	467
Application Guide	469
Technical Notes	477
Tables	479
Accessories	488
Team Cart	491
Occasional Tables	494
Laptop Tables	495

FreeFit Height Adjustable Tables

Product Overview	496
Bases	501
Tops	506
Storage	511
Power/Data	512
Dividers	515
Accessories	522

Kadin Tables

Product Overview	523
Power	524
Tables	527

Licence

Product Overview	529
Woodgrain Chart	530
Grommet Chart	531
Desks	534
Reception Desks	542
Desks & Return Desks	544
Shaped Table Desks	561
Runoff Shaped Tables	569
Floating Shaped Tables	570
Modesty Panels	572
Storage	573
Pantry	601
Collaboration Tables	603
Conference Tables	616
Conference Table Bases	621
Visual Board	625
Conference Table Modules	626

Terina Tables

Product Overview	629
------------------	-----

Vice Versa Tables

Product Overview	630
------------------	-----

Terms and Conditions

This illustrated list price book has been designed to facilitate fast reference and easy use. The line drawings match actual products (where possible) to aid in instant recognition of each item, but they are graphic representations only.

Sales of Global Contract's products are made only on Global Contract's standard Terms and Conditions of sale which are contained in this list price book. The "Purchaser" in these Terms, Conditions and General Information shall refer to Dealers and those who originally purchase directly from Global Contract for use or re-sale. These standard Terms and Conditions may be modified or supplemented only by a separately written document signed by Global Contract's authorized personnel at its head office in Toronto, Ontario, Canada. Any term or condition contained in any purchase order or other form used by the Purchaser to order goods (including standard, printed language) which is different from, in addition to, or in any way inconsistent with Global Contract's standard Terms and Conditions shall be of no force or effect whatsoever.

All illustrations, specifications and prices in this list price book are based on the latest product information available at the time of publication. Global Contract reserves the right to make changes at any time and without prior notice to prices, colours, materials, specifications and models offered.

Description

Each product shown or described in this list price book is standard Global Contract product. Available options are noted at the beginning of each series or at the beginning of the price list. Available options may require additional delivery time and cost, and may affect the warranty given. Sizes and weights shown are approximate and are subject to slight changes from time to time.

Prices and Payment

The prices shown in this Book, as well as those quoted by Global Contract, shall be Canadian dollars for orders shipped to destinations in Canada.

The price does not include any provincial or local property license, privilege, sales, use, value added, gross receipts, G.S.T. or other like taxes which may now or hereafter be applicable to, measured by or imposed upon or with respect to the transaction, the product, its sale, its value or its use, or any services performed in connection therewith.

If shipping date requested is more than 90 days from date of order, Global Contract shall have the right to use published list prices effective at the time of shipment.

Not included in the list price is special or export packing, freight, unpacking and installation. Orders are invoiced at the time of shipment.

Orders are invoiced at the time of shipment. Terms of payment are net 30 days. All orders are subject to the Purchaser complying with Global's prevailing credit policy.

Any product sold shall remain the property of Global Contract until fully paid for. The Purchaser agrees to perform all acts which may be necessary to perfect and assure retention of title to such products to Global Contract until such time as the goods have been paid for in full.

Delivery shall occur and risk of loss or damage to the product shall pass to Purchaser F.O.B. point of shipment. Purchaser is responsible for filing claims with the carrier for losses or damage to the product occurring during transit, including concealed damage.

Prices are suggested list prices only and are subject to change without notice. Global Contract will, however, attempt to keep the Purchaser's up-to-date on all developments including price changes.

Taxes

All prices shown in this list price book are exclusive of sales, use, excise, HST and other applicable taxes and duties which may be the Purchaser's responsibility as per the invoice issued by Global. If the Purchaser claims an exemption from such taxes, it shall be the Purchaser's responsibility to furnish Global with an appropriate exemption certificate at time of order.

Order Information

Global Contract requires that all orders be submitted in writing. All orders submitted to Global Contract in writing will be acknowledged on Global Contract's acknowledgement forms governing the transaction.

The details appearing on this acknowledgement will describe the items to be shipped and the approximate shipping date. It is the Purchaser's responsibility to determine that the information in the acknowledgment is correct. In the event of an error, the Purchaser must notify their Global Contract Customer Service representative immediately by telephone followed by written confirmation. Shipping dates are assigned to orders based on the items having the longest manufacturing lead time (unless instructed to partial ship).

Purchaser must indicate if multiple shipping schedules are required. Each shipment will be invoiced at time of shipping and will be subject to payment terms described above.

When ordering, please provide the following information:

1. Account number (if possible)
2. PO number
3. "Bill to" and/or "Ship to" and name and address
4. Complete model number and selected options including textiles/finishes
5. Special instructions and tag information
6. Shipping instructions, please indicate:
 - a. pick up
 - b. Global trailer program
 - c. common carrier, provide name of carrier, your account number
7. Special quote (SQ) # (if applicable)
8. Customer's Own Material (COM), Global Contract Purchased Material (GPM), Customer's Own Leather (COL) - please see below.
9. For specials and custom quoted product, please indicate the custom quote # on your PO. If changes are made to the quote, a new quote must be issued prior to submitting the order. It is the Purchaser's responsibility to determine that the information on the quote is correct. Global will not be responsible for wrong product due to errors in the quote.

The above points will be checked by Global Contract for accuracy. Global Contract will process orders using the codes provided by the Purchaser. Price discrepancy is the responsibility of the Purchaser. The Purchaser must notify Global Contract prior to invoicing.

The Purchaser is responsible for providing correct information when placing an order. If no option(s) are selected the system, will default to standard feature(s). Orders with missing/incorrect information (finish, etc.) will be put on hold until all information is complete. Orders will be scheduled for manufacturing upon receipt of complete information.

Specifications and application drawing may be requested to be supplied for examination prior to approval.

Special Colours

Use of Customer's Own Material must be approved by Global Contract prior to acceptance of order. Fabric yardage requirement will be advised by factory, and additional yardage may be required if pattern requires matching. If Customers Own Material (C.O.M.) is difficult to apply or if product must be modified, extra charges will be made. Global Contract reserves the right to cancel an order at any time if C.O.M. is inadequate for any reason. Customer's own material should be shipped freights and duties paid to Global Contract, 565 Petrolia Road, North York, Ontario.

Such shipment must be fully identified with purchaser's order number, Global Contract's acknowledgment number and the item for which material is intended. For C.O.M. prices, use Grade 1 price. Performance of C.O.M. when applied to product is the sole responsibility of the purchaser.

Deposit on Special Orders

Orders for nonstandard products may, at Global Contract's discretion, require deposit prior to scheduling of production, the amount of the deposit being credited against the total price of the project.

Changes and Cancellation

After the date of Global's acknowledgment of the Purchaser's order, the order may not be changed or cancelled by the Purchaser without the written consent of Global. Orders for products upholstered in "special order textiles" (GPM) cannot be cancelled once material has been purchased. Special order items, COM and textile-covered items already in production are not subject to change or cancellation under any circumstances. Textile-covered items are considered to be in production once the textile is scheduled for cutting. Other standard items already in production are subject to a minimum 35% cancellation charge.

Global Contract reserves the right to cancel an order at any time if Special Order is in the sole judgement of Global Contract, inadequate for any reason.

Errors and Omissions

All quotations, acknowledgments and invoices are subject to corrections for any errors and omissions.

Disclaimer

Prices shown are current manufacturer's suggested list prices at the time of printing. Updated pricing is available on Global's website. All applicable taxes are extra. Descriptions, specifications and prices are subject to change without notice. Errors and omissions are subject to correction.

Custom Wood Staining

Custom wood staining procedure for wood seating is as follows. Customer provides a sample of the desired wood finish. That sample is sent to Global Contract Customer Service. Several finished samples will be sent back. The customer/end user will sign off on the samples (keeping one for their records) and return the rest of the samples. Global Contract will not necessarily match the wood species but rather will generate a colour that will coordinate with the sample when it is applied to the wood species used in the seating frame.

Metal File Finishes

There is no upcharge for any standard file finish. Any custom file finish must be approved by Global Contract prior to acceptance of order and will be subject to an upcharge to be confirmed at time of color matching.

Wood Veneer Finishes

Because the distinctive characteristics and the nature of wood products cause variations, exact matches are not always possible. Global Contract will not be held responsible if the finishes cannot be matched.

Customer's Own Material (COM)

Use of COM must be approved by Global Contract prior to acceptance of order. Please submit the Authorization Request Form. Photocopy and use this form as often as necessary. The customer must provide a 12" x 12" textile sample and advise how the textile is to be applied and quantity of textile being sent. Textile yardage requirement will be advised by the factory, and additional yardage may be required if pattern requires matching. Upon approval from Global Contract, send textile to the COM Department at 565 Petrolia Road, North York, ON, M3J 2X8.

If COM is difficult to apply or if product is required to be modified, extra charges will apply. Global Contract reserves the right to cancel an order at any time if COM is inadequate for any reason. COM must be shipped freight and duties paid if applicable to our factory. Such shipment must be fully identified with the Purchaser's order number, and the item for which the material is intended. Performance of COM when applied to product is the sole responsibility of the Purchaser. Global Contract's standard product warranty shall not apply to COM. The COM price is the lowest published price/grade for the series. The published yardage requirement for COM orders is approximate and shown beside each item in the list price book. The yardage shown there is based on the textile requirements for cutting and sewing a single chair in a plain patterned textile. For textiles with a pattern repeat or for COM orders involving 10 or more chairs, please consult with Customer Service for recalculation of the yardage requirements as this may significantly change the textile requirement.

Textile Grading

All products are priced according to their standard textile grade. Lower grade textiles may be available but at the same price as standard textile grade.

Combining two grades of textiles may result in a revised grade. Please refer to "Fabric Grades Combination Chart" in the Seating list price book. For more than two textiles a special quotation is required.

GPM (Global Contract Purchased Material, Customer Specified)

Global Contract may purchase material specified by the customer. Use of GPM must be approved by Global Contract prior to acceptance of order. If it is difficult to apply or if product is required to be modified, extra charges will apply. Global Contract reserves the right to cancel an order at any time if GPM is inadequate for any reason. Performance of GPM when applied to product is the sole responsibility of the textile vendor. Global Contract's standard warranty will not apply to GPM materials.

Customer's Own Leather (COL)

Not all seating can be upholstered in leather. Please consult series notes for availability. COL price is the lowest published grade for the series (leather or fabric).

Upholstery Coverings

Slight variations in colour may occur between dye lots. Although Global Contract attempts to minimize these variances, they do occur and must be accepted as normal and will not be considered defects.

Leather is a Natural Product

Natural variations occur in the colour, grain and texture of leather. As a result, a degree of variation should be expected. As leather is used it develops a patina. Its colour changes slightly, it will get marked and it will stretch and pull, these are the hallmarks of genuine leather and are not considered defects.

Yardage

Required yardage (yd) is based on unmatched materials with widths of 54" for seating, 63" for panels.

Arms

A wide selection of arms are available for some series. See Arm Chart in the Seating list price book.

Cubic Measure

The stated cubage is an approximate cubic foot measure to calculate freight costs. The figure shown is the volume for one carton, (one unit per carton unless otherwise noted) and is subject to change without notice.

Delays

Global Contract's order acknowledgement will state a shipping date which Global Contract best estimate at the time the order is acknowledged. However, Global Contract shall not incur any obligation or liability to Purchaser for failure to ship by specified date unless Global Contract has agreed to an unequivocal, firm shipping date in a separately signed written document executed by its authorized personnel at its head office. In addition, Global Contract shall not be liable for any loss or damage resulting from any delay or failure in shipment or other failure to perform all or any part of the agreement between the parties with respect to the goods shown on the face of the order acknowledgments where such delay, failure, loss or damage is the proximate result of any act or any governmental authority or political subdivision thereof, revolution, riot, civil disorder or disturbance, act of enemies, delay or default in transportation, strike disputes among or between labour unions or other labour disputes, delay or inability in obtaining materials and facilities, fire, flood, act of God or any cause not within the reasonable control of Global Contract, whether of the class of causes enumerated or otherwise. Without limiting the generality of the foregoing, Global Contract may, without causing breach or incurring liability, allocate goods which are in short supply, irrespective of the reasons therefore, among purchaser, in any manner which Global Contract, in its sole discretion, deems advisable.

Suspension

In the event that the Purchaser defaults in the payment of any sum due to Global Contract, or in the event the Purchaser's financial condition becomes unsatisfactory to Global Contract, Global Contract shall have the right to defer or discontinue shipment of any goods until such time as the default is cured or the Purchaser provides assurance of payment to Global Contract.

Combined Shipments

Global Contract will make every effort to combine shipments and orders on written request. However, Global Contract cannot be held responsible where such request is not complied with.

Shipments

Purchaser must select, at time of order entry, one of two methods of freight payment. Global Contract will make no end-user shipments unless special arrangements have been made.

- 1) F.O.B. point of shipment, freight collect - pick up and common carrier.
- 2) F.O.B. point of shipment, freight pre-paid and invoiced to purchaser.

The Purchaser will determine the method of transportation and routing of shipment. In the event that the purchaser does not specify method and routing, Global Contract will have shipments expedited in the manner deemed appropriate. Contact Customer Service Department, Global Contract Inc., 565 Petrolia Road, North York, Ontario M3J 2X8 (416) 739-5000 with questions concerning shipping information on acknowledged orders.

F.O.B.

F.O.B. point is Global Contract's factory, Toronto, Ontario, Canada.

Back Charges

Global Contract will not accept charges for expense incurred by the Purchaser in expediting shipments. Global Contract will not accept charges for the repair of damage by others.

Code Restrictions

Global Contract items are within the limitations of local codes.

Service

Service problems are normally handled by the Global Contract's authorized dealer, as appropriate. Where this cannot be accomplished on a local level, service problems should be referred to Customer Service Department, Global Contract Inc., 565 Petrolia Road, North York, Ontario M3J 2X8, (416) 739-5000, csr@globalcontract.com.

Storage

In the event Purchaser requests postponement of delivery beyond the scheduled shipping date after the goods have become work in progress, or at the time when Global Contract is then about to make shipment, Global Contract may transfer the goods to storage for Purchaser's account and at Purchaser's risk and expense. Such transfer to storage shall be deemed delivered to Purchaser for all purposes, including invoicing and payment.

Claims

All goods are sold F.O.B. plant. Global Contract is not responsible for damage which occurs in transit or in storage. The carrier signs for all goods received in apparently good order. It is the Purchaser's responsibility to examine goods upon receipt and to file any claims with the carrier for losses or damage to the product occurring during transit, including concealed damage. Any claims made against Global Contract for apparent defects, errors or shortages must be made by the purchaser in writing within 15 working days after any delivery. Failure by the Purchaser to do so shall constitute acceptance of the goods and a waiver of any apparent defects, errors or shortages.

Installation

Global Contract requires the use of a certified installer when installing Global Contracts' products and systems so as to avoid any installation misrepresentations and/or unnecessary delivery and installation claims.

"Customer assumes full responsibility for the attachment method of work surfaces which were not purchased as part of a complete table assembly. Failure to secure the work surface capable of supporting the load capacity listed may result in property damage and/or personal injury. Customer agrees to indemnify and hold harmless Global Upholstery Co. Inc., its affiliates, subsidiaries, officers, directors, employees and shareholders (collectively "Global") from and against any lawsuits or threat of lawsuits and all liabilities, direct or implied, claims, proceedings, actions, causes of action, damages, losses, costs and expenses, including, without limitation, legal fees whatsoever which Global may suffer or incur as a result of fulfilling your product order. Customer acknowledges that this product order will not be covered under Global's Lifetime Warranty."

Returns

No returns of goods will be accepted without written consent and shipping instruction of Global Contract. A restocking charge of 35% based on list pricing is made on all authorized returns for credit or refund, provided goods are received by Global Contract in the condition in which they left the factory. This may increase depending on the type of product. No credit will be given if goods cannot be reused. Global's Return Goods Authorization (RGA) numbers must appear prominently on all authorized returns. Special order items are in no event subject to return. All returns must be approved and authorized in writing by Global Contract Customer Service. Global reserves the right to refuse delivery of any unauthorized returns.

Tolerances

All dimensions must be limited by a specified tolerance. When not specified it is understood that Global Contract's normal tolerances and standards shall apply. When purchaser has submitted his own plans and/or specifications, Global Contract will not be responsible for the design and fitting of parts. The conforming of Global Contract products to the specified tolerance is sufficient evidence as to the correctness of the product. Standards of finish, quality and appearance shall, unless specified in writing, be the normal standards of Global Contract.

Copyright

All catalogues, photographs, drawings, price lists and other printed material are protected by copyright. All rights reserved.

Trademark

Most series names are Global Contract's trademarks.

Design

Many of the products produced by Global Contract are protected by Design Registrations, Design Patents and/or Patents. Designs and specifications are subject to change, discontinuance or additions without notice.

Offer of Sale

Possession of this price list or any other literature shall not imply Global Contract's willingness to sell the holder and shall not be construed as a direct offer of sale. If a conflict arises between: (i) prices found in software support packages furnished to the customer by Global Contract or by any other source on behalf of Global Contract; and (ii) Global-Contract's current printed price lists, then the most current shall prevail.

Testing Qualifications

Many Global products pass or exceed the most stringent industry testing standards.

This list price book is effective as of June, 2016.

For periodic updates, please check the PDF at www.globalcontract.com. After login, select Resources then Price Lists. From here you will have the option to select any of our price lists. Global Contract warrants that all commercial products are free from defects in material and workmanship, for the life of the product, to the original Purchaser.

WARNING - SEATING PRODUCTS
TO PREVENT PRODUCT FAILURE AND POSSIBLE INJURY:

Ensure that the appropriate selection is made for the intended use of the chair including user's weight. Some chairs are not recommended for users above a certain weight. Frequently inspect the chair for visible cracks and tighten all screws, bolts and adjustable knobs. If the chair is damaged or unstable, immediately remove it from service.

Casters

The list price book specifies the caster which comes standard with each chair model. Most chairs are equipped with hard casters which are best used on carpeted surfaces. If it is intended to use the product on hard surfaces such as ceramics, concrete, linoleum or hardwood, it is recommended to use different casters. It is the responsibility of the customer to determine the standard caster for a particular product and whether such caster is appropriate for the given application.

Any information or suggestions concerning applications, specifications or compliances with codes and standards is provided solely for your convenient reference and without any representation as to accuracy or suitability. Global disclaims any legal responsibility. The user must verify and test the suitability of any information or products for his specific application. Global reserves the right to change the Terms and Conditions in the list price book without notice.

LIFETIME WARRANTY

Global Contract warrants that all commercial products are free from defects in material and workmanship, for the life of the product, to the original Purchaser.

Global Contract will repair or replace, at Global Contract's option, as the sole remedy for any defect covered by the warranty. The warranty applies to products manufactured after June 1, 2016.

This Lifetime Warranty is NOT applicable to customers who use Global Contract products for rental purposes, product installed by non-certified installer and is effective only for products, parts or components manufactured after August 1, 1998.

General Commercial Seating

Global's warranty for general commercial seating covers all chair components including pneumatic cylinders, bases, casters, glides, frames, arms, plastic seats, backs and other structural components.

Exceptions to the warranty for general commercial seating are as follows:

- Foam, textiles (as sampled on Global Contract branded and textile program cards), mesh material and electrical devices, are warranted for five (5) years
- Control mechanisms are warranted for twelve (12) years

The warranty applies to single shift, standard commercial usage, defined as a standard eight (8) hour day, forty (40) hour week for users weighing up to 300 lbs.

Textiles

Global Contract warrants Global Contract branded textiles and Global Contract carded textile programs inclusive of fabrics, vinyls and leather products for five (5) years. Global does not warrant COM (Customer's Own Material) or GPM (Global Contract Purchased Material) that are customer specified materials, or graded-in and purchased by Global Contract for a customer. For GPM or COM products, please contact the textile supplier for performance information and warranty details. Please refer to our website at www.globalcontract.com for detailed information on cleaning and care instructions. Improper usage of disinfecting/cleaning products may void the warranty.

Seating Warranty Summary

Seating Type - General Commercial Seating
Components Warranty For Original Purchaser - lifetime
Use Time For Warranty Coverage - 8 hours/5 days per week

Exceptions

Foam/textiles/mesh/electrical devices - 5 years
control mechanisms - 10 years

Files, Desks, Modular Furniture, Tables, Panels & Accessories
Global Contract warrants all components of metal storage and filing, laminate and wood veneer surfaces, laminate and wood veneer tables, metal leg components and panels for the lifetime of the product to the original Purchaser.

Exceptions to the warranty for files/desks/tables and panels are as follows:

- Electrical devices, panel and tackboard textiles, adjustable keyboard mechanisms and task lights - five (5) years
- Folding tables - one (1) year

Files, Desks, Modular Furniture, Tables, Panels & Accessories Warranty Summary

Product Type

Metal Storage & Filing - Lifetime Warranty
Keyless lock option - 2 years

Laminate/Wood Veneer Surfaces and Modular Furniture - Lifetime Warranty
Exceptions: tackboard textiles, electrical devices, task lights - 5 years

Boardroom, Conference and Training and general Tables - Lifetime Warranty
Exceptions: movable parts and electrics - 5 years

Terina Folding Tables - 1 Year Warranty

FreeFit height adjustable bases
Exceptions: movable parts and electrics - 7 years, battery packs - 1 year

Panel Systems - Lifetime Warranty
Exceptions: panel textiles, electrical devices, task lights - 5 years, writeable surfaces - 3 years

Panels - Lifetime Warranty

Exceptions: panel textiles, electrical devices, task lights - 5 years

Folding Tables - 1 Year Warranty

FreeFit height adjustable bases
• Movable parts and electrics - 7 years

Global's warranty does not apply (for any product category) to the following:

- Nominal or normal amount of wear and tear that can occur over time
- Failures which result from negligence, abuse, accident or misuse
- Failure to apply, install or maintain products according to Global Contract's written instructions and warnings
- Modifications, attachments or repair methods not approved by Global
- Damage caused by a carrier in transit, or delivery/installation contractors
- The matching of colours, grains or textures (wood, leather, etc.) of natural materials
- Products exposed to extreme hot or cold temperatures or excessively dry or humid environments
- Colour fastness or the matching of colour of textiles, dye lots of textile can vary
- Damage by markings or staining; damage by sharp objects or imprinting from instruments
- Damage to textiles or laminate and wood surfaces/edges from exposure to sunlight (including UV rays)

- Products used for rental purposes
- Products installed by a non-certified installer
- Purchased parts are warranted for one (1) year
- Failure to follow specific cleaning and care instructions posted on www.globalcontract.com

Global Contract's warranty does not cover the costs of transportation or labour. Repair or replacement will be at Global Contract's discretion.

Non-obsolescence Policy

All Global Contract products are designed and manufactured to withstand repeated service, repair and handling, and carry a lifetime warrantee. Global Contract's goal is to ensure that products can be refurbished, disassembled or upgraded as required. In addition, standardization of many parts and components facilitate ease of maintenance, servicing, assembly, and reconfiguration or reassembly.

Global Contract will provide Purchaser with product(s) of comparable function for a term equal to the warranty period. Fabrics and finishes are updated periodically to meet the growing demand of the market. As a result, some fabrics and finishes may be discontinued before expiration of the warrantee period.

Global Contract makes no warranty that any of its products are suitable for any particular purpose and makes no other warranties, express or implied, other than those set out here. As codes and standards vary from one jurisdiction to another, references to compliance are solely for convenience and without any representation as to accuracy or suitability. Users must verify the suitability of such information or product for their specific application. In no event shall Global Contract be liable in either tort or contract for any loss or direct, special, incidental, consequential, or exemplary damages.

PANEL FINISHES

Panel Frame/Raceway/Hardware	Compile Panel Frame Options	Tempered Glass	9300 Series Storage Finish
Black	BLK	Clear	CLR
Blizzard	BZD	Frosted	FRST
Charcoal	CHR		
Designer White	DWT		
Nevada	NEV		
Silver	SIL		
Stonedust	SDT	Clear	CLR
Taupe	TPE	Frosted	FRS
Tungsten	TUN		

Acrylic Glazing	
Clear	CLR
Frosted	FRS

Standard Leadtime:	
Black	BLK
Designer White	DWT
Nevada	NEV
Fog	FOG

Extended Lead Time of 2 Weeks Extra:	
Blizzard	BZD
Charcoal	CHR
Silver	SIL
Stonedust	SDT
Taupe	TPE
Tungsten	TUN

STORAGE AND WORKSURFACE FINISHES

Metal Storage Colors - Panel Frame	PVC Edge Finishes - Panel Frame Matches	Worksurface PVC Edge Trim - Wood
Matches		Grain Matches
Black	BLK	Absolute Acajou
Blizzard	**BZD	Asian Night
Charcoal	CHR	Avant Cherry
Designer White	**DWT	Avant Honey
Nevada	NEV	Clear Maple
Silver	SIL	Dark Espresso
Stonedust	**SDT	Fashionista
Taupe	TPE	First Class
Tungsten	TUN	Noce Biondo
		Noce Grigio

Noce Leggero	NEL
Noce Medio	NML
Quartered Mahogany	QTM
Sheer Beauty	SBY
Walnut Heights	WHE
White Chocolate	CBE
Winter Cherry	WCE

** Not available for radius or linear handles.

Low Pressure Laminates (LP) Panel

Frame Matches	
Black	BLKLP
Blizzard	BZDLP
Brushed Cobalt (Tungsten)	BRCLP
Custom Grey (Silver)	CGYLP
Designer White	DWTLP
Stonedust	SDTLP
Storm Grey (Charcoal)	SOGLP

High Pressure Laminates (HP) Panel

Frame Matches	
Black	BLKHP
Blizzard	BZDHP
Brushed Cobalt (Tungsten)	BRCHP
Custom Grey (Silver)	CGYHP
Designer White	DWTHP
Stonedust	SDTHP
Storm Grey (Charcoal)	SOGHP

Low Pressure Laminates (LP) Wood Grain

Laminates	
Absolute Acajou	ACJLP
Asian Night	ASNLP
Avant Cherry	AWCLP
Avant Honey	AWHLP
Clear Maple	CMBLP
Dark Espresso	DESLP
Fashionista	*FASLP
First Class	*FCLLP
Noce Biondo	NBLLP
Noce Grigio	NGLLP

High Pressure Laminates (HP) Wood Grain

Laminates	
Absolute Acajou	ACJHP
Asian Night	ASNHP
Avant Cherry	AWCHP
Avant Honey	AWHHP
Clear Maple	CMBHP
Dark Espresso	DESHP
Fashionista *	FASHP
First Class *	FCLHP
Noce Biondo	NBLHP
Noce Grigio	NGLHP

* The maximum length to have wood grain match will be 108" for Fashionista FAS, First-Class FCL, Sheer Beauty SBY.

WOOD VENEER FINISHES

Custom staining service is available, cost to match finish is \$482 net.

Walnut		Maple	
Walnut	WLW	Natural Maple	MPW
Mahogany on Walnut	MHW	White Maple	WMW
Espresso Walnut	EWV	Hazelnut	HAW
Cocoa Walnut	CAW		
Latte Walnut	LTW	White Oak	
Natural Walnut	NLW	Biscotti	BTW
Umber Walnut	ULW	Grey on Oak	GRW
Dark Walnut	DWW	Java	JAW
		Milestone	MTW
		Evening Oak	EVW
		Coral	CRW

Cherry	
Red Cherry	RCW
Dark Cherry	DCW
Amber Cherry	ACW
Warm Cherry	WCW
Almond Cherry	AMW
Vintage Cherry	VNW

PET FELT COLOURS

Amethyst	AMT
Apricot	APR
Black	BLK
Blue Smoke	BSK
Carnation	CNN
Emerald	EMD
Graphite	GPH
Lapis	LAP
Mist	MTS
Navy	NVY
Pewter	PWT
Ruby	RBV
Sunflower	SFR
White	WHT
Brick	BRI
Denim	DEN
Harvest	HVT
Shamrock	SHR

PREMIUM COLOURS FOR STORAGE

Black Coffee Textured	BKC
Bone	BNE
Business Grey	BGR
Claret	CLT
Dark Chocolate Textured	DCH
Desert Putty	DPT
Grey	GRY
Ice	ICE
Ivory	IVR
Light Grey	LGR
Metro	MET
Mocha Textured	MCH
Moss	MOS
Navy	NVY
Oyster	OYS
Sky	SKY
Stone	STN
Storm Grey	SGR
Tahiti Sand	TSA
Willow	WIL

PANEL FABRICS GRADE 1

Anchorage (R)	Linea (R)	Merge (R)	Tek (R)	
Birch	AN40	Fawn	MG20	
Green Apple	AN41	Marshmallow	MG21	
Lapis	AN42	Driftwood	MG22	
Straw	AN43	Dove	MG23	
Wolf	AN44	Graphite	MG24	
Goose	AN45	Slate	MG25	
Angora	AN46	Eucalyptus	MG26	
Cumin	AN47	Fire Engine	MG27	
Asteroid	AN48	Mediterranean	MG28	
Geranium	AN49	Midnight	MG29	
Thistle	AN50			
Graphite	AN51	Pinpoint (R)		
Slate	AN52	Bliss	PN11	
Quarry Blue	AN53	Delight	PN12	
Onyx	AN54	Dune	PN13	
Pumpkin	AN55	Infusion	PN14	
Red Delicious	AN56	Ebony	PN15	
Sunshine	AN57	Fresh	PN16	
Vanilla	AN61	Carrot	PN17	
Cobalt	AN62	Splash	PN18	
Clouds	AN64	Vibe	PN19	
		Gala	PN20	
	Loopy (R)		Terrace (R)	
	Oyster	LP60	Terrace is 57" wide, it cannot fit on panels wider than 54", it may be railroaded, but will require special application and pricing.	
	Putty	LP61	Lotus	TC60
	Marble	LP62	Tigerlily	TC61
	Hazelnut	LP63	Shadow	TC62
	Latte	LP64	Cobble	TC63
	Bay	LP65	Cherry Blossom	TC64
	Wild Rice	LP66	Bluebell	TC65
	Harbor	LP67	Apple	TC66
			Haze	TC67
	Melody (R)		Cerise	TC68
	Spray	ME40	Twilight	TC69
	Pond	ME41	Wintergreen	TC70
	Sand Bar	ME42	Ironwork	TC71
	Silt	ME43	Pine Cone	TC72
	Pebble	ME44	Flirt	TC73
	Lake	ME45	Echo	TC74
	Gravel	ME46	Glacier	TC75
	Boulder	ME47		

Chance (R)	
Mist	CN51
Dill	CN52
Island	CN53
Plaza	CN54
Tranquil	CN55
Malt	CN56
Navajo	CN57
Prairie	CN58
Cinder	CN59
Oasis	CN66

Note:
(R) = Recycled Fabric

PANEL FABRICS GRADE 2

Cyclone		Quadrille (not available on Diet) (R)	Fanfare	Repose				
Stove Pipe	IM37	Quadrille is only 54" wide, it cannot fit on panels wider than 48", it may be railroaded, but will require special application and pricing.	Denim	FA70	Jute	RP70		
Stainless	IM40		Blush	FA71	Cedar	RP71		
Polished Pewter	IM41		Marzipan	FA72	Flint	RP72		
Welded Steel	IM43		Hazel	FA73	Pelican	RP73		
Etched Bronze	IM44		Escapade	QU30	Matcha	FA74	Dew Drop	RP74
Fired Titanium	IM46		Shenanigan	QU31	Sand Dollar	FA75	Dusty Blue	RP75
Chrome	IM49		Revelry	QU32	Silver Birch	FA76	Dawn	RP76
Dark Annealed	IM50		Spring	QU33	Winter Sky	FA77	Steel Gray	RP77
Karat	IM54		Regalia	QU34	Mirage	FA78	Obsidian	RP78
Red Metal	IM55		Soiree	QU35	Misty Morning	FA79	Forrest	RP79
Oxidized Bronze	IM56		Zest	QU36				
Bright Ray	IM57		Gambol	QU37				
Bismuth Crystal	IM58		Leisure	QU38				
Gallium Blue	IM59		Fair	QU39				
			Fiesta	QU40				
Dashing (R)		Carnival	QU41					
Classic Silver	DS21	Spree	QU42					
Refined Marble	DS22	Opus	QU43					
Antique Sage	DS23	Jubilee	QU44					
Polished Slate	DS24	Masquerade	QU45					
Genteel Beige	DS25	Cabaret	QU46					
Bespoke Tan	DS26							
Dapper Grey	DS27							

SEATING FABRICS

For cushions, please chose from any of the Global Furniture Group seating fabrics.
 Seating fabric cannot be used on panels, dividers and tackboards, please choose a panels fabric.
 COM fabric is priced as grade 1.

- BAKAF - Blvd Fileco
- BAKAP - Blvd Profile
- LAKA - Licence
- AAKA - GC ADA
- DAKA - Descor
- BRAKA - Bridges II
- CMAKAF-Compile Fileco
- CMAKAP-Compile Profile
- SONBRAKA - Sonoma
- ALBRAKA - Aldon

SO# _____

PO TAG#

DATE

KEY #	SETS REQ'D	KEY #	SETS REQ'D	KEY #	SETS REQ'D	KEY #	SETS REQ'D	KEY #
401		431		461		491		521
402		432		462		492		522
403		433		463		493		523
404		434		464		494		524
405		435		465		495		525
406		436		466		496		526
407		437		467		497		527
408		438		468		498		528
409		439		469		499		529
410		440		470		500		530
411		441		471		501		531
412		442		472		502		532
413		443		473		503		533
414		444		474		504		534
415		445		475		505		535
416		446		476		506		536
417		447		477		507		537
418		448		478		508		538
419		449		479		509		539
420		450		480		510		540
421		451		481		511		541
422		452		482		512		542
423		453		483		513		543
424		454		484		514		544
425		455		485		515		545
426		456		486		516		546
427		457		487		517		547
428		458		488		518		548
429		459		489		519		549
430		460		490		520		550

BOULEVARD 1 PANELS**Features:**

- Desk height power and data management
- Patented "Knuckle-Loc", rigid connection, prevents light and sound transmission
- Built-in acoustical/tackable properties
- Sectional multi-accent design options
- Fabric surfaces are able to be replaced on-site
- Frame incorporates 1" centred slots for component adjustability
- Requires no additional top caps, end caps, trim caps, hinges, kick plates or clips
- Simple to specify
- Reduced installation time
- Easy to reconfigure
- High-tech look/stackable grid appearance
- Rigid, no sway, straight panel sight line
- Self levelers reduce assembly time, ensure even height
- Over panels extend to 10 feet to enclose an office in fabric and glazed options
- Patented Raceway cover easily removed
- Raceway panels top and bottom portion semi tackable

Construction:

- Rigid extruded aluminum, finished frame, self-leveling 2 5/8" thick panel
- 1 1/8" sound absorbent Mineral Wool each side of hardboard septum Sizes:
- 8 Heights: 29", 37", 42", 50", 54", 58", 66" 74" and 82"
- 9 Widths: 6", 18" to 60" in 6" increments, 72" wide in selected panel configurations.

Adjustability:

- 3" glide stem permits 2 1/2" height adjustment
- Slotted at 1" increments
- Over panels, 8", 16", 24", 37" and 42" for enclosed offices (Non-slotted) Acoustic Rating
- .80NRC/26STC

Door:

- 2 door panel widths, glazed/unglazed, lockable, reversible
- 2 sliding door widths, non-lockable

Flexibility:

- Universal connector

Panel Finishes:

- 2 grades of fabric, air flow grill, glaze, tempered glass, laminate & COM

Electrical:

- Desk height 8 wire/4 circuit - 1 dedicated

Communication:

- Desk height data channel
- Raceway cover easily removed
- Fabric covered raceways available

SYSTEM 3 PANELS**Features:**

- Base power and data lay-in
- Desk height power and data feed thru
- Top data lay-in
- Patented "Knuckle-Loc", rigid connection, prevents light and sound transmission
- Removable multi-functional tile design options
- Fabric surfaces are able to be replaced on-site
- Reduced installation time
- Easy to reconfigure
- High-tech look/stackable grid appearance
- Rigid, no sway, straight panel sight line
- Self levelers reduce assembly time, ensure even height
- Over panels extend height to enclose an office in fabric, glazed or laminate options
- Raceway cover easily removed

Construction:

- Rigid extruded aluminum

Sizes:

- 5 Heights: 34", 42", 50", 54", 66"
- 8 Widths: 18" to 60"

Adjustability:

- 3" glide stem permits 2 1/2" height adjustment
- Slotted at 1" centres
- Over panels, 8" and 16" (Non-slotted)

Door:

- 2 widths, glazed/solid, lockable, reversible
- 2 sliding door widths, non-lockable

Flexibility:

- Universal connector

Panel Finishes:

- Fabric, air flow accessory, tempered glass, laminate, whiteboard, corkboard (at base only)

ELECTRICAL FOR BOULEVARD 1 PANELS**Features:**

- Customized power capabilities in each panel
- State-of-the-art snap-in electrical
- 8 wire with 3 regular 15 AMP circuits and 1 isolated 15 AMP circuit.
- 3N and 8K electrical available upon request.
- Snap-in installation - harnesses, junction boxes, duplexes
- Accessibility makes changing circuits easy
- Flexibility in choice of duplexes within panel: choice of circuits for each duplex; choice of quantity of duplexes (1 or 2 duplexes per panel)

- Electrical cords are concealed
- Separate large channel for data
- Change electrical without moving pedestals
- Lower installation/reconfiguration costs
- Data terminals snap into cable holder
- Floor or ceiling feed
- Duplexes accessible from both sides

ELECTRICAL FOR SYSTEM 3 PANELS**Features:**

- Customized power capabilities in each panel
- State-of-the-art snap-in duplex receptacles
- 8 wire with 3 regular 15 AMP circuits and 1 isolated 15 AMP circuit
- Snap-in installation - harnesses, junction boxes, duplexes

- Accessibility makes changing circuits easy
- Flexibility in choice of duplexes within panel
- Data terminals snap into base raceway cover and mid panel electrical tile
- Floor or ceiling feed
- Duplexes accessible from both sides

WORKSURFACES / HARDWARE**Features:**

- One universal cantilever support
- Pedestal eliminates need for end panel/cantilever
- Grommets are not needed
- Continuous cable accessibility across back
- Adjustable to any height, in 1" increments
- Flush abutment side edge minimize seam crevice
- Metal-to-metal connections (Metal Inserts)
- Additional cable manager under worksurface

Construction:

- Medium-density particle board 1 1/16" thick

Sizes:

- 3 Depths: 18", 24" and 30"
- 12 Widths: 18" to 84" in 6" increments

Finishes:

- Tops: High Pressure Laminate, Low Pressure Laminate or Wood
- Edges: Edge banded PVC or Wood

Types:

- Transaction, keyboard, rectangular worksurface, corner, curved, D-top, P-top, Arc-top and freestanding

OVERHEAD STORAGE**Features:**

- Steel and all laminate based options
- Panel mount and up-mount options
- Completely enclosed unit for 16" overheads
- Style dependent- ship fully assembled or knocked down
- 13.5" inside height for oversized binders
- Metal-to-metal connection
- Lock secures into bottom shelf
- Doors operate smoothly
- Flipper door retrofittable on site
- Safety bracket used for extra support
- Reinforcement built in for larger unit
- Can be removed and reconfigured without disassembly

Fronts:

- Open or closed fronts
- AODA compliant options available

Sizes:

- Overheads - 7 widths in 6" increments
- Shelves - 7 widths in 6" increments
- 13.5" deep welded overheads
- 14.2" deep AODA overheads
- 16.5" deep welded overheads for EDP, ring binder, letter/legal

Paint:

- Dry epoxy powder coating

PEDESTALS**Features:**

- Premium quality steel reinforced welded construction
- Double wall construction on all drawer fronts
- Fully progressive suspension system
- Centre pull
- Worksurface supporting option
- Full extension roller bearing glides on all file drawers
- Rubber bumpers for quietness
- Movable drawer divider in box drawers
 - Pencil Tray
 - Each file drawer includes a hanging file bar (22" and 28" depth only)
- 3 depths with varying filing capacity
- Random or specific keying instructions available

Construction:

- Double wall drawer fronts
- 18-20 gauge steel case components

Sizes:

- (Prime) 18", 22", 28" depth
- (9300) 19", 23", 29" depth

Types:

- Worksurface Supporting, Mobile, Freestanding

Paint:

- Dry epoxy powder coating

HOW BOULEVARD 1 CAN REDUCE YOUR COSTS**Finished Panel:**

- No inventory costs for connectors, trim caps, top caps, kick plates and clips.
- Less time required to install, or to disassemble, move and re-install.

Fewer Parts:

- Only 1 universal cantilever and 3 brackets are needed to build most workstations.
- Easy to attach and remove components from panels.
- Universal post for 2-way, 3-way and 4-way applications.

Desk Height Electric:

- Ease of initial electrical installation lowers energy management costs.
- Snap-in electrical components reduce reconfiguration costs.
- Can customize power in each panel, pay only for what is required.

Simplified Specifications:

- Fewer parts and components make specifying, ordering, and verifying less work.
- Product fits a 6" planning module.

Replaceable Panels:

- Panels can be re-upholstered on site.
- Communications/Data Channel:
 - Desk height data channel reduces time to install and change cables.

Floor to Ceiling Enclosed Office:

- Re-usable enclosed offices with doors eliminate future costs for drywall demolition, new construction, mess and extensive cash flow.
- Depreciation expense indirectly increases cash flow.

Warranty:

- Limited Lifetime Warranty on materials and workmanship.

Product:

- Priced less than most other "A" Grade panel systems.

HOW BOULEVARD SYSTEM 3 REDUCES YOUR COSTS**Finished Panel:**

- No inventory costs for connectors, top caps, kick plates and clips.
- Less time required to install, or to disassemble, move and re-install.

Fewer Parts:

- Only 1 universal cantilever and 3 brackets are needed to build most workstations.
- Easy to attach and remove components from panels.
- Universal post for 2-way, 3-way and 4-way applications.

Base Panel Electric System:

- Ease of initial electrical installation lowers energy management costs.
- Snap-in electrical components reduce reconfigurations costs.
- Can customize power in each panel, pay only for what is required.

Simplified Specifications:

- Fewer parts and components make specifying, ordering, and verifying less work.
- Product fits a 6" planning module.

Replaceable Panel Tiles:

- Over Panels and face tiles can be added and interchanged as needs change.
- Communications/Data Channel:
 - Base and top lay-in communications channel reduces time to install and change cables.

Warranty:

- Limited Lifetime Warranty on materials and workmanship.

Product:

- Priced less than most other "A" Grade panel systems.

Value-Added Benefits

On the following pages, we selected a grouping of Boulevard 1, System 3 configurations, some with electrical components and task lights, to give you a better understanding of our product's specifications as they relate to workstations. Our objective is to not only illustrate applications using panels and components, but also to have this serve as a pricing exercise.

All of the value-added benefits of the Boulevard 1 are standard as follows:

- Desk height power and data capabilities.
- Finished panel including top, corner and end caps.
- Sectional panel with multiple fabric options.
- Ease of installation and reconfigurations.
- Removable fabric for on-site refurbishing.
- Exceptional storage capacity in pedestals, overheads, lateral files, storage cabinets and towers.
- Simplified specifications.

All of the value-added benefits of the Boulevard System 3 are standard as follows:

- Base power and data capabilities.
- Finished panel including top and corner.
- Monolithic or Pass-Thru panels with multiple fabric options.

- Ease of installation and reconfiguration.
- Removable fabric tiles in Pass-Thru Panels for on-site refurbishing.
- Exceptional storage capacity in pedestals, overheads, lateral files, storage cabinets and towers.
- Simplified specifications.

All of the value-added benefits of the Diet System are standard as follows:

- Finished panel including top, corner and end caps.
- Sectional panels with multiple fabric options.
- Ease of installation and reconfigurations.
- Removable fabric for on-site refurbishing.
- Exceptional storage capacity in pedestals, overheads, lateral files, storage cabinets and towers.
- Simplified specifications.

When specifying Boulevard 1, Boulevard System 3 or Diet, you benefit from the ability to:

- Customize the energy management.
- Minimize the number of necessary parts.
- Offer a competitive list price.

NOTE: If Key Alike Instructions are not submitted to GLOBAL CONTRACT with the Customer's Purchase Order, all components will be keyed randomly.

WOOD GRAIN (WG) LAMINATE DIRECTION



* Panel general direction will default to vertical if monolithic panel is 54" high and if raceway panels are on same order.

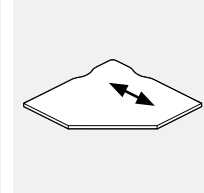
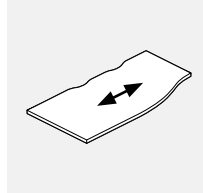
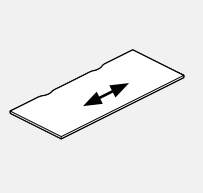
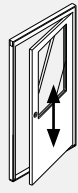

All Panels
With Exception of 66" or higher panels, the grain is vertical.

BPD
Doors.

BWS
Worksurfaces.

BWSC
Worksurfaces.

BWCF
Corner Worksurfaces.

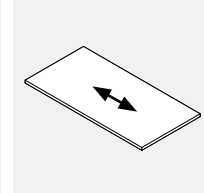
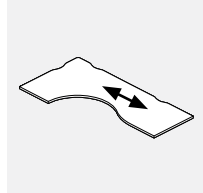
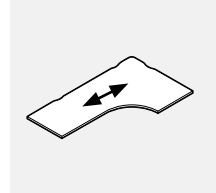
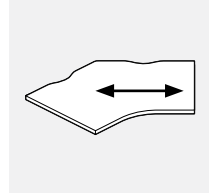
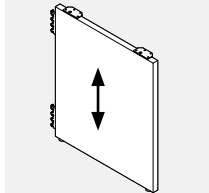
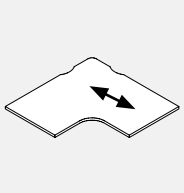

BWCL
Corner Worksurfaces.

BHFG
Full Gable.

BWAC Angled Corner
Worksurfaces

BWCE
Extended Worksurfaces.

BWCEC
Extended Worksurfaces.

BK
Desking Worksurfaces.

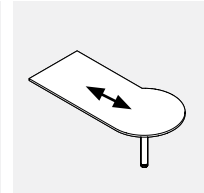
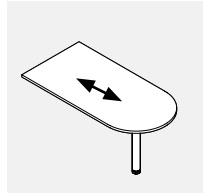
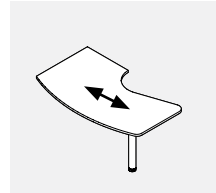
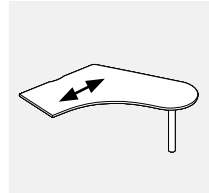
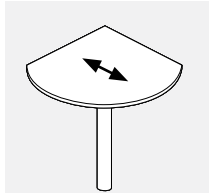
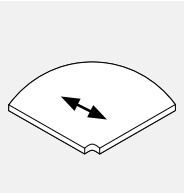

BWR
Radius Worksurfaces.

BWRTD
Teardrop Worksurfaces.

BWC
Extended "D"
Worksurfaces.

BWSL
Curvilinear Work-
surfaces.

BWD
Worksurfaces.

BWP
Worksurfaces.

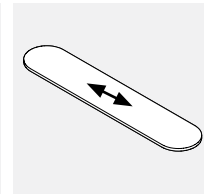
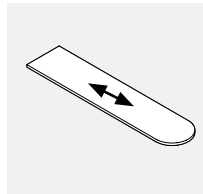
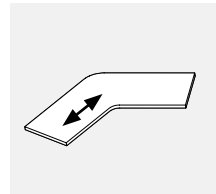
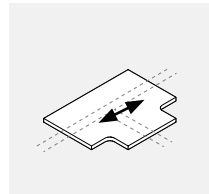
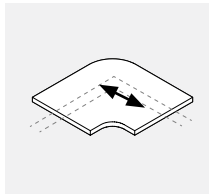
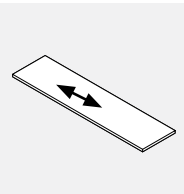

BWT
Transaction Worksurfaces.

BWTC
Corner Transaction
Worksurfaces.

BWTT
Transaction Work-
surfaces.

BWTAC
Transaction Worksur-
faces.

BWTD "D"
Transaction Worksurfaces.

BWTD "D"
Transaction Worksurfaces.

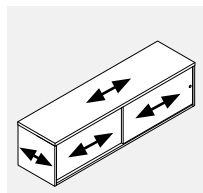
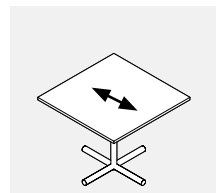
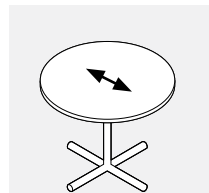
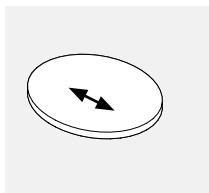
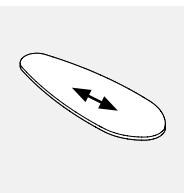

BWTE
Ellipse Transaction
Worksurfaces

BWTP
Round Transaction
Worksurfaces.

BWCD
Round Tables.

BWSQ
Square Tables.

BSP
Laminate Divider Storage

Boulevard 1 Panel System

The Boulevard philosophy is based on simplicity. A product that is simple to install... simple to reconfigure... and simple to specify, without sacrificing delivery time or quality.

Technically superb and exceptionally precise aluminum extrusion and die-cast fittings achieve exact levels of consistency, panel after panel; everything fits, aligns, and assembles, first time, every time. Most of all it requires very few of the "small parts" associated with most systems. This cross-market integration is celebrated in Boulevard.

Truly a system of broad application, whether installed in a high-tech environment, factory application or executive office, Boulevard will perform! We invite you to share with us a product designed, built and marketed for a global economy.

Our Mission

Our mission is to continue to develop and offer innovative, quality office furniture to value-oriented customers, through a dealer network that provides consistent, high quality service. Our approach in the contract furniture industry is to focus on customer concerns and needs to develop products that minimize your costs of ownership. It represents the culmination of creativity, industry expertise, specialists, and integrity to help you achieve

cost-effective solutions to problems. Our vision is to create a company-wide environment that supports constant improvement and promotes customer satisfaction. We believe that as good as we are today, we must be better tomorrow. Thus, our desire to improve is both continuous and tireless.

Environmental Commitment

At Global Contract, protecting the next generations' environment is of paramount concern. Global Contract believes that it is our responsibility to help protect the environment for future generations. We continue to operate with the environment in mind, making wise business decisions that help protect the earth and its precious natural resources. Our manufacturing procedure incorporates the latest technology for painting products, using a dry epoxy powder or gel paint. This process produces no toxic residue, and therefore is environmentally safe, while other manufacturers still use the wet paint process. Our packaging, veneer selections, and reduction in waste programs all contribute to a better environment. In addition, our concern for the reduction of finishing emissions and wood dust has resulted in a healthier work environment in many ways, including this price book, printed on recycled paper.

Technical Information

Panels

- All panels are 2 5/8" thick.
- Lightweight aluminum box frame construction creates superior panel rigidity.
- Panel frame finish is durable epoxy powder coated.
- Hang-on capabilities at 1" increments.
- Patented "Knuckle-Loc" design provides solid panel-to-panel connection for fast installation and reconfiguration.
- Knuckle lock feature ensures even panel heights throughout installation.
- 3" glide stem permits 2 1/2" height adjustment.
- Panel sizes are actual, eliminating creepage.
- Panels come complete, eliminating need for separate top, corner end trim and clips.
- Fabric is replaceable on site.
- All panels include 2 "Capture Strip" panel connectors.
- Fabric retainer is clear.
- Panels are UL listed and CSA approved and have a Class "A" fire rating except when Customer's Own Material (COM) is used.
- Centre septum above raceway overlaid on either side with tackable, 1 1/8" "Sound Absorbent Mineral Board".
- For glazing - Smoke developed index 500.
- For tempered glass, add "TG" to the end of the product code and add 20% to the price regardless of fabric grade.
- Solid metal sheet is an OPT option and price accordingly, however, the sheets are 48" wide and cannot be specified on 48" and wider unless they are railroaded. Contact your Customer Service Representative for more information.

Panel Options

- Laminate, whiteboard, or corkboard may be substituted for fabric on panels only, not raceways, see "OPT" column.
- Laminate and whiteboard are held in place with a PVC retainer matching the frame colour and can be retrofitted on site.
- Laminate and whiteboard options reduce the acoustical value of the panel.

Raceway Options

- Raceways are standard in PVC matching the panel frame finish.
- Fabric Covered Raceway (FRC) available. Aluminum raceway available.
- Wood veneer raceway available.
- Face mount electrical raceway available.
- Face mount openings are 1.5x2.85 for electrical and 1.37x2.755 for data.
- Cable capacity in raceways is 83 - 0.220" dia. cables (cat.6).

Desk Height Management

- Desk height electrical and communication raceway system.
- State-of-the-art engineering.
- Snap-in modularity of all electrical components including harnesses, junction boxes, duplexes and circuit designations.
- All power and data outlets are easily accessible from both sides of panel.
- 8 wire system with 4, 15 amp circuits (including 1 dedicated circuit).
- Optional facemount electrical with 2 duplexes per panel side.
- Outlet and circuit changes accomplished without disruption to workstation.
- Large raceway cavity permits storage of excess cables and equipment cords.
- Total flexibility for 8 wire system: choice of 1, 2 or 4 duplexes per panel; choice of circuitry in each duplex.
- Unique design of fire retardant PVC raceway cover permits access to raceway without disruption to equipment on worksurfaces.
- Clip-on communication management channel (BECC01 and BPH001) included with each raceway panel.
- Communication management channel accepts modular Data/Comm terminals (not supplied by Global Contract Inc.).

Posts

- Enables connection for multiple panel runs such as 90°, 45° or 60° angles and 2 way, 3 way or 4 way.
- Provides route for base, ceiling, and worksurface cable entry to a panel.
- Self levelling feature maintains even height of all connected panels.
- Solid lightweight aluminum extrusion fits together through a unique "Knuckle-Loc" design providing rigid post-to-panel connection.
- Includes all required panel connectors and caps.
- Posts add 2 5/8" to a panel run.
- Posts are 1/8" oversized to allow for "panel wrap around" of freestanding desks.
- For all panel runs with multiple posts, this 1/8" must be allotted for.

PANELS - GUIDELINES FOR ORDERING PRODUCT**Codes**

The product guide uses a numbering system with meaningful alphanumeric characters to create a simple-to-understand product number. This makes specifying the product much easier and more accurate.

Example of Panel: **BPRA6636 CHR CHR**

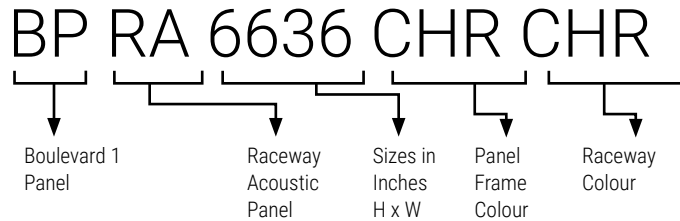

AN50

Inside Lower Fabric

AN50

Inside Upper Fabric

BE21

Outside Lower Fabric

BE21

Outside Upper Fabric

How to Specify

- Specify Boulevard 1 panel type and size by code.
- Specify panel frame finish - ie. CHR (Charcoal).
- Specify PVC raceway finish - ie. CHR (Charcoal). If PVC raceway colour not specified at time of order, default will be the panel frame colour.
- Specify all four panel fabric options if necessary.
- Some fabrics have directional pattern and cannot be applied horizontally or vertically. Panels wider than 60" will have fabrics applied horizontally (railroad). Please specify if you want adjacent panels and the rest of the installation upholstered the same way.

Example of Post: **BHP066 CHR**

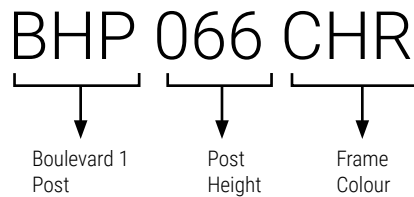
**How to Specify**

- Specify Boulevard 1 post by code.
- Specify frame colour - ie. CHR (Charcoal).

Raceways**PVC:**

- Standard, at time of order, includes 2 covers.
- Standard, when ordering individuals: RCSxxCOL.
- Facemount raceways: RCWxxD.

Fabric:

- Standard, at time of order: RCWxxFAB, panel mounted.
- Standard, when ordering individuals: 1006FRCxx, shipped separately.
- Facemount raceways: FCRxxD.

Aluminum:

- Standard, when ordering individuals: BARCxx,
- Facemount raceways: RCAxxD.

ORDERS

Each Order Must Include

- Purchase Order
- Layout showing where the image(s) appear in the run of panels.
- A completed Price Chart, showing the location of the image(s) on each appropriate panel.

Artwork must be submitted in accordance with the following artwork specifications.

NOTE: Final artwork specification approval must be given before order can be processed.

Transfer Devices

- E-mail up to 10MB to your Global Contract Customer Service Representative.
- Courier CD/DVD/USB stick to your Global Contract Customer Service Representative.

Artwork Specifications

- Non-Photographic artwork should be vector art, saved in Adobe Illustrator (.ai) or as an SVG or EPS (.eps)
- All bitmap or photographic artwork has to be at a minimum of 100 dpi at the full size of the panel to be printed.
- We accept Adobe CS5 files.
- Any linked files must be included or imbedded.
- Leave any PSD files unflattened
- All fonts must be converted to outlines.
- Do not convert to CMYK, leave all images as RGB if possible
- No Word, Powerpoint, Publisher or other Microsoft files can be used.
- Include a PDF or .jpg for reference when sending native Photoshop or Illustrator format files.

Colour Matching

- A Pantone colour reference must be supplied or we cannot accept responsibility for correct colour.
- When it is not possible to refer to Pantone colours, we will do our best to meet your requirements.

Image Clarity

- We will advise should the selected image not lend itself to the element size requested.

NOTE:

We reserve the right to put an order on hold when the files are found to be incomplete or when documents have been either incorrectly saved. Fonts not converted to curves or the

job appears not to be commercially acceptable.

Image Bleed:

To facilitate placement on the panel. Extension of the image past the finished visible area of the panel (bleed) is required

- Boulevard Panels need a 5" Bleed on all sides.

Example Of Image resolution:

The resolution required for a 36 wide x 24 high Boulevard panel at 100 dpi (minimum resolution)

The resolution required for a 36 wide x 24 high Boulevard panel at 300 dpi (higher quality)

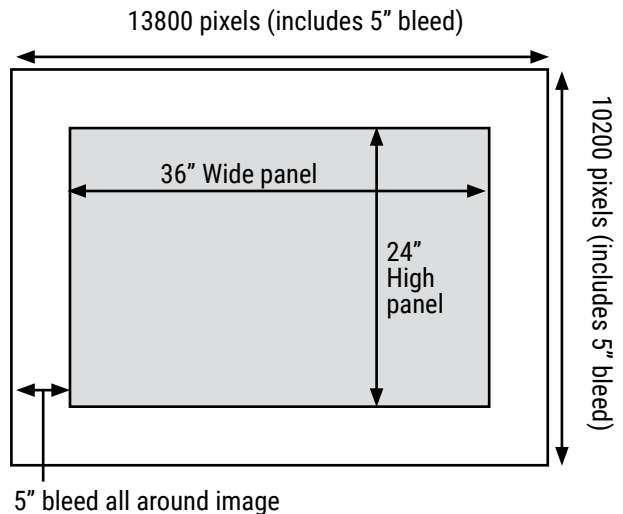
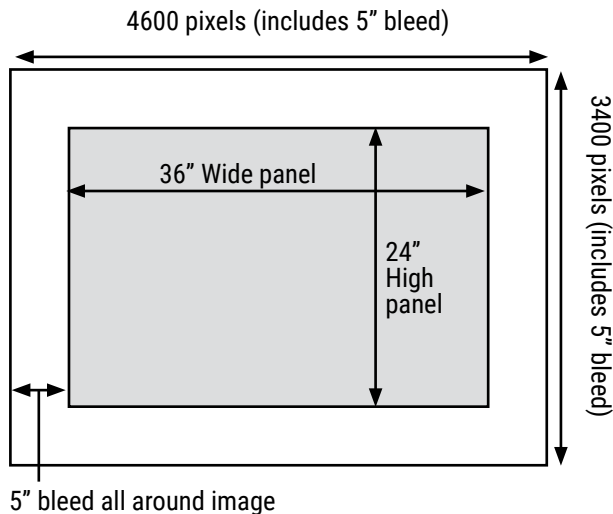

Pricing, Initial Set-Up Charge per Order:\$264 net

Boulevard 1 Panels • Below Raceway Only

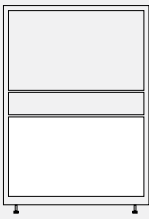

- This List applies to the following panels:
- BPRG
- BPRP
- BPAR

PANEL HEIGHT	PANEL WIDTH	LIST PRICE
29"	24"	309
29"	30"	364
29"	36"	421
29"	42"	476
29"	48"	537
29"	54"	589
29"	60"	641
29"	66"	693
29"	72"	747

Boulevard 1 • Above Raceway Only

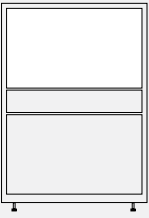

- This List applies to the following panels:
- BPRG
- BPRP

PANEL WIDTH	HEIGHT	LIST PRICE						
		42"	50"	54"	58"	66"	74"	82"
24"	N/A	183	217	248	317	384	446	
30"	N/A	218	259	295	377	452	527	
36"	N/A	259	299	340	431	520	610	
42"	N/A	286	340	392	488	589	693	
48"	N/A	324	382	438	550	661	791	
54"	N/A	353	415	476	604	731	852	
60"	N/A	384	452	520	661	800	935	
66"	N/A	415						
72"	N/A	452						

Boulevard Fabric Acoustic Panels

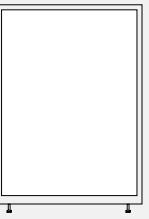

- This List applies to the following panels:
- BPPA

PANEL WIDTH	HEIGHT	LIST PRICE					
		50"	54"	58"	66"	74"	82"
24"	408	476	510	543	604	671	740
30"	483	557	602	641	717	791	867
36"	557	649	693	740	829	913	1001
42"	633	731	784	837	935	1040	1139
48"	711	823	880	935	1050	1160	1273
54"	784	905	970	1033	1154	1283	1409
60"	852	996	1063	1131	1266	1404	1539
66"	920	1063					
72"	996	1154					

Boulevard 1 Over Panels



- This List applies to the following Panels:
- BPOF

PANEL WIDTH	HEIGHT	LIST PRICE			
		16"	24"	37"	42"
24"	144	211	271	377	421
30"	171	248	324	446	499
36"	197	286	370	513	574
42"	227	324	421	589	649
48"	248	364	469	649	723
54"	279	408	520	723	800
60"	303	446	567	942	874
66"	324	476	610	852	942
72"	353	513	656	920	1018

Note: Prices shown are an upcharge to the panel price, please add to the list price of panel which you are specifying the graphic for.

BPRA • Acoustical Raceway Panel

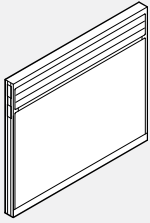

37" High

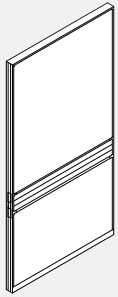

72" Wide

- Fabric above the raceway provides visual and acoustic privacy.
- Centre septum above and below raceway overlaid on either side with tackable, 1 1/8" "Sound absorbent mineral board".
- Centre septum below raceway overlaid on either side with 1 1/8" Mineral board.
- Acoustic rating of .80 NRC and 26 STC.
- OPT* = Laminate or Whiteboard.

PRODUCT CODE	PRICE			SIZE / INCHES			WEIGHT VOL	
	GR 1	GR 2	OPT*	H	W	D	LBS	FT ³
BPRA3718	528	543	557	37	18	2.61	18	1.58
BPRA3724	590	604	619	37	24	2.61	21	2.054
BPRA3730	652	661	680	37	30	2.61	25	2.528
BPRA3736	705	754	806	37	36	2.61	28	3.002
BPRA3742	763	814	867	37	42	2.61	32	3.476
BPRA3748	823	870	925	37	48	2.61	35	3.950
BPRA3754	883	931	985	37	54	2.61	39	4.424
BPRA3760	938	988	1041	37	60	2.61	44	4.898
BPRA3766	999	1060	1123	37	66	2.61	50	5.499
BPRA3772	1060	1118	1181	37	72	2.61	56	6.000
BPRA4218	565	592	623	42	18	2.61	22	1.782
BPRA4224	625	654	683	42	24	2.61	28	2.317
BPRA4230	686	714	745	42	30	2.61	32	2.852
BPRA4236	737	794	854	42	36	2.61	36	3.387
BPRA4242	800	856	917	42	42	2.61	40	3.921
BPRA4248	856	915	973	42	48	2.61	44	4.456
BPRA4254	917	973	1034	42	54	2.61	48	4.991
BPRA4260	973	1030	1091	42	60	2.61	52	5.525
BPRA4266	1087	1204	1330	42	66	2.61	62	6.148
BPRA4272	1197	1315	1441	42	72	2.61	72	6.770
BPRA5018	603	630	659	50	18	2.61	25	2.106
BPRA5024	661	707	751	50	24	2.61	30	2.738
BPRA5030	726	773	816	50	30	2.61	35	3.370
BPRA5036	792	864	938	50	36	2.61	40	4.002
BPRA5042	852	922	998	50	42	2.61	45	4.634
BPRA5048	917	987	1063	50	48	2.61	50	5.266
BPRA5054	976	1050	1123	50	54	2.61	55	5.898
BPRA5060	1040	1112	1187	50	60	2.61	60	6.530
BPRA5066	1137	1258	1382	50	66	2.61	70	7.300
BPRA5072	1233	1351	1476	50	72	2.61	80	8.000
BPRA5418	629	657	688	54	18	2.61	27	2.250
BPRA5424	692	734	780	54	24	2.61	32	2.960
BPRA5430	754	796	842	54	30	2.61	37	3.689
BPRA5436	820	905	997	54	36	2.61	42	4.318
BPRA5442	883	966	1060	54	42	2.61	47	4.934
BPRA5448	948	1030	1123	54	48	2.61	52	5.666
BPRA5454	1007	1092	1186	54	54	2.61	59	6.398
BPRA5460	1073	1157	1250	54	60	2.61	62	7.035

BPRA • Acoustical Raceway Panel ...Cont

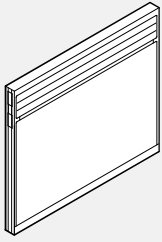

37" High

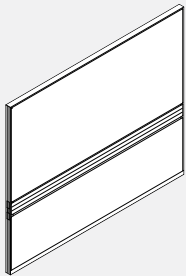
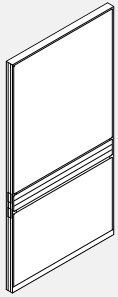

72" Wide

- Fabric above the raceway provides visual and acoustic privacy.
- Centre septum above and below raceway overlaid on either side with tackable, 1 1/8" "Sound absorbent mineral board".
- Centre septum below raceway overlaid on either side with 1 1/8" Mineral board.
- Acoustic rating of .80 NRC and 26 STC.
- OPT* = Laminate or Whiteboard.

PRODUCT CODE	PRICE			SIZE / INCHES			WEIGHT LBS	VOL FT ³
	GR 1	GR 2	OPT*	H	W	D		
BPRA5818	655	683	714	58	18	2.61	28	2.431
BPRA5824	721	762	809	58	24	2.61	33	3.160
BPRA5830	780	823	867	58	30	2.61	38	3.889
BPRA5836	846	930	1023	58	36	2.61	43	4.618
BPRA5842	913	997	1089	58	42	2.61	48	5.347
BPRA5848	975	1061	1153	58	48	2.61	53	6.076
BPRA5854	1040	1125	1216	58	54	2.61	58	6.806
BPRA5860	1106	1189	1283	58	60	2.61	63	7.535
BPRA6618	699	745	788	66	18	2.61	32	2.755
BPRA6624	770	826	886	66	24	2.61	37	3.581
BPRA6630	837	894	955	66	30	2.61	42	4.407
BPRA6636	903	1001	1108	66	36	2.61	48	5.234
BPRA6642	970	1067	1174	66	42	2.61	53	6.060
BPRA6648	1037	1137	1241	66	48	2.61	58	6.887
BPRA6654	1103	1203	1309	66	54	2.61	63	7.713
BPRA6660	1170	1269	1375	66	60	2.61	68	8.539
BPRA7418	759	802	849	74	18	2.61	34	3.079
BPRA7424	826	884	943	74	24	2.61	39	4.002
BPRA7430	894	952	1012	74	30	2.61	45	4.926
BPRA7436	963	1078	1198	74	36	2.61	50	5.850
BPRA7442	1034	1147	1267	74	42	2.61	55	6.773
BPRA7448	1102	1214	1336	74	48	2.61	60	7.697
BPRA7454	1170	1284	1405	74	54	2.61	65	8.620
BPRA7460	1238	1352	1473	74	60	2.61	70	9.544
BPRA8218	823	864	909	82	18	2.61	36	3.403
BPRA8224	893	963	1038	82	24	2.61	42	4.424
BPRA8230	963	1034	1109	82	30	2.61	48	5.444
BPRA8236	1035	1165	1300	82	36	2.61	54	6.465
BPRA8242	1106	1233	1369	82	42	2.61	60	7.486
BPRA8248	1175	1302	1440	82	48	2.61	66	8.507
BPRA8254	1245	1374	1511	82	54	2.61	72	9.528
BPRA8260	1320	1445	1583	82	60	2.61	78	10.549

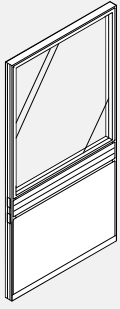
BPRG • Partly Glazed Raceway Panel

- Glazing above the raceway provides visual accessibility.
- Centre septum below raceway overlaid on either side with 1 1/8" "Sound absorbent mineral board".
- Glazing replaceable on site.
- Standard glaze is acrylic.
- For tempered glass, add "TG" to the end of the product code and add 20% to the price regardless of fabric grade or finish.
- OPT* = Laminate or Whiteboard.

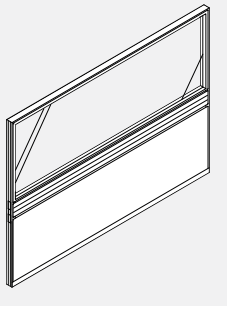

72" Wide

PRODUCT CODE	PRICE			SIZE/INCHES			WEIGHT LBS	VOL FT ³
	GR 1	GR 2	OPT*	H	W	D		
BPRG4218	712	723	740	42	18	2.61	22	1.782
BPRG4224	778	805	835	42	24	2.61	28	2.317
BPRG4230	845	872	903	42	30	2.61	32	2.852
BPRG4236	913	970	1029	42	36	2.61	36	3.387
BPRG4242	976	1034	1094	42	42	2.61	40	3.921
BPRG4248	1045	1102	1165	42	48	2.61	44	4.456
BPRG4254	1112	1169	1231	42	54	2.61	48	4.991
BPRG4260	1177	1235	1296	42	60	2.61	52	5.525
BPRG4266	1244	1303	1369	42	66	2.61	62	6.148
BPRG4272	1312	1370	1436	42	72	2.61	72	6.770
BPRG5018	791	805	820	50	18	2.61	24	2.106
BPRG5024	856	885	916	50	24	2.61	29	2.738
BPRG5030	926	955	985	50	30	2.61	34	3.370
BPRG5036	996	1053	1113	50	36	2.61	39	4.002
BPRG5042	1063	1121	1180	50	42	2.61	44	4.634
BPRG5048	1131	1188	1246	50	48	2.61	48	5.266
BPRG5054	1200	1259	1318	50	54	2.61	54	5.898
BPRG5060	1267	1326	1385	50	60	2.61	59	6.530
BPRG5066	1309	1368	1434	50	66	2.61	70	7.300
BPRG5072	1348	1407	1441	50	72	2.61	78	8.000
BPRG5418	831	846	862	54	18	2.61	27	2.250
BPRG5424	897	928	958	54	24	2.61	30	2.960
BPRG5430	970	998	1028	54	30	2.61	35	3.689
BPRG5436	1040	1096	1157	54	36	2.61	40	4.318
BPRG5442	1109	1168	1227	54	42	2.61	45	4.934
BPRG5448	1177	1235	1296	54	48	2.61	49	5.666
BPRG5454	1246	1304	1367	54	54	2.61	55	6.398
BPRG5460	1318	1375	1436	54	60	2.61	60	7.035
BPRG5818	872	886	901	58	18	2.61	26	2.431
BPRG5824	941	970	999	58	24	2.61	31	3.160
BPRG5830	1012	1040	1069	58	30	2.61	36	3.889
BPRG5836	1086	1142	1201	58	36	2.61	41	4.618
BPRG5842	1156	1212	1273	58	42	2.61	46	5.347
BPRG5848	1225	1283	1343	58	48	2.61	51	6.076
BPRG5854	1296	1352	1412	58	54	2.61	56	6.806
BPRG5860	1367	1424	1483	58	60	2.61	61	7.535
BPRG6618	949	962	976	66	18	2.61	29	2.755
BPRG6624	1023	1052	1083	66	24	2.61	34	3.581
BPRG6630	1096	1126	1156	66	30	2.61	39	4.407
BPRG6636	1171	1231	1290	66	36	2.61	45	5.234
BPRG6642	1245	1303	1366	66	42	2.61	50	6.060
BPRG6648	1324	1379	1440	66	48	2.61	55	6.887
BPRG6654	1396	1454	1514	66	54	2.61	60	7.713
BPRG6660	1475	1534	1594	66	60	2.61	65	8.539
BPRG7418	1024	1037	1053	74	18	2.61	30	3.079
BPRG7424	1103	1132	1165	74	24	2.61	35	4.002
BPRG7430	1181	1238	1300	74	30	2.61	41	4.926
BPRG7436	1261	1318	1378	74	36	2.61	46	5.850
BPRG7442	1339	1396	1457	74	42	2.61	51	6.773
BPRG7448	1419	1476	1539	74	48	2.61	56	7.697
BPRG7454	1498	1554	1615	74	54	2.61	61	8.620
BPRG7460	1590	1647	1710	74	60	2.61	66	9.544
BPRG8218	1079	1091	1107	82	18	2.61	31	3.403
BPRG8224	1168	1197	1226	82	24	2.61	36	4.424
BPRG8230	1259	1288	1317	82	30	2.61	43	5.444
BPRG8236	1348	1406	1466	82	36	2.61	49	6.465
BPRG8242	1435	1491	1550	82	42	2.61	55	7.486
BPRG8248	1526	1583	1644	82	48	2.61	61	8.507
BPRG8254	1613	1670	1731	82	54	2.61	67	9.528
BPRG8260	1714	1774	1832	82	60	2.61	73	10.549

BPRF • Air Flow Panel

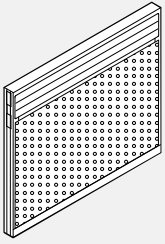

37" High

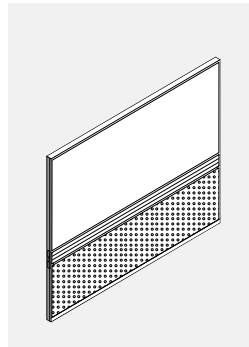
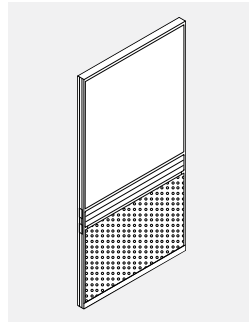

72" Wide

- Double wall of perforated metal below the raceway allows air to flow freely through the bottom of the panel.
- Centre septum above raceway overlaid on either side with tackable, 1 1/8" "Sound absorbent mineral board".
- For air flow option above the raceway, add 20% to the Grade 1 price and tag each item with "air flow above raceway". For example: BPRF4218 TAG:*air flow above raceway.
- OPT* = Laminate or Whiteboard.

PRODUCT CODE	PRICE			SIZE/INCHES			WEIGHT VOL	
	GR 1	GR 2	OPT*	H	W	D	LBS	FT ³
BPRF3718	592	-	-	37	18	2.61	18	1.58
BPRF3724	670	-	-	37	24	2.61	21	2.054
BPRF3730	755	-	-	37	30	2.61	25	2.528
BPRF3736	833	-	-	37	36	2.61	28	3.002
BPRF3742	916	-	-	37	42	2.61	32	3.476
BPRF3748	996	-	-	37	48	2.61	35	3.950
BPRF3754	1074	-	-	37	54	2.61	39	4.424
BPRF3760	1156	-	-	37	60	2.61	44	4.898
BPRF3766	1243	-	-	37	66	2.61	50	5.449
BPRF3772	1330	-	-	37	72	2.61	56	6.000
BPRF4218	612	621	627	42	18	2.61	22	1.782
BPRF4224	694	701	712	42	24	2.61	28	2.317
BPRF4230	778	784	791	42	30	2.61	32	2.852
BPRF4236	860	872	888	42	36	2.61	36	3.387
BPRF4242	943	958	972	42	42	2.61	40	3.921
BPRF4248	1026	1038	1055	42	48	2.61	44	4.456
BPRF4254	1108	1122	1137	42	54	2.61	48	4.991
BPRF4260	1196	1208	1224	42	60	2.61	52	5.525
BPRF4266	1333	1394	1458	42	66	2.61	62	6.270
BPRF4272	1473	1533	1599	42	72	2.61	72	6.770
BPRF5018	688	699	717	50	18	2.61	25	2.106
BPRF5024	773	784	800	50	24	2.61	30	2.738
BPRF5030	857	870	886	50	30	2.61	35	3.370
BPRF5036	947	973	1003	50	36	2.61	40	4.002
BPRF5042	1034	1063	1092	50	42	2.61	45	4.634
BPRF5048	1121	1148	1178	50	48	2.61	50	5.266
BPRF5054	1205	1235	1265	50	54	2.61	55	5.898
BPRF5060	1294	1324	1352	50	60	2.61	60	6.530
BPRF5066	1424	1482	1547	50	66	2.61	70	7.300
BPRF5072	1550	1609	1675	50	72	2.61	80	8.000
BPRF5418	713	733	755	54	18	2.61	27	2.250
BPRF5424	797	819	842	54	24	2.61	32	2.960
BPRF5430	886	908	930	54	30	2.61	37	3.689
BPRF5436	973	1017	1062	54	36	2.61	42	4.318
BPRF5442	1063	1106	1152	54	42	2.61	47	4.934
BPRF5448	1152	1194	1237	54	48	2.61	52	5.666
BPRF5454	1237	1279	1326	54	54	2.61	57	6.398
BPRF5460	1327	1369	1414	54	60	2.61	62	7.035

BPRF • Air Flow Panel ...Cont

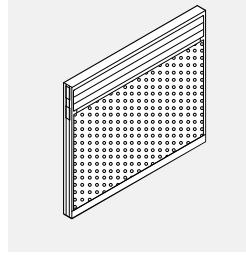

37" High

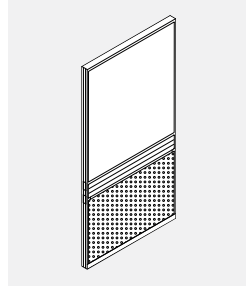

72" Wide

- Double wall of perforated metal below the raceway allows air to flow freely through the bottom of the panel.
- Centre septum above raceway overlaid on either side with tackable, 1 1/8" "Sound absorbent mineral board".
- For air flow option above the raceway, add 20% to the Grade 1 price and tag each item with "air flow above raceway". For example: BPRF4218 TAG:*air flow above raceway.
- OPT* = Laminate or Whiteboard.

PRODUCT CODE	PRICE			SIZE/INCHES			WEIGHT LBS	VOL FT ³
	GR 1	GR 2	OPT*	H	W	D		
BPRF5818	734	755	779	58	18	2.61	28	2.431
BPRF5824	824	845	867	58	24	2.61	33	3.160
BPRF5830	916	936	959	58	30	2.61	38	3.889
BPRF5836	1001	1045	1090	58	36	2.61	43	4.618
BPRF5842	1090	1132	1177	58	42	2.61	48	5.347
BPRF5848	1180	1224	1267	58	48	2.61	53	6.076
BPRF5854	1267	1310	1355	58	54	2.61	58	6.806
BPRF5860	1358	1401	1445	58	60	2.61	63	7.535
BPRF6618	784	813	843	66	18	2.61	32	2.755
BPRF6624	879	907	936	66	24	2.61	37	3.581
BPRF6630	969	997	1027	66	30	2.61	42	4.407
BPRF6636	1060	1108	1160	66	36	2.61	48	5.234
BPRF6642	1212	1264	1317	66	42	2.61	53	6.060
BPRF6648	1288	1336	1389	66	48	2.61	58	6.887
BPRF6654	1395	1443	1498	66	54	2.61	63	7.713
BPRF6660	1435	1483	1538	66	60	2.61	68	8.539
BPRF7418	842	869	898	74	18	2.61	34	3.079
BPRF7424	931	960	992	74	24	2.61	39	4.002
BPRF7430	1026	1055	1086	74	30	2.61	45	4.926
BPRF7436	1121	1193	1266	74	36	2.61	50	5.850
BPRF7442	1294	1366	1440	74	42	2.61	55	6.773
BPRF7448	1332	1405	1480	74	48	2.61	60	7.697
BPRF7454	1397	1470	1543	74	54	2.61	65	8.620
BPRF7460	1491	1563	1638	74	60	2.61	70	9.544
BPRF8218	907	949	995	82	18	2.61	36	3.403
BPRF8224	1000	1043	1089	82	24	2.61	42	4.424
BPRF8230	1094	1137	1181	82	30	2.61	48	5.444
BPRF8236	1201	1279	1363	82	36	2.61	54	6.465
BPRF8242	1332	1411	1496	82	42	2.61	60	7.486
BPRF8248	1395	1473	1556	82	48	2.61	66	8.507
BPRF8254	1543	1622	1706	82	54	2.61	72	9.528
BPRF8260	1575	1654	1738	82	60	2.61	78	10.549

BPRAE • Raceway Panel Electrical

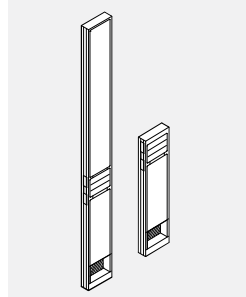

- A 6" raceway panel allows power and communication/data entry along a straight run of panels where a standard post entry cannot be utilized.
- Sections above and below the raceway are upholstered in fabric.
- Inner lower raceway area allows for single or double power feed entry and provides 1.3" x 2.9" opening for communication/data cables.
- All 6" panels must be used in conjunction with a second panel to form a standard panel width. For example: BPRAE6606 + BPRA6618 is equivalent to BPRA6624.
- 6" panels are not to be used as a stability panel in a panel run.

PRODUCT CODE	PRICE			SIZE/ INCHES			WEIGHT LBS	VOL FT ³
	GR 1	GR 2	OPT*	H	W	D		
BPRAE3706	590	605	621	37	6	2.61	24	0.6
BPRAE4206	590	619	652	42	6	2.61	26	0.7
BPRAE5006	661	709	752	50	6	2.61	29	0.8
BPRAE5406	692	736	781	54	6	2.61	31	0.9
BPRAE5806	721	763	811	58	6	2.61	32	0.9
BPRAE6606	770	826	888	66	6	2.61	35	1.0
BPRAE7406	826	884	947	74	6	2.61	37	1.1
BPRAE8206	893	963	1040	82	6	2.61	41	1.2

BPRA • Raceway Panel Filler

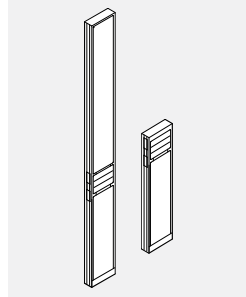

- A 6" (BPRA) raceway panel for use as a filler panel.
- Sections above and below the raceway are upholstered in fabric.
- All 6" panels must be used in conjunction with a second panel to form a standard panel width. For example: BPRA6606 + BPRA6618 is equivalent to BPRA6624.
- 6" panels are not to be used as a stability panel in a panel run.

PRODUCT CODE	PRICE			SIZE/INCHES			WEIGHT LBS	VOL FT ³
	GR 1	GR 2	OPT*	H	W	D		
BPRA3706	590	604	619	37	6	2.61	24	0.6
BPRA4206	590	619	649	42	6	2.61	26	0.7
BPRA5006	661	707	751	50	6	2.61	29	0.8
BPRA5406	692	734	780	54	6	2.61	31	0.9
BPRA5806	721	762	809	58	6	2.61	32	0.9
BPRA6606	770	826	886	66	6	2.61	35	1.0
BPRA7406	826	884	943	74	6	2.61	37	1.1
BPRA8206	893	963	1038	82	6	2.61	41	1.2

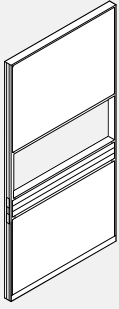
BPRP • Pass-Thru Raceway Panel

- **10.5" Open cavity allows accessibility between workstations.**
- Center septum above 10.5" opening overlaid on either side with tackable, 1 1/8" mineral board.
- Center septum below raceway overlaid on either side with tackable, 1 1/8" mineral board.
- Pass-thru opening is 10.5" high starting above the raceway.
- Panel height to top of opening is fixed.

PRODUCT CODE	PRICE			SIZE/INCHES			WEIGHT LBS	VOL FT ³
	GR 1	GR 2	OPT*	H	W	D		
BPRP6618	949	962	976	66	18	2.61	32	2.755
BPRP6624	1023	1052	1083	66	24	2.61	33	3.581
BPRP6630	1096	1126	1156	66	30	2.61	38	4.407
BPRP6636	1171	1231	1290	66	36	2.61	44	5.234
BPRP6642	1245	1303	1366	66	42	2.61	49	6.060
BPRP6648	1324	1379	1440	66	48	2.61	54	6.887
BPRP6654	1396	1454	1514	66	54	2.61	59	7.713
BPRP6660	1475	1534	1594	66	60	2.61	64	8.539
BPRP7418	1024	1060	1094	74	18	2.61	31	3.079
BPRP7424	1103	1160	1223	74	24	2.61	36	4.002
BPRP7430	1181	1238	1300	74	30	2.61	42	4.926
BPRP7436	1261	1329	1405	74	36	2.61	47	5.850
BPRP7442	1339	1396	1457	74	42	2.61	52	6.773
BPRP7448	1419	1514	1613	74	48	2.61	57	7.697
BPRP7454	1498	1590	1690	74	54	2.61	62	8.620
BPRP7460	1590	1647	1710	74	60	2.61	67	9.544
BPRP8218	1079	1119	1165	82	18	2.61	34	3.403
BPRP8224	1168	1223	1279	82	24	2.61	40	4.424
BPRP8230	1259	1312	1370	82	30	2.61	46	5.444
BPRP8236	1348	1447	1552	82	36	2.61	52	6.465
BPRP8242	1435	1547	1668	82	42	2.61	58	7.486
BPRP8248	1526	1639	1758	82	48	2.61	64	8.507
BPRP8254	1613	1724	1846	82	54	2.61	70	9.528
BPRP8260	1714	1827	1949	82	60	2.61	76	10.549

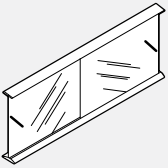
BPRPSD • Pass-Thru Sliding Door Kit

- **To close the opening in a Boulevard 1 Pass-Thru Panel.**
- Sliding frosted tempered glass doors.

PRODUCT CODE	PRICE	SIZE/INCHES			WEIGHT LBS	VOL FT ³
		H	W	D		
BPRPSD36	385	10	36	2.61	13	1.2
BPRPSD42	433	10	42	2.61	16	1.4
BPRPSD48	483	10	48	2.61	18	1.5
BPRPSD54	528	10	54	2.61	20	1.7
BPRPSD60	578	10	60	2.61	22	2.0

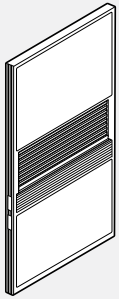
BPAR • Accessory Rail Panel

- **12" Accessory rail covers the standard pass-thru opening and allows users to hang accessories.**
- Centre septum above 12" opening overlaid on either side with tackable, 1 1/8" "Sound absorbent mineral board".
- Centre septum below raceway overlaid on either side with 1 1/8" mineral board.
- Accessory rail is 12" high starting above the raceway. Panel height to top of opening is fixed.
- OPT* = Laminate or Whiteboard.

PRODUCT CODE	PRICE			SIZE/INCHES			WEIGHT LBS	VOL FT ³
	GR 1	GR 2	OPT*	H	W	D		
BPAR6618	1107	1121	1135	66	18	2.61	35	2.755
BPAR6624	1201	1232	1261	66	24	2.61	42	3.581
BPAR6630	1320	1348	1378	66	30	2.61	49	4.407
BPAR6636	1442	1500	1561	66	36	2.61	57	5.234
BPAR6642	1595	1653	1713	66	42	2.61	65	6.060
BPAR6648	1714	1774	1832	66	48	2.61	72	6.887
BPAR6654	1838	1893	1955	66	54	2.61	79	7.713
BPAR6660	1953	2012	2071	66	60	2.61	86	8.539
BPAR7418	1186	1220	1258	74	18	2.61	38	3.079
BPAR7424	1279	1338	1397	74	24	2.61	45	4.002
BPAR7430	1397	1456	1515	74	30	2.61	53	4.926
BPAR7436	1529	1600	1672	74	36	2.61	60	5.850
BPAR7442	1683	1741	1801	74	42	2.61	68	6.773
BPAR7448	1805	1903	2007	74	48	2.61	75	7.697
BPAR7454	1930	1987	2049	74	54	2.61	82	8.620
BPAR7460	2060	2117	2177	74	60	2.61	89	9.544
BPAR8218	1234	1273	1318	82	18	2.61	41	3.403
BPAR8224	1340	1395	1454	82	24	2.61	49	4.424
BPAR8230	1470	1525	1581	82	30	2.61	57	5.444
BPAR8236	1608	1710	1813	82	36	2.61	65	6.465
BPAR8242	1775	1888	2007	82	42	2.61	74	7.486
BPAR8248	1906	2019	2141	82	48	2.61	82	8.507
BPAR8254	2042	2156	2277	82	54	2.61	90	9.528
BPAR8260	2174	2288	2408	82	60	2.61	98	10.549

BPFA • Acoustical Fabric Panel

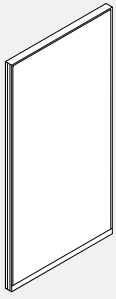

- Complete fabric panel without raceway.
- Acoustical rating of .80 NRC and 26 STC.
- Centre septum overlaid on either side with 1/8" Mineral board, non tackable.
- OPT* = Laminate or Whiteboard.

PRODUCT CODE	PRICE			SIZE / INCHES			WEIGHT LBS	VOL FT ³
	GR 1	GR 2	OPT*	H	W	D		
BPFA2918	364	391	420	29	18	2.61	15	1.256
BPFA2924	392	422	456	29	24	2.61	17	1.633
BPFA2930	419	449	478	29	30	2.61	19	2.009
BPFA2936	450	508	568	29	36	2.61	21	2.386
BPFA2942	477	536	593	29	42	2.61	23	2.763
BPFA2948	508	565	625	29	48	2.61	25	3.139
BPFA2954	536	591	653	29	54	2.61	27	3.513
BPFA2960	563	621	681	29	60	2.61	29	3.893
BPFA2966	582	643	709	29	66	2.61	36	4.332
BPFA2972	604	660	-	29	72	2.61	42	4.770
BPFA4218	477	507	537	42	18	2.61	18	1.782
BPFA4224	509	567	626	42	24	2.61	21	2.317
BPFA4230	539	593	655	42	30	2.61	24	2.852
BPFA4236	569	639	715	42	36	2.61	27	3.387
BPFA4242	600	670	746	42	42	2.61	30	3.921
BPFA4248	629	698	777	42	48	2.61	33	4.456
BPFA4254	658	727	805	42	54	2.61	36	4.991
BPFA4260	691	761	837	42	60	2.61	39	5.525
BPFA4266	779	896	1024	42	66	2.61	47	6.148
BPFA4272	865	985	-	42	72	2.61	54	6.770
BPFA5018	540	568	596	50	18	2.61	22	2.106
BPFA5024	573	613	658	50	24	2.61	25	2.738
BPFA5030	605	647	692	50	30	2.61	28	3.370
BPFA5036	636	722	813	50	36	2.61	31	4.002
BPFA5042	668	752	845	50	42	2.61	34	4.634
BPFA5048	698	784	877	50	48	2.61	38	5.266
BPFA5054	733	817	909	50	54	2.61	41	5.898
BPFA5060	765	851	942	50	60	2.61	43	6.530
BPFA5066	843	962	1089	50	66	2.61	53	7.300
BPFA5072	920	1038	-	50	72	2.61	62	8.000
BPFA5418	570	600	629	54	18	2.61	23	2.250
BPFA5424	604	645	691	54	24	2.61	26	2.960
BPFA5430	636	680	723	54	30	2.61	30	3.689
BPFA5436	670	754	846	54	36	2.61	34	4.318
BPFA5442	701	786	880	54	42	2.61	38	4.934
BPFA5448	736	820	913	54	48	2.61	41	5.666
BPFA5454	770	853	947	54	54	2.61	43	6.398
BPFA5460	805	891	983	54	60	2.61	46	7.035

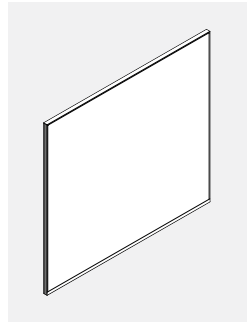

72" Wide

BPFA • Acoustical Fabric Panel ...Cont

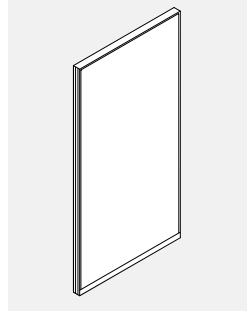

- Complete fabric panel without raceway.
- Acoustical rating of .80 NRC and 26 STC.
- Centre septum overlaid on either side with 1 1/8" Mineral board, non tackable.
- OPT* = Laminate or Whiteboard.

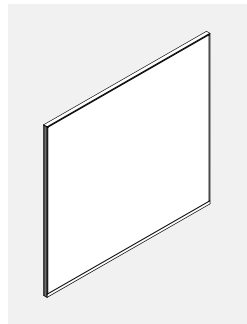

72" Wide

PRODUCT CODE	PRICE			SIZE/INCHES			WEIGHT LBS	VOL FT ³
	GR 1	GR 2	OPT*	H	W	D		
BPFA5818	602	643	688	58	18	2.61	24	2.431
BPFA5824	634	692	752	58	24	2.61	27	3.160
BPFA5830	668	724	785	58	30	2.61	31	3.889
BPFA5836	699	801	907	58	36	2.61	35	4.618
BPFA5842	736	835	941	58	42	2.61	39	5.347
BPFA5848	773	869	975	58	48	2.61	42	6.076
BPFA5854	805	905	1011	58	54	2.61	46	6.806
BPFA5860	843	942	1050	58	60	2.61	50	7.535
BPFA6618	656	697	745	66	18	2.61	26	2.755
BPFA6624	693	751	812	66	24	2.61	29	3.581
BPFA6630	731	788	850	66	30	2.61	34	4.407
BPFA6636	770	883	1001	66	36	2.61	39	5.234
BPFA6642	809	921	1041	66	42	2.61	43	6.060
BPFA6648	846	959	1080	66	48	2.61	47	6.887
BPFA6654	885	998	1119	66	54	2.61	51	7.713
BPFA6660	921	1034	1155	66	60	2.61	55	8.539
BPFA7418	720	761	806	74	18	2.61	28	3.079
BPFA7424	758	829	905	74	24	2.61	32	4.002
BPFA7430	797	868	943	74	30	2.61	37	4.926
BPFA7436	837	963	1101	74	36	2.61	42	5.850
BPFA7442	879	1003	1142	74	42	2.61	47	6.773
BPFA7448	918	1045	1181	74	48	2.61	51	7.697
BPFA7454	958	1086	1223	74	54	2.61	55	8.620
BPFA7460	999	1126	1264	74	60	2.61	60	9.544
BPFA8218	778	833	894	82	18	2.61	30	3.403
BPFA8224	819	891	964	82	24	2.61	35	4.424
BPFA8230	863	933	1007	82	30	2.61	40	5.444
BPFA8236	907	1050	1199	82	36	2.61	45	6.465
BPFA8242	949	1090	1239	82	42	2.61	50	7.486
BPFA8248	994	1134	1286	82	48	2.61	55	8.507
BPFA8254	1037	1178	1329	82	54	2.61	60	9.528
BPFA8260	1084	1225	1375	82	60	2.61	65	10.549

BPFG • Glazed Panel

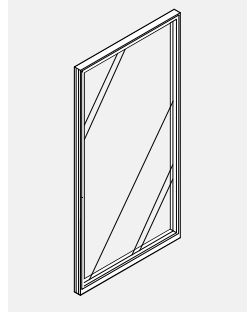

- Full-height glazing provides visual accessibility.
- Glazing is replaceable on site.
- For tempered glass, add "TG" to the end of the product code and 20% to the list price regardless of finish.

PRODUCT CODE	PRICE	SIZE/ INCHES			WEIGHT LBS	VOL FT ³
		H	W	D		
BPFG5824	833	58	24	2.61	21	3.160
BPFG5830	918	58	30	2.61	24	3.889
BPFG5836	1000	58	36	2.61	27	4.618
BPFG5842	1086	58	42	2.61	30	5.347
BPFG5848	1167	58	48	2.61	33	6.076
BPFG6624	1004	66	24	2.61	25	3.581
BPFG6630	1090	66	30	2.61	28	4.407
BPFG6636	1177	66	36	2.61	31	5.234
BPFG6642	1264	66	42	2.61	34	6.060
BPFG6648	1352	66	48	2.61	37	6.887
BPFG7424	1053	74	24	2.61	28	4.002
BPFG7430	1143	74	30	2.61	31	4.926
BPFG7436	1235	74	36	2.61	34	5.850
BPFG7442	1327	74	42	2.61	37	6.773
BPFG7448	1416	74	48	2.61	40	7.697
BPFG8224	1148	82	24	2.61	31	4.424
BPFG8230	1255	82	30	2.61	34	5.444
BPFG8236	1352	82	36	2.61	37	6.465
BPFG8242	1454	82	42	2.61	40	7.486
BPFG8248	1554	82	48	2.61	43	8.507

BPOF • Fabric Over Panel

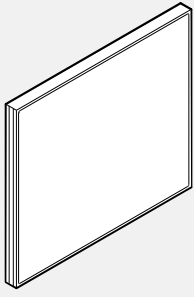

- **Attaches to top of a panel to create floor-to-ceiling wall.**

- Centre septum overlaid on either side with 1 1/8" Mineral board.
- Non-slotted.
- Factory installed PVC strip attaches and aligns over panel to top of base panel.
- PVC strip runs entire width eliminating light seepage.
- For custom heights and widths, please order size required and price as next size up. Example: 26" high, 35" wide, order BPOF2635 at \$473 Grade 1.
- Custom heights over 42" must be quoted separately.
- Overpanels can be stacked on any panel. Example: BPOF2418 stacked on BPRA4218 to give an overall height of 66".
- When stacking on 29" or 37" high B1 panels, custom height required, please contact customer service.
- Exact height should be specified when ordering, with allowance of at least 1" of free space between over panel and ceiling to accommodate height variations in ceiling and floor. Runs of over panels should be captured at either end with full height posts, wall adapters, taller panels, and/or vertical trims.
- Minimum height of 6".
- OPT* = Laminate or Whiteboard.

PRODUCT CODE	PRICE			SIZE / INCHES			WEIGHT LBS	VOL FT ³
	GR 1	GR 2	OPT*	H	W	D		
BPOF0818	182	199	212	8	18	2.61	6	0.351
BPOF0824	212	240	271	8	24	2.61	6	0.468
BPOF0830	252	281	312	8	30	2.61	8	0.730
BPOF0836	293	320	351	8	36	2.61	10	0.912
BPOF0842	323	351	382	8	42	2.61	10	0.912
BPOF0848	364	391	420	8	48	2.61	12	1.094
BPOF0854	406	434	464	8	54	2.61	12	1.094
BPOF0860	434	462	491	8	60	2.61	14	1.277
BPOF0866	473	534	595	8	66	2.61	17	1.549
BPOF0872	509	568	631	08	72	2.61	20	1.820
BPOF1618	241	259	271	16	18	2.61	8	0.730
BPOF1624	274	303	332	16	24	2.61	8	0.730
BPOF1630	313	342	372	16	30	2.61	10	0.912
BPOF1636	353	383	412	16	36	2.61	12	1.094
BPOF1642	385	415	446	16	42	2.61	12	1.094
BPOF1648	425	454	484	16	48	2.61	14	1.277
BPOF1654	465	494	523	16	54	2.61	14	1.277
BPOF1660	495	523	553	16	60	2.61	15	1.368
BPOF1666	521	580	645	16	66	2.61	20	1.774
BPOF1672	574	631	695	16	72	2.61	24	2.180
BPOF2418	333	347	364	24	18	2.61	12	1.094
BPOF2424	361	388	418	24	24	2.61	14	1.422
BPOF2430	389	418	449	24	30	2.61	17	1.750
BPOF2436	417	457	505	24	36	2.61	18	2.078
BPOF2442	446	486	535	24	42	2.61	21	2.406
BPOF2448	475	516	562	24	48	2.61	22	2.734
BPOF2454	501	528	561	24	54	2.61	24	3.063
BPOF2460	528	573	615	24	60	2.61	27	3.391
BPOF2466	569	627	692	24	66	2.61	32	3.766
BPOF2472	607	665	727	24	72	2.61	36	4.140
BPOF3718	378	408	438	37	18	2.61	17	1.580
BPOF3724	410	439	471	37	24	2.61	19	2.054
BPOF3730	441	483	527	37	30	2.61	22	2.528
BPOF3736	473	543	619	37	36	2.61	24	3.006
BPOF3742	501	573	647	37	42	2.61	28	3.476
BPOF3748	535	604	680	37	48	2.61	30	3.950
BPOF3754	563	633	711	37	54	2.61	32	4.424
BPOF3760	592	661	740	37	60	2.61	34	4.898
BPOF3766	661	783	909	37	66	2.61	41	5.449
BPOF3772	733	852	-	37	72	2.61	48	6.000
BPOF4218	477	507	537	42	18	2.61	18	1.780
BPOF4224	509	567	626	42	24	2.61	21	2.310
BPOF4230	539	593	655	42	30	2.61	24	2.850
BPOF4236	569	639	715	42	36	2.61	27	3.390
BPOF4242	600	670	746	42	42	2.61	30	3.920
BPOF4248	630	699	778	42	48	2.61	33	4.460
BPOF4254	658	727	805	42	54	2.61	36	4.990
BPOF4260	691	761	837	42	60	2.61	39	5.250
BPOF4266	774	892	1018	42	66	2.61	47	6.015
BPOF4272	853	972	-	42	72	2.61	54	6.780

BPOG • Glazed Over Panel

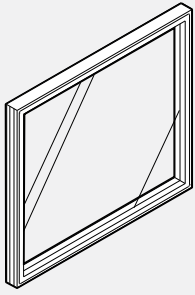

- **Attaches to top of a panel to create floor-to-ceiling wall.**
- Non-slotted.
- Factory installed PVC strip attaches and aligns over panel to top of base panel.
- PVC strip runs entire width eliminating light seepage.
- For custom heights and widths, order size required and price as next size up. Example: 26" high, 35" wide, order BPOG2635 at \$639 in acrylic.
- Custom heights over 42" must be quoted separately.
- Over panels can be stacked on any panel. Example: BPOG2418 stacked on BPRA4218 to give an overall height of 66".
- When stacking on 29" or 37" high B1 panels, custom height required, please contact customer service.
- Exact height should be specified when ordering, with allowance of at least 1" of free space between over panel and ceiling to accommodate height variations in ceiling and floor. Runs of over panels should be captured at either end with full height posts, wall adapters, taller panels, and/or vertical trims.
- Minimum height of 6".
- For tempered glass option, add "TG" to the end of the product code and 20% to the list price.

PRODUCT CODE	PRICE	SIZE/ INCHES			WEIGHT LBS	VOL FT ³
		H	W	D		
BPOG0818	122	8	18	2.61	6	0.351
BPOG0824	151	8	24	2.61	6	0.468
BPOG0830	182	8	30	2.61	8	0.730
BPOG0836	211	8	36	2.61	10	0.912
BPOG0842	241	8	42	2.61	10	0.912
BPOG0848	275	8	48	2.61	12	1.094
BPOG0854	305	8	54	2.61	12	1.094
BPOG0860	336	8	60	2.61	14	1.277
BPOG0866	354	8	66	2.61	17	1.549
BPOG0872	375	8	72	2.61	20	1.820
BPOG1618	194	16	18	2.61	8	0.730
BPOG1624	234	16	24	2.61	8	0.730
BPOG1630	275	16	30	2.61	10	0.912
BPOG1636	323	16	36	2.61	12	1.094
BPOG1642	353	16	42	2.61	12	1.094
BPOG1648	394	16	48	2.61	14	1.277
BPOG1654	434	16	54	2.61	14	1.277
BPOG1660	476	16	60	2.61	15	1.368
BPOG1666	495	16	66	2.61	20	1.774
BPOG1672	516	16	72	2.61	24	2.180
BPOG2418	344	24	18	2.61	12	1.094
BPOG2424	389	24	24	2.61	14	1.422
BPOG2430	432	24	30	2.61	17	1.750
BPOG2436	475	24	36	2.61	18	2.078
BPOG2442	516	24	42	2.61	21	2.406
BPOG2448	561	24	48	2.61	22	2.734
BPOG2454	602	24	54	2.61	24	3.063
BPOG2460	641	24	60	2.61	27	3.391
BPOG2466	699	24	66	2.61	32	3.766
BPOG2472	761	24	72	2.61	36	4.140
BPOG3718	494	37	18	2.61	17	1.580
BPOG3724	543	37	24	2.61	19	2.054
BPOG3730	593	37	30	2.61	22	2.528
BPOG3736	639	37	36	2.61	24	3.006
BPOG3742	691	37	42	2.61	28	3.476
BPOG3748	736	37	48	2.61	30	3.950
BPOG3754	786	37	54	2.61	32	4.424
BPOG3760	833	37	60	2.61	34	4.898
BPOG3766	872	37	66	2.61	41	5.449
BPOG3772	913	37	72	2.61	48	6.000
BPOG4218	523	42	18	2.61	18	1.780
BPOG4224	577	42	24	2.61	21	2.310
BPOG4230	630	42	30	2.61	24	2.850
BPOG4236	678	42	36	2.61	27	3.390
BPOG4242	736	42	42	2.61	30	3.920
BPOG4248	786	42	48	2.61	33	4.460
BPOG4254	833	42	54	2.61	36	4.990
BPOG4260	886	42	60	2.61	39	5.250
BPOG4266	931	42	66	2.61	47	6.015
BPOG4272	976	42	72	2.61	54	6.780

BAPAS • Glass Over Panel with Round Pucks for Boulevard 1

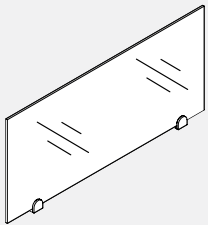

- **Glass Over Panel creates division.**
- Glass Over Panel with no frame sits on top of a Boulevard 1 Panel with clamps that are secured to the top of the panel.
- Tempered glass is 16" high.
- Custom sizes available, contact your Customer Service Representative.
- For application where the over panel is sandwiched between two taller panels, please request a special as the glass will not fit due to trims.

PRODUCT CODE	PRICE CLR	FRST	SIZE/INCHES			WEIGHT LBS	VOL FT ³
			H	W	D		
BAPAS0824	204	235	8	24	1.3	4	0.22
BAPAS0830	229	262	8	30	1.3	5	0.30
BAPAS0836	241	283	8	36	1.3	6	0.37
BAPAS0842	262	306	8	42	1.3	7	0.43
BAPAS0848	281	323	8	48	1.3	8	0.48
BAPAS1624	218	248	16	24	1.3	8	0.44
BAPAS1630	241	276	16	30	1.3	10	0.59
BAPAS1636	260	299	16	36	1.3	12	0.73
BAPAS1642	276	320	16	42	1.3	14	0.85
BAPAS1648	281	339	16	48	1.3	16	0.96

BAPASS • Glass Over Panel with Square Pucks for Boulevard 1

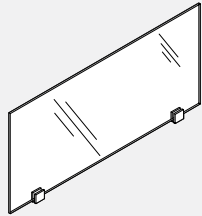

- **Glass Over Panel creates division.**
- Glass Over Panel with no frame sits on top of a Boulevard 1 Panel with clamps that are secured to the top of the panel.
- Tempered glass is 16" high.
- Custom sizes available, contact your Customer Service Representative.
- For application where the over panel is sandwiched between two taller panels, please request a special as the glass will not fit due to trims.

PRODUCT CODE	PRICE		SIZE/INCHES			WEIGHT VOL	
	CLR	FRST	H	W	D	LBS	FT ³
BAPASS0824	218	248	8	24	1.3	4	0.22
BAPASS0830	241	276	8	30	1.3	5	0.30
BAPASS0836	262	299	8	36	1.3	6	0.37
BAPASS0842	276	320	8	42	1.3	7	0.43
BAPASS0848	298	339	8	48	1.3	8	0.48
BAPASS1624	235	264	16	24	1.3	8	0.44
BAPASS1630	260	291	16	30	1.3	10	0.59
BAPASS1636	274	313	16	36	1.3	12	0.73
BAPASS1642	291	338	16	42	1.3	14	0.85
BAPASS1648	299	352	16	48	1.3	16	0.96

BAPAST • Felt Over Panel with Round Pucks for Boulevard 1

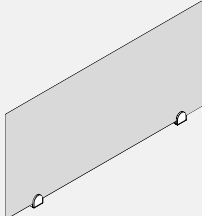

- **Felt Over Panel creates division.**
- Felt Over Panel with no frame sits on top of a Boulevard 1 panel with round clamps that are secured to the top of the panel.
- Felt panel is 8" and 16" high.
- Felt is 9mm thick, please choose from our standard 18 finishes.
- For application where the over panel is sandwiched between two taller panels, please request a special as the glass will not fit due to trims.

PRODUCT CODE	PRICE	SIZE/INCHES			WEIGHT VOL	
		H	W	D	LBS	FT ³
BAPAST0824	103	8	22.7	1.13	1.0	0.11
BAPAST0830	110	8	28.7	1.13	1.1	0.14
BAPAST0836	117	8	34.7	1.13	1.2	0.17
BAPAST0842	129	8	40.7	1.13	1.3	0.20
BAPAST0848	139	8	46.7	1.13	1.4	0.23
BAPAST1624	132	16	22.7	1.13	1.4	0.23
BAPAST1630	148	16	28.7	1.13	1.5	0.29
BAPAST1636	170	16	34.7	1.13	1.7	0.35
BAPAST1642	183	16	40.7	1.13	1.9	0.42
BAPAST1648	197	16	46.7	1.13	2.0	0.48

BAPASST • Felt Over Panel with Square Pucks for Boulevard 1

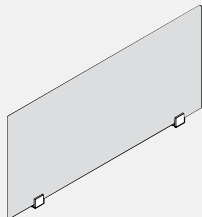

- **Felt Over Panel creates division.**
- Felt Over Panel with no frame sits on top of a Boulevard 1 panel with round clamps that are secured to the top of the panel.
- Felt panel is 8" and 16" high.
- Felt is 9mm thick, please choose from our standard 18 finishes.
- For application where the over panel is sandwiched between two taller panels, please request a special as the glass will not fit due to trims.

PRODUCT CODE	PRICE	SIZE/INCHES			WEIGHT VOL	
		H	W	D	LBS	FT ³
BAPASST0824	103	8	22.7	1.13	1.0	0.11
BAPASST0830	110	8	28.7	1.13	1.1	0.14
BAPASST0836	117	8	34.7	1.13	1.2	0.17
BAPASST0842	129	8	40.7	1.13	1.3	0.20
BAPASST0848	139	8	46.7	1.13	1.4	0.23
BAPASST1624	132	16	22.7	1.13	1.4	0.23
BAPASST1630	148	16	28.7	1.13	1.5	0.29
BAPASST1636	170	16	34.7	1.13	1.7	0.35
BAPASST1642	183	16	40.7	1.13	1.9	0.42
BAPASST1648	197	16	46.7	1.13	2.0	0.48

BPDS • Solid Door Panel

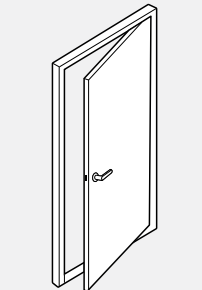

- **Aluminum frame with high pressure laminate.**
- 1 3/8" thick hollow core door.
- Actual door size:
80" x 32 1/2" in 82" x 36" frame
80" x 38 1/2" in 82" x 42" frame
- 42" wide Door Panel permits wheelchair accessibility.
- No hang-on capabilities.
- Non slotted frame.
- 180 degree swing.
- Specify Door Knob (DL01) or Door Lever (DL02).
- Lock standard.
- Handedness can be changed on site.
- Please specify Right hand (R) or Left hand (L) hung.

PRODUCT CODE	PRICE HP	SIZE/INCHES			WEIGHT VOL	
		H	W	D	LBS	FT ³
BPDS8236R	2331	82	36	2.61	61	6.465
BPDS8242R	2539	82	42	2.61	68	7.486
BPDS8236L	2331	82	36	2.61	61	6.465
BPDS8242L	2539	82	42	2.61	68	7.486

Door Hanging Directions

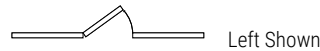

Door Handle Option

Door Knob - DL01
• Lock Standard



Door Lever - DL02(Default)

• Lock Standard
• Lever complies with all accessibility standards



BPDH • Half Glazed Door Panel

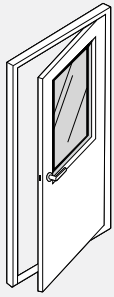

- Aluminum frame with high pressure laminate door and window.
- 1 3/8" thick hollow core door.
- Actual door size:
80" x 32 1/2" in 82" x 36" frame
80"x381/2" in 82"x42" frame
- 42" wide Door Panel permits wheelchair accessibility.
- No hang-on capabilities.
- 180 degree swing.
- Specify Door Knob (DL01) or Door Lever (DL02).
- Lock standard.
- Handedness can be changed on site.
- Please specify Right hand (R) or Left hand (L) hung.
- For tempered glass option, add "TG" at the end of the product code and add an upcharge of \$149 for 36" wide doors and \$179 for 42" wide doors.

PRODUCT CODE	PRICE HP	SIZE/INCHES			WEIGHT VOL	
		H	W	D	LBS	FT ³
BPDH8236R	2891	82	36	2.61	53	6.465
BPDH8242R	3160	82	42	2.61	59	7.486
BPDH8236L	2891	82	36	2.61	53	6.465
BPDH8242L	3160	82	42	2.61	59	7.486

Door Hanging Directions

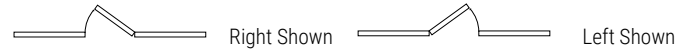

Door Handle Option

- Door Knob - DL01
- Lock Standard
- Door Lever - DL02(Default)
- Lock Standard
- Lever complies with all accessibility standards



BPDG • Solid Glazed Door Panel

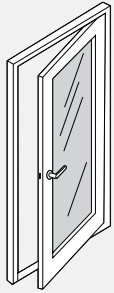

- Aluminum frame with either high pressure laminate door and window.
- 1 3/8" thick hollow core door.
- Actual door size:
80" x 32 1/2" in 82" x 36" frame
80"x381/2" in 82"x42" frame
- 42" wide Door Panel permits wheelchair accessibility.
- No hang-on capabilities.
- 180 degree swing.
- Specify Door Knob (DL01) or Door Lever (DL02).
- Lock standard.
- Handedness can be changed on site.
- Please specify Right hand (R) or Left hand (L) hung.
- For tempered glass option, add "TG" at the end of the product code and add an upcharge of \$302 for 36" wide doors and \$376 for 42" wide doors.
- Laminate frame is 5" thick on sides and 4" at top and bottom.

PRODUCT CODE	PRICE HP	SIZE/INCHES			WEIGHT VOL	
		H	W	D	LBS	FT ³
BPDG8236R	3324	82	36	2.61	53	6.465
BPDG8242R	3637	82	42	2.61	59	7.486
BPDG8236L	3324	82	36	2.61	53	6.465
BPDG8242L	3637	82	42	2.61	59	7.486

Door Hanging Directions

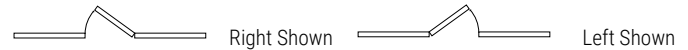

Door Handle Option

- Door Knob - DL01
- Lock Standard
- Door Lever - DL02(Default)
- Lock Standard
- Lever complies with all accessibility standards

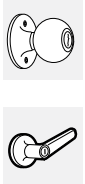

BPDSL • Privacy Screen

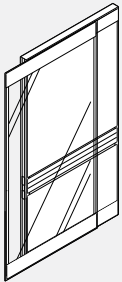

- Provides territorial privacy in an open plan environment.
- Lightweight, panel mounted sliding partition.
- Consists of translucent textured polycarbonate.
- Must be mounted to a straight panel of the same size.
- The face of the Privacy Screen sits 3" away from the face of the panel to which it is attached.
- Cable lay-in modules, wood trim and non-load bearing panels may be applied to the top of a panel to which the screen is attached, but not the screen itself.
- When open, the screen may interfere with access doors that open on the outside of an adjacent panel.
- Must specify left or right for the direction in which the door will slide once installed.
- Caps located on the end of the frame default to the panel frame colour.
- All hardware included.
- Can be mounted on Boulevard 1 or Boulevard System 3 panels of the same width as the Privacy Screen.
- Note: Specify left or right for the direction in which the door will slide as per examples above.

PRODUCT CODE	PRICE	SIZE/ INCHES			WEIGHT VOL	
		H	W	D	LBS	FT ³
BPDSL6636R	1981	66	36	2.61	35	5.98
BPDSL6642R	2132	66	42	2.61	42	6.93
BPDSL8136R	2377	81	36	2.61	43	7.30
BPDSL8142R	2551	81	42	2.61	50	8.45
BPDSL6636L	1981	66	36	2.61	35	5.98
BPDSL6642L	2132	66	42	2.61	42	6.93
BPDSL8136L	2377	81	36	2.61	43	7.30
BPDSL8142L	2551	81	42	2.61	50	8.45

Left Hang Option

Right Hang Hung

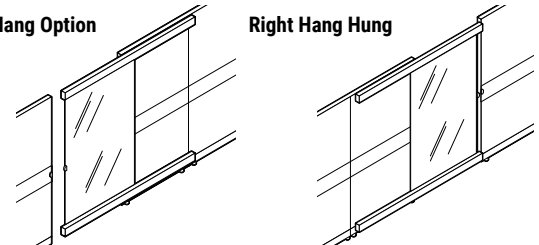

BPDSLLOCK • Privacy Screen Lock

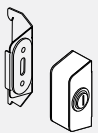

Left Hand Shown

- Lock bracket attaches to Privacy Screen with screws
- Includes strike plate bracket which attaches to slots in connector.
- Lock included.
- Available in tungsten only.
- Requires on site installation, drilling into the Privacy Screen aluminum frame.

PRODUCT CODE	PRICE	SIZE/ INCHES			WEIGHT LBS	VOL FT ³
		H	W	D		
BPDSLLOCKR	240	2.65	1.2	0.9	1	0.2
BPDSLLOCKL	240	2.65	1.2	0.9	1	0.2

BPXCF • Ceiling Filler

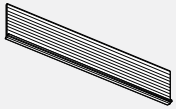

- Durable PVC designed to seal a gap between ceiling and over panel.
- Available in lengths of 124" to be pressed into over panel's horizontal wing profile.
- Can be applied during installation or retrofitted later.
- For use only with Boulevard 1 panels.

PRODUCT CODE	PRICE	SIZE/INCHES			WEIGHT VOL	
		H	W	D	LBS	FT ³
BPXCF124	65	3.25	124	0.125	1	1.2

BHP • 90 Degree Post

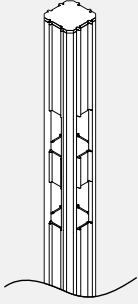

- Enables connection for multiple panel runs such as 90 degree, 3 way and 4 way.
- Includes 2 "Capture Strip" panel connectors, 4 end strips, 4 pairs of raceway end caps, and 1 post cap.
- Posts are designed to accept the following:
 - 75 cables 5.6mm (0.220") diameter
 - 60 cables 5.6mm (0.220") diameter with 1 powerfeed
 - 45 cables 5.6mm (0.220") diameter with 2 powerfeeds

PRODUCT CODE	PRICE	SIZE/INCHES			WEIGHT VOL	
		H	W	D	LBS	FT ³
BHP029	81	29	2.61	2.61	4	0.154
BHP037	132	37	2.61	2.61	5	0.195
BHP042	145	42	2.61	2.61	5	0.221
BHP050	162	50	2.61	2.61	6	0.263
BHP054	170	54	2.61	2.61	6	0.284
BHP058	178	58	2.61	2.61	7	0.305
BHP066	195	66	2.61	2.61	8	0.346
BHP074	211	74	2.61	2.61	9	0.388
BHP082	228	82	2.61	2.61	9	0.430
BHP106	272	106	2.61	2.61	12	0.560
BHP119	291	119	2.61	2.61	13	0.622

BHP45 • 45 Degree Post

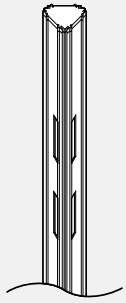

- Enables connection for two panels at 45 degrees.
- Includes 2 "Capture Strip" panel connectors, 4 end strips, 2 pairs of raceway end caps, and 1 post cap.
- 45 degree post does not accept PVC or Wood End Trim.
- No power infeed/post extension capabilities.
- Posts are designed to accept 30 cables 5.6mm (0.220") diameter

PRODUCT CODE	PRICE	SIZE/INCHES			WEIGHT VOL	
		H	W	D	LBS	FT ³
BHP4529	81	29	2.61	2.61	4	0.154
BHP4537	132	37	2.61	2.61	5	0.195
BHP4542	145	42	2.61	2.61	5	0.221
BHP4550	162	50	2.61	2.61	6	0.263
BHP4554	170	54	2.61	2.61	6	0.284
BHP4558	178	58	2.61	2.61	7	0.305
BHP4566	195	66	2.61	2.61	8	0.346
BHP4574	211	74	2.61	2.61	9	0.388
BHP4582	228	82	2.61	2.61	9	0.430
BHP45106	272	106	2.61	2.61	12	0.560
BHP45119	291	119	2.61	2.61	13	0.622

BHP60 • 60 Degree Post

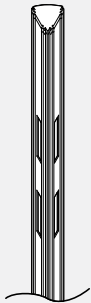

- Enables connection for multiple panel runs such as 120 degrees and 3 way.
- Includes 2 "Capture Strip" panel connectors, 4 end strips, 3 pair of raceway end caps, and 1 post cap.
- No power infeed/post extension capabilities.

PRODUCT CODE	PRICE	SIZE/INCHES			WEIGHT VOL	
		H	W	D	LBS	FT ³
BHP6029	81	29	2.61	2.61	4	0.154
BHP6037	132	37	2.61	2.61	5	0.195
BHP6042	145	42	2.61	2.61	5	0.221
BHP6050	162	50	2.61	2.61	6	0.263
BHP6054	170	54	2.61	2.61	6	0.284
BHP6058	178	58	2.61	2.61	7	0.305
BHP6066	195	66	2.61	2.61	8	0.346
BHP6074	211	74	2.61	2.61	9	0.388
BHP6082	228	82	2.61	2.61	9	0.430
BHP60106	272	106	2.61	2.61	12	0.560
BHP60119	291	119	2.61	2.61	13	0.622

BHWA • Wall Adapter

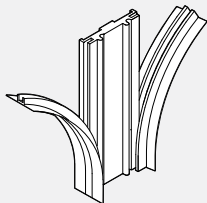

- Starts a run of panels off an existing wall.
- Includes 2 "Capture Strip" panel connectors and 1 pair of raceway end caps.
- Mounting hardware not included. The mounting hardware selected must be based on the wall or wall stud material.
- Wall adapter adds 5/16" to a panel run.

PRODUCT CODE	PRICE	SIZE/INCHES			WEIGHT VOL	
		H	W	D	LBS	FT ³
BHWA029	57	29	2.61	0.375	4	0.01
BHWA037	60	37	2.61	0.375	5	0.013
BHWA042	64	42	2.61	0.375	5	0.015
BHWA050	68	50	2.61	0.375	6	0.018
BHWA054	72	54	2.61	0.375	6	0.020
BHWA058	74	58	2.61	0.375	7	0.021
BHWA066	80	66	2.61	0.375	8	0.024
BHWA074	90	74	2.61	0.375	9	0.027
BHWA082	93	82	2.61	0.375	9	0.030
BHWA106	119	106	2.61	0.375	12	0.039
BHWA119	137	119	2.61	0.375	13	0.043

BHWASL • Adapter Sleeve

- **Wall Adapter Sleeve is attached to the building to provide flexible support to a panel run.**
- As opposed to the BHWA wall adapter, which connects to the panels securely to a wall, B1 and B3 Boulevard panels rest inside the vertical "U" channel, providing up to 3.5" of flexible adjustment.
- For panel runs taller than 66" order two Wall Adapter Sleeve and either have them cut short on site below the ceiling, or cut a rectangular hole in the ceiling tile. Rectangular slots in the Channels correspond to 66", 58", 50" and 42" high B1 and B3 panels.
- Powder coated steel; specify metal finish.
- Note: the Wall Adapter Sleeve provides flexible, connection, blocks vertical 1" increment clots and cannot, therefore, be used to support overheads and worksurfaces, they must be supported by perpendicular panels, c-legs or gables.
- Note: No fasteners are provided with the Wall Adapter Sleeve. Select the appropriate fasteners according to a structurally wall type.
- Cannot be used to support a door or panel and cannot be used with laminate, airflow or metal skin panels.

PRODUCT CODE	PRICE	SIZE/ INCHES			WEIGHT VOL	
		H	W	D	LBS	FT ³
BHWASL42	149	34.7	4	2	2.5	0.161
BHWASL50	162	42.7	4	2	3.6	0.198
BHWASL54	170	46.7	4	2	4.2	0.220
BHWASL58	174	50.7	4	2	5.1	0.244
BHWASL66	187	58.7	4	2	6.0	0.272

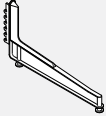
BHHF • High Profile Foot

- **Provides added support to panel under load.**
- Adjustable glides included.
- Made of cast aluminum and cold rolled steel.
- Cannot be used with System 3 Panels

PRODUCT CODE	PRICE	SIZE/INCHES			WEIGHT VOL	
		H	W	D	LBS	FT ³
BHHF01	229	9	1	18.375	4	0.130

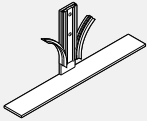
BHLF • Low Profile Foot

- **Stabilizes a run of panels.**
- Attaches with supplied connectors to an end of a panel.
- Made of cold rolled steel.
- Cannot be used with System 3 Panels

PRODUCT CODE	PRICE	SIZE/ INCHES			WEIGHT VOL	
		H	W	D	LBS	FT ³
BHLF01	54	6	9	2.5	7	0.230

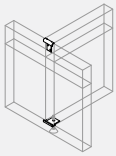
BHPA • Panel to Panel Adapter

- **Enables mid panel, off-module connection.**
- Slim profile.
- Formed steel construction.
- Permanent clamps fit around base channel and fits to top rail.
- Priced as a complete kit.
- Designed for use with Boulevard 1 panels of the same height only.
- Not to be used on the panel seam, with over panels or laminate and metal faced panels.

PRODUCT CODE	PRICE	SIZE/ INCHES			WEIGHT VOL	
		H	W	D	LBS	FT ³
BHPA02	54	2	2.5	00.0	0.25	0.120

BHCS • Capture Strip Slot Cover

- **An extruded PVC channel to adjoin two panels or a panel to a post. Runs the full length of the panel on both sides providing a positive connection of the "Knuckle-Loc" design.**
- Priced per pair.
- Pliable side membranes cover panel slots.
- Included with panel components.
- Only to be ordered separately if required.

PRODUCT CODE	PRICE	SIZE/ INCHES			WEIGHT VOL	
		H	W	D	LBS	FT ³
BHCS29	12	29			0.21	0.09
BHCS37	13	37			0.24	0.11
BHCS42	13	42			0.28	0.13
BHCS50	14	50			0.33	0.15
BHCS54	14	54			0.31	0.17
BHCS58	16	58			0.63	0.19
BHCS66	21	66			0.40	0.19
BHCS74	22	74			0.43	0.20
BHCS82	24	82			0.47	0.20

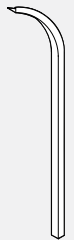
BHCE • End Strip Slot Cover

- **End strips with pliable side membrane covers panel slots at end of run.**
- Priced per pair.
- Included with panel components.
- Only to be ordered separately if required.

PRODUCT CODE	PRICE	SIZE/ INCHES			WEIGHT VOL	
		H	W	D	LBS	FT ³
BHCE29	11	29			0.10	0.04
BHCE37	12	37			0.12	0.05
BHCE42	12	42			0.14	0.06
BHCE50	13	50			0.16	0.07
BHCE54	13	54			0.31	0.08
BHCE58	13	58			0.18	0.08
BHCE66	14	66			0.20	0.09
BHCE74	16	74			0.22	0.10
BHCE82	21	82			0.23	0.11

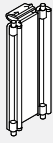
BHRC • Raceway End Cap

- Provides clean detail at the end of a panel run or post. End caps fit flush into communication and power channel entry.
- Priced per pair.
- Made of injection molded ABS.
- Included with panel components. Only to be ordered separately if required.

PRODUCT CODE	PRICE	SIZE/ INCHES			WEIGHT VOL	
		H	W	D	LBS	FT ³
BHRC02	10	3	2.61	0.5	0.04	0.02

BVTE • Vertical End PVC Trim

- Provides a rounded finished detail to the end of the panel run, or a post.
- Includes 2 "Capture Strip" panel connectors and 1 injection molded top cap.
- The PVC end trim is designed to snap at the end of the panel or post.
- Site installed.

PRODUCT CODE	PRICE	SIZE/ INCHES			WEIGHT VOL	
		H	W	D	LBS	FT ³
BVTE37	42	37	2.61	0.25	0.41	0.065
BVTE42	49	42	2.61	0.25	0.48	0.074
BVTE50	56	50	2.61	0.25	0.57	0.088
BVTE54	70	54	2.61	0.25	0.62	0.095
BVTE58	77	58	2.61	0.25	0.66	0.102
BVTE66	80	66	2.61	0.25	0.75	0.115
BVTE74	85	74	2.61	0.25	0.84	0.013
BVTE82	92	82	2.61	0.25	0.93	0.143

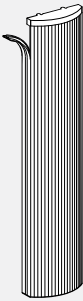
BVTS • Vertical Step Down PVC Trim

- Provides a rounded finished detail to the end of the panel run where two different height panels are specified.
- Includes 2 "Capture Strip" panel connectors and 1 injection molded top cap.
- The PVC end trim is designed to snap at the end of the panel or post.
- Site installed.
- Please specify panels to be used when ordering a 29" step (BVTS29).

PRODUCT CODE	PRICE	SIZE/ INCHES			WEIGHT VOL	
		H	W	D	LBS	FT ³
BVTS04	12	4	2.61	0.25	0.05	0.010
BVTS08	14	8	2.61	0.25	0.09	0.015
BVTS12	21	12	2.61	0.25	0.12	0.021
BVTS16	29	16	2.61	0.25	0.18	0.029
BVTS20	31	20	2.61	0.25	0.20	0.035
BVTS24	34	24	2.61	0.25	0.27	0.043
BVTS32	38	32	2.61	0.25	0.36	0.056
BVTS38	45	38	2.61	0.25	0.45	0.067
BVTS40	47	40	2.61	0.25	0.45	0.070
BVTS48	55	48	2.61	0.25	0.54	0.084
BVTS56	65	56	2.61	0.25	0.63	0.098

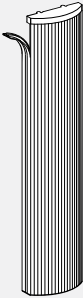
BVTS • Vertical Step Down PVC Trim for 37" High Panels

- Provides a finished detail to the end of the panel run that sits next to a 37" high panel. This PVC trim will bridge the distance between the 37" and higher panel.
- Includes 2 "Capture Strip" panel connectors and 1 injection molded top cap.
- The PVC end trim is designed to snap at the end of the panel or post.
- Site installed.
- Please specify panels to be used when ordering a 29" step (BVTS29).

PRODUCT CODE	PRICE	SIZE/ INCHES			WEIGHT VOL	
		H	W	D	LBS	FT ³
BVTS05	12	5	2.61	0.25	0.06	0.015
BVTS13	21	13	2.61	0.25	0.15	0.029
BVTS17	30	17	2.61	0.25	0.15	0.035
BVTS21	32	21	2.61	0.25	0.24	0.043
BVTS29	35	29	2.61	0.25	0.33	0.051
BVTS37	44	37	2.61	0.25	0.41	0.067
BVTS45	48	45	2.61	0.25	0.51	0.084

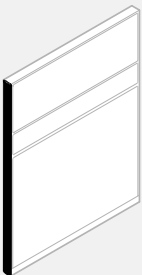
BAVTE • Aluminum Vertical End Round Trim

- Provides a finished detail to the end of a panel run.
- Aluminum radiused front section and injection molded top cap.
- Includes 2 "Capture Strip" panel connectors and 1 injection molded top cap.
- The Aluminum End Trim is designed to snap at the end of the panel or post.
- Site installed.
- BAVTE119 cannot ship via courier and must be combined with other product.

PRODUCT CODE	PRICE	SIZE/ INCHES			WEIGHT VOL	
		H	W	D	LBS	FT ³
BAVTE37	44	37	2.61	0.125	1.2	0.03
BAVTE42	49	42	2.61	0.125	1.4	0.03
BAVTE50	56	50	2.61	0.125	1.7	0.04
BAVTE54	70	54	2.61	0.125	1.8	0.04
BAVTE58	77	58	2.61	0.125	1.9	0.04
BAVTE66	80	66	2.61	0.125	2.2	0.05
BAVTE74	85	74	2.61	0.125	2.4	0.05
BAVTE82	92	82	2.61	0.125	2.7	0.06
BAVTE119	137	119	2.61	0.125	3.9	0.08

BAVTS • Aluminum Vertical End Round Trim - Standard Step Down

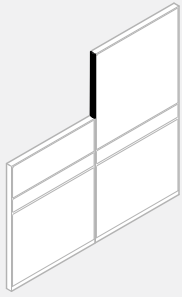

- Provides a finished detail to the end of a panel run where two different height panels are specified.
- Aluminum radiused front section and injection molded top cap.
- Includes 2 "Capture Strip" panel connectors and 1 injection molded top cap.
- The Aluminum End Trim is designed to snap at the end of the panel or post.
- Site installed.
- Specify panels to be used when ordering a 29" step.

PRODUCT CODE	PRICE	SIZE/ INCHES			WEIGHT VOL	
		H	W	D	LBS	FT ³
BAVTS04	12	4	2.61	0.125	0.2	0.01
BAVTS08	14	8	2.61	0.125	0.3	0.02
BAVTS12	21	12	2.61	0.125	0.4	0.02
BAVTS16	29	16	2.61	0.125	0.5	0.03
BAVTS20	31	20	2.61	0.125	0.7	0.04
BAVTS24	34	24	2.61	0.125	0.8	0.04
BAVTS32	38	32	2.61	0.125	1.1	0.06
BAVTS38	45	38	2.61	0.125	1.3	0.07
BAVTS40	46	40	2.61	0.125	1.3	0.07
BAVTS48	55	48	2.61	0.125	1.6	0.08
BAVTS56	65	56	2.61	0.125	1.8	0.10

BAVTSF • Aluminum Vertical End Round Trim - Step Down for 37" High Panels

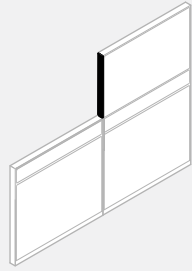

- Provides a finished detail to the end of a panel run adjacent to a 37" high panel.
- Aluminum radiused front section and injection molded top cap.
- Includes 2 "Capture Strip" panel connectors and 1 injection molded top cap.
- The Aluminum End Trim is designed to snap at the end of the panel or post.
- Site installed.

PRODUCT CODE	PRICE	SIZE/ INCHES			WEIGHT VOL	
		H	W	D	LBS	FT ³
BAVTSF05	13	5	2.61	0.125	0.2	0.02
BAVTSF13	22	13	2.61	0.125	0.4	0.03
BAVTSF17	30	17	2.61	0.125	0.6	0.04
BAVTSF21	32	21	2.61	0.125	0.7	0.04
BAVTSF29	35	29	2.61	0.125	1.0	0.05
BAVTSF37	44	37	2.61	0.125	1.2	0.07
BAVTSF45	53	45	2.61	0.125	1.5	0.08

BARC • Aluminum Raceway Cover

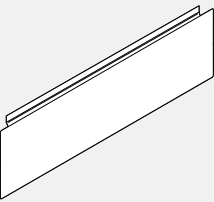

- Offers an alternative to the existing raceway options.
- Cover hinges upward for easy access to power and data/communication terminals.
- Cover may be removed for installation and reconfiguration.
- May not be used with Boulevard System 3 panels.
- Sold as singles.

PRODUCT CODE	PRICE	SIZE/ INCHES			WEIGHT VOL	
		H	W	D	LBS	FT ³
BARC06	25	00.0	5	0.125	0.3	0.001
BARC18	27	00.0	17	0.125	1.1	0.001
BARC24	32	00.0	23	0.125	1.4	0.001
BARC30	35	00.0	29	0.125	1.8	0.002
BARC36	37	00.0	35	0.125	2.2	0.002
BARC42	40	00.0	41	0.125	2.5	0.002
BARC48	42	00.0	47	0.125	2.9	0.003
BARC54	48	00.0	53	0.125	3.2	0.003
BARC60	58	00.0	59	0.125	3.7	0.003
BARC66	63	00.0	65	0.125	4.1	0.004
BARC72	67	00.0	72	0.125	4.4	0.004

Boulevard 1 • Flat Aluminum Trims

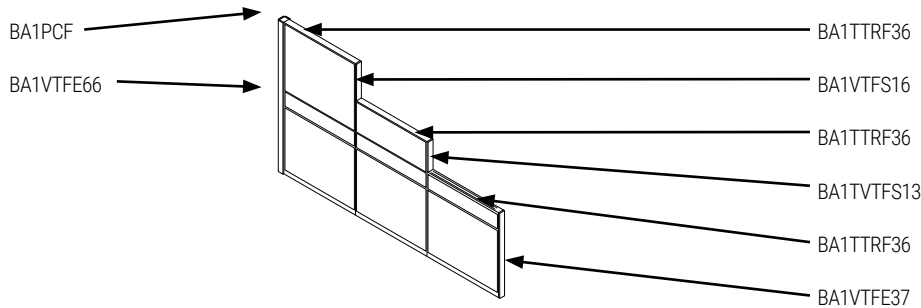

- Flat Aluminum Trims For Boulevard 1: Designed to use top and vertical trims together on the panel. Specifying vertical trims only will make them too long and will not fit correctly.
- You must specify vertical trims as a special if you are NOT using top trims.
- Post caps BA1PCF must be specified separately when using trims, .

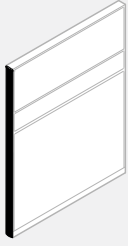
BA1VTFE • Aluminum Vertical Flat End Trim

- Provides a finish detail to the end of a panel run.
- Aluminum flat profile with injection molded top cap.
- Included: 2 "capture strip" panel connectors and 1 injection molded top cap.
- The Aluminum End Trim is designed to snap at the end of the panel or post.
- Site installed.
- For use with Aluminum Top Caps.

PRODUCT CODE	PRICE	SIZE/ INCHES			WEIGHT VOL	
		H	W	D	LBS	FT ³
BA1VTFE29	36	29	2.61	0.125	0.7	0.01
BA1VTFE37	44	37	2.61	0.125	1.0	0.02
BA1VTFE42	49	42	2.61	0.125	1.2	0.03
BA1VTFE50	56	50	2.61	0.125	1.5	0.04
BA1VTFE54	70	54	2.61	0.125	1.6	0.04
BA1VTFE58	77	58	2.61	0.125	1.7	0.04
BA1VTFE66	80	66	2.61	0.125	2.0	0.05
BA1VTFE74	85	74	2.61	0.125	2.2	0.05
BA1VTFE82	92	82	2.61	0.125	2.4	0.06

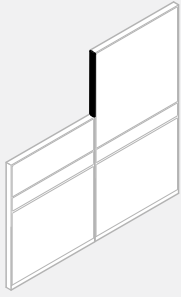
BA1VTFS • Aluminum Vertical Flat End Trim - Standard Step Down

- Provides a finish detail to the end of a panel run where 2 different height panels are specified.
- Aluminum flat profile with injection molded top cap.
- Included: 2 "capture strip" panel connectors and 1 injection molded top cap.
- The aluminum end trim is designed to snap at the end of the panel or post.
- Site installed.
- For use with Aluminum Top Caps.

PRODUCT CODE	PRICE	SIZE/ INCHES			WEIGHT VOL	
		H	W	D	LBS	FT ³
BA1VTFS04	12	4	2.61	0.125	0.1	0.01
BA1VTFS08	14	8	2.61	0.125	0.2	0.01
BA1VTFS12	21	12	2.61	0.125	0.4	0.02
BA1VTFS16	29	16	2.61	0.125	0.6	0.02
BA1VTFS20	31	20	2.61	0.125	0.6	0.03
BA1VTFS24	34	24	2.61	0.125	0.7	0.03
BA1VTFS32	38	32	2.61	0.125	0.9	0.03
BA1VTFS38	45	38	2.61	0.125	1.1	0.03
BA1VTFS40	47	40	2.61	0.125	1.1	0.03
BA1VTFS48	56	48	2.61	0.125	1.3	0.04
BA1VTFS56	65	56	2.61	0.125	1.6	0.05

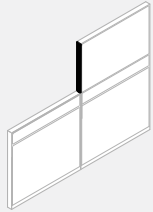
BA1VTFS • Aluminum Vertical Flat End Trim - Standard Step Down 37" High Panels

- Provides a finish detail to the end of a panel run adjacent to a 37" high panel.
- Aluminum flat profile with injection molded top cap
- Included 2 "capture strip" panel connectors and 1 injection molded top cap
- The aluminum end trim is designed to snap at the end of the panel or post
- Site installed
- Specify panels to be used when ordering a 29" step down trim.
- For use with Aluminum Top Caps.

PRODUCT CODE	PRICE	SIZE/ INCHES			WEIGHT VOL	
		H	W	D	LBS	FT ³
BA1VTFS05	13	5	2.61	0.125	0.2	0.01
BA1VTFS13	22	13	2.61	0.125	0.4	0.01
BA1VTFS17	30	17	2.61	0.125	0.4	0.01
BA1VTFS21	32	21	2.61	0.125	0.6	0.02
BA1VTFS29	35	19	2.61	0.125	0.7	0.03
BA1VTFS37	44	37	2.61	0.125	1.1	0.03
BA1VTFS45	53	45	2.61	0.125	1.3	0.04

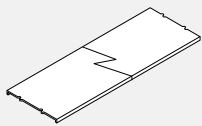
BA1TTRF • Aluminum Top Cap

- Provides a finish detail to the top of a Boulevard 1 panel.
- Designed to snap to the top of a panel rail.
- Must be used on panels of corresponding width.
- Site installed.
- For applications using transaction tops and top mounted storage, please use BHBT02FT bracket
- To be used with Flat Vertical Trim.

PRODUCT CODE	PRICE	SIZE/ INCHES			WEIGHT VOL	
		H	W	D	LBS	FT ³
BA1TTRF06	13	0.125	6	2.61	0.2	0.01
BA1TTRF18	30	0.125	18	2.61	0.6	0.02
BA1TTRF24	34	0.125	24	2.61	0.7	0.03
BA1TTRF30	36	0.125	30	2.61	0.9	0.04
BA1TTRF36	43	0.125	36	2.61	1.1	0.05
BA1TTRF42	49	0.125	42	2.61	1.3	0.06
BA1TTRF48	57	0.125	48	2.61	1.5	0.06
BA1TTRF54	70	0.125	54	2.61	1.6	0.07
BA1TTRF60	77	0.125	60	2.61	1.8	0.08
BA1TTRF66	80	0.125	66	2.61	2.0	0.09
BA1TTRF72	85	0.125	72	2.61	2.2	0.10

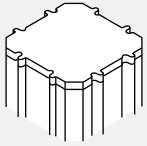
BA1PCF • Post Cap

- Bridges the height difference when using Boulevard 1 panels only with Aluminum Horizontal Top Trims.
- Injection molded post cap to fit on top of 90 degree corner post.
- Extends post's overall height to the level corresponding with the height of aluminum horizontal top trim installed on standard Boulevard panel.
- Site installed.
- Used for Boulevard 1 panels when top aluminum horizontal trim is used.

PRODUCT CODE	PRICE	SIZE/ INCHES			WEIGHT VOL	
		H	W	D	LBS	FT ³
BA1PCF	10	0.25	2.61	2.61	0.02	0.01

BHBT37FT • Transaction Bracket for 37" Panels with Flat Trim

- Provides a secure attachment of a transaction worksurface for a 37" high panel with top trim.
- Includes a left and right bracket and bracket retainer clips.

PRODUCT CODE	PRICE	SIZE/ INCHES			WEIGHT VOL	
		H	W	D	LBS	FT ³
BHBT37FT	26	3.3	1.5	2.3	2.0	0.010

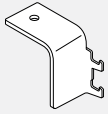
BHBT02FT • Transaction Bracket for 42" Panels with Flat Trim

- Provides a secure attachment of a transaction worksurface for a 42" high Boulevard panels with flat trim.
- Includes a left and right bracket and bracket retainer clips.

PRODUCT CODE	PRICE	SIZE/ INCHES			WEIGHT VOL	
		H	W	D	LBS	FT ³
BHBT02FT	31	4	1	3	0.5	0.007

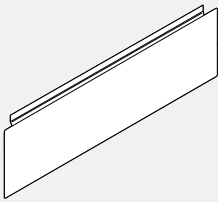
FRC • Fabric Raceway Cover

- Offers an alternative to the existing raceway options.
- Cover hinges upward for easy access to power and data/communication terminals.
- Cover may be removed for installation and reconfiguration.
- May not be used with Boulevard System 3 panels.
- Sold as singles.

PRODUCT CODE	PRICE	SIZE/ INCHES			WEIGHT VOL	
		H	W	D	LBS	FT ³
FRC24	29	7	23	0.125	1.4	0.001
FRC30	35	7	29	0.125	1.8	0.002
FRC36	37	7	35	0.125	2.2	0.002
FRC42	40	7	41	0.125	2.5	0.002
FRC48	42	7	47	0.125	2.9	0.003
FRC54	52	7	53	0.125	3.2	0.003
FRC60	55	7	59	0.125	3.7	0.003
FRC66	58	7	65	0.125	4.1	0.004
FRC72	60	7	72	0.125	4.4	0.004

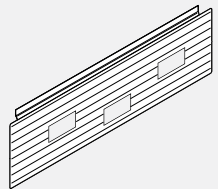
RCW-D • PVC Facemount Raceway Cover

- PVC raceway cover is punched out to align with the Face Mount Power Distribution Housing and Duplexes.
- Data punch-out accepts industry standard terminal faceplates (not supplied by Global Contract Inc.) Size of opening is 1.37" x 2.755".
- Electrical cut-outs have black PVC trim. Size of opening is 1.5" x 2.85".
- May not be used with Boulevard System 3 Panels.
- Cover hinges upward for easy access to power and data/communication terminals.

PRODUCT CODE	PRICE	SIZE/ INCHES			WEIGHT VOL	
		H	W	D	LBS	FT ³
RCW24D	36	7	24	0.125	3	0.05
RCW30D	38	7	30	0.125	3	0.06
RCW36D	43	7	36	0.125	4	0.07
RCW42D	53	7	42	0.125	5	0.08
RCW48D	57	7	48	0.125	5	0.09
RCW54D	60	7	54	0.125	6	0.10
RCW60D	64	7	60	0.125	7	0.11
RCW66D	67	7	66	0.125	7	0.12
RCW72D	72	7	72	0.125	8	0.12

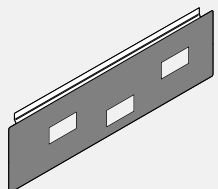
FCR-D • Fabric Covered Facemount Raceway

- Fabric raceway cover is punched out to align with the Face Mount Power Distribution Housing and Duplexes.
- Data punch-out accepts industry standard terminal faceplates (not supplied by Global Contract Inc.) Size of opening is 1.37" x 2.755".
- Electrical cut-outs have black PVC trim. Size of opening is 1.5" x 2.85".
- May not be used with Boulevard System 3 Panels.
- Cover hinges upward for easy access to power and data/communication terminals.

PRODUCT CODE	PRICE	SIZE/ INCHES			WEIGHT VOL	
		H	W	D	LBS	FT ³
FCR24D	82	7	24	0.125	3	0.05
FCR30D	89	7	30	0.125	3	0.06
FCR36D	92	7	36	0.125	4	0.07
FCR42D	97	7	42	0.125	5	0.08
FCR48D	103	7	48	0.125	5	0.09
FCR54D	106	7	54	0.125	6	0.10
FCR60D	112	7	60	0.125	7	0.11
FCR66D	116	7	66	0.125	7	0.12
FCR72D	124	7	72	0.125	8	0.12

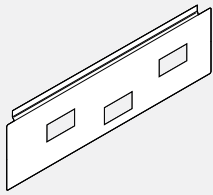
RCA-D • Aluminum Raceway Cover for Face Mounted

- Aluminum raceway cover is punched out to align with the Face Mount Power Distribution Housing and Duplexes.
- Data punch-out accepts industry standard terminal faceplates (not supplied by Global Contract Inc.) Size of opening is 1.37" x 2.755".
- Electrical cut-outs have black PVC trim. Size of opening is 1.5" x 2.85".
- May not be used with Boulevard System 3 Panels.
- Cover hinges upward for easy access to power and data/communication terminals.

PRODUCT CODE	PRICE	SIZE/ INCHES			WEIGHT VOL	
		H	W	D	LBS	FT ³
RCA24D	63	7	24	0.125	2.0	0.06
RCA30D	66	7	30	0.125	2.1	0.06
RCA36D	72	7	36	0.125	2.2	0.07
RCA42D	78	7	42	0.125	2.5	0.08
RCA48D	80	7	48	0.125	2.9	0.09
RCA54D	88	7	54	0.125	3.2	0.10
RCA60D	91	7	60	0.125	3.7	0.11
RCA66D	95	7	66	0.125	3.9	0.12
RCA72D	102	7	72	0.125	4.1	0.12

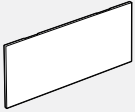
BPMB • Raceway Cover Caps

- To provide clean detail for the punch-outs of a raceway cover when the punch-outs are not in use. Order only when required.
- Made of injection molded ABS.
- B = Black
- W = White
- G = Grey

PRODUCT CODE	PRICE	SIZE/ INCHES			WEIGHT VOL	
		H	W	D	LBS	FT ³
BPMB020104B	10	1.5	3	0.125	0.04	0.02
BPMB020104G	10	1.5	3	0.125	0.04	0.02
BPMB020104W	10	1.5	3	0.125	0.04	0.02

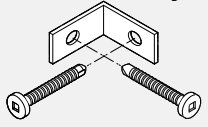
BHSL • Safety Lock

- Provides customers a higher degree of privacy.
- Safety Lock is a set of two ready made brackets and
- It is installed from the inside of a panel adjacent to a opening the door through the raceway.
- To be used for PVC raceways only.

PRODUCT CODE	PRICE
BHSL02	31

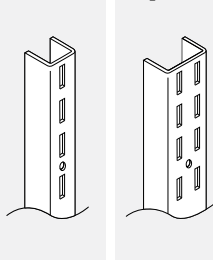
BHV • Component Wall Adapter - Single and Double

- Used to attach system components to fixed wall.
- Panel frame finish.
- The vertical wall adapter is a "U" shaped channel with a vertical row of slots with 1" centers.
- The double Component Wall Adapter has a double row of slots with 1" centers.
- Comes in 60" length only.
- Care should be taken to mount adapters only to wall studs using correct fasteners.
- Does not include mounting hardware. Mounting hardware selection to be based on wall material.
- Sold in pairs.
- Failure to do this may result in collapse of the unit and subsequent possible personal injury.

PRODUCT CODE	PRICE	SIZE/ INCHES			WEIGHT VOL	
		H	W	D	LBS	FT ³
BHV01	102	60	0.75	0.5	4	0.009
BHV02	117	60	1.50	0.5	5	0.026

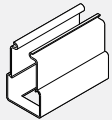
BECC01 • Cable Terminal Channel

- Houses various combinations of voice and data cables.
- 1 included with every Raceway Panel.
- Accommodates assorted snap-in modular voice and data terminals (not supplied by Global Contract Inc).
- Black only.

PRODUCT CODE	PRICE	SIZE/ INCHES			WEIGHT VOL	
		H	W	D	LBS	FT ³
BECC01	31	6	4.5	2.5	.20	0.21

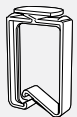
BPHC01 • Cable Terminal Channel

- Houses various combinations of voice and data cables.
- 2 included with every Raceway Panel.
- Black only.
- For use with Boulevard 1 Panels only.

PRODUCT CODE	PRICE	SIZE/ INCHES			WEIGHT VOL	
		H	W	D	LBS	FT ³
BPHC01	9	2.5	1	2	0.1	0.003

BOULEVARD SYSTEM 3

Boulevard System 3 Panel System

Boulevard System 3... The next generation of BOULEVARD offers the freedom to plan the office environment 'your way', while keeping an eye on the bottom line. Boulevard System 3 boasts a rich toolbox featuring stack-on panels, complete data/communication lay-in at the top, comprehensive power and data/communication at both the base and at desk height, a selection of interchangeable tiles, monolithic panels, up-mounted storage, new ergonomic worksurface shapes & a revised colour pallet featuring recycled fabrics... all wrapped up in a sophisticated design statement. Enjoy planning it your way and having the tools to really do it. Boulevard System 3 offers the building blocks to create the framework that perfectly suits your office environment. Combinations of fabric, glazed, open and slat wall panel surface tiles effectively support the creation of various work settings, whether open (to encourage interaction and teamwork) or traditional, with enclosed functional task organizers. Boulevard System 3 lets you plan more effectively and with more versatility than ever before.

It is simple to comprehend, specify, install, maintain and reconfigure. Offering multifunctional furnishing solutions, Boulevard System 3 can be specified on its own or used as a power/data and privacy provider, bridging freestanding/mobile furniture and panels and task related options such as worksurface shapes that help you work better. By utilizing up-mount storage, lower panel heights can be maintained without sacrificing overhead storage where and when needed. Another value-oriented tool... Consider 'Spine' planning to create a power wall that feeds data/communication to a string of perpendicular offices. Incorporate monolithic panels which offer the best cost/performance advantages for value sensitive environments with base panel raceway power/data cable distribution, while adding visual interest...and of course, reconfiguration is a breeze. Now you can have an endless visual pallet and array of practical solutions for today's ever changing and demanding workplace. When you add it all up, Boulevard System 3 gives you more value than ever before.

Technical Information

Panels

- All panels are 2 5/8" thick.
- Lightweight aluminum box frame construction creates superior panel rigidity.
- Panel frame finish is durable epoxy powder coated.
- Hang-on capabilities at 1" increments.
- Patented "Knuckle-Loc" design provides solid panel-to-panel connection for fast installation and reconfiguration.
- Knuckle lock feature ensures even panel heights throughout installation.
- 3" glide stem permits 2 1/2" height adjustment.
- Panel sizes are actual, eliminating creepage.
- Vertical end trims must be specified to give the panel a finished appearance.
- Horizontal top trims are included with all panels.
- All panels include 2 "Capture Strip" panel connectors.
- Panels are UL listed and CSA approved and have a Class "A" fire rating except when Customer's Own Material (COM) is used.
- All panels accept Over Panels (see page D.7).

Panel Options

- Laminate, whiteboard, or corkboard may be substituted for fabric on panels only, see "OPT" column.
- Laminate and whiteboard are held in place with a PVC retainer matching the frame colour and can be retrofitted on site.
- Laminate and whiteboard options reduce the acoustical value of the panel.

Monolithic Panels

- Fabric on Monolithic Panels can be re-upholstered on site.

Pass Thru Panels

- Fabric at base of Pass-Thru Panels can be re-upholstered on site.
- Tiles cannot be re-upholstered on site.

Bottom Lay-in Raceway

- Bottom raceway snaps to the bottom of the panel and can be completely removed for unobstructed cable lay-in installation.
- Bottom lay-in raceway is 60 mm (2.380") wide x 141 mm (5.560") high.
- Maximum capacity: 70 cables 5 mm (0.200) diameter, 2 parallel 8 wire, 4 circuit power distribution.
- State-of-the-art engineering.
- Snap-in modularity of all electrical components including harnesses, distribution housings, duplexes and circuit designations.
- All power and data outlets are easily accessible from both sides of panel.
- 8 wire system with 4, 15 amp circuits (including 1 dedicated circuit).
- Facemount electrical with 2 duplex per panel side.
- Included is 1 data/communication terminal bracket per side.

- Raceway cover openings of 2.71" x 1.38" can accommodate a single modular Data/Comm terminal plate per side (not supplied by Global Contract Inc).
- Opening complies with the ANSI/TIA/EIA standard furniture openings.
- Outlet and circuit changes accomplished without disruption to work station.
- Large raceway cavity permits storage of excess cables and equipment cords.
- Total flexibility for 8 wire system: choice of up to 4 duplexes per panel; choice of circuitry in each duplex .
- Unique design of fire retardant metal raceway cover permits access to raceway without disruption to equipment.

Horizontal Lay-in Channel (Excluding all panels with Embedded Glass)

- Integrated horizontal lay-in channel 33.5 mm (1.320") wide and 38 mm (1.500") high at the top of panels and on top of the door frame.
- Maximum capacity: 36 cables 5 mm (0.200") in diameter.
- Maximum cable bending radius between two perpendicular panels: 141.2 mm (5.560") [5 mm (0.200") in diameter cables].

Vertical Wire Channel

- Where applicable, the vertical wire channel connects horizontal channel above desk height with floor level raceway.
- Opening in horizontal channel allows for vertical cable passage from top lay-in channel to base raceway.
- Integrated vertical channel 76 mm (2.990") x 27 mm (1.060").
- Maximum capacity: 60 cables 5 mm (0.200") in diameter.
- Maximum cable bending radius: 141.2 mm (5.560").

Posts

- Enables connection for multiple panel runs such as 90°, 45° or 60° angle and 2 way, 3 way or 4 way.
- Starts at the top of the bottom lay-in raceway.
- 90 degree post provides route for ceiling power and data entry to a panel raceway.
- Knuckle lock feature maintains even height of all connected panels.
- Solid lightweight aluminum extrusion fits together through a unique "Knuckle-Loc" design providing rigid post-to-panel connection.
- Post has punch-outs at the top to allow for unobstructed horizontal cable passage between adjacent panels.
- Includes all required panel connectors and caps.
- Posts add 2 5/8" to a panel run.
- Posts are 1/8" oversized to allow for "panel wrap around" of freestanding desks.
- For all panel runs with multiple posts, this 1/8" must be allotted for.
- Maximum capacity:
 - 80 cables 5mm(0.200") diameter
 - 65 cables 5mm(0.200") diameter with 1 power feed
 - 50 cables 5mm (0.200") diameter with 2 power feeds

PANELS - GUIDELINES FOR ORDERING PRODUCT**Codes**

The product guide uses a numbering system with meaningful alphanumeric characters to create a simple-to-understand product number. This makes specifying the product much easier and more accurate.

Example of Panel: **BPX3MA6636 CHR CHR P1**

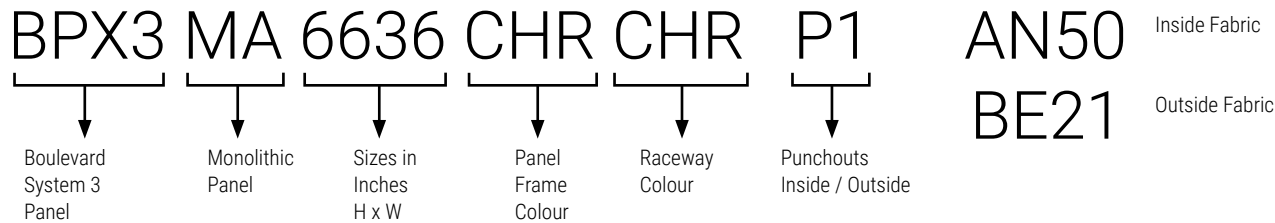
**How to Specify**

- Specify Boulevard System 3 panel type and size by code.
- Specify panel frame finish - ie. CHR (Charcoal).
- Specify PVC raceway finish - ie. CHR (Charcoal). If raceway colour not specified at time of order, default will be the panel frame colour.
- Specify all two panel fabric options if necessary.
- Some fabrics have directional pattern and cannot be applied horizontally or vertically. Panels wider than 60" will have fabrics applied horizontally (railroad). Please specify if you want adjacent panels and the rest of the installation upholstered the same way.
- Specify whether punchouts are required inside and outside of raceway or if no knockouts are required.
 - P2 - Punchouts on both sides.
 - P1 - Punchouts on one side.
 - NP - No punchouts.
- For special width panels, a special must be processed and additional costs apply. Please contact your customer service representative.

Example of Post: **BH3PS066 CHR**

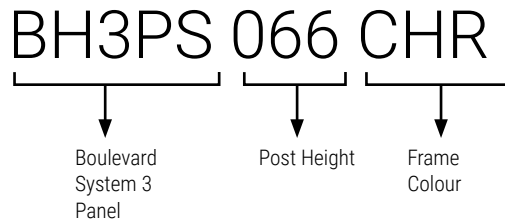
**How to Specify**

- Specify Boulevard System 3 post by code.
- Specify frame colour - ie. CHR (Charcoal).

ORDERS

Each Order Must Include

- Purchase Order
- Layout showing where the image(s) appear in the run of panels.
- A completed Price Chart, showing the location of the image(s) on each appropriate panel.

Transfer Devices

- E-mail up to 10MB to your Global Contract Customer Service Representative.
- Courier CD/DVD/USB stick to your Global Contract Customer Service Representative.

Artwork Specifications

- Non-Photographic artwork should be vector art, saved in Adobe Illustrator (.ai), SVG or an EPS (.eps)
- All bitmap or photographic artwork has to be at a minimum of 100 dpi at the full size of the panel to be printed.
- We accept Adobe CS5 files.
- Any linked files must be included or imbedded.
- Leave any PSD files unflattened
- All fonts must be converted to outlines.
- Do not convert to CMYK, leave all images as RGB if possible
- No Word, Powerpoint, Publisher or other Microsoft files can be used.
- Include a PDF or .jpg for reference when sending native Photoshop or Illustrator format files.

Colour Matching

- A Pantone colour reference must be supplied or we cannot accept responsibility for correct colour.
- When it is not possible to refer to Pantone colours, we will do our best to meet your requirements.

Image Clarity

- We will advise should the selected image not lend itself to the element size requested.

NOTE:

We reserve the right to put an order on hold when the files are found to be incomplete or when documents have been either incorrectly saved. Fonts not converted to curves or the job appears not to be commercially acceptable.

Image Bleed:

To facilitate placement on the panel. Extension of the image past the finished visible area of the panel (bleed) is required

- Boulevard Panels need a 5" Bleed on all sides.

Example Of Image resolution:

The resolution required for a 36 wide x 24 high Boulevard panel at 100dpi (minimum resolution)

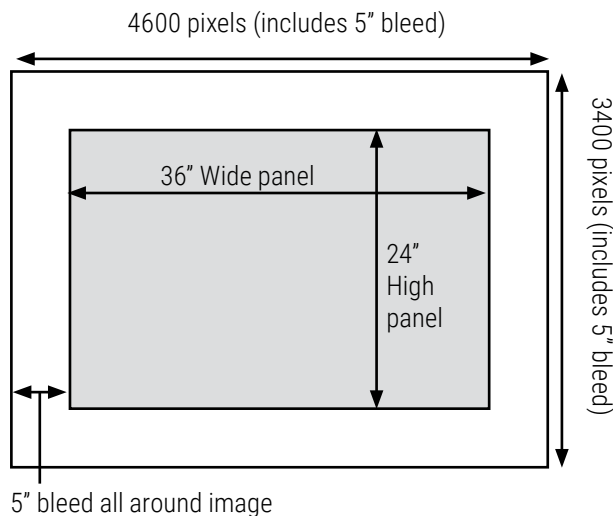

The resolution required for a 36 wide x 24 high Boulevard panel at 300dpi (higher quality)

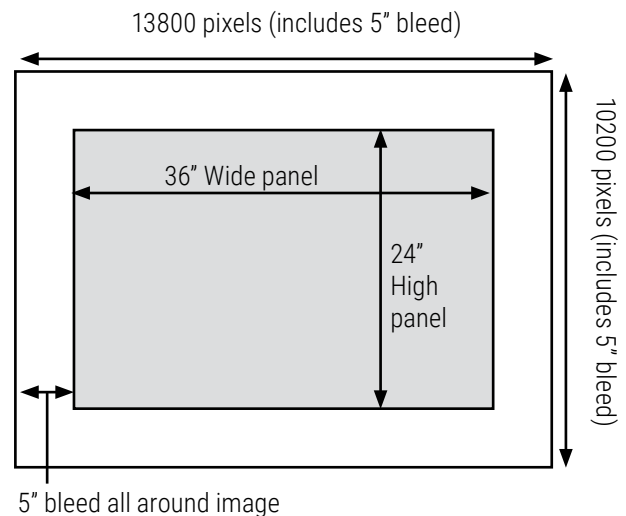

Pricing, Initial Set-Up Charge per Image:\$264 net

Boulevard System 3 Tiles



- This List applies to the following panels:
- BP3FT
- BP3ET

PANEL WIDTH	HEIGHT 8"	LIST PRICE 16"
24"	144	211
30"	173	248
36"	197	286
42"	227	324
48"	248	364
54"	279	408
60"	303	446
66"	324	476
72"	353	513

Boulevard System 3 Bottom Section of Pass-Through Panel

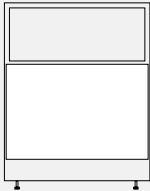

- This List applies to the following panels:
- BPX3PT
- BPX3PV

PANEL WIDTH	LIST PRICE 28"
24"	303
30"	353
36"	408
42"	469
48"	520
54"	574
60"	626
66"	680
72"	731

Boulevard System 3 Monolithic Panels

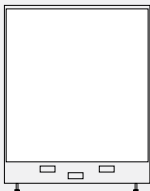

- This List applies to the following panels:
- BPX3MA
- BPX3MV

PANEL WIDTH	HEIGHT 34"	LIST PRICE 42"	50"	66"
24"	303	370	431	567
30"	353	431	513	661
36"	408	499	589	770
42"	469	567	656	874
48"	520	633	754	972
54"	574	699	823	1079
60"	626	770	905	1175
66"	680			
72"	731			

Note: Prices shown are an upcharge to the panel price, please add to the list price of panel which you are specifying the graphic for.

BPX3MA • Monolithic Acoustical Panel

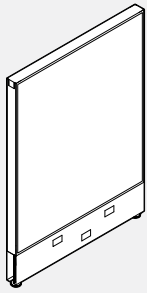

- Provides visual and acoustic privacy.
- Centre septum above raceway overlaid on either side with 1 1/8" "Sound absorbent mineral board".
- Acoustic rating of .70 NRC and 25 STC.
- OPT* = Laminate or Whiteboard
- "No Knockouts" option for raceways available at no additional charge. Please choose option for interior and/or exterior raceways.

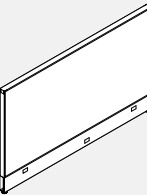

72" Wide

PRODUCT CODE	PRICE			SIZE/ INCHES			WEIGHT LBS	VOL FT ³
	GR 1	GR 2	OPT*	H	W	D		
BPX3MA3418	371	392	415	34	18	2.61	11	1.337
BPX3MA3424	411	433	455	34	24	2.61	12	1.738
BPX3MA3430	452	475	495	34	30	2.61	13	2.139
BPX3MA3436	491	537	580	34	36	2.61	15	2.540
BPX3MA3442	537	578	623	34	42	2.61	16	2.941
BPX3MA3448	577	619	661	34	48	2.61	18	3.342
BPX3MA3454	621	660	709	34	54	2.61	20	3.743
BPX3MA3460	658	699	747	34	60	2.61	22	4.144
BPX3MA3466	697	757	823	34	66	2.61	26	4.612
BPX3MA3472	737	796	-	34	72	2.61	30	5.080
BPX3MA4218	398	426	456	42	18	2.61	12	1.782
BPX3MA4224	442	472	501	42	24	2.61	13	2.317
BPX3MA4230	485	514	544	42	30	2.61	15	2.852
BPX3MA4236	527	584	645	42	36	2.61	17	3.387
BPX3MA4242	574	630	691	42	42	2.61	19	3.921
BPX3MA4248	619	676	736	42	48	2.61	21	4.456
BPX3MA4254	660	720	780	42	54	2.61	23	4.991
BPX3MA4260	701	759	820	42	60	2.61	25	5.525
BPX3MA4266	774	888	1012	42	66	2.61	29	6.148
BPX3MA4272	840	956	-	42	72	2.61	34	6.770
BPX3MA5018	512	552	600	50	18	2.61	13	2.106
BPX3MA5024	565	607	653	50	24	2.61	15	2.738
BPX3MA5030	621	660	709	50	30	2.61	17	3.370
BPX3MA5036	671	755	849	50	36	2.61	20	4.002
BPX3MA5042	724	811	901	50	42	2.61	23	4.634
BPX3MA5048	779	863	955	50	48	2.61	24	5.266
BPX3MA5054	830	916	1006	50	54	2.61	25	5.898
BPX3MA5060	885	970	1062	50	60	2.61	27	6.530
BPX3MA5066	958	1073	1198	50	66	2.61	33	7.265
BPX3MA5072	1029	1146	-	50	72	2.61	40	8.000
BPX3MA5418	535	575	621	54	18	2.61	14	2.406
BPX3MA5424	586	629	673	54	24	2.61	16	3.181
BPX3MA5430	643	686	727	54	30	2.61	19	3.907
BPX3MA5436	694	780	870	54	36	2.61	22	4.602
BPX3MA5442	751	835	928	54	42	2.61	25	5.306
BPX3MA5448	804	888	982	54	48	2.61	26	5.966
BPX3MA5454	857	942	1034	54	54	2.61	27	7.287
BPX3MA5460	913	997	1089	54	60	2.61	30	7.539
BPX3MA6618	596	668	745	66	18	2.61	14	2.755
BPX3MA6624	656	725	802	66	24	2.61	17	3.581
BPX3MA6630	711	780	854	66	30	2.61	20	4.407
BPX3MA6636	766	882	1000	66	36	2.61	24	5.234
BPX3MA6642	826	938	1061	66	42	2.61	26	6.060
BPX3MA6648	883	996	1117	66	48	2.61	28	6.887
BPX3MA6654	937	1052	1171	66	54	2.61	30	7.713
BPX3MA6660	996	1108	1231	66	60	2.61	32	8.539

BPX3MAH • Monolithic Acoustical Hallway Panel

- Provides visual and acoustic privacy.
- Centre septum above raceway overlaid on either side with 1 1/8" "Sound absorbent mineral board".
- One side is with raceway at base, other side has full fabric.
- Acoustic rating of .70 NRC and 25 STC.
- Must specify a BE8JM19 Mesh Jumper at 90 degree corners.
- OPT* = Laminate or Whiteboard
- No Knockouts" option for raceways available at no additional charge. Please choose option for interior and/or exterior raceways.

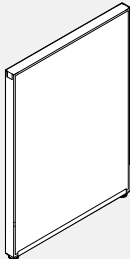
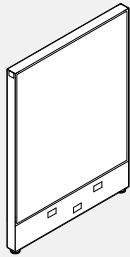

Outside

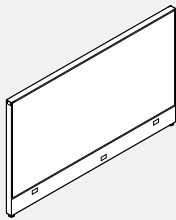

72" Wide

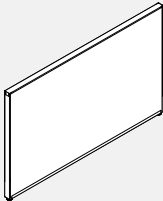

72" Wide Outside

PRODUCT CODE	PRICE			SIZE/ INCHES			WEIGHT LBS	VOL FT³
	GR 1	GR 2	OPT*	H	W	D		
BPX3MAH3418	371	392	415	34	18	2.61	11	1.34
BPX3MAH3424	411	433	455	34	24	2.61	12	1.74
BPX3MAH3430	452	475	495	34	30	2.61	13	2.14
BPX3MAH3436	491	537	580	34	36	2.61	15	2.54
BPX3MAH3442	537	578	623	34	42	2.61	16	2.94
BPX3MAH3448	577	619	661	34	48	2.61	18	3.34
BPX3MAH3454	621	660	709	34	54	2.61	20	3.74
BPX3MAH3460	658	699	747	34	60	2.61	22	4.14
BPX3MAH3466	697	757	823	34	66	2.61	26	4.61
BPX3MAH3472	737	796	-	34	72	2.61	30	5.08
BPX3MAH4218	398	426	456	42	18	2.61	12	1.78
BPX3MAH4224	442	472	501	42	24	2.61	13	2.32
BPX3MAH4230	485	514	544	42	30	2.61	15	2.85
BPX3MAH4236	527	584	645	42	36	2.61	17	3.39
BPX3MAH4242	574	630	691	42	42	2.61	19	3.92
BPX3MAH4248	619	676	736	42	48	2.61	21	4.46
BPX3MAH4254	660	720	780	42	54	2.61	23	4.99
BPX3MAH4260	701	759	820	42	60	2.61	25	5.53
BPX3MAH4266	774	888	1012	42	66	2.61	29	6.15
BPX3MAH4272	840	956	-	42	72	2.61	34	6.77
BPX3MAH5018	512	552	600	50	18	2.61	13	2.11
BPX3MAH5024	565	607	653	50	24	2.61	15	2.74
BPX3MAH5030	621	660	709	50	30	2.61	17	3.37
BPX3MAH5036	671	755	849	50	36	2.61	20	4.00
BPX3MAH5042	724	811	901	50	42	2.61	23	4.63
BPX3MAH5048	779	863	955	50	48	2.61	24	5.27
BPX3MAH5054	830	916	1006	50	54	2.61	25	5.90
BPX3MAH5060	885	970	1062	50	60	2.61	27	6.53
BPX3MAH5066	958	1073	1198	50	66	2.61	33	7.27
BPX3MAH5072	1029	1146	-	50	72	2.61	40	8.00
BPX3MAH5418	535	575	621	54	18	2.61	14	2.41
BPX3MAH5424	586	629	673	54	24	2.61	16	3.18
BPX3MAH5430	643	686	727	54	30	2.61	19	3.91
BPX3MAH5436	694	780	870	54	36	2.61	22	4.60
BPX3MAH5442	751	835	928	54	42	2.61	25	5.31
BPX3MAH5448	804	888	982	54	48	2.61	26	5.97
BPX3MAH5454	857	942	1034	54	54	2.61	27	7.29
BPX3MAH5460	913	997	1089	54	60	2.61	30	7.54
BPX3MAH6618	596	668	745	66	18	2.61	14	2.76
BPX3MAH6624	656	725	802	66	24	2.61	17	3.58
BPX3MAH6630	711	780	854	66	30	2.61	20	4.41
BPX3MAH6636	766	882	1000	66	36	2.61	24	5.23
BPX3MAH6642	826	938	1061	66	42	2.61	26	6.06
BPX3MAH6648	883	996	1117	66	48	2.61	28	6.89
BPX3MAH6654	937	1052	1171	66	54	2.61	30	7.71
BPX3MAH6660	996	1108	1231	66	60	2.61	32	8.54

BPX3MV • Monolithic Acoustical Panel with Vertical Wire Channel

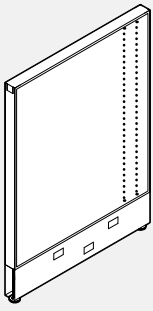

- Provides visual and acoustic privacy and allows for vertical cable passage from top lay-in channel to bottom raceway within panel.
- Centre septum above raceway overlaid on either side with 1 1/8" "Sound absorbent mineral board".
- Acoustic rating of .70 NRC and 25 STC. Includes integrated vertical wire channel.
- OPT* = Laminate or Whiteboard
- "No Knockouts" option for raceways available at no additional charge. Please choose option for interior and/or exterior raceways.

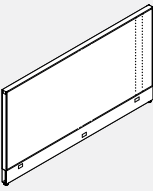

72" Wide

PRODUCT CODE	PRICE			SIZE/ INCHES			WEIGHT LBS	VOL FT ³
	GR 1	GR 2	OPT*	H	W	D		
BPX3MV3430	486	509	534	34	30	2.61	15	2.139
BPX3MV3436	527	570	614	34	36	2.61	17	2.540
BPX3MV3442	569	610	656	34	42	2.61	18	2.941
BPX3MV3448	610	654	697	34	48	2.61	20	3.342
BPX3MV3454	654	694	741	34	54	2.61	22	3.743
BPX3MV3460	692	734	780	34	60	2.61	24	4.144
BPX3MV3466	783	842	907	34	66	2.61	29	4.612
BPX3MV3472	785	845	-	34	72	2.61	34	5.080
BPX3MV4230	535	562	591	42	30	2.61	17	2.852
BPX3MV4236	574	630	691	42	36	2.61	19	3.387
BPX3MV4242	622	680	740	42	42	2.61	21	3.921
BPX3MV4248	660	720	780	42	48	2.61	23	4.456
BPX3MV4254	707	762	824	42	54	2.61	25	4.991
BPX3MV4260	749	806	867	42	60	2.61	27	5.525
BPX3MV4266	827	943	1066	42	66	2.61	32	6.148
BPX3MV4272	898	1017	-	42	72	2.61	38	6.770
BPX3MV5030	672	715	759	50	30	2.61	19	3.370
BPX3MV5036	727	814	907	50	36	2.61	22	4.002
BPX3MV5042	780	864	956	50	42	2.61	25	4.634
BPX3MV5048	835	920	1012	50	48	2.61	26	5.266
BPX3MV5054	886	971	1063	50	54	2.61	27	5.898
BPX3MV5060	942	1027	1119	50	60	2.61	29	6.530
BPX3MV5066	1026	1142	1265	50	66	2.61	35	7.265
BPX3MV5072	1108	1225	-	50	72	2.61	40	8.000
BPX3MV5430	701	746	790	54	30	2.61	19	3.907
BPX3MV5436	758	843	935	54	36	2.61	22	4.602
BPX3MV5442	812	895	987	54	42	2.61	25	5.306
BPX3MV5448	867	952	1043	54	48	2.61	26	5.966
BPX3MV5454	920	1003	1095	54	54	2.61	27	7.287
BPX3MV5460	975	1061	1153	54	60	2.61	30	7.539
BPX3MV6630	791	863	937	66	30	2.61	22	4.407
BPX3MV6636	845	958	1079	66	36	2.61	26	5.234
BPX3MV6642	905	1018	1139	66	42	2.61	28	6.060
BPX3MV6648	960	1073	1196	66	48	2.61	30	6.887
BPX3MV6654	1017	1129	1250	66	54	2.61	32	7.713
BPX3MV6660	1073	1187	1306	66	60	2.61	34	8.539

BPX3MG • Monolithic Glazed Panel

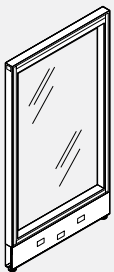

- Full-height glazing provides visual accessibility.
- Glazing is replaceable on site. Tempered clear glass standard.
- Glazing is standard on one side.
- "No Knockouts" option for raceways available at no additional charge. Please choose option for interior and/or exterior raceways.

PRODUCT CODE	PRICE		SIZE/ INCHES			WEIGHT LBS	VOL FT ³
	CLR	FRST	H	W	D		
BPX3MG5024	898	1080	50	24	2.61	25	2.738
BPX3MG5030	1142	1369	50	30	2.61	29	3.370
BPX3MG5036	1209	1450	50	36	2.61	33	4.002
BPX3MG5042	1276	1533	50	42	2.61	36	4.634
BPX3MG5048	1344	1611	50	48	2.61	41	5.266
BPX3MG5424	958	1148	54	24	2.61	29	3.138
BPX3MG5430	1160	1394	54	30	2.61	34	3.807
BPX3MG5436	1236	1483	54	36	2.61	38	4.602
BPX3MG5442	1310	1573	54	42	2.61	43	5.334
BPX3MG5448	1383	1661	54	48	2.61	48	6.066
BPX3MG6624	1121	1345	66	24	2.61	33	3.581
BPX3MG6630	1216	1460	66	30	2.61	39	4.407
BPX3MG6636	1318	1581	66	36	2.61	44	5.234
BPX3MG6642	1411	1694	66	42	2.61	49	6.060
BPX3MG6648	1506	1809	66	48	2.61	54	6.887

BPX3PT • Pass-Thru Panel - Fabric Base

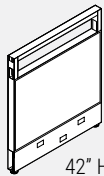

42" High

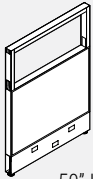

50" High

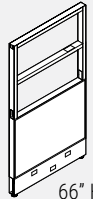

66" High

- Opening allows choice of tile above desk height.
- Solid fabric base up to 34".
- Single 8" opening above 34" for 42" high panels.
- Single 16" opening above 34" for 50" high panels.
- Two individual 16" openings above 34" for 66" high panels.
- Horizontal cable management at 34" height.
- OPT* = Laminate or Whiteboard.
- "No Knockouts" option for raceways available at no additional charge. Please choose option for interior and/or exterior raceways.

PRODUCT CODE	PRICE			SIZE/ H	INCHES			WEIGHT LBS	VOL FT ³
	GR 1	GR 2	OPT*		W	D			
BPX3PT4218	380	409	441	42	18	2.61	14	1.689	
BPX3PT4224	431	457	488	42	24	2.61	16	2.233	
BPX3PT4230	476	505	537	42	30	2.61	17	2.792	
BPX3PT4236	520	548	580	42	36	2.61	19	3.351	
BPX3PT4242	567	593	626	42	42	2.61	21	3.908	
BPX3PT4248	614	644	676	42	48	2.61	23	4.466	
BPX3PT4254	659	689	721	42	54	2.61	26	5.025	
BPX3PT4260	705	733	763	42	60	2.61	27	5.592	
BPX3PT4266	752	812	877	42	66	2.61	32	6.148	
BPX3PT4272	801	860	-	42	72	2.61	38	6.700	
BPX3PT5018	380	409	441	50	18	2.61	15	2.106	
BPX3PT5024	431	457	488	50	24	2.61	17	2.738	
BPX3PT5030	476	505	537	50	30	2.61	18	3.370	
BPX3PT5036	520	548	580	50	36	2.61	20	4.002	
BPX3PT5042	567	593	626	50	42	2.61	22	4.634	
BPX3PT5048	614	644	676	50	48	2.61	24	5.266	
BPX3PT5054	659	689	721	50	54	2.61	27	5.898	
BPX3PT5060	705	733	763	50	60	2.61	29	6.530	
BPX3PT5066	752	812	877	50	66	2.61	34	7.265	
BPX3PT5072	801	860	-	50	72	2.61	40	8.000	
BPX3PT6618	475	505	536	66	18	2.61	19	2.755	
BPX3PT6624	527	557	589	66	24	2.61	21	3.581	
BPX3PT6630	586	615	647	66	30	2.61	23	4.407	
BPX3PT6636	638	668	697	66	36	2.61	25	5.234	
BPX3PT6642	694	724	755	66	42	2.61	27	6.060	
BPX3PT6648	754	784	814	66	48	2.61	30	6.887	
BPX3PT6654	805	835	865	66	54	2.61	33	7.713	
BPX3PT6660	863	893	922	66	60	2.61	36	8.539	

BPX3PTH • Pass-Thru Hallway Panel - Fabric Base

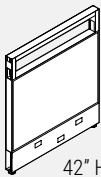

42" High

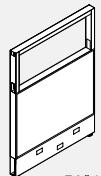
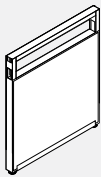

50" High

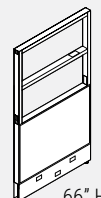
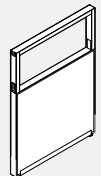

66" High

- Opening allows choice of tile above desk height.
- Solid fabric base up to 34".
- Single 8" opening above 34" for 42" high panels.
- Single 16" opening above 34" for 50" high panels.
- Two individual 16" openings above 34" for 66" high panels.
- One side is with raceway at base, other side has full fabric.
- Horizontal cable management at 34" height.
- Must specify a BE8JM19 Mesh Jumper at 90 degree corners.
- OPT* = Laminate or Whiteboard
- "No Knockouts" option for raceways available at no additional charge. Please choose option for interior and/or exterior raceways.

PRODUCT CODE	PRICE			SIZE/ H	INCHES			WEIGHT LBS	VOL FT ³
	GR 1	GR 2	OPT*		W	D			
BPX3PTH4218	380	409	441	42	18	2.61	14	1.69	
BPX3PTH4224	431	457	488	42	24	2.61	16	2.23	
BPX3PTH4230	476	505	537	42	30	2.61	17	2.79	
BPX3PTH4236	520	548	580	42	36	2.61	19	3.35	
BPX3PTH4242	567	593	626	42	42	2.61	21	3.91	
BPX3PTH4248	614	644	676	42	48	2.61	23	4.47	
BPX3PTH4254	659	689	721	42	54	2.61	26	5.03	
BPX3PTH4260	705	733	763	42	60	2.61	27	5.59	
BPX3PTH4266	752	812	877	42	66	2.61	32	6.15	
BPX3PTH4272	801	860	-	42	72	2.61	38	6.70	
BPX3PTH5018	380	409	441	50	18	2.61	15	2.11	
BPX3PTH5024	431	457	488	50	24	2.61	17	2.74	
BPX3PTH5030	476	505	537	50	30	2.61	18	3.37	
BPX3PTH5036	520	548	580	50	36	2.61	20	4.00	
BPX3PTH5042	567	593	626	50	42	2.61	22	4.63	
BPX3PTH5048	614	644	676	50	48	2.61	24	5.27	
BPX3PTH5054	659	689	721	50	54	2.61	27	5.90	
BPX3PTH5060	705	733	763	50	60	2.61	29	6.53	
BPX3PTH5066	752	812	877	50	66	2.61	34	7.27	
BPX3PTH5072	801	860	-	50	72	2.61	40	8.00	
BPX3PTH6618	475	505	536	66	18	2.61	19	2.76	
BPX3PTH6624	527	557	589	66	24	2.61	21	3.58	
BPX3PTH6630	586	615	647	66	30	2.61	23	4.41	
BPX3PTH6636	638	668	697	66	36	2.61	25	5.23	
BPX3PTH6642	694	724	755	66	42	2.61	27	6.06	
BPX3PTH6648	754	784	814	66	48	2.61	30	6.89	
BPX3PTH6654	805	835	865	66	54	2.61	33	7.71	
BPX3PTH6660	863	893	922	66	60	2.61	36	8.54	

BPX3PV • Pass-Thru Panel with Vertical Wire Channel

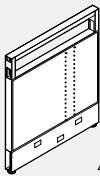

42" High

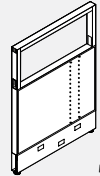

50" High

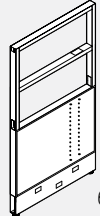

66" High

- Opening allows choice of tile above desk height. Vertical wire channel allows passage of cables from top lay-in channel to bottom raceway within panel.
- Solid fabric base up to 34".
- Single 8" opening above 34" for 42" high panels.
- Single 16" opening above 34" for 50" high panels.
- Two individual 16" openings above 34" for 66" high panels.
- Includes integrated vertical wire channel.
- Horizontal cable management at 34" height.
- OPT* = Laminate or Whiteboard.
- "No Knockouts" option for raceways available at no additional charge. Please choose option for interior and or exterior raceways.

PRODUCT CODE	PRICE			SIZE/ INCHES			WEIGHT LBS	VOL FT ³
	GR 1	GR 2	OPT*	H	W	D		
BPX3PV4230	520	548	580	42	30	2.61	19	2.792
BPX3PV4236	567	593	626	42	36	2.61	21	3.351
BPX3PV4242	614	644	676	42	42	2.61	23	3.908
BPX3PV4248	659	689	721	42	48	2.61	23	4.466
BPX3PV4254	705	733	763	42	54	2.61	28	5.025
BPX3PV4260	755	784	816	42	60	2.61	30	5.592
BPX3PV4266	792	852	917	42	66	2.61	36	6.148
BPX3PV4272	830	891	-	42	72	2.61	42	6.700
BPX3PV5030	520	548	580	50	30	2.61	20	3.370
BPX3PV5036	567	593	626	50	36	2.61	22	4.002
BPX3PV5042	614	644	676	50	42	2.61	24	4.634
BPX3PV5048	659	689	721	50	48	2.61	26	5.266
BPX3PV5054	705	733	763	50	54	2.61	29	5.898
BPX3PV5060	755	784	816	50	60	2.61	31	6.530
BPX3PV5066	792	852	917	50	66	2.61	37	7.265
BPX3PV5072	830	891	-	50	72	2.61	44	8.000
BPX3PV6630	630	659	691	66	30	2.61	25	4.407
BPX3PV6636	688	718	748	66	36	2.61	27	5.234
BPX3PV6642	741	773	801	66	42	2.61	29	6.060
BPX3PV6648	797	827	857	66	48	2.61	32	6.887
BPX3PV6654	852	883	913	66	54	2.61	35	7.713
BPX3PV6660	908	937	969	66	60	2.61	38	8.539

BPX3PF • Pass-Thru Panel - Air Flow Base

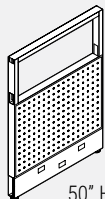

50" High

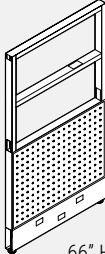

66" High

- Allows air to flow freely through the bottom of the panel.
- Double wall perforated metal base up to 34".
- Single 16" opening above 34" for 50" high panels.
- Two individual 16" openings above 34" for 66" high panels.
- Horizontal cable management at 34" height.
- "No Knockouts" option for raceways available at no additional charge. Please choose option for interior and/or exterior raceways.

PRODUCT CODE	PRICE	SIZE/ INCHES			WEIGHT LBS	VOL FT ³
		H	W	D		
BPX3PF5018	536	50	18	2.61	17	2.106
BPX3PF5024	605	50	24	2.61	18	2.738
BPX3PF5030	673	50	30	2.61	20	3.370
BPX3PF5036	749	50	36	2.61	22	4.002
BPX3PF5042	824	50	42	2.61	23	4.634
BPX3PF5048	895	50	48	2.61	26	5.266
BPX3PF5054	969	50	54	2.61	28	5.898
BPX3PF5060	1038	50	60	2.61	31	6.530
BPX3PF6618	625	66	18	2.61	21	2.755
BPX3PF6624	705	66	24	2.61	23	3.581
BPX3PF6630	791	66	30	2.61	25	4.407
BPX3PF6636	874	66	36	2.61	27	5.234
BPX3PF6642	960	66	42	2.61	29	6.060
BPX3PF6648	1045	66	48	2.61	32	6.887
BPX3PF6654	1129	66	54	2.61	35	7.713
BPX3PF6660	1212	66	60	2.61	37	8.539

BPX3OP • Over Panel Frame

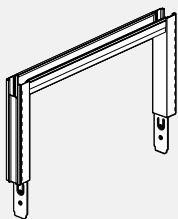

- Attaches to the top of any Boulevard System 3 panel to create a floor-to-ceiling wall.
- Any tile can be attached to either side to enclose the frame.
- Two slotted uprights at either end slide into vertical extrusions on the base panel.
- Shipped without horizontal and vertical trim; the horizontal trim from the base panel will be used.
- Openings in horizontal channels allow for vertical cable passage from top lay-in channel and behind the cover tiles
- Over Panel Frames 18" and 24" wide are not punched for vertical wire channel.
- Boulevard System 3 Over Panel is not compatible with Boulevard 1 panels.
- Hang-on capabilities not to exceed 66" high or in conjunction with glass tiles.

PRODUCT CODE	PRICE	SIZE/ INCHES			WEIGHT LBS	VOL FT ³
		H	W	D		
BPX3OP0818	93	8	18	2.61	3	0.383
BPX3OP0824	102	8	24	2.61	4	0.438
BPX3OP0830	109	8	30	2.61	4	0.656
BPX3OP0836	117	8	36	2.61	4	0.712
BPX3OP0842	131	8	42	2.61	5	0.875
BPX3OP0848	138	8	48	2.61	5	0.930
BPX3OP0854	146	8	54	2.61	6	1.040
BPX3OP0860	156	8	60	2.61	6	1.204
BPX3OP0866	173	8	66	2.61	7	1.310
BPX3OP0872	192	8	72	2.61	8	1.420
BPX3OP1618	93	16	18	2.61	4	0.638
BPX3OP1624	102	16	24	2.61	5	0.730
BPX3OP1630	109	16	30	2.61	5	1.094
BPX3OP1636	117	16	36	2.61	5	1.186
BPX3OP1642	131	16	42	2.61	6	1.459
BPX3OP1648	138	16	48	2.61	6	1.550
BPX3OP1654	146	16	54	2.61	7	1.733
BPX3OP1660	156	16	60	2.61	7	2.006
BPX3OP1666	173	16	66	2.61	9	2.165
BPX3OP1672	192	16	72	2.61	10	2.370

BP3PBEG • Embedded Glass and Top Trim Kit

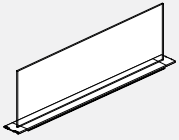

- **Embedded Glass and Top Trim Kit attaches on top of panels to add privacy or divide space.**
- Embedded Glass Top Trim Kit consist of the extruded aluminum channel, die-cast channel end covers, glass partition, gasket and hardware required to secure the trim to the panel's horizontal channel.
- Specify standard metal paint finish.
- Clear tempered glass is standard.
- NOTE: When specifying an application where two panels are side by side at different heights, a special is required to ensure proper fit.

PRODUCT CODE	PRICE		SIZE/INCHES			WEIGHT LBS	VOL FT ³
	CLR	FRST	H	W	D		
BP3PBEG0824	129	213	8	24	2.61	9.42	0.29
BP3PBEG0830	137	220	8	30	2.61	11.79	0.36
BP3PBEG0836	144	229	8	36	2.61	14.15	0.44
BP3PBEG0842	152	237	8	42	2.61	16.52	0.51
BP3PBEG0848	168	262	8	48	2.61	18.88	0.58
BP3PBEG0854	186	291	8	54	2.61	19.52	0.65
BP3PBEG0860	204	320	8	60	2.61	20.58	0.73
BP3PBEG0866	221	350	8	66	2.61	21.55	0.80
BP3PBEG0872	245	385	8	72	2.61	23.62	0.87
BP3PBEG1624	134	218	16	24	2.61	9.89	0.58
BP3PBEG1630	165	264	16	30	2.61	12.38	0.73
BP3PBEG1636	184	311	16	36	2.61	14.86	0.87
BP3PBEG1642	210	357	16	42	2.61	17.35	1.02
BP3PBEG1648	236	404	16	48	2.61	19.82	1.16
BP3PBEG1654	261	425	16	54	2.61	21.25	1.31
BP3PBEG1660	286	496	16	60	2.61	23.62	1.45
BP3PBEG1666	312	543	16	66	2.61	25.98	1.60
BP3PBEG1672	343	595	16	72	2.61	28.35	1.74

BP3PBEF • Embedded PET Felt and Top Trim Kit

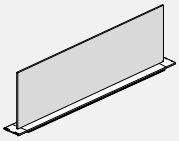

- **Embedded PET Felt and Top Trim Kit attaches on top of panels to add privacy or divide space.**
- Embedded PET Felt Top Trim Kit consist of the extruded aluminum channel, die-cast channel end covers, PET felt partition and hardware required to secure the trim to the panels horizontal channel.
- Specify standard metal paint finish.
- 9mm PET felt material is tackable and comes in 18 different colours. Please specify colour.
- NOTE: When specifying an application where two panels are side by side at different heights, a special is required to ensure proper fit.

PRODUCT CODE	PRICE		SIZE/INCHES			WEIGHT LBS	VOL FT ³
	H	W	D	LBS	FT ³		
BP3PBEF0824	63		8	24	2.61	1.32	0.29
BP3PBEF0830	66		8	30	2.61	1.65	0.36
BP3PBEF0836	88		8	36	2.61	1.99	0.44
BP3PBEF0842	92		8	42	2.61	2.32	0.51
BP3PBEF0848	165		8	48	2.61	2.65	0.58
BP3PBEF0854	169		8	54	2.61	2.98	0.65
BP3PBEF0860	172		8	60	2.61	3.32	0.73
BP3PBEF0866	176		8	66	2.61	3.65	0.80
BP3PBEF0872	185		8	72	2.61	3.98	0.87
BP3PBEF1624	63		16	24	2.61	1.83	0.58
BP3PBEF1630	66		16	30	2.61	2.30	0.73
BP3PBEF1636	88		16	36	2.61	2.76	0.87
BP3PBEF1642	92		16	42	2.61	3.22	1.02
BP3PBEF1648	165		16	48	2.61	3.68	1.16
BP3PBEF1654	169		16	54	2.61	4.14	1.31
BP3PBEF1660	172		16	60	2.61	4.61	1.45
BP3PBEF1666	176		16	66	2.61	5.07	1.60
BP3PBEF1672	185		16	72	2.61	5.53	1.74

BP3PBEFP • Embedded Perforated PET Felt and Top Trim Kit

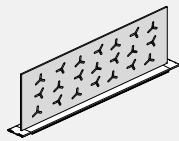

- **Embedded PET Felt and Top Trim Kit attaches on top of panels to add privacy or divide space.**
- Embedded PET Felt Top Trim Kit consist of the extruded aluminum channel, die-cast channel end covers, PET felt partition and hardware required to secure the trim to the panels horizontal channel.
- Specify standard metal paint finish.
- 9mm PET felt material is tackable and comes in 18 different colours. Please specify colour.
- NOTE: When specifying an application where two panels are side by side at different heights, a special is required to ensure proper fit.

PRODUCT CODE	PRICE		SIZE/INCHES			WEIGHT LBS	VOL FT ³
	H	W	D	LBS	FT ³		
BP3PBEFP0824	126		8	24	2.61	1.32	0.29
BP3PBEFP0830	133		8	30	2.61	1.65	0.36
BP3PBEFP0836	175		8	36	2.61	1.99	0.44
BP3PBEFP0842	182		8	42	2.61	2.32	0.51
BP3PBEFP0848	330		8	48	2.61	2.65	0.58
BP3PBEFP0854	337		8	54	2.61	2.98	0.65
BP3PBEFP0860	345		8	60	2.61	3.32	0.73
BP3PBEFP0866	352		8	66	2.61	3.65	0.80
BP3PBEFP0872	371		8	72	2.61	3.98	0.87
BP3PBEFP1624	126		16	24	2.61	1.83	0.58
BP3PBEFP1630	133		16	30	2.61	2.30	0.73
BP3PBEFP1636	175		16	36	2.61	2.76	0.87
BP3PBEFP1642	182		16	42	2.61	3.22	1.02
BP3PBEFP1648	330		16	48	2.61	3.68	1.16
BP3PBEFP1654	337		16	54	2.61	4.14	1.31
BP3PBEFP1660	345		16	60	2.61	4.61	1.45
BP3PBEFP1666	352		16	66	2.61	5.07	1.60
BP3PBEFP1672	371		16	72	2.61	5.53	1.74

BP3DS • Solid Door Panel

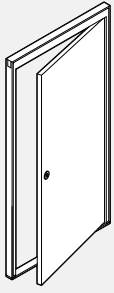

- **Aluminum frame with either high pressure laminate door.**
- 1 3/8" thick hollow core door.
- Actual door size:
79.9" x 32 1/2" in 82" x 36" frame
79.9" x 38 1/2" in 82" x 42" frame
- 42" wide Door Panel permits wheelchair accessibility.
- No hang-on capabilities.
- 180 degree swing.
- Specify Door Knob (DL01) or Door Lever (DL02).
- Lock standard.
- Handedness can be changed on site.
- Please specify Right hand (R) or Left hand (L) hung.
- Includes a Horizontal Lay-in Channel.

PRODUCT CODE	PRICE HP	SIZE/ H	INCHES			WEIGHT VOL	
			W	D	LBS	FT ³	
BP3DS8236R	2331	82	36	2.61	61	6.465	
BP3DS8242R	2539	82	42	2.61	68	7.486	
BP3DS8236L	2331	82	36	2.61	61	6.465	
BP3DS8242L	2539	82	42	2.61	68	7.486	

Door Hanging Directions

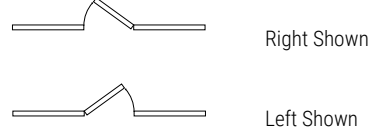

Door Handle Option

- Door Knob - DL01
- Lock Standard
- Door Lever - DL02 (Default)
- Lock Standard
- Lever complies with all accessibility standards



BP3DH • Half Glazed Door Panel

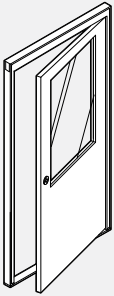

- **Aluminum frame with either high pressure laminate door and window.**
- 1 3/8" thick hollow core door.
- Actual door size:
79.9" x 32 1/2" in 82" x 36" frame
79.9" x 38 1/2" in 82" x 42" frame
- 42" wide Door Panel permits wheelchair accessibility.
- No hang-on capabilities.
- 180 degree swing.
- Specify Door Knob (DL01) or Door Lever (DL02).
- Lock standard.
- Handedness can be changed on site.
- Please specify Right hand (R) or Left hand (L) hung.
- For tempered glass option, add "TG" at the end of the product code and add an upcharge of \$149 for 36" wide doors and \$189 for 42" wide doors.
- Includes a Horizontal Lay-in Channel.

PRODUCT CODE	PRICE HP	SIZE/ H	INCHES			WEIGHT VOL	
			W	D	LBS	FT ³	
BP3DH8236R	2891	82	36	2.61	53	6.465	
BP3DH8242R	3160	82	42	2.61	59	7.486	
BP3DH8236L	2891	82	36	2.61	53	6.465	
BP3DH8242L	3160	82	42	2.61	59	7.486	

Door Hanging Directions

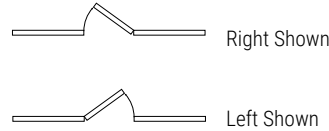

Door Handle Option

- Door Knob - DL01
- Lock Standard
- Door Lever - DL02 (Default)
- Lock Standard
- Lever complies with all accessibility standards



BP3DG • Full Glazed Door Panel

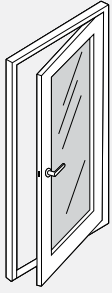

- Aluminum frame with either high pressure laminate door and window.
- 1 3/8" thick hollow core door.
- Actual door size:
79.9" x 32 1/2" in 82" x 36" frame
79.9" x 38 1/2" in 82" x 42" frame
- 42" wide Door Panel permits wheelchair accessibility.
- No hang-on capabilities.
- 180 degree swing.
- Specify Door Knob (DL01) or Door Lever (DL02).
- Lock standard.
- Handedness can be changed on site.
- Please specify Right hand (R) or Left hand (L) hung.
- For tempered glass option, add "TG" at the end of the product code and add an upcharge of \$302 for 36" wide doors and \$376 for 42" wide doors.
- Includes a Horizontal Lay-in Channel.
- Laminate frame is 5" thick at the sides and 4" at the top and bottom.

PRODUCT CODE	PRICE		SIZE/ INCHES			WEIGHT VOL	
	HP		H	W	D	LBS	FT ³
BP3DG8236R	3324		82	36	2.61	53	6.465
BP3DG8242R	3637		82	42	2.61	59	7.486
BP3DG8236L	3324		82	36	2.61	53	6.465
BP3DG8242L	3637		82	42	2.61	59	7.486

Door Hanging Directions

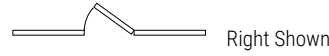

Right Shown

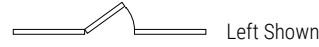

Left Shown

Door Handle Option

Door Knob - DL01

- Lock Standard

Door Lever - DL02 (Default)

- Lock Standard

- Lever complies with all accessibility standards



BPX3NET • Removable Face Tile - Electrical Tile Kit

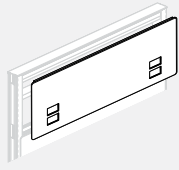
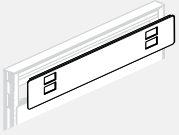

- Attaches to an 8" or 16" opening in a Pass-Thru Panel.
- Fabric covered tile with knock-out for power and data. (Data/Comm blank covers not included).
- 24" wide tiles have one duplex and one data/comm opening. 30" and wider tiles have two duplex and two data/comm openings.
- Easily interchangeable on site.
- Provides access to electrical and data at a required location.
- Specify Tile Electrical Kit separately.
- Duplexes and covers must be specified separately.
- For power outlets on both sides of the panel, specify two Electrical Tiles per panel. For power outlets on one side only, specify one Electrical Tile and a Fabric Tile for the opposite side.
- OPT* = Laminate or Whiteboard.
- For use on panels manufactured after November 1, 2014

PRODUCT CODE	PRICE			SIZE/ INCHES			WEIGHT VOL	
	GR 1	GR 2	OPT*	H	W	D	LBS	FT ³
BPX3NET0824	197	210	225	8	24	0.125	2.0	0.170
BPX3NET0830	221	236	249	8	30	0.125	2.5	0.200
BPX3NET0836	247	262	276	8	36	0.125	2.5	0.250
BPX3NET0842	259	270	284	8	42	0.125	2.5	0.292
BPX3NET0848	263	276	291	8	48	0.125	3.0	0.333
BPX3NET0854	274	286	303	8	54	0.125	3.0	0.375
BPX3NET0860	280	295	309	8	60	0.125	4.5	0.417
BPX3NET0866	312	371	435	8	66	0.125	4.7	0.475
BPX3NET0872	343	405	-	8	72	0.125	5.0	0.500
BPX3NET1624	197	210	225	16	24	0.125	2.5	3.400
BPX3NET1630	221	236	249	16	30	0.125	3.0	0.416
BPX3NET1636	247	262	276	16	36	0.125	3.0	0.500
BPX3NET1642	259	270	284	16	42	0.125	3.0	0.583
BPX3NET1648	263	276	291	16	48	0.125	4.0	0.666
BPX3NET1654	274	286	303	16	54	0.125	4.0	0.750
BPX3NET1660	280	295	309	16	60	0.125	5.0	0.833
BPX3NET1666	312	371	435	16	66	0.125	5.5	0.911
BPX3NET1672	343	405	-	16	72	0.125	6.0	1.000

BP3GT • Removable Face Tile - Glazed

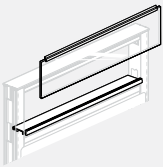

- Attaches to any opening in a Pass-Thru Panel.
- 8" or 16" high glazing provides visual accessibility and light transfer.
- Easily interchangeable on site.
- Specify one Glazed Tile for panel opening of corresponding width.
- Clear tempered glass standard.

PRODUCT CODE	PRICE		SIZE/ INCHES			WEIGHT VOL	
	CLR	FRST	H	W	D	LBS	FT ³
BP3GT0818	103	124	8	18	2.61	2.3	0.146
BP3GT0824	115	138	8	24	2.61	3.1	0.165
BP3GT0830	127	151	8	30	2.61	3.9	0.200
BP3GT0836	148	178	8	36	2.61	4.7	0.250
BP3GT0842	173	208	8	42	2.61	5.5	0.292
BP3GT0848	200	238	8	48	2.61	6.3	0.333
BP3GT0854	225	270	8	54	2.61	7.1	0.375
BP3GT0860	249	301	8	60	2.61	7.8	0.417
BP3GT0866	276	331	8	66	2.61	8.6	0.460
BP3GT0872	301	363	8	72	2.61	9.4	0.500
BP3GT1618	109	131	16	18	2.61	4.3	0.292
BP3GT1624	125	149	16	24	2.61	5.8	0.333
BP3GT1630	144	172	16	30	2.61	7.2	0.416
BP3GT1636	174	210	16	36	2.61	8.7	0.500
BP3GT1642	204	245	16	42	2.61	10.2	0.583
BP3GT1648	235	280	16	48	2.61	11.6	0.666
BP3GT1654	264	317	16	54	2.61	13.1	0.750
BP3GT1660	295	352	16	60	2.61	14.6	0.833
BP3GT1666	324	372	16	66	2.61	16.0	0.911
BP3GT1672	352	406	16	72	2.61	17.5	1.000

BP3DGT • Removable Face Tile - Double Glazed

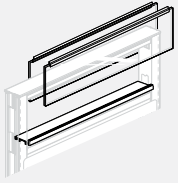

- Attaches to any opening in a Pass-Thru Panel.
- 8" or 16" high glazing provides visual accessibility and light transfer.
- Easily interchangeable on site.
- Specify one Double Glazed Tile for panel opening of corresponding width.
- Clear tempered glass standard.

PRODUCT CODE	PRICE CLR	FRST	SIZE/ INCHES			WEIGHT LBS	VOL FT ³
			H	W	D		
BP3DGT0818	191	227	8	18	2.61	6.0	0.292
BP3DGT0824	210	249	8	24	2.61	8.2	0.330
BP3DGT0830	234	276	8	30	2.61	10.4	0.400
BP3DGT0836	284	340	8	36	2.61	12.6	0.500
BP3DGT0842	331	397	8	42	2.61	14.7	0.584
BP3DGT0848	378	456	8	48	2.61	16.9	0.666
BP3DGT0854	430	514	8	54	2.61	19.0	0.750
BP3DGT0860	477	573	8	60	2.61	21.3	0.834
BP3DGT0866	524	629	8	66	2.61	23.4	0.920
BP3DGT0872	573	687	8	72	2.61	25.6	1.000
BP3DGT1618	202	240	16	18	2.61	10.0	0.584
BP3DGT1624	215	260	16	24	2.61	13.6	0.666
BP3DGT1630	274	328	16	30	2.61	17.1	0.832
BP3DGT1636	333	399	16	36	2.61	20.6	1.000
BP3DGT1642	388	465	16	42	2.61	24.1	1.166
BP3DGT1648	446	536	16	48	2.61	27.7	1.322
BP3DGT1654	503	604	16	54	2.61	31.2	1.500
BP3DGT1660	561	672	16	60	2.61	34.7	1.666
BP3DGT1666	618	711	16	66	2.61	38.2	1.822
BP3DGT1672	672	774	16	72	2.61	41.7	2.000

BP30T • Removable Face Tile - Open Pass-Thru Kit

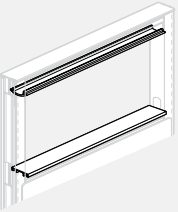

- Attaches to any opening in a Pass-Thru Panel.
- Trims and internal corners included to create an opening.
- Easily interchangeable on site.
- Specify one Pass-Thru Kit for panel opening of corresponding width.
- Kit works for 8" & 16" openings.
- Please specify panel frame colour.

PRODUCT CODE	PRICE	SIZE/ INCHES			WEIGHT LBS	VOL FT ³
		H	W	D		
BP30T1618	19	16	18	2.61	0.4	0.292
BP30T1624	22	16	24	2.61	0.6	0.333
BP30T1630	27	16	30	2.61	0.8	0.416
BP30T1636	31	16	36	2.61	1.0	0.500
BP30T1642	35	16	42	2.61	1.1	0.583
BP30T1648	41	16	48	2.61	1.3	0.666
BP30T1654	45	16	54	2.61	1.5	0.750
BP30T1660	48	16	60	2.61	1.7	0.833
BP30T1666	54	16	66	2.61	1.9	0.911
BP30T1672	56	16	72	2.61	2.0	1.000

BP3AT • Removable Face Tile - Accessory

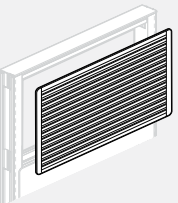

- Attaches to any opening in a Pass-Thru Panel.
- Provides support for accessories.
- Easily interchangeable on site.
- Two tile clips included.
- Specify two tiles per panel opening of corresponding width. Tiles can be combined. For example, Fabric Tile on one side and Accessory Tile on the opposite side of the same panel.
- Accessory Tile cannot be installed opposite an electrical tile.

PRODUCT CODE	PRICE	SIZE/ INCHES			WEIGHT LBS	VOL FT ³
		H	W	D		
BP3AT0818	97	08	18	0.25	1.7	0.146
BP3AT0824	115	08	24	0.25	2.3	0.167
BP3AT0830	127	08	30	0.25	2.9	0.208
BP3AT0836	149	08	36	0.25	3.5	0.250
BP3AT0842	180	08	42	0.25	4.1	0.292
BP3AT0848	211	08	48	0.25	4.7	0.333
BP3AT0854	227	08	54	0.25	5.3	0.375
BP3AT0860	259	08	60	0.25	5.9	0.417
BP3AT0866	279	08	66	0.25	6.5	0.459
BP3AT0872	303	08	72	0.25	7.0	0.500
BP3AT1618	114	16	18	0.25	3.5	0.292
BP3AT1624	138	16	24	0.25	4.7	0.333
BP3AT1630	147	16	30	0.25	5.7	0.416
BP3AT1636	178	16	36	0.25	7.0	0.500
BP3AT1642	211	16	42	0.25	8.2	0.583
BP3AT1648	245	16	48	0.25	9.4	0.666
BP3AT1654	265	16	54	0.25	10.6	0.750
BP3AT1660	304	16	60	0.25	11.9	0.833
BP3AT1666	336	16	66	0.25	13.0	0.916
BP3AT1672	366	16	72	0.25	14.0	1.000

BP3FT • Removable Face Tile - Fabric

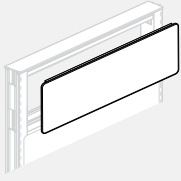

- Attaches to any opening in a Pass-Thru Panel.
- Tile clips included.
- Easily interchangeable on site.
- Specify two tiles per panel opening of corresponding width. Tiles can be combined. For example, Fabric Tile on one side and Accessory Tile on the opposite side of the same panel.
- OPT* = Laminate or Whiteboard.

PRODUCT CODE	PRICE			SIZE/ INCHES			WEIGHT VOL	
	GR1	GR2	OPT*	H	W	D	LBS	FT ³
BP3FT0818	92	100	108	8	18	0.25	1	0.146
BP3FT0824	97	106	113	8	24	0.25	1	0.165
BP3FT0830	106	117	134	8	30	0.25	2	0.200
BP3FT0836	131	144	159	8	36	0.25	2	0.250
BP3FT0842	139	151	169	8	42	0.25	2	0.292
BP3FT0848	145	159	173	8	48	0.25	3	0.333
BP3FT0854	153	169	181	8	54	0.25	3	0.375
BP3FT0860	159	172	187	8	60	0.25	4	0.417
BP3FT0866	180	239	305	8	66	0.25	4	0.460
BP3FT0872	233	307	-	8	72	0.25	4	0.500
BP3FT1618	103	110	116	16	18	0.25	2	0.292
BP3FT1624	109	115	124	16	24	0.25	2	0.333
BP3FT1630	116	132	146	16	30	0.25	3	0.416
BP3FT1636	144	157	172	16	36	0.25	3	0.500
BP3FT1642	153	169	181	16	42	0.25	3	0.583
BP3FT1648	161	174	192	16	48	0.25	4	0.666
BP3FT1654	170	181	199	16	54	0.25	4	0.750
BP3FT1660	187	247	205	16	60	0.25	5	0.833
BP3FT1666	205	264	329	16	66	0.25	5	0.920
BP3FT1672	253	336	-	16	72	0.25	6	1.000

BP3OPFA • Fabric Over Panel

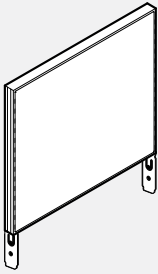

- Attaches to top of a panel to create floor-to-ceiling wall.
- Centre septum overlaid on either side with 1 1/8" "Sound absorbent mineral board".
- Exact height should be specified when ordering, with allowance of at least 1" of free space between over panel and ceiling to accommodate height variations in ceiling and floor. Can be any height from 4.4" minimum to 15.9" maximum. Please tag exact height required.
- Runs of over panels must be captured at either end with full height posts, wall adapters, taller panels, and/or vertical trims.
- OPT* = Laminate or Whiteboard.

PRODUCT CODE	PRICE			SIZE/ INCHES			WEIGHT VOL	
	GR1	GR2	OPT*	H	W	D	LBS	FT ³
BP3OPFA18	241	259	271	16	18	2.61	8	0.730
BP3OPFA24	274	286	303	16	24	2.61	8	0.730
BP3OPFA30	313	328	342	16	30	2.61	10	0.912
BP3OPFA36	353	369	383	16	36	2.61	12	1.094
BP3OPFA42	385	399	415	16	42	2.61	12	1.094
BP3OPFA48	425	439	454	16	48	2.61	14	1.277
BP3OPFA54	465	480	494	16	54	2.61	14	1.277
BP3OPFA60	495	510	523	16	60	2.61	15	1.368

BP3OPFV • Fabric Over Panel with Vertical Wire Channel

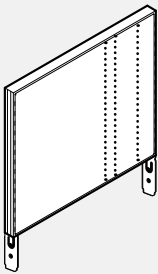

- Attaches to top of a panel to create floor-to-ceiling wall.
- Centre septum overlaid on either side with 1" sound absorbent mineral board.
- Exact height should be specified when ordering, with allowance of at least 1" of free space between over panel and ceiling to accommodate height variations in ceiling and floor. Can be any height from 4.4" minimum to 15.9" maximum. Please tag exact height required.
- Runs of over panels must be captured at either end with full height posts, wall adapters, taller panels, and/or vertical trims.
- OPT* = Laminate or Whiteboard.

PRODUCT CODE	PRICE			SIZE/ INCHES			WEIGHT VOL	
	GR1	GR2	OPT*	H	W	D	LBS	FT ³
BP3OPFV18	286	301	314	16	18	2.61	8	0.73
BP3OPFV24	317	331	344	16	24	2.61	8	0.73
BP3OPFV30	355	371	385	16	30	2.61	10	0.912
BP3OPFV36	398	411	426	16	36	2.61	12	1.094
BP3OPFV42	431	443	457	16	42	2.61	12	1.094
BP3OPFV48	471	483	499	16	48	2.61	14	1.277
BP3OPFV54	510	522	540	16	54	2.61	14	1.277
BP3OPFV60	540	551	568	16	60	2.61	15	1.368

BA3PAS • Glass Over Panel with Round Pucks for System 3

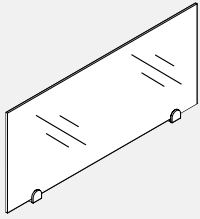

- **Glass Over Panel creates division.**
- Glass Over Panel with no frame sits on top of a System 3 Panel with clamps that are secured to the top of the panel.
- Tempered glass is 16" high.
- Custom sizes available, contact your Customer Service Representative.
- For application where the over panel is sandwiched between two taller panels, please request a special as the glass will not fit due to trims.

PRODUCT CODE	PRICE CLR	FRST	SIZE/ INCHES			WEIGHT VOL	
			H	W	D	LBS	FT ³
BA3PAS0824	204	235	8	24	1.3	4	0.22
BA3PAS0830	229	262	8	30	1.3	5	0.30
BA3PAS0836	241	283	8	36	1.3	6	0.37
BA3PAS0842	262	306	8	42	1.3	7	0.43
BA3PAS0848	281	323	8	48	1.3	8	0.48
BA3PAS1624	218	248	16	24	1.3	8	0.44
BA3PAS1630	241	276	16	30	1.3	10	0.59
BA3PAS1636	260	299	16	36	1.3	12	0.73
BA3PAS1642	276	320	16	42	1.3	14	0.85
BA3PAS1648	281	339	16	48	1.3	16	0.96

BA3PASS • Glass Over Panel with Square Pucks for System 3

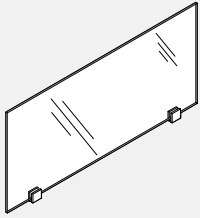

- **Glass Over Panel creates division.**
- Glass Over Panel with no frame sits on top of a System 3 Panel with clamps that are secured to the top of the panel.
- Tempered glass is 16" high.
- Custom sizes available, contact your Customer Service Representative.
- For application where the over panel is sandwiched between two taller panels, please request a special as the glass will not fit due to trims.

PRODUCT CODE	PRICE CLR	FRST	SIZE/ INCHES			WEIGHT VOL	
			H	W	D	LBS	FT ³
BA3PASS0824	218	248	8	24	1.3	4	0.22
BA3PASS0830	241	276	8	30	1.3	5	0.30
BA3PASS0836	262	299	8	36	1.3	6	0.37
BA3PASS0842	276	320	8	42	1.3	7	0.43
BA3PASS0848	298	339	8	48	1.3	8	0.48
BA3PASS1624	235	264	16	24	1.3	8	0.44
BA3PASS1630	260	291	16	30	1.3	10	0.59
BA3PASS1636	274	313	16	36	1.3	12	0.73
BA3PASS1642	291	338	16	42	1.3	14	0.85
BA3PASS1648	299	352	16	48	1.3	16	0.96

BPMB • Raceway Cover Caps



- **To provide clean detail for the punch-outs of a raceway cover when the punch-outs are not in use. Order only when required.**
- Made of injection molded ABS.
- B = Black
- G = Grey
- W = White

PRODUCT CODE	PRICE	SIZE/ INCHES			WEIGHT VOL	
		H	W	D	LBS	FT ³
BPMB020104B	10	1.5	3	0.125	0.04	0.02
BPMB020104G	10	1.5	3	0.125	0.04	0.02
BPMB020104W	10	1.5	3	0.125	0.04	0.02

BH3PS • 90 Degree Post



- **Enables connection for multiple panel runs such as 90°, 3 way and 4 way.**
- Includes 2 "Capture Strip" panel connectors, 4 end strips, 2 pairs of raceway end caps, and 1 post cap.
- Posts are designed to accept the following:
 - 75 cables 5.6mm (0.220") diameter
 - 60 ccables 5.6mm (0.220") diameter with 1 power feed
 - 45 cables 5.6mm (0.220") diameter with 2 power feeds

PRODUCT CODE	PRICE	SIZE/ INCHES			WEIGHT VOL	
		H	W	D	LBS	FT ³
BH3PS034	126	27	2.61	2.61	4	0.14
BH3PS042	138	35	2.61	2.61	5	0.18
BH3PS050	156	43	2.61	2.61	7	0.22
BH3PS054	174	47	2.61	2.61	7	0.27
BH3PS058	179	51	2.61	2.61	8	0.29
BH3PS066	187	59	2.61	2.61	8	0.31

BH3PS45 • 45 Degree Post



- **Enables connection for two panels at 45°.**
- Includes 2 "Capture Strip" panel connectors and 1 post cap.
- 45 degree post does not accept End Trim.
- No power infeed capabilities.
- Posts are designed to accept the following:
 - 30 cables 5.6mm (0.220") diameter

PRODUCT CODE	PRICE	SIZE/ INCHES			WEIGHT VOL	
		H	W	D	LBS	FT ³
BH3PS45034	126	27	2.61	2.61	4	0.14
BH3PS45042	138	35	2.61	2.61	5	0.18
BH3PS45050	156	43	2.61	2.61	7	0.22
BH3PS45054	174	47	2.61	2.61	7	0.27
BH3PS45058	179	51	2.61	2.61	8	0.29
BH3PS45066	187	59	2.61	2.61	8	0.31

BH3PS60 • 60 Degree Post



- **Enables connection for multiple panel runs such as 120° and 3 way.**
- Includes 2 "Capture Strip" panel connectors and 1 post cap.
- No power infeed capabilities.
- Posts are designed to accept the following:
 - 35 cables 5.6mm (0.220") diameter

PRODUCT CODE	PRICE	SIZE/ INCHES			WEIGHT VOL	
		H	W	D	LBS	FT ³
BH3PS60034	126	27	2.61	2.61	4	0.14
BH3PS60042	138	35	2.61	2.61	5	0.18
BH3PS60050	156	43	2.61	2.61	7	0.22
BH3PS60054	174	47	2.61	2.61	7	0.27
BH3PS60058	179	51	2.61	2.61	8	0.29
BH3PS60066	187	59	2.61	2.61	8	0.31

BH3PE • Post Extension for Over Panels

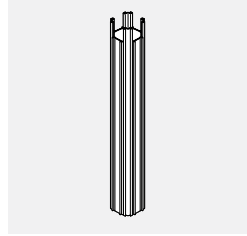

- Provides route for ceiling data or electrical cables through the post to the panel.
- Includes 2 "Capture Strip" panel connectors.

PRODUCT CODE	PRICE	SIZE/ INCHES			WEIGHT VOL	
		H	W	D	LBS	FT ³
BH3PE008	30	8	2.61	2.61	1	0.03
BH3PE016	54	16	2.61	2.61	2	0.07
BH3PE032	78	32	2.61	2.61	4	0.14
BH3PE45016	54	16	2.61	2.61	2	0.07
BH3PE45032	78	32	2.61	2.61	4	0.14
BH3PE60016	54	16	2.61	2.61	2	0.07
BH3PE60032	78	32	2.61	2.61	4	0.14

BH3PA • Off-Module Connector (Panel to Panel Adapter)

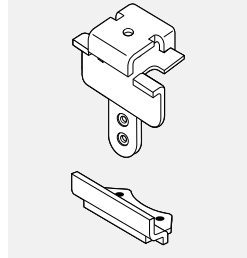

- Connects Boulevard System 3 panel to another perpendicular Boulevard System 3 Monolithic Panel off-module.
- Top and bottom brackets bolt to panel vertical of one panel and engage to top and bottom "fabric" edges of adjacent, perpendicular Monolithic Panel of even height.
- While connecting tile panel to Monolithic Panel is possible, never attempt to secure Off-Module Connectors to a tile panel.
- Once an off-module panel is secure to Monolithic Panel spine with Off-Module Connecting Kit, the raceway on the spine panel cannot be accessed and can only be opened from the opposite side.
- Special top trim required, provide application to your Customer Service Representative.
- This connector is not a load-bearing connection.
- Not to be used on the panel seam, with over panels or laminate and metal faced panels.

PRODUCT CODE	PRICE	SIZE/ H	INCHES W	D	WEIGHT VOL	
					LBS	FT ³
BH3PA02	93	3.5			0.5	0.035

RCX3WMP2 • Raceway Cover with Punchouts Both Sides

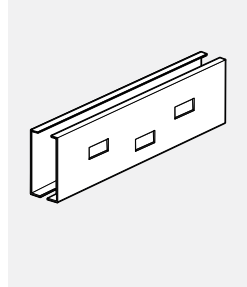

- Metal raceway organizes cables at the base.
- Snaps directly into the base of the panel.
- When opened, cover's side rests on the floor, providing unobstructed access to data/power installation.
- 18" Raceway Covers do not have power and data/communication punch-outs.
- 24" Raceway covers have electrical and one data opening.
- Data opening sizing is as follows: 1.38" x 2.71".
- Comes standard with all System 3 panels.
- "No Knockouts" option for raceways available at no additional charge. Please choose option for interior and/or exterior raceways.

PRODUCT CODE	PRICE	SIZE/ INCHES			WEIGHT VOL	
		H	W	D	LBS	FT ³
RCX3WM24P2	63	5.62	24	2.61	3.3	0.21
RCX3WM30P2	68	5.62	30	2.61	4.1	0.26
RCX3WM36P2	78	5.62	36	2.61	4.9	0.31
RCX3WM42P2	90	5.62	42	2.61	5.7	0.36
RCX3WM48P2	95	5.62	48	2.61	6.6	0.42
RCX3WM54P2	104	5.62	54	2.61	7.4	0.47
RCX3WM60P2	113	5.62	60	2.61	8.3	0.52
RCX3WM66P2	117	5.62	66	2.61	9.1	0.57
RCX3WM72P2	127	5.62	72	2.61	9.8	0.62

RCX3WMP1 • Raceway Cover with Punchouts One Side, None Other Side

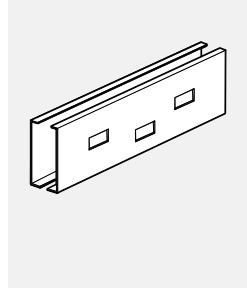

- Metal raceway organizes cables at the base.
- Snaps directly into the base of the panel.
- When opened, cover's side rests on the floor, providing unobstructed access to data/power installation.
- 18" Raceway Covers do not have power and data/communication punch-outs.
- 24" Raceway covers have electrical and one data opening.
- Data opening sizing is as follows: 1.38" x 2.71".
- Comes standard with all System 3 panels.
- "No Knockouts" option for raceways available at no additional charge. Please choose option for interior and/or exterior raceways.

PRODUCT CODE	PRICE	SIZE/ INCHES			WEIGHT VOL	
		H	W	D	LBS	FT ³
RCX3WM24P1	63	5.62	24	2.61	3.3	0.21
RCX3WM30P1	68	5.62	30	2.61	4.1	0.26
RCX3WM36P1	78	5.62	36	2.61	4.9	0.31
RCX3WM42P1	90	5.62	42	2.61	5.7	0.36
RCX3WM48P1	95	5.62	48	2.61	6.6	0.42
RCX3WM54P1	104	5.62	54	2.61	7.4	0.47
RCX3WM60P1	113	5.62	60	2.61	8.3	0.52
RCX3WM66P1	117	5.62	66	2.61	9.1	0.57
RCX3WM72P1	127	5.62	72	2.61	9.8	0.62

RCX3WMNP • Raceway Cover with No Punchouts Both Sides

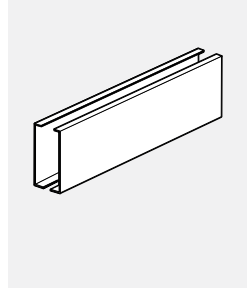

- Metal raceway organizes cables at the base.
- Snaps directly into the base of the panel.
- When opened, cover's side rests on the floor, providing unobstructed access to data/power installation.
- Specified separately for reconfiguration purposes.

PRODUCT CODE	PRICE	SIZE/ INCHES			WEIGHT VOL	
		H	W	D	LBS	FT ³
RCX3WM18NP	56	5.62	18	2.61	2.4	0.16
RCX3WM24NP	63	5.62	24	2.61	3.3	0.21
RCX3WM30NP	68	5.62	30	2.61	4.1	0.26
RCX3WM36NP	78	5.62	36	2.61	4.9	0.31
RCX3WM42NP	90	5.62	42	2.61	5.7	0.36
RCX3WM48NP	95	5.62	48	2.61	6.6	0.42
RCX3WM54NP	104	5.62	54	2.61	7.4	0.47
RCX3WM60NP	113	5.62	60	2.61	8.3	0.52
RCX3WM66NP	117	5.62	66	2.61	9.1	0.57
RCX3WM72NP	127	5.62	72	2.61	9.8	0.62

B3HWA • Wall Adapter

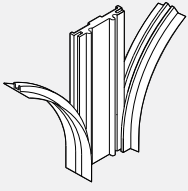

- Starts a run of panels off an existing wall.
- Includes 2 "Capture Strip" panel connectors and 1 pair of raceway end caps.
- Mounting hardware not included.
- Mounting hardware selection should be based on wall or wall stud material.
- Wall Adapter adds 5/16" to a panels run.

PRODUCT CODE	PRICE	SIZE/ INCHES			WEIGHT VOL	
		H	W	D	LBS	FT ³
B3HWA034	61	34	2.61	0.375	2	0.011
B3HWA042	64	42	2.61	0.375	3	0.015
B3HWA050	68	50	2.61	0.375	3	0.018
B3HWA054	74	54	2.61	0.375	3	0.020
B3HWA058	78	58	2.61	0.375	4	0.021
B3HWA066	80	66	2.61	0.375	4	0.021

BHWASL • Adapter Sleeve



- Wall Adapter Sleeve is attached to the building to provide flexible support to a panel run.

- As opposed to the BHW wall adapter, which connects to the panels rigidly to a wall, B1 and B3 Boulevard panels rest inside of the vertical "U" channel, providing up to 3.5" of flexible adjustment.
- For panel runs taller than 66" order two Wall Adapter Sleeves and either have it cut short on the site below ceiling, or cut a rectangular hole in the ceiling tile. Rectangular slots in the Channels correspond to 66", 58", 54", 50" and 42" high B1 and B3 panels.
- Powder coated steel; specify metal finish.

- Note: the Wall Adapter Sleeve provides flexible, non-structural connection, blocks vertical 1" increment clots and cannot, therefore, be used to support overheads and work surfaces, they must be supported by perpendicular panels, c-legs or gables.
- Note: no fasteners are provided with the Wall Adapter Sleeve. Select the appropriate fasteners according to a structurally sound connection.
- Cannot be used to support a door or panel and cannot be used with laminate, airflow or metal skin panels.

PRODUCT CODE	PRICE	SIZE/ INCHES			WEIGHT VOL	
		H	W	D	LBS	FT ³
BHWASL42	149	34.7	4	2	2.5	0.161
BHWASL50	162	42.7	4	2	3.6	0.148
BHWASL54	170	46.7	4	2	4.2	0.216
BHWASL58	174	52.7	4	2	5.1	0.244
BHWASL66	187	58.7	4	2	6.0	0.272

BH3CS • Capture Strip Slot Cover

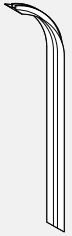

- An extruded PVC channel to adjoin two panels or a panel to a post. Runs the full length of the panel on both sides providing a positive connection of the "Knuckle-Loc" design.

- Priced per pair.
- Pliable side membranes cover panel slots.
- Included with panel components.
- Only to be ordered separately if required.

PRODUCT CODE	PRICE	SIZE/ INCHES			WEIGHT VOL	
		H	W	D	LBS	FT ³
BH3CS34	12	37			0.24	0.11
BH3CS42	12	42			0.28	0.13
BH3CS50	13	50			0.33	0.15
BH3CS54	13	54			0.31	0.17
BH3CS66	21	66			0.4	0.19

BH3CE • End Strip Slot Cover



- End strips with pliable side membrane covers panel slots at end of run.

- Priced per pair.
- Included with panel components.
- Only to be ordered separately if required.

PRODUCT CODE	PRICE	SIZE/ INCHES			WEIGHT VOL	
		H	W	D	LBS	FT ³
BH3CE34	12	37			0.12	0.05
BH3CE42	12	42			0.14	0.06
BH3CE50	13	50			0.16	0.07
BH3CE54	13	54			0.31	0.08
BH3CE66	14	66			0.20	0.09

BA3VTR • Vertical Aluminum End Trim

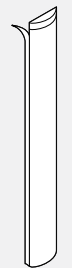

- Finishes the vertical edges of panels and posts (90 and 60 degree).

- In the case of the panel, the trim runs from the top of the panel to the bottom of the raceway, enclosing the horizontal channel openings and the raceway opening.
- In the case of the Over Panel, the trim runs from the top of the Over Panel to the bottom of the Over Panel, enclosing the horizontal channel openings.

PRODUCT CODE	PRICE	TYPE	SIZE/ INCHES			WEIGHT VOL	
			H	W	D	LBS	FT ³
BA3VTR34	38	REGULAR PANEL	34	2.61	0.25	1.1	0.03
BA3VTR42	46		42	2.61	0.25	1.4	0.03
BA3VTR50	56		50	2.61	0.25	1.7	0.04
BA3VTR54	64		54	2.61	0.25	1.9	0.04
BA3VTR58	67		58	2.61	0.25	2.1	0.05
BA3VTR66	75		66	2.61	0.25	2.2	0.05
BA3VTE16	24	OVER PANEL	16	2.61	0.25	0.5	0.03
BA3VTE32	38		32	2.61	0.25	1.1	0.06

BA3VTS • Vertical Aluminum End Trim Standard Step Down

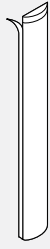

- Finishes the vertical edges of panels and posts (90 and 60 degree).
- Trims run from the top of one panel to the top of lower panel enclosing the horizontal channel opening.

PRODUCT CODE	PRICE	SIZE/ INCHES			WEIGHT VOL	
		H	W	D	LBS	FT ³
BA3VTS04	12	4	2.61	0.25	0.2	0.010
BA3VTS08	14	8	2.61	0.25	0.3	0.015
BA3VTS12	21	12	2.61	0.25	0.4	0.022
BA3VTS16	24	16	2.61	0.25	0.5	0.030
BA3VTS20	29	20	2.61	0.25	0.7	0.039
BA3VTS24	31	24	2.61	0.25	0.9	0.045
BA3VTS32	38	32	2.61	0.25	1.1	0.060

BV3VTR • Vertical PVC End Trim



- Finishes the vertical edges of panels and posts (90 and 60 degree).
- In the case of the panel, the trim runs from the top of the panel to the bottom of the raceway, enclosing the horizontal channel openings and the raceway opening.
- In the case of the over panel, the trim runs from the top of the over panel to the bottom of the over panel, enclosing the horizontal channel openings.

PRODUCT CODE	PRICE	TYPE	SIZE/ INCHES			WEIGHT VOL	
			H	W	D	LBS	FT ³
BV3VTR34	29	REGULAR PANEL	34	2.61	0.25	0.6	0.030
BV3VTR42	30		42	2.61	0.25	0.7	0.030
BV3VTR50	35		50	2.61	0.25	0.9	0.040
BV3VTR54	37		54	2.61	0.25	1.0	0.045
BV3VTR58	40		58	2.61	0.25	1.0	0.047
BV3VTR66	43		66	2.61	0.25	1.1	0.050
BV3VTE16	22	OVER PANEL	16	2.61	0.25	0.3	0.030
BV3VTE32	29		32	2.61	0.25	0.6	0.060

BV3VTS • Vertical PVC End Trim Standard Step Down



- Finishes the vertical edges of panels and posts (90 and 60 degree).
- Trims run from the top of one panel to the top of lower panel enclosing the horizontal channel opening.

PRODUCT CODE	PRICE	SIZE/ INCHES			WEIGHT VOL	
		H	W	D	LBS	FT ³
BV3VTS04	12	3.75	2.61	0.25	0.1	0.010
BV3VTS08	14	7.75	2.61	0.25	0.1	0.015
BV3VTS12	21	11.75	2.61	0.25	0.2	0.020
BV3VTS16	23	15.75	2.61	0.25	0.3	0.030
BV3VTS20	30	19.75	2.61	0.25	0.3	0.035
BV3VTS24	25	23.75	2.61	0.25	0.4	0.045
BV3VTS32	29	31.75	2.61	0.25	0.6	0.060

BA3VTRF • Vertical Aluminum Flat End Trim



- Finishes the vertical edges of panels and posts (90 and 60 degree).
- In the case of the panel, the trim runs from the top of the panel to the bottom of the raceway, enclosing the horizontal channel openings and the raceway opening.
- In the case of the over panel, the trim runs from the top of the over panel to the bottom of the over panel, enclosing the horizontal channel openings.
- BABVTRF119 cannot ship via courier and must be combined with other product.

PRODUCT CODE	PRICE	TYPE	SIZE/ INCHES			WEIGHT VOL	
			H	W	D	LBS	FT ³
BA3VTRF34	38	REGULAR PANEL	34	2.61	0.125	1.1	0.03
BA3VTRF42	46		42	2.61	0.125	1.4	0.03
BA3VTRF50	56		50	2.61	0.125	1.7	0.04
BA3VTRF54	64		54	2.61	0.125	1.9	0.04
BA3VTRF58	67		58	2.61	0.125	1.9	0.04
BA3VTRF66	69		66	2.61	0.125	2.2	0.05
BA3VTRF119	134		119	2.61	0.125	3.6	0.08
BA3VTEF8	11	OVER PANEL	8	2.61	0.125	0.2	0.01
BA3VTEF16	24		16	2.61	0.125	0.5	0.03
BA3VTEF32	38		32	2.61	0.125	1.1	0.06

BA3VTSF • Vertical Aluminum Flat End Trim Standard Step Down

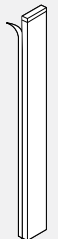

- Finishes the vertical edges of panels and posts (90 and 60 degree).
- Trims run from the top of one panel to the top of lower panel enclosing the horizontal channel opening.

PRODUCT CODE	PRICE	SIZE/ INCHES			WEIGHT VOL	
		H	W	D	LBS	FT ³
BA3VTSF04	12	3.75	2.61	0.125	0.1	0.010
BA3VTSF08	14	7.75	2.61	0.125	0.3	0.015
BA3VTSF12	21	11.75	2.61	0.125	0.4	0.020
BA3VTSF16	24	15.75	2.61	0.125	0.5	0.030
BA3VTSF20	29	19.75	2.61	0.125	0.8	0.035
BA3VTSF24	31	23.75	2.61	0.125	0.9	0.045
BA3VTSF32	38	31.75	2.61	0.125	1.1	0.060

B3LEP-NC • End of Run Gallery Panel in a T configuration, No Connectors for Additional Gallery Panels

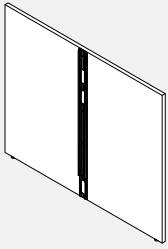

- Provides floor standing support while enclosing the end of a panel run on two sides.
- Attaches to the end of a Boulevard 1 or System 3 Panel with capture strips to form a T configuration.
- Connection is on the interior face center.
- Includes all attachment hardware and glides.
- Total height is inclusive of panel glides extended to their full height.
- 51" wide gallery panel accommodates two 24" deep surfaces while the 63" wide accommodates two 30" deep surfaces and 75" wide two 36" deep surfaces.
- Please specify LP laminate finish and PVC edge finish.
- If a wood grain laminate is chosen, grain direction run horizontally.
- Edged in PVC on three exposed edges and self edged on bottom.

PRODUCT CODE	PRICE LP	SIZE /INCHES			WEIGHT LBS	VOL FT³
		H	W	D		
B3LEP4227NC	416	42	26.5	1	29.49	0.64
B3LEP4251NC	653	42	51	1	55.17	1.24
B3LEP4263NC	731	42	63	1	68.01	1.53
B3LEP4275NC	814	42	75	1	80.86	1.82
B3LEP5027NC	485	50	26.5	1	35.25	0.77
B3LEP5051NC	758	50	51	1	65.92	1.48
B3LEP5063NC	854	50	63	1	81.27	1.82
B3LEP5075NC	964	50	75	1	96.62	2.17
B3LEP5427NC	485	54	26.5	1	38.12	0.83
B3LEP5451NC	781	54	51	1	71.3	1.59
B3LEP5463NC	880	54	63	1	87.9	1.97
B3LEP5475NC	994	54	75	1	104.49	2.34

B3LSEPL-NC • Left End of Run Single Gallery Panel in L Configuration, No Connectors for Additional Gallery Panels



- Provides floor standing support while enclosing the end of a panel run on one side.
- Attaches to the end of a Boulevard 1 or System 3 Panel with capture strips to form an L configuration.
- Connection is on interior face near it's right end.
- Includes all attachment hardware and glides.
- Total height is inclusive of panel glides extended to their full height.
- 27" wide gallery panel accommodates a 24" deep surface while the 33" wide accommodates a 30" deep surface and 39" wide a 36" deep surface.
- Please specify LP laminate finish and PVC edge finish.
- If a wood grain laminate is chosen, grain direction run horizontally.
- Edged in PVC on three exposed edges and self edged on bottom.

PRODUCT CODE	PRICE LP	SIZE /INCHES			WEIGHT LBS	VOL FT³
		H	W	D		
B3LSEPL4215NC	342	42	14.25	1	16.64	0.35
B3LSEPL4227NC	497	42	27	1	29.47	0.66
B3LSEPL4233NC	537	42	33	1	35.89	0.80
B3LSEPL4239NC	564	42	39	1	42.32	0.95
B3LSEPL5015NC	389	50	14.25	1	19.9	0.41
B3LSEPL5027NC	565	50	27	1	35.23	0.78
B3LSEPL5033NC	613	50	33	1	42.9	0.95
B3LSEPL5039NC	656	50	39	1	50.57	1.13
B3LSEPL5415NC	389	54	14.25	1	21.52	0.45
B3LSEPL5427NC	582	54	27	1	38.1	0.84
B3LSEPL5433NC	632	54	33	1	46.4	1.03
B3LSEPL5439NC	677	54	39	1	54.7	1.22

B3LSEPR-NC • Right End of Run Single Gallery Panel in L Configuration, No Connectors for Additional Gallery Panels



- Provides floor standing support while enclosing the end of a panel run on one side.
- Attaches to the end of a Boulevard 1 or System 3 Panel with capture strips to form an L configuration.
- Connection is on interior face near it's right end.
- Includes all attachment hardware and glides.
- Total height is inclusive of panel glides extended to their full height.
- 27" wide gallery panel accommodates a 24" deep surface while the 33" wide accommodates a 30" deep surface and 39" wide a 36" deep surface.
- Please specify LP laminate finish and PVC edge finish.
- If a wood grain laminate is chosen, grain direction run horizontally.
- Edged in PVC on three exposed edges and self edged on bottom.

PRODUCT CODE	PRICE LP	SIZE /INCHES			WEIGHT LBS	VOL FT³
		H	W	D		
B3LSEPR4215NC	342	42	14.25	1	16.64	0.35
B3LSEPR4227NC	497	42	27	1	29.47	0.66
B3LSEPR4233NC	537	42	33	1	35.89	0.80
B3LSEPR4239NC	564	42	39	1	42.32	0.95
B3LSEPR5015NC	389	50	14.25	1	19.9	0.41
B3LSEPR5027NC	565	50	27	1	35.23	0.78
B3LSEPR5033NC	613	50	33	1	42.9	0.95
B3LSEPR5039NC	656	50	39	1	50.57	1.13
B3LSEPR5415NC	389	54	14.25	1	21.52	0.45
B3LSEPR5427NC	582	54	27	1	38.1	0.84
B3LSEPR5433NC	632	54	33	1	46.4	1.03
B3LSEPR5439NC	677	54	39	1	54.7	1.22

B3LMP-NC • Middle of Run Single Gallery Panel in X Configuration, No Connectors for Additional Gallery Panels

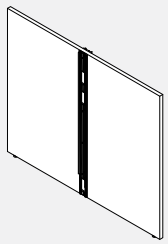

- Provides floor standing support in the middle of a panel run.
- Attaches between panels in a straight Boulevard 1 or System 3 Panel run with capture strips to form an X configuration.
- Connections are at the center of the interior and exterior faces.
- Includes all attachment hardware and glides.
- Total height is inclusive of panel glides extended to their full height.
- 51" wide gallery panel accommodates two 24" deep surfaces while the 63" wide accommodates two 30" deep surfaces and 75" wide two 36" deep surfaces.
- Please specify LP laminate finish and PVC edge finish.
- If a wood grain laminate is chosen, grain direction run horizontally.
- Edged in PVC on three exposed edges and self edged on bottom.

PRODUCT CODE	PRICE LP	SIZE /INCHES			WEIGHT LBS	VOL FT³
		H	W	D		
B3LMP4251NC	865	42	51	1	55.98	1.24
B3LMP4263NC	942	42	63	1	68.83	1.53
B3LMP4275NC	1028	42	75	1	81.68	1.85
B3LMP5051NC	981	50	51	1	66.97	1.48
B3LMP5063NC	1077	50	63	1	82.32	1.82
B3LMP5075NC	1188	50	75	1	97.67	2.17
B3LMP5451NC	1009	54	51	1	72.46	1.59
B3LMP5463NC	1109	54	63	1	89.06	1.97
B3LMP5475NC	1223	54	75	1	105.66	2.34

B3LSMP-NC • Middle of Run Single Gallery Panel in T Configuration, No Connectors for Additional Gallery Panels



- Provides floor standing support at the middle of a panel run.
- Attaches in the middle of a straight Boulevard 1 or System 3 panel run with capture strips to form a T configuration.
- Connections are on the interior and exterior faces of one end.
- Includes all attachment hardware and glides.
- Total height is inclusive of panel glides extended to their full height.
- 27" wide gallery panel accommodates a 24" deep surface while the 33" wide accommodates a 30" deep surface and 39" wide a 36" deep surface.
- Please specify LP laminate finish and PVC edge finish.
- If a wood grain laminate is chosen, grain direction run horizontally.
- Edged in PVC on three exposed edges and self edged on bottom.

PRODUCT CODE	PRICE LP	SIZE /INCHES			WEIGHT LBS	VOL FT³
		H	W	D		
B3LSMP4227NC	712	42	27	1	30.28	0.66
B3LSMP4233NC	749	42	33	1	36.71	0.80
B3LSMP4239NC	778	42	39	1	43.13	0.95
B3LSMP5027NC	788	50	27	1	36.28	0.78
B3LSMP5033NC	835	50	33	1	43.95	0.95
B3LSMP5039NC	879	50	39	1	51.63	1.13
B3LSMP5427NC	812	54	27	1	39.26	0.84
B3LSMP5433NC	861	54	33	1	47.56	1.03
B3LSMP5439NC	905	54	39	1	55.86	1.22

B3LEP • End of Run Gallery Panel in a T configuration, with Connectors for Additional Gallery Panels

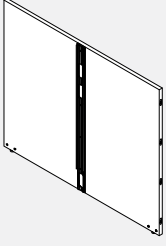

- Provides floor standing support while enclosing the end of a panel run.
- Attaches to the end of a Boulevard 1 or System 3 panel with capture strips to form a T configuration.
- Connections at both ends as well as on the middle of interior face.
- The end connections are to connect other Gallery Panels.
- The side right is compatible with right hand Gallery Panels (B3LXPRxxxx and B3LX-PRxxxxNC, B3L2PRxxxx and B3L3PRxxxx) only.
- The left side is compatible with left hand Gallery Panels (B3LXPLxxxx and B3LX-PLxxxxNC, B3L2PLxxxx and B3L3PLxxxx) only.
- The middle interior face connections are for Boulevard panels.
- Includes all attachment hardware and glides.
- Total height is inclusive of panel glides extended to their full height.
- 51" wide gallery panel accommodates two 24" deep surface while the 63" wide accommodates two 30" deep surfaces and 75" wide two 36" deep surfaces.
- Please specify LP laminate finish and PVC edge finish.
- If a wood grain laminate is chosen, grain direction run horizontally.
- Gallery panel is edged in PVC on exposed top edge only and self edged on the three other edges.

PRODUCT CODE	PRICE LP	SIZE /INCHES			WEIGHT LBS	VOL FT³
		H	W	D		
B3LEP4251	667	42	51	1	55.25	1.24
B3LEP4263	745	42	63	1	68.1	1.53
B3LEP4275	828	42	75	1	80.95	1.82
B3LEP5051	773	50	51	1	66.01	1.48
B3LEP5063	868	50	63	1	81.36	1.82
B3LEP5075	979	50	75	1	96.71	2.17
B3LEP5451	795	54	51	1	71.38	1.59
B3LEP5463	894	54	63	1	87.98	1.97
B3LEP5475	1008	54	75	1	104.58	2.34

B3LSEPL • Left End of Run Single Gallery Panel in L Configuration, with Connectors for Additional Gallery Panels

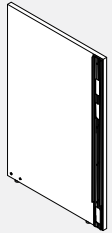

- Provides floor standing support while enclosing the end of a panel run.
- Attaches at the end of a Boulevard 1 or System 3 panel with capture strips to form an L configuration.
- Connection to the Boulevard panel is on interior face near it's right end.
- Connections for a Gallery Panel are on the left edge.
- Compatible with left hand Gallery Panels (B3LXPLxxxx and B3LXPLxxxxNC, B3L2PLxxxx and B3L3PLxxxx) only.
- Includes all attachment hardware and glides.
- Total height is inclusive of panel glides extended to their full height.
- 27" wide gallery panel accommodates a 24" deep surface while the 33" wide accommodates a 30" deep surface and 39" wide a 36" deep surface.
- Please specify LP laminate finish and PVC edge finish.
- If a wood grain laminate is chosen, grain direction run horizontally.
- Edged in PVC on two exposed edges, self edged on connecting to gallery panel edge and the bottom.

PRODUCT CODE	PRICE LP	SIZE /INCHES			WEIGHT LBS	VOL FT³
		H	W	D		
B3LSEPL4227	505	42	27	1	29.51	0.66
B3LSEPL4233	544	42	33	1	35.94	0.80
B3LSEPL4239	571	42	39	1	42.36	0.95
B3LSEPL5027	573	50	27	1	35.27	0.78
B3LSEPL5033	621	50	33	1	42.94	0.95
B3LSEPL5039	664	50	39	1	50.62	1.13
B3LSEPL5427	589	54	27	1	38.14	0.84
B3LSEPL5433	639	54	33	1	46.44	1.03
B3LSEPL5439	683	54	39	1	54.74	1.22

B3LSEPR • Right End of Run Single Gallery Panel in L Configuration, with Connectors for additional Gallery Panels



- Provides floor standing support while enclosing the end of a panel run.
- Attaches at the end of a Boulevard 1 or System 3 panel with capture strips to form an L configuration.
- Connection to the Boulevard panel is on interior face near it's left end.
- Connections for a Gallery Panel are on the right edge.
- Compatible with right hand Gallery Panels (B3LXPRxxxx and B3LXPRxxxxNC, B3L2PRxxxx and B3L3PRxxxx) only.
- Includes all attachment hardware and glides.
- Total height is inclusive of panel glides extended to their full height.
- 27" wide gallery panel accommodates a 24" deep surface while the 33" wide accommodates a 30" deep surface and 39" wide a 36" deep surface.
- Please specify LP laminate finish and PVC edge finish.
- If a wood grain laminate is chosen, grain direction run horizontally.
- Edged in PVC on two exposed edges, self edged on connecting to gallery panel edge and the bottom.

PRODUCT CODE	PRICE LP	SIZE /INCHES			WEIGHT LBS	VOL FT³
		H	W	D		
B3LSEPR4227	505	42	27	1	29.51	0.66
B3LSEPR4233	544	42	33	1	35.94	0.80
B3LSEPR4239	571	42	39	1	42.36	0.95
B3LSEPR5027	573	50	27	1	35.27	0.78
B3LSEPR5033	621	50	33	1	42.94	0.95
B3LSEPR5039	664	50	39	1	50.62	1.13
B3LSEPR5427	589	54	27	1	38.14	0.84
B3LSEPR5433	639	54	33	1	46.44	1.03
B3LSEPR5439	683	54	39	1	54.74	1.22

B3LMP • Middle of Run Single Gallery Panel in X Configuration, with Connectors for Additional Gallery Panels

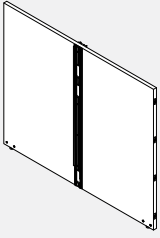

- Provides floor standing support in the middle of a panel run.
- Attached in the middle of a straight Boulevard 1 or System 3 panel run with capture strips to form an X configuration.
- Connections at both ends (for Gallery Panels) as well as on the middle of the interior and exterior faces (for Boulevard Panels).
- The right side is compatible with right hand Gallery Panels (B3LXPRxxxx and B3LX-PRxxxxNC, B3L2PRxxxx and B3L3PRxxxx) only.
- The left side is compatible with left hand Gallery Panels (B3LXPLxxxx and B3LX-PLxxxxNC, B3L2PLxxxx and B3L3PLxxxx) only.
- Includes all attachment hardware and glides.
- Total height is inclusive of panel glides extended to their full height.
- 51" wide gallery panel accommodates two 24" deep surface while the 63" wide accommodates two 30" deep surfaces and 75" wide two 36" deep surfaces.
- Please specify LP laminate finish and PVC edge finish.
- If a wood grain laminate is chosen, grain direction run horizontally.
- Edged in PVC on exposed top edge only and self edged on the three other.

PRODUCT CODE	PRICE LP	SIZE /INCHES			WEIGHT LBS	VOL FT ³
		H	W	D		
B3LMP4251	880	42	51	1	56.07	1.24
B3LMP4263	958	42	63	1	68.91	1.53
B3LMP4275	1041	42	75	1	81.76	1.82
B3LMP5051	995	50	51	1	67.06	1.48
B3LMP5063	1090	50	63	1	82.41	1.82
B3LMP5075	1201	50	75	1	97.76	2.17
B3LMP5451	1024	54	51	1	72.55	1.59
B3LMP5463	1123	54	63	1	89.15	1.97
B3LMP5475	1237	54	75	1	105.74	2.34

B3LSMP - Middle of Run Single Gallery Panel in T Configuration, with Connectors for Additional Gallery Panels

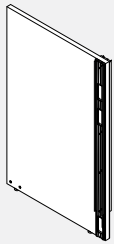

- Provides floor standing support at the middle of a panel run.
- Attached in the middle of a straight Boulevard 1 or System 3 panel run with capture strips to form a T configuration.
- Connections are on the exposed edge (for Gallery Panel) and near the opposite end on both interior and exterior faces (for Boulevard Panels).
- Compatible with left hand gallery panels (B3LXPLxxxx and B3LXPLxxxxNC, B3L2PLxxxx and B3L3PLxxxx) only.
- Includes all attachment hardware and glides.
- Total height is inclusive of panel glides extended to their full height.
- 27" wide gallery panel accommodates a 24" deep surface while the 33" wide accommodates a 30" deep surface and 39" wide a 36" deep surface.
- Please specify LP laminate finish and PVC edge finish.
- If a wood grain laminate is chosen, grain direction run horizontally.
- Edged in PVC on two exposed edges, self edged on connecting to gallery panel edge and the bottom.

PRODUCT CODE	PRICE LP	SIZE /INCHES			WEIGHT LBS	VOL FT ³
		H	W	D		
B3LSMP4227	717	42	27	1	30.33	0.66
B3LSMP4233	757	42	33	1	36.75	0.80
B3LSMP4239	784	42	39	1	43.17	0.95
B3LSMP5027	795	50	27	1	36.32	0.78
B3LSMP5033	843	50	33	1	43.99	0.95
B3LSMP5039	886	50	39	1	51.67	1.13
B3LSMP5427	819	54	27	1	39.31	0.84
B3LSMP5433	868	54	33	1	47.61	1.03
B3LSMP5439	913	54	39	1	55.91	1.22

B3LXPL • Left Gallery Panel Extension, with Connectors for Additional Gallery Panels

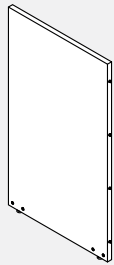

- Provides floor standing support while extending the Gallery Panels run.
- Attaches to the left edge of a Gallery Panel by the pin connectors to allow for additional Gallery Panels to be added on the left side.
- Pin connectors on the right edge and modular connectors on the left edge of the interior face.
- The right side is compatible with Gallery Panels (B3LEPxxx, B3LSEPL, B3LMPxxx, B3LSMP and B3LXPLxxx) only.
- The left side is compatible with left hand Gallery Panels (B3LXPLxxxx and B3LX-PLxxxxNC, B3L2PLxxxx and B3L3PLxxxx) only.
- Includes all attachment hardware and glides.
- Total height is inclusive of panel glides extended to their full height.
- Please specify LP laminate finish and PVC edge finish.
- If a wood grain laminate is chosen, grain direction run horizontally.
- Edged in PVC on exposed top edge only and self edges on the three other.
- Edged in PVC on two exposed edges, self edged on connecting to gallery panel edge and the bottom.

PRODUCT CODE	PRICE LP	SIZE /INCHES			WEIGHT LBS	VOL FT ³
		H	W	D		
B3LXPL4224	260	42	24	1	25.83	0.58
B3LXPL4230	299	42	30	1	32.26	0.73
B3LXPL4236	338	42	36	1	38.68	0.88
B3LXPL4242	376	42	42	1	45.11	1.02
B3LXPL4248	415	42	48	1	51.53	1.17
B3LXPL5024	309	50	24	1	30.83	0.69
B3LXPL5030	357	50	30	1	38.51	0.87
B3LXPL5036	406	50	36	1	46.18	1.04
B3LXPL5042	453	50	42	1	53.86	1.22
B3LXPL5048	502	50	48	1	61.53	1.39
B3LXPL5424	319	54	24	1	33.34	0.75
B3LXPL5430	369	54	30	1	41.64	0.94
B3LXPL5436	417	54	36	1	49.94	1.13
B3LXPL5442	466	54	42	1	58.24	1.31
B3LXPL5448	518	54	48	1	66.54	1.50

B3LXPR • Right Gallery Panel Extension, with Connectors for Additional Gallery Panels



- Provides floor standing support while extending the Gallery Panels run.
- Attaches to the right edge of a Gallery Panel by the pin connectors to allow for additional Gallery Panels to be added on the right side.
- Pin connectors on the right edge and modular connectors on the left edge of the interior face.
- The right side is compatible with right hand Gallery Panels (B3LXPRxxxx and B3LXPRxxxxNC, B3L2PRxxxx and B3L3PRxxxx) only.
- The left side is compatible with Gallery Panels (B3LEPxxx, B3LSEPRxxx, B3LMPxxx and B3LXPRxxx) only.
- Includes all attachment hardware and glides.
- Total height is inclusive of panel glides extended to their full height.
- Please specify LP laminate finish and PVC edge finish.
- If a wood grain laminate is chosen, grain direction run horizontally.
- Edged in PVC on exposed top edge only and self edges on the three other.

PRODUCT CODE	PRICE LP	SIZE /INCHES			WEIGHT LBS	VOL FT ³
		H	W	D		
B3LXPR4224	260	42	24	1	25.83	0.58
B3LXPR4230	299	42	30	1	32.26	0.73
B3LXPR4236	338	42	36	1	38.68	0.88
B3LXPR4242	376	42	42	1	45.11	1.02
B3LXPR4248	415	42	48	1	51.53	1.17
B3LXPR5024	309	50	24	1	30.83	0.69
B3LXPR5030	357	50	30	1	38.51	0.87
B3LXPR5036	406	50	36	1	46.18	1.04
B3LXPR5042	453	50	42	1	53.86	1.22
B3LXPR5048	502	50	48	1	61.53	1.39
B3LXPR5424	319	54	24	1	33.34	0.75
B3LXPR5430	369	54	30	1	41.64	0.94
B3LXPR5436	417	54	36	1	49.94	1.13
B3LXPR5442	466	54	42	1	58.24	1.31
B3LXPR5448	518	54	48	1	66.54	1.50

B3LXPL-NC • Left Gallery Panel Extension, No Connectors for Additional Gallery Panels

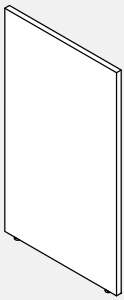

- Provides floor standing support while enclosing the end of a Gallery Panel left run.
- Attached to the left edge of a Gallery Panel by the pin connectors to finish the run.
- Pin connectors are on the right edge of the interior face.
- Compatible with gallery panels (B3LEPxxxx, B3LSEPLxxxx, B3LMPxxxx, B3LMPxxxx and B3LXPLxxxx) only.
- Includes all attachment hardware and glides.
- Total height is inclusive of panel glides extended to their full height.
- Please specify LP laminate finish and PVC edge finish.
- If a wood grain laminate is chosen, grain direction run horizontally.
- Edged in PVC on two exposed edges, self edged on connecting to gallery panel edge and the bottom.

PRODUCT CODE	PRICE LP	SIZE /INCHES			WEIGHT LBS	VOL FT ³
		H	W	D		
B3LXPL4212NC	142	42	12	1	12.95	0.29
B3LXPL4224NC	252	42	24	1	25.8	0.58
B3LXPL4230NC	291	42	30	1	32.22	0.73
B3LXPL4236NC	330	42	36	1	38.65	0.88
B3LXPL4242NC	370	42	42	1	45.07	1.02
B3LXPL4248NC	408	42	48	1	51.5	1.17
B3LXPL5012NC	177	50	12	1	15.45	0.35
B3LXPL5024NC	303	50	24	1	30.8	0.69
B3LXPL5030NC	350	50	30	1	38.47	0.87
B3LXPL5036NC	398	50	36	1	46.15	1.04
B3LXPL5042NC	448	50	42	1	53.82	1.22
B3LXPL5048NC	495	50	48	1	61.5	1.39
B3LXPL5412NC	177	54	12	1	16.7	0.38
B3LXPL5424NC	312	54	24	1	33.3	0.75
B3LXPL5430NC	362	54	30	1	41.6	0.94
B3LXPL5436NC	410	54	36	1	49.9	1.13
B3LXPL5442NC	460	54	42	1	58.2	1.31
B3LXPL5448NC	509	54	48	1	66.5	1.50

B3LXPR-NC • Right Gallery Panel Extension, No Connectors for Additional Gallery Panels

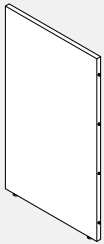

- Provides floor standing support while enclosing the end of a Gallery Panel right run.
- Attached to the right edge of a Gallery Panel by the pin connectors to finish the run.
- Pin connectors are on the left edge of the interior face.
- Compatible with gallery panels (B3LEPxxxx, B3LSEPRxxxx, B3LMPxxxx and B3LXPRxxxx) only.
- Includes all attachment hardware and glides.
- Total height is inclusive of panel glides extended to their full height.
- Please specify LP laminate finish and PVC edge finish.
- If a wood grain laminate is chosen, grain direction run horizontally.
- Edged in PVC on two exposed edges, self edged on connecting to gallery panel edge and the bottom.

PRODUCT CODE	PRICE LP	SIZE /INCHES			WEIGHT LBS	VOL FT ³
		H	W	D		
B3LXPR4212NC	142	42	12	1	12.95	0.29
B3LXPR4224NC	252	42	24	1	25.8	0.58
B3LXPR4230NC	291	42	30	1	32.22	0.73
B3LXPR4236NC	330	42	36	1	38.65	0.88
B3LXPR4242NC	370	42	42	1	45.07	1.02
B3LXPR4248NC	408	42	48	1	51.5	1.17
B3LXPR5012NC	177	50	12	1	15.45	0.35
B3LXPR5024NC	303	50	24	1	30.8	0.69
B3LXPR5030NC	350	50	30	1	38.47	0.87
B3LXPR5036NC	398	50	36	1	46.15	1.04
B3LXPR5042NC	448	50	42	1	53.82	1.22
B3LXPR5048NC	495	50	48	1	61.5	1.39
B3LXPR5412NC	177	54	12	1	16.7	0.38
B3LXPR5424NC	312	54	24	1	33.3	0.75
B3LXPR5430NC	362	54	30	1	41.6	0.94
B3LXPR5436NC	410	54	36	1	49.9	1.13
B3LXPR5442NC	460	54	42	1	58.2	1.31
B3LXPR5448NC	509	54	48	1	66.5	1.50

B3L2PR • Right Gallery Panel End of Run Return

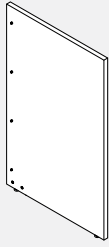

- Provides floor standing support while enclosing the end of a Gallery Panel run.
- Attaches at the Gallery Panel right edge with connectors to form an L configuration.
- Connections to Gallery Panel are on the interior face near it's left end.
- Compatible with Gallery Panels (B3LEPxxxx, B3LSEPRxxxx, B3LMPxxxx and B3LX-PRxxxx) only.
- Includes all attachment hardware and glides.
- Total height is inclusive of panel glides extended to their full height.
- 25" wide gallery panel accomodates a 24" deep surface while the 31" wide accomo- dates a 30" deep surface and 37" wide a 36" deep surface.
- Please specify LP laminate finish and PVC edge finish.
- If a wood grain laminate is chosen, grain direction run horizontally.
- Edged in PVC on three exposed edges and self edged on the bottom edge.

PRODUCT CODE	PRICE LP	SIZE /INCHES			WEIGHT LBS	VOL FT³
		H	W	D		
B3L2PR4213	153	42	13	1	14.02	0.32
B3L2PR4225	291	42	25	1	26.87	0.61
B3L2PR4231	330	42	31	1	33.29	0.75
B3L2PR4237	357	42	37	1	39.72	0.90
B3L2PR5013	192	50	13	1	16.73	0.38
B3L2PR5025	350	50	25	1	32.08	0.72
B3L2PR5031	398	50	31	1	39.75	0.90
B3L2PR5037	441	50	37	1	47.43	1.07
B3L2PR5413	192	54	13	1	18.08	0.41
B3L2PR5425	362	54	25	1	34.68	0.78
B3L2PR5431	410	54	31	1	42.98	0.97
B3L2PR5437	454	54	37	1	51.28	1.16

B3L2PL • Left Gallery Panel End of Run Return

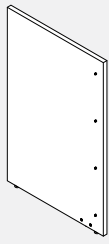

- Provides floor standing support while enclosing the end of a gallery panel run.
- Attaches at the Gallery Panel left edge with connectors to form an L configuration.
- Connections to Gallery Panel are on the interior face near it's right end.
- Compatible with Gallery Panels (B3LEPxxxx, B3LSEPLxxxx, B3LMPxxxx, B3LS- MPxxxx and B3LXPLxxxx) only.
- Includes all attachment hardware and glides.
- Total height is inclusive of panel glides extended to their full height.
- 25" wide gallery panel accomodates a 24" deep surface while the 31" wide accomo- dates a 30" deep surface and 37" wide a 36" deep surface.
- Please specify LP laminate finish and PVC edge finish.
- If a wood grain laminate is chosen, grain direction run horizontally.
- Edged in PVC on three exposed edges and self edged on the bottom edge.

PRODUCT CODE	PRICE LP	SIZE /INCHES			WEIGHT LBS	VOL FT³
		H	W	D		
B3L2PL4213	153	42	13	1	14.02	0.32
B3L2PL4225	291	42	25	1	26.87	0.61
B3L2PL4231	330	42	31	1	33.29	0.75
B3L2PL4237	357	42	37	1	39.72	0.90
B3L2PL5013	192	50	13	1	16.73	0.38
B3L2PL5025	350	50	25	1	32.08	0.72
B3L2PL5031	398	50	31	1	39.75	0.90
B3L2PL5037	441	50	37	1	47.43	1.07
B3L2PL5413	192	54	13	1	18.08	0.41
B3L2PL5425	362	54	25	1	34.68	0.78
B3L2PL5431	410	54	31	1	42.98	0.97
B3L2PL5437	454	54	37	1	51.28	1.16

B3L3PL • Left Gallery Panel End of Run 3-Way Return

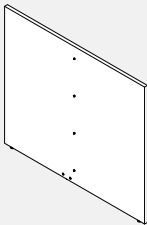

- Provides floor standing support while enclosing the end of a Gallery Panel run.
- Attaches to the Gallery Panel left edge with connectors to form an T configuration.
- Connections to Gallery Panel are on the interior face in the middle.
- Compatible with Gallery Panels (B3LEPxxxx, B3LSEPLxxxx, B3LMPxxxx, B3LS- MPxxxx and B3LXPLxxxx) only.
- Includes all attachment hardware and glides.
- Total height is inclusive of panel glides extended to their full height.
- 49" wide gallery panel accomodates two 24" deep surfaces while the 61" wide accomodates two 30" deep surface and 73" wide two 36" deep surface.
- Please specify LP laminate finish and PVC edge finish.
- If a wood grain laminate is chosen, grain direction run horizontally.
- Edged in PVC on three exposed edges and self edged on the bottom edge.

PRODUCT CODE	PRICE LP	SIZE /INCHES			WEIGHT LBS	VOL FT³
		H	W	D		
B3L3PL4225	229	42	25	1	26.87	0.61
B3L3PL4249	396	42	49	1	52.57	1.19
B3L3PL4261	524	42	61	1	65.41	1.48
B3L3PL4273	609	42	73	1	78.26	1.77
B3L3PL5025	286	50	25	1	32.08	0.72
B3L3PL5049	543	50	49	1	62.77	1.42
B3L3PL5061	639	50	61	1	78.12	1.77
B3L3PL5073	749	50	73	1	93.47	2.11
B3L3PL5425	286	54	25	1	34.68	0.78
B3L3PL5449	559	54	49	1	67.88	1.53
B3L3PL5461	658	54	61	1	84.48	1.91
B3L3PL5473	773	54	73	1	101.08	2.28

B3L3PR • Right Gallery Panel End of Run 3-Way Return

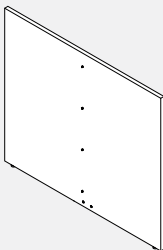

- Provides floor standing support while enclosing the end of a Gallery Panel run.
- Attaches to the Gallery Panel right edge with connectors to form an T configuration.
- Connections to Gallery Panel are on the interior face in the middle.
- Compatible with gallery panels (B3LEPxxxx, B3LSEPRxxxx, B3LMPxxxx and B3LXPRxxxx) only.
- Includes all attachment hardware and glides.
- Total height is inclusive of panel glides extended to their full height.
- 49" wide gallery panel accomodates two 24" deep surfaces while the 61" wide accomodates two 30" deep surface and 73" wide two 36" deep surface.
- Please specify LP laminate finish and PVC edge finish.
- If a wood grain laminate is chosen, grain direction run horizontally.
- Edged in PVC on three exposed edges and self edged on the bottom edge.

PRODUCT CODE	PRICE LP	SIZE /INCHES			WEIGHT LBS	VOL FT³
		H	W	D		
B3L3PR4225	229	42	25	1	26.87	0.61
B3L3PR4249	396	42	49	1	52.57	1.19
B3L3PR4261	524	42	61	1	65.41	1.48
B3L3PR4273	609	42	73	1	78.26	1.77
B3L3PR5025	286	50	25	1	32.08	0.72
B3L3PR5049	543	50	49	1	62.77	1.42
B3L3PR5061	639	50	61	1	78.12	1.77
B3L3PR5073	749	50	73	1	93.47	2.11
B3L3PR5425	286	54	25	1	34.68	0.78
B3L3PR5449	559	54	49	1	67.88	1.53
B3L3PR5461	658	54	61	1	84.48	1.91
B3L3PR5473	773	54	73	1	101.08	2.28

B3HLPBB01 • Gallery Panel Bottom Inline Bracket

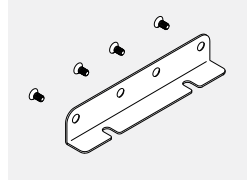

- Gallery Panel Bottom Inline Bracket connects two Gallery Panels at the bottom with screws.
- Available in standard paint colors.

PRODUCT CODE	PRICE	SIZE /INCHES			WEIGHT LBS	VOL FT ³
		H	W	D		
B3HLPBB01	35	7	1.5	8	1	0.5

B3HLPCB01 • Gallery Panel Corner Bracket

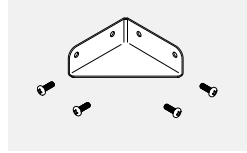

- Gallery Panel Corner Bottom bracket connects two Gallery Panels at 90 degrees.
- Available in standard paint colors.

PRODUCT CODE	PRICE	SIZE /INCHES			WEIGHT LBS	VOL FT ³
		H	W	D		
B3HLPCB01	34	7	1.5	4	4	0.5

B3PMP-GI-W • Privacy Glass for 1" Laminate Panels

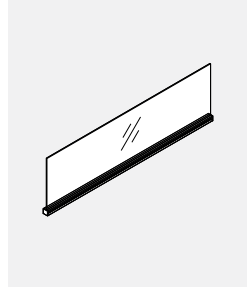

- Privacy glass integrated with aluminum top trim.
- Attaches on top of gallery panels to add privacy or divide space.
- Includes aluminum trim with channel, end caps and glass tile.
- Top rail may also be used to hang accessories.
- Glass and attachment hardware ship separately.
- Please specify standard paint finish for the channel.
- Standard in clear (CLR) or frosted (FRST).

PRODUCT CODE	PRICE		SIZE /INCHES			WEIGHT LBS	VOL FT ³
	CLR	FRST	H	W	D		
B3PMP24GI8W	201	251	8	24	1	4.84	0.11
B3PMP30GI8W	219	276	8	30	1	6.06	0.14
B3PMP36GI8W	235	291	8	36	1	7.28	0.17
B3PMP42GI8W	251	313	8	42	1	8.5	0.19
B3PMP48GI8W	262	327	8	48	1	9.72	0.22
B3PMP24GI16W	201	251	16	24	1	8.92	0.22
B3PMP30GI16W	219	276	16	30	1	11.17	0.28
B3PMP36GI16W	235	291	16	36	1	13.43	0.33
B3PMP42GI16W	251	313	16	42	1	15.68	0.39
B3PMP48GI16W	262	327	16	48	1	17.92	0.44

B3PFD-W • Felt divider for 1" Laminate Panels

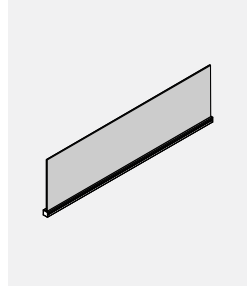

- Privacy felt integrated with aluminum top trim.
- Attaches on top of gallery panels to add privacy or divide space.
- Includes aluminum trim with channel, end caps and felt tile.
- Top rail may also be used to hang accessories.
- Felt and attachment hardware ship separately.
- Please specify standard paint finish for the channel.
- Please specify standard felt finish.

PRODUCT CODE	PRICE		SIZE /INCHES			WEIGHT LBS	VOL FT ³
	H	W	D				
B3PFD0824W	72		8	24	1	1.32	0.11
B3PFD0830W	88		8	30	1	1.65	0.14
B3PFD0836W	102		8	36	1	1.99	0.17
B3PFD0842W	114		8	42	1	2.32	0.19
B3PFD0848W	170		8	48	1	2.65	0.22
B3PFD0854W	183		8	54	1	2.98	0.25
B3PFD0860W	199		8	60	1	3.32	0.28
B3PFD0866W	210		8	66	1	3.65	0.31
B3PFD0872W	238		8	72	1	3.98	0.33
B3PFD1624W	83		16	24	1	1.83	0.22
B3PFD1630W	98		16	30	1	2.3	0.28
B3PFD1636W	116		16	36	1	2.76	0.33
B3PFD1642W	130		16	42	1	3.22	0.39
B3PFD1648W	193		16	48	1	3.68	0.44
B3PFD1654W	210		16	54	1	4.14	0.50
B3PFD1660W	226		16	60	1	4.61	0.56
B3PFD1666W	238		16	66	1	5.07	0.61
B3PFD1672W	271		16	72	1	5.53	0.67

Electrical

Affordability and widespread availability of wireless networking is gradually diminishing the need for extensive cable capacity housing. However, as our desk top equipment still requires electricity, providing access to power from within a work station is an integral part of any work place design.

The Global Contract family of power components has been assembled to address a variety of common requirements as well as to satisfy specific customer needs and budgets.

Global Contract can now offer the option of 3 duplex per panel, please contact your Customer Service Representative.

Direct Access:

When office equipment plugs directly into a wall or raised floor power source, cable troughs, as well the Boulevard panel internal cavity serve the purpose of organizing cables.

Extensions:

Keeping minimal installation costs in mind, the next natural step is the employment of fused and surge protected power bars, worksurface-clamped receptacles or floor standing power towers.

Four circuit power systems:

In the absence of a raised floor, or when office equipment is to be installed further away from wall outlets, the Boulevard panel or Bridges unit the building power supply - office equipment gap by distributing power at either floor or desk height level, or both.

While Boulevard panels are capable of surrounding a given work station with power and data outlets at multiple levels, it is important to remember that the most economical way of providing four-circuit power distribution is if the harness, junction box and receptacle system remained within the central spine structure. The cost savings here come from a number and lengths of individual connecting power harnesses.

Should there be a need to branch power from Boulevard or central spine onto adjacent, perpendicular work surfaces, the employment of fused and surge protected power bars will assist in keeping the cost under control.

However, the very same, 4-circuit system is capable of delivering a considerable amount of power as there can be up to six, 8 wire-4 circuit systems accommodated within System3 pass-thru panel. For instance: three systems at the floor level and two systems at the desk height.

Various ceiling or floor level power entry feeds are available. See the following pages for individual component description and technical specifications.

Technical Information

Wire Schematic

4-2-2 Wiring Schematic

8-Wire Shared Neutral

"3+1" -3 Utility circuits, 1 dedicated circuit.

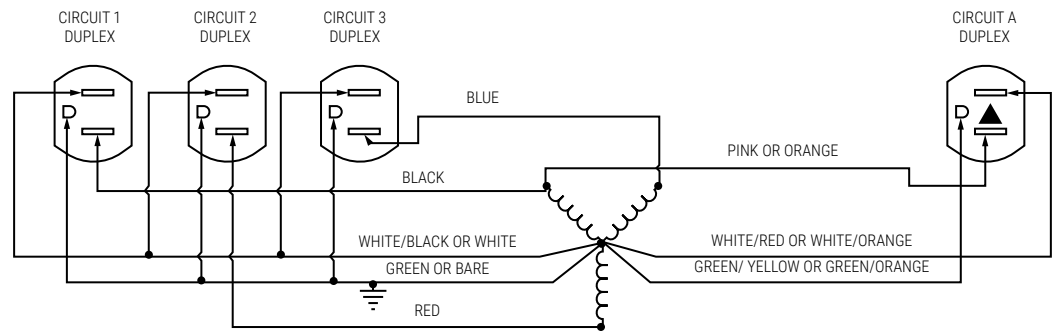

8 Wires

4 Lines (12 ga.)
2 Neutrals (10 ga.)
2 Grounds (12 ga.)

4 Circuits

3 Utility Circuits
1 Dedicated Circuits

Receptacles

Duplex – Up to 6 duplex
receptacles per circuit
(Up to 48 infeed)

Specifications

System rated for connection to a grounded 120/240 V, single phase*, 20A, 60Hz or 120/208 V, 3 phase, 20A, 60Hz branch circuit for U.S. and 15A if product is marked with a C-UL Mark. Outlets rated 15A max.

* When connected to Single Phase. Only
Circuit 1,3 & A are available.

UL Recognised CSA Certified

Warning: It is recommended that installation of the electrical harness be made under the supervision of a licensed electrician in accordance with applicable codes and regulations.

Special Note: Always determine that harness is electrically connected to only one power supply.

STEP-BY-STEP SPECIFICATION - 8 WIRE ELECTRICAL FOR BOULEVARD 1 AND RACEWAY PANELS

STEP 1: Determine the location of the source power entry entering the panel through a post.

a) From the floor:

i) Choose from a selection of single or double Base Feeds (BE81BF721, BE81BF722, BE81BF1441, BE81BF1442) to bring the power from the floor to the raceway channel.

ii) Select a post adjacent to the panel (or panels if using a Double Base Feed) to which the end of the Base Feed will be attached. This panel requires a Power Distribution Housing and must be located next to the post through which the Base Feed is entering.

Note: If it is not practical to have a Power Distribution Housing in a panel adjacent to the selected Base Feed Post, use a BE8CPxxHJ Housing-to-Jumper Pass-Thru Cable to transition through the adjacent non-powered panel(s) that are between the Base Feed Post and the first powered panel. The length of the cable will equal the combined width of the non-powered panel(s).

b) From the Ceiling:

i) Choose from a selection of single or double Ceiling Feeds (BE81CF1201, BE81CF120-2, BE81CF1441, BE81CF1442) to bring the power from the ceiling to the raceway.

ii) Select a post adjacent to the panel (or panels if using a Double Ceiling Feed) to which the Ceiling Feed will be attached. This panel requires a Power Distribution Housing and must be located next to the post through which the Ceiling Feed is entering.

STEP 2: Determine which panels are to be powered.

a) Use a BE81D Concealed Desk Height Power Distribution Housing or a BE8U2D Face Mount Desk Height Power Distribution Housing that corresponds with the width of each panel selected to be powered.

Note: Specify Face Mount Raceway Covers for panels that contain BE8U2D Face Mount Desk Height Power Distribution Housings.

STEP 3: Connect power to the panels.

a) Use a BE8JC16 Jumper between two adjacent powered panels.

b) Use a BE8JC20 Jumper between two powered panels separated by a post.

c) **Use a BE8JM19 Shielded Mesh Jumper between two powered panels separated by a post.**

d) Use a BE8CPxxHJ Housing-to-Jumper Pass-Thru Cable to electrically connect a BE8JM19 Shielded Mesh Jumper and a powered panel when the two are separated by one or more non-powered panels in a straight line application only.

i) The length of the BE8CPxxHJ Housing-to-Jumper Pass-Thru Cable will equal the combined width of the non-powered panel(s).

e) Use a BE8CPxxHH Housing-to-Housing Pass-Thru Cable to electrically connect two powered panel separated by one or more non-powered panels in a straight line application only.

i) The length of the Pass-Thru Cable corresponds with the width(s) of the non-powered panels that separate two powered panels plus 16" (the termination blocks of the Power Distribution Housing are 8" in from the edge of the powered panel), plus 4" for each post.

f) Connect two jumpers or cables together by using the I-Connector BE8CI1. This functions as a female-female adapter and it allows the male ends of jumpers and pass-thru cables to connect together.

STEP 4: Designate which circuit each duplex is to tap into.

a) Each powered panel has four (4) potential locations for duplex receptacles - 2 per side. (Exception: 24" wide panel has only two (2) potential locations - 1 per side, 18" wide panel has no locations for receptacles).

b) At each location there is a choice of four (4) circuit options. Select the circuit option for each location.

Circuit Selections : Circuits 1, 2, and 3 are utility circuits, all sharing a ground and a neutral. Circuit A is a dedicated circuit with its own ground and neutral.

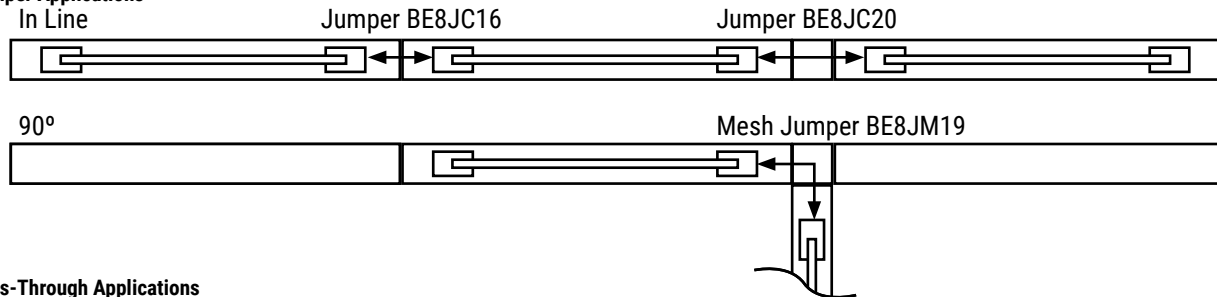
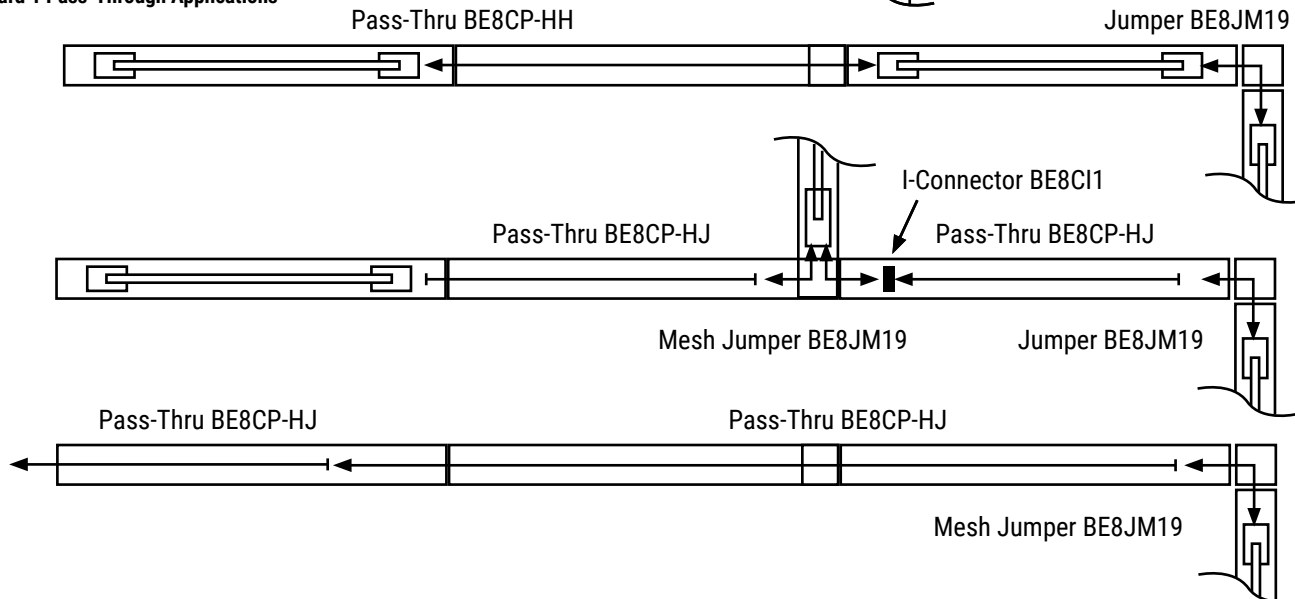
SPECIFICATION APPLICATIONS**Boulevard 1 Jumper Applications****Boulevard 1 Pass-Through Applications**

STEP-BY-STEP SPECIFICATION - 8 WIRE ELECTRICAL FOR BOULEVARD SYSTEM 3 BASE RACEWAY

STEP 1: Determine the location of the source power entry entering the panel.

- a. At the base of a panel:
 - i. Use a BE8BFxx Base Feed.
 - ii. Select the panel to which the Base Feed will be attached. This panel requires a BE83D Power Distribution Housing.
 - iii. Select the side of the panel and the receptacle outlet to which the Base Feed is to be attached.
- b. From the ceiling:
 - i. Use a BE8CFxx-1or -2 (single or double).
 - ii. Select the post through which to feed the Ceiling Feed.
 - iii. One panel adjacent to the selected post requires a BE83D Power Distribution Housing. Attach the Ceiling Feed to the nearest end of the Power Distribution Housing.

Note: If it is not practical to have a Power Distribution Housing in a panel adjacent to the selected Ceiling Feed Post, use a BE8CPxxHJ Housing-to-Jumper Pass-Thru Cable to transition through the adjacent non-powered panel(s) that are between the Ceiling Feed Post and the first powered panel. The length of the cable will equal the combined width of the non-powered panel(s).

- c. At the base of an adjoining panel:
 - i. Use a BE83BFR72 Raceway Entry Base Feed
 - ii. Select a non-powered panel adjacent to the panel with a Power Distribution Housing.
 - iii. Choose a duplex opening on either side of the panel to insert and attach the Raceway Entry Base Feed at that point.
 - iv. The Raceway Entry Base Feed will attach to the nearest end of the Power Distribution Housing (similar to the Ceiling Feed attachment).

STEP 2: Determine which panels are to be powered.

- a. Use a BE83D Power Distribution Housing that corresponds with the width of the selected panel.

STEP 3: Connect power to the panels.

- a. Use a BE8JC16 Jumper between two adjacent powered panels.
- b. Use a BE8JC20 Jumper between two powered panels separated by a post.
- c. Use a BE8CPxxHH Housing-to-Housing Pass-Thru Cable to connect two powered panels separated by one or more non-powered panels. i. The length of the Pass-Thru Cable corresponds with the width(s) of the non-powered panels that separate two powered panels plus 16" (the termination blocks of the Power Distribution Housing are 8" in from the edge of the powered panel plus 4" for each post).

STEP 4: Designate which circuit each duplex is to tap into.

- a. Each powered panel has four (4) potential locations for duplex receptacles - 2 per side. (Exception: 24" wide panel has only two (2) potential locations - 1 per side, 18" wide panel has no locations for receptacles).
- b. At each location there is a choice of four (4) circuit options. Select the circuit option for each location.

Circuit Selections : Circuits 1, 2, and 3 are utility circuits, all sharing a ground and a neutral. Circuit A is a dedicated circuit with its own ground and neutral.

SPECIFICATION APPLICATIONS

Boulevard System 3 Jumper Applications

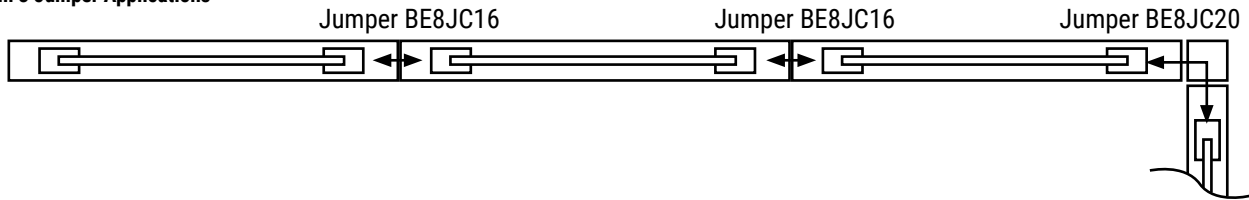

Boulevard System 3 Jumper Applications

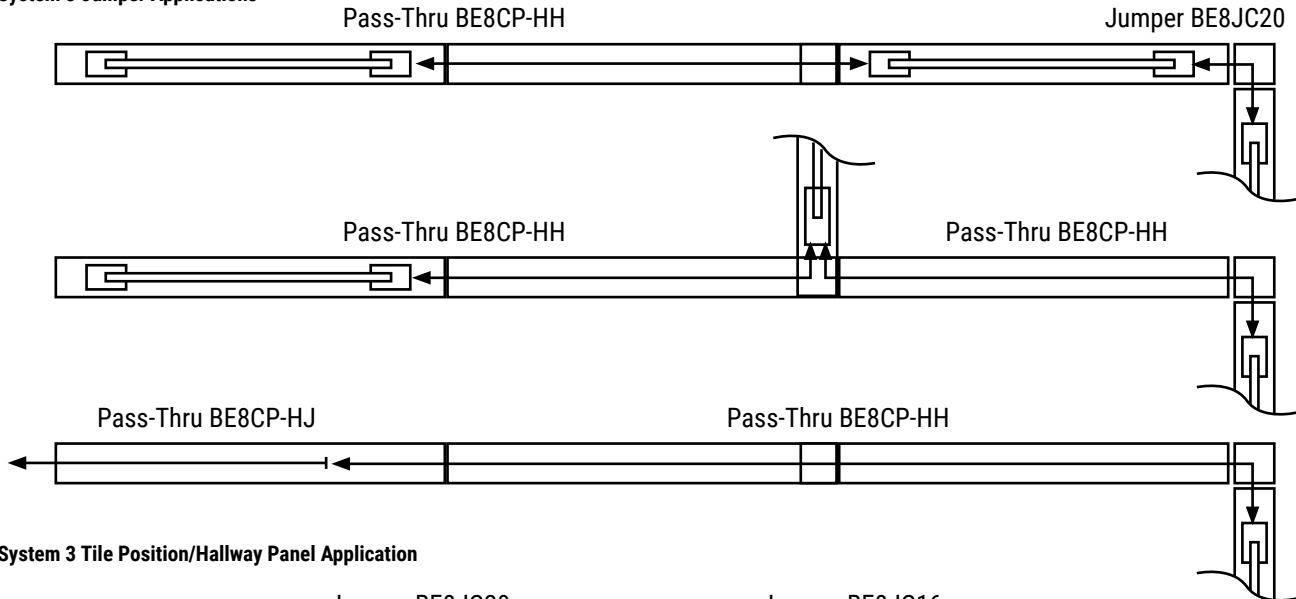

Boulevard System 3 Tile Position/Hallway Panel Application

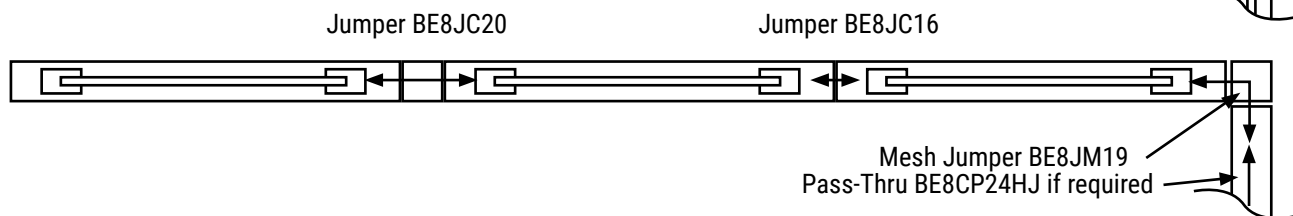

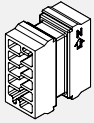
BE8CI-1 • "I" Connector

- Connects two Pass Thru Cables.
- Inline coupler used to connect two BE8CPxxHH Pass-Thru Cables.

PRODUCT CODE	PRICE	SIZE/ INCHES			WEIGHT VOL	
		H	W	D	LBS	FT ³
BE8CI1	85	1.5	1.5	4.625	0.06	0.03

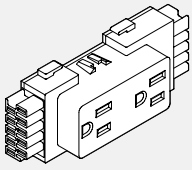
BE8D • Duplex Receptacles

- Snaps into Power Distribution Housing.
- Up to 6 duplex receptacles per circuit.
- BE8D1 = Circuit #1 (utility circuit)
- BE8D2 = Circuit #2 (utility circuit)
- BE8D3 = Circuit #3 (utility circuit)
- BE8DA - Circuit #A (dedicated circuit)

PRODUCT CODE	PRICE	SIZE/ INCHES			WEIGHT VOL	
		H	W	D	LBS	FT ³
BE8D1	35	2	4.625	1.25	0.10	0.01
BE8D2	35	2	4.625	1.25	0.10	0.01
BE8D3	35	2	4.625	1.25	0.10	0.01
BE8DA	35	2	4.625	1.25	0.10	0.01

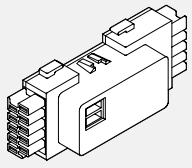
BE8D • USB Receptacles

- Snaps into Power Distribution Housing.
- USB charging module provides convenient charging power access through dual ports on face of receptacles.
- Two USB ports.
- 2 amp output, considered as circuit #1.

PRODUCT CODE	PRICE	SIZE/ INCHES			WEIGHT VOL	
		H	W	D	LBS	FT ³
BE8DU1-B	238	2	4.625	1.25	0.10	0.01
BE8DU1-W	238	2	4.625	1.25	0.10	0.01

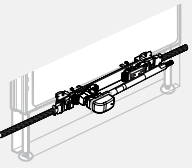
BE83BF • Reversible Base Feed (Boulevard System 3 only)

- Provides single power entry from floor circuit to raceway.
- Takes the place of a duplex receptacle by connecting to the base raceway channel of a Boulevard System 3 panel.
- BE83BF72 includes 72" long liquid-tite conduit, BE83BF144 includes 144" long liquid-tite conduit.
- Must be hard wired to power source by a licensed electrician.

PRODUCT CODE	PRICE	SIZE/ INCHES			WEIGHT VOL	
		H	L	D	LBS	FT ³
BE83BF72	353	3	72	3	3.82	2
BE83BF144	450	3	144	3	6.98	2

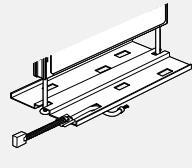
BE83BFR72 • Raceway Entry Base Feed (Boulevard System 3 only)

- Brings power to an adjacent panel by entering a non-powered raceway of a Boulevard System 3 panel through a duplex opening.
- Includes 72" long liquid-tite conduit.
- Must be hard wired to power source by a licensed electrician.

PRODUCT CODE	PRICE	SIZE/ INCHES			WEIGHT VOL	
		H	L	D	LBS	FT ³
BE83BFR72	437	3	88	3	4.82	2

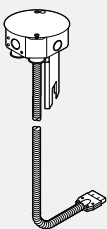
BE8CF-1 • Ceiling Feed - Single

- Provides single power entry from ceiling, through post and into raceway channel.
- Power entry cable penetrates 8" into a panel and plugs into either a Power Distribution Housing or BE8CPxxHJ Pass-Thru Harness.
- Specify Post Extension separately.
- Must be hard wired to power source by a licensed electrician.

PRODUCT CODE	PRICE	SIZE/ INCHES			WEIGHT VOL	
		H	L	D	LBS	FT ³
BE8CF1201	353	6	120	6	5.24	2
BE8CF1441	479	6	144	6	5.96	2

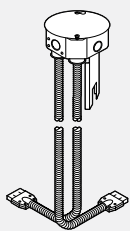
BE8CF-2 • Ceiling Feed - Double

- Provides dual power entry from ceiling, through post and into raceway channel.
- Power entry cable penetrates 8" into a panel and plugs into either a Power Distribution Housing or a BE8CPxxHJ Pass-Thru Harness.
- Use 1) In middle of run to distribute power in two directions.
2) At beginning of run where second Ceiling Feed harness is connected to BE8CPxxHJ and distributes power underneath Power Distribution Housing to pick-up second circuit grouping in long panel run.
- Specify Post Extension separately.
- Must be hard wired to power source by a licensed electrician.

PRODUCT CODE	PRICE	SIZE/ INCHES			WEIGHT VOL	
		H	L	D	LBS	FT ³
BE8CF1202	620	6	120	3	5.24	2
BE8CF1442	701	6	144	3	5.96	2

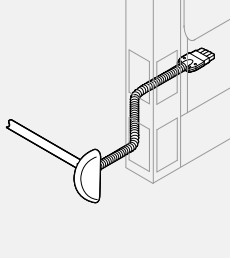
BE81BF-1 • Base Feed - Single (Boulevard 1 only)

- Provides single power entry from floor, through post and into Boulevard 1 raceway channel.
- Power entry cable penetrates 8" into a panel and plugs into either a Power Distribution Housing or a BE8CPxxHJ Pass-Thru Harness.
- Power entry dome available in black only, but "Capture Strip" connector will match the post colour as standard.
- 2 1/2" clearance in depth and 5 1/2" away from any obstructions required from power entry point.
- Comes with 32" harness attached. Liquid-tite whip 72" and 144".
- Must be hard wired to power source by a licensed electrician.

PRODUCT CODE	PRICE	SIZE/ INCHES			WEIGHT VOL	
		H	L	D	LBS	FT ³
BE81BF721	349	6	107	3	3.82	2
BE81BF1441	466	6	179	3	5.96	2

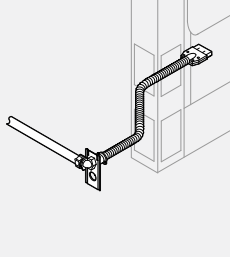
BE81BF-1FL • Base Feed - Single (Boulevard 1 only)

- Provides single power entry from floor, through post and into Boulevard 1 raceway channel.
- Power entry cable penetrates 8" into a panel and plugs into either a Power Distribution Housing or a BE8CPxxHJ Pass-Thru Harness.
- Power entry plate available in black only, but "Capture Strip" connector will match the post colour as standard.
- 2 1/2" clearance in depth and 5 1/2" away from any obstructions required from power entry point.
- Comes with 32" harness attached. Liquid-tite whip 72" and 144".
- Must be hard wired to power source by a licensed electrician.

PRODUCT CODE	PRICE	SIZE/ INCHES			WEIGHT VOL	
		H	L	D	LBS	FT ³
BE81BF721FL	349	6	107	3	3.82	2
BE81BF1441FL	466	6	179	3	3.82	2

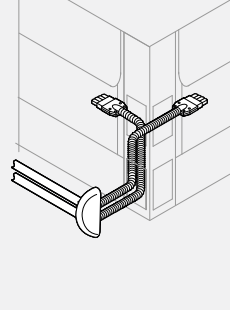
BE81BF-2 • Base Feed - Double (Boulevard 1 only)

- Provides dual power entry from floor, through post and into Boulevard 1 raceway channel.
- Power entry cable penetrates 8" into a panel and plugs into either a Power Distribution Housing or a BE8CPxxHJ Pass-Thru Harness.
- Use 1) In middle of run to distribute power in two directions.
2) At beginning of run where second Base Feed Harness is connected to BE8CPxxHJ and distributes power underneath Power Distribution Housing to pick-up second circuit grouping in long panel run.
- Liquitite whip 72" and 144".
- Power entry box available in black only, but "Capture Strip" connector will match the post colour as standard.
- 2 1/2" clearance in depth and 5 1/2" away from any obstructions required from power entry point.
- Comes with 32" harness attached.
- Must be hard wired to power source by a licensed electrician.

PRODUCT CODE	PRICE	SIZE/ INCHES			WEIGHT VOL	
		H	L	D	LBS	FT ³
BE81BF722	737	6	107	3	6.98	2
BE81BF1442	983	6	179	3	6.98	2

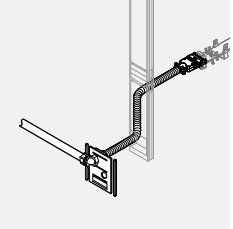
BE81BF601 • Base Feed - Single (Boulevard 1 only)

- Provides single power entry from floor, through 6" panel and into Boulevard 1 raceway panel.
- Power entry cable penetrates 8" into a panel and plugs into either a Power Distribution Housing or a BE8CPxxHJ Pass-Thru Harness.
- For 6" Power/Cable Access Panel only.
- Comes with 32" harness attached.
- Liquitite whip 72".
- Must be hard wired to power source by a licensed electrician.

PRODUCT CODE	PRICE	SIZE/ INCHES			WEIGHT VOL	
		H	L	D	LBS	FT ³
BE81BF601	380	6	107	3	4.90	0.062

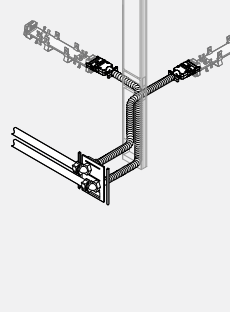
BE81BF602 • Base Feed - Double (Boulevard 1 only)

- Provides dual power entry from floor, through 6" panel and into Boulevard 1 raceway panel.
- Power entry cable penetrates 8" into a panel and plugs into either a Power Distribution Housing or a BE8CPxxHJ Pass-Thru Harness.
- Use 1. In middle of run to distribute power in two directions.
2. At beginning of run where second Base Feed Harness is connected to BE8CPxxHJ and distributes power underneath Power Distribution Housing to pick-up second circuit grouping in long panel run.
- For 6" Power/Cable Access Panel only.
- Comes with 2x32" harness attached.
- Liquitite whip 72".
- Must be hard wired to power source by a licensed electrician.

PRODUCT CODE	PRICE	SIZE/ INCHES			WEIGHT VOL	
		H	L	D	LBS	FT ³
BE81BF602	761	6	107	3	5.30	0.071

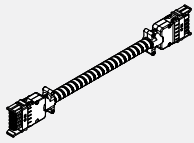
BE8JC • Jumper Cable

- **Electrically connects two Power Distribution Housings.**
- The BE8JC16 electrically connects two powered panels positioned side by side.
- The BE8JC20 electrically connects two powered panels separated by a post.
- Wires are concealed in a flexible metal conduit.
- Cannot go through a Boulevard 1 post in a corner application. (Please use the Jumper Cable Mesh)

PRODUCT CODE	PRICE	SIZE/ H	INCHES			WEIGHT VOL	
			L	D	LBS	FT ³	
BE8JC16	160	2	16.75	0.5	0.66	1.17	
BE8JC20	162	2	20.75	0.5	0.78	1.17	

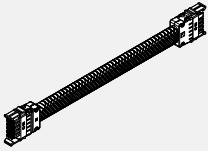
BE8JM19 • Jumper Cable Mesh

- **Electrically connects two Power Distribution Housings in Boulevard 1 panels that are separated by a post in a corner application.**
- BE8JM19 - Wires are covered with a durable nylon mesh.
- BE8JMS19 - Wires are concealed in a flexible metal shroud and covered with a durable nylon mesh.
- Used in System 3 Panels at tile position passing through post at corner application.

PRODUCT CODE	PRICE	SIZE/ H	INCHES			WEIGHT VOL	
			L	D	LBS	FT ³	
BE8JM19	162	2	19	0.5	0.75	1.17	
BE8JMS19	184	2	19	0.5	0.75	1.17	

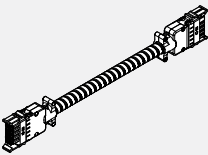
BE83BT • Base-to-Tile Cable

- **Electrically connects a Base Raceway Power Distribution Housing to a Face Mount Tile Power Distribution Housing within a System 3 PV panel.**
- Wires are concealed in a flexible metal conduit.
- BE83BT82 to be used on panels manufactured before November 1st, 2014 and BE83BT40 after.

PRODUCT CODE	PRICE	SIZE/ H	INCHES			WEIGHT VOL	
			L	D	LBS	FT ³	
BE83BT82	191	2	82.5	0.5	3.05	1.38	
BE83BT40	161	2	40.5	0.5	1.44	1.17	

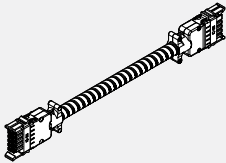
BE8CP-HH • Housing-to-Housing Pass-Thru Cable

- **Electrically connects two Power Distribution Housings in panels separated by one or more non-powered panels.**
- Wires are concealed in a flexible metal conduit.
- **NOTE** : In Boulevard 1 and or System 3 tile position applications, the Housing-to-Housing Pass-Thru Cables can only be used in a straight run.

PRODUCT CODE	PRICE	SIZE/ H	INCHES			WEIGHT VOL	
			L	D	LBS	FT ³	
BE8CP40HH	161	2	40.5	0.5	1.44	1.17	
BE8CP46HH	167	2	46.5	0.5	1.71	1.17	
BE8CP52HH	177	2	52.5	0.5	1.95	1.17	
BE8CP58HH	184	2	58.5	0.5	2.21	1.17	
BE8CP64HH	190	2	64.5	0.5	2.37	1.17	
BE8CP70HH	196	2	70.5	0.5	2.6	1.17	
BE8CP76HH	204	2	76.5	0.5	2.81	1.17	
BE8CP82HH	213	2	82.5	0.5	3.03	1.17	
BE8CP88HH	221	2	88.5	0.5	3.05	1.17	
BE8CP94HH	226	2	94.5	0.5	3.30	1.17	
BE8CP100HH	233	2	100.5	0.5	3.47	1.17	
BE8CP106HH	242	2	106.5	0.5	3.87	1.17	
BE8CP118HH	256	2	118.5	0.5	4.08	1.17	
BE8CP130HH	268	2	130.5	0.5	4.73	1.17	
BE8CP142HH	282	2	142.5	0.5	4.99	1.17	

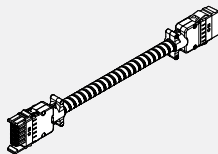
BE8CP-HJ • Housing-to-Jumper Pass-Thru Cable

- **Electrically connects a Power Distribution Housing to a Housing connection of a harness.**
- Wires are concealed in a flexible metal conduit.
- **NOTE** : In both Boulevard 1 and System 3 Tile Position applications, the Housing-to-Jumper Pass-Thru Cables can only be used in a straight run.

PRODUCT CODE	PRICE	SIZE/ H	INCHES			WEIGHT VOL	
			L	D	LBS	FT ³	
BE8CP24HJ	144	2	24	0.5	0.9	1.17	
BE8CP30HJ	151	2	30	0.5	1.3	1.17	
BE8CP36HJ	156	2	36	0.5	1.44	1.17	
BE8CP42HJ	169	2	42	0.5	1.71	1.17	
BE8CP48HJ	177	2	48	0.5	1.95	1.17	
BE8CP54HJ	188	2	54	0.5	2.21	1.17	
BE8CP60HJ	196	2	60	0.5	2.37	1.17	
BE8CP72HJ	204	2	72	0.5	2.81	1.17	
BE8CP84HJ	220	2	84	0.5	3.05	1.17	
BE8CP96HJ	233	2	96	0.5	3.3	1.17	
BE8CP108HJ	243	2	108	0.5	3.87	1.17	
BE8CP120HJ	257	2	120	0.5	4.08	1.17	
BE8CP144HJ	293	2	144	0.5	4.59	1.17	

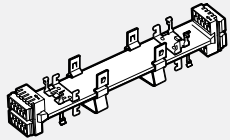
BE81D • Power Distribution Housing Kit - Concealed Desk Height (Boulevard 1 only)

- Provides two duplex receptacles per panel for all panel widths above 24" wide.
- Power Distribution Housing is specified per panel size. eg. BE81D36 is for use with a 36" panel.

PRODUCT CODE	PRICE	SIZE/ H	INCHES		WEIGHT VOL	
			L	D	LBS	FT ³
BE81D24	198	2	9.25	2.61	0.83	1.17
BE81D30	208	2	15.25	2.61	1.28	1.17
BE81D36	220	2	21.25	2.61	1.62	1.65
BE81D42	226	2	27.25	2.61	2.00	2.00
BE81D48	238	2	33.25	2.61	2.32	2.54
BE81D54	242	2	39.25	2.61	2.66	3.20
BE81D60	243	2	45.25	2.61	3.04	3.20
BE81D66	310	2	51.25	2.61	3.49	3.25
BE81D72	341	2	57.2	2.61	3.76	3.30

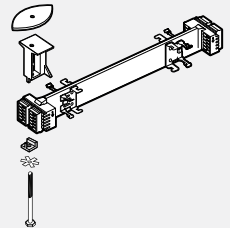
BE8U2D • Power Distribution Housing Kit - Face Mount Desk Height (Boulevard 1 only)

- Provides two duplex receptacles per panel side for all panel widths above 24" wide.
- Power Distribution Housing is specified per panel size. eg. BE8U2D36 is for use with a 36" panel.
- 24" wide panel allows for only one (1) duplex receptacle per panel side.

PRODUCT CODE	PRICE	SIZE/ H	INCHES		WEIGHT VOL	
			L	D	LBS	FT ³
BE8U2D24	198	2	9.25	2.61	0.83	1.17
BE8U2D30	208	2	15.25	2.61	1.28	1.17
BE8U2D36	220	2	21.25	2.61	1.62	1.65
BE8U2D42	226	2	27.25	2.61	2.00	2.00
BE8U2D48	238	2	33.25	2.61	2.32	2.54
BE8U2D54	242	2	39.25	2.61	2.66	3.20
BE8U2D60	243	2	45.25	2.61	3.04	3.20
BE8U2D66	310	2	51.25	2.61	3.49	3.25
BE8U2D72	341	2	57.25	2.61	3.76	3.30

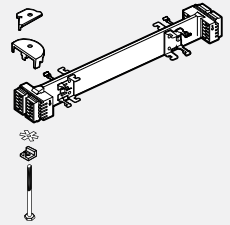
BE83D • Power Distribution Housing Kit - Base Raceway (Boulevard System 3 only)

- Provides two duplex receptacles per panel side for all panel widths above 24" wide.
- Power Distribution Housing is specified per panel size. eg. BE83D36 is for use with a 36" panel.
- 24" wide panel allows for only one (1) duplex receptacle per panel side.

PRODUCT CODE	PRICE	SIZE/ H	INCHES		WEIGHT VOL	
			L	D	LBS	FT ³
BE83D24	198	2	9.25	2.61	0.83	1.17
BE83D30	208	2	15.25	2.61	1.28	1.17
BE83D36	220	2	21.25	2.61	1.62	1.65
BE83D42	226	2	27.25	2.61	2.00	2.00
BE83D48	238	2	33.25	2.61	2.32	2.54
BE83D54	242	2	39.25	2.61	2.66	3.20
BE83D60	243	2	45.25	2.61	3.04	3.20
BE83D66	310	2	51.25	2.61	3.49	3.25
BE83D72	341	2	57.25	2.61	3.76	3.30

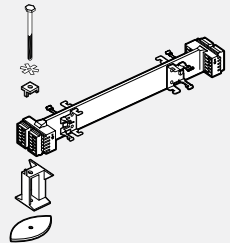
BE8U3FM • Power Distribution Housing Kit - Face Mount Tile (Boulevard System 3 only)

- Provides two duplex receptacles for all tile widths above 24". 24" wide tile allows for one (1) duplex receptacle.
- Housing and mounting hardware included.
- Specify duplexes, cables and tiles separately.
- BE83BT40 Base-to-Tile Cable is used to connect the tile mounted housing to the Power Distribution Housing tile in the base of the same "PV" panel.
- 24" wide tiles have one duplex and one data/comm opening. 30" and wider tiles have two data/comm openings.
- Note: Not compatible with panels built prior November 1st, 2014.

PRODUCT CODE	PRICE	SIZE/ H	INCHES		WEIGHT VOL	
			L	D	LBS	FT ³
BE8U3FM24	198	2	9.25	2.61	0.83	1.17
BE8U3FM30	208	2	15.25	2.61	1.28	1.17
BE8U3FM36	220	2	21.25	2.61	1.62	1.65
BE8U3FM42	226	2	27.25	2.61	2.00	2.00
BE8U3FM48	238	2	33.25	2.61	2.32	2.54
BE8U3FM54	242	2	39.25	2.61	2.66	3.20
BE8U3FM60	243	2	45.25	2.61	3.04	3.20
BE8U3FM66	310	2	51.25	2.61	3.49	3.25
BE8U3FM72	341	2	57.25	2.61	3.76	3.30

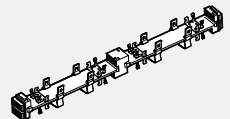
BE81D-CM • Centermount Power Distribution Housing Quad Kit - Concealed Desk Height (B1 only)

- Provides four duplex receptacles per panel for widths 36" and above.
- Centermount Distribution Housing is specified per panel size. ie. BE81D36CM is for 36" panel.
- Not available for panels less than 36" wide.

PRODUCT CODE	PRICE	SIZE/ H	INCHES		WEIGHT VOL	
			L	D	LBS	FT ³
BE81D36CM	363	2	21.99	2.61	3.24	1.65
BE81D42CM	374	2	27.99	2.61	4.00	2.00
BE81D48CM	382	2	33.99	2.61	4.64	2.54
BE81D54CM	389	2	39.99	2.61	5.32	3.20
BE81D60CM	396	2	45.99	2.61	6.04	3.20
BE81D66CM	462	2	51.99	2.61	6.98	3.25
BE81D72CM	529	2	57.99	2.61	7.52	3.30

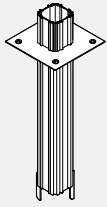
BEPE • Post Extension

- **Lightweight aluminum pole to be used to bring power and/or data/communication cables from ceiling to a panel through a post.**
- Attaches to ceiling and post.
- Includes connectors, ceiling trim plate and screws.
- Post extension will accept:
 - 75 cables 5.6mm (0.220") dia. data cables
 - 60 cables 5.6mm (0.220") dia. data cables with 1 power feed
 - 45 cables 5.6mm (0.220") dia. data cables with 2 power feeds.
- Ceiling bezel is white only.

PRODUCT CODE	PRICE	SIZE/	INCHES			WEIGHT VOL	
			L	D	LBS	FT ³	
BEPE49	124	49	2.61	2.61	5.00	0.258	
BEPE81	188	81	2.61	2.61	9.00	0.424	

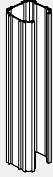
BHPOST • Lay in Post Extension

- **Three sided lightweight aluminum pole to be used to bring power and/or data/communication cables from ceiling to a panel. True lay-in application use**
- Attaches to ceiling and post.
- Includes connectors and ceiling bezel plate and screws.
- Requires vertical end trim to enclose when used in 2 way and 3 way panel run application.
- Trim encloses lay-in cable post extension, sold separately.

PRODUCT CODE	PRICE	TYPE	SIZE/	INCHES			WEIGHT VOL	
				H	L	D	LBS	FT ³
BHPOST66	195	BASE	66	2.61	2.61	8	0.346	
BHPOSTE30	91	EXTENSION	30	2.61	2.61	5	0.195	
BHPOSTE78	237	EXTENSION	78	2.61	2.61	9	0.430	

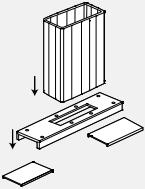
BE2PE • Off-Module Post Extension

- **An alternative to the existing Ceiling Post, allows for an off-module Ceiling Feed location.**
- Attaches to the top of horizontal trim.
- Panel ceiling post consists of two aluminum extrusions for a true lay-in application.
- Includes brackets, hardware and ceiling trim plate and screws.
- Harness length will vary in length depending on post location along the panel.
- Can only be used with Boulevard System 3 "PV" and "MV" Panels.
- Requires on site cutting of top trim for placement along panel.

PRODUCT CODE	PRICE	SIZE/	INCHES			WEIGHT VOL	
			H	L	D	LBS	FT ³
BE2PE49	281	49	7.61	3.00	5	0.258	
BE2PE81	415	81	7.61	3.00	9	0.424	

Worksurfaces

Global Contract offers a wide variety of worksurfaces and user friendly worksurface shapes to support a variety of tasks, applications and personal preferences.

- 1 1/16" particle board.
- 45 lb. density
- 100% recycled from post consumer industrial material
- "Scoops" for cable management.
- All worksurfaces have threaded inserts for metal-to-metal connection of support hardware.

- High and Low pressure worksurfaces are 3mm edge banded.
- Wood veneer surfaces or solid wood edges available.

Technical Information

Worksurfaces

- All worksurfaces have threaded inserts for metal-to-metal connection of support hardware.
- Back edge features scoop detail.
- Worksurfaces 48" or less have one scoop while those that are 54" or more have a double scoop feature with a 1/2" wire passage trough between the scoops.
- LP and HP worksurfaces are 3mm edge banded.
- LP worksurfaces are 1" thick particle board with laminate finish.
- HP worksurfaces are 1 1/16" thick particle board with laminate finish.
- T worksurfaces are 1 1/16" thick particle board with laminate finish and wood trim.
- W worksurfaces are 1 3/16" thick particle board with wood veneer finish. Edge is solid wood edge banded.
- One universal cantilever supports two abutting worksurfaces.

- 20" deep worksurfaces available at same price as 24" deep worksurfaces.
- Support hardware must be ordered separately.
- Edge banded worksurfaces without scoops available, substitute "NFL" for "SCP" at the end of the code.

Transaction Worksurfaces

- To install transaction worksurfaces to a 42" high panel, use BHBT02 bracket.
- To install transaction worksurfaces to a 37" high panel, use BHBT37 bracket.

WORKSURFACE COMPONENTS - GUIDELINES FOR ORDERING PRODUCT

Codes

The price list uses a numbering system with meaningful alphanumeric characters to create a simple-to-understand product number. This makes specifying the product much easier and more accurate.

Example of Worksurface: **BWS2460PHPMR71TCHR**

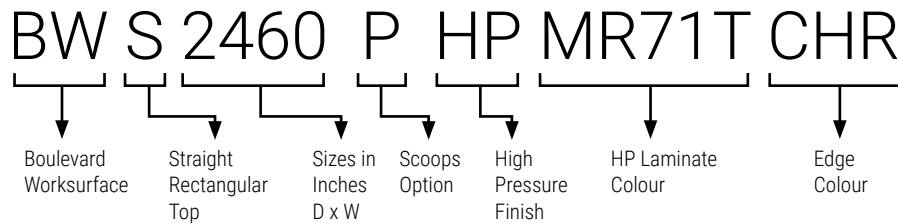

How to Specify

- Specify Boulevard worksurface type and size by code.
- Specify scoops option by adding "P" at end of code.
- Specify type of finish.
- Specify High Pressure Laminate Colour.
- Specify PVC edge colour.

Example of Hardware: **BHC24 CHR**

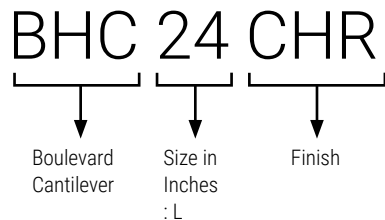

How to Specify

- Specify Boulevard hardware type and size by code.
- Specify type of finish.

BWS • Straight Rectangular Worksurface

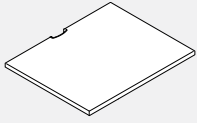

Worksurfaces 54" or Less

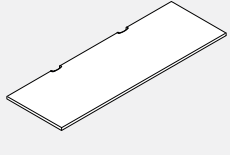

Worksurfaces 60" or Longer

- **Straight rectangular worksurfaces are non-handed and can be interchanged on site.**
- Please choose from DWT - Designer White, SIL - Silver or BLK - Black for scoop covers.
- Surfaces with wood trim (T) and complete wood (W) will not have the plastic scoop, they will remain with the curve cut scoop.
- To specify wood trim (T) or complete wood (W) surfaces, please remove the last "P" from the code, replace with "SCP" and add either a "T" or "W" and the old scoop style is going to be created.

PRODUCT CODE	PRICE		GROUP			SIZE / INCHES				WEIGHT	VOL
	LP*	HP*	T*	W*	H	W	D	LBS	FT ³		
BWS1818P	127	161	377	494	1	18	18	9	0.29		
BWS1824P	131	174	384	584	1	24	18	12	0.39		
BWS1830P	138	183	413	683	1	30	18	15	0.49		
BWS1836P	159	210	450	780	1	36	18	18	0.59		
BWS1842P	208	278	532	913	1	42	18	21	0.68		
BWS1848P	249	328	540	952	1	48	18	24	0.78		
BWS1854P	293	385	773	1096	1	54	18	27	0.88		
BWS1860P	329	422	780	1115	1	60	18	30	1.00		
BWS1866P	344	452	803	1145	1	66	18	32	1.10		
BWS1872P	363	478	828	1173	1	72	18	35	1.20		
BWS1878P	380	503	999	1250	1	78	18	38	1.30		
BWS1884P	417	546	1026	1325	1	84	18	41	1.40		
BWS2418P	131	168	410	549	1	18	24	12	0.40		
BWS2424P	133	178	419	652	1	24	24	16	0.52		
BWS2430P	145	190	448	768	1	30	24	20	0.65		
BWS2436P	161	213	483	875	1	36	24	23	0.78		
BWS2442P	211	280	565	1030	1	42	24	28	0.90		
BWS2448P	252	339	575	1129	1	48	24	31	1.03		
BWS2454P	299	394	803	1282	1	54	24	35	1.20		
BWS2460P	336	443	809	1313	1	60	24	39	1.30		
BWS2466P	350	462	819	1352	1	66	24	43	1.41		
BWS2472P	366	484	852	1391	1	72	24	47	1.54		
BWS2478P	392	516	922	1486	1	78	24	51	1.70		
BWS2484P	422	553	1023	1584	1	84	24	55	1.80		
BWS3018P	149	192	442	655	1	18	30	15	0.50		
BWS3024P	159	208	450	788	1	24	30	20	0.70		
BWS3030P	170	225	518	911	1	30	30	25	0.97		
BWS3036P	200	264	563	1055	1	36	30	30	1.06		
BWS3042P	283	373	668	1101	1	42	30	34	1.12		
BWS3048P	299	394	679	1176	1	48	30	39	1.30		
BWS3054P	327	420	873	1342	1	54	30	44	1.44		
BWS3060P	350	462	878	1381	1	60	30	49	1.60		
BWS3066P	364	483	908	1472	1	66	30	54	1.80		
BWS3072P	385	510	957	1560	1	72	30	59	2.00		
BWS3078P	410	540	1039	1669	1	78	30	64	2.10		
BWS3084P	456	596	1101	1780	1	84	30	69	2.24		
BWS3672P	544	714	1158	1855	1	72	36	71	2.30		

• LP = Thermally Fused Laminate, HP = High Pressure Laminate, T= High Pressure Laminate with Wood Trim, W= Wood Veneer

BWSP • Straight Rectangular Worksurface to span a Post

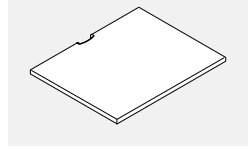

Worksurfaces 57" or Less

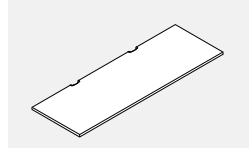

Worksurfaces 63" or Longer

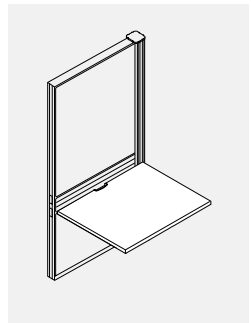

Application of Worksurface

- Straight rectangular worksurfaces are non-handed and can be interchanged on site.
- Worksurface will span the width of a post eliminating a gap between standard sizes.
- Please choose from DWT - Designer White, SIL - Silver or BLK - Black for scoop covers.
- Surfaces with wood trim (T) and complete wood (W) will not have the plastic scoop, they will remain with the curve cut scoop.
- To specify wood trim (T) or complete wood (W) surfaces, please remove the last "P" from the code, replace with "SCP" and add either a "T" or "W" and the old scoop style is going to be created.

PRODUCT CODE	PRICE LP*	GROUP HP*	T*	W*	SIZE / INCHES			WEIGHT LBS	VOL FT ³
					H	W	D		
BWSP1821P	131	174	384	584	1	21	18	10	0.34
BWSP1827P	138	183	413	683	1	27	18	13	0.44
BWSP1833P	159	210	450	780	1	33	18	16	0.53
BWSP1839P	208	278	532	913	1	39	18	19	0.63
BWSP1845P	249	328	540	952	1	45	18	22	0.72
BWSP1851P	293	385	647	972	1	51	18	25	0.82
BWSP1857P	329	422	780	1115	1	57	18	28	0.92
BWSP1863P	344	452	803	1145	1	63	18	31	1.01
BWSP1869P	363	478	828	1173	1	69	18	34	1.11
BWSP1875P	380	503	897	1250	1	75	18	37	1.21
BWSP1881P	417	546	946	1325	1	81	18	40	1.30
BWSP1887P	448	590	996	1405	1	87	18	43	1.40
BWSP2421P	133	178	419	652	1	21	24	14	0.45
BWSP2427P	145	190	448	768	1	27	24	17	0.60
BWSP2433P	161	213	483	875	1	33	24	21	0.70
BWSP2439P	211	280	565	1030	1	39	24	25	0.83
BWSP2445P	252	339	575	1129	1	45	24	29	1.00
BWSP2451P	299	394	678	1158	1	51	24	33	1.10
BWSP2457P	336	443	809	1313	1	57	24	37	1.22
BWSP2463P	350	462	852	1352	1	63	24	41	1.34
BWSP2469P	366	484	896	1391	1	69	24	45	1.47
BWSP2475P	392	516	922	1486	1	75	24	49	1.60
BWSP2481P	422	553	974	1584	1	81	24	53	1.73
BWSP2487P	456	607	1025	1678	1	87	24	57	1.90
BWSP3021P	168	208	450	788	1	21	30	17	0.56
BWSP3027P	170	225	518	911	1	27	30	22	0.72
BWSP3033P	200	264	563	1055	1	33	30	27	0.88
BWSP3039P	283	373	668	1101	1	39	30	32	1.04
BWSP3045P	299	394	679	1176	1	45	30	37	1.20
BWSP3051P	327	420	748	1217	1	51	30	41	1.40
BWSP3057P	350	462	878	1381	1	57	30	46	1.51
BWSP3063P	364	483	908	1472	1	63	30	51	1.67
BWSP3069P	385	510	957	1560	1	69	30	56	1.83
BWSP3075P	410	540	1039	1669	1	75	30	61	2.00
BWSP3081P	456	596	1101	1780	1	81	30	66	2.20
BWSP3087P	503	665	1161	1887	1	87	30	70	2.30
BWSP3675P	557	733	1158	1855	1	75	36	73	2.40

• LP = Thermally Fused Laminate, HP = High Pressure Laminate, T= High Pressure Laminate with Wood Trim, W= Wood Veneer

BWS • Straight Rectangular Worksurface without Flex Lip or Scoops

- Straight rectangular worksurfaces are non-handed and can be interchanged on site.
- Worksurface features no scoop or flex lip.

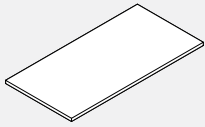

PRODUCT CODE	PRICE LP*	GROUP HP*	T*	W*	SIZE/INCHES			WEIGHT LBS	VOL FT ³
					H	W	D		
BWS1818NFL	127	161	249	367	1	18	18	9	0.28
BWS1824NFL	131	174	259	458	1	24	18	12	0.40
BWS1830NFL	138	183	289	560	1	30	18	15	0.50
BWS1836NFL	159	210	324	655	1	36	18	18	0.59
BWS1842NFL	208	278	407	788	1	42	18	21	0.68
BWS1848NFL	249	328	416	825	1	48	18	24	0.78
BWS1854NFL	293	385	522	847	1	54	18	27	0.88
BWS1860NFL	329	422	530	863	1	60	18	29	0.97
BWS1866NFL	344	452	554	906	1	66	18	32	1.10
BWS1872NFL	363	478	583	922	1	72	18	35	1.20
BWS1878NFL	380	503	647	999	1	78	18	38	1.30
BWS1884NFL	417	546	696	1077	1	84	18	41	1.40
BWS2418NFL	131	168	285	425	1	18	24	12	0.40
BWS2424NFL	133	178	291	528	1	24	24	16	0.52
BWS2430NFL	145	190	321	645	1	30	24	20	0.65
BWS2436NFL	161	213	357	751	1	36	24	24	0.78
BWS2442NFL	211	280	439	902	1	42	24	28	0.90
BWS2448NFL	252	339	449	1004	1	48	24	31	1.03
BWS2454NFL	299	394	554	1033	1	54	24	35	1.20
BWS2460NFL	336	443	561	1063	1	60	24	39	1.30
BWS2466NFL	350	462	600	1104	1	66	24	43	1.41
BWS2472NFL	366	484	645	1142	1	72	24	47	1.54
BWS2478NFL	392	516	670	1239	1	78	24	51	1.70
BWS2484NFL	422	553	722	1334	1	84	24	55	1.80
BWS3018NFL	149	192	318	530	1	18	30	15	0.50
BWS3024NFL	159	208	325	662	1	24	30	20	0.65
BWS3030NFL	170	225	392	784	1	30	30	25	0.81
BWS3036NFL	200	264	437	929	1	36	30	29	1.00
BWS3042NFL	283	373	544	975	1	42	30	34	1.13
BWS3048NFL	299	394	555	1051	1	48	30	39	1.30
BWS3054NFL	327	420	624	1092	1	54	30	44	1.44
BWS3060NFL	350	462	628	1132	1	60	30	49	1.60
BWS3066NFL	364	483	658	1221	1	66	30	54	1.76
BWS3072NFL	385	510	706	1245	1	72	30	59	1.91
BWS3078NFL	410	540	789	1420	1	78	30	64	2.10
BWS3084NFL	456	596	851	1530	1	84	30	69	2.24
BWS3672NFL	544	714	1158	1855	1	72	36	71	2.30

BWSC • Curvelinear Front Edge Worksurface

- Curvelinear front edge worksurface.
- Allows efficient use of a small footprint.
- The curve on the 30" and 36" wide worksurfaces have been modified to allow a pedestal to fit.
- Please choose from DWT - Designer White, SIL - Silver or BLK - Black for scoop covers.
- Surfaces with wood trim (T) and complete wood (W) will not have the plastic scoop, they will remain with the curve cut scoop.
- To specify wood trim (T) or complete wood (W) surfaces, please remove the last "P" from the code, replace with "SCP" and add either a "T" or "W" and the old scoop style is going to be created.
- Surfaces 60" wide will have two scoops, all others have one scoop.

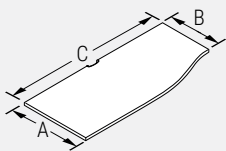

NOTE: BWSC

24	18	30
A	B	C
WIDTH	WIDTH	LENGTH

PRODUCT CODE	PRICE LP*	GROUP HP*	T*	W*	SIZE/INCHES			WEIGHT LBS	VOL FT ³
					H	W	D		
BWSC182430P	182	240	614	1010	1	30	24	18	0.65
BWSC182436P	217	289	659	1156	1	36	24	22	0.78
BWSC182442P	252	339	765	1202	1	42	24	26	0.90
BWSC182448P	289	385	775	1279	1	48	24	30	1.03
BWSC182454P	327	433	967	1445	1	54	24	34	1.20
BWSC182460P	354	483	975	1485	1	60	24	38	1.30
BWSC241830P	182	240	614	1010	1	30	24	18	0.65
BWSC241836P	217	289	659	1156	1	36	24	22	0.78
BWSC241842P	252	339	765	1202	1	42	24	26	0.90
BWSC241848P	289	385	775	1279	1	48	24	30	1.03
BWSC241854P	327	433	967	1445	1	54	24	34	1.2
BWSC241860P	354	483	975	1485	1	60	24	38	1.3
BWSC243030P	192	251	760	1272	1	30	30	23	0.81
BWSC243036P	229	289	819	1378	1	36	30	28	1
BWSC243042P	312	412	958	1629	1	42	30	33	1.13
BWSC243048P	327	433	967	1648	1	48	30	38	1.3
BWSC243054P	364	483	1184	1938	1	54	30	42	1.44
BWSC243060P	391	528	1193	1955	1	60	30	47	1.6
BWSC302430P	192	251	760	1272	1	30	30	23	0.81
BWSC302436P	229	289	819	1378	1	36	30	28	1
BWSC302442P	312	412	958	1629	1	42	30	33	1.13
BWSC302448P	327	433	967	1648	1	48	30	38	1.3
BWSC302454P	364	483	1184	1938	1	54	30	42	1.44
BWSC302460P	391	528	1193	1955	1	60	30	47	1.6

• LP = Thermally Fused Laminate, HP = High Pressure Laminate, T= High Pressure Laminate with Wood Trim, W= Wood Veneer

BWCC • Curved Corner Worksurface

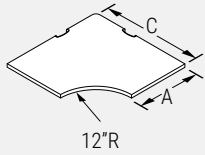

NOTE: BWCC

36 C WIDTH
18 A DEPTH

- Allows efficient use of corner space for computer or printer applications.
- BWCC3624 has a front radius of 12". It is not usable for keyboard support.
- Please choose from DWT - Designer White, SIL - Silver or BLK - Black for scoop covers.
- Surfaces with wood trim (T) and complete wood (W) will not have the plastic scoop, they will remain with the curve cut scoop.
- To specify wood trim (T) or complete wood (W) surfaces, please remove the last "P" from the code, replace with "SCP" and add either a "T" or "W" and the old scoop style is going to be created.

PRODUCT CODE	PRICE LP*	GROUP			SIZE/INCHES			WEIGHT LBS	VOL FT ³
		HP*	T*	W*	H	W	D		
BWCC3618P	397	495	875	1528	1	36	36	29	1.20
BWCC3624P	439	548	875	1528	1	36	36	32	1.20
BWCC4224P	591	736	1111	1762	1	42	42	41	1.60
BWCC4230P	607	759	1111	1762	1	42	42	45	1.60
BWCC4824P	688	857	1377	2243	1	48	48	50	2.00
BWCC4830P	688	857	1377	2243	1	48	48	56	2.00

CODE	RADIUS "R"
BWCC3618P	18"
BWCC3624P	12"
BWCC4224P	18"
BWCC4230P	12"
BWCC4824P	24"
BWCC4830P	18"

NOTE: 12" radius not recommended for keyboards

BWCF • Five Sided Corner Worksurface

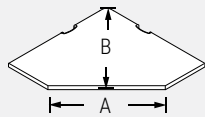

- Creates efficient use of corner space for computer or printer applications.
- Please choose from DWT - Designer White, SIL - Silver or BLK - Black for scoop covers.
- Surfaces with wood trim (T) and complete wood (W) will not have the plastic scoop, they will remain with the curve cut scoop.
- To specify wood trim (T) or complete wood (W) surfaces, please remove the last "P" from the code, replace with "SCP" and add either a "T" or "W" and the old scoop style is going to be created.

PRODUCT CODE	PRICE LP*	GROUP			SIZE/INCHES			WEIGHT LBS	VOL FT ³
		HP*	T*	W*	H	W	D		
BWCF3012P	259	320	828	1366	1	30	30	28	1.00
BWCF3612P	341	425	944	1380	1	36	36	30	1.03
BWCF3618P	341	425	844	1380	1	36	36	31	1.20
BWCF3624P	354	446	844	1380	1	36	36	33	1.20
BWCF3630P	372	465	844	1380	1	36	36	35	1.20
BWCF4218P	485	607	1064	1612	1	42	42	40	1.60
BWCF4224P	503	627	1064	1612	1	42	42	45	1.60
BWCF4230P	517	652	1064	1612	1	42	42	47	1.60
BWCF4818P	550	689	1158	1767	1	48	48	40	1.60
BWCF4824P	567	707	1158	1767	1	48	48	45	1.60
BWCF4830P	596	747	1158	1767	1	48	48	47	1.60

CODE	PANEL SIZES	ADJOINED WORKSURFACE DEPTH	A	B
BWCF3012P	30	12	25.5	29.8
BWCF3612P	36	12	34.0	34.0
BWCF3618P	36	18	25.5	37.9
BWCF3624P	36	24	17.0	42.1
BWCF3630P	36	30	8.5	46.4
BWCF4218P	42	18	33.9	42.1
BWCF4224P	42	24	25.5	46.4
BWCF4230P	42	30	17.0	50.6
BWCF4818P	48	18	42.4	46.4
BWCF4824P	48	24	33.9	50.6
BWCF4830P	48	30	25.5	54.8

BWCL • "L" Corner Worksurface

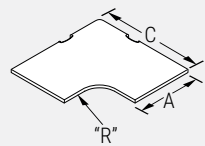

NOTE: BWCL
• 5" radius not recommended for keyboards.

36 C WIDTH
18 A DEPTH

- Creates efficient use of corner space for computer or printer applications.
- Please choose from DWT - Designer White, SIL - Silver or BLK - Black for scoop covers.
- Surfaces with wood trim (T) and complete wood (W) will not have the plastic scoop, they will remain with the curve cut scoop.
- To specify wood trim (T) or complete wood (W) surfaces, please remove the last "P" from the code, replace with "SCP" and add either a "T" or "W" and the old scoop style is going to be created.

PRODUCT CODE	PRICE LP*	GROUP			SIZE/INCHES			WEIGHT LBS	VOL FT ³
		HP*	T*	W*	H	W	D		
BWCL3018P	236	293	463	1336	1	30	30	20	0.80
BWCL3024P	241	305	463	1336	1	30	30	23	0.80
BWCL3618P	354	446	626	1342	1	36	36	27	1.20
BWCL3624P	373	465	626	1342	1	36	36	31	1.20
BWCL3630P	389	485	626	1342	1	36	36	34	1.20
BWCL4218P	518	645	861	1575	1	42	42	32	1.60
BWCL4224P	536	668	861	1575	1	42	42	39	1.60
BWCL4230P	550	689	861	1575	1	42	42	44	1.60
BWCL4818P	567	709	997	1739	1	48	48	38	2.00
BWCL4824P	581	726	997	1739	1	48	48	47	2.00
BWCL4830P	600	749	997	1739	1	48	48	54	2.00

• LP = Thermally Fused Laminate, HP = High Pressure Laminate, T= High Pressure Laminate with Wood Trim, W= Wood Veneer

BWAC45 • Curved Corner Worksurface for 45 Degree Angle

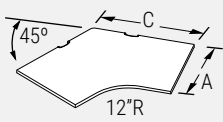

- **Five sided corner unit for 45 degree Corner Posts.**
- Creates efficient use of space for computer or printer application.
- Please choose from DWT - Designer White, SIL - Silver or BLK - Black for scoop covers.
- Surfaces with wood trim (T) and complete wood (W) will not have the plastic scoop, they will remain with the curve cut scoop.
- To specify wood trim (T) or complete wood (W) surfaces, please remove the last "P" from the code, replace with "SCP" and add either a "T" or "W" and the old scoop style is going to be created.

NOTE: BWAC

45°	24	18
	C	A
45° POST	WIDTH	DEPTH

PRODUCT CODE	PRICE LP*	GROUP HP*	T*	W*	SIZE/INCHES			WEIGHT LBS	VOL FT³
					H	W	D		
BWAC452418P	397	495	1077	1437	1	24	18	38	1.14
BWAC452424P	411	516	1624	2168	1	24	24	42	1.29
BWAC452430P	431	537	2146	2864	1	24	30	48	1.45
BWAC453018P	512	638	1309	1742	1	30	18	53	1.61
BWAC453024P	578	723	1556	2075	1	30	24	60	1.80
BWAC453030P	641	802	1991	2655	1	30	30	66	2.01
BWAC453618P	720	895	1515	2022	1	36	18	66	2.01
BWAC453624P	797	998	1868	2486	1	36	24	71	2.16
BWAC453630P	877	1094	2352	3135	1	36	30	76	2.30

BWAC60 • Curved Corner Worksurface for 60 Degree Angle

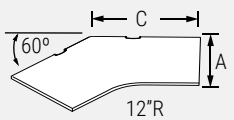

- **Five sided corner unit for 60 degree Corner Posts.**
- Creates efficient use of space for computer or printer application.
- Please choose from DWT - Designer White, SIL - Silver or BLK - Black for scoop covers.
- Surfaces with wood trim (T) and complete wood (W) will not have the plastic scoop, they will remain with the curve cut scoop.
- To specify wood trim (T) or complete wood (W) surfaces, please remove the last "P" from the code, replace with "SCP" and add either a "T" or "W" and the old scoop style is going to be created.

NOTE: BWAC

60°	24	18
	C	A
60° POST	WIDTH	DEPTH

PRODUCT CODE	PRICE LP*	GROUP HP*	T*	W*	SIZE/INCHES			WEIGHT LBS	VOL FT³
					H	W	D		
BWAC602418P	341	425	896	1192	1	24	18	33	0.99
BWAC602424P	354	446	1073	1427	1	24	24	36	1.09
BWAC602430P	372	465	1137	1517	1	24	30	39	1.19
BWAC603018P	465	581	1097	1461	1	30	18	48	1.46
BWAC603024P	508	631	1291	1725	1	30	24	52	1.58
BWAC603030P	544	683	1407	1875	1	30	30	56	1.71
BWAC603618P	661	829	1281	1706	1	36	18	66	2.01
BWAC603624P	712	892	1515	2022	1	36	24	71	2.16
BWAC603630P	762	954	1649	2200	1	36	30	76	2.31

BWCE • Extended Curved Corner Worksurface

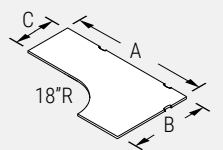

- **Extended curved corner unit with a radius user edge.**
- Creates efficient use of a corner unit.
- Please choose from DWT - Designer White, SIL - Silver or BLK - Black for scoop covers.
- Surfaces with wood trim (T) and complete wood (W) will not have the plastic scoop, they will remain with the curve cut scoop.
- To specify wood trim (T) or complete wood (W) surfaces, please remove the last "P" from the code, replace with "SCP" and add either a "T" or "W" and the old scoop style is going to be created.

NOTE: BWCE

60	42	24
A	B	C
WIDTH	WIDTH	LENGTH

PRODUCT CODE	PRICE LP*	GROUP HP*	T*	W*	SIZE/INCHES			WEIGHT LBS	VOL FT³
					H	W	D		
BWCE426024P	688	857	1316	2161	1	60	42	57	2.2
BWCE426624P	758	947	1376	2254	1	66	42	62	2.5
BWCE427224P	835	1045	1541	2527	1	72	42	66	2.7
BWCE427824P	893	1117	1647	2695	1	78	42	71	2.9
BWCE428424P	962	1201	1772	2905	1	84	42	75	3.1
BWCE486024P	786	984	1635	2682	1	60	48	66	2.5
BWCE486624P	874	1092	1685	2826	1	66	48	71	2.8
BWCE487224P	956	1197	1685	2826	1	72	48	76	3.1
BWCE487824P	1021	1273	1854	3041	1	78	48	83	3.3
BWCE488424P	1083	1352	1854	3041	1	84	48	93	3.6
BWCE486030P	874	1092	1635	2682	1	60	48	68	2.5
BWCE486630P	956	1197	1721	2825	1	66	48	74	2.8
BWCE487230P	1021	1273	1762	2887	1	72	48	80	3.1
BWCE487830P	1083	1352	1910	3131	1	78	48	85	3.3
BWCE488430P	1158	1450	2058	3369	1	84	48	96	3.6
BWCE604224P	688	857	1316	2161	1	42	60	57	2.2
BWCE604824P	786	984	1635	2682	1	48	60	66	2.6
BWCE604830P	874	1092	1635	2682	1	48	60	68	2.6
BWCE664224P	758	947	1376	2254	1	42	66	62	2.5
BWCE664824P	874	1092	1685	2826	1	48	66	71	2.8
BWCE664830P	956	1197	1721	2825	1	48	66	74	2.8
BWCE724224P	835	1045	1541	2527	1	42	72	66	2.7
BWCE724824P	956	1197	1685	2826	1	48	72	76	3.1
BWCE724830P	1021	1273	1762	2887	1	48	72	80	3.1
BWCE784224P	893	1117	1647	2695	1	42	78	71	2.9
BWCE784824P	1021	1273	1854	3041	1	48	78	83	3.3
BWCE784830P	1083	1352	1910	3131	1	48	78	85	3.3
BWCE844224P	962	1201	1772	2905	1	42	84	75	3.1
BWCE844824P	1083	1352	1854	3043	1	48	84	93	3.6
BWCE844830P	1158	1450	2058	3369	1	48	84	96	3.6

• LP = Thermally Fused Laminate, HP = High Pressure Laminate, T= High Pressure Laminate with Wood Trim, W= Wood Veneer

BWCEC • Extended Curvilinear Corner Worksurface

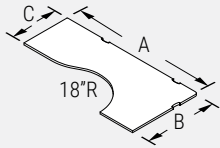

- **Extended curved corner unit with a radius user edge.**
- Creates efficient use of a corner unit.
- Please choose from DWT - Designer White, SIL - Silver or BLK - Black for scoop covers.
- Surfaces with wood trim (T) and complete wood (W) will not have the plastic scoop, they will remain with the curve cut scoop.
- To specify wood trim (T) or complete wood (W) surfaces, please remove the last "P" from the code, replace with "SCP" and add either a "T" or "W" and the old scoop style is going to be created.

NOTE: BWSC

66	42	24
A	B	C
WIDTH	WIDTH	LENGTH

PRODUCT CODE	PRICE LP*	GROUP HP*	T*	W*	SIZE/INCHES			WEIGHT LBS	VOL FT ³
					A	B	C		
BWCEC366024P	645	805	1631	2172	36	60	24	59	0.05
BWCEC366624P	678	846	1692	2254	36	66	24	65	0.60
BWCEC367224P	737	922	1868	2486	36	72	24	71	0.07
BWCEC367824P	801	1000	1976	2633	36	78	24	77	0.07
BWCEC368424P	894	1117	2174	2810	36	84	24	83	0.08
BWCEC426624P	780	973	1972	2629	42	66	24	76	0.07
BWCEC427224P	863	1078	2174	2900	42	72	24	83	0.08
BWCEC427824P	920	1152	2306	3073	42	78	24	90	0.08
BWCEC428424P	992	1238	2461	3281	42	84	24	96	0.09
BWCEC487230P	1053	1317	2402	3200	48	72	30	94	0.09
BWCEC487830P	1132	1416	2564	3415	48	78	30	102	0.09
BWCEC488430P	1196	1495	2726	3629	48	84	30	110	0.10
BWCEC488424P	1131	1416	2461	3281	48	84	24	110	0.10
BWCEC603624P	645	805	1631	2172	60	36	24	59	0.05
BWCEC663624P	678	846	1692	2254	66	36	24	65	0.60
BWCEC664224P	780	973	1972	2629	66	42	24	76	0.07
BWCEC723624P	737	922	1868	2486	72	36	24	71	0.07
BWCEC724224P	863	1078	2174	2900	72	42	24	83	0.08
BWCEC724830P	1053	1317	2402	3200	72	48	30	94	0.09
BWCEC783624P	801	1000	1976	2633	78	36	24	77	0.07
BWCEC784224P	920	1152	2306	3073	78	42	24	89	0.08
BWCEC784830P	1132	1416	2564	3415	78	48	30	102	0.09
BWCEC843624P	894	1117	2174	2810	84	36	24	83	0.08
BWCEC844224P	992	1238	2174	2810	84	42	24	96	0.09
BWCEC844824P	1131	1416	2461	3281	84	48	24	110	0.10
BWCEC844830P	1196	1495	2726	3629	84	48	30	110	0.10

BWSL • Curvilinear Arc Worksurface

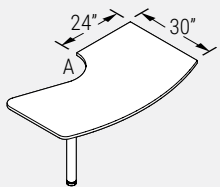

- **Arc shaped worksurface provides an extended conferencing area.**
- 1 BHML03 Monoleg included.
- Not recommended for use with modesty panel due to knee swing interference.
- For chrome finish on leg, please add \$109 list upcharge.

RIGHT HAND SHOWN MONO-LEG MOUNTED ON THE RIGHT USER SIDE.

PRODUCT CODE	PRICE LP*	GROUP HP*	T*	W*	SIZE/INCHES			WEIGHT LBS	VOL FT ³
					H	W	D		
BWSL3060L	893	1062	1214	2063	29	60	30	48	1.69
BWSL3066L	935	1112	1349	2311	29	66	30	53	1.85
BWSL3072L	972	1165	1485	2564	29	72	30	58	2.01
BWSL3060R	893	1062	1214	2063	29	60	30	48	1.69
BWSL3066R	935	1112	1349	2311	29	66	30	53	1.85
BWSL3072R	972	1165	1485	2564	29	72	30	58	2.01

- A = 27" for 60", 66" worksurfaces
- A = 26.5" for 72" worksurfaces

BWSL • Curvilinear Arc Worksurface

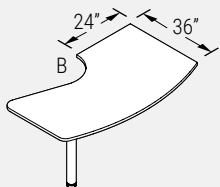

- **Arc shaped worksurface provides an extended conferencing area.**
- 1 BHML03 Monoleg included.
- For chrome finish on leg, please add \$109 list upcharge.

RIGHT HAND SHOWN MONO-LEG MOUNTED ON THE RIGHT USER SIDE.

PRODUCT CODE	PRICE LP*	GROUP HP*	T*	W*	SIZE/INCHES			WEIGHT LBS	VOL FT ³
					H	W	D		
BWSL3660L	1012	1212	1380	2375	29	60	36	57	2.07
BWSL3666L	1095	1317	1541	2663	29	66	36	64	2.26
BWSL3672L	1174	1416	1698	2955	29	72	36	71	2.45
BWSL3660R	1012	1212	1380	2375	29	60	36	57	2.07
BWSL3666R	1095	1317	1541	2663	29	66	36	64	2.26
BWSL3672R	1174	1416	1698	2955	29	72	36	71	2.45

- B = 33" for 60", 66" worksurfaces
- B = 32.5" for 72" worksurfaces

• LP = Thermally Fused Laminate, HP = High Pressure Laminate, T= High Pressure Laminate with Wood Trim, W= Wood Veneer

BWD • “D” Worksurface

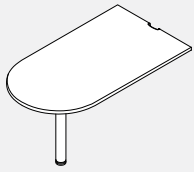

- **Rounded worksurface for conferencing.**
- Supported by Monoleg at one end and panel at the opposite end.
- 1 BHML03 Monoleg included.
- Modesty panel available, see BWMP (not included).
- For chrome finish on leg, please add \$109 list upcharge.
- Please choose from DWT - Designer White, SIL - Silver or BLK - Black for scoop covers.
- Surfaces with wood trim (T) and complete wood (W) will not have the plastic scoop, they will remain with the curve cut scoop.
- To specify wood trim (T) or complete wood (W) surfaces, please remove the last “P” from the code, replace with “SCP” and add either a “T” or “W” and the old scoop style is going to be created.

PRODUCT CODE	PRICE LP*	GROUP			SIZE/INCHES			WEIGHT LBS	VOL FT ³
		HP*	T*	W*	H	W	D		
BWD2442P	569	659	722	1243	1	42	24	27	0.97
BWD2448P	593	693	754	1285	1	48	24	31	1.11
BWD2454P	610	712	832	1530	1	54	24	35	1.24
BWD2460P	623	725	870	1774	1	60	24	39	1.36
BWD2466P	641	754	908	1840	1	66	24	43	1.52
BWD2472P	661	779	946	1933	1	72	24	47	1.66
BWD3048P	596	695	863	1766	1	48	30	38	1.38
BWD3054P	627	733	897	1826	1	54	30	43	1.56
BWD3060P	665	780	941	1941	1	60	30	48	1.69
BWD3066P	694	817	1010	2036	1	66	30	53	1.82
BWD3072P	731	864	1034	2135	1	72	30	58	2.01
BWD3078P	774	917	1103	2295	1	78	30	63	2.25
BWD3084P	840	999	1173	2457	1	84	30	68	2.42

BWP • “P” Worksurface

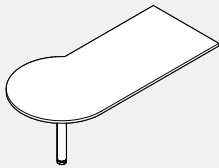

LEFT HAND SHOWN

- **Rounded worksurface provides an extended conferencing area.**
- **36” diameter end.**
- Supported by monoleg at one end and panel at the opposite end.
- 1 BHML03 Monoleg included.
- Modesty panel available, see BWMP (not included).
- For chrome finish on leg, please add \$109 list upcharge.

PRODUCT CODE	PRICE LP*	GROUP			SIZE/INCHES			WEIGHT LBS	VOL FT ³
		HP*	T*	W*	H	W	D		
BWPL3054	877	1038	1203	2567	1	54	36	51	1.87
BWPL3060	916	1088	1214	2593	1	60	36	58	2.03
BWPL3066	992	1182	1245	2915	1	66	36	65	2.24
BWPL3072	1034	1236	1370	3239	1	72	36	70	2.41
BWPL3084	1143	1374	1731	3821	1	84	36	81	2.79
BWPR3054	877	1038	1203	2567	1	54	36	51	1.87
BWPR3060	916	1088	1214	2593	1	60	36	58	2.03
BWPR3066	992	1182	1245	2915	1	66	36	65	2.24
BWPR3072	1034	1236	1370	3239	1	72	36	70	2.41
BWPR3084	1143	1374	1731	3821	1	84	36	81	2.79

BWMP • “D” and “P” Worksurface Modesty Panel

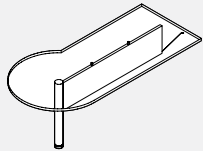

- **Made of cold rolled steel, fastens to the worksurface and Monoleg for additional privacy.**

PRODUCT CODE	PRICE	SIZE/INCHES			WEIGHT LBS	VOL FT ³
		H	W	D		
BWMP1248	126	1	32	12	12	0.4
BWMP1254	149	1	38	12	15	0.47
BWMP1260	174	1	44	12	17	0.53
BWMP1266	200	1	50	12	20	0.61
BWMP1272	225	1	56	12	22	0.66
BWMP1278	240	1	62	12	25	0.71
BWMP1284	260	1	68	12	27	0.79

BWR • Radius Worksurface

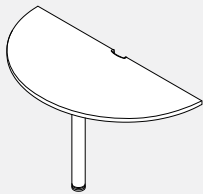

- **Rounded worksurface for conferencing provides a radius corner.**
- 18” and 24” come with 1 BHML03 Monoleg and 30” comes with 2.
- Radius cut out on the straight edge allows space for aluminum trims.
- For chrome finish on leg, please add \$109 list upcharge for each leg.
- Please choose from DWT - Designer White, SIL - Silver or BLK - Black for scoop covers.
- Surfaces with wood trim (T) and complete wood (W) will not have the plastic scoop, they will remain with the curve cut scoop.
- To specify wood trim (T) or complete wood (W) surfaces, please remove the last “P” from the code and add either a “T” or “W” and the old scoop style is going to be created.

PRODUCT CODE	PRICE LP*	GROUP			SIZE/INCHES			WEIGHT LBS	VOL FT ³
		HP*	T*	W*	H	W	D		
BWR18P	503	578	819	1379	1	38.5	18	27	1.70
BWR24P	577	668	896	1631	1	50.5	24	41	2.20
BWR30P	969	1108	1339	2466	1	62.5	30	59	2.70

BWRTD • Teardrop Worksurface

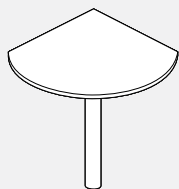

- **Rounded worksurface for conferencing provides a radius corner from a worksurface to worksurface.**
- 1 BHML03 Monoleg included.
- For chrome finish on leg, please add \$109 list upcharge.

PRODUCT CODE	PRICE LP*	GROUP			SIZE/INCHES			WEIGHT LBS	VOL FT ³
		HP*	T*	W*	H	W	D		
BWRTD18	324	369	677	831	1	18	18	24	1.60
BWRTD24	391	443	804	1004	1	24	24	33	1.90
BWRTD30	469	569	973	1235	1	30	30	43	2.20

• LP = Thermally Fused Laminate, HP = High Pressure Laminate, T= High Pressure Laminate with Wood Trim, W= Wood Veneer

BWRP • Corner Radius Worksurface with Cutout

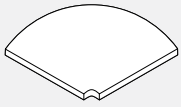

- **Corner Radius Worksurface with Cut-Out allows worksurface to be used around a post.**
- Cut out fits snug to the post, if trim is attached to the post, the worksurface or PVC trim may need to be cut on site to fit.

PRODUCT CODE	PRICE LP*	GROUP HP*	T*	W*	SIZE/INCHES			WEIGHT LBS	VOL FT ³
					H	W	D		
BWRP1818	162	202	400	554	1	21	21	12	0.40
BWRP2424	235	293	533	815	1	27	27	19	0.64
BWRP3030	289	364	666	919	1	33	33	29	1.00

BWT • Transaction Worksurface

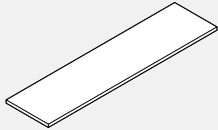

- **Attaches to the top of a 37" or 42" high panel to form a transaction worksurface.**
- To attach a Boulevard 1 37" high panel please specify BHBT37, all other heights specify BHBT02.
- To attach a Boulevard 1 panel with flat trim, please specify BHBT37FT or BHBT02FT.

PRODUCT CODE	PRICE LP*	GROUP HP*	T*	W*	SIZE/INCHES			WEIGHT LBS	VOL FT ³
					H	W	D		
BWT1512	60	77	162	235	1	12	15	5	0.22
BWT1518	74	102	202	269	1	18	15	7	0.30
BWT1524	93	124	245	355	1	24	15	10	0.38
BWT1530	112	146	287	422	1	30	15	12	0.46
BWT1536	128	170	330	459	1	36	15	14	0.54
BWT1542	146	194	380	532	1	42	15	17	0.62
BWT1548	166	217	403	575	1	48	15	19	0.70
BWT1554	178	239	455	601	1	54	15	22	0.78
BWT1560	199	263	472	630	1	60	15	24	0.86
BWT1566	213	284	515	692	1	66	15	28	0.94
BWT1572	234	307	556	727	1	72	15	29	1.02
BWT1578	249	333	600	938	1	78	15	31	1.10
BWT1584	267	353	714	1021	1	84	15	34	1.18

BWTC • Transaction Corner Worksurface

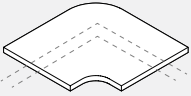

- **Attaches to the top of a 37" or 42" high panel to form a corner transaction worksurface.**
- Covers 12" of a panel.
- To attach a 37" high panel please specify BHBT37, all other heights specify BHBT02.
- To attach a Boulevard 1 panel with flat trim, please specify BHBT37FT or BHBT02FT.

PRODUCT CODE	PRICE LP*	GROUP HP*	T*	W*	SIZE/INCHES			WEIGHT LBS	VOL FT ³
					H	W	D		
BWTC90	159	199	332	714	1	20.7	20.7	11	0.49
BWTC45	195	241	387	742	1	21.5	21.5	12	0.53
BWTC60	204	241	387	742	1	22.5	22.5	14	0.60

BWTT • Transaction "T" Worksurface

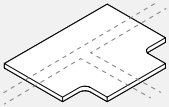

- **Attaches to the top of a 37" or 42" high panel to form a "T" corner transaction worksurface**
- Covers 12" of a panel.
- To attach a 37" high panel please specify BHBT37, all other heights specify BHBT02.

PRODUCT CODE	PRICE LP*	GROUP HP*	T*	W*	SIZE/INCHES			WEIGHT LBS	VOL FT ³
					H	W	D		
BWTT2721	171	212	349	893	1	21.5	26.5	15	0.6

BWTAC • Transaction Worksurface for 45 Degree Corner Worksurface

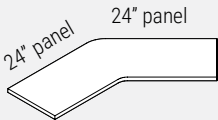

- **Attaches to the top of 37" or 42" high panel to form a 45 degree corner transaction worksurface.**
- To attach a 37" high panel please specify BHBT37, all other heights specify BHBT02.

PRODUCT CODE	PRICE LP*	GROUP HP*	T*	W*	SIZE/INCHES			WEIGHT LBS	VOL FT ³
					H	W	D		
BWTAC452415	707	885	948	1294	1	47	15	39	1.38

BWTAC • Transaction Worksurface for 60 Degree Corner Worksurface

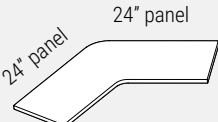

- **Attaches to the top of 42" high panel to form a 60 degree corner transaction worksurface.**
- To attach a 37" high panel please specify BHBT37, all other heights specify BHBT02.

PRODUCT CODE	PRICE LP*	GROUP HP*	T*	W*	SIZE/INCHES			WEIGHT LBS	VOL FT ³
					H	W	D		
BWTAC602415	765	958	1010	1348	1	44	15	38	1.32

• LP = Thermally Fused Laminate, HP = High Pressure Laminate, T= High Pressure Laminate with Wood Trim, W= Wood Veneer

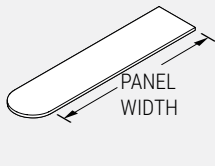
BWTD • Transaction “D” Worksurface

- Attaches to the top of a 37” or 42” high panel to form a transaction worksurface with a radiused end.
- Surface overhangs the panel by 7 1/2” on one side.
- To attach a 37” high panel please specify BHBT37, all other heights specify BHBT02.

PRODUCT CODE	PRICE LP*	GROUP HP*	T*	W*	SIZE/INCHES			WEIGHT LBS	VOL FT ³
					H	W	D		
BWTD1530	145	190	365	590	1	37.5	15	17	0.65
BWTD1536	153	204	386	626	1	43.5	15	19	0.69
BWTD1542	171	229	427	691	1	49.5	15	22	0.74
BWTD1548	192	251	448	748	1	55.5	15	25	0.77
BWTD1554	207	274	465	775	1	61.5	15	27	0.85
BWTD1560	229	303	478	796	1	67.5	15	30	0.94
BWTD1566	245	323	548	913	1	73.5	15	33	1.02
BWTD1572	265	351	615	1025	1	79.5	15	35	1.10

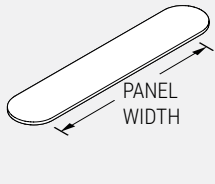
BWTDD • Transaction Double “D” Worksurface

- Attaches to the top of a 37” or 42” high panel to form a transaction worksurface with 2 radius ends.
- Surface overhangs the panel by 7 1/2” on each end.
- To attach a 37” high panel please specify BHBT37, all other heights specify BHBT02.

PRODUCT CODE	PRICE LP*	GROUP HP*	T*	W*	SIZE/ INCHES			WEIGHT LBS	VOL FT ³
					H	W	D		
BWTDD1548	213	284	548	913	1	63	15	28	1.00
BWTDD1554	234	307	564	941	1	69	15	31	1.01
BWTDD1560	249	333	579	965	1	75	15	33	1.04
BWTDD1566	271	355	649	1077	1	81	15	35	1.13
BWTDD1572	289	385	716	1192	1	87	15	38	1.21

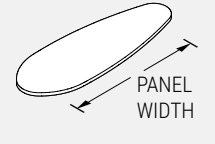
BWTE • Elliptical Transaction Worksurface

- Attaches to the top of a 37” or 42” high panel to form a transaction worksurface.
- To attach a 37” high panel please specify BHBT37, all other heights specify BHBT02.
- Depth different than standard tops.

PRODUCT CODE	PRICE LP*	GROUP HP*	T*	W*	SIZE/ INCHES			WEIGHT LBS	VOL FT ³
					H	W	D		
BWTE36	341	425	1060	1556	1	52	18	22	0.78
BWTE42	389	485	1060	1556	1	58	19	24	0.81

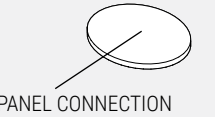
BWTP • Oval Transaction Worksurface

- Attaches to the top of a 37” or 42” high panel to form a transaction worksurface.
- To attach a 37” high panel please specify BHBT37, all other heights specify BHBT02.
- Must be specified at post condition or panel joint.

PRODUCT CODE	PRICE LP*	GROUP HP*	T*	W*	SIZE/ INCHES			WEIGHT LBS	VOL FT ³
					H	W	D		
BWTP1518	245	305	442	638	1	15	18	10	0.35

BWCD • Round Table

- Freestanding round meeting table with 4 prong tubular base.
- For chrome base please upcharge \$109 list.

PRODUCT CODE	PRICE LP*	GROUP HP*	T*	W*	SIZE/ INCHES			WEIGHT LBS	VOL FT ³
					H	W	D		
BWCD30	505	557	885	1150	29	30 dia	30 dia	35	10.0
BWCD36	573	641	1004	1321	29	36 dia	36 dia	42	10.0
BWCD42	701	805	1326	1788	29	42 dia	42 dia	52	11.0

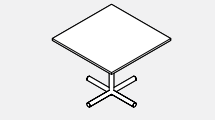
BWSQ • Square Table

- Freestanding square meeting table with 4 prong tubular base.
- For chrome base please upcharge \$109 list.

PRODUCT CODE	PRICE LP*	GROUP HP*	T*	W*	SIZE/ INCHES			WEIGHT LBS	VOL FT ³
					H	W	D		
BWSQ24	483	528	626	819	29	24	24	34	10.0
BWSQ30	505	557	766	1079	29	30	30	38	10.0
BWSQ36	573	641	893	1310	29	36	36	46	11.0
BWSQ42	701	805	1026	1708	29	42	42	57	11.0

BHCL • "C" Leg

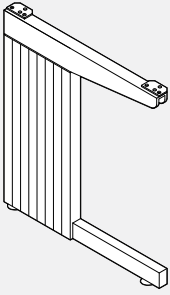

- **Attaches to panel support worksurface or to provide freestanding table support.**

- Steel structure, PVC cover.
- Universal non-handed.
- For a single rectangular freestanding worksurface application, specify two "C" Legs and one Modesty Panel of corresponding width.
- May be used as a shared leg between two adjoining worksurfaces. Specify one "C" Leg, one Modesty Panel of corresponding width, plus one Modesty Panel Extension Bracket.
- For corner worksurfaces, specify two "C" Legs, one Corner Leg and two Modesty Panels 6" shorter than rear sides of the corner worksurface.
- Can be used as a floor support in a panel attached application (similar to a cantilever).
- Includes worksurface mounting brackets with screws, Bracket Retainer Clip and panel bracket.
- Accommodates 15" knee space.
- Intended for use with flexlip worksurfaces. When used on other worksurfaces, modesty panel must be installed upside down.

PRODUCT CODE	PRICE	SIZE/ INCHES			WEIGHT VOL	
		H	W	D	LBS	FT ³
BHCL2618	227	25	1	18	7	0.27
BHCL2624	235	25	1	24	8	0.36
BHCL2918	245	28	1	18	8	0.30
BHCL2924	253	28	1	24	9	0.40

BKC • Corner Leg



- **Five sided worksurface support.**

- Steel construction.
- Non handed.
- Includes bolts for modesty panel attachment.
- For corner worksurfaces, specify two "C" Legs, one Corner Leg and two Modesty Panels 6" shorter than rear sides of the corner worksurface.

PRODUCT CODE	PRICE	SIZE/ INCHES			WEIGHT VOL	
		H	W	D	LBS	FT ³
BKC26	144	25	7	7	3.0	0.02
BKC29	162	28	7	7	3.2	0.02

BKMP • Modesty Panel

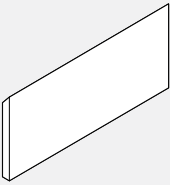

- **For rectangular worksurfaces, specify Modesty Panel of corresponding width. For corner worksurfaces, specify two Modesty Panels 6" shorter than rear side of corner worksurface.**

- Attaches between two "C" Legs, or between one "C" Leg and a Corner Leg, or a shared "C" Leg and "C" Leg at the end of a run.
- Includes brackets and screws to attach Modesty Panel to worksurface.
- For use with flex lip worksurfaces only.
- To install on "SCP" or "NFL" worksurface, modesty panel must be inverted.

PRODUCT CODE	PRICE	SIZE/ INCHES			WEIGHT VOL	
		H	W	D	LBS	FT ³
BKMP1224	170	11	24	0.25	2.75	0.17
BKMP1230	179	11	30	0.25	2.75	0.21
BKMP1236	194	11	36	0.25	3.00	0.25
BKMP1242	201	11	42	0.25	4.00	0.29
BKMP1248	212	11	48	0.25	4.50	0.33
BKMP1254	221	11	54	0.25	5.00	0.38
BKMP1260	235	11	60	0.25	5.50	0.42

BHMEB • Modesty Panel Extension Bracket



- **Modesty Panel Extension Bracket made of cold rolled steel.**

- Attaches the Modesty Panel of an adjoining worksurface to a shared "C" Leg.
- Includes all attachment hardware.

PRODUCT CODE	PRICE	SIZE/ INCHES			WEIGHT VOL	
		H	W	D	LBS	FT ³
BHMEB01	23	10	1.5	0.125	0.5	0.01

BHFG • Full Gable - Self Edged

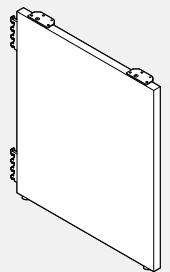

- **Provides floor standing support while enclosing an end of a run of worksurfaces.**

- Includes attachment hardware, Bracket Retainer Clip and levelling glides.
- Non-handed.
- May be used as a shared gable between two adjoining worksurfaces.

PRODUCT CODE	PRICE LP*	GROUP HP*	SIZE/ INCHES			WEIGHT VOL	
			H	W	D	LBS	FT ³
BHFG2608	156	192	25	1	8	7	0.14
BHFG2612	187	234	25	1	12	13	0.21
BHFG2618	229	284	25	1	18	13	0.27
BHFG2624	251	313	25	1	24	19	0.36
BHFG2630	339	420	25	1	30	23	0.45
BHFG2636	422	528	25	1	36	24	0.57
BHFG2908	156	192	28	1	8	7	0.16
BHFG2912	187	234	28	1	12	14	0.30
BHFG2918	229	284	28	1	18	14	0.30
BHFG2924	251	313	28	1	24	17	0.40
BHFG2930	339	420	28	1	30	21	0.50
BHFG2936	422	528	28	1	36	26	0.65

* LP = Thermally Fused Laminate, HP = High Pressure Laminate, T= High Pressure Laminate with Wood Trim, W= Wood Veneer

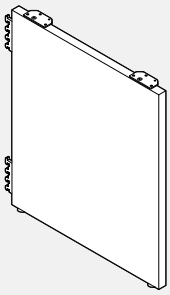
BHFGP • Full Gable - 3mm PVC Edged

- Provides floor standing support while enclosing an end of a run of worksurfaces.
- Includes attachment hardware, Bracket Retainer Clip and levelling glides.
- Provides consistent edging matching the worksurface trim.
- Handed once installed.
- May be used as a shared gable between two adjoining worksurfaces.

PRODUCT CODE	PRICE LP*	GROUP HP*	SIZE/ INCHES			WEIGHT VOL	
			H	W	D	LBS	FT ³
BHFGP2608	146	182	25	1	8	7	0.14
BHFGP2612	187	234	25	1	12	13	0.21
BHFGP2618	229	284	25	1	18	13	0.27
BHFGP2624	251	313	25	1	24	19	0.36
BHFGP2630	339	420	25	1	30	23	0.45
BHFGP2636	422	528	25	1	36	24	0.57
BHFGP2908	146	182	28	1	8	7	0.16
BHFGP2912	187	234	28	1	12	14	0.30
BHFGP2918	229	284	28	1	18	14	0.30
BHFGP2924	251	313	28	1	24	17	0.40
BHFGP2930	339	420	28	1	30	21	0.50
BHFGP2936	422	528	28	1	36	26	0.65

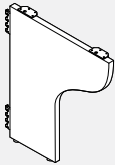
BHPG • "P" Shaped Full Gable - 3mm PVC Edged

- Provides floor standing support while enclosing an end of a run of worksurfaces.
- Includes attachment hardware, Bracket Retainer Clip and levelling glides.
- Handed due to hardware attachment and PVC edge.

PRODUCT CODE	PRICE LP*	GROUP HP*	SIZE/ INCHES			WEIGHT VOL	
			H	W	D	LBS	FT ³
BHPG2624L	251	313	25	1	24	19	0.36
BHPG2924L	251	313	28	1	24	17	0.40
BHPG2624R	251	313	25	1	24	19	0.36
BHPG2924R	251	313	28	1	24	17	0.40

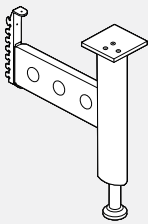
BHLEG • Gable Leg

- Support the worksurface and enhances the stability of connected panels.
- Universal leg plate bolts to the underside of the worksurface.
- Can be configured on-site for left, right or shared worksurface support application on front edge
- Back edge does not have shared support.
- Tubular leg section adjusts in 1" increments, the leveller can be used for fine adjustment.
- 1" increment leg adjustment and 1" increment panel slots allow the leg of installed worksurface to be supported from 26" to 32". (Leg must be removed from panel to manually adjust.)
- Side plate is secured to the slots in the vertical of the Boulevard 1 or System 3 panels and the leg plate bolts to underside of the worksurface.
- Made of extruded aluminum and steel.
- Includes all mounting hardware to connect to panel and worksurface.

PRODUCT CODE	PRICE	GROUP	SIZE/ INCHES			WEIGHT VOL	
			H	W	D	LBS	FT ³
BHLEG	211		28	6	23	8	0.15

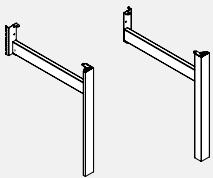
BRTBLEG • Boulevard Leg Assembly

- Boulevard Leg Assembly attaches to a Boulevard panel for applications which require functionality of Boulevard panels with an open environment of Bridges tables.
- One leg with horizontal member connecting to 1" increment slots in panel's vertical frame member. Provides support to panel and panel-connected worksurface at the end of a run; design coordinated with Bridges freestanding tables.
- Supports 24" and 30" deep worksurfaces. By adding 2 BHBF01 flat brackets and 1 BHBC02 corner bracket, a single leg can then support the adjoining worksurface. Leveling glide is standard. No worksurface supporting beams, use panel cantilevers and storage for worksurface support. One aluminum leg with steel structure - specify Left or Right and 24" or 30" deep for corresponding worksurface depths. Panel bracket, dislodgment clip and worksurface hardware included.
- Anodized aluminum leg upcharge \$31.
- Please specify paint finish for support.

PRODUCT CODE	PRICE	GROUP	SIZE/ INCHES			WEIGHT VOL	
			H	W	D	LBS	FT ³
BRTBLEG24LL	317		28	2.5	24	9	1.25
BRTBLEG24RL	317		28	2.5	24	9	1.25
BRTBLEG30LL	333		28	2.5	30	11	1.45
BRTBLEG30RL	333		28	2.5	30	11	1.45

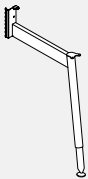
BRTBL • Boulevard Leg Assembly

- Boulevard Leg Assembly attaches to a Boulevard panel for applications which require functionality of Boulevard panels with an open environment of Bridge 2 tables.
- Panel bracket secures the leg to the panel in 1" increments, within a 24" to 32" height range.
- Panel mounting bracket is reversible for non-handed applications.
- Supports 24" and 30" deep worksurfaces. By adding 2 BHBF01 flat brackets and 1 BHBC02 corner bracket, a single leg can then support the adjoining worksurface. Leveling glide is standard. No worksurface supporting beams, use panel cantilevers and storage for worksurface support. Panel bracket, dislodgment clip and worksurface hardware included.
- Leveling glide is standard.

PRODUCT CODE	PRICE	GROUP	SIZE/ INCHES			WEIGHT VOL	
			H	W	D	LBS	FT ³
BRTBL	338		28	3	24	12	1.25

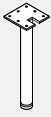
BHML • Monoleg

- **3" diameter Monoleg provides support for worksurfaces.**
- Top plate welded to leg.
- 8" x 8" plated attached to worksurface with #10 3/4" wood screws, included.
- 1" height adjustment range.
- For chrome finish on leg, please add \$109 list upcharge.

PRODUCT CODE	PRICE	SIZE/ INCHES			WEIGHT VOL	
		H	W	D	LBS	FT ³
BHML03	207	28	3	3	8	0.15

LATBL • Tapered Leg

- **Tapered leg provides support for worksurfaces.**
- Top plate welded to leg.
- 8" x 8" plated attached to worksurface with #10 3/4" wood screws, included.
- 1" height adjustment range.
- For chrome finish on leg, please add \$109 list upcharge.

PRODUCT CODE	PRICE	SIZE/ INCHES			WEIGHT VOL	
		H	W	D	LBS	FT ³
LATBL28	195	28	3	3	8	0.15

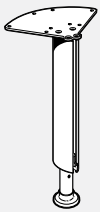
VVLEGLV • Leg with Leveler

- **The Viceversa leg features a push button height adjustment mechanism. This mechanism allows the user to easily set the height of a table. The universal mounting plate can be used to gang 2 tables without metal skirt simply by rotating 45 degrees to span both tops.**
- The Viceversa Leg has a wire management channel that neatly organizes electrical and communication cables running from the worksurface to the floor.
- Legs have a height range of 25" to 32" in 1" increments (includes 1" top).
- The wire channel is covered by a clear PVC snap-on cover.
- Levelers have a 1/2" height range.
- Levelers come in charcoal only.
- Includes mounting hardware.

PRODUCT CODE	PRICE	SIZE/ INCHES			WEIGHT VOL	
		H	D	W	LBS	FT ³
VVLEGLV	182	25-32	8	10	8	1.5

VVLEGLC • Leg with Caster

- **The Viceversa leg features a push button height adjustment mechanism. This mechanism allows the user to easily set the height of a table. The universal mounting plate can be used to gang 2 tables without metal skirt simply by rotating 45 degrees to span both tops.**
- The Viceversa Leg has a wire management channel that neatly organizes electrical and communication cables running from the worksurface to the floor.
- Legs have a height range of 26" to 33" in 1" increments.
- The wire channel is covered by a clear PVC snap-on cover.
- Casters come in grey with black only.
- Includes mounting hardware.

PRODUCT CODE	PRICE	SIZE/ INCHES			WEIGHT VOL	
		H	D	W	LBS	FT ³
VVLEGLC	182	26-33	8	10	8	1.5

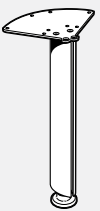
VVLEGF • Fixed Height Leg

- **The Viceversa fixed height leg with leveler supports the worksurface at a fixed height of 29".**
- The Viceversa leg has a wire management channel that neatly organizes electrical and communication cables running from the worksurface to the floor.
- Leg can be installed for each corner of the worksurface or can be shared at adjoining surfaces.
- The wire channel is covered by a clear PVC snap-on cover.
- Levelers have a 1/2" height range.
- Levelers come in charcoal only.
- Includes mounting hardware.

PRODUCT CODE	PRICE	SIZE/ INCHES			WEIGHT VOL	
		H	D	W	LBS	FT ³
VVLEGF	145	28	8	10	8	1.5

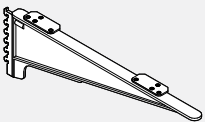
BHC • Cantilever

- **Universal cantilever with steel attachment bracket constructed of cast aluminum to provide support for worksurfaces.**
- Attaches a worksurface to a panel.
- May be used for shared worksurface support.
- Interchangeable in the field for left or right positioning.
- Includes Bracket Retainer Clip.

PRODUCT CODE	PRICE	SIZE/ INCHES			WEIGHT VOL	
		H	W	D	LBS	FT ³
BHC18	104	7	17	2.5	17	0.04
BHC24	122	7	23	2.5	23	0.05

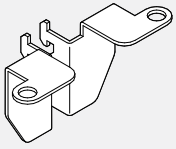
BHBC • Corner End Bracket

- Formed steel bracket for a corner worksurface or a straight worksurface.
- Attaches a corner of any worksurface to a panel through the panel vertical slots.
- Priced one left and one right per package.
- Includes Bracket Retainer Clip.

PRODUCT CODE	PRICE	SIZE/ INCHES			WEIGHT VOL	
		H	W	D	LBS	FT ³
BHBC02	26	3.3	1.5	2.3	2	0.007

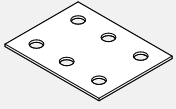
BHBF • Flat Bracket

- Flat Bracket made of cold rolled steel.
- May be used to ensure alignment of neighboring worksurfaces.

PRODUCT CODE	PRICE	SIZE/ INCHES			WEIGHT VOL	
		H	W	D	LBS	FT ³
BHBF01	13	0.1	3	4	0.5	0.007

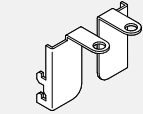
BHBT • Transaction Bracket

- For use on 34", 42", 50", 58", 66", 74" and 82" high Boulevard panels.
- Transaction Bracket made of cold rolled steel.
- To provide a secure attachment of a transaction worksurface.
- Priced one left and one right per package.
- Includes Bracket Retainer Clip.

PRODUCT CODE	PRICE	SIZE/ INCHES			WEIGHT VOL	
		H	W	D	LBS	FT ³
BHBT02	26	3.3	1.5	2.3	2	0.001

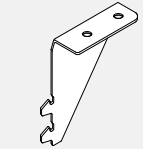
BHBT • Transaction Bracket for 37" High Boulevard 1 Panels

- Transaction Bracket made of cold rolled steel.
- To provide a secure attachment of a transaction worksurface for a 37" high Boulevard 1 panel only. Transaction Bracket engages with the top slots in the 37" high panel to supported for the transaction worksurface.
- Priced one left and one right per package.
- Includes Bracket Retainer Clip.

PRODUCT CODE	PRICE	SIZE/ INCHES			WEIGHT VOL	
		H	W	D	LBS	FT ³
BHBT37	31	4	1	3	0.5	0.007

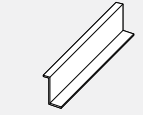
BHBZ • "Z" Bracket

- Attaches two different heights of worksurfaces.
- To be used in conjunction with a cantilever.

PRODUCT CODE	PRICE	SIZE/ INCHES			WEIGHT VOL	
		H	W	D	LBS	FT ³
BHBZ03	81	4	21	4	2	0.190

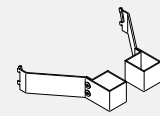
FTATB • Boulevard Connector Kit

- FreeFit to Boulevard kit secures FreeFit height adjustable freestanding tables to parallel Boulevard panels.
- It provides panel/table alignment, preventing moving parts from rubbing against panel vertical surfaces and maintains 1" clearance around table surface perimeter.
- Standard metal finishes.
- All hardware included.
- Sold as a pair.

PRODUCT CODE	PRICE	SIZE/ INCHES			WEIGHT VOL	
		H	W	D	LBS	FT ³
FTATB	144	10	6.5	10	7.00	0.50

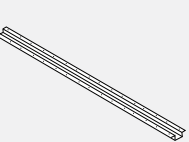
LHC • HAT Channel

PRODUCT CODE	PRICE	SIZE/ INCHES			WEIGHT VOL	
		H	W	D	LBS	FT ³
LHC40	58	1.4	40	5	4	0.20
LHC46	64	1.4	46	5	6	0.22
LHC52	68	1.4	52	5	7	0.25
LHC58	78	1.4	58	5	8	0.28
LHC64	88	1.4	64	5	9	0.31
LHC70	94	1.4	70	5	10	0.33

Technical Information for 9300 Series Pedestals

General Information:

9300 Series Pedestals feature center pull handles (models ending in "C") and full pull handles (models ending in "P"). Freestanding, mobile, and worksurface supporting options available. Quality steel construction. File drawers hold letter or A4 front to back and legal side to side configurations. Products are finished in a highly durable dry epoxy powder coating and drawer body interiors are finished with 100% recycled paint. Counterweights are included in freestanding and mobile pedestals to meet applicable ANSI/BIFMA X5.9.

Features:

- Cold rolled steel construction consisting of 16 ga front and back base with 22 ga case
- Reinforced welded construction
- Inset drawer fronts and flush base
- Double wall construction on all drawer fronts
- Full extension ball bearing slides on file drawers and $\frac{3}{4}$ extension on box drawers
- Rubber bumpers on slides for quietness
- Worksurface supporting option available (includes mounting holes at top of unit)
- 1 pencil tray and 1 drawer divider are included with each unit containing a box drawer
- Each file drawer includes a hanging file bar
- Levelers provide 1" height adjustment
- Counterweights included for freestanding and mobile pedestals
- Includes lock with 2 keys
- Lock is located at the top right of the case above the top drawer
- Keyed alike option available and can be keyed alike to other storage components

Technical Information for Prime Series

General Information:

Prime premium filing and storage products pre-configured to suit your needs; featuring fixed front or receding doors with center pull handles and fully welded seamless tops to deliver strength and clean aesthetics. Premium quality steel construction. File drawers accommodate legal, letter or A4 sizes in back-to-front and side-to-side configurations. Products are finished in a highly durable dry epoxy powder coating and drawer body interiors are finished with 100% recycled paint.

Counterweights are recommended for use in all laterals, pedestals and freestanding files of all widths and heights to meet applicable ANSI/BIFMA X5.9. (Counterweights are offered as an option on all products where required to meet applicable ANSI/BIFMA standard)

Features

- Premium steel construction, 18-22 gauge steel components
- Full welded and reinforced case construction
- Interlock system allows only one drawer to open at a time for safety
- Most products feature full overlay fronts, with some exceptions such as units with receding doors where the front is inset in the case
- Double wall construction on all drawer and door fronts
- Full extension roller bearing glides on all drawers
- Anti-bounce-back safety feature prevents drawers from sliding open
- Receding doors slide into the cabinet and allow the shelf to be pulled out
- All pedestals are equipped with four levelling glides, providing 1.5" of height adjustment
- All other units equipped with four levelling glides providing 1" height adjustment and can be accessed from the interior of the cabinets for ease of adjustment
- On units with drawers and hinged doors, locks are located at the center of the case above the top opening
- Lock position on towers with wardrobes is below the handle when center pull is selected
- Each lock includes 2 keys; locks are standard with removable cores
- Key assignment is random or can be specified for specific key number for key alike applications

Overhead Storage:

- Overhead cabinets - 7 widths in 6" increments
- 14 5/8" high cases with interior clear height of 12"
- 13" deep units have interior clear dimension of 12.7"
- 16" deep units have interior clear dimension of 15.7"
- Open shelves - 7 widths in 6" increments
- Shelves are 12 1/2" deep with 7 1/2" high side gables

Sizes:

- 15" width
- 19", 23", 29" depths
- Interior drawer depths:

19" Deep pedestals
17 1/4" deep box drawers
16 1/16" deep file drawers

23" deep pedestals
20 3/16" deep box drawers
19 7/16" deep file drawers

29" deep pedestals
26 5/16" deep box drawers
26 1/16" deep file drawers

Drawer Heights:

Box drawer fronts are 6"H with 5" interior height
File drawer fronts are 12"H with 10 9/16" interior height

Pedestals:

- Freestanding and worksurface supporting options available
- Worksurface supporting includes mounting holes at top of unit
- 1 pencil tray and 1 drawer divider are included with each unit containing a box drawer
- File drawers hold legal, letter or A4 sizes in back-to-front and side-to-side configurations
- Each file drawer includes a hanging file bar and conversion rails
- Freestanding units BSPF can be specified with optional non-locking casters to convert to a mobile unit
- 15" width x 18", 22", 28" depths

Interior drawer depth is as follows:

- 15" deep drawers for 18" deep pedestals
- 19" deep drawers for 22" deep pedestals
- 25" deep drawers for 28" deep pedestals

File drawer capacity:

- 14 3/8" filing capacity for file drawers in 18" pedestal
- 18 3/8" filing capacity for file drawers in 22" pedestal
- 24 3/8" filing capacity for file drawers in 28" pedestal

Laterals:

- 18" depth with interior depth of 16"
- 30", 36", 42" widths
- Available in 2 to 6 drawer high (28"h – 77.6"h)

File Drawer Capacity:

- 30" wide units
- Letter & legal side-to-side = 26 5/8"
 - Letter front-to-back = 30 1/2"
 - Legal front-to-back = 15 1/4" + 10" side space
- 36" wide units
- Letter & legal side-to-side = 32 5/8"
 - Letter front-to-back = 30 1/2" + 6 1/2" side space
 - Legal front-to-back = 30 1/2"
- 42" wide units
- Letter & legal side-to-side = 58 5/8"
 - Letter front-to-back = 45 3/4"
 - Legal front-to-back = 30 1/2" + 6 1/2" side space

Technical Information for Prime Series

Storage Cabinets:

- 18" depth
- 30", 36", 42" widths
- Available in 2 to 5 high configurations (28"h – 65.6"h)

Towers:

- Include coat rod and shelf to accommodate personal items
- The top of the storage compartment is perforated for ventilation

- Includes locks with 2 keys each
 - Closed storage comes with 3 locks – one of the drawers, one for the cupboard, and one for the wardrobe
 - Side open storage comes with 2 locks – one of the drawers and one for the wardrobe
- 24" width
- 50", 54", and 66" nominal heights available to coordinate with Global's panel systems

STORAGE COMPONENTS - GUIDELINES FOR ORDERING PRODUCT

Codes

The price list uses a numbering system with meaningful alphanumeric characters to create a simple-to-understand product number. This makes specifying the product much easier and more accurate.

How to Specify

- Specify storage pedestal type and size by code, including depth.
- Specify metal color (eg. BLK for Black)
- Specify key random, key list provided, or key number (eg. 401)
- Specify worksurface supporting (1 = Yes, 2 = No)
- Specify counterweight if pedestal is not worksurface supporting (NN = No Counterweight)

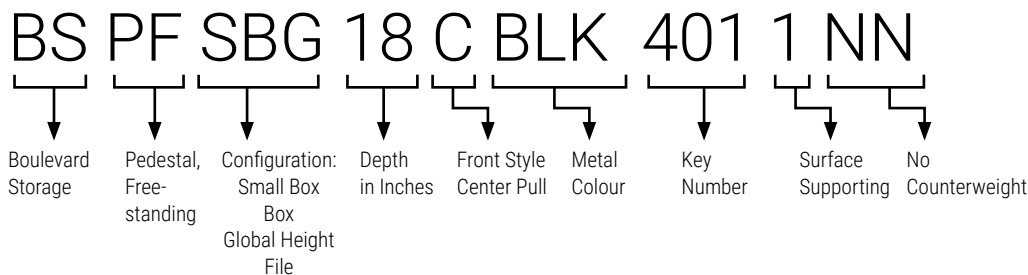

BSKSS • Panel Mount Shelf

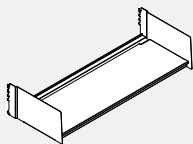

- 14" deep panel mounted storage shelf with backlip.
- Mounting brackets are included.

PRODUCT CODE	PRICE	SIZE/INCHES			WEIGHT LBS	VOL FT ³
		H	W	D		
BSKSS24	220	7.45	23.44	14.73	12.8	1.5
BSKSS30	229	7.45	29.44	14.73	14.8	1.9
BSKSS36	244	7.45	35.44	14.73	16.8	2.3
BSKSS42	254	7.45	41.44	14.73	18.8	2.6
BSKSS48	259	7.45	47.44	14.73	20.8	3.0
BSKSS54	293	7.45	53.44	14.73	22.8	3.4
BSKSS60	322	7.45	59.44	14.73	24.8	3.8

BSLSF • Flush Front Overhead Cabinet

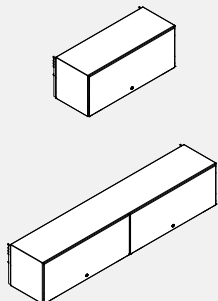

Cabinets 54" and 60" wide come with two doors

- Flush Front Overhead Cabinet is panel mounted lockable storage unit.
- The door retracts inside/within the overhead cabinet.
- Locks can be keyed alike to match other lockable storage components or keyed random to provide a dedicated lock.
- Available in 13" and 16" depths, 24" to 60" widths at 6" increments.
- Cabinets 54" and 60" wide come with two doors.
- Includes mounting hardware as specified, lock and keys.
- Lock secures into bottom shelf.
- Can be mounted at any height, however 66"h panels are recommended.
- Shipped assembled.

PRODUCT CODE	PRICE	SIZE/INCHES			WEIGHT LBS	VOL FT ³
		H	W	D		
BSLSF1324MN	869	14.62	23.87	13.5	39.3	2.7
BSLSF1330MN	947	14.62	29.87	13.5	44.3	3.4
BSLSF1336MN	1044	14.62	35.87	13.5	49.3	4.1
BSLSF1342MN	1147	14.62	41.87	13.5	54.3	4.8
BSLSF1348MN	1244	14.62	47.87	13.5	59.3	5.5
BSLSF1354MN	1324	14.62	53.87	13.5	64.3	6.2
BSLSF1360MN	1449	14.62	59.87	13.5	69.3	6.8
BSLSF1624MN	966	14.62	23.87	16.5	38.6	3.4
BSLSF1630MN	1044	14.62	29.87	16.5	43.9	4.2
BSLSF1636MN	1147	14.62	35.87	16.5	49.2	5.0
BSLSF1642MN	1244	14.62	41.87	16.5	54.5	5.8
BSLSF1648MN	1342	14.62	47.87	16.5	59.8	6.7
BSLSF1654MN	1449	14.62	53.87	16.5	65.1	7.5
BSLSF1660MN	1547	14.62	59.87	16.5	70.4	8.4

BSADA-PM • Panel Mounted Overhead Storage Unit - AODA Compliant

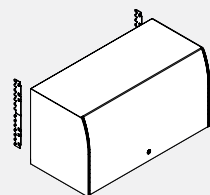

- Panel mounted metal overhead storage with opaque acrylic door. The mechanism lifts the door up and stores it out of the way, above the storage unit.
- Meets CSA B651 Barrier Free Design & AODA (Accessibility for Ontarians with Disabilities Act).
- 16" high units accept standard and A4 binders.
- All shelves are reinforced for proper weight distribution.
- Inside dimensions: 14.25" high x 13.4" deep.
- Unit includes attachment hardware, lock and mounting brackets. Back not included.
- Not recommended for use with wall rails.
- Unit can be converted to Up-Mount Overhead Storage Unit in the field by adding BSADAxKIT.
- Shipped partially assembled.

PRODUCT CODE	PRICE	SIZE/INCHES			WEIGHT LBS	VOL FT ³
		H	W	D		
BSADA24PM	780	16	24	14.2	22	4.3
BSADA30PM	839	16	30	14.2	27	5.3
BSADA36PM	906	16	36	14.2	32	6.3
BSADA42PM	970	16	42	14.2	37	7.3
BSADA48PM	1037	16	48	14.2	42	8.3
BSADA54PM	1101	16	54	14.2	47	9.3
BSADA60PM	1167	16	60	14.2	53	10.3

BSADA-UM • Up-Mount Overhead Storage Unit - AODA Compliant

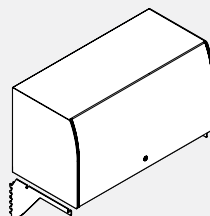

- Up mounted storage can reduce furniture costs by reducing the height of all panels to 50". Complete 50" panel installations simplify cable routing at one level, within the top lay-in channel. Up-mounted cantilevers maintain accessibility and functionality of the panels' top lay-in channel.
- Meets CSA B651 Barrier Free Design & AODA (Accessibility for Ontarians with Disabilities Act).
- 16" high units accept standard and A4 binders.
- All shelves are reinforced for proper weight distribution.
- Inside dimensions: 14.25" high x 13.4" deep.
- Unit includes attachment hardware, lock, mounting cantilevers and has a finished back.
- Unit can be converted to a Panel Mounted Overhead Storage Unit in the field by adding BSADAPMxxKIT.
- Shipped partially assembled.

PRODUCT CODE	PRICE	SIZE/INCHES			WEIGHT LBS	VOL FT ³
		H	W	D		
BSADA24UM	956	16	24	14.2	25	4.3
BSADA30UM	999	16	30	14.2	33	5.3
BSADA36UM	1046	16	36	14.2	40	6.3
BSADA42UM	1105	16	42	14.2	46	7.3
BSADA48UM	1166	16	48	14.2	53	8.3
BSADA54UM	1222	16	54	14.2	59	9.3
BSADA60UM	1293	16	60	14.2	66	10.3

BSADA-KIT • Up-Mount Conversion Kit

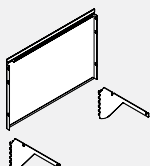

- Converts an existing Panel Mounted Overhead Storage Unit BSADA-PM to an Up-Mounted Overhead Storage unit BSADA-UM.
- When used on a 50" high panel, the top of the overhead will match the height of 66" high panels.
- Kit includes a back panel for the Overhead and Up-Mount Cantilevers.

PRODUCT CODE	PRICE	SIZE/INCHES			WEIGHT LBS	VOL FT ³
		H	W	D		
BSADA24KIT	194	16	24	2	6	0.6
BSADA30KIT	201	16	30	2	8	0.6
BSADA36KIT	210	16	36	2	10	0.7
BSADA42KIT	225	16	42	2	11	0.8
BSADA48KIT	235	16	48	2	13	0.9
BSADA54KIT	247	16	54	2	14	1.0
BSADA60KIT	261	16	60	2	15	1.1

BSADA-OMKIT • Off-Module Conversion Kit

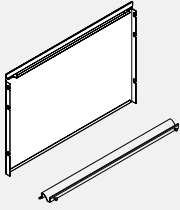

- Converts an existing Panel Mounted Storage Unit BSADA-PM to Off-Module Overhead Storage unit BSADA-OMKIT.
- Kit includes a back panel with integrated hanging bracket and an extruded bottom bracket.
- **IMPORTANT:** BSADA Overhead with Off-Module Conversion kit can only be installed on B3 fabric tile. Tiles below the overhead can be fabric, laminate and accessory tile. However, the tile the overhead is hanging on must be fabric.
- BSADA Overhead with Off-Module Conversion Kit can be suspended off of a single fabric tile, or can span two fabric tiles on two adjacent, directly interconnected panels.
- BSADA Overhead with Off-Module Conversion Kit **CANNOT** be suspended off of two panels separated by a post.

PRODUCT CODE	PRICE	SIZE/INCHES			WEIGHT VOL	
		H	W	D	LBS	FT ³
BSADA240MKIT	194	16	24	2	6	0.5
BSADA300MKIT	201	16	30	2	8	0.6
BSADA360MKIT	210	16	36	2	10	0.7
BSADA420MKIT	225	16	42	2	11	0.8
BSADA480MKIT	235	16	48	2	13	0.9
BSADA540MKIT	247	16	54	2	14	1.0
BSADA600MKIT	261	16	60	2	15	1.1

BSADA-KIT • Panel Mount Conversion Kit



- Converts an existing Up-Mount Overhead Storage Unit BSADA-UM to a Panel Mounted Overhead Storage Unit BSADA-PM.
- Kit includes panel mounting brackets.

PRODUCT CODE	PRICE	SIZE/INCHES			WEIGHT VOL	
		H	W	D	LBS	FT ³
BSADAPMKIT	40	16	0.5	2	2	0.009

BSP1DO • Overhead Divider Storage for Boulevard 1 - Open Double Sided

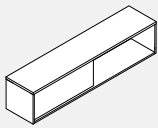

- Panel top mount allows access on both sides.
- Storage compartment internal height: 14".
- Overhead available in standard GC laminate finishes.
- Top mount on panels.
- Connecting hardware included.

PRODUCT CODE	PRICE		SIZE/INCHES			WEIGHT VOL	
	LP	HP	H	W	D	LBS	FT ³
BSP1DO36	655	737	16	36	16	81	7
BSP1DO42	675	766	16	42	16	96	8
BSP1DO48	700	808	16	48	16	100	9

BSP1LDS • Overhead Divider Storage for Boulevard 1 - Open Double Sided with Sliding Laminate Door

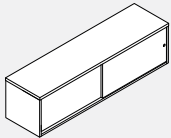

- Panel top mount allows access on both sides.
- Storage compartment internal height: 14".
- Overhead available in standard GC laminate finishes.
- Top mount on panels.
- Connecting hardware included.
- Sliding laminate doors are not locking.

PRODUCT CODE	PRICE		SIZE/INCHES			WEIGHT VOL	
	LP	HP	H	W	D	LBS	FT ³
BSP1LDS36	2057	2136	16	36	16	87	7
BSP1LDS42	2103	2199	16	42	16	103	8
BSP1LDS48	2131	2240	16	48	16	108	9

BSP1GDS • Overhead Divider Storage for Boulevard 1 - Open Double Sided with Sliding Glass Door

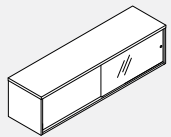

- Panel top mount allows access on both sides.
- Storage compartment internal height: 14".
- Overhead available in standard GC laminate finishes.
- Top mount on panels.
- Connecting hardware included.
- Sliding glass doors are not locking.

PRODUCT CODE	PRICE		SIZE/INCHES			WEIGHT VOL	
	LP	HP	H	W	D	LBS	FT ³
BSP1GDS36	2129	2210	16	36	16	92	7
BSP1GDS42	2165	2261	16	42	16	108	8
BSP1GDS48	2196	2304	16	48	16	113	9

BSP3DO • Overhead Divider Storage for Boulevard System 3 - Open Double Sided

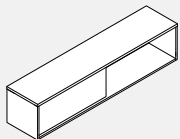

- Panel top mount allows access on both sides.
- Storage compartment internal height: 14".
- Overhead available in standard GC laminate finishes.
- Top mount on panels.
- Connecting hardware included.

PRODUCT CODE	PRICE		SIZE/INCHES			WEIGHT VOL	
	LP	HP	H	W	D	LBS	FT ³
BSP3DO36	633	716	16	36	16	81	9
BSP3DO42	660	756	16	42	16	96	10.5
BSP3DO48	689	796	16	48	16	100	12

BSP3LDS • Overhead Divider Storage for Boulevard System 3 - Open Double Sided with Sliding Laminate Door

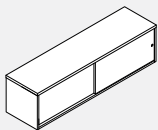

- Panel top mount allows access on both sides.
- Storage compartment internal height: 14".
- Overhead available in standard GC laminate finishes.
- Top mount on panels.
- Connecting hardware included.
- Sliding laminate doors are not locking.

PRODUCT CODE	PRICE		SIZE/INCHES			WEIGHT VOL	
	LP	HP	H	W	D	LBS	FT ³
BSP3LDS36	2036	2117	16	36	16	106	7
BSP3LDS42	2086	2178	16	42	16	126	8
BSP3LDS48	2110	2221	16	48	16	134	9

BSP3GDS • Overhead Divider Storage for Boulevard System 3 - Open Double Sided with Sliding Glass Door

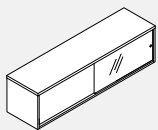

- Panel top mount allows access on both sides.
- Storage compartment internal height: 14".
- Overhead available in standard GC laminate finishes.
- Top mount on panels.
- Connecting hardware included.
- Sliding glass doors are not locking.

PRODUCT CODE	PRICE		SIZE/INCHES			WEIGHT VOL	
	LP	HP	H	W	D	LBS	FT ³
BSP3GDS36	2108	2190	16	36	16	87	6
BSP3GDS42	2143	2240	16	42	16	103	7
BSP3GDS48	2174	2284	16	48	16	107	9

BS93FPxxBFC • 9300 Series Freestanding Box File Pedestal

- One box and one file drawer pedestal.
- Freestanding, counterweight included.
- All drawers are locking.
- Box drawer includes pencil tray.

PRODUCT CODE	PRICE	SIZE/INCHES			WEIGHT LBS	VOL FT ³
		H	W	D		
BS93FP19BFC	559	21.31	15	19	50	5.1
BS93FP23BFC	566	21.31	15	23	55	6.0
BS93FP29BFC	678	21.31	15	29	64	7.5

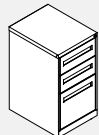
BS93FPxxBBFC • 9300 Series Freestanding Box Box File Pedestal

- Two box and one file drawer pedestal.
- Freestanding, counterweight included.
- All drawers are locking.
- Top box drawer includes pencil tray.

PRODUCT CODE	PRICE	SIZE/INCHES			WEIGHT LBS	VOL FT ³
		H	W	D		
BS93FP19BBFC	617	27.87	15	19	55	6.5
BS93FP23BBFC	628	27.87	15	23	68	7.7
BS93FP29BBFC	741	27.87	15	29	78	9.6

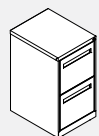
BS93FPxxFFC • 9300 Series Freestanding File File Pedestal

- Two file drawer pedestal.
- Freestanding, counterweight included.
- All drawers are locking.

PRODUCT CODE	PRICE	SIZE/INCHES			WEIGHT LBS	VOL FT ³
		H	W	D		
BS93FP19FFC	589	27.87	15	19	53	6.5
BS93FP23FFC	597	27.87	15	23	60	7.7
BS93FP29FFC	699	27.87	15	29	70	9.6

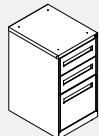
BS93WPxxBBFC • 9300 Series Worksurface Supporting Box Box File Pedestal

- Two box and one file drawer pedestal.
- Worksurface supporting, includes mounting holes in the top.
- All drawers are locking.
- Top box drawer includes pencil tray.
- Note: Specify bracket and filler kit separately, BSPWSB93.

PRODUCT CODE	PRICE	SIZE/INCHES			WEIGHT LBS	VOL FT ³
		H	W	D		
BS93WP19BBFC	613	27.87	15	19	55	6.5
BS93WP23BBFC	621	27.87	15	23	68	7.7
BS93WP29BBFC	711	27.87	15	29	78	9.6

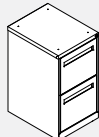
BS93WPxxFFC • 9300 Series Worksurface Supporting File File Pedestal

- Two file drawer pedestal.
- Worksurface supporting, includes mounting holes in the top.
- All drawers are locking.
- Note: Specify bracket and filler kit separately, BSPWSB93.

PRODUCT CODE	PRICE	SIZE/INCHES			WEIGHT LBS	VOL FT ³
		H	W	D		
BS93WP19FFC	582	27.87	15	19	53	6.5
BS93WP23FFC	587	27.87	15	23	60	7.7
BS93WP29FFC	700	27.87	15	29	70	9.6

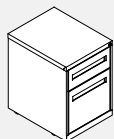
BS93MPxxBFC • 9300 Series Mobile Box File Pedestal

- One box and one file drawer mobile pedestal.
- Casters preinstalled, casters non-locking.
- Counterweight included.
- All drawers locking.
- Box drawer includes pencil tray.
- NOTE: Cannot be used as guest seating.

PRODUCT CODE	PRICE	SIZE/INCHES			WEIGHT LBS	VOL FT ³
		H	W	D		
BS93MP19BFC	659	21.87	15	19	66	5.2
BS93MP23BFC	681	21.87	15	23	72	6.2
BS93MP29BFC	730	21.87	15	29	92	7.6

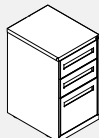
BS93MPxxBBFC • 9300 Series Mobile Box Box File Pedestal

- Two box and one file drawer mobile pedestal.
- Casters preinstalled, casters non-locking.
- Counterweight included.
- All drawers locking.
- Top box drawer includes pencil tray.
- NOTE: Cannot be used as guest seating.

PRODUCT CODE	PRICE	SIZE/INCHES			WEIGHT LBS	VOL FT ³
		H	W	D		
BS93MP19BBFC	695	27.93	15	19	76	6.5
BS93MP23BBFC	702	27.93	15	23	85	7.7
BS93MP29BBFC	757	27.93	15	29	94	9.6

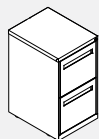
BS93MPxxFFC • 9300 Series Mobile File File Pedestal

- Two file drawer pedestal.
- Casters preinstalled, casters non-locking.
- Counterweight included.
- All drawers locking.
- NOTE: Cannot be used as guest seating.

PRODUCT CODE	PRICE	SIZE/INCHES			WEIGHT LBS	VOL FT ³
		H	W	D		
BS93MP19FFC	654	27.93	15	19	73	6.5
BS93MP23FFC	681	27.93	15	23	81	7.7
BS93MP29FFC	748	27.93	15	29	90	9.6

BSPF0BFxxC • Prime Freestanding Box File Pedestal

- One box and one file drawer pedestal.
- All drawers are locking.
- Box drawer includes pencil tray.
- For freestanding, to add counterweight (W2 option), add \$49 list.
- For mobile to add casters and counterweight (W1 option), add \$73 list. Adds 0.5" to height.
- NOTE: Cannot be used as guest seating.

PRODUCT CODE	PRICE	SIZE/INCHES			WEIGHT LBS	VOL FT ³
		H	W	D		
BSPF0BF18C	722	20.8	15	18	52.4	4.2
BSPF0BF22C	756	20.8	15	22	58.8	5.0
BSPF0BF28C	791	20.8	15	28	68.7	6.3

BSPFSBGxxC • Prime Box Box File Pedestal

- Two box and one file drawer pedestal.
- All drawers are locking.
- Top box drawer includes pencil tray.
- For freestanding, to add counterweight (W2 option), add \$49 list.
- For mobile to add casters and counterweight (W1 option), add \$73 list. Adds 0.5" to height.
- Top box drawer 4.8"h; middle box drawer 6.4"h; bottom file drawer 13.6"h (interior 12.5"h).
- Note: Specify bracket and filler kit separately, BSPWSBPM18 for 18" deep and BSPWSBPM22 for 22 and 28" deep.

PRODUCT CODE	PRICE	SIZE/INCHES			WEIGHT LBS	VOL FT ³
		H	W	D		
BSPFSBG18C	834	28	15	18	67.5	5.5
BSPFSBG22C	874	28	15	22	75.0	6.6
BSPFSBG28C	913	28	15	28	86.8	8.3

BSPF0FGxxC • Prime File File Pedestal

- Two file drawer pedestal.
- All drawers are locking.
- For freestanding, to add counterweight (W2 option), add \$49 list.
- For mobile to add casters and counterweight (W1 option), add \$73 list. Adds 0.5" to height.
- Top file drawer 11.2"h (interior 10.6"h); bottom file drawer 13.6"h (interior 12.5"h).
- Note: Specify bracket and filler kit separately, BSPWSBPM18 for 18" deep and BSPWSBPM22 for 22 and 28" deep.

PRODUCT CODE	PRICE	SIZE/INCHES			WEIGHT LBS	VOL FT ³
		H	W	D		
BSPF0FG18C	761	28	15	18	67.5	5.5
BSPF0FG22C	791	28	15	22	75.0	6.6
BSPF0FG28C	825	28	15	28	86.8	8.3

BSPW0BFxxC • Prime Mobile Box File Pedestal

- Mobile one box and one file drawer pedestal.
- All drawers are locking.
- 60mm casters.
- Front casters are locking.

PRODUCT CODE	PRICE	SIZE/INCHES			WEIGHT LBS	VOL FT ³
		H	W	D		
BSPW0BF18C	888	23.3	15	18	73.5	4.6
BSPW0BF22C	917	23.3	15	22	79.1	5.6
BSPW0BF28C	947	23.3	15	28	87.7	7.0

BSPWSB93 • Boulevard Worksurface Supporting Bracket for 9300 Series Pedestals

- Kit includes filler and bracket.

PRODUCT CODE	PRICE	SIZE/	INCHES		WEIGHT LBS	VOL FT ³
		H	W	D		
BSPWSB93	45	27.6	0.85	1	1.78	0.014

BSPWSBPM18 • Boulevard Worksurface Supporting Bracket for Prime Series 18" deep Pedestals

- Kit includes bracket.

PRODUCT CODE	PRICE	SIZE/	INCHES		WEIGHT LBS	VOL FT ³
		H	W	D		
BSPWSBPM18	19	10.7	0.85	1	0.45	0.005

BSPWSBPM22 • Boulevard Worksurface Supporting Bracket for Prime Series 22 and 28" deep Pedestals

- Kit includes filler and bracket.

PRODUCT CODE	PRICE	SIZE/	INCHES		WEIGHT LBS	VOL FT ³
		H	W	D		
BSPWSBPM22	51	28	1.85	1	2.45	0.299

BSTC • Pedestal/Lateral Seat Cushion

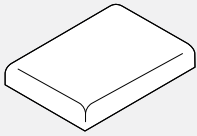

PRODUCT CODE	YRDS	SIZE/ INCHES			WEIGHT VOL	
		H	W	D	LBS	FT ³
BSTCP1518	0.75	2	15	18	5.00	0.41
BSTCP1522	0.75	2	15	22	5.25	0.45
BSTCP1528	1.00	2	15	28	5.5	0.55
BSTCL1830	1.00	2	18	30	6.0	0.55
BSTCL1836	1.25	2	18	36	6.5	0.65

PRODUCT CODE	PRICE																			
	GR1	GR2	GR3	GR4	GR5	GR6	GR7	GR8	GR9	GR10	GR11	GR12	GR13	GR14	GR15	GR16	GR17	GR18	GR19	GR20
BSTCP1518	202	233	252	280	323	364	401	435	477	518	574	652	724	802	972	1142	1312	1482	1652	1839
BSTCP1522	212	240	264	291	333	372	411	448	486	528	582	659	736	813	984	1153	1324	1495	1661	1848
BSTCP1528	267	305	336	371	426	480	534	579	631	688	759	864	964	1065	1294	1517	1747	1973	2198	2448
BSTCL1830	289	328	355	394	450	503	552	603	655	712	783	886	987	1089	1317	1541	1772	1996	2221	2471
BSTCL1836	343	391	430	475	543	608	673	733	801	869	960	1089	1214	1343	1628	1908	2194	2474	2757	3070

BSLPS0BF18xxC • Prime Box File Lateral

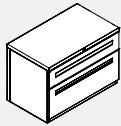

- One and a half height lateral filing cabinet.
- Fixed front drawers, top box drawer front 4.8" bottom file drawer front 13.6" (interior 12.5").
- Locking.
- Side to side hanging bars included.
- To add counterweight (W2 option), add \$400 list.

PRODUCT CODE	PRICE	SIZE/INCHES			WEIGHT LBS	VOL FT ³
		H	W	D		
BSLPS0BF1830C	1191	20.98	30	18.06	119.96	8.0
BSLPS0BF1836C	1283	20.98	36	18.06	129.86	9.5
BSLPS0BF1842C	1371	20.98	42	18.06	165.45	11.1

BSLF20G18xxC • Prime 2 High Lateral File

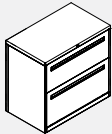

- Two high lateral filing cabinet.
- Fixed front file drawers, top drawer front 11.2" (interior 10.6") bottom drawer front 13.6" (interior 12.5").
- Locking.
- Side to side hanging bars included.
- To add counterweight (W2 option), add \$195 list.

PRODUCT CODE	PRICE	SIZE/INCHES			WEIGHT LBS	VOL FT ³
		H	W	D		
BSLF20G1830C	1279	28	30	18	98.7	10.5
BSLF20G1836C	1366	28	36	18	114.4	12.5
BSLF20G1842C	1454	28	42	18	129.4	14.5

BSLF30G18xxC • Prime 3 High Lateral File



- Three high lateral filing cabinet.
- Fixed front file drawers, top & middle drawer front 11.2" (interior 10.6") bottom drawer front 13.6" (interior 12.5").
- Locking.
- Side to side hanging bars included.
- Will not line up with 42" high panels.
- To add counterweight (W2 option), add \$195 list.

PRODUCT CODE	PRICE	SIZE/INCHES			WEIGHT LBS	VOL FT ³
		H	W	D		
BSLF30G1830C	1747	39.2	30	18	127.9	14.5
BSLF30G1836C	1869	39.2	36	18	147.6	17.2
BSLF30G1842C	1994	39.2	42	18	167.5	20.0

BSLF40G18xxC • Prime 4 High FFFF Lateral File

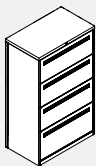

- Four high fixed front lateral filing cabinet.
- Fixed front file drawers, top drawer front 10.4" (interior 9.8") , second and third drawers 11.2" (interior 10.6") bottom drawer front 13.6" (interior 12.5").
- Locking.
- Side to side hanging bars included.
- To add counterweight (W2 option), add \$195 list.

PRODUCT CODE	PRICE	SIZE/INCHES			WEIGHT LBS	VOL FT ³
		H	W	D		
BSLF40G1830C	2103	49.6	30	18	159.1	18.2
BSLF40G1836C	2255	49.6	36	18	183.4	21.6
BSLF40G1842C	2406	49.6	42	18	208.5	25.1

BSLF40H18xxC • Prime 4 High RFFF Lateral File

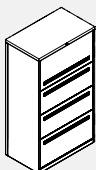

- Four high receding top door and remaining fixed front lateral filing cabinet.
- Top opening receding door + roll-out shelf 14.4" front, accepts binder height; fixed front drawers second and third drawers 11.2" (interior 10.6") bottom drawer front 13.6" (interior 12.5").
- Locking.
- Side to side hanging bars included.
- To add counterweight (W2 option), add \$195 list.

PRODUCT CODE	PRICE	SIZE/INCHES			WEIGHT LBS	VOL FT ³
		H	W	D		
BSLF40H1830C	2323	53.6	30	18	171.9	19.6
BSLF40H1836C	2474	53.6	36	18	198.2	23.3
BSLF40H1842C	2630	53.6	42	18	225.3	27.0

BSLF50P18xxC • Prime 5 High RFFFF Lateral File

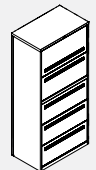

- Five high receding top door and remaining fixed front lateral filing cabinet.
- Locking.
- Side to side hanging bars included.
- Top opening receding door + roll-out shelf 14.4" front, accepts binder height; fixed front drawers below - second and third 11.2" (interior 10.6") bottom drawer front 13.6" (interior 12.5").
- To add counterweight (W2 option), add \$195 list.

PRODUCT CODE	PRICE	SIZE/INCHES			WEIGHT LBS	VOL FT ³
		H	W	D		
BSLF50P1830C	2860	65.6	30	18	208.9	23.9
BSLF50P1836C	3035	65.6	36	18	239.9	28.4
BSLF50P1842C	3221	65.6	42	18	272.7	32.9

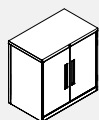
BSSC21G18xxC • Prime 2 High Storage Cabinet

- Two high storage cabinet.
- One adjustable shelf + fixed bottom shelf.
- Locking.

PRODUCT CODE	PRICE	SIZE/INCHES			WEIGHT LBS	VOL FT ³
		H	W	D		
BSSC21G1830C	1005	28	30	18	75.08	10.5
BSSC21G1836C	1074	28	36	18	86.48	12.5
BSSC21G1842C	1142	28	42	18	95.78	14.5

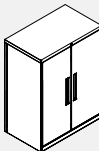
BSSC31G18xxC • Prime 3 High Storage Cabinet

- Three high storage cabinet.
- Two adjustable shelves + fixed bottom shelf.
- Will not line up to 42" high panels.
- Locking.

PRODUCT CODE	PRICE	SIZE/INCHES			WEIGHT LBS	VOL FT ³
		H	W	D		
BSSC31G1830C	1401	39.2	30	18	96.69	14.5
BSSC31G1836C	1493	39.2	36	18	111.59	17.2
BSSC31G1842C	1571	39.2	42	18	124.49	20.0

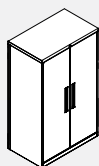
BSSC41G18xxC • Prime 4 High Storage Cabinet

- Three high storage cabinet to line up to 50" high panels.
- Three adjustable shelves + fixed bottom shelf.
- Locking.

PRODUCT CODE	PRICE	SIZE/INCHES			WEIGHT LBS	VOL FT ³
		H	W	D		
BSSC41G1830C	1645	49.6	30	18	111.22	18.2
BSSC41G1836C	1752	49.6	36	18	129.32	21.6
BSSC41G1842C	1840	49.6	42	18	145.42	25.1

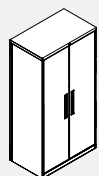
BSSC41H18xxC • Prime 4 High Storage Cabinet

- Four high storage cabinet.
- Three adjustable shelves + fixed bottom shelf.
- Locking.

PRODUCT CODE	PRICE	SIZE/INCHES			WEIGHT LBS	VOL FT ³
		H	W	D		
BSSC41H1830C	1713	53.6	30	18	120.17	19.6
BSSC41H1836C	1825	53.6	36	18	138.27	23.3
BSSC41H1842C	1913	53.6	42	18	154.37	27.0

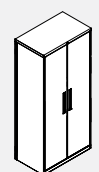
BSSC51C18xxC • Prime 5 High Storage Cabinet

- Five high storage cabinet.
- Four adjustable shelves + fixed bottom shelf.
- Locking.

PRODUCT CODE	PRICE	SIZE/INCHES			WEIGHT LBS	VOL FT ³
		H	W	D		
BSSC51C1830C	1947	65.6	30	18	138.5	23.9
BSSC51C1836C	2069	65.6	36	18	160.4	28.4
BSSC51C1842C	2162	65.6	42	18	180.4	32.9

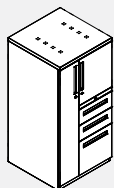
BSSLFxx24BCCL • Prime Tower, Left Wardrobe, Half Height Door, Box Box File Drawers

- Left wardrobe tower with half height door and box box file drawers.
- Wardrobe section includes top shelf and coat bar.
- Hinged door compartment of 50"h and 54"h includes one adjustable shelf; 66"h includes two adjustable open shelves.
- Wardrobe section includes top perforations for ventilation.
- Three locks included - wardrobe door, hinged door shelving compartment and drawers.
- To add counterweight (W2 option), add \$102 list.

PRODUCT CODE	PRICE	SIZE/INCHES			WEIGHT LBS	VOL FT ³
		H	W	D		
BSSLF4G24BCCL	3348	49.6	24	24	176.71	19.2
BSSLF4H24BCCL	3348	53.6	24	24	181.63	19.8
BSSLF5024BCCL	3514	65.6	24	24	204.52	25.2

"4G" Tower Shown

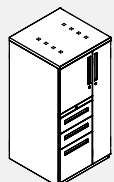
BSSLFxx24BCCR • Prime Tower, Right Wardrobe, Half Height Door, Box Box File Drawers

- Right wardrobe tower with half height door and box box file drawers.
- Wardrobe section includes top shelf and coat bar.
- Hinged door compartment of 50"h and 54"h includes one adjustable shelf; 66"h includes two adjustable open shelves.
- Wardrobe section includes top perforations for ventilation.
- Three locks included - wardrobe door, hinged door shelving compartment and drawers.
- To add counterweight (W2 option), add \$102 list.

PRODUCT CODE	PRICE	SIZE/INCHES			WEIGHT LBS	VOL FT ³
		H	W	D		
BSSLF4G24BCCR	3348	49.6	24	24	176.71	19.2
BSSLF4H24BCCR	3348	53.6	24	24	181.63	19.8
BSSLF5024BCCR	3514	65.6	24	24	204.52	25.2

"4G" Tower Shown

BSSLFxx24FCCL • Prime Tower, Left Wardrobe, Half Height Door, File File Drawers

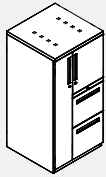

"4G" Tower Shown

- Left wardrobe tower with half height door and file file drawers.
- Wardrobe section includes top shelf and coat bar.
- Hinged door compartment of 50"h and 54"h includes one adjustable shelf; 66"h includes two adjustable open shelves.
- Wardrobe section includes top perforations for ventilation.
- Three locks included - wardrobe door, hinged door shelving compartment and drawers.
- To add counterweight (W2 option), add \$102 list.

PRODUCT CODE	PRICE	SIZE/INCHES			WEIGHT LBS	VOL FT ³
		H	W	D		
BSSLF4G24FCCL	3260	49.6	24	24	181.05	19.2
BSSLF4H24FCCL	3260	53.6	24	24	186.43	19.8
BSSLF5024FCCL	3431	65.6	24	24	231.53	25.2

BSSLFxx24FCCR • Prime Tower, Right Wardrobe, Half Height Door, File File Drawers

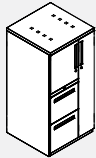

"4G" Tower Shown

- Right wardrobe tower with half height door and file file drawers.
- Wardrobe section includes top shelf and coat bar.
- Hinged door compartment of 50"h and 54"h includes one adjustable shelf; 66"h includes two adjustable open shelves.
- Wardrobe section includes top perforations for ventilation.
- Three locks included - wardrobe door, hinged door shelving compartment and drawers.
- To add counterweight (W2 option), add \$102 list.

PRODUCT CODE	PRICE	SIZE/INCHES			WEIGHT LBS	VOL FT ³
		H	W	D		
BSSLF4G24FCCR	3260	49.6	24	24	181.05	19.2
BSSLF4H24FCCR	3260	53.6	24	24	186.43	19.8
BSSLF5024FCCR	3431	65.6	24	24	231.53	25.2

BSSLSxx2424BOCL • Prime Tower, Left Wardrobe, Side Open Shelf, Box Box File Drawers

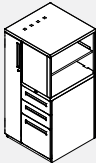

"4G" Tower Shown

- Left wardrobe tower with side open shelving and box box file drawers.
- Wardrobe section includes top shelf and coat bar.
- 50"h and 54"h include open side shelf with one adjustable shelf; 66"h includes open side shelf with two adjustable shelves.
- Wardrobe section includes top perforations for ventilation.
- Two locks included - wardrobe door and drawers.

PRODUCT CODE	PRICE	SIZE/INCHES			WEIGHT LBS	VOL FT ³
		H	W	D		
BSSLS4G2424BOCL	3475	49.6	24	24	186.18	19.2
BSSLS4H2424BOCL	3475	53.6	24	24	186.91	19.8
BSSLS502424BOCL	3684	65.6	24	24	236.34	25.2

BSSLSxx2424BOCR • Prime Tower, Right Wardrobe, Side Open Shelf, Box Box File Drawers

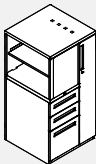

"4G" Tower Shown

- Right wardrobe tower with side open shelving and box box file drawers.
- Wardrobe section includes top shelf and coat bar.
- 50"h and 54"h include open side shelf with one adjustable shelf; 66"h includes open side shelf with two adjustable shelves.
- Wardrobe section includes top perforations for ventilation.
- Two locks included - wardrobe door and drawers.

PRODUCT CODE	PRICE	SIZE/INCHES			WEIGHT LBS	VOL FT ³
		H	W	D		
BSSLS4G2424BOCR	3392	49.6	24	24	186.18	19.2
BSSLS4H2424BOCR	3392	53.6	24	24	186.91	19.8
BSSLS502424BOCR	3601	65.6	24	24	236.34	25.2

BSSLSxx2424FOCL • Prime Tower, Left Wardrobe, Side Open Shelf, File File Drawers

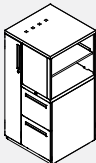

"4G" Tower Shown

- Left wardrobe tower with side open shelving and file file drawers.
- Wardrobe section includes top shelf and coat bar.
- 50"h and 54"h include open side shelf with one adjustable shelf; 66"h includes open side shelf with two adjustable shelves.
- Wardrobe section includes top perforations for ventilation.
- Two locks included - wardrobe door and drawers.

PRODUCT CODE	PRICE	SIZE/INCHES			WEIGHT LBS	VOL FT ³
		H	W	D		
BSSLS4G2424FOCL	3392	49.6	24	24	179.54	19.2
BSSLS4H2424FOCL	3392	53.6	24	24	180.26	19.8
BSSLS502424FOCL	3601	65.6	24	24	232.55	25.2

BSSLSxx2424FOCR • Prime Tower, Right Wardrobe, Side Open Shelf, File File Drawers

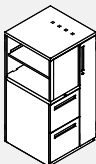

"4G" Tower Shown

- Right wardrobe tower with side open shelving and file file drawers.
- Wardrobe section includes top shelf and coat bar.
- 50"h and 54"h include open side shelf with one adjustable shelf; 66"h includes open side shelf with two adjustable shelves.
- Wardrobe section includes top perforations for ventilation.
- Two locks included - wardrobe door and drawers.

PRODUCT CODE	PRICE	SIZE/INCHES			WEIGHT LBS	VOL FT ³
		H	W	D		
BSSLS4G2424FOCR	3392	49.6	24	24	179.54	19.2
BSSLS4H2424FOCR	3392	53.6	24	24	180.26	19.8
BSSLS502424FOCR	3601	65.6	24	24	232.55	25.2

BSWC51C18xxC • Prime Wardrobe

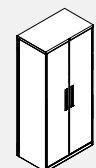

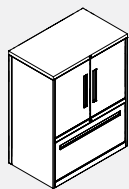
BSCC31G18xxC • Prime Three High Combination Cabinet

- Multi stor cabinet including hinged door upper section with one adjustable shelf; one fixed front file drawers below.
- Will not line up to 42" high panels.
- Locking.

PRODUCT CODE	PRICE	SIZE/INCHES			WEIGHT LBS	VOL FT ³
		H	W	D		
BSCC31G1830C	1664	39.2	30	18	117.3	14.5
BSCC31G1836C	1767	39.2	36	18	135.5	17.2
BSCC31G1842C	1869	39.2	42	18	152.5	20.0

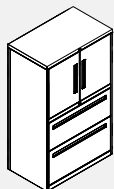
BSCC41G18xxC • Prime Four High Combination Cabinet

- Multi stor cabinet including hinged door upper section with one adjustable shelf; two fixed front file drawers below, lines up to 50" high panels.
- Locking.
- To add counterweight (W2 option), add \$195 list.

PRODUCT CODE	PRICE	SIZE/INCHES			WEIGHT LBS	VOL FT ³
		H	W	D		
BSCC41G1830C	2064	49.6	30	18	149.96	18.2
BSCC41G1836C	2201	49.6	36	18	172.96	21.6
BSCC41G1842C	2333	49.6	42	18	195.36	25.1

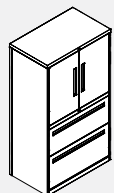
BSCC41H18xxC • Prime Four High Combination Cabinet

- Multi stor cabinet including hinged door upper section with one adjustable shelf; two fixed front file drawers below, lines up to 54" high panels.
- Locking.
- To add counterweight (W2 option), add \$195 list.

PRODUCT CODE	PRICE	SIZE/INCHES			WEIGHT LBS	VOL FT ³
		H	W	D		
BSCC41H1830C	2133	53.6	30	18	154.54	19.6
BSCC41H1836C	2264	53.6	36	18	178.54	23.3
BSCC41H1842C	2396	53.6	42	18	202.04	27.0

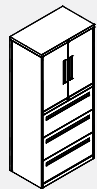
BSCC31C18xxC • Prime Five High Combination Cabinet

- Multi stor cabinet including hinged door upper section with one adjustable shelf; three fixed front file drawers below.
- Locking.
- To add counterweight (W2 option), add \$195 list.

PRODUCT CODE	PRICE	SIZE/INCHES			WEIGHT LBS	VOL FT ³
		H	W	D		
BSCC51C1830C	2518	65.6	30	18	188.5	23.9
BSCC51C1836C	2679	65.6	36	18	216.9	28.4
BSCC51C1842C	2840	65.6	42	18	245.5	32.9

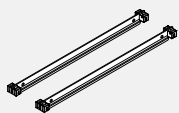
BSLFA0718 • Prime Front to Back File Bars

- Package of two, grey finish.

PRODUCT CODE	PRICE	SIZE/INCHES			WEIGHT LBS	VOL FT ³
		H	W	D		
BSLFA0718	45	1	17.3	1	1	0.04

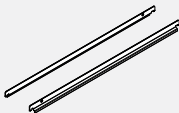
BSLFS • Prime Hanging File Bars

- Package of two, grey finish.

PRODUCT CODE	PRICE	SIZE/INCHES			WEIGHT LBS	VOL FT ³
		H	W	D		
BSLFA01	48	1.3	27.5	0.5	2	0.03
BSLFA02	48	1.3	33.5	0.5	2.4	0.04
BSLFA03	48	1.3	39.5	0.5	2.8	0.05

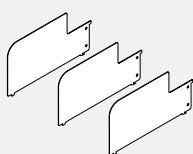
BSLFA1018 • Prime Plate Dividers

- Package of three, grey finish.

PRODUCT CODE	PRICE	SIZE/INCHES			WEIGHT LBS	VOL FT ³
		H	W	D		
BSLFA1018	49	7.25	13.5	0.2	4	0.07

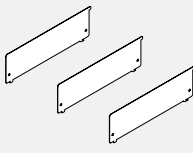
BSLFA2418 • Prime Half Height Plate Dividers

- Package of three, grey finish.

PRODUCT CODE	PRICE	SIZE/INCHES			WEIGHT LBS	VOL FT ³
		H	W	D		
BSLFA2418	49	3.95	13.5	0.2	2.2	0.04

BSLFA2018 • Prime EDP Adapters

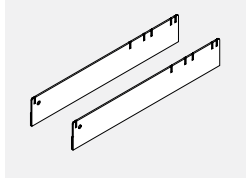

PRODUCT CODE	PRICE	SIZE/INCHES			WEIGHT LBS	VOL FT ³
		H	W	D		
BSLFA2018	49	2.6	16.5	0.15	2.5	0.02

BSEK93 / BSCK093 • Keys and Replacement Lock Core (Profile 9300 Series)

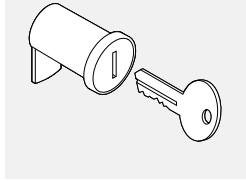

- BSEK93 - Set of two extra keys for existing 9300 Series storage. Specify core #. Key range W401-W550.
- BSCK093 - Includes one lock core and a set of two keys for 9300 Series storage. Specify core #. Key range W401-W550.

PRODUCT CODE	PRICE	SIZE/INCHES			WEIGHT LBS	VOL FT ³
		H	W	D		
BSEK93 EXTRA KEY	19	1.75	0.75	0.2	0.2	0.01
BSCK093 LOCK CORE & KEY	31	2	1	0.5	0.4	0.01

BSKY / BSKC • Keys and Replacement Lock Core (Fileco Prime Series)

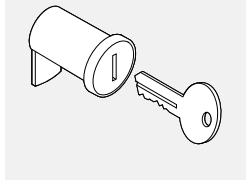

- BSKY - Set of two extra keys for existing Prime storage. Specify core #. Key range W401-W550.
- BSKC - Includes one lock core and a set of two keys for Prime storage. Specify core #. Key range W401-W550.

PRODUCT CODE	PRICE	SIZE/INCHES			WEIGHT LBS	VOL FT ³
		H	W	D		
BSKY EXTRA KEY	13	1.75	0.75	0.2	0.2	0.01
BSKC LOCK CORE & KEY	30	2	1	0.5	0.4	0.01

BSSA • Prime Extra Cabinet Shelves

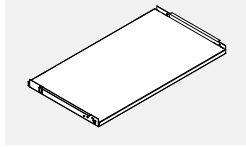

- Shelf, non-slotted.

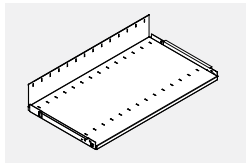

- Shelf, slotted.

PRODUCT CODE	PRICE	SIZE/INCHES			WEIGHT LBS	VOL FT ³
		H	W	D		
Shelf, non-slotted.						
BSSA011830	83	0.8	28.4	16	7.2	1.8
BSSA011836	93	0.8	34.4	16	8.4	2.2
BSSA011842	98	0.8	40.4	16	9.5	2.6
Shelf, slotted.						
BSSA021830	98	5.25	28.4	16	8.2	1.8
BSSA021836	114	5.25	34.4	16	9.6	2.2
BSSA021842	120	5.25	40.4	16	10.8	2.6

Diet Panel System

Diet represents an innovative tool for creating an economical, efficient work space, accommodating various tasks. From 42" high panels which provide an open office feel to 50" and 54" high panels, for seated privacy and 66" high panels for standing privacy, Diet effectively supports the creation of various work environments. Diet is simple, easy to comprehend, easy to specify and install, with a minimum of add-on and dedicated/handed components to maximize reconfiguration flexibility. All Diet panels ship with a set of self-leveling connectors that accommodate any angle, but also straight, 90°, three-way T and 120° configurations, as well as four-way "X". Truly universal connectors support the above panel configurations regardless of panel heights. Such a configuration and height independent connecting method eliminates the need to order additional components during future office reconfigurations. Diet is an economical, "soft wire" system with simple means of optional power and data/communication cable management trough that snaps to the bottom of the panel.

With the exception of panels with open area below the mid rail, all Diet panels are built with 6" clearance opening between the floor and the bottom rail. This feature not only serves as a simple passage for cables between back-to-back stations and an interface for a snap on cable trough, but it mainly provides ultimate flexibility of panel station placement even if one panel needs to be located right above a floor monument. Diet's slim appearance, sophisticated industrial design, detailing and advanced engineering communicate high perceived value, exceeding expectations usually related to budget products. Diet can be specified on its own, with integrated worksurface, storage and accessory support, privacy and space organization in free standing office environments. Whether combined with Boulevard system, or raised floors, Diet, as a tool, bridges mobile or stationary freestanding furniture with power/data delivery solutions, that are hard wired to a building power supply.

Technical Information

Panels

- Panels are 1.3" thick.
- Width ranges from 24" to 60" at 6" increments.
- Heights include 42", 50", 54" and 66" (nominal).
- Extruded aluminum frame surrounds a fabric wrapped interior with a 7/8" particle board frame, sandwiched between 2 pieces of 1/8" masonite.
- Panel frame finish is durable epoxy powder coated.
- Finished panel includes top, corner and end caps.
- For glazing - Smoke development index 500.
- For tempered glass, add "TG" to the end of the product code and add 20% to the price regardless of fabric grade.
- Top rail accepts Global Contract accessories, monitor arm supports, off-module shelves, and task light brackets.
- Top rail on Glazed Top Panels is not intended for use with panel mounted shelves and panel mounted overhead.
- Middle rail accepts bracket for off-module worksurface support, Global Contract accessories, off-module shelves and power bar.
- Bottom rail accepts brackets for off-module worksurface support, Global Contract accessories, off-module shelves and optional cable manager and power bar.

- Optional PVC cable manager friction fits into bottom rail.
- Two leveler are included with a 1.75" leveling range.
- Vertical frame members have integrated grooves for additional components.
- Charcoal covers are provided at front of vertical members where connectors attach.
- Panels include 3 sets of hinge connectors, 1 set of spacers and 6 pins.
- Connecting method is simple, accommodating typical configuration, as well as connection of panels at any angle, regardless of height.

Panel Options

- Laminate or whiteboard may be substituted for fabric on panels only, see "OPT" column.
 - Tackboard panels available, please add 25% upcharge.
 - Steel facing available, contact your customer service representative.
- Note:
- 42" High Diet panels do not match Boulevard 42"
 - 50" High Diet panels match Boulevard 50"
 - 54" High Diet panels do not match standard Boulevard 54"
 - 66" High Diet panels matches Boulevard 66"
 - To order 42" and 54" high Diet panels to match Boulevard, please order "BDPFF" and "BDPOF".

HOW DIET REDUCES YOUR COSTS

Finished Panel:

- No inventory costs for connectors, top caps, kick plates and clips.
- Less time required to install, or to disassemble, move and re-install.
- Open bottom panels can reduce cost and improve circulation within the office.

Fewer Parts:

- Only 1 universal cantilever and 3 brackets are needed to build most workstations.
- Easy to attach and remove components from panels.

Simplified Specifications:

- Fewer parts and components make specifying, ordering, and verifying less work.
- Product fits a 6" planning module.

Communications Channel:

- Base communication channel reduces time to install and change cables.

Warranty:

- Limited Lifetime Warranty on materials and workmanship.

DIET PANELS - GUIDELINES FOR ORDERING PRODUCT

Codes

The product guide uses a numbering system with meaningful alphanumeric characters to create a simple-to-understand product number. This makes specifying the product much easier and more accurate.

Example of Panel: **DPFRF6636 CHR**

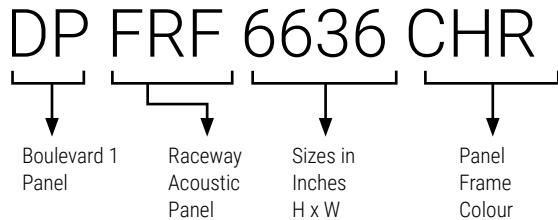

How to Specify

- Specify Diet Panel type and size by code.
- Specify panel frame finish - ie. CHR (Charcoal).
- Specify all six panel fabric options if necessary.

AN50	Inside Lower Fabric
AN50	Inside Middle Fabric
AN50	Inside Upper Fabric
BE21	Outside Lower Fabric
BE21	Outside Middle Fabric
BE21	Outside Upper Fabric

DPFF • Fabric Bottom and Fabric Top Panel

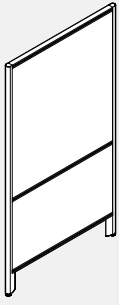

- Fabric above and below the middle rail provides visual privacy.
- Full panel with top, middle and bottom rail.
- OPT* = Laminate or Whiteboard.
- DPFF Panels do not match standard Boulevard heights of 42" and 54".
- DPFF Panels of 50" and 66" height will match standard Boulevard panel heights.

PRODUCT CODE	PRICE			SIZE/ H	INCHES			WEIGHT VOL	
	GR1	GR2	OPT*		W	D	LBS	FT ³	
DPFF4224	388	434	485	42	24	1.3	16	1.32	
DPFF4230	409	455	508	42	30	1.3	19	1.62	
DPFF4236	433	517	609	42	36	1.3	23	1.94	
DPFF4242	455	541	631	42	42	1.3	27	2.24	
DPFF4248	480	565	656	42	48	1.3	31	2.55	
DPFF4254	503	586	680	42	54	1.3	35	2.85	
DPFF4260	523	609	699	42	60	1.3	39	3.16	
DPFF5024	484	534	581	50	24	1.3	16	1.62	
DPFF5030	510	555	608	50	30	1.3	21	2.08	
DPFF5036	537	649	770	50	36	1.3	25	2.47	
DPFF5042	562	673	794	50	42	1.3	30	2.85	
DPFF5048	590	701	824	50	48	1.3	35	3.25	
DPFF5054	614	726	850	50	54	1.3	40	3.63	
DPFF5060	641	754	874	50	60	1.3	45	4.02	
DPFF5424	484	534	581	54	24	1.3	18	1.62	
DPFF5430	510	555	608	54	30	1.3	23	2.08	
DPFF5436	537	649	770	54	36	1.3	27	2.47	
DPFF5442	562	673	794	54	42	1.3	32	2.85	
DPFF5448	590	701	824	54	48	1.3	37	3.25	
DPFF5454	614	726	850	54	54	1.3	42	3.63	
DPFF5460	641	754	874	54	60	1.3	47	4.02	
DPFF6624	527	604	683	66	24	1.3	23	2.04	
DPFF6630	557	633	714	66	30	1.3	29	2.52	
DPFF6636	589	699	823	66	36	1.3	35	3.00	
DPFF6642	619	731	852	66	42	1.3	41	3.46	
DPFF6648	645	758	880	66	48	1.3	47	3.93	
DPFF6654	672	785	907	66	54	1.3	53	4.40	
DPFF6660	699	814	935	66	60	1.3	59	4.90	

BDPFF • Fabric Bottom and Fabric Top Panel to Match Boulevard Panels

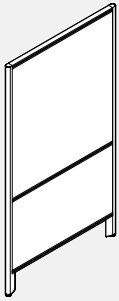

- Fabric above and below the middle rail provides visual privacy.
- Full panel with top, middle and bottom rail.
- OPT* = Laminate or Whiteboard
- Panels will match corresponding Boulevard Panel heights.

PRODUCT CODE	PRICE			SIZE/ H	INCHES			WEIGHT VOL	
	GR1	GR2	OPT*		W	D	LBS	FT ³	
BDPFF4224	388	434	485	42	24	1.3	16	1.32	
BDPFF4230	409	455	508	42	30	1.3	19	1.62	
BDPFF4236	433	517	609	42	36	1.3	23	1.94	
BDPFF4242	455	541	631	42	42	1.3	27	2.24	
BDPFF4248	480	565	656	42	48	1.3	31	2.55	
BDPFF4254	503	586	680	42	54	1.3	35	2.85	
BDPFF4260	523	609	699	42	60	1.3	39	3.16	
BDPFF5424	484	534	581	54	24	1.3	18	1.62	
BDPFF5430	510	555	608	54	30	1.3	23	2.08	
BDPFF5436	537	649	770	54	36	1.3	27	2.47	
BDPFF5442	562	673	794	54	42	1.3	32	2.85	
BDPFF5448	590	701	824	54	48	1.3	37	3.25	
BDPFF5454	614	726	850	54	54	1.3	42	3.63	
BDPFF5460	641	754	874	54	60	1.3	47	4.02	

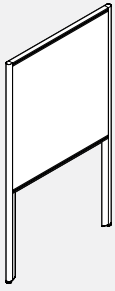
DPOF • Open Bottom and Fabric Top Panel

- Fabric above the middle rail provides visual privacy.
- Panel with top and middle rail only.
- Open bottom reduces cost and improves air circulation within the office.
- OPT* = Laminate or Whiteboard.
- DPOF Panels do not match standard Boulevard heights of 42" and 54".
- DPOF Panels of 50" and 66" height will match standard Boulevard panel heights.

PRODUCT CODE	PRICE			SIZE/ H	INCHES			WEIGHT VOL	
	GR1	GR2	OPT*		W	D	LBS	FT ³	
DPOF4224	253	268	283	42	24	1.3	9	1.32	
DPOF4230	271	284	301	42	30	1.3	12	1.62	
DPOF4236	313	342	372	42	36	1.3	15	1.94	
DPOF4242	328	354	385	42	42	1.3	17	2.24	
DPOF4248	343	372	404	42	48	1.3	19	2.55	
DPOF4254	361	388	418	42	54	1.3	22	2.85	
DPOF4260	373	404	433	42	60	1.3	24	3.16	
DPOF5024	319	349	378	50	24	1.3	10	1.62	
DPOF5030	340	369	398	50	30	1.3	13	2.08	
DPOF5036	406	462	522	50	36	1.3	16	2.47	
DPOF5042	425	483	543	50	42	1.3	19	2.85	
DPOF5048	446	503	563	50	48	1.3	21	3.25	
DPOF5054	464	521	581	50	54	1.3	25	3.63	
DPOF5060	484	542	603	50	60	1.3	28	4.02	
DPOF5424	319	349	378	54	24	1.3	12	1.62	
DPOF5430	340	369	398	54	30	1.3	15	2.08	
DPOF5436	406	462	522	54	36	1.3	18	2.47	
DPOF5442	425	483	543	54	42	1.3	21	2.85	
DPOF5448	446	503	563	54	48	1.3	24	3.25	
DPOF5454	464	521	581	54	54	1.3	27	3.63	
DPOF5460	484	542	603	54	60	1.3	30	4.02	
DPOF6624	389	448	508	66	24	1.3	17	2.04	
DPOF6630	412	472	534	66	30	1.3	21	2.52	
DPOF6636	485	543	604	66	36	1.3	25	3.00	
DPOF6642	536	591	653	66	42	1.3	29	3.46	
DPOF6648	561	615	678	66	48	1.3	33	3.93	
DPOF6654	582	641	699	66	54	1.3	37	4.40	
DPOF6660	607	661	723	66	60	1.3	41	4.90	

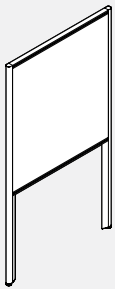
BDPOF • Open Bottom and Fabric Top Panel to Match Boulevard Panels

- Fabric above the middle rail provides visual privacy.
- Panel with top and middle rail only.
- Open bottom reduces cost and improves air circulation within the office.
- OPT* = Laminate or Whiteboard
- Panels will match corresponding Boulevard Panel heights.

PRODUCT CODE	PRICE			SIZE/ H	INCHES			WEIGHT VOL	
	GR1	GR2	OPT*		W	D	LBS	FT ³	
BDPOF4224	253	268	283	42	24	1.3	9	1.32	
BDPOF4230	271	284	301	42	30	1.3	12	1.62	
BDPOF4236	313	342	372	42	36	1.3	15	1.94	
BDPOF4242	328	354	385	42	42	1.3	17	2.24	
BDPOF4248	343	372	404	42	48	1.3	19	2.55	
BDPOF4254	361	388	418	42	54	1.3	22	2.85	
BDPOF4260	373	404	433	42	60	1.3	24	3.16	
BDPOF5424	319	349	378	54	24	1.3	12	1.62	
BDPOF5430	340	369	398	54	30	1.3	15	2.08	
BDPOF5436	406	462	522	54	36	1.3	18	2.47	
BDPOF5442	425	483	543	54	42	1.3	21	2.85	
BDPOF5448	446	503	563	54	48	1.3	24	3.25	
BDPOF5454	464	521	581	54	54	1.3	27	3.63	
BDPOF5460	484	542	603	54	60	1.3	30	4.02	

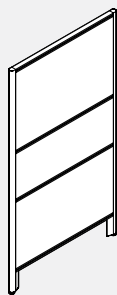
DPFRF • Fabric Bottom, Middle and Top Panel

- Fabric above, below and between the middle rails provides visual privacy.
- Full panel with additional rail at 42" high.
- Upper middle rail accepts Global Contract Accessories, Monitor Arm Support and Off-Module Shelves.
- OPT* = Laminate or Whiteboard

PRODUCT CODE	PRICE			SIZE/ H	INCHES			WEIGHT VOL	
	GR1	GR2	OPT*		W	D	LBS	FT ³	
DPFRF5024	509	553	607	50	24	1.3	16	1.62	
DPFRF5030	537	569	604	50	30	1.3	21	2.08	
DPFRF5036	563	621	681	50	36	1.3	25	2.47	
DPFRF5042	591	658	731	50	42	1.3	30	2.85	
DPFRF5048	621	705	796	50	48	1.3	35	3.25	
DPFRF5054	645	727	823	50	54	1.3	40	3.63	
DPFRF5060	672	774	879	50	60	1.3	45	4.02	
DPFRF5424	509	553	607	54	24	1.3	18	1.62	
DPFRF5430	537	569	604	54	30	1.3	23	2.08	
DPFRF5436	563	621	681	54	36	1.3	27	2.47	
DPFRF5442	591	658	731	54	42	1.3	32	2.85	
DPFRF5448	621	705	796	54	48	1.3	37	3.25	
DPFRF5454	645	727	823	54	54	1.3	42	3.63	
DPFRF5460	672	757	850	54	60	1.3	47	4.02	
DPFRF6624	553	607	659	66	24	1.3	23	2.04	
DPFRF6630	586	638	692	66	30	1.3	29	2.52	
DPFRF6636	619	701	794	66	36	1.3	35	3.00	
DPFRF6642	652	747	850	66	42	1.3	41	3.46	
DPFRF6648	678	775	877	66	48	1.3	47	3.93	
DPFRF6654	707	809	917	66	54	1.3	53	4.40	
DPFRF6660	736	879	1028	66	60	1.3	59	4.90	

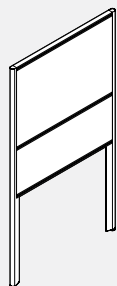
DPORF • Open Bottom Fabric Middle and Top Panel

- Fabric above the middle rail provides visual privacy.
- Open bottom panel with additional rail at 42" high.
- Upper middle rail accepts Global Contract Accessories, Monitor Arm Support and Off-Module Shelves.
- Open bottom reduces cost and improves air circulation within the office.
- OPT* = Laminate or Whiteboard

PRODUCT CODE	PRICE			SIZE/ H	INCHES			WEIGHT VOL	
	GR1	GR2	OPT*		W	D	LBS	FT ³	
DPORF5024	336	369	404	50	24	1.3	10	1.62	
DPORF5030	354	389	422	50	30	1.3	13	2.08	
DPORF5036	425	459	495	50	36	1.3	16	2.47	
DPORF5042	446	488	540	50	42	1.3	19	2.85	
DPORF5048	469	513	562	50	48	1.3	21	3.25	
DPORF5054	486	535	580	50	54	1.3	25	3.63	
DPORF5060	509	561	613	50	60	1.3	28	4.02	
DPORF5424	336	369	404	54	24	1.3	12	1.62	
DPORF5430	354	389	422	54	30	1.3	15	2.08	
DPORF5436	425	459	495	54	36	1.3	18	2.47	
DPORF5442	446	488	540	54	42	1.3	21	2.85	
DPORF5448	469	513	562	54	48	1.3	24	3.25	
DPORF5454	486	540	592	54	54	1.3	27	3.63	
DPORF5460	509	561	613	54	60	1.3	30	4.02	
DPORF6624	409	454	503	66	24	1.3	17	2.04	
DPORF6630	434	480	527	66	30	1.3	21	2.52	
DPORF6636	512	584	661	66	36	1.3	25	3.00	
DPORF6642	562	641	724	66	42	1.3	29	3.46	
DPORF6648	589	660	741	66	48	1.3	33	3.93	
DPORF6654	612	692	778	66	54	1.3	37	4.40	
DPORF6660	636	712	788	66	60	1.3	41	4.90	

DPFFG • Fabric Bottom, Middle and Glazed Top Panel

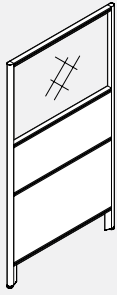

- Fabric below and between the middle rails provides visual privacy.
- Fabric bottom panel with additional rail at 28" high.
- Upper middle rail accepts Global Contract Accessories, Monitor Arm Support and Off-Module Shelves.
- Extruded aluminum frame surrounds acrylic glazing at top.
- PVC Extrusion is only Charcoal.
- For tempered glass, add "TG" to the end of the product code and add 20% to the price regardless of fabric grade.
- OPT* = Laminate or Whiteboard

PRODUCT CODE	PRICE			SIZE/ H	INCHES			WEIGHT VOL	
	GR1	GR2	OPT*		W	D	LBS	FT ³	
DPFFG5024	513	546	580	50	24	1.3	12	1.62	
DPFFG5030	562	593	629	50	30	1.3	15	2.08	
DPFFG5036	610	682	757	50	36	1.3	18	2.47	
DPFFG5042	659	731	806	50	42	1.3	21	2.85	
DPFFG5048	709	779	853	50	48	1.3	24	3.25	
DPFFG5054	759	830	907	50	54	1.3	27	3.63	
DPFFG5060	824	892	963	50	60	1.3	30	4.02	
DPFFG5424	513	546	580	54	24	1.3	17	1.62	
DPFFG5430	562	593	629	54	30	1.3	21	2.08	
DPFFG5436	610	682	757	54	36	1.3	25	2.47	
DPFFG5442	659	731	806	54	42	1.3	29	2.85	
DPFFG5448	709	779	853	54	48	1.3	33	3.25	
DPFFG5454	759	830	907	54	54	1.3	37	3.63	
DPFFG5460	824	894	970	54	60	1.3	41	4.02	
DPFFG6624	608	665	724	66	24	1.3	20	2.04	
DPFFG6630	673	731	791	66	30	1.3	25	2.52	
DPFFG6636	741	814	893	66	36	1.3	30	3.00	
DPFFG6642	809	883	960	66	42	1.3	35	3.46	
DPFFG6648	877	951	1028	66	48	1.3	40	3.93	
DPFFG6654	942	1017	1094	66	54	1.3	45	4.40	
DPFFG6660	1024	1108	1200	66	60	1.3	50	4.90	

DPOFG • Open Bottom, Middle Fabric and Glazed Top Panel

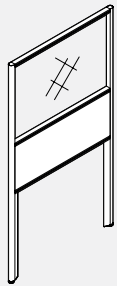

- Fabric between the middle rails.
- Open bottom panel with additional rail at 42" high.
- Upper middle rail accepts Global Contract Accessories, Monitor Arm Support and Off-Module Shelves.
- Extruded aluminum frame surrounds acrylic glazing at top.
- PVC Extrusion is only Charcoal.
- For tempered glass, add "TG" to the end of the product code and add 20% to the price regardless of fabric grade.
- OPT* = Laminate or Whiteboard

PRODUCT CODE	PRICE			SIZE/ H	INCHES			WEIGHT VOL	
	GR1	GR2	OPT*		W	D	LBS	FT ³	
DPOFG5024	405	418	433	50	24	1.3	14	1.62	
DPOFG5030	442	455	472	50	30	1.3	17	2.08	
DPOFG5036	478	490	508	50	36	1.3	20	2.47	
DPOFG5042	517	534	546	50	42	1.3	24	2.85	
DPOFG5048	553	569	582	50	48	1.3	27	3.25	
DPOFG5054	592	622	653	50	54	1.3	30	3.63	
DPOFG5060	636	665	694	50	60	1.3	34	4.02	
DPOFG5424	405	418	433	54	24	1.3	14	1.62	
DPOFG5430	442	455	472	54	30	1.3	17	2.08	
DPOFG5436	478	490	508	54	36	1.3	20	2.47	
DPOFG5442	517	534	546	54	42	1.3	24	2.85	
DPOFG5448	553	569	582	54	48	1.3	27	3.25	
DPOFG5454	592	622	653	54	54	1.3	30	3.63	
DPOFG5460	636	665	694	54	60	1.3	34	4.02	
DPOFG6624	505	517	535	66	24	1.3	17	2.04	
DPOFG6630	561	574	589	66	30	1.3	21	2.52	
DPOFG6636	619	647	678	66	36	1.3	25	3.00	
DPOFG6642	659	689	720	66	42	1.3	29	3.46	
DPOFG6648	718	747	778	66	48	1.3	33	3.93	
DPOFG6654	773	800	829	66	54	1.3	37	4.40	
DPOFG6660	833	863	893	66	60	1.3	41	4.90	

DPFG • Fabric Bottom and Glazed Top Panel

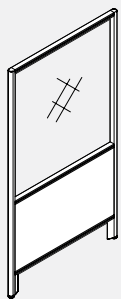

- **Fabric between the middle rails.**
- Open bottom panel with additional rail at 42" high.
- Upper middle rail accepts Global Contract Accessories, Monitor Arm Support and Off-Module Shelves.
- Open bottom reduces cost and improves air circulation within the office.
- Extruded aluminum frame surrounds acrylic glazing at top.
- PVC Extrusion is only Charcoal.
- For tempered glass, add "TG" to the end of the product code and add 20% to the price regardless of fabric grade.
- OPT* = Laminate or Whiteboard

PRODUCT CODE	PRICE			SIZE/ INCHES			WEIGHT VOL	
	GR1	GR2	OPT*	H	W	D	LBS	FT³
DPFG4224	555	575	595	42	24	1.3	11	1.32
DPFG4230	603	621	641	42	30	1.3	14	1.62
DPFG4236	655	672	693	42	36	1.3	16	1.94
DPFG4242	697	755	816	42	42	1.3	18	2.24
DPFG4248	746	802	863	42	48	1.3	21	2.55
DPFG4254	796	853	915	42	54	1.3	23	2.85
DPFG4260	842	897	959	42	60	1.3	26	3.16
DPFG5024	671	689	712	50	24	1.3	12	1.62
DPFG5030	724	745	763	50	30	1.3	15	2.08
DPFG5036	774	790	812	50	36	1.3	18	2.47
DPFG5042	826	884	943	50	42	1.3	21	2.85
DPFG5048	874	931	994	50	48	1.3	24	3.25
DPFG5054	926	984	1043	50	54	1.3	27	3.63
DPFG5060	976	1034	1094	50	60	1.3	29	4.02
DPFG5424	671	689	712	54	24	1.3	13	1.62
DPFG5430	724	745	763	54	30	1.3	16	2.08
DPFG5436	774	790	812	54	36	1.3	20	2.47
DPFG5442	826	884	943	54	42	1.3	23	2.85
DPFG5448	874	931	994	54	48	1.3	26	3.25
DPFG5454	926	984	1043	54	54	1.3	29	3.63
DPFG5460	976	1034	1094	54	60	1.3	32	4.02
DPFG6624	727	748	770	66	24	1.3	17	2.04
DPFG6630	784	802	824	66	30	1.3	21	2.52
DPFG6636	837	894	955	66	36	1.3	24	3.00
DPFG6642	892	949	1007	66	42	1.3	28	3.46
DPFG6648	943	1000	1062	66	48	1.3	32	3.93
DPFG6654	999	1057	1118	66	54	1.3	36	4.40
DPFG6660	1056	1113	1173	66	60	1.3	40	4.90

DPFS • Fabric Bottom Slat Top Panel

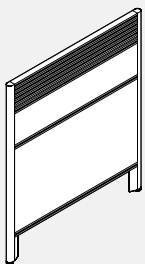

- **Integrated 6" slat rail provides flexibility of use.**
- Panel integrated slat rail accepts Global Contract Accessories, Monitor Arm Support, Off-Module Shelves, Task Light Bracket and Power Bar.
- OPT* = Laminate or Whiteboard

PRODUCT CODE	PRICE			SIZE/ INCHES			WEIGHT VOL	
	GR1	GR2	OPT*	H	W	D	LBS	FT³
DPFS4224	397	421	450	42	24	1.3	19	1.32
DPFS4230	484	510	539	42	30	1.3	23	1.62
DPFS4236	540	609	686	42	36	1.3	28	1.94
DPFS4242	589	658	734	42	42	1.3	33	2.24
DPFS4248	634	707	781	42	48	1.3	37	2.55
DPFS4254	687	757	831	42	54	1.3	42	2.85
DPFS4260	733	804	880	42	60	1.3	47	3.16

DPFSF • Fabric Bottom, Slat Middle and Fabric Top Panel

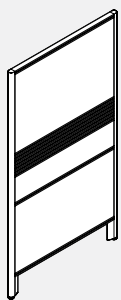

- **Integrated 6" slat rail between the middle rails provides flexibility of use. Fabric at the top provides visual privacy.**
- Panel integrated slat rail accepts Global Contract Accessories, Monitor Arm Support, Off-Module Shelves, Task Light Bracket and Power Bar.
- OPT* = Laminate or Whiteboard

PRODUCT CODE	PRICE			SIZE/ INCHES			WEIGHT VOL	
	GR1	GR2	OPT*	H	W	D	LBS	FT³
DPFSF5024	551	578	605	50	24	1.3	21	1.62
DPFSF5030	610	636	661	50	30	1.3	28	2.08
DPFSF5036	671	744	817	50	36	1.3	34	2.47
DPFSF5042	727	801	877	50	42	1.3	40	2.85
DPFSF5048	790	862	936	50	48	1.3	46	3.25
DPFSF5054	845	916	992	50	54	1.3	52	3.63
DPFSF5060	903	973	1051	50	60	1.3	58	4.02
DPFSF5424	551	578	605	54	24	1.3	23	1.62
DPFSF5430	610	636	661	54	30	1.3	30	2.08
DPFSF5436	671	744	817	54	36	1.3	36	2.47
DPFSF5442	727	801	877	54	42	1.3	42	2.85
DPFSF5448	790	862	936	54	48	1.3	48	3.25
DPFSF5454	845	916	992	54	54	1.3	54	3.63
DPFSF5460	903	973	1051	54	60	1.3	60	4.02
DPFSF6624	633	681	731	66	24	1.3	28	2.04
DPFSF6630	695	745	794	66	30	1.3	35	2.52
DPFSF6636	763	879	998	66	36	1.3	42	3.00
DPFSF6642	826	938	1061	66	42	1.3	49	3.46
DPFSF6648	888	1000	1122	66	48	1.3	56	3.93
DPFSF6654	951	1063	1182	66	54	1.3	63	4.40
DPFSF6660	1011	1123	1243	66	60	1.3	70	4.90

DPOSF • Open Bottom, Slat Middle Panel

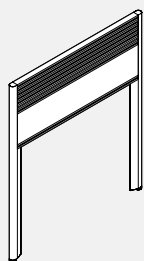

- Integrated 6" slat rail between the middle rails provides flexibility of use.
- Panel integrated slat rail accepts Global Contract Accessories, Monitor Arm Support, Off-Module Shelves, Task Light Bracket and Power Bar.
- OPT* = Laminate or Whiteboard

PRODUCT CODE	PRICE			SIZE/ INCHES			WEIGHT VOL	
	GR1	GR2	OPT*	H	W	D	LBS	FT ³
DPOSF4224	355	366	371	42	24	1.3	12	1.32
DPOSF4230	398	406	411	42	30	1.3	17	1.62
DPOSF4236	441	454	471	42	36	1.3	24	1.94
DPOSF4242	480	491	509	42	42	1.3	28	2.24
DPOSF4248	522	539	551	42	48	1.3	36	2.55
DPOSF4254	563	577	591	42	54	1.3	40	2.85
DPOSF4260	603	614	630	42	60	1.3	44	3.16

DPOSF • Open Bottom, Slat Middle and Fabric Top Panel

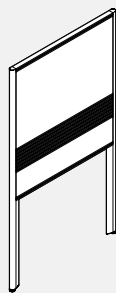

- Integrated 6" slat rail between the middle rails provides flexibility of use. Fabric above middle rail provides privacy.
- Panel integrated slat rail accepts Global Contract Accessories, Monitor Arm Support, Off-Module Shelves, Task Light Bracket and Power Bar.
- Open bottom reduces cost and improves air circulation within the office.
- OPT* = Laminate or Whiteboard

PRODUCT CODE	PRICE			SIZE/ INCHES			WEIGHT VOL	
	GR1	GR2	OPT*	H	W	D	LBS	FT ³
DPOSF5024	475	494	517	50	24	1.3	13	1.62
DPOSF5030	523	546	569	50	30	1.3	14	2.08
DPOSF5036	574	614	659	50	36	1.3	21	2.47
DPOSF5042	625	666	713	50	42	1.3	25	2.85
DPOSF5048	672	715	759	50	48	1.3	29	3.25
DPOSF5054	724	766	813	50	54	1.3	31	3.63
DPOSF5060	774	814	860	50	60	1.3	35	4.02
DPOSF5424	475	494	517	54	24	1.3	15	1.62
DPOSF5430	523	546	569	54	30	1.3	19	2.08
DPOSF5436	574	614	659	54	36	1.3	23	2.47
DPOSF5442	625	666	713	54	42	1.3	27	2.85
DPOSF5448	672	715	759	54	48	1.3	31	3.25
DPOSF5454	724	766	813	54	54	1.3	34	3.63
DPOSF5460	774	814	860	54	60	1.3	38	4.02
DPOSF6624	557	592	630	66	24	1.3	18	2.04
DPOSF6630	612	647	686	66	30	1.3	23	2.52
DPOSF6636	665	736	812	66	36	1.3	28	3.00
DPOSF6642	721	791	867	66	42	1.3	33	3.46
DPOSF6648	775	857	951	66	48	1.3	38	3.93
DPOSF6654	829	915	1004	66	54	1.3	43	4.40
DPOSF6660	883	966	1060	66	60	1.3	47	4.90

DPOSG • Open Bottom, Slat Middle and Glazed Top Panel

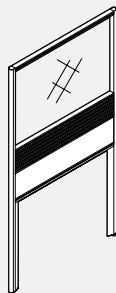

- Integrated 6" slat rail between the middle rails provides flexibility of use.
- Panel integrated slat rail accepts Global Contract Accessories, Monitor Arm Support, Off-Module Shelves, Task Light Bracket and Power Bar.
- Open bottom reduces cost and improves air circulation within the office.
- Extruded aluminum frame surrounds acrylic glazing at top.
- PVC Extrusion is only Charcoal.
- For tempered glass, add "TG" to the end of the product code and add 20% to the price regardless of fabric grade.
- OPT* = Laminate or Whiteboard

PRODUCT CODE	PRICE			SIZE/ INCHES			WEIGHT VOL	
	GR1	GR2	OPT*	H	W	D	LBS	FT ³
DPOSG5024	705	713	718	50	24	1.3	12	1.62
DPOSG5030	759	766	775	50	30	1.3	15	2.08
DPOSG5036	812	825	840	50	36	1.3	18	2.47
DPOSG5042	867	882	895	50	42	1.3	22	2.85
DPOSG5048	918	931	948	50	48	1.3	25	3.25
DPOSG5054	972	986	1000	50	54	1.3	28	3.63
DPOSG5060	1024	1037	1053	50	60	1.3	32	4.02
DPOSG5424	705	713	718	54	24	1.3	14	1.62
DPOSG5430	759	766	775	54	30	1.3	17	2.08
DPOSG5436	812	825	840	54	36	1.3	20	2.47
DPOSG5442	867	882	895	54	42	1.3	24	2.85
DPOSG5448	918	931	948	54	48	1.3	27	3.25
DPOSG5454	972	986	1000	54	54	1.3	30	3.63
DPOSG5460	1024	1037	1053	54	60	1.3	34	4.02
DPOSG6624	765	775	780	66	24	1.3	17	2.04
DPOSG6630	824	830	837	66	30	1.3	21	2.52
DPOSG6636	880	893	908	66	36	1.3	25	3.00
DPOSG6642	936	951	964	66	42	1.3	29	3.46
DPOSG6648	992	1003	1021	66	48	1.3	33	3.93
DPOSG6654	1051	1063	1079	66	54	1.3	37	4.40
DPOSG6660	1108	1122	1137	66	60	1.3	41	4.90

DPFSG • Fabric Bottom, Slat Middle and Glazed Top Panel

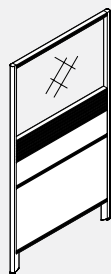

- **Integrated 6" slat rail provides flexibility of use.**
- Panel integrated slat rail accepts Global Contract Accessories, Monitor Arm Support, Off-Module Shelves, Task Light Bracket and Power Bar.
- Extruded aluminum frame surrounds acrylic glazing at top.
- PVC Extrusion is only Charcoal.
- For tempered glass, add "TG" to the end of the product code and add 20% to the price regardless of fabric grade.
- OPT* = Laminate or Whiteboard

PRODUCT CODE	PRICE			SIZE/ INCHES			WEIGHT VOL	
	GR1	GR2	OPT*	H	W	D	LBS	FT ³
DPFSG5024	774	797	825	50	24	1.3	15	1.62
DPFSG5030	831	857	885	50	30	1.3	19	2.08
DPFSG5036	892	962	1037	50	36	1.3	23	2.47
DPFSG5042	951	1022	1095	50	42	1.3	27	2.85
DPFSG5048	1004	1078	1153	50	48	1.3	31	3.25
DPFSG5054	1063	1134	1209	50	54	1.3	35	3.63
DPFSG5060	1122	1194	1267	50	60	1.3	39	4.02
DPFSG5424	774	797	825	54	24	1.3	17	1.62
DPFSG5430	831	857	885	54	30	1.3	21	2.08
DPFSG5436	892	962	1037	54	36	1.3	25	2.47
DPFSG5442	951	1022	1095	54	42	1.3	29	2.85
DPFSG5448	1004	1078	1153	54	48	1.3	33	3.25
DPFSG5454	1063	1134	1209	54	54	1.3	37	3.63
DPFSG5460	1122	1194	1267	54	60	1.3	41	4.02
DPFSG6624	840	865	893	66	24	1.3	20	2.04
DPFSG6630	903	929	956	66	30	1.3	25	2.52
DPFSG6636	962	1033	1108	66	36	1.3	30	3.00
DPFSG6642	1024	1094	1170	66	42	1.3	35	3.46
DPFSG6648	1088	1157	1234	66	48	1.3	40	3.93
DPFSG6654	1147	1218	1294	66	54	1.3	45	4.40
DPFSG6660	1212	1286	1360	66	60	1.3	50	4.90

DPOPF • Diet Over Panel

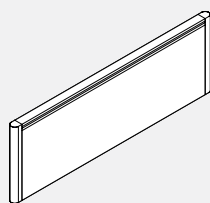

- **Over Panels attach to regular Diet Panels to provide additional visual privacy.**
- Over Panel is secured to regular Diet Panels with 4 brackets and set screws.
- Accessory loading capabilities only.
- Not for use with overhead storage.
- OPT* = Laminate or Whiteboard

PRODUCT CODE	PRICE			SIZE/ INCHES			WEIGHT VOL	
	GR1	GR2	OPT*	H	W	D	LBS	FT ³
DPOPF1224	210	224	238	12	24	1.3	5	0.30
DPOPF1230	239	252	268	12	30	1.3	7	0.60
DPOPF1236	270	299	329	12	36	1.3	8	0.75
DPOPF1242	293	320	351	12	42	1.3	9	0.88
DPOPF1248	324	352	383	12	48	1.3	11	1.00
DPOPF1254	354	384	415	12	54	1.3	12	1.13
DPOPF1260	377	406	435	12	60	1.3	13	1.25
DPOPF2424	291	319	350	24	24	1.3	10	1.00
DPOPF2430	317	344	375	24	30	1.3	14	1.25
DPOPF2436	339	380	425	24	36	1.3	16	1.45
DPOPF2442	361	401	448	24	42	1.3	18	1.75
DPOPF2448	383	425	472	24	48	1.3	22	2.00
DPOPF2454	406	449	491	24	54	1.3	24	2.25
DPOPF2460	431	473	517	24	60	1.3	26	2.50

DTMPP • Table Mounted Diet Panels

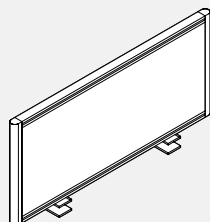

- **Creates privacy and flexibility at the end of work-surfaces.**
- Side Panels for sides of Viceversa® Tables or sides of work-surfaces available 24", and 36" widths (nominal width).
- Back Panels for sides of Viceversa® Tables available 48", 54" and 60" widths.
- Attaches with similar clamp to other clamp on accessories.
- Non tackable, non load-bearing, no hang on capabilities and not for use with transaction tops.
- Not for use with Licence product due to interference of gables and flush modesties.
- OPT* = Laminate or Whiteboard

PRODUCT CODE	PRICE			SIZE/ INCHES			WEIGHT VOL	
	GR1	GR2	OPT*	H	W	D	LBS	FT ³
SIDE PANELS								
DTMPP24	231	241	260	16.5	21	1.3	7	0.75
DTMPP30	247	262	276	16.5	27	1.3	8	0.94
DTMPP36	265	295	324	16.5	33	1.3	10	1.13
BACK PANELS								
DTMPP48	293	320	351	16.5	48	1.3	15	1.53
DTMPP54	320	350	380	16.5	54	1.3	17	1.72
DTMPP60	350	378	409	16.5	60	1.3	18	1.91

DPCBM • Panel Cable Manager

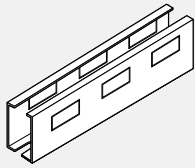

- Provides wire management for the Diet Panels.
- Extruded, dual durometer "U" channel organizes cables below panels.
- Snaps into bottom rail and into mid rail on open bottom panels.
- One data partial knock-out (2.67" wide x 1.36" high) provided on either side of the Raceway Cover accommodates terminal plates from various vendors.
- Panel Cable Manager comes in charcoal only.

PRODUCT CODE	PRICE	SIZE/ INCHES			WEIGHT VOL	
		H	W	D	LBS	FT ³
DPCBM24	16	4	18	1.3	1.3	0.07
DPCBM30	24	4	24	1.3	1.4	0.08
DPCBM36	26	4	30	1.3	1.5	0.10
DPCBM42	29	4	36	1.3	1.6	0.13
DPCBM48	31	4	42	1.3	1.7	0.15
DPCBM54	35	4	48	1.3	1.8	0.16
DPCBM60	37	4	54	1.3	1.9	0.19

DPOFM • Off Module Panel Connector

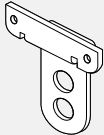

- Connects two perpendicular Diet Panels Off-Module.
- Top and bottom brackets bolt to Diet Panel verticals and engage to top and bottom rails of adjacent, perpendicular panel of even or lower height.
- Connectors can also be used to connect a panel in the middle of perpendicular DPFRR, DPORF, DPFFG, DPFSG ad DPFSF at their 42" height secondary middle rail.
- Top and bottom brackets fit in place of standard hinge connectors.
- All fasteners included.

PRODUCT CODE	PRICE	SIZE/ INCHES			WEIGHT VOL	
		H	W	D	LBS	FT ³
DPOFM	60	4	3	2	1	0.08

DPPWA • Wall Adapter

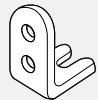
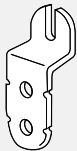

- Connects Diet Panels to walls.
- Bolts to Diet Panel vertical in place of the standard hinge connectors.
- Keyhole openings in Diet adapter slide over fasteners pre-installed to the wall.
- All fasteners included, however, the mounting hardware to affix adapter to wall not included, they will be based on type of wall material.

PRODUCT CODE	PRICE	SIZE/ INCHES			WEIGHT VOL	
		H	W	D	LBS	FT ³
DPPWA	43	40	2.5		1	0.08

DPCSTR • Casters

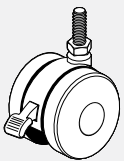

- Changes a freestanding Diet Panel to mobile.
- Must be used on two panels or more.
- Order 1 caster more than the number of panels. (Using only 1 caster where panels connect.) For example, 3 panels, 4 casters or 2 panels, 3 casters.
- Casters raise Diet Panels by a height of 1.1".

PRODUCT CODE	PRICE	SIZE/ INCHES			WEIGHT VOL	
		H	W	D	LBS	FT ³
DPCSTR	12	1.5	1.5	1.5	.25	1.02

DPLTSBKIT • Telescopic Sliding Kit

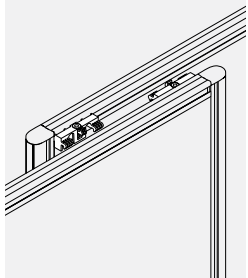

- Diet Telescopic Sliding Kit flexibly connects two standard parallel Diet panels and forms a length-adjustable partition.
- Kit consists of two top and two bottom sliding box assemblies and all the necessary connecting hardware.
- Made of black injection molded resin.
- The panels must be of the same height and equipped with top and bottom standard Diet extrusions.
- The kit can be installed as right or left on site, determining the direction of nesting/sliding.
- The kit offsets the parallel panel and the resulting gap is 12.5mm (½")
- Up to three standard Diet panels can be connected to form the length-adjustable partition.
- The kit is not intended to be used in place of a sliding door.
- The kit cannot be used with Diet overpanels or Diet Linking Panels.

PRODUCT CODE	PRICE	SIZE/ INCHES			WEIGHT VOL	
		H	W	D	LBS	FT ³
DPLTSBKIT	78	0.75	3	0.5	0.04	0.15

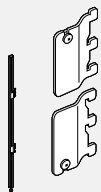
DBSCB • Diet to Boulevard Slot Connector

- Connects a Diet Panel to a Boulevard Panel via slots eliminating the need for the Boulevard Post and reducing the overall length and cost of a panel run.
- Connector can be installed in left or right configuration.
- Comes as a pair (Upper and lower brackets).
- Worksurfaces should be ordered based on application keeping in mind that this connector will align to the left or right of the end of the Boulevard Panel.
- Application drawings and layout must be provided for specials.

PRODUCT CODE	PRICE	SIZE/ INCHES			WEIGHT VOL	
		H	W	D	LBS	FT ³
DBSCB02	58	3	0.5	00.0	1	0.05

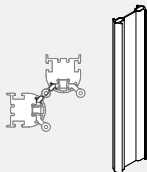
DAPPF • Diet Gap Filler

- Closes the gap between panels.
- Must be used on two or more panels.
- Order 1 DAPPF36 for a 42" high panel, 1 DAPPF36 and 1 DAPPF12 for a 54" high panel, or 1 DAPPF36 and 2 DAPPF12 for 66" high panel.

PRODUCT CODE	PRICE	SIZE/ INCHES			WEIGHT VOL	
		H	W	D	LBS	FT ³
DAPPF12	10	11.5				
DAPPF36	23	36.33				

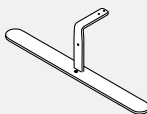
DHFFA • Single Flat Foot

- Used to create a freestanding panel
- Foot is flat to the floor with no adjustable glides
- No load capabilities on freestanding panel
- Only for use with Fabric Bottom panels
- Can be used to retro fit existing Diet panels on site
- Not for use with Diet Linking Panels
- Specify standard panel frame paint finishes

PRODUCT CODE	PRICE	SIZE/ INCHES			WEIGHT VOL	
		H	W	D	LBS	FT ³
DHFFA	100	6	20	2	3.48	0.15

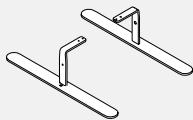
DHFFA02 • Flat Foot Kit

- Used to create a freestanding panel
- Feet are flat to the floor with no adjustable glides
- No load capabilities on freestanding panel
- Cannot be used with open bottom panels or Linking Panels.
- Can be used to retro fit existing Diet panels on site
- Not for use with Diet Linking Panels
- Specify standard panel frame paint finishes

PRODUCT CODE	PRICE	SIZE/ INCHES			WEIGHT VOL	
		H	W	D	LBS	FT ³
DHFFA02	197	6	20	2	7	0.3

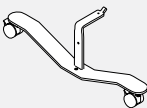
DHCFAN • Single Caster Foot

- Used to create a mobile panel
- Casters are locking
- No load capabilities on mobile panel
- Only for use with Fabric Bottom panels
- Can be used to retro fit existing Diet panels on site
- Not for use with Diet Linking Panels
- Specify standard panel frame paint finishes

PRODUCT CODE	PRICE	SIZE/ INCHES			WEIGHT VOL	
		H	W	D	LBS	FT ³
DHCFAN	131	6	20	2	3.87	0.15

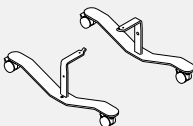
DHCFAN02 • Caster Foot Kit

- Used to create a mobile panel
- Casters are locking
- No load capabilities on mobile panel
- Only for use with Fabric Bottom panels
- Can be used to retro fit existing Diet panels on site
- Not for use with Diet Linking Panels
- Specify standard panel frame paint finishes

PRODUCT CODE	PRICE	SIZE/ INCHES			WEIGHT VOL	
		H	W	D	LBS	FT ³
DHCFAN02	261	6	20	2	7.7	0.3

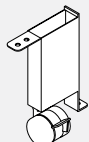
DHCFAL01 • Diet Caster Assembly Kit

- To be used on one side to create a mobile panel with DHCFAN on the other side.
- Caster is locking.
- No load capabilities on mobile panel
- Only for use with Fabric Bottom panels.
- Can be used to retrofit existing Diet panels on site.
- Not for use with Diet Linking Panels.
- Specify standard panel frame paint finishes.

PRODUCT CODE	PRICE	SIZE/ INCHES			WEIGHT VOL	
		H	W	D	LBS	FT ³
DHCFAL01	63	6	1	4.8	1	0.02

DB-P-X • Diet to Boulevard Slim Connector in "X" Configuration

- Creates a perpendicular connection between Diet Panel and Boulevard Panel that eliminates the need for special sized worksurfaces.
- Note: For use with new BDPFF & BDPOF panels.

Diet to Boulevard 1 "X" Configuration

PRODUCT CODE	PRICE	B1 HEIGHT	DIET PANEL HEIGHT	SIZE/ H	INCHES W	D	WEIGHT LBS	VOL FT ³
BDB1P4242X	132	42"	42"	42	1.3	2.6	4	0.207
BDB1P4250X	147	50"	42"	50	1.3	2.6	5	0.245
BDB1P4254X	156	54"	42"	54	1.3	2.6	5	0.264
BDB1P4258X	162	58"	42"	58	1.3	2.6	6	0.283
BDB1P4266X	178	66"	42"	66	1.3	2.6	7	0.322
BDB1P4274X	194	74"	42"	74	1.3	2.6	8	0.360
BDB1P4282X	208	82"	42"	82	1.3	2.6	9	0.399
BDB1P5050X	178	50"	50"	50	1.3	2.6	5	0.245
BDB1P5054X	178	54"	50"	54	1.3	2.6	5	0.264
BDB1P5058X	178	58"	50"	58	1.3	2.6	6	0.283
BDB1P5066X	178	66"	50"	66	1.3	2.6	7	0.322
BDB1P5074X	194	74"	50"	74	1.3	2.6	8	0.360
BDB1P5082X	208	82"	50"	82	1.3	2.6	9	0.399
BDB1P5454X	149	54"	54"	54	1.3	2.6	5	0.264
BDB1P5458X	162	58"	54"	58	1.3	2.6	6	0.283
BDB1P5466X	178	66"	54"	66	1.3	2.6	7	0.322
BDB1P5474X	194	74"	54"	74	1.3	2.6	8	0.360
BDB1P5482X	208	82"	54"	82	1.3	2.6	9	0.399
BDB1P6666X	178	66"	66"	66	1.3	2.6	7	0.322
BDB1P6674X	194	74"	66"	74	1.3	2.6	8	0.360
BDB1P6682X	208	82"	66"	82	1.3	2.6	9	0.399

Diet to System 3 "X" Configuration

PRODUCT CODE	PRICE	SYSTEM 3 HEIGHT	DIET PANEL HEIGHT	SIZE/ H	INCHES W	D	WEIGHT LBS	VOL FT ³
BDB3P4242X	132	42"	42"	42	1.3	2.6	4	0.207
BDB3P4250X	147	50"	42"	50	1.3	2.6	5	0.245
BDB3P4254X	149	54"	42"	54	1.3	2.6	6	0.260
BDB3P4266X	178	66"	42"	66	1.3	2.6	7	0.322
BDB3P5050X	178	50"	50"	50	1.3	2.6	5	0.245
BDB3P5054X	149	54"	50"	54	1.3	2.6	6	0.260
BDB3P5066X	178	66"	50"	66	1.3	2.6	7	0.322
BDB3P5454X	149	54"	54"	54	1.3	2.6	6	0.260
BDB3P5466X	178	66"	54"	66	1.3	2.6	7	0.322
BDB3P6666X	178	66"	66"	66	1.3	2.6	7	0.322

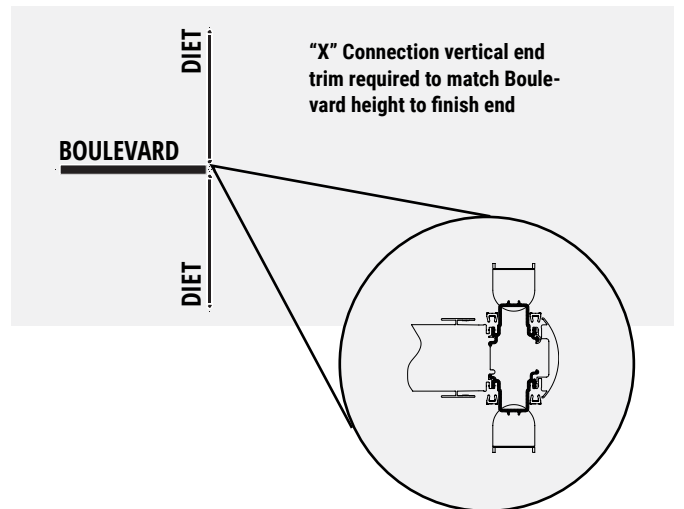
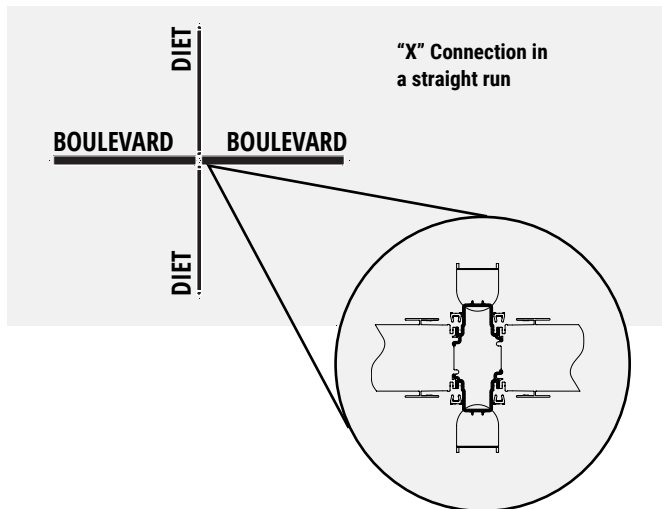

* Please specify separate end trim (round or flat) to close end.

DBXP-T • Diet to Boulevard Slim Connector in "T" Configuration

- Creates a perpendicular connection between Diet Panel and Boulevard Panel that eliminates the need for special sized worksurfaces.
- Note: For use with new BDPFF & BDPOF panels.

Diet to Boulevard 1 "T" Configuration

PRODUCT CODE	PRICE	B1 HEIGHT	DIET PANEL HEIGHT	SIZE/ H	INCHES W	D	WEIGHT LBS	VOL FT ³
BDB1P4242T	132	42"	42"	42	1.3	2.6	4	0.207
BDB1P4250T	147	50"	42"	50	1.3	2.6	5	0.245
BDB1P4254T	156	54"	42"	54	1.3	2.6	5	0.264
BDB1P4258T	162	58"	42"	58	1.3	2.6	6	0.283
BDB1P4266T	178	66"	42"	66	1.6	2.6	7	0.322
BDB1P4274T	194	74"	42"	74	1.3	2.6	8	0.360
BDB1P4282T	208	82"	42"	82	1.3	2.6	9	0.399
BDB1P5050T	178	50"	50"	50	1.3	2.6	5	0.245
BDB1P5054T	178	54"	50"	54	1.3	2.6	5	0.264
BDB1P5058T	178	58"	50"	58	1.3	2.6	6	0.283
BDB1P5066T	178	66"	50"	66	1.3	2.6	7	0.322
BDB1P5074T	194	74"	50"	74	1.3	2.6	8	0.360
BDB1P5082T	208	82"	50"	82	1.3	2.6	9	0.399
BDB1P5454T	149	54"	54"	54	1.3	2.6	6	0.245
BDB1P5458T	162	58"	54"	58	1.3	2.6	6	0.283
BDB1P5466T	178	66"	54"	66	1.3	2.6	7	0.322
BDB1P5474T	194	74"	54"	74	1.3	2.6	8	0.360
BDB1P5482T	208	82"	54"	82	1.3	2.6	9	0.399
BDB1P6666T	178	66"	66"	66	1.3	2.6	7	0.322
BDB1P6674T	194	74"	66"	74	1.3	2.6	8	0.360
BDB1P6682T	208	82"	66"	82	1.3	2.6	9	0.399

Diet to System 3 "T" Configuration

PRODUCT CODE	PRICE	SYSTEM 3 HEIGHT	DIET PANEL HEIGHT	SIZE/ H	INCHES W	D	WEIGHT LBS	VOL FT ³
BDB3P4242T	132	42"	42"	42	1.3	2.6	4	0.207
BDB3P4250T	147	50"	42"	50	1.3	2.6	5	0.245
BDB3P4254T	149	54"	42"	54	1.3	2.6	6	0.245
BDB3P4266T	178	66"	42"	66	1.3	2.6	7	0.322
BDB3P5050T	178	50"	50"	50	1.3	2.6	5	0.245
BDB3P5054T	149	54"	50"	54	1.3	2.6	6	0.245
BDB3P5066T	178	66"	50"	66	1.3	2.6	7	0.322
BDB3P5454T	149	54"	54"	54	1.3	2.6	6	0.245
BDB3P5466T	178	66"	54"	66	1.3	2.6	7	0.322
BDB3P6666T	178	66"	66"	66	1.3	2.6	7	0.322

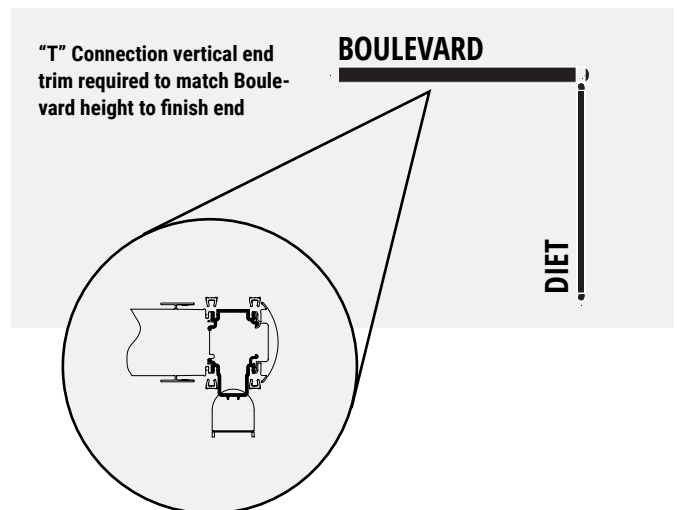
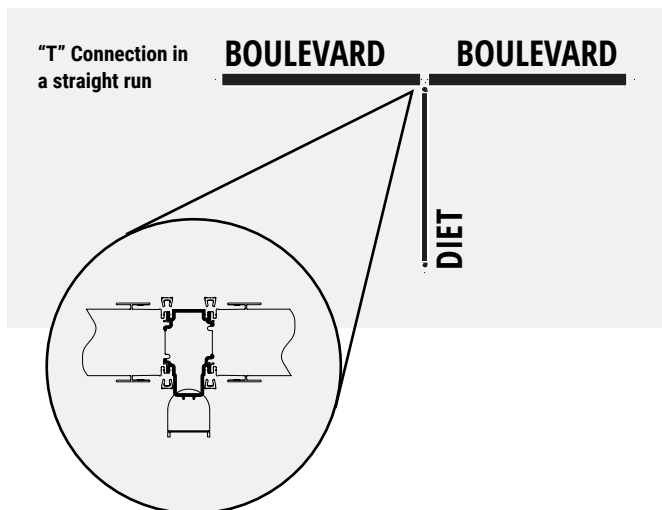

* Please specify separate end trim (round or flat) to close end.

DB-P-X • Diet to Boulevard Slim Connector in “X” Configuration

- Creates a perpendicular connection between Diet Panel and Boulevard Panel that eliminates the need for special sized worksurfaces.
- Note: For use with regular DP panels.

Diet to Boulevard 1 “X” Configuration

PRODUCT CODE	PRICE	B1 HEIGHT	DIET PANEL HEIGHT	SIZE/ H	INCHES W	D	WEIGHT LBS	VOL FT ³
DB1P4242X	132	42"	42"	42	1.3	2.6	4	0.207
DB1P4250X	147	50"	42"	50	1.3	2.6	5	0.245
DB1P4254X	159	54"	42"	54	1.3	2.6	6	0.266
DB1P4266X	178	66"	42"	66	1.3	2.6	7	0.322
DB1P4274X	194	74"	42"	74	1.3	2.6	8	0.360
DB1P4282X	208	82"	42"	82	1.3	2.6	9	0.399
DB1P5050X	178	50"	50"	50	1.3	2.6	5	0.245
DB1P5054X	178	54"	50"	54	1.3	2.6	6	0.266
DB1P5058X	178	58"	50"	58	1.3	2.6	6	0.283
DB1P5066X	178	66"	50"	66	1.3	2.6	7	0.322
DB1P5074X	194	74"	50"	74	1.3	2.6	8	0.360
DB1P5082X	208	82"	50"	82	1.3	2.6	9	0.399
DB1P5458X	162	58"	54"	58	1.3	2.6	6	0.283
DB1P5466X	178	66"	54"	66	1.3	2.6	7	0.322
DB1P5474X	194	74"	54"	74	1.3	2.6	8	0.360
DB1P5482X	208	82"	54"	82	1.3	2.6	9	0.399
DB1P6666X	178	66"	66"	66	1.3	2.6	7	0.322
DB1P6674X	194	74"	66"	74	1.3	2.6	8	0.360
DB1P6682X	208	82"	66"	82	1.3	2.6	9	0.399

Diet to System 3 “X” Configuration

PRODUCT CODE	PRICE	SYSTEM 3 HEIGHT	DIET PANEL HEIGHT	SIZE/ H	INCHES W	D	WEIGHT LBS	VOL FT ³
DB3P4242X	132	42"	42"	42	1.3	2.6	4	0.207
DB3P4250X	147	50"	42"	50	1.3	2.6	5	0.245
DB3P4266X	178	66"	42"	66	1.3	2.6	7	0.322
DB3P5050X	178	50"	50"	50	1.3	2.6	5	0.245
DB3P5066X	178	66"	50"	66	1.3	2.6	7	0.322
DB3P5466X	178	66"	54"	66	1.3	2.6	7	0.322
DB3P5454X	178	54"	54"	54	1.3	2.6	6	0.266
DB3P6666X	178	66"	66"	66	1.3	2.6	7	0.322

Diet to Boulevard 1 Overpanels

PRODUCT CODE	PRICE	OVERPANEL HEIGHT	SIZE/ H	INCHES W	D	WEIGHT LBS	VOL FT ³
DB1OPPC08X	60	8"	8	1.3	2.6	0.8	0.043
DB1OPPC16X	64	16"	16	1.3	2.6	1.6	0.082
DB1OPPC24X	66	24"	24	1.3	2.6	2.5	0.120
DB1OPPC37X	74	37"	37	1.3	2.6	3.5	0.183
DB1OPPC42X	83	42"	42	1.3	2.6	4.0	0.207

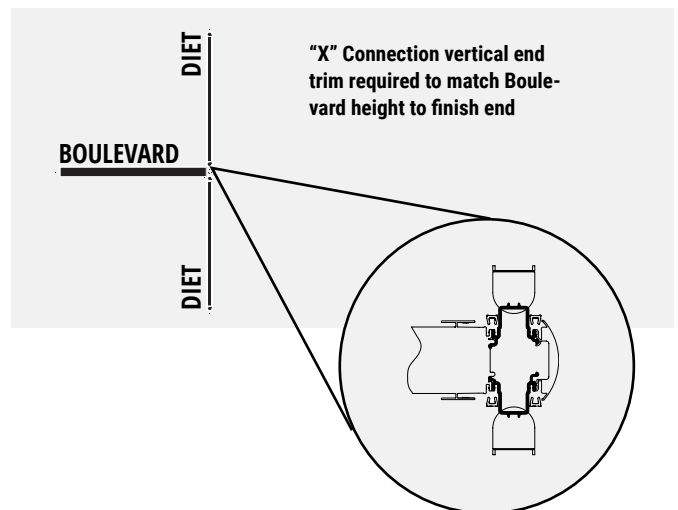
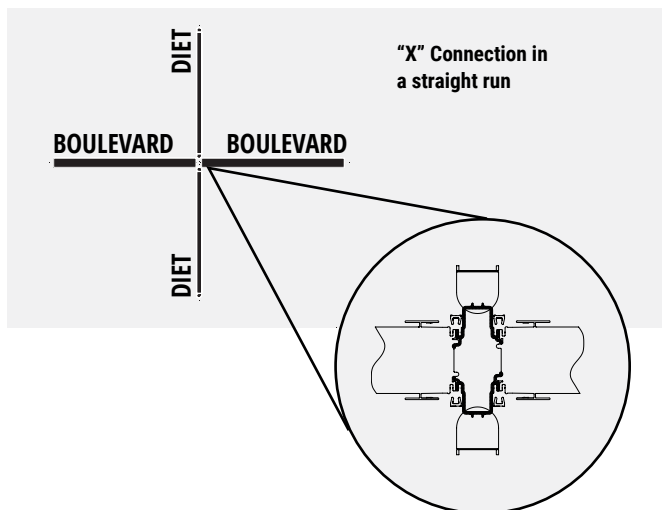

DBXP-T • Diet to Boulevard Slim Connector in “T” Configuration

- Creates a perpendicular connection between Diet Panel and Boulevard Panel that eliminates the need for special sized worksurfaces.
- Note: For use with regular DP panels.

Diet to Boulevard 1 “T” Configuration

PRODUCT CODE	PRICE	B1 HEIGHT	DIET PANEL HEIGHT	SIZE/ H	INCHES W	D	WEIGHT LBS	VOL FT ³
DB1P4242T	132	42"	42"	42	1.3	2.6	4	0.207
DB1P4250T	147	50"	42"	50	1.3	2.6	5	0.245
DB1P4258T	162	58"	42"	58	1.3	2.6	6	0.283
DB1P4266T	178	66"	42"	66	1.6	2.6	7	0.322
DB1P4274T	194	74"	42"	74	1.3	2.6	8	0.360
DB1P4282T	208	82"	42"	82	1.3	2.6	9	0.399
DB1P5050T	178	50"	50"	50	1.3	2.6	5	0.245
DB1P5058T	178	58"	50"	58	1.3	2.6	6	0.283
DB1P5066T	178	66"	50"	66	1.3	2.6	7	0.322
DB1P5074T	194	74"	50"	74	1.3	2.6	8	0.360
DB1P5082T	208	82"	50"	82	1.3	2.6	9	0.399
DB1P5458T	162	58"	54"	58	1.3	2.6	6	0.283
DB1P5466T	178	66"	54"	66	1.3	2.6	7	0.322
DB1P5474T	194	74"	54"	74	1.3	2.6	8	0.360
DB1P5482T	208	82"	54"	82	1.3	2.6	9	0.399
DB1P6666T	178	66"	66"	66	1.3	2.6	7	0.322
DB1P6674T	194	74"	66"	74	1.3	2.6	8	0.360
DB1P6682T	208	82"	66"	82	1.3	2.6	9	0.399

Diet to System 3 “T” Configuration

PRODUCT CODE	PRICE	SYSTEM 3 HEIGHT	DIET PANEL HEIGHT	SIZE/ H	INCHES W	D	WEIGHT LBS	VOL FT ³
DB3P4242T	132	42"	42"	42	1.3	2.6	4	0.207
DB3P4250T	147	50"	42"	50	1.3	2.6	5	0.245
DB3P4266T	178	66"	42"	66	1.3	2.6	7	0.322
DB3P5050T	178	50"	50"	50	1.3	2.6	5	0.245
DP3P5066T	178	66"	50"	66	1.3	2.6	7	0.322
DB3P5466T	178	66"	54"	66	1.3	2.6	7	0.322
DB3P6666T	178	66"	66"	66	1.3	2.6	7	0.322

Diet to System 3 Overpanels

PRODUCT CODE	PRICE	OVERPANEL HEIGHT	SIZE/ H	INCHES W	D	WEIGHT LBS	VOL FT ³
DB30PPC16	64	16"	16	1.3	2.6	1.6	0.082
DB30PPC32	74	32"	32	1.3	2.6	3.2	0.159

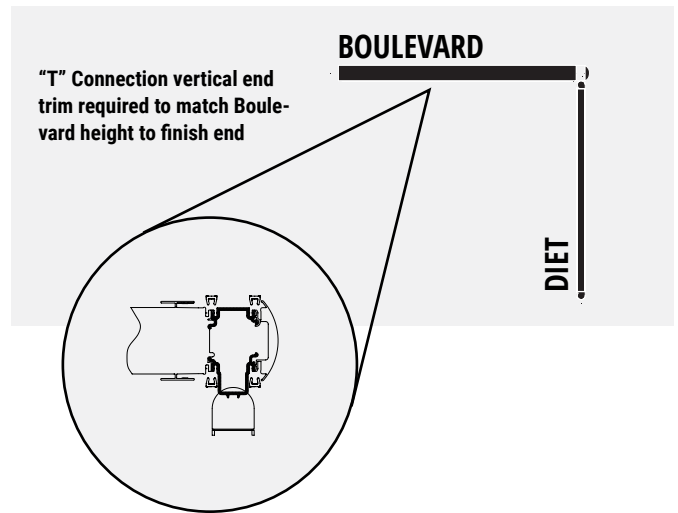
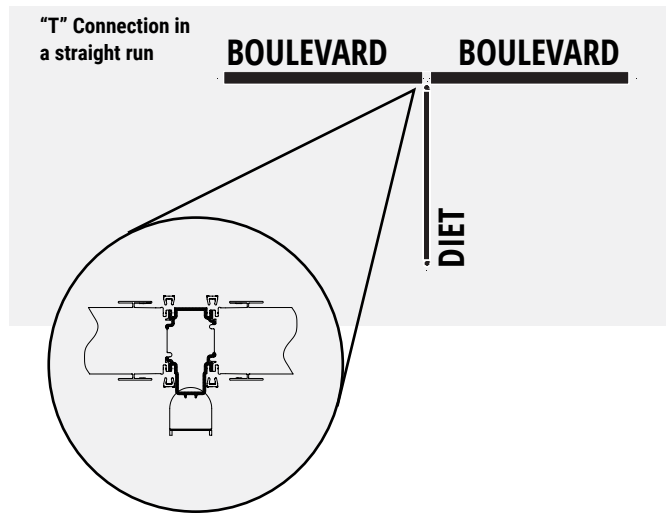

* Please specify separate end trim (round or flat) to close end.

DEK • Jumper Harness

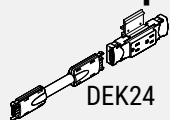

DEK24

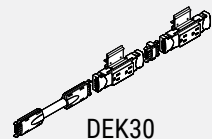

DEK30



DEK36-60

• **Kit includes all components to add power to Diet Panels.**

- Typical kit includes: 2 Duplex Receptacle Blocks (either circuit #1 or circuit #2), the Jumper Harness between the Duplex Receptacle Blocks, the Jumper Harness to the next panel, the pre-punched Raceway Cover, the aluminum Raceway Junction Cover, 2 PVC Duplex Receptacle Block Spacers and the hardware to attach the components.
- The length of the Jumper Harness between two Duplex Receptacle Blocks is based on the panel width.
- Jumper Harness going into the next panel and the aluminum Raceway Junction Covers are standard size.
- Raceway Cover and Raceway Junction Cover are Charcoal (CHR) only.
- Each kit is identified as circuit #1 (ie. DEK240*1") or circuit #2 (ie. DEK240*2").
- 24" wide panels have a single Duplex Receptacle Block only.
- 30" wide panels have 2 Duplex Receptacle Blocks, however they must be facing the same direction.
- 24" and 30" wide panels are not pre-punched for data.
- 36" to 60" wide panels are pre-punched for Duplex Receptacle Blocks on either side and for data just off-center on both sides.

PRODUCT CODE	PRICE	SIZE/ INCHES			WEIGHT VOL	
		H	W	D	LBS	FT ³
DEK2401	202	4	18	1.3	4.90	0.07
DEK3001	294	4	24	1.3	5.25	0.08
DEK3601	306	4	30	1.3	5.70	0.10
DEK4201	319	4	36	1.3	6.00	0.13
DEK4801	331	4	42	1.3	6.40	0.15
DEK5401	347	4	48	1.3	7.10	0.16
DEK6001	363	4	54	1.3	7.60	0.19
DEK2402	202	4	18	1.3	4.90	0.07
DEK3002	294	4	24	1.3	5.25	0.08
DEK3602	306	4	30	1.3	5.70	0.10
DEK4202	319	4	36	1.3	6.00	0.13
DEK4802	331	4	42	1.3	6.40	0.15
DEK5402	347	4	48	1.3	7.10	0.16
DEK6002	363	4	54	1.3	7.60	0.19

DEJH • Diet Pass-Thru Kit

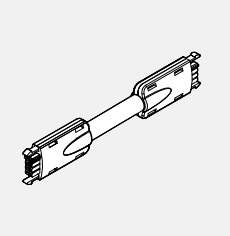

• **Kit allows electrical to pass through a Diet Panel.**

- Kit includes: female-female jumper harness, Raceway Cover and Raceway Junction Cover.
- Pass-Thru harness connects to a Duplex Receptacle Block within one powered panel; passes through a non-powered panel, and the opposite end connects to another Receptacle Block within the second powered panel.
- Raceway Cover and Raceway Junction Cover are Charcoal (CHR) only.

PRODUCT CODE	PRICE	SIZE/ INCHES			WEIGHT VOL	
		H	L	D	LBS	FT ³
DEJH24	140	2	42	1	1.81	0.025
DEJH30	155	2	48	1	2.07	0.028
DEJH36	171	2	54	1	2.12	0.032
DEJH42	184	2	60	1	2.60	0.035
DEJH48	196	2	66	1	2.86	0.038
DEJH54	213	2	72	1	3.13	0.041
DEJH60	226	2	78	1	3.39	0.044

DEBF • Diet Base Feed

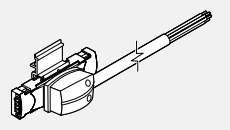

• **Provides single power entry from floor into raceway.**

- Single Ceiling Feed has a 6' whip, liquid tight.
- Raceway connection replaces one Duplex Receptacle Block in a standard kit.

PRODUCT CODE	PRICE	SIZE/ INCHES			WEIGHT VOL	
		H	L	D	LBS	FT ³
DEBF01	197	2	72	2	5.6	0.06

DECF • Diet Ceiling Feed



• **Provides single power entry from ceiling through a post into raceway.**

- Raceway connection replaces one Duplex Receptacle Block in a standard kit.

PRODUCT CODE	PRICE	SIZE/ INCHES			WEIGHT VOL	
		H	L	D	LBS	FT ³
DECF01	299	2	144	2	5.6	0.06

DEPE • Diet Post Extension

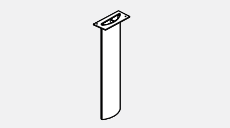

• **Lightweight aluminum pole manages power and data cables between ceiling and floor level raceway.**

- Aluminum extrusion with PVC extruded cover secures to the outside of the panel and passes through the worksurface scoop.
- Includes all hardware and bezel.
- Intended for use on Diet panels with fabric bottoms.

PRODUCT CODE	PRICE	SIZE/ INCHES			WEIGHT VOL	
		H	W	D	LBS	FT ³
DEPE116	179	116	4.5	1	7	0.82

DERJC • Raceway Junction Cover

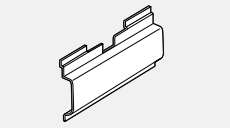

- **Provides an external cover for cables passing between adjacent, in-line panels and off-module "X" panel configurations. Also, capable of bridging two in-line panels in a "T" configuration (outside).**
- Aluminum, powder coated finish.

PRODUCT CODE	PRICE	SIZE/ INCHES			WEIGHT VOL	
		H	W	D	LBS	FT ³
DERJC	23	4.3	10	1	0.5	0.1

DPL • Linking Panel - Levelers on both legs

- **Diet Linking Panel provides privacy.**
- Aluminum extrusion comes in powder coated paint finish, DWT - Designer White or TUN - Tungsten.
- Laminate core available in DWTLPL - Designer White or ACJLP - Absolute Acajou.
- Edge banded to match laminate finish.
- Standard height of 54", 66", width in 6" increments from 24" to 60".
- Comes complete with hinge kits and levelers on both legs.

PRODUCT CODE	PRICE	SIZE/ INCHES			WEIGHT VOL	
		H	W	D	LBS	FT ³
DPL5424	397	54	24	1.3	18	1.62
DPL5430	441	54	30	1.3	23	2.08
DPL5436	484	54	36	1.3	27	2.47
DPL5442	527	54	42	1.3	32	2.85
DPL5448	573	54	48	1.3	37	3.25
DPL5454	615	54	54	1.3	42	3.63
DPL5460	658	54	60	1.3	47	4.02
DPL6624	450	66	24	1.3	23	2.04
DPL6630	499	66	30	1.3	29	2.52
DPL6636	547	66	36	1.3	35	3.00
DPL6642	593	66	42	1.3	41	3.46
DPL6648	644	66	48	1.3	47	3.93
DPL6654	691	66	54	1.3	53	4.40
DPL6660	739	66	60	1.3	59	4.90

DPLSCH • Diet Laminate Panel - Single caster on one leg, leveler on the other

- **Diet Linking Panel provides privacy.**
- Aluminum extrusion comes in powder coated paint finish, DWT - Designer White or TUN - Tungsten.
- Laminate core available in DWTLPL - Designer White or ACJLP - Absolute Acajou.
- Edge banded to match laminate finish.
- Standard height of 54", 66", width in 6" increments from 24" to 60".
- Comes complete with hinge kits, caster on one leg and leveler on the other.

PRODUCT CODE	PRICE	SIZE/ INCHES			WEIGHT VOL	
		H	W	D	LBS	FT ³
DPLSCH5424	476	54	24	1.3	18	1.62
DPLSCH5430	522	54	30	1.3	23	2.08
DPLSCH5436	568	54	36	1.3	27	2.47
DPLSCH5442	613	54	42	1.3	32	2.85
DPLSCH5448	658	54	48	1.3	37	3.25
DPLSCH5454	705	54	54	1.3	42	3.63
DPLSCH5460	751	54	60	1.3	47	4.02
DPLSCH6624	530	66	24	1.3	23	2.04
DPLSCH6630	580	66	30	1.3	29	2.52
DPLSCH6636	630	66	36	1.3	35	3
DPLSCH6642	681	66	42	1.3	41	3.46
DPLSCH6648	731	66	48	1.3	47	3.93
DPLSCH6654	800	66	54	1.3	53	4.4
DPLSCH6660	830	66	60	1.3	59	4.9

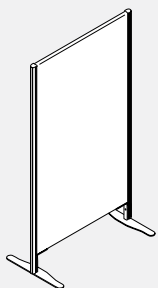
DPLDF • Diet Linking Panel - Flat foot on both legs

- **Diet Linking Panel provides privacy.**
- Aluminum extrusion comes in powder coated paint finish, DWT - Designer White or TUN - Tungsten.
- Laminate core available in DWTLPL - Designer White or ACJLP - Absolute Acajou.
- Edge banded to match laminate finish.
- Standard height of 54", 66", width in 6" increments from 24" to 60".
- Comes complete with hinge kits and flat foot on both legs.

PRODUCT CODE	PRICE	SIZE/ INCHES			WEIGHT VOL	
		H	W	D	LBS	FT ³
DPLDF5424	544	54	24	1.3	40.2	1.6
DPLDF5430	582	54	30	1.3	47.6	2.1
DPLDF5436	619	54	36	1.3	54.9	2.5
DPLDF5442	657	54	42	1.3	62.3	2.9
DPLDF5448	695	54	48	1.3	69.6	3.3
DPLDF5454	734	54	54	1.3	77.0	3.6
DPLDF5460	774	54	60	1.3	84.3	4.0
DPLDF6624	589	66	24	1.3	48.6	2.0
DPLDF6630	630	66	30	1.3	57.9	2.5
DPLDF6636	673	66	36	1.3	67.3	3.0
DPLDF6642	714	66	42	1.3	76.6	3.5
DPLDF6648	757	66	48	1.3	85.9	3.9
DPLDF6654	797	66	54	1.3	95.2	4.4
DPLDF6660	840	66	60	1.3	104.5	4.9

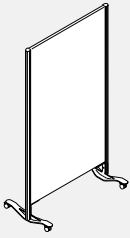
DPLMN • Diet Linking Panel - Double caster base on both legs

- **Diet Linking Panel provides privacy.**
- Aluminum extrusion comes in powder coated paint finish, DWT - Designer White or TUN - Tungsten.
- Laminate core available in DWTL - Designer White or ACJLP - Absolute Acajou.
- Edge banded to match laminate finish.
- Standard height of 54", 66", width in 6" increments from 24" to 60".
- Comes complete with hinge kits, and double caster foot on both legs.

PRODUCT CODE	PRICE	SIZE/ INCHES			WEIGHT VOL	
		H	W	D	LBS	FT ³
DPLMN5424	578	54	24	1.3	41.8	1.6
DPLMN5430	627	54	30	1.3	49.1	2.1
DPLMN5436	679	54	36	1.3	56.5	2.5
DPLMN5442	726	54	42	1.3	63.8	2.9
DPLMN5448	779	54	48	1.3	71.2	3.3
DPLMN5454	828	54	54	1.3	78.5	3.6
DPLMN5460	879	54	60	1.3	85.8	4.0
DPLMN6624	641	66	24	1.3	50.2	2.0
DPLMN6630	693	66	30	1.3	59.5	2.5
DPLMN6636	749	66	36	1.3	68.8	3.0
DPLMN6642	805	66	42	1.3	78.1	3.5
DPLMN6648	860	66	48	1.3	87.4	3.9
DPLMN6654	916	66	54	1.3	96.8	4.4
DPLMN6660	971	66	60	1.3	106.1	4.9

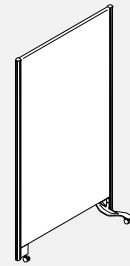
DPLDCMN • Diet Linking Panel - Single caster on one leg and double caster base on the other

- **Diet Linking Panel provides privacy.**
- Aluminum extrusion comes in powder coated paint finish, DWT - Designer White or TUN - Tungsten.
- Laminate core available in DWTL - Designer White or ACJLP - Absolute Acajou.
- Edge banded to match laminate finish.
- Standard height of 54", 66", width in 6" increments from 24" to 60".
- Comes complete with hinge kits, single caster on the one leg and double caster foot on the other.

PRODUCT CODE	PRICE	SIZE/ INCHES			WEIGHT VOL	
		H	W	D	LBS	FT ³
DPLDCMN5424	543	54	24	1.3	37.6	1.6
DPLDCMN5430	591	54	30	1.3	45.0	2.1
DPLDCMN5436	639	54	36	1.3	52.3	2.5
DPLDCMN5442	688	54	42	1.3	59.7	2.9
DPLDCMN5448	736	54	48	1.3	67.0	3.3
DPLDCMN5454	783	54	54	1.3	74.4	3.6
DPLDCMN5460	830	54	60	1.3	81.7	4.0
DPLDCMN6624	602	66	24	1.3	46.0	2.0
DPLDCMN6630	654	66	30	1.3	55.3	2.5
DPLDCMN6636	707	66	36	1.3	64.7	3.0
DPLDCMN6642	758	66	42	1.3	74.0	3.5
DPLDCMN6648	812	66	48	1.3	83.3	3.9
DPLDCMN6654	863	66	54	1.3	92.6	4.4
DPLDCMN6660	917	66	60	1.3	101.9	4.9

DPLDCHN • Diet Linking Panel - Leveler on one leg and double caster base on the other

- **Diet Linking Panel provides privacy.**
- Aluminum extrusion comes in powder coated paint finish, DWT - Designer White or TUN - Tungsten.
- Laminate core available in DWTL - Designer White or ACJLP - Absolute Acajou.
- Edge banded to match laminate finish.
- Standard height of 54", 66", width in 6" increments from 24" to 60".
- Comes complete with hinge kits, leveler on one leg and double caster foot on the other.

PRODUCT CODE	PRICE	SIZE/ INCHES			WEIGHT VOL	
		H	W	D	LBS	FT ³
DPLDCHN5424	512	54	24	1.3	37.1	1.6
DPLDCHN5430	556	54	30	1.3	44.5	2.1
DPLDCHN5436	608	54	36	1.3	51.8	2.5
DPLDCHN5442	655	54	42	1.3	59.2	2.9
DPLDCHN5448	701	54	48	1.3	66.5	3.3
DPLDCHN5454	751	54	54	1.3	73.9	3.6
DPLDCHN5460	799	54	60	1.3	81.2	4.0
DPLDCHN6624	568	66	24	1.3	45.5	2.0
DPLDCHN6630	621	66	30	1.3	54.9	2.5
DPLDCHN6636	673	66	36	1.3	64.2	3.0
DPLDCHN6642	724	66	42	1.3	73.5	3.5
DPLDCHN6648	779	66	48	1.3	82.8	3.9
DPLDCHN6654	830	66	54	1.3	92.1	4.4
DPLDCHN6660	885	66	60	1.3	101.4	4.9

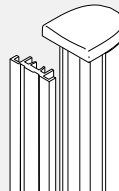
DPLWA • Wall Connection for Linking Panels

- **Wall Connection connects Linking**
- Panels to walls.
- Aluminum extrusion comes in powder coated paint finish, DWT - Designer White or TUN - Tungsten.
- Kit consists of Diet vertical extrusion, charcoal PVC cover and hinge kits.

PRODUCT CODE	PRICE	SIZE/ INCHES			WEIGHT VOL	
		H	W	D	LBS	FT ³
DPLWA54	103	54	2	2	2.3	0.13
DPLWA66	115	66	2	2	3.5	0.15

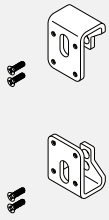
DPLEKIT • Expanding Kit

- **Expanding Kit connects two linking panels in a straight line.**
- This kit will accommodate any special width by overlapping the panels.
- Aluminum extrusion comes in powder coated paint finish, DWT - Designer White or TUN - Tungsten.
- Kit consists of a top and bottom bracket and all the hardware needed.

PRODUCT CODE	PRICE	SIZE/ INCHES			WEIGHT VOL	
		H	W	D	LBS	FT ³
DPLEKIT	179	3	2	2.0	1	0.05

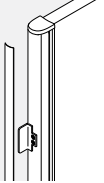
DP • Door and Door Catch Kit for Linking Panels

- **Door Catch Kit converts any Linking Panel into a door.**
- Aluminum extrusion comes in powder coated paint finish, DWT - Designer White or TUN - Tungsten.
- Kit consists of striker plate, two hinge kits, single caster foot assembly and 1" Diet caster

PRODUCT CODE	PRICE	SIZE/ INCHES			WEIGHT VOL	
		H	W	D	LBS	FT ³
DPDC01	112	6	3	1.3	2	0.50

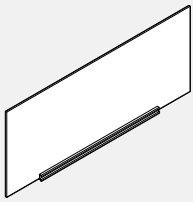
DP • Over Panel for Linking Panels

- **Over Panel sits atop of Linking Panel and bridges the gap between the top of 66" high Linking Panel and the top of the Screening Booth.**
- Kit contains aluminum extrusion and felt insert.
- Aluminum extrusion comes in powder coated paint finish, DWT - Designer White or TUN - Tungsten.

PRODUCT CODE	PRICE	SIZE/ INCHES			WEIGHT VOL	
		H	W	D	LBS	FT ³
DPLOP24	92	16.8	24	1.05	1.74	0.39
DPLOP30	108	16.8	30	1.05	2.20	0.49
DPLOP36	128	16.8	36	1.05	2.67	0.59
DPLOP42	143	16.8	42	1.05	3.14	0.70
DPLOP48	212	16.8	48	1.05	3.60	0.80
DPLOP54	231	16.8	54	1.05	4.07	0.90
DPLOP60	248	16.8	60	1.05	4.35	1.01

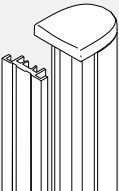
DP • Booth to Linking Panel Connector

- **Booth to Linking Panel Connector facilitates the connection of a Linking Panel to the back gable edge of the Screening Booth.**
- Aluminum extrusion comes in powder coated paint finish, DWT - Designer White or TUN - Tungsten.
- Kit includes a Diet vertical extrusion, charcoal PVC cover and all hardware.

PRODUCT CODE	PRICE	SIZE/ INCHES			WEIGHT VOL	
		H	W	D	LBS	FT ³
DEBPA	79	66	3	1.3	3.5	0.15

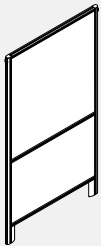
DPVAC • Diet VAC Laminate Panels

- **Special panel construction designed specifically for clinical applications.**
- Segmentated panels offer a thermally fused laminate lower and high pressure upper pressed on a lightweight core.
- Minimal footprint for storage.
- Easy to connect.
- Easy to reconfigure.
- Easy to clean.
- Laminate core available in DWTL/HP Designer White or ACJLP/ACJHP Absolute Acajou.
- Aluminum extrusion comes in powder coated paint finish. DWT Designer White or TUN Tungsten.
- Comes completed with hinge kits and levelers on both legs.

PRODUCT CODE	PRICE	SIZE/ INCHES			WEIGHT VOL	
		H	W	D	LBS	FT ³
DPVAC6636	689	66	36	1.3	35	3.00
DPVAC6642	711	66	42	1.3	41	3.46
DPVAC6648	724	66	48	1.3	47	3.93
DPVAC6660	1091	66	60	1.3	59	4.90

DWS • Worksurface for Diet Panels

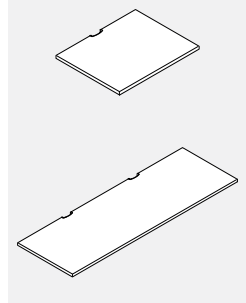

- **Worksurfaces have scoops at back to allow wires and cables to pass to and from floor level.**
- Includes support brackets (DHBRKT), 4 for work-surfaces up to 48", and 5 for any worksurface longer than 48".
- Please choose from DWT - Designer White, SIL - Silver or BLK - Black for scoop covers.

PRODUCT CODE	PRICE LP*	HP*	SIZE/ INCHES			WEIGHT VOL	
			H	W	D	LBS	FT ³
DWS2424P	149	187	1	24	24	15	0.60
DWS2430P	159	199	1	30	24	19	0.72
DWS2436P	180	225	1	36	24	23	0.85
DWS2442P	235	295	1	42	24	27	0.98
DWS2448P	283	353	1	48	24	31	1.11
DWS2454P	333	412	1	54	24	35	1.23
DWS2460P	373	465	1	60	24	39	1.36
DWS2466P	389	485	1	66	24	43	1.49
DWS2472P	408	509	1	72	24	48	1.62
DWS3024P	174	218	1	24	30	19	0.74
DWS3030P	190	236	1	30	30	24	0.90
DWS3036P	221	278	1	36	30	29	1.06
DWS3042P	313	392	1	42	30	34	1.22
DWS3048P	333	412	1	48	30	39	1.38
DWS3054P	364	454	1	54	30	43	1.54
DWS3060P	389	485	1	60	30	48	1.69
DWS3066P	406	508	1	66	30	53	1.85
DWS3072P	430	537	1	72	30	58	2.01

BHC • Diet/Boulevard Worksurface 12" Cantilever Support

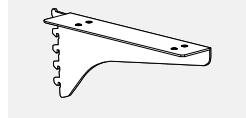

- An economical way to connect rear part of the side edge of a worksurface to the Boulevard Panel.
- Front part of the side edge of the worksurface must be supported by an off-module Diet Worksurface Bracket and locked into the adjacent Diet Panel.
- This cantilever is not a shared support

PRODUCT CODE	PRICE	SIZE/ INCHES			WEIGHT VOL	
		H	W	D	LBS	FT ³
BHC12L	41	6	2	12	2	0.03
BHC12R	41	6	2	12	2	0.03

DHLEG • Diet Gable Leg

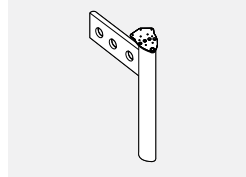

- **Universal leg, plate and side panel are non handed.**
- Supports the worksurface at 29° and enhances the stability of connected panels.
- Side plate is secured to the side of the Diet panel and leg plate bolts to worksurface.
- Made of extruded aluminum and steel.
- Levelers have 1.75" height adjustment.
- Includes all mounting hardware to connect to panel and worksurface.
- Must attach to Diet Panel vertical.

PRODUCT CODE	PRICE	SIZE/ INCHES			WEIGHT VOL	
		H	W	D	LBS	FT ³
DHLEG	211	28	23	6	12	2.02

DHBRKT • Diet Worksurface Bracket

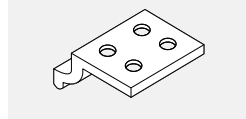

- **Extruded aluminum bracket that is bolted to the underside of the worksurface.**
- Bracket supports worksurface at any location along the mid rail of panel.
- Includes mounting hardware.
- Brackets are included for all worksurfaces DWS, 4 for worksurfaces up to 48", and 5 for any worksurface longer than 48".

PRODUCT CODE	PRICE	SIZE/ INCHES			WEIGHT VOL	
		H	W	D	LBS	FT ³
DHBRKT	11	0.75	2.25	3.25	0.1	0.05

DHTBRKT • Diet Transaction Bracket

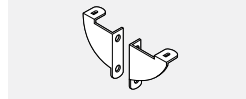

- Connects transaction tops to Diet Panels.
- Includes 1 set of two brackets and all hardware.

PRODUCT CODE	PRICE	SIZE/ INCHES			WEIGHT VOL	
		H	W	D	LBS	FT ³
DHTBRKT	41	2.5	1.2	2.5	3	0.01

DWSCSB • Diet Support Bar

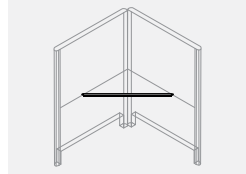

- **Supports worksurface in 90 degree corner application and eliminates the need for a leg.**
- Diagonally installed.
- If using a keyboard, spacers will be required.

PRODUCT CODE	PRICE	SIZE/ INCHES			WEIGHT VOL	
		H	W	D	LBS	FT ³
DWSCSB46	109	1	46	1	7	0.116
DWSCSB80	157	1	80	1	12	0.189

For corner application where 24" deep or smaller adjoining worksurface:
 For corner application where adjoining worksurface is larger than 24":

DHOMC • Diet Off-Module Cantilever



- **To be used with Diet Panels that have a fabric bottom.**
- Installs on horizontal rails of panels to provide worksurface support.
- Frees up space under the worksurface.

PRODUCT CODE	PRICE	SIZE/ INCHES			WEIGHT VOL	
		H	W	D	LBS	FT ³
DHOMC	109	21	3	12	4	0.42

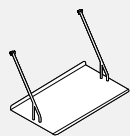
DSOMSHLF • Diet Off Module 24" Shelf

- Shelf hangs anywhere along Diet panel rails or Boulevard System 3 panel accessory tile.
- Can create a supplementary surface at worksurface level when suspended from a 42" high Diet panel.
- Shelves may be stacked, one hanging above the other from a higher rail.
- Shelf made of formed steel and includes suspended arms made of steel.

PRODUCT CODE	PRICE	SIZE/	INCHES			WEIGHT VOL	
		H	W	D	LBS	FT ³	
DSOMSHLF	246	11.5	24	12	4	1.00	

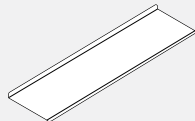
DSOS • Diet Panel Mounted Shelf

- Provides overhead storage capacity on top of 42" and 54" high Diet panels.
- Made of formed steel and includes steel mounting brackets.
- Support brackets lock to the top of Diet rail at the back and both sides of overhead.
- Must be installed on a "U" or "H" panel configuration.
- Due to structural issues, this product may not be used on top of glazed or partially glazed panels.

PRODUCT CODE	PRICE	SIZE/	INCHES			WEIGHT VOL	
		H	W	D	LBS	FT ³	
DSOS48	297	15	48	13.5	40	5.60	
DSOS60	316	15	60	13.5	52	7.00	

DOHLS • Diet Overhead Support

- To be used with Diet back panel and Diet wing panel either left or right. The support leg will support only one side and eliminate the need for a third panel.
- To be used and supported on worksurface installed at standard height. Ensure the worksurface that the leg sits on is properly supported.

PRODUCT CODE	PRICE	SIZE/	INCHES			WEIGHT VOL	
		H	W	D	LBS	FT ³	
DOHLS42	375	12	2	3.5	4	0.139	
DOHLS54	406	24	2	3.5	6	0.278	

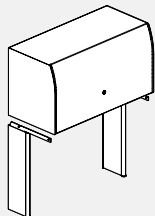
DSADA • Easy-Up Diet Overhead

- Diet Panel mounted metal overhead storage with opaque acrylic door. The Metal finish (page A.29). mechanism lifts the door up and stores it out of the way, above the storage unit.
- Meets CSA B651 Barrier Free Design & AODA (Accessibility for Ontarians with Disabilities Act).
- Meets CSA B651 Barrier Free Design & ADA (Americans with Disabilities Act).
- 16" high units accept standard and A4 binders.
- All shelves are reinforced for proper weight distribution.
- Inside dimensions: 14.375" high x 12" deep.
- Unit includes back, support cantilevers, attachment hardware, and lock.
- Shipped partially assembled.

PRODUCT CODE	PRICE	SIZE/	INCHES			WEIGHT VOL	
		H	W	D	LBS	FT ³	
DSADA30PM	1050	16	30	14.4	33	5.3	
DSADA36PM	1095	16	36	14.4	38	6.3	
DSADA42PM	1145	16	42	14.4	43	7.3	
DSADA48PM	1201	16	48	14.4	48	8.3	
DSADA54PM	1256	16	54	14.4	53	9.3	
DSADA60PM	1317	16	60	14.4	59	10.3	

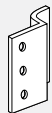
DHPEDB • Pedestal Bracket Kit for Diet Panels

- Attaches to a metal Worksurface Supporting Pedestal at the back and connects the pedestal to the Diet Panel vertical.

PRODUCT CODE	PRICE	SIZE/	INCHES			WEIGHT VOL	
		H	W	D	LBS	FT ³	
DHPEDB	36	8	1	1	0.5	0.001	

Introduction

Compile Systems - Protecting the Environment for Future Generations

- Our environmental success story began with the challenge to create an office system that would meet today's business requirements while maintaining a firm commitment to save and protect the environment.
- Sustainability became a part of the creative focus and development of Compile that incorporates the latest technology and design features to provide excellent performance at a competitive price.
- As government and industry environment ratings such as LEED & Greenguard become more prevalent, Compile offers designers and architects functional, attractive, and economical office designs that meet these standards.
- Global Contract is a leader in reducing waste in the manufacturing of its products as well as utilizing recycled materials wherever possible. We make extensive use of recycled plastic and wood waste from other Global factories.
- Global Contract is committed to the continuous improvement of our environmental systems, the prevention of pollution, and to comply with both the spirit and the letter of all relevant environmental legislation.

- Compile Panels are 82.3% recyclable at the end of their lifespan. Nothing from a Compile Panel needs to end up in a landfill.

Compile Systems - Product Information

- Compile offers fabrics that are made from 100% recycled polyester, which means less waste going to landfills. These fabrics also reduced the demand for petroleum products, and decrease the environmental impacts of processing those petroleum products into polyester.
- Compile's epoxy powder coating process involves no liquids and is solvent free. It contains no harmful VOC's or lead. Up to 99% of over sprayed powder is reclaimed, mixed with virgin powder and resused.
- Compile's entire panel is up to 82.3% recycled.
- Compile masonite is up to 85% recycled.
- Compile recycled wood for worksurfaces is up to 85% recycled.
- Compile's entire product line is up to 99.9% recyclable.

Components • Panel Configuration

Many components make up a panel configuration. This page provides an exploded view of a sample configuration highlighting each panel component required when specifying this configuration.

- A) CMET66 66"h. End of Run Trim Insert for Panel
- B) CMFF6636 66"h. x 36"w Single Segmented Fabric Panel
- C) CHP66 66"h. Universal Corner Post
- D) CMETP66 Trim Insert for 66"h. Universal Corner Post
- E) CMPC2 Post Base Cover for 2-Way Application
- F) CMET24 24"h Trim Insert for Step Down
- G) CMFF4236N1 42"h. x 36"w Single Segmented Fabric Panel, Punchouts on one side.
- H) CMET42 42"h. End of Run Trim Insert for Panel
- I) CMRC36NP 36"w Raceway Cover without Knockouts (if ordered separately)
- J) Panel Connectors, comes standard with panels and universal corner post

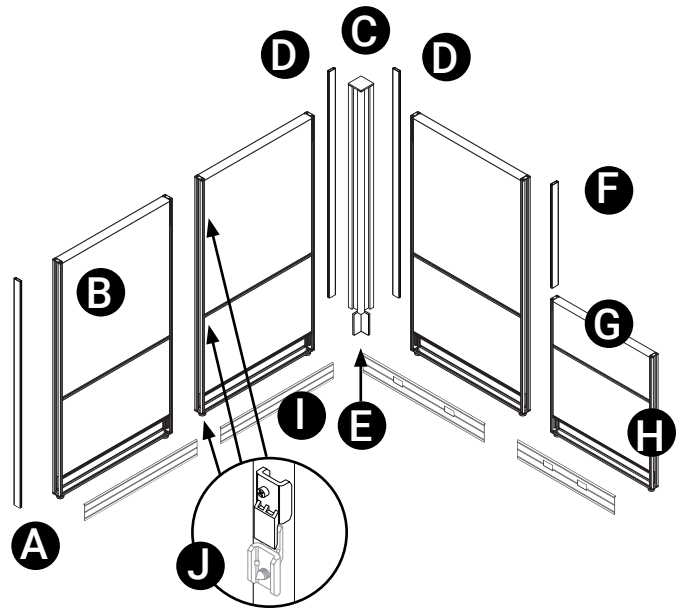

Components • Worksurfaces

- Compile thermally fused Worksurfaces are 1" thick and are finished with 3 mm PVC edging on all sides.
- Worksurfaces have pilot holes to enable proper alignment with worksurface supports.
- Most standard laminate offerings are available in thermally-fused. See laminate listings for details.
- Wood grain laminates on corner worksurfaces up to 42" available with laminate running diagonally at an upcharge. Otherwise, standard horizontal application of laminate will be used, as per drawings at right.
- Most wood grain laminate worksurfaces will have matching woodgrain trim unless specified otherwise.
- Depth of the worksurface scoops are 1 1/8" when measured from the panel the worksurface is attached to.
- All worksurfaces require support items. These are priced separately within this section.
- Grain direction for worksurfaces are as follows:
- Communication and electrical wires are routed through a cable scoop located at the back of the worksurface. When specifying a Straight Worksurface (CWS) or a Curvilinear Worksurface (CWVL), note that the number of cable scoops depends upon the width of the worksurface. All other Worksurface shapes have one scoop on panel edges.

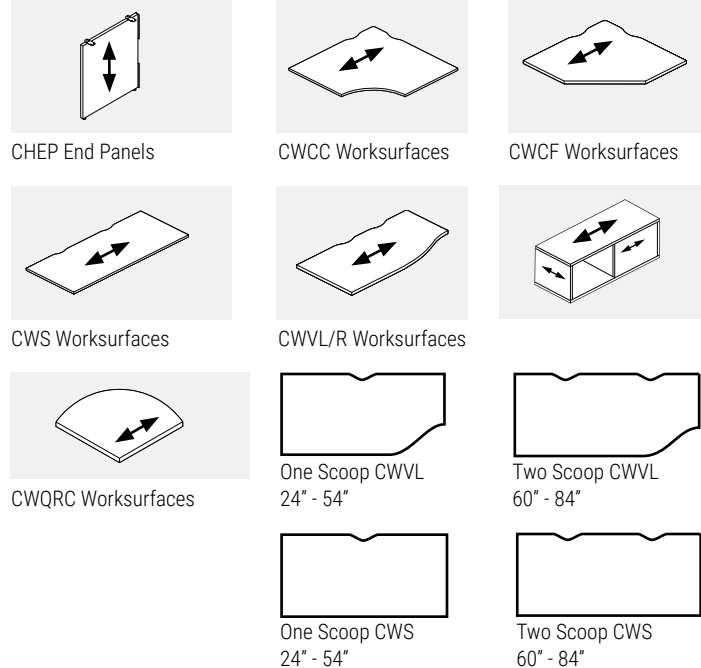

Components • Electrical

2+2 Configuration (8 wire, 4 circuit)

Two Utility Circuits [Compile's #1 & #2 circuits] share one neutral wire and one (system) ground wire. (2 hot [circuit] wires + 1 neutral wire*** + 1 green ground wire* = 4 wires)

Two Dedicated Circuits [Compile's "A" & "B" circuits] share one neutral wire and one (isolated) ground wire. (2 hot [circuit] wires + neutral wire *** + 1 green/yellow ground wire** = 4 wires)

Note: It is the ground wire that makes the difference between "Utility" and "Dedicated" circuits. Refer to Wiring Schematics found above.

*A Green ground wire is a "system" ground. This means it could be grounded to any piece of metal, including the panel.

**A Green/Yellow ground wire is isolated, within the wiring conduit, all the way back to the box at the source (building ground).

***All neutral wires are 10 gauge rather than 12 gauge meaning they are larger than normal allowing greater protection against 'noise' or interference on the circuit.

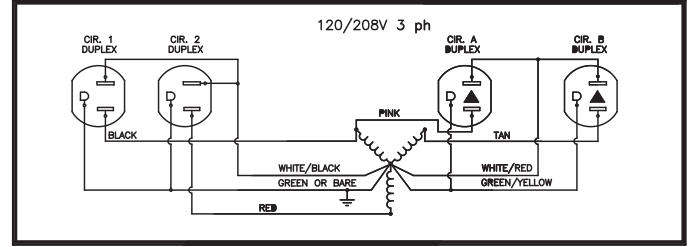
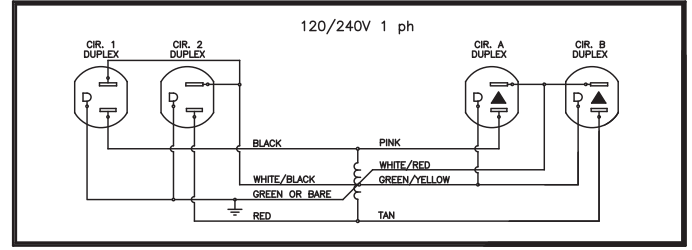

UL RECOGNIZED AND CSA CERTIFIED

Warning: It is recommended that installation of the electrical harness be made under the supervision of a licensed electrician in accordance with applicable codes and regulations.

Special Note: Always ensure that harness is electrically connected to only one power supply.

Components • Panel Configuration - Electrical

Many components make up a configuration. This page provides an exploded view of a sample configuration highlighting each Electrical component required when specifying this configuration.

A) CE8PD36 Power Distribution Housing

Note: 8 wire, 4 circuits, 2+2 configuration

B) CE8CP17 Flexible Mesh Jumper Cable (connects two panels side by side or separated by a post in a corner application)

C) CE8RD Duplex Receptacle

D) CE8CI1 "I" Connector

E) CE8CP Pass-Through Cable

Note: Must run in a straight line application only

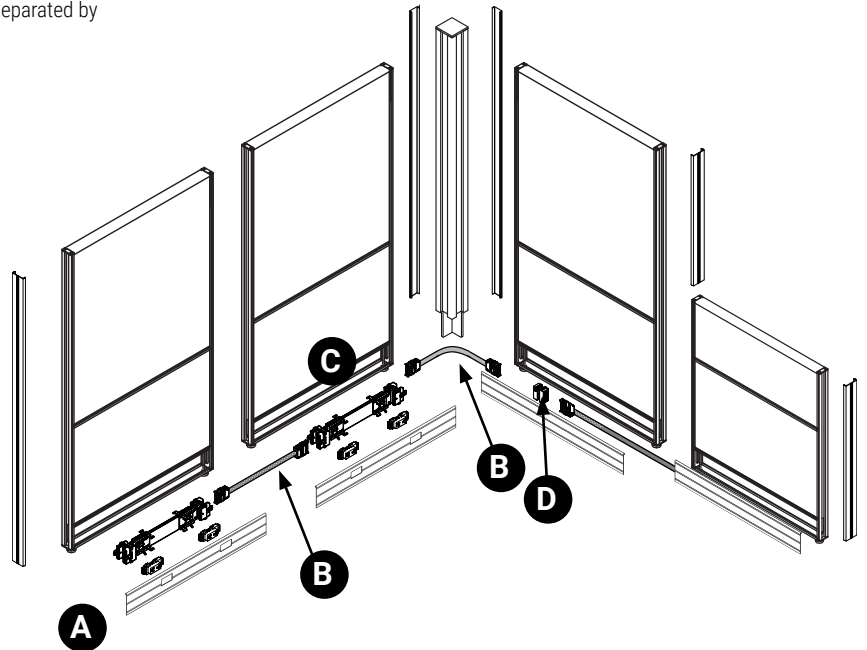

PANEL FINISHES

Panel Frame

Black	BLK
Designer White	DWT
Nevada	NEV
Fog	FOG

Glazing Options

Clear	CLR
Frosted	FRS

COMPILE - GUIDELINES FOR ORDERING PRODUCT

Codes

The product guide uses a numbering system with meaningful alphanumeric characters to create a simple-to-understand product number. This makes specifying the product much easier and more accurate.

Example of Panel **CMFM4236** Product Code

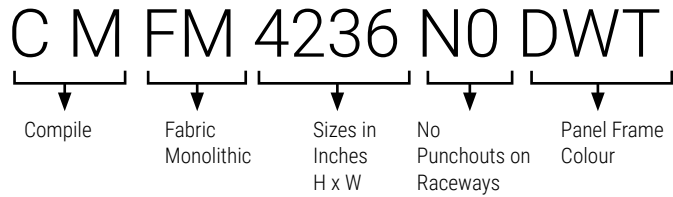

How to Specify

- Specify Compile panel type and size by code.
- Specify panel frame finish - ie. DWT (Designer White)
- Specify raceway power option.
- Specify all necessary panel fabric options.

The information listed below provides you with basic features of Compile Panels.

- Compile Panels can only be stacked one high.
- Available in four (4) basic heights: 30", 42", 54" and 66"; and seven (7) widths: 24", 30" 36", 42", 48", 54" and 60".
- 2 3/8" thick.
- Available in Monolithic and Single Segmented at just below the worksurface.
- Compile panels are not tackable.
- Raceway openings are 1.345" x 2.80".
- Opposite sides of each Module may have a different fabric within the same grade at no upcharge.
- Standard with aluminum frame.
- Individual fabric covered modules incorporated into an aluminum frame.
- Aluminum raceway covers can be ordered separately and shipped separately for reconfigurations. Raceway covers can be replaced in the field to change a panel from non powered to powered (or vice versa).

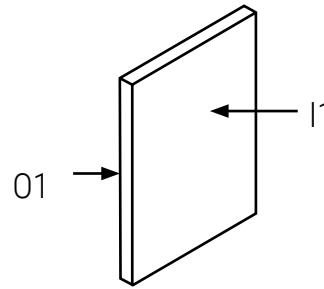

I1 AN50
01 BE21

Inside Fabric Position #1

Outside Fabric Position #1

NOTE: If different grades of fabric are used on one panel, the entire panel must be priced out at the higher grade.

- On Compile Laminate and Gallery panels, if a wood grain laminate is chosen, grain direction runs horizontally.
- Base raceway lifts up and locks in an upright 90-degree position, or can be removed for open access to base raceway.
- Electric knockouts in the raceway have plastic covers that snap into place from the outside of the cover, when a duplex is not required. Electric knockout covers must be specified separately.
- 3 panel connector brackets per side for 30"h., 42"h. and 54"h. come installed on panels and 60° and 90° posts.
- 4 panel connector brackets per side for 66"h. panels come installed on panels and 60° and 90° posts.
- Panel connector brackets are opposite direction of each other per panel side, and can be removed with one screw per bracket.
- CMFF and CMFM 66" and 72" panels must have fabric railroaded. Please confirm at time of order if all panels or only those need fabric to be railroaded.

CMFM-N0 • Monolithic Non Powered Fabric Panel, No Punchouts

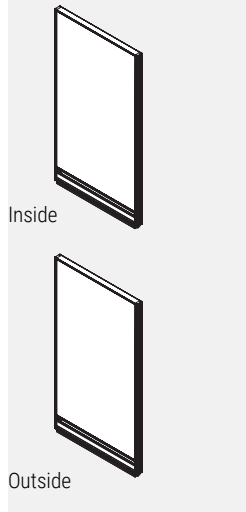

- Individual fabric-covered modules incorporated into an aluminum frame.
- Opposite sides of each module may have a different fabric within the same grade at no upcharge.
- If different grades of fabric are used on one panel, the entire panel must be priced at highest grade.
- Panels are not tackable.
- 3 Panel connector brackets per side come standard with 30”h., 42”h. and 54”h. panels.
- 4 Panel connector brackets per side come standard with 66”h. panels.
- Panels include 2 raceway covers with no punchouts, an integrated aluminum top cap and levelling glides.
- Note: Trim is not required at a straight connection between two panels of the same height.

PRODUCT CODE	PRICE		SIZE/ INCHES			WEIGHT VOL	
	GR 1	GR 2	H	W	D	LBS	FT³
CMFM3024N0	271	298	30	24	2.3	20	2.31
CMFM3030N0	336	363	30	30	2.3	25	2.85
CMFM3036N0	365	412	30	36	2.3	31	3.38
CMFM3042N0	399	450	30	42	2.3	36	3.92
CMFM3048N0	433	483	30	48	2.3	41	4.45
CMFM3054N0	477	524	30	54	2.3	46	4.99
CMFM3060N0	507	553	30	60	2.3	51	5.52
CMFM4224N0	271	298	42	24	2.3	20	2.31
CMFM4230N0	336	363	42	30	2.3	25	2.85
CMFM4236N0	365	412	42	36	2.3	31	3.38
CMFM4242N0	399	450	42	42	2.3	36	3.92
CMFM4248N0	433	483	42	48	2.3	41	4.45
CMFM4254N0	477	524	42	54	2.3	46	4.99
CMFM4260N0	507	553	42	60	2.3	51	5.52
CMFM4824N0	309	340	48	24	2.3	26	2.73
CMFM4830N0	350	380	48	30	2.3	33	3.37
CMFM4836N0	398	443	48	36	2.3	39	4.00
CMFM4842N0	454	514	48	42	2.3	46	4.63
CMFM4848N0	490	551	48	48	2.3	52	5.26
CMFM4854N0	539	596	48	54	2.3	59	5.89
CMFM4860N0	570	630	48	60	2.3	65	6.53
CMFM5424N0	309	340	54	24	2.3	26	2.73
CMFM5430N0	350	380	54	30	2.3	33	3.37
CMFM5436N0	398	443	54	36	2.3	39	4.00
CMFM5442N0	454	514	54	42	2.3	46	4.63
CMFM5448N0	490	551	54	48	2.3	52	5.26
CMFM5454N0	539	596	54	54	2.3	59	5.89
CMFM5460N0	570	630	54	60	2.3	65	6.53
CMFM6624N0	354	396	66	24	2.3	32	3.58
CMFM6630N0	412	452	66	30	2.3	40	4.40
CMFM6636N0	503	578	66	36	2.3	48	5.23
CMFM6642N0	555	631	66	42	2.3	56	6.06
CMFM6648N0	575	652	66	48	2.3	64	6.88
CMFM6654N0	591	666	66	54	2.3	72	7.71
CMFM6660N0	609	686	66	60	2.3	80	8.53

CMFM-N1 • Monolithic Non Powered Fabric Panel, Punchouts on One Side

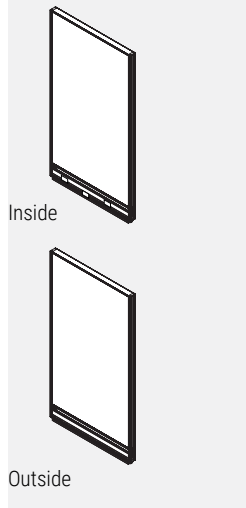

- Individual fabric-covered modules incorporated into an aluminum frame.
- Opposite sides of each module may have a different fabric within the same grade at no upcharge.
- If different grades of fabric are used on one panel, the entire panel must be priced at highest grade.
- Panels are not tackable.
- 3 Panel connector brackets per side come standard with 30" h., 42" h. and 54" h. panels.
- 4 Panel connector brackets per side come standard with 66" h. panels.
- Panels include 1 raceway cover with punchouts on one side, 1 raceway cover with no punchouts on the other, an integrated aluminum top cap and levelling glides.
- 24" wide panels have one punchout, 30" wide panels and wider have 3 punchouts.
- Note: Trim is not required at a straight connection between two panels of the same height.

PRODUCT CODE	PRICE		SIZE/ INCHES			WEIGHT VOL	
	GR 1	GR 2	H	W	D	LBS	FT ³
CMFM3024N1	271	298	30	24	2.3	20	2.31
CMFM3030N1	336	363	30	30	2.3	25	2.85
CMFM3036N1	365	412	30	36	2.3	31	3.38
CMFM3042N1	399	450	30	42	2.3	36	3.92
CMFM3048N1	433	483	30	48	2.3	41	4.45
CMFM3054N1	477	524	30	54	2.3	46	4.99
CMFM3060N1	507	553	30	60	2.3	51	5.52
CMFM4224N1	271	298	42	24	2.3	20	2.31
CMFM4230N1	336	363	42	30	2.3	25	2.85
CMFM4236N1	365	412	42	36	2.3	31	3.38
CMFM4242N1	399	450	42	42	2.3	36	3.92
CMFM4248N1	433	483	42	48	2.3	41	4.45
CMFM4254N1	477	524	42	54	2.3	46	4.99
CMFM4260N1	507	553	42	60	2.3	51	5.52
CMFM4824N1	309	340	48	24	2.3	26	2.73
CMFM4830N1	350	380	48	30	2.3	33	3.37
CMFM4836N1	398	443	48	36	2.3	39	4.00
CMFM4842N1	454	514	48	42	2.3	46	4.63
CMFM4848N1	490	551	48	48	2.3	52	5.26
CMFM4854N1	539	596	48	54	2.3	59	5.89
CMFM4860N1	570	630	48	60	2.3	65	6.53
CMFM5424N1	309	340	54	24	2.3	26	2.73
CMFM5430N1	350	380	54	30	2.3	33	3.37
CMFM5436N1	398	443	54	36	2.3	39	4.00
CMFM5442N1	454	514	54	42	2.3	46	4.63
CMFM5448N1	490	551	54	48	2.3	52	5.26
CMFM5454N1	539	596	54	54	2.3	59	5.89
CMFM5460N1	570	630	54	60	2.3	65	6.53
CMFM6624N1	354	396	66	24	2.3	32	3.58
CMFM6630N1	412	452	66	30	2.3	40	4.40
CMFM6636N1	503	578	66	36	2.3	48	5.23
CMFM6642N1	555	631	66	42	2.3	56	6.06
CMFM6648N1	575	652	66	48	2.3	64	6.88
CMFM6654N1	591	666	66	54	2.3	72	7.71
CMFM6660N1	609	686	66	60	2.3	80	8.53

CMFM-N2 • Monolithic Non Powered Fabric Panel, Punchouts on Both Sides

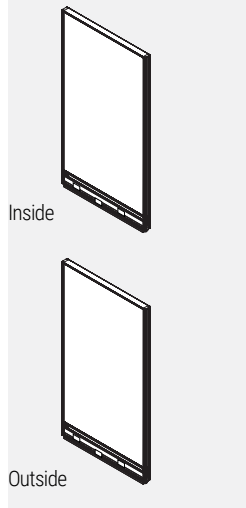

- Individual fabric-covered modules incorporated into an aluminum frame.
- Opposite sides of each module may have a different fabric within the same grade at no upcharge.
- If different grades of fabric are used on one panel, the entire panel must be priced at highest grade.
- Panels are not tackable.
- 3 Panel connector brackets per side come standard with 30”h., 42”h. and 54”h. panels.
- 4 Panel connector brackets per side come standard with 66”h. panels.
- Panels include 2 raceway covers with punchouts on both sides, an integrated aluminum top cap and levelling glides.
- 24” wide panels have two punchouts, one for electrical and one for data.
- 30” wide panels and wider have three punchouts, two for electrical and one for data.
- Note: Trim is not required at a straight connection between two panels of the same height.

PRODUCT CODE	PRICE		SIZE/ INCHES			WEIGHT VOL	
	GR 1	GR 2	H	W	D	LBS	FT³
CMFM3024N2	271	298	30	24	2.3	20	2.31
CMFM3030N2	336	363	30	30	2.3	25	2.85
CMFM3036N2	365	412	30	36	2.3	31	3.38
CMFM3042N2	399	450	30	42	2.3	36	3.92
CMFM3048N2	433	483	30	48	2.3	41	4.45
CMFM3054N2	477	524	30	54	2.3	46	4.99
CMFM3060N2	507	553	30	60	2.3	51	5.52
CMFM4224N2	271	298	42	24	2.3	20	2.31
CMFM4230N2	336	363	42	30	2.3	25	2.85
CMFM4236N2	365	412	42	36	2.3	31	3.38
CMFM4242N2	399	450	42	42	2.3	36	3.92
CMFM4248N2	433	483	42	48	2.3	41	4.45
CMFM4254N2	477	524	42	54	2.3	46	4.99
CMFM4260N2	507	553	42	60	2.3	51	5.52
CMFM4824N2	309	340	48	24	2.3	26	2.73
CMFM4830N2	350	380	48	30	2.3	33	3.37
CMFM4836N2	398	443	48	36	2.3	39	4.00
CMFM4842N2	454	514	48	42	2.3	46	4.63
CMFM4848N2	490	551	48	48	2.3	52	5.26
CMFM4854N2	539	596	48	54	2.3	59	5.89
CMFM4860N2	570	630	48	60	2.3	65	6.53
CMFM5424N2	309	340	54	24	2.3	26	2.73
CMFM5430N2	350	380	54	30	2.3	33	3.37
CMFM5436N2	398	443	54	36	2.3	39	4.00
CMFM5442N2	454	514	54	42	2.3	46	4.63
CMFM5448N2	490	551	54	48	2.3	52	5.26
CMFM5454N2	539	596	54	54	2.3	59	5.89
CMFM5460N2	570	630	54	60	2.3	65	6.53
CMFM6624N2	354	396	66	24	2.3	32	3.58
CMFM6630N2	412	452	66	30	2.3	40	4.40
CMFM6636N2	503	578	66	36	2.3	48	5.23
CMFM6642N2	555	631	66	42	2.3	56	6.06
CMFM6648N2	575	652	66	48	2.3	64	6.88
CMFM6654N2	591	666	66	54	2.3	72	7.71
CMFM6660N2	609	686	66	60	2.3	80	8.53

CMFM-P1 • Monolithic Fabric Panel with Power Distribution Housing, Punchouts on One Side

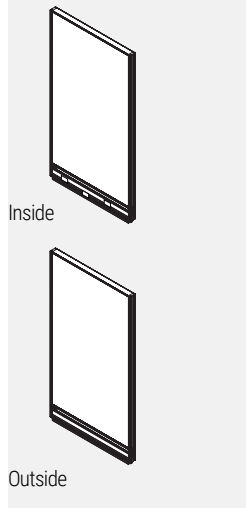

- Individual fabric-covered modules incorporated into an aluminum frame.
- Opposite sides of each module may have a different fabric within the same grade at no upcharge.
- If different grades of fabric are used on one panel, the entire panel must be priced at highest grade.
- Panels are not tackable.
- 3 Panel connector brackets per side come standard with 30”h., 42”h. and 54”h. panels.
- 4 Panel connector brackets per side come standard with 66”h. panels.
- Panels include 1 raceway cover with punchouts on one side, 1 raceway cover with no punchouts on the other, a power distribution housing, an integrated aluminum top cap and levelling glides.
- 24” wide panels have two punchouts, one for electrical and one for data.
- 30” wide panels and wider have three punchouts, two for electrical and one for data.
- Note: Trim is not required at a straight connection between two panels of the same height.
- Please specify duplex receptacles separately.

PRODUCT CODE	PRICE		SIZE/ INCHES			WEIGHT VOL	
	GR 1	GR 2	H	W	D	LBS	FT ³
CMFM3024P1	410	435	30	24	2.3	20	2.31
CMFM3030P1	521	547	30	30	2.3	25	2.85
CMFM3036P1	561	609	30	36	2.3	31	3.38
CMFM3042P1	603	653	30	42	2.3	36	3.92
CMFM3048P1	647	695	30	48	2.3	41	4.45
CMFM3054P1	693	745	30	54	2.3	46	4.99
CMFM3060P1	723	775	30	60	2.3	51	5.52
CMFM4224P1	410	435	42	24	2.3	20	2.31
CMFM4230P1	521	547	42	30	2.3	25	2.85
CMFM4236P1	561	609	42	36	2.3	31	3.38
CMFM4242P1	603	653	42	42	2.3	36	3.92
CMFM4248P1	647	695	42	48	2.3	41	4.45
CMFM4254P1	693	745	42	54	2.3	46	4.99
CMFM4260P1	723	775	42	60	2.3	51	5.52
CMFM4824P1	449	478	48	24	2.3	26	2.73
CMFM4830P1	539	568	48	30	2.3	33	3.37
CMFM4836P1	593	639	48	36	2.3	39	4.00
CMFM4842P1	656	717	48	42	2.3	46	4.63
CMFM4848P1	707	765	48	48	2.3	52	5.26
CMFM4854P1	754	814	48	54	2.3	59	5.89
CMFM4860P1	788	850	48	60	2.3	65	6.53
CMFM5424P1	449	478	54	24	2.3	26	2.73
CMFM5430P1	539	568	54	30	2.3	33	3.37
CMFM5436P1	593	639	54	36	2.3	39	4.00
CMFM5442P1	656	717	54	42	2.3	46	4.63
CMFM5448P1	707	765	54	48	2.3	52	5.26
CMFM5454P1	754	814	54	54	2.3	59	5.89
CMFM5460P1	788	850	54	60	2.3	65	6.53
CMFM6624P1	494	536	66	24	2.3	32	3.58
CMFM6630P1	602	639	66	30	2.3	40	4.40
CMFM6636P1	697	775	66	36	2.3	48	5.23
CMFM6642P1	758	833	66	42	2.3	56	6.06
CMFM6648P1	788	864	66	48	2.3	64	6.88
CMFM6654P1	809	884	66	54	2.3	72	7.71
CMFM6660P1	827	903	66	60	2.3	80	8.53

CMFM-P2 • Monolithic Fabric Panel with Power Distribution Housing, Punchouts on Both Sides

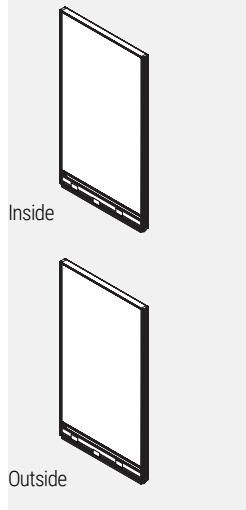

- Individual fabric-covered modules incorporated into an aluminum frame.
- Opposite sides of each module may have a different fabric within the same grade at no upcharge.
- If different grades of fabric are used on one panel, the entire panel must be priced at highest grade.
- Panels are not tackable.
- 3 Panel connector brackets per side come standard with 30”h., 42”h. and 54”h. panels.
- 4 Panel connector brackets per side come standard with 66”h. panels.
- Panels include 2 raceway covers with punchouts on both sides, a power distribution housing, an integrated aluminum top cap and levelling glides.
- 24” wide panels have two punchouts, one for electrical and one for data.
- 30” wide panels and wider have three punchouts, two for electrical and one for data.
- Note: Trim is not required at a straight connection between two panels of the same height.
- Please specify duplex receptacles separately.

PRODUCT CODE	PRICE		SIZE/ INCHES			WEIGHT VOL	
	GR 1	GR 2	H	W	D	LBS	FT ³
CMFM3024P2	410	435	30	24	2.3	20	2.31
CMFM3030P2	521	547	30	30	2.3	25	2.85
CMFM3036P2	561	609	30	36	2.3	31	3.38
CMFM3042P2	603	653	30	42	2.3	36	3.92
CMFM3048P2	647	695	30	48	2.3	41	4.45
CMFM3054P2	693	745	30	54	2.3	46	4.99
CMFM3060P2	723	775	30	60	2.3	51	5.52
CMFM4224P2	410	435	42	24	2.3	20	2.31
CMFM4230P2	521	547	42	30	2.3	25	2.85
CMFM4236P2	561	609	42	36	2.3	31	3.38
CMFM4242P2	603	653	42	42	2.3	36	3.92
CMFM4248P2	647	695	42	48	2.3	41	4.45
CMFM4254P2	693	745	42	54	2.3	46	4.99
CMFM4260P2	723	775	42	60	2.3	51	5.52
CMFM4824P2	449	478	48	24	2.3	26	2.73
CMFM4830P2	539	568	48	30	2.3	33	3.37
CMFM4836P2	593	639	48	36	2.3	39	4.00
CMFM4842P2	656	717	48	42	2.3	46	4.63
CMFM4848P2	707	765	48	48	2.3	52	5.26
CMFM4854P2	754	814	48	54	2.3	59	5.89
CMFM4860P2	788	850	48	60	2.3	65	6.53
CMFM5424P2	449	478	54	24	2.3	26	2.73
CMFM5430P2	539	568	54	30	2.3	33	3.37
CMFM5436P2	593	639	54	36	2.3	39	4.00
CMFM5442P2	656	717	54	42	2.3	46	4.63
CMFM5448P2	707	765	54	48	2.3	52	5.26
CMFM5454P2	754	814	54	54	2.3	59	5.89
CMFM5460P2	788	850	54	60	2.3	65	6.53
CMFM6624P2	494	536	66	24	2.3	32	3.58
CMFM6630P2	602	639	66	30	2.3	40	4.40
CMFM6636P2	697	775	66	36	2.3	48	5.23
CMFM6642P2	758	833	66	42	2.3	56	6.06
CMFM6648P2	788	864	66	48	2.3	64	6.88
CMFM6654P2	809	884	66	54	2.3	72	7.71
CMFM6660P2	827	903	66	60	2.3	80	8.53

CMLFM-N0 • Monolithic Non Powered Laminate One Side, Fabric One Side Panel, No Punchouts

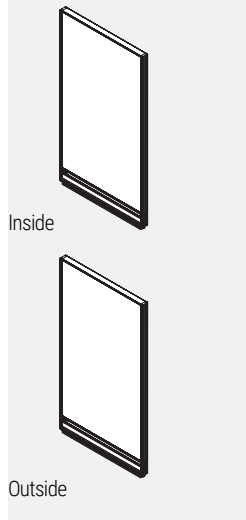

- Individual modules, one in fabric and one in laminate, incorporated into an aluminum frame.
- Panels are not tackable.
- 3 panel connector brackets per side come standard with 30”h., 42”h., and 54”h. panels.
- 4 panel connector brackets per side come standard with 66”h. panels.
- Panels include 2 raceway covers with no punchouts, an integrated aluminum top cap and levelling glides.
- Note: Trim is not required at a straight connection between two panels of the same height.

PRODUCT CODE	PRICE		SIZE/ INCHES			WEIGHT VOL	
	GR 1	GR 2	H	W	D	LBS	FT³
CMLFM3024N0	391	399	30	24	2.3	20	2.31
CMLFM3030N0	456	469	30	30	2.3	25	2.85
CMLFM3036N0	520	535	30	36	2.3	31	3.38
CMLFM3042N0	591	604	30	42	2.3	36	3.92
CMLFM3048N0	639	654	30	48	2.3	41	4.45
CMLFM3054N0	713	725	30	54	2.3	46	4.99
CMLFM3060N0	770	794	30	60	2.3	51	5.52
CMLFM4224N0	464	477	42	24	2.3	20	2.31
CMLFM4230N0	542	553	42	30	2.3	25	2.85
CMLFM4236N0	623	641	42	36	2.3	31	3.38
CMLFM4242N0	707	724	42	42	2.3	36	3.92
CMLFM4248N0	766	788	42	48	2.3	41	4.45
CMLFM4254N0	853	877	42	54	2.3	46	4.99
CMLFM4260N0	935	960	42	60	2.3	51	5.52
CMLFM4824N0	550	573	48	24	2.3	26	2.73
CMLFM4830N0	647	665	48	30	2.3	33	3.37
CMLFM4836N0	741	762	48	36	2.3	39	4.00
CMLFM4842N0	839	863	48	42	2.3	46	4.63
CMLFM4848N0	917	943	48	48	2.3	52	5.26
CMLFM4854N0	1021	1052	48	54	2.3	59	5.89
CMLFM5424N0	550	573	54	24	2.3	65	6.53
CMLFM5430N0	647	665	54	30	2.3	33	3.37
CMLFM5436N0	741	762	54	36	2.3	39	4.00
CMLFM5442N0	839	863	54	42	2.3	46	4.63
CMLFM5448N0	917	943	54	48	2.3	52	5.26
CMLFM5454N0	1021	1052	54	54	2.3	59	5.89
CMLFM6624N0	683	699	66	24	2.3	32	3.58
CMLFM6630N0	796	820	66	30	2.3	40	4.40
CMLFM6636N0	918	947	66	36	2.3	48	5.23
CMLFM6642N0	1046	1078	66	42	2.3	56	6.06
CMLFM6648N0	1139	1174	66	48	2.3	64	6.68

CMLFM-N1 • Monolithic Non Powered Laminate One Side, Fabric Other, Punchouts on One Side

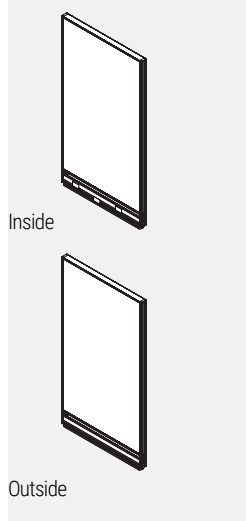

- Individual modules, one in fabric and one in laminate, incorporated into an aluminum frame.
- Panels are not tackable.
- 3 panel connector brackets per side come standard with 30”h., 42”h., and 54”h. panels.
- 4 panel connector brackets per side come standard with 66”h. panels.
- Panels include 1 raceway cover with punchouts on one side, 1 raceway cover with no punchouts on the other, an integrated aluminum top cap and levelling glides.
- 24” wide panels have two punchouts, one for electrical and one for data.
- 30” wide panels and wider have three punchouts, two for electrical and one for data.
- Note: Trim is not required at a straight connection between two panels of the same height.

PRODUCT CODE	PRICE		SIZE/ INCHES			WEIGHT VOL	
	GR 1	GR 2	H	W	D	LBS	FT³
CMLFM3024N1	391	399	30	24	2.3	20	2.31
CMLFM3030N1	456	469	30	30	2.3	25	2.85
CMLFM3036N1	520	535	30	36	2.3	31	3.38
CMLFM3042N1	591	604	30	42	2.3	36	3.92
CMLFM3048N1	639	654	30	48	2.3	41	4.45
CMLFM3054N1	713	725	30	54	2.3	46	4.99
CMLFM3060N1	770	794	30	60	2.3	51	5.52
CMLFM4224N1	464	477	42	24	2.3	20	2.31
CMLFM4230N1	542	553	42	30	2.3	25	2.85
CMLFM4236N1	623	641	42	36	2.3	31	3.38
CMLFM4242N1	707	724	42	42	2.3	36	3.92
CMLFM4248N1	766	788	42	48	2.3	41	4.45
CMLFM4254N1	853	877	42	54	2.3	46	4.99
CMLFM4260N1	935	960	42	60	2.3	51	5.52
CMLFM4824N1	550	573	48	24	2.3	26	2.73
CMLFM4830N1	647	665	48	30	2.3	33	3.37
CMLFM4836N1	741	762	48	36	2.3	39	4.00
CMLFM4842N1	839	863	48	42	2.3	46	4.63
CMLFM4848N1	917	943	48	48	2.3	52	5.26
CMLFM4854N1	1021	1052	48	54	2.3	59	5.89
CMLFM5424N1	550	573	54	24	2.3	65	6.53
CMLFM5430N1	647	665	54	30	2.3	33	3.37
CMLFM5436N1	741	762	54	36	2.3	39	4.00
CMLFM5442N1	839	863	54	42	2.3	46	4.63
CMLFM5448N1	917	943	54	48	2.3	52	5.26
CMLFM5454N1	1021	1052	54	54	2.3	59	5.89
CMLFM6624N1	683	699	66	24	2.3	32	3.58
CMLFM6630N1	796	820	66	30	2.3	40	4.40
CMLFM6636N1	918	947	66	36	2.3	48	5.23
CMLFM6642N1	1046	1078	66	42	2.3	56	6.06
CMLFM6648N1	1139	1174	66	48	2.3	64	6.68

CMLFM-N2 • Monolithic Non Powered Laminate 1 Side, Fabric Other Panel, Punchouts on Both Sides

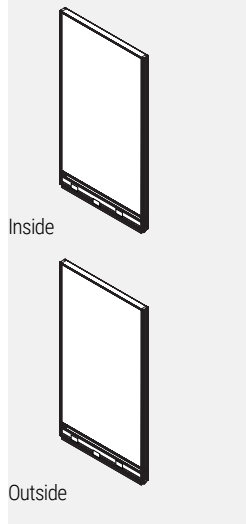

- Individual modules, one in fabric and one in laminate, incorporated into an aluminum frame.
- Panels are not tackable.
- 3 panel connector brackets per side come standard with 30”h., 42”h., and 54”h. panels.
- 4 panel connector brackets per side come standard with 66”h. panels.
- Panels include 2 raceway covers with punchouts, an integrated aluminum top cap and levelling glides.
- 24” wide panels have two punchouts, one for electrical and one for data.
- 30” wide panels and wider have three punchouts, two for electrical and one for data.
- Note: Trim is not required at a straight connection between two panels of the same height.

PRODUCT CODE	PRICE		SIZE/ INCHES			WEIGHT VOL	
	GR 1	GR 2	H	W	D	LBS	FT³
CMLFM3024N2	391	399	30	24	2.3	20	2.31
CMLFM3030N2	456	469	30	30	2.3	25	2.85
CMLFM3036N2	520	535	30	36	2.3	31	3.38
CMLFM3042N2	591	604	30	42	2.3	36	3.92
CMLFM3048N2	639	654	30	48	2.3	41	4.45
CMLFM3054N2	713	725	30	54	2.3	46	4.99
CMLFM3060N2	770	794	30	60	2.3	51	5.52
CMLFM4224N2	464	477	42	24	2.3	20	2.31
CMLFM4230N2	542	553	42	30	2.3	25	2.85
CMLFM4236N2	623	641	42	36	2.3	31	3.38
CMLFM4242N2	707	724	42	42	2.3	36	3.92
CMLFM4248N2	766	788	42	48	2.3	41	4.45
CMLFM4254N2	853	877	42	54	2.3	46	4.99
CMLFM4260N2	935	960	42	60	2.3	51	5.52
CMLFM4824N2	550	573	48	24	2.3	26	2.73
CMLFM4830N2	647	665	48	30	2.3	33	3.37
CMLFM4836N2	741	762	48	36	2.3	39	4.00
CMLFM4842N2	839	863	48	42	2.3	46	4.63
CMLFM4848N2	917	943	48	48	2.3	52	5.26
CMLFM4854N2	1021	1052	48	54	2.3	59	5.89
CMLFM5424N2	550	573	54	24	2.3	65	6.53
CMLFM5430N2	647	665	54	30	2.3	33	3.37
CMLFM5436N2	741	762	54	36	2.3	39	4.00
CMLFM5442N2	839	863	54	42	2.3	46	4.63
CMLFM5448N2	917	943	54	48	2.3	52	5.26
CMLFM5454N2	1021	1052	54	54	2.3	59	5.89
CMLFM6624N2	683	699	66	24	2.3	32	3.58
CMLFM6630N2	796	820	66	30	2.3	40	4.40
CMLFM6636N2	918	947	66	36	2.3	48	5.23
CMLFM6642N2	1046	1078	66	42	2.3	56	6.06
CMLFM6648N2	1139	1174	66	48	2.3	64	6.68

CMLFM-P1 • Monolithic Laminate One Side, Fabric Other Side Panel with PDH, Punchouts on One Side

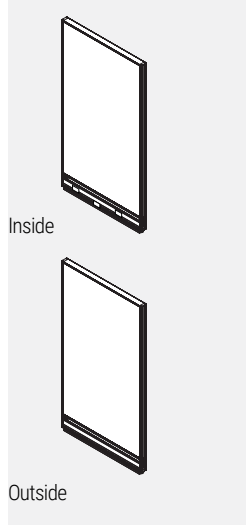

- Individual modules, one in fabric and one in laminate, incorporated into an aluminum frame.
- Panels are not tackable.
- 3 panel connector brackets per side come standard with 30”h., 42”h., and 54”h. panels.
- 4 panel connector brackets per side come standard with 66”h. panels.
- Panels include 1 raceway cover with punchouts on one side, 1 raceway cover with no punchouts on the other, a power distribution housing, an integrated aluminum top cap and levelling glides.
- 24” wide panels have two punchouts, one for electrical and one for data.
- 30” wide panels and wider have three punchouts, two for electrical and one for data.
- Note: Trim is not required at a straight connection between two panels of the same height.
- Please specify duplex receptacles separately.

PRODUCT CODE	PRICE		SIZE/ INCHES			WEIGHT VOL	
	GR 1	GR 2	H	W	D	LBS	FT³
CMLFM3024P1	522	535	30	24	2.3	20	2.31
CMLFM3030P1	645	655	30	30	2.3	25	2.85
CMLFM3036P1	713	720	30	36	2.3	31	3.38
CMLFM3042P1	784	796	30	42	2.3	36	3.92
CMLFM3048P1	843	856	30	48	2.3	41	4.45
CMLFM3054P1	918	933	30	54	2.3	46	4.99
CMLFM3060P1	986	1001	30	60	2.3	51	5.52
CMLFM4224P1	596	609	42	24	2.3	20	2.31
CMLFM4230P1	720	733	42	30	2.3	25	2.85
CMLFM4236P1	811	827	42	36	2.3	31	3.38
CMLFM4242P1	897	918	42	42	2.3	36	3.92
CMLFM4248P1	971	994	42	48	2.3	41	4.45
CMLFM4254P1	1061	1084	42	54	2.3	46	4.99
CMLFM4260P1	1143	1169	42	60	2.3	51	5.52
CMLFM4824P1	683	697	48	24	2.3	26	2.73
CMLFM4830P1	825	843	48	30	2.3	33	3.37
CMLFM4836P1	928	951	48	36	2.3	39	4.00
CMLFM4842P1	1030	1056	48	42	2.3	46	4.63
CMLFM4848P1	1121	1147	48	48	2.3	52	5.26
CMLFM4854P1	1171	1226	48	54	2.3	59	5.89
CMLFM5424P1	683	697	54	24	2.3	65	6.53
CMLFM5430P1	825	843	54	30	2.3	33	3.37
CMLFM5436P1	928	951	54	36	2.3	39	4.00
CMLFM5442P1	1030	1056	54	42	2.3	46	4.63
CMLFM5448P1	1121	1147	54	48	2.3	52	5.26
CMLFM5454P1	1226	1259	54	54	2.3	59	5.89
CMLFM6624P1	816	833	66	24	2.3	32	3.58
CMLFM6630P1	973	998	66	30	2.3	40	4.40
CMLFM6636P1	1106	1132	66	36	2.3	48	5.23
CMLFM6642P1	1238	1269	66	42	2.3	56	6.06
CMLFM6648P1	1343	1378	66	48	2.3	64	6.68

CMLFM-P2 • Monolithic Laminate One Side, Fabric Other Panel with PDH, Punchouts on Both Side

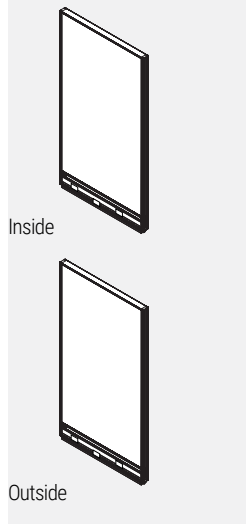

- Individual modules, one in fabric and one in laminate, incorporated into an aluminum frame.
- Panels are not tackable.
- 3 panel connector brackets per side come standard with 30”h., 42”h., and 54”h. panels.
- 4 panel connector brackets per side come standard with 66”h. panels.
- Panels include 2 raceway cover with punchouts, a power distribution housing, an integrated aluminum top cap and levelling glides.
- 24” wide panels have two punchouts, one for electrical and one for data.
- 30” wide panels and wider have three punchouts, two for electrical and one for data.
- Note: Trim is not required at a straight connection between two panels of the same height.
- Please specify duplex receptacles separately.

PRODUCT CODE	PRICE		SIZE/ INCHES			WEIGHT VOL	
	GR 1	GR 2	H	W	D	LBS	FT³
CMLFM3024P2	522	535	30	24	2.3	20	2.31
CMLFM3030P2	645	655	30	30	2.3	25	2.85
CMLFM3036P2	713	720	30	36	2.3	31	3.38
CMLFM3042P2	784	796	30	42	2.3	36	3.92
CMLFM3048P2	843	856	30	48	2.3	41	4.45
CMLFM3054P2	918	933	30	54	2.3	46	4.99
CMLFM3060P2	986	1001	30	60	2.3	51	5.52
CMLFM4224P2	596	609	42	24	2.3	20	2.31
CMLFM4230P2	720	733	42	30	2.3	25	2.85
CMLFM4236P2	811	827	42	36	2.3	31	3.38
CMLFM4242P2	897	918	42	42	2.3	36	3.92
CMLFM4248P2	971	994	42	48	2.3	41	4.45
CMLFM4254P2	1061	1084	42	54	2.3	46	4.99
CMLFM4260P2	1143	1169	42	60	2.3	51	5.52
CMLFM4824P2	683	697	48	24	2.3	26	2.73
CMLFM4830P2	825	843	48	30	2.3	33	3.37
CMLFM4836P2	928	951	48	36	2.3	39	4.00
CMLFM4842P2	1030	1056	48	42	2.3	46	4.63
CMLFM4848P2	1121	1147	48	48	2.3	52	5.26
CMLFM4854P2	1171	1226	48	54	2.3	59	5.89
CMLFM5424P2	683	697	54	24	2.3	65	6.53
CMLFM5430P2	825	843	54	30	2.3	33	3.37
CMLFM5436P2	928	951	54	36	2.3	39	4.00
CMLFM5442P2	1030	1056	54	42	2.3	46	4.63
CMLFM5448P2	1121	1147	54	48	2.3	52	5.26
CMLFM5454P2	1226	1259	54	54	2.3	59	5.89
CMLFM6624P2	816	833	66	24	2.3	32	3.58
CMLFM6630P2	973	998	66	30	2.3	40	4.40
CMLFM6636P2	1106	1132	66	36	2.3	48	5.23
CMLFM6642P2	1238	1269	66	42	2.3	56	6.06
CMLFM6648P2	1343	1378	66	48	2.3	64	6.68

CMLLM-N0 • Monolithic Non Powered Laminate Two Sides Panel, No Punchouts

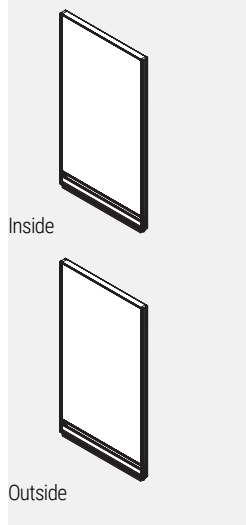

- Individual laminate modules incorporated into an aluminum frame.
- Panels are not tackable.
- 3 panel connector brackets per side come standard with 30”h., 42”h., and 54”h. panels.
- 4 panel connector brackets per side come standard with 66”h. panels.
- Panels include 2 raceway covers with no punchouts, an integrated aluminum top cap and levelling glides.
- Note: Trim is not required at a straight connection between two panels of the same height.

PRODUCT CODE	PRICE		SIZE/ INCHES			WEIGHT VOL	
	GR 1	GR 2	H	W	D	LBS	FT³
CMLLM3024N0	448		30	24	2.3	20	2.31
CMLLM3030N0	527		30	30	2.3	25	2.85
CMLLM3036N0	604		30	36	2.3	31	3.38
CMLLM3042N0	687		30	42	2.3	36	3.92
CMLLM3048N0	766		30	48	2.3	41	4.45
CMLLM3054N0	850		30	54	2.3	46	4.99
CMLLM3060N0	918		30	60	2.3	51	5.52
CMLLM4224N0	527		42	24	2.3	20	2.31
CMLLM4230N0	622		42	30	2.3	25	2.85
CMLLM4236N0	722		42	36	2.3	31	3.38
CMLLM4242N0	825		42	42	2.3	36	3.92
CMLLM4248N0	922		42	48	2.3	41	4.45
CMLLM4254N0	1017		42	54	2.3	46	4.99
CMLLM4260N0	1107		42	60	2.3	51	5.52
CMLLM4824N0	625		48	24	2.3	26	2.73
CMLLM4830N0	741		48	30	2.3	33	3.37
CMLLM4836N0	860		48	36	2.3	39	4.00
CMLLM4842N0	983		48	42	2.3	46	4.63
CMLLM4848N0	1107		48	48	2.3	52	5.26
CMLLM4854N0	1216		48	54	2.3	59	5.89
CMLLM5424N0	625		54	24	2.3	65	6.53
CMLLM5430N0	741		54	30	2.3	33	3.37
CMLLM5436N0	860		54	36	2.3	39	4.00
CMLLM5442N0	983		54	42	2.3	46	4.63
CMLLM5448N0	1107		54	48	2.3	52	5.26
CMLLM5454N0	1216		54	54	2.3	59	5.89
CMLLM6624N0	788		66	24	2.3	32	3.58
CMLLM6630N0	935		66	30	2.3	40	4.40
CMLLM6636N0	1087		66	36	2.3	48	5.23
CMLLM6642N0	1244		66	42	2.3	56	6.06
CMLLM6648N0	1395		66	48	2.3	64	6.68

CMLLM-N1 • Monolithic Non Powered Laminate Two Sides Panel, Punchouts on One Side

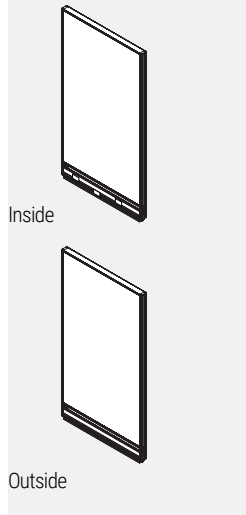

- Individual laminate modules incorporated into an aluminum frame.
- Panels are not tackable.
- 3 panel connector brackets per side come standard with 30”h., 42”h., and 54”h. panels.
- 4 panel connector brackets per side come standard with 66”h. panels.
- Panels include 1 raceway cover with punchouts on one side, 1 raceway cover with no punchouts on the other, an integrated aluminum top cap and levelling glides.
- 24” wide panels have two punchouts, one for electrical and one for data.
- 30” wide panels and wider have three punchouts, two for electrical and one for data.
- Note: Trim is not required at a straight connection between two panels of the same height.

PRODUCT CODE	PRICE	SIZE/ INCHES			WEIGHT VOL	
		H	W	D	LBS	FT³
CMLLM3024N1	448	30	24	2.3	20	2.31
CMLLM3030N1	527	30	30	2.3	25	2.85
CMLLM3036N1	604	30	36	2.3	31	3.38
CMLLM3042N1	687	30	42	2.3	36	3.92
CMLLM3048N1	766	30	48	2.3	41	4.45
CMLLM3054N1	850	30	54	2.3	46	4.99
CMLLM3060N1	918	30	60	2.3	51	5.52
CMLLM4224N1	527	42	24	2.3	20	2.31
CMLLM4230N1	622	42	30	2.3	25	2.85
CMLLM4236N1	722	42	36	2.3	31	3.38
CMLLM4242N1	825	42	42	2.3	36	3.92
CMLLM4248N1	922	42	48	2.3	41	4.45
CMLLM4254N1	1017	42	54	2.3	46	4.99
CMLLM4260N1	1107	42	60	2.3	51	5.52
CMLLM4824N1	625	48	24	2.3	26	2.73
CMLLM4830N1	741	48	30	2.3	33	3.37
CMLLM4836N1	860	48	36	2.3	39	4.00
CMLLM4842N1	983	48	42	2.3	46	4.63
CMLLM4848N1	1107	48	48	2.3	52	5.26
CMLLM4854N1	1216	48	54	2.3	59	5.89
CMLLM5424N1	625	54	24	2.3	65	6.53
CMLLM5430N1	741	54	30	2.3	33	3.37
CMLLM5436N1	860	54	36	2.3	39	4.00
CMLLM5442N1	983	54	42	2.3	46	4.63
CMLLM5448N1	1107	54	48	2.3	52	5.26
CMLLM5454N1	1216	54	54	2.3	59	5.89
CMLLM6624N1	788	66	24	2.3	32	3.58
CMLLM6630N1	935	66	30	2.3	40	4.40
CMLLM6636N1	1087	66	36	2.3	48	5.23
CMLLM6642N1	1244	66	42	2.3	56	6.06
CMLLM6648N1	1395	66	48	2.3	64	6.68

CMLLM-N2 • Monolithic Non Powered Laminate Two Sides Panel, Punchouts on Both Sides

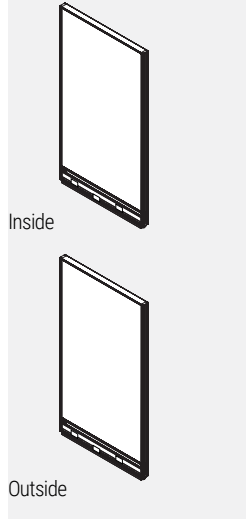

- Individual laminate modules incorporated into an aluminum frame.
- Panels are not tackable.
- 3 panel connector brackets per side come standard with 30”h., 42”h., and 54”h. panels.
- 4 panel connector brackets per side come standard with 66”h. panels.
- Panels include 2 raceway covers with punchouts, an integrated aluminum top cap and levelling glides.
- 24” wide panels have two punchouts, one for electrical and one for data.
- 30” wide panels and wider have three punchouts, two for electrical and one for data.
- Note: Trim is not required at a straight connection between two panels of the same height.

PRODUCT CODE	PRICE	SIZE/ INCHES			WEIGHT VOL	
		H	W	D	LBS	FT³
CMLLM3024N2	448	30	24	2.3	20	2.31
CMLLM3030N2	527	30	30	2.3	25	2.85
CMLLM3036N2	604	30	36	2.3	31	3.38
CMLLM3042N2	687	30	42	2.3	36	3.92
CMLLM3048N2	766	30	48	2.3	41	4.45
CMLLM3054N2	850	30	54	2.3	46	4.99
CMLLM3060N2	918	30	60	2.3	51	5.52
CMLLM4224N2	527	42	24	2.3	20	2.31
CMLLM4230N2	622	42	30	2.3	25	2.85
CMLLM4236N2	722	42	36	2.3	31	3.38
CMLLM4242N2	825	42	42	2.3	36	3.92
CMLLM4248N2	922	42	48	2.3	41	4.45
CMLLM4254N2	1017	42	54	2.3	46	4.99
CMLLM4260N2	1107	42	60	2.3	51	5.52
CMLLM4824N2	625	48	24	2.3	26	2.73
CMLLM4830N2	741	48	30	2.3	33	3.37
CMLLM4836N2	860	48	36	2.3	39	4.00
CMLLM4842N2	983	48	42	2.3	46	4.63
CMLLM4848N2	1107	48	48	2.3	52	5.26
CMLLM4854N2	1216	48	54	2.3	59	5.89
CMLLM5424N2	625	54	24	2.3	65	6.53
CMLLM5430N2	741	54	30	2.3	33	3.37
CMLLM5436N2	860	54	36	2.3	39	4.00
CMLLM5442N2	983	54	42	2.3	46	4.63
CMLLM5448N2	1107	54	48	2.3	52	5.26
CMLLM5454N2	1216	54	54	2.3	59	5.89
CMLLM6624N2	788	66	24	2.3	32	3.58
CMLLM6630N2	935	66	30	2.3	40	4.40
CMLLM6636N2	1087	66	36	2.3	48	5.23
CMLLM6642N2	1244	66	42	2.3	56	6.06
CMLLM6648N2	1395	66	48	2.3	64	6.68

CMLLM-P1 • Monolithic Laminate Two Sides Panel with PDH, Punchouts on One Side

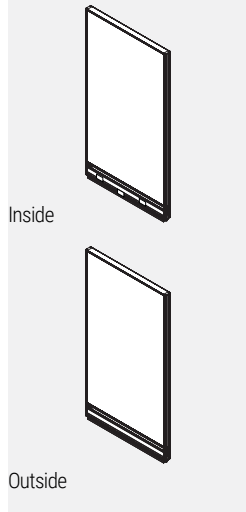

- Individual laminate modules incorporated into an aluminum frame.
- Panels are not tackable.
- 3 panel connector brackets per side come standard with 30”h., 42”h., and 54”h. panels.
- 4 panel connector brackets per side come standard with 66”h. panels.
- Panels include 1 raceway cover with punchouts on one side, 1 raceway cover with no punchouts on the other, a power distribution housing, an integrated aluminum top cap and levelling glides.
- 24” wide panels have two punchouts, one for electrical and one for data.
- 30” wide panels and wider have three punchouts, two for electrical and one for data.
- Note: Trim is not required at a straight connection between two panels of the same height.
- Please specify duplex receptacles separately.

PRODUCT CODE	PRICE	SIZE/ INCHES			WEIGHT VOL	
		H	W	D	LBS	FT³
CMLLM3024P1	579	30	24	2.3	20	2.31
CMLLM3030P1	707	30	30	2.3	25	2.85
CMLLM3036P1	790	30	36	2.3	31	3.38
CMLLM3042P1	880	30	42	2.3	36	3.92
CMLLM3048P1	971	30	48	2.3	41	4.45
CMLLM3054P1	1056	30	54	2.3	46	4.99
CMLLM3060P1	1126	30	60	2.3	51	5.52
CMLLM4224P1	659	42	24	2.3	20	2.31
CMLLM4230P1	800	42	30	2.3	25	2.85
CMLLM4236P1	909	42	36	2.3	31	3.38
CMLLM4242P1	1018	42	42	2.3	36	3.92
CMLLM4248P1	1126	42	48	2.3	41	4.45
CMLLM4254P1	1224	42	54	2.3	46	4.99
CMLLM4260P1	1315	42	60	2.3	51	5.52
CMLLM4824P1	757	48	24	2.3	26	2.73
CMLLM4830P1	918	48	30	2.3	33	3.37
CMLLM4836P1	1046	48	36	2.3	39	4.00
CMLLM4842P1	1174	48	42	2.3	46	4.63
CMLLM4848P1	1310	48	48	2.3	52	5.26
CMLLM4854P1	1424	48	54	2.3	59	5.89
CMLLM5424P1	757	54	24	2.3	65	6.53
CMLLM5430P1	918	54	30	2.3	33	3.37
CMLLM5436P1	1046	54	36	2.3	39	4.00
CMLLM5442P1	1174	54	42	2.3	46	4.63
CMLLM5448P1	1310	54	48	2.3	52	5.26
CMLLM5454P1	1424	54	54	2.3	59	5.89
CMLLM6624P1	921	66	24	2.3	32	3.58
CMLLM6630P1	1113	66	30	2.3	40	4.40
CMLLM6636P1	1272	66	36	2.3	48	5.23
CMLLM6642P1	1438	66	42	2.3	56	6.06
CMLLM6648P1	1600	66	48	2.3	64	6.68

CMLLM-P2 • Monolithic Laminate Two Sides Panel with PDH, Punchouts on Both Side

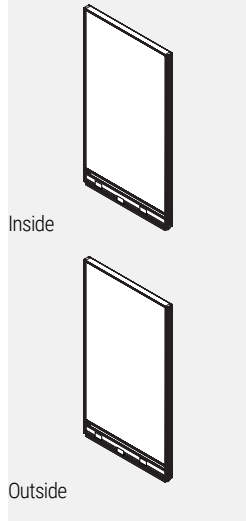

- Individual laminate modules incorporated into an aluminum frame.
- Panels are not tackable.
- 3 panel connector brackets per side come standard with 30”h., 42”h., and 54”h. panels.
- 4 panel connector brackets per side come standard with 66”h. panels.
- Panels include 2 raceway cover with punchouts, a power distribution housing, an integrated aluminum top cap and levelling glides.
- 24” wide panels have two punchouts, one for electrical and one for data.
- 30” wide panels and wider have three punchouts, two for electrical and one for data.
- Note: Trim is not required at a straight connection between two panels of the same height.
- Please specify duplex receptacles separately.

PRODUCT CODE	PRICE	SIZE/ INCHES			WEIGHT VOL	
		H	W	D	LBS	FT³
CMLLM3024P2	579	30	24	2.3	20	2.31
CMLLM3030P2	707	30	30	2.3	25	2.85
CMLLM3036P2	790	30	36	2.3	31	3.38
CMLLM3042P2	880	30	42	2.3	36	3.92
CMLLM3048P2	971	30	48	2.3	41	4.45
CMLLM3054P2	1056	30	54	2.3	46	4.99
CMLLM3060P2	1126	30	60	2.3	51	5.52
CMLLM4224P2	659	42	24	2.3	20	2.31
CMLLM4230P2	800	42	30	2.3	25	2.85
CMLLM4236P2	909	42	36	2.3	31	3.38
CMLLM4242P2	1018	42	42	2.3	36	3.92
CMLLM4248P2	1126	42	48	2.3	41	4.45
CMLLM4254P2	1224	42	54	2.3	46	4.99
CMLLM4260P2	1315	42	60	2.3	51	5.52
CMLLM4824P2	757	48	24	2.3	26	2.73
CMLLM4830P2	918	48	30	2.3	33	3.37
CMLLM4836P2	1046	48	36	2.3	39	4.00
CMLLM4842P2	1174	48	42	2.3	46	4.63
CMLLM4848P2	1310	48	48	2.3	52	5.26
CMLLM4854P2	1424	48	54	2.3	59	5.89
CMLLM5424P2	757	54	24	2.3	65	6.53
CMLLM5430P2	918	54	30	2.3	33	3.37
CMLLM5436P2	1046	54	36	2.3	39	4.00
CMLLM5442P2	1174	54	42	2.3	46	4.63
CMLLM5448P2	1310	54	48	2.3	52	5.26
CMLLM5454P2	1424	54	54	2.3	59	5.89
CMLLM6624P2	921	66	24	2.3	32	3.58
CMLLM6630P2	1113	66	30	2.3	40	4.40
CMLLM6636P2	1272	66	36	2.3	48	5.23
CMLLM6642P2	1438	66	42	2.3	56	6.06
CMLLM6648P2	1600	66	48	2.3	64	6.68

CMFF-N0 • Single Segmented Non Powered Fabric Panel, No Punchouts

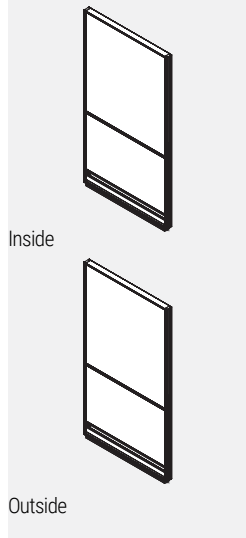

- Individual fabric-covered modules incorporated into an aluminum frame.
- Opposite sides of each module may have a different fabric within the same grade at no upcharge.
- If different grades of fabric are used on one panel, the entire panel must be priced at highest grade.
- Panels are not tackable.
- Note: Trim is not required at a straight connection between two panels of the same height.
- 3 Panel connector brackets per side come standard with 42”h. and 54”h. panels.
- 4 Panel connector brackets per side come standard with 66”h. panels.
- Panels include 2 raceway covers with no punchouts, an integrated aluminum top cap and levelling glides.

PRODUCT CODE	PRICE		SIZE/ INCHES			WEIGHT VOL	
	GR 1	GR 2	H	W	D	LBS	FT³
CMFF4224N0	295	319	42	24	2.3	20	2.31
CMFF4230N0	366	391	42	30	2.3	25	2.85
CMFF4236N0	394	443	42	36	2.3	31	3.38
CMFF4242N0	451	501	42	42	2.3	36	3.92
CMFF4248N0	482	534	42	48	2.3	41	4.45
CMFF4254N0	524	577	42	54	2.3	46	4.99
CMFF4260N0	578	627	42	60	2.3	51	5.52
CMFF4266N0	748	857	42	66	2.3	55	6.05
CMFF4272N0	786	895	42	72	2.3	60	6.60
CMFF4824N0	344	375	48	24	2.3	26	2.73
CMFF4830N0	394	422	48	30	2.3	33	3.37
CMFF4836N0	449	491	48	36	2.3	39	4.00
CMFF4842N0	514	575	48	42	2.3	46	4.63
CMFF4848N0	547	608	48	48	2.3	52	5.26
CMFF4854N0	602	659	48	54	2.3	59	5.89
CMFF4860N0	636	695	48	60	2.3	65	6.53
CMFF5424N0	344	375	54	24	2.3	26	2.73
CMFF5430N0	394	422	54	30	2.3	33	3.37
CMFF5436N0	449	491	54	36	2.3	39	4.00
CMFF5442N0	514	575	54	42	2.3	46	4.63
CMFF5448N0	547	608	54	48	2.3	52	5.26
CMFF5454N0	602	659	54	54	2.3	59	5.89
CMFF5460N0	636	695	54	60	2.3	65	6.53
CMFF6624N0	382	420	66	24	2.3	32	3.58
CMFF6630N0	425	464	66	30	2.3	40	4.40
CMFF6636N0	510	584	66	36	2.3	48	5.23
CMFF6642N0	578	654	66	42	2.3	56	6.06
CMFF6648N0	605	681	66	48	2.3	64	6.88
CMFF6654N0	660	737	66	54	2.3	72	7.71
CMFF6660N0	707	781	66	60	2.3	80	8.53

CMFF-N1 • Single Segmented Non Powered Fabric Panel, Punchouts on One Side

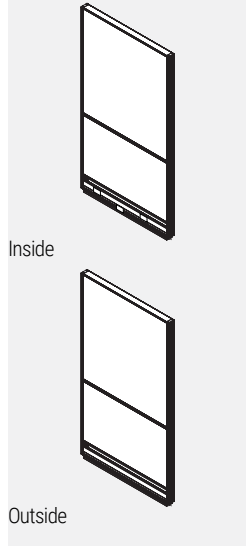

- Individual fabric-covered modules incorporated into an aluminum frame.
- Opposite sides of each module may have a different fabric within the same grade at no upcharge.
- If different grades of fabric are used on one panel, the entire panel must be priced at highest grade.
- Panels are not tackable.
- Note: Trim is not required at a straight connection between two panels of the same height.
- 3 Panel connector brackets per side come standard with 42”h. and 54”h. panels.
- 4 Panel connector brackets per side come standard with 66”h. panels.
- Panels include 1 raceway cover with punchouts on one side, 1 raceway cover with no punchouts on the other, an integrated aluminum top cap and levelling glides.
- 24” wide panels have two punchouts, one for electrical and one for data.
- 30” wide panels and wider have three punchouts, two for electrical and one for data.

PRODUCT CODE	PRICE		SIZE/ INCHES			WEIGHT VOL	
	GR 1	GR 2	H	W	D	LBS	FT³
CMFF4224N1	295	319	42	24	2.3	20	2.31
CMFF4230N1	366	391	42	30	2.3	25	2.85
CMFF4236N1	394	443	42	36	2.3	31	3.38
CMFF4242N1	451	501	42	42	2.3	36	3.92
CMFF4248N1	482	534	42	48	2.3	41	4.45
CMFF4254N1	524	577	42	54	2.3	46	4.99
CMFF4260N1	578	627	42	60	2.3	51	5.52
CMFF4266N1	748	857	42	66	2.3	55	6.05
CMFF4272N1	786	895	42	72	2.3	60	6.60
CMFF4824N1	344	375	48	24	2.3	26	2.73
CMFF4830N1	394	422	48	30	2.3	33	3.37
CMFF4836N1	449	491	48	36	2.3	39	4.00
CMFF4842N1	514	575	48	42	2.3	46	4.63
CMFF4848N1	547	608	48	48	2.3	52	5.26
CMFF4854N1	602	659	48	54	2.3	59	5.89
CMFF4860N1	636	695	48	60	2.3	65	6.53
CMFF5424N1	344	375	54	24	2.3	26	2.73
CMFF5430N1	394	422	54	30	2.3	33	3.37
CMFF5436N1	449	491	54	36	2.3	39	4.00
CMFF5442N1	514	575	54	42	2.3	46	4.63
CMFF5448N1	547	608	54	48	2.3	52	5.26
CMFF5454N1	602	659	54	54	2.3	59	5.89
CMFF5460N1	636	695	54	60	2.3	65	6.53
CMFF6624N1	382	420	66	24	2.3	32	3.58
CMFF6630N1	425	464	66	30	2.3	40	4.40
CMFF6636N1	510	584	66	36	2.3	48	5.23
CMFF6642N1	578	654	66	42	2.3	56	6.06
CMFF6648N1	605	681	66	48	2.3	64	6.88
CMFF6654N1	660	737	66	54	2.3	72	7.71
CMFF6660N1	707	781	66	60	2.3	80	8.53

CMFF-N2 • Single Segmented Non Powered Fabric Panel, Punchouts on Both Sides

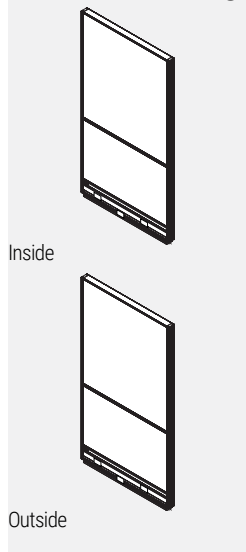

- Individual fabric-covered modules incorporated into an aluminum frame.
- Opposite sides of each module may have a different fabric within the same grade at no upcharge.
- If different grades of fabric are used on one panel, the entire panel must be priced at highest grade.
- Panels are not tackable.
- Note: Trim is not required at a straight connection between two panels of the same height.
- 3 Panel connector brackets per side come standard with 42”h. and 54”h. panels.
- 4 Panel connector brackets per side come standard with 66”h. panels.
- Panels include 2 raceway covers with punchouts on both sides, an integrated aluminum top cap and levelling glides.
- 24” wide panels have two punchouts, one for electrical and one for data.
- 30” wide panels and wider have three punchouts, two for electrical and one for data.

PRODUCT CODE	PRICE		SIZE/ H	INCHES			WEIGHT VOL	
	GR 1	GR 2		W	D	LBS	FT³	
CMFF4224N2	295	319	42	24	2.3	20	2.31	
CMFF4230N2	366	391	42	30	2.3	25	2.85	
CMFF4236N2	394	443	42	36	2.3	31	3.38	
CMFF4242N2	451	501	42	42	2.3	36	3.92	
CMFF4248N2	482	534	42	48	2.3	41	4.45	
CMFF4254N2	524	577	42	54	2.3	46	4.99	
CMFF4260N2	578	627	42	60	2.3	51	5.52	
CMFF4266N2	748	857	42	66	2.3	55	6.05	
CMFF4272N2	786	895	42	72	2.3	60	6.60	
CMFF4824N2	344	375	48	24	2.3	26	2.73	
CMFF4830N2	394	422	48	30	2.3	33	3.37	
CMFF4836N2	449	491	48	36	2.3	39	4.00	
CMFF4842N2	514	575	48	42	2.3	46	4.63	
CMFF4848N2	547	608	48	48	2.3	52	5.26	
CMFF4854N2	602	659	48	54	2.3	59	5.89	
CMFF4860N2	636	695	48	60	2.3	65	6.53	
CMFF5424N2	344	375	54	24	2.3	26	2.73	
CMFF5430N2	394	422	54	30	2.3	33	3.37	
CMFF5436N2	449	491	54	36	2.3	39	4.00	
CMFF5442N2	514	575	54	42	2.3	46	4.63	
CMFF5448N2	547	608	54	48	2.3	52	5.26	
CMFF5454N2	602	659	54	54	2.3	59	5.89	
CMFF5460N2	636	695	54	60	2.3	65	6.53	
CMFF6624N2	382	420	66	24	2.3	32	3.58	
CMFF6630N2	425	464	66	30	2.3	40	4.40	
CMFF6636N2	510	584	66	36	2.3	48	5.23	
CMFF6642N2	578	654	66	42	2.3	56	6.06	
CMFF6648N2	605	681	66	48	2.3	64	6.88	
CMFF6654N2	660	737	66	54	2.3	72	7.71	
CMFF6660N2	707	781	66	60	2.3	80	8.53	

CMFF-P1 • Single Segmented Powered Fabric Panel, Punchouts on One Side

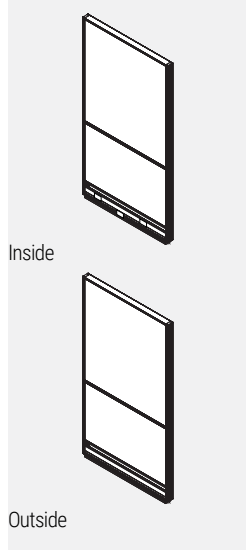

- Individual fabric-covered modules incorporated into an aluminum frame.
- Opposite sides of each module may have a different fabric within the same grade at no upcharge.
- If different grades of fabric are used on one panel, the entire panel must be priced at highest grade.
- Panels are not tackable.
- Note: Trim is not required at a straight connection between two panels of the same height.
- 3 Panel connector brackets per side come standard with 42”h. and 54”h. panels.
- 4 Panel connector brackets per side come standard with 66”h. panels.
- Panels include 1 raceway cover with punchouts on one side, 1 raceway cover with no punchouts on the other, a power distribution housing, an integrated aluminum top cap and levelling glides.
- 24” wide panels have two punchouts, one for electrical and one for data.
- 30” wide panels and wider have three punchouts, two for electrical and one for data.
- Please specify duplex receptacles separately.

PRODUCT CODE	PRICE		SIZE/ H	INCHES			WEIGHT VOL	
	GR 1	GR 2		W	D	LBS	FT³	
CMFF4224P1	433	457	42	24	2.3	20	2.31	
CMFF4230P1	551	578	42	30	2.3	25	2.85	
CMFF4236P1	590	639	42	36	2.3	31	3.38	
CMFF4242P1	654	701	42	42	2.3	36	3.92	
CMFF4248P1	694	746	42	48	2.3	41	4.45	
CMFF4254P1	745	792	42	54	2.3	46	4.99	
CMFF4260P1	796	846	42	60	2.3	51	5.52	
CMFF4266P1	975	1086	42	66	2.3	55	6.05	
CMFF4272P1	1022	1130	42	72	2.3	60	6.60	
CMFF4824P1	484	514	48	24	2.3	26	2.73	
CMFF4830P1	580	610	48	30	2.3	33	3.37	
CMFF4836P1	644	689	48	36	2.3	39	4.00	
CMFF4842P1	717	778	48	42	2.3	46	4.63	
CMFF4848P1	761	823	48	48	2.3	52	5.26	
CMFF4854P1	817	879	48	54	2.3	59	5.89	
CMFF4860P1	854	916	48	60	2.3	65	6.53	
CMFF5424P1	484	514	54	24	2.3	26	2.73	
CMFF5430P1	580	610	54	30	2.3	33	3.37	
CMFF5436P1	644	689	54	36	2.3	39	4.00	
CMFF5442P1	717	778	54	42	2.3	46	4.63	
CMFF5448P1	761	823	54	48	2.3	52	5.26	
CMFF5454P1	817	879	54	54	2.3	59	5.89	
CMFF5460P1	854	916	54	60	2.3	65	6.53	
CMFF6624P1	520	561	66	24	2.3	32	3.58	
CMFF6630P1	612	653	66	30	2.3	40	4.40	
CMFF6636P1	707	781	66	36	2.3	48	5.23	
CMFF6642P1	780	854	66	42	2.3	56	6.06	
CMFF6648P1	819	894	66	48	2.3	64	6.88	
CMFF6654P1	880	955	66	54	2.3	72	7.71	
CMFF6660P1	925	999	66	60	2.3	80	8.53	

CMFF-P2 • Single Segmented Powered Fabric Panel, Punchouts on Both Sides

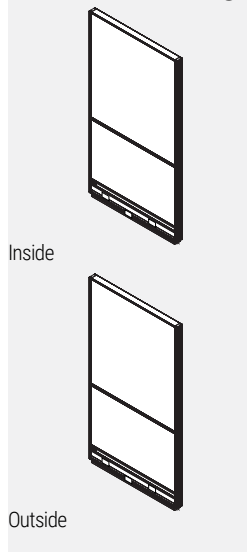

- Individual fabric-covered modules incorporated into an aluminum frame.
- Opposite sides of each module may have a different fabric within the same grade at no upcharge.
- If different grades of fabric are used on one panel, the entire panel must be priced at highest grade.
- Panels are not tackable.
- Note: Trim is not required at a straight connection between two panels of the same height.
- 3 Panel connector brackets per side come standard with 42”h. and 54”h. panels.
- 4 Panel connector brackets per side come standard with 66”h. panels.
- Panels include 2 raceway covers with punchouts on both sides, a power distribution housing, an integrated aluminum top cap and levelling glides.
- 24” wide panels have two punchouts, one for electrical and one for data.
- 30” wide panels and wider have three punchouts, two for electrical and one for data.
- Please specify duplex receptacles separately.

PRODUCT CODE	PRICE		SIZE/ INCHES			WEIGHT VOL	
	GR 1	GR 2	H	W	D	LBS	FT³
CMFF4224P2	433	457	42	24	2.3	20	2.31
CMFF4230P2	551	578	42	30	2.3	25	2.85
CMFF4236P2	590	639	42	36	2.3	31	3.38
CMFF4242P2	654	701	42	42	2.3	36	3.92
CMFF4248P2	694	746	42	48	2.3	41	4.45
CMFF4254P2	745	792	42	54	2.3	46	4.99
CMFF4260P2	796	846	42	60	2.3	51	5.52
CMFF4266P2	975	1086	42	66	2.3	55	6.05
CMFF4272P2	1022	1130	42	72	2.3	60	6.60
CMFF4824P2	484	514	48	24	2.3	26	2.73
CMFF4830P2	580	610	48	30	2.3	33	3.37
CMFF4836P2	644	689	48	36	2.3	39	4.00
CMFF4842P2	717	778	48	42	2.3	46	4.63
CMFF4848P2	761	823	48	48	2.3	52	5.26
CMFF4854P2	817	879	48	54	2.3	59	5.89
CMFF4860P2	854	916	48	60	2.3	65	6.53
CMFF5424P2	484	514	54	24	2.3	26	2.73
CMFF5430P2	580	610	54	30	2.3	33	3.37
CMFF5436P2	644	689	54	36	2.3	39	4.00
CMFF5442P2	717	778	54	42	2.3	46	4.63
CMFF5448P2	761	823	54	48	2.3	52	5.26
CMFF5454P2	817	879	54	54	2.3	59	5.89
CMFF5460P2	854	916	54	60	2.3	65	6.53
CMFF6624P2	520	561	66	24	2.3	32	3.58
CMFF6630P2	612	653	66	30	2.3	40	4.40
CMFF6636P2	707	781	66	36	2.3	48	5.23
CMFF6642P2	780	854	66	42	2.3	56	6.06
CMFF6648P2	819	894	66	48	2.3	64	6.88
CMFF6654P2	880	955	66	54	2.3	72	7.71
CMFF6660P2	925	999	66	60	2.3	80	8.53

CMFL-N0 • Single Segmented Non Powered Laminate One Side Panel, No Punchouts

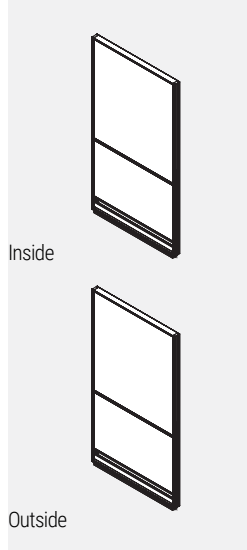

- Individual fabric or laminate covered modules incorporated into an aluminum frame.
- Modules have laminate on one side and fabric on the other.
- If different grades of fabric are used on one panel, the entire panel must be priced at highest grade.
- Panels are not tackable.
- Note: Trim is not required at a straight connection between two panels of the same height.
- 3 Panel connector brackets per side come standard with 30” to 54”h. panels.
- 4 Panel connector brackets per side come standard with 66”h. panels.
- Panels include 2 raceway covers with no punchouts, an integrated aluminum top cap and levelling glides.

PRODUCT CODE	PRICE		SIZE/ INCHES			WEIGHT VOL	
	GR 1	GR 2	H	W	D	LBS	FT³
CMFL4224N0	464	477	42	24	2.3	20	2.31
CMFL4230N0	542	553	42	30	2.3	25	2.85
CMFL4236N0	623	641	42	36	2.3	31	3.38
CMFL4242N0	707	724	42	42	2.3	36	3.92
CMFL4248N0	766	788	42	48	2.3	41	4.45
CMFL4254N0	853	879	42	54	2.3	46	4.99
CMFL4260N0	935	962	42	60	2.3	51	5.52
CMFL4824N0	550	567	48	24	2.3	26	2.73
CMFL4830N0	647	665	48	30	2.3	33	3.37
CMFL4836N0	741	762	48	36	2.3	39	4.00
CMFL4842N0	839	864	48	42	2.3	46	4.63
CMFL4848N0	917	947	48	48	2.3	52	5.26
CMFL4854N0	1021	1052	48	54	2.3	59	5.89
CMFL4860N0	1122	1156	48	60	2.3	65	6.53
CMFL5424N0	550	567	54	24	2.3	26	2.73
CMFL5430N0	647	665	54	30	2.3	33	3.37
CMFL5436N0	741	762	54	36	2.3	39	4.00
CMFL5442N0	839	864	54	42	2.3	46	4.63
CMFL5448N0	917	947	54	48	2.3	52	5.26
CMFL5454N0	1021	1052	54	54	2.3	59	5.89
CMFL5460N0	1122	1156	54	60	2.3	65	6.53
CMFL6624N0	683	699	66	24	2.3	32	3.58
CMFL6630N0	796	820	66	30	2.3	40	4.4
CMFL6636N0	918	948	66	36	2.3	48	5.23
CMFL6642N0	1046	1078	66	42	2.3	56	6.06
CMFL6648N0	1139	1174	66	48	2.3	64	6.88
CMFL6654N0	1265	1303	66	54	2.3	72	7.71
CMFL6660N0	1395	1438	66	60	2.3	80	8.53

CMFL-N1 • Single Segmented Non Powered Laminate One Side Panel, Punchouts on One Side

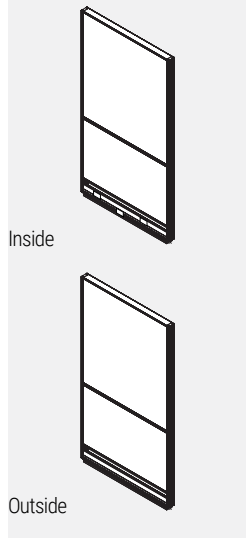

- Individual fabric or laminate covered modules incorporated into an aluminum frame.
- Modules have laminate on one side and fabric on the other.
- If different grades of fabric are used on one panel, the entire panel must be priced at highest grade.
- Panels are not tackable.
- Note: Trim is not required at a straight connection between two panels of the same height.
- 3 Panel connector brackets per side come standard with 30”h. to 54”h. panels.
- 4 Panel connector brackets per side come standard with 66”h. panels.
- Panels include 1 raceway cover with punchouts on one side, 1 raceway cover with no punchouts on the other, an integrated aluminum top cap and levelling glides.
- 24” wide panels have two punchouts, one for electrical and one for data.
- 30” wide panels and wider have three punchouts, two for electrical and one for data.

PRODUCT CODE	PRICE		SIZE/ INCHES			WEIGHT VOL	
	GR 1	GR 2	H	W	D	LBS	FT³
CMFL4224N1	464	477	42	24	2.3	20	2.31
CMFL4230N1	542	553	42	30	2.3	25	2.85
CMFL4236N1	623	641	42	36	2.3	31	3.38
CMFL4242N1	707	724	42	42	2.3	36	3.92
CMFL4248N1	766	788	42	48	2.3	41	4.45
CMFL4254N1	853	879	42	54	2.3	46	4.99
CMFL4260N1	935	962	42	60	2.3	51	5.52
CMFL4824N1	550	567	48	24	2.3	26	2.73
CMFL4830N1	647	665	48	30	2.3	33	3.37
CMFL4836N1	741	762	48	36	2.3	39	4.00
CMFL4842N1	839	864	48	42	2.3	46	4.63
CMFL4848N1	917	947	48	48	2.3	52	5.26
CMFL4854N1	1021	1052	48	54	2.3	59	5.89
CMFL4860N1	1122	1156	48	60	2.3	65	6.53
CMFL5424N1	550	567	54	24	2.3	26	2.73
CMFL5430N1	647	665	54	30	2.3	33	3.37
CMFL5436N1	741	762	54	36	2.3	39	4.00
CMFL5442N1	839	864	54	42	2.3	46	4.63
CMFL5448N1	917	947	54	48	2.3	52	5.26
CMFL5454N1	1021	1052	54	54	2.3	59	5.89
CMFL5460N1	1122	1156	54	60	2.3	65	6.53
CMFL6624N1	683	699	66	24	2.3	32	3.58
CMFL6630N1	796	820	66	30	2.3	40	4.40
CMFL6636N1	918	948	66	36	2.3	48	5.23
CMFL6642N1	1046	1078	66	42	2.3	56	6.06
CMFL6648N1	1139	1174	66	48	2.3	64	6.88
CMFL6654N1	1265	1303	66	54	2.3	72	7.71
CMFL6660N1	1395	1438	66	60	2.3	80	8.53

CMFL-N2 • Single Segmented Non Powered Laminate One Side Panel, Punchouts on Both Sides

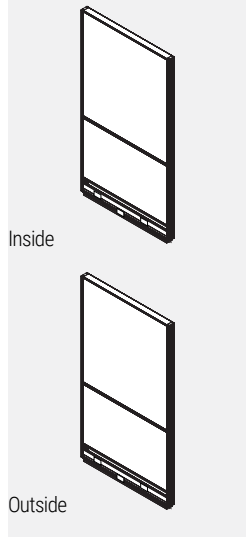

- Individual fabric or laminate covered modules incorporated into an aluminum frame.
- Modules have laminate on one side and fabric on the other.
- If different grades of fabric are used on one panel, the entire panel must be priced at highest grade.
- Panels are not tackable.
- Note: Trim is not required at a straight connection between two panels of the same height.
- 3 Panel connector brackets per side come standard with 30”h. to 54”h. panels.
- 4 Panel connector brackets per side come standard with 66”h. panels.
- Panels include 2 raceway covers with punchouts on both sides, an integrated aluminum top cap and levelling glides.
- 24” wide panels have two punchouts, one for electrical and one for data.
- 30” wide panels and wider have three punchouts, two for electrical and one for data.

PRODUCT CODE	PRICE		SIZE/ INCHES			WEIGHT VOL	
	GR 1	GR 2	H	W	D	LBS	FT³
CMFL4224N2	464	477	42	24	2.3	20	2.31
CMFL4230N2	542	553	42	30	2.3	25	2.85
CMFL4236N2	623	641	42	36	2.3	31	3.38
CMFL4242N2	707	724	42	42	2.3	36	3.92
CMFL4248N2	766	788	42	48	2.3	41	4.45
CMFL4254N2	853	879	42	54	2.3	46	4.99
CMFL4260N2	935	962	42	60	2.3	51	5.52
CMFL4824N2	550	567	48	24	2.3	26	2.73
CMFL4830N2	647	665	48	30	2.3	33	3.37
CMFL4836N2	741	762	48	36	2.3	39	4.00
CMFL4842N2	839	864	48	42	2.3	46	4.63
CMFL4848N2	917	947	48	48	2.3	52	5.26
CMFL4854N2	1021	1052	48	54	2.3	59	5.89
CMFL4860N2	1122	1156	48	60	2.3	65	6.53
CMFL5424N2	550	567	54	24	2.3	26	2.73
CMFL5430N2	647	665	54	30	2.3	33	3.37
CMFL5436N2	741	762	54	36	2.3	39	4.00
CMFL5442N2	839	864	54	42	2.3	46	4.63
CMFL5448N2	917	947	54	48	2.3	52	5.26
CMFL5454N2	1021	1052	54	54	2.3	59	5.89
CMFL5460N2	1122	1156	54	60	2.3	65	6.53
CMFL6624N2	683	699	66	24	2.3	32	3.58
CMFL6630N2	796	820	66	30	2.3	40	4.40
CMFL6636N2	918	948	66	36	2.3	48	5.23
CMFL6642N2	1046	1078	66	42	2.3	56	6.06
CMFL6648N2	1139	1174	66	48	2.3	64	6.88
CMFL6654N2	1265	1303	66	54	2.3	72	7.71
CMFL6660N2	1395	1438	66	60	2.3	80	8.53

CMFL-P1 • Single Segmented Powered Laminate One Side Panel, Punchouts on One Side

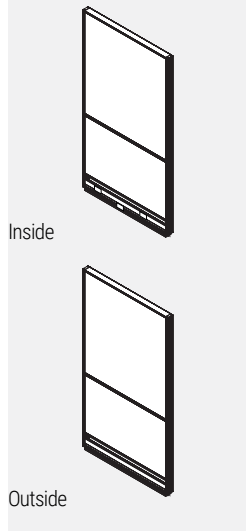

- Individual fabric or laminate covered modules incorporated into an aluminum frame.
- Modules have laminate on one side and fabric on the other.
- If different grades of fabric are used on one panel, the entire panel must be priced at highest grade.
- Panels are not tackable.
- Note: Trim is not required at a straight connection between two panels of the same height.
- 3 Panel connector brackets per side come standard with 30”h. to 54”h. panels.
- 4 Panel connector brackets per side come standard with 66”h. panels.
- Panels include 1 raceway cover with punchouts on one side, 1 raceway cover with no punchouts on the other, a power distribution housing, an integrated aluminum top cap and levelling glides.
- 24” wide panels have two punchouts, one for electrical and one for data.
- 30” wide panels and wider have three punchouts, two for electrical and one for data.
- Please specify duplex receptacles separately.

PRODUCT CODE	PRICE		SIZE/ H	INCHES			WEIGHT VOL	
	GR 1	GR 2		W	D	LBS	FT ³	
CMFL4224P1	604	614	42	24	2.3	20	2.31	
CMFL4230P1	726	744	42	30	2.3	25	2.85	
CMFL4236P1	819	837	42	36	2.3	31	3.38	
CMFL4242P1	908	928	42	42	2.3	36	3.92	
CMFL4248P1	983	1001	42	48	2.3	41	4.45	
CMFL4254P1	1069	1094	42	54	2.3	46	4.99	
CMFL4260P1	1154	1180	42	60	2.3	51	5.52	
CMFL4824P1	689	705	48	24	2.3	26	2.73	
CMFL4830P1	833	852	48	30	2.3	33	3.37	
CMFL4836P1	936	959	48	36	2.3	39	4.00	
CMFL4842P1	1040	1065	48	42	2.3	46	4.63	
CMFL4848P1	1131	1158	48	48	2.3	52	5.26	
CMFL4854P1	1236	1267	48	54	2.3	59	5.89	
CMFL4860P1	1340	1375	48	60	2.3	65	6.53	
CMFL5424P1	689	705	54	24	2.3	26	2.73	
CMFL5430P1	833	852	54	30	2.3	33	3.37	
CMFL5436P1	936	959	54	36	2.3	39	4.00	
CMFL5442P1	1040	1065	54	42	2.3	46	4.63	
CMFL5448P1	1131	1158	54	48	2.3	52	5.26	
CMFL5454P1	1236	1267	54	54	2.3	59	5.89	
CMFL5460P1	1340	1375	54	60	2.3	65	6.53	
CMFL6624P1	823	840	66	24	2.3	32	3.58	
CMFL6630P1	984	1006	66	30	2.3	40	4.40	
CMFL6636P1	1114	1143	66	36	2.3	48	5.23	
CMFL6642P1	1246	1278	66	42	2.3	56	6.06	
CMFL6648P1	1352	1389	66	48	2.3	64	6.88	
CMFL6654P1	1482	1520	66	54	2.3	72	7.71	
CMFL6660P1	1613	1656	66	60	2.3	80	8.53	

CMFL-P2 • Single Segmented Powered Laminate One Side Panel, Punchouts on Both Sides

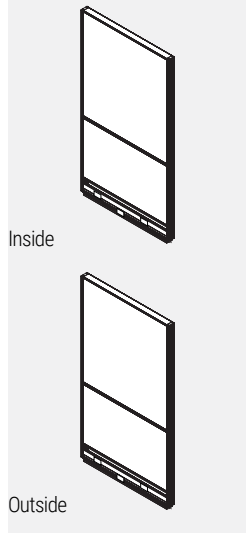

- Individual fabric or laminate covered modules incorporated into an aluminum frame.
- Modules have laminate on one side and fabric on the other.
- If different grades of fabric are used on one panel, the entire panel must be priced at highest grade.
- Panels are not tackable.
- Note: Trim is not required at a straight connection between two panels of the same height.
- 3 Panel connector brackets per side come standard with 30”h. to 54”h. panels.
- 4 Panel connector brackets per side come standard with 66”h. panels.
- Panels include 2 raceway covers with punchouts on both sides, a power distribution housing, an integrated aluminum top cap and levelling glides.
- 24” wide panels have two punchouts, one for electrical and one for data.
- 30” wide panels and wider have three punchouts, two for electrical and one for data.
- Please specify duplex receptacles separately.

PRODUCT CODE	PRICE		SIZE/ H	INCHES			WEIGHT VOL	
	GR 1	GR 2		W	D	LBS	FT ³	
CMFL4224P2	604	614	42	24	2.3	20	2.31	
CMFL4230P2	726	744	42	30	2.3	25	2.85	
CMFL4236P2	819	837	42	36	2.3	31	3.38	
CMFL4242P2	908	928	42	42	2.3	36	3.92	
CMFL4248P2	983	1001	42	48	2.3	41	4.45	
CMFL4254P2	1069	1094	42	54	2.3	46	4.99	
CMFL4260P2	1154	1180	42	60	2.3	51	5.52	
CMFL4824P2	689	705	48	24	2.3	26	2.73	
CMFL4830P2	833	852	48	30	2.3	33	3.37	
CMFL4836P2	936	959	48	36	2.3	39	4.00	
CMFL4842P2	1040	1065	48	42	2.3	46	4.63	
CMFL4848P2	1131	1158	48	48	2.3	52	5.26	
CMFL4854P2	1236	1267	48	54	2.3	59	5.89	
CMFL4860P2	1340	1375	48	60	2.3	65	6.53	
CMFL5424P2	689	705	54	24	2.3	26	2.73	
CMFL5430P2	833	852	54	30	2.3	33	3.37	
CMFL5436P2	936	959	54	36	2.3	39	4.00	
CMFL5442P2	1040	1065	54	42	2.3	46	4.63	
CMFL5448P2	1131	1158	54	48	2.3	52	5.26	
CMFL5454P2	1236	1267	54	54	2.3	59	5.89	
CMFL5460P2	1340	1375	54	60	2.3	65	6.53	
CMFL6624P2	823	840	66	24	2.3	32	3.58	
CMFL6630P2	984	1006	66	30	2.3	40	4.40	
CMFL6636P2	1114	1143	66	36	2.3	48	5.23	
CMFL6642P2	1246	1278	66	42	2.3	56	6.06	
CMFL6648P2	1352	1389	66	48	2.3	64	6.88	
CMFL6654P2	1482	1520	66	54	2.3	72	7.71	
CMFL6660P2	1613	1656	66	60	2.3	80	8.53	

CMLL-N0 • Single Segmented Non Powered Laminate Two Sides Panel, No Punchouts

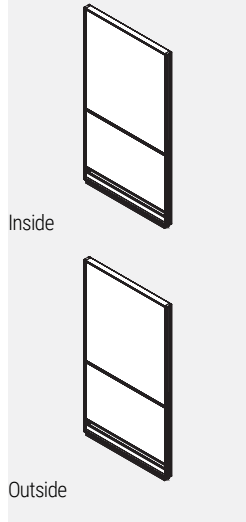

- Individual laminate covered modules incorporated into an aluminum frame.
- Opposite sides of each module may have a different laminate within the same grade at no upcharge.
- Note: Trim is not required at a straight connection between two panels of the same height.
- 3 Panel connector brackets per side come standard with 30”h. to 54”h. panels.
- 4 Panel connector brackets per side come standard with 66”h. panels.
- Panels include 2 raceway covers with no punchouts, an integrated aluminum top cap and levelling glides.

PRODUCT CODE	PRICE	SIZE/ INCHES			WEIGHT VOL	
		H	W	D	LBS	FT ³
CMLL4224N0	527	42	24	2.3	20	2.31
CMLL4230N0	622	42	30	2.3	25	2.85
CMLL4236N0	722	42	36	2.3	31	3.38
CMLL4242N0	825	42	42	2.3	36	3.92
CMLL4248N0	922	42	48	2.3	41	4.45
CMLL4254N0	1017	42	54	2.3	46	4.99
CMLL4260N0	1107	42	60	2.3	51	5.52
CMLL4824N0	625	48	24	2.3	26	2.73
CMLL4830N0	741	48	30	2.3	33	3.37
CMLL4836N0	860	48	36	2.3	39	4.00
CMLL4842N0	983	48	42	2.3	46	4.63
CMLL4848N0	1107	48	48	2.3	52	5.26
CMLL4854N0	1216	48	54	2.3	59	5.89
CMLL4860N0	1326	48	60	2.3	65	6.53
CMLL5424N0	625	54	24	2.3	26	2.73
CMLL5430N0	741	54	30	2.3	33	3.37
CMLL5436N0	860	54	36	2.3	39	4.00
CMLL5442N0	983	54	42	2.3	46	4.63
CMLL5448N0	1107	54	48	2.3	52	5.26
CMLL5454N0	1216	54	54	2.3	59	5.89
CMLL5460N0	1326	54	60	2.3	65	6.53
CMLL6624N0	788	66	24	2.3	32	3.58
CMLL6630N0	935	66	30	2.3	40	4.40
CMLL6636N0	1087	66	36	2.3	48	5.23
CMLL6642N0	1244	66	42	2.3	56	6.06
CMLL6648N0	1395	66	48	2.3	64	6.88
CMLL6654N0	1541	66	54	2.3	72	7.71
CMLL6660N0	1684	66	60	2.3	80	8.53

CMLL-N1 • Single Segmented Non Powered Laminate Two Sides Panel, Punchouts on One Side

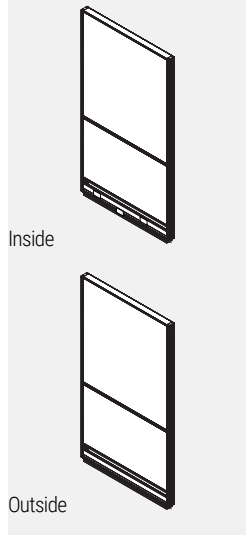

- Individual laminate covered modules incorporated into an aluminum frame.
- Opposite sides of each module may have a different laminate within the same grade at no upcharge.
- Note: Trim is not required at a straight connection between two panels of the same height.
- 3 Panel connector brackets per side come standard with 30”h. to 54”h. panels.
- 4 Panel connector brackets per side come standard with 66”h. panels.
- Panels include 1 raceway cover with punchouts on one side, 1 raceway cover with no punchouts on the other, an integrated aluminum top cap and levelling glides.
- 24” wide panels have two punchouts, one for electrical and one for data.
- 30” wide panels and wider have three punchouts, two for electrical and one for data.

PRODUCT CODE	PRICE	SIZE/ INCHES			WEIGHT VOL	
		H	W	D	LBS	FT ³
CMLL4224N1	527	42	24	2.3	20	2.31
CMLL4230N1	622	42	30	2.3	25	2.85
CMLL4236N1	722	42	36	2.3	31	3.38
CMLL4242N1	825	42	42	2.3	36	3.92
CMLL4248N1	922	42	48	2.3	41	4.45
CMLL4254N1	1017	42	54	2.3	46	4.99
CMLL4260N1	1107	42	60	2.3	51	5.52
CMLL4824N1	625	48	24	2.3	26	2.73
CMLL4830N1	741	48	30	2.3	33	3.37
CMLL4836N1	860	48	36	2.3	39	4.00
CMLL4842N1	983	48	42	2.3	46	4.63
CMLL4848N1	1107	48	48	2.3	52	5.26
CMLL4854N1	1216	48	54	2.3	59	5.89
CMLL4860N1	1326	48	60	2.3	65	6.53
CMLL5424N1	625	54	24	2.3	26	2.73
CMLL5430N1	741	54	30	2.3	33	3.37
CMLL5436N1	860	54	36	2.3	39	4.00
CMLL5442N1	983	54	42	2.3	46	4.63
CMLL5448N1	1107	54	48	2.3	52	5.26
CMLL5454N1	1216	54	54	2.3	59	5.89
CMLL5460N1	1326	54	60	2.3	65	6.53
CMLL6624N1	788	66	24	2.3	32	3.58
CMLL6630N1	935	66	30	2.3	40	4.40
CMLL6636N1	1087	66	36	2.3	48	5.23
CMLL6642N1	1244	66	42	2.3	56	6.06
CMLL6648N1	1395	66	48	2.3	64	6.88
CMLL6654N1	1541	66	54	2.3	72	7.71
CMLL6660N1	1684	66	60	2.3	80	8.53

CMLL-N2 • Single Segmented Non Powered Laminate Two Sides Panel, Punchouts on Both Sides

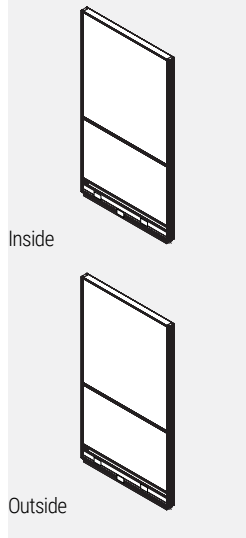

- Individual laminate covered modules incorporated into an aluminum frame.
- Opposite sides of each module may have a different laminate within the same grade at no upcharge.
- Note: Trim is not required at a straight connection between two panels of the same height.
- 3 Panel connector brackets per side come standard with 30”h. to 54”h. panels.
- 4 Panel connector brackets per side come standard with 66”h. panels.
- Panels include 2 raceway covers with punchouts on both sides, an integrated aluminum top cap and levelling glides.
- 24” wide panels have two punchouts, one for electrical and one for data.
- 30” wide panels and wider have three punchouts, two for electrical and one for data.

PRODUCT CODE	PRICE	SIZE/ INCHES			WEIGHT VOL	
		H	W	D	LBS	FT ³
CMLL4224N2	527	42	24	2.3	20	2.31
CMLL4230N2	622	42	30	2.3	25	2.85
CMLL4236N2	722	42	36	2.3	31	3.38
CMLL4242N2	825	42	42	2.3	36	3.92
CMLL4248N2	922	42	48	2.3	41	4.45
CMLL4254N2	1017	42	54	2.3	46	4.99
CMLL4260N2	1107	42	60	2.3	51	5.52
CMLL4824N2	625	48	24	2.3	26	2.73
CMLL4830N2	741	48	30	2.3	33	3.37
CMLL4836N2	860	48	36	2.3	39	4.00
CMLL4842N2	983	48	42	2.3	46	4.63
CMLL4848N2	1107	48	48	2.3	52	5.26
CMLL4854N2	1216	48	54	2.3	59	5.89
CMLL4860N2	1326	48	60	2.3	65	6.53
CMLL5424N2	625	54	24	2.3	26	2.73
CMLL5430N2	741	54	30	2.3	33	3.37
CMLL5436N2	860	54	36	2.3	39	4
CMLL5442N2	983	54	42	2.3	46	4.63
CMLL5448N2	1107	54	48	2.3	52	5.26
CMLL5454N2	1216	54	54	2.3	59	5.89
CMLL5460N2	1326	54	60	2.3	65	6.53
CMLL6624N2	788	66	24	2.3	32	3.58
CMLL6630N2	935	66	30	2.3	40	4.4
CMLL6636N2	1087	66	36	2.3	48	5.23
CMLL6642N2	1244	66	42	2.3	56	6.06
CMLL6648N2	1395	66	48	2.3	64	6.88
CMLL6654N2	1541	66	54	2.3	72	7.71
CMLL6660N2	1684	66	60	2.3	80	8.53

CMLL-P1 • Single Segmented Powered Laminate Two Sides Panel, Punchouts on One Side

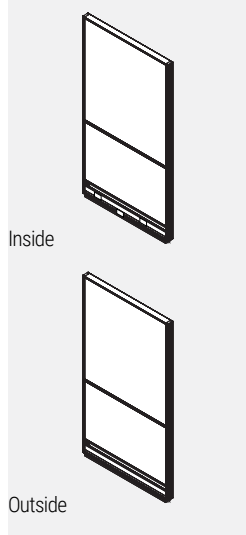

- Individual laminate covered modules incorporated into an aluminum frame.
- Opposite sides of each module may have a different laminate within the same grade at no upcharge.
- Note: Trim is not required at a straight connection between two panels of the same height.
- 3 Panel connector brackets per side come standard with 30”h. to 54”h. panels.
- 4 Panel connector brackets per side come standard with 66”h. panels.
- Panels include 1 raceway cover with punchouts on one side, 1 raceway cover with no punchouts on the other, a power distribution housing, an integrated aluminum top cap and levelling glides.
- 24” wide panels have two punchouts, one for electrical and one for data.
- 30” wide panels and wider have three punchouts, two for electrical and one for data.
- Please specify duplex receptacles separately.

PRODUCT CODE	PRICE	SIZE/ INCHES			WEIGHT VOL	
		H	W	D	LBS	FT ³
CMLL4224P1	666	42	24	2.3	20	2.31
CMLL4230P1	809	42	30	2.3	25	2.85
CMLL4236P1	918	42	36	2.3	31	3.38
CMLL4242P1	1027	42	42	2.3	36	3.92
CMLL4248P1	1137	42	48	2.3	41	4.45
CMLL4254P1	1234	42	54	2.3	46	4.99
CMLL4260P1	1326	42	60	2.3	51	5.52
CMLL4824P1	762	48	24	2.3	26	2.73
CMLL4830P1	928	48	30	2.3	33	3.37
CMLL4836P1	1056	48	36	2.3	39	4.00
CMLL4842P1	1182	48	42	2.3	46	4.63
CMLL4848P1	1323	48	48	2.3	52	5.26
CMLL4854P1	1435	48	54	2.3	59	5.89
CMLL4860P1	1543	48	60	2.3	65	6.53
CMLL5424P1	762	54	24	2.3	26	2.73
CMLL5430P1	928	54	30	2.3	33	3.37
CMLL5436P1	1056	54	36	2.3	39	4
CMLL5442P1	1182	54	42	2.3	46	4.63
CMLL5448P1	1323	54	48	2.3	52	5.26
CMLL5454P1	1435	54	54	2.3	59	5.89
CMLL5460P1	1543	54	60	2.3	65	6.53
CMLL6624P1	928	66	24	2.3	32	3.58
CMLL6630P1	1122	66	30	2.3	40	4.4
CMLL6636P1	1283	66	36	2.3	48	5.23
CMLL6642P1	1447	66	42	2.3	56	6.06
CMLL6648P1	1608	66	48	2.3	64	6.88
CMLL6654P1	1757	66	54	2.3	72	7.71
CMLL6660P1	1903	66	60	2.3	80	8.53

CMLL-P2 • Single Segmented Powered Laminate Two Sides Panel, Punchouts on Both Sides

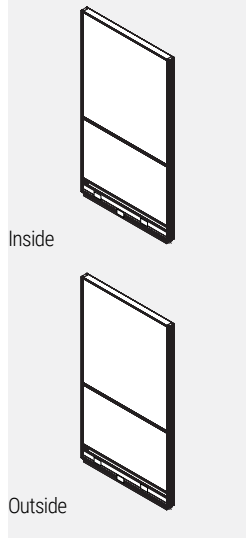

- Individual laminate covered modules incorporated into an aluminum frame.
- Opposite sides of each module may have a different laminate within the same grade at no upcharge.
- Note: Trim is not required at a straight connection between two panels of the same height.
- 3 Panel connector brackets per side come standard with 30”h. to 54”h. panels.
- 4 Panel connector brackets per side come standard with 66”h. panels.
- Panels include 2 raceway covers with punchouts on both sides, a power distribution housing, an integrated aluminum top cap and levelling glides.
- 24” wide panels have two punchouts, one for electrical and one for data.
- 30” wide panels and wider have three punchouts, two for electrical and one for data.
- Please specify duplex receptacles separately.

PRODUCT CODE	PRICE	SIZE/ INCHES			WEIGHT VOL	
		H	W	D	LBS	FT ³
CMLL4224P2	666	42	24	2.3	20	2.31
CMLL4230P2	809	42	30	2.3	25	2.85
CMLL4236P2	918	42	36	2.3	31	3.38
CMLL4242P2	1027	42	42	2.3	36	3.92
CMLL4248P2	1137	42	48	2.3	41	4.45
CMLL4254P2	1234	42	54	2.3	46	4.99
CMLL4260P2	1326	42	60	2.3	51	5.52
CMLL4824P2	762	48	24	2.3	26	2.73
CMLL4830P2	928	48	30	2.3	33	3.37
CMLL4836P2	1056	48	36	2.3	39	4.00
CMLL4842P2	1182	48	42	2.3	46	4.63
CMLL4848P2	1323	48	48	2.3	52	5.26
CMLL4854P2	1435	48	54	2.3	59	5.89
CMLL4860P2	1543	48	60	2.3	65	6.53
CMLL5424P2	762	54	24	2.3	26	2.73
CMLL5430P2	928	54	30	2.3	33	3.37
CMLL5436P2	1056	54	36	2.3	39	4
CMLL5442P2	1182	54	42	2.3	46	4.63
CMLL5448P2	1323	54	48	2.3	52	5.26
CMLL5454P2	1435	54	54	2.3	59	5.89
CMLL5460P2	1543	54	60	2.3	65	6.53
CMLL6624P2	928	66	24	2.3	32	3.58
CMLL6630P2	1122	66	30	2.3	40	4.4
CMLL6636P2	1283	66	36	2.3	48	5.23
CMLL6642P2	1447	66	42	2.3	56	6.06
CMLL6648P2	1608	66	48	2.3	64	6.88
CMLL6654P2	1757	66	54	2.3	72	7.71
CMLL6660P2	1903	66	60	2.3	80	8.53

CMFW-N0 • Single Segmented Non Powered Write Board One Side Panel, No Punchouts

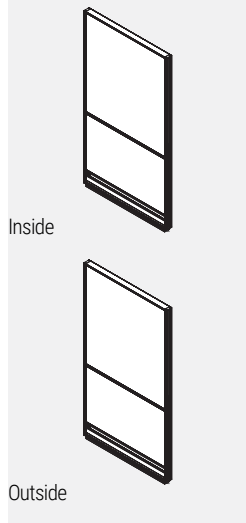

- Individual fabric or write board covered modules incorporated into an aluminum frame.
- Modules have write board on one side and fabric on the other at the top and fabric on two sides at the bottom.
- If different grades of fabric are used on one panel, the entire panel must be priced at highest grade.
- Panels are not tackable.
- Note: Trim is not required at a straight connection between two panels of the same height.
- 3 Panel connector brackets per side come standard with 30”h. to 54”h. panels.
- 4 Panel connector brackets per side come standard with 66”h. panels.
- Panels include 2 raceway covers with no punchouts, an integrated aluminum top cap and levelling glides.

PRODUCT CODE	PRICE		SIZE/ INCHES			WEIGHT VOL	
	GR 1	GR 2	H	W	D	LBS	FT ³
CMFW4824N0	494	517	48	24	2.3	26	2.73
CMFW4830N0	595	623	48	30	2.3	33	3.37
CMFW4836N0	658	691	48	36	2.3	39	4.00
CMFW4842N0	744	781	48	42	2.3	46	4.63
CMFW4848N0	837	877	48	48	2.3	52	5.26
CMFW4854N0	931	964	48	54	2.3	59	5.89
CMFW4860N0	1026	1079	48	60	2.3	65	6.53
CMFW5424N0	494	517	54	24	2.3	26	2.73
CMFW5430N0	593	622	54	30	2.3	33	3.37
CMFW5436N0	658	691	54	36	2.3	39	4
CMFW5442N0	745	781	54	42	2.3	46	4.63
CMFW5448N0	837	879	54	48	2.3	52	5.26
CMFW5454N0	931	963	54	54	2.3	59	5.89
CMFW5460N0	1026	1079	54	60	2.3	65	6.53
CMFW6624N0	623	654	66	24	2.3	32	3.58
CMFW6630N0	741	778	66	30	2.3	40	4.4
CMFW6636N0	824	867	66	36	2.3	48	5.23
CMFW6642N0	933	984	66	42	2.3	56	6.06
CMFW6648N0	1041	1096	66	48	2.3	64	6.88
CMFW6654N0	1160	1223	66	54	2.3	72	7.71
CMFW6660N0	1279	1348	66	60	2.3	80	8.53

CMFW-N1 • Single Segmented Non Powered Write Board One Side Panel, Punchouts on One Side

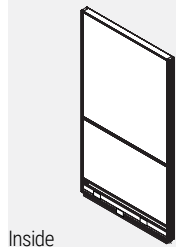

Inside

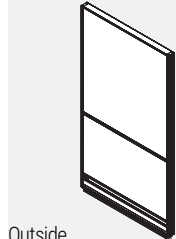

Outside

- Individual fabric or write board covered modules incorporated into an aluminum frame.
- Modules have write board on one side and fabric on the other at the top and fabric on two sides at the bottom.
- If different grades of fabric are used on one panel, the entire panel must be priced at highest grade.
- Panels are not tackable.
- Note: Trim is not required at a straight connection between two panels of the same height.
- 3 Panel connector brackets per side come standard with 30”h. to 54”h. panels.
- 4 Panel connector brackets per side come standard with 66”h. panels.
- Panels include 1 raceway cover with punchouts on one side, 1 raceway cover with no punchouts on the other, an integrated aluminum top cap and levelling glides.
- 24” wide panels have two punchouts, one for electrical and one for data.
- 30” wide panels and wider have three punchouts, two for electrical and one for data.

PRODUCT CODE	PRICE		SIZE/ INCHES			WEIGHT VOL	
	GR 1	GR 2	H	W	D	LBS	FT ³
CMFW4824N1	494	517	48	24	2.3	26	2.73
CMFW4830N1	595	623	48	30	2.3	33	3.37
CMFW4836N1	658	691	48	36	2.3	39	4.00
CMFW4842N1	744	781	48	42	2.3	46	4.63
CMFW4848N1	837	877	48	48	2.3	52	5.26
CMFW4854N1	931	964	48	54	2.3	59	5.89
CMFW4860N1	1026	1079	48	60	2.3	65	6.53
CMFW5424N1	494	517	54	24	2.3	26	2.73
CMFW5430N1	593	622	54	30	2.3	33	3.37
CMFW5436N1	658	691	54	36	2.3	39	4
CMFW5442N1	745	781	54	42	2.3	46	4.63
CMFW5448N1	837	879	54	48	2.3	52	5.26
CMFW5454N1	931	963	54	54	2.3	59	5.89
CMFW5460N1	1026	1079	54	60	2.3	65	6.53
CMFW6624N1	623	654	66	24	2.3	32	3.58
CMFW6630N1	741	778	66	30	2.3	40	4.4
CMFW6636N1	824	867	66	36	2.3	48	5.23
CMFW6642N1	933	984	66	42	2.3	56	6.06
CMFW6648N1	1041	1096	66	48	2.3	64	6.88
CMFW6654N1	1160	1223	66	54	2.3	72	7.71
CMFW6660N1	1279	1348	66	60	2.3	80	8.53

CMFW-N2 • Single Segmented Non Powered Write Board One Side Panel, Punchouts on Both Sides

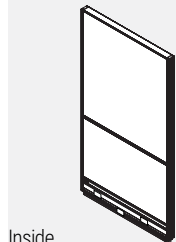

Inside

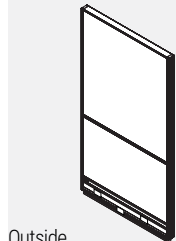

Outside

- Individual fabric or write board covered modules incorporated into an aluminum frame.
- Modules have write board on one side and fabric on the other at the top and fabric on two sides at the bottom.
- If different grades of fabric are used on one panel, the entire panel must be priced at highest grade.
- Panels are not tackable.
- Note: Trim is not required at a straight connection between two panels of the same height.
- 3 Panel connector brackets per side come standard with 30”h. to 54”h. panels.
- 4 Panel connector brackets per side come standard with 66”h. panels.
- Panels include 2 raceway covers with punchouts on both sides, an integrated aluminum top cap and levelling glides.
- 24” wide panels have two punchouts, one for electrical and one for data.
- 30” wide panels and wider have three punchouts, two for electrical and one for data.

PRODUCT CODE	PRICE		SIZE/ INCHES			WEIGHT VOL	
	GR 1	GR 2	H	W	D	LBS	FT ³
CMFW4824N2	494	517	48	24	2.3	26	2.73
CMFW4830N2	595	623	48	30	2.3	33	3.37
CMFW4836N2	658	691	48	36	2.3	39	4.00
CMFW4842N2	744	781	48	42	2.3	46	4.63
CMFW4848N2	837	877	48	48	2.3	52	5.26
CMFW4854N2	931	964	48	54	2.3	59	5.89
CMFW4860N2	1026	1079	48	60	2.3	65	6.53
CMFW5424N2	494	517	54	24	2.3	26	2.73
CMFW5430N2	593	622	54	30	2.3	33	3.37
CMFW5436N2	658	691	54	36	2.3	39	4
CMFW5442N2	745	781	54	42	2.3	46	4.63
CMFW5448N2	837	879	54	48	2.3	52	5.26
CMFW5454N2	931	963	54	54	2.3	59	5.89
CMFW5460N2	1026	1079	54	60	2.3	65	6.53
CMFW6624N2	623	654	66	24	2.3	32	3.58
CMFW6630N2	741	778	66	30	2.3	40	4.4
CMFW6636N2	824	867	66	36	2.3	48	5.23
CMFW6642N2	933	984	66	42	2.3	56	6.06
CMFW6648N2	1041	1096	66	48	2.3	64	6.88
CMFW6654N2	1160	1223	66	54	2.3	72	7.71
CMFW6660N2	1279	1348	66	60	2.3	80	8.53

CMFW-P1 • Single Segmented Powered Write Board One Side Panel, Punchouts on One Side

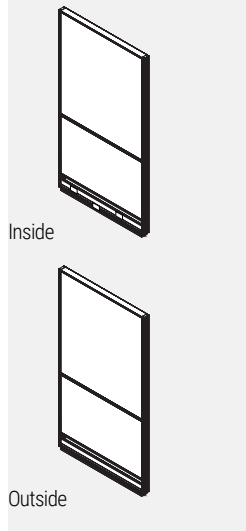

- Individual fabric or write board covered modules incorporated into an aluminum frame.
- Modules have write board on one side and fabric on the other at the top and fabric on two sides at the bottom.
- If different grades of fabric are used on one panel, the entire panel must be priced at highest grade.
- Panels are not tackable.
- Note: Trim is not required at a straight connection between two panels of the same height.
- 3 Panel connector brackets per side come standard with 30”h. to 54”h. panels.
- 4 Panel connector brackets per side come standard with 66”h. panels.
- Panels include 1 raceway cover with punchouts on one side, 1 raceway cover with no punchouts on the other, a power distribution housing, an integrated aluminum top cap and levelling glides.
- 24” wide panels have two punchouts, one for electrical and one for data.
- 30” wide panels and wider have three punchouts, two for electrical and one for data.
- Please specify duplex receptacles separately.

PRODUCT CODE	PRICE		SIZE/ INCHES			WEIGHT VOL	
	GR 1	GR 2	H	W	D	LBS	FT³
CMFW4824P1	633	656	48	24	2.3	26	2.73
CMFW4830P1	781	808	48	30	2.3	33	3.37
CMFW4836P1	854	886	48	36	2.3	39	4.00
CMFW4842P1	947	984	48	42	2.3	46	4.63
CMFW4848P1	1052	1091	48	48	2.3	52	5.26
CMFW4854P1	1148	1179	48	54	2.3	59	5.89
CMFW4860P1	1243	1298	48	60	2.3	65	6.53
CMFW5424P1	633	656	54	24	2.3	26	2.73
CMFW5430P1	781	809	54	30	2.3	33	3.37
CMFW5436P1	854	886	54	36	2.3	39	4
CMFW5442P1	947	984	54	42	2.3	46	4.63
CMFW5448P1	1052	1091	54	48	2.3	52	5.26
CMFW5454P1	1148	1180	54	54	2.3	59	5.89
CMFW5460P1	1243	1298	54	60	2.3	65	6.53
CMFW6624P1	761	791	66	24	2.3	32	3.58
CMFW6630P1	928	963	66	30	2.3	40	4.4
CMFW6636P1	1021	1063	66	36	2.3	48	5.23
CMFW6642P1	1135	1186	66	42	2.3	56	6.06
CMFW6648P1	1258	1312	66	48	2.3	64	6.88
CMFW6654P1	1378	1438	66	54	2.3	72	7.71
CMFW6660P1	1499	1567	66	60	2.3	80	8.53

CMFW-P2 • Single Segmented Powered Write Board One Side Panel, Punchouts on Both Sides

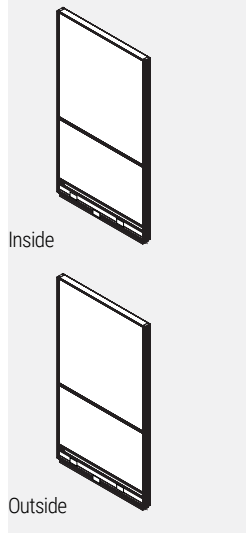

- Individual fabric or write board covered modules incorporated into an aluminum frame.
- Modules have write board on one side and fabric on the other at the top and fabric on two sides at the bottom.
- If different grades of fabric are used on one panel, the entire panel must be priced at highest grade.
- Panels are not tackable.
- Note: Trim is not required at a straight connection between two panels of the same height.
- 3 Panel connector brackets per side come standard with 30”h. to 54”h. panels.
- 4 Panel connector brackets per side come standard with 66”h. panels.
- Panels include 2 raceway covers with punchouts on both sides, a power distribution housing, an integrated aluminum top cap and levelling glides.
- 24” wide panels have two punchouts, one for electrical and one for data.
- 30” wide panels and wider have three punchouts, two for electrical and one for data.
- Please specify duplex receptacles separately.

PRODUCT CODE	PRICE		SIZE/ INCHES			WEIGHT VOL	
	GR 1	GR 2	H	W	D	LBS	FT³
CMFW4824P2	633	656	48	24	2.3	26	2.73
CMFW4830P2	781	808	48	30	2.3	33	3.37
CMFW4836P2	854	886	48	36	2.3	39	4.00
CMFW4842P2	947	984	48	42	2.3	46	4.63
CMFW4848P2	1052	1091	48	48	2.3	52	5.26
CMFW4854P2	1148	1179	48	54	2.3	59	5.89
CMFW4860P2	1243	1298	48	60	2.3	65	6.53
CMFW5424P2	633	656	54	24	2.3	26	2.73
CMFW5430P2	781	809	54	30	2.3	33	3.37
CMFW5436P2	854	886	54	36	2.3	39	4
CMFW5442P2	947	984	54	42	2.3	46	4.63
CMFW5448P2	1052	1091	54	48	2.3	52	5.26
CMFW5454P2	1148	1180	54	54	2.3	59	5.89
CMFW5460P2	1243	1298	54	60	2.3	65	6.53
CMFW6624P2	761	791	66	24	2.3	32	3.58
CMFW6630P2	928	963	66	30	2.3	40	4.4
CMFW6636P2	1021	1063	66	36	2.3	48	5.23
CMFW6642P2	1135	1186	66	42	2.3	56	6.06
CMFW6648P2	1258	1312	66	48	2.3	64	6.88
CMFW6654P2	1378	1438	66	54	2.3	72	7.71
CMFW6660P2	1499	1567	66	60	2.3	80	8.53

CMWW-N0 • Single Segmented Non Powered Write Board Two Sides Panel, No Punchouts

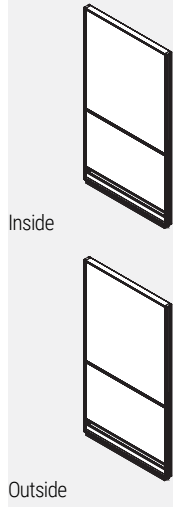

- Individual fabric or write board covered modules incorporated into an aluminum frame.
- Modules have either write board on two sides at the top and fabric on two sides at the bottom.
- If different grades of fabric are used on one panel, the entire panel must be priced at highest grade.
- Panels are not tackable.
- Note: Trim is not required at a straight connection between two panels of the same height.
- 3 Panel connector brackets per side come standard with 30”h. to 54”h. panels.
- 4 Panel connector brackets per side come standard with 66”h. panels.
- Panels include 2 raceway covers with no punchouts, an integrated aluminum top cap and levelling glides.

PRODUCT CODE	PRICE		SIZE/ INCHES			WEIGHT		VOL FT³
	GR 1	GR 2	H	W	D	LBS		
CMWW4824N0	539	551	48	24	2.3	26	2.73	
CMWW4830N0	671	688	48	30	2.3	33	3.37	
CMWW4836N0	725	751	48	36	2.3	39	4.00	
CMWW4842N0	825	849	48	42	2.3	46	4.63	
CMWW4848N0	965	995	48	48	2.3	52	5.26	
CMWW4854N0	1074	1108	48	54	2.3	59	5.89	
CMWW4860N0	1186	1216	48	60	2.3	65	6.53	
CMWW5424N0	539	551	54	24	2.3	26	2.73	
CMWW5430N0	671	688	54	30	2.3	33	3.37	
CMWW5436N0	725	751	54	36	2.3	39	4	
CMWW5442N0	825	850	54	42	2.3	46	4.63	
CMWW5448N0	964	995	54	48	2.3	52	5.26	
CMWW5454N0	1074	1107	54	54	2.3	59	5.89	
CMWW5460N0	1186	1218	54	60	2.3	65	6.53	
CMWW6624N0	661	687	66	24	2.3	32	3.58	
CMWW6630N0	817	845	66	30	2.3	40	4.4	
CMWW6636N0	892	922	66	36	2.3	48	5.23	
CMWW6642N0	1016	1053	66	42	2.3	56	6.06	
CMWW6648N0	1166	1205	66	48	2.3	64	6.88	
CMWW6654N0	1299	1345	66	54	2.3	72	7.71	
CMWW6660N0	1436	1485	66	60	2.3	80	8.53	

CMWW-N1 • Single Segmented Non Powered Write Board Two Sides Panel, Punchouts on One Side

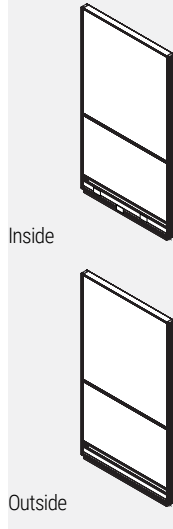

- Individual fabric or write board covered modules incorporated into an aluminum frame.
- Modules have either write board on two sides at the top and fabric on two sides at the bottom.
- If different grades of fabric are used on one panel, the entire panel must be priced at highest grade.
- Panels are not tackable.
- Note: Trim is not required at a straight connection between two panels of the same height.
- 3 Panel connector brackets per side come standard with 30”h. to 54”h. panels.
- 4 Panel connector brackets per side come standard with 66”h. panels.
- Panels include 1 raceway cover with punchouts on two sides, 1 raceway cover with no punchouts on the other, an integrated aluminum top cap and levelling glides.
- 24” wide panels have two punchouts, one for electrical and one for data.
- 30” wide panels and wider have three punchouts, two for electrical and one for data.

PRODUCT CODE	PRICE		SIZE/ INCHES			WEIGHT		VOL FT³
	GR 1	GR 2	H	W	D	LBS		
CMWW4824N1	539	551	48	24	2.3	26	2.73	
CMWW4830N1	671	688	48	30	2.3	33	3.37	
CMWW4836N1	725	751	48	36	2.3	39	4.00	
CMWW4842N1	825	849	48	42	2.3	46	4.63	
CMWW4848N1	965	995	48	48	2.3	52	5.26	
CMWW4854N1	1074	1108	48	54	2.3	59	5.89	
CMWW4860N1	1186	1216	48	60	2.3	65	6.53	
CMWW5424N1	539	551	54	24	2.3	26	2.73	
CMWW5430N1	671	688	54	30	2.3	33	3.37	
CMWW5436N1	725	751	54	36	2.3	39	4	
CMWW5442N1	825	850	54	42	2.3	46	4.63	
CMWW5448N1	964	995	54	48	2.3	52	5.26	
CMWW5454N1	1074	1107	54	54	2.3	59	5.89	
CMWW5460N1	1186	1218	54	60	2.3	65	6.53	
CMWW6624N1	661	687	66	24	2.3	32	3.58	
CMWW6630N1	817	845	66	30	2.3	40	4.4	
CMWW6636N1	892	922	66	36	2.3	48	5.23	
CMWW6642N1	1016	1053	66	42	2.3	56	6.06	
CMWW6648N1	1166	1205	66	48	2.3	64	6.88	
CMWW6654N1	1299	1345	66	54	2.3	72	7.71	
CMWW6660N1	1436	1485	66	60	2.3	80	8.53	

CMWW-N2 • Single Segmented Non Powered Write Board Two Sides Panel, Punchouts on Both Sides

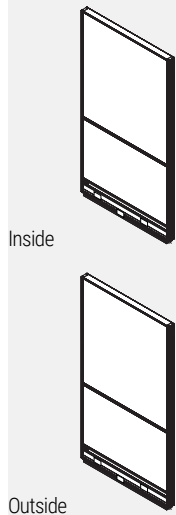

- Individual fabric or write board covered modules incorporated into an aluminum frame.
- Modules have either write board on two sides at the top and fabric on two sides at the bottom.
- If different grades of fabric are used on one panel, the entire panel must be priced at highest grade.
- Panels are not tackable.
- Note: Trim is not required at a straight connection between two panels of the same height.
- 3 Panel connector brackets per side come standard with 30”h. to 54”h. panels.
- 4 Panel connector brackets per side come standard with 66”h. panels.
- Panels include 2 raceway covers with punchouts on both sides, an integrated aluminum top cap and levelling glides.
- 24” wide panels have two punchouts, one for electrical and one for data.
- 30” wide panels and wider have three punchouts, two for electrical and one for data.

PRODUCT CODE	PRICE		SIZE/ INCHES			WEIGHT		VOL FT ³
	GR 1	GR 2	H	W	D	LBS		
CMWW4824N2	539	551	48	24	2.3	26	2.73	
CMWW4830N2	671	688	48	30	2.3	33	3.37	
CMWW4836N2	725	751	48	36	2.3	39	4.00	
CMWW4842N2	825	849	48	42	2.3	46	4.63	
CMWW4848N2	965	995	48	48	2.3	52	5.26	
CMWW4854N2	1074	1108	48	54	2.3	59	5.89	
CMWW4860N2	1186	1216	48	60	2.3	65	6.53	
CMWW5424N2	539	551	54	24	2.3	26	2.73	
CMWW5430N2	671	688	54	30	2.3	33	3.37	
CMWW5436N2	725	751	54	36	2.3	39	4	
CMWW5442N2	825	850	54	42	2.3	46	4.63	
CMWW5448N2	964	995	54	48	2.3	52	5.26	
CMWW5454N2	1074	1107	54	54	2.3	59	5.89	
CMWW5460N2	1186	1218	54	60	2.3	65	6.53	
CMWW6624N2	661	687	66	24	2.3	32	3.58	
CMWW6630N2	817	845	66	30	2.3	40	4.4	
CMWW6636N2	892	922	66	36	2.3	48	5.23	
CMWW6642N2	1016	1053	66	42	2.3	56	6.06	
CMWW6648N2	1166	1205	66	48	2.3	64	6.88	
CMWW6654N2	1299	1345	66	54	2.3	72	7.71	
CMWW6660N2	1436	1485	66	60	2.3	80	8.53	

CMWW-P1 • Single Segmented Powered Write Board Two Sides Panel, Punchouts on One Side

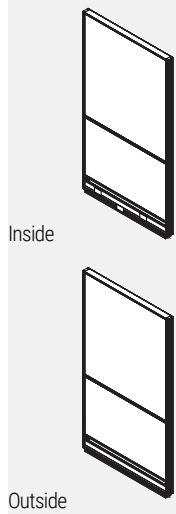

- Individual fabric or write board covered modules incorporated into an aluminum frame.
- Modules have either write board on two sides at the top and fabric on two sides at the bottom.
- If different grades of fabric are used on one panel, the entire panel must be priced at highest grade.
- Panels are not tackable.
- Note: Trim is not required at a straight connection between two panels of the same height.
- 3 Panel connector brackets per side come standard with 30”h. to 54”h. panels.
- 4 Panel connector brackets per side come standard with 66”h. panels.
- Panels include 1 raceway cover with punchouts on two sides, 1 raceway cover with no punchouts on the other, a power distribution housing, an integrated aluminum top cap and levelling glides.
- 24” wide panels have two punchouts, one for electrical and one for data.
- 30” wide panels and wider have three punchouts, two for electrical and one for data.
- Please specify duplex receptacles separately.

PRODUCT CODE	PRICE		SIZE/ INCHES			WEIGHT		VOL FT ³
	GR 1	GR 2	H	W	D	LBS		
CMWW4824P1	676	691	48	24	2.3	26	2.73	
CMWW4830P1	857	873	48	30	2.3	33	3.37	
CMWW4836P1	922	948	48	36	2.3	39	4.00	
CMWW4842P1	1027	1052	48	42	2.3	46	4.63	
CMWW4848P1	1178	1208	48	48	2.3	52	5.26	
CMWW4854P1	1292	1324	48	54	2.3	59	5.89	
CMWW4860P1	1405	1437	48	60	2.3	65	6.53	
CMWW5424P1	676	691	54	24	2.3	26	2.73	
CMWW5430P1	857	874	54	30	2.3	33	3.37	
CMWW5436P1	922	948	54	36	2.3	39	4	
CMWW5442P1	1027	1052	54	42	2.3	46	4.63	
CMWW5448P1	1178	1208	54	48	2.3	52	5.26	
CMWW5454P1	1292	1325	54	54	2.3	59	5.89	
CMWW5460P1	1405	1437	54	60	2.3	65	6.53	
CMWW6624P1	802	825	66	24	2.3	32	3.58	
CMWW6630P1	1003	1030	66	30	2.3	40	4.4	
CMWW6636P1	1088	1119	66	36	2.3	48	5.23	
CMWW6642P1	1216	1257	66	42	2.3	56	6.06	
CMWW6648P1	1378	1419	66	48	2.3	64	6.88	
CMWW6654P1	1515	1563	66	54	2.3	72	7.71	
CMWW6660P1	1654	1706	66	60	2.3	80	8.53	

CMWW-P2 • Single Segmented Powered Write Board Two Sides Panel, Punchouts on Both Sides

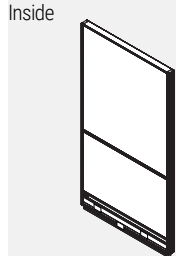
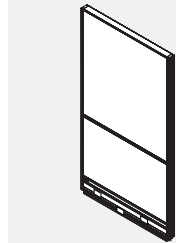

Inside

Outside

- Individual fabric or write board covered modules incorporated into an aluminum frame.
- Modules have either write board on two sides at the top and fabric on two sides at the bottom.
- If different grades of fabric are used on one panel, the entire panel must be priced at highest grade.
- Panels are not tackable.
- Note: Trim is not required at a straight connection between two panels of the same height.
- 3 Panel connector brackets per side come standard with 30”h. to 54”h. panels.
- 4 Panel connector brackets per side come standard with 66”h. panels.
- Panels include 2 raceway covers with punchouts on both sides, a power distribution housing, an integrated aluminum top cap and levelling glides.
- 24” wide panels have two punchouts, one for electrical and one for data.
- 30” wide panels and wider have three punchouts, two for electrical and one for data.
- Please specify duplex receptacles separately.

PRODUCT CODE	PRICE		SIZE/ INCHES			WEIGHT VOL	
	GR 1	GR 2	H	W	D	LBS	FT ³
CMWW4824P2	676	691	48	24	2.3	26	2.73
CMWW4830P2	857	873	48	30	2.3	33	3.37
CMWW4836P2	922	948	48	36	2.3	39	4.00
CMWW4842P2	1027	1052	48	42	2.3	46	4.63
CMWW4848P2	1178	1208	48	48	2.3	52	5.26
CMWW4854P2	1292	1324	48	54	2.3	59	5.89
CMWW4860P2	1405	1437	48	60	2.3	65	6.53
CMWW5424P2	676	691	54	24	2.3	26	2.73
CMWW5430P2	857	874	54	30	2.3	33	3.37
CMWW5436P2	922	948	54	36	2.3	39	4
CMWW5442P2	1027	1052	54	42	2.3	46	4.63
CMWW5448P2	1178	1208	54	48	2.3	52	5.26
CMWW5454P2	1292	1325	54	54	2.3	59	5.89
CMWW5460P2	1405	1437	54	60	2.3	65	6.53
CMWW6624P2	802	825	66	24	2.3	32	3.58
CMWW6630P2	1003	1030	66	30	2.3	40	4.4
CMWW6636P2	1088	1119	66	36	2.3	48	5.23
CMWW6642P2	1216	1257	66	42	2.3	56	6.06
CMWW6648P2	1378	1419	66	48	2.3	64	6.88
CMWW6654P2	1515	1563	66	54	2.3	72	7.71
CMWW6660P2	1654	1706	66	60	2.3	80	8.53

CMFG-N0 • Single Glazed, Non Powered Fabric Panel, No Punchouts

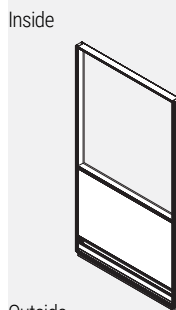
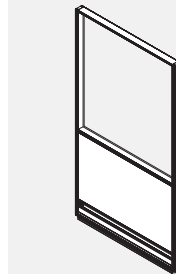

Inside

Outside

- Individual fabric-covered module in lower position with glazed module in upper position incorporated into an aluminum frame.
- Opposite sides of each module may have a different fabric within the same grade at no upcharge.
- If different grades of fabric are used on one panel, the entire panel must be priced at highest grade.
- Panels are not tackable.
- Note: Trim is not required at a straight connection between two panels of the same height.
- 3 Panel connector brackets per side come standard with 42”h. and 54”h. panels.
- 4 Panel connector brackets per side come standard with 66”h. panels.
- Panels include 2 raceway covers with no punchouts, an integrated aluminum top cap and levelling glides.
- Standard in clear (CLR) plexi.
- Optional frosted (FRST) plexi
- Glazing starts at 29” high to the top of the panel.

PRODUCT CODE	PRICE		SIZE/ INCHES			WEIGHT VOL	
	GR 1	GR 2	H	W	D	LBS	FT ³
CMFG4224N0	446	459	42	24	2.3	20	2.31
CMFG4230N0	488	507	42	30	2.3	25	2.85
CMFG4236N0	537	567	42	36	2.3	31	3.38
CMFG4242N0	593	625	42	42	2.3	36	3.92
CMFG4248N0	652	681	42	48	2.3	41	4.45
CMFG4254N0	736	765	42	54	2.3	46	4.99
CMFG4260N0	811	840	42	60	2.3	51	5.52
CMFG4824N0	482	495	48	24	2.3	26	2.73
CMFG4830N0	524	542	48	30	2.3	33	3.37
CMFG4836N0	599	629	48	36	2.3	39	4.00
CMFG4842N0	671	700	48	42	2.3	46	4.63
CMFG4848N0	734	763	48	48	2.3	52	5.26
CMFG4854N0	854	885	48	54	2.3	59	5.89
CMFG4860N0	966	997	48	60	2.3	65	6.53
CMFG5424N0	482	495	54	24	2.3	26	2.73
CMFG5430N0	524	542	54	30	2.3	33	3.37
CMFG5436N0	600	629	54	36	2.3	39	4.00
CMFG5442N0	671	699	54	42	2.3	46	4.63
CMFG5448N0	734	763	54	48	2.3	52	5.26
CMFG5454N0	854	885	54	54	2.3	59	5.89
CMFG5460N0	966	997	54	60	2.3	65	6.53
CMFG6624N0	619	633	66	24	2.3	32	3.58
CMFG6630N0	720	734	66	30	2.3	40	4.40
CMFG6636N0	820	851	66	36	2.3	48	5.23
CMFG6642N0	918	949	66	42	2.3	56	6.06
CMFG6648N0	1006	1037	66	48	2.3	64	6.88
CMFG6654N0	1113	1143	66	54	2.3	72	7.71
CMFG6660N0	1212	1243	66	60	2.3	80	8.53

CMFG-N1 • Single Glazed, Non Powered Fabric Panel, Punchouts on One Side

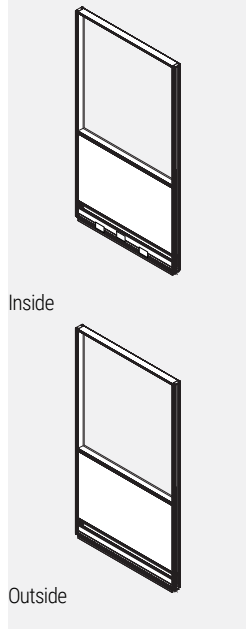

- Individual fabric-covered module in lower position with glazed module in upper position incorporated into an aluminum frame.
- Opposite sides of each module may have a different fabric within the same grade at no upcharge.
- If different grades of fabric are used on one panel, the entire panel must be priced at highest grade.
- Panels are not tackable.
- Note: Trim is not required at a straight connection between two panels of the same height.
- 3 Panel connector brackets per side come standard with 42" h. and 54" h. panels.
- 4 Panel connector brackets per side come standard with 66" h. panels.
- Panels include 1 raceway cover with punchouts on one side, 1 raceway cover with no punchouts on the other, an integrated aluminum top cap and levelling glides.
- Standard in clear (CLR) plexi.
- Optional frosted (FRST) plexi
- 24" wide panels have two punchouts, one for electrical and one for data.
- 30" wide panels and wider have three punchouts, two for electrical and one for data.
- Glazing starts at 29" high to the top of the panel.

PRODUCT CODE	PRICE		SIZE/ INCHES			WEIGHT VOL	
	GR 1	GR 2	H	W	D	LBS	FT ³
CMFG4224N1	446	459	42	24	2.3	20	2.31
CMFG4230N1	488	507	42	30	2.3	25	2.85
CMFG4236N1	537	567	42	36	2.3	31	3.38
CMFG4242N1	593	625	42	42	2.3	36	3.92
CMFG4248N1	652	681	42	48	2.3	41	4.45
CMFG4254N1	736	765	42	54	2.3	46	4.99
CMFG4260N1	811	840	42	60	2.3	51	5.52
CMFG4824N1	482	495	48	24	2.3	26	2.73
CMFG4830N1	524	542	48	30	2.3	33	3.37
CMFG4836N1	599	629	48	36	2.3	39	4.00
CMFG4842N1	671	700	48	42	2.3	46	4.63
CMFG4848N1	734	763	48	48	2.3	52	5.26
CMFG4854N1	854	885	48	54	2.3	59	5.89
CMFG4860N1	966	997	48	60	2.3	65	6.53
CMFG5424N1	482	495	54	24	2.3	26	2.73
CMFG5430N1	524	542	54	30	2.3	33	3.37
CMFG5436N1	600	629	54	36	2.3	39	4.00
CMFG5442N1	671	699	54	42	2.3	46	4.63
CMFG5448N1	734	763	54	48	2.3	52	5.26
CMFG5454N1	854	885	54	54	2.3	59	5.89
CMFG5460N1	966	997	54	60	2.3	65	6.53
CMFG6624N1	619	633	66	24	2.3	32	3.58
CMFG6630N1	720	734	66	30	2.3	40	4.40
CMFG6636N1	820	851	66	36	2.3	48	5.23
CMFG6642N1	918	949	66	42	2.3	56	6.06
CMFG6648N1	1006	1037	66	48	2.3	64	6.88
CMFG6654N1	1113	1143	66	54	2.3	72	7.71
CMFG6660N1	1212	1243	66	60	2.3	80	8.53

CMFG-N2 • Single Glazed, Non Powered Fabric Panel, Punchouts on Both Sides

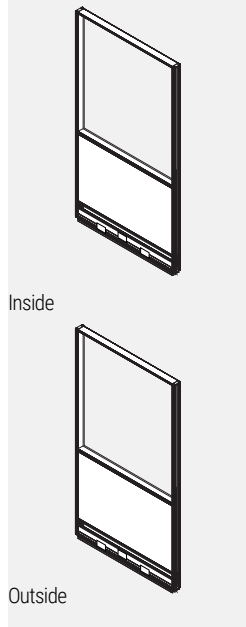

- Individual fabric-covered module in lower position with glazed module in upper position incorporated into an aluminum frame.
- Opposite sides of each module may have a different fabric within the same grade at no upcharge.
- If different grades of fabric are used on one panel, the entire panel must be priced at highest grade.
- Panels are not tackable.
- Note: Trim is not required at a straight connection between two panels of the same height.
- 3 Panel connector brackets per side come standard with 42" h. and 54" h. panels.
- 4 Panel connector brackets per side come standard with 66" h. panels.
- Panels include 2 raceway covers with punchouts on both sides, an integrated aluminum top cap and levelling glides.
- Standard in clear (CLR) plexi.
- Optional frosted (FRST) plexi
- 24" wide panels have two punchouts, one for electrical and one for data.
- 30" wide panels and wider have three punchouts, two for electrical and one for data.
- Glazing starts at 29" high to the top of the panel.

PRODUCT CODE	PRICE		SIZE/ INCHES			WEIGHT VOL	
	GR 1	GR 2	H	W	D	LBS	FT ³
CMFG4224N2	446	459	42	24	2.3	20	2.31
CMFG4230N2	488	507	42	30	2.3	25	2.85
CMFG4236N2	537	567	42	36	2.3	31	3.38
CMFG4242N2	593	625	42	42	2.3	36	3.92
CMFG4248N2	652	681	42	48	2.3	41	4.45
CMFG4254N2	736	765	42	54	2.3	46	4.99
CMFG4260N2	811	840	42	60	2.3	51	5.52
CMFG4824N2	482	495	48	24	2.3	26	2.73
CMFG4830N2	524	542	48	30	2.3	33	3.37
CMFG4836N2	599	629	48	36	2.3	39	4.00
CMFG4842N2	671	700	48	42	2.3	46	4.63
CMFG4848N2	734	763	48	48	2.3	52	5.26
CMFG4854N2	854	885	48	54	2.3	59	5.89
CMFG4860N2	966	997	48	60	2.3	65	6.53
CMFG5424N2	482	495	54	24	2.3	26	2.73
CMFG5430N2	524	542	54	30	2.3	33	3.37
CMFG5436N2	600	629	54	36	2.3	39	4.00
CMFG5442N2	671	699	54	42	2.3	46	4.63
CMFG5448N2	734	763	54	48	2.3	52	5.26
CMFG5454N2	854	885	54	54	2.3	59	5.89
CMFG5460N2	966	997	54	60	2.3	65	6.53
CMFG6624N2	619	633	66	24	2.3	32	3.58
CMFG6630N2	720	734	66	30	2.3	40	4.40
CMFG6636N2	820	851	66	36	2.3	48	5.23
CMFG6642N2	918	949	66	42	2.3	56	6.06
CMFG6648N2	1006	1037	66	48	2.3	64	6.88
CMFG6654N2	1113	1143	66	54	2.3	72	7.71
CMFG6660N2	1212	1243	66	60	2.3	80	8.53

CMFG-P1 • Single Glazed, Powered Fabric Panel, Punchouts on One Side

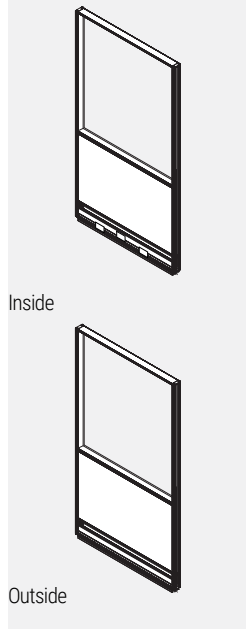

- Individual fabric-covered module in lower position with glazed module in upper position incorporated into an aluminum frame.
- Opposite sides of each module may have a different fabric within the same grade at no upcharge.
- If different grades of fabric are used on one panel, the entire panel must be priced at highest grade.
- Panels are not tackable.
- Note: Trim is not required at a straight connection between two panels of the same height.
- 3 Panel connector brackets per side come standard with 42" h. and 54" h. panels.
- 4 Panel connector brackets per side come standard with 66" h. panels.
- Panels include 1 raceway cover with punchouts on one side, 1 raceway cover with no punchouts on the other, a power distribution housing, an integrated aluminum top cap and levelling glides.
- Standard in clear (CLR) plexi.
- Optional frosted (FRST) plexi
- 24" wide panels have two punchouts, one for electrical and one for data.
- 30" wide panels and wider have three punchouts, two for electrical and one for data.
- Glazing starts at 29" high to the top of the panel.
- Please specify duplex receptacles separately.

PRODUCT CODE	PRICE		SIZE/ INCHES			WEIGHT VOL	
	GR 1	GR 2	H	W	D	LBS	FT ³
CMFG4224P1	582	600	42	24	2.3	20	2.31
CMFG4230P1	678	692	42	30	2.3	25	2.85
CMFG4236P1	731	761	42	36	2.3	31	3.38
CMFG4242P1	796	826	42	42	2.3	36	3.92
CMFG4248P1	864	894	42	48	2.3	41	4.45
CMFG4254P1	954	984	42	54	2.3	46	4.99
CMFG4260P1	1028	1060	42	60	2.3	51	5.52
CMFG4824P1	621	634	48	24	2.3	26	2.73
CMFG4830P1	714	727	48	30	2.3	33	3.37
CMFG4836P1	795	825	48	36	2.3	39	4.00
CMFG4842P1	872	903	48	42	2.3	46	4.63
CMFG4848P1	949	977	48	48	2.3	52	5.26
CMFG4854P1	1072	1102	48	54	2.3	59	5.89
CMFG4860P1	1186	1214	48	60	2.3	65	6.53
CMFG5424P1	621	634	54	24	2.3	26	2.73
CMFG5430P1	714	726	54	30	2.3	33	3.37
CMFG5436P1	794	825	54	36	2.3	39	4.00
CMFG5442P1	872	903	54	42	2.3	46	4.63
CMFG5448P1	949	977	54	48	2.3	52	5.26
CMFG5454P1	1072	1102	54	54	2.3	59	5.89
CMFG5460P1	1186	1214	54	60	2.3	65	6.53
CMFG6624P1	757	774	66	24	2.3	32	3.58
CMFG6630P1	907	921	66	30	2.3	40	4.40
CMFG6636P1	1017	1046	66	36	2.3	48	5.23
CMFG6642P1	1121	1152	66	42	2.3	56	6.06
CMFG6648P1	1223	1254	66	48	2.3	64	6.88
CMFG6654P1	1329	1360	66	54	2.3	72	7.71
CMFG6660P1	1434	1463	66	60	2.3	80	8.53

CMFG-P2 • Single Glazed, Powered Fabric Panel, Punchouts on Both Sides

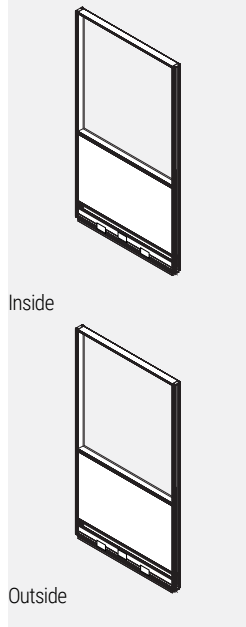

- Individual fabric-covered module in lower position with glazed module in upper position incorporated into an aluminum frame.
- Opposite sides of each module may have a different fabric within the same grade at no upcharge.
- If different grades of fabric are used on one panel, the entire panel must be priced at highest grade.
- Panels are not tackable.
- Note: Trim is not required at a straight connection between two panels of the same height.
- 3 Panel connector brackets per side come standard with 42" h. and 54" h. panels.
- 4 Panel connector brackets per side come standard with 66" h. panels.
- Panels include 2 raceway covers with punchouts on both sides, a power distribution housing, an integrated aluminum top cap and levelling glides.
- Standard in clear (CLR) plexi.
- Optional frosted (FRST) plexi
- 24" wide panels have two punchouts, one for electrical and one for data.
- 30" wide panels and wider have three punchouts, two for electrical and one for data.
- Glazing starts at 29" high to the top of the panel.
- Please specify duplex receptacles separately.

PRODUCT CODE	PRICE		SIZE/ INCHES			WEIGHT VOL	
	GR 1	GR 2	H	W	D	LBS	FT ³
CMFG4224P2	582	600	42	24	2.3	20	2.31
CMFG4230P2	678	692	42	30	2.3	25	2.85
CMFG4236P2	731	761	42	36	2.3	31	3.38
CMFG4242P2	796	826	42	42	2.3	36	3.92
CMFG4248P2	864	894	42	48	2.3	41	4.45
CMFG4254P2	954	984	42	54	2.3	46	4.99
CMFG4260P2	1028	1060	42	60	2.3	51	5.52
CMFG4824P2	621	634	48	24	2.3	26	2.73
CMFG4830P2	714	727	48	30	2.3	33	3.37
CMFG4836P2	795	825	48	36	2.3	39	4.00
CMFG4842P2	872	903	48	42	2.3	46	4.63
CMFG4848P2	949	977	48	48	2.3	52	5.26
CMFG4854P2	1072	1102	48	54	2.3	59	5.89
CMFG4860P2	1186	1214	48	60	2.3	65	6.53
CMFG5424P2	621	634	54	24	2.3	26	2.73
CMFG5430P2	714	726	54	30	2.3	33	3.37
CMFG5436P2	794	825	54	36	2.3	39	4.00
CMFG5442P2	872	903	54	42	2.3	46	4.63
CMFG5448P2	949	977	54	48	2.3	52	5.26
CMFG5454P2	1072	1102	54	54	2.3	59	5.89
CMFG5460P2	1186	1214	54	60	2.3	65	6.53
CMFG6624P2	757	774	66	24	2.3	32	3.58
CMFG6630P2	907	921	66	30	2.3	40	4.40
CMFG6636P2	1017	1046	66	36	2.3	48	5.23
CMFG6642P2	1121	1152	66	42	2.3	56	6.06
CMFG6648P2	1223	1254	66	48	2.3	64	6.88
CMFG6654P2	1329	1360	66	54	2.3	72	7.71
CMFG6660P2	1434	1463	66	60	2.3	80	8.53

CMPLG-N0 • Single 12" Glazed at top, Non Powered Fabric Panel, No Punchouts

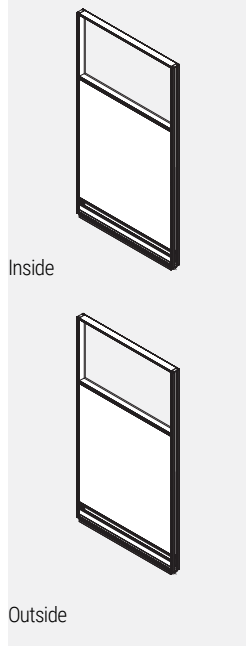

- Individual fabric-covered module in lower position with glazed module in upper position incorporated into an aluminum frame.
- Opposite sides of each module may have a different fabric within the same grade at no upcharge.
- If different grades of fabric are used on one panel, the entire panel must be priced at highest grade.
- Panels are not tackable.
- Note: Trim is not required at a straight connection between two panels of the same height.
- 3 Panel connector brackets per side come standard with 42"h. and 54"h. panels.
- 4 Panel connector brackets per side come standard with 66"h. panels.
- Panels include 2 raceway covers with no punchouts, an integrated aluminum top cap and levelling glides.
- Standard in clear (CLR) plexi.
- Optional frosted (FRST) plexi
- Glazing is 12" nominal from the top of the panel.

PRODUCT CODE	PRICE		SIZE/ INCHES			WEIGHT VOL	
	GR 1	GR 2	H	W	D	LBS	FT³
CMPLG4224N0	446	459	42	24	2.3	20	2.31
CMPLG4230N0	488	507	42	30	2.3	25	2.85
CMPLG4236N0	537	567	42	36	2.3	31	3.38
CMPLG4242N0	593	625	42	42	2.3	36	3.92
CMPLG4248N0	652	681	42	48	2.3	41	4.45
CMPLG4254N0	736	765	42	54	2.3	46	4.99
CMPLG4260N0	811	840	42	60	2.3	51	5.52
CMPLG4824N0	477	491	48	24	2.3	26	2.73
CMPLG4830N0	550	567	48	30	2.3	33	3.37
CMPLG4836N0	613	644	48	36	2.3	39	4.00
CMPLG4842N0	690	720	48	42	2.3	46	4.63
CMPLG4848N0	759	790	48	48	2.3	52	5.26
CMPLG4854N0	839	870	48	54	2.3	59	5.89
CMPLG4860N0	913	941	48	60	2.3	65	6.53
CMPLG5424N0	477	490	54	24	2.3	26	2.73
CMPLG5430N0	550	567	54	30	2.3	33	3.37
CMPLG5436N0	613	644	54	36	2.3	39	4.00
CMPLG5442N0	689	720	54	42	2.3	46	4.63
CMPLG5448N0	759	790	54	48	2.3	52	5.26
CMPLG5454N0	840	869	54	54	2.3	59	5.89
CMPLG5460N0	913	942	54	60	2.3	65	6.53
CMPLG6624N0	524	555	66	24	2.3	32	3.58
CMPLG6630N0	608	638	66	30	2.3	40	4.40
CMPLG6636N0	676	736	66	36	2.3	48	5.23
CMPLG6642N0	754	814	66	42	2.3	56	6.06
CMPLG6648N0	833	894	66	48	2.3	64	6.88
CMPLG6654N0	920	982	66	54	2.3	72	7.71
CMPLG6660N0	999	1061	66	60	2.3	80	8.53

CMPLG-N1 • Single 12" Glazed at top, Non Powered Panel, Punchouts on One Side

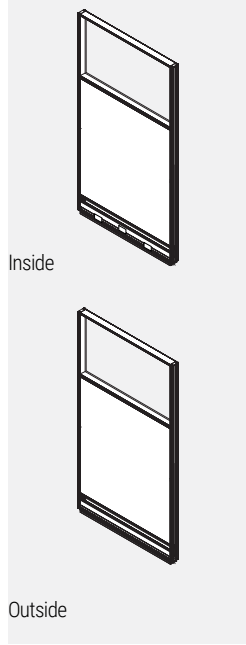

- Individual fabric-covered module in lower position with glazed module in upper position incorporated into an aluminum frame.
- Opposite sides of each module may have a different fabric within the same grade at no upcharge.
- If different grades of fabric are used on one panel, the entire panel must be priced at highest grade.
- Panels are not tackable.
- Note: Trim is not required at a straight connection between two panels of the same height.
- 3 Panel connector brackets per side come standard with 42"h. and 54"h. panels.
- 4 Panel connector brackets per side come standard with 66"h. panels.
- Panels include 1 raceway cover with punchouts on one side, 1 raceway cover with no punchouts on the other, an integrated aluminum top cap and levelling glides.
- Standard in clear (CLR) plexi.
- Optional frosted (FRST) plexi
- 24" wide panels have two punchouts, one for electrical and one for data.
- 30" wide panels and wider have three punchouts, two for electrical and one for data.
- Glazing is 12" nominal from the top of the panel.

PRODUCT CODE	PRICE		SIZE/ INCHES			WEIGHT VOL	
	GR 1	GR 2	H	W	D	LBS	FT³
CMPLG4224N1	446	459	42	24	2.3	20	2.31
CMPLG4230N1	488	507	42	30	2.3	25	2.85
CMPLG4236N1	537	567	42	36	2.3	31	3.38
CMPLG4242N1	593	625	42	42	2.3	36	3.92
CMPLG4248N1	652	681	42	48	2.3	41	4.45
CMPLG4254N1	736	765	42	54	2.3	46	4.99
CMPLG4260N1	811	840	42	60	2.3	51	5.52
CMPLG4824N1	477	491	48	24	2.3	26	2.73
CMPLG4830N1	550	567	48	30	2.3	33	3.37
CMPLG4836N1	613	644	48	36	2.3	39	4.00
CMPLG4842N1	690	720	48	42	2.3	46	4.63
CMPLG4848N1	759	790	48	48	2.3	52	5.26
CMPLG4854N1	839	870	48	54	2.3	59	5.89
CMPLG4860N1	913	941	48	60	2.3	65	6.53
CMPLG5424N1	477	490	54	24	2.3	26	2.73
CMPLG5430N1	550	567	54	30	2.3	33	3.37
CMPLG5436N1	613	644	54	36	2.3	39	4.00
CMPLG5442N1	689	720	54	42	2.3	46	4.63
CMPLG5448N1	759	790	54	48	2.3	52	5.26
CMPLG5454N1	840	869	54	54	2.3	59	5.89
CMPLG5460N1	913	942	54	60	2.3	65	6.53
CMPLG6624N1	524	555	66	24	2.3	32	3.58
CMPLG6630N1	608	638	66	30	2.3	40	4.40
CMPLG6636N1	676	736	66	36	2.3	48	5.23
CMPLG6642N1	754	814	66	42	2.3	56	6.06
CMPLG6648N1	833	894	66	48	2.3	64	6.88
CMPLG6654N1	920	982	66	54	2.3	72	7.71
CMPLG6660N1	999	1061	66	60	2.3	80	8.53

CMPLG-N2 • Single 12" at Top, Non Powered Fabric Panel, Punchouts on Both Sides

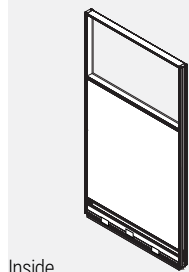

Inside

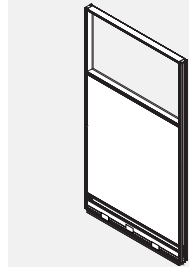

Outside

- Individual fabric-covered module in lower position with glazed module in upper position incorporated into a solid steel frame.
- Opposite sides of each module may have a different fabric within the same grade at no upcharge.
- If different grades of fabric are used on one panel, the entire panel must be priced at highest grade.
- Panels are not tackable.
- Note: Trim is not required at a straight connection between two panels of the same height.
- 3 Panel connector brackets per side come standard with 42"h. and 54"h. panels.
- 4 Panel connector brackets per side come standard with 66"h. panels.
- Panels include 2 raceway covers with punchouts on both sides, an integrated aluminum top cap and levelling glides.
- Standard in clear (CLR) plexi.
- Optional frosted (FRST) plexi
- 24" wide panels have two punchouts, one for electrical and one for data.
- 30" wide panels and wider have three punchouts, two for electrical and one for data.
- Glazing is 12" nominal from the top of the panel.

PRODUCT CODE	PRICE		SIZE/ INCHES			WEIGHT VOL	
	GR 1	GR 2	H	W	D	LBS	FT ³
CMPLG4224N2	446	459	42	24	2.3	20	2.31
CMPLG4230N2	488	507	42	30	2.3	25	2.85
CMPLG4236N2	537	567	42	36	2.3	31	3.38
CMPLG4242N2	593	625	42	42	2.3	36	3.92
CMPLG4248N2	652	681	42	48	2.3	41	4.45
CMPLG4254N2	736	765	42	54	2.3	46	4.99
CMPLG4260N2	811	840	42	60	2.3	51	5.52
CMPLG4824N2	477	491	48	24	2.3	26	2.73
CMPLG4830N2	550	567	48	30	2.3	33	3.37
CMPLG4836N2	613	644	48	36	2.3	39	4.00
CMPLG4842N2	690	720	48	42	2.3	46	4.63
CMPLG4848N2	759	790	48	48	2.3	52	5.26
CMPLG4854N2	839	870	48	54	2.3	59	5.89
CMPLG4860N2	913	941	48	60	2.3	65	6.53
CMPLG5424N2	477	490	54	24	2.3	26	2.73
CMPLG5430N2	550	567	54	30	2.3	33	3.37
CMPLG5436N2	613	644	54	36	2.3	39	4.00
CMPLG5442N2	689	720	54	42	2.3	46	4.63
CMPLG5448N2	759	790	54	48	2.3	52	5.26
CMPLG5454N2	840	869	54	54	2.3	59	5.89
CMPLG5460N2	913	942	54	60	2.3	65	6.53
CMPLG6624N2	524	555	66	24	2.3	32	3.58
CMPLG6630N2	608	638	66	30	2.3	40	4.40
CMPLG6636N2	676	736	66	36	2.3	48	5.23
CMPLG6642N2	754	814	66	42	2.3	56	6.06
CMPLG6648N2	833	894	66	48	2.3	64	6.88
CMPLG6654N2	920	982	66	54	2.3	72	7.71
CMPLG6660N2	999	1061	66	60	2.3	80	8.53

CMPLG-P1 • Single 12" Glazed at Top, Powered Fabric Panel, Punchouts on One Side

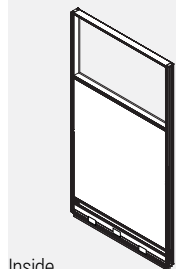

Inside

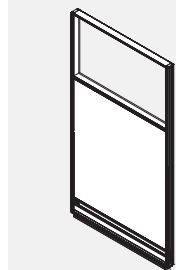

Outside

- Individual fabric-covered module in lower position with glazed module in upper position incorporated into a solid steel frame.
- Opposite sides of each module may have a different fabric within the same grade at no upcharge.
- If different grades of fabric are used on one panel, the entire panel must be priced at highest grade.
- Panels are not tackable.
- Note: Trim is not required at a straight connection between two panels of the same height.
- 3 Panel connector brackets per side come standard with 42"h. and 54"h. panels.
- 4 Panel connector brackets per side come standard with 66"h. panels.
- Panels include 1 raceway cover with punchouts on one side, 1 raceway cover with no punchouts on the other, a power distribution housing, an integrated aluminum top cap and levelling glides.
- Standard in clear (CLR) plexi.
- Optional frosted (FRST) plexi
- 24" wide panels have two punchouts, one for electrical and one for data.
- 30" wide panels and wider have three punchouts, two for electrical and one for data.
- Please specify duplex receptacles separately.
- Glazing is 12" nominal from the top of the panel.

PRODUCT CODE	PRICE		SIZE/ INCHES			WEIGHT VOL	
	GR 1	GR 2	H	W	D	LBS	FT ³
CMPLG4224P1	582	600	42	24	2.3	20	2.31
CMPLG4230P1	678	692	42	30	2.3	25	2.85
CMPLG4236P1	731	761	42	36	2.3	31	3.38
CMPLG4242P1	796	826	42	42	2.3	36	3.92
CMPLG4248P1	864	894	42	48	2.3	41	4.45
CMPLG4254P1	954	984	42	54	2.3	46	4.99
CMPLG4260P1	1028	1060	42	60	2.3	51	5.52
CMPLG4824P1	614	630	48	24	2.3	26	2.73
CMPLG4830P1	737	752	48	30	2.3	33	3.37
CMPLG4836P1	809	839	48	36	2.3	39	4.00
CMPLG4842P1	892	921	48	42	2.3	46	4.63
CMPLG4848P1	974	1004	48	48	2.3	52	5.26
CMPLG4854P1	1057	1087	48	54	2.3	59	5.89
CMPLG4860P1	1131	1160	48	60	2.3	65	6.53
CMPLG5424P1	614	630	54	24	2.3	26	2.73
CMPLG5430P1	737	752	54	30	2.3	33	3.37
CMPLG5436P1	811	840	54	36	2.3	39	4.00
CMPLG5442P1	892	921	54	42	2.3	46	4.63
CMPLG5448P1	973	1003	54	48	2.3	52	5.26
CMPLG5454P1	1057	1088	54	54	2.3	59	5.89
CMPLG5460P1	1131	1160	54	60	2.3	65	6.53
CMPLG6624P1	665	694	66	24	2.3	32	3.58
CMPLG6630P1	794	825	66	30	2.3	40	4.40
CMPLG6636P1	870	931	66	36	2.3	48	5.23
CMPLG6642P1	956	1017	66	42	2.3	56	6.06
CMPLG6648P1	1050	1108	66	48	2.3	64	6.88
CMPLG6654P1	1137	1198	66	54	2.3	72	7.71
CMPLG6660P1	1218	1278	66	60	2.3	80	8.53

CMPLG-P2 • Single 12" Glazed at Top, Powered Fabric Panel, Punchouts on Both Sides

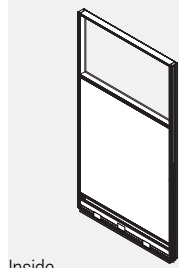

Inside

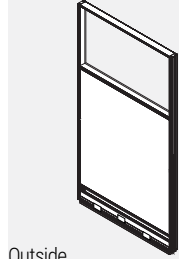

Outside

- Individual fabric-covered module in lower position with glazed module in upper position incorporated into an aluminum frame.
- Opposite sides of each module may have a different fabric within the same grade at no upcharge.
- If different grades of fabric are used on one panel, the entire panel must be priced at highest grade.
- Panels are not tackable.
- Note: Trim is not required at a straight connection between two panels of the same height.
- 3 Panel connector brackets per side come standard with 42"h. and 54"h. panels.
- 4 Panel connector brackets per side come standard with 66"h. panels.
- Panels include 2 raceway covers with punchouts on both sides, a power distribution housing, an integrated aluminum top cap and levelling glides.
- Standard in clear (CLR) plexi.
- Optional frosted (FRST) plexi
- 24" wide panels have two punchouts, one for electrical and one for data.
- 30" wide panels and wider have three punchouts, two for electrical and one for data.
- Glazing is 12" nominal from the top of the panel. panels and wider have 2 punchouts.
- Please specify duplex receptacles separately.

PRODUCT CODE	PRICE		SIZE/ H	INCHES			WEIGHT VOL	
	GR 1	GR 2		W	D	LBS	FT³	
CMPLG4224P2	582	600	42	24	2.3	20	2.31	
CMPLG4230P2	678	692	42	30	2.3	25	2.85	
CMPLG4236P2	731	761	42	36	2.3	31	3.38	
CMPLG4242P2	796	826	42	42	2.3	36	3.92	
CMPLG4248P2	864	894	42	48	2.3	41	4.45	
CMPLG4254P2	954	984	42	54	2.3	46	4.99	
CMPLG4260P2	1028	1060	42	60	2.3	51	5.52	
CMPLG4824P2	614	630	48	24	2.3	26	2.73	
CMPLG4830P2	737	752	48	30	2.3	33	3.37	
CMPLG4836P2	809	839	48	36	2.3	39	4.00	
CMPLG4842P2	892	921	48	42	2.3	46	4.63	
CMPLG4848P2	974	1004	48	48	2.3	52	5.26	
CMPLG4854P2	1057	1087	48	54	2.3	59	5.89	
CMPLG4860P2	1131	1160	48	60	2.3	65	6.53	
CMPLG5424P2	614	630	54	24	2.3	26	2.73	
CMPLG5430P2	737	752	54	30	2.3	33	3.37	
CMPLG5436P2	811	840	54	36	2.3	39	4.00	
CMPLG5442P2	892	921	54	42	2.3	46	4.63	
CMPLG5448P2	973	1003	54	48	2.3	52	5.26	
CMPLG5454P2	1057	1088	54	54	2.3	59	5.89	
CMPLG5460P2	1131	1160	54	60	2.3	65	6.53	
CMPLG6624P2	665	694	66	24	2.3	32	3.58	
CMPLG6630P2	794	825	66	30	2.3	40	4.40	
CMPLG6636P2	870	931	66	36	2.3	48	5.23	
CMPLG6642P2	956	1017	66	42	2.3	56	6.06	
CMPLG6648P2	1050	1108	66	48	2.3	64	6.88	
CMPLG6654P2	1137	1198	66	54	2.3	72	7.71	
CMPLG6660P2	1218	1278	66	60	2.3	80	8.53	

CMPG-N0 • Single 14" Glazed at Top Glazed Panel, Non Powered Fabric Panel, No Punchouts

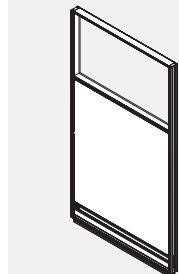

Inside

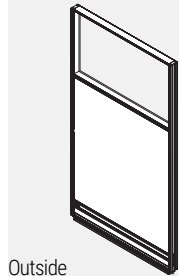

Outside

- Individual fabric-covered module in lower position with glazed module in upper position incorporated into an aluminum frame.
- Opposite sides of each module may have a different fabric within the same grade at no upcharge.
- If different grades of fabric are used on one panel, the entire panel must be priced at highest grade.
- Panels are not tackable.
- Note: Trim is not required at a straight connection between two panels of the same height.
- 3 Panel connector brackets per side come standard with 42"h. and 54"h. panels.
- 4 Panel connector brackets per side come standard with 66"h. panels.
- Panels include 2 raceway covers with no punchouts, an integrated aluminum top cap and levelling glides.
- Standard in clear (CLR) plexi.
- Optional frosted (FRST) plexi
- PVC Glass Retainer may match any panel frame finish.
- Glazing is 14" nominal from the top of the panel.

PRODUCT CODE	PRICE		SIZE/ H	INCHES			WEIGHT VOL	
	GR 1	GR 2		W	D	LBS	FT³	
CMPG4224N0	446	459	42	24	2.3	20	2.31	
CMPG4230N0	488	507	42	30	2.3	25	2.85	
CMPG4236N0	537	567	42	36	2.3	31	3.38	
CMPG4242N0	593	625	42	42	2.3	36	3.92	
CMPG4248N0	652	681	42	48	2.3	41	4.45	
CMPG4254N0	736	765	42	54	2.3	46	4.99	
CMPG4260N0	811	840	42	60	2.3	51	5.52	
CMPG4824N0	477	491	48	24	2.3	26	2.73	
CMPG4830N0	550	567	48	30	2.3	33	3.37	
CMPG4836N0	613	644	48	36	2.3	39	4.00	
CMPG4842N0	690	720	48	42	2.3	46	4.63	
CMPG4848N0	759	790	48	48	2.3	52	5.26	
CMPG4854N0	839	870	48	54	2.3	59	5.89	
CMPG4860N0	913	941	48	60	2.3	65	6.53	
CMPG5424N0	477	490	54	24	2.3	26	2.73	
CMPG5430N0	550	567	54	30	2.3	33	3.37	
CMPG5436N0	613	644	54	36	2.3	39	4.00	
CMPG5442N0	689	720	54	42	2.3	46	4.63	
CMPG5448N0	759	790	54	48	2.3	52	5.26	
CMPG5454N0	840	869	54	54	2.3	59	5.89	
CMPG5460N0	913	942	54	60	2.3	65	6.53	
CMPG6624N0	524	555	66	24	2.3	32	3.58	
CMPG6630N0	608	638	66	30	2.3	40	4.40	
CMPG6636N0	676	736	66	36	2.3	48	5.23	
CMPG6642N0	754	814	66	42	2.3	56	6.06	
CMPG6648N0	833	894	66	48	2.3	64	6.88	
CMPG6654N0	920	982	66	54	2.3	72	7.71	
CMPG6660N0	999	1061	66	60	2.3	80	8.53	

CMPG-N1 • Single 14" Glazed at Top Glazed Panel, Non Powered Fabric Panel, Punchouts on One Side

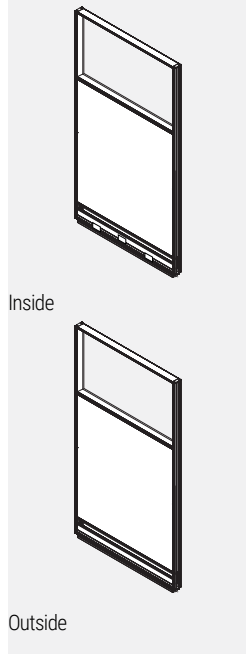

- Individual fabric-covered module in lower position with glazed module in upper position incorporated into an aluminum frame.
- Opposite sides of each module may have a different fabric within the same grade at no upcharge.
- If different grades of fabric are used on one panel, the entire panel must be priced at highest grade.
- Panels are not tackable.
- Note: Trim is not required at a straight connection between two panels of the same height.
- 3 Panel connector brackets per side come standard with 42" h. and 54" h. panels.
- 4 Panel connector brackets per side come standard with 66" h. panels.
- Panels include 1 raceway cover with punchouts on one side, 1 raceway cover with no punchouts on the other, an integrated aluminum top cap and levelling glides.
- Standard in clear (CLR) plexi.
- Optional frosted (FRST) plexi
- 24" wide panels have two punchouts, one for electrical and one for data.
- 30" wide panels and wider have three punchouts, two for electrical and one for data.
- Glazing is 14" nominal from the top of the panel.

PRODUCT CODE	PRICE		SIZE/ INCHES			WEIGHT VOL	
	GR 1	GR 2	H	W	D	LBS	FT ³
CMPG4224N1	446	459	42	24	2.3	20	2.31
CMPG4230N1	488	507	42	30	2.3	25	2.85
CMPG4236N1	537	567	42	36	2.3	31	3.38
CMPG4242N1	593	625	42	42	2.3	36	3.92
CMPG4248N1	652	681	42	48	2.3	41	4.45
CMPG4254N1	736	765	42	54	2.3	46	4.99
CMPG4260N1	811	840	42	60	2.3	51	5.52
CMPG4824N1	477	491	48	24	2.3	26	2.73
CMPG4830N1	550	567	48	30	2.3	33	3.37
CMPG4836N1	613	644	48	36	2.3	39	4.00
CMPG4842N1	690	720	48	42	2.3	46	4.63
CMPG4848N1	759	790	48	48	2.3	52	5.26
CMPG4854N1	839	870	48	54	2.3	59	5.89
CMPG4860N1	913	941	48	60	2.3	65	6.53
CMPG5424N1	477	490	54	24	2.3	26	2.73
CMPG5430N1	550	567	54	30	2.3	33	3.37
CMPG5436N1	613	644	54	36	2.3	39	4.00
CMPG5442N1	689	720	54	42	2.3	46	4.63
CMPG5448N1	759	790	54	48	2.3	52	5.26
CMPG5454N1	840	869	54	54	2.3	59	5.89
CMPG5460N1	913	942	54	60	2.3	65	6.53
CMPG6624N1	524	555	66	24	2.3	32	3.58
CMPG6630N1	608	638	66	30	2.3	40	4.40
CMPG6636N1	676	736	66	36	2.3	48	5.23
CMPG6642N1	754	814	66	42	2.3	56	6.06
CMPG6648N1	833	894	66	48	2.3	64	6.88
CMPG6654N1	920	982	66	54	2.3	72	7.71
CMPG6660N1	999	1061	66	60	2.3	80	8.53

CMPG-N2 • Single 14" Glazed at Top, Non Powered Fabric Panel, Punchouts on Both Sides

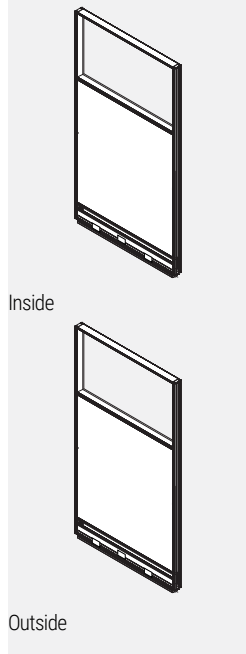

- Individual fabric-covered module in lower position with glazed module in upper position incorporated into a solid steel frame.
- Opposite sides of each module may have a different fabric within the same grade at no upcharge.
- If different grades of fabric are used on one panel, the entire panel must be priced at highest grade.
- Panels are not tackable.
- Note: Trim is not required at a straight connection between two panels of the same height.
- 3 Panel connector brackets per side come standard with 42" h. and 54" h. panels.
- 4 Panel connector brackets per side come standard with 66" h. panels.
- Panels include 2 raceway covers with punchouts on both sides, an integrated aluminum top cap and levelling glides.
- Standard in clear (CLR) plexi.
- Optional frosted (FRST) plexi
- 24" wide panels have two punchouts, one for electrical and one for data.
- 30" wide panels and wider have three punchouts, two for electrical and one for data.
- Glazing is 14" nominal from the top of the panel.

PRODUCT CODE	PRICE		SIZE/ INCHES			WEIGHT VOL	
	GR 1	GR 2	H	W	D	LBS	FT ³
CMPG4224N2	446	459	42	24	2.3	20	2.31
CMPG4230N2	488	507	42	30	2.3	25	2.85
CMPG4236N2	537	567	42	36	2.3	31	3.38
CMPG4242N2	593	625	42	42	2.3	36	3.92
CMPG4248N2	652	681	42	48	2.3	41	4.45
CMPG4254N2	736	765	42	54	2.3	46	4.99
CMPG4260N2	811	840	42	60	2.3	51	5.52
CMPG4824N2	477	491	48	24	2.3	26	2.73
CMPG4830N2	550	567	48	30	2.3	33	3.37
CMPG4836N2	613	644	48	36	2.3	39	4.00
CMPG4842N2	690	720	48	42	2.3	46	4.63
CMPG4848N2	759	790	48	48	2.3	52	5.26
CMPG4854N2	839	870	48	54	2.3	59	5.89
CMPG4860N2	913	941	48	60	2.3	65	6.53
CMPG5424N2	477	490	54	24	2.3	26	2.73
CMPG5430N2	550	567	54	30	2.3	33	3.37
CMPG5436N2	613	644	54	36	2.3	39	4.00
CMPG5442N2	689	720	54	42	2.3	46	4.63
CMPG5448N2	759	790	54	48	2.3	52	5.26
CMPG5454N2	840	869	54	54	2.3	59	5.89
CMPG5460N2	913	942	54	60	2.3	65	6.53
CMPG6624N2	524	555	66	24	2.3	32	3.58
CMPG6630N2	608	638	66	30	2.3	40	4.40
CMPG6636N2	676	736	66	36	2.3	48	5.23
CMPG6642N2	754	814	66	42	2.3	56	6.06
CMPG6648N2	833	894	66	48	2.3	64	6.88
CMPG6654N2	920	982	66	54	2.3	72	7.71
CMPG6660N2	999	1061	66	60	2.3	80	8.53

CMPG-P1 • Single 14" Glazed at Top, Powered Fabric Panel, Punchouts on One Side

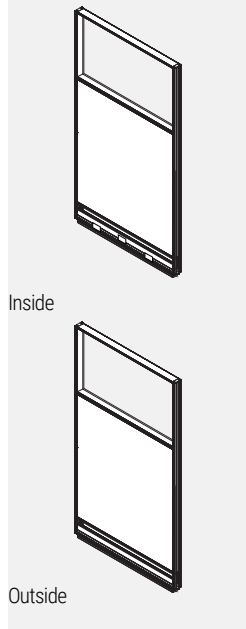

- Individual fabric-covered module in lower position with glazed module in upper position incorporated into a solid steel frame.
- Opposite sides of each module may have a different fabric within the same grade at no upcharge.
- If different grades of fabric are used on one panel, the entire panel must be priced at highest grade.
- Panels are not tackable.
- Note: Trim is not required at a straight connection between two panels of the same height.
- 3 Panel connector brackets per side come standard with 42"h. and 54"h. panels.
- 4 Panel connector brackets per side come standard with 66"h. panels.
- Panels include 1 raceway cover with punchouts on one side, 1 raceway cover with no punchouts on the other, a power distribution housing, an integrated aluminum top cap and levelling glides.
- Standard in clear (CLR) plexi.
- Optional frosted (FRST) plexi
- 24" wide panels have two punchouts, one for electrical and one for data.
- 30" wide panels and wider have three punchouts, two for electrical and one for data.
- Please specify duplex receptacles separately.
- Glazing is 14" nominal from the top of the panel.

PRODUCT CODE	PRICE		SIZE/ H	INCHES			WEIGHT VOL	
	GR 1	GR 2		W	D	LBS	FT ³	
CMPG4224P1	582	600	42	24	2.3	20	2.31	
CMPG4230P1	678	692	42	30	2.3	25	2.85	
CMPG4236P1	731	761	42	36	2.3	31	3.38	
CMPG4242P1	796	826	42	42	2.3	36	3.92	
CMPG4248P1	864	894	42	48	2.3	41	4.45	
CMPG4254P1	954	984	42	54	2.3	46	4.99	
CMPG4260P1	1028	1060	42	60	2.3	51	5.52	
CMPG4824P1	614	630	48	24	2.3	26	2.73	
CMPG4830P1	737	752	48	30	2.3	33	3.37	
CMPG4836P1	809	839	48	36	2.3	39	4.00	
CMPG4842P1	892	921	48	42	2.3	46	4.63	
CMPG4848P1	974	1004	48	48	2.3	52	5.26	
CMPG4854P1	1057	1087	48	54	2.3	59	5.89	
CMPG4860P1	1131	1160	48	60	2.3	65	6.53	
CMPG5424P1	614	630	54	24	2.3	26	2.73	
CMPG5430P1	737	752	54	30	2.3	33	3.37	
CMPG5436P1	811	840	54	36	2.3	39	4.00	
CMPG5442P1	892	921	54	42	2.3	46	4.63	
CMPG5448P1	973	1003	54	48	2.3	52	5.26	
CMPG5454P1	1057	1088	54	54	2.3	59	5.89	
CMPG5460P1	1131	1160	54	60	2.3	65	6.53	
CMPG6624P1	665	694	66	24	2.3	32	3.58	
CMPG6630P1	794	825	66	30	2.3	40	4.40	
CMPG6636P1	870	931	66	36	2.3	48	5.23	
CMPG6642P1	956	1017	66	42	2.3	56	6.06	
CMPG6648P1	1050	1108	66	48	2.3	64	6.88	
CMPG6654P1	1137	1198	66	54	2.3	72	7.71	
CMPG6660P1	1218	1278	66	60	2.3	80	8.53	

CMPG-P2 • Single 14" Glazed at Top, Powered Fabric Panel, Punchouts on Both Sides

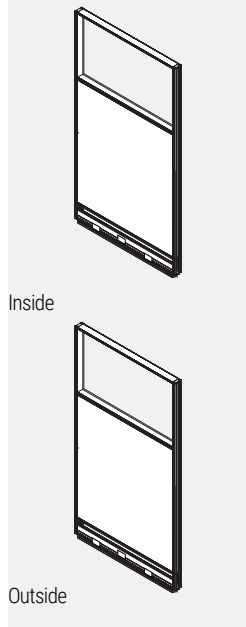

- Individual fabric-covered module in lower position with glazed module in upper position incorporated into an aluminum frame.
- Opposite sides of each module may have a different fabric within the same grade at no upcharge.
- If different grades of fabric are used on one panel, the entire panel must be priced at highest grade.
- Panels are not tackable.
- Note: Trim is not required at a straight connection between two panels of the same height.
- 3 Panel connector brackets per side come standard with 42"h. and 54"h. panels.
- 4 Panel connector brackets per side come standard with 66"h. panels.
- Panels include 2 raceway covers with punchouts on both sides, a power distribution housing, an integrated aluminum top cap and levelling glides.
- Standard in clear (CLR) plexi.
- Optional frosted (FRST) plexi
- 24" wide panels have two punchouts, one for electrical and one for data.
- 30" wide panels and wider have three punchouts, two for electrical and one for data.
- Glazing is 14" nominal from the top of the panel. panels and wider have 2 punchouts.
- Please specify duplex receptacles separately.

PRODUCT CODE	PRICE		SIZE/ H	INCHES			WEIGHT VOL	
	GR 1	GR 2		W	D	LBS	FT ³	
CMPG4224P2	582	600	42	24	2.3	20	2.31	
CMPG4230P2	678	692	42	30	2.3	25	2.85	
CMPG4236P2	731	761	42	36	2.3	31	3.38	
CMPG4242P2	796	826	42	42	2.3	36	3.92	
CMPG4248P2	864	894	42	48	2.3	41	4.45	
CMPG4254P2	954	984	42	54	2.3	46	4.99	
CMPG4260P2	1028	1060	42	60	2.3	51	5.52	
CMPG4824P2	614	630	48	24	2.3	26	2.73	
CMPG4830P2	737	752	48	30	2.3	33	3.37	
CMPG4836P2	809	839	48	36	2.3	39	4.00	
CMPG4842P2	892	921	48	42	2.3	46	4.63	
CMPG4848P2	974	1004	48	48	2.3	52	5.26	
CMPG4854P2	1057	1087	48	54	2.3	59	5.89	
CMPG4860P2	1131	1160	48	60	2.3	65	6.53	
CMPG5424P2	614	630	54	24	2.3	26	2.73	
CMPG5430P2	737	752	54	30	2.3	33	3.37	
CMPG5436P2	811	840	54	36	2.3	39	4.00	
CMPG5442P2	892	921	54	42	2.3	46	4.63	
CMPG5448P2	973	1003	54	48	2.3	52	5.26	
CMPG5454P2	1057	1088	54	54	2.3	59	5.89	
CMPG5460P2	1131	1160	54	60	2.3	65	6.53	
CMPG6624P2	665	694	66	24	2.3	32	3.58	
CMPG6630P2	794	825	66	30	2.3	40	4.40	
CMPG6636P2	870	931	66	36	2.3	48	5.23	
CMPG6642P2	956	1017	66	42	2.3	56	6.06	
CMPG6648P2	1050	1108	66	48	2.3	64	6.88	
CMPG6654P2	1137	1198	66	54	2.3	72	7.71	
CMPG6660P2	1218	1278	66	60	2.3	80	8.53	

CMFO-N0 • Single Segmented Open Bottom Non Powered Fabric Panel, No Punchouts

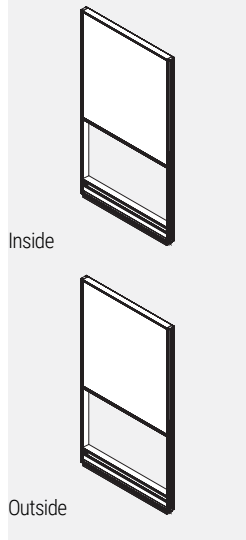

- Individual fabric-covered module in upper position incorporated into an aluminum frame.
- Bottom is open.
- Opposite sides of each module may have a different fabric within the same grade at no upcharge.
- If different grades of fabric are used on one panel, the entire panel must be priced at highest grade.
- Panels are not tackable.
- Note: Trim is not required at a straight connection between two panels of the same height.
- 3 Panel connector brackets per side come standard with 42”h. and 54”h. panels.
- 4 Panel connector brackets per side come standard with 66”h. panels.
- Panels include 2 raceway covers with no punchouts, an integrated aluminum top cap and levelling glides.
- PVC trim kit available in black only.

PRODUCT CODE	PRICE		SIZE/ INCHES			WEIGHT VOL	
	GR 1	GR 2	H	W	D	LBS	FT ³
CMFO4224N0	271	281	42	24	2.3	15	2.31
CMFO4230N0	339	349	42	30	2.3	17	2.85
CMFO4236N0	365	383	42	36	2.3	21	3.38
CMFO4242N0	418	438	42	42	2.3	24	3.92
CMFO4248N0	446	464	42	48	2.3	28	4.45
CMFO4254N0	486	513	42	54	2.3	31	4.99
CMFO4260N0	536	552	42	60	2.3	34	5.52
CMFO5424N0	319	336	54	24	2.3	20	2.73
CMFO5430N0	365	378	54	30	2.3	25	3.37
CMFO5436N0	415	431	54	36	2.3	29	4.00
CMFO5442N0	476	507	54	42	2.3	34	4.63
CMFO5448N0	508	539	54	48	2.3	38	5.26
CMFO5454N0	553	584	54	54	2.3	43	5.89
CMFO5460N0	589	619	54	60	2.3	48	6.53
CMFO6624N0	352	377	66	24	2.3	25	3.58
CMFO6630N0	394	418	66	30	2.3	31	4.40
CMFO6636N0	473	516	66	36	2.3	38	5.23
CMFO6642N0	536	578	66	42	2.3	44	6.06
CMFO6648N0	561	604	66	48	2.3	50	6.88
CMFO6654N0	612	656	66	54	2.3	56	7.71
CMFO6660N0	654	695	66	60	2.3	63	8.53

CMFO-N1 • Single Segmented Open Bottom Non Powered Fabric Panel, Punchouts on One Side

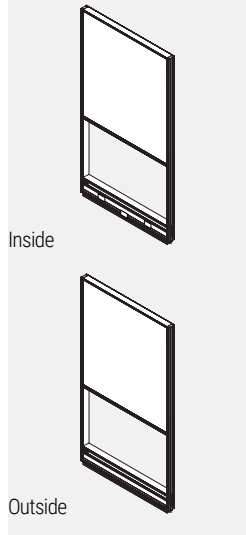

- Individual fabric-covered module in upper position incorporated into an aluminum frame.
- Bottom is open.
- Opposite sides of each module may have a different fabric within the same grade at no upcharge.
- If different grades of fabric are used on one panel, the entire panel must be priced at highest grade.
- Panels are not tackable.
- Note: Trim is not required at a straight connection between two panels of the same height.
- 3 Panel connector brackets per side come standard with 42”h. and 54”h. panels.
- 4 Panel connector brackets per side come standard with 66”h. panels.
- Panels include 1 raceway cover with punchouts on one side, 1 raceway cover with no punchouts on the other, an integrated aluminum top cap and levelling glides.
- 24” wide panels have two punchouts, one for electrical and one for data.
- 30” wide panels and wider have three punchouts, two for electrical and one for data.
- PVC trim kit available in black only.

PRODUCT CODE	PRICE		SIZE/ INCHES			WEIGHT VOL	
	GR 1	GR 2	H	W	D	LBS	FT ³
CMFO4224N1	271	281	42	24	2.3	15	2.31
CMFO4230N1	339	349	42	30	2.3	17	2.85
CMFO4236N1	365	383	42	36	2.3	21	3.38
CMFO4242N1	418	438	42	42	2.3	24	3.92
CMFO4248N1	446	464	42	48	2.3	28	4.45
CMFO4254N1	486	513	42	54	2.3	31	4.99
CMFO4260N1	536	552	42	60	2.3	34	5.52
CMFO5424N1	319	336	54	24	2.3	20	2.73
CMFO5430N1	365	378	54	30	2.3	25	3.37
CMFO5436N1	415	431	54	36	2.3	29	4.00
CMFO5442N1	476	507	54	42	2.3	34	4.63
CMFO5448N1	508	539	54	48	2.3	38	5.26
CMFO5454N1	553	584	54	54	2.3	43	5.89
CMFO5460N1	589	619	54	60	2.3	48	6.53
CMFO6624N1	352	377	66	24	2.3	25	3.58
CMFO6630N1	394	418	66	30	2.3	31	4.40
CMFO6636N1	473	516	66	36	2.3	38	5.23
CMFO6642N1	536	578	66	42	2.3	44	6.06
CMFO6648N1	561	604	66	48	2.3	50	6.88
CMFO6654N1	612	656	66	54	2.3	56	7.71
CMFO6660N1	654	695	66	60	2.3	63	8.53

CMFO-N2 • Single Segmented Open Bottom Non Powered Fabric Panel, Punchouts on Both Sides

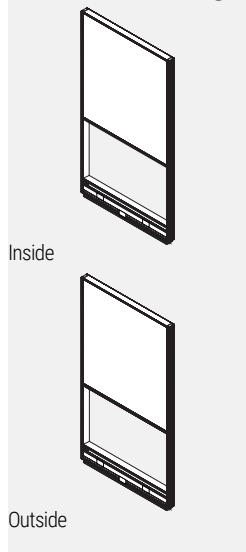

- Individual fabric-covered module in upper position incorporated into an aluminum frame.
- Bottom is open.
- Opposite sides of each module may have a different fabric within the same grade at no upcharge.
- If different grades of fabric are used on one panel, the entire panel must be priced at highest grade.
- Panels are not tackable.
- Note: Trim is not required at a straight connection between two panels of the same height.
- 3 Panel connector brackets per side come standard with 42”h. and 54”h. panels.
- 4 Panel connector brackets per side come standard with 66”h. panels.
- Panels include 2 raceway covers with punchouts on both sides, an integrated aluminum top cap and levelling glides.
- 24” wide panels have two punchouts, one for electrical and one for data.
- 30” wide panels and wider have three punchouts, two for electrical and one for data.
- PVC trim kit available in black only.

PRODUCT CODE	PRICE		SIZE/ INCHES			WEIGHT VOL	
	GR 1	GR 2	H	W	D	LBS	FT³
CMFO4224N2	271	281	42	24	2.3	15	2.31
CMFO4230N2	339	349	42	30	2.3	17	2.85
CMFO4236N2	365	383	42	36	2.3	21	3.38
CMFO4242N2	418	438	42	42	2.3	24	3.92
CMFO4248N2	446	464	42	48	2.3	28	4.45
CMFO4254N2	486	513	42	54	2.3	31	4.99
CMFO4260N2	536	552	42	60	2.3	34	5.52
CMFO5424N2	319	336	54	24	2.3	20	2.73
CMFO5430N2	365	378	54	30	2.3	25	3.37
CMFO5436N2	415	431	54	36	2.3	29	4.00
CMFO5442N2	476	507	54	42	2.3	34	4.63
CMFO5448N2	508	539	54	48	2.3	38	5.26
CMFO5454N2	553	584	54	54	2.3	43	5.89
CMFO5460N2	589	619	54	60	2.3	48	6.53
CMFO6624N2	352	377	66	24	2.3	25	3.58
CMFO6630N2	394	418	66	30	2.3	31	4.40
CMFO6636N2	473	516	66	36	2.3	38	5.23
CMFO6642N2	536	578	66	42	2.3	44	6.06
CMFO6648N2	561	604	66	48	2.3	50	6.88
CMFO6654N2	612	656	66	54	2.3	56	7.71
CMFO6660N2	654	695	66	60	2.3	63	8.53

CMFO-P1 • Single Segmented Open Bottom Powered Fabric Panel, Punchouts on One Side

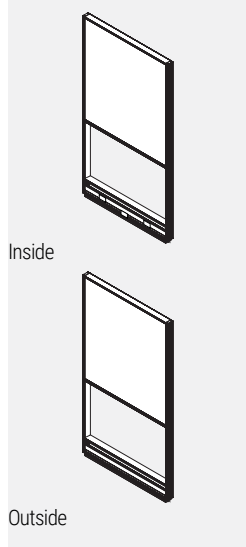

- Individual fabric-covered module in upper position incorporated into an aluminum frame.
- Bottom is open.
- Opposite sides of each module may have a different fabric within the same grade at no upcharge.
- If different grades of fabric are used on one panel, the entire panel must be priced at highest grade.
- Panels are not tackable.
- Note: Trim is not required at a straight connection between two panels of the same height.
- 3 Panel connector brackets per side come standard with 42”h. and 54”h. panels.
- 4 Panel connector brackets per side come standard with 66”h. panels.
- Panels include 1 raceway cover with punchouts on one side, 1 raceway cover with no punchouts on the other, a power distribution housing, an integrated aluminum top cap and levelling glides.
- 24” wide panels have two punchouts, one for electrical and one for data.
- 30” wide panels and wider have three punchouts, two for electrical and one for data.
- Please specify duplex receptacles separately.
- PVC trim kit available in black only.

PRODUCT CODE	PRICE		SIZE/ INCHES			WEIGHT VOL	
	GR 1	GR 2	H	W	D	LBS	FT³
CMFO4224P1	401	411	42	24	2.3	15	2.31
CMFO4230P1	512	521	42	30	2.3	17	2.85
CMFO4236P1	546	567	42	36	2.3	21	3.38
CMFO4242P1	605	625	42	42	2.3	24	3.92
CMFO4248P1	644	661	42	48	2.3	28	4.45
CMFO4254P1	689	698	42	54	2.3	31	4.99
CMFO4260P1	737	757	42	60	2.3	34	5.52
CMFO5424P1	449	462	54	24	2.3	20	2.73
CMFO5430P1	540	552	54	30	2.3	25	3.37
CMFO5436P1	595	610	54	36	2.3	29	4.00
CMFO5442P1	661	693	54	42	2.3	34	4.63
CMFO5448P1	707	736	54	48	2.3	38	5.26
CMFO5454P1	757	786	54	54	2.3	43	5.89
CMFO5460P1	791	823	54	60	2.3	48	6.53
CMFO6624P1	482	507	66	24	2.3	25	3.58
CMFO6630P1	568	591	66	30	2.3	31	4.40
CMFO6636P1	654	695	66	36	2.3	38	5.23
CMFO6642P1	722	765	66	42	2.3	44	6.06
CMFO6648P1	758	802	66	48	2.3	50	6.88
CMFO6654P1	814	857	66	54	2.3	56	7.71
CMFO6660P1	856	898	66	60	2.3	63	8.53

CMFO-P2 • Single Segmented Open Bottom Powered Fabric Panel, Punchouts on Both Sides

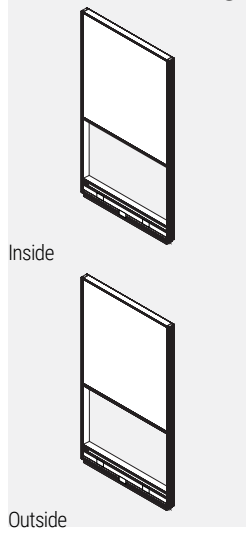

- Individual fabric-covered module in upper position incorporated into an aluminum frame.
- Bottom is open.
- Opposite sides of each module may have a different fabric within the same grade at no upcharge.
- If different grades of fabric are used on one panel, the entire panel must be priced at highest grade.
- Panels are not tackable.
- Note: Trim is not required at a straight connection between two panels of the same height.
- 3 Panel connector brackets per side come standard with 42”h. and 54”h. panels.
- 4 Panel connector brackets per side come standard with 66”h. panels.
- Panels include 2 raceway covers with punchouts on both sides, a power distribution housing, an integrated aluminum top cap and levelling glides.
- 24” wide panels have two punchouts, one for electrical and one for data.
- 30” wide panels and wider have three punchouts, two for electrical and one for data.
- Please specify duplex receptacles separately.
- PVC trim kit available in black only.

PRODUCT CODE	PRICE		SIZE/ INCHES			WEIGHT VOL	
	GR 1	GR 2	H	W	D	LBS	FT ³
CMFO4224P2	401	411	42	24	2.3	15	2.31
CMFO4230P2	512	521	42	30	2.3	17	2.85
CMFO4236P2	546	567	42	36	2.3	21	3.38
CMFO4242P2	605	625	42	42	2.3	24	3.92
CMFO4248P2	644	661	42	48	2.3	28	4.45
CMFO4254P2	689	698	42	54	2.3	31	4.99
CMFO4260P2	737	757	42	60	2.3	34	5.52
CMFO5424P2	449	462	54	24	2.3	20	2.73
CMFO5430P2	540	552	54	30	2.3	25	3.37
CMFO5436P2	595	610	54	36	2.3	29	4.00
CMFO5442P2	661	693	54	42	2.3	34	4.63
CMFO5448P2	707	736	54	48	2.3	38	5.26
CMFO5454P2	757	786	54	54	2.3	43	5.89
CMFO5460P2	791	823	54	60	2.3	48	6.53
CMFO6624P2	482	507	66	24	2.3	25	3.58
CMFO6630P2	568	591	66	30	2.3	31	4.40
CMFO6636P2	654	695	66	36	2.3	38	5.23
CMFO6642P2	722	765	66	42	2.3	44	6.06
CMFO6648P2	758	802	66	48	2.3	50	6.88
CMFO6654P2	814	857	66	54	2.3	56	7.71
CMFO6660P2	856	898	66	60	2.3	63	8.53

CMOF • Compile Fabric Over Panel

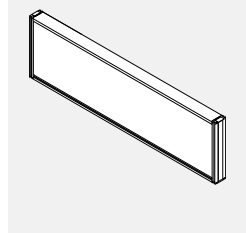

- Individual fabric-covered modules incorporated into an aluminum frame.
- Opposite sides of each module may have a different fabric within the same grade at no upcharge.
- If different grades of fabric are used on one panel, the entire panel must be priced at highest grade.
- Panels are not tackable.
- 2 Panel connector brackets per side are standard
- CHSD Compile Slider Kit for Over Panel required for installation and is included with each over panel.
- Note: Trim is not required at a straight connection between two panels of the same height.
- **Note: All over panels are non load bearing.**

PRODUCT CODE	PRICE		SIZE/ INCHES			WEIGHT VOL	
	GR 1	GR 2	H	W	D	LBS	FT ³
CMOF1224	134	156	12	24	2.3	8	0.38
CMOF1230	158	178	12	30	2.3	10	0.48
CMOF1236	174	196	12	36	2.3	12.4	0.58
CMOF1242	199	218	12	42	2.3	14.4	0.67
CMOF1248	231	249	12	48	2.3	16.4	0.7
CMOF1254	238	260	12	54	2.3	18.4	0.86
CMOF1260	283	304	12	60	2.3	20.4	0.96
CMOF1624	157	180	16	30	2.3	15	0.64
CMOF1630	182	208	16	36	2.3	18.6	0.77
CMOF1636	194	217	16	42	2.3	21.6	0.89
CMOF1642	233	255	16	48	2.3	24.6	1.02
CMOF1648	264	287	16	54	2.3	27.6	1.15
CMOF1654	276	302	16	60	2.3	30.6	1.28
CMOF1660	324	349	16	66	2.3	33.6	1.42
CMOF2424	202	240	24	24	2.3	16	0.77
CMOF2430	235	268	24	30	2.3	20	0.96
CMOF2436	263	298	24	36	2.3	24.8	1.15
CMOF2442	297	330	24	42	2.3	28.8	1.34
CMOF2448	317	351	24	48	2.3	32.8	1.53
CMOF2454	352	386	24	54	2.3	36.8	1.73
CMOF2460	406	439	24	60	2.3	40.8	1.92

CMOLF • Compile Laminate One Side, Fabric One Side Over Panel

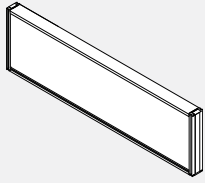

- Individual modules, one side in fabric and one side in laminate, incorporated into an aluminum frame.
- Panels are not tackable.
- 2 Panel connector brackets per side are standard
- CHSD Compile Slider Kit for Over Panel required for installation and is included with each over panel.
- Note: Trim is not required at a straight connection between two panels of the same height.
- **Note: All over panels are non load bearing.**

PRODUCT CODE	PRICE		SIZE/ INCHES			WEIGHT VOL	
	GR 1	GR 2	H	W	D	LBS	FT ³
CMOLF1224	151	161	12	24	2.3	8	0.38
CMOLF1230	178	187	12	30	2.3	10	0.48
CMOLF1236	201	211	12	36	2.3	12.4	0.58
CMOLF1242	229	238	12	42	2.3	14.4	0.67
CMOLF1248	264	274	12	48	2.3	16.4	0.7
CMOLF1254	276	285	12	54	2.3	18.4	0.86
CMOLF1260	327	336	12	60	2.3	20.4	0.96
CMOLF1624	179	193	16	30	2.3	15	0.64
CMOLF1630	215	229	16	36	2.3	18.6	0.77
CMOLF1636	238	249	16	42	2.3	21.6	0.89
CMOLF1642	271	283	16	48	2.3	24.6	1.02
CMOLF1648	309	320	16	54	2.3	27.6	1.15
CMOLF1654	328	340	16	60	2.3	30.6	1.28
CMOLF1660	380	392	16	66	2.3	33.6	1.41
CMOLF2424	237	252	24	24	2.3	16	0.77
CMOLF2430	283	301	24	30	2.3	20	0.96
CMOLF2436	313	330	24	36	2.3	24.8	1.15
CMOLF2442	353	371	24	42	2.3	28.8	1.34
CMOLF2448	385	404	24	48	2.3	32.8	1.53
CMOLF2454	430	444	24	54	2.3	36.8	1.73
CMOLF2460	488	507	24	60	2.3	40.8	1.92

CMOLL • Compile Laminate Two Sides Over Panel

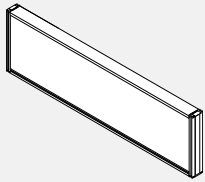

- Individual laminate modules incorporated into an aluminum frame.
- Panels are not tackable.
- 2 Panel connector brackets per side are standard
- CHSD Compile Slider Kit for Over Panel required for installation and is included with each over panel.
- Note: Trim is not required at a straight connection between two panels of the same height.
- **Note: All over panels are non load bearing.**

PRODUCT CODE	PRICE		SIZE/ INCHES			WEIGHT VOL	
	GR 1	GR 2	H	W	D	LBS	FT ³
CMOLL1224	168		12	24	2.3	8	0.38
CMOLL1230	192		12	30	2.3	10	0.48
CMOLL1236	225		12	36	2.3	12.4	0.58
CMOLL1242	255		12	42	2.3	14.4	0.67
CMOLL1248	295		12	48	2.3	16.4	0.7
CMOLL1254	312		12	54	2.3	18.4	0.86
CMOLL1260	365		12	60	2.3	20.4	0.96
CMOLL1624	200		16	24	2.3	12	0.51
CMOLL1630	237		16	30	2.3	15	0.64
CMOLL1636	270		16	36	2.3	18.6	0.77
CMOLL1642	306		16	42	2.3	21.6	0.89
CMOLL1648	350		16	48	2.3	24.6	1.02
CMOLL1654	373		16	54	2.3	27.6	1.15
CMOLL1660	433		16	60	2.3	30.6	1.28
CMOLL2424	268		24	24	2.3	16	0.77
CMOLL2430	316		24	30	2.3	20	0.96
CMOLL2436	361		24	36	2.3	24.8	1.15
CMOLL2442	408		24	42	2.3	28.8	1.34
CMOLL2448	448		24	48	2.3	32.8	1.53
CMOLL2454	499		24	54	2.3	36.8	1.73
CMOLL2460	568		24	60	2.3	40.8	1.92

CMOG • Compile Glazed Over Panel

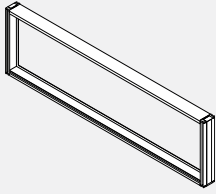

- Individual glazed module incorporated into an aluminum frame.
- Standard in clear (CLR) plexi.
- Optional frosted (FRST) plexi.
- Panels are not tackable.
- 2 Panel connector brackets per side are standard
- The PVC trim for glass can be different finish than the frame of the over panels, please specify two finishes.
- CHSD Compile Slider Kit for Over Panel required for installation and is included with each over panel.
- Note: Trim is not required at a straight connection between two panels of the same height.
- **Note: All over panels are non load bearing.**

PRODUCT CODE	PRICE	SIZE/ INCHES			WEIGHT VOL	
		H	W	D	LBS	FT ³
CMOG1224	122	12	24	2.3	8	0.38
CMOG1230	139	12	30	2.3	10	0.48
CMOG1236	156	12	36	2.3	12.4	0.58
CMOG1242	174	12	42	2.3	14.4	0.67
CMOG1248	201	12	48	2.3	16.4	0.7
CMOG1254	210	12	54	2.3	18.4	0.86
CMOG1260	248	12	60	2.3	20.4	0.96
CMOG1624	139	16	24	2.3	12	0.51
CMOG1630	161	16	30	2.3	15	0.64
CMOG1636	179	16	36	2.3	18.6	0.77
CMOG1642	202	16	42	2.3	21.6	0.89
CMOG1648	233	16	48	2.3	24.6	1.02
CMOG1654	239	16	54	2.3	27.6	1.15
CMOG1660	283	16	60	2.3	30.6	1.28
CMOG2424	178	24	24	2.3	16	0.77
CMOG2430	194	24	30	2.3	20	0.96
CMOG2436	227	24	36	2.3	24.8	1.15
CMOG2442	253	24	42	2.3	28.8	1.34
CMOG2448	273	24	48	2.3	32.8	1.53
CMOG2454	303	24	54	2.3	36.8	1.73
CMOG2460	350	24	60	2.3	40.8	1.92

CMOFW • Compile One Side Write Board Over Panel

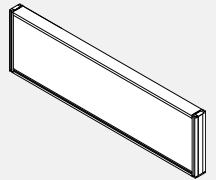

- Individual fabric or write board covered modules incorporated into an aluminum frame.
- Modules have write board on one side and fabric on the other.
- Panels are not tackable.
- 2 Panel connector brackets per side are standard
- CHSD Compile Slider Kit for Over Panel required for installation and is included with each over panel.
- Note: Trim is not required at a straight connection between two panels of the same height.
- **Note: All over panels are non load bearing.**

PRODUCT CODE	PRICE		SIZE/ INCHES			WEIGHT VOL	
	GR 1	GR 2	H	W	D	LBS	FT ³
CMOFW1224	170	179	12	24	2.3	8	0.38
CMOFW1230	201	211	12	30	2.3	10	0.48
CMOFW1236	229	238	12	36	2.3	12.4	0.58
CMOFW1242	262	271	12	42	2.3	14.4	0.67
CMOFW1248	287	299	12	48	2.3	16.4	0.7
CMOFW1254	318	329	12	54	2.3	18.4	0.86
CMOFW1260	371	380	12	60	2.3	20.4	0.96
CMOFW1624	204	215	16	24	2.3	12	0.51
CMOFW1630	241	253	16	30	2.3	15	0.64
CMOFW1636	276	287	16	36	2.3	18.6	0.77
CMOFW1642	313	327	16	42	2.3	21.6	0.89
CMOFW1648	357	371	16	48	2.3	24.6	1.02
CMOFW1654	383	396	16	54	2.3	27.6	1.15
CMOFW1660	442	454	16	60	2.3	30.6	1.28
CMOFW2424	265	281	24	24	2.3	16	0.77
CMOFW2430	305	320	24	30	2.3	20	0.96
CMOFW2436	373	389	24	36	2.3	24.8	1.15
CMOFW2442	418	435	24	42	2.3	28.8	1.34
CMOFW2448	441	456	24	48	2.3	32.8	1.53
CMOFW2454	525	543	24	54	2.3	36.8	1.73
CMOFW2460	584	602	24	60	2.3	40.8	1.92

CMOWW• Compile Write Board Two Sides Over Panel

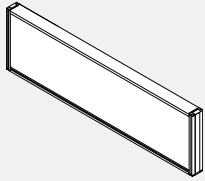

- Individual write board covered modules incorporated into an aluminum frame.
- Modules have write board on both sides.
- Panels are not tackable.
- 2 Panel connector brackets per side are standard
- CHSD Compile Slider Kit for Over Panel required for installation and is included with each over panel.
- Note: Trim is not required at a straight connection between two panels of the same height.
- **Note: All over panels are non load bearing.**

PRODUCT CODE	PRICE	SIZE/ INCHES			WEIGHT VOL	
		H	W	D	LBS	FT ³
CMOWW1224	207	12	24	2.3	8	0.38
CMOWW1230	239	12	30	2.3	10	0.48
CMOWW1236	284	12	36	2.3	12.4	0.58
CMOWW1242	318	12	42	2.3	14.4	0.67
CMOWW1248	373	12	48	2.3	16.4	0.7
CMOWW1254	394	12	54	2.3	18.4	0.86
CMOWW1260	455	12	60	2.3	20.4	0.96
CMOWW1624	252	16	24	2.3	12	0.51
CMOWW1630	304	16	30	2.3	15	0.64
CMOWW1636	349	16	36	2.3	18.6	0.77
CMOWW1642	399	16	42	2.3	21.6	0.89
CMOWW1648	456	16	48	2.3	24.6	1.02
CMOWW1654	494	16	54	2.3	27.6	1.15
CMOWW1660	565	16	60	2.3	30.6	1.28
CMOWW2424	347	24	24	2.3	16	0.77
CMOWW2430	416	24	30	2.3	20	0.96
CMOWW2436	480	24	36	2.3	24.8	1.15
CMOWW2442	548	24	42	2.3	28.8	1.34
CMOWW2448	608	24	48	2.3	32.8	1.53
CMOWW2454	679	24	54	2.3	36.8	1.73
CMOWW2460	766	24	60	2.3	40.8	1.92

BPDSL • Sliding Door

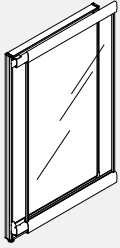

- Provides territorial privacy in an open plan environment.
- Lightweight, panel mounted sliding partition.
- Consists of translucent polycarbonate.
- Must be mounted to a straight panel of the same size.
- The face of the Privacy Screen sits 3" away from the face of the panel to which it is attached.
- When open, the screen may interfere with access doors that open on the outside of an adjacent panel.
- Caps located on the end of the frame default to the panel frame colour.
- Four sliders included for each door.
- Can be mounted on panels of the same width.
- Note: Specify left or right for the direction in which the door will slide as per examples above.

PRODUCT CODE	PRICE	SIZE/ INCHES			WEIGHT VOL	
		H	W	D	LBS	FT ³
BPDSL6636R	1981	66	36	2.61	35	5.98
BPDSL6642R	2132	66	42	2.61	42	6.93
BPDSL6636L	1981	66	36	2.61	35	5.98
BPDSL6642L	2132	66	42	2.61	42	6.93

Left Hang Option

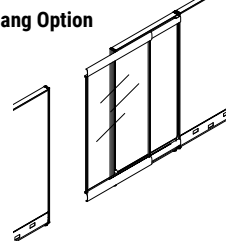

Right Hang Hung

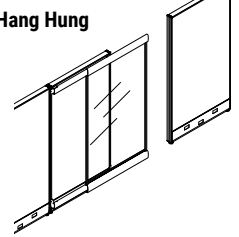

CMPS • Privacy Glass

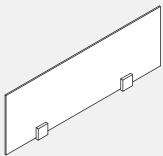

- Privacy Glass with no frame sits on top of a Panel with clamps that are secured to the top of the panel to provide division.
- Tempered glass is 12", 9" or 6" high (nominal).
- Custom sizes available, contact your Customer Service Representative.
- Square clamps included.

PRODUCT CODE	PRICE		SIZE/ INCHES			WEIGHT VOL	
	CLR	FRST	H	W	D	LBS	FT ³
12"							
CMPS24	200	227	12	24	1.3	8	0.44
CMPS30	219	249	12	30	1.3	10	0.59
CMPS36	235	271	12	36	1.3	12	0.73
CMPS42	249	293	12	42	1.3	14	0.88
CMPS48	259	306	12	48	1.3	16	0.96
CMPS54	259	306	12	54	1.3	18	1.13
CMPS60	299	339	12	60	1.3	20	1.28
9"							
CMPS0924	200	227	9	24	1.3	8	0.44
CMPS0930	219	249	9	30	1.3	10	0.59
CMPS0936	235	271	9	36	1.3	12	0.73
CMPS0942	249	293	9	42	1.3	14	0.88
CMPS0948	259	306	9	48	1.3	18	0.98
CMPS0954	259	306	9	54	1.3	18	1.13
CMPS0960	299	339	9	60	1.3	20	1.28
6"							
CMPS0624	200	227	6	24	1.3	8	0.44
CMPS0630	219	249	6	30	1.3	10	0.59
CMPS0636	235	271	6	36	1.3	12	0.73
CMPS0642	249	293	6	42	1.3	14	0.88
CMPS0648	259	306	6	48	1.3	18	0.98
CMPS0654	259	306	6	54	1.3	18	1.13
CMPS0660	299	339	6	60	1.3	20	1.28

CMPSEG • Integrated Privacy Glass Extended Divider

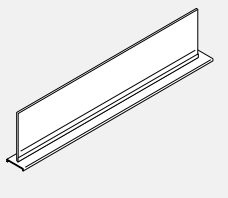

- Privacy Glass integrated with aluminum top trim.
- Attaches on top of panels to add privacy or divide space Includes aluminum trim with channel and glass tile.
- Standard in clear (CLR) or frosted (FRST) glass.
- Glass and attachment hardware to ship seperarately.

PRODUCT CODE	PRICE		SIZE/INCHES			WEIGHT VOL	
	CLR	FRST	H	W	D	LBS	FT ³
CMPSEG0624	182	229	6.4	23.88	2.41	3.54	0.21
CMPSEG0630	200	251	6.4	29.88	2.41	4.49	0.27
CMPSEG0636	212	265	6.4	35.88	2.41	5.44	0.32
CMPSEG0642	229	284	6.4	41.88	2.41	6.39	0.37
CMPSEG0648	238	297	6.4	47.88	2.41	7.34	0.43
CMPSEG0654	245	306	6.4	53.88	2.41	8.29	0.48
CMPSEG0660	251	312	6.4	59.88	2.41	9.23	0.54
CMPSEG0924	182	229	9.4	23.88	2.41	4.99	0.31
CMPSEG0930	200	251	9.4	29.88	2.41	6.32	0.39
CMPSEG0936	212	265	9.4	35.88	2.41	7.66	0.47
CMPSEG0942	229	284	9.4	41.88	2.41	8.99	0.55
CMPSEG0948	238	297	9.4	47.88	2.41	10.33	0.63
CMPSEG0954	245	306	9.4	53.88	2.41	11.66	0.71
CMPSEG0960	251	312	9.4	59.88	2.41	13	0.79
CMPSEG1224	182	229	12.4	23.88	2.41	6.43	0.41
CMPSEG1230	200	251	12.4	29.88	2.41	8.15	0.52
CMPSEG1236	212	265	12.4	35.88	2.41	9.87	0.62
CMPSEG1242	229	284	12.4	41.88	2.41	11.59	0.73
CMPSEG1248	238	297	12.4	47.88	2.41	13.31	0.83
CMPSEG1254	245	306	12.4	53.88	2.41	15.04	0.93
CMPSEG1260	251	312	12.4	59.88	2.41	16.76	1.04

CMPSEG • Integrated Privacy Glass Extended Divider

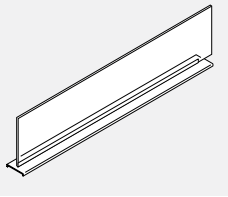

- Privacy Glass integrated with aluminum top trim.
- Glass is longer to extend partially over the post for a corner application.
- Attaches on top of panels to add privacy or divide space Includes aluminum trim with channel and glass tile.
- Standard in clear (CLR) or frosted (FRST) glass.
- Glass and attachment hardware to ship seperarately.

PRODUCT CODE	PRICE		SIZE/INCHES			WEIGHT VOL	
	CLR	FRST	H	W	D	LBS	FT ³
CMPSEG0624	182	229	6.4	23.88	2.41	3.54	0.21
CMPSEG0630	200	251	6.4	29.88	2.41	4.49	0.27
CMPSEG0636	212	265	6.4	35.88	2.41	5.44	0.32
CMPSEG0642	229	284	6.4	41.88	2.41	6.39	0.37
CMPSEG0648	238	297	6.4	47.88	2.41	7.34	0.43
CMPSEG0654	245	306	6.4	53.88	2.41	8.29	0.48
CMPSEG0660	251	312	6.4	59.88	2.41	9.23	0.54
CMPSEG0924	182	229	9.4	23.88	2.41	4.99	0.31
CMPSEG0930	200	251	9.4	29.88	2.41	6.32	0.39
CMPSEG0936	212	265	9.4	35.88	2.41	7.66	0.47
CMPSEG0942	229	284	9.4	41.88	2.41	8.99	0.55
CMPSEG0948	238	297	9.4	47.88	2.41	10.33	0.63
CMPSEG0954	245	306	9.4	53.88	2.41	11.66	0.71
CMPSEG0960	251	312	9.4	59.88	2.41	13	0.79
CMPSEG1224	182	229	12.4	23.88	2.41	6.43	0.41
CMPSEG1230	200	251	12.4	29.88	2.41	8.15	0.52
CMPSEG1236	212	265	12.4	35.88	2.41	9.87	0.62
CMPSEG1242	229	284	12.4	41.88	2.41	11.59	0.73
CMPSEG1248	238	297	12.4	47.88	2.41	13.31	0.83
CMPSEG1254	245	306	12.4	53.88	2.41	15.04	0.93
CMPSEG1260	251	312	12.4	59.88	2.41	16.76	1.04

CMPSF • Integrated Felt Divider

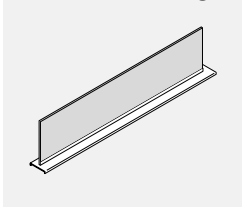

- Privacy felt panel intergrated with aluminum top trim.
- Attaches on top of panels to add privacy or divide space. Includes aluminum trim with channel and felt tile.
- Felt and attachment hardware to ship seperaretyly.
- 9mm Felt material is tackable and comes in 18 different colours. Please specify colour.

PRODUCT CODE	PRICE	SIZE/INCHES			WEIGHT VOL	
		H	W	D	LBS	FT ³
CMPSF0624	66	6.33	22.42	2.41	1.21	0.20
CMPSF0630	78	6.33	28.42	2.41	1.54	0.25
CMPSF0636	92	6.33	34.42	2.41	1.86	0.30
CMPSF0642	103	6.33	40.42	2.41	2.19	0.36
CMPSF0648	156	6.33	46.42	2.41	2.51	0.41
CMPSF0654	169	6.33	52.42	2.41	2.84	0.46
CMPSF0660	180	6.33	58.42	2.41	3.16	0.52
CMPSF0924	66	9.33	22.42	2.41	1.48	0.29
CMPSF0930	78	9.33	28.42	2.41	1.87	0.37
CMPSF0936	92	9.33	34.42	2.41	2.27	0.45
CMPSF0942	103	9.33	40.42	2.41	2.66	0.53
CMPSF0948	156	9.33	46.42	2.41	3.06	0.60
CMPSF0954	169	9.33	52.42	2.41	3.45	0.68
CMPSF0960	180	9.33	58.42	2.41	3.85	0.76
CMPSF1224	66	12.33	22.42	2.41	1.74	0.39
CMPSF1230	78	12.33	28.42	2.41	2.20	0.49
CMPSF1236	92	12.33	34.42	2.41	2.67	0.59
CMPSF1242	103	12.33	40.42	2.41	3.14	0.70
CMPSF1248	156	12.33	46.42	2.41	3.60	0.80
CMPSF1254	169	12.33	52.42	2.41	4.07	0.90
CMPSF1260	180	12.33	58.42	2.41	4.53	1.01

CMPEF • Integrated Felt Extended Divider

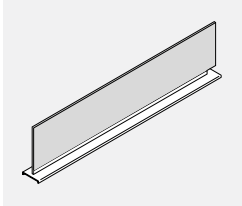

- Privacy felt panel intergrated with aluminum top trim.
- Felt is longer to extend partially over the post for a corner application.
- Attaches on top of panels to add privacy or divide space. Includes aluminum trim with channel and felt tile.
- Felt and attachment hardware to ship seperaretyly.
- 9mm Felt material is tackable and comes in 18 different colours. Please specify colour.

PRODUCT CODE	PRICE	SIZE/INCHES			WEIGHT VOL	
		H	W	D	LBS	FT ³
CMPEF0624	66	6.33	23.88	2.41	1.21	0.21
CMPEF0630	78	6.33	29.88	2.41	1.54	0.36
CMPEF0636	92	6.33	35.88	2.41	1.86	0.32
CMPEF0642	103	6.33	41.88	2.41	2.19	0.37
CMPEF0648	156	6.33	47.88	2.41	2.51	0.42
CMPEF0654	169	6.33	53.88	2.41	2.84	0.48
CMPEF0660	180	6.33	59.88	2.41	3.16	0.53
CMPEF0924	66	9.33	23.88	2.41	1.48	0.31
CMPEF0930	78	9.33	29.88	2.41	1.87	0.39
CMPEF0936	92	9.33	35.88	2.41	2.27	0.47
CMPEF0942	103	9.33	41.88	2.41	2.66	0.55
CMPEF0948	156	9.33	47.88	2.41	3.06	0.62
CMPEF0954	169	9.33	53.88	2.41	3.45	0.7
CMPEF0960	180	9.33	59.88	2.41	3.85	0.78
CMPEF1224	66	12.33	23.88	2.41	1.74	0.41
CMPEF1230	78	12.33	29.88	2.41	2.2	0.51
CMPEF1236	92	12.33	35.88	2.41	2.67	0.62
CMPEF1242	103	12.33	41.88	2.41	3.14	0.72
CMPEF1248	156	12.33	47.88	2.41	3.6	0.82
CMPEF1254	169	12.33	53.88	2.41	4.07	0.93
CMPEF1260	180	12.33	59.88	2.41	4.53	1.03

CMLEP-NC • End of Run Gallery Panel With No End Connection

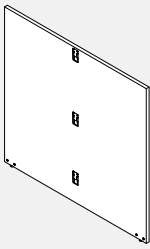

- Provides floor standing support while enclosing the end of a panel run.
- Attached at the end of a straight panel run with connectors to form a T configuration.
- No connections at both ends, connection is at the center interior face.
- Includes all attachment hardware and glides.
- Total height is inclusive of panel glides extended to their full height.
- 51" wide gallery panel accommodates two 24" deep surface while the 63" wide accommodates two 30" deep surfaces.
- Please specify LP laminate finish and PVC edge finish.
- If a wood grain laminate is chosen, grain direction run horizontally.
- Gallery panel is edged in PVC on exposed edges and self edged on bottom.

PRODUCT CODE	PRICE LP	SIZE /INCHES			WEIGHT LBS	VOL FT³
		H	W	D		
CMLEP4227NC	299	42	26.25	1	28.70	0.64
CMLEP4251NC	523	42	50.30	1	57.25	3.67
CMLEP4263NC	607	42	62.30	1	70.75	4.54
CMLEP4827NC	329	48	26.25	1	32.80	0.73
CMLEP4851NC	575	48	50.30	1	65.50	4.19
CMLEP4863NC	667	48	62.30	1	80.95	5.19
CMLEP5427NC	358	54	26.25	1	36.90	0.82
CMLEP5451NC	626	54	50.30	1	73.65	4.72
CMLEP5463NC	727	54	62.30	1	91.05	5.84

CMLMP-NC • Middle of Run Gallery Panel With No End Connection

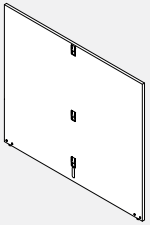

- Provides floor standing support in the middle of a panel run.
- Attached in the middle of a straight panel run with connectors to form an X configuration..
- No connections at both ends, connection is at center on both faces.
- Includes all attachment hardware and glides.
- Total height is inclusive of panel glides extended to their full height.
- 51" wide gallery panel accommodates two 24" deep surface while the 63" wide accommodates two 30" deep surfaces.
- Please specify LP laminate finish and PVC edge finish.
- If a wood grain laminate is chosen, grain direction run horizontally.
- Gallery panel is edged in PVC on exposed edges and self edged on bottom.

PRODUCT CODE	PRICE LP	SIZE /INCHES			WEIGHT LBS	VOL FT³
		H	W	D		
CMLMP4251NC	608	42	50.30	1	57.25	3.67
CMLMP4263NC	692	42	62.30	1	70.75	4.54
CMLMP4851NC	658	48	50.30	1	65.50	4.19
CMLMP4863NC	752	48	62.30	1	80.95	5.19
CMLMP5451NC	711	54	50.30	1	73.65	4.72
CMLMP5463NC	814	54	62.30	1	91.05	5.84

CMLSEPL-NC • Single End Of Run Gallery Panel With No End Connection



- Provides floor standing support while enclosing the end of a panel run.
- Attached at the end of a straight panel run with connectors to form an L configuration.
- No connection at ends, connection is on interior face at one end.
- Includes all attachment hardware and glides.
- Total height is inclusive of panel glides extended to their full height.
- 27" wide gallery panel accommodates a 24" deep surface while the 33" wide accommodates a 30" deep surface.
- Please specify LP laminate finish and PVC edge finish.
- If a wood grain laminate is chosen, grain direction run horizontally.
- Gallery panel is edged in PVC on exposed edges and self edged on bottom.

PRODUCT CODE	PRICE LP	SIZE /INCHES			WEIGHT LBS	VOL FT³
		H	W	D		
CMLSEPL4215NC	225	42	14.25	1	15.72	0.35
CMLSEPR4215NC	225	48	14.25	1	15.72	0.40
CMLSEPL4815NC	244	48	14.25	1	17.95	0.40
CMLSEPR4815NC	244	48	14.25	1	17.95	0.40
CMLSEPL5415NC	263	54	14.25	1	20.18	0.45
CMLSEPR5415NC	263	54	14.25	1	20.18	0.45
CMLSEPL4227NC	397	42	26.30	1	29.99	1.9
CMLSEPR4227NC	397	42	26.30	1	29.99	1.9
CMLSEPL4827NC	434	48	26.30	1	34.28	2.2
CMLSEPR4827NC	434	48	26.30	1	34.28	2.2
CMLSEPL5427NC	473	54	26.30	1	38.56	2.5
CMLSEPR5427NC	473	54	26.30	1	38.56	2.5
CMLSEPL4233NC	410	42	32.33	1	36.77	2.4
CMLSEPR4233NC	410	42	32.33	1	36.77	2.4
CMLSEPL4833NC	448	48	32.33	1	42.03	2.7
CMLSEPR4833NC	448	48	32.33	1	42.03	2.7
CMLSEPL5433NC	485	54	32.33	1	47.3	3.0
CMLSEPR5433NC	485	54	32.33	1	47.3	3.0

CMLSMP-NC • Single Middle of Run Gallery Panel With No End Connection

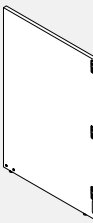

- Provides floor standing support at the middle of a panel run.
- Attached in the middle of a straight panel run with connectors to form a T configuration.
- No connections at the exposed end, connection is at both the interior and exterior face near the opposite end.
- Includes all attachment hardware and glides.
- Total height is inclusive of panel glides extended to their full height.
- 27" wide gallery panel accommodates a 24" deep surface while the 33" wide accommodates a 30" deep surface.
- Please specify LP laminate finish and PVC edge finish.
- If a wood grain laminate is chosen, grain direction run horizontally.
- Gallery panel is edged in PVC on exposed edges and self edged on bottom.

PRODUCT CODE	PRICE LP	SIZE /INCHES			WEIGHT LBS	VOL FT³
		H	W	D		
CMLSMP4227NC	483	42	26.30	1	30.14	1.92
CMLSMP4827NC	520	48	26.30	1	34.42	2.19
CMLSMP5427NC	556	54	26.30	1	38.72	2.47
CMLSMP4233NC	497	42	32.30	1	36.92	2.36
CMLSMP4833NC	536	48	32.30	1	42.18	2.69
CMLSMP5433NC	574	54	32.30	1	47.45	3.03

CMLEP • End Of Run Gallery Panel With End Connections

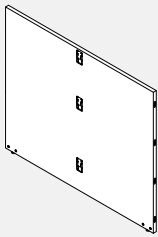

- Provides floor standing support while enclosing the end of a panel run.
- Attached at the end of a straight panel run with connectors to form a T configuration.
- Connections at both ends as well as the center on the interior face.
- Includes all attachment hardware and glides.
- Total height is inclusive of panel glides extended to their full height.
- 51" wide gallery panel accommodates two 24" deep surface while the 63" wide accommodates two 30" deep surfaces.
- Please specify LP laminate finish and PVC edge finish.
- If a wood grain laminate is chosen, grain direction run horizontally.
- Gallery panel is edged in PVC on exposed edges and self edged on edge connecting to panel and bottom edge.

PRODUCT CODE	PRICE LP	SIZE/INCHES			WEIGHT VOL	
		H	W	D	LBS	FT ³
CMLEP4251	543	42	50.30	1	57.25	3.67
CMLEP4263	626	42	62.30	1	70.75	4.54
CMLEP4851	593	48	50.30	1	65.50	4.19
CMLEP4863	688	48	62.30	1	80.95	5.19
CMLEP5451	646	54	50.30	1	73.65	4.72
CMLEP5463	748	54	62.30	1	91.05	5.84

CMLMP • Middle of Run Gallery Panel With End Connections

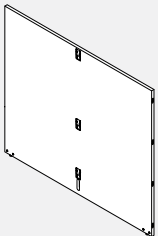

- Provides floor standing support in the middle of a panel run.
- Attached in the middle of a straight panel run with connectors to form an X configuration.
- Connections at both ends as well as the center on the interior and exterior face.
- Includes all attachment hardware and glides.
- Total height is inclusive of panel glides extended to their full height.
- 51" wide gallery panel accommodates two 24" deep surface while the 63" wide accommodates two 30" deep surfaces.
- Please specify LP laminate finish and PVC edge finish.
- If a wood grain laminate is chosen, grain direction run horizontally.
- Gallery panel is edged in PVC on exposed edges and self edged on edge connecting to panel and bottom edge.

PRODUCT CODE	PRICE LP	SIZE/INCHES			WEIGHT VOL	
		H	W	D	LBS	FT ³
CMLMP4251	612	42	50.30	1	57.25	3.67
CMLMP4263	695	42	62.30	1	70.75	4.54
CMLMP4851	665	48	50.30	1	65.50	4.19
CMLMP4863	757	48	62.30	1	80.95	5.19
CMLMP5451	715	54	50.30	1	73.65	4.72
CMLMP5463	818	54	62.30	1	91.05	5.84

CMLSEPL • Single End Panel With End Connections

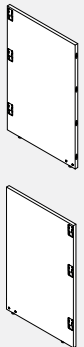

- Provides floor standing support while enclosing the end of a panel run.
- Attached at the end of a straight panel run with connectors to form an L configuration.
- Connections are at the exposed end on one side and near the end on the other interior face.
- Total height is inclusive of panel glides extended to their full height.
- 27" wide gallery panel accommodates a 24" deep surface while the 33" wide accommodates a 30" deep surface.
- Please specify LP laminate finish and PVC edge finish.
- If a wood grain laminate is chosen, grain direction run horizontally.
- Gallery panel is edged in PVC on exposed edges and self edged on edge connecting to panel and bottom edge.

PRODUCT CODE	PRICE LP	SIZE/INCHES			WEIGHT VOL	
		H	W	D	LBS	FT ³
CMLSEPL4227	408	42	26.30	1	29.99	1.9
CMLSEPR4227	408	42	26.30	1	29.99	1.9
CMLSEPL4827	444	48	26.30	1	34.28	2.2
CMLSEPR4827	444	48	26.30	1	34.28	2.2
CMLSEPL5427	482	54	26.30	1	38.56	2.5
CMLSEPR5427	482	54	26.30	1	38.56	2.5
CMLSEPL4233	419	42	32.33	1	36.77	2.4
CMLSEPR4233	419	42	32.33	1	36.77	2.4
CMLSEPL4833	457	48	32.33	1	42.03	2.7
CMLSEPR4833	457	48	32.33	1	42.03	2.7
CMLSEPL5433	496	54	32.33	1	47.3	3.0
CMLSEPR5433	496	54	32.33	1	47.3	3.0

CMLSMP • Single Middle of Run Gallery Panel With End Connections

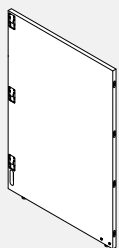

- Provides floor standing support at the middle of a panel run.
- Attached in the middle of a straight panel run with connectors to form a T configuration
- Connections are at the exposed end and at the interior and exterior near the opposite end, allows for left connection of CML2PL only.
- Includes all attachment hardware and glides.
- Total height is inclusive of panel glides extended to their full height.
- 27" wide gallery panel accommodates a 24" deep surface while the 33" wide accommodates a 30" deep surface.
- Please specify LP laminate finish and PVC edge finish.
- If a wood grain laminate is chosen, grain direction run horizontally.
- Gallery panel is edged in PVC on exposed edges and self edged on edge connecting to panel and bottom edge.

PRODUCT CODE	PRICE LP	SIZE/INCHES			WEIGHT VOL	
		H	W	D	LBS	FT ³
CMLSMP4227	494	42	26.30	1.00	30.14	1.92
CMLSMP4827	529	48	26.30	1.00	34.42	2.19
CMLSMP5427	567	54	26.30	1.00	38.72	2.47
CMLSMP4233	508	42	32.30	1.00	36.92	2.36
CMLSMP4833	546	48	32.30	1.00	42.18	2.69
CMLSMP5433	584	54	32.30	1.00	47.45	3.03

CML2PL • Left Two Way Return End of Run Gallery Panel With End Connections

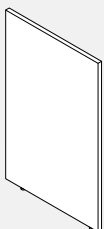

- Provides floor standing support while enclosing the end of a panel run.
- Attached at the end of a gallery panel with connectors to form an L configuration.
- Connections are at one exposed end.
- Includes all attachment hardware and glides.
- Total height is inclusive of panel glides extended to their full height.
- 25" wide gallery panel accommodates a 24" deep surface while the 31" wide accommodates a 30" deep surface.
- Please specify LP laminate finish and PVC edge finish.
- If a wood grain laminate is chosen, grain direction run horizontally.
- Gallery panel is edged in PVC on exposed edges and self edged on edge connecting to panel and bottom edge.

PRODUCT CODE	PRICE LP	SIZE/INCHES			WEIGHT VOL	
		H	W	D	LBS	FT ³
CML2PL4213	153	42	13	1	14.16	0.32
CML2PL4225	323	42	25	1	27.14	1.82
CML2PL4231	331	42	31	1	33.62	2.26
CML2PL4813	172	48	13	1	16.19	0.36
CML2PL4825	359	48	25	1	31.04	2.08
CML2PL4831	370	48	31	1	38.47	2.58
CML2PL5413	192	54	13	1	18.22	0.41
CML2PL5425	396	54	25	1	34.95	2.34
CML2PL5431	408	54	31	1	43.31	2.91

CML2PR • Right Two Way Return End of Run Gallery Panel With End Connections



- Provides floor standing support while enclosing the end of a panel run.
- Attached at the end of a gallery panel with connectors to form an L configuration.
- Connections are at one exposed end.
- Includes all attachment hardware and glides.
- Total height is inclusive of panel glides extended to their full height.
- 25" wide gallery panel accommodates a 24" deep surface while the 31" wide accommodates a 30" deep surface.
- Please specify LP laminate finish and PVC edge finish.
- If a wood grain laminate is chosen, grain direction run horizontally.
- Gallery panel is edged in PVC on exposed edges and self edged on edge connecting to panel and bottom edge.

PRODUCT CODE	PRICE LP	SIZE/INCHES			WEIGHT VOL	
		H	W	D	LBS	FT ³
CML2PR4213	153	42	13	1	14.16	0.32
CML2PR4225	323	42	25	1	27.14	1.82
CML2PR4231	331	42	31	1	33.62	2.26
CML2PR4813	172	48	13	1	16.19	0.36
CML2PR4825	359	48	25	1	31.04	2.08
CML2PR4831	370	48	31	1	38.47	2.58
CML2PR5413	192	54	13	1	18.22	0.41
CML2PR5425	396	54	25	1	34.95	2.34
CML2PR5431	408	54	31	1	43.31	2.91

CML3PL • Left Three Way Return End of Run Gallery Panel

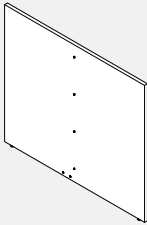

- Provides floor standing support while enclosing the end of a gallery panel run.
- Attached at the end of a gallery panel with connectors to form a T configuration.
- There are no connections at the exposed ends. Connection is at the center of the interior face.
- Connects to CMLXPL or CMLSEPL.
- Includes all attachment hardware and glides.
- Total height is inclusive of panel glides extended to their full height.
- 49" wide gallery panel accommodates two 24" deep surface while the 61" wide accommodates two 30" deep surfaces.
- Please specify LP laminate finish and PVC edge finish.
- If a wood grain laminate is chosen, grain direction run horizontally.
- Gallery panel is edged in PVC on exposed edges and self edged on edge connecting to panel and bottom edge.

PRODUCT CODE	PRICE LP	SIZE/INCHES			WEIGHT VOL	
		H	W	D	LBS	FT ³
CML3PL4225	229	42	25	1.3	27.14	0.79
CML3PL4249	448	42	49	1	53.09	3.57
CML3PL4261	529	42	61	1	66.06	4.45
CML3PL4825	256	48	25	1.3	31.04	0.90
CML3PL4849	499	48	49	1	60.74	4.08
CML3PL4861	591	48	61	1	75.60	5.08
CML3PL5425	286	54	25	1.3	34.95	1.02
CML3PL5449	550	54	49	1	68.40	4.59
CML3PL5461	653	54	61	1	85.13	5.72

CML3PR • Right Three Way Return End of Run Gallery Panel

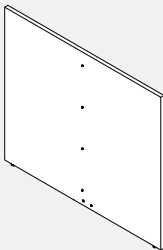

- Provides floor standing support while enclosing the end of a gallery panel run.
- Attached at the end of a gallery panel with connectors to form a T configuration.
- There are no connections at the exposed ends. Connection is at the center of the interior face.
- Connects to CMLXPR or CMLSEPR.
- Includes all attachment hardware and glides.
- Total height is inclusive of panel glides extended to their full height.
- 49" wide gallery panel accommodates two 24" deep surface while the 61" wide accommodates two 30" deep surfaces.
- Please specify LP laminate finish and PVC edge finish.
- If a wood grain laminate is chosen, grain direction run horizontally.
- Gallery panel is edged in PVC on exposed edges and self edged on edge connecting to panel and bottom edge.

PRODUCT CODE	PRICE LP	SIZE/INCHES			WEIGHT VOL	
		H	W	D	LBS	FT ³
CML3PR4225	229	42	25	1.3	27.14	0.79
CML3PR4249	448	42	49	1	53.09	3.57
CML3PR4261	529	42	61	1	66.06	4.45
CML3PR4825	256	48	25	1.3	31.04	0.90
CML3PR4849	499	48	49	1	60.74	4.08
CML3PR4861	591	48	61	1	75.60	5.08
CML3PR5425	286	54	25	1.3	34.95	1.02
CML3PR5449	550	54	49	1	68.40	4.59
CML3PR5461	653	54	61	1	85.13	5.72

CMLXPL • Left Extension End of Run Return Gallery Panel With End Connection

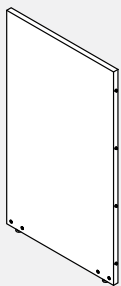

- Provides floor standing support while enclosing the end of a gallery panel run.
- Attached at the end of a panel to allow for extending the gallery panel run.
- Connections at both exposed ends, one to connect to the panel and one to connect to another gallery panel.
- Includes all attachment hardware and glides.
- Total height is inclusive of panel glides extended to their full height.
- Please specify LP laminate finish and PVC edge finish.
- If a wood grain laminate is chosen, grain direction run horizontally.
- Gallery panel is edged in PVC on exposed edges and self edges on edge connecting to panel.

PRODUCT CODE	PRICE LP	SIZE/INCHES			WEIGHT VOL	
		H	W	D	LBS	FT ³
CMLXPL4212	142	42	12.3	1	13.08	0.30
CMLXPL4224	268	42	24	1	26.1	1.75
CMLXPL4230	314	42	30	1	32.59	2.19
CMLXPL4236	361	42	36	1	39.07	2.63
CMLXPL4242	454	42	42	1	45.56	3.06
CMLXPL4248	469	42	48	1	52.05	3.50
CMLXPL4812	159	48	12.3	1	14.95	0.34
CMLXPL4824	276	48	24	1	29.85	2.00
CMLXPL4830	324	48	30	1	37.27	2.50
CMLXPL4836	372	48	36	1	44.7	3.00
CMLXPL4842	469	48	42	1	52.12	3.50
CMLXPL4848	482	48	48	1	59.55	4.00
CMLXPL5412	177	54	12.3	1	16.83	0.38
CMLXPL5424	295	54	24	1	33.55	2.25
CMLXPL5430	346	54	30	1	41.92	2.81
CMLXPL5436	397	54	36	1	50.28	3.38
CMLXPL5442	450	54	42	1	58.64	3.94
CMLXPL5448	552	54	48	1	67.01	4.50

CMLXPR • Right Extension End of Run Return Gallery Panel With End Connection

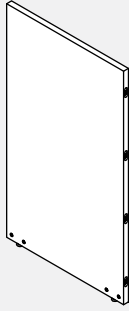

- Provides floor standing support while enclosing the end of a gallery panel run.
- Attached at the end of a panel to allow for extending the gallery panel run.
- Connections are at both exposed ends, one to connect to the panel and one to connect to another gallery panel.
- Includes all attachment hardware and glides.
- Total height is inclusive of panel glides extended to their full height.
- Please specify LP laminate finish and PVC edge finish.
- If a wood grain laminate is chosen, grain direction run horizontally.
- Gallery panel is edged in PVC on exposed edges and self edged on edge connecting to panel.

PRODUCT CODE	PRICE LP	SIZE/INCHES			WEIGHT VOL	
		H	W	D	LBS	FT ³
CMLXPR4212	142	42	12.3	1	13.08	0.30
CMLXPR4224	268	42	24	1	26.1	1.75
CMLXPR4230	314	42	30	1	32.59	2.19
CMLXPR4236	361	42	36	1	39.07	2.63
CMLXPR4242	454	42	42	1	45.56	3.06
CMLXPR4248	469	42	48	1	52.05	3.50
CMLXPR4812	159	48	12.3	1	14.95	0.34
CMLXPR4824	276	48	24	1	29.85	2.00
CMLXPR4830	324	48	30	1	37.27	2.50
CMLXPR4836	372	48	36	1	44.7	3.00
CMLXPR4842	469	48	42	1	52.12	3.50
CMLXPR4848	482	48	48	1	59.55	4.00
CMLXPR5412	177	54	12.3	1	16.83	0.38
CMLXPR5424	295	54	24	1	33.55	2.25
CMLXPR5430	346	54	30	1	41.92	2.81
CMLXPR5436	397	54	36	1	50.28	3.38
CMLXPR5442	450	54	42	1	58.64	3.94
CMLXPR5448	552	54	48	1	67.01	4.50

CMLXPL-NC • Extension End of Run, Left, No Connection

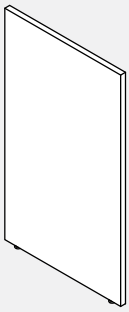

- Provides floor standing support while enclosing the end of a gallery panel run.
- Attached at the end of a gallery panel to extend the gallery panel run.
- Connections only at one exposed end.
- Includes all attachment hardware and glides.
- Total height is inclusive of panel glides extended to their full height.
- Please specify LP laminate finish and PVC edge finish.
- If a wood grain laminate is chosen, grain direction run horizontally.
- Gallery panel is edged in PVC on exposed edges and self edged on edge connecting to panel.

PRODUCT CODE	PRICE LP	SIZE/INCHES			WEIGHT VOL	
		H	W	D	LBS	FT ³
CMLXPL4224NC	265	42	24	1	26.05	1.75
CMLXPL4230NC	312	42	30	1	32.54	2.19
CMLXPL4236NC	359	42	36	1	39.03	2.63
CMLXPL4242NC	452	42	42	1	45.52	3.06
CMLXPL4248NC	465	42	48	1	52.01	3.50
CMLXPL4824NC	274	48	24	1	29.8	2.00
CMLXPL4830NC	323	48	30	1	37.23	2.50
CMLXPL4836NC	370	48	36	1	44.66	3.00
CMLXPL4842NC	465	48	42	1	52.08	3.50
CMLXPL4848NC	480	48	48	1	59.51	4.00
CMLXPL5424NC	293	54	24	1	33.55	2.25
CMLXPL5430NC	344	54	30	1	41.92	2.81
CMLXPL5436NC	396	54	36	1	50.28	3.38
CMLXPL5442NC	448	54	42	1	58.64	3.94
CMLXPL5448NC	550	54	48	1	67.01	4.50

CMLXPR-NC • Extension End of Run, Right, No Connection

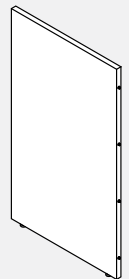

- Provides floor standing support while enclosing the end of a gallery panel run.
- Attached at the end of a gallery panel to extend the gallery panel run.
- Connections only at one exposed end.
- Includes all attachment hardware and glides.
- Total height is inclusive of panel glides extended to their full height.
- Please specify LP laminate finish and PVC edge finish.
- If a wood grain laminate is chosen, grain direction run horizontally.
- Gallery panel is edged in PVC on exposed edges and self edges on edge connecting to panel.

PRODUCT CODE	PRICE LP	SIZE/INCHES			WEIGHT VOL	
		H	W	D	LBS	FT ³
CMLXPR4224NC	265	42	24	1	26.05	1.75
CMLXPR4230NC	312	42	30	1	32.54	2.19
CMLXPR4236NC	359	42	36	1	39.03	2.63
CMLXPR4242NC	452	42	42	1	45.52	3.06
CMLXPR4248NC	465	42	48	1	52.01	3.5
CMLXPR4824NC	274	48	24	1	29.8	2
CMLXPR4830NC	323	48	30	1	37.23	2.5
CMLXPR4836NC	370	48	36	1	44.66	3
CMLXPR4842NC	465	48	42	1	52.08	3.5
CMLXPR4848NC	480	48	48	1	59.51	4
CMLXPR5424NC	293	54	24	1	33.55	2.25
CMLXPR5430NC	344	54	30	1	41.92	2.81
CMLXPR5436NC	396	54	36	1	50.28	3.38
CMLXPR5442NC	448	54	42	1	58.64	3.94
CMLXPR5448NC	550	54	48	1	67.01	4.5

CMHLPBB01 • Gallery Panel Bracket

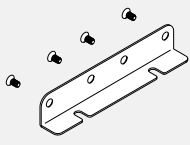

- Gallery panel bottom bracket connects two gallery end panels at bottom with screws.
- Available in standard paint colors.
- Screws are included with the bracket.

PRODUCT CODE	PRICE	SIZE/INCHES			WEIGHT VOL	
		H	W	D	LBS	FT ³
CMHLPBB01	35	1.5	8.00	1	0.5	0.11

CMHLPCB01 • Gallery Panel Corner Bracket

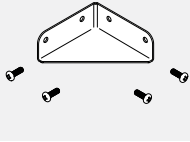

- Gallery panel corner bottom bracket connects two laminate panels at 90 degrees.
- Available in standard paint colors.
- Screws are included with the bracket.

PRODUCT CODE	PRICE	SIZE/INCHES			WEIGHT VOL	
		H	W	D	LBS	FT ³
CMHLPCB01	34	1.5	4.00	4	0.5	0.11

CMPMP-GI-W • Privacy Glass for 1" Laminate Gallery Panels

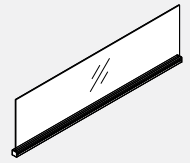

- **Privacy glass integrated with aluminum top trim.**
- Attaches on top of gallery panels to add privacy or divide space.
- Includes aluminum trim with channel, end caps and glass tile.
- Top rail may also be used to hang accessories.
- Glass and attachment hardware ship separately.
- Please specify standard paint finish for the channel.
- Standard in clear (CLR) or frosted (FRST).

PRODUCT CODE	PRICE	FRST	SIZE/INCHES			WEIGHT LBS	VOL FT ³
			H	W	D		
CMPMP24GI6W	201	251	6	24	1	3.58	0.08
CMPMP30GI6W	219	276	6	30	1	4.48	0.10
CMPMP36GI6W	235	291	6	36	1	5.37	0.13
CMPMP42GI6W	251	313	6	42	1	6.26	0.15
CMPMP48GI6W	262	327	6	48	1	7.16	0.17
CMPMP24GI9W	201	251	9	24	1	4.77	0.13
CMPMP30GI9W	219	276	9	30	1	5.97	0.16
CMPMP36GI9W	235	291	9	36	1	7.16	0.19
CMPMP42GI9W	251	313	9	42	1	8.35	0.22
CMPMP48GI9W	262	327	9	48	1	9.55	0.25
CMPMP24GIW	201	251	12	24	1	4.77	0.17
CMPMP30GIW	219	276	12	30	1	5.97	0.21
CMPMP36GIW	235	291	12	36	1	7.16	0.25
CMPMP42GIW	251	313	12	42	1	8.35	0.29
CMPMP48GIW	262	327	12	48	1	9.55	0.33

CMPFD-W • Privacy Felt for 1" Laminate Gallery Panels

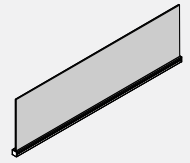

- **Privacy felt integrated with aluminum top trim.**
- Attaches on top of gallery panels to add privacy or divide space.
- Includes aluminum trim with channel, end caps and felt tile.
- Top rail may also be used to hang accessories.
- Felt and attachment hardware ship separately.
- Please specify standard paint finish for the channel.
- Please specify standard felt finish.

PRODUCT CODE	PRICE	SIZE/INCHES			WEIGHT LBS	VOL FT ³
		H	W	D		
CMPFD0624W	72	6	24	1	1.42	0.08
CMPFD0630W	88	6	30	1	1.73	0.10
CMPFD0636W	102	6	36	1	2.03	0.13
CMPFD0642W	114	6	42	1	2.34	0.15
CMPFD0648W	170	6	48	1	2.64	0.17
CMPFD0654W	183	6	54	1	2.95	0.19
CMPFD0660W	199	6	60	1	3.25	0.21
CMPFD0666W	210	6	66	1	3.56	0.23
CMPFD0672W	238	6	72	1	3.86	0.25
CMPFD0924W	72	9	24	1	2.26	0.13
CMPFD0930W	88	9	30	1	2.77	0.16
CMPFD0936W	102	9	36	1	3.29	0.19
CMPFD0942W	114	9	42	1	3.8	0.22
CMPFD0948W	170	9	48	1	4.32	0.25
CMPFD0954W	183	9	54	1	4.83	0.28
CMPFD0960W	199	9	60	1	5.35	0.31
CMPFD0966W	210	9	66	1	6.68	0.34
CMPFD0972W	238	9	72	1	7.2	0.38
CMPFD1224W	72	12	24	1	2.26	0.17
CMPFD1230W	88	12	30	1	2.77	0.21
CMPFD1236W	102	12	36	1	3.29	0.25
CMPFD1242W	114	12	42	1	3.8	0.29
CMPFD1248W	170	12	48	1	4.32	0.33
CMPFD1254W	183	12	54	1	4.83	0.38
CMPFD1260W	199	12	60	1	5.35	0.42
CMPFD1266W	210	12	66	1	6.68	0.46
CMPFD1272W	238	12	72	1	7.2	0.50

CHP • 90 Degree Corner Post Kits



- Standard Compile paint options.
- Specify the corner post height that matches the tallest or smallest panel connection.
- 6" shorter than panel height to accommodate electric in base.
- Made of aluminum.
- 2-Way Kits include 2 trims (CMETP), 2 way post base (CMPC) and post cap (CMPC).
- 3-Way Kits include 1 trim (CMTEP), 3 way post base (CMPC) and post cap (CMPC).
- 4 Way Kits includes post cap (CMPC) only.

PRODUCT CODE	PRICE	SIZE/ H	INCHES			WEIGHT VOL	
			W	D	LBS	FT ³	
2-Way Kits							
CHP30-2	104	30	2.3	2.3	5	0.22	
CHP42-2	104	42	2.3	2.3	5	0.22	
CHP46-2	109	46	2.3	2.3	5	0.22	
CHP48-2	126	48	2.3	2.3	5	0.22	
CHP54-2	126	54	2.3	2.3	5	0.22	
CHP58-2	136	58	2.3	2.3	5	0.22	
CHP60-2	136	60	2.3	2.3	5	0.22	
CHP64-2	158	64	2.3	2.3	5	0.22	
CHP66-2	151	66	2.3	2.3	5	0.22	
CHP70-2	161	70	2.3	2.3	5	0.22	
CHP72-2	158	72	2.3	2.3	5	0.22	
CHP78-2	179	78	2.3	2.3	5	0.22	
CHP82-2	190	82	2.3	2.3	5	0.22	
CHP90-2	190	90	2.3	2.3	5	0.22	
3-Way Kits							
CHP30-3	91	30	2.3	2.3	5	0.22	
CHP42-3	91	42	2.3	2.3	5	0.22	
CHP46-3	100	46	2.3	2.3	5	0.22	
CHP48-3	110	48	2.3	2.3	5	0.22	
CHP54-3	110	54	2.3	2.3	5	0.22	
CHP58-3	124	58	2.3	2.3	5	0.22	
CHP60-3	124	60	2.3	2.3	5	0.22	
CHP64-3	132	64	2.3	2.3	5	0.22	
CHP66-3	136	66	2.3	2.3	5	0.22	
CHP70-3	143	70	2.3	2.3	5	0.22	
CHP72-3	143	72	2.3	2.3	5	0.22	
CHP78-3	161	78	2.3	2.3	5	0.22	
CHP82-3	170	82	2.3	2.3	5	0.22	
CHP90-3	187	90	2.3	2.3	5	0.22	
4-Way Kits							
CHP30-4	68	30	2.3	2.3	5	0.22	
CHP42-4	68	42	2.3	2.3	5	0.22	
CHP46-4	90	46	2.3	2.3	5	0.22	
CHP48-4	89	48	2.3	2.3	5	0.22	
CHP54-4	89	54	2.3	2.3	5	0.22	
CHP58-4	102	58	2.3	2.3	5	0.22	
CHP60-4	102	60	2.3	2.3	5	0.22	
CHP64-4	106	64	2.3	2.3	5	0.22	
CHP66-4	112	66	2.3	2.3	5	0.22	
CHP70-4	116	70	2.3	2.3	5	0.22	
CHP72-4	116	72	2.3	2.3	5	0.22	
CHP78-4	133	78	2.3	2.3	5	0.22	
CHP82-4	139	82	2.3	2.3	5	0.22	
CHP90-4	156	90	2.3	2.3	5	0.22	

CHOP • 90 Degree Corner Post Kits for Over Panels



- Standard Compile paint options.
- Specify the corner post height that matches the height of the over panel
- Made of aluminum.

PRODUCT CODE	PRICE	SIZE/ H	INCHES			WEIGHT VOL	
			W	D	LBS	FT ³	
CHOP12-4	27	12	2.3	2.3	5	0.22	
CHOP16-4	41	16	2.3	2.3	5	0.22	
CHOP24-4	40	24	2.3	2.3	5	0.22	

CHP2W • 60 Degree 2 Way Corner Post



- Standard Compile paint options.
- Specify the corner post height that matches the tallest or smallest panel connection.
- Note: Made of aluminum.
- Outer part is full panel height, inner part is 6" shorter.
- Post cap included.

PRODUCT CODE	PRICE	SIZE/ INCHES			WEIGHT VOL	
		H	W	D	LBS	FT ³
CHP2W30	68	30	2.3	2.3	5	0.22
CHP2W42	68	42	2.3	2.3	5	0.22
CHP2W46	75	46	2.3	2.3	5	0.22
CHP2W48	89	48	2.3	2.3	5	0.22
CHP2W54	89	54	2.3	2.3	5	0.22
CHP2W58	93	58	2.3	2.3	5	0.22
CHP2W60	103	60	2.3	2.3	5	0.22
CHP2W64	112	64	2.3	2.3	5	0.22
CHP2W66	112	66	2.3	2.3	5	0.22
CHP2W70	117	70	2.3	2.3	5	0.22
CHP2W72	117	72	2.3	2.3	5	0.22
CHP2W78	133	78	2.3	2.3	5	0.22
CHP2W82	139	82	2.3	2.3	5	0.22
CHP2W90	153	90	2.3	2.3	5	0.22

CHP3W • 60 Degree 3 Way Corner Post



- Standard Compile paint options.
- Specify the corner post height that matches the tallest or smallest panel connection.
- 6" shorter than panel height to accommodate electric in base.
- Note: Made of aluminum.
- Actual post size is 6" shorter than panel height.
- Post cap included.

PRODUCT CODE	PRICE	SIZE/ INCHES			WEIGHT VOL	
		H	W	D	LBS	FT ³
CHP3W30	68	30	2.3	2.3	5	0.22
CHP3W42	68	42	2.3	2.3	5	0.22
CHP3W46	75	46	2.3	2.3	5	0.22
CHP3W48	89	48	2.3	2.3	5	0.22
CHP3W54	89	54	2.3	2.3	5	0.22
CHP3W58	93	58	2.3	2.3	5	0.22
CHP3W60	103	60	2.3	2.3	5	0.22
CHP3W64	112	64	2.3	2.3	5	0.22
CHP3W66	112	66	2.3	2.3	5	0.22
CHP3W70	117	70	2.3	2.3	5	0.22
CHP3W72	117	72	2.3	2.3	5	0.22
CHP3W78	133	78	2.3	2.3	5	0.22
CHP3W82	139	82	2.3	2.3	5	0.22
CHP3W90	153	90	2.3	2.3	5	0.22

CMPC • 90 Degree Post Cap

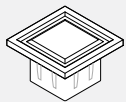

- Included with any post.
- Specified separately for reconfiguration purposes.
- Available in standard Compile paint options.

PRODUCT CODE	PRICE	SIZE/ INCHES			WEIGHT VOL	
		H	W	D	LBS	FT ³
CMPC	8	0.7	2.5	2.5	0.02	0.01

CMPC • 60 Degree Post Cap

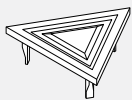

- Included with any post.
- Specified separately for reconfiguration purposes.
- Available in standard Compile paint options.

PRODUCT CODE	PRICE	SIZE/ INCHES			WEIGHT VOL	
		H	W	D	LBS	FT ³
CMPC60	8	0.7	2.5	2.5	0.02	0.01

CMPC • Post Base Cover



- Included with any post kit.
- Specified separately for reconfiguration purposes.
- Available in standard Compile paint options.
- Available for 2-way and 3-way configurations.
- Note: Finish is smooth plastic.

PRODUCT CODE	PRICE	SIZE/INCHES			WEIGHT VOL		
		H	W	D	LBS	FT ³	
CMPC1	12	3-Way	5	2.3	0.33	0.04	0.02
CMPC2	13	2-Way	5	2.3	2.31	0.08	0.04

CEPE • Data Post Extension



- Data Post extension comes with 4 trims, 3 brackets, connecting hardware and ceiling bezel and two post clips.
- Data Post extension available in standard Compile paint options. (Ceiling bezel available in white only.)
- Includes cut out along the post for easy cable insert.

PRODUCT CODE	PRICE	SIZE/INCHES			WEIGHT VOL	
		H	W	D	LBS	FT ³
CEPE64	190	64	2.3	2.3	9	0.42
CEPE82	245	82	2.3	2.3	9	0.42

CMET • End of Run Insert for Panel



- End of Run inserts are not included with panels.
- Cannot be used for a 60° and 90° post application.
- Used at the end of each panel run and cannot be used to attach a panel run to a fixed wall.
- Vertical trims must be specified separately. Trim snaps in the panel at the end of run.
- Available in standard Compile paint options.

PRODUCT CODE	PRICE	SIZE/INCHES			WEIGHT VOL	
		H	W	D	LBS	FT³
CMET16	12	16	2.3	0.5	0.12	0.01
CMET30	14	30	2.3	0.5	0.12	0.05
CMET42	14	42	2.3	0.5	0.74	0.05
CMET46	14	46	2.3	0.5	0.74	0.05
CMET48	14	48	2.3	0.5	0.82	0.18
CMET54	14	54	2.3	0.5	0.90	0.18
CMET58	15	58	2.3	0.5	0.9	0.18
CMET60	15	60	2.3	0.5	1.48	0.31
CMET64	19	64	2.3	0.5	1.48	0.31
CMET66	19	66	2.3	0.5	1.48	0.31
CMET70	20	70	2.3	0.5	1.48	0.31
CMET72	20	72	2.3	0.5	1.48	0.31
CMET78	21	78	2.3	0.5	2.06	0.44
CMET82	22	82	2.3	0.5	2.06	0.44
CMET90	24	90	2.3	0.5	2.06	0.44

CMET • End of Run Trim Insert for Step Down



- Specify for any step down application and to meet the taller post or panel.
- Trim snaps in the post or end of run at a change in height.
- Available in standard Compile paint options.

PRODUCT CODE	PRICE	SIZE/INCHES			WEIGHT VOL	
		H	W	D	LBS	FT³
CEMT06	5	6	2.3	0.5	0.06	0.05
CMET12	9	12	2.3	0.5	0.12	0.05
CMET24	12	24	2.3	0.5	0.12	0.05
CMET36	14	36	2.3	0.5	0.12	0.05

CMETP • Trim Insert for Corner Post



- Trim installs on all sides of an exposed Corner Post.
- Specify to equal post height.
- Vertical trims must be specified separately. Trim snaps in the post.
- Available in standard Compile paint options.

PRODUCT CODE	PRICE	SIZE/INCHES			WEIGHT VOL	
		H	W	D	LBS	FT³
CMETP30	14	30	2.3	0.5	0.12	0.05
CMETP42	14	42	2.3	0.5	0.74	0.05
CMETP46	14	46	2.3	0.5	0.74	0.05
CMETP48	16	48	2.3	0.5	0.82	1.18
CMETP54	16	54	2.3	0.5	0.90	0.18
CMETP58	16	58	2.3	0.5	0.9	0.18
CMETP60	16	60	2.3	0.5	2.06	0.44
CMETP64	19	64	2.3	0.5	1.48	0.31
CMETP66	19	66	2.3	0.5	1.48	0.31
CMETP70	19	70	2.3	0.5	1.48	0.31
CMETP72	19	72	2.3	0.5	2.06	0.44
CMETP78	21	78	2.3	0.5	2.06	0.44
CMETP82	22	82	2.3	0.5	2.06	0.44
CMETP90	24	90	2.3	0.5	2.06	0.44

CHWA • Wall Mount Extrusion



- Starts a run of panels off an existing wall.
- Includes panel connectors.
- Mounting hardware not included. The mounting hardware selected must be based on the wall or wall stud material.
- Wall adapter adds 5/16" to a panel run.

PRODUCT CODE	PRICE	SIZE/INCHES			WEIGHT VOL	
		H	W	D	LBS	FT³
CHWA30	37	30	2.3	0.5	0.12	0.05
CHWA42	37	42	2.3	0.5	0.74	0.05
CHWA54	46	54	2.3	0.5	0.90	0.18
CHWA66	56	66	2.3	0.5	1.48	0.31

CWMA • Wall Vertical Channel



- Used to attach system components to fixed wall.
- Panel frame finish.
- Comes in 60" length only.
- Care should be taken to mount adapters only to wall studs using correct fasteners.
- Does not include mounting hardware. Mounting hardware selection to be based on wall material.
- Sold in pairs.
- Failure to do this may result in collapse of the unit and subsequent possible personal injury.

PRODUCT CODE	PRICE	SIZE/INCHES			WEIGHT VOL	
		H	W	D	LBS	FT³
CWMA60	31	60	0.6	0.7	1.07	0.006

CHHF01 • High Profile Foot

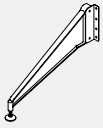

- Provides added support to a panel or worksurface under load.
- Includes Compile attachment bracket and two levelling glides to adapt to different panel clearances.

PRODUCT CODE	PRICE	SIZE/INCHES			WEIGHT VOL	
		H	W	D	LBS	FT ³
CHHF01	249	6	1	21	2.80	0.15

CMPS01 • Post Separator

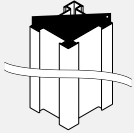

- Creates a diagonal division within a compile post.
- Please specify post height.

PRODUCT CODE	PRICE	SIZE/INCHES			WEIGHT VOL	
		H	W	D	LBS	FT ³
CMPS01	136	96	3.25	14 guage	0.01	0.015

CBEZEL • Post Extension Bezel

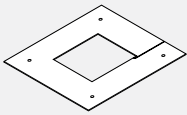

- Finishes the connection between post extension and ceiling.
- Comes in white only.
- Includes screws.

PRODUCT CODE	PRICE	SIZE/INCHES			WEIGHT VOL	
		H	W	D	LBS	FT ³
CBEZEL	12	0.06	6	6	0.01	0.006

CMRC • Raceway Cover Without Punchouts (Each)

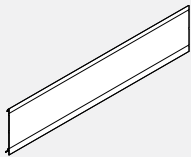

- Durable extruded aluminum.

PRODUCT CODE	PRICE	SIZE/INCHES			WEIGHT VOL	
		H	W	D	LBS	FT ³
CMRC24NP	16	5	24	0.8	1.9	0.06
CMRC30NP	21	5	30	0.8	2.0	0.06
CMRC36NP	23	5	36	0.8	2.2	0.07
CMRC42NP	25	5	42	0.8	2.5	0.08
CMRC48NP	27	5	48	0.8	2.9	0.09
CMRC54NP	34	5	54	0.8	3.2	0.10
CMRC60NP	36	5	60	0.8	3.7	0.11

CMHLPF • Flat Leg for Freestanding Panels

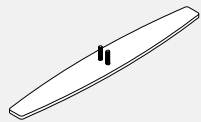

- Single flat leg for end of run/wing applications where the customer is looking for more stability.
- Kit will contains one legs and all attachment hardware.
- For the installation the customer will have to remove the existing levelers on the panel and replace it with the legs.
- Please specify paint finish.

PRODUCT CODE	PRICE	SIZE/ INCHES			WEIGHT VOL	
		H	W	D	LBS	FT ³
CMHLPF01	81	0.31	21	3	3	0.01

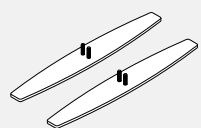

- Double kit for freestanding applications.
- Kit will contains two legs and all attachment hardware.
- For the installation the customer will have to remove the existing levelers on the panel and replace it with the legs.
- Please specify paint finish.

PRODUCT CODE	PRICE	SIZE/ INCHES			WEIGHT VOL	
		H	W	D	LBS	FT ³
CMHLPF02	162	0.31	21	3	6	0.02

CMHLLP01 • Low Profile Foot

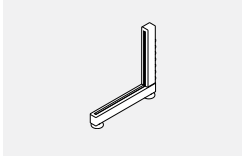

- Provides added support to a panel under load.
- Adjustable glides and connectors included.
- Made of powder coated steel.
- Please choose panel frame finish.

PRODUCT CODE	PRICE	SIZE/INCHES			WEIGHT VOL	
		H	W	D	LBS	FT ³
CMHLLP01	123	12	11	1.1	2.87	0.08

CMHLLP02 • Low Profile Foot, Set of 2

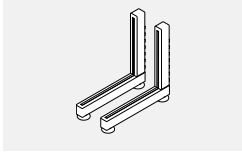

- Provides added support to a panel under load.
- Adjustable glides and connectors included.
- Made of powder coated steel.
- Please choose panel frame finish.
- Set includes 2 complete legs.

PRODUCT CODE	PRICE	SIZE/INCHES			WEIGHT VOL	
		H	W	D	LBS	FT ³
CMHLLP02	245	12	11	1.1	5.74	0.17

CMRCB01 • Electrical Blank Cover

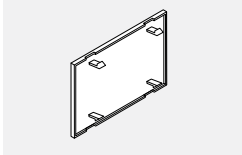

- Fills punchout when opening is not used.
- Available in Black (BLK), Tungsten (TUN), White (WHT) and Nevada (NEV).
- Note: Punchout covers are made of plastic.

PRODUCT CODE	PRICE	SIZE/INCHES			WEIGHT VOL	
		H	W	D	LBS	FT ³
CMRCB01	14	1.5	2.756	0.01	0.04	0.02

CMRC • Raceway Cover With Punchouts (Each)

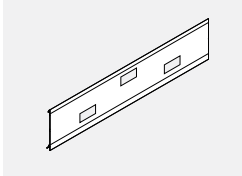

- Cover not included
- Raceway Punchout Cover must be added to openings where duplex receptacles are not used.
- Durable extruded aluminum.
- 24" wide panels have two punchouts, one for electrical and one for data.
- 30" wide panels and wider have three punchouts, two for electrical and one for data.

PRODUCT CODE	PRICE	SIZE/INCHES			WEIGHT VOL	
		H	W	D	LBS	FT ³
CMRC24PO	16	5	24	0.8	1.9	0.06
CMRC30PO	21	5	30	0.8	2.0	0.06
CMRC36PO	23	5	36	0.8	2.2	0.07
CMRC42PO	25	5	42	0.8	2.5	0.08
CMRC48PO	27	5	48	0.8	2.9	0.09
CMRC54PO	34	5	54	0.8	3.2	0.10
CMRC60PO	36	5	60	0.8	3.7	0.11
CMRC66PO	40	5	66	0.8	4.0	0.12
CMRC72PO	44	5	72	0.8	4.4	0.13

CM0100LKCLIP • Lock Clip

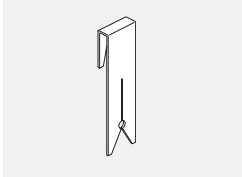

- Use to hold and lock 2 panels or panel post together and prevents disconnection.

PRODUCT CODE	PRICE	SIZE/INCHES			WEIGHT VOL	
		H	W	D	LBS	FT ³
CM0100LKCLIP	8	2.6	0.75	0.32	0.026	0.001

CPN01 • Name Plate

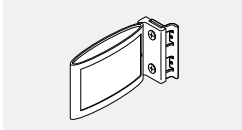

- Name plate can be set either as a single-sided (parallel to panel surface) or double-sided (perpendicular to panel surface - for isle applications, displaying name on both sides).
- Injection molded frame and die-cast base with black rubberized finish. Steel bracket and fasteners included.
- Includes two slide-in name cards.

PRODUCT CODE	PRICE	SIZE/ INCHES			WEIGHT VOL	
		H	W	D	LBS	FT ³
CPNP01	74	3.3	5.3	1.25	0.3	0.013

CE8PD • Power Distribution Housing

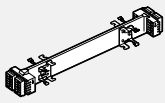

- Power distribution housing is specified per panel size (e.g. CE8PD36 is for use in a 36" panel).
- 8 wire, 4 circuits (A and B circuit dedicated). Provides two duplex receptacles per panel side on all panel widths except the 24" wide panel.
- 24" wide panel allows for only one (1) duplex receptacle on one panel side.
- Each power distribution housing supports 15 amps.
- Must specify Raceway Cover with punchouts on panels, where Power Distribution Housings will be utilized. (Panel Kits P1 and P2)

PRODUCT CODE	PRICE	SIZE/INCHES			WEIGHT VOL	
		H	W	D	LBS	FT ³
CE8PD24	156	2	9.25	2.3	0.83	1.17
CE8PD30	208	2	15.25	2.3	1.28	1.17
CE8PD36	220	2	21.25	2.3	1.62	1.65
CE8PD42	226	2	27.25	2.3	2.00	2.00
CE8PD48	238	2	33.25	2.3	2.32	2.54
CE8PD54	242	2	39.25	2.3	2.66	3.20
CE8PD60	243	2	45.25	2.3	3.04	3.20
CE8PD66	253	2	51.25	2.3	3.42	3.48
CE8PD72	262	2	57.25	2.3	3.80	3.48

CE8CP • 17" Mesh Jumper Cable

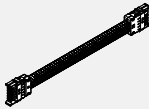

- 17" mesh jumper.
- Jumper cable is used to pass through a post or connect two panels together.

PRODUCT CODE	PRICE	SIZE/INCHES			WEIGHT VOL	
		H	W	D	LBS	FT ³
CE8CP17	149	2	17	0.5	0.71	0.67

CE8CP • Pass Through Cable

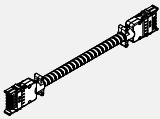

- Flexible metal conduit is used to distribute electrical power through non-powered panels.
- Metal conduit pass through cables should be in used in a straight runs. Metal conduit pass through cables cannot go around a post.
- Flexible conduit is required to turn a post. This only comes as 17"w. If panels at the posts do not all have power distribution housings, they must be added even if duplexes are not specified.
- To calculate the length of a Pass-Through Cable, add the widths of the non-powered panels separating the powered panels (panels with distribution housing attached). To this add 16" (distance from the edge of the panel to the distribution housing x 2).
- Add additional 3" when passing through a corner post.

PRODUCT CODE	PRICE	SIZE/INCHES			WEIGHT VOL	
		H	W	D	LBS	FT ³
CE8CP40	164	2	40.5	0.5	1.44	1.17
CE8CP46	169	2	46.5	0.5	1.71	1.17
CE8CP52	177	2	52.5	0.5	1.95	1.17
CE8CP58	188	2	58.5	0.5	2.21	1.17
CE8CP64	196	2	64.5	0.5	2.37	1.17
CE8CP70	200	2	70.5	0.5	2.60	1.17
CE8CP76	204	2	76.5	0.5	2.81	1.17
CE8CP82	213	2	82.5	0.5	3.03	1.17
CE8CP88	220	2	88.5	0.5	3.05	1.17
CE8CP94	228	2	94.5	0.5	3.30	1.17
CE8CP100	233	2	100.5	0.5	3.47	1.17
CE8CP106	243	2	106.5	0.5	3.87	1.17
CE8CP118	257	2	118.5	0.5	4.08	1.17
CE8CP130	281	2	130.5	0.5	4.73	1.17
CE8CP142	293	2	142.5	0.5	4.99	1.17

CE8CI • "I" Connector

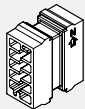

- Female - Female connector connects two Pass-Through Cables .
- Connects 17" Flexible Jumper Cable or ceiling feeds to pass through cables.

PRODUCT CODE	PRICE	SIZE/INCHES			WEIGHT VOL	
		H	W	D	LBS	FT ³
CE8CI1	81	1.5	1.5	4.625	0.06	0.03

CE8RD • Duplex Receptacle

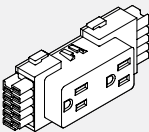

- Up to 6 receptacles per circuit.
- Duplex Receptacles standard in Black (BLK).
- CE8RD1 = Circuit #1 (utility circuit)
- CE8RD2 = Circuit #2 (utility circuit)
- CE8RDA = Circuit A (dedicated)
- CE8RDB = Circuit B (dedicated)
- Note:
- CE8RD1 and CE8RD2 (#1 and #2 share common ground)
- CE8RDA and CE8RDB (A and B share dedicated ground)

PRODUCT CODE	PRICE	SIZE/INCHES			WEIGHT VOL	
		H	W	D	LBS	FT ³
CE8RD1	35	2	4.625	1.25	0.10	0.01
CE8RD2	35	2	4.625	1.25	0.10	0.01
CE8RDA	35	2	4.625	1.25	0.10	0.01
CE8RDB	35	2	4.625	1.25	0.10	0.01

CMEUSB • USB Receptacle

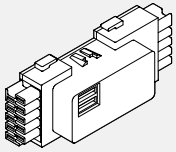

- USB charging module provides convenient charging power access through dual ports on face of the receptacle.
- Two USB ports.
- 2 Amp output via two USB ports.

PRODUCT CODE	PRICE	SIZE/INCHES			WEIGHT VOL	
		H	W	D	LBS	FT ³
CMEUSB01WHT	238	2	4.625	1.25	0.10	0.01
CMEUSB01BLK	238	2	4.625	1.25	0.10	0.01

CE8EC • Ceiling Power Entry

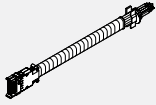

- Snaps into the end of Power Distribution Housing.
- Flexible metal conduit extends into the ceiling through a corner post and post extension (both ordered separately).
- Must be hard wired to source power by a licensed electrician.
- 4" Junction Box included.

PRODUCT CODE	PRICE	SIZE/INCHES			WEIGHT VOL	
		H	L	D	LBS	FT ³
CE8EC1	268	2	132	0.5	5.24	2.00
CE8EC2	479	2	144	0.5	5.96	2.00

CE8FR • Base Feed

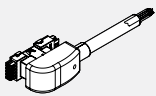

- Takes the place of a duplex receptable by snapping into the base power way.
- CE8FR1 Includes 72" long flexible metal conduit. CE8FR2 Includes 144" long flexible metal conduit.
- Must be hard wired to source power by a licensed electrician.

PRODUCT CODE	PRICE	SIZE/INCHES			WEIGHT VOL	
		H	W	D	LBS	FT ³
CE8FR1	353	6	72	3	3.82	2
CE8FR2	454	6	144	3	5.96	2

GCLEDES • Undercabinet LED Task Light

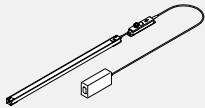

- Linear LED Light.
- Includes light fixture with lens and ON/OFF switch.
 - Magnet mounted with adhesive metal plates.
 - Plug-in power supply with 72" cord length plus 78" DC cord.
- Technical information:
- 4100 K Colour Temperature
 - 90 Colour Rendering Index
 - 30,000 hrs rated Lifespan
 - Total power input per light, 9.0 for 24", 13.5 per 36" and 18.0 for 48"

PRODUCT CODE	PRICE	SIZE/	INCHES		WEIGHT VOL	
		H	W	D	LBS	FT ³
GCLEDES24	164	1	22.9	1	2.5	0.135
GCLEDES36	189	1	33.5	1	2.8	0.161
GCLEDES48	209	1	45.5	1	3.2	0.213

GCLEDES-DCS • Undercabinet Daisychain LED Light

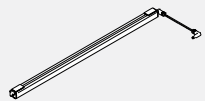

- Undercabinet LED light, 48 inches nominal size , daisychain unit with 1 meter (39 inches) linking cable but no power supply.
- Daisychain units can only be linked up to a total of 48 Watts for all lights on one power supply. This equates to a maximum of 10 feet total nominal length of lights per power supply.

- Technical information:
- 4100 K Colour Temperature
 - 90 Colour Rendering Index
 - 30,000 hrs rated Lifespan
 - Total power input per light, 9.0 for 24", 13.5 per 36" and 18.0 for 48"

PRODUCT CODE	PRICE	SIZE/	INCHES		WEIGHT VOL	
		H	W	D	LBS	FT ³
GCLEDES24DSC	134	1	24	1	2.5	0.135
GCLEDES36DSC	157	1	36	1	2.8	0.161
GCLEDES48DSC	178	1	48	1	3.2	0.213

GCLEDESOS • Occupancy Sensor and Dimmer

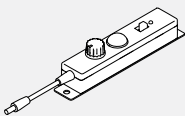

- Inline add-on controller for dimming & occupancy sensor.
- Included, from right to left, a rotary dimmer control, an occupancy sensor and a sensor bypass switch.

PRODUCT CODE	PRICE	SIZE/	INCHES		WEIGHT VOL	
		H	W	D	LBS	FT ³
GCLEDESOS	66	6	2.5	2	0.4	0.500

CWS • Rectangular Worksurface

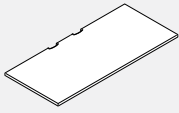

- All tops are thermally fused 1" thick with pilot holes to enable proper alignment with worksurface supports. Wood screws must be used.
- Compile worksurfaces feature a 3mm edge.
- Support hardware must be ordered separately.
- All surfaces longer than 54" have 2 scoops, all others have one.
- Please choose from DWT - Designer White, SIL- Silver or BLK - Black for scoop covers.
- Note: Width and depth dimensions listed include a nominal measurement (3/8") to account for wire management between the worksurface and adjoining panel.

PRODUCT CODE	PRICE LP	SIZE/INCHES			WEIGHT LBS	VOL FT ³
		H	W	D		
CWS2424P	133	1	24	24	16	0.52
CWS2430P	145	1	30	24	20	0.62
CWS2436P	161	1	36	24	23	0.78
CWS2442P	211	1	42	24	28	0.90
CWS2448P	252	1	48	24	31	1.03
CWS2454P	299	1	54	24	35	1.20
CWS2460P	336	1	60	24	39	1.30
CWS2466P	350	1	66	24	43	1.41
CWS2472P	366	1	72	24	47	1.54
CWS2478P	392	1	78	24	51	1.70
CWS2484P	422	1	84	24	55	1.80
CWS2490P	486	1	90	24	58	1.96
CWS2496P	517	1	96	24	63	2.10
CWS3024P	159	1	24	30	20	0.70
CWS3030P	170	1	30	30	25	0.97
CWS3036P	200	1	36	30	30	1.06
CWS3042P	283	1	42	30	34	1.12
CWS3048P	299	1	48	30	39	1.30
CWS3054P	327	1	54	30	44	1.44
CWS3060P	350	1	60	30	49	1.60
CWS3066P	364	1	66	30	54	1.80
CWS3072P	385	1	72	30	59	2.00
CWS3078P	410	1	78	30	64	2.10
CWS3084P	456	1	84	30	69	2.24

CWSNSCP • Rectangular Worksurface, No Scoops

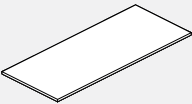

- All tops are thermally fused 1" thick with pilot holes to enable proper alignment with worksurface supports. Wood screws must be used.
- Compile worksurfaces feature a 3mm edge.
- Support hardware must be ordered separately. See the listings in this section.
- All surfaces have no scoops.

PRODUCT CODE	PRICE LP	SIZE/INCHES			WEIGHT LBS	VOL FT ³
		H	W	D		
CWS2424NSCP	133	1	24	24	16	0.52
CWS2430NSCP	145	1	30	24	20	0.62
CWS2436NSCP	161	1	36	24	23	0.78
CWS2442NSCP	211	1	42	24	28	0.90
CWS2448NSCP	252	1	48	24	31	1.03
CWS2454NSCP	299	1	54	24	35	1.20
CWS2460NSCP	336	1	60	24	39	1.30
CWS2466NSCP	350	1	66	24	43	1.41
CWS2472NSCP	366	1	72	24	47	1.54
CWS2478NSCP	392	1	78	24	51	1.70
CWS2484NSCP	422	1	84	24	55	1.80
CWS2490NSCP	486	1	90	24	58	1.96
CWS2496NSCP	517	1	96	24	63	2.10
CWS3024NSCP	159	1	24	30	20	0.70
CWS3030NSCP	170	1	30	30	25	0.97
CWS3036NSCP	200	1	36	30	30	1.06
CWS3042NSCP	283	1	42	30	34	1.12
CWS3048NSCP	299	1	48	30	39	1.30
CWS3054NSCP	327	1	54	30	44	1.44
CWS3060NSCP	350	1	60	30	49	1.60
CWS3066NSCP	364	1	66	30	54	1.80
CWS3072NSCP	385	1	72	30	59	2.00
CWS3078NSCP	410	1	78	30	64	2.10
CWS3084NSCP	456	1	84	30	69	2.24

CWSP • Worksurface to Span a Post

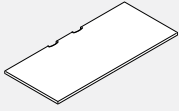

- All tops are thermally fused 1" thick with pilot holes to enable proper alignment with worksurface supports. Wood screws must be used.
- Compile worksurfaces feature a 3mm edge.
- Support hardware must be ordered separately.
- All surfaces longer than 54" have 2 scoops, all others have one.
- Please choose from DWT - Designer White, SIL- Silver or BLK - Black for scoop covers.
- Note: Width and depth dimensions listed include a nominal measurement (3/8") to account for wire management between the worksurface and adjoining panel.

PRODUCT CODE	PRICE LP	SIZE/INCHES			WEIGHT LBS	VOL FT ³
		H	W	D		
CWSP2426P	145	1	26	24	17	0.60
CWSP2432P	161	1	32	24	21	0.70
CWSP2438P	211	1	38	24	25	0.83
CWSP2444P	252	1	44	24	29	1.00
CWSP2450P	299	1	50	24	33	1.10
CWSP2456P	336	1	56	24	37	1.22
CWSP2462P	350	1	62	24	41	1.34
CWSP2468P	366	1	68	24	45	1.47
CWSP2474P	391	1	74	24	49	1.60
CWSP2480P	422	1	80	24	53	1.73
CWSP2486P	456	1	86	24	57	1.90
CWSP3026P	170	1	26	30	22	0.72
CWSP3032P	200	1	32	30	27	0.88
CWSP3038P	283	1	38	30	32	1.04
CWSP3044P	299	1	44	30	37	1.20
CWSP3050P	327	1	50	30	41	1.40
CWSP3056P	350	1	56	30	46	1.51
CWSP3062P	364	1	62	30	51	1.67
CWSP3068P	385	1	68	30	56	1.83
CWSP3074P	410	1	74	30	61	2.00
CWSP3080P	456	1	80	30	66	2.20
CWSP3086P	503	1	86	30	70	2.30

CWVL • Left Curvilinear Worksurface

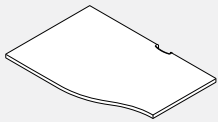

- All tops are thermally fused 1" thick with pilot holes to enable proper alignment with worksurface supports. Wood screws must be used.
- Compile worksurfaces feature a 3mm edge.
- When deepest end equals 24", the opposite depth is 18". When deepest end equals 30", the opposite depth is 24".
- Support hardware must be ordered separately.
- All surfaces longer than 54" have 2 scoops, all others have one.
- Please choose from DWT - Designer White, SIL- Silver or BLK - Black for scoop covers.
- Note: Width and depth dimensions listed include a nominal measurement (3/8") to account for wire management between the worksurface and adjoining panel.

PRODUCT CODE	PRICE LP	SIZE/INCHES			WEIGHT LBS	VOL FT ³
		H	W	D		
CWVL2424P	172	1	24	24	15	0.59
CWVL2430P	182	1	30	24	18	0.65
CWVL2436P	217	1	36	24	22	0.78
CWVL2442P	252	1	42	24	26	0.90
CWVL2448P	289	1	48	24	30	1.03
CWVL2454P	327	1	54	24	34	1.20
CWVL2460P	354	1	60	24	38	1.30
CWVL2466P	392	1	66	24	43	1.49
CWVL2472P	420	1	72	24	47	1.62
CWVL2478P	516	1	78	24	57	2.16
CWVL2484P	749	1	84	24	61	2.33
CWVL3024P	174	1	24	30	19	0.74
CWVL3030P	192	1	30	30	23	0.81
CWVL3036P	229	1	36	30	28	1.00
CWVL3042P	312	1	42	30	33	1.13
CWVL3048P	327	1	48	30	38	1.30
CWVL3054P	364	1	54	30	42	1.44
CWVL3060P	391	1	60	30	47	1.60
CWVL3066P	420	1	66	30	52	1.81
CWVL3072P	451	1	72	30	59	2.01
CWVL3078P	653	1	78	30	72	2.71
CWVL3084P	833	1	84	30	77	2.91

CWVR • Right Curvilinear Worksurface

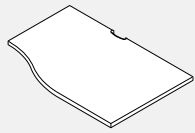

- All tops are thermally fused 1" thick with pilot holes to enable proper alignment with worksurface supports. Wood screws must be used.
- Compile worksurfaces feature a 3mm edge.
- When deepest end equals 24", the opposite depth is 18". When deepest end equals 30", the opposite depth is 24".
- Support hardware must be ordered separately.
- All surfaces longer than 54" have 2 scoops, all others have one.
- Please choose from DWT - Designer White, SIL- Silver or BLK - Black for scoop covers.
- Note: Width and depth dimensions listed include a nominal measurement (3/8") to account for wire management between the worksurface and adjoining panel.

PRODUCT CODE	PRICE LP	SIZE/INCHES			WEIGHT VOL	
		H	W	D	LBS	FT ³
CWVR2424P	172	1	24	24	15	0.59
CWVR2430P	182	1	30	24	18	0.65
CWVR2436P	217	1	36	24	22	0.78
CWVR2442P	252	1	42	24	26	0.90
CWVR2448P	289	1	48	24	30	1.03
CWVR2454P	327	1	54	24	34	1.20
CWVR2460P	354	1	60	24	38	1.30
CWVR2466P	392	1	66	24	43	1.49
CWVR2472P	420	1	72	24	47	1.62
CWVR2478P	516	1	78	24	57	2.16
CWVR2484P	749	1	84	24	61	2.33
CWVR3024P	174	1	24	30	19	0.74
CWVR3030P	192	1	30	30	23	0.81
CWVR3036P	229	1	36	30	28	1.00
CWVR3042P	312	1	42	30	33	1.13
CWVR3048P	327	1	48	30	38	1.30
CWVR3054P	364	1	54	30	42	1.44
CWVR3060P	391	1	60	30	47	1.60
CWVR3066P	420	1	66	30	52	1.81
CWVR3072P	451	1	72	30	59	2.01
CWVR3078P	653	1	78	30	72	2.71
CWVR3084P	833	1	84	30	77	2.91

CWBT • Transition Worksurface

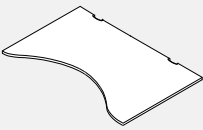

Right Shown

- Support hardware must be ordered separately.
- Please choose from DWT - Designer White, SIL- Silver or BLK - Black for scoop covers.
- Opposing side of the 30" deep surface has a depth of 24"
- Must be specified as right or left handed.

PRODUCT CODE	PRICE LP	SIZE/INCHES			WEIGHT VOL	
		H	W	D	LBS	FT ³
CWBTL302460P	614	1	60	30	55	2.08
CWBTL302466P	678	1	66	30	61	2.29
CWBTL302472P	701	1	72	30	66	2.50
CWBTR302460P	614	1	60	30	55	2.08
CWBTR302466P	678	1	66	30	61	2.29
CWBTR302472P	701	1	72	30	66	2.50

CWCC • Corner Curved Worksurface



- All tops are thermally fused 1" thick with pilot holes to enable proper alignment with worksurface supports. Wood screws must be used.
- Compile worksurfaces feature a 3mm edge.
- Support hardware must be ordered separately.
- Please choose from DWT - Designer White, SIL- Silver or BLK - Black for scoop covers.
- Note: Width and depth dimensions listed include a nominal measurement (3/8") to account for wire management between the worksurface and adjoining panel.
- "WG" indicates diagonal woodgrain.
- "WG" worksurface over 42" cannot be done on the diagonal.

PRODUCT CODE	PRICE LP	SIZE/INCHES			WEIGHT VOL	
		H	W	D	LBS	FT ³
CWCC3618P	397	1	36	36	29	1.20
CWCC3624P	439	1	36	36	32	1.20
CWCC3618WGP	575	1	36	36	29	1.20
CWCC3624WGP	740	1	36	36	32	1.20
CWCC4224P	591	1	42	42	41	1.60
CWCC4230P	607	1	42	42	45	1.60
CWCC4224WGP	846	1	42	42	41	1.60
CWCC4230WGP	963	1	42	42	45	1.60
CWCC4824P	688	1	48	48	50	2.00
CWCC4830P	688	1	48	48	56	2.00

CWCF • Five Sided Worksurface

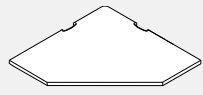

- All tops are thermally fused 1" thick with pilot holes to enable proper alignment with worksurface supports. Wood screws must be used.
- Compile worksurfaces feature a 3mm edge.
- Support hardware must be ordered separately.
- Please choose from DWT - Designer White, SIL- Silver or BLK - Black for scoop covers.
- Note: Width and depth dimensions listed include a nominal measurement (3/8") to account for wire management between the worksurface and adjoining panel.
- "WG" indicates diagonal woodgrain.
- "WG" worksurface over 42" cannot be done on the diagonal.

PRODUCT CODE	PRICE LP	SIZE/INCHES			WEIGHT VOL	
		H	W	D	LBS	FT ³
CWCF3618P	341	1	36	36	29	1.20
CWCF3624P	354	1	36	36	32	1.20
CWCF3618WGP	563	1	36	36	29	1.20
CWCF3624WGP	621	1	36	36	32	1.20
CWCF4224P	503	1	42	42	41	1.60
CWCF4230P	517	1	42	42	45	1.60
CWCF4224WGP	835	1	42	42	41	1.60
CWCF4230WGP	911	1	42	42	45	1.60
CWCF4824P	567	1	48	48	50	2.00
CWCF4830P	596	1	48	48	56	2.00

CWC6 • Corner Curved Worksurface for 60° post

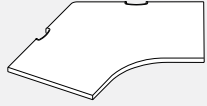

- When specifying wood grain laminate for worksurfaces 42" wide or less, grain will be run diagonally.
- Please add "WG" to the end of the product code and add 50% upcharge to the list price.
- Support hardware must be ordered separately.
- Please choose from DWT - Designer White, SIL- Silver or BLK - Black for scoop covers.

PRODUCT CODE	PRICE LP	SIZE/INCHES			WEIGHT VOL	
		H	W	D	LBS	FT ³
CWC62424P	399	1	24	24	21.25	0.47
CWC62430P	709	1	30	24	28.59	0.64
CWC62436P	800	1	36	24	35.94	0.80
CWC62442P	1223	1	42	24	43.28	0.96
CWC62448P	1330	1	48	24	50.63	1.13
CWC63024P	399	1	24	30	23.72	0.53
CWC63030P	709	1	30	30	32.94	0.73
CWC63036P	800	1	36	30	42.16	0.94
CWC63042P	1223	1	42	30	51.38	1.14
CWC63048P	1330	1	48	30	60.60	1.35

CWCEL • Extended Curved Corner Left

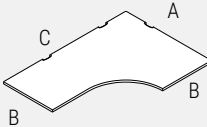

- For 48" wide ("C" dimension) worksurfaces, there are two cable scoops, all others have three.
- All tops are thermally fused 1" thick with pilot holes to enable proper alignment with worksurface supports. Wood screws must be used.
- Compile worksurfaces feature a 3mm edge.
- Support hardware must be ordered separately.
- Please choose from DWT - Designer White, SIL- Silver or BLK - Black for scoop covers.
- Note: Width and depth dimensions listed include a nominal measurement (3/8") to account for wire management between the worksurface and adjoining panel.

NOTE: CWCEL

A	B	C
DEPTH	DEPTH	WIDTH

PRODUCT CODE	PRICE LP	SIZE/INCHES			WEIGHT VOL	
		H	W"C"	D"A"	LBS	FT ³
CWCEL362448P	600	1	48	36	43.92	1.25
CWCEL362460P	655	1	60	36	52.79	1.50
CWCEL362466P	721	1	66	36	57.18	1.62
CWCEL362472P	796	1	72	36	61.58	1.75
CWCEL362478P	850	1	78	36	65.98	1.87
CWCEL362484P	917	1	84	36	70.38	2.00
CWCEL422460P	688	1	60	42	57.18	1.63
CWCEL422466P	758	1	66	42	61.58	1.57
CWCEL422472P	835	1	72	42	65.98	1.87
CWCEL422478P	893	1	78	42	70.38	2.00
CWCEL422484P	962	1	84	42	74.78	2.00
CWCEL423060P	775	1	60	42	63.78	1.82
CWCEL423066P	850	1	66	42	69.28	1.96
CWCEL423072P	929	1	72	42	74.78	2.12
CWCEL423078P	996	1	78	42	80.28	2.28
CWCEL423084P	1062	1	84	42	85.78	2.43
CWCEL482460P	786	1	60	48	65.18	1.90
CWCEL482466P	874	1	66	48	71.39	1.92
CWCEL482472P	956	1	72	48	76.18	1.95
CWCEL482478P	1021	1	78	48	74.78	2.20
CWCEL482484P	1083	1	84	48	96.78	3.66
CWCEL483060P	874	1	60	48	68.18	1.93
CWCEL483066P	956	1	66	48	73.68	2.09
CWCEL483072P	1021	1	72	48	79.18	2.25
CWCEL483078P	1083	1	78	48	84.68	2.40
CWCEL483084P	1158	1	84	48	90.18	2.56

CWCER • Extended Curved Corner Right

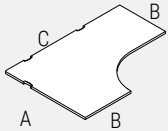

- For 48" wide ("C" dimension) worksurfaces, there are two cable scoops, all others have three.
- All tops are thermally fused 1" thick with pilot holes to enable proper alignment with worksurface supports. Wood screws must be used.
- Compile worksurfaces feature a 3mm edge.
- Support hardware must be ordered separately.
- Please choose from DWT - Designer White, SIL- Silver or BLK - Black for scoop covers.
- Note: Width and depth dimensions listed include a nominal measurement (3/8") to account for wire management between the worksurface and adjoining panel.

NOTE: CWCER

A	B	C
DEPTH	DEPTH	WIDTH

PRODUCT CODE	PRICE LP	SIZE/INCHES			WEIGHT LBS	VOL FT ³
		H	W"C"	D"A"		
CWCER362448P	600	1	48	36	43.92	1.25
CWCER362460P	655	1	60	36	52.79	1.50
CWCER362466P	721	1	66	36	57.18	1.62
CWCER362472P	796	1	72	36	61.58	1.75
CWCER362478P	850	1	78	36	65.98	1.87
CWCER362484P	917	1	84	36	70.38	2.00
CWCER422460P	688	1	60	42	57.18	1.63
CWCER422466P	758	1	66	42	61.58	1.57
CWCER422472P	835	1	72	42	65.98	1.87
CWCER422478P	893	1	78	42	70.38	2.00
CWCER422484P	962	1	84	42	74.78	2.00
CWCER423060P	775	1	60	42	63.78	1.82
CWCER423066P	850	1	66	42	69.28	1.96
CWCER423072P	929	1	72	42	74.78	2.12
CWCER423078P	996	1	78	42	80.28	2.28
CWCER423084P	1062	1	84	42	85.78	2.43
CWCER482460P	786	1	60	48	65.18	1.90
CWCER482466P	874	1	66	48	71.39	1.92
CWCER482472P	956	1	72	48	76.18	1.95
CWCER482478P	1021	1	78	48	74.78	2.20
CWCER482484P	1083	1	84	48	96.78	3.66
CWCER483060P	874	1	60	48	68.18	1.93
CWCER483066P	956	1	66	48	73.68	2.09
CWCER483072P	1021	1	72	48	79.18	2.25
CWCER483078P	1083	1	78	48	84.68	2.40
CWCER483084P	1158	1	84	48	90.18	2.56

CWD • "D" Worksurface

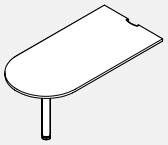

- Includes Monoleg available in standard compile finishes.
- All tops are thermally fused 1" thick with pilot holes to enable proper alignment with worksurface supports. Wood screws must be used.
- Compile worksurfaces feature a 3mm edge.
- Support hardware must be ordered separately. See the listings in this section.
- Please choose from DWT - Designer White, SIL- Silver or BLK - Black for scoop covers.
- Note: Width and depth dimensions listed include a nominal measurement (3/8") to account for wire management between the worksurface and adjoining panel.

PRODUCT CODE	PRICE LP	SIZE/INCHES			WEIGHT LBS	VOL FT ³
		H	W	D		
CWD2442P	569	1	42	24	28.00	0.98
CWD2448P	593	1	48	24	32.00	1.11
CWD2460P	623	1	60	24	40.00	1.36
CWD2472P	661	1	72	24	48.00	1.61
CWD3042P	573	1	42	30	35.00	1.10
CWD3048P	596	1	48	30	39.00	1.37
CWD3060P	665	1	60	30	49.00	1.69
CWD3072P	731	1	72	30	59.00	2.01

CWSW • Straight Wedge Worksurface

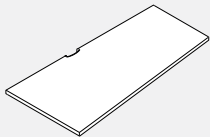

- All tops are thermally fused 1" thick with pilot holes to enable proper alignment with worksurface supports. Wood screws must be used.
- Compile worksurfaces feature a 3mm edge.
- Support hardware must be ordered separately.
- All surfaces longer than 48" have 2 scoops, all others have one.
- Please choose from DWT - Designer White, SIL- Silver or BLK - Black for scoop covers.
- Note: Width and depth dimensions listed include a nominal measurement (3/8") to account for wire management between the worksurface and adjoining panel.

PRODUCT CODE	PRICE LP	SIZE/INCHES			WEIGHT LBS	VOL FT ³
		H	W	D		
CWSW241848P	286	1	48	24	30.00	0.58
CWSW241854P	320	1	54	24	34.00	0.65
CWSW241860P	354	1	60	24	38.00	0.73
CWSW241866P	392	1	66	24	42.00	0.80
CWSW241872P	430	1	72	24	46.00	0.88
CWSW302448P	354	1	48	30	38.00	0.75
CWSW302454P	404	1	54	30	42.00	0.84
CWSW302460P	448	1	60	30	47.00	0.94
CWSW302466P	490	1	66	30	51.00	1.03
CWSW302472P	537	1	72	30	56.00	1.13
CWSW182448P	286	1	48	24	30.00	0.58
CWSW182454P	320	1	54	24	34.00	0.65
CWSW182460P	354	1	60	24	38.00	0.73
CWSW182466P	392	1	66	24	42.00	0.80
CWSW182472P	430	1	72	24	46.00	0.88
CWSW243048P	354	1	48	30	38.00	0.75
CWSW243054P	404	1	54	30	42.00	0.84
CWSW243060P	448	1	60	30	47.00	0.94
CWSW243066P	490	1	66	30	51.00	1.03
CWSW243072P	537	1	72	30	56.00	1.13

CWSW-NSCP • Straight Wedge Worksurface

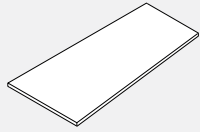

- All tops are thermally fused 1" thick with pilot holes to enable proper alignment with worksurface supports. Wood screws must be used.
- Compile worksurfaces feature a 3mm edge.
- Support hardware must be ordered separately. See the listings in this section.
- All worksurfaces have no scoops.

PRODUCT CODE	PRICE LP	SIZE/INCHES			WEIGHT VOL	
		H	W	D	LBS	FT ³
CWSW241848NSCP	286	1	48	24	30.00	0.58
CWSW241854NSCP	320	1	54	24	34.00	0.65
CWSW241860NSCP	354	1	60	24	38.00	0.73
CWSW241866NSCP	392	1	66	24	42.00	0.80
CWSW241872NSCP	430	1	72	24	46.00	0.88
CWSW302448NSCP	354	1	48	30	38.00	0.75
CWSW302454NSCP	404	1	54	30	42.00	0.84
CWSW302460NSCP	448	1	60	30	47.00	0.94
CWSW302466NSCP	490	1	66	30	51.00	1.03
CWSW302472NSCP	537	1	72	30	56.00	1.13
CWSW182448NSCP	286	1	48	24	30.00	0.58
CWSW182454NSCP	320	1	54	24	34.00	0.65
CWSW182460NSCP	354	1	60	24	38.00	0.73
CWSW182466NSCP	392	1	66	24	42.00	0.80
CWSW182472NSCP	430	1	72	24	46.00	0.88
CWSW243048NSCP	354	1	48	30	38.00	0.75
CWSW243054NSCP	404	1	54	30	42.00	0.84
CWSW243060NSCP	448	1	60	30	47.00	0.94
CWSW243066NSCP	490	1	66	30	51.00	1.03
CWSW243072NSCP	537	1	72	30	56.00	1.13

CWHL/R • Hatchet Worksurface

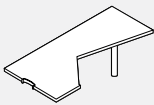

Right Shown

- Wood grain laminate not available on the diagonal.
- Must be specified either left or right.
- Includes Monoleg, available in standard compile finishes.
- Please choose from DWT - Designer White, SIL - Silver or BLK - Black for scoop covers.

PRODUCT CODE	PRICE LP		SIZE/INCHES			WEIGHT VOL	
			H	W	D	LBS	FT ³
CWHL3672P	1079	Left	1	72	36	73.00	2.70
CWHR3672P	1079	Right	1	72	36	73.00	2.70

CWQRL/R • Quarter Round Worksurface



Left Shown

- The worksurface edge running along the panel face is a slightly different length than that of the worksurface end, causing the surface to be handed.
- The user edge abutting the adjacent worksurface runs straight for 2" before starting to curve.

PRODUCT CODE	PRICE LP		SIZE/INCHES			WEIGHT VOL	
			H	W	D	LBS	FT ³
CWQRL2424	200	Left	1	24	24	16	0.52
CWQRL3030	259		1	30	30	25	0.81
CWQRR2424	200	Right	1	24	24	16	0.52
CWQRR3030	259		1	30	30	25	0.81

CWQRC • Quarter Round Corner Worksurface

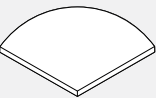

- Wraps around a 90° corner post.
- Putting the adjacent worksurface runs straight for 3" before starting to curve.
- Note: Width and depth dimensions listed include a nominal measurement (3/8") to account for wire management between the worksurface and adjoining panel.

PRODUCT CODE	PRICE LP	SIZE/INCHES			WEIGHT VOL	
		H	W	D	LBS	FT ³
CWQRC2424	235	1	24	24	17.00	0.58
CWQRC3030	289	1	30	30	25.50	0.86

CWT • Straight Transaction Worksurface

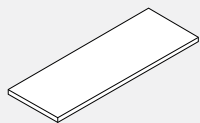

- Support hardware must be ordered separately.
- All tops are thermally fused 1" thick with pilot holes to enable proper alignment with worksurface supports. Wood screws must be used.
- Compile worksurfaces feature a 3mm edge.

PRODUCT CODE	PRICE LP	SIZE/INCHES			WEIGHT VOL	
		H	W	D	LBS	FT ³
CWT1512	57	1	12	15	5	0.22
CWT1518	69	1	18	15	7	0.30
CWT1524	90	1	24	15	10	0.38
CWT1530	106	1	30	15	12	0.46
CWT1536	123	1	36	15	14	0.54
CWT1542	139	1	42	15	17	0.62
CWT1548	157	1	48	15	19	0.70
CWT1554	170	1	54	15	22	0.78
CWT1560	190	1	60	15	24	0.86
CWT1566	204	1	66	15	28	0.94
CWT1572	221	1	72	15	29	1.02
CWT1578	238	1	78	15	31	1.10
CWT1584	253	1	84	15	34	1.18

CWTCL90 • “L” Corner Transaction Surface

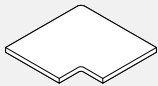

- Used where two panels meet at a 90° angle.
- Support hardware must be ordered separately.

PRODUCT CODE	PRICE	SIZE/INCHES			WEIGHT VOL	
		H	W	D	LBS	FT³
CWTCL90	159	1	20.7	15	12.00	0.75

CW9T • Corner Transaction Surface for 90° Post

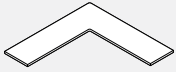

- Used where two panels meet at a 90° angle.
- Support hardware must be ordered separately.

Note: CW9T15 xx Panel Width

PRODUCT CODE	PRICE	SIZE/INCHES			WEIGHT VOL	
		H	W	D	LBS	FT³
CW9T1524	168	1	32.7	15	10.00	0.70
CW9T1530	265	1	38.7	15	12.00	0.75
CW9T1536	373	1	44.7	15	14.00	0.82
CW9T1542	509	1	50.7	15	16.00	0.95
CW9T1548	665	1	56.7	15	18.00	1.00

CHMSL1 • Round Mid Support Leg

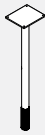

- Available in standard compile standard panel frame colours.
- Includes levelling glide, PVC sleeve and 4.8" x 4.8" plate.
- 1.5" diameter.

PRODUCT CODE	PRICE	LEG DIAMETER	SIZE/INCHES			WEIGHT VOL	
			H	W	D	LBS	FT³
CHMSL1	77	1.5	28	4.8	4.8	8	0.15

CHMSL2 • Square Mid Support Leg

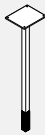

- Available in standard compile standard panel frame colours.
- Includes levelling glide, PVC sleeve and 4.8" x 4.8" plate.

PRODUCT CODE	PRICE	LEG SIZE	SIZE/INCHES			WEIGHT VOL	
			H	W	D	LBS	FT³
CHMSL2	77	1.5	28	4.8	4.8	8	0.15

BHML • Monoleg

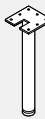

- Provides support for a worksurface.
- Includes an adjustable foot and an attachment plate.
- 3" diameter.
- 1" Height adjustment range.

PRODUCT CODE	PRICE	LEG DIAMETER	SIZE/INCHES			WEIGHT VOL	
			H	W	D	LBS	FT³
BHML03	207	3	28	3	3	8	0.15

CMHCL1 • Round Corner Leg With Leveler



- Provides support for worksurface.
- Includes levelling glide, PVC Sleeve and attachment plate.
- 1.5" diameter.
- Available in standard paint colours.
- Legs can be used in the corner of a single worksurface or be rotated 45 degrees to support the corners of two worksurfaces.

PRODUCT CODE	PRICE	LEG DIAMETER	SIZE/INCHES			WEIGHT VOL	
			H	W	D	LBS	FT³
CMHCL1	108	1.5	28	3	3	8	0.15

CMHCL2 • Square Corner Leg With Leveler



- Provides support for worksurface.
- Includes levelling glide, PVC Sleeve and attachment plate.
- 1.5" diameter.
- Available in standard paint colours.
- Legs can be used in the corner of a single worksurface or be rotated 45 degrees to support the corners of two worksurfaces.

PRODUCT CODE	PRICE	LEG DIAMETER	SIZE/INCHES			WEIGHT VOL	
			H	W	D	LBS	FT³
CMHCL2	108	1.5	28	3	3	8	0.15

CHC • Cantilever



- CHC15 come with wood screws and 3 hole slider, while CHC22 comes with wood screws & 4 hole slider.
- Corresponding panel frame colours only.
- Cantilevers do not share support.

PRODUCT CODE	PRICE	SIZE/INCHES			WEIGHT VOL	
		H	W	D	LBS	FT³
CHC15L	48	5	1.2	15.2	2	0.04
CHC15R	48	5	1.2	15.2	2	0.04
CHC22L	80	8	1.2	21.5	2.6	0.06
CHC22R	80	8	1.2	21.5	2.6	0.06

CHCB2 • Corner and Transaction Bracket

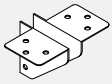

- Attaches the corner of any worksurface to a panel connector.
- Priced and shipped in pairs.
- Available in Standard paint colours.
- Cannot be used off modular.
- Comes with a 2 hole slider.

PRODUCT CODE	PRICE	SIZE/INCHES			WEIGHT LBS	VOL FT ³
		H	W	D		
CHCB2	22	3	1.81	3	0.5	0.02

CH • Worksurface Bracket

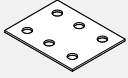

- Black (BLK) only

PRODUCT CODE	PRICE	SIZE/INCHES			WEIGHT LBS	VOL FT ³	
		H	W	D			
CHFB1	21	Flat Bracket	0.1	3	4	0.5	0.007

CHWB • Mid Span Bracket



- Attaches to a segmented panel.
- Must be specified with a worksurface longer than 48".
- Zinc finish only.

PRODUCT CODE	PRICE	SIZE/INCHES			WEIGHT LBS	VOL FT ³
		H	W	D		
CHWB1	13	0.5	2.8	2.1	0.5	0.02

DHPEDB • Pedestal Bracket



- Available in standard paint colours.
- Attaches pedestal to panel and end panel.

PRODUCT CODE	PRICE	SIZE/INCHES			WEIGHT LBS	VOL FT ³
		H	W	D		
DHPEDB	36	8	1	1	0.5	0.001

CHEP • End Panel

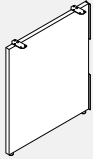

- Supports the worksurface and enhances the stability of connected panels.
- Provides solid support at the end of a run of worksurfaces.
- Finished in thermally-fused laminate.
- End panel height is inclusive of panel glides extended to their fullest height.
- Includes 2 flat brackets (black), 2 pedestal brackets (frame colour) and required screws.
- If wood grains is selected, grain runs vertically.
- Note: May be used as a shared gable between two adjoining worksurfaces.

PRODUCT CODE	PRICE	SIZE/ INCHES			WEIGHT LBS	VOL FT ³
		H	W	D		
CHEP2924	239	28	1	24	17	0.40
CHEP2930	280	28	1	30	21	0.50

CHWSRL01 • Worksurface round Support Leg

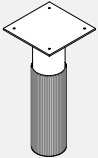

- Provides supports when worksurface overhangs 21" Double Wall Storage or 1.5H 1200 Series Cabinet Storage must have File Top.
- Must be used to support the worksurface in conjunction with panel mounted hardware.
- Contains a levelling glide and PVC sleeve.
- 1.5 diameter round tube.
- Available in BLK (Black) only

PRODUCT CODE	PRICE	SIZE/	INCHES		WEIGHT VOL	
		H	W	D	LBS	FT ³
CHWSRL01	46	4.5	3	3	1.00	0.03

CHMEGR • Metal End Gable Leg, Non-handed

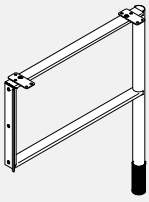

Left Assembly Shown

- **Metal End Gable Leg supports the worksurface and enhances the stability of connected panels.**
- Includes a leveling glide and decorative PVC sleeve to cover the glide.
- Attached to Compile panel connectors. The mounting bracket is universal and attaches with screws to the back of the leg.
- Please specify standard paint finish.
- Non-handed, can be adjusted to left or right handed application.
- NOTE: Cannot be used to support worksurfaces side by side. Please use EVHMSRL12 for supporting adjoining worksurfaces.

PRODUCT CODE	PRICE	SIZE/INCHES			WEIGHT LBS	VOL FT ³
		H	W	D		
CHMEGR24	173	29	2	23	6.00	0.73
CHMEGR30	185	29	2	29	6.80	0.90

CHMSRL • Metal Mid Support Round Leg, Non-handed

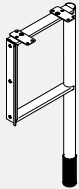

Left Assembly Shown

- **Metal Mid Support Leg supports two adjoining worksurfaces and enhances the stability of connected panels.**
- Includes a leveling glide and decorative PVC sleeve to cover the glide.
- Attached to Compile Panels.
- Please specify standard paint finish.
- Non-handed, can be adjusted to left or right handed application.

PRODUCT CODE	PRICE	SIZE/INCHES			WEIGHT LBS	VOL FT ³
		H	W	D		
CHMSRL12	149	29	2	11	4.60	0.36

CHMEGS • Metal End Gable Square Leg, Non-handed

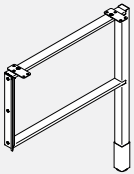

Left Assembly Shown

- **Metal End Gable Leg supports the worksurface and enhances the stability of connected panels.**
- Includes a leveling glide and decorative PVC sleeve to cover the glide.
- Attached to Compile panel connectors. The mounting bracket is universal and attaches with screws to the back of the leg.
- Please specify standard paint finish.
- Non-handed, can be adjusted to left or right handed application.
- NOTE: Cannot be used to support worksurfaces side by side. Please use EVHMSL12 for supporting adjoining worksurfaces.

PRODUCT CODE	PRICE	SIZE/INCHES			WEIGHT LBS	VOL FT ³
		H	W	D		
CHMEGS24	177	29	2	23	6.00	0.73
CHMEGS30	188	29	2	29	6.80	0.90

CHMSL • Metal Mid Support Square Leg, Non-handed

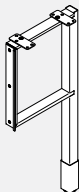

Left Assembly Shown

- **Metal Mid Support Leg supports two adjoining worksurfaces and enhances the stability of connected panels.**
- Includes a leveling glide and decorative PVC sleeve to cover the glide.
- Attached to Compile Panels.
- Please specify standard paint finish.
- Non-handed, can be adjusted to left or right handed application.

PRODUCT CODE	PRICE	SIZE/INCHES			WEIGHT LBS	VOL FT ³
		H	W	D		
CHMSL12	152	29	2	11	4.60	0.36

CMHLEG • Compile Bridges Leg Assembly

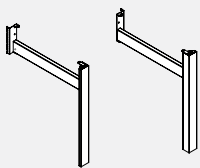

- **Compile Bridges Leg Assembly attaches to a Compile panel for applications which require functionality of Compile panels with an open environment of Bridges tables.**
- One leg with horizontal member connecting to 1" increment slots in panel's vertical frame member. Provides support to panel and panel-connected worksurface at the end of a run; design coordinated with Bridges freestanding tables.
- Supports 24" and 30" deep worksurfaces. By adding 2 CHFB1 flat brackets and 1 CHCB2 corner bracket, a single leg can then support the adjoining worksurface. Leveling glide is standard. No worksurface supporting beams, use panel cantilevers and storage for worksurface support. One aluminum leg with steel structure - specify Left or Right and 24" or 30" deep for corresponding worksurface depths. Panel bracket, dislodgment clip and worksurface hardware included.
- Anodized aluminum leg upcharge \$23.
- Please specify paint finish for support.

PRODUCT CODE	PRICE	SIZE/INCHES			WEIGHT LBS	VOL FT ³
		H	W	D		
CMHLEG24LL	317	28	2.5	24	9	1.25
CMHLEG24RL	317	28	2.5	24	9	1.25
CMHLEG30LL	333	28	2.5	30	11	1.45
CMHLEG30RL	333	28	2.5	30	11	1.45

CMHC • HAT Channel

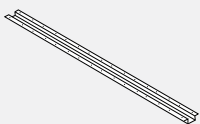

- Support worksurfaces.

PRODUCT CODE	PRICE	SIZE/INCHES			WEIGHT LBS	VOL FT ³
		H	W	D		
CMHC40	58	1.4	40	5	4	0.20
CMHC46	64	1.4	46	5	6	0.22
CMHC52	68	1.4	52	5	7	0.25
CMHC58	78	1.4	58	5	8	0.28
CMHC64	88	1.4	64	5	9	0.31
CMHC70	94	1.4	70	5	10	0.33

CSSL13 • Panel Mount Shelf

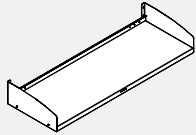

- 13" deep panel-mounted storage shelf with backlip.
- Mounting brackets are included.

PRODUCT CODE	PRICE	SIZE/INCHES			WEIGHT VOL	
		H	W	D	LBS	FT ³
CSSL1324	146	5	24	13	11	1.28
CSSL1330	152	5	30	13	12	1.28
CSSL1336	154	5	36	13	13	1.28
CSSL1342	166	5	42	13	15	1.70
CSSL1348	182	5	48	13	16	1.70
CSSL1354	195	5	54	13	19	2.12
CSSL1360	204	5	60	13	21	2.12

CSOF13 • Flush Front KD Overhead Cabinet

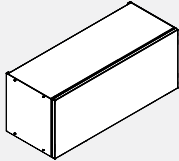

- Door retracts up and over the cabinet.
- Ready for quick assembly on site.
- Quality steel construction.
- Mounting brackets are included.
- 60" unit is reinforced for proper weight distribution.
- Inside dimensions: 12" h. x 12.75" d.
- Lock is not included, please order separately.

PRODUCT CODE	PRICE	SIZE/INCHES			WEIGHT VOL	
		H	W	D	LBS	FT ³
CSOF1324	499	14.5	24	13	27	1.28
CSOF1330	517	14.5	30	13	31	1.28
CSOF1336	573	14.5	36	13	34	1.28
CSOF1342	630	14.5	42	13	38	1.70
CSOF1348	690	14.5	48	13	43	1.70
CSOF1354	747	14.5	54	13	48	2.12
CSOF1360	803	14.5	60	13	53	2.12

CMSLK13 • Lock for CSOF13

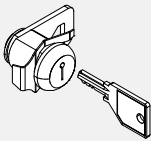

- Lock and key for CSOF13 overhead cabinet.
- Includes one lock assembly and two keys.

PRODUCT CODE	PRICE
CMSLK13	30

CMADA • Panel Mounted Overhead Storage, AODA Compliant

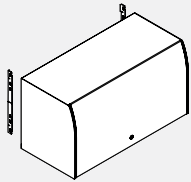

- Panel mounted metal overhead storage with opaque acrylic door. The mechanism lifts the door up and stores it out of the way, above the storage unit.
- Meets CSA B651 Barrier Free Design & AODA (Accessibility for Ontarians with Disabilities Act).
- 16" high units accept standard and A4 binders.
- All shelves are reinforced for proper weight distribution.
- Inside dimensions: 14.25" high x 13.4" deep.
- Shipped partially assembled.
- Unit includes attachment hardware, lock and mounting brackets. Back not included.

PRODUCT CODE	PRICE	SIZE/INCHES			WEIGHT VOL	
		H	W	D	LBS	FT ³
CMADA30PM	839	16	30	14.2	27	5.3
CMADA36PM	906	16	36	14.2	32	6.3
CMADA42PM	970	16	42	14.2	37	7.3
CMADA48PM	1037	16	48	14.2	42	8.3
CMADA54PM	1101	16	54	14.2	47	9.3
CMADA60PM	1167	16	60	14.2	53	10.3

CMDAOH • Center Mount Overhead

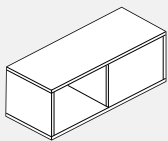

- Inside dimensions 13" high x 13" deep.
- Laminate Overhead.
- Available in standard Compile laminate finishes.
- Top mount on panels.
- Overhead Support Brackets included.

PRODUCT CODE	PRICE	SIZE/INCHES			WEIGHT VOL	
		H	W	D	LBS	FT ³
CMDAOH36	1135	15	36	14.12	10	4.4
CMDAOH42	1222	15	42	14.12	11	5.1
CMDAOH48	1273	15	48	14.12	12	5.8
CMDAOH54	1367	15	54	14.12	13	6.6
CMDAOH60	1415	15	60	14.12	14	7.3

CS93FPxxBFP • 9300 Series Freestanding Box File Pedestal

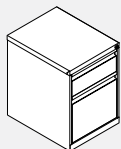

- One box and one file drawer pedestal.
- Freestanding, counterweight included.
- All drawers are locking.
- Box drawer includes pencil tray.

PRODUCT CODE	PRICE	SIZE/INCHES			WEIGHT VOL	
		H	W	D	LBS	FT ³
CS93FP19BFP	524	21.31	15	19	50	5.1
CS93FP23BFP	531	21.31	15	23	55	6.0
CS93FP29BFP	642	21.31	15	29	64	7.5

CS93FPxxBBFP • 9300 Series Freestanding Box Box File Pedestal

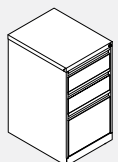

- Two box and one file drawer pedestal.
- Freestanding, counterweight included.
- All drawers are locking.
- Top box drawer includes pencil tray.

PRODUCT CODE	PRICE	SIZE/INCHES			WEIGHT VOL	
		H	W	D	LBS	FT ³
CS93FP19BBFP	568	27.87	15	19	55	6.5
CS93FP23BBFP	578	27.87	15	23	68	7.7
CS93FP29BBFP	692	27.87	15	29	78	9.6

CS93FPxxFFP • 9300 Series Freestanding File File Pedestal

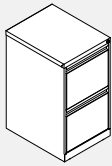

- Two file drawer pedestal.
- Freestanding, counterweight included.
- All drawers are locking.

PRODUCT CODE	PRICE	SIZE / INCHES			WEIGHT VOL	
		H	W	D	LBS	FT ³
CS93FP19FFP	547	27.87	15	19	53	6.5
CS93FP23FFP	554	27.87	15	23	60	7.7
CS93FP29FFP	656	27.87	15	29	70	9.6

CS93WPxxBBFP • 9300 Series Worksurface Supporting Box Box File Pedestal

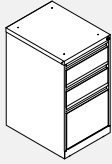

- Two box and one file drawer pedestal.
- Worksurface supporting, includes mounting holes in the top.
- All drawers are locking.
- Top box drawer includes pencil tray.
- Note: Specify bracket and filler kit separately, CSPWSB93.

PRODUCT CODE	PRICE	SIZE / INCHES			WEIGHT VOL	
		H	W	D	LBS	FT ³
CS93WP19BBFP	563	27.87	15	19	55	6.5
CS93WP23BBFP	571	27.87	15	23	68	7.7
CS93WP29BBFP	662	27.87	15	29	78	9.6

CS93WPxxFFP • 9300 Series Worksurface Supporting File File Pedestal

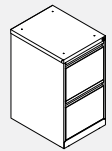

- Two file drawer pedestal.
- Worksurface supporting, includes mounting holes in the top.
- All drawers are locking.
- Note: Specify bracket and filler kit separately, CSPWSB93.

PRODUCT CODE	PRICE	SIZE / INCHES			WEIGHT VOL	
		H	W	D	LBS	FT ³
CS93WP19FFP	540	27.87	15	19	53	6.5
CS93WP23FFP	545	27.87	15	23	60	7.7
CS93WP29FFP	658	27.87	15	29	70	9.6

CS93MPxxBFP • 9300 Series Mobile Box File Pedestal

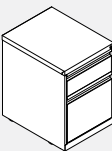

- One box and one file drawer mobile pedestal.
- Casters preinstalled, casters non-locking.
- Counterweight included.
- All drawers locking.
- Box drawer includes pencil tray.
- NOTE: Cannot be used as guest seating.

PRODUCT CODE	PRICE	SIZE / INCHES			WEIGHT VOL	
		H	W	D	LBS	FT ³
CS93MP19BFP	624	21.87	15	19	66	5.2
CS93MP23BFP	646	21.87	15	23	72	6.2
CS93MP29BFP	694	21.87	15	29	92	7.6

CS93MPxxBBFP • 9300 Series Mobile Box Box File Pedestal

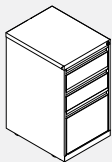

- Two box and one file drawer mobile pedestal.
- Casters preinstalled, casters non-locking.
- Counterweight included.
- All drawers locking.
- Top box drawer includes pencil tray.
- NOTE: Cannot be used as guest seating.

PRODUCT CODE	PRICE	SIZE / INCHES			WEIGHT VOL	
		H	W	D	LBS	FT ³
CS93MP19BBFP	646	27.87	15	19	76	6.5
CS93MP23BBFP	653	27.87	15	23	85	7.7
CS93MP29BBFP	708	27.87	15	29	94	9.6

CS93MPxxFFP • 9300 Series Mobile File File Pedestal

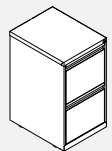

- Two file drawer pedestal.
- Casters preinstalled, casters non-locking.
- Counterweight included.
- All drawers locking.
- NOTE: Cannot be used as guest seating.

PRODUCT CODE	PRICE	SIZE / INCHES			WEIGHT VOL	
		H	W	D	LBS	FT ³
CS93MP19FFP	612	27.87	15	19	73	6.5
CS93MP23FFP	638	27.87	15	23	81	7.7
CS93MP29FFP	706	27.87	15	29	90	9.6

BSPF0BFxxC • Prime Freestanding Box File Pedestal

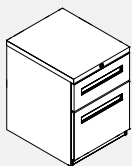

- One box and one file drawer pedestal.
- All drawers are locking.
- Box drawer includes pencil tray.
- For freestanding, to add counterweight (W2 option), add \$49 list.
- For mobile, to add casters and counterweight (W1 option), add \$73 list. Adds 0.5" to height.
- NOTE: Cannot be used as guest seating.

PRODUCT CODE	PRICE	SIZE / INCHES			WEIGHT VOL	
		H	W	D	LBS	FT ³
BSPF0BF18C	722	20.8	15	18	52.4	4.2
BSPF0BF22C	756	20.8	15	22	58.8	5.0
BSPF0BF28C	791	20.8	15	28	68.7	6.3

BSPFSBGxxC • Prime Box Box File Pedestal



- Two box and one file drawer pedestal.
- All drawers are locking.
- Top box drawer includes pencil tray.
- For freestanding, to add counterweight (W2 option), add \$49 list.
- For mobile, to add casters and counterweight (W1 option), add \$73 list. Adds 0.5" to height.
- Top box drawer 4.8"h; middle box drawer 6.4"h; bottom file drawer 13.6"h (interior 12.5"h).
- Note: Specify bracket and filler kit separately, CSPWSBPM18 for 18" deep and CSPWSBPM22 for 22 and 28" deep.

PRODUCT CODE	PRICE	SIZE/INCHES			WEIGHT VOL	
		H	W	D	LBS	FT ³
BSPFSBG18C	834	28	15	18	67.5	5.5
BSPFSBG22C	874	28	15	22	75.0	6.6
BSPFSBG28C	913	28	15	28	86.8	8.3

BSPF0FGxxC • Prime File File Pedestal

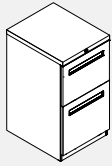

- Two file drawer pedestal.
- All drawers are locking.
- For freestanding, to add counterweight (W2 option), add \$49 list.
- For mobile, to add casters and counterweight (W1 option), add \$73 list. Adds 0.5" to height.
- Top file drawer 11.2"h (interior 10.6"h); bottom file drawer 13.6"h (interior 12.5"h).
- Note: Specify bracket and filler kit separately, CSPWSBPM18 for 18" deep and CSPWSBPM22 for 22 and 28" deep.

PRODUCT CODE	PRICE	SIZE/INCHES			WEIGHT VOL	
		H	W	D	LBS	FT ³
BSPF0FG18C	761	28	15	18	67.5	5.5
BSPF0FG22C	791	28	15	22	75.0	6.6
BSPF0FG28C	825	28	15	28	86.8	8.3

BSPW0BFxxC • Prime Mobile Box File Pedestal



- Mobile one box and one file drawer pedestal.
- All drawers are locking.
- 60mm casters.
- Front casters are locking.

PRODUCT CODE	PRICE	SIZE/INCHES			WEIGHT VOL	
		H	W	D	LBS	FT ³
BSPW0BF18C	888	23.3	15	18	73.5	4.6
BSPW0BF22C	917	23.3	15	22	79.1	5.6
BSPW0BF28C	947	23.3	15	28	87.7	7.0

BSK • Keys and Replacement Lock Core (Fileco Prime Series)

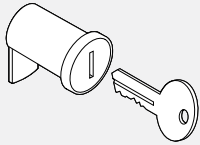

- BSKY - Set of two extra keys for existing Prime storage. Specify core #. Key range W401-W550.
- BSKC - Includes one lock core and a set of two keys for Prime storage. Specify core #. Key range W401-W550.

PRODUCT CODE	PRICE	SIZE/INCHES			WEIGHT VOL	
		H	W	D	LBS	FT ³
BSKY EXTRA KEY	13	1.75	0.75	0.2	0.2	0.01
BSKC LOCK CORE & KEY	30	2	1	0.5	0.4	0.01

CSPWSB93 • Compile Worksurface Supporting Bracket for 9300 Series Pedestals



- Kit includes filler and bracket.

PRODUCT CODE	PRICE	SIZE/	INCHES		WEIGHT VOL	
		H	W	D	LBS	FT ³
CSPWSB93	68	27.63	0.855	1	2.16	0.014

CSPWSBPM18 • Compile Worksurface Supporting Bracket for Prime Series 18" deep Pedestals

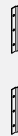

- Kit includes bracket.

PRODUCT CODE	PRICE	SIZE/	INCHES		WEIGHT VOL	
		H	W	D	LBS	FT ³
CSPWSBPM18	31	9	1.27	1	0.83	0.007

CSPWSBPM22 • Compile Worksurface Supporting Bracket for Prime Series 22 and 28" deep Pedestals



- Kit includes filler and bracket.

PRODUCT CODE	PRICE	SIZE/	INCHES		WEIGHT VOL	
		H	W	D	LBS	FT ³
CSPWSBPM22	73	28	1.75	1	2.83	0.284

ACCESSORIES

Boulevard, Boulevard System 3, Compile, Diet & Evolve Ergonomic Solutions

Helping Office Inhabitants be Healthy and Efficient

- Ergonomic Computer Accessories
- Energy Efficient Lighting and Power Accessories
- Paper Management Accessories
- Workstation Enhancement Accessories

For use with Boulevard, Boulevard System 3, Compile, Diet and Evolve (unless otherwise specified).

GAKSM01 • Keyboard Support Mechanism

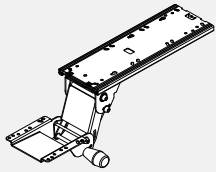

- Soft Touch Knob for simultaneous height & tilt adjustment.
- Spring-assist mechanism helps counter balance weight of keyboard & tray.
- Low-profile design for maximum leg room.
- Includes 21.75" under worksurface Glide Track
- Optional Glide Tracks available at no upcharge:
 - 12" Glide Track add suffix "12" (EXAMPLE GAKSM0112)
 - 18" Glide Track add suffix "18" (EXAMPLE GAKSM0118)
- Available in black only
- To be used with keyboard trays, sold separately.

PRODUCT CODE	PRICE	SIZE/ INCHES			WEIGHT VOL	
		H	W	D	LBS	FT ³
GAKSM01	244	4.3	9	23.8	9.2	0.533

- Height Range 6" (+1.0"/-5.5")
- Soft Touch Knob tilt adjustable range +15°/-15°
- 360° base swivel

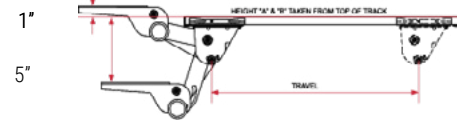
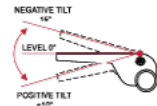

GAKSML • Slim Fit Keyboard Support Mechanism

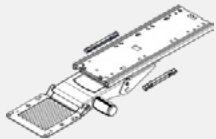

- Height Range 8.88" (+2.38" / - 6.5")
- Tilt Range (+10° / -20°)
- 360° Swivel.
- Meets ANSI/HFES, 100-2007 conformance requirement for height clearance.
- Super slim mechanism design increases clearance under the worksurface.
- Height & depth indicator incorporated together in an intelligently designed dashboard.
- Patented Lift-N-Lock™ height adjustment without knobs or levers automatically locks into position with release of tray for better AODA/Barrier Free compliance.
- Easy access to tilt control knob.
- Designed for disassembly and fully recyclable.
- Includes 21.75" undersurface Glide Track.
- Optional Glide Tracks available:
 - 12" Glide Track add suffix "12" (EXAMPLE GAKSML12)
 - 18" Glide Track add suffix "18" (EXAMPLE GAKSML18)
- "W" Indicated white finish.

PRODUCT CODE	PRICE	SIZE/ INCHES			WEIGHT VOL	
		H	W	D	LBS	FT ³
GAKSML	321	4.75	9.5	24	9	0.627
GAKSMLW	321	4.75	9.5	24	9	0.627

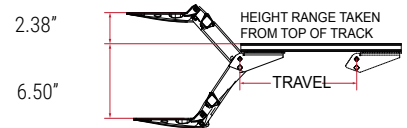
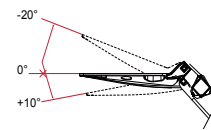

GAKSM02 • Lift-N-Lock Keyboard Support Mechanism

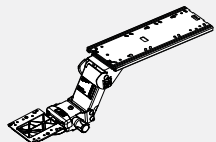

- Patent Pending Height Indicator Gauge allows for precise height setting when used by multiple users, or for returning to optimal height setting after storage.
- Exceeds BIFMA performance standards.

- Includes 21.75" under worksurface Glide Track
- Optional Glide Tracks available at no upcharge:
 - 12" Glide Track add suffix "12" (EXAMPLE GAKSM0212)
 - 18" Glide Track add suffix "18" (EXAMPLE GAKSM0218)
- Available in Black Only
- To be used with keyboard trays, sold separately.

NOTE: Positive Tilt Lockout available. Contact your Customer Service Representative.
 • Patented Lift-N-Lock™ height adjustment without knobs or levers automatically locks into position with release of tray for greater. Meets CSA B651 Barrier Free Design & AODA (Accessibility for Ontarians with Disabilities Act).

PRODUCT CODE	PRICE	SIZE/ INCHES			WEIGHT VOL	
		H	W	D	LBS	FT ³
GAKSM02	321	4.3	9	23.8	9.7	0.533

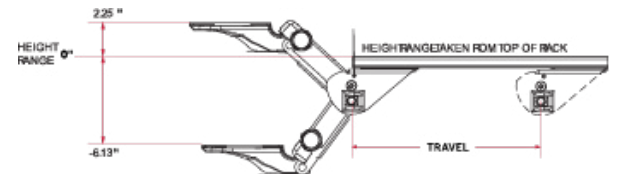

- Height Range 8.38" (+2.25"/-6.13")
- Dial-Tilt Gauge shows precise tilt angles from +10°/-15° positions.
- 360° base swivel

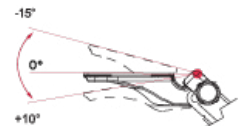

ACCESSORIES

GAKSM03 • Lift-N-Lock Keyboard Support Mechanism

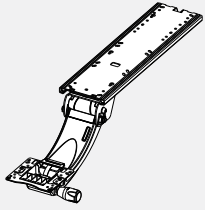

- Patent Pending Height Indicator Gauge allows for precise height setting when used by multiple users, or for returning to optimal height setting after storage.
- Curved neck allows user to be closer to the desk when in standing position.
- Exceeds BIFMA performance standards.

- Includes 21.75" under worksurface Glide Track
- Optional Glide Tracks available at no upcharge:
 - 12" Glide Track add suffix "12" (EXAMPLE GAKSM0312)
 - 18" Glide Track add suffix "18" (EXAMPLE GAKSM0318)

- Available in black only
- To be used with keyboard trays, sold separately.

- **NOTE:** Positive Tilt Lockout available. Contact your Customer Service Representative.
- Maximizes ergonomic support for both seated and standing positions.
- Patented Lift-N-Lock™ height adjustment without knobs or levelers automatically locks into position with release of tray for greater. Meets CSA B651 Barrier Free Design & AODA (Accessibility for Ontarians with Disabilities Act).

PRODUCT CODE	PRICE	SIZE/ INCHES			WEIGHT VOL	
		H	W	D	LBS	FT ³
GAKSM03	519	5.8	9	23.8	11.3	0.719

- Height Range 14.13" (+8.25"/-5.88")
- Dial-Tilt Gauge shows precise tilt angles from +10°/-15° positions.
- 360° base swivel

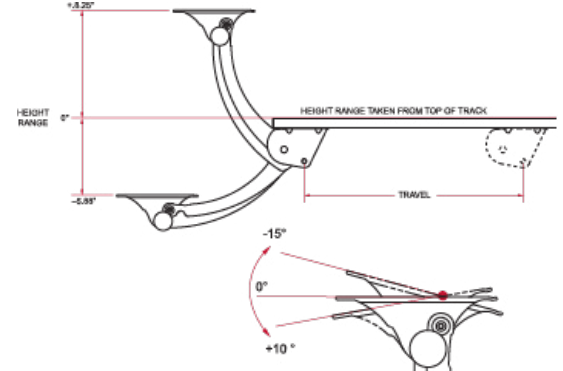

GAKSM05 • Fixed Mount Trackless Keyboard Arm

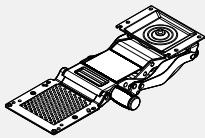

Features:

- Direct Mount, no track required. Ideal solution for Bridges and FreeFit Tables.
- Total height adjustment of 5.73" (-1.25" to -6.98" under the desk surface).
- Enhanced patented Lift-N-Lock™ braking mechanism.
- Soft Touch Knob Dial Tilt with +10° to -15° tilt angles.
- Low profile tray head.
- Separate height and tilt gauges.
- 360° of swivel.
- Optional factory or field installable tilt lockout available.

Benefits:

- Full storage in 9 3/8" undersurface space.
- Exceeds HFES & BIFMA 5" percentile seated keyboarding heights (HFES 22" BIFMA 22.6").
- Easy height adjustment, providing superior lock up and stability with infinite adjustment.
- ADA Compliant tilt adjustment with easily accessible tilt knob.
- Greater knee clearance under desk surface.

PRODUCT CODE	PRICE	SIZE/ INCHES			WEIGHT VOL	
		H	W	D	LBS	FT ³
GAKSM05	300	5	13	9	6	0.317
GAKSM05W	300	5	13	9	6	0.317

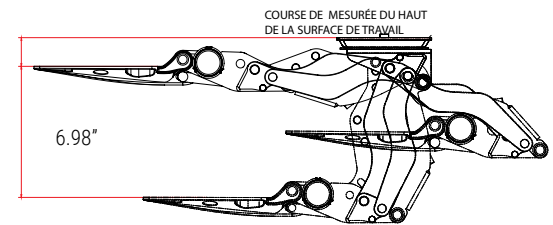

- Allows accurate, repeatable tray placement.
- Allows side to side arm movement.
- Locks out positive tilt for specific ergonomic applications or users preference.
- Provides increased storage where space permits.
- "W" indicated white finish.

GATM01 • Tray with Sliding Mouse Support

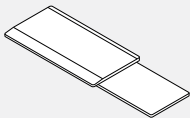

MDF Tray:

- Formed MDF with Textured Finish.
- Foam Anti-skid mat.

Sliding Retractable Mouse Support:

- ABS tray
- Sliding Retractable Mouse Support slides below the tray for left or right mouse positioning.
- Extends 9.91" beyond the end of the Keyboard Tray.
 - 33% recycled content by weight content) and 92.64% recyclable.
- Available in black only

PRODUCT CODE	PRICE	SIZE/ INCHES			WEIGHT VOL	
		H	W	D	LBS	FT ³
GATM01	245	2	21.3	10.5	7	0.259

GATM02 • 27" HDPE Tray with Two Mousing Surfaces

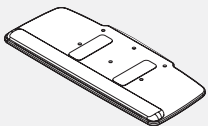

HDPE Tray:

- 1/2" thick High Density Polyethylene with textured finish.
- Includes removable plug-in, gel free foam palm rest.
- Anti-skid strips.

Mousing Surface:

- Keyboard and Mouse can be set up left or right.
- Includes Mouse Fence with Cable Manager.
 - 92.64% recyclable.
- Available in black only

PRODUCT CODE	PRICE	SIZE/ INCHES			WEIGHT VOL	
		H	W	D	LBS	FT ³
GATM02	317	1	27	11	6	0.179

ACCESSORIES

GATM03 • Phenolic Tray with Height Adjustable Mouse Support

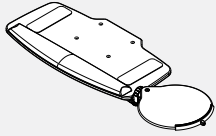

Height Adjustable Mouse Support:

- Ergonomic adjustment of tilt, swivel & height adjustment.
- Can be mounted either left or right.
- Includes mouse fence with cable manager.
- Available in black or white.
- "W" indicates white finish.

PRODUCT CODE	PRICE	SIZE/ INCHES			WEIGHT VOL	
		H	W	D	LBS	FT ³
GATM03	341	2.8	20.5	11	5.8	0.429
GATM03W	341	2.8	20.5	11	5.8	0.429

Phenolic Tray:

- Solid low profile keyboard tray.
- Graphite finish helps hide fingerprints and smudges.
- Includes removable plug-in, gel-free foam palm rest.
- Includes foam Anti-skid strips.

GATM04 • HDPE Tray with Height Adjustable Mouse Support

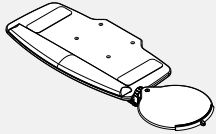

HDPE Tray:

- 1/2" thick High Density Polyethylene with textured finish.
- Includes removable plug-in, gel free foam palm rest.
- 45% recycled content by weight (45% Post Industrial content) and 99.97% recyclable.
- Includes foam anti-skid strips.

PRODUCT CODE	PRICE	SIZE/ INCHES			WEIGHT VOL	
		H	W	D	LBS	FT ³
GATM04	383	3.2	20.5	11	6	0.5

Height Adjustable Mouse Support:

- Ergonomic adjustment of tilt, swivel & height adjustment.
- Can be mounted either left or right.
- Includes mouse fence with cable manager.
 - 92.64% recyclable.
- Available in black only.

GAGTA01 • Glide Tray Adapter (set of 2)

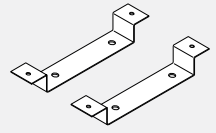



- Attaches to Glide Tracks of all Keyboard Mechanisms and Sliding CPU Holders found within this price list.
- Mounting hardware included.
- Available in black only.
- Not required for use with GAKSM05.

PRODUCT CODE	PRICE	SIZE/ INCHES			WEIGHT VOL	
		H	W	D	LBS	FT ³
GAGTA01	88	2.5	9	2	0.5	0.025

- Accommodates the placement of sliding keyboard mechanisms and CPU holders below the cross beam of a Bridges tables.

Keyboard Combination Chart • Package Codes and Pricing

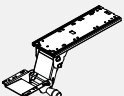
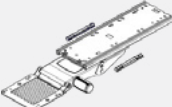
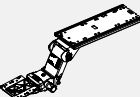
- "W" at the end of the code designates white keyboard.
- "W" before 2 numbers designates white mechanism.
- "W" in both places in code designates white keyboard and mechanism.

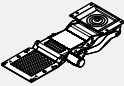
	GATM01	GATM02	GATM03/GATM03W	GATM04
 GAKSM01	GAKSP0101 \$492	GAKSP0102 \$560	GAKSP0103 / GAKSP103W \$586	GAKSP0104 \$626
 GAKSML/GAKSMLW	GAKSPML01 / GAKSPMLW01 \$564	GAKSPML02 / GAKSPMLW02 \$637	GAKSPML03 / GAKSPML03W / GAKSPMLW03 / GAKSPMLW03W \$662	GAKSPML04 / GAKSPMLW04 \$702
 GAKSM02	GAKSP0201 \$564	GAKSP0202 \$637	GAKSP0203 / GAKSP0203W \$662	GAKSP0204 \$702
 GAKSM03	GAKSP0301 \$762	GAKSP0302 \$832	GAKSP0303 / GAKSP0303W \$858	GAKSP0304 \$898
 GAKSM05/GAKSM05W	GAKSP0501 / GAKSP0501W \$547	GAKSP0502 / GAKSP0502W \$616	GAKSP0503 / GAKSP0503W / GAKSP0503W \$640	GAKSP0504 / GAKSP0504W \$681

ACCESSORIES

GACPU01 • Fixed Mount CPU Holder

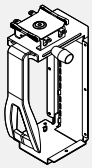

- Fully adjustable clamping mechanism to accept tower CPU's with a wide range of 3.5" to 9.3" and a height range of 12.5" to 22.5".
- Directly mounts to underside of desk surface.
- Soft Touch knob for side clamp adjustment and bayonet lance for vertical height adjustment.
- CPU Holder can also be mounted directly to an upright desk leg surface or wall, via side mounting holes.
- Manufactured from Steel and Engineered Resin,
- providing rugged durability and support.
- Available in Black Only

PRODUCT CODE	PRICE	SIZE/ INCHES			WEIGHT VOL	
		H	W	D	LBS	FT ³
GACPU01	202	18.5	11.7	9.2	9	1.152

GACPU02 • CPU Holder on Glide Track

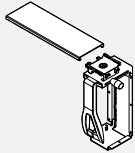

- Accepts tower CPU's with a width range of 3.5" to 9.3" and a height range of 12.5" to 22.5".
- Soft Touch knob for side clamp adjustment and bayonet lance for vertical height adjustment.
- 12" Glide Track mounted and 360° swivel for easy access for rear of CPU
- Manufactured from Steel and Engineered Resin, providing rugged durability and support.
- Available in Black Only

PRODUCT CODE	PRICE	SIZE/ INCHES			WEIGHT VOL	
		H	W	D	LBS	FT ³
GACPU02	290	18.5	11.7	9.2	12.6	1.152

GACPUH • Woof CPU Holder

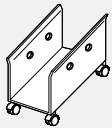

- Provides convenience access to front and back of CPU.
- Expandable width accommodates various sizes of CPU's. Adjusts from 7" to 10".
- Includes 4 locking casters and 4 protective "O" rings.
- Available in Tungsten Only

PRODUCT CODE	PRICE	SIZE/ INCHES			WEIGHT VOL	
		H	W	D	LBS	FT ³
GACPUH	187	11	16	7-10	5	1.0

GAAKS1818 • CRT Corner Plate

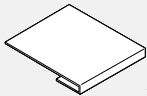

- Converts two abutting worksurfaces in a 90° corner into a 45° angle keyboard worksurface.
- Keyboard mechanism not included.
- Fits worksurfaces 1" to 1.25" thick.
- Available in Panel Frame Finish

PRODUCT CODE	PRICE	SIZE/ INCHES			WEIGHT VOL	
		H	W	D	LBS	FT ³
GAAKS1818	99	1.25	18	18	3.7	0.454

GAMA1 • Single Clamp Mount Monitor Arm

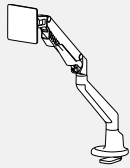

- Finger touch dynamic height adjustment, 12" height range. 4.4 to 19.8 lbs. per monitor loading capacity; accepts screen size 17"-30".
- Maximum monitor width of 34".
- Maximum of 20.5" extension from rear of desk to back of monitor, folds to 4.5".
- Tilt, pan and landscape to portrait rotation; quick release VESA plate, 180 degree lock out.
- Clamp mount and grommet mount options included, accommodates 0.5" to 2" thick tops.
- Accepts mini slide arm GAMS.
- Available in Tungsten (TUN)

PRODUCT CODE	PRICE	SIZE/ INCHES			WEIGHT VOL	
		H	W	D	LBS	FT ³
GAMA1	418	21		5.5	6.6	0.4

GAMA2 • Double Clamp Mount Monitor Arm

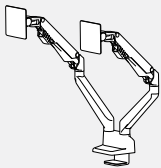

- Finger touch dynamic height adjustment, 12" height range.
- 4.4 to 19.8 lbs. per monitor loading capacity; accepts screen size 17"-30".
- Maximum monitor width of 34".
- Maximum of 20.5" extension from rear of desk to back of monitor, folds to 4.5".
- Tilt, pan and landscape to portrait rotation; quick release VESA plate, 180 degree lock out.
- Clamp mount and grommet mount options included, accommodates 0.5" to 2" thick tops.
- Accepts mini slide arm GAMS.
- Available in Tungsten (TUN)

PRODUCT CODE	PRICE	SIZE/ INCHES			WEIGHT VOL	
		H	W	D	LBS	FT ³
GAMA2	734	21		5.5	12.8	1

GAMS • Mini Slide Monitor Arm

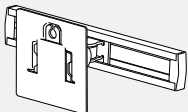

- Works with GAMA1 and GAMA2 monitor arms.
- 9" slide, loading capacity 13.2lbs.
- Quick release VESA plate.
- Available in Tungsten (TUN)

PRODUCT CODE	PRICE	SIZE/ INCHES			WEIGHT VOL	
		H	W	D	LBS	FT ³
GAMS	145	4.5	11	6	3.3	0.3

ACCESSORIES

Monitor Arm Specs

- VESA Mounting plate contains 75 mm & 100 mm mounting configuration
- VESA Plate head is fully adjustable with 180° of tilt, 180° of swivel and 360° of rotation for portrait to landscape viewing
- Keyhole slots in VESA Plate for quick mounting of Display Screen
- Counterbalance spring mechanism does not contain gas cylinders (that are prone to leakage)
- Cable Management provided on arm swivel joints
- Arm components manufactured from 100% recyclable aluminum die cast material, providing stability and durability
- 13" Arm height adjustment on 11" Stainless Steel Pole.
- Pole Support Ring doubles as cable manager.
- 360° of arm swivel around pole.
- Desk Clamp and Grommet mounting options standard on pole applications.
- Monitor arms available in Silver (SIL), Black (BLK), or White (WHT).

GAMCSSDE • Double Extension Monitor Arm for Single Screen

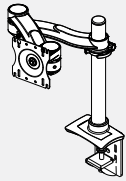

Monitor Arm Single Screen Dual Arm Extension.

- 9 1/2" reach from centre of pole to front of VESA Plate
 - Display Viewing - 180° of tilt, 180° of swivel and 360° of rotation.
 - Quick Mount Versa Plate.
 - 12" Pole Adjustment.
 - 9" Chrome pole adjustment.
- Available in Silver (SIL), Black (BLK) or White (WHT).
- Post is chromed.

PRODUCT CODE	PRICE	SIZE/ INCHES			WEIGHT VOL	
		H	W	D	LBS	FT ³
GAMCSSDE	506	29.3	6.8	9.5	7.5	1.095

GAMCSSDEH • Double Extension with Height Adjustable Monitor Arm for Single Screen

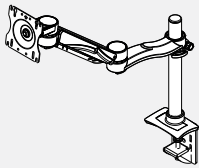

Double extension with height adjustable monitor arm for single screen frees up worksurface space and supports a sit/stand working posture.

- Attaches to the edge of the worksurface or through a grommet.
- Monitor arm adjusts from 3" to 12" from the worksurface.
- Counterbalanced arm provides an additional 13" of height adjustment.
- Monitor connecting bracket swivels 360 degrees and tilts +/- 90 degrees (180 degrees).
- Double extension has 19" of back and forth movement to allow for different focal depths of viewing comfort.
- Built-in cable clips on underside of extension arms and pole base allows organized cable management.
- Available in Silver (SIL), Black (BLK) or White (WHT).
- Post is chromed.

PRODUCT CODE	PRICE	SIZE/ INCHES			WEIGHT VOL	
		H	W	D	LBS	FT ³
GAMCSSDEH	609	29.3	6.8	9.5	8.2	1.095

GAMCDSDE • Monitor Arms for Dual Screens

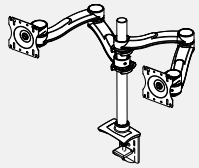

Double extension monitor arms for dual screens frees up worksurface space.

- Used for side-by-side or back-to-back applications.
- Attaches to the edge of the worksurface or through a grommet.
- Monitor arm adjusts from 3" to 12" from the worksurface.
- Monitor connecting extension has 19" of back and forth movement to allow for different focal depths of viewing comfort.
- Max 32" screen width.
- Built-in cable clips on underside of extension arms and pole base allows organized cable management.
- Available in Silver (SIL), Black (BLK) or White (WHT).
- Post is chromed.

PRODUCT CODE	PRICE	SIZE/ INCHES			WEIGHT VOL	
		H	W	D	LBS	FT ³
GAMCDSDE	898	29.3	6.8	9.5	10.7	1.095

GAMCDSDEH • Double Extension with Height Adjustable Monitor Arms for Dual Screens

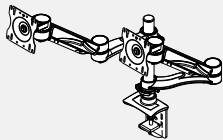

Double extension with height adjustable monitor arms for dual screens frees up the worksurface space and supports a sit/stand working posture.

- Used for side-by-side or back-to-back applications.
- Attaches to the edge of the worksurface or through a grommet.
- Monitor arm adjusts from 3" to 12" from the worksurface.
- Counterbalanced arm provides an additional 13" of height adjustment.
- Monitor connecting bracket swivels 360 degrees and tilts +/- 90 degrees (180 degrees).
- Double extension has 19" of back and forth movement to allow for different focal depths of viewing comfort.
- Built-in cable clips on underside of extension arms and pole base allows organized cable management.
- Max 35" screen width.
- Available in Silver (SIL), Black (BLK) or White (WHT).
- Post is chromed.

PRODUCT CODE	PRICE	SIZE/ INCHES			WEIGHT VOL	
		H	W	D	LBS	FT ³
GAMCDSDEH	1114	29.3	6.8	9.5	12.2	1.095

ACCESSORIES

GAMLDM20 • Single Screen Monitor Arm for 5 to 20lbs

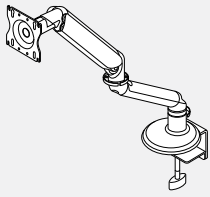

- Comes with clamp and grommet mount, ideal for all desk mounting configurations, minimizing SKU's.
- Adjustable counterbalance cylinder provides smooth 14 1/2" of height adjustment with fingertip control. - counterbalances monitors from 5 lbs. to 20 lbs.
- Double extension arms provide a maximum of 26 3/4" extension from the rear edge of the mounting surface to the VESA Plate for greater monitor adjustment on deep or corner workstations.
- Arms fold back to a minimum dimension of 4 1/2" to provide maximum desk utilization.
- Monitor mounting bracket, with Quick Connect adaptor, contains both 75mm & 100mm hole patterns to match most screen types and compliant with VESA mounting standards.
- Weight gauge provided to allow for quick and easy counterbalance adjustment of the arm prior to installing the screen. Saves time and guesswork especially for multiple arm installations.
- VESA Plate rotates for portrait or landscape viewing with 180° side to side rotation and -90° to +45° tilt for optimal viewing adjustment.
- Die cast aluminum construction provides greater stability and contains high recycled material content with full recyclability.
- Adjustable rotation limiter to restrict arm rotation to 180°, preventing arms from hitting walls.
- Comes with all tools and mounting hardware for quick and easy installation (Tool-free).
- Available in Silver (SIL), Black (BLK) or White (WHT).

PRODUCT CODE	PRICE	SIZE/ INCHES			WEIGHT VOL	
		H	W	D	LBS	FT ³
GAMLDM20	471	38	6	8.5	10.23	1.122

GAMLDM30 • Single Screen Monitor Arm for 10 to 30lbs

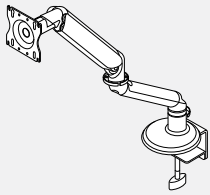

- Comes with clamp and grommet mount, ideal for all desk mounting configurations, minimizing multiple SKU's
- Adjustable counterbalance cylinder provides smooth 14 1/2" of height adjustment with fingertip control - counterbalances monitors from 10 lbs. to 30 lbs.
- Double extension arms provides a maximum of 26.7" extension from the rear edge of the mounting surface to the VESA Plate for greater monitor adjustment on deep or corner workstations
- Arms fold back to a minimum dimension of 4 1/2" to provide maximum desk utilization
- Monitor mounting bracket with Quick Connect adaptor, contains both 75mm & 100mm hole patterns to match most screen types and compliant with VESA mounting standards
- Weight gauge provided to allow for quick and easy counterbalance adjustment of the arm prior to installing the screen.
- Saves time and guesswork especially for multiple arm installations VESA Plate rotates for portrait and landscape viewing with 180° side to side rotation and -90° to +45° tilt for optimal viewing adjustment
- Die cast aluminum construction provides greater stability and contains high recycled material content with full recyclability
- Adjustable rotation limiter to restrict arm rotation to 180°, preventing arms from contacting walls
- Comes with all tools and mounting hardware for quick and easy installation (Tool-free)
- Available in Silver (SIL), Black (BLK) or White (WHT).

PRODUCT CODE	PRICE	SIZE/ INCHES			WEIGHT VOL	
		H	W	D	LBS	FT ³
GAMLDM30	505	38	6	8.5	10.23	1.122

GAMLDM40 • Dual Screen Monitor Arm for combined 15 to 40lbs

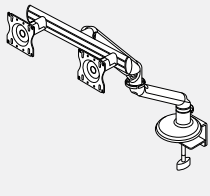

- Comes with clamp and grommet mount, ideal for all desk mounting configurations, minimizing multiple SKU's
- Adjustable counterbalance cylinder provides smooth 14 1/2" of height adjustment with fingertip control and a counterbalance range from 15 lbs. to 40 lbs.
- Double extension arms provide a maximum of 30 3/4" extension from the rear edge of the mounting surface to the VESA Plate for greater monitor adjustment on deep or corner workstations
- Arms fold back to a minimum dimension of 8 3/8" to provide maximum desk utilization
- Monitor mounting bracket with Quick Connect Adaptor, contains both 75mm & 100mm hole patterns to match most screen types and is compliant with VESA mounting standards
- Weight gauge provided to allow for quick and easy counterbalance adjustment of the arm prior to installing the screen. Saves time and guesswork especially for multiple arm installations.
- VESA Plate rotates for portrait and landscape viewing with 180° side to side rotation and -90° to +45° tilt for optimal viewing adjustment
- Die cast aluminum construction provides greater stability and contains high recycled material content with full recyclability
- Adjustable rotation limiter to restrict arm rotation to 180°, preventing arms from contacting walls
- Comes with all tools and mounting hardware for quick and easy installation (Tool-free)
- Available in Silver (SIL), Black (BLK) or White (WHT).

PRODUCT CODE	PRICE	SIZE/ INCHES			WEIGHT VOL	
		H	W	D	LBS	FT ³
GAMLDM40	607	38	6.25	8.5	12.75	1.168

ACCESSORIES

BLVELEDVS • LED Single Arm Lamp

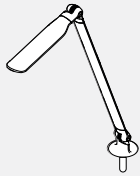

- 7 System watts, 18-fractional LEDs.
- 3500K 250 lumens, 84 CRI.
- Soft touch - instant on, fade to off.
- Infinite dimming 100% down to 15%, last state memory.
- Standard 10 hours turn off (ATO).
- 50,000 hour life LEDs.
- 15 watt, 24 volt wall transformer, 6' cord.
- White (WHT) Silver (SIL) or Black (BLK) - Must specify colour choice.

PRODUCT CODE	PRICE	SIZE/ INCHES			WEIGHT VOL	
		H	W	D	LBS	FT ³
BLVELEDVS	616	8	7	33	7.3	0.98
With Occupancy Sensor						
BLVELEDVSO	920	10	9	35	8.3	1.51

- UL, CUL and CSA compliant, ETL Listed.
- Base not included.

BLVELEDVD • LED Double Arm Lamp

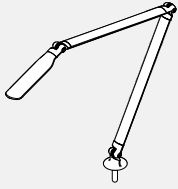

- 7 System watts, 18-fractional LEDs.
- 3500K 250 lumens, 84 CRI.
- Double arm articulation with 20" base to head reaches.
- Soft touch - instant on, fade to off.
- Infinite dimming 100% down to 15%, last state memory.
- Standard 10 hours turn off (ATO).
- 50,000 hour life LEDs.
- 15 watt, 24 volt wall transformer, 6' cord.

PRODUCT CODE	PRICE	SIZE/ INCHES			WEIGHT VOL	
		H	W	D	LBS	FT ³
BLVELEDVD	646	8	7	33	7.6	1.02
With Occupancy Sensor						
BLVELEDVDO	931	10	9	35	8.6	1.57

- White (WHT) Silver (SIL) or Black (BLK) - Must specify colour choice.
- UL, CUL and CSA compliant, ETL Listed.
- Base not included.

BLVELEDRS • LED Single Arm Lamp

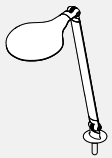

- 7 System watts, 18-fractional LEDs.
- 3500K 250 lumens, 84 CRI.
- Soft touch - instant on, fade to off.
- Infinite dimming 100% down to 15%, last state memory.
- Standard 10 hours turn off (ATO).
- 50,000 hour life LEDs.
- 15 watt, 24 volt wall transformer, 6' cord.
- White (WHT) Silver (SIL) or Black (BLK) - Must specify colour choice.

PRODUCT CODE	PRICE	SIZE/ INCHES			WEIGHT VOL	
		H	W	D	LBS	FT ³
BLVELEDRS	616	8	7	33	7.3	0.98
With Occupancy Sensor						
BLVELEDRSO	920	10	9	35	8.3	1.51

- UL, CUL and CSA compliant, ETL Listed.
- Base not included.

BLVELEDRD • LED Double Arm Lamp

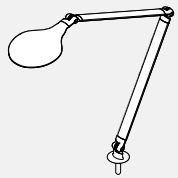

- 7 System watts, 18-fractional LEDs.
- 3500K 250 lumens, 84 CRI.
- Double arm articulation with 20" base to head reaches.
- Soft touch - instant on, fade to off.
- Infinite dimming 100% down to 15%, last state memory.
- Standard 10 hours turn off (ATO).
- 50,000 hour life LEDs.
- 15 watt, 24 volt wall transformer, 6' cord.

PRODUCT CODE	PRICE	SIZE/ INCHES			WEIGHT VOL	
		H	W	D	LBS	FT ³
BLVELEDRD	633	8	7	33	7.6	1.02
With Occupancy Sensor						
BLVELEDRDO	931	10	9	35	8.6	1.57

- White (WHT) Silver (SIL) or Black (BLK) - Must specify colour choice.
- UL, CUL and CSA compliant, ETL Listed.
- Base not included.

Lamp Mounting Options

- White (WHT) Silver (SIL) or Black (BLK) - Must specify colour choice.



Grommet Mount						
PRODUCT CODE	PRICE	SIZE/ INCHES			WEIGHT VOL	
		H	W	D	LBS	FT ³
BLVELEDASM	155	3	6	6	3	0.06



Worksurface Clamp Mount						
PRODUCT CODE	PRICE	SIZE/ INCHES			WEIGHT VOL	
		H	W	D	LBS	FT ³
BLVELEDASCM	155	3	6	6	2	0.04



Slat Wall Mount						
PRODUCT CODE	PRICE	SIZE/ INCHES			WEIGHT VOL	
		H	W	D	LBS	FT ³
BLVELEDASW	155	3	6	6	3	0.06



Panel Mount						
PRODUCT CODE	PRICE	SIZE/ INCHES			WEIGHT VOL	
		H	W	D	LBS	FT ³
BLVELEDAPM	155	3	6	6	3	0.06

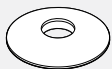

Freestanding Base						
PRODUCT CODE	PRICE	SIZE/ INCHES			WEIGHT VOL	
		H	W	D	LBS	FT ³
BLVELEDAFS	173	4	12	12	6	0.50

ACCESSORIES

GCLEDES • Undercabinet LED Task Light

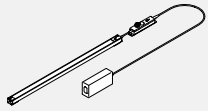

Linear LED Light.

- Includes light fixture with lens and ON/OFF switch.
- Magnet mounted with adhesive metal plates.
- Plug-in power supply with 72" cord length plus 78" DC cord.

Technical information:

- 4100 K Colour Temperature
- 90 Colour Rendering Index
- 30,000 hrs rated Lifespan
- Total power input per light, 9.0 for 24", 13.5 per 36" and 18.0 for 48"

PRODUCT CODE	PRICE	SIZE/ INCHES			WEIGHT VOL	
		H	W	D	LBS	FT ³
GCLEDES24	164	1	22.9	1	2.5	0.135
GCLEDES36	189	1	33.5	1	2.8	0.161
GCLEDES48	209	1	45.5	1	3.2	0.213

GCLEDES-DCS • Undercabinet Daisychain LED Light

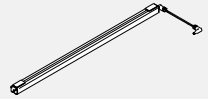

- Undercabinet LED light, 48 inches nominal size , daisychain unit with 1 meter (39 inches) linking cable but no power supply.
- Daisychain units can only be linked up to a total of 48 Watts for all lights on one power supply. This equates to a maximum of 10 feet total nominal length of lights per power supply.

Technical information:

- 4100 K Colour Temperature
- 90 Colour Rendering Index
- 30,000 hrs rated Lifespan
- Total power input per light, 9.0 for 24", 13.5 per 36" and 18.0 for 48"

PRODUCT CODE	PRICE	SIZE/ INCHES			WEIGHT VOL	
		H	W	D	LBS	FT ³
GCLEDES24DSC	134	1	24	1	2.5	0.135
GCLEDES36DSC	157	1	36	1	2.8	0.161
GCLEDES48DSC	178	1	48	1	3.2	0.213

GCLEDESOS • Occupancy Sensor and Dimmer

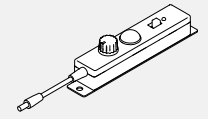

- Inline add-on controller for dimming & occupancy sensor.
- Included, from right to left, a rotary dimmer control, an occupancy sensor and a sensor bypass switch.

PRODUCT CODE	PRICE	SIZE/ INCHES			WEIGHT VOL	
		H	W	D	LBS	FT ³
GCLEDESOS	66	6	2.5	2	0.4	0.500

BEMAE • Mini-Adapt Power Module

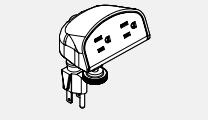

- **Accessory Data/Power House.**
- Attaches to scoop at the back of a worksurface.
- BEMAE1 includes 2 simplex outlets, 6' power cord.
- Available in Black Only

PRODUCT CODE	PRICE	SIZE/ INCHES			WEIGHT VOL	
		H	W	D	LBS	FT ³
BEMAE1	193	2	3.625	3	2.5	0.149

BRED50AC • Duo Module with A+C

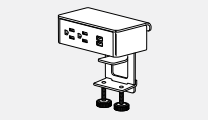

- **The Duo power module is completely integrated with a mounting clamp to attach to the edge of a worksurface.**
- Provides two 15 Amp 120 Volt AC Receptacles; 2.4 amp USB-A port and 60 watt USB-C power delivery port.
- 10' long three-prong cord.
- Available in W - White or B - Black as indicated by last letter of model number.

PRODUCT CODE	PRICE	SIZE/ INCHES			WEIGHT VOL	
		H	W	D	LBS	FT ³
BRED50ACW	695	3	5.5	3.2	3	0.2
BRED50ACB	695	3	5.5	3.2	3	0.2

BREDU51AC • Duo Under Module with A+C

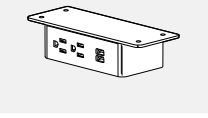

- **The Duo under power module comes with a thin flush mounting bracket to attach to the underside of a work surface or above work surface shelves.**
- Provides two 15 Amp 120 Volt AC Receptacles; 2.4 amp USB-A port and 60 watt USB-C power delivery port.
- 10' long three-prong cord.
- Available in W - White or B - Black as indicated by last letter of model number.

PRODUCT CODE	PRICE	SIZE/ INCHES			WEIGHT VOL	
		H	W	D	LBS	FT ³
BREDU51ACW	695	1.8	5.5	2.8	3	0.2
BREDU51ACB	695	1.8	5.5	2.8	3	0.2

BREDB52AC • Duo Under Module with A+C



- **The Duo bezel power module is embedded and flush-mounted in a piece of furniture or a work surface.**
- Provides two 15 Amp 120 Volt AC Receptacles; 2.4 amp USB-A port and 60 watt USB-C power delivery port.
- 10' long three-prong cord, silver trim.
- Available in W - White or B - Black as indicated by last letter of model number.
- Will not work on W thick worksurfaces, please contact your Customer Service Representative for specific surface applications.

PRODUCT CODE	PRICE	SIZE/ INCHES			WEIGHT VOL	
		H	W	D	LBS	FT ³
BREDB52ACW	695	4	6.5	3.2	3	0.2
BREDB52ACB	695	4	6.5	3.2	3	0.2

ACCESSORIES

BRETP53AC • Trio Module with A+C

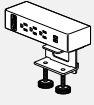

- The Trio plus power module is completely integrated with a mounting clamp to attach to the edge of a work surface or above work surface shelves.
- Provides two 15 Amp 120 Volt AC Receptacles; 2.4 amp USB-A port and 60 watt USB-C power delivery port and an adapter kit containing blank cover, HDMI, RJ45 or VGA adapter brackets. Note: HDMI, RJ45 and VGA connectors are not included.
- 10' long three-prong cord, silver trim.
- Available in W - White or B - Black as indicated by last letter of model number.

PRODUCT CODE	PRICE	SIZE/ INCHES			WEIGHT VOL	
		H	W	D	LBS	FT ³
BRETP53ACW	735	3	8	3.2	2.5	0.14
BRETP53ACB	735	3	8	3.2	2.5	0.14

BRETB55AC • Trio Plus Module with A+C



- The Trio plus bezel power module is embedded and flush-mounted in a piece of furniture or a work surface.
- Provides two 15 Amp 120 Volt AC Receptacles; 2.4 amp USB-A port and 60 watt USB-C power delivery port and an adapter kit containing blank cover, HDMI, RJ45 or VGA adapter brackets. Note: HDMI, RJ45 and VGA connectors are not included.
- 10' long three-prong cord, silver trim.
- Available in W - White or B - Black as indicated by last letter of model number.
- Will not work on W thick worksurfaces, please contact your Customer Service Representative for specific surface applications.

PRODUCT CODE	PRICE	SIZE/ INCHES			WEIGHT VOL	
		H	W	D	LBS	FT ³
BRETB55ACW	752	4	9	3.2	2.5	0.14
BRETPB55ACB	752	4	9	3.2	2.5	0.14

Telecom Plates

Note: To be used in conjunction with BPGDPS21 and BPGDPS41.



PRODUCT CODE	PRICE
Black telecom plate with 2 RJ45 cat 6 data ABLBB	245



Black telecom plate with 3 RJ45 cat 6 data ABLBBB	361
--	-----



Black telecom plate with 4 RJ45 cat 6 data ABLBBBB	476
---	-----

ACCESSORIES

GCRTMCS401 • Recessed Power Block, 1 Duplex, 1 Data Knock-outs, 1 Power Duplex

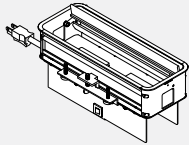

- Single sided recessed power block with 1 regular duplex and 1 data knock-out on top, 1 power duplex on bottom.
- 10 ft power cord with straight plug.
- Telecom plates ordered separately.
- Available in Black - B, Tungsten - T or Designer White - W as indicated by last letter of model number; duplexes always grey.
- Not approved for daisy-chain applications.

PRODUCT CODE	PRICE	SIZE			WEIGHT LBS	VOL FT ³
		H	W	D		
GCRTMCS401B	578	4.86	10.78	4.22	4.3	0.51
GCRTMCS401T	578	4.86	10.78	4.22	4.3	0.51
GCRTMCS401W	578	4.86	10.78	4.22	4.3	0.51

GCRTMCS421 • Recessed Power Block, 1 Power including USB A+C, 1 Data Knock-outs, 1 Power Duplex

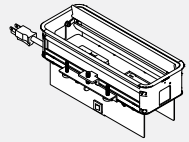

- Single sided recessed power block with 1 power and USB A+C duplex and 1 data knock-out on top, 1 power duplex on bottom.
- USB Type A port charges maximum 2.4 amps at 5V and Type C port charges maximum 3 amps at 5V.
- 10 ft power cord with straight plug.
- Telecom plates ordered separately.
- Available in Black - B, Tungsten - T or Designer White - W as indicated by last letter of model number; duplexes always grey.
- Not approved for daisy-chain applications.

PRODUCT CODE	PRICE	SIZE			WEIGHT LBS	VOL FT ³
		H	W	D		
GCRTMCS421B	759	4.86	10.78	4.22	4.3	0.51
GCRTMCS421T	759	4.86	10.78	4.22	4.3	0.51
GCRTMCS421W	759	4.86	10.78	4.22	4.3	0.51

GCRTMCD602 • Recessed Power Block, 2 Duplex, 2 Data Knock-outs, 1 Power Duplex

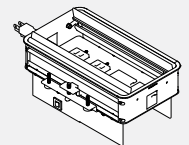

- Double sided recessed power block with 2 regular duplex and 2 data knock-outs on top, 1 power duplex on bottom.
- 10 ft power cord with straight plug.
- Telecom plates ordered separately.
- Available in Black - B, Tungsten - T or Designer White - W as indicated by last letter of model number; duplexes always grey.
- Not approved for daisy-chain applications.

PRODUCT CODE	PRICE	SIZE			WEIGHT LBS	VOL FT ³
		H	W	D		
GCRTMCD602B	660	4.86	10.78	6.22	5.9	0.51
GCRTMCD602T	660	4.86	10.78	6.22	5.9	0.51
GCRTMCD602W	660	4.86	10.78	6.22	5.9	0.51

GCRTMCD622 • Recessed Power Block, 1 Duplex, 1 Power including USB A+C, 2 Data Knock-outs, 1 Power Duplex

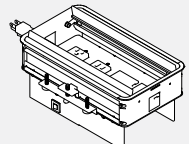

- Double sided recessed power block with 1 regular duplex, 1 power and USB A+C and 2 data knock-outs on top, 1 power duplex on bottom.
- USB Type A port charges maximum 2.4 amps at 5V and Type C port charges maximum 3 amps at 5V.
- 10 ft power cord with straight plug.
- Telecom plates ordered separately.
- Available in Black - B, Tungsten - T or Designer White - W as indicated by last letter of model number; duplexes always grey.
- Not approved for daisy-chain applications.

PRODUCT CODE	PRICE	SIZE			WEIGHT LBS	VOL FT ³
		H	W	D		
GCRTMCD622B	831	4.86	10.78	6.22	6.1	0.51
GCRTMCD622T	831	4.86	10.78	6.22	6.1	0.51
GCRTMCD622W	831	4.86	10.78	6.22	6.1	0.51

GCRTMCD642 • Recessed Power Block, 2 Power including USB A+C, 2 Data Knock-outs, 1 Power Duplex

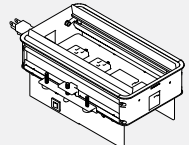

- Double sided recessed power block with 2 power and USB A+C and 2 data knock-outs on top, 1 power duplex on bottom.
- USB Type A port charges maximum 2.4 amps at 5V and Type C port charges maximum 3 amps at 5V.
- 10 ft power cord with straight plug.
- Telecom plates ordered separately.
- Available in Black - B, Tungsten - T or Designer White - W as indicated by last letter of model number; duplexes always grey.
- Not approved for daisy-chain applications.

PRODUCT CODE	PRICE	SIZE			WEIGHT LBS	VOL FT ³
		H	W	D		
GCRTMCD642B	1001	4.86	10.78	6.22	6.3	0.51
GCRTMCD642T	1001	4.86	10.78	6.22	6.3	0.51
GCRTMCD642W	1001	4.86	10.78	6.22	6.3	0.51

DABAR • Power Bar

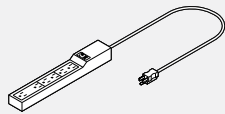

- Power bar with 5 + 1 receptacles (one spaced wide for adapter use), built-in transient voltage surge suppressor and power switch.
- Standard with 10' cord.
- Integrated key hole mounting in the back.
- Rating 15A, 125V, AC 60Hz, 1875W.
- Suppressed voltage rating: 330V peak.

PRODUCT CODE	PRICE	SIZE/ INCHES			WEIGHT LBS	VOL FT ³
		H	W	D		
DABAR	65			12	2	0.02

BABC • Wire Manager



- Attaches to the underside of the worksurface with a peel and stick adhesive that is located on the top of the wire manager. Comes 10 per package.
- Black only

PRODUCT CODE	PRICE	SIZE/ INCHES			WEIGHT LBS	VOL FT ³
		H	W	D		
BABC04	41	2	4	2	2	0.14

BRACS • Cable Snake



- Flexible cable management trough.
- Two pathways within the snake, one for data/communication and one for routing power cables.
- Clear (CLR) available only.

PRODUCT CODE	PRICE	SIZE/ INCHES			WEIGHT LBS	VOL FT ³
		H	W	D		
BRACS	127	30	8		3	0.19
BRACSH	213	49	8		5	0.27

ACCESSORIES

ModPower Power Solution

- Power solutions for flexible spaces. Connect up to four units (in Canada)/six units in the USA from a single infeed with NEMA plug to deliver power and charging ports to the table top. In-surface modules and clamp on modules available.
- Easy to install; code compliant that allows users to optimize any space providing convenient power access. Perfect for training areas, meeting rooms, in-office workstations and more. Units feature tamper-resistant receptacles as well as both USB-A and USB-C charging ports.
- Easy to use connectors that are touch-safe with added latch to prevent unintended separation. Easy push together to connect, and simple press down on latch to disconnect.
- Maximum overall length not to exceed 48.5 feet per infeed. UL listed to UL962A SD, the standard for furniture power distribution units for portable/moveable work space tables.
- Certified to CSA standard C22.2 No. 203-16.
- Will work with Licence, Terina and Bridges Products.

- Surface mounted module ships with a clamp mount that will accommodate any material 1/2" to 1-1/2" thick; additional brackets are also included for screw in mounting options that can accommodate vertical or horizontal positions.
- Modules can be integrated into surfaces but the surface must be specified as a special.

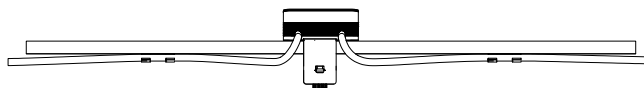
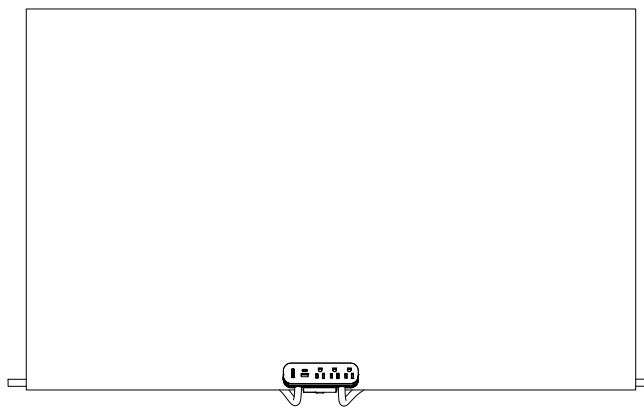
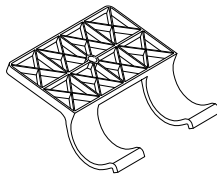

GMDSF10 • ModPower In Surface Starter Unit

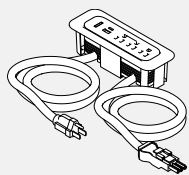

- ModPower starter unit includes one 10' cord with a NEMA plug and one 3' connector cord.
- Unit equipped with three 15A tamper resistant receptacles, one USB-A and one USB-C charging ports and a circuit breaker.
- 4 cable management cord clips included.
- MG at the end of the code indicates a magnesium finish, while WH is a white finish.

PRODUCT CODE	PRICE	DIMENSIONS			WEIGHT		VOL FT ³
		H	W	D	LBS		
GMDSF10MG	597	2.63	7.63	2.63	3.44	1.0	
GMDSF10WH	597	2.63	7.63	2.63	3.44	1.0	

GMDCF3 • ModPower In Surface Middle Unit

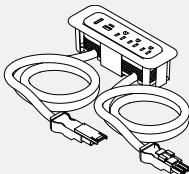

- ModPower middle unit includes two 3' connector cords.
- Unit equipped with three 15A rated 12A tamper resistant receptacles, one USB-A and one USB-C charging ports and a circuit breaker.
- 4 cable management cord clips included.
- MG at the end of the code indicates a magnesium finish, while WH is a white finish.

PRODUCT CODE	PRICE	DIMENSIONS			WEIGHT		VOL FT ³
		H	W	D	LBS		
GMDCF3MG	562	2.63	7.63	2.63	2.44	1.0	
GMDCF3WH	562	2.63	7.63	2.63	2.44	1.0	

GMDEF3 • ModPower In Surface End Unit

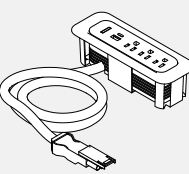

- ModPower end unit includes one 3' connector cord.
- Unit equipped with three 15A rated 12A tamper resistant receptacles, one USB-A and one USB-C charging ports and a circuit breaker.
- 2 cable management cord clips included.
- MG at the end of the code indicates a magnesium finish, while WH is a white finish.

PRODUCT CODE	PRICE	DIMENSIONS			WEIGHT		VOL FT ³
		H	W	D	LBS		
GMDEF3MG	494	2.63	7.63	2.63	1.85	1.0	
GMDEF3WH	494	2.63	7.63	2.63	1.85	1.0	

ACCESSORIES

GMDSA10 • ModPower Starter Mounted Unit

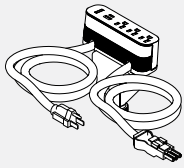

- ModPower starter unit includes one 10' cord with a NEMA plug and one 3' connector cord.
- Unit equipped with three 15A tamper resistant receptacles, one USB-A and one USB-C charging ports and a circuit breaker.
- Includes edge clamp and 3 other mounting methods; and 4 cable management cord clips.
- MG at the end of the code indicates a magnesium finish, while WH is a white finish.

PRODUCT CODE	PRICE	PRICE			WEIGHT		VOL FT ³
		H	W	D	LBS	FT ³	
GMDSA10MG	631	2.5	6.13	1.75	4.33	1.0	
GMDSA10WH	631	2.5	6.13	1.75	4.33	1.0	

GMDCA3 • ModPower Middle Mounted Unit

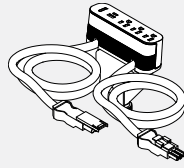

- ModPower middle unit includes two 3' connector cords.
- Unit equipped with three 15A rated 12A tamper resistant receptacles, one USB-A and one USB-C charging ports and a circuit breaker.
- Includes edge clamp and 3 other mounting methods; and 4 cable management cord clips.
- MG at the end of the code indicates a magnesium finish, while WH is a white finish.

PRODUCT CODE	PRICE	PRICE			WEIGHT		VOL FT ³
		H	W	D	LBS	FT ³	
GMDCA3MG	597	2.5	6.13	1.75	3.33	1.0	
GMDCA3WH	597	2.5	6.13	1.75	3.33	1.0	

GMDEA3 • ModPower End Mounted Unit

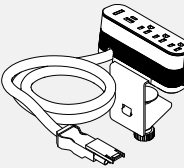

- ModPower end unit includes one 3' connector cord.
- Unit equipped with three 15A rated 12A tamper resistant receptacles, one USB-A and one USB-C charging ports and a circuit breaker.
- Includes edge clamp and 3 other mounting methods; and 2 cable management cord clips.
- MG at the end of the code indicates a magnesium finish, while WH is a white finish.

PRODUCT CODE	PRICE	PRICE			WEIGHT		VOL FT ³
		H	W	D	LBS	FT ³	
GMDEA3MG	528	2.5	6.13	1.75	2.75	1.0	
GMDEA3WH	528	2.5	6.13	1.75	2.75	1.0	

GMDCLIPS • ModPower Management Clips

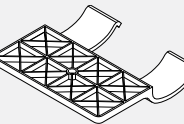

- Includes 10 clips.

PRODUCT CODE	PRICE	PRICE			WEIGHT		VOL FT ³
		H	W	D	LBS	FT ³	
GMDCLIPS	102	0.6	2.6	2.5	0.3	0.2	

GMDJ36BK • ModPower Interconnecting Jumper

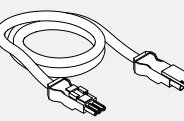

- ModPower interconnecting jumper cord to add an additional 3 feet of cord length between ModPower units.
- Package of 2, each 3 feet with male & female connector.

PRODUCT CODE	PRICE	PRICE			WEIGHT		VOL FT ³
		H	W	D	LBS	FT ³	
GMDJ36BK	329		36		1.38	0.9	

GMDPC22W • Slim Desktop Power Module, 2 Duplex

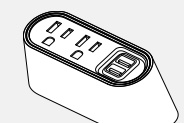

- Desktop power center with two 15A tamper resistant power receptacles, one USB-A and one USB-C (provides 3.1A); 10' power cord.
- Includes three mounting options (i) a screw-in mounting plate for forward facing outlets; or (ii) an under surface mount bracket; or (iii) a clamp mounting kit for 0.5-1.5" thick surfaces.
- Gloss white body with grey face.

PRODUCT CODE	PRICE	PRICE			WEIGHT		VOL FT ³
		H	W	D	LBS	FT ³	
GMDPC22W	449	2.25	4.88	2.25	2.5	0.5	

GMDPC32W • Slim Desktop Power Module, 3 Duplex

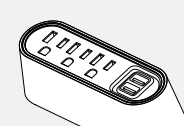

- Desktop power center with three 15A tamper resistant power receptacles, one USB-A and one USB-C (provides 3.1A); 10' power cord.
- Includes three mounting options (i) a screw-in mounting plate for forward facing outlets; or (ii) an under surface mount bracket; or (iii) a clamp mounting kit for 0.5-1.5" thick surfaces.
- Gloss white body with grey face.

PRODUCT CODE	PRICE	PRICE			WEIGHT		VOL FT ³
		H	W	D	LBS	FT ³	
GMDPC32W	586	2.25	6.00	2.25	2.6	0.5	

ACCESSORIES

BAVC • Vertical Wire Channel



- PVC extrusion attaches to panel vertical to provide enclosure for a power or light cord.
- Available in 16" and 32" lengths, six per package.
- Can be cut to required lengths on site.
- Panel frame finish

PRODUCT CODE	PRICE	SIZE/	INCHES		WEIGHT VOL	
		H	W	D	LBS	FT ³
BAVC016	38		16		0.5	0.018
BAVC032	80		32		1.0	0.036

VVCM • Wire Manager

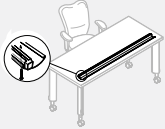

- Replacement wire manager can be added to Viceversa tables. Wire manager neatly organizes and stores electrical and communication cables.
- Two lengths, 46" for tops 60" and under, 58" for tops 72".
- Mounts below surface via threaded metal inserts.
- Integrated steel reinforcement bar.
- Not required on oval, 1/2 ellipse, 1/2 moon, square or round table.

PRODUCT CODE	PRICE	SIZE/	INCHES			WEIGHT VOL	
		H	D	W	LBS	FT ³	
VVCM43	143	3	5	46	8	0.67	
VVCM55	169	3	5	58	9	0.85	

BAR • Panel Mounted Slotted Accessory Rail for Boulevard

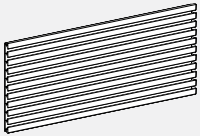

- Includes 10 horizontal slats for hanging capacity.
- Includes mousing hardware.
- Panel frame finish

Hangs on standard Boulevard panels and accepts standard accessories.

PRODUCT CODE	PRICE	SIZE/	INCHES			WEIGHT VOL	
		H	W	D	LBS	FT ³	
BAR18	161	10.6	18	0.5	3	0.12	
BAR24	176	10.6	24	0.5	4	0.17	
BAR30	195	10.6	30	0.5	5	0.22	
BAR36	211	10.6	36	0.5	6	0.26	
BAR42	231	10.6	42	0.5	7	0.31	
BAR48	246	10.6	48	0.5	8	0.35	
BAR54	262	10.6	54	0.5	9	0.43	
BAR60	280	10.6	60	0.5	10	0.49	

BALB • Panel Mounted Load Bar for Boulevard

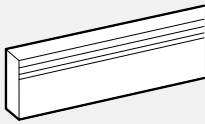

- Can be panel mounted or wall mounted on rail (BHV01 or BHV02).
- Includes mousing brackets and end caps.
- Panel frame finish

PRODUCT CODE	PRICE	SIZE/	INCHES			WEIGHT VOL	
		H	W	D	LBS	FT ³	
BALB18	122	3.5	18	0.75	2	0.031	
BALB24	133	3.5	24	0.75	2	0.038	
BALB30	146	3.5	30	0.75	3	0.048	
BALB36	162	3.5	36	0.75	3	0.057	
BALB42	187	3.5	42	0.75	4	0.067	
BALB48	213	3.5	48	0.75	4	0.076	
BALB54	234	3.5	54	0.75	5	0.086	
BALB60	247	3.5	60	0.75	5	0.096	

BADLB • Panel Mounted Accessory Rail for Boulevard

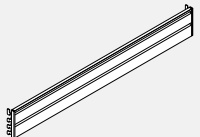

- Enables accessory items to be hung from a panel.
- Includes end caps and mounting brackets.

PRODUCT CODE	PRICE	SIZE/	INCHES			WEIGHT VOL	
		H	W	D	LBS	FT ³	
BADLB18	195	4.23	18	1.53	2.34	0.07	
BADLB24	205	4.23	24	1.53	2.88	0.09	
BADLB30	217	4.23	30	1.53	3.42	0.11	
BADLB36	231	4.23	36	1.53	3.97	0.13	
BADLB42	240	4.23	42	1.53	4.51	0.16	
BADLB48	253	4.23	48	1.53	5.05	0.18	
BADLB54	265	4.23	54	1.53	5.59	0.20	
BADLB60	275	4.23	60	1.53	6.13	0.22	

BABB01 • Binder Bin

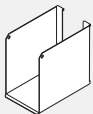

- Load bar/accessory rail mounted metal binder bin.
- Panel frame finish

PRODUCT CODE	PRICE	SIZE/	INCHES			WEIGHT VOL	
		H	W	D	LBS	FT ³	
BABB01	58	9	5.75	9.25	1.85	0.21	

BAFS01 • Flip Sorter

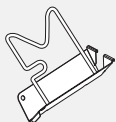

- Load bar/accessory rail mounted metal flip sorter. Comes with chrome wire.
- Panel frame finish

PRODUCT CODE	PRICE	SIZE/	INCHES			WEIGHT VOL	
		H	W	D	LBS	FT ³	
BAFS01	40	9	3	9	0.6	0.14	

ACCESSORIES

BASS01 • Slant Sorter

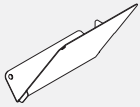

Right Shown

- Load bar/accessory rail mounted metal slant sorter.
- Panel frame finish

PRODUCT CODE	PRICE	SIZE/ INCHES			WEIGHT VOL	
		H	W	D	LBS	FT ³
BASS01R	35	9.25	2.75	9	1	0.28
BASS01L	35	9.25	2.75	9	1	0.28

BALT • Letter Tray/Legal Tray

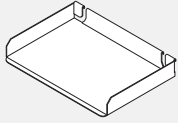

- Load bar/accessory rail mounted metal letter or legal tray.
- Panel frame finish

PRODUCT CODE	PRICE	SIZE/ INCHES			WEIGHT VOL	
		H	W	D	LBS	FT ³
BALT01	43	1.75	12	8.75	0.5	0.15
BALT01LGL	58	1.75	14.7	8.75	0.5	0.15

BAMB01 • Media Bin

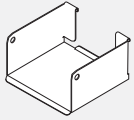

- Load bar/accessory rail mounted metal media bin.
- Panel frame finish

PRODUCT CODE	PRICE	SIZE/ INCHES			WEIGHT VOL	
		H	W	D	LBS	FT ³
BAMB01	43	3	5.75	5.25	0.8	0.05

BAUT01 • Utility Tray

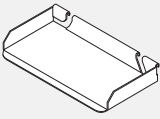

- Load bar/accessory rail mounted metal utility tray.
- Panel frame finish

PRODUCT CODE	PRICE	SIZE/ INCHES			WEIGHT VOL	
		H	W	D	LBS	FT ³
BAUT01	30	1	7.5	4	0.5	0.02

BAPP01 • Mail Box

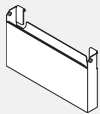

- Freestanding unit or load bar/accessory rail mounted.
- Panel frame finish

PRODUCT CODE	PRICE	SIZE/ INCHES			WEIGHT VOL	
		H	W	D	LBS	FT ³
BAPP01	72	7	12	1.75	2	0.25

BATH01 • Telephone Holder

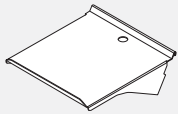

- Load bar/rail mounted telephone holder.
- Panel frame finish

PRODUCT CODE	PRICE	SIZE/ INCHES			WEIGHT VOL	
		H	W	D	LBS	FT ³
BATH01	68	2	8	10	2	0.26

BAPD1821 • Pencil Drawer

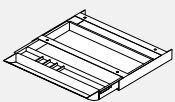

- Provides accommodation for writing instruments and small items at the workspace.
- Attaches to the underside of worksurface with drawer slides.
- Available in Black ABS Only

PRODUCT CODE	PRICE	TAILLE/ POUCES			POIDS VOLUME	
		H	L	P	LB	PI ³
BAPD1821	125	1.9	21.2	16.1	0.5	0.3

BAHO • Coat Hook

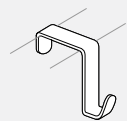

- Over the panel mounted coat hook for Boulevard 1 panels only. Priced six per package.
- Panel Frame Finish

PRODUCT CODE	PRICE	SIZE/ INCHES			WEIGHT VOL	
		H	W	D	LBS	FT ³
BAHO3080	63	3	1	3	0.2	0.001

BAHB3CH • Coat Hook for System 3

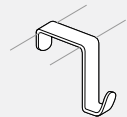

- Over the panel mounted coat hook for Boulevard, System 3 panels or Boulevard 1 panels with top trim. Priced six per package.
- Panel Frame Finish

PRODUCT CODE	PRICE	SIZE/ INCHES			WEIGHT VOL	
		H	W	D	LBS	FT ³
BAHB3CH	83	3	1	3	0.2	0.001

DAHOCH • Coat Hook for Diet

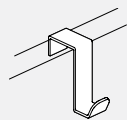

- Panel mounted coat hook Diet Panels.
- Panel Frame Finish

PRODUCT CODE	PRICE	SIZE/ INCHES			WEIGHT VOL	
		H	W	D	LBS	FT ³
DAHOCH	29	3	0.75	3	0.2	0.001

ACCESSORIES

BPNP • Boulevard Name Plate

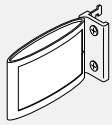

- Name plate attaches to 1" increment slots of Boulevard. It can be set either as a single-sided (parallel to panel surface) or double-sided (perpendicular to panel surface - for aisle applications, displaying name on both sides).
- Injection molded frame and die-cast base with black rubberized finish. Steel bracket and fasteners included.
- Includes two slide-in name cards.

PRODUCT CODE	PRICE	SIZE/ INCHES			WEIGHT VOL	
		H	W	D	LBS	FT ³
BPNP01	82	3.3	5.3	1.25	0.3	0.013

DPNP01 • Diet Name Plate

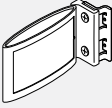

- Name plate can be set either as a single-sided (parallel to panel surface) or double-sided (perpendicular to panel surface - for aisle applications, displaying name on both sides).
- Injection molded frame and die-cast base with black rubberized finish. Steel bracket and fasteners included.
- Includes two slide-in name cards.

PRODUCT CODE	PRICE	SIZE/ INCHES			WEIGHT VOL	
		H	W	D	LBS	FT ³
DPNP01	82	3.3	5.3	1.25	0.3	0.013

BHTPO1 • Bracket to connect Licence Towers to Boulevard Panels

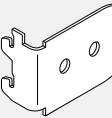

- Panel Frame Finish

PRODUCT CODE	PRICE	SIZE/ INCHES			WEIGHT VOL	
		H	W	D	LBS	FT ³
BHTPO1	64	2	2.5	1	2	0.05

BATB • Fabric Tackboard for Boulevard

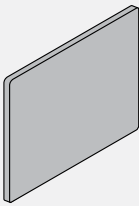

- To provide a tackable surface for notes and memos in a work area. Panel mounted.
- Includes mounting brackets.
- Class "A" Fire Rated Fabric.

PRODUCT CODE	PRICE		SIZE/ INCHES			WEIGHT VOL	
	GR1	GR2	H	W	D	LBS	FT ³
BATB2430	298	312	24	30		3	0.416
BATB2436	340	352	24	36		4	0.500
BATB2442	388	404	24	42		4	0.583
BATB2448	433	462	24	48		5	0.666
BATB2454	478	509	24	54		5	0.750
BATB2460	524	555	24	60		6	0.833
BATB2472	636	678	24	72		6	0.999

BAWB • Write Board for Boulevard

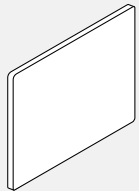

- To provide a writing surface in a work area. Panel mounted.
- Includes mounting brackets.
- Black Trim Only

PRODUCT CODE	PRICE	SIZE/ INCHES			WEIGHT VOL	
		H	W	D	LBS	FT ³
BAWB2436	350	24	36		13	0.500
BAWB2442	391	24	42		15	0.583
BAWB2448	454	24	48		18	0.666

BAMT12 • Marker Tray

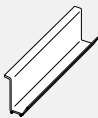

- Marker tray intended for BATB and BAWB only.

PRODUCT CODE	PRICE	SIZE/ INCHES			WEIGHT VOL	
		H	W	D	LBS	FT ³
BAMT12	16		12		0.5	0.01

BATP • Touch Up Paint Kit



- Paint to match panel frame colours for easy touch ups. 1/2oz. (15ml) bottle

PRODUCT CODE	PRICE	SIZE/ INCHES			WEIGHT VOL	
		H	W	D	LBS	FT ³
BATP91	41				0.41	0.1

ACCESSORIES

CATB • Tackboard for Compile

- Mounting brackets included.

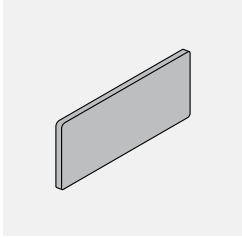

PRODUCT CODE	PRICE		SIZE/INCHES			WEIGHT VOL	
	GR1	GR2	H	W	D	LBS	FT ³
CATB1024	192	200	10	24	1	1	0.175
CATB1030	201	212	10	30	1	1	0.208
CATB1036	221	236	10	36	1	2	0.250
CATB1042	245	260	10	42	1	2	0.291
CATB1048	270	284	10	48	1	3	0.333
CATB1054	297	317	10	54	1	3	0.370
CATB1060	317	340	10	60	1	4	0.415
CATB2124	276	284	21	24	1	2	0.340
CATB2130	298	312	21	30	1	2	0.406
CATB2136	340	352	21	36	1	3	0.490
CATB2142	388	404	21	42	1	3	0.573
CATB2148	433	462	21	48	1	4	0.656
CATB2154	478	509	21	54	1	4	0.740
CATB2160	524	555	21	60	1	5	0.823
CATB2424	276	284	24	24	1	3	0.350
CATB2430	298	312	24	30	1	3	0.416
CATB2436	340	352	24	36	1	4	0.500
CATB2442	388	404	24	42	1	4	0.583
CATB2448	433	462	24	48	1	5	0.666
CATB2454	478	509	24	54	1	5	0.750
CATB2460	524	555	24	60	1	6	0.833

CAWB • Whiteboard for Compile

- Mounting brackets included.

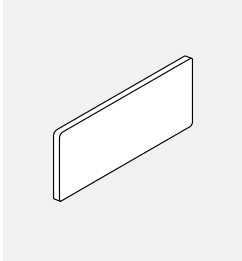

PRODUCT CODE	PRICE	SIZE/INCHES			WEIGHT VOL	
		H	W	D	LBS	FT ³
CAWB1024	168	10	24	0.625	5	0.210
CAWB1036	190	10	36	0.625	6	0.394
CAWB1042	211	10	42	0.625	7	0.470
CAWB1048	240	10	48	0.625	8	0.540
CAWB2124	279	21	24	0.625	11	0.400
CAWB2136	333	21	36	0.625	12	0.485
CAWB2142	372	21	42	0.625	14	0.564
CAWB2148	433	21	48	0.625	17	0.621
CAWB2424	279	24	24	0.625	12	0.422
CAWB2436	333	24	36	0.625	13	0.500
CAWB2442	372	24	42	0.625	15	0.583
CAWB2448	433	24	48	0.625	18	0.666

CALB • Load Bar for Compile

- Available in standard panel frame colours.
- Mounting brackets and clear end caps included.
- Optional - Load Bar can connect to each other to create a "Slat Wall".

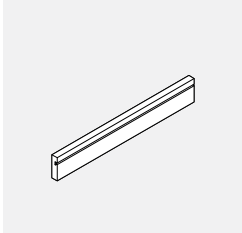

PRODUCT CODE	PRICE	SIZE/INCHES			WEIGHT VOL	
		H	W	D	LBS	FT ³
CALB24	133	2.25	24	1	2	0.083
CALB30	146	2.25	30	1	3	0.048
CALB36	161	2.25	36	1	3	0.057
CALB42	187	2.25	42	1	4	0.067
CALB48	213	2.25	48	1	4	0.076
CALB54	234	2.25	54	1	5	0.086
CALB60	247	2.25	60	1	5	0.096

CMECC • Cable Cover for Compile

- Available in standard panel frame colours.
- Comes 6 per package

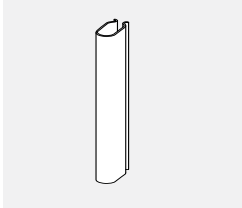

PRODUCT CODE	PRICE	SIZE/INCHES			WEIGHT VOL	
		H	W	D	LBS	FT ³
CMECC21	31	21	0.5	1	0.5	0.018
CMECC36	56	36	0.5	1	1.0	0.036

CMCH01 • Coat Hook for Compile

- Coat hook for Compile panels.

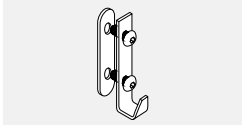

PRODUCT CODE	PRICE	SIZE/	INCHES		WEIGHT VOL	
		H	W	D	LBS	FT ³
CMCH01	43	5.5	0.65	1	0.06	0.001

ENVIRONMENTAL COMMITMENT

Evolve Systems-Protecting the Environment for Future Generations

- Our environmental success story began with the challenge to create an office system that would meet today's business requirements while maintaining a firm commitment to save and protect the environment.
- Sustainability became a part of the creative focus and development of Evolve that incorporates the latest technology and design features to provide excellent performance at a competitive price.
- As government and industry environment ratings such as LEED become more prevalent, Evolve offers designers and architects functional, attractive, and economical office designs that meet these standards.
- Evolve is a leader in reducing waste and recycling materials in the manufacture of its products. We make extensive use of recycled plastic and wood waste from other Global factories.
- Evolve is committed to exercise diligence in the continuous improvement of our environmental systems, the prevention of pollution, and to comply with both the spirit and the letter of all relevant environmental legislation.
- Evolve panels are 100% recyclable at the end of their lifespan. Nothing from an Evolve panel needs to end up in a landfill.

Evolve Systems-Product Information

- Evolve offers fabrics that are made from 100% recycled polyester, which means less waste going to landfills, reduced demand for petroleum products, and fewer environmental impacts from the processing of petroleum products into polyester.
- Evolve has developed a panel interior made from 100% recycled wood and polypropylene. Through innovative design and technology, Evolve utilizes waste that would have normally been sent to landfill.
- Evolve panels are insulated with a mineral fibre insulation made from slag (an inert steel by-product) and basalt rock. This material's high density provides maximum sound absorption to reduce noise in the work environment. Mineral fibre insulation is fire resistant, water repellent and will not support the growth of fungi or mildew.

Evolve Systems-Special Product

- When ordering specials, copies of the Special Quote Form (SQ's) must be submitted with the order to ensure accuracy of the special product.

PANELS

- Panel Fabric modules consist of Module Frames, Module Interiors and Fabric Skins. **Module Construction**

- Module Frames feature a combination of 100% recycled PVC horizontal extrusions and unique, molded vertical ends made from equal parts of 100% recycled polypropylene and 100% recycled wood (from Global's factory waste).
- Module Interiors feature honeycomb made from 75% recycled kraft paper and acoustical mineral board derived from slag (inert steel by-product) and volcanic material.

Fabric

- Fabric offerings include selections woven with 100% recycled yarn.

Panel Frame

- Panel Frame is made of cold rolled steel which has a recycled content of 25%. **Metal Components/Raceway Finish**
- All metal components are painted with environmentally friendly epoxy powder.
- Raceway interiors are coated with recycled epoxy powder.

Panel Options

- Factory installed Panel Modules are available in 6", 12", 18" and 24" heights and a variety of options including: Semi-Tackable Fabric Acoustic, Glass, Open, Slatwall, Laminate and Whiteboard Modules.

- Standard Fabric Acoustic Panels come in a variety of heights: 30", 42", 54" and 66". Monolithic Panels are available in 42", 48", 54".
- Panel Extension Modules attach to the top of the base structural panels. These are offered in 6", 12", 18" and 24" heights and can be stacked one on top of the other to create a visually continuous panel in excess of 14'-0" high.
- Panels can be modified on-site by swapping fabric modules for glazed, open, laminate or whiteboard modules at any time after the initial installation. Panels can also be altered in height by replacing the vertical liners (panel sides) and adding or subtracting modules as required.
- Panel widths come in 8 sizes including: 18", 24", 30", 36", 42", 48", 54" and 60".
- All Fabric Modules are semi-tackable.
- One sided and two sided whiteboard modules are available.
- Panels conform to CGSB and ANSI/BIFMA standards.
- Evolve panels carry an acoustical rating of .65 NRC and 20 STC.
- Rigid, steel panel frame is 2 7/8" thick.
- Levelling glides extend 2 1/2".

VOICE/DATA AND ELECTRIC POWER

- Voice/data cables can be laid in at both the base and the top of the panel.
- 8 wire, 4 circuit electrical capability, 2 utility + 2 dedicated circuits, each with 10 gauge (oversized) neutrals. All circuits are 20 amps (15 CSA).
- Additional 8 wire features. No tools required.
- Both power and data is available at desk height.
- Raceway Cover opening sizes conform to the ANSI/TIA/EIA Furniture Opening Standard of 1.37 x 2.68.
- Panels and electrical components are CSA/UL approved.

WORKSURFACES

- Worksurfaces come in a variety of shapes and sizes. Essentially, they are 18", 24" or 30" deep and are available in 6" increments from 24" to 72" wide. Custom tops are available at a modest upcharge and on the same delivery schedule.
- Cable scoops located at the back of each worksurface provide routing of power and data cables.
- Metal inserts for the connection of supporting hardware.
- Thermally fused and high pressure laminate tops are available, both with tough PVC edging.
- All worksurfaces utilize balanced construction.
- Curved worksurfaces incorporate ergonomic design.

OVERHEAD STORAGE

Features:

- Steel and all laminate based options
- Panel mount and up-mount options
- Completely enclosed unit for 16" overheads
- Style dependent- ship fully assembled or knocked down
- 13.5" inside height for oversized binders
- Metal-to-metal connection
- Lock secures into bottom shelf
- Doors operate smoothly
- Flipper door retrofittable on site
- Safety bracket used for extra support
- Reinforcement built in for larger unit
- Can be removed and reconfigured without disassembly

Fronts:

- Open or closed fronts
- AODA compliant options available

Sizes:

- Overheads - 7 widths in 6" increments
- Shelves - 7 widths in 6" increments
- 13.5" deep welded overheads
- 14.2" deep AODA overheads
- 16.5" deep welded overheads for EDP, ring binder, letter/legal

Paint:

- Dry epoxy powder coating

PEDESTALS

Features:

- Premium quality steel reinforced welded construction
- Double wall construction on all drawer fronts
- Fully progressive suspension system
- Full pull
- Worksurface supporting option
- Full extension roller bearing glides on all file drawers
- Rubber bumpers for quietness
- Movable drawer divider in box drawers
 - Pencil Tray
 - Each file drawer includes a hanging file bar (22" and 28" depth only)
- 3 depths with varying filing capacity
- Random or specific keying instructions available

Construction:

- Double wall drawer fronts
- 18-20 gauge steel case components

Sizes:

- (Prime) 18", 22", 28" depth
- (9300) 19", 23", 29" depth

Types:

- Worksurface Supporting, Mobile, Freestanding

Paint:

- Dry epoxy powder coating

WARRANTIES AND PERFORMANCE

- Lifetime Warranty.
- Non Obsolescence Warranty.
- Aggressive product pricing.
- Reduced cost of assembly and reconfiguration.
- Exceptions: panel textiles, electrical devices and task lights - 5 years.
- ISO9001:2000 Registered.
- ISO14001:2004 Registered.
- Greenguard Certified.
- ANSI/BIFMA CGSB testing on all products.
- Run through capability.

PANELS • TECHNICAL INFORMATION

- Evolve panels are 2 7/8" thick. They are available in four (5) basic heights: 30", 42", 48", 54" and 66" and eight (8) widths: 18" to 60" in 6" increments.
- Individual fabric covered acoustic modules incorporated into a rigid steel frame.
- Opposite side of each module may have a different fabric within the same grade at no upcharge.
- If different grades of fabric are used on one panel, the entire panel must be priced at highest grade.
- A low profile top cap is included. It allows for storage of up to 8, 5mm (0.002") diameter data cables.
- No panel creep.
- All Panels, except Monolithic are composed of a 6" raceway module and a 24"

high base module. Subsequent heights are created by adding either a 12" high module or a 24" high module.

- Raceway openings are 1.37 x 2.68
- 12" high and 24" high modules of all types (fabric, laminate, glass, open) are available for field installation. Contact your Customer Service Representative for requirements and installation.
- Frosted glazing is available at an upcharge, please contact your Customer Service Representative.
- Laminate for laminate panels cannot be replaced in the field, complete module must be ordered.
- Writeboard for Writeboard panels cannot be replaced in the field, complete module must be ordered.

PANEL CONNECTORS • TECHNICAL INFORMATION

Panel Connectors

- Available in one-way, two-way, three-way or four-way based on the configuration.
- Available with either PVC or Aluminum Trims.
- 6" high connectors cannot be stacked on top of each other.

Panel Trims

- Available in PVC or Aluminum.

COMPONENTS

A. EVPERA66

End-of-Run Kit (Wall mount) Note: adds 1" to the width of a panel run.

B. EVPFA6636

Fabric Acoustic Panel Note: there is no panel creep.

C. EVPIC66

Inline Panel Connector

D. EVPCPA266

Two-Way Corner Post Note: trim kit included. Post Connectors can be custom manufactured with or without slots on one side only. Contact your Evolve Customer Service Representative for a special quote.

E. EVPVTLA66

Vertical "L" Trim Note: Can be purchased separately when required for reconfiguration

F. EVPVC66

Variable-Height Connector Note: Connector height must reference taller panel. (Must be ordered separately).

G. EVPTVA24

Panel Trim Variable-Height

H. EVPFA4236

Fabric Acoustic Panel

I. EVPTNTA36

Panel Top Notched Trim

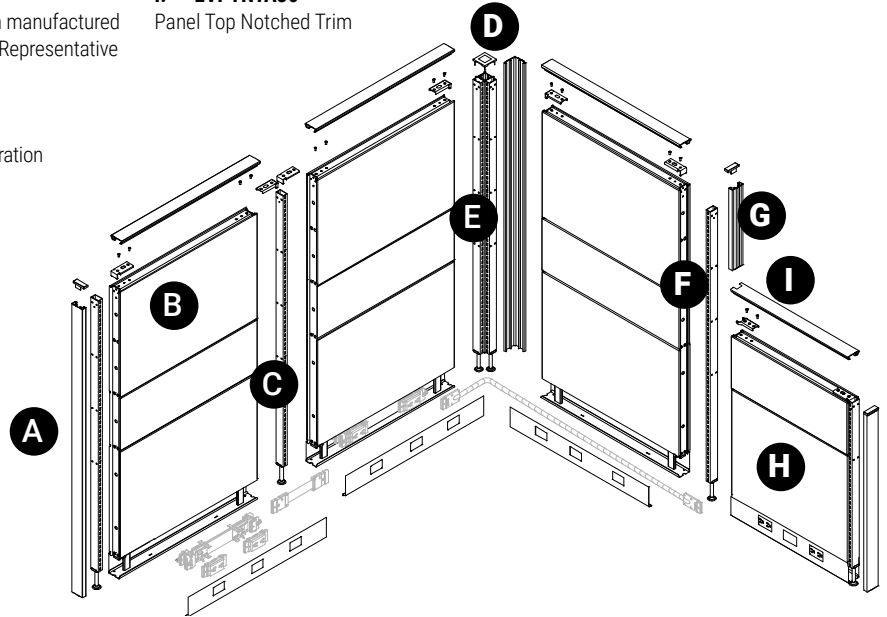

CONNECTORS • TECHNICAL INFORMATION

Slotted connectors and trim are included with each Variable-Height Corner Post. The height of each slotted connector must be specified when ordering a Variable-Height Corner Post. Slotted connector height is determined by the height of the connecting panel run.

Example:

Step 1 Specify base code listed on pricing page.

Fabric Acoustic Panel:

Step 2 Specify slotted connector heights.

Note: To specify height, use the first number of the connecting panel run height dimension.

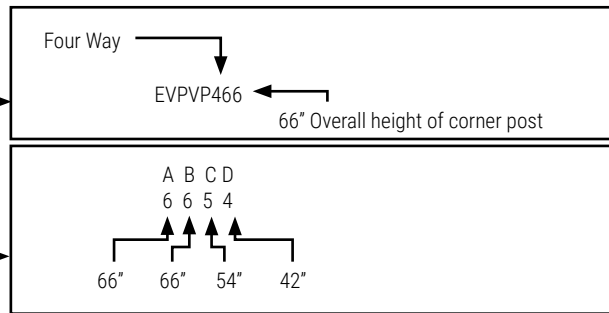

PANELS

- The entire Evolve panel and the processes to manufacture it are designed to save and protect the environment. Evolve panels are made from recycled materials and are 100% recyclable.
- Evolve makes it easy to select a panel function type and height that is suitable for your application.
- The extension module makes private offices available, with the use of Panel Extension Modules combined with a door.
- When Panel Extension Modules are used in the initial installation in conjunction with low panels (30" to 42"), future panel height flexibility is attained while maintaining storage hang-on capabilities up to 66".
- Panel frames can be totally disassembled in the field. Panel modules can be reconfigured or replaced and panel heights altered as changing circumstances demand.
- This level of flexibility makes it easy to select the correct height of panel to suit your requirements.
- Whiteboards incorporated into the panel remove the need for add-ons.
- The quality, and performance level of these panels has been tested to equal or exceed the requirements of the Canadian and US governments.
- Classified as acoustic, these panels meet the acoustical requirements of both Canadian and US governments.
- Solid steel panel frame combined with easy to assemble panel to panel clamps, create a rigid panel wall.
- Panel glide adjustment enables the client to deal with severe uneven floors of a building.

VOICE/DATA AND ELECTRIC POWER

- The base raceway cavity can accommodate 140 Category 5 data cables or 48 Category 5 data cables when the power distribution housings are present. In addition, 8 Category 5 data cables can be housed within a standard Panel Top Cap and 50 Category 5 cables can be accommodated in the optional High Profile Top Cap. This is a "true lay-in" method whereby cables can be run from the ceiling to worksurface without needing to be "fished".
- Evolve's 8 wire system provides two utility circuits plus two separate dedicated circuits (2+2).
- Snap-in Power Distribution Housings and lay-in Jumper and Pass-Through cables enable quick and simple electrical installation and modification by a qualified electrician. Circuits can easily be added, or exchanged (circuit #1 for circuit #2, circuit #1 for dedicated circuit #A or #B etc. if all are connected to base)
- The Desk Top Data/Power House attaches to the back of the worksurface to provide access to two simplex power outlets and two voice/data outlets.
- Standard Data Face Mount Plates can be used without the need of adapter plates (supplied by others).

WORKSURFACES

- The addition of custom sizes shows a commitment to client satisfaction that not every manufacturer offers. With this choice of product, we can tailor each installation to your requirements.
- This convenient scoop feature, together with a 3/8" gap between the worksurface and the panel, allows access to cables without having grommet holes in the worksurface.
- Metal-to-metal connection ensures that, no matter how many times you reconfigure your product, it will perform over the long term.
- Highest quality, thermally fused laminated surfaces ensure lasting durability. High pressure laminates are also available for those areas where rugged use is expected. A 3mm PVC edge banding is used on both options, to take the knocks of everyday wear and tear.
- Whether thermally fused or high pressure, all worksurfaces are manufactured with equal laminates on both sides of the worksurface to deter warpage.
- Curved worksurfaces are ergonomically designed to facilitate the interaction between the keyboard, mouse and worksurface.

STORAGE

- Steel construction guarantees the performance of the product over the long term. Welded joints with a full top, back and base ensure that the pedestal will sit square and adequately support the worksurface where necessary.
- Due to the quality of the construction and the slides, the pedestal drawers will continue to operate efficiently for the lifetime of the furniture. The rubber bumpers dampen the noise of closing a drawer and stop any metal-to-metal contact.
- The pencil tray is double width for extra storage.
- The glides enable you to level the cabinet to the floor and or worksurface. This convenient adjustment feature allows the installer to adjust the height of the cabinet while it is under the worksurface. This saves time in the installation process.
- For additional security and piece of mind. These locks can be keyed alike or master keyed for additional convenience.
- Quality construction with no exposed metal edges. Recessed handle offers uncluttered aesthetic.
- The construction of the drawer enables you to hang files from the drawer side so no extra hardware is necessary. File drawers accept legal, letter and metric sized files.
- Some manufacturers use the same drawer for their 24" deep pedestal as they do for their 30" deep pedestal. The 24" deep drawer gives you only 19.5" of filing. This is 25% extra filing in every file pedestal drawer.
- Worksurface supporting pedestal feature saves you money as you do not have to buy worksurface supporting hardware. Each pedestal comes with a finished end panel. The addition of a non handed bracket enables the pedestal to attach to a structural panel.
- This item, which is shipped knocked down, is more economically priced to minimize shipping damage. The lock is optional in the 12" overhead and included in the 13" overhead. The base shelf features a back lip which stops binders touching the fabric of the panel it is mounted on. All components are metal and the door slides are roller bearing for longer life.
- These rugged overhead units are extremely well priced yet accommodate a full load of binders with ease. They can be mounted above or below the worksurface.
- Storage Towers provide storage without pedestals or binder bins. This allows for greater flexibility in worksurface heights and increases the viability of 54" panels.
- "Environmentally friendly" epoxy powder coat is 15 times more durable in independent testing than a wet paint spray. This helps maintain the look of the product over its many years of service.

WARRANTIES AND PERFORMANCE

- For peace of mind over the long term, we cover you with a comprehensive warranty that is supported by our dealer network.
- We agree to make product available for a period of 20 years from the date of purchase. This product will be 100% compatible with your existing system.
- Evolve is priced well below other major "A" grade products on the market.
- Some installation companies claim that the Evolve System panels can be installed in half the time it takes to install most of our competitor's panels. This cost saving can amount to thousands of dollars over the lifetime of our furniture.
- Your assurance of consistent quality to an international standard. Evolve Systems is committed to design, manufacture and distribute superior quality office furniture, which meets or exceeds the requirements of our customers.
- Confirmation that Evolve is committed: (1) to providing product that, through their entire life cycle, minimize negative environmental impacts on the environment, (2) to continuous improvement to our environmental systems and programs and, (3) to comply to all relevant environmental legislation and regulations.
- Evolve Systems meets LEED requirements for office furniture.
- Evolve components are tested to the highest standard in the industry. This is your assurance of quality and longevity.
- On occasion, parts and pieces get missed. The run-through program is an emergency production space that we use to make items you need in a hurry.

WOOD GRAIN (WG) LAMINATE DIRECTION

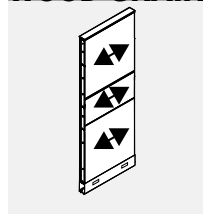

EVP Panels
With Exception of 66" high monolithic panels, they are vertical.

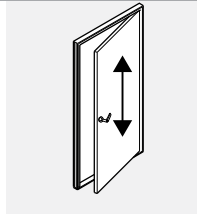

EVPD
Doors.

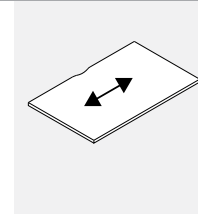

EVWS
Worksurfaces.

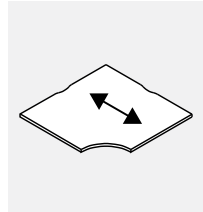

EVWCC
Worksurfaces.

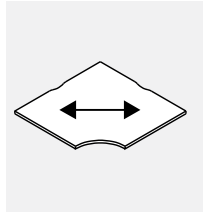

EVWCC-WG
Worksurfaces.

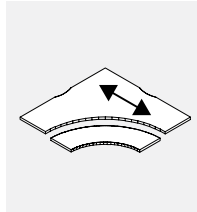

EVWCCK
Worksurfaces.

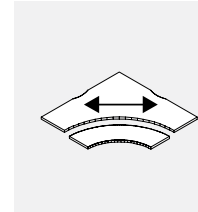

EVWCCK-WG
Worksurfaces.

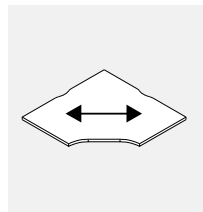

EVWCK-WG
Worksurfaces.

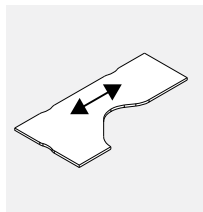

EVWCF
Worksurfaces.

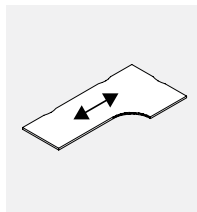

EVWCE
Worksurfaces.

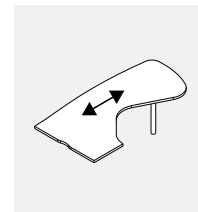

EVWHL/R
Worksurfaces.

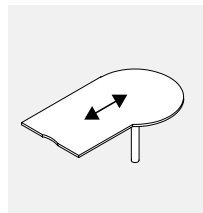

EVWP
Worksurfaces.

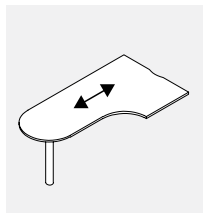

EVWPL/R
Worksurfaces.

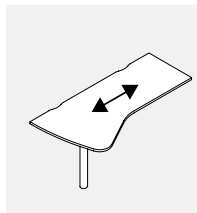

EVWWL/R
Worksurfaces.

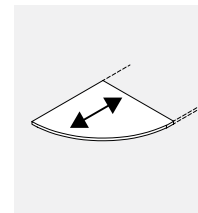

EVQR and EVWQRC
Worksurfaces.

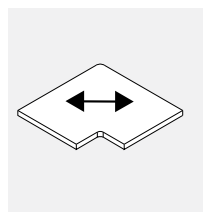

EVWTCL-WG
Worksurfaces.

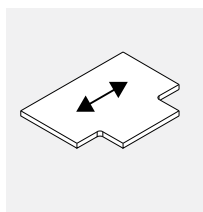

EVWTC
Worksurfaces.

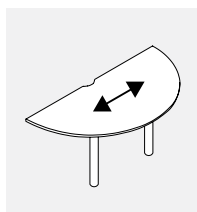

EVWR
Worksurfaces.

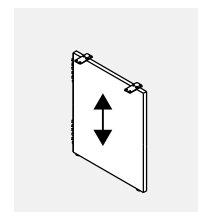

EVHP/EVLMP
End Panels.

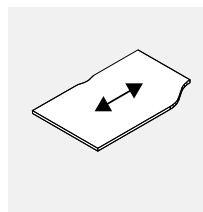

EVWVL/R
Worksurfaces.

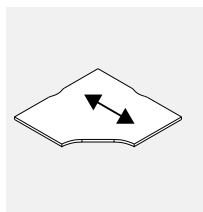

EVWCK
Worksurfaces.

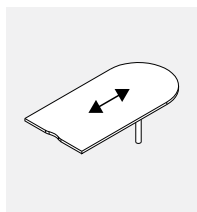

EVWD
Worksurfaces.

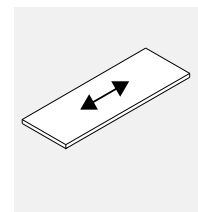

EVWT, EVWTV, EVWTE, EVWTEV, EVWTD, EVWTDV, EVWTDG
Worksurfaces.

WG - indiscated woodgrain in cross pattern

ORDERS

Each Order Must Include

Purchase Order
 Layout showing where the image(s) appear in the run of panels.
 A completed Price Chart, showing the location of the image(s) on each appropriate panel.

Artwork must be submitted in accordance with the following artwork specifications.

NOTE: Final artwork specification approval must be given before order can be processed.

Transfer Devices

- E-mail up to 10MB to your Evolve/Global Contract Customer Service Representative.
- Courier CD/DVD/USB stick to your Evolve/Global Contract Customer Service Representative.

Artwork Specifications

- Non-Photographic artwork should be vector art. Saved in Adobe Illustrator (.ai) or as an EPS (.eps)
- All bitmap or photographic artwork has to be at a minimum of 100 dpi at the full size of the panel to be printed.
- We accept Adobe CS5 files.
- Any linked files must be included or imbedded.
- Leave any PSD files un-flattened
- All fonts must be converted to outlines.
- Do not convert to CMYK, leave all images as RGB if possible
- No Word, Powerpoint, Publisher or other Microsoft files can be used.
- Include a PDF or .jpg for reference when sending native Photoshop or Illustrator format files.

Colour Matching

- A Pantone colour reference must be supplied or we cannot accept responsibility for correct colour or colour correction.
- When it is not possible to refer to Pantone colours, we will do our best to meet your requirements.

Image Clarity

- We will advise should the selected image not lend itself to the element size requested.

NOTE:

We reserve the right to put an order on hold when the files are found to be incomplete or when documents have been either incorrectly saved, fonts have not been converted to curves or the job appears not to be commercially acceptable.

Image Bleed:

To facilitate placement on the panel. Extension of the image past the finished visible area of the panel (bleed) is required.
 • Evolve Panels need a 3" bleed on all sides.

Example of Image resolution:

The resolution required for a 36 wide x 24 high Evolve panel at 100dpi (minimum resolution)

The resolution required for a 36 wide x 24 high Evolve panel at 300dpi (higher quality)

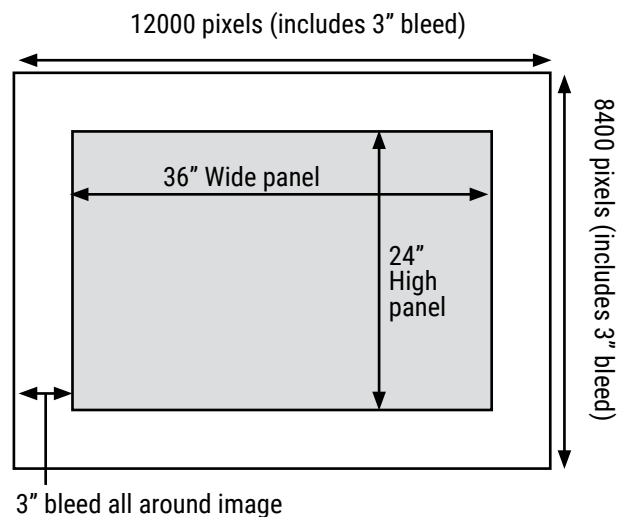
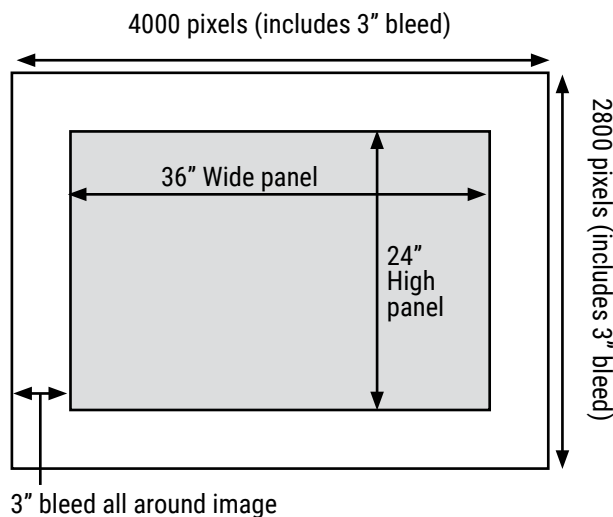

Pricing Initial Set-Up Charge per Image: \$264 net

Evolve 12" Modules

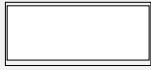

PANEL WIDTH	LIST PRICE
24"	144
30"	179
36"	217
42"	249
48"	289
54"	329
60"	366

- Applies to the following panels:
- EVPFA
 - EVPPOL
 - EVPPFP
 - EVPPFO
 - EVPPF1W
 - EVPPFPO
 - EVPPF2W
 - EVPPFE12
 - EVPPF1S
 - EVPPFPE
 - EVPPF2S
 - EVPPFGT
 - EVPPFGTU
 - EVPPFOL

Evolve 24" Modules



PANEL WIDTH	LIST PRICE
24"	283
30"	363
36"	433
42"	508
48"	579
54"	655
60"	725

- Applies to the following panels:
- EVPFA
 - EVPPGTX
 - EVPPFP
 - EVPPGTX
 - EVPPF1W
 - EVPPFOL
 - EVPPF2W
 - EVPPFO
 - EVPPF1S
 - EVPPFPO
 - EVPPF2S
 - EVPPFOX
 - EVPPFGT
 - EVPPFE24
 - EVPPFGTU

Evolve Monolithic Panels

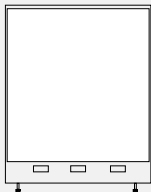

PANEL WIDTH	HEIGHT	LIST PRICE
	42"	48"
24"	42	48
30"	433	508
36"	555	652
42"	665	779
48"	779	908
54"	891	1038
60"	999	1168
		54"
		66"
		54
		66
		579
		726
		741
		928
		891
		1112
		1038
		1298
		1186
		1482
		1333
		1666

- Applies to the following panels:
- EVPFAM

Note: Prices shown are an upcharge to the panel price, please add to the list price of panel which you are specifying the graphic for.

EVOLVE SYSTEMS - GRAPHIC PANEL EXAMPLE PROCEDURE

STEP 1: Customer orders the following EVPFA6636 panel with;

- Bottom module inside face (24/36 size fabric) with image 01.
- Middle module inside face (12/36 size fabric) with image 02.
- All other fabric material is regular fabric - top module inside face and all outside module faces.

STEP 2: On the regular panel - replace fabric pieces with corresponding graphic pieces.

STEP 3: Enter separate lines in order for the corresponding fabric image graphic pieces:

- EVPGRP1236 for the middle module inside face
- EVPGRP2436 for the bottom module inside face

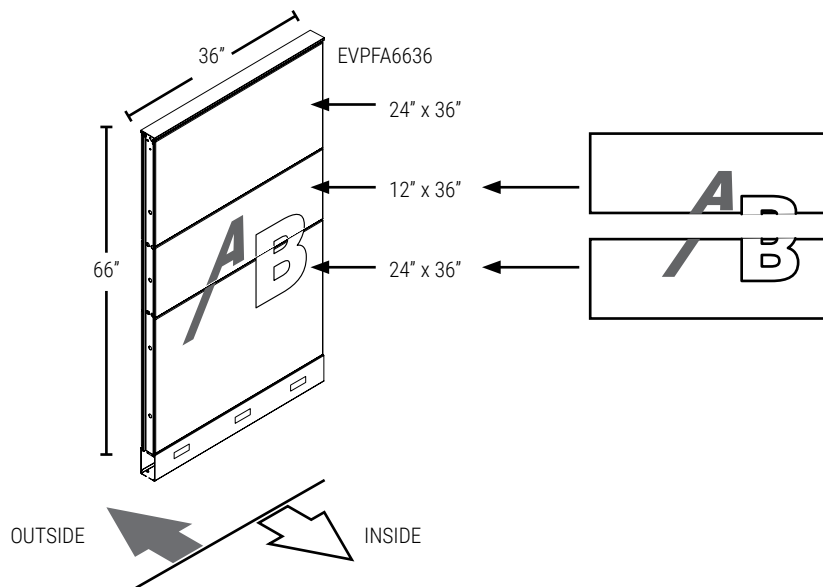

Note: To order, please use graphic codes below

(A)
EVPGRP1236

(B)
EVPGRP2436

PANELS • TECHNICAL INFORMATION

- Evolve panels are 2 7/8" thick. They are available in four (5) basic heights: 30", 42", 48" and 54" and eight (8) widths: 18" to 60" in 6" increments.
- Individual fabric covered acoustic modules incorporated into a rigid steel frame.
- Opposite side of each module may have a different fabric within the same grade at no upcharge.
- If different grades of fabric are used on one panel, the entire panel must be priced at highest grade.
- A low profile top cap is included.
- No panel creep.
- All Panels, except Monolithic are composed of a 6" raceway module and a 24" high base module. Subsequent heights are created by adding either a 12" high module or a 24" high module.
- Raceway openings are 1.37 x 2.68
- 12" high and 24" high modules of all types (fabric, laminate, glass, open) are available for field installation. Contact your Customer Service Representative.
- Frosted glazing is available at an upcharge, please contact your Customer Service Representative.
- Laminate for laminate panels cannot be replaced in the field, complete module must be ordered.
- Writeboard for Writeboard panels cannot be replaced in the field, complete module must be ordered.
- Panels 18" wide have no knockout, panels 24" wide have 1 knockout, panels 30" have 2 knockouts and panels 36" to 60" have 3 knockouts.

PANEL EXTENSION MODULES • TECHNICAL INFORMATION

- 6", 12", 18" and 24" Panel Extension Modules attach to the top of the panel.
- Modules can be stacked to add privacy or divide space.
- Each side of a fabric module may have a different fabric within the same grade at no upcharge.
- When extension modules are used, the double or single clamp is moved to the top of the extension for panel connection.

PANELS • GUIDELINES FOR ORDERING PRODUCT

The price list uses a numbering system with meaningful alphanumeric characters to create a simple-to-understand product number. This makes specifying the product much easier and more accurate.

EXAMPLE OF PANEL CODE

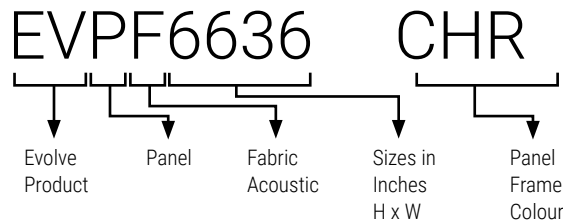

I1	AN50	Inside Fabric Position #1
I2	AN50	Inside Fabric Position #2
I3	AN50	Inside Fabric Position #3
O1	BE21	Outside Fabric Position #1
O2	BE21	Outside Fabric Position #2
O3	BE21	Outside Fabric Position #3

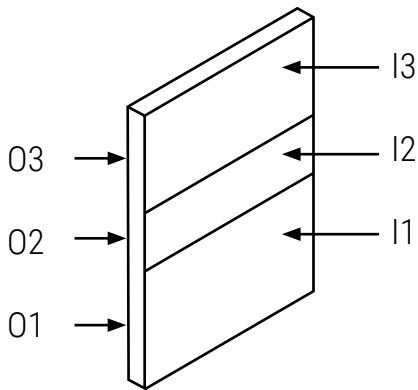

HOW TO SPECIFY

- Specify Evolve panel type and size by code.
- Specify panel frame finish - ie. CHR (Charcoal).
- Specify all necessary panel fabric options.

NOTE: If different grades of fabric are used on one panel, the entire panel must be priced out at the higher grade.

EVPFA • Fabric Acoustic Panel

- Standard panels incorporate a single 12" or 24" module or combination of 12" and 24" modules above the 30" base section. Application is based on panel height.
- 66" high panel can be configured with 12" at the top of the panel, see EVPFA66-S.

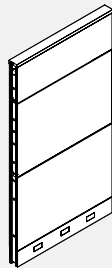
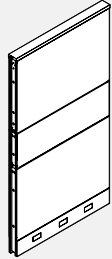
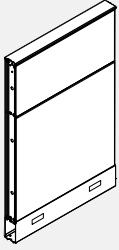

PRODUCT CODE	PRICE		SIZE/ INCHES			WEIGHT LBS	VOL FT ³
	GR 1	GR 2	H	W	D		
EVPFA3018	305	317	30	18	2.875	15.38	1.23
EVPFA3024	318	336	30	24	2.875	18.20	1.63
EVPFA3030	352	372	30	30	2.875	21.76	2.00
EVPFA3036	378	401	30	36	2.875	24.80	2.38
EVPFA3042	408	434	30	42	2.875	26.49	2.76
EVPFA3048	451	482	30	48	2.875	32.00	3.13
EVPFA3054	486	520	30	54	2.875	35.31	3.51
EVPFA3060	522	562	30	60	2.875	38.20	3.89
EVPFA4218	338	354	42	18	2.875	20.58	1.71
EVPFA4224	354	382	42	24	2.875	24.60	2.31
EVPFA4230	412	443	42	30	2.875	29.35	2.81
EVPFA4236	446	482	42	36	2.875	35.60	3.38
EVPFA4242	509	548	42	42	2.875	39.29	3.92
EVPFA4248	548	593	42	48	2.875	43.20	4.45
EVPFA4254	607	657	42	54	2.875	47.52	4.98
EVPFA4260	665	721	42	60	2.875	51.60	5.52
EVPFA5418	363	385	54	18	2.875	23.98	2.19
EVPFA5424	397	431	54	24	2.875	27.80	2.94
EVPFA5430	452	490	54	30	2.875	33.15	3.62
EVPFA5436	505	550	54	36	2.875	37.40	4.31
EVPFA5442	570	625	54	42	2.875	40.69	4.99
EVPFA5448	634	694	54	48	2.875	48.20	5.67
EVPFA5454	691	758	54	54	2.875	52.92	6.35
EVPFA5460	740	814	54	60	2.875	57.40	7.03
EVPFA6618	455	486	66	18	2.875	29.98	2.68
EVPFA6624	490	536	66	24	2.875	35.00	3.58
EVPFA6630	544	593	66	30	2.875	41.54	4.40
EVPFA6636	638	697	66	36	2.875	49.00	5.23
EVPFA6642	722	790	66	42	2.875	54.29	6.06
EVPFA6648	774	850	66	48	2.875	60.20	6.08
EVPFA6654	842	926	66	54	2.875	65.93	7.70
EVPFA6660	909	1001	66	60	2.875	71.60	8.53
EVPFA6618S	455	486	66	18	2.875	29.98	2.68
EVPFA6624S	490	536	66	24	2.875	35.00	3.58
EVPFA6630S	544	593	66	30	2.875	41.54	4.40
EVPFA6636S	638	695	66	36	2.875	49.00	5.23
EVPFA6642S	722	790	66	42	2.875	54.29	6.06
EVPFA6648S	774	850	66	48	2.875	60.20	6.88
EVPFA6654S	842	926	66	54	2.875	65.93	6.88
EVPFA6660S	909	1001	66	60	2.875	71.60	8.53

EVFPF • Fabric Acoustic Panel Premium

• Premium panels incorporate 12" high acoustic modules above the 30" base section.

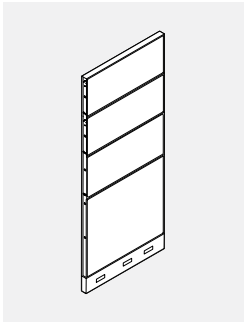
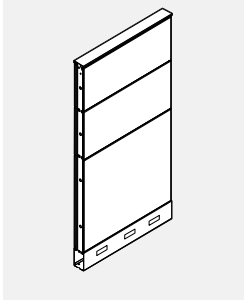

PRODUCT CODE	PRICE		SIZE/ INCHES			WEIGHT LBS	VOL FT ³
	GR 1	GR 2	H	W	D		
EVFPF5418	422	450	54	18	2.875	26.18	2.19
EVFPF5424	451	484	54	24	2.875	31.40	2.06
EVFPF5430	499	540	54	30	2.875	37.34	2.58
EVFPF5436	589	634	54	36	2.875	46.80	3.09
EVFPF5442	661	718	54	42	2.875	52.49	3.61
EVFPF5448	707	765	54	48	2.875	54.80	4.36
EVFPF5454	755	824	54	54	2.875	60.13	6.35
EVFPF5460	797	872	54	60	2.875	65.40	5.16
EVFPF6618	537	568	66	18	2.875	32.18	2.68
EVFPF6624	574	613	66	24	2.875	38.60	3.58
EVFPF6630	634	686	66	30	2.875	45.73	4.40
EVFPF6636	747	809	66	36	2.875	58.40	5.23
EVFPF6642	843	911	66	42	2.875	66.09	6.06
EVFPF6648	905	983	66	48	2.875	66.80	6.88
EVFPF6654	985	1067	66	54	2.875	73.14	7.70
EVFPF6660	1055	1147	66	60	2.875	79.60	8.53

EVPFAM • Fabric Acoustic Panel Monolithic

• Monolithic panels incorporate a single acoustic module within a solid rigid steel frame.

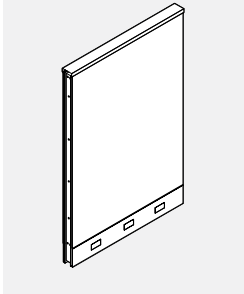

PRODUCT CODE	PRICE		SIZE/ INCHES			WEIGHT LBS	VOL FT ³
	GR 1	GR 2	H	W	D		
EVPFAM4218	333	364	42	18	2.875	20.58	1.71
EVPFAM4224	355	394	42	24	2.875	23.40	2.31
EVPFAM4230	406	450	42	30	2.875	26.96	2.85
EVPFAM4236	436	487	42	36	2.875	30.00	3.38
EVPFAM4242	483	543	42	42	2.875	31.69	3.92
EVPFAM4248	525	593	42	48	2.875	37.20	4.45
EVPFAM4254	579	653	42	54	2.875	40.51	4.98
EVPFAM4260	629	711	42	60	2.875	43.40	5.52
EVPFAM4818	340	371	48	18	2.875	21.38	1.92
EVPFAM4824	374	410	48	24	2.875	24.40	2.62
EVPFAM4830	431	476	48	30	2.875	27.76	3.23
EVPFAM4836	469	520	48	36	2.875	30.80	3.85
EVPFAM4842	524	584	48	42	2.875	32.49	4.45
EVPFAM4848	572	637	48	48	2.875	37.80	5.06
EVPFAM4854	630	704	48	54	2.875	41.31	5.66
EVPFAM4860	684	767	48	60	2.875	44.20	6.27
EVPFAM5418	342	374	54	18	2.875	24.58	2.19
EVPFAM5424	376	415	54	24	2.875	27.40	2.94
EVPFAM5430	437	482	54	30	2.875	30.96	3.62
EVPFAM5436	486	541	54	36	2.875	34.00	4.31
EVPFAM5442	545	605	54	42	2.875	35.69	4.99
EVPFAM5448	591	661	54	48	2.875	41.20	5.67
EVPFAM5454	651	728	54	54	2.875	44.51	6.35
EVPFAM5460	712	796	54	60	2.875	47.40	7.03
EVPFAM6618	425	455	66	18	2.875	27.58	2.68
EVPFAM6624	463	503	66	24	2.875	30.40	3.58
EVPFAM6630	524	573	66	30	2.875	33.96	4.40
EVPFAM6636	608	663	66	36	2.875	37.00	5.23
EVPFAM6642	684	743	66	42	2.875	38.69	6.06
EVPFAM6648	743	811	66	48	2.875	44.20	6.88
EVPFAM6654	826	900	66	54	2.875	47.51	7.70
EVPFAM6660	909	991	66	60	2.875	50.40	8.53

EVPH1S • Laminate Panel - One Side

• Laminate faces on one side of all modules provide durable, washable surfaces. Opposite side is fabric.

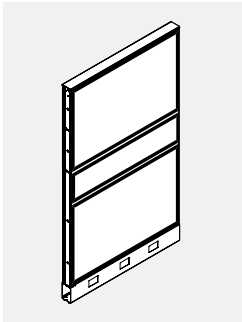
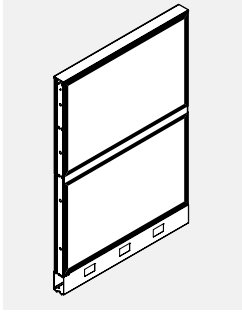

PRODUCT CODE	PRICE		SIZE / INCHES			WEIGHT LBS	VOL FT ³
	GR 1	GR 2	H	W	D		
EVPH1S3018	364	370	30	18	2.875	15.88	1.23
EVPH1S3024	434	443	30	24	2.875	18.70	1.63
EVPH1S3030	509	518	30	30	2.875	22.26	2.00
EVPH1S3036	578	591	30	36	2.875	24.85	2.58
EVPH1S3042	656	670	30	42	2.875	26.99	2.76
EVPH1S3048	712	724	30	48	2.875	32.05	3.13
EVPH1S3054	790	806	30	54	2.875	35.81	3.51
EVPH1S3060	864	883	30	60	2.875	38.07	3.89
EVPH1S4218	432	441	42	18	2.875	21.38	1.71
EVPH1S4224	516	528	42	24	2.875	22.13	2.31
EVPH1S4230	603	615	42	30	2.875	30.15	2.31
EVPH1S4236	692	713	42	36	2.875	36.40	3.38
EVPH1S4242	784	805	42	42	2.875	40.09	3.92
EVPH1S4248	853	877	42	48	2.875	44.00	4.45
EVPH1S4254	949	973	42	54	2.875	48.32	4.98
EVPH1S4260	1038	1066	42	60	2.875	52.40	5.52
EVPH1S5418	508	520	54	18	2.875	24.98	2.19
EVPH1S5424	612	629	54	24	2.875	28.80	2.94
EVPH1S5430	720	740	54	30	2.875	34.15	3.62
EVPH1S5436	824	849	54	36	2.875	38.40	4.31
EVPH1S5442	931	959	54	42	2.875	41.69	4.99
EVPH1S5448	1018	1051	54	48	2.875	49.20	5.67
EVPH1S5454	1132	1168	54	54	2.875	53.92	6.35
EVPH1S5460	1245	1286	54	60	2.875	58.40	7.03
EVPH1S6618	629	645	66	18	2.875	31.29	2.68
EVPH1S6624	758	780	66	24	2.875	36.30	3.58
EVPH1S6630	885	911	66	30	2.875	42.84	4.40
EVPH1S6636	1022	1052	66	36	2.875	50.30	5.23
EVPH1S6642	1165	1197	66	42	2.875	55.59	6.06
EVPH1S6648	1265	1303	66	48	2.875	61.50	5.23
EVPH1S6654	1406	1448	66	54	2.875	67.23	7.70
EVPH1S6660	1549	1600	66	60	2.875	72.90	8.53

EVPH2S • Laminate Panel - Two Sides

• Laminate faces on both sides of all modules provide durable, washable surfaces.

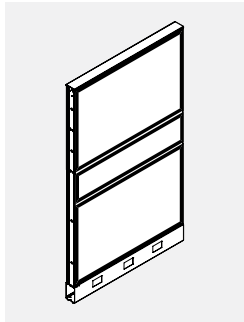
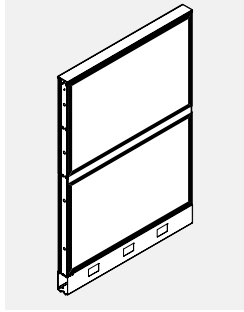

PRODUCT CODE	PRICE	SIZE/ INCHES			WEIGHT LBS	VOL FT ³
		H	W	D		
EVPH2S3018	406	30	18	2.875	16.38	1.23
EVPH2S3024	495	30	24	2.875	19.20	1.63
EVPH2S3030	586	30	30	2.875	22.76	2.00
EVPH2S3036	670	30	36	2.875	25.80	2.58
EVPH2S3042	762	30	42	2.875	27.49	2.76
EVPH2S3048	852	30	48	2.875	33.00	3.35
EVPH2S3054	943	30	54	2.875	36.31	3.95
EVPH2S3060	1022	30	60	2.875	39.20	4.52
EVPH2S4218	483	42	18	2.875	22.18	1.71
EVPH2S4224	586	42	24	2.875	26.20	2.31
EVPH2S4230	691	42	30	2.875	30.95	2.85
EVPH2S4236	802	42	36	2.875	37.20	3.38
EVPH2S4242	917	42	42	2.875	40.89	3.92
EVPH2S4248	1026	42	48	2.875	42.80	4.45
EVPH2S4254	1129	42	54	2.875	49.12	5.52
EVPH2S4260	1232	42	60	2.875	53.20	5.52
EVPH2S5418	565	54	18	2.875	25.98	2.19
EVPH2S5424	693	54	24	2.875	29.80	2.94
EVPH2S5430	824	54	30	2.875	35.15	3.62
EVPH2S5436	955	54	36	2.875	39.40	4.31
EVPH2S5442	1090	54	42	2.875	42.69	4.99
EVPH2S5448	1231	54	48	2.875	50.20	5.67
EVPH2S5454	1352	54	54	2.875	52.92	6.35
EVPH2S5460	1473	54	60	2.875	59.40	7.03
EVPH2S6618	712	66	18	2.875	32.58	2.68
EVPH2S6624	877	66	24	2.875	37.60	3.58
EVPH2S6630	1038	66	30	2.875	44.14	4.40
EVPH2S6636	1205	66	36	2.875	51.60	5.23
EVPH2S6642	1383	66	42	2.875	56.89	6.06
EVPH2S6648	1549	66	48	2.875	62.80	6.88
EVPH2S6654	1713	66	54	2.875	68.53	7.70
EVPH2S6660	1870	66	60	2.875	74.20	8.53

EVPF1W • Writeboard Panel - One Side

• Writing surface is built into the top module on one side of the panel, alleviating the need for a panel-mounted Writeboard.
 • Use of erasable Writeboard markers only.

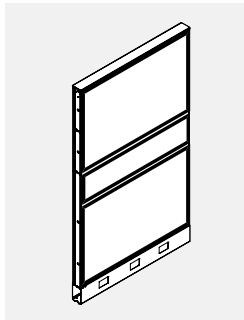
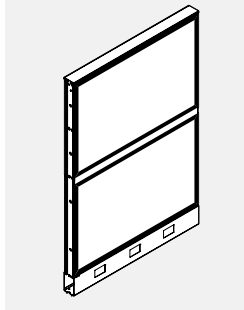

PRODUCT CODE	PRICE		SIZE/ INCHES			WEIGHT LBS	VOL FT ³
	GR 1	GR 2	H	W	D		
EVPF1W5418	441	456	54	18	2.875	24.98	2.19
EVPF1W5424	548	575	54	24	2.875	28.80	2.94
EVPF1W5430	659	691	54	30	2.875	34.15	3.62
EVPF1W5436	731	766	54	36	2.875	38.40	4.31
EVPF1W5442	826	867	54	42	2.875	41.69	4.99
EVPF1W5448	930	975	54	48	2.875	49.20	5.67
EVPF1W5454	1035	1069	54	54	2.875	53.92	6.35
EVPF1W5460	1140	1198	54	60	2.875	58.40	7.03
EVPF1W6618	562	582	66	18	2.875	30.48	2.57
EVPF1W6624	692	724	66	24	2.875	35.50	3.58
EVPF1W6630	823	863	66	30	2.875	42.04	4.40
EVPF1W6636	916	963	66	36	2.875	49.50	5.23
EVPF1W6642	1037	1091	66	42	2.875	54.79	6.06
EVPF1W6648	1157	1220	66	48	2.875	60.70	6.88
EVPF1W6654	1290	1357	66	54	2.875	66.43	7.70
EVPF1W6660	1422	1498	66	60	2.875	72.10	8.53

EVVPF2W • Writeboard Panel - Two Side

- Writing surface is built into the top module on both sides of the panel, alleviating the need for 2 panel-mounted Writeboards.
- Use of erasable Writeboard markers only.

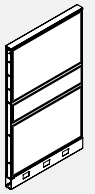
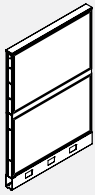

PRODUCT CODE	PRICE		SIZE/ INCHES			WEIGHT LBS	VOL FT ³
	GR 1	GR 2	H	W	D		
EVVPF2W5418	476	487	54	18	2.875	25.48	2.19
EVVPF2W5424	596	613	54	24	2.875	29.30	2.94
EVVPF2W5430	746	763	54	30	2.875	34.65	3.62
EVVPF2W5436	809	833	54	36	2.875	38.90	4.31
EVVPF2W5442	917	943	54	42	2.875	42.19	4.99
EVVPF2W5448	1072	1103	54	48	2.875	49.70	5.67
EVVPF2W5454	1196	1231	54	54	2.875	54.51	6.35
EVVPF2W5460	1317	1354	54	60	2.875	58.90	7.03
EVVPF2W6618	593	613	66	18	2.875	30.98	2.57
EVVPF2W6624	737	762	66	24	2.875	36.00	3.58
EVVPF2W6630	908	937	66	30	2.875	42.54	4.40
EVVPF2W6636	992	1026	66	36	2.875	50.00	5.23
EVVPF2W6642	1128	1169	66	42	2.875	55.29	6.06
EVVPF2W6648	1294	1340	66	48	2.875	61.20	6.88
EVVPF2W6654	1442	1496	66	54	2.875	66.93	7.70
EVVPF2W6660	1595	1653	66	60	2.875	72.60	8.53

EVVPF1S • Slat Wall Panel - One Sided

- Standard panels incorporating a single 12" or 24" module or combination of 12" and 24" modules above the 30" base section.
- Slat module is only on one side, fabric on the other.
- 66" high panel can be configured with either a 24" slat module at the top, see EVVPF1S66, or a 12" slat module at the centre, see EVVPF1S66M.

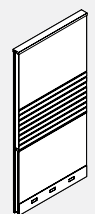
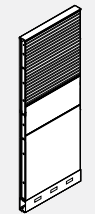
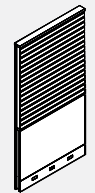
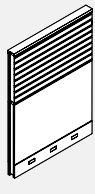

PRODUCT CODE	PRICE		SIZE/ INCHES			WEIGHT LBS	VOL FT ³
	GR 1	GR 2	H	W	D		
EVVPF1S4218	383	399	42	18	2.875	13.50	1.71
EVVPF1S4224	419	441	42	24	2.875	33.50	2.31
EVVPF1S4230	490	517	42	30	2.875	45.50	2.85
EVVPF1S4236	542	573	42	36	2.875	49.50	3.38
EVVPF1S4242	625	658	42	42	2.875	54.50	3.92
EVVPF1S4248	671	711	42	48	2.875	60.50	4.47
EVVPF1S4254	747	788	42	54	2.875	67.50	4.98
EVVPF1S4260	819	865	42	60	2.875	74.50	5.52
EVVPF1S5418	464	484	54	18	2.875	36.50	2.19
EVVPF1S5424	527	552	54	24	2.875	36.40	2.94
EVVPF1S5430	612	643	54	30	2.875	40.40	3.62
EVVPF1S5436	694	731	54	36	2.875	44.40	4.31
EVVPF1S5442	790	830	54	42	2.875	46.40	5.67
EVVPF1S5448	884	929	54	48	2.875	48.40	5.67
EVVPF1S5454	969	1021	54	54	2.875	50.00	6.35
EVVPF1S5460	1050	1106	54	60	2.875	52.40	7.03
EVVPF1S6618	561	584	66	18	2.875	42.00	2.57
EVVPF1S6624	623	656	66	24	2.875	48.00	3.58
EVVPF1S6630	705	746	66	30	2.875	50.00	4.40
EVVPF1S6636	829	879	66	36	2.875	54.00	5.23
EVVPF1S6642	938	995	66	42	2.875	60.00	6.06
EVVPF1S6648	1022	1084	66	48	2.875	67.00	6.88
EVVPF1S6654	1119	1187	66	54	2.875	80.00	7.07
EVVPF1S6660	1216	1292	66	60	2.875	86.00	8.53
EVVPF1S6618M	503	534	66	18	2.875	42.00	2.57
EVVPF1S6624M	553	592	66	24	2.875	48.00	3.58
EVVPF1S6630M	623	668	66	30	2.875	50.00	4.40
EVVPF1S6636M	734	788	66	36	2.875	54.00	5.23
EVVPF1S6642M	835	896	66	42	2.875	60.00	6.06
EVVPF1S6648M	896	966	66	48	2.875	67.00	6.88
EVVPF1S6654M	983	1060	66	54	2.875	80.00	7.70
EVVPF1S6660M	1063	1147	66	60	2.875	86.00	8.53

EVVPF2S • Slat Wall Module Panel - Two Sided

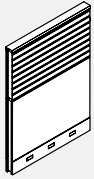

- Standard panels incorporating a single 12" or 24" module or combination of 12" and 24" modules above the 30" base section.
- Slat module is only on both sides.
- 66" high panel can be configured with either a 24" slat module at the top, see EVVPF2S66, or a 12" slat module at the centre, see EVVPF2S66-M.

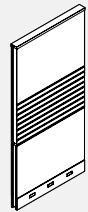
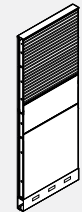
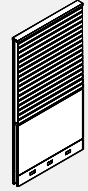

PRODUCT CODE	PRICE		SIZE/ INCHES			WEIGHT VOL	
	GR 1	GR 2	H	W	D	LBS	FT ³
EVVPF2S4218	411	425	42	18	2.875	16.50	1.71
EVVPF2S4224	459	477	42	24	2.875	36.50	2.31
EVVPF2S4230	543	563	42	30	2.875	48.50	2.85
EVVPF2S4236	604	627	42	36	2.875	52.50	3.38
EVVPF2S4242	694	722	42	42	2.875	57.50	3.92
EVVPF2S4248	755	786	42	48	2.875	63.50	4.47
EVVPF2S4254	842	877	42	54	2.875	70.50	4.98
EVVPF2S4260	922	960	42	60	2.875	77.50	5.52
EVVPF2S5418	542	553	54	18	2.875	38.50	2.19
EVVPF2S5424	631	649	54	24	2.875	44.40	2.94
EVVPF2S5430	744	761	54	30	2.875	46.40	3.62
EVVPF2S5436	852	877	54	36	2.875	48.40	4.31
EVVPF2S5442	973	1000	54	42	2.875	50.40	4.99
EVVPF2S5448	1095	1128	54	48	2.875	52.40	5.67
EVVPF2S5454	1205	1239	54	54	2.875	54.40	6.35
EVVPF2S5460	1315	1352	54	60	2.875	56.40	7.03
EVVPF2S6618	634	655	66	18	2.875	45.00	2.57
EVVPF2S6624	725	752	66	24	2.875	51.00	3.58
EVVPF2S6630	835	865	66	30	2.875	53.00	4.40
EVVPF2S6636	986	1023	66	36	2.875	57.00	5.23
EVVPF2S6642	1125	1167	66	42	2.875	63.00	6.06
EVVPF2S6648	1234	1279	66	48	2.875	70.40	6.88
EVVPF2S6654	1358	1409	66	54	2.875	83.40	7.70
EVVPF2S6660	1482	1540	66	60	2.875	89.40	8.53
EVVPF2S6618M	535	557	66	18	2.875	45.00	2.57
EVVPF2S6624M	593	627	66	24	2.875	51.00	3.58
EVVPF2S6630M	672	714	66	30	2.875	53.00	4.40
EVVPF2S6636M	797	846	66	36	2.875	57.00	5.23
EVVPF2S6642M	908	962	66	42	2.875	63.00	6.06
EVVPF2S6648M	977	1040	66	48	2.875	70.40	6.88
EVVPF2S6654M	1074	1143	66	54	2.875	83.40	7.70
EVVPF2S6660M	1168	1241	66	60	2.875	89.40	8.53

EVVPF2S-F • Frameless Slat Wall Module Panel - Two Sided

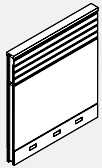

- Slat Wall is manufactured with 2 snap-in sections.
- Accessories can be hung on Slat Wall. Please see accessories section for additional details.
- For 42" H Slat Wall Panel only Aluminum Top Trim can be used. Aluminum Top Trim is included.
- Stackability: Evolve panels can be increased in height in 6", 12" and 24" increments. See module listing for part numbers.

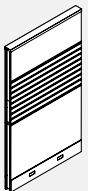

PRODUCT CODE	PRICE		SIZE/ INCHES			WEIGHT VOL	
	GR 1	GR 2	H	W	D	LBS	FT ³
EVVPF2S4224F	412	431	42	24	2.875	33.50	2.31
EVVPF2S4230F	485	507	42	30	2.875	45.50	2.81
EVVPF2S4236F	567	590	42	36	2.875	49.50	3.38
EVVPF2S4242F	641	668	42	42	2.875	54.50	3.92
EVVPF2S4248F	711	741	42	48	2.875	60.50	4.45
EVVPF2S4254F	785	820	42	54	2.875	67.50	4.98
EVVPF2S4260F	865	903	42	60	2.875	74.50	5.52
EVVPF2S5424F	563	589	54	24	2.875	36.40	2.94
EVVPF2S5430F	658	689	54	30	2.875	40.40	3.62
EVVPF2S5436F	763	801	54	36	2.875	44.40	4.31
EVVPF2S5442F	867	908	54	42	2.875	46.60	4.99
EVVPF2S5448F	962	1007	54	48	2.875	48.40	5.67
EVVPF2S5454F	1090	1142	54	54	2.875	50.40	6.35
EVVPF2S5460F	1173	1232	54	60	2.875	52.40	7.03
EVVPF2S6624F	623	656	66	24	2.875	48.00	3.58
EVVPF2S6630F	726	770	66	30	2.875	50.00	4.40
EVVPF2S6636F	860	908	66	36	2.875	54.00	5.23
EVVPF2S6642F	966	1022	66	42	2.875	60.00	6.06
EVVPF2S6648F	1069	1132	66	48	2.875	67.00	6.08
EVVPF2S6654F	1177	1244	66	54	2.875	80.00	7.70
EVVPF2S6660F	1294	1369	66	60	2.875	86.00	8.53

EVPFGT • Fabric Glazed Panel - Tempered Glass

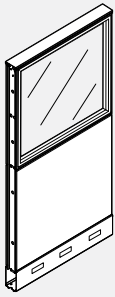

- Fabric Glazed Panel consists of individual fabric covered acoustic module in lower position(s) with one 12" or 24" glazed module in upper position.
- Glazing is replaceable on site.

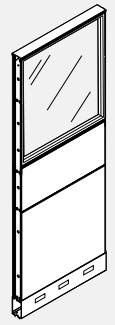

PRODUCT CODE	PRICE		SIZE/ INCHES			WEIGHT		VOL FT ³
	GR 1	GR 2	H	W	D	LBS		
EVPFGT4218	406	419	42	18	2.875	23.96	1.71	
EVPFGT4224	478	494	42	24	2.875	28.98	2.31	
EVPFGT4230	542	562	42	30	2.875	34.62	2.85	
EVPFGT4236	609	633	42	36	2.875	39.76	3.38	
EVPFGT4242	673	699	42	42	2.875	43.45	3.92	
EVPFGT4248	736	766	42	48	2.875	51.56	4.45	
EVPFGT4254	826	862	42	54	2.875	56.87	4.98	
EVPFGT4260	911	949	42	60	2.875	61.95	5.52	
EVPFGT5418	448	459	54	18	2.875	28.25	2.19	
EVPFGT5424	520	539	54	24	2.875	34.76	2.94	
EVPFGT5430	605	625	54	30	2.875	41.80	3.62	
EVPFGT5436	688	713	54	36	2.875	48.34	4.31	
EVPFGT5442	770	796	54	42	2.875	53.12	4.99	
EVPFGT5448	840	870	54	48	2.875	62.11	5.67	
EVPFGT5454	973	1007	54	54	2.875	68.42	6.35	
EVPFGT5460	1106	1143	54	60	2.875	74.49	7.03	
EVPFGT6618	569	589	66	18	2.875	34.25	2.68	
EVPFGT6624	660	688	66	24	2.875	41.96	3.58	
EVPFGT6630	763	794	66	30	2.875	50.19	4.40	
EVPFGT6636	870	908	66	36	2.875	59.94	5.23	
EVPFGT6642	984	1024	66	42	2.875	66.72	6.06	
EVPFGT6648	1065	1113	66	48	2.875	74.11	6.88	
EVPFGT6654	1226	1276	66	54	2.875	81.43	7.70	
EVPFGT6660	1389	1445	66	60	2.875	88.69	8.53	

EVFPFGT • Fabric Glazed Panel Premium - Tempered Glass

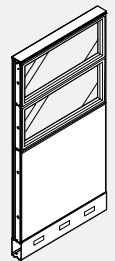

- Fabric Glazed Panel consists of individual fabric covered acoustic module in lower position with 2 or 3 glazed modules in upper position.
- Glazing is replaceable on site.

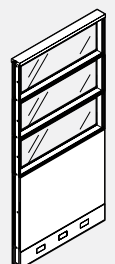

PRODUCT CODE	PRICE		SIZE/ INCHES			WEIGHT		VOL FT ³
	GR 1	GR 2	H	W	D	LBS		
EVFPFGT5418	542	553	54	18	2.875	32.95	2.19	
EVFPFGT5424	652	668	54	24	2.875	40.16	2.06	
EVFPFGT5430	726	749	54	30	2.875	47.89	2.58	
EVFPFGT5436	809	831	54	36	2.875	55.14	3.09	
EVFPFGT5442	898	929	54	42	2.875	60.82	3.61	
EVFPFGT5448	988	1022	54	48	2.875	71.78	4.36	
EVFPFGT5454	1107	1142	54	54	2.875	78.83	6.35	
EVFPFGT5460	1224	1262	54	60	2.875	86.09	5.16	
EVFPFGT6618	678	691	66	18	2.875	42.33	2.68	
EVFPFGT6624	817	835	66	24	2.875	51.74	3.58	
EVFPFGT6630	916	936	66	30	2.875	61.55	5.23	
EVFPFGT6636	1011	1035	66	36	2.875	70.90	5.23	
EVFPFGT6642	1128	1155	66	42	2.875	78.58	6.06	
EVFPFGT6648	1241	1273	66	48	2.875	91.87	6.88	
EVFPFGT6654	1405	1438	66	54	2.875	101.20	6.88	
EVFPFGT6660	1568	1607	66	60	2.875	110.64	6.30	

EVPFGTU • Fabric 12" Glazed Panel - Tempered Glass

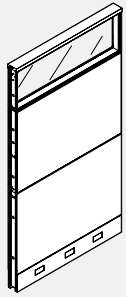

- Fabric 12" Glazed Panel incorporates one 12" glazed module and one 24" fabric modules above the 30" base section.
- Glazing is replaceable on site.

PRODUCT CODE	PRICE		SIZE/ INCHES			WEIGHT LBS	VOL FT ³
	GR 1	GR 2	H	W	D		
EVPFGTU6618	573	596	66	18	2.875	33.36	2.68
EVPFGTU6624	670	701	66	24	2.875	39.38	3.58
EVPFGTU6630	763	805	66	30	2.875	46.81	4.40
EVPFGTU6636	860	908	66	36	2.875	53.17	5.23
EVPFGTU6642	966	1022	66	42	2.875	58.45	6.06
EVPFGTU6648	1052	1113	66	48	2.875	68.56	6.88
EVPFGTU6654	1173	1239	66	54	2.875	75.28	7.70
EVPFGTU6660	1294	1369	66	60	2.875	81.95	8.53

EVFPFGTU • Fabric 12" Glazed Panel Premium - Tempered Glass

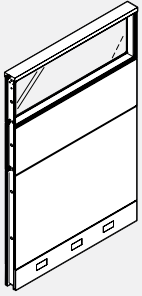

- Premium Fabric 12" Glazed Panel incorporates one 12" glazed module and 1 or 2 12" fabric module or 2 fabric modules above a 30" base section.
- Glazing is replaceable on site.

PRODUCT CODE	PRICE		SIZE/ INCHES			WEIGHT LBS	VOL FT ³
	GR 1	GR 2	H	W	D		
EVFPFGTU5418	524	546	54	18	2.875	29.56	2.19
EVFPFGTU5424	621	645	54	24	2.875	35.78	2.06
EVFPFGTU5430	699	731	54	30	2.875	42.61	2.58
EVFPFGTU5436	791	827	54	36	2.875	50.97	3.09
EVFPFGTU5442	886	929	54	42	2.875	56.65	3.61
EVFPFGTU5448	962	1007	54	48	2.875	63.16	4.36
EVFPFGTU5454	1079	1129	54	54	2.875	69.48	7.70
EVFPFGTU5460	1197	1255	54	60	2.875	75.75	5.16
EVFPFGTU6618	652	676	66	18	2.875	35.56	2.68
EVFPFGTU6624	761	794	66	24	2.875	42.98	3.58
EVFPFGTU6630	864	905	66	30	2.875	51.00	4.38
EVFPFGTU6636	973	1023	66	36	2.875	62.56	5.23
EVFPFGTU6642	1101	1155	66	42	2.875	70.25	6.06
EVFPFGTU6648	1188	1250	66	48	2.875	75.16	7.23
EVFPFGTU6654	1330	1401	66	54	2.875	82.50	7.70
EVFPFGTU6660	1475	1550	66	60	2.875	82.95	6.30

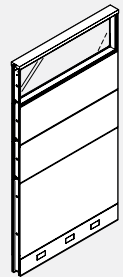

EVPMGTU • Monolithic 12" Glazed Panel - Tempered Glass

- Monolithic 12" Glazed Panel incorporates one 12" glazed module at the top of an otherwise Monolithic Panel.
- Glazing is replaceable on site.

PRODUCT CODE	PRICE		SIZE/ INCHES			WEIGHT LBS	VOL FT ³
	GR 1	GR 2	H	W	D		
EVPMGTU4818	495	521	48	18	2.875	26.96	1.92
EVPMGTU4824	580	618	48	24	2.875	31.98	2.62
EVPMGTU4830	674	718	48	30	2.875	37.62	3.23
EVPMGTU4836	773	829	48	36	2.875	42.77	3.85
EVPMGTU4842	856	914	48	42	2.875	46.45	4.45
EVPMGTU4848	932	1000	48	48	2.875	54.45	5.06
EVPMGTU4854	1035	1106	48	54	2.875	59.87	5.66
EVPMGTU4860	1135	1220	48	60	2.875	67.15	6.27
EVPMGTU5418	510	542	54	18	2.875	29.56	2.19
EVPMGTU5424	593	633	54	24	2.875	34.58	2.94
EVPMGTU5430	678	755	54	30	2.875	40.22	3.62
EVPMGTU5436	755	859	54	36	2.875	45.37	4.31
EVPMGTU5442	845	897	54	42	2.875	49.05	4.99
EVPMGTU5448	932	1059	54	48	2.875	57.16	5.67
EVPMGTU5454	1020	1162	54	54	2.875	62.47	6.32
EVPMGTU5460	1108	1268	54	60	2.875	67.55	7.03
EVPMGTU6618	547	578	66	18	2.875	33.96	2.68
EVPMGTU6624	656	697	66	24	2.875	38.98	3.58
EVPMGTU6630	755	800	66	30	2.875	44.62	4.40
EVPMGTU6636	836	888	66	36	2.875	49.77	5.23
EVPMGTU6642	930	992	66	42	2.875	53.45	6.06
EVPMGTU6648	1027	1096	66	48	2.875	61.16	6.88
EVPMGTU6654	1126	1201	66	54	2.875	66.87	6.88
EVPMGTU6660	1222	1307	66	60	2.875	71.95	8.53

EVPFGTX • Fabric 36" Glazed Panel - Tempered Glass

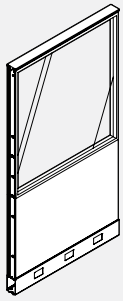

- Fabric 36" Glazed Panel incorporates one 36" glazed module above the 30" base section.
- Glazing is replaceable on site.

PRODUCT CODE	PRICE		SIZE/ INCHES			WEIGHT LBS	VOL FT ³
	GR 1	GR 2	H	W	D		
EVPFGTX6618	658	672	66	18	2.875	35.45	4.23
EVPFGTX6624	727	747	66	24	2.875	42.54	5.23
EVPFGTX6630	845	864	66	30	2.875	50.15	6.23
EVPFGTX6636	960	985	66	36	2.875	57.26	6.23
EVPFGTX6642	1074	1102	66	42	2.875	63.02	6.56
EVPFGTX6648	1175	1208	66	48	2.875	72.99	6.88
EVPFGTX6654	1294	1328	66	54	2.875	80.28	7.70
EVPFGTX6660	1411	1448	66	60	2.875	87.32	8.53

EVPXGT • Fully Glazed Monolithic Panel - Tempered Glass

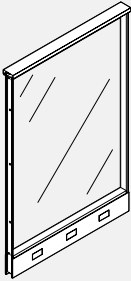

- Fully Glazed Monolithic Panel incorporates one glazed module into a rigid steel frame.
- Glazing is replaceable on site.

PRODUCT CODE	PRICE		SIZE/ INCHES			WEIGHT LBS	VOL FT ³
	H	W	D	LBS	FT ³		
EVPXGT4218	463	42	18	2.875	26.05	1.71	
EVPXGT4224	510	42	24	2.875	32.14	2.31	
EVPXGT4230	593	42	30	2.875	37.96	3.11	
EVPXGT4236	670	42	36	2.875	43.86	3.46	
EVPXGT4242	745	42	42	2.875	48.02	4.46	
EVPXGT4818	411	48	18	2.875	29.02	1.92	
EVPXGT4824	529	48	24	2.875	35.61	2.62	
EVPXGT4830	587	48	30	2.875	41.93	3.23	
EVPXGT4836	724	48	36	2.875	48.33	3.85	
EVPXGT4842	760	48	42	2.875	52.98	4.45	
EVPXGT5418	516	54	18	2.875	31.60	2.19	
EVPXGT5424	605	54	24	2.875	37.60	2.58	
EVPXGT5430	702	54	30	2.875	45.48	3.29	
EVPXGT5436	790	54	36	2.875	52.39	4.58	
EVPXGT5442	880	54	42	2.875	57.54	5.58	
EVPXGT6618	604	66	18	2.875	37.54	2.68	
EVPXGT6624	700	66	24	2.875	45.61	3.58	
EVPXGT6630	810	66	30	2.875	53.43	3.99	
EVPXGT6636	909	66	36	2.875	61.32	4.58	
EVPXGT6642	1013	66	42	2.875	67.46	5.58	

EVPGPT • Fully Glazed Premium Panel - Tempered Glass

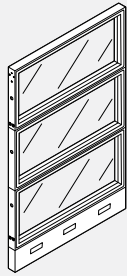

- Fully Glazed Premium Panel incorporates all 12" glazed modules above the 6" base raceway channel.
- Glazing is replaceable on site.

PRODUCT CODE	PRICE		SIZE/ INCHES			WEIGHT LBS	VOL FT ³
	H	W	D	LBS	FT ³		
EVPGPT4218	608	42	18	2.875	32.13	1.71	
EVPGPT4224	744	42	24	2.875	39.74	2.31	
EVPGPT4230	826	42	30	2.875	47.56	2.85	
EVPGPT4236	898	42	36	2.875	50.90	3.38	
EVPGPT4242	999	42	42	2.875	54.98	3.92	
EVPGPT4248	1109	42	48	2.875	72.27	4.45	
EVPGPT4254	1225	42	54	2.875	70.89	4.98	
EVPGPT4260	1333	42	60	2.875	87.44	5.52	
EVPGPT5418	773	54	18	2.875	35.19	2.19	
EVPGPT5424	949	54	24	2.875	49.76	2.58	
EVPGPT5430	1050	54	30	2.875	52.08	3.62	
EVPGPT5436	1142	54	36	2.875	64.54	4.31	
EVPGPT5442	1267	54	42	2.875	72.62	4.99	
EVPGPT5448	1415	54	48	2.875	78.11	5.67	
EVPGPT5454	1560	54	54	2.875	86.04	6.35	
EVPGPT5460	1700	54	60	2.875	94.09	7.03	
EVPGPT6618	936	66	18	2.875	41.15	2.68	
EVPGPT6624	1148	66	24	2.875	50.96	3.58	
EVPGPT6630	1269	66	30	2.875	60.47	3.58	
EVPGPT6636	1385	66	36	2.875	76.14	4.58	
EVPGPT6642	1539	66	42	2.875	86.22	6.06	
EVPGPT6648	1714	66	48	2.875	90.11	6.88	
EVPGPT6654	1891	66	54	2.875	99.05	7.70	
EVPGPT6660	2063	66	60	2.875	108.29	8.53	

EVPGT • Fully Glazed Panel - Tempered Glass

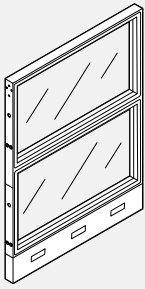

- 54" H Fully Glazed Panels incorporates two 24" Glazed modules.
- Stackability: Evolve Panels can be increased in height in 6", 12" or 24" increments.
- See Extension Module listings for part numbers.
- Standard in clear (CLR)
- Frosted Glass (FRST) upcharge varies. Contact EVOLVE Customer Support for details.
- Glazing is replaceable on site.

PRODUCT CODE	PRICE	SIZE/ INCHES			WEIGHT LBS	VOL FT³
		H	W	D		
EVPGT5418	619	54	18	2.875	35.19	2.19
EVPGT5424	758	54	24	2.875	49.76	2.58
EVPGT5430	837	54	30	2.875	52.08	3.62
EVPGT5436	916	54	36	2.875	64.54	4.31
EVPGT5442	1016	54	42	2.875	72.62	4.99
EVPGT5448	1132	54	48	2.875	78.11	5.67
EVPGT5454	1245	54	54	2.875	86.04	6.35
EVPGT5460	1360	54	60	2.875	94.09	7.03

EVPFOL • Open Bottom Panel

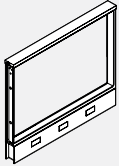

- Open Bottom Panel incorporates a 24" opening in the base section to provide maximum air circulation and access to electrical or data panels.

PRODUCT CODE	PRICE		SIZE/ INCHES			WEIGHT LBS	VOL FT³
	GR 1	GR 2	H	W	D		
EVPFOL3018	236	-	30	18	2.875	17.08	1.23
EVPFOL3024	270	-	30	24	2.875	19.20	1.63
EVPFOL3030	306	-	30	30	2.875	23.05	2.00
EVPFOL3036	339	-	30	36	2.875	25.80	2.38
EVPFOL3042	371	-	30	42	2.875	27.99	2.76
EVPFOL3048	399	-	30	48	2.875	34.00	3.13
EVPFOL3054	433	-	30	54	2.875	37.71	3.51
EVPFOL3060	464	-	30	60	2.875	41.00	3.89
EVPFOL4218	354	365	42	18	2.875	22.28	1.71
EVPFOL4224	409	418	42	24	2.875	25.60	2.31
EVPFOL4230	464	476	42	30	2.875	30.65	2.85
EVPFOL4236	520	535	42	36	2.875	36.60	3.38
EVPFOL4242	579	592	42	42	2.875	40.79	3.92
EVPFOL4248	625	639	42	48	2.875	45.20	4.45
EVPFOL4254	687	705	42	54	2.875	49.92	4.98
EVPFOL4260	744	761	42	60	2.875	54.40	5.52
EVPFOL5418	404	417	54	18	2.875	25.68	2.19
EVPFOL5424	460	478	54	24	2.875	28.80	2.94
EVPFOL5430	524	546	54	30	2.875	34.45	3.24
EVPFOL5436	591	614	54	36	2.875	38.40	4.31
EVPFOL5442	658	687	54	42	2.875	42.19	4.99
EVPFOL5448	712	744	54	48	2.875	50.20	5.67
EVPFOL5454	780	814	54	54	2.875	55.32	6.35
EVPFOL5460	846	884	54	60	2.875	60.20	7.03
EVPFOL6618	523	544	66	18	2.875	31.68	2.68
EVPFOL6624	603	627	66	24	2.875	36.00	3.58
EVPFOL6630	691	721	66	30	2.875	42.84	4.40
EVPFOL6636	775	811	66	36	2.875	50.00	5.23
EVPFOL6642	870	913	66	42	2.875	55.79	6.06
EVPFOL6648	936	984	66	48	2.875	62.20	6.88
EVPFOL6654	1033	1086	66	54	2.875	68.33	7.70
EVPFOL6660	1128	1186	66	60	2.875	74.40	8.53

EVPFPOL • Open Bottom Panel Premium

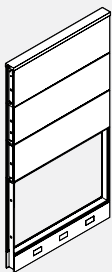

- Open Bottom Premium Panel incorporates a 24" opening in the base section to provide maximum air circulation and access to electrical or data panels.
- 12" high acoustic modules incorporated above the 30" base section.

PRODUCT CODE	PRICE		SIZE/ INCHES			WEIGHT LBS	VOL FT³
	GR 1	GR 2	H	W	D		
EVPFPOL5418	476	487	54	18	2.875	27.88	2.19
EVPFPOL5424	548	568	54	24	2.875	32.40	2.94
EVPFPOL5430	626	647	54	30	2.875	38.64	3.24
EVPFPOL5436	701	725	54	36	2.875	47.80	4.31
EVPFPOL5442	792	820	54	42	2.875	53.99	4.99
EVPFPOL5448	850	882	54	48	2.875	56.80	5.67
EVPFPOL5454	937	972	54	54	2.875	62.53	6.35
EVPFPOL5460	1024	1062	54	60	2.875	68.20	7.03
EVPFPOL6618	596	615	66	18	2.875	33.88	1.84
EVPFPOL6624	692	718	66	24	2.875	39.60	2.52
EVPFPOL6630	786	819	66	30	2.875	47.03	3.15
EVPFPOL6636	888	925	66	36	2.875	59.40	5.23
EVPFPOL6642	1001	1043	66	42	2.875	67.59	4.41
EVPFPOL6648	1073	1121	66	48	2.875	68.80	6.06
EVPFPOL6654	1194	1243	66	54	2.875	75.54	7.70
EVPFPOL6660	1304	1362	66	60	2.875	82.40	6.30

EVPFO • Fabric Open Panel 12" Opening

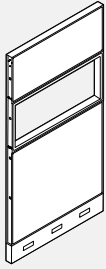

- Fabric Open Panel incorporates a 12" opening above the 30" base section to provide pass-through convenience.

PRODUCT CODE	PRICE		SIZE/ INCHES			WEIGHT		VOL FT ³
	GR 1	GR 2	H	W	D	LBS		
EVPFO5418	484	505	54	18	2.875	26.58	2.19	
EVPFO5424	563	589	54	24	2.875	31.80	2.94	
EVPFO5430	653	682	54	30	2.875	37.64	3.38	
EVPFO5436	736	774	54	36	2.875	45.00	4.31	
EVPFO5442	830	870	54	42	2.875	49.69	4.99	
EVPFO5448	895	942	54	48	2.875	55.20	5.67	
EVPFO5454	994	1043	54	54	2.875	60.53	6.35	
EVPFO5460	1089	1146	54	60	2.875	65.80	7.03	
EVPFO6618	536	561	66	18	2.875	30.38	2.68	
EVPFO6624	619	653	66	24	2.875	35.40	3.58	
EVPFO6630	709	748	66	30	2.875	41.84	5.86	
EVPFO6636	809	856	66	36	2.875	47.20	5.23	
EVPFO6642	909	963	66	42	2.875	51.49	6.06	
EVPFO6648	985	1046	66	48	2.875	60.60	6.88	
EVPFO6654	1090	1157	66	54	2.875	66.33	7.70	
EVPFO6660	1196	1269	66	60	2.875	72.00	8.53	

EVPFPO • Fabric Open Premium Panel 12" Opening

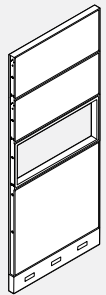

- Fabric Open Premium Panel incorporates a 12" opening above the 30" base section to provide pass-through convenience.
- Two 12" fabric acoustic modules are placed above the 12" opening.

PRODUCT CODE	PRICE		SIZE/ INCHES			WEIGHT		VOL FT ³
	GR 1	GR 2	H	W	D	LBS		
EVPFPO6618	607	631	66	18	2.875	32.58	1.84	
EVPFPO6624	701	736	66	24	2.875	39.00	3.58	
EVPFPO6630	811	851	66	30	2.875	46.03	4.47	
EVPFPO6636	917	963	66	36	2.875	56.60	5.23	
EVPFPO6642	1041	1095	66	42	2.875	63.29	6.06	
EVPFPO6648	1122	1182	66	48	2.875	67.20	6.88	
EVPFPO6654	1245	1315	66	54	2.875	73.54	7.70	
EVPFPO6660	1369	1443	66	60	2.875	80.00	8.53	

EVPFOX • Fabric Open Premium Panel 24" Opening

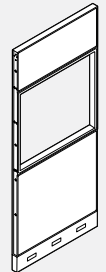

- Fabric Open Premium Panel incorporates a 24" opening above the 30" base section to provide pass-through convenience.
- May or may not have a 12" fabric acoustic module above the 24" opening.

PRODUCT CODE	PRICE		SIZE/ INCHES			WEIGHT		VOL FT ³
	GR 1	GR 2	H	W	D	LBS		
EVPFOX5418	404	417	54	18	2.875	25.68	2.19	
EVPFOX5424	460	478	54	24	2.875	28.80	2.94	
EVPFOX5430	524	546	54	30	2.875	34.45	3.38	
EVPFOX5436	591	614	54	36	2.875	38.40	4.31	
EVPFOX5442	657	686	54	42	2.875	42.19	4.99	
EVPFOX5448	709	740	54	48	2.875	50.20	5.67	
EVPFOX5454	779	813	54	54	2.875	55.32	6.35	
EVPFOX5460	846	884	54	60	2.875	60.20	7.03	
EVPFOX6618	523	544	66	18	2.875	31.68	2.68	
EVPFOX6624	603	627	66	24	2.875	36.00	3.58	
EVPFOX6630	709	737	66	30	2.875	42.84	5.86	
EVPFOX6636	775	811	66	36	2.875	50.00	5.23	
EVPFOX6642	870	913	66	42	2.875	55.79	6.06	
EVPFOX6648	936	984	66	48	2.875	62.20	6.88	
EVPFOX6654	1033	1086	66	54	2.875	68.33	7.70	
EVPFOX6660	1128	1186	66	60	2.875	74.40	8.53	

EVPFSG5M66 - Reception Panels, 24" Fabric Bottom Module and 6" Pass Thru

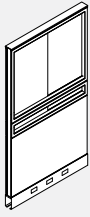

- Reception panel incorporates glazed tempered glass module and pass thru module within steel frame.
- 6" pass thru with sliding tempered glass door module.
- 24" fabric bottom module.
- Aluminum low profile top is included.
- Stackability: Evolve panels can be increased in height in 6", 12", 24" increments. See module listing for part numbers.

PRODUCT CODE	PRICE	SIZE/ INCHES			WEIGHT LBS	VOL FT ³
		H	W	D		
EVPFSG5M6636	1016	66	36	2.875	70.9	5.23
EVPFSG5M6642	1131	66	42	2.875	78.58	6.06
EVPFSG5M6648	1244	66	48	2.875	91.87	6.88

EVPFSG3M66 - Reception Panels, 30" Fabric Bottom Module and 6" Pass Thru

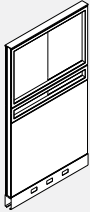

- Reception panel incorporates glazed tempered glass module and pass thru module within steel frame.
- 6" pass thru with sliding tempered glass door module.
- 30" fabric bottom module.
- Aluminum low profile top is included.
- Stackability: Evolve panels can be increased in height in 6", 12", 24" increments. See module listing for part numbers.

PRODUCT CODE	PRICE	SIZE/ INCHES			WEIGHT LBS	VOL FT ³
		H	W	D		
EVPFSG3M6636	1053	66	36	2.875	70.9	5.23
EVPFSG3M6642	1148	66	42	2.875	78.58	6.06
EVPFSG3M6648	1246	66	48	2.875	91.87	6.88

EVPFSG2M66 - Reception Panels, 24" Fabric Bottom Module and 12" Pass Thru

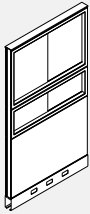

- Reception panel incorporates glazed tempered glass module and pass thru module within steel frame.
- 12" pass thru with sliding tempered glass door module.
- 24" fabric bottom module.
- Aluminum low profile top is included.
- Stackability: Evolve panels can be increased in height in 6", 12", 24" increments. See module listing for part numbers.

PRODUCT CODE	PRICE	SIZE/ INCHES			WEIGHT LBS	VOL FT ³
		H	W	D		
EVPFSG2M6636	998	66	36	2.875	70.9	5.23
EVPFSG2M6642	1100	66	42	2.875	78.58	6.06
EVPFSG2M6648	1211	66	48	2.875	91.87	6.88

EVPHSG5M66 - Reception Panels, 24" Laminate Bottom Module and 6" Pass Thru

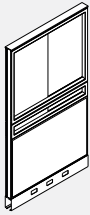

- Reception panel incorporates glazed tempered glass module and pass thru module within steel frame.
- 6" pass thru with sliding tempered glass door module.
- 24" laminate bottom module.
- Aluminum low profile top is included.
- Stackability: Evolve panels can be increased in height in 6", 12", 24" increments. See module listing for part numbers.

PRODUCT CODE	PRICE	SIZE/ INCHES			WEIGHT LBS	VOL FT ³
		H	W	D		
EVPHSG5M6636	1137	66	36	2.875	70.9	5.23
EVPHSG5M6642	1233	66	42	2.875	78.58	6.06
EVPHSG5M6648	1328	66	48	2.875	91.87	6.88

EVPHSG3M66 - Reception Panels, 30" Laminate Bottom Module and 6" Pass Thru

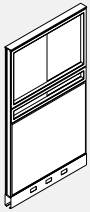

- Reception panel incorporates glazed tempered glass module and pass thru module within steel frame.
- 6" pass thru with sliding tempered glass door module.
- 30" laminate bottom module.
- Aluminum low profile top is included.
- Stackability: Evolve panels can be increased in height in 6", 12", 24" increments. See module listing for part numbers.

PRODUCT CODE	PRICE	SIZE/ INCHES			WEIGHT LBS	VOL FT ³
		H	W	D		
EVPHSG3M6636	1137	66	36	2.875	70.9	5.23
EVPHSG3M6642	1233	66	42	2.875	78.58	6.06
EVPHSG3M6648	1328	66	48	2.875	91.87	6.88

EVPHSG2M66 - Reception Panels, 24" Laminate Bottom Module and 12" Pass Thru

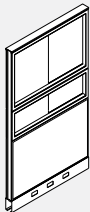

- Reception panel incorporates glazed tempered glass module and pass thru module within steel frame.
- 12" pass thru with sliding tempered glass door module.
- 24" laminate bottom module.
- Aluminum low profile top is included.
- Stackability: Evolve panels can be increased in height in 6", 12", 24" increments. See module listing for part numbers.

PRODUCT CODE	PRICE	SIZE/ INCHES			WEIGHT LBS	VOL FT ³
		H	W	D		
EVPHSG2M6636	1112	66	36	2.875	70.9	5.23
EVPHSG2M6642	1204	66	42	2.875	78.58	6.06
EVPHSG2M6648	1302	66	48	2.875	91.87	6.88

EVPPFAF • Air Flow Panel

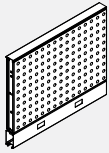

- Metal Air Flow Panel.
- Stackability: Evolve panels can be increased in height in 6", 12", 24" increments. See module listing for part numbers.

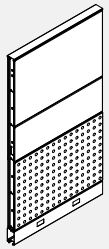
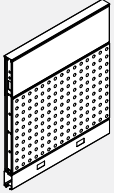

PRODUCT CODE	PRICE		SIZE/ INCHES			WEIGHT LBS	VOL FT ³
	GR 1	GR 2	H	W	D		
EVPPFAF3024	399	-	30	24	2.875	22.08	1.63
EVPPFAF3030	475	-	30	30	2.875	26.51	2.00
EVPPFAF3036	524	-	30	36	2.875	29.67	2.38
EVPPFAF3042	581	-	30	42	2.875	32.19	2.76
EVPPFAF3048	657	-	30	48	2.875	39.10	3.13
EVPPFAF3054	755	-	30	54	2.875	43.37	3.51
EVPPFAF3060	852	-	30	60	2.875	47.15	3.89
EVPPFAF4224	509	517	42	24	2.875	29.44	2.31
EVPPFAF4230	603	612	42	30	2.875	35.25	2.81
EVPPFAF4236	670	682	42	36	2.875	42.09	3.38
EVPPFAF4242	746	758	42	42	2.875	46.91	3.92
EVPPFAF4248	842	856	42	48	2.875	51.98	4.45
EVPPFAF4254	958	975	42	54	2.875	57.41	4.98
EVPPFAF4260	972	994	42	60	2.875	62.56	5.52
EVPPFAF5424	570	586	54	24	2.875	33.12	2.94
EVPPFAF5430	656	676	54	30	2.875	39.62	3.62
EVPPFAF5436	736	759	54	36	2.875	44.16	4.31
EVPPFAF5442	820	849	54	42	2.875	48.52	4.99
EVPPFAF5448	921	954	54	48	2.875	57.73	5.67
EVPPFAF5454	1073	1108	54	54	2.875	63.62	6.35
EVPPFAF5460	1169	1205	54	60	2.875	69.23	7.03
EVPPFAF6624	665	691	66	24	2.875	41.40	3.58
EVPPFAF6630	785	816	66	30	2.875	49.27	4.40
EVPPFAF6636	882	917	66	36	2.875	57.50	5.23
EVPPFAF6642	983	1023	66	42	2.875	64.16	6.06
EVPPFAF6648	1106	1153	66	48	2.875	71.53	6.08
EVPPFAF6654	1255	1303	66	54	2.875	78.58	7.70
EVPPFAF6660	1391	1447	66	60	2.875	85.56	8.53

EVPPPAF • Premium Air Flow Panel

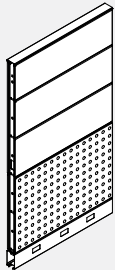

- Metal Air Flow Panel.
- Each side of panel may have different fabric within same grade at no upcharge.
- There is no panel creep.
- Stackability: Evolve panels can be increased in height in 6", 12", 24" increments. See module listing for part numbers.

PRODUCT CODE	PRICE		SIZE/ INCHES			WEIGHT LBS	VOL FT ³
	GR 1	GR 2	H	W	D		
EVPPPAF5424	633	653	54	24	2.875	37.26	2.94
EVPPPAF5430	724	747	54	30	2.875	44.44	3.62
EVPPPAF5436	814	839	54	36	2.875	54.97	4.31
EVPPPAF5442	903	930	54	42	2.875	62.09	4.99
EVPPPAF5448	1023	1055	54	48	2.875	65.32	5.67
EVPPPAF5454	1157	1194	54	54	2.875	73.06	6.35
EVPPPAF5460	1294	1330	54	60	2.875	78.43	7.03
EVPPPAF6624	725	752	66	24	2.875	45.54	3.58
EVPPPAF6630	853	885	66	30	2.875	54.08	4.40
EVPPPAF6636	956	994	66	36	2.875	68.31	5.23
EVPPPAF6642	1062	1102	66	42	2.875	77.73	6.06
EVPPPAF6648	1205	1255	66	48	2.875	79.12	6.08
EVPPPAF6654	1358	1409	66	54	2.875	86.87	7.70
EVPPPAF6660	1514	1570	66	60	2.875	94.76	8.53

EVPPMAF • Premium Air Flow Panel

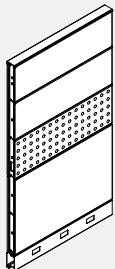

- Metal Air Flow Panel.
- Each side of panel may have different fabric within same grade at no upcharge.
- There is no panel creep.
- Stackability: Evolve panels can be increased in height in 6", 12", 24" increments. See module listing for part numbers.

PRODUCT CODE	PRICE		SIZE/ INCHES			WEIGHT LBS	VOL FT ³
	GR 1	GR 2	H	W	D		
EVPPMAF5424	695	722	54	24	2.875	36.57	2.94
EVPPMAF5430	825	854	54	30	2.875	43.29	3.62
EVPPMAF5436	937	973	54	36	2.875	51.75	4.31
EVPPMAF5442	1055	1094	54	42	2.875	57.14	4.99
EVPPMAF5448	1175	1224	54	48	2.875	63.48	5.67
EVPPMAF5454	1330	1382	54	54	2.875	69.61	6.35
EVPPMAF5460	1484	1542	54	60	2.875	75.67	7.03
EVPPMAF6624	791	825	66	24	2.875	44.85	3.58
EVPPMAF6630	935	975	66	30	2.875	52.93	4.40
EVPPMAF6636	1063	1112	66	36	2.875	65.09	5.23
EVPPMAF6642	1193	1244	66	42	2.875	72.78	6.06
EVPPMAF6648	1330	1394	66	48	2.875	77.28	6.08
EVPPMAF6654	1500	1568	66	54	2.875	84.58	7.70
EVPPMAF6660	1669	1745	66	60	2.875	92.00	8.53

EVPDS • Door Panel - Solid

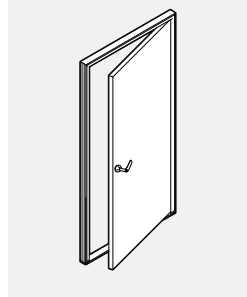

- 90" Door Panel height = 66" high panel plus one 24" or two 12" Panel Extension Modules.
- 1 3/8" thick hollow core door.
- Handedness can be changed in the field.
- Handle sold separately. Specify type of handle required.

PRODUCT CODE	PRICE	SIZE/ INCHES			WEIGHT LBS	VOL FT ³
		H	W	D		
EVPDS7836L	2356	78	36	2.875	64.00	7.50
EVPDS7836R	2356	78	36	2.875	64.00	7.50
EVPDS7842L	2740	78	42	2.875	74.00	8.50
EVPDS7842R	2740	78	42	2.875	74.00	8.50
EVPDS8436L	2480	84	36	2.875	62.00	7.00
EVPDS8436R	2480	84	36	2.875	62.00	7.00
EVPDS8442L	2871	84	42	2.875	72.00	8.00
EVPDS8442R	2871	84	42	2.875	72.00	8.00
EVPDS9036L	2490	90	36	2.875	66.00	8.00
EVPDS9036R	2490	90	36	2.875	66.00	8.00
EVPDS9042L	2871	90	42	2.875	76.00	9.00
EVPDS9042R	2871	90	42	2.875	76.00	9.00

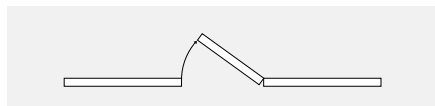

RIGHT HAND HUNG

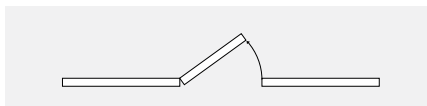

LEFT HAND HUNG

EVPDG • Full Glazed Door panel

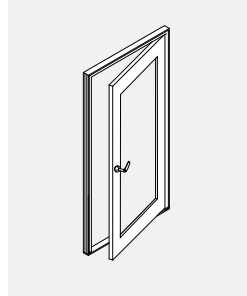

- All door surfaces are high pressure laminate with window.
- If laminate is selected in wood grain, the grain runs vertical.
- HP laminate finish available in all standard finishes.
- Select frame color from standard trim colors.
- 84" Door panel height is 66"h panel and 18" H Panel extension modules.
- 90" Door panel height is 66"h panel and 24" H or two 12" H Panel extension modules.
- Door and door trim can be specified left or right handed.
- Handedness of Door can be changed in field.
- Door Sizes:
 36" W door is 33.63" W without frame (This door is not ADA compliant)
 42" W door is 39.63" W without frame
 84" H door is 81.50" H without frame
 90" H door is 87.50" H without frame
- Customer is responsible to confirm and meet, city, county or any other municipality codes in relation to door clearances.
- Knob or lever to be ordered separately.

PRODUCT CODE	PRICE CLR	FRST	SIZE/INCHES			WEIGHT LBS	VOL FT ³
			H	W	D		
EVPDG8436L	2762	2862	84	36	2.875	62	7
EVPDG8436R	2762	2862	84	36	2.875	62	7
EVPDG8442L	3146	3243	84	42	2.875	72	8
EVPDG8442R	3146	3243	84	42	2.875	72	8
EVPDG9036L	2762	2862	90	36	2.875	66	8
EVPDG9036R	2762	2862	90	36	2.875	66	8
EVPDG9042L	3146	3243	90	42	2.875	76	9
EVPDG9042R	3146	3243	90	42	2.875	76	9

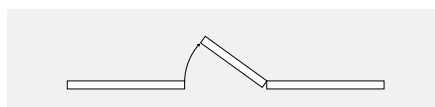

RIGHT HAND HUNG

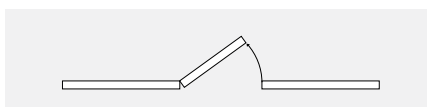

LEFT HAND HUNG

EVPDSL • Door Handles

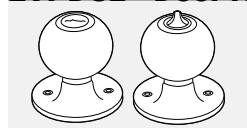

EVPDSL01

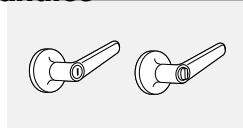

EVPDSL02

PRODUCT CODE	PRICE	SIZE/ INCHES			WEIGHT LBS	VOL FT ³
		H	W	D		
EVPDSL01	90				0.50	0.50
EVPDSL02	127				0.30	0.10

EVPDSL • Sliding Door

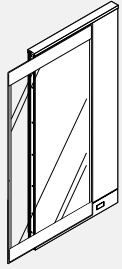

- Provides territorial privacy in an open plan environment.
- Lightweight, panel mounted sliding partition.
- Consists of translucent textured polycarbonate.
- Must be mounted to a panel of the same size.
- The face of the Privacy Screen sits 3" away from the face of the panel to which it is attached.
- When open, the screen may interfere with raceway doors that open on the outside of an adjacent panel.
- Must specify left or right for the direction in which the door will slide once installed.
- Caps located on the end of the frame default to the panel frame colour.
- All hardware included.

• Note: Specify left or right for the direction in which the door will slide as per examples above.

PRODUCT CODE	PRICE	SIZE/ INCHES			WEIGHT VOL	
		H	W	D	LBS	FT ³
EVPDSL6636R	1981	66	36	2.61	35	5.98
EVPDSL6636L	1981	66	36	2.61	35	5.98
EVPDSL6642R	2132	66	42	2.61	42	6.93
EVPDSL6642L	2132	66	42	2.61	42	6.93
EVPDSL8136R	2377	81	36	2.61	43	7.30
EVPDSL8136L	2377	81	36	2.61	43	7.30
EVPDSL8142R	2551	81	42	2.61	50	8.45
EVPDSL8142L	2551	81	42	2.61	50	8.45

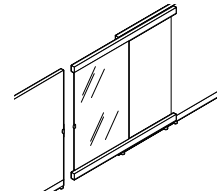

Left Hand Option

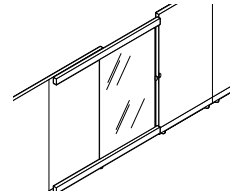

Right Hand Option

EVPDSLLOCK • Sliding Door Lock

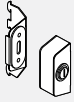

Left Hand Shown

- Lock bracket attaches to Sliding door with screws
- Includes strike plate bracket which attaches to slots in connector.
- Lock included.
- Available in tungsten only.

PRODUCT CODE	PRICE	SIZE/INCHES			WEIGHT VOL	
		H	W	D	LBS	FT ³
EVPDSLLOCKR	240	2.65	1.2	0.9	1.0	0.2
EVPDSLLOCKL	240	2.65	1.2	0.9	1.0	0.2

EVAFMB01 • Floor Mount Plate

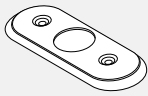

- Attached to floor.
- Secures panel to floor.
- Attachment screws not included.
- Care should be taken to use correct fasteners for type of floor.
- Available in chrome finish only.

PRODUCT CODE	PRICE	SIZE/ INCHES			WEIGHT VOL	
		H	W	D	LBS	FT ³
EVAFMB01	72	0.25	5	2.5	0.2	0.02

EVPFE • Panel Extension Module

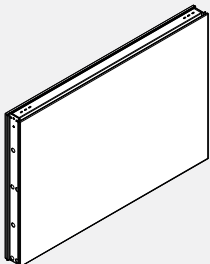

- Single modules are 6", 12", 18" or 24" high.
- When ordering Panel Extension Module, additional connectors are required.

PRODUCT CODE	PRICE		SIZE/ INCHES			WEIGHT VOL	
	GR 1	GR 2	H	W	D	LBS	FT ³
EVPFE0618	153	160	6	18	2.875	4.80	0.21
EVPFE0624	159	169	6	24	2.875	6.40	0.29
EVPFE0630	174	183	6	30	2.875	7.40	0.36
EVPFE0636	195	207	6	36	2.875	8.20	0.43
EVPFE0642	217	233	6	42	2.875	9.40	0.51
EVPFE0648	235	248	6	48	2.875	10.20	0.58
EVPFE0654	253	271	6	54	2.875	14.40	0.65
EVPFE0660	276	295	6	60	2.875	16.00	0.73
EVPFE1218	153	160	12	18	2.875	7.40	0.38
EVPFE1224	159	168	12	24	2.875	8.60	0.50
EVPFE1230	174	183	12	30	2.875	9.60	0.63
EVPFE1236	195	207	12	36	2.875	12.80	0.75
EVPFE1242	217	231	12	42	2.875	14.80	0.88
EVPFE1248	235	248	12	48	2.875	15.00	1.00
EVPFE1254	253	271	12	54	2.875	16.20	1.12
EVPFE1260	276	295	12	60	2.875	17.80	1.25
EVPFE1818	190	201	18	18	2.875	9.01	0.54
EVPFE1824	197	211	18	24	2.875	10.47	0.72
EVPFE1830	212	234	18	30	2.875	11.93	0.90
EVPFE1836	246	268	18	36	2.875	13.39	1.08
EVPFE1842	274	301	18	42	2.875	14.84	1.26
EVPFE1848	298	328	18	48	2.875	16.29	1.44
EVPFE1854	324	355	18	54	2.875	17.76	1.62
EVPFE1860	352	382	18	60	2.875	19.21	1.80
EVPFE2418	190	201	24	18	2.875	10.60	0.75
EVPFE2424	197	212	24	24	2.875	12.32	1.00
EVPFE2430	212	234	24	30	2.875	14.03	1.25
EVPFE2436	246	268	24	36	2.875	15.75	1.50
EVPFE2442	274	301	24	42	2.875	17.46	1.75
EVPFE2448	298	328	24	48	2.875	19.17	2.00
EVPFE2454	324	355	24	54	2.875	20.89	2.25
EVPFE2460	352	391	24	60	2.875	22.60	2.50

EVPFPE • Panel Extension Module Premium

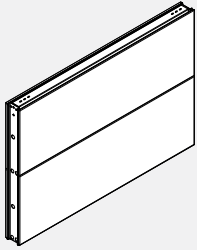

- Two 12" modules are incorporated into one 24" high metal frame.
- When ordering Panel Extension Module, additional connectors are required.

PRODUCT CODE	PRICE		SIZE/ INCHES			WEIGHT		VOL FT ³
	GR 1	GR 2	H	W	D	LBS		
EVPFPE2418	260	270	24	18	2.875	13.90	1.02	
EVPFPE2424	276	293	24	24	2.875	16.80	1.42	
EVPFPE2430	307	328	24	30	2.875	19.58	1.75	
EVPFPE2436	350	373	24	36	2.875	26.40	2.07	
EVPFPE2442	391	418	24	42	2.875	31.04	2.40	
EVPFPE2448	419	450	24	48	2.875	38.40	2.73	
EVPFPE2454	464	499	24	54	2.875	30.90	2.25	
EVPFPE2460	508	544	24	60	2.875	34.00	3.39	

EVPW1SE • Writeboard Extension Module - One Side

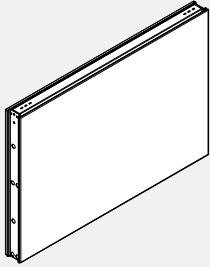

- Single 18" or 24" high module with Writeboard on one side and fabric on the other side.
- Use of erasable Writeboard markers only.
- When ordering Panel Extension Module, additional connectors are required.

PRODUCT CODE	PRICE		SIZE/ INCHES			WEIGHT		VOL FT ³
	GR 1	GR 2	H	W	D	LBS		
EVPW1SE0618	212	217	06	18	3	2.77	0.25	
EVPW1SE0624	247	259	06	24	3	3.20	0.35	
EVPW1SE0630	280	284	06	30	3	3.63	0.43	
EVPW1SE0636	319	327	06	36	3	4.06	0.51	
EVPW1SE0642	361	367	06	42	3	4.49	0.60	
EVPW1SE0648	394	404	06	48	3	4.91	0.68	
EVPW1SE0654	446	454	06	54	3	5.34	0.76	
EVPW1SE0660	469	477	06	60	3	5.77	0.84	
EVPW1SE0666	488	500	06	66	3	6.17	0.91	
EVPW1SE0672	542	550	06	72	3	6.57	0.99	
EVPW1SE1218	212	217	12	18	3	5.55	0.51	
EVPW1SE1224	247	259	12	24	3	6.41	0.71	
EVPW1SE1230	280	284	12	30	3	7.26	0.87	
EVPW1SE1236	319	327	12	36	3	8.12	1.03	
EVPW1SE1242	361	367	12	42	3	8.98	1.20	
EVPW1SE1248	394	404	12	48	3	9.83	1.36	
EVPW1SE1254	446	454	12	54	3	10.69	1.53	
EVPW1SE1260	469	477	12	60	3	11.55	1.69	
EVPW1SE1266	488	500	12	66	3	12.41	1.85	
EVPW1SE1272	542	550	12	72	3	13.27	1.99	
EVPW1SE1818	233	237	18	18	2.875	9.44	0.54	
EVPW1SE1824	263	270	18	24	2.875	10.90	0.72	
EVPW1SE1830	293	303	18	30	2.875	12.35	0.90	
EVPW1SE1836	344	355	18	36	2.875	13.81	1.08	
EVPW1SE1842	389	405	18	42	2.875	15.27	1.26	
EVPW1SE1848	430	448	18	48	2.875	16.72	1.44	
EVPW1SE1854	465	483	18	54	2.875	18.18	1.62	
EVPW1SE1860	503	520	18	60	2.875	19.64	1.80	
EVPW1SE2418	233	237	24	18	2.875	11.10	1.02	
EVPW1SE2424	263	271	24	24	2.875	12.82	2.07	
EVPW1SE2430	293	304	24	30	2.875	14.53	2.17	
EVPW1SE2436	344	355	24	36	2.875	16.25	2.27	
EVPW1SE2442	389	405	24	42	2.875	17.96	2.37	
EVPW1SE2448	430	443	24	48	2.875	19.67	2.47	
EVPW1SE2454	465	483	24	54	2.875	21.39	2.25	
EVPW1SE2460	503	520	24	60	2.875	23.10	3.47	

EVPW2SE • Writeboard Extension Module - Two Side

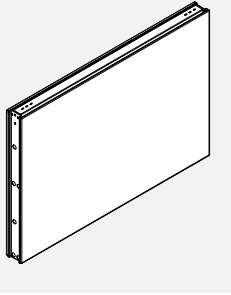

- Single 18" or 24" high module with Writeboard on both sides.
- Use of erasable Writeboard markers only.
- When ordering Panel Extension Module, additional connectors are required.

PRODUCT CODE	PRICE	SIZE/ INCHES			WEIGHT VOL	
		H	W	D	LBS	FT ³
EVPW2SE0618	234	06	18	3	2.77	0.25
EVPW2SE0624	274	06	24	3	3.20	0.35
EVPW2SE0630	318	06	30	3	3.63	0.43
EVPW2SE0636	364	06	36	3	4.06	0.51
EVPW2SE0642	410	06	42	3	4.49	0.60
EVPW2SE0648	460	06	48	3	4.91	0.68
EVPW2SE0654	535	06	54	3	5.34	0.76
EVPW2SE0660	544	06	60	3	5.77	0.84
EVPW2SE0666	555	06	66	3	6.17	0.91
EVPW2SE0672	627	06	72	3	6.57	0.99
EVPW2SE1218	234	12	18	3	5.55	0.51
EVPW2SE1224	274	12	24	3	6.41	0.71
EVPW2SE1230	318	12	30	3	7.26	0.87
EVPW2SE1236	364	12	36	3	8.12	1.03
EVPW2SE1242	410	12	42	3	8.98	1.20
EVPW2SE1248	460	12	48	3	9.83	1.36
EVPW2SE1254	535	12	54	3	10.69	1.53
EVPW2SE1260	544	12	60	3	11.55	1.69
EVPW2SE1266	555	12	66	3	12.41	1.85
EVPW2SE1272	627	12	72	3	13.27	1.99
EVPW2SE1818	279	18	18	2.875	10.29	0.54
EVPW2SE1824	328	18	24	2.875	11.75	0.72
EVPW2SE1830	375	18	30	2.875	13.20	0.90
EVPW2SE1836	446	18	36	2.875	14.66	1.08
EVPW2SE1842	503	18	42	2.875	16.12	1.26
EVPW2SE1848	562	18	48	2.875	17.57	1.44
EVPW2SE1854	622	18	54	2.875	19.03	1.62
EVPW2SE1860	678	18	60	2.875	20.49	1.80
EVPW2SE2418	279	24	18	2.875	12.10	0.75
EVPW2SE2424	328	24	24	2.875	13.82	2.07
EVPW2SE2430	375	24	30	2.875	15.53	2.17
EVPW2SE2436	446	24	36	2.875	17.25	2.27
EVPW2SE2442	503	24	42	2.875	18.96	2.37
EVPW2SE2448	562	24	48	2.875	20.67	2.73
EVPW2SE2454	622	24	54	2.875	22.39	2.35
EVPW2SE2460	678	24	60	2.875	24.10	3.39

EVPGTE • Tempered Glass Panel Extension Module

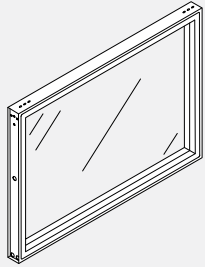

- Single 6", 12", 18" or 24" high module with glazing.
- When ordering Panel Extension Module, additional connectors are required.

PRODUCT CODE	PRICE	SIZE/ INCHES			WEIGHT LBS	VOL FT ³
		H	W	D		
EVPGTE0618	305	6	18	2.875	7.60	0.18
EVPGTE0624	328	6	24	2.875	9.24	0.25
EVPGTE0630	397	6	30	2.875	10.78	0.31
EVPGTE0636	412	6	36	2.875	12.32	0.37
EVPGTE0642	508	6	42	2.875	14.10	0.43
EVPGTE0648	567	6	48	2.875	15.80	0.50
EVPGTE0654	621	6	54	2.875	17.42	0.56
EVPGTE0660	666	6	60	2.875	19.28	0.63
EVPGTE1218	305	12	18	2.875	10.06	0.38
EVPGTE1224	328	12	24	2.875	12.08	0.50
EVPGTE1230	397	12	30	2.875	14.10	0.63
EVPGTE1236	412	12	36	2.875	16.12	0.75
EVPGTE1242	508	12	42	2.875	18.24	0.88
EVPGTE1248	567	12	48	2.875	20.56	1.00
EVPGTE1254	621	12	54	2.875	22.66	1.12
EVPGTE1260	666	12	60	2.875	25.00	1.25
EVPGTE1818	459	18	18	2.875	12.00	0.54
EVPGTE1824	473	18	24	2.875	14.93	0.72
EVPGTE1830	505	18	30	2.875	17.77	0.90
EVPGTE1836	551	18	36	2.875	20.57	1.08
EVPGTE1842	627	18	42	2.875	23.31	1.26
EVPGTE1848	701	18	48	2.875	25.94	1.44
EVPGTE1854	762	18	54	2.875	28.51	1.62
EVPGTE1860	819	18	60	2.875	31.28	1.80
EVPGTE2418	459	24	18	2.875	14.12	0.75
EVPGTE2424	473	24	24	2.875	17.56	1.00
EVPGTE2430	505	24	30	2.875	20.90	1.25
EVPGTE2436	551	24	36	2.875	24.20	1.50
EVPGTE2442	627	24	42	2.875	27.42	1.75
EVPGTE2448	701	24	48	2.875	30.52	2.00
EVPGTE2454	762	24	54	2.875	33.54	2.25
EVPGTE2460	819	24	60	2.875	36.80	2.50

EVPGPTE • Tempered Glass Premium Panel Extension Module

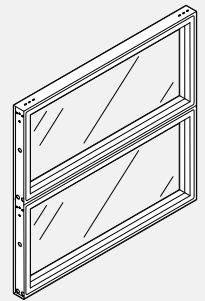

- Two 12" high glazed modules are incorporated into one 24" high metal frame.
- When ordering Panel Extension Module, additional connectors are required.

PRODUCT CODE	PRICE	SIZE/ INCHES			WEIGHT LBS	VOL FT ³
		H	W	D		
EVPGPTE2418	452	24	18	2.875	18.82	1.02
EVPGPTE2424	503	24	24	2.875	22.96	1.42
EVPGPTE2430	573	24	30	2.875	26.99	1.42
EVPGPTE2436	655	24	36	2.875	31.04	1.54
EVPGPTE2442	726	24	42	2.875	35.12	1.72
EVPGPTE2448	816	24	48	2.875	39.99	2.73
EVPGPTE2454	888	24	54	2.875	43.95	3.06
EVPGPTE2460	962	24	60	2.875	48.40	3.39

EVPH1SE • Laminate Extension Module - One Side

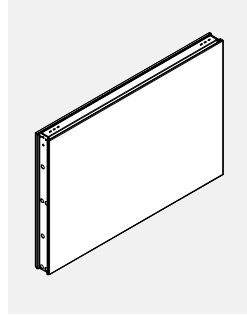

- Laminate face on one side of the module provides durable, washable surfaces. Opposite side is fabric.
- When ordering Panel Extension Module, additional connectors are required.

PRODUCT CODE	PRICE		SIZE/ INCHES			WEIGHT		VOL FT ³
	GR 1	GR 2	H	W	D	LBS		
EVPH1SE0618	212	217	6	18	2.875	2.77	0.25	
EVPH1SE0624	247	259	6	24	2.875	3.20	0.35	
EVPH1SE0630	280	284	6	30	2.875	3.63	0.43	
EVPH1SE0636	319	327	6	36	2.875	4.06	0.51	
EVPH1SE0642	361	367	6	42	2.875	4.49	0.60	
EVPH1SE0648	394	404	6	48	2.875	4.91	0.68	
EVPH1SE0654	446	454	6	54	2.875	5.34	0.76	
EVPH1SE0660	469	477	6	60	2.875	5.77	0.84	
EVPH1SE1218	212	217	12	18	2.875	5.55	0.51	
EVPH1SE1224	247	259	12	24	2.875	6.41	0.71	
EVPH1SE1230	280	284	12	30	2.875	7.26	0.87	
EVPH1SE1236	319	327	12	36	2.875	8.12	1.03	
EVPH1SE1242	361	367	12	42	2.875	8.98	1.20	
EVPH1SE1248	394	404	12	48	2.875	9.83	1.36	
EVPH1SE1254	446	454	12	54	2.875	10.69	1.53	
EVPH1SE1260	469	477	12	60	2.875	11.55	1.69	
EVPH1SE1818	276	281	18	18	2.875	9.44	0.54	
EVPH1SE1824	340	347	18	24	2.875	10.90	0.72	
EVPH1SE1830	391	401	18	30	2.875	12.35	0.90	
EVPH1SE1836	448	457	18	36	2.875	13.81	1.08	
EVPH1SE1842	505	518	18	42	2.875	15.27	1.26	
EVPH1SE1848	553	570	18	48	2.875	16.72	1.44	
EVPH1SE1854	602	619	18	54	2.875	18.18	1.62	
EVPH1SE1860	660	687	18	60	2.875	19.64	1.80	
EVPH1SE2418	286	293	24	18	2.875	11.10	1.02	
EVPH1SE2424	340	349	24	24	2.875	12.82	1.42	
EVPH1SE2430	391	404	24	30	2.875	14.53	1.75	
EVPH1SE2436	448	457	24	36	2.875	16.25	2.07	
EVPH1SE2442	505	517	24	42	2.875	17.96	2.40	
EVPH1SE2448	553	570	24	48	2.875	19.67	2.73	
EVPH1SE2454	602	615	24	54	2.875	21.39	3.06	
EVPH1SE2460	660	682	24	60	2.875	23.10	3.39	

EVPH2SE • Laminate Extension Module - Two Sides

- Laminate face on both sides of the module provides durable, washable surfaces.
- When ordering Panel Extension Module, additional connectors are required.

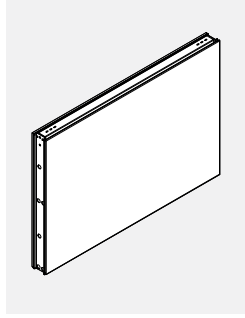

PRODUCT CODE	PRICE	SIZE/ INCHES			WEIGHT LBS	VOL FT ³
		H	W	D		
EVPH2SE0618	234	6	18	2.875	3.03	0.26
EVPH2SE0624	274	6	24	2.875	3.46	0.36
EVPH2SE0630	318	6	30	2.875	3.89	0.44
EVPH2SE0636	364	6	36	2.875	4.32	0.52
EVPH2SE0642	410	6	42	2.875	4.74	0.60
EVPH2SE0648	460	6	48	2.875	5.17	0.69
EVPH2SE0654	535	6	54	2.875	5.60	0.77
EVPH2SE0660	544	6	60	2.875	6.03	0.85
EVPH2SE1218	234	12	18	2.875	6.05	0.51
EVPH2SE1224	274	12	24	2.875	6.91	0.71
EVPH2SE1230	318	12	30	2.875	7.77	0.88
EVPH2SE1236	364	12	36	2.875	8.63	1.04
EVPH2SE1242	410	12	42	2.875	9.48	1.20
EVPH2SE1248	460	12	48	2.875	10.34	1.37
EVPH2SE1254	535	12	54	2.875	11.20	1.53
EVPH2SE1260	544	12	60	2.875	12.05	1.70
EVPH2SE1818	329	18	18	2.875	10.29	0.54
EVPH2SE1824	404	18	24	2.875	11.75	0.72
EVPH2SE1830	469	18	30	2.875	13.20	0.90
EVPH2SE1836	542	18	36	2.875	14.66	1.08
EVPH2SE1842	614	18	42	2.875	16.12	1.26
EVPH2SE1848	694	18	48	2.875	17.57	1.44
EVPH2SE1854	762	18	54	2.875	19.03	1.62
EVPH2SE1860	823	18	60	2.875	20.49	1.80
EVPH2SE2418	329	24	18	2.875	12.10	1.02
EVPH2SE2424	404	24	24	2.875	13.82	1.42
EVPH2SE2430	469	24	30	2.875	15.53	1.75
EVPH2SE2436	542	24	36	2.875	17.25	2.07
EVPH2SE2442	614	24	42	2.875	18.96	2.40
EVPH2SE2448	694	24	48	2.875	20.67	2.73
EVPH2SE2454	762	24	54	2.875	22.39	3.06
EVPH2SE2460	823	24	60	2.875	24.10	3.39

EVPOE • Open Panel Extension Module

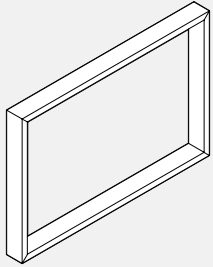

- Provides an opening within a run of panels at a desired location.
- When ordering Panel Extension Module, additional connectors are required.

PRODUCT CODE	PRICE	SIZE/ INCHES			WEIGHT LBS	VOL FT ³
		H	W	D		
EVPOE0618	246	6	18	2.875	6.22	0.26
EVPOE0624	252	6	24	2.875	7.40	0.29
EVPOE0630	307	6	30	2.875	8.48	0.36
EVPOE0636	323	6	36	2.875	9.56	0.43
EVPOE0642	392	6	42	2.875	10.88	0.51
EVPOE0648	442	6	48	2.875	12.12	0.58
EVPOE0654	483	6	54	2.875	13.25	0.65
EVPOE0660	520	6	60	2.875	14.68	0.73
EVPOE1218	246	12	18	2.875	7.30	0.51
EVPOE1224	252	12	24	2.875	8.40	0.59
EVPOE1230	307	12	30	2.875	9.50	0.82
EVPOE1236	323	12	36	2.875	10.60	1.00
EVPOE1242	392	12	42	2.875	11.84	1.00
EVPOE1248	442	12	48	2.875	13.20	1.18
EVPOE1254	483	12	54	2.875	14.38	1.25
EVPOE1260	520	12	60	2.875	15.80	1.32
EVPOE1818	329	18	18	2.875	7.74	0.54
EVPOE1824	369	18	24	2.875	9.18	0.72
EVPOE1830	392	18	30	2.875	10.53	0.90
EVPOE1836	431	18	36	2.875	11.88	1.08
EVPOE1842	485	18	42	2.875	13.09	1.26
EVPOE1848	546	18	48	2.875	14.22	1.44
EVPOE1854	592	18	54	2.875	15.28	1.62
EVPOE1860	638	18	60	2.875	16.56	1.80
EVPOE2418	329	24	18	2.875	8.60	1.02
EVPOE2424	369	24	24	2.875	10.20	1.42
EVPOE2430	392	24	30	2.875	11.70	1.75
EVPOE2436	431	24	36	2.875	13.20	1.95
EVPOE2442	485	24	42	2.875	14.54	2.40
EVPOE2448	546	24	48	2.875	15.80	2.73
EVPOE2454	592	24	54	2.875	16.98	3.06
EVPOE2460	638	24	60	2.875	18.40	3.39

EVPAE • Air Flow Extension Module

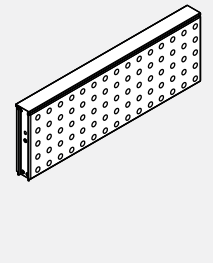

- Metal Air Flow Panel Extension
- Attaches to top of panel
- Panel Extension Modules are not load bearing above 66"
- When ordering Panel Extension Module, additional connectors are required.

PRODUCT CODE	PRICE	SIZE/ INCHES			WEIGHT LBS	VOL FT ³
		H	W	D		
EVPAE1224	270	12	24	2.875	9.66	0.59
EVPAE1230	318	12	30	2.875	10.93	0.82
EVPAE1236	363	12	36	2.875	12.19	1.00
EVPAE1242	401	12	42	2.875	13.62	1.05
EVPAE1248	452	12	48	2.875	15.18	1.18
EVPAE1260	596	12	60	2.875	18.17	1.32
EVPAE1824	339	18	24	2.875	10.56	0.72
EVPAE1830	394	18	30	2.875	12.11	0.90
EVPAE1836	435	18	36	2.875	13.66	1.08
EVPAE1842	478	18	42	2.875	15.05	1.26
EVPAE1848	547	18	48	2.875	16.35	1.44
EVPAE1860	711	18	60	2.875	19.04	1.80
EVPAE2424	339	24	24	2.875	11.73	1.42
EVPAE2430	394	24	30	2.875	13.46	1.75
EVPAE2436	435	24	36	2.875	15.18	1.95
EVPAE2442	478	24	42	2.875	16.72	2.40
EVPAE2448	547	24	48	2.875	18.17	2.73
EVPAE2460	711	24	60	2.875	21.16	3.39

EVPSGE - Pass Thru Sliding Tempered Glass Extension Module

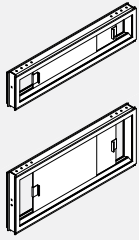

- Pass thru module with sliding tempered glass door.
- Attaches on top of a panel.
- Module can be stacked to add privacy or divide space.
- Panel extension module is not load bearing if installed higher than 66" High.
- When ordering panel extension modules, additional connectors are required.

PRODUCT CODE	PRICE		SIZE/ INCHES			WEIGHT LBS	VOL FT³
	CLR		H	W	D		
EVPSGE0636	297		6	36	2.875	12.32	0.37
EVPSGE0642	316		6	42	2.875	14.1	0.43
EVPSGE0648	384		6	48	2.875	15.8	0.5
EVPSGE1236	357		12	36	2.875	16.12	0.75
EVPSGE1242	378		12	42	2.875	18.24	0.88
EVPSGE1248	398		12	48	2.875	20.56	1

EVPSGXE - Talk Thru Tempered Glass Extension Module

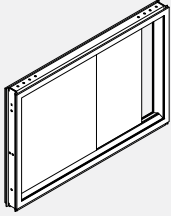

- Talk thru tempered glass module.
- Attaches on top of a panel.
- Module can be stacked to add privacy or divide space.
- Panel extension module is not load bearing if installed higher than 66" High.
- When ordering panel extension modules , additional connectors are required.

PRODUCT CODE	PRICE		SIZE/ INCHES			WEIGHT LBS	VOL FT³
	CLR		H	W	D		
EVPSGXE2436	460		24	36	2.875	24.2	1.25
EVPSGXE2442	509		24	42	2.875	27.42	1.75
EVPSGXE2448	553		24	48	2.875	30.52	2
EVPSGXE3036	503		30	36	2.875	28.1	1.87
EVPSGXE3042	567		30	42	2.875	31.56	2.2
EVPSGXE3048	613		30	48	2.875	35.28	2.5

EVPFEB • Fabric Panel Bridge Module

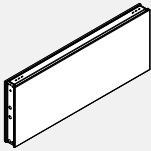

- Bridge modules connects two panels above an opening.
- Requires bridge extension connectors and connects with clamps on top and at bottom.
- Aluminum trim for bottom to be ordered separately.

PRODUCT CODE	PRICE		SIZE/INCHES			WEIGHT LBS	VOL FT³
	GR1	GR2	H	W	D		
EVPFEB0618	153	160	6	18	2.88	4.80	0.21
EVPFEB0624	159	169	6	24	2.88	6.40	0.29
EVPFEB0630	174	183	6	30	2.88	7.40	0.36
EVPFEB0636	195	207	6	36	2.88	8.20	0.43
EVPFEB0642	217	233	6	42	2.88	9.40	0.51
EVPFEB0648	235	248	6	48	2.88	10.20	0.58
EVPFEB0654	253	271	6	54	2.88	14.40	0.65
EVPFEB0660	276	295	6	60	2.88	16.00	0.73
EVPFEB1218	153	160	12	18	2.88	7.40	0.38
EVPFEB1224	159	168	12	24	2.88	8.60	0.50
EVPFEB1230	174	183	12	30	2.88	9.60	0.63
EVPFEB1236	195	207	12	36	2.88	12.80	0.75
EVPFEB1242	217	231	12	42	2.88	14.80	0.88
EVPFEB1248	235	248	12	48	2.88	15.00	1.00
EVPFEB1254	253	271	12	54	2.88	16.20	1.12
EVPFEB1260	276	295	12	60	2.88	17.80	1.25
EVPFEB1818	190	201	18	18	2.88	9.01	0.54
EVPFEB1824	197	211	18	24	2.88	10.47	0.72
EVPFEB1830	212	234	18	30	2.88	11.93	0.90
EVPFEB1836	246	268	18	36	2.88	13.39	1.08
EVPFEB1842	274	301	18	42	2.88	14.84	1.26
EVPFEB1848	298	328	18	48	2.88	16.29	1.44
EVPFEB1854	324	355	18	54	2.88	17.76	1.62
EVPFEB1860	352	382	18	60	2.88	19.21	1.80
EVPFEB2418	190	201	24	18	2.88	10.60	0.75
EVPFEB2424	197	212	24	24	2.88	12.32	1.00
EVPFEB2430	212	234	24	30	2.88	14.03	1.25
EVPFEB2436	246	268	24	36	2.88	15.75	1.50
EVPFEB2442	274	301	24	42	2.88	17.46	1.75
EVPFEB2448	298	328	24	48	2.88	19.17	2.00
EVPFEB2454	324	355	24	54	2.88	20.89	2.25
EVPFEB2460	352	391	24	60	2.88	22.60	2.50

EVPGTEB • Tempered Glass Bridge Module

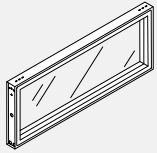

- Bridge modules connects two panels above an opening.
- Requires bridge extension connectors and connects with clamps at bottom.
- Standard in clear (CLR).
- Frosted glass available with a 40% upcharge.
- When ordering bridge modules, additional bridge connectors are required.
- Aluminum trim for bottom to be ordered separately.

PRODUCT CODE	PRICE	SIZE/INCHES			WEIGHT LBS	VOL FT ³
		H	W	D		
EVPGTEB0618	263	6	18	3	7.60	0.18
EVPGTEB0624	281	6	24	3	9.24	0.25
EVPGTEB0630	342	6	30	3	10.78	0.31
EVPGTEB0636	355	6	36	3	12.32	0.37
EVPGTEB0642	437	6	42	3	14.10	0.43
EVPGTEB0648	488	6	48	3	15.80	0.50
EVPGTEB0654	535	6	54	3	17.42	0.56
EVPGTEB0660	574	6	60	3	19.28	0.63
EVPGTEB1218	263	12	18	3	10.06	0.38
EVPGTEB1224	281	12	24	3	12.08	0.50
EVPGTEB1230	342	12	30	3	14.10	0.63
EVPGTEB1236	355	12	36	3	16.12	0.75
EVPGTEB1242	437	12	42	3	18.24	0.88
EVPGTEB1248	488	12	48	3	20.56	1.00
EVPGTEB1254	535	12	54	3	22.66	1.12
EVPGTEB1260	574	12	60	3	25.00	1.25
EVPGTEB1818	396	18	18	3	12.00	0.54
EVPGTEB1824	407	18	24	3	14.93	0.72
EVPGTEB1830	435	18	30	3	17.77	0.90
EVPGTEB1836	475	18	36	3	20.57	1.08
EVPGTEB1842	541	18	42	3	23.31	1.26
EVPGTEB1848	605	18	48	3	25.94	1.44
EVPGTEB1854	657	18	54	3	28.51	1.62
EVPGTEB1860	706	18	60	3	31.28	1.80
EVPGTEB2418	396	24	18	3	14.12	0.75
EVPGTEB2424	407	24	24	3	17.56	1.00
EVPGTEB2430	435	24	30	3	20.90	1.25
EVPGTEB2436	475	24	36	3	24.20	1.50
EVPGTEB2442	541	24	42	3	27.42	1.75
EVPGTEB2448	605	24	48	3	30.52	2.00
EVPGTEB2454	657	24	54	3	33.54	2.25
EVPGTEB2460	706	24	60	3	36.80	2.50

EVPH1SEB • Laminate Bridge Module - Single Sided

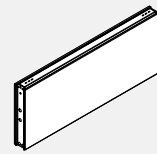

- Bridge modules connects two panels above an opening.
- Requires bridge extension connectors and connects with clamps at bottom.
- Laminate face on one side of module provides durable, washable surface.
- Panel extension module is not load bearing if installed higher than 66" high.
- When ordering bridge modules, additional bridge connectors are required.
- Aluminum trim for bottom to be ordered separately.

PRODUCT CODE	PRICE		SIZE/INCHES			WEIGHT LBS	VOL FT ³
	GR1	GR2	H	W	D		
EVPH1SEB0618	182	187	6	18	3	2.77	0.25
EVPH1SEB0624	213	221	6	24	3	3.20	0.35
EVPH1SEB0630	242	245	6	30	3	3.63	0.43
EVPH1SEB0636	276	280	6	36	3	4.06	0.51
EVPH1SEB0642	310	316	6	42	3	4.49	0.60
EVPH1SEB0648	339	346	6	48	3	4.91	0.68
EVPH1SEB0654	384	391	6	54	3	5.34	0.76
EVPH1SEB0660	403	411	6	60	3	5.77	0.84
EVPH1SEB1218	182	187	12	18	3	5.55	0.51
EVPH1SEB1224	213	221	12	24	3	6.41	0.71
EVPH1SEB1230	242	245	12	30	3	7.26	0.87
EVPH1SEB1236	276	280	12	36	3	8.12	1.03
EVPH1SEB1242	310	316	12	42	3	8.98	1.20
EVPH1SEB1248	339	346	12	48	3	9.83	1.36
EVPH1SEB1254	384	391	12	54	3	10.69	1.53
EVPH1SEB1260	403	411	12	60	3	11.55	1.69
EVPH1SEB1818	238	243	18	18	3	9.44	0.54
EVPH1SEB1824	293	300	18	24	3	10.90	0.72
EVPH1SEB1830	337	345	18	30	3	12.35	0.90
EVPH1SEB1836	385	394	18	36	3	13.81	1.08
EVPH1SEB1842	435	447	18	42	3	15.27	1.26
EVPH1SEB1848	477	491	18	48	3	16.72	1.44
EVPH1SEB1854	517	534	18	54	3	18.18	1.62
EVPH1SEB1860	571	591	18	60	3	19.64	1.80
EVPH1SEB2418	238	243	24	18	3	11.10	1.02
EVPH1SEB2424	293	300	24	24	3	12.82	1.42
EVPH1SEB2430	337	345	24	30	3	14.53	1.75
EVPH1SEB2436	385	394	24	36	3	16.25	2.07
EVPH1SEB2442	435	447	24	42	3	17.96	2.40
EVPH1SEB2448	477	491	24	48	3	19.67	2.73
EVPH1SEB2454	517	534	24	54	3	21.39	3.06
EVPH1SEB2460	571	591	24	60	3	23.10	3.39

EVPH2SEB • Laminate Bridge Module - Double Sided

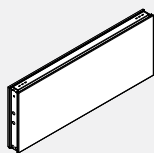

- Bridge modules connects two panels above an opening.
- Requires bridge extension connectors and connects with clamps at bottom.
- Laminate face on two sides of module provides durable, washable surface.
- Panel extension module is not load bearing if installed higher than 66" high.
- When ordering panel extension modules, additional connectors are required.
- Aluminum trim for bottom to be ordered separately.

PRODUCT CODE	PRICE	SIZE/INCHES			WEIGHT LBS	VOL FT ³
		H	W	D		
EVPH2SEB0618	200	6	18	3	3.03	0.26
EVPH2SEB0624	236	6	24	3	3.46	0.36
EVPH2SEB0630	275	6	30	3	3.89	0.44
EVPH2SEB0636	312	6	36	3	4.32	0.52
EVPH2SEB0642	353	6	42	3	4.74	0.60
EVPH2SEB0648	398	6	48	3	5.17	0.69
EVPH2SEB0654	459	6	54	3	5.60	0.77
EVPH2SEB0660	469	6	60	3	6.03	0.85
EVPH2SEB1218	200	12	18	3	6.05	0.51
EVPH2SEB1224	236	12	24	3	6.91	0.71
EVPH2SEB1230	275	12	30	3	7.77	0.88
EVPH2SEB1236	312	12	36	3	8.63	1.04
EVPH2SEB1242	353	12	42	3	9.48	1.20
EVPH2SEB1248	398	12	48	3	10.34	1.37
EVPH2SEB1254	459	12	54	3	11.20	1.53
EVPH2SEB1260	469	12	60	3	12.05	1.70
EVPH2SEB1818	283	18	18	3	10.29	0.54
EVPH2SEB1824	346	18	24	3	11.75	0.72
EVPH2SEB1830	403	18	30	3	13.20	0.90
EVPH2SEB1836	467	18	36	3	14.66	1.08
EVPH2SEB1842	529	18	42	3	16.12	1.26
EVPH2SEB1848	598	18	48	3	17.57	1.44
EVPH2SEB1854	657	18	54	3	19.03	1.62
EVPH2SEB1860	709	18	60	3	20.49	1.80
EVPH2SEB2418	283	24	18	3	12.10	1.02
EVPH2SEB2424	346	24	24	3	13.82	1.42
EVPH2SEB2430	403	24	30	3	15.53	1.75
EVPH2SEB2436	467	24	36	3	17.25	2.07
EVPH2SEB2442	529	24	42	3	18.96	2.40
EVPH2SEB2448	598	24	48	3	20.67	2.73
EVPH2SEB2454	657	24	54	3	22.39	3.06
EVPH2SEB2460	709	24	60	3	24.10	3.39

EVPMP-GI-P • Panel Mount Privacy Glass for U Channel, Extended at Both Ends

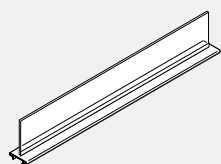

- Privacy Glass integrated with aluminum top trim.
- Attaches on top of panels to add privacy or divide space
- Includes aluminum trim with channel and glass tile.
- Standard in clear (CLR), frosted (FRST) or writeable (WRW) glass.
- Aluminum trim must be specified for entire station when ordering panel mount privacy glass.
- Glass and attachment hardware ship seperately.

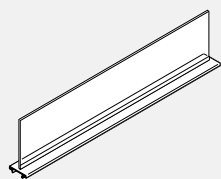
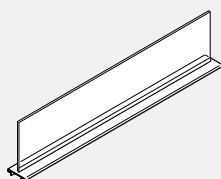

PRODUCT CODE	PRICE			SIZE/ INCHES			WEIGHT LBS	VOL FT ³
	CLR	FRST	WRW	H	W	D		
EVPMP24GI6P	201	251	-	6	24	2.875	2.39	0.25
EVPMP30GI6P	219	276	-	6	30	2.875	2.99	0.32
EVPMP36GI6P	235	291	-	6	36	2.875	3.58	0.37
EVPMP42GI6P	251	313	-	6	42	2.875	4.18	0.43
EVPMP48GI6P	262	327	-	6	48	2.875	4.78	0.50
EVPMP54GI6P	270	338	-	6	54	2.875	5.38	0.56
EVPMP60GI6P	276	343	-	6	60	2.875	5.97	0.63
EVPMP66GI6P	422	562	-	6	66	2.875	6.57	0.69
EVPMP72GI6P	450	587	-	6	72	2.875	7.16	0.76
EVPMP24GI9P	201	251	-	9	24	2.875	3.58	0.38
EVPMP30GI9P	219	276	-	9	30	2.875	4.48	0.47
EVPMP36GI9P	235	291	-	9	36	2.875	5.37	0.56
EVPMP42GI9P	251	313	-	9	42	2.875	6.26	0.65
EVPMP48GI9P	262	327	-	9	48	2.875	7.16	0.75
EVPMP54GI9P	270	338	-	9	54	2.875	8.06	0.84
EVPMP60GI9P	276	343	-	9	60	2.875	8.96	0.94
EVPMP66GI9P	422	562	-	9	66	2.875	9.85	1.04
EVPMP72GI9P	450	587	-	9	72	2.875	10.74	1.13
EVPMP24GIP	201	251	350	12	24	2.875	4.77	0.50
EVPMP30GIP	219	276	357	12	30	2.875	5.97	0.63
EVPMP36GIP	235	291	364	12	36	2.875	7.16	0.75
EVPMP42GIP	251	313	401	12	42	2.875	8.35	0.87
EVPMP48GIP	262	327	439	12	48	2.875	9.55	1.00
EVPMP54GIP	270	338	475	12	54	2.875	10.75	1.12
EVPMP60GIP	276	343	512	12	60	2.875	11.95	1.25
EVPMP66GIP	422	562	701	12	66	2.875	13.05	1.37
EVPMP72GIP	450	587	734	12	72	2.875	14.25	1.51

EVPMPN-GIP • 12" Integrated Panel Mounted Privacy Glass, 1 Notch

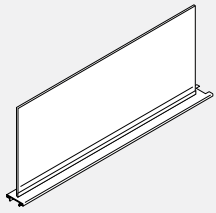

- Privacy Glass Integrated with aluminum top trim.
- Attaches on top of panels to add privacy or divide space.
- Includes aluminum top trim with channel with notched end and glass tile.
- Standard in clear (CLR) or frosted (FRST) glass
- Aluminum trim must be specified for entire station when ordering panel mount privacy glass.
- Glass and attachment hardware to ship separately.

PRODUCT CODE	PRICE		SIZE/ INCHES			WEIGHT LBS	VOL FT³
	CLR	FRST	H	W	D		
EVPMPN24GIP	201	251	12	24	2.875	4.77	0.50
EVPMPN30GIP	219	276	12	30	2.875	5.97	0.63
EVPMPN36GIP	235	291	12	36	2.875	7.16	0.75
EVPMPN42GIP	251	313	12	42	2.875	8.35	0.87
EVPMPN48GIP	262	327	12	48	2.875	9.55	1.00
EVPMPN54GIP	270	338	12	54	2.875	10.75	1.12
EVPMPN60GIP	276	343	12	60	2.875	11.95	1.25

EVPMPDN-GIP • 12" Integrated Panel Mounted Privacy Glass, 2 Notches

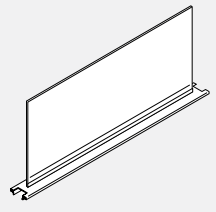

- Privacy Glass Integrated with aluminum top trim.
- Attaches on top of panels to add privacy or divide space.
- Includes aluminum top trim with channel with notched ends and glass tile.
- Standard in clear (CLR) or frosted (FRST) glass
- Aluminum trim must be specified for entire station when ordering panel mount privacy glass.
- Glass and attachment hardware to ship separately.

PRODUCT CODE	PRICE		SIZE/ INCHES			WEIGHT LBS	VOL FT³
	CLR	FRST	H	W	D		
EVPMPDN24GIP	201	251	12	24	2.875	4.77	0.50
EVPMPDN30GIP	219	276	12	30	2.875	5.97	0.63
EVPMPDN36GIP	235	291	12	36	2.875	7.16	0.75
EVPMPDN42GIP	251	313	12	42	2.875	8.35	0.87
EVPMPDN48GIP	262	327	12	48	2.875	9.55	1.00
EVPMPDN54GIP	270	338	12	54	2.875	10.75	1.12
EVPMPDN60GIP	276	343	12	60	2.875	11.95	1.25

EVPMP-GI-PDU • Panel Mount Privacy Glass for U Channel, Extended at Both Ends

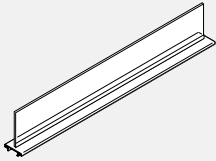

- Privacy glass integrated within aluminum top trim to be used with U channel, with connector for Gallery Panels.
- Attaches on top of panels to add privacy or divide space
- Includes aluminum trim with channel and glass tile
- Standard in clear (CLR) or frosted (FRST) glass
- Aluminum trim must be specified for entire station when ordering panel mount privacy glass.
- Glass and attachment hardware to ship separately
- Trim and glass extended for U channel from both ends.

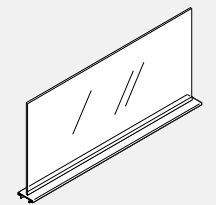
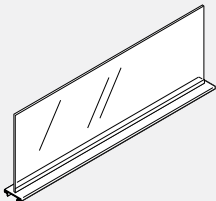
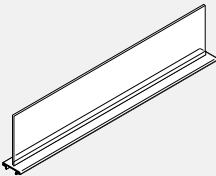

PRODUCT CODE	PRICE		SIZE/ INCHES			WEIGHT LBS	VOL FT³
	CLR	FRST	H	W	D		
EVPMP24GI6PDU	212	264	6	25.25	2.39	0.25	
EVPMP30GI6PDU	225	281	6	31.25	2.99	0.32	
EVPMP36GI6PDU	241	303	6	37.25	3.58	0.37	
EVPMP42GI6PDU	249	313	6	43.25	4.18	0.43	
EVPMP48GI6PDU	260	324	6	49.25	4.78	0.50	
EVPMP54GI6PDU	264	331	6	55.25	5.38	0.56	
EVPMP60GI6PDU	408	540	6	61.25	5.97	0.63	
EVPMP66GI6PDU	433	564	6	67.25	6.57	0.69	
EVPMP72GI6PDU	457	589	6	73.25	7.16	0.76	
EVPMP24GI9PDU	212	264	9	25.25	3.58	0.38	
EVPMP30GI9PDU	225	281	9	31.25	4.48	0.47	
EVPMP36GI9PDU	241	303	9	37.25	5.37	0.56	
EVPMP42GI9PDU	249	313	9	43.25	6.26	0.65	
EVPMP48GI9PDU	260	324	9	49.25	7.16	0.75	
EVPMP54GI9PDU	264	331	9	55.25	8.06	0.84	
EVPMP60GI9PDU	408	540	9	61.25	8.96	0.94	
EVPMP66GI9PDU	433	564	9	67.25	9.85	1.04	
EVPMP72GI9PDU	457	589	9	73.25	10.74	1.13	
EVPMP24GIPDU	212	264	12	25.25	4.77	0.50	
EVPMP30GIPDU	225	281	12	31.25	5.97	0.63	
EVPMP36GIPDU	241	303	12	37.25	7.16	0.75	
EVPMP42GIPDU	249	313	12	43.25	8.35	0.87	
EVPMP48GIPDU	260	324	12	49.25	9.55	1.00	
EVPMP54GIPDU	264	331	12	55.25	10.75	1.12	
EVPMP60GIPDU	408	540	12	61.25	11.94	1.25	
EVPMP66GIPDU	433	564	12	67.25	13.13	1.38	
EVPMP72GIPDU	457	589	12	73.25	14.32	1.51	
EVPMP24GI18PDU	392	450	18	25.25	7.16	0.75	
EVPMP30GI18PDU	418	457	18	31.25	8.96	0.94	
EVPMP36GI18PDU	435	505	18	37.25	10.74	1.13	
EVPMP42GI18PDU	461	551	18	43.25	12.53	1.31	
EVPMP48GI18PDU	478	596	18	49.25	14.33	1.50	
EVPMP54GI18PDU	494	645	18	55.25	16.13	1.69	
EVPMP60GI18PDU	553	733	18	61.25	17.91	1.88	
EVPMP66GI18PDU	587	766	18	67.25	19.70	2.06	
EVPMP72GI18PDU	621	800	18	73.25	21.48	2.25	

EVPMP-GI-PU • Panel Mount Privacy Glass for U Channel, Extended at One End

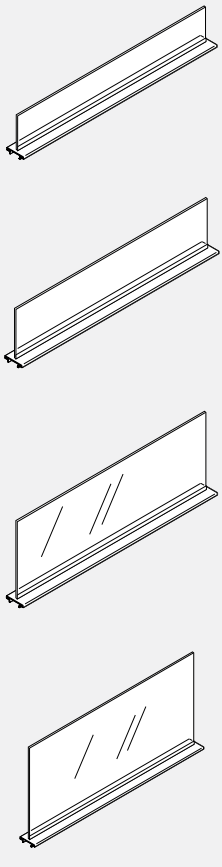

- Privacy glass integrated within aluminum top trim to be used with U channel, with connector for Gallery Panels.
- Attaches on top of panels to add privacy or divide space.
- Includes aluminum trim with channel and glass tile.
- Standard in clear (CLR) or frosted (FRST) glass.
- Aluminium trim must be specified for entire station when ordering panel mount privacy glass.
- Glass and attachment hardware to ship separately.
- Trim and glass extended for U channel on one end.

PRODUCT CODE	PRICE		SIZE/ H	INCHES		WEIGHT VOL	
	CLR	FRST		W	D	LBS	FT³
EVPMP24GI6PU	212	264	6	24.625		2.39	0.25
EVPMP30GI6PU	225	281	6	30.625		2.99	0.32
EVPMP36GI6PU	241	303	6	36.625		3.58	0.37
EVPMP42GI6PU	249	313	6	42.625		4.18	0.43
EVPMP48GI6PU	260	324	6	48.625		4.78	0.50
EVPMP54GI6PU	264	331	6	54.625		5.38	0.56
EVPMP60GI6PU	408	540	6	60.625		5.97	0.63
EVPMP66GI6PU	433	564	6	66.625		6.57	0.69
EVPMP72GI6PU	457	589	6	72.625		7.16	0.76
EVPMP24GI9PU	212	264	9	24.625		3.58	0.38
EVPMP30GI9PU	225	281	9	30.625		4.48	0.47
EVPMP36GI9PU	241	303	9	36.625		5.37	0.56
EVPMP42GI9PU	249	313	9	42.625		6.26	0.65
EVPMP48GI9PU	260	324	9	48.625		7.16	0.75
EVPMP54GI9PU	264	331	9	54.625		8.06	0.84
EVPMP60GI9PU	408	540	9	60.625		8.96	0.94
EVPMP66GI9PU	433	564	9	66.625		9.85	1.04
EVPMP72GI9PU	457	589	9	72.625		10.74	1.13
EVPMP24GIPU	212	264	12	24.625		4.77	0.50
EVPMP30GIPU	225	281	12	30.625		5.97	0.63
EVPMP36GIPU	241	303	12	36.625		7.16	0.75
EVPMP42GIPU	249	313	12	42.625		8.35	0.87
EVPMP48GIPU	260	324	12	48.625		9.55	1.00
EVPMP54GIPU	264	331	12	54.625		10.75	1.12
EVPMP60GIPU	408	540	12	60.625		11.94	1.25
EVPMP66GIPU	433	564	12	66.625		13.13	1.38
EVPMP72GIPU	457	589	12	72.625		14.32	1.51
EVPMP24GI18PU	392	450	18	24.625		7.16	0.75
EVPMP30GI18PU	418	457	18	30.625		8.96	0.94
EVPMP36GI18PU	435	505	18	36.625		10.74	1.13
EVPMP42GI18PU	461	551	18	42.625		12.53	1.31
EVPMP48GI18PU	478	596	18	48.625		14.33	1.50
EVPMP54GI18PU	494	645	18	54.625		16.13	1.69
EVPMP60GI18PU	553	733	18	60.625		17.91	1.88
EVPMP66GI18PU	587	766	18	66.625		19.70	2.06
EVPMP72GI18PU	621	800	18	72.625		21.48	2.25

EVFDK-P • Panel Mount Privacy Felt

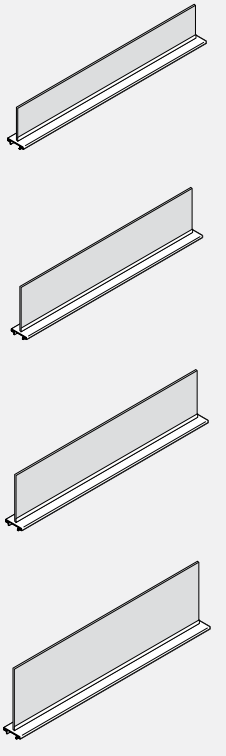

- Privacy felt panel intergrated within aluminum top trim.
- Attaches on top of panels to add privacy or divide space.
- Includes aluminum trim with channel and felt tile.
- Aluminum trim must be specified for entire station when ordering panel mount privacy felt.
- Felt and attachment hardware to ship seperately.
- 9mm Felt material is tackable and comes in 18 different colours. Please specify colour.

PRODUCT CODE	PRICE	SIZE/ INCHES			WEIGHT LBS	VOL FT³
		H	W	D		
EVFDK0624P	72	6	24	2.83	1.42	0.25
EVFDK0630P	88	6	30	2.83	1.73	0.32
EVFDK0636P	102	6	36	2.83	2.03	0.37
EVFDK0642P	113	6	42	2.83	2.34	0.43
EVFDK0648P	170	6	48	2.83	2.64	0.50
EVFDK0654P	183	6	54	2.83	2.95	0.56
EVFDK0660P	199	6	60	2.83	3.25	0.63
EVFDK0666P	210	6	66	2.83	3.56	0.69
EVFDK0672P	238	6	72	2.83	3.86	0.76
EVFDK0924P	72	9	24	2.83	1.63	0.38
EVFDK0930P	88	9	30	2.83	1.99	0.47
EVFDK0936P	102	9	36	2.83	2.35	0.56
EVFDK0942P	113	9	42	2.83	2.70	0.65
EVFDK0948P	170	9	48	2.83	3.06	0.75
EVFDK0954P	183	9	54	2.83	3.42	0.84
EVFDK0960P	199	9	60	2.83	3.78	0.94
EVFDK0966P	210	9	66	2.83	4.13	1.04
EVFDK0972P	238	9	72	2.83	4.49	1.13
EVFDK1224P	72	12	24	2.83	1.84	0.50
EVFDK1230P	88	12	30	2.83	2.25	0.63
EVFDK1236P	102	12	36	2.83	2.66	0.75
EVFDK1242P	113	12	42	2.83	3.07	0.87
EVFDK1248P	170	12	48	2.83	3.48	1.00
EVFDK1254P	183	12	54	2.83	3.89	1.12
EVFDK1260P	199	12	60	2.83	4.30	1.25
EVFDK1266P	210	12	66	2.83	5.12	1.38
EVFDK1272P	238	12	72	2.83	5.53	1.51
EVFDK1824P	92	18	24	2.83	2.26	0.75
EVFDK1830P	108	18	30	2.83	2.77	0.94
EVFDK1836P	128	18	36	2.83	3.29	1.13
EVFDK1842P	143	18	42	2.83	3.80	1.31
EVFDK1848P	212	18	48	2.83	4.32	1.50
EVFDK1854P	231	18	54	2.83	4.83	1.69
EVFDK1860P	248	18	60	2.83	5.35	1.88
EVFDK1866P	262	18	66	2.83	6.68	2.06
EVFDK1872P	298	18	72	2.83	7.20	2.25

EVFDK-PU • Panel Mount Privacy Divider for U Channel

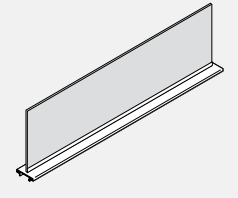

- Attaches on top of panels to add privacy or divide space.
- Privacy felt divider integrated within aluminum top trim to be used with U channel, with connector for Gallery Panels.
- Includes aluminum trim with channel and felt tile.
- Felt and attachment hardware ship separately.
- 9 mm felt material is tackable. Please specify felt finish.
- Aluminum top trim available in standard paint finishes.

PRODUCT CODE	PRICE	SIZE / INCHES			WEIGHT		VOL FT ³
		H	W	D	LBS		
EVFDK0618PU	72	6	18.62	2.83	1.42	0.25	
EVFDK0624PU	87	6	24.62	2.83	1.73	0.32	
EVFDK0630PU	101	6	30.62	2.83	2.03	0.37	
EVFDK0636PU	113	6	36.62	2.83	2.34	0.43	
EVFDK0642PU	170	6	42.62	2.83	2.64	0.50	
EVFDK0648PU	184	6	48.62	2.83	2.95	0.56	
EVFDK0654PU	199	6	54.62	2.83	3.25	0.63	
EVFDK0660PU	211	6	60.62	2.83	3.56	0.69	
EVFDK0666PU	238	6	66.62	2.83	3.86	0.76	
EVFDK0672PU	267	6	72.62	2.83	4.16	0.83	
EVFDK0918PU	72	9	18.62	2.83	1.63	0.38	
EVFDK0924PU	87	9	24.62	2.83	1.99	0.47	
EVFDK0930PU	101	9	30.62	2.83	2.35	0.56	
EVFDK0936PU	113	9	36.62	2.83	2.70	0.65	
EVFDK0942PU	170	9	42.62	2.83	3.06	0.75	
EVFDK0948PU	184	9	48.62	2.83	3.42	0.84	
EVFDK0954PU	199	9	54.62	2.83	3.78	0.94	
EVFDK0960PU	211	9	60.62	2.83	4.13	1.04	
EVFDK0966PU	238	9	66.62	2.83	4.49	1.13	
EVFDK0972PU	267	9	72.62	2.83	4.85	1.22	
EVFDK1218PU	72	12	18.62	2.83	1.84	0.50	
EVFDK1224PU	87	12	24.62	2.83	2.25	0.63	
EVFDK1230PU	101	12	30.62	2.83	2.66	0.75	
EVFDK1236PU	113	12	36.62	2.83	3.07	0.87	
EVFDK1242PU	170	12	42.62	2.83	3.48	1.00	
EVFDK1248PU	184	12	48.62	2.83	3.89	1.12	
EVFDK1254PU	199	12	54.62	2.83	4.30	1.25	
EVFDK1260PU	211	12	60.62	2.83	5.12	1.38	
EVFDK1266PU	238	12	66.62	2.83	5.53	1.51	
EVFDK1272PU	267	12	72.62	2.83	5.94	1.64	
EVFDK1818PU	92	18	18.62	2.83	2.83	0.75	
EVFDK1824PU	109	18	24.62	2.83	2.77	0.94	
EVFDK1830PU	128	18	30.62	2.83	3.29	1.13	
EVFDK1836PU	143	18	36.62	2.83	3.80	1.31	
EVFDK1842PU	213	18	42.62	2.83	4.32	1.50	
EVFDK1848PU	231	18	48.62	2.83	4.83	1.69	
EVFDK1854PU	250	18	54.62	2.83	5.35	1.88	
EVFDK1860PU	263	18	60.62	2.83	6.68	2.06	
EVFDK1866PU	298	18	66.62	2.83	7.20	2.25	
EVFDK1872PU	335	18	72.62	2.83	7.72	2.44	

EVFDK-PDU • Panel Mount Privacy Divider for U channel , Extended at Both Ends

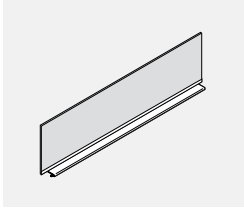

- Attaches on top of panels to add privacy or divide space.
- Privacy felt divider integrated within aluminum top trim to be used with U channel, with connector for Gallery Panels.
- Includes aluminum trim with channel and felt tile.
- Felt and attachment hardware ship separately.
- 9 mm felt material is tackable. Please specify felt finish.
- Aluminum top trim available in standard paint finishes.

PRODUCT CODE	PRICE	SIZE / INCHES			WEIGHT LBS	VOL FT ³
		H	W	D		
EVFDK0618PDU	72	6	19.25	2.83	1.42	0.25
EVFDK0624PDU	87	6	25.25	2.83	1.73	0.32
EVFDK0630PDU	101	6	31.25	2.83	2.03	0.37
EVFDK0636PDU	113	6	37.25	2.83	2.34	0.43
EVFDK0642PDU	170	6	43.25	2.83	2.64	0.50
EVFDK0648PDU	184	6	49.25	2.83	2.95	0.56
EVFDK0654PDU	199	6	55.25	2.83	3.25	0.63
EVFDK0660PDU	211	6	61.25	2.83	3.56	0.69
EVFDK0666PDU	238	6	67.25	2.83	3.86	0.76
EVFDK0672PDU	267	6	73.25	2.83	4.16	0.83
EVFDK0918PDU	72	9	19.25	2.83	1.63	0.38
EVFDK0924PDU	87	9	25.25	2.83	1.99	0.47
EVFDK0930PDU	101	9	31.25	2.83	2.35	0.56
EVFDK0936PDU	113	9	37.25	2.83	2.70	0.65
EVFDK0942PDU	170	9	43.25	2.83	3.06	0.75
EVFDK0948PDU	184	9	49.25	2.83	3.42	0.84
EVFDK0954PDU	199	9	55.25	2.83	3.78	0.94
EVFDK0960PDU	211	9	61.25	2.83	4.13	1.04
EVFDK0966PDU	238	9	67.25	2.83	4.49	1.13
EVFDK0972PDU	267	9	73.25	2.83	4.85	1.22
EVFDK1218PDU	72	12	19.25	2.83	1.84	0.50
EVFDK1224PDU	87	12	25.25	2.83	2.25	0.63
EVFDK1230PDU	101	12	31.25	2.83	2.66	0.75
EVFDK1236PDU	113	12	37.25	2.83	3.07	0.87
EVFDK1242PDU	170	12	43.25	2.83	3.48	1.00
EVFDK1248PDU	184	12	49.25	2.83	3.89	1.12
EVFDK1254PDU	199	12	55.25	2.83	4.30	1.25
EVFDK1260PDU	211	12	61.25	2.83	5.12	1.38
EVFDK1266PDU	238	12	67.25	2.83	5.53	1.51
EVFDK1272PDU	267	12	73.25	2.83	5.94	1.64
EVFDK1818PDU	92	18	19.25	2.83	2.83	0.75
EVFDK1824PDU	109	18	25.25	2.83	2.77	0.94
EVFDK1830PDU	128	18	31.25	2.83	3.29	1.13
EVFDK1836PDU	143	18	37.25	2.83	3.80	1.31
EVFDK1842PDU	213	18	43.25	2.83	4.32	1.50
EVFDK1848PDU	231	18	49.25	2.83	4.83	1.69
EVFDK1854PDU	250	18	55.25	2.83	5.35	1.88
EVFDK1860PDU	263	18	61.25	2.83	6.68	2.06
EVFDK1866PDU	298	18	67.25	2.83	7.20	2.25
EVFDK1872PDU	335	18	73.25	2.83	7.72	2.44

EVFDK12-PN • 12" Panel Mount Privacy Felt 1 Notch

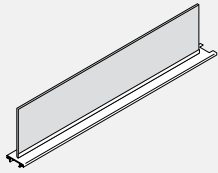

- Privacy felt panel intergrated within aluminum top trim.
- Attaches on top of panels to add privacy or divide space. Includes aluminum trim with channel and felt tile.
- Aluminum trim must be specified for entire station when ordering panel mount privacy felt.
- Felt and attachment hardware to ship seperately.
- 9mm Felt material is tackable. Please specify colour.

PRODUCT CODE	PRICE	SIZE/ INCHES			WEIGHT LBS	VOL FT ³
		H	W	D		
EVFDK1224PN	72	12	24	2.83	1.84	0.50
EVFDK1230PN	88	12	30	2.83	2.25	0.63
EVFDK1236PN	102	12	36	2.83	2.66	0.75
EVFDK1242PN	113	12	42	2.83	3.07	0.87
EVFDK1248PN	170	12	48	2.83	3.48	1.00
EVFDK1254PN	183	12	54	2.83	3.89	1.12
EVFDK1260PN	199	12	60	2.83	4.30	1.25

EVFDK12-PDN • 12" Panel Mount Privacy Felt 2 Notch

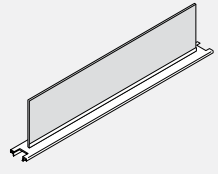

- Privacy felt panel intergrated within aluminum top trim.
- Attaches on top of panels to add privacy or divide space. Includes aluminum trim with channel and felt tile.
- Aluminum trim must be specified for entire station when ordering panel mount privacy felt.
- Felt and attachment hardware to ship seperately.
- 9mm Felt material is tackable. Please specify colour.

PRODUCT CODE	PRICE	SIZE/ INCHES			WEIGHT LBS	VOL FT ³
		H	W	D		
EVFDK1224PDN	72	12	24	2.83	1.84	0.50
EVFDK1230PDN	88	12	30	2.83	2.25	0.63
EVFDK1236PDN	102	12	36	2.83	2.66	0.75
EVFDK1242PDN	113	12	42	2.83	3.07	0.87
EVFDK1248PDN	170	12	48	2.83	3.48	1.00
EVFDK1254PDN	183	12	54	2.83	3.89	1.12
EVFDK1260PDN	199	12	60	2.83	4.30	1.25

EVFPDK06-PCF • 6" H Panel Mount Privacy Divider Ceiling Filler Kit

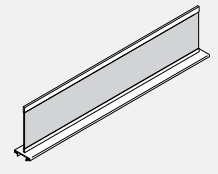

- Privacy Felt Divider integrated within aluminum top trim.
- Includes aluminum trim with channel and Felt tile.
- Felt tile and attachment hardware to ship seperately.
- Please specify felt finish.
- Aluminum top trim available in standard paint finishes.
- PVC cap for closing gap at ceiling included.
- PVC cap available in white only.
- Felt ceiling filler should be used to close the gap between top of panel and ceiling.

PRODUCT CODE	PRICE	SIZE/ INCHES			WEIGHT LBS	VOL FT ³
		H	W	D		
EVFPDK0618PCF	75	6	18	2.83	1.11	0.20
EVFPDK0624PCF	82	6	24	2.83	1.42	0.26
EVFPDK0630PCF	100	6	30	2.83	1.73	0.32
EVFPDK0636PCF	115	6	36	2.83	2.03	0.37
EVFPDK0642PCF	131	6	42	2.83	2.34	0.43
EVFPDK0648PCF	196	6	48	2.83	2.64	0.43
EVFPDK0654PCF	212	6	54	2.83	2.95	0.56
EVFPDK0660PCF	229	6	60	2.83	3.25	0.63
EVFPDK0666PCF	240	6	66	2.83	3.56	0.69
EVFPDK0672PCF	274	6	72	2.83	3.86	0.76

EVFDK06-PCF • 6" H Panel Mount Privacy Divider Ceiling Filler Kit

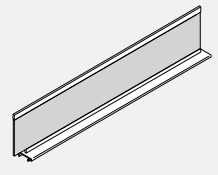

- Privacy Felt Divider integrated with aluminum top trim.
- Includes aluminum trim with channel and Felt tile.
- Felt tile and attachment hardware to ship seperately.
- Please specify felt finish.
- Felt tile is longer and overhangs half of the width of post.
- Aluminum trim is width of panel.
- Aluminum top trim available in standard paint finishes.
- PVC cap for closing gap at ceiling included.
- PVC cap available in white only.
- Felt ceiling filler should be used to close the gap between top of panel and ceiling.

PRODUCT CODE	PRICE	SIZE/ INCHES			WEIGHT LBS	VOL FT ³
		H	W	D		
EVFDK0619PCF	82	6	19.75	2.83	1.42	0.26
EVFDK0625PCF	100	6	25.75	2.83	1.73	0.32
EVFDK0631PCF	115	6	31.75	2.83	2.03	0.37
EVFDK0637PCF	131	6	37.75	2.83	2.34	0.43
EVFDK0643PCF	196	6	43.75	2.83	2.64	0.43
EVFDK0649PCF	212	6	49.75	2.83	2.95	0.56
EVFDK0655PCF	229	6	55.75	2.83	3.25	0.63
EVFDK0661PCF	240	6	61.75	2.83	3.56	0.69
EVFDK0667PCF	274	6	67.75	2.83	3.86	0.76
EVFDK0673PCF	306	6	73.75	2.83	4.16	0.83

POST CONFIGURATIONS • TECHNICAL INFORMATION

As illustrated in the example below, start with position "A" and continue clockwise specifying the height of each slotted connector.

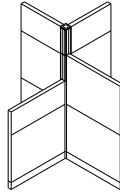
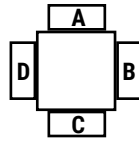
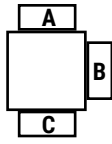
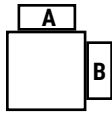

PANEL EXTENSION MODULES

When ordering Panel Extension Modules, Inline Panel Extension Connectors (EVPIEC) must be ordered separately.

Inline Panel Extension Connectors connect two panel extension modules of equal height in a straight run.

Extension connectors do not provide support for hang-on storage above 66".

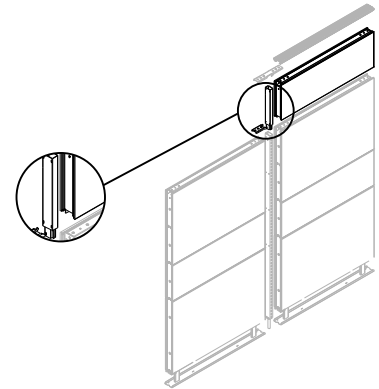
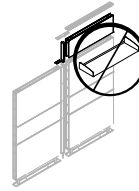

VPIC • Inline Panel Connector

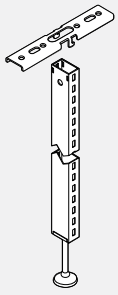

- Connects two panels of equal height in a straight run.
- Provides slotted support for worksurfaces and hang-on storage components.
- Includes slotted connectors with leveling glide and connection hardware.

PRODUCT CODE	PRICE	SIZE/INCHES		WEIGHT VOL	
		H	W	LBS	FT ³
VPIC30	63	30	2	3.30	0.50
VPIC42	67	42	2	4.60	0.07
VPIC48	69	48	2	5.25	0.07
VPIC54	74	54	2	5.90	0.09
VPIC66	83	66	2	7.20	0.10

VPVC • Variable Height Connector

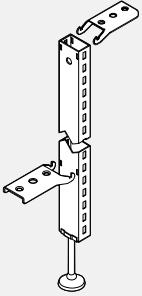

- Connects two panels of different heights in a straight run.
- Connector must reference taller panel.
- Can be used for any variation of panel heights.
- Provides slotted support for worksurfaces and hang-on storage components.
- Includes slotted connector with levelling glide and connection hardware.
- Variable-height trim must be ordered separately, see EVPTV or EVPTVA.

PRODUCT CODE	PRICE	SIZE/INCHES		WEIGHT VOL	
		H	W	LBS	FT ³
VPVC42	74	42	2	4.60	0.70
VPVC48	77	48	2	5.25	0.70
VPVC54	78	54	2	5.90	0.90
VPVC66	88	66	2	7.20	0.10

VEPERA • End of Run Kit (Wall Mount)

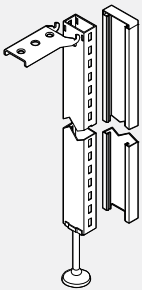

- Finishes the end of each panel run and can be used to attach a panel run to a fixed wall.
- Adds 1" to the width of a panel run.
- Provides slotted support for worksurfaces and hang-on storage components.
- Includes slotted connector with levelling glide, connection hardware and trim kit.
- Can be attached to face of another panel to provide off-modular panel connection by Screwing the trim to the horizontals of the panel.

PRODUCT CODE	PRICE	TYPE	SIZE/INCHES		WEIGHT VOL	
			H	W	LBS	FT ³
VEPERA30	78	Aluminum	30	2.875	3.30	0.07
VEPERA42	94	Aluminum	42	2.875	4.60	0.10
VEPERA48	100	Aluminum	48	2.875	6.75	0.10
VEPERA54	112	Aluminum	54	2.875	5.09	0.18
VEPERA66	126	Aluminum	66	2.875	7.20	0.22

VEPUERA • Upmount End of Run Kit

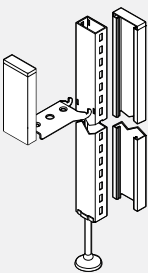

- Replaces the standard End-of-Run Kit VEPERA.
- Used at the end of a panel run to support worksurfaces and Upmount overhead storage.
- Can attach a panel run to a fixed wall.
- Adds 1" to the width of a panel run.
- Includes slotted connector with levelling glide, connection hardware, Upmount End-of-Run Trim EVPUET and one Upmount Extension Trim EVPUET12.

PRODUCT CODE	PRICE	TYPE	SIZE/INCHES		WEIGHT VOL	
			H	W	LBS	FT ³
VEPUERA66	138	Aluminum	66	2.875	7.20	0.22

EVPCPA1 • One Way Post

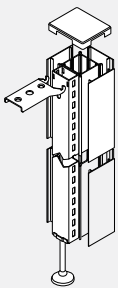

- Replaces an VEPERA End-of-Run Post Kit at the end of a run of panels.
- Used with EVDPE Post Extension to allow for ceiling entry at end of panel run.
- Adds 2 7/8" to the end of a run of panels.
- Provides slotted support for worksurfaces and hang-on storage components.
- Includes corner post, one slotted connector with levelling glides, attachment hardware and trim.

PRODUCT CODE	PRICE	TYPE	SIZE/INCHES			WEIGHT VOL	
			H	W	D	LBS	FT ³
EVPCPA130	103	Aluminum	30	2.875		4.97	0.24
EVPCPA142	117	Aluminum	42	2.875		6.93	0.33
EVPCPA148	139	Aluminum	48	2.875		7.93	0.38
EVPCPA154	160	Aluminum	54	2.875		8.93	0.43
EVPCPA166	199	Aluminum	66	2.875		10.87	0.53

EVPIPA2 • Inline Two Way Post

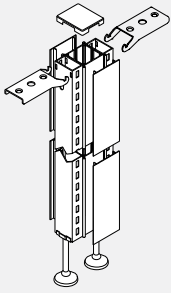

- Connects two panels of equal height in a straight line in place of an EVPIC Inline Panel Connector.
- Adds 2 7/8" to the end of a run of panels.
- Provides slotted support for worksurfaces and hang-on storage components.
- Includes corner post, two slotted connectors with levelling glides, attachment hardware and trim.

PRODUCT CODE	PRICE	TYPE	SIZE/ H	INCHES W	WEIGHT LBS	VOL FT ³
EVPIPA230	162	Aluminum	30	2.875	8.20	0.31
EVPIPA242	207	Aluminum	42	2.875	11.50	0.43
EVPIPA248	217	Aluminum	48	2.875	13.50	0.54
EVPIPA254	251	Aluminum	54	2.875	15.00	0.61
EVPIPA266	299	Aluminum	66	2.875	19.00	0.75

EVPCPA2 • Two Way Corner Post

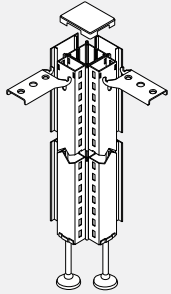

- Attaches two panels of equal height in 90° configuration.
- Provides slotted support for worksurfaces and hang-on storage components.
- Includes corner post, two slotted connectors with levelling glides, attachment hardware and trim.

PRODUCT CODE	PRICE	TYPE	SIZE/ H	INCHES W	WEIGHT LBS	VOL FT ³
EVPCPA230	162	Aluminum	30	2.875	8.50	0.31
EVPCPA242	207	Aluminum	42	2.875	11.50	0.43
EVPCPA248	217	Aluminum	48	2.875	11.50	0.43
EVPCPA254	251	Aluminum	54	2.875	15.00	0.61
EVPCPA266	299	Aluminum	66	2.875	19.00	0.75

EVPCPA3 • Three Way Corner Post

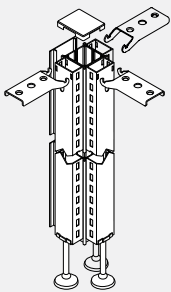

- Attaches three panels of equal height in a "T" configuration.
- Provides slotted support for worksurfaces and hang-on storage components.
- Includes corner post, three slotted connectors with levelling glides, attachment hardware top cap and trim.

PRODUCT CODE	PRICE	TYPE	SIZE/ H	INCHES W	WEIGHT LBS	VOL FT ³
EVPCPA330	195	Aluminum	30	2.875	11.80	0.36
EVPCPA342	260	Aluminum	42	2.875	16.10	0.50
EVPCPA348	286	Aluminum	48	2.875	18.75	0.61
EVPCPA354	317	Aluminum	54	2.875	20.50	0.70
EVPCPA366	373	Aluminum	66	2.875	26.20	0.85

EVPCP4 • Four Way Corner Post

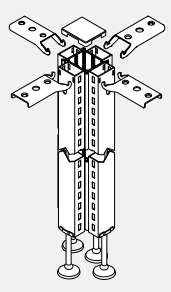

- Attaches four panels of equal height in an "X" configuration.
- Provides slotted support for worksurfaces and hang-on storage components.
- Includes corner post, four slotted connectors with levelling glides, attachment hardware and top cap.

PRODUCT CODE	PRICE	TYPE	SIZE/ H	INCHES W	WEIGHT LBS	VOL FT ³
EVPCP430	213	Aluminum	30	2.875	15.50	0.41
EVPCP442	279	Aluminum	42	2.875	21.00	0.57
EVPCP448	307	Aluminum	48	2.875	24.00	0.68
EVPCP454	339	Aluminum	54	2.875	26.50	0.79
EVPCP466	397	Aluminum	66	2.875	33.20	0.95

EVVPA2 • Two Way Variable Height Corner Post

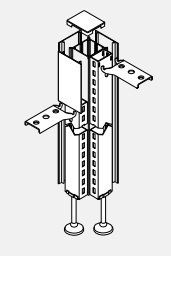

- Attaches two panels of different heights at a corner.
- Specify the corner post height that matches the tallest panel attached to the post face.
- Provides slotted support for worksurfaces and hang-on storage components.
- Includes corner post, two slotted connectors with levelling glides, attachment hardware and trim.
- Configuration of connecting panels must be specified. ie. 54/66. See Technical Information at the beginning of this section.

PRODUCT CODE	PRICE	TYPE	SIZE/ H	INCHES W	WEIGHT LBS	VOL FT ³
EVVPA242	207	Aluminum	42	2.875	10.00	1.30
EVVPA248	229	Aluminum	48	2.875	13.50	1.50
EVVPA254	251	Aluminum	54	2.875	17.00	1.80
EVVPA266	299	Aluminum	66	2.875	20.50	2.10

EVPVPA3 • Three Way Variable Height Corner Post

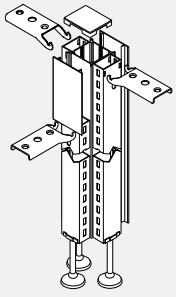

- Attaches three panels of different heights in a "T" configuration.
- Specify the corner post height that matches the tallest panel attached to the post face.
- Provides slotted support for worksurfaces and hang-on storage components.
- Includes corner post, three slotted connectors with levelling glides, attachment hardware and trim.
- Configuration of connecting panels must be specified. ie. 54/42/66. See Technical information page at the beginning of this section.

PRODUCT CODE	PRICE	TYPE	SIZE/ H	INCHES W	WEIGHT LBS	VOL FT ³
EVPVPA342	260	Aluminum	42	2.875	12.50	0.30
EVPVPA348	286	Aluminum	48	2.875	15.50	0.66
EVPVPA354	317	Aluminum	54	2.875	18.50	0.68
EVPVPA366	373	Aluminum	66	2.875	24.20	0.90

EVPVPA4 • Four Way Variable Height Corner Post

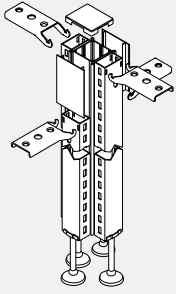

- Attaches four panels of different heights in an "X" configuration.
- Specify the corner post height that matches the tallest panel attached to the post face.
- Provides slotted support for worksurfaces and hang-on storage components.
- Includes corner post, four slotted connectors with levelling glides, attachment hardware and trim.
- Configuration of connecting panels must be specified. ie. 42/66/54/42. See Technical information page at the beginning of this section.

PRODUCT CODE	PRICE	TYPE	SIZE/ H	INCHES W	WEIGHT LBS	VOL FT ³
EVPVPA442	293	Aluminum	42	2.875	18.50	0.35
EVPVPA448	323	Aluminum	48	2.875	20.50	0.70
EVPVPA454	353	Aluminum	54	2.875	24.50	1.05
EVPVPA466	417	Aluminum	66	2.875	30.20	1.40

EVPIEC • Inline Panel Extension Connector - Non Slotted

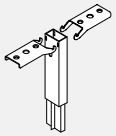

- Connects two panel extension modules of equal height in a straight run.
- Does not provide support for hang-on storage components.

PRODUCT CODE	PRICE	SIZE/ H	INCHES W	WEIGHT LBS	VOL FT ³
EVPIEC06	30	6	2	1.00	0.06
EVPIEC12	30	12	2	2.00	0.12
EVPIEC18	36	18	2	3.00	0.18
EVPIEC24	36	24	2	4.00	0.24

EVPIECS • Inline Panel Extension Connector - Slotted

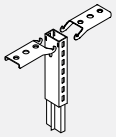

- Connects two panel extension modules of equal height in a straight run.
- Provides slotted support up to 66" high for worksurfaces and hang-on storage components.

PRODUCT CODE	PRICE	SIZE/ H	INCHES W	WEIGHT LBS	VOL FT ³
EVPIECS06	37	6	2	1.00	0.06
EVPIECS12	37	12	2	2.00	0.12
EVPIECS18	43	18	2	3.00	0.18
EVPIECS24	43	24	2	4.00	0.24

EVPEERA • End of Run Extension - Non Slotted

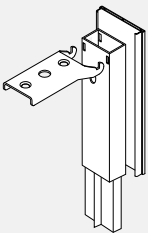

- Extends an End-of-Run Kit.
- Does not provide support for hang-on storage components.
- Includes Inline Panel Extension Connector (EVPIEC) and Panel Extension Trim (EVPTEA).

PRODUCT CODE	PRICE	TYPE	SIZE/ H	INCHES W	WEIGHT LBS	VOL FT ³
EVPEERA06	34	Aluminum	6	2.875	1.00	0.06
EVPEERA12	34	Aluminum	12	2.875	2.00	0.12
EVPEERA18	40	Aluminum	18	2.875	3.00	0.18
EVPEERA24	40	Aluminum	24	2.875	4.00	0.24

EVPEERSA • End of Run Extension - Slotted

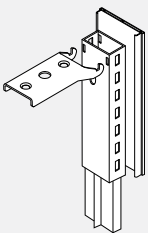

- Extends an End-of-Run Kit.
- Provides slotted support up to 66" high for worksurfaces and hang-on storage components.
- Includes Inline Panel Extension Connector (EVPIECS) and Panel Extension Trim (EVPTE or EVPTEA).

PRODUCT CODE	PRICE	TYPE	SIZE/ H	INCHES W	WEIGHT LBS	VOL FT ³
EVPEERSA06	40	Aluminum	6	2.875	1.00	0.06
EVPEERSA12	40	Aluminum	12	2.875	2.00	0.12
EVPEERSA18	61	Aluminum	18	2.875	3.00	0.18
EVPEERSA24	61	Aluminum	24	2.875	4.00	0.24

EVPCEPA1 • One Way Post Extension - Non Slotted

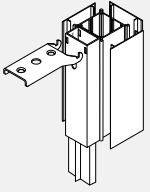

- Attaches to a corner post at the end of a run of panel extension modules.
- Includes corner extension post, one non-slotted connector, attachment hardware and trim.

PRODUCT CODE	PRICE	TYPE	SIZE/ H	INCHES W	WEIGHT LBS	VOL FT ³
EVPCEPA106	66	Aluminum	6	2.875	2.00	0.07
EVPCEPA112	66	Aluminum	12	2.875	4.00	0.14
EVPCEPA118	91	Aluminum	18	2.875	6.00	0.21
EVPCEPA124	91	Aluminum	24	2.875	8.00	0.28

EVPCEPSA1 • One Way Post Extension - Slotted

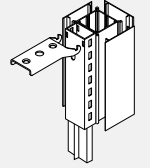

- Attaches to a corner post at the end of a run of panel extension modules.
- Provides slotted support up to 66" high for worksurfaces and hang-on storage components.
- Includes corner extension post, one slotted connector, attachment hardware and trim.

PRODUCT CODE	PRICE	TYPE	SIZE/ H	INCHES W	WEIGHT LBS	VOL FT ³
EVPCEPSA106	89	Aluminum	6	2.875	2.00	0.07
EVPCEPSA112	89	Aluminum	12	2.875	4.00	0.14
EVPCEPSA118	112	Aluminum	18	2.875	6.00	0.21
EVPCEPSA124	112	Aluminum	24	2.875	8.00	0.28

EVPCEIPA2 • Inline Post Extension - Non Slotted

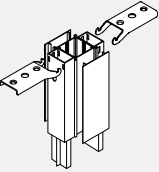

- Attaches to a corner post and connects two panel extension modules in a straight line.
- Includes corner extension post, two non-slotted connectors, attachment hardware and trim.

PRODUCT CODE	PRICE	TYPE	SIZE/ H	INCHES W	WEIGHT LBS	VOL FT ³
EVPCEIPA206	90	Aluminum	6	2.875	2.00	0.07
EVPCEIPA212	90	Aluminum	12	2.875	4.00	0.14
EVPCEIPA218	140	Aluminum	18	2.875	6.00	0.18
EVPCEIPA224	140	Aluminum	24	2.875	8.00	0.28

EVPCEIPSA2 • Inline Post Extension - Slotted

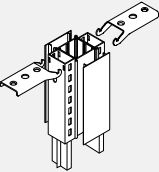

- Attaches to a corner post and connects two panel extension modules in a straight line.
- Provides slotted support up to 66" high for worksurfaces and hang-on storage components.
- Includes corner extension post, two slotted connectors, attachment hardware and trim.

PRODUCT CODE	PRICE	TYPE	SIZE/ H	INCHES W	WEIGHT LBS	VOL FT ³
EVPCEIPSA206	90	Aluminum	6	2.875	2.00	0.07
EVPCEIPSA212	90	Aluminum	12	2.875	4.00	0.14
EVPCEIPSA218	140	Aluminum	18	2.875	6.00	0.18
EVPCEIPSA224	140	Aluminum	24	2.875	8.00	0.28

EVPCEPA2 • Two Way Post Extension - Non Slotted

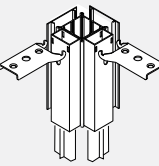

- Connects two panel extension modules of equal height in a corner "L" configuration.
- Includes corner extension post, two non-slotted connectors, attachment hardware and trim.

PRODUCT CODE	PRICE	TYPE	SIZE/ H	INCHES W	WEIGHT LBS	VOL FT ³
EVPCEPA206	72	Aluminum	6	2.875	2.00	0.07
EVPCEPA212	72	Aluminum	12	2.875	4.00	0.14
EVPCEPA218	122	Aluminum	18	2.875	6.00	0.21
EVPCEPA224	122	Aluminum	24	2.875	8.00	0.28

EVPCEPSA2 • Two Way Post Extension - Slotted

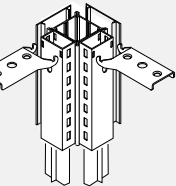

- Connects two panel extension modules of equal height in a 90° configuration.
- Includes corner extension post, two slotted connectors, attachment hardware and trim.

PRODUCT CODE	PRICE	TYPE	SIZE/ H	INCHES W	WEIGHT LBS	VOL FT ³
EVPCEPSA206	90	Aluminum	6	2.875	2.00	0.07
EVPCEPSA212	90	Aluminum	12	2.875	4.00	0.14
EVPCEPSA218	140	Aluminum	18	2.875	6.00	0.21
EVPCEPSA224	140	Aluminum	24	2.875	8.00	0.28

EVPCEPA3 • Three Way Post Extension - Non Slotted

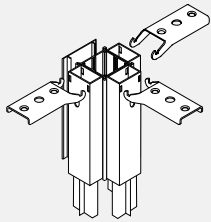

- Connects three panel extension modules of equal height in a corner "T" configuration.
- Includes corner extension post, three non-slotted connectors, attachment hardware and trim.

PRODUCT CODE	PRICE	TYPE	SIZE/ H	INCHES W	WEIGHT LBS	VOL FT ³
EVPCEPA306	80	Aluminum	6	2.875	3.00	0.08
EVPCEPA312	80	Aluminum	12	2.875	6.00	0.16
EVPCEPA318	133	Aluminum	18	2.875	9.00	0.24
EVPCEPA324	133	Aluminum	24	2.875	12.00	0.32

EVPCEPSA3 • Three Way Post Extension - Slotted

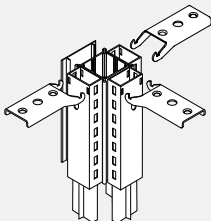

- Connects three panel extension modules of equal height in a corner "T" configuration.
- Includes corner extension post, three slotted connectors, attachment hardware and trim.

PRODUCT CODE	PRICE	TYPE	SIZE/ H	INCHES W	WEIGHT LBS	VOL FT ³
EVPCEPSA306	103	Aluminum	6	2.875	3.00	0.08
EVPCEPSA312	103	Aluminum	12	2.875	6.00	0.16
EVPCEPSA318	161	Aluminum	18	2.875	9.00	0.24
EVPCEPSA324	161	Aluminum	24	2.875	12.00	0.32

EVPCEP4 • Four Way Post Extension - Non Slotted

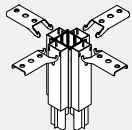

- Connects four panel extension modules of equal height in a corner "X" configuration.
- Includes corner extension post, four non-slotted connectors and attachment hardware.

PRODUCT CODE	PRICE	SIZE/ H	INCHES W	WEIGHT LBS	VOL FT ³
EVPCEP406	74	6	2.875	4.00	0.09
EVPCEP412	74	12	2.875	8.00	0.18
EVPCEP418	117	18	2.875	12.00	0.27
EVPCEP424	117	24	2.875	16.00	0.36

EVPCEPS4 • Four Way Extension Post - Slotted

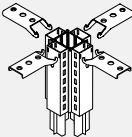

- Connects four panel extension modules of equal height in a corner "X" four-way configuration.
- Includes corner extension post, four slotted connectors and attachment hardware.

PRODUCT CODE	PRICE	SIZE/ H	INCHES W	WEIGHT LBS	VOL FT ³
EVPCEPS406	106	6	2.875	4.00	0.09
EVPCEPS412	106	12	2.875	8.00	0.18
EVPCEPS418	145	18	2.875	12.00	0.27
EVPCEPS424	159	24	2.875	16.00	0.36

EVP4PA • Two Way 45° Corner Post

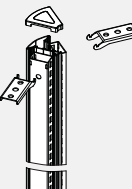

- Attaches two Panels of equal height in a 135° configuration.
- Provides slotted support for worksurfaces and hang-on storage components.
- Includes corner post, two slotted connectors with leveling glides and connecting hardware.
- Connectors available without slots as a special at no upcharge. Contact Customer Support.
- Does not allow to run wires under top trim.

PRODUCT CODE	PRICE	SIZE/ H	INCHES W	WEIGHT LBS	VOL FT ³
EVP4PA230	147	30	3.65	8.50	0.310
EVP4PA242	187	42	3.65	11.50	0.430
EVP4PA248	197	48	3.65	13.50	0.540
EVP4PA254	229	54	3.65	15.00	0.610
EVP4PA266	271	66	3.65	19.00	0.750

EVP4VPA • Variable Height Two Way 45° Corner Post - Aluminum

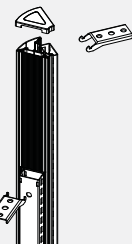

- Attaches two Panels of different height in a 135° configuration.
- Specify the corner post height that matches the tallest panel attached to the post face.
- Provides slotted support for worksurfaces and hang-on storage components.
- Includes corner post, two slotted connectors with leveling glides and connecting hardware.
- Connectors available without slots as a special at no upcharge. Contact Customer Support.
- Do not allow to run wires under the top trim.

PRODUCT CODE	PRICE	SIZE/ H	INCHES W	WEIGHT LBS	VOL FT ³
EVP4VPA242	197	42	3.65	8.50	0.310
EVP4VPA248	218	48	3.65	11.50	0.430
EVP4VPA254	240	54	3.65	13.50	0.540
EVP4VPA266	286	66	3.65	15.00	0.610

EVP4CEPSA • One Way 45° Corner Post Extension - Slotted - Aluminum

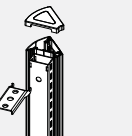

- Attached to a corner post at the end of run of panel extension modules.
- Provides slotted support up to 66" high for worksurfaces and hang-on storage components.
- Includes corner extension post, one slotted connectors, connecting hardware and trim kit.

PRODUCT CODE	PRICE	SIZE/ H	INCHES W	WEIGHT LBS	VOL FT ³
EVP4CEPSA106	80	6	3.65	6	3.65
EVP4CEPSA112	83	12	3.65	12	3.65
EVP4CEPSA118	109	18	3.65	18	3.65
EVP4CEPSA124	109	24	3.65	24	3.65

EVP4CEPA • One Way 45° Corner Post Extension - Non Slotted - Aluminum

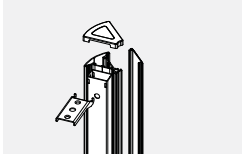

- Attached to a corner post at the end of run of panel extension modules.
- Includes corner extension post, one non-slotted connectors, connecting hardware and trim kit.

PRODUCT CODE	PRICE	SIZE/ H	INCHES W	WEIGHT LBS	VOL FT ³
EVP4CEPA106	61	6	3.65	6	3.65
EVP4CEPA112	65	12	3.65	12	3.65
EVP4CEPA118	88	18	3.65	18	3.65
EVP4CEPA124	88	24	3.65	24	3.65

EVP6PA2 • Two Way 60° Corner Post - Aluminum

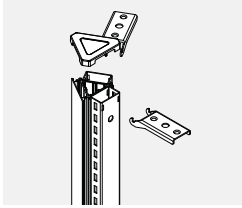

- Attaches two Panels of equal height in a 120° configuration.
- Provides slotted support for worksurfaces and hang-on storage components.
- Includes corner post, two slotted connectors with leveling glides, connecting hardware and trim kit.
- Connectors available without slots as a special at no upcharge. Contact Customer Support.

PRODUCT CODE	PRICE	SIZE/ H	INCHES W	WEIGHT LBS	VOL FT ³
EVP6PA230	157	30	3.65	8.50	0.310
EVP6PA242	195	42	3.65	11.50	0.430
EVP6PA248	212	48	3.65	13.50	0.540
EVP6PA254	241	54	3.65	15.00	0.610
EVP6PA266	286	66	3.65	19.00	0.750

EVP6P3 • Three Way 60° Corner Post

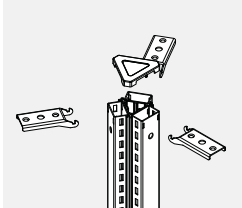

- Attaches three panels of equal height in a 120° configuration.
- Provides slotted support for worksurfaces and hang-on storage components.
- Includes corner post, two slotted connectors with leveling glides and connecting hardware.
- Connectors available without slots as a special at no upcharge. Contact Customer Support.

PRODUCT CODE	PRICE	SIZE/ H	INCHES W	WEIGHT LBS	VOL FT ³
EVP6P330	169	30	3.65	11.90	0.360
EVP6P342	227	42	3.65	16.10	0.500
EVP6P348	249	48	3.65	18.75	0.610
EVP6P354	276	54	3.65	20.50	0.700
EVP6P366	327	66	3.65	26.20	0.850

EVP6VPA2 • Variable Height Two Way 60° Corner Post - Aluminum

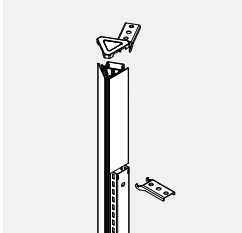

- Attaches two Panels of different height in a 120° configuration.
- Specify the corner post height that matches the tallest panel attached to the post face.
- Provides slotted support for worksurfaces and hang-on storage components.
- Includes corner post, two slotted connectors with leveling glides, connecting hardware and trim kit.
- Connectors available without slots as a special at no upcharge. Contact Customer Support

PRODUCT CODE	PRICE	SIZE/ H	INCHES W	WEIGHT LBS	VOL FT ³
EVP6VPA242	197	30	3.65	12.50	0.490
EVP6VPA248	218	42	3.65	15.40	0.660
EVP6VPA254	240	48	3.65	19.00	0.700
EVP6VPA266	286	54	3.65	22.50	0.750

EVP6VPA3 • Variable Height Three Way 60° Corner Post - Aluminum

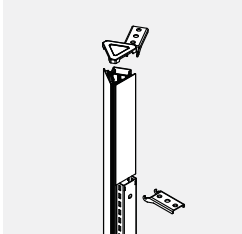

- Attaches two Panels of different height in a 120° configuration.
- Specify the corner post height that matches the tallest panel attached to the post face.
- Provides slotted support for worksurfaces and hang-on storage components.
- Includes corner post, two slotted connectors with leveling glides, connecting hardware and trim kit.
- Connectors available without slots as a special at no upcharge. Contact Customer Support

PRODUCT CODE	PRICE	SIZE/ H	INCHES W	WEIGHT LBS	VOL FT ³
EVP6VPA342	247	30	3.65	18.50	0.550
EVP6VPA348	276	42	3.65	20.50	0.700
EVP6VPA354	313	48	3.65	24.50	1.050
EVP6VPA366	361	54	3.65	30.20	1.400

EVP4CEPS2 • Two Way 45° Corner Post Extension - Slotted

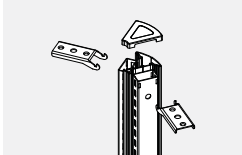

- Used to connect two panel extension modules of equal height.
- Provides slotted support up to 66" high for worksurfaces and hang-on storage components.
- Includes corner extension post, two slotted connectors and connecting hardware.

PRODUCT CODE	PRICE	SIZE/ H	INCHES W	WEIGHT LBS	VOL FT ³
EVP4CEPS206	74	6	3.65	6	3.65
EVP4CEPS212	74	12	3.65	12	3.65
EVP4CEPS218	115	18	3.65	18	3.65
EVP4CEPS224	115	24	3.65	24	3.65

EVP4CEP2 • Two Way 45° Corner Post Extension - Non Slotted

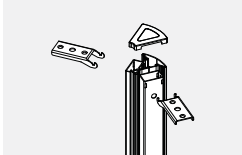

- Used to connect two panel extension modules of equal height.
- Includes corner extension post, two non-slotted connectors and connecting hardware.

PRODUCT CODE	PRICE	SIZE/ H	INCHES W	WEIGHT LBS	VOL FT ³
EVP4CEP206	60	6	3.65	6	3.65
EVP4CEP212	60	12	3.65	12	3.65
EVP4CEP218	108	18	3.65	18	3.65
EVP4CEP224	108	24	3.65	24	3.65

EVP6CEPSA • One Way 60° Corner Post Extension - Slotted - Aluminum

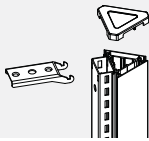

- Attached to a corner post at the end of run of panel extension modules.
- Provides slotted support up to 66" high for worksurfaces and hang-on storage components.
- Includes corner extension post, one slotted connectors, connecting hardware and trim kit.

PRODUCT CODE	PRICE	SIZE/ H	INCHES W	WEIGHT LBS	VOL FT ³
EVP6CEPSA106	80	6	3.65	6	3.65
EVP6CEPSA112	83	12	3.65	12	3.65
EVP6CEPSA118	109	18	3.65	18	3.65
EVP6CEPSA124	109	24	3.65	24	3.65

EVP6CEPA • One Way 60° Corner Post Extension - Non Slotted - Aluminum

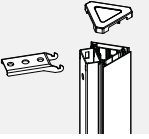

- Attached to a corner post at the end of run of panel extension modules.
- Includes corner extension post, one non-slotted connectors, connecting hardware and trim kit.

PRODUCT CODE	PRICE	SIZE/ H	INCHES W	WEIGHT LBS	VOL FT ³
EVP6CEPA106	61	6	3.65	6	3.65
EVP6CEPA112	65	12	3.65	12	3.65
EVP6CEPA118	88	18	3.65	18	3.65
EVP6CEPA124	88	24	3.65	24	3.65

EVP6CEPSA2 • Two Way 60° Corner Post Extension - Slotted - Aluminum

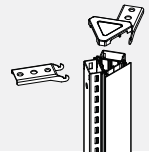

- Used to connect two panel extension modules of equal height.
- Provides slotted support up to 66" high for worksurfaces and hang-on storage components.
- Includes corner extension post, two non-slotted connectors, connecting hardware and trim kit.

PRODUCT CODE	PRICE	SIZE/ H	INCHES W	WEIGHT LBS	VOL FT ³
EVP6CEPSA206	88	6	3.65	6	3.65
EVP6CEPSA212	88	12	3.65	12	3.65
EVP6CEPSA218	136	18	3.65	18	3.65
EVP6CEPSA224	136	24	3.65	24	3.65

EVP6CEPA2 • Two Way 60° Corner Post Extension - Non Slotted - Aluminum

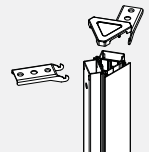

- Used to connect two panel extension modules of equal height.
- Includes corner extension post, two non-slotted connectors, connecting hardware and trim kit.

PRODUCT CODE	PRICE	SIZE/ H	INCHES W	WEIGHT LBS	VOL FT ³
EVP6CEPA206	72	6	3.65	6	3.65
EVP6CEPA212	81	12	3.65	12	3.65
EVP6CEPA218	116	18	3.65	18	3.65
EVP6CEPA224	116	24	3.65	24	3.65

EVP6CEPS3 • Three Way 60° Corner Post Extension - Slotted

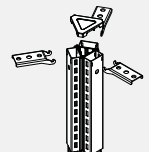

- Used to connect two panel extension modules of equal height.
- Provides slotted support up to 66" high for worksurfaces and hang-on storage components.
- Includes corner extension post, two slotted connectors and connecting hardware

PRODUCT CODE	PRICE	SIZE/ H	INCHES W	WEIGHT LBS	VOL FT ³
EVP6CEPS306	89	6	3.65	6	3.65
EVP6CEPS312	89	12	3.65	12	3.65
EVP6CEPS318	139	18	3.65	18	3.65
EVP6CEPS324	139	24	3.65	24	3.65

EVP6CEP3 • Three Way 60° Corner Post Extension - Non Slotted

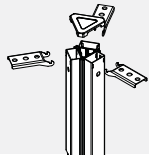

- Used to connect two panel extension modules of equal height.
- Includes corner extension post, two non-slotted connectors and connecting hardware.

PRODUCT CODE	PRICE	SIZE/ H	INCHES W	WEIGHT LBS	VOL FT ³
EVP6CEP306	69	6	3.65	6	3.65
EVP6CEP312	69	12	3.65	12	3.65
EVP6CEP318	112	18	3.65	18	3.65
EVP6CEP324	112	24	3.65	24	3.65

EVPVTFA • Flat Trim - Aluminum

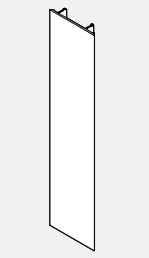

- Finishes exposed faces of one way, two way, three way and inline posts.
- For reconfiguration and replacement use only.

PRODUCT CODE	PRICE	SIZE/ H	INCHES W	WEIGHT LBS	VOL FT ³
EVPVTFA30	16	29.125	2.875	0.39	0.05
EVPVTFA36	16	35.125	2.875	0.44	0.06
EVPVTFA42	23	41.125	2.875	0.56	0.07
EVPVTFA48	24	47.125	2.875	0.62	0.08
EVPVTFA54	25	53.125	2.875	0.75	0.09
EVPVTFA66	27	65.125	2.875	0.86	0.12
EVPVTFA72	29	71.125	2.875	0.92	0.12
EVPVTFA78	30	77.125	2.875	0.97	0.12
EVPVTFA84	31	83.125	2.875	1.09	0.14
EVPVTFA90	31	89.125	2.875	1.14	0.15
EVPVTFA96	33	95.125	2.875	1.19	0.21

EVPVTFEA • Flat Variable Height Extension Trim - Aluminum



- Finishes exposed faces of one way, two way, three way and inline post extensions.
- For reconfiguration and replacement use only.

PRODUCT CODE	PRICE	SIZE/ H	INCHES W	WEIGHT LBS	VOL FT ³
EVPVTFEA06	12	6.375	2.875	0.12	0.01
EVPVTFEA12	13	12.375	2.875	0.16	0.02
EVPVTFEA18	14	18.375	2.875	0.28	0.03
EVPVTFEA24	14	24.375	2.875	0.32	0.04
EVPVTFEA30	16	30.375	2.875	0.36	0.05
EVPVTFEA36	21	36.375	2.875	0.40	0.06
EVPVTFEA42	23	42.375	2.875	0.44	0.07
EVPVTFEA48	24	48.375	2.875	0.48	0.08
EVPVTFEA54	25	54.375	2.875	0.52	0.09
EVPVTFEA66	27	66.375	2.875	0.56	0.10
EVPVTFEA78	30	78.375	2.875	0.64	0.12
EVPVTFEA90	31	90.375	2.875	0.72	0.14

EVPTVA • Panel Trim Variable Height - Aluminum



- Attaches to the exposed end of the taller panel when 2 panels of different height meet in straight run.
- Must be ordered separately.

PRODUCT CODE	PRICE	SIZE/ H	INCHES W	WEIGHT LBS	VOL FT ³
EVPTVA06	23	5.621	2.875	0.10	0.03
EVPTVA12	26	11.621	2.875	0.20	0.03
EVPTVA18	34	18.621	2.875	0.22	0.04
EVPTVA24	40	23.621	2.875	0.20	0.10
EVPTVA30	53	29.621	2.875	0.20	0.15
EVPTVA36	61	35.621	2.875	0.30	0.20

EVPERTA • End of Run Trim - Aluminum



- Finishes the exposed connector at the end of a run of panels.
- Slotted connector not included.
- For reconfiguration and replacement use only.

PRODUCT CODE	PRICE	SIZE/ H	INCHES W	WEIGHT LBS	VOL FT ³
EVPERTA30	54	28.815	2.875	1.00	0.65
EVPERTA42	64	40.815	2.875	1.40	0.70
EVPERTA48	68	46.815	2.875	1.60	0.90
EVPERTA54	78	52.815	2.875	1.80	0.95
EVPERTA66	90	64.815	2.875	2.20	0.98
EVPERTA78	97	76.815	2.875	1.12	0.15
EVPERTA84	106	82.815	2.875	1.20	0.16
EVPERTA90	106	88.815	2.875	1.29	0.18

EVPTEA • Panel Extension Trim - Aluminum



- Attaches to bottom of exposed end of panel to provide extension for End-of-Run trim when using panel extensions.
- Does not include slotted connector or connecting hardware.

PRODUCT CODE	PRICE	SIZE/ H	INCHES W	WEIGHT LBS	VOL FT ³
EVPTEA06	23	6	2.875	0.08	0.03
EVPTEA12	26	12	2.875	0.10	0.03
EVPTEA18	34	18	2.875	0.12	0.03
EVPTEA24	40	24	2.875	0.20	0.60

EVPUETA12 • Upmount Extension Trim - Aluminum

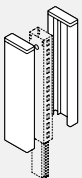

- Attaches to the Upmount Extension Connector EVPUECSA12 or to an Inline Connector EVPVC66 66" high.
- Used to finish the exposed Upmount Extension Connector on both sides.
- Priced in pairs.

PRODUCT CODE	PRICE	SIZE/ H	INCHES W	WEIGHT LBS	VOL FT ³
EVPUETA12	40	12	2.875	0.20	0.03

EVPUETA66 • End of Line Trim for Raised Storage – Aluminum

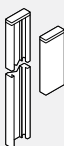

- Replaces 66" H end-of-stroke trim only.
- Includes EVPUETA12 Raised Storage Extension Trim and Raised Storage End Trim.
- Trim must be used in conjunction with slotted fittings.

PRODUCT CODE	PRICE	SIZE/ H	INCHES W	WEIGHT LBS	VOL FT ³
EVPUETA66	102	66	2.875	0.55	0.08

EVPIECH • 12 "h Channel for Center Mount Overhead



- 12" channel to attaches panel to the side of a pre-installed center mount overhead with screws.
- Includes 12 "h channel and connecting hardware.

PRODUCT CODE	PRICE	SIZE/INCHES			WEIGHT LBS	VOL FT ³
		H	W	D		
EVPIECH12	38	12	3		1.32	0.12

EVPTTA • Panel Top Trim Aluminum

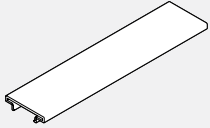

- Comes standard on all panels.
- Supplied at no charge.
- Field install no longer necessary.

PRODUCT CODE	PRICE	SIZE/ INCHES		WEIGHT LBS	VOL FT ³
		H	W		
EVPTTA18	13	18	2.875	0.18	0.03
EVPTTA24	16	24	2.875	0.22	0.04
EVPTTA30	23	30	2.875	0.29	0.05
EVPTTA36	25	36	2.875	0.30	0.06
EVPTTA42	29	42	2.875	0.34	0.07
EVPTTA48	34	48	2.875	0.38	0.08
EVPTTA54	37	54	2.875	0.42	0.09
EVPTTA60	43	60	2.875	0.46	0.10

EVPTNTA • Panel Top Notched Trim Aluminum

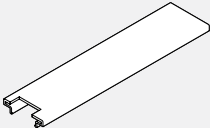

- Comes standard on all panels.
- Used when connecting a lower panel to a higher panel.
- To be used when shipping new panels with aluminum trim.
- Supplied at no charge when using panels in variable height configurations.
- Field install no longer necessary.

PRODUCT CODE	PRICE	SIZE/ INCHES		WEIGHT LBS	VOL FT ³
		H	W		
EVPTNTA18	14	18	2.875	0.18	0.03
EVPTNTA24	21	24	2.875	0.22	0.04
EVPTNTA30	24	30	2.875	0.26	0.05
EVPTNTA36	26	36	2.875	0.30	0.06
EVPTNTA42	30	42	2.875	0.34	0.07
EVPTNTA48	35	48	2.875	0.38	0.08
EVPTNTA54	38	54	2.875	0.42	0.09
EVPTNTA60	46	60	2.875	0.46	0.10

EVPTDNTA • Panel Top Double Notched Trim Aluminum

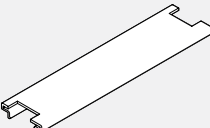

- Comes standard on all panels.
- Used when connecting a lower panel to two higher panels.
- To be used when shipping new panels with aluminum trim.
- Supplied at no charge when using panels in variable height configurations.
- Field install no longer necessary.

PRODUCT CODE	PRICE	SIZE/ INCHES		WEIGHT LBS	VOL FT ³
		H	W		
EVPTDNTA18	16	18	2.875	0.18	0.03
EVPTDNTA24	23	24	2.875	0.22	0.04
EVPTDNTA30	25	30	2.875	0.26	0.05
EVPTDNTA36	27	36	2.875	0.30	0.06
EVPTDNTA42	31	42	2.875	0.34	0.07
EVPTDNTA48	36	48	2.875	0.38	0.08
EVPTDNTA54	40	54	2.875	0.42	0.09
EVPTDNTA60	48	60	2.875	0.46	0.10

EVPTTCA - Aluminum Top Trim with Channel for Acoustic Grid

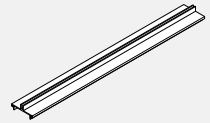

- Top trim with channel.
- Available in standard paint colors.
- Note: Trim can span inline connector, but not a post.

PRODUCT CODE	PRICE	SIZE/INCHES			WEIGHT LBS	VOL FT ³
		H	W	D		
EVPTTCA18	14	18	2 7/8	0.18	0.03	
EVPTTCA24	17	24	2 7/8	0.22	0.04	
EVPTTCA30	25	30	2 7/8	0.29	0.05	
EVPTTCA36	28	36	2 7/8	0.30	0.06	
EVPTTCA42	31	42	2 7/8	0.34	0.07	
EVPTTCA48	36	48	2 7/8	0.38	0.08	
EVPTTCA54	40	54	2 7/8	0.42	0.09	
EVPTTCA60	47	60	2 7/8	0.46	0.10	
EVPTTCA66	50	66	2 7/8	0.50	0.11	
EVPTTCA72	54	72	2 7/8	0.54	0.12	
EVPTTCA78	60	78	2 7/8	0.58	0.13	
EVPTTCA84	65	84	2 7/8	0.62	0.14	
EVPTTCA90	73	90	2 7/8	0.66	0.15	
EVPTTCA96	84	96	2 7/8	0.70	0.16	

EVSC12 • Slot Cover



- Covers the slots of a slotted connector between panels as well as a corner post and end-of-run kit.
- Sold by the foot and cut on site by the installers.
- To order the required length, calculate the sum of the length of all inline connectors (including the posts and end-of-run kit) and multiply by 2.

PRODUCT CODE	PRICE	SIZE/ INCHES		WEIGHT VOL	
		H	W	LBS	FT ³
EVSC12	5	12	1	0.01	0.01

EVECC310 • Wire Manager

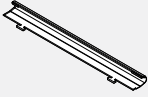

- Attaches to panels vertically between modules to provide enclosures for power or data cords.
- Sold in packages of 6.
- Can be overlapped to achieve required length.

PRODUCT CODE	PRICE	SIZE/ INCHES		WEIGHT VOL	
		H	W	LBS	FT ³
EVECC310	40	10	1	0.01	0.01

EVHLPF01 • Low Profile Foot

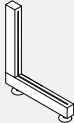

- Used to provide additional support to panel run without adding panels.
- Connects to inline connector or end of run at base of panels.

PRODUCT CODE	PRICE	SIZE/ INCHES			WEIGHT VOL	
		H	W	D	LBS	FT ³
EVHLPF01	100	11	11	1	2.6	0.07

EVCLVAR • Connector Variable Height Clamp

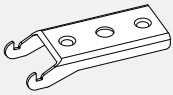

- Used for connecting two panels of variable height.

PRODUCT CODE	PRICE	SIZE/ INCHES			WEIGHT VOL	
		H	W	D	LBS	FT ³
EVCLVAR	9				0.5	0.01

EVPIECBS • Bridge Panel Inline Extension Connector



- Connects bridge panel to inline extension connector.
- Includes one bridge extension connector and connecting hardware.

PRODUCT CODE	PRICE	SIZE/INCHES			WEIGHT VOL		
		H	W	D	LBS	FT ³	
EVPIECBS06	29	31	6	3	3	1.00	0.06
EVPIECBS12	29	31	12	3	3	2.00	0.12
EVPIECBS18	34	37	18	3	3	3.00	0.18
EVPIECBS24	34	37	24	3	3	4.00	0.24

EVPEERBSA • Bridge Panel End of Run Extension Connector - Aluminum Trim



- Connects at end of run of bridge panel and can attach panel to fixed wall.
- Adds 1" to width of panel run.
- Provides slotted support for worksurfaces and hang on components up to 66" high.
- Includes one slotted bridge extension connector and connecting hardware and trim kit.

PRODUCT CODE	PRICE	SIZE/INCHES			WEIGHT VOL		
		H	W	D	LBS	FT ³	
EVPEERBSA06	34		6	3	3	1.00	0.06
EVPEERBSA12	34		12	3	3	2.00	0.12
EVPEERBSA18	52		18	3	3	3.00	0.18
EVPEERBSA24	52		24	3	3	4.00	0.24

EVPICBS • Bridge Panel Inline Connector without Aluminum Insert



- Connects two bridge panel to inline connector.
- Inline connector in middle between two bridge panels, above opening, using double clamp at bottom.
- Includes one bridge extension connector without aluminum insert and connecting hardware.

PRODUCT CODE	PRICE	SIZE/INCHES			WEIGHT VOL		
		H	W	D	LBS	FT ³	
EVPICBS06	32		6	3	3	1.00	0.06
EVPICBS12	32		12	3	3	2.00	0.12
EVPICBS18	38		18	3	3	3.00	0.18
EVPICBS24	38		24	3	3	4.00	0.24

EVPCEPB1 • Bridge Panel Corner Extension Post 1-way



- Connects at end of a run of extension modules.
- Post and connecting hardware add 3.25" to power beam run.
- Includes one extension post, one slotted extension connectors for bridge panel, connecting hardware and trim kit.

PRODUCT CODE	PRICE	SIZE / INCHES			WEIGHT LBS	VOL FT ³
		H	W	D		
EVPCEPBSA106	75	6	3	3	2.00	0.07
EVPCEPBSA112	75	12	3	3	4.00	0.14
EVPCEPBSA118	97	18	3	3	6.00	0.21
EVPCEPBSA124	97	24	3	3	8.00	0.14

EVPCEPB4 • Bridge Panel Corner Extension Post 4-way

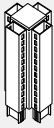

- Connects four bridge panels in 90 degree configuration.
- Post and connecting hardware add 3.25" to power beam run.
- Includes one extension post, four one slotted extension connectors for bridge panel, connecting hardware and trim kit.

PRODUCT CODE	PRICE	SIZE / INCHES			WEIGHT LBS	VOL FT ³
		H	W	D		
EVPCEPBS406	100	6	3	3	4.00	0.09
EVPCEPBS412	100	12	3	3	8.00	0.18
EVPCEPBS418	157	18	3	3	12.00	0.27
EVPCEPBS424	157	24	3	3	16.00	0.36

EVPCEPB3 • Bridge Panel Corner Extension Post 3-way

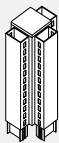

- Connects three bridge panels in 90 degree configuration.
- Post and connecting hardware add 3.25" to power beam run.
- Includes one extension post, three one slotted extension connectors for bridge panel, connecting hardware and trim kit.

PRODUCT CODE	PRICE	SIZE / INCHES			WEIGHT LBS	VOL FT ³
		H	W	D		
EVPCEPBSA306	89	6	3	3	3.00	0.08
EVPCEPBSA312	89	12	3	3	6.00	0.16
EVPCEPBSA318	139	18	3	3	9.00	0.24
EVPCEPBSA324	139	24	3	3	12.00	0.32

EVPCEPB2 • Bridge Panel Corner Extension Post 2-way

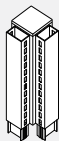

- Connects two bridge panels in 90 degree configuration.
- Post and connecting hardware add 3.25" to power beam run.
- Includes one extension post, two one slotted extension connectors for bridge panel, connecting hardware and trim kit.

PRODUCT CODE	PRICE	SIZE / INCHES			WEIGHT LBS	VOL FT ³
		H	W	D		
EVPCEPBSA206	76	6	3	3	2.00	0.07
EVPCEPBSA212	76	12	3	3	4.00	0.14
EVPCEPBSA218	122	18	3	3	6.00	0.21
EVPCEPBSA224	122	24	3	3	8.00	0.14

EVPCEIPBSA2 • Bridge Panel Inline 2-way Post Extension

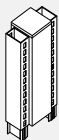

- Connects two bridge panels in straight run.
- Post and connecting hardware add 3.25" to power beam run.
- Includes one extension post, two slotted extension connectors for bridge panel, connecting hardware and trim kit.

PRODUCT CODE	PRICE	SIZE / INCHES			WEIGHT LBS	VOL FT ³
		H	W	D		
EVPCEIPBSA206	76	6	3	3	2.00	0.07
EVPCEIPBSA212	76	12	3	3	4.00	0.14
EVPCEIPBSA218	122	18	3	3	6.00	0.21
EVPCEIPBSA224	122	24	3	3	8.00	0.14

NO RACEWAY PANELS • TECHNICAL INFORMATION

- Evolve panels are 2 7/8" thick. They are available in four (5) basic heights: 30", 42", 48", 54" and 66" and eight (8) widths: 18" to 60" in 6" increments.
- Individual fabric covered acoustic modules incorporated into a rigid steel frame.
- Opposite side of each module may have a different fabric within the same grade at no upcharge.
- If different grades of fabric are used on one panel, the entire panel must be priced at highest grade.
- A low profile top cap is included.
- No panel creep.
- 12" high and 24" high modules of 2 types (fabric and laminate) are available for field installation. Contact your Customer Service Representative.
- Laminate for laminate panels cannot be replaced in the field, complete module must be ordered.

PANELS • GUIDELINES FOR ORDERING PRODUCT

The price list uses a numbering system with meaningful alphanumeric characters to create a simple-to-understand product number. This makes specifying the product much easier and more accurate.

EXAMPLE OF PANEL CODE

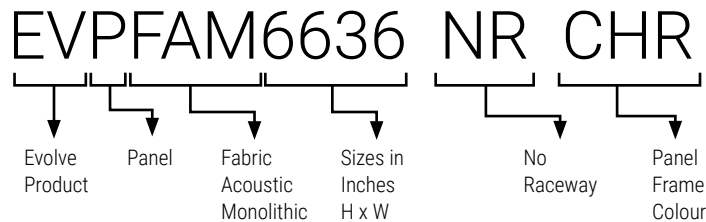

I1	AN50	Inside Fabric Position #1
I2	AN50	Inside Fabric Position #2
I3	AN50	Inside Fabric Position #3
O1	BE21	Outside Fabric Position #1
O2	BE21	Outside Fabric Position #2
O3	BE21	Outside Fabric Position #3

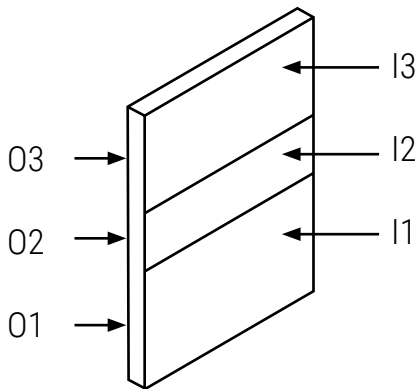

HOW TO SPECIFY

- Specify Evolve panel type and size by code.
- Specify panel frame finish - ie. CHR (Charcoal).
- Specify all necessary panel fabric options.

NOTE: If different grades of fabric are used on one panel, the entire panel must be priced out at the higher grade.

EVPFA-NR • Segmented (No Raceway) Panel

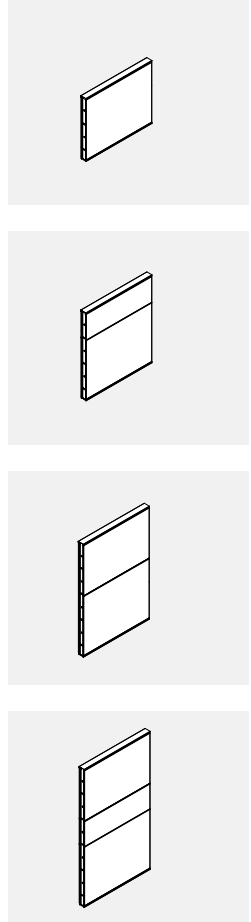

- Segmented (No Raceway) panel incorporates fabric modules within steel frame.
- There is no base raceway in No Raceway Panels to accommodate electric.
- **No Raceway connectors to be used.**
- Fabric covered modules are tackable and acoustical.
- Each side of fabric module may have different fabric within the same grade at no charge.
- If different grades of fabric are used, the entire module must be price at highest grade.
- Aluminum low profile top and bottom cap is included.
- Stackability: Evolve panels can be increased in height in 6", 12", 24" increments. See module listing for part numbers.

PRODUCT CODE	PRICE		SIZE/ INCHES			WEIGHT LBS	VOL FT ³
	GR 1	GR 2	H	W	D		
EVPFA3018NR	305	317	30	18	2.875	15.38	1.23
EVPFA3024NR	318	372	30	24	2.875	18.20	1.63
EVPFA3030NR	352	372	30	30	2.875	21.76	2.00
EVPFA3036NR	378	401	30	36	2.875	24.80	2.38
EVPFA3042NR	408	434	30	42	2.875	26.49	2.76
EVPFA3048NR	451	482	30	48	2.875	32.00	3.13
EVPFA3054NR	486	520	30	54	2.875	35.31	3.51
EVPFA3060NR	522	562	30	60	2.875	38.20	3.89
EVPFA4218NR	338	354	42	18	2.875	20.58	1.71
EVPFA4224NR	354	382	42	24	2.875	24.60	2.31
EVPFA4230NR	412	443	42	30	2.875	29.35	2.81
EVPFA4236NR	446	482	42	36	2.875	35.60	3.38
EVPFA4242NR	509	548	42	42	2.875	39.29	3.92
EVPFA4248NR	548	593	42	48	2.875	43.20	4.45
EVPFA4254NR	607	657	42	54	2.875	47.52	4.98
EVPFA4260NR	665	721	42	60	2.875	51.60	5.52
EVPFA4818NR	363	385	48	18	2.875	23.98	2.19
EVPFA4824NR	397	431	48	24	2.875	27.80	2.94
EVPFA4830NR	452	490	48	30	2.875	33.15	3.62
EVPFA4836NR	505	550	48	36	2.875	37.40	4.31
EVPFA4842NR	570	625	48	42	2.875	40.69	4.99
EVPFA4848NR	634	694	48	48	2.875	48.20	5.67
EVPFA4854NR	691	758	48	54	2.875	52.92	6.35
EVPFA4860NR	740	814	48	60	2.875	57.40	7.03
EVPFA5418NR	363	385	54	18	2.875	23.98	2.19
EVPFA5424NR	397	431	54	24	2.875	27.80	2.94
EVPFA5430NR	452	490	54	30	2.875	33.15	3.62
EVPFA5436NR	505	550	54	36	2.875	37.40	4.31
EVPFA5442NR	570	625	54	42	2.875	40.69	4.99
EVPFA5448NR	634	694	54	48	2.875	48.20	5.67
EVPFA5454NR	691	758	54	54	2.875	52.92	6.35
EVPFA5460NR	740	814	54	60	2.875	57.40	7.03
EVPFA6618NR	455	486	66	18	2.875	29.98	2.68
EVPFA6624NR	353	536	66	24	2.875	35.00	3.58
EVPFA6630NR	544	593	66	30	2.875	41.54	4.40
EVPFA6636NR	638	697	66	36	2.875	49.00	5.23
EVPFA6642NR	722	790	66	42	2.875	54.29	6.06
EVPFA6648NR	774	850	66	48	2.875	60.20	6.08
EVPFA6654NR	842	926	66	54	2.875	65.93	7.70
EVPFA6660NR	909	1001	66	60	2.875	71.60	8.53

EVPFAM-NR • Monolithic (No Raceway) Panel

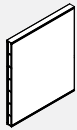

- Monolithic (No Raceway) panel incorporates fabric modules within steel frame.
- There is no base raceway in No Raceway Panels to accommodate electric.
- **No Raceway connectors to be used.**
- Fabric covered modules are tackable and acoustical.
- Each side of fabric module may have different fabric within the same grade at no charge.
- If different grades of fabric are used, the entire module must be price at highest grade.
- Aluminum low profile top and bottom cap is included.
- Stackability: Evolve panels can be increased in height in 6", 12", 24" increments. See module listing for part numbers.

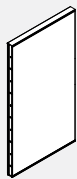
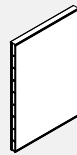
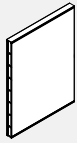

PRODUCT CODE	PRICE		SIZE/ INCHES			WEIGHT	VOL
	GR 1	GR 2	H	W	D	LBS	FT ³
EVPFAM4218NR	333	364	42	18	2.875	20.58	1.71
EVPFAM4224NR	355	394	42	24	2.875	23.40	2.31
EVPFAM4230NR	406	450	42	30	2.875	26.96	2.85
EVPFAM4236NR	436	487	42	36	2.875	30.00	3.38
EVPFAM4242NR	483	543	42	42	2.875	31.69	3.92
EVPFAM4248NR	525	593	42	48	2.875	37.20	4.45
EVPFAM4254NR	579	653	42	54	2.875	40.51	4.98
EVPFAM4260NR	629	711	42	60	2.875	43.40	5.52
EVPFAM4818NR	340	371	48	18	2.875	21.38	1.92
EVPFAM4824NR	374	410	48	24	2.875	24.40	2.62
EVPFAM4830NR	431	476	48	30	2.875	27.76	3.23
EVPFAM4836NR	469	520	48	36	2.875	30.80	3.85
EVPFAM4842NR	524	584	48	42	2.875	32.49	4.45
EVPFAM4848NR	572	637	48	48	2.875	37.80	5.06
EVPFAM4854NR	630	704	48	54	2.875	41.31	5.66
EVPFAM4860NR	684	767	48	60	2.875	44.20	6.27
EVPFAM5418NR	342	374	54	18	2.875	24.58	2.19
EVPFAM5424NR	376	415	54	24	2.875	27.40	2.94
EVPFAM5430NR	437	482	54	30	2.875	30.96	3.62
EVPFAM5436NR	486	541	54	36	2.875	34.00	4.31
EVPFAM5442NR	545	605	54	42	2.875	35.69	4.99
EVPFAM5448NR	591	661	54	48	2.875	41.20	5.67
EVPFAM5454NR	651	728	54	54	2.875	44.51	6.35
EVPFAM5460NR	712	796	54	60	2.875	47.40	7.03
EVPFAM6618NR	425	455	66	18	2.875	27.58	2.68
EVPFAM6624NR	463	503	66	24	2.875	30.40	3.58
EVPFAM6630NR	524	573	66	30	2.875	33.96	4.40
EVPFAM6636NR	608	663	66	36	2.875	37.00	5.23
EVPFAM6642NR	684	743	66	42	2.875	38.69	6.06
EVPFAM6648NR	743	811	66	48	2.875	44.20	6.88
EVPFAM6654NR	826	900	66	54	2.875	47.51	7.70
EVPFAM6660NR	909	991	66	60	2.875	50.40	8.53
EVPFAM9018NR	752	805	90	18	2.875	38.18	3.43
EVPFAM9024NR	810	873	90	24	2.875	42.72	4.58
EVPFAM9030NR	900	985	90	30	2.875	47.99	5.65
EVPFAM9036NR	1047	1139	90	36	2.875	52.75	6.73

EVPH1S-NR • Laminate (No Raceway) Panel Single Sided

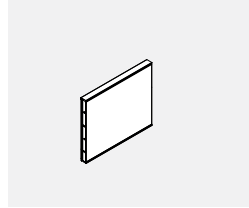

- Laminate (No Raceway) panel incorporates single sided laminate modules within steel frame.
- Opposite side is fabric covered.
- Laminate faces on all modules provide durable, washable surface on Single sided of the panel.
- Available in high pressure laminate only.
- If wood grain is selected, grain runs horizontally.
- There is no base raceway in No Raceway Panels to accommodate electric.

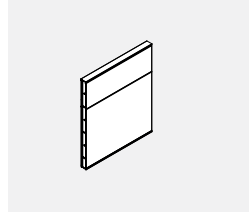

- **No Raceway connectors to be used.**
- If different grades of fabric are used, the entire module must be price at highest grade.
- Aluminum low profile top and bottom cap is included.
- Stackability: Evolve panels can be increased in height in 6", 12", 24" increments. See module listing for part numbers.

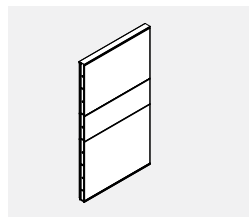
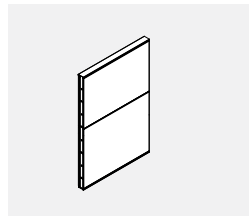

PRODUCT CODE	PRICE		SIZE/ INCHES			WEIGHT		VOL FT ³
	GR 1	GR 2	H	W	D	LBS		
EVPH1S3018NR	373	380	30	18	2.875	15.88	1.23	
EVPH1S3024NR	448	456	30	24	2.875	18.70	1.63	
EVPH1S3030NR	523	535	30	30	2.875	22.26	2.00	
EVPH1S3036NR	593	610	30	36	2.875	24.85	2.38	
EVPH1S3042NR	676	689	30	42	2.875	26.99	2.76	
EVPH1S3048NR	732	747	30	48	2.875	32.05	3.13	
EVPH1S3054NR	814	830	30	54	2.875	35.81	3.51	
EVPH1S3060NR	891	908	30	60	2.875	38.07	3.89	
EVPH1S4218NR	443	482	42	18	2.875	21.38	1.71	
EVPH1S4224NR	530	546	42	24	2.875	22.13	2.31	
EVPH1S4230NR	619	634	42	30	2.875	30.15	2.81	
EVPH1S4236NR	713	733	42	36	2.875	36.40	3.38	
EVPH1S4242NR	806	829	42	42	2.875	40.09	3.92	
EVPH1S4248NR	879	903	42	48	2.875	44.00	4.45	
EVPH1S4254NR	976	1001	42	54	2.875	48.32	4.98	
EVPH1S4260NR	1068	1100	42	60	2.875	52.40	5.52	
EVPH1S5418NR	522	537	54	18	2.875	24.98	2.19	
EVPH1S5424NR	630	648	54	24	2.875	28.80	2.94	
EVPH1S5430NR	741	761	54	30	2.875	34.15	3.62	
EVPH1S5436NR	849	872	54	36	2.875	38.40	4.31	
EVPH1S5442NR	960	987	54	42	2.875	41.69	4.99	
EVPH1S5448NR	1050	1083	54	48	2.875	49.20	5.67	
EVPH1S5454NR	1167	1201	54	54	2.875	53.92	6.35	
EVPH1S5460NR	1284	1325	54	60	2.875	58.40	7.03	
EVPH1S6618NR	648	665	66	18	2.875	31.29	2.68	
EVPH1S6624NR	781	802	66	24	2.875	36.30	3.58	
EVPH1S6630NR	911	937	66	30	2.875	42.84	4.40	
EVPH1S6636NR	1052	1084	66	36	2.875	50.30	5.23	
EVPH1S6642NR	1198	1233	66	42	2.875	55.59	6.06	
EVPH1S6648NR	1303	1343	66	48	2.875	61.50	6.08	
EVPH1S6654NR	1448	1494	66	54	2.875	67.23	7.70	
EVPH1S6660NR	1595	1646	66	60	2.875	72.90	8.53	

EVPH2S-NR • Laminate (No Raceway) Panel Double Sided

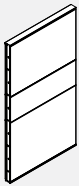
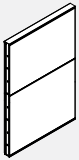
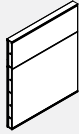
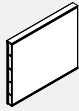

- Laminate (No Raceway) panel incorporates double sided laminate modules within steel frame
- Laminate faces on all modules provide durable, washable surface on both sides of the panel
- Available in high pressure laminate only
- If wood grain is selected, grain runs horizontally
- There is no base raceway in No Raceway Panels to accommodate electric
- **No Raceway connectors to be used.**
- Aluminum low profile top and bottom cap is included
- Stackability: Evolve panels can be increased in height in 6", 12", 24" increments. See module listing for part numbers.

PRODUCT CODE	PRICE	SIZE/ INCHES			WEIGHT LBS	VOL FT ³
		H	W	D		
EVPH2S3018NR	417	30	18	2.875	16.38	1.23
EVPH2S3024NR	510	30	24	2.875	19.20	1.63
EVPH2S3030NR	604	30	30	2.875	22.76	2.00
EVPH2S3036NR	689	30	36	2.875	25.80	2.38
EVPH2S3042NR	785	30	42	2.875	27.49	2.76
EVPH2S3048NR	877	30	48	2.875	33.00	3.13
EVPH2S3054NR	972	30	54	2.875	36.31	3.51
EVPH2S3060NR	1052	30	60	2.875	39.20	3.89
EVPH2S4218NR	497	42	18	2.875	22.18	1.71
EVPH2S4224NR	604	42	24	2.875	26.20	2.31
EVPH2S4230NR	712	42	30	2.875	30.95	2.81
EVPH2S4236NR	827	42	36	2.875	37.20	3.38
EVPH2S4242NR	943	42	42	2.875	40.89	3.92
EVPH2S4248NR	1056	42	48	2.875	42.80	4.45
EVPH2S4254NR	1162	42	54	2.875	49.12	4.98
EVPH2S4260NR	1267	42	60	2.875	53.20	5.52
EVPH2S5418NR	581	54	18	2.875	25.98	2.19
EVPH2S5424NR	714	54	24	2.875	29.80	2.94
EVPH2S5430NR	849	54	30	2.875	35.15	3.62
EVPH2S5436NR	984	54	36	2.875	39.40	4.31
EVPH2S5442NR	1123	54	42	2.875	42.69	4.99
EVPH2S5448NR	1266	54	48	2.875	50.20	5.67
EVPH2S5454NR	1394	54	54	2.875	52.92	6.35
EVPH2S5460NR	1517	54	60	2.875	59.40	7.03
EVPH2S6618NR	732	66	18	2.875	32.58	2.68
EVPH2S6624NR	903	66	24	2.875	37.60	3.58
EVPH2S6630NR	1068	66	30	2.875	44.14	4.40
EVPH2S6636NR	1241	66	36	2.875	51.60	5.23
EVPH2S6642NR	1428	66	42	2.875	56.89	6.06
EVPH2S6648NR	1595	66	48	2.875	62.80	6.08
EVPH2S6654NR	1764	66	54	2.875	68.53	7.70
EVPH2S6660NR	1927	66	60	2.875	74.20	8.53

EVPXGT-NR • Fully Glazed (No Raceway) Panel

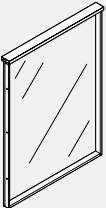

- **EVPXGTNR - Fully Glazed Monolithic No Raceway Panel.**
- There is no base raceway in No Raceway Panels to accommodate electric.
- No Raceway connectors to be used.
- Fully Glazed Monolithic No Raceway panel are incorporated in solid steel frame.
- Standard in clear (CLR).
- Frosted glass (FRST) 40% upcharge.
- Size 90"x36"W is maximum size allowed.
- Panel height to align with standard door height.
- Aluminum low profile top and bottom cap is included.

PRODUCT CODE	PRICE	SIZE/ INCHES			WEIGHT LBS	VOL FT ³
		H	W	D		
EVPXGT9018NR	784	90	18	2.875	15.88	1.23
EVPXGT9024NR	895	90	24	2.875	18.70	1.63
EVPXGT9030NR	1016	90	30	2.875	22.26	2.00
EVPXGT9036NR	1100	90	36	2.875	24.85	2.38

EVPGTNR-NR • Fully Glazed Segmented (No Raceway) Panel

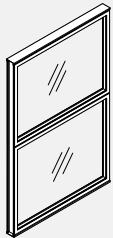

- **Fully Glazed Segmented No Raceway Panel with solid steel frame..**
- There is no base raceway in No Raceway Panels to accommodate electrical.
- No Raceway connectors to be used.
- Standard in clear (CLR).
- Frosted glass (FRST) 40% upcharge.
- Aluminum low profile top and bottom cap is included.

PRODUCT CODE	PRICE	SIZE/ INCHES			WEIGHT LBS	VOL FT ³
		H	W	D		
EVPGT4818NR	625	48	18	2.875	35.19	2.19
EVPGT4824NR	765	48	24	2.875	49.76	2.94
EVPGT4830NR	846	48	30	2.875	52.08	3.62
EVPGT4836NR	925	48	36	2.875	64.54	4.31
EVPGT4842NR	1024	48	42	2.875	72.62	4.99
EVPGT4848NR	1143	48	48	2.875	78.11	5.67
EVPGT4854NR	1258	48	54	2.875	86.04	6.35
EVPGT4860NR	1372	48	60	2.875	94.09	7.03

EVPIC-NR • Inline Connector (No Raceway) Panel



- Connects two No Raceway panel in straight run.
- Provides slotted support for worksurfaces and hang on components.
- Includes one slotted connector with leveling glide and connecting hardware.
- Connectors available without slots, as a special at no extra charge. Contact customer support.

PRODUCT CODE	PRICE	SIZE/INCHES			WEIGHT LBS	VOL FT ³
		H	W	D		
EVPIC30NR	63	30	2		3.30	0.05
EVPIC42NR	67	42	2		4.60	0.07
EVPIC48NR	69	48	2		5.25	0.07
EVPIC54NR	74	54	2		5.90	0.09
EVPIC66NR	83	66	2		7.20	0.10

EVVIC-NR • Inline Connector (No Raceway) Panel



- Connects two 90" H No Raceway panel in straight run.
- Includes one slotted connector with leveling glide and connecting hardware.
- Connectors are without slots.
- To be used only with 90" H NR Glazed Panels

PRODUCT CODE	PRICE	SIZE/INCHES			WEIGHT LBS	VOL FT ³
		H	W	D		
EVVIC90NR	117	90	2		11.2	0.19

EVVVC-NR • Inline Variable Height Connector (No Raceway) Panel



- Connects two No Raceway panels of differing height in straight run.
- Connector must reference taller panel.
- Can be used for any variation of pane height.
- Variable height trim must be ordered separately (see EVPTVA).
- Provides slotted support for worksurfaces and hang on components.
- Includes one slotted connector with leveling glide and connecting hardware.
- Connectors available without slots, as a special at no extra charge. Contact customer support.

PRODUCT CODE	PRICE	SIZE/INCHES			WEIGHT LBS	VOL FT ³
		H	W	D		
EVVVC42NR	74	42	2		4.60	0.07
EVVVC48NR	77	48	2		5.25	0.07
EVVVC54NR	78	54	2		5.90	0.09
EVVVC66NR	88	66	2		7.20	0.10

EVPERA-NR • End of Run Post Kit for (No Raceway) Panel



- Connects at end of No Raceway panel and can attach to a panel to fixed wall.
- Adds 1" to width of panel run.
- Provides slotted support for worksurfaces and hang on components.
- Includes one slotted connector with leveling glide and connecting hardware and trim kit.
- Can be attached to face of another panel to provide off modular connection.
- Connectors available without slots, as a special at no extra charge. Contact customer support.

PRODUCT CODE	PRICE	SIZE/INCHES			WEIGHT LBS	VOL FT ³
		H	W	D		
EVPERA30NR	78	30	2		3.30	0.07
EVPERA42NR	94	42	2		4.60	0.10
EVPERA48NR	100	48	2		5.25	0.10
EVPERA54NR	112	54	2		5.90	0.18
EVPERA66NR	126	66	2		7.20	0.22

EVPERA-NR • End of Run Post Kit for (No Raceway) Panel



- Connects two 90" H No Raceway panel and can attach to a panel to fixed wall.
- Adds 1" width of panel run.
- Includes one slotted connector with leveling glide and connecting hardware and trim kit.
- Can be attached to face of another panel to provide off modular connection.
- Connectors are without slots.
- To be used only with 90" H NR Glazed Panels

PRODUCT CODE	PRICE	SIZE/INCHES			WEIGHT LBS	VOL FT ³
		H	W	D		
EVPERA90NR	162	90	2		11.2	0.19

EVPCPA2-NR • Two Way Corner Post (No Raceway) Panel



- Connects two No Raceway panel of equal height in 90 degree configuration.
- Post and connecting hardware add 3.25" to power beam run.
- Provides slotted support for worksurfaces and hang on components.
- Includes post, panel connectors and power beam connectors, post with trim all around, levelling glide, hardware and trim kit.
- Connectors available without slots, as a special at no extra charge. Contact customer support.

PRODUCT CODE	PRICE	SIZE/INCHES			WEIGHT		VOL FT ³
		H	W	D	LBS		
EVPCPA230NR	162	30	2.875		8.50	0.31	
EVPCPA242NR	207	42	2.875		11.50	0.43	
EVPCPA248NR	217	48	2.875		11.50	0.54	
EVPCPA254NR	251	54	2.875		15.00	0.61	
EVPCPA266NR	299	66	2.875		19.00	0.75	

EVPCPA2-NR • Two Way Corner Post (No Raceway) Panel



- Connects two No Raceway panel of equal height in 90 degree configuration.
- Post and connecting hardware add 3.25" to power beam run.
- Includes post, panel connectors and power beam connectors, post with trim all around, levelling glide, hardware and trim kit.
- Connectors are without slots.
- To be used only with 90" H NR Glazed Panels

PRODUCT CODE	PRICE	SIZE/INCHES			WEIGHT		VOL FT ³
		H	W	D	LBS		
EVPCPA290NR	412	90	2.875		27	1.03	

EVPCPA3-NR • Three Way Corner Post (No Raceway) Panel



- Connects three No Raceway panel of equal height in "T" configuration.
- Post and connecting hardware add 3.25" to power beam run.
- Provides slotted support for worksurfaces and hang on components.
- Includes post, panel connectors and power beam connectors, post with trim all around, levelling glide, hardware and trim kit.
- Connectors available without slots, as a special at no extra charge. Contact customer support.

PRODUCT CODE	PRICE	SIZE/INCHES			WEIGHT		VOL FT ³
		H	W	D	LBS		
EVPCPA330NR	195	30	2.875		11.80	0.36	
EVPCPA342NR	260	42	2.875		16.10	0.50	
EVPCPA348NR	286	48	2.875		18.75	0.61	
EVPCPA354NR	317	54	2.875		20.50	0.70	
EVPCPA366NR	373	66	2.875		26.20	0.85	

EVPCPA3-NR • Three Way Corner Post (No Raceway) Panel



- Connects three No Raceway panel of equal height in "T" configuration.
- Post and connecting hardware add 3.25" to power beam run.
- Includes post, panel connectors and power beam connectors, post with trim all around, levelling glide, hardware and trim kit.
- Connectors are without slots.
- To be used only with 90" H NR Glazed Panels

PRODUCT CODE	PRICE	SIZE/INCHES			WEIGHT		VOL FT ³
		H	W	D	LBS		
EVPCPA390NR	500	90	2.875		38.2	1.17	

EVPCPA4-NR • Four Way Corner Post (No Raceway) Panel



- Connects four No Raceway panel of equal height in "+" configuration.
- Post and connecting hardware add 3.25" to power beam run.
- Provides slotted support for worksurfaces and hang on components.
- Includes post, panel connectors and power beam connectors, post with trim all around, levelling glide, hardware and trim kit.
- Connectors available without slots, as a special at no extra charge. Contact customer support.

PRODUCT CODE	PRICE	SIZE/INCHES			WEIGHT		VOL FT ³
		H	W	D	LBS		
EVPCPA430NR	213	30	2.875		15.5	0.40	
EVPCPA442NR	279	42	2.875		21.00	0.57	
EVPCPA448NR	307	48	2.875		24.00	0.68	
EVPCPA454NR	339	54	2.875		26.50	0.79	
EVPCPA466NR	397	66	2.875		33.20	0.95	

EVPCPA4-NR • Four Way Corner Post (No Raceway) Panel



- Connects three No Raceway panel of equal height in "+" configuration.
- Post and connecting hardware add 3.25" to power beam run.
- Includes post, panel connectors and power beam connectors, post with trim all around, levelling glide, hardware and trim kit.
- Connectors are without slots.
- To be used only with 90" H NR Glazed Panels

PRODUCT CODE	PRICE	SIZE/INCHES			WEIGHT		VOL FT ³
		H	W	D	LBS		
EVPCPA490NR	510	90	2.875		49.2	1.31	

EVPIPA2-NR • Inline Two Way Corner Post (No Raceway Panel)



- Connects two No Raceway panel of equal height in straight run.
- Post and connecting hardware add 3.25" to power beam run.
- Provides slotted support for worksurfaces and hang on components.
- Includes post, panel connectors and power beam connectors, post with trim all around, levelling glide, hardware and trim kit.
- Connectors available without slots, as a special at no extra charge. Contact customer support.

PRODUCT CODE	PRICE	SIZE/INCHES			WEIGHT LBS	VOL FT³
		H	W	D		
EVPIPA230NR	162	30	2.875		8.20	0.31
EVPIPA242NR	207	42	2.875		11.50	0.43
EVPIPA248NR	217	48	2.875		13.50	0.54
EVPIPA254NR	251	54	2.875		15.00	0.61
EVPIPA266NR	299	66	2.875		19.00	0.75

EVPIPA2-NR • Inline Two Way Corner Post (No Raceway Panel)



- Connects three No Raceway panel of equal height in a straight run.
- Post and connecting hardware add 3.25" to power beam run.
- Includes post, panel connectors and power beam connectors, post with trim all around, levelling glide, hardware and trim kit.
- Connectors are without slots.
- To be used only with 90" H NR Glazed Panels

PRODUCT CODE	PRICE	SIZE/INCHES			WEIGHT LBS	VOL FT³
		H	W	D		
EVPIPA290NR	433	90	2.875		27	1.03

EVPCPA1-NR • One Way Corner Post (No Raceway Panel)



- Connects at end of No Raceway panel run in place of EVPERA-End of run post kit.
- Should not be used to attach pane to fixed wall.
- Post and connecting hardware add 3.25" to power beam run.
- Provides slotted support for worksurfaces and hang on components.
- Includes post, panel connectors and power beam connectors, post with trim all around, levelling glide, hardware and trim kit.
- Connectors available without slots, as a special at no extra charge. Contact customer support.

PRODUCT CODE	PRICE	SIZE/INCHES			WEIGHT LBS	VOL FT³
		H	W	D		
EVPCPA130NR	103	30	2.875		4.97	0.24
EVPCPA142NR	117	42	2.875		6.93	0.33
EVPCPA148NR	139	48	2.875		7.93	0.38
EVPCPA154NR	160	54	2.875		8.93	0.43
EVPCPA166NR	199	66	2.875		10.87	0.53

EVPCPA1-NR • Inline One Way Corner Post (No Raceway Panel)



- Connects three No Raceway panel of equal height in a straight run.
- Should not be used to attach pane to fixed wall.
- Post and connecting hardware add 3.25" to power beam run.
- Includes post, panel connectors and power beam connectors, post with trim all around, levelling glide, hardware and trim kit.
- Connectors are without slots.
- To be used only with 90" H NR Glazed Panels

PRODUCT CODE	PRICE	SIZE/INCHES			WEIGHT LBS	VOL FT³
		H	W	D		
EVPCPA190NR	284	90	2.875		14.87	0.67

EVVVC-PNR • Inline variable height connector Panel (No Raceway Panel)



- Connects Panel to No Raceway panels of differing height in straight run.
- Connector must reference taller panel.
- Can be used for any variation of panel height.
- Variable height trim must be ordered separately (see EVPTVA).
- Provides slotted support for worksurfaces and hang on components.
- Includes one slotted connector with leveling glide and connecting hardware.
- Connectors available without slots, as a special at no extra charge. Contact your Customer Service Representative.

PRODUCT CODE	PRICE	SIZE/INCHES			WEIGHT LBS	VOL FT³
		H	W	D		
EVVVC42PNR	74	42	2		4.60	0.07
EVVVC48PNR	77	48	2		5.25	0.07
EVVVC54PNR	78	54	2		5.90	0.09
EVVVC66PNR	88	66	2		7.20	0.10

EVPCPA2-PNR • Two Way Corner Post (No Raceway Panel)



- Connects No Raceway panel and Panel of equal height in 90 degree configuration.
- Post and connecting hardware add 3.25" to power beam run.
- Provides slotted support for worksurfaces and hang on components.
- Includes post, panel connectors and power beam connectors, post with trim all around, levelling glide, hardware and trim kit.
- Connectors available without slots, as a special at no extra charge. Contact customer support.

PRODUCT CODE	PRICE	SIZE/INCHES			WEIGHT LBS	VOL FT³
		H	W	D		
EVPCPA230PNR	162	30	2.875		8.50	0.31
EVPCPA242PNR	207	42	2.875		11.50	0.43
EVPCPA248PNR	217	48	2.875		11.50	0.54
EVPCPA254PNR	251	54	2.875		15.00	0.61
EVPCPA266PNR	299	66	2.875		19.00	0.75

EVPCPA3-NR • Three Way Corner Post (No Raceway Panel)



- Connects two No Raceway panel and Panel of equal height in "T" configuration.
- Post and connecting hardware add 3.25" to power beam run.
- Provides slotted support for worksurfaces and hang on components.
- Includes post, panel connectors and power beam connectors, post with trim all around, levelling glide, hardware and trim kit.
- Connectors available without slots, as a special at no extra charge. Contact customer support.

PRODUCT CODE	PRICE	SIZE/INCHES			WEIGHT LBS	VOL FT ³
		H	W	D		
EVPCPA330PNR	195	30	2.875		11.80	0.36
EVPCPA342PNR	260	42	2.875		16.10	0.50
EVPCPA348PNR	286	48	2.875		18.75	0.61
EVPCPA354PNR	317	54	2.875		20.50	0.70
EVPCPA366PNR	373	66	2.875		26.20	0.85

EVPIC-PNR • Inline connector Panel (No Raceway Panel)



- Connects Panel to No Raceway panel in straight run
- Provides slotted support for worksurfaces and hang on components
- Includes one slotted connector with leveling glide and connecting hardware
- Connectors available without slots, as a special at no extra charge. Contact your Customer Service Representative.

PRODUCT CODE	PRICE	SIZE/INCHES			WEIGHT LBS	VOL FT ³
		H	W	D		
EVPIC30PNR	63	30	2		3.30	0.05
EVPIC42PNR	67	42	2		4.60	0.07
EVPIC48PNR	69	48	2		5.25	0.07
EVPIC54PNR	74	54	2		5.90	0.09
EVPIC66PNR	83	66	2		7.20	0.10

EVPIC-PNR • Inline connector Panel (No Raceway Panel)



- Connects 90" H No Raceway panel to 90" H door in straight run.
- Includes one non slotted connector with leveling glide and connecting hardware.
- Connectors are without slots.
- Note: To be used only with 90" H NR Glazed Panels and 90" H door.

PRODUCT CODE	PRICE	SIZE/INCHES			WEIGHT LBS	VOL FT ³
		H	W	D		
EVPIC90PNR	117	90	2		11.2	0.19

EVPCPA4-NR • Four Way Corner Post (No Raceway Panel)

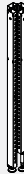

- Connects two No Raceway panel and two Panel of equal height in "+" configuration.
- Post and connecting hardware add 3.25" to power beam run.
- Provides slotted support for worksurfaces and hang on components.
- Includes post, panel connectors and power beam connectors, post with trim all around, levelling glide, hardware and trim kit
- Connectors available without slots, as a special at no extra charge. Contact customer support.

PRODUCT CODE	PRICE	SIZE/INCHES			WEIGHT LBS	VOL FT ³
		H	W	D		
EVPCPA430PNR	213	30	2.875		15.5	0.40
EVPCPA442PNR	279	42	2.875		21.00	0.57
EVPCPA448PNR	307	48	2.875		24.00	0.68
EVPCPA454PNR	339	54	2.875		26.50	0.79
EVPCPA466PNR	397	66	2.875		33.20	0.95

EVPIPA2-NR • Inline Two Way Corner Post (No Raceway Panel)



- Connects No Raceway panel and Panel of equal height in straight run.
- Post and connecting hardware add 3.25" to power beam run.
- Provides slotted support for worksurfaces and hang on components.
- Includes post, panel connectors and power beam connectors, post with trim all around, levelling glide, hardware and trim kit.
- Connectors available without slots, as a special at no extra charge. Contact customer support.
- Note: Inline two way post must be used when No Panel and Panel are next to each other in run

PRODUCT CODE	PRICE	SIZE/INCHES			WEIGHT LBS	VOL FT ³
		H	W	D		
EVPIPA230PNR	162	30	2.875		8.20	0.31
EVPIPA242PNR	207	42	2.875		11.50	0.43
EVPIPA248PNR	217	48	2.875		13.50	0.54
EVPIPA254PNR	251	54	2.875		15.00	0.61
EVPIPA266PNR	299	66	2.875		19.00	0.75

EVPERCHxxNR • Laminate Panel Connector with U Channel (No Raceway Panel)



- U channel attaches with screws to laminate end panel or laminate middle panel.
- Evolve NO Raceway Panels attach to connector.
- U Channel is welded to a No Raceway Connector.
- Includes No Raceway connector with U channel and hardware.

PRODUCT CODE	PRICE	SIZE/INCHES			WEIGHT LBS	VOL FT ³
		H	W	D		
EVPERCH42NR	133	42	2.875		4.60	0.14
EVPERCH48NR	140	48	2.875		5.09	0.18
EVPERCH54NR	151	54	2.875		6.75	0.22

EVPPXGT • Freestanding Glazed Monolithic Privacy Panel

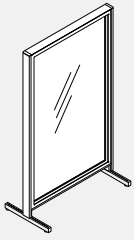

- Includes panel with two connectors with T legs with glides and end of run trims.
- Available in standard clear (CLR) tempered glass
- Available in standard frosted (FRST) tempered glass
- 22"d T-Legs (9.5" extension on each side of panel)
- Glazing is replaceable on site.

PRODUCT CODE	PRICE		SIZE/INCHES			WEIGHT		VOL FT ³
	CLR	FRST	H	W	D	LBS		
EVPPXGT4218	590	711	42	18	2.875	50.53	2.46	
EVPPXGT4224	650	795	42	24	2.875	58.14	3.06	
EVPPXGT4230	704	873	42	30	2.875	65.96	3.6	
EVPPXGT4236	760	948	42	36	2.875	69.3	4.13	
EVPPXGT4242	820	1035	42	42	2.875	73.38	4.67	
EVPPXGT5418	688	836	54	18	2.875	56.19	2.99	
EVPPXGT5424	759	935	54	24	2.875	70.76	3.38	
EVPPXGT5430	825	1025	54	30	2.875	73.08	4.42	
EVPPXGT5436	887	1117	54	36	2.875	85.54	5.11	
EVPPXGT5442	958	1217	54	42	2.875	93.62	5.79	
EVPPXGT6618	794	970	66	18	2.875	62.74	3.48	
EVPPXGT6624	871	1080	66	24	2.875	70.81	4.38	
EVPPXGT6630	948	1189	66	30	2.875	78.63	4.79	
EVPPXGT6636	1021	1291	66	36	2.875	86.52	5.38	
EVPPXGT6642	1108	1410	66	42	2.875	92.66	6.38	

EVPPXGT-F • Freestanding Glazed Monolithic Privacy Panel with Flat Foot

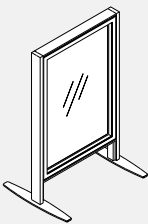

- Includes panel with two connectors with flat foot and end of run trims
- Available in standard clear (CLR) tempered glass
- Available in standard frosted (FRST) tempered glass
- Flat foot does not extend past end trim, no gaps between end trims
- 22"d T-Legs (9.5" extension on each side of panel)
- Glazing is replaceable on site.

PRODUCT CODE	PRICE		SIZE/INCHES			WEIGHT		VOL FT ³
	CLR	FRST	H	W	D	LBS		
EVPPXGT4218F	590	711	42	18	2.875	50.53	2.46	
EVPPXGT4224F	650	795	42	24	2.875	58.14	3.06	
EVPPXGT4230F	704	873	42	30	2.875	65.96	3.6	
EVPPXGT4236F	760	948	42	36	2.875	69.3	4.13	
EVPPXGT4242F	820	1035	42	42	2.875	73.38	4.67	
EVPPXGT5418F	688	836	54	18	2.875	56.19	2.99	
EVPPXGT5424F	759	935	54	24	2.875	70.76	3.38	
EVPPXGT5430F	825	1025	54	30	2.875	73.08	4.42	
EVPPXGT5436F	887	1117	54	36	2.875	85.54	5.11	
EVPPXGT5442F	958	1217	54	42	2.875	93.62	5.79	
EVPPXGT6618F	794	970	66	18	2.875	62.74	3.48	
EVPPXGT6624F	871	1080	66	24	2.875	70.81	4.38	
EVPPXGT6630F	948	1189	66	30	2.875	78.63	4.79	
EVPPXGT6636F	1021	1291	66	36	2.875	86.52	5.38	
EVPPXGT6642F	1108	1410	66	42	2.875	92.66	6.38	

EVPPXGT-FS • Freestanding Glazed Monolithic Privacy Panel with Shared Flat Foot

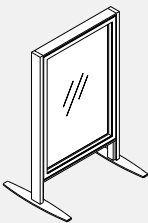

- Includes panel with two connectors with flat foot and end of run trims
- Available in standard clear (CLR) tempered glass
- Available in standard frosted (FRST) tempered glass
- Shared flat foot with connector in middle of flat foot
- 22"d T-Legs (9.5" extension on each side of panel)
- Glazing is replaceable on site.

PRODUCT CODE	PRICE		SIZE/INCHES			WEIGHT		VOL FT ³
	CLR	FRST	H	W	D	LBS		
EVPPXGT4218FS	590	711	42	18	2.875	50.53	2.46	
EVPPXGT4224FS	650	795	42	24	2.875	58.14	3.06	
EVPPXGT4230FS	704	873	42	30	2.875	65.96	3.6	
EVPPXGT4236FS	760	948	42	36	2.875	69.3	4.13	
EVPPXGT4242FS	820	1035	42	42	2.875	73.38	4.67	
EVPPXGT5418FS	688	836	54	18	2.875	56.19	2.99	
EVPPXGT5424FS	759	935	54	24	2.875	70.76	3.38	
EVPPXGT5430FS	825	1025	54	30	2.875	73.08	4.42	
EVPPXGT5436FS	887	1117	54	36	2.875	85.54	5.11	
EVPPXGT5442FS	958	1217	54	42	2.875	93.62	5.79	
EVPPXGT6618FS	794	970	66	18	2.875	62.74	3.48	
EVPPXGT6624FS	871	1080	66	24	2.875	70.81	4.38	
EVPPXGT6630FS	948	1189	66	30	2.875	78.63	4.79	
EVPPXGT6636FS	1021	1291	66	36	2.875	86.52	5.38	
EVPPXGT6642FS	1108	1410	66	42	2.875	92.66	6.38	

EVPPXGT-M • Mobile Glazed Monolithic Panel

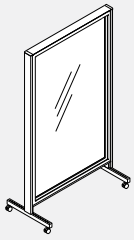

- Includes panel with two connectors with T legs with castors and end of run trims
- Available in standard clear (CLR) tempered glass
- Available in standard frosted (FRST) tempered glass
- Available in standard writeable (WRW) glass.
- 22"d T-Legs (9.5" extension on each side of panel)
- 1" locking casters
- Glazing is replaceable on site.

PRODUCT CODE	PRICE			SIZE/INCHES			WEIGHT LBS	VOL FT ³
	CLR	FRST	WRW	H	W	D		
EVPPXGT4218M	663	783	-	42	18	2.875	50.53	2.46
EVPPXGT4224M	724	868	-	42	24	2.875	58.14	3.06
EVPPXGT4230M	777	946	-	42	30	2.875	65.96	3.6
EVPPXGT4236M	833	1021	-	42	36	2.875	69.3	4.13
EVPPXGT4242M	894	1108	-	42	42	2.875	73.38	4.67
EVPPXGT5418M	760	909	1213	54	18	2.875	56.19	2.99
EVPPXGT5424M	832	1008	1398	54	24	2.875	70.76	3.38
EVPPXGT5430M	898	1098	1574	54	30	2.875	73.08	4.42
EVPPXGT5436M	959	1189	1749	54	36	2.875	85.54	5.11
EVPPXGT5442M	1032	1290	1933	54	42	2.875	93.62	5.79
EVPPXGT6618M	867	1043	1426	66	18	2.875	62.74	3.48
EVPPXGT6624M	944	1153	1641	66	24	2.875	70.81	4.38
EVPPXGT6630M	1021	1262	1854	66	30	2.875	78.63	4.79
EVPPXGT6636M	1093	1364	2060	66	36	2.875	86.52	5.38
EVPPXGT6642M	1180	1484	2287	66	42	2.875	92.66	6.38

EVPPGT • Freestanding Segmented Glazed Privacy Panels

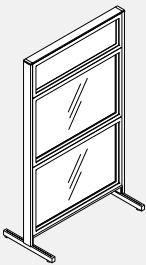

- Includes panel with two connectors with T legs with glides and end of run trims
- Available in standard clear (CLR) tempered glass
- Available in standard frosted (FRST) tempered glass
- 22"d T-Legs (9.5" extension on each side of panel)
- Glazing is replaceable on site.

PRODUCT CODE	PRICE			SIZE/INCHES			WEIGHT LBS	VOL FT ³
	CLR	FRST	WRW	H	W	D		
EVPPGT5424	733	909	-	54	24	2.875	70.8	3.38
EVPPGT5430	805	1011	-	54	30	2.875	73.1	4.42
EVPPGT5436	877	1109	-	54	36	2.875	85.5	5.11
EVPPGT5442	954	1220	-	54	42	2.875	93.6	5.79
EVPPGT5448	1029	1326	-	54	48	2.875	99.1	6.47
EVPPGT5454	1109	1438	-	54	54	2.875	107	7.15
EVPPGT5460	1178	1536	-	54	60	2.875	115.1	7.83
EVPPGT6624	918	1156	-	66	24	2.875	78.63	4.38
EVPPGT6630	1004	1279	-	66	30	2.875	86.52	4.79
EVPPGT6636	1144	1475	-	66	36	2.875	92.66	5.38
EVPPGT6642	1241	1611	-	66	42	2.875	98.19	6.38
EVPPGT6648	1341	1751	-	66	48	2.875	105.48	7.68
EVPPGT6654	1450	1904	-	66	54	2.875	112.52	8.5
EVPPGT6660	1570	2069	-	66	60	2.875	129.3	9.33

EVPPGT-M • Mobile Segmented Glazed Privacy Panels

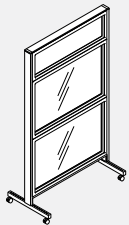

- Includes panel with two connectors with T legs with castors and end of run trims
- Available in standard clear (CLR) tempered glass
- Available in standard frosted (FRST) tempered glass
- 22"d T-Legs (9.5" extension on each side of panel)
- 1" locking casters
- Glazing is replaceable on site.

PRODUCT CODE	PRICE			SIZE/INCHES			WEIGHT LBS	VOL FT ³
	CLR	FRST	WRW	H	W	D		
EVPPGT5424M	801	977	-	54	24	2.875	70.8	3.38
EVPPGT5430M	874	1079	-	54	30	2.875	73.1	4.42
EVPPGT5436M	947	1178	-	54	36	2.875	85.5	5.11
EVPPGT5442M	1022	1288	-	54	42	2.875	93.6	5.79
EVPPGT5448M	1099	1394	-	54	48	2.875	99.1	6.47
EVPPGT5454M	1178	1507	-	54	54	2.875	107	7.15
EVPPGT5460M	1246	1604	-	54	60	2.875	115.1	7.83
EVPPGT6624M	986	1224	-	66	24	2.875	78.63	4.38
EVPPGT6630M	1073	1348	-	66	30	2.875	86.52	4.79
EVPPGT6636M	1212	1543	-	66	36	2.875	92.66	5.38
EVPPGT6642M	1310	1679	-	66	42	2.875	98.19	6.38
EVPPGT6648M	1409	1819	-	66	48	2.875	105.48	7.68
EVPPGT6654M	1519	1972	-	66	54	2.875	112.52	8.5
EVPPGT6660M	1639	2138	-	66	60	2.875	129.3	9.33

EVPPHGT • Freestanding Segmented Glazed and Laminate Privacy Panels - Two Sides

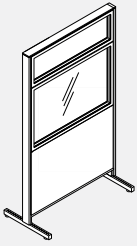

- 30" base panel with laminate faces both sides provides for durable and washable surfaces
- Available in standard clear (CLR) tempered glass
- Available in standard frosted (FRST) tempered glass
- 22"d T-Legs (9.5" extension on each side of panel)
- Glazing is replaceable on site.

PRODUCT CODE	PRICE		SIZE / INCHES			WEIGHT LBS	VOL FT ³
	CLR	FRST	H	W	D		
EVPPHGT5424	777	870	54	24	2.875	55.8	3.38
EVPPHGT5430	862	975	54	30	2.875	62.8	4.42
EVPPHGT5436	950	1083	54	36	2.875	69.3	5.11
EVPPHGT5442	1037	1187	54	42	2.875	74.1	5.79
EVPPHGT5448	1123	1289	54	48	2.875	83.1	6.47
EVPPHGT5454	1216	1401	54	54	2.875	89.4	7.15
EVPPHGT5460	1298	1498	54	60	2.875	95.5	7.83
EVPPHGT6624	960	1088	66	24	2.875	70.81	4.38
EVPPHGT6630	1062	1210	66	30	2.875	78.63	4.79
EVPPHGT6636	1197	1372	66	36	2.875	86.52	5.38
EVPPHGT6642	1300	1496	66	42	2.875	92.66	6.38
EVPPHGT6648	1405	1621	66	48	2.875	98.19	7.68
EVPPHGT6654	1524	1764	66	54	2.875	105.48	8.5
EVPPHGT6660	1666	1933	66	60	2.875	116.2	9.33

EVPPHGT-M • Mobile Segmented Glazed and Laminate Privacy Panels - Two Sides

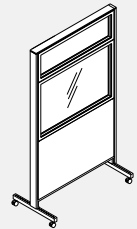

- 30" base panel with laminate faces both sides provides for durable and washable surfaces
- Available in standard clear (CLR) tempered glass
- Available in standard frosted (FRST) tempered glass
- 22"d T-Legs (9.5" extension on each side of panel)
- 1" locking casters
- Glazing is replaceable on site.

PRODUCT CODE	PRICE		SIZE / INCHES			WEIGHT LBS	VOL FT ³
	CLR	FRST	H	W	D		
EVPPHGT5424M	845	938	54	24	2.875	55.8	3.38
EVPPHGT5430M	930	1043	54	30	2.875	62.8	4.42
EVPPHGT5436M	1018	1152	54	36	2.875	69.3	5.11
EVPPHGT5442M	1105	1255	54	42	2.875	74.1	5.79
EVPPHGT5448M	1192	1357	54	48	2.875	83.1	6.47
EVPPHGT5454M	1284	1470	54	54	2.875	89.4	7.15
EVPPHGT5460M	1366	1566	54	60	2.875	95.5	7.83
EVPPHGT6624M	1028	1156	66	24	2.875	70.81	4.38
EVPPHGT6630M	1130	1278	66	30	2.875	78.63	4.79
EVPPHGT6636M	1265	1441	66	36	2.875	86.52	5.38
EVPPHGT6642M	1368	1564	66	42	2.875	92.66	6.38
EVPPHGT6648M	1473	1690	66	48	2.875	98.19	7.68
EVPPHGT6654M	1592	1832	66	54	2.875	105.48	8.5
EVPPHGT6660M	1733	2001	66	60	2.875	116.2	9.33

EVPPHGTU • Freestanding Segmented Glazed and Laminate Privacy Panels - Two Sides

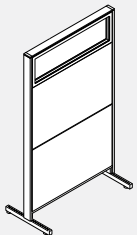

- Laminate faces both sides provides for durable and washable surfaces
- Available in standard clear (CLR) tempered glass
- Available in standard frosted (FRST) tempered glass
- 22"d T-Legs (9.5" extension on each side of panel)
- 12" Glazed segment
- Glazing is replaceable on site.

PRODUCT CODE	PRICE		SIZE / INCHES			WEIGHT LBS	VOL FT ³
	CLR	FRST	H	W	D		
EVPPHGTU5424	894	1017	54	24	2.875	49.2	3.38
EVPPHGTU5430	994	1133	54	30	2.875	55.8	4.42
EVPPHGTU5436	1094	1257	54	36	2.875	62.8	5.11
EVPPHGTU5442	1194	1374	54	42	2.875	69.3	5.79
EVPPHGTU5448	1294	1495	54	48	2.875	74.1	6.47
EVPPHGTU5454	1403	1622	54	54	2.875	83.1	7.15
EVPPHGTU5460	1502	1744	54	60	2.875	89.4	7.83
EVPPHGTU6624	1001	1137	66	24	2.875	53.34	4.38
EVPPHGTU6630	1118	1277	66	30	2.875	60.76	4.79
EVPPHGTU6636	1259	1447	66	36	2.875	68.18	5.38
EVPPHGTU6642	1372	1583	66	42	2.875	76.2	6.38
EVPPHGTU6648	1485	1720	66	48	2.875	87.76	7.68
EVPPHGTU6654	1616	1877	66	54	2.875	95.45	8.5
EVPPHGTU6660	1757	2046	66	60	2.875	99.7	9.33

EVPPHGTU-M • Mobile Segmented Glazed and Laminate Privacy Panels - Two Sides

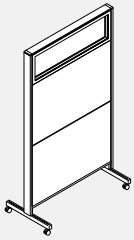

- Laminate faces both sides provides for durable and washable surfaces
- Available in standard clear (CLR) tempered glass
- Available in standard frosted (FRST) tempered glass
- 22"d T-Legs (9.5" extension on each side of panel)
- 1" locking casters
- 12" Glazed segment
- Glazing is replaceable on site.

PRODUCT CODE	PRICE		SIZE/INCHES			WEIGHT LBS	VOL FT ³
	CLR	FRST	H	W	D		
EVPPHGTU5424M	962	1086	54	24	2.875	49.2	3.38
EVPPHGTU5430M	1062	1201	54	30	2.875	55.8	4.42
EVPPHGTU5436M	1162	1325	54	36	2.875	62.8	5.11
EVPPHGTU5442M	1262	1442	54	42	2.875	69.3	5.79
EVPPHGTU5448M	1363	1563	54	48	2.875	74.1	6.47
EVPPHGTU5454M	1471	1691	54	54	2.875	83.1	7.15
EVPPHGTU5460M	1570	1812	54	60	2.875	89.4	7.83
EVPPHGTU6624M	1069	1205	66	24	2.875	53.34	4.38
EVPPHGTU6630M	1187	1345	66	30	2.875	60.76	4.79
EVPPHGTU6636M	1327	1515	66	36	2.875	68.18	5.38
EVPPHGTU6642M	1441	1652	66	42	2.875	76.2	6.38
EVPPHGTU6648M	1554	1788	66	48	2.875	87.76	7.68
EVPPHGTU6654M	1684	1945	66	54	2.875	95.45	8.5
EVPPHGTU6660M	1825	2114	66	60	2.875	99.7	9.33

EVPPH2S • Freestanding Segmented Laminate Privacy Panels - Two Sides

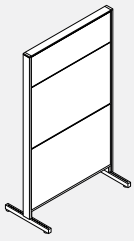

- All laminate faces both sides provides for durable and washable surfaces
- 22"d T-Legs (9.5" extension on each side of panel)

PRODUCT CODE	PRICE	SIZE/INCHES			WEIGHT LBS	VOL FT ³
		H	W	D		
EVPPH2S5424	818	54	24	2.875	50.8	3.38
EVPPH2S5430	918	54	30	2.875	56.2	4.42
EVPPH2S5436	1023	54	36	2.875	60.4	5.11
EVPPH2S5442	1121	54	42	2.875	63.7	5.79
EVPPH2S5448	1216	54	48	2.875	71.2	6.47
EVPPH2S5454	1320	54	54	2.875	73.9	7.15
EVPPH2S5460	1414	54	60	2.875	80.4	7.83
EVPPH2S6624	990	66	24	2.875	62.8	4.38
EVPPH2S6630	1121	66	30	2.875	69.3	4.79
EVPPH2S6636	1267	66	36	2.875	76.8	5.38
EVPPH2S6642	1394	66	42	2.875	82.1	6.38
EVPPH2S6648	1516	66	48	2.875	88	7.68
EVPPH2S6654	1645	66	54	2.875	93.7	8.5
EVPPH2S6660	1782	66	60	2.875	95.2	9.33

EVPPH2S-M • Mobile Segmented Laminate Privacy Panels - Two Sides

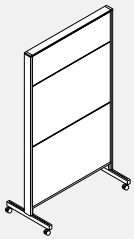

- All laminate faces both sides provides for durable and washable surfaces
- Includes panel with two connectors with T legs with castors and end of run trims
- 22"d T-Legs (9.5" extension on each side of panel)
- 1" locking casters

PRODUCT CODE	PRICE	SIZE/INCHES			WEIGHT LBS	VOL FT ³
		H	W	D		
EVPPH2S5424M	886	54	24	2.875	50.8	3.38
EVPPH2S5430M	986	54	30	2.875	56.2	4.42
EVPPH2S5436M	1091	54	36	2.875	60.4	5.11
EVPPH2S5442M	1189	54	42	2.875	63.7	5.79
EVPPH2S5448M	1284	54	48	2.875	71.2	6.47
EVPPH2S5454M	1389	54	54	2.875	73.9	7.15
EVPPH2S5460M	1482	54	60	2.875	80.4	7.83
EVPPH2S6624M	1060	66	24	2.875	62.8	4.38
EVPPH2S6630M	1189	66	30	2.875	69.3	4.79
EVPPH2S6636M	1336	66	36	2.875	76.8	5.38
EVPPH2S6642M	1462	66	42	2.875	82.1	6.38
EVPPH2S6648M	1585	66	48	2.875	88	7.68
EVPPH2S6654M	1713	66	54	2.875	93.7	8.5
EVPPH2S6660M	1850	66	60	2.875	95.2	9.33

EVPPF2W • Freestanding Segmented Write Board Privacy Panels

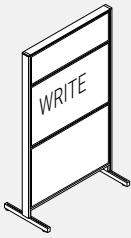

- Writing surface is built into the top module on both sides of the panel, alleviating the need for a panel-mounted Writeboard.
- Use of erasable Writeboard markers only.
- 22"d T-Legs (9.5" extension on each side of panel)

PRODUCT CODE	PRICE		SIZE/INCHES			WEIGHT LBS	VOL FT ³
	GR1	GR2	H	W	D		
EVPPF2W5424	790	805	54	24	2.875	49.8	3.38
EVPPF2W5430	885	905	54	30	2.875	55.2	4.42
EVPPF2W5436	981	1000	54	36	2.875	59.4	5.11
EVPPF2W5442	1073	1100	54	42	2.875	62.7	5.79
EVPPF2W5448	1181	1211	54	48	2.875	70.2	6.47
EVPPF2W5454	1283	1329	54	54	2.875	74.9	7.15
EVPPF2W5460	1375	1414	54	60	2.875	79.4	7.83
EVPPF2W6624	955	970	66	24	2.875	57.8	4.38
EVPPF2W6630	1119	1139	66	30	2.875	62.8	4.79
EVPPF2W6636	1261	1283	66	36	2.875	69.3	5.38
EVPPF2W6642	1393	1417	66	42	2.875	76.8	6.38
EVPPF2W6648	1537	1566	66	48	2.875	82.1	7.68
EVPPF2W6654	1669	1714	66	54	2.875	88	8.5
EVPPF2W6660	1835	1867	66	60	2.875	98.3	9.33

EVPPF2W-M • Mobile Segmented Write Board Privacy Panels

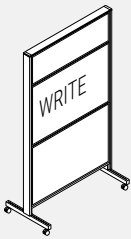

- Writing surface is built into the top module on both sides of the panel, alleviating the need for a panel-mounted Writeboard.
- Use of erasable Writeboard markers only.
- 22"d T-Legs (9.5" extension on each side of panel)
- 1" locking casters

PRODUCT CODE	PRICE		SIZE/INCHES			WEIGHT LBS	VOL FT ³
	GR1	GR2	H	W	D		
EVPPF2W5424M	858	874	54	24	2.875	49.8	3.38
EVPPF2W5430M	954	973	54	30	2.875	55.2	4.42
EVPPF2W5436M	1049	1068	54	36	2.875	59.4	5.11
EVPPF2W5442M	1142	1168	54	42	2.875	62.7	5.79
EVPPF2W5448M	1250	1279	54	48	2.875	70.2	6.47
EVPPF2W5454M	1351	1397	54	54	2.875	74.9	7.15
EVPPF2W5460M	1443	1482	54	60	2.875	79.4	7.83
EVPPF2W6624M	1023	1038	66	24	2.875	57.8	4.38
EVPPF2W6630M	1188	1208	66	30	2.875	62.8	4.79
EVPPF2W6636M	1329	1351	66	36	2.875	69.3	5.38
EVPPF2W6642M	1461	1485	66	42	2.875	76.8	6.38
EVPPF2W6648M	1605	1634	66	48	2.875	82.1	7.68
EVPPF2W6654M	1737	1783	66	54	2.875	88	8.5
EVPPF2W6660M	1904	1935	66	60	2.875	98.3	9.33

EVPPH2W • Freestanding Segmented Write Board and Laminate Privacy Panels

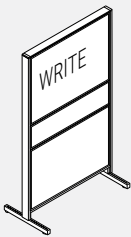

- 30" base panel with laminate faces both sides provides for durable and washable surfaces
- Writing surface is built into upper modules on both sides of the panel, alleviating the need for a panel-mounted Writeboard.
- Use of erasable Writeboard markers only.
- 22"d T-Legs (9.5" extension on each side of panel)

PRODUCT CODE	PRICE	SIZE/INCHES			WEIGHT LBS	VOL FT ³
		H	W	D		
EVPPH2W5424	868	54	24	2.875	50.8	3.38
EVPPH2W5430	982	54	30	2.875	56.2	4.42
EVPPH2W5436	1099	54	36	2.875	60.4	5.11
EVPPH2W5442	1209	54	42	2.875	63.7	5.79
EVPPH2W5448	1315	54	48	2.875	71.2	6.47
EVPPH2W5454	1434	54	54	2.875	73.9	7.15
EVPPH2W5460	1540	54	60	2.875	80.4	7.83
EVPPH2W6624	1024	66	24	2.875	62.8	4.38
EVPPH2W6630	1214	66	30	2.875	69.34	4.79
EVPPH2W6636	1388	66	36	2.875	76.8	5.38
EVPPH2W6642	1527	66	42	2.875	82.09	6.38
EVPPH2W6648	1672	66	48	2.875	88	7.68
EVPPH2W6654	1819	66	54	2.875	93.73	8.5
EVPPH2W6660	1971	66	60	2.875	95.2	9.33

EVPPH2W-M • Mobile Segmented Write Board and Laminate Privacy Panels

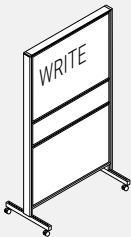

- 30" base panel with laminate faces both sides provides for durable and washable surfaces
- Writing surface is built into upper modules on both sides of the panel, alleviating the need for a panel-mounted Writeboard.
- Use of erasable Writeboard markers only.
- 22"d T-Legs (9.5" extension on each side of panel)

PRODUCT CODE	PRICE	SIZE/INCHES			WEIGHT LBS	VOL FT ³
		H	W	D		
EVPPH2W5424M	936	54	24	2.875	50.8	3.38
EVPPH2W5430M	1050	54	30	2.875	56.2	4.42
EVPPH2W5436M	1167	54	36	2.875	60.4	5.11
EVPPH2W5442M	1277	54	42	2.875	63.7	5.79
EVPPH2W5448M	1383	54	48	2.875	71.2	6.47
EVPPH2W5454M	1502	54	54	2.875	73.9	7.15
EVPPH2W5460M	1608	54	60	2.875	80.4	7.83
EVPPH2W6624M	1092	66	24	2.875	62.8	4.38
EVPPH2W6630M	1283	66	30	2.875	69.34	4.79
EVPPH2W6636M	1456	66	36	2.875	76.8	5.38
EVPPH2W6642M	1595	66	42	2.875	82.09	6.38
EVPPH2W6648M	1740	66	48	2.875	88	7.68
EVPPH2W6654M	1888	66	54	2.875	93.73	8.5
EVPPH2W6660M	2039	66	60	2.875	95.2	9.33

EVPRGLA • Acoustic Grid - 60" wide

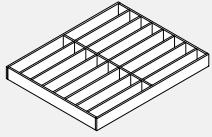

Configuration: 30" - 30"

- PET felt Acoustic Grid to be installed on top of Evolve panels.
- Acoustic Grid kit includes felt pieces, aluminum channel and all necessary hardware.
- PET felt slats run from side to side.
- PET felt pieces available in standard PET felt colours.
- Top trim with channel and beam above opening to be ordered separately.
- Shipped KD.
- For a different felt color for the outer PET frame, choose the code with a D at the end.

PRODUCT CODE	PRICE	SIZE/INCHES			WEIGHT LBS	VOL FT ³
		H	W	D		
EVPRGLA4860	1976	5.5	60	48	18.25	9.2
EVPRGLA6060	2342	5.5	60	60	19.02	11.5
EVPRGLA7260	2709	5.5	60	72	22.04	13.8
EVPRGLA8460	3074	5.5	60	84	25.06	16.0
EVPRGLA9060	3258	5.5	60	90	26.57	17.2
EVPRGLA9660	3468	5.5	60	96	28.29	18.3
EVPRGLA4860D	1976	5.5	60	48	18.25	9.2
EVPRGLA6060D	2342	5.5	60	60	19.02	11.5
EVPRGLA7260D	2709	5.5	60	72	22.04	13.8
EVPRGLA8460D	3074	5.5	60	84	25.06	16.0
EVPRGLA9060D	3258	5.5	60	90	26.57	17.2
EVPRGLA9660D	3468	5.5	60	96	28.29	18.3

EVPRGLA • Acoustic Grid - 72" wide

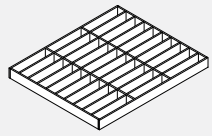

Configuration: 24" - 24" - 24"

- PET felt Acoustic Grid to be installed on top of Evolve panels.
- Acoustic Grid kit includes felt pieces, aluminum channel and all necessary hardware.
- PET felt slats run from side to side.
- PET felt pieces available in standard PET felt colours.
- Top trim with channel and beam above opening to be ordered separately.
- Shipped KD.
- For a different felt color for the outer PET frame, choose the code with a D at the end.

PRODUCT CODE	PRICE	SIZE/INCHES			WEIGHT LBS	VOL FT ³
		H	W	D		
EVPRGLA4872	2378	5.5	72	48	20.10	11.0
EVPRGLA6072	2821	5.5	72	60	23.96	13.8
EVPRGLA7272	3263	5.5	72	72	27.81	16.5
EVPRGLA8472	3705	5.5	72	84	31.67	19.3
EVPRGLA9072	3927	5.5	72	90	33.60	20.6
EVPRGLA9672	4176	5.5	72	96	35.75	22.0
EVPRGLA4872D	2378	5.5	72	48	20.10	11.0
EVPRGLA6072D	2821	5.5	72	60	23.96	13.8
EVPRGLA7272D	3263	5.5	72	72	27.81	16.5
EVPRGLA8472D	3705	5.5	72	84	31.67	19.3
EVPRGLA9072D	3927	5.5	72	90	33.60	20.6
EVPRGLA9672D	4176	5.5	72	96	35.75	22.0

EVPRGLA • Acoustic Grid - 84" wide

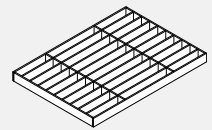

Configuration: 24" - 36" - 24"

- PET felt Acoustic Grid to be installed on top of Evolve panels.
- Acoustic Grid kit includes felt pieces, aluminum channel and all necessary hardware.
- PET felt slats run from side to side.
- PET felt pieces available in standard PET felt colours.
- Top trim with channel and beam above opening to be ordered separately.
- Shipped KD.
- For a different felt color for the outer PET frame, choose the code with a D at the end.

PRODUCT CODE	PRICE	SIZE/INCHES			WEIGHT LBS	VOL FT ³
		H	W	D		
EVPRGLA4884	2657	5.5	84	48	22.15	12.8
EVPRGLA6084	3147	5.5	84	60	26.35	16.0
EVPRGLA7284	3636	5.5	84	72	30.54	19.3
EVPRGLA8484	4124	5.5	84	84	34.74	22.5
EVPRGLA9084	4368	5.5	84	90	36.83	24.1
EVPRGLA9684	4640	5.5	84	96	39.14	25.7
EVPRGLA4884D	2657	5.5	84	48	22.15	12.8
EVPRGLA6084D	3147	5.5	84	60	26.35	16.0
EVPRGLA7284D	3636	5.5	84	72	30.54	19.3
EVPRGLA8484D	4124	5.5	84	84	34.74	22.5
EVPRGLA9084D	4368	5.5	84	90	36.83	24.1
EVPRGLA9684D	4640	5.5	84	96	39.14	25.7

EVPRGLA • Acoustic Grid - 90" wide

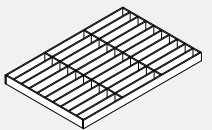

Configuration: 30" - 30" - 30"

- PET felt Acoustic Grid to be installed on top of Evolve panels.
- Acoustic Grid kit includes felt pieces, aluminum channel and all necessary hardware.
- PET felt slats run from side to side.
- PET felt pieces available in standard PET felt colours.
- Top trim with channel and beam above opening to be ordered separately.
- Shipped KD.
- For a different felt color for the outer PET frame, choose the code with a D at the end.

PRODUCT CODE	PRICE	SIZE/INCHES			WEIGHT LBS	VOL FT ³
		H	W	D		
EVPRGLA4890	2759	5.5	90	48	23.27	13.8
EVPRGLA6090	3271	5.5	90	60	27.65	17.2
EVPRGLA7290	3784	5.5	90	72	30.04	20.6
EVPRGLA8490	4296	5.5	90	84	36.42	24.1
EVPRGLA9090	4553	5.5	90	90	38.62	25.8
EVPRGLA9690	4837	5.5	90	96	41.01	27.5
EVPRGLA4890D	2759	5.5	90	48	23.27	13.8
EVPRGLA6090D	3271	5.5	90	60	27.65	17.2
EVPRGLA7290D	3784	5.5	90	72	30.04	20.6
EVPRGLA8490D	4296	5.5	90	84	36.42	24.1
EVPRGLA9090D	4553	5.5	90	90	38.62	25.8
EVPRGLA9690D	4837	5.5	90	96	41.01	27.5

EVPRGLA • Acoustic Grid - 96" wide

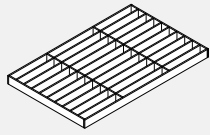

Configuration: 30"- 36"- 30"

- PET felt Acoustic Grid to be installed on top of Evolve panels.
- Acoustic Grid kit includes felt pieces, aluminum channel and all necessary hardware.
- PET felt slats run from side to side.
- PET felt pieces available in standard PET felt colours.
- Top trim with channel and beam above opening to be ordered separately.
- Shipped KD.
- For a different felt color for the outer PET frame, choose the code with a D at the end.

PRODUCT CODE	PRICE	SIZE/INCHES			WEIGHT LBS	VOL FT ³
		H	W	D		
EVPRGLA4896	2963	5.5	96	48	24.47	14.7
EVPRGLA6096	3500	5.5	96	60	29.02	18.3
EVPRGLA7296	4036	5.5	96	72	33.56	22.0
EVPRGLA8496	4570	5.5	96	84	38.11	25.7
EVPRGLA9096	4839	5.5	96	90	40.38	27.5
EVPRGLA9696	5132	5.5	96	96	42.86	29.3
EVPRGLA4896D	2963	5.5	96	48	24.47	14.7
EVPRGLA6096D	3500	5.5	96	60	29.02	18.3
EVPRGLA7296D	4036	5.5	96	72	33.56	22.0
EVPRGLA8496D	4570	5.5	96	84	38.11	25.7
EVPRGLA9096D	4839	5.5	96	90	40.38	27.5
EVPRGLA9696D	5132	5.5	96	96	42.86	29.3

EVPRGLA • Acoustic Grid - 144" wide

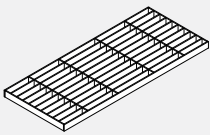

Configuration: 24"- 30"- 36"- 30"- 24"

- PET felt Acoustic Grid to be installed on top of Evolve panels.
- Acoustic Grid kit includes felt pieces, aluminum channel and all necessary hardware.
- PET felt slats run from side to side.
- PET felt pieces available in standard PET felt colours.
- Top trim with channel and beam above opening to be ordered separately.
- Shipped KD.
- For a different felt color for the outer PET frame, choose the code with a D at the end.

PRODUCT CODE	PRICE	SIZE/INCHES			WEIGHT LBS	VOL FT ³
		H	W	D		
EVPRGLA120144	7655	6	144	120	73.86	55.0
EVPRGLA120144D	7655	6	144	120	73.86	55.0

STEP BY STEP SPECIFICATION • 8 WIRE ELECTRICAL SYSTEM

Step 1 Determine the location of the power source entering the panel run.

1. At the base of the panel.
 - a) Use EVE8FR Reversible Floor Power Entry (default to EVE8FR).
 - b) Select the panel to which the Floor Power Entry will be attached. This panel requires an EVE8PD Power Distribution Housing.
 - c) Select the side of the panel and the receptacle outlet to which the Floor Power Entry is to be attached.
2. From the ceiling.
 - a) Use EVE8EC1 Ceiling Power Entry.
 - b) Select the post through which to feed the Ceiling Power Entry.
 - c) One panel adjacent to the selected post requires an EVE8PD Power Distribution Housing.
 - d) Attach Ceiling Power entry to the nearest end of the Power Distribution Housing.

Step 2 Determine which panels are to be powered.

1. Use EVE8PD Power Distribution Housing that corresponds with the width of the panel.

Step 3 Connect power to the powered panels.

1. Use EVE8CP16 Jumper Cable between two adjacent powered panels.
2. Use EVE8CP20 Jumper Cable between two adjacent powered panels separated by a post.

3. Use EVE8CP Pass-Through Cables to connect powered panels that are separated by one or more non-powered panels (maximum distance between the powered panels is 12 feet).
 - a) The length of the Pass-Through Cable is calculated by adding together the widths of the non-powered panels that separate the two powered panels and applying an additional 16" to the total. (EVE8PD Power Distribution Housing is positioned 8" in from the ends of the powered panel.)
 - b) An additional 4" must be added to the Pass-Through Cable for each post that the cable passes through.
4. From the price list, select the EVE8CP Pass-Through Cable that matches the calculated length. If the length is between listed sizes, use the next size up.

Step 4 Determine the location and circuitry of the receptacles.

1. Each powered panel has four (4) potential locations for EVE8RD Duplex Receptacles – 2 per side. (Exception: 24" wide panel has only two potential locations – 1 per side, 18" wide panel has no locations for receptacles.)
2. At each receptacle location there is a choice of four (4) circuit options. Select a circuit option for each location. Circuits one and two are utility circuits; circuits A and B are dedicated circuits.

DEFINITION OF COMPONENTS**Power Distribution Housing**

Power Distribution Housing must be specified for each panel where power is required. Order a power kit for the panel width requiring power. The kit is field installed.

Jumper Cable

A Jumper Cable must be ordered to connect two powered panels. The EVE8CP16 connects two powered panels. The EVE8CP20 connects two powered panels with a 90° connector post between the panels (two-way, three-way, four-way configurations).

A Pass-Through Cable

A Pass-Through Cable allows cables to be passed from a powered panel through one or more non-powered panels (panels that do not require electrical outlets) to connect to another powered panel. (See Step-by-Step Specification for details.)

Duplex Receptacles

Duplex Receptacles snap into place in the power housing. Four circuits may be specified. Circuits A and B are dedicated. Up to two duplexes per side may be installed in a power way for panels 30" and wider. 24" panels will accept one Duplex Receptacle per side. 18" panels will not accept Duplex Receptacles.

Power Entry

To power an Evolve panel, order either a floor power entry or a ceiling power entry. A floor power entry module will take the place of a duplex receptacle by snapping into the base power way.

Desktop Data/Power Receptacle

This module is positioned in the scoop of an Evolve worksurface and provides two simplex plugs and two voice/data ports or two simplex plugs only and two voice data only. A 6 foot power cord can be plugged into a powered Evolve raceway.

WIRE SCHEMATIC

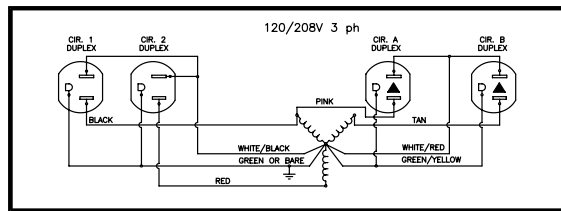
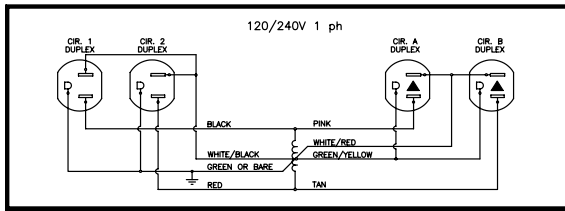

4-2-2 Wiring Schematic
 8-Wire Shared Neutral
 "2+2" - 2 Utility circuits, 2 dedicated

8 Wires
 4 Lines (12 ga.)
 2 Neutrals (10 ga.)
 2 Grounds (12 ga.)

4 Circuits
 2 Utility Circuits
 2 Dedicated Circuits

Receptacles
 Duplex - Up to 6 receptacles per circuit (Up to 48 infeed)

Specifications
 System rated for connection to a grounded 120/240 V, single phase, 20A, 60Hz or 120/208 V, 3 phase, 20A, 60Hz branch circuit for U.S. and 15A if product is marked with a C-UL Mark. Outlets rated 15A max.

UL RECOGNIZED AND CSA CERTIFIED

Warning: It is recommended that installation of the electrical harness be made under the supervision of a licensed electrician in accordance with applicable codes and regulations.

Special Note: Always determine that harness is electrically connected to only one power supply.

COMPONENTS REQUIRED

- a) EVE8PD42 • Power Distribution Housing
Note: 8 wire, 4 circuits (A and B circuits access dedicated circuits).
- b) EVE8CP16 • Jumper Cable
Note: EVE8CP16 connects two powered panels positioned side by side. EVE8CP20 connects two powered panels separated by a post.
- c) EVE8RD • Duplex Receptacle
Note: 1 and 2 access utility circuits.
- d) EVE8CP • Pass-Through Cable
Note: An "I" connector is available to connect 2 Pass-Through Cables.

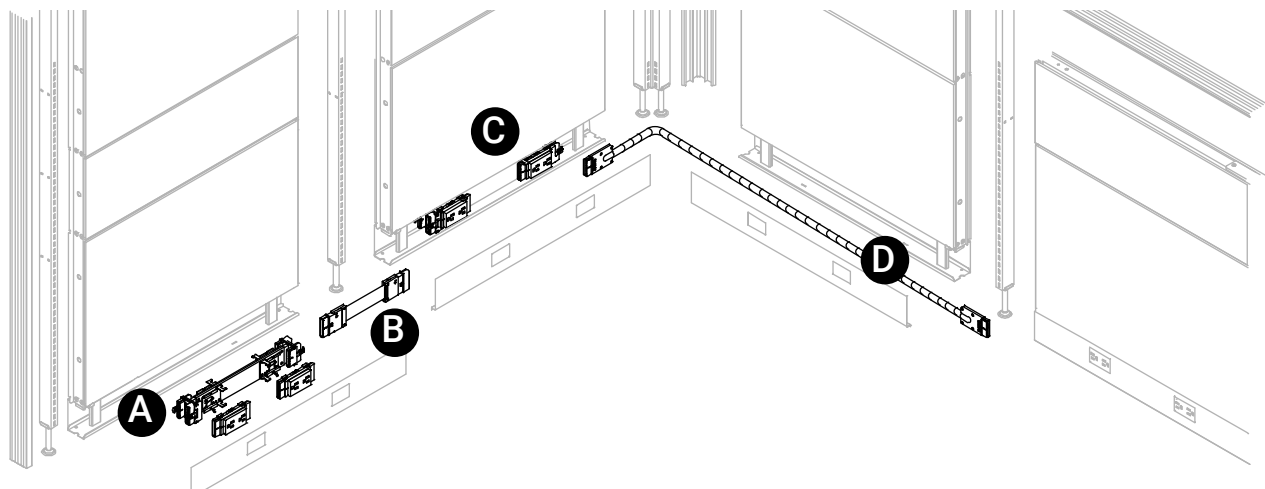

EVE8CI-1 • “I” Connector

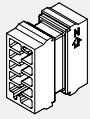

- Female - Female connector used to connect two Pass-Through Cables.

PRODUCT CODE	PRICE	SIZE/ INCHES			WEIGHT VOL	
		H	W	D	LBS	FT ³
EVE8CI-1	85	15	15	0.75	0.06	0.20

EVE8RD • Duplex Receptacles

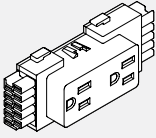

- Up to 6 duplex receptacles per circuit.
- EVE8RD1 = Circuit #1 (utility circuit)
- EVE8RD2 = Circuit #2 (utility circuit)
- EVE8RDA = Circuit #A (dedicated)
- EVE8RDB = Circuit #B (dedicated)

PRODUCT CODE	PRICE	SIZE/ INCHES			WEIGHT VOL	
		H	W	D	LBS	FT ³
EVE8RD1	35	2	4.625	1.25	0.16	0.01
EVE8RD2	35	2	4.625	1.25	0.16	0.01
EVE8RDA	35	2	4.625	1.25	0.16	0.01
EVE8RDB	35	2	4.625	1.25	0.16	0.01

EVEUSB01 • Duplex Receptacles

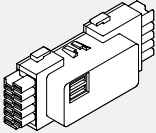

- The USB charging module provides convenient charging power access through dual ports on face of the receptacle.
- Two USB ports.
- 2 Amp output via two USB ports, considered as circuit #1.
- Available in white, black.

PRODUCT CODE	PRICE	SIZE/ INCHES			WEIGHT VOL	
		H	W	D	LBS	FT ³
EVEUSB01WHT	238	2	4.625	1.25	0.16	0.01
EVEUSB01BLK	238	2	4.625	1.25	0.16	0.01

EVE8RDx-20 • Duplex Receptacles, 20AMP

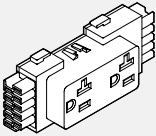

- Up to 6 receptacles per circuit (24 per infeed) not to exceed total 20 Amps per circuit.
- EVE8RD1 = Circuit #1 (utility circuit)
- EVE8RD2 = Circuit #2 (utility circuit)
- EVE8RDA = Circuit #A (dedicated)
- EVE8RDB = Circuit #B (dedicated)

PRODUCT CODE	PRICE	SIZE/ INCHES			WEIGHT VOL	
		H	W	D	LBS	FT ³
EVE8RD1-20	40	2	4.625	1.25	0.16	0.01
EVE8RD2-20	40	2	4.625	1 1/4	0.16	0.01
EVE8RDA-20	40	2	4.625	1 1/4	0.16	0.01
EVE8RDB-20	40	2	4.625	1 1/4	0.16	0.01

EVE8FR1 • Reversible Floor Power Entry

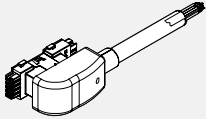

- Takes the place of a duplex receptacle by snapping into the base power way.
- Includes 72" long liquid-tight conduit.
- Must be hard wired to source power by a licenced electrician.

PRODUCT CODE	PRICE	SIZE/ INCHES	WEIGHT VOL	
			L	LBS
EVE8FR1	353	72	3.82	2.00

EVE8FR2 • Reversible Floor Power Entry

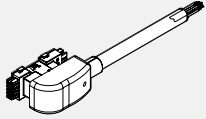

- Takes the place of a duplex receptacle by snapping into the base power way.
- Includes 144" long liquid-tight conduit.
- Must be hard wired to source power by a licenced electrician.

PRODUCT CODE	PRICE	SIZE/ INCHES	WEIGHT VOL	
			L	LBS
EVE8FR2	454	144	6.98	2.00

EVE8FP • Floor Power Supply

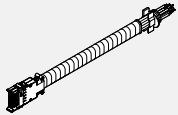

- Snaps in end of power distribution housing
- Includes flexible vinyl conduit
- Must be hard wired to source by licenced electrician
- Diameter is 0,85"

PRODUCT CODE	PRICE	SIZE/ INCHES	WEIGHT VOL	
			L	LBS
EVE8F1P	353	72	3.82	2
EVE8F2P	454	144	6.98	2

EVE8PD • Power Distribution Housing

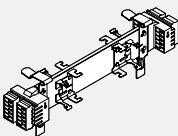

- Power housing is specified per panel size. eg. EVE8PD36 is for use with a 36" panel.
- 8 wire, 4 circuits (A and B circuits are dedicated).
- Provides two duplex receptacles per panel side on all panel widths above the 24" wide panel.
- 24" wide panel allows for only one (1) duplex receptacle per panel side.

PRODUCT CODE	PRICE	SIZE/ INCHES	WEIGHT VOL	
			W	LBS
EVE8PD24	156	9.25	0.83	1.17
EVE8PD30	208	15.25	1.28	1.17
EVE8PD36	220	21.25	1.62	1.65
EVE8PD42	226	27.25	2.00	2.00
EVE8PD48	238	33.25	0.18	0.16
EVE8PD54	242	39.25	2.66	3.20
EVE8PD60	243	45.25	3.04	3.20
EVE8PD66	253	51.25	3.49	3.25
EVE8PD72	262	57.20	3.76	3.30

EVE8CT • Transition Cable

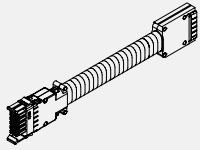

- The EVE8CT16 electrically connects an EVEPD Power Distribution Housing (pre-April 1, 2005) to an EVE8PD Power Distribution Housing when connecting powered panels that are positioned side by side.
- The EVE8CT20 electrically connects an EVEPD Power Distribution Housing (pre-April 1, 2005) to an EVE8PD Power Distribution Housing when connecting powered panels that are separated by a post.
- If there is one or more pass-through panels that contain the old Power Distribution Housing (pre-April 1, 2005) and a panel that contains the new Power Distribution Housing, then an EVE9CI-1 "I" Connector can be attached to the Transition Jumper Cable. This allows for the addition of an appropriate EVE8CP Pass-Through Cable to span the gap between the EVE8CT Transition Cable and the EVE8PD Power Distribution Housing.

PRODUCT CODE	PRICE	SIZE/ INCHES	WEIGHT LBS	VOL FT ³
EVE8CT16	128	16	0.78	1.17
EVE8CT20	147	20	0.92	1.17

EVE8CP • Jumper Cable

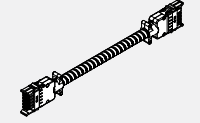

- The EVE8CP16 electrically connects two powered panels positioned side by side.
- The EVE8CP20 electrically connects two powered panels separated by a post.

PRODUCT CODE	PRICE	SIZE/ INCHES	WEIGHT LBS	VOL FT ³
EVE8CP16	128	16	0.66	1.17
EVE8CP20	147	20	0.78	1.17

EVE8CP-H • Hybrid Pass Through Cables with Wire Mesh

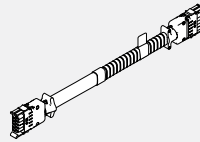

- Flexible metal conduit with wire mesh distributes electrical power through non powered panels.
- To calculate the length of Hybrid Pass Through Cable, add the width of non powered panels separating the powered panels. To this add 16" (distance from edge of the panels to power distribution housing x2).
- Please add an additional 3" when passing through a post. Please see the the beginning of this section.
- Hybrid Pass Through Cables with wire mesh allows connection at 90 degree post and one end for Power Beam.

PRODUCT CODE	PRICE	SIZE/INCHES			WEIGHT LBS	VOL FT ³
		H	W	D		
EVE8CP40-H	196		40		1.44	1.17
EVE8CP46-H	204		46		1.71	1.17
EVE8CP52-H	212		52		1.95	1.17
EVE8CP58-H	226		58		2.21	1.17
EVE8CP64-H	235		64		2.37	1.17
EVE8CP70-H	240		70		2.60	1.17
EVE8CP76-H	244		76		2.81	1.17
EVE8CP82-H	255		82		3.03	1.17
EVE8CP88-H	264		88		3.05	1.17
EVE8CP94-H	273		94		3.42	1.17
EVE8CP100-H	281		100		3.47	1.17
EVE8CP106-H	292		106		3.87	1.17
EVE8CP118-H	309		118		4.08	1.17
EVE8CP130-H	337		130		4.73	1.17
EVE8CP142-H	351		142		4.89	1.17

EVE8CP • Pass Through Cable

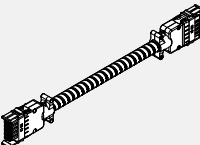

- Flexible metal conduit is used to distribute electrical power through non-powered panels.
- To calculate the length of a Pass-Through Cable, add the widths of the non-powered panels separating the powered panels (panels with distribution housing attached). To this, add 16" (distance from the edge of the panel to the distribution housing x 2). See Technical Information page at the beginning of this section.

PRODUCT CODE	PRICE	SIZE/ INCHES	WEIGHT LBS	VOL FT ³
EVE8CP40	164	40	1.44	1.17
EVE8CP46	169	46	1.71	1.17
EVE8CP52	177	52	1.95	1.17
EVE8CP58	188	58	2.21	1.17
EVE8CP64	196	64	2.37	1.17
EVE8CP70	200	70	2.60	1.17
EVE8CP76	204	76	2.81	1.17
EVE8CP82	213	82	3.03	1.17
EVE8CP88	220	88	3.05	1.17
EVE8CP94	228	94	3.92	1.17
EVE8CP100	233	100	3.47	1.17
EVE8CP106	243	106	3.87	1.17
EVE8CP118	257	118	4.08	1.17
EVE8CP130	281	185	4.73	1.17
EVE8CP142	293	142	4.59	1.17

EVE8CP18 • Flexible Mesh Jumper Cable

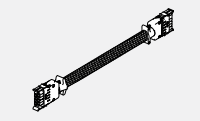

- Electrically connects two powered panels separated by post.
- Used to connect two power distribution housing in Power Beam at 90 degrees.

PRODUCT CODE	PRICE	SIZE/INCHES			WEIGHT LBS	VOL FT ³
		H	W	D		
EVE8CP18	147		18.5		0.78	1.17

EVH8RC • Raceway Covers

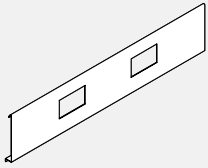

- Raceway Covers with 1.35 x 2.68" duplex receptacle openings.
- Includes 2 receptacle opening shields.
- Raceway Covers are sold individually.
- Used when adding to existing panel installation ordered prior to April 1, 2005.

PRODUCT CODE	PRICE	SIZE/ INCHES		WEIGHT VOL	
		H	W	LBS	FT ³
EVH8RC24	30	6	24	1.00	0.11
EVH8RC30	37	6	30	1.10	0.12
EVH8RC36	41	6	36	1.20	0.13
EVH8RC42	48	6	42	1.30	0.14
EVH8RC48	58	6	48	1.40	0.15
EVH8RC54	66	6	54	1.40	0.15
EVH8RC60	68	6	60	1.50	0.16

EVH8RA • Raceway Opening Adapter

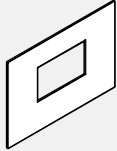

- Used when using new electrical and adding to existing panel installation ordered prior to April 1, 2005.
- PVC Adapter reduces the size of the Duplex Receptacle opening to accommodate the new style Duplex Receptacles.
- Pressure fits inside existing (old style) Raceway Cover.
- Opening size is 1.35" x 2.68".
- Sold in packs of 12, black only.

PRODUCT CODE	PRICE	SIZE/ INCHES		WEIGHT VOL	
		W	L	LBS	FT ³
EVH8RA01	93	16	16	0.01	0.01

EVE8EC • Ceiling Power Entry

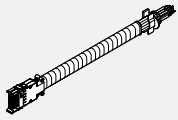

- Snaps into the end of Power Distribution Housing.
- Flexible metal conduit extends into the ceiling through a corner post and post extension (both ordered separately).
- Must be hard wired to source power by a licensed electrician.
- 4" Junction Box included.

PRODUCT CODE	PRICE	SIZE/ L	INCHES		WEIGHT VOL	
			L	LBS	FT ³	
EVE8EC1	268	132	5.24	2.00		
EVE8EC2	479	144	5.96	2.00		

EVDPE • Post Extension Data/Comm Lay-in

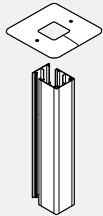

- Attaches to the top of a post to bring power and/or data cables from the ceiling to panel power way.
- Three-sided power pole with snap-on fourth side.
- Post extension can be opened on one side for lay-in for power and/or data cables.
- Made of aluminum and can be field cut.
- Accommodates up to 25 CAT5 cables with electric. Accommodates up to 45 CAT5 cables without electric.
- Ceiling infeed installed on one way post with T Leg requires securing post with two Floor mount plates.
- Post extension bigger than 82" is made of two parts.

PRODUCT CODE	PRICE	SIZE/ H	INCHES		WEIGHT VOL	
			H	W	LBS	FT ³
EVDPE64	160	64	2.875	3.00	0.70	
EVDPE82	197	82	2.875	4.20	0.80	
EVDPE88	302	88	2.875	4.50	0.85	
EVDPE94	323	94	2.875	4.80	0.92	
EVDPE100	344	100	2.875	5.12	0.97	

EVDP4E • 45° Post Extension Data/Comm Lay-in



- Attached to the top of the 45° Corner Post to bring power and/or data cables from the ceiling to the panel run through.
- Cable Capacity
 - 40 CAT5 cables without electric feed.
 - 10 CAT5 cables with electric feed.

PRODUCT CODE	PRICE	SIZE/ H	INCHES		WEIGHT VOL	
			H	W	LBS	FT ³
EVDP4E64	162	64	3.65	3.00	0.70	
EVDP4E82	218	82	3.65	4.20	0.80	

EVDP6E • 60° Post Extension Data/Comm Lay-in



- Attached to the top of the 60° Corner Post to bring power and/or data cables from the ceiling to the panel run through.
- Post extension can be opened on one side for lay-in power and/or data cables.
- Made of aluminum and can be field cut.
- Two sided power pole with snap-on third side.
- Cable Capacity
 - 32 CAT5 cables without electric.
 - 15 CAT5 cables with electric

PRODUCT CODE	PRICE	SIZE/ H	INCHES		WEIGHT VOL	
			H	W	LBS	FT ³
EVDP6E64	157	64	2	3.00	0.70	
EVDP6E82	192	82	2	4.20	0.80	

EVEJBC1 • Hardwire Junction Box

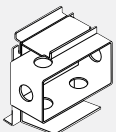

- Provides economical single circuit capability.
- Can be used in addition to 8 wire system to support isolated hospital power.
- Can be retrofitted in any size of panel at the receptacle location.
- Gives access from one side only at each location.
- Customer to supply conduit, wiring, receptacle, and face plate.
- A licensed electrician must provide hardwire connection with the junction box.

PRODUCT CODE	PRICE	WEIGHT VOL	
		LBS	FT ³
EVEJBC1	105	1.50	0.02

Power Beam

- All metal components are painted with environmentally friendly epoxy powder.
- Raceway interiors are coated with recycled epoxy powder.
- The entire Evolve Power Beam and the processes used to manufacture it are designed to save and protect the environment. Evolve panels are made from recycled materials and are 100% recyclable.
- Components conform to CGSB and ANSI/BIFMA Standards.
- The quality and performance level of these panels have been tested to equal or exceed the requirements of the U.S. Government.
- Power Beam has a steel frame and is 2 7/8" thick. Corner posts create a panel creep of 3 1/4".
- Leveling glides extend 1 1/2" high.

Power Beam Options

- Power Beams are available in the following heights: 24", 30", and 36".
- Module widths come in seven (7) sizes: 36", 42", 48", 54", 60", 66" and 72".
- Straight, 90 degree & 120 degree.

Extension Module Options

- Acoustic Fabric (Tackable), Glazed, Open, Laminate, Whiteboard, Air Flow.
- Attaches to the top of the Power Beam or another extension module (not to exceed 42" above finished floor).
- Offered in 6", 12", and 18" heights.
- Can be stacked up to 42" high above the finished floor (A.F.F.).

Beam Reconfiguration

- Extension Modules can be modified on site by replacing fabric modules with Glazed, Open, Laminate, Whiteboard or Air Flow at any time after the initial installation.
- Fabric can be replaced easily; using pre-cut segments of fabric, a drawstring (C-Jex) is sewn in around the edges. Then a rubber spline is used to 'screen' the fabric in place.

Voice/Data And Electrical Power

- NOTE: Panels and Electric components are CSA/UL approved. Tools are not required to install electrical in the Power Beam.

Electric Information

- Electric can be run in all three Power Beam heights (24" h, 30" h or 36" h).
 - 8-Wire, 4 circuit capability
 - 2 utility + 2 dedicated circuits
 - 10 gauge (oversized) neutrals
- All circuits can support up to 15 a max.
- Contact Evolve customer care for additional wiring options.

Raceway Information

- Raceway knockouts sizes conform to the ANSI/TIA/ EIA Furniture Opening Standard of 1.38" x 2.71".
- Power Beam raceway covers 36"-60" wide accommodate knockouts for two electrical duplexes and one communication face plate on each side. 66" wide beam accommodates 4 electrical duplexes and one communication face plate on each side. 72" wide beam accommodates 4 duplex receptacles and 2 communication face plates on each side.
- Standard data face mount plates can be used without the need of adapter plates (supplied by others).
- Cabling capacities (calculations below are based on .25" diameter communication cables.)
- Power Modules:
 - Without electric – 65 Cables
 - With electric – 54 Cables
- Panel Connectors - 90 Degree Connector Posts:
 - Without electric – 45 cables
 - With electric – 25 Cables

Work Tables

- Freestanding tables
 - Foli height adjustable (23" or 29"d)
 - Bungee (20", 24" or 30"d)
 - Junction (20", 24" or 30"d)
 - 2gether (18" or 24"d)

Power Beam is a freestanding beam system and does not support attachment of an Evolve brackets or overhead storage including cantilevers or other support brackets.

Features, Benefits & General Information

Technical Features of Power Beam:

- Evolve Power Beam is 2 7/8" thick.
- An aluminum low profile top cap is included with Power Beams.
- Power Beam will accommodate 65 x 0.25" diameter communication cables without electrical or 54 x 0.25" diameter communication cables with electrical.
- 90-degree post extension accommodates 45 x 0.25" diameter communication cables without electrical and 25 x 0.25" diameter communication cables with electric.
- Raceway knockout openings are 1.38" x 2.71".

Basic Features of Power Beam

- Power Beam is available in three (3) heights: 24" h, 30" h and 36" h; and seven (7) widths: 36" w, 42" w, 48" w, 54" w, 60" w, 66" w and 72" w.
- There is no panel creep in a straight Beam-to-Beam configuration; however, a corner post (2, 3, 4 way) will add 3.25" inches to a beam run.

Basic Features of Extension Modules

- Extension modules stack on the top of a Power Beam or another extension module (maximum height - 42" h, above finished floor).
- Fabric extension modules may have different fabrics on opposite sides within the same grade with no up-charge.
- If different grades of fabric are used on one module, the entire modules will be priced utilizing the fabric with the highest grade.

Power Beam Parts

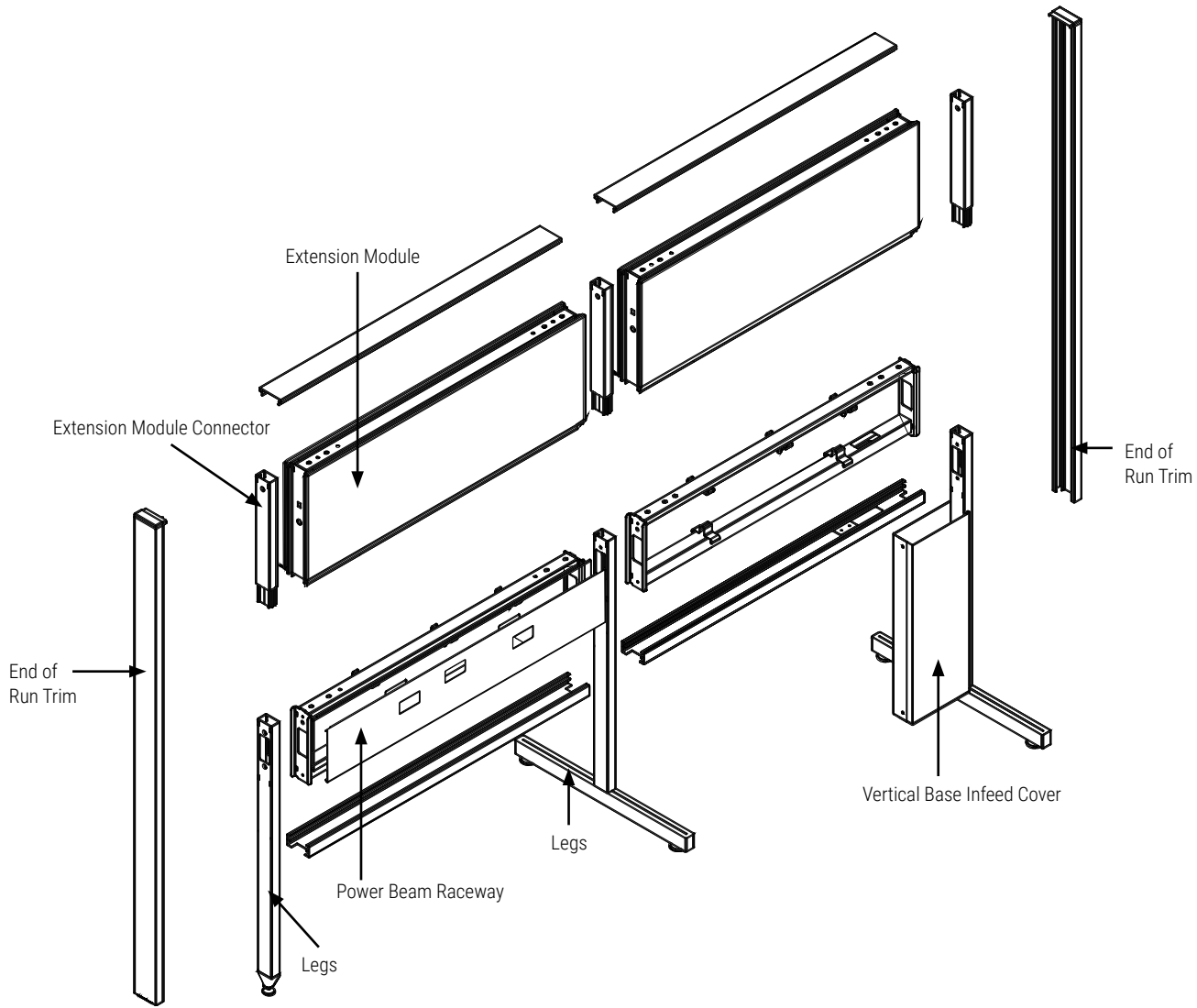

Extension Module Materials

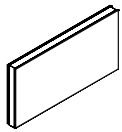

Fabric

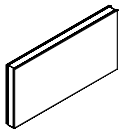

Laminate

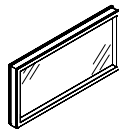

Glass



Write Board

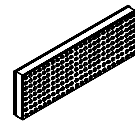

Airflow

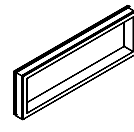

Open

EVPB • Power Beam

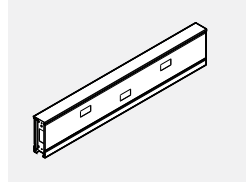

- Aluminum top trim and bottom trim included
- No access for base infeed
- Support legs ordered separately

PRODUCT CODE	PRICE	SIZE/ INCHES			WEIGHT VOL	
		H	W	D	LBS	FT ³
EVPB36	215	6	36	2.875	15.5	0.48
EVPB42	237	6	42	2.875	17.1	0.56
EVPB48	256	6	48	2.875	18.6	0.64
EVPB54	281	6	54	2.875	20.2	0.72
EVPB60	306	6	60	2.875	21.8	0.80

EVPB • 6" High Power Beam

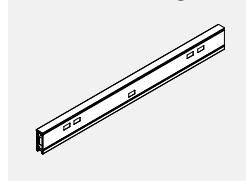

- One piece aluminum top trim and one piece aluminum bottom trim included.

PRODUCT CODE	PRICE	SIZE/ INCHES			WEIGHT VOL	
		H	W	D	LBS	FT ³
EVPB66	479	6	66	2.875	31	0.91
EVPB72	495	6	72	2.875	32	1.00

EVPBE • Power Beam with Electrical Cut-out for Base Feed

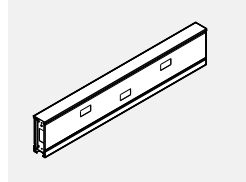

- Power beam with bottom cut out (on one end) for base infeed
- Aluminum top and bottom trims included
- Bottom trim has a cut out on one side for electrical access and a bracket to connect to the vertical base infeed cover (ordered separately)
- Vertical base infeed cover with support leg ordered separately

PRODUCT CODE	PRICE	SIZE/ INCHES			WEIGHT VOL	
		H	W	D	LBS	FT ³
EVPBE36	227	6	36	2.875	15.5	0.48
EVPBE42	252	6	42	2.875	17.1	0.56
EVPBE48	276	6	48	2.875	18.6	0.64
EVPBE54	297	6	54	2.875	20.2	0.72
EVPBE60	325	6	60	2.875	21.8	0.80

EVPBE • Power Beam Kit with Electrical Cut-out for Base Feed

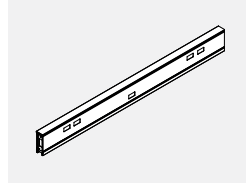

- 66" Power Beam Kit consists of (1) 30" Power Beam and (1) 36" Power Beam with bottom cut out on one side for a base infeed. Inline connector and hardware included.
- Vertical base infeed cover with support leg ordered separately.

PRODUCT CODE	PRICE	SIZE/ INCHES			WEIGHT VOL	
		H	W	D	LBS	FT ³
EVPBE66	507	6	66	2.875	31	0.91
EVPBE72	524	6	72	2.875	32	1.00

EVPBEP-KIT • Power Beam with Electrical Cut-out for Pass Through Cabinet

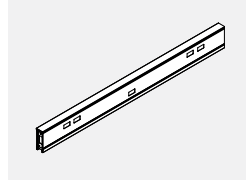

- Power beam with electrical cutout for base feed from pass through cabinet.
- Aluminum top trim included.
- 60" Power beam kit includes two 30" power distribution housing (EVE8PD30) and jumper cable (EVE8CP17).
- 72" Power beam kit includes two 36" power distribution housing (EVE8PD36) and jumper cable (EVE8CP17).
- Provides two duplex receptacle per panel side.
- Power beam base feed to be ordered separately.
- Power beam storage cabinet with pass through be ordered separately (EVPBSCGDP or EVPBSCP).
- Note: To be used with cable pass through cabinet EVPBSSCGDPR/L.

PRODUCT CODE	PRICE	SIZE/ INCHES			WEIGHT VOL	
		H	W	D	LBS	FT ³
EVPBEP60KIT	789	6	60	2.875	23.4	0.86
EVPBEP72KIT	1000	6	72	2.875	25.1	0.96

EVPBEP-KIT01 • Power Beam with Electrical Cut-out for Pass Through Cabinet with Two Raceway Covers per Side

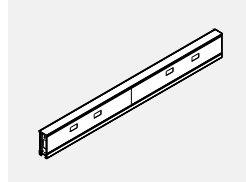

- Power beam with electrical cut out for base feed from pass through cabinet.
- Aluminum top trim included.
- 60" Power beam kit includes two 30" raceway covers per side.
- 72" Power beam kit includes two 36" raceway covers per side.
- 60" Power beam kit includes two 30" power distribution housing (EVE8PD30) and jumper cable (EVE8CP17).
- 72" Power beam kit includes two 36" power distribution housing (EVE8PD36) and jumper cable (EVE8CP17).
- Provides four duplex receptacle per panel side.
- Power beam base feed to be ordered separately.
- Power beam storage cabinet with pass through be ordered separately (EVPBSCGDP or EVPBSCP).
- Note: To be used with cable pass through cabinet EVPBSSCGDPR/L.

PRODUCT CODE	PRICE	SIZE/ INCHES			WEIGHT VOL	
		H	W	D	LBS	FT ³
EVPBEP60KIT01	789	6	60	2.875	23.4	0.88
EVPBEP72KIT01	1000	6	72	2.875	25.1	0.96

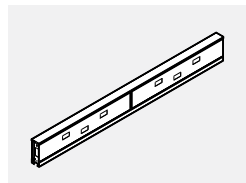

EVPBFCL • Vertical Base Power Feed Cover with Leg

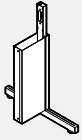

- Connects to Power Beam Kit with electrical cut out.
- Includes vertical cover and slotted connector support leg with foot.
- Power Beam kit with electrical cut out ordered separately.
- Base infeed ordered separately.

PRODUCT CODE	PRICE	SIZE/ INCHES			WEIGHT VOL	
		H	W	D	LBS	FT ³
EVPBFCL24	195	24	6	21	10.1	1.75
EVPBFCL30	218	30	6	21	11.2	2.18
EVPBFCL36	240	36	6	21	12.3	2.62

EVPBFCSL • Base Power Feed Cover with Single Leg

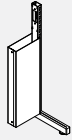

- Connects to Power Beam Kit with electrical cut out
- Includes vertical cover and slotted connector support with single leg.
- For one sided Power beam application.
- Laminate end panels must be attached to single leg at the end of power beam run for stability.
- Laminate end panels to be ordered separately.
- End of run trim below power beam included.
- Power beam with electrical cut out to be ordered separately.
- Note: Cannot be used with Power Beam storage or Power Beam overhead.

PRODUCT CODE	PRICE	SIZE/ INCHES			WEIGHT VOL	
		H	W	D	LBS	FT ³
EVPBFCSL24	186	24	6	21	10.10	1.75
EVPBFCSL30	208	30	6	21	11.20	2.18
EVPBFCSL36	228	36	6	21	12.30	2.62

EVPBFCLS • Vertical Base Power Feed Cover with Slotted Leg

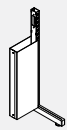

- Slotted connector allows for the attachment of brackets for worksurfaces.
- Connects two Power Beams on equal height.
- Includes vertical covers, slotted connector with leg and end of run trim below the Power Beam.
- Note: Power Beam must be installed in stable configuration using two way posts, three way posts or four way posts to provide support for worksurfaces.

PRODUCT CODE	PRICE	SIZE/ INCHES			WEIGHT VOL	
		H	W	D	LBS	FT ³
EVPBFCLS24	186	24	6	21	10.10	1.75
EVPBFCLS30	208	30	6	21	11.20	2.18
EVPBFCLS36	228	36	6	21	12.30	2.62

EVPBF CG • Vertical Base Power Feed Cover with Glide

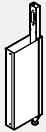

- Connects to Power Beam Kit with electrical cut out
- Includes vertical cover and slotted connector support leg with glide.
- Power Beam Kit with electrical cut out ordered separately.
- Base infeed ordered separately.

PRODUCT CODE	PRICE	SIZE/ INCHES			WEIGHT VOL	
		H	W	D	LBS	FT ³
EVPBF CG24	162	24	6	3	7.1	0.25
EVPBF CG30	183	30	6	3	8.4	0.31
EVPBF CG36	205	36	6	3	9.7	0.38

EVPBF CGS • Vertical Base Power Feed Cover with Glide and Slotted Connector

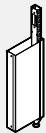

- Slotted connector allows for the attachment of brackets for worksurfaces.
- Connects two Power Beams on equal height.
- Includes vertical covers, slotted connector with glide base and end of run trim below Power Beam.
- Power Beam with electrical cut out to be ordered separately.
- Note: Power Beam must be installed in stable configuration using two way posts, three way posts or four way posts to provide support for worksurfaces.

PRODUCT CODE	PRICE	SIZE/ INCHES			WEIGHT VOL	
		H	W	D	LBS	FT ³
EVPBF CGS24	154	24	6	3	7.10	0.25
EVPBF CGS30	173	30	6	3	8.40	0.31
EVPBF CGS36	194	36	6	3	9.70	0.38

EVPBF CGS • Vertical Base Power Feed Cover with Glide



- 42" H Slotted connector allows to attached brackets for worksurfaces
- Connects to electrical cut out power beam
- Includes vertical covers and slotted connector with glide base
- End of run trim below power beam included
- Power beam with electrical cut out to be ordered separately
- Note: Power beam to be installed in stable configuration using two way posts, three way posts, four way posts to provide support for worksurfaces

PRODUCT CODE	PRICE	SIZE/ INCHES			WEIGHT VOL	
		H	W	D	LBS	FT ³
EVPB24FCGS42	190	42	6	3	10.40	0.43
EVPB30FCGS42	204	42	6	3	10.40	0.43
EVPB36FCGS42	224	42	6	3	10.40	0.43

EVPBGFC • Power Beam Gallery Base Feed Cover



- Connects to electrical cut out power beam attached to gallery panels.
- Includes vertical covers and slotted connector attaches to gallery panel.
- Power beam with electrical cut out to be ordered separately.

PRODUCT CODE	PRICE	SIZE/ INCHES			WEIGHT VOL	
		H	W	D	LBS	FT ³
EVPBGFC24	156	24	6	3	7.1	0.25
EVPBGFC30	177	30	6	3	8.40	0.31
EVPBGFC36	195	36	6	3	9.70	0.38

EVPBGDP • Power Beam Gallery Panel Data Post / Comm Lay-In



- Attaches to Power beam gallery end panel to bring power and/or data cables from ceiling to power beam.
- Three-sided power pole with snap-on fourth side.
- Made of aluminum and can be field cut.
- Standard data post extension used above.
- Accommodates up to 25 CAT 5 cables with electric, up to 45 CAT 5 cables without electric.
- Standard data post extension to be ordered separately.
- Standard code is for 24" H power beam. Please add at code end for option. B- 30" h Power beam. C- 36" h Power beam.

PRODUCT CODE	PRICE	SIZE/ INCHES			WEIGHT VOL	
		H	W	D	LBS	FT ³
EVPBGDP42	149	42	2	2	2.20	0.60
EVPBGDP48	165	48	2	2	3.00	0.70
EVPBGDP54	202	54	2	2	4.20	0.80

EVE8FR3PBD • Double Entry for Power Beam

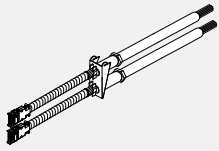

- Each power feed entry snaps into separate power distribution housing.
- Includes two 84" long flexible vinyl conduit.
- Includes double bracket to attach to Verticle base power feed cover leg.
- Must be installed in middle between two power beams, one base feed plugs to powerbeam on opposite side of leg than attached bracket.
- Vertical base power feed cover with leg to be ordered seperately.
- Must be hardwired to source by licenced electrician.
- Note: Always determine that harness is electrically connected to only one power supply.

PRODUCT CODE	PRICE	SIZE/ INCHES			WEIGHT VOL	
		H	W	D	LBS	FT ³
EVE8FR3PBD	661		84		7.64	2.00

EVHCBP01 • Ceiling Bracket for Post

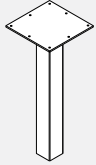

- Used to secure corner post to ceiling.
- 4.8"x4.8" top plate with 1.5x1.5 square tube 12" H , square tube fits inside aluminum corner post.
- Square tube can slide in post, bracket pushed to ceiling to be secured.

PRODUCT CODE	PRICE	SIZE/ INCHES			WEIGHT VOL	
		H	W	D	LBS	FT ³
EVHCBP01	60	12	4.8	4.8	3.2	0.18

EVHCBIC01 • Ceiling Bracket for Inline Connector

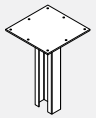

- Used to secure corner post to ceiling .
- 4.8"x4.8" top plate with 7.5" h insert in middle of plate, insert its inside connector.
- 7.5" H insert can slide in connector, bracket pushed to ceiling to secure.
- Note: Care should be taken to attach ceiling brackets to secure ceiling using correct fastners.
- Failure to do so may result in collapse of unit and subsequent possible injury.

PRODUCT CODE	PRICE	SIZE/ INCHES			WEIGHT VOL	
		H	W	D	LBS	FT ³
EVHCBIC01	60	7.5	4.8	4.8	3.2	0.18

EVHCBER01 • Ceiling Bracket for End of Run Connector

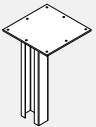

- Used to secure corner post to ceiling.
- 4.8"x4.8" top plate with 7.5" h insert in middle of plate, insert its inside connector.
- 7.5" H insert can slide in connector , bracket pushed to ceiling to secure.
- Note: Care should be taken to attach ceiling brackets to secure ceiling using correct fastners.
- Failure to do so may result in collapse of unit and subsequent possible injury.

PRODUCT CODE	PRICE	SIZE/ INCHES			WEIGHT VOL	
		H	W	D	LBS	FT ³
EVHCBIC01	80	7.5	4.8	4.8	3.2	0.18

EVPBL • Power Beam Connector with Leg

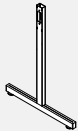

- Connects two Power Beams in a straight run.
- 24" h -- 18" open to floor.
- 30" h -- 24" open to floor.
- 36" h -- 30" open to floor.

PRODUCT CODE	PRICE	SIZE/ INCHES			WEIGHT VOL	
		H	W	D	LBS	FT ³
EVPBL24	99	24	18	3	5.9	0.30
EVPBL30	103	30	18	3	7.2	0.38
EVPBL36	110	36	18	3	8.5	0.45

EVPBLS • Power Beam Slotted Connector with Leg

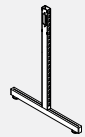

- Slotted connector allows for the attachment of brackets for worksurfaces.
- Connects two Power Beams on equal height.
- Includes slotted connector with leg, glides and connecting hardware.
- Note: Power Beam must be installed in stable configuration using two way posts, three way posts or four way posts to provide support for worksurfaces.

PRODUCT CODE	PRICE	SIZE/ INCHES			WEIGHT VOL	
		H	W	D	LBS	FT ³
EVPBLS24	96	24	18	3	5.90	0.30
EVPBLS30	99	30	18	3	7.20	0.38
EVPBLS36	103	36	18	3	8.50	0.45

EVPBLFF • Power Beam Leg with Flat Foot

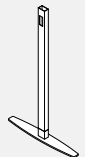

- Connects two power beams on equal height.
- Includes connector with flat foot, connecting hardware
- Note: Leg has to be used next to Post legs with glides.
- When specifying please keep sequence post leg with glide, leg with flat foot, post leg with glide.
- Only post legs with glide provides adjustment for levelling power beams run.

PRODUCT CODE	PRICE	SIZE/ INCHES			WEIGHT VOL	
		H	W	D	LBS	FT ³
EVPBLFF24	116	24	21		5.9	0.30
EVPBLFF30	120	30	21		7.2	0.38
EVPBLFF36	125	36	21		8.5	0.45

EVPBSL • Power Beam Single Leg

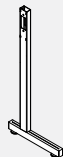

- Connects two Power Beams on equal height.
- Includes non slotted connector with leg, glides and connecting hardware.
- For one sided power beam application.
- Laminate end panels must be attached to single leg at end of power beam run for stability.
- Laminate end panels to be ordered seperately.
- Note: It can not be used with Power Beam storage or Power Beam overhead.

PRODUCT CODE	PRICE	SIZE/ INCHES			WEIGHT VOL	
		H	W	D	LBS	FT ³
EVPBSL24	96	24	15	3	5.9	0.21
EVPBSL30	99	30	15	3	7.2	0.26
EVPBSL36	103	36	15	3	8.5	0.32

EVPBGICB • Power Beam Connector with Base for Glide



- Connects two Power Beams in a straight run.
- 24”h -- 18” open to floor.
- 30”h -- 24” open to floor.
- 36”h -- 30” open to floor.

PRODUCT CODE	PRICE	SIZE/ INCHES			WEIGHT VOL	
		H	W	D	LBS	FT ³
EVPBGICB24	67	24	2	3	3.30	0.03
EVPBGICB30	69	30	2	3	4.60	0.04
EVPBGICB36	72	36	2	3	5.90	0.04

EVPBGICBS • Power Beam Slotted Connector with Base for Glide



- Slotted connector allows for the attachment of brackets for worksurfaces.
- Connects two Power Beams of equal heights.
- Includes slotted connector with glide and connecting hardware.
- Note: Power Beam must be installed in stable configuration using two way posts, three way posts or four way posts to provide support for worksurfaces.

PRODUCT CODE	PRICE	SIZE/ INCHES			WEIGHT VOL	
		H	W	D	LBS	FT ³
EVPBGICBS24	63	24	2	3	3.30	0.03
EVPBGICBS30	65	30	2	3	4.60	0.04
EVPBGICBS36	68	36	2	3	5.90	0.04

EVPBGICBS • Power Beam Connector with Base for Glide



- 42” H Slotted connector allows to attached brackets for worksurfaces
- Connects two power beams on equal height and extension panel above
- Includes slotted connector with glide and connecting hardware
- Note: Power beam to be installed in stable configuration using two way posts, three way posts, four way posts to provide support for worksurfaces

PRODUCT CODE	PRICE	SIZE/ INCHES			WEIGHT VOL	
		H	W	D	LBS	FT ³
EVPB24GICBS42	99	42	2	3	6.60	0.16
EVPB30GICBS42	99	42	2	3	6.60	0.16
EVPB36GICBS42	99	42	2	3	6.60	0.16

EVPB24CPA • One Way Post with T Leg for 24” H Power Beam

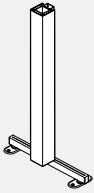

- One way post attaches to end of power beam run.
- Post and connecting hardware add 3.25 to power beam run.
- Includes post power beam T leg, post with trim all round, leveling glide, hardware and trim kit.
- Includes two floor mount plates to secure post to floor.

PRODUCT CODE	PRICE	SIZE/ INCHES			WEIGHT VOL	
		H	W	D	LBS	FT ³
EVPB24CPA124	271	24	3	3	5.5	0.75
EVPB24CPA130	286	30	3	3	8.5	0.94
EVPB24CPA136	298	36	3	3	11.5	1.12
EVPB24CPA142	334	42	3	3	15	1.31

EVPB30CPA • One Way Post with T Leg for 30” H Power Beam

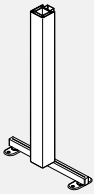

- One way post attaches to end of power beam run.
- Post and connecting hardware add 3.25 to power beam run.
- Includes post power beam T leg, post with trim all round, leveling glide, hardware and trim kit.
- Includes two floor mount plates to secure post to floor.

PRODUCT CODE	PRICE	SIZE/ INCHES			WEIGHT VOL	
		H	W	D	LBS	FT ³
EVPB30CPA130	286	30	3	3	8.5	0.94
EVPB30CPA136	298	36	3	3	11.5	1.12
EVPB30CPA142	334	42	3	3	15	1.31

EVPB36CPA • One Way Post with T Leg for 36” H Power Beam

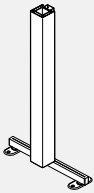

- One way post attaches to end of power beam run.
- Post and connecting hardware add 3.25 to power beam run.
- Includes post power beam T leg, post with trim all round, leveling glide, hardware and trim kit.
- Includes two floor mount plates to secure post to floor.

PRODUCT CODE	PRICE	SIZE/ INCHES			WEIGHT VOL	
		H	W	D	LBS	FT ³
EVPB36CPA136	298	36	3	3	11.5	1.12
EVPB36CPA142	334	42	3	3	15	1.31

EVPBCEPLA4 • Power Beam 4-way Corner Post



- Connects four power beams of equal height in 90 degree configuration.
- Post and connecting hardware add 3.25” to power beam run.
- Includes one post, four nonslotted power beam connectors, post with trim all around, levelling glide, hardware and trim kit.

PRODUCT CODE	PRICE	SIZE/ INCHES			WEIGHT VOL	
		H	W	D	LBS	FT ³
EVPBCEPLA424	188	24	3	3	6.30	0.22
EVPBCEPLA430	210	30	3	3	7.60	0.27
EVPBCEPLA436	205	36	3	3	8.90	0.33

EVPBCEPLA3 • Power Beam 3-way Corner Post



- Connects three power beams of equal height in 90 degree configuration.
- Post and connecting hardware add 3.25" to power beam run.
- Includes one post, three nonslotted power beam connectors, post with trim all around, levelling glide, hardware and trim kit.

PRODUCT CODE	PRICE	SIZE/ INCHES			WEIGHT VOL	
		H	W	D	LBS	FT ³
EVPBCEPLA324	158	24	3	3	5.80	0.22
EVPBCEPLA330	164	30	3	3	7.10	0.27
EVPBCEPLA336	172	36	3	3	8.40	0.33

EVPBCEPLA2 • Power Beam 2-way Corner Post



- Includes one post, four nonslotted power beam connectors, post with trim all around, levelling glide, hardware and trim kit.
- Connects four power beams of equal height in 90 degree configuration.
- Post and connecting hardware add 3.25" to power beam run.

PRODUCT CODE	PRICE	SIZE/ INCHES			WEIGHT VOL	
		H	W	D	LBS	FT ³
EVPBCEPLA224	143	24	3	3	5.30	0.22
EVPBCEPLA230	149	30	3	3	6.60	0.27
EVPBCEPLA236	157	36	3	3	7.90	0.33

EVPBCIPLA2 • Power Beam In Line 2-way Corner Post



- Connects two power beams of equal height in inline configuration.
- Post and connecting hardware add 3.25" to power beam run.
- Includes one post, two nonslotted power beam connectors, post with trim all around, levelling glide, hardware and trim kit.

PRODUCT CODE	PRICE	SIZE/ INCHES			WEIGHT VOL	
		H	W	D	LBS	FT ³
EVPBCIPLA224	143	24	3	3	5.30	0.22
EVPBCIPLA230	149	30	3	3	6.60	0.27
EVPBCIPLA236	157	36	3	3	7.90	0.33

EVPB6CEPLA3 • Power Beam 3-way 120 Degree Corner Post



- Connects three power beams of equal height in 120 degree configuration.
- Includes one post, three nonslotted power beam connectors, post with trim all around, levelling glide, hardware and trim kit.

PRODUCT CODE	PRICE	SIZE/ INCHES			WEIGHT VOL	
		H	W	D	LBS	FT ³
EVPB6CEPLA324	183	24	3	3	5.30	0.22
EVPB6CEPLA330	186	30	3	3	6.60	0.27
EVPB6CEPLA336	195	36	3	3	7.90	0.33

EVPB6CEPLA2 - Power Beam 2-way 120 Degree Corner Post



- Connects three power beams of equal height in 120 degree configuration.
- Includes one post, three nonslotted power beam connectors, post with trim all around, levelling glide, hardware and trim kit.

PRODUCT CODE	PRICE	SIZE/ INCHES			WEIGHT VOL	
		H	W	D	LBS	FT ³
EVPB6CEPLA224	183	24	3	3	5.30	0.22
EVPB6CEPLA230	186	30	3	3	6.60	0.27
EVPB6CEPLA236	195	36	3	3	7.90	0.33

EVPBIEC • Extension Connector for Power Beam



- Attaches to power beam connector.
- Includes non slotted extension connector and connecting hardware.
- Must be attached to power beam connector with provided screw before installing power beam.

PRODUCT CODE	PRICE	SIZE/ INCHES			WEIGHT VOL	
		H	W	D	LBS	FT ³
EVPBIEC06	32	6	2.875	3	1.0	0.06
EVPBIEC12	32	12	2.875	3	2.0	0.12
EVPBIEC18	39	18	2.875	3	3.0	0.18
EVPBIEC24	39	24	2.875	3	4.0	0.24

EVPBIEC • Slotted Extension Connector for Power Beam



- Attaches to Power Beam connector.
- Includes slotted extension connector and connecting hardware.
- Must be attached to Power Beam connector with provided screw before installing Power Beam.

PRODUCT CODE	PRICE	SIZE/ INCHES			WEIGHT VOL	
		H	W	D	LBS	FT ³
EVPBIECS06	32	6	2.875	3	1.00	0.06
EVPBIECS12	32	12	2.875	3	2.00	0.12
EVPBIECS18	39	18	2.875	3	3.00	0.18
EVPBIECS24	39	24	2.875	3	4.00	0.24

EVPBCEP4 • Power Beam Corner Extension Post 4 Way

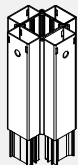

- Connects four extension modules in 90 degree configuration.
- Post and connecting hardware add 3.25" to power beam run.
- Includes one extension post, four non slotted extension connectors for power beam, connecting hardware and trim kit Power Beam.
- Corner Extension Post is not stackable.

PRODUCT CODE	PRICE	SIZE/ INCHES			WEIGHT VOL	
		H	W	D	LBS	FT ³
EVPBCEP406	79	6	3	3	4	0.09
EVPBCEP412	79	12	3	3	8	0.18
EVPBCEP418	125	18	3	3	12	0.27
EVPBCEP424	125	24	3	3	16	0.36

EVPBCEPA3 • Power Beam Corner Extension Post 3 Way

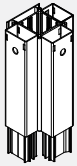

- Connects four extension modules in 90 degree configuration.
- Post and connecting hardware add 3.25" to power beam run.
- Includes one extension post, three non slotted extension connectors for power beam, connecting hardware and trim kit.
- Power Beam Corner Extension Post is not stackable.

PRODUCT CODE	PRICE	SIZE/ INCHES			WEIGHT VOL	
		H	W	D	LBS	FT ³
EVPBCEPA306	86	6	3	3	3	0.08
EVPBCEPA312	86	12	3	3	6	0.16
EVPBCEPA318	142	18	3	3	9	0.24
EVPBCEPA324	142	24	3	3	12	0.32

EVPBCEPA2 • Power Beam Corner Extension Post 2 Way

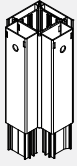

- Connects four extension modules in 90 degree configuration.
- Post and connecting hardware add 3.25" to power beam run.
- Includes one extension post, two non slotted extension connectors for power beam, connecting hardware and trim kit.
- Power Beam Corner Extension Post is not stackable.

PRODUCT CODE	PRICE	SIZE/ INCHES			WEIGHT VOL	
		H	W	D	LBS	FT ³
EVPBCEPA206	77	6	3	3	2	0.07
EVPBCEPA212	77	12	3	3	4	0.14
EVPBCEPA218	130	18	3	3	6	0.21
EVPBCEPA224	130	24	3	3	8	0.28

EVPBCEIPA2 • Power Beam In Line Corner Extension Post 2 Way

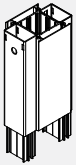

- Connects four extension modules in inline configuration.
- Post and connecting hardware add 3.25" to power beam run.
- Includes one extension post, two non slotted extension connectors for power beam, connecting hardware and trim kit.
- Power Beam Corner Extension Post is not stackable.

PRODUCT CODE	PRICE	SIZE/ INCHES			WEIGHT VOL	
		H	W	D	LBS	FT ³
EVPBCEIPA206	96	6	3	3	2	0.07
EVPBCEIPA212	96	12	3	3	4	0.14
EVPBCEIPA218	134	18	3	3	6	0.21
EVPBCEIPA224	134	24	3	3	8	0.28

EVPBCEPA1 • Power Beam Corner Extension Post 1 Way

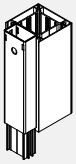

- Connects at end of run of extension modules.
- Post and connecting hardware add 3.25" to power beam run.
- Includes one extension post, one non slotted extension connectors for power beam, connecting hardware and trim kit.
- Power Beam Corner Extension Post is not stackable.

PRODUCT CODE	PRICE	SIZE/ INCHES			WEIGHT VOL	
		H	W	D	LBS	FT ³
EVPBCEPA106	70	6	3	3	2	0.07
EVPBCEPA112	70	12	3	3	4	0.14
EVPBCEPA118	97	18	3	3	6	0.21
EVPBCEPA124	97	24	3	3	6	0.21

EVPB6CEP3 • Power Beam 120 Degree Corner Extension Post 3 Way



- Connects three extension modules in 120 degree configuration.
- Includes one extension post, three non slotted extension connectors for power beam, connecting hardware and trim kit.
- Power Beam Corner Extension Post is not stackable.

PRODUCT CODE	PRICE	SIZE/ INCHES			WEIGHT VOL	
		H	W	D	LBS	FT ³
EVPB6CEP306	116	6	3	3	3	0.08
EVPB6CEP312	116	12	3	3	6	0.16
EVPB6CEP318	183	18	3	3	9	0.24
EVPB6CEP324	183	24	3	3	12	0.32

EVPB6CEPA2 • Power Beam 120 Degree Corner Extension Post 2 Way

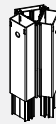

- Connects two extension modules in 120 degree configuration.
- Includes one extension post, two non slotted extension connectors for power beam, connecting hardware and trim kit.
- Power Beam Corner Extension Post is not stackable.

PRODUCT CODE	PRICE	SIZE/ INCHES			WEIGHT VOL	
		H	W	D	LBS	FT ³
EVPB6CEPA206	98	6	3	3	2	0.07
EVPB6CEPA212	98	12	3	3	4	0.14
EVPB6CEPA218	153	18	3	3	6	0.21
EVPB6CEPA224	153	24	3	3	8	0.28

EVPB6CEPA1 • Power Beam 60 Degree Corner Extension Post 1 Way



- Connects one extension module in 120 degree configuration.
- Includes one extension post, three non slotted extension connectors for power beam, connecting hardware and trim kit.
- Power Beam Corner Extension Post is not stackable.

PRODUCT CODE	PRICE	SIZE/ INCHES			WEIGHT VOL	
		H	W	D	LBS	FT ³
EVPB6CEPA106	65	6	3	3	2	0.07
EVPB6CEPA112	69	12	3	3	4	0.14
EVPB6CEPA118	94	18	3	3	6	0.21
EVPB6CEPA124	94	24	3	3	8	0.28

EVPB24CPA • Panel to 24" H Power Beam 4 Way Corner Post



- Connects two panels and two 24" H power beams in 90 degree configuration.
- Post and connecting hardware add 3.25" to power beam run.
- Includes post, panel connectors and power beam connectors, post with trim all around, levelling glide, hardware and trim kit
- Pass thru only for power beam.

PRODUCT CODE	PRICE	SIZE/ INCHES			WEIGHT VOL	
		H	W	D	LBS	FT ³
EVPB24CPA430	240	30	3	3	15.5	0.41
EVPB24CPA436	312	36	3	3	18	0.48
EVPB24CPA442	312	42	3	3	21	0.57

EVPB30CPA • Panel to 30" H Power Beam 4 Way Corner Post



- Connects two panels and two 24" H power beams in 90 degree configuration.
- Post and connecting hardware add 3.25" to power beam run.
- Includes post, panel connectors and power beam connectors, post with trim all around, levelling glide, hardware and trim kit.
- Pass thru only for power beam.

PRODUCT CODE	PRICE	SIZE/ INCHES			WEIGHT VOL	
		H	W	D	LBS	FT ³
EVPB30CPA430	240	30	3	3	15.5	0.41
EVPB30CPA436	312	36	3	3	18	0.48
EVPB30CPA442	312	42	3	3	21	0.57

EVPB36CPA • Panel to 36" H Power Beam 4 Way Corner Post



- Connects two panels and two 24" H power beams in 90 degree configuration.
- Post and connecting hardware add 3.25" to power beam run.
- Includes post, panel connectors and power beam connectors, post with trim all around, levelling glide, hardware and trim kit.
- Pass thru only for power beam.

PRODUCT CODE	PRICE	SIZE/ INCHES			WEIGHT VOL	
		H	W	D	LBS	FT ³
EVPB36CPA436	312	36	3	3	18	0.48
EVPB36CPA442	312	42	3	3	21	0.57

EVPB24CPSA4 • Panel to 24" H Power Beam 4 Way Corner Post - Slotted



- Connects two panels and two 24" H power beams in a 90 degree configuration.
- Post and connecting hardware add 3.25" to the power beam run.
- Includes post, panel connectors, power beam connectors, post with trim all around, levelling glide, hardware and trim kit.
- Pass thru only for power beam, power beam leg slotted.

PRODUCT CODE	PRICE	SIZE/ INCHES			WEIGHT VOL	
		H	W	D	LBS	FT ³
EVPB24CPSA430	240	30	3	3	15.5	0.41
EVPB24CPSA436	312	36	3	3	18	0.48
EVPB24CPSA442	312	42	3	3	21	0.57

EVPB30CPSA4 • Panel to 30" H Power Beam 4 Way Corner Post - Slotted

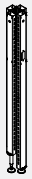

- Connects two panels and two 30" H power beams in a 90 degree configuration.
- Post and connecting hardware add 3.25" to the power beam run.
- Includes post, panel connectors, power beam connectors, post with trim all around, levelling glide, hardware and trim kit.
- Pass thru only for power beam, power beam leg slotted.

PRODUCT CODE	PRICE	SIZE/ INCHES			WEIGHT VOL	
		H	W	D	LBS	FT ³
EVPB30CPSA430	240	30	3	3	15.5	0.41
EVPB30CPSA436	312	36	3	3	18	0.48
EVPB30CPSA442	312	42	3	3	21	0.57

EVPB36CPSA4 • Panel to 36" H Power Beam 4 Way Corner Post - Slotted



- Connects two panels and two 36" H power beams in a 90 degree configuration.
- Post and connecting hardware add 3.25" to the power beam run.
- Includes post, panel connectors, power beam connectors, post with trim all around, levelling glide, hardware and trim kit.
- Pass thru only for power beam, power beam leg slotted.

PRODUCT CODE	PRICE	SIZE/ INCHES			WEIGHT VOL	
		H	W	D	LBS	FT ³
EVPB36CPSA436	312	36	3	3	18	0.48
EVPB36CPSA442	312	42	3	3	21	0.57

EVPB24CPA • Panel to 24" H Power Beam 3 Way Corner Post



- Connects panels and 24" H power beams in 90 degree configuration.
- Post and connecting hardware add 3.25" to power beam run.
- Includes post, panel connectors and power beam connectors, post with trim all around, levelling glide, hardware and trim kit.
- Pass thru only for power beam.

PRODUCT CODE	PRICE	SIZE/ INCHES			WEIGHT VOL	
		H	W	D	LBS	FT ³
EVPB24CPA330	218	30	3	3	11.8	0.36
EVPB24CPA336	289	36	3	3	13	0.42
EVPB24CPA342	289	42	3	3	16.1	0.50

EVPB30CPA • Panel to 30" H Power Beam 3 Way Corner Post



- Connects panels and 30" H power beams in 90 degree configuration.
- Post and connecting hardware add 3.25" to power beam run.
- Includes post, panel connectors and power beam connectors, post with trim all around, levelling glide, hardware and trim kit.
- Pass thru only for power beam.

PRODUCT CODE	PRICE	SIZE/ INCHES			WEIGHT VOL	
		H	W	D	LBS	FT ³
EVPB30CPA330	218	30	3	3	11.8	0.36
EVPB30CPA336	289	36	3	3	13	0.42
EVPB30CPA342	289	42	3	3	16.1	0.50

EVPB36CPA • Panel to 36" H Power Beam 3 Way Corner Post



- Connects panels and 36" H power beams in 90 degree configuration.
- Post and connecting hardware add 3.25" to power beam run.
- Includes post, panel connectors and power beam connectors, post with trim all around, levelling glide, hardware and trim kit.
- Pass thru only for power beam.

PRODUCT CODE	PRICE	SIZE/ INCHES			WEIGHT VOL	
		H	W	D	LBS	FT ³
EVPB36CPA336	289	36	3	3	13	0.42
EVPB36CPA342	289	42	3	3	16.1	0.50

EVPB24CPSA3 • Panel to 24" H Power Beam 3 Way Corner Post - Slotted



- Connects panels and 24" H power beam in a 90 degree configuration.
- Post and connecting hardware add 3.25" to the power beam run.
- Includes post, panel connectors, power beam connectors, post with trim all around, levelling glide, hardware and trim kit.
- Pass thru only for power beam, power beam leg slotted.

PRODUCT CODE	PRICE	SIZE/INCHES			WEIGHT VOL	
		H	W	D	LBS	FT ³
EVPB24CPSA330	218	30	3	3	11.8	0.36
EVPB24CPSA336	289	36	3	3	13	0.42
EVPB24CPSA342	289	42	3	3	16.1	0.50

EVPB30CPSA3 • Panel to 30" H Power Beam 3 Way Corner Post - Slotted



- Connects panels and 30" H power beam in a 90 degree configuration.
- Post and connecting hardware add 3.25" to the power beam run.
- Includes post, panel connectors, power beam connectors, post with trim all around, levelling glide, hardware and trim kit.
- Pass thru only for power beam, power beam leg slotted.

PRODUCT CODE	PRICE	SIZE/INCHES			WEIGHT VOL	
		H	W	D	LBS	FT ³
EVPB30CPSA330	218	30	3	3	11.8	0.36
EVPB30CPSA336	289	36	3	3	13	0.42
EVPB30CPSA342	289	42	3	3	16.1	0.50

EVPB36CPSA3 • Panel to 36" H Power Beam 3 Way Corner Post - Slotted



- Connects panels and 36" H power beam in a 90 degree configuration.
- Post and connecting hardware add 3.25" to the power beam run.
- Includes post, panel connectors, power beam connectors, post with trim all around, levelling glide, hardware and trim kit.
- Pass thru only for power beam, power beam leg slotted.

PRODUCT CODE	PRICE	SIZE/INCHES			WEIGHT VOL	
		H	W	D	LBS	FT ³
EVPB36CPSA336	289	36	3	3	13	0.42
EVPB36CPSA342	289	42	3	3	16.1	0.50

EVPB24CPA • Panel to 24" H Power Beam 2 Way Corner Post



- Connects one panels and one 24" H power beams in 90 degree configuration.
- Post and connecting hardware add 3.25" to power beam run.
- Includes post, panel connectors and power beam connectors, post with trim all around, levelling glide, hardware and trim kit.
- Pass thru only for power beam.

PRODUCT CODE	PRICE	SIZE/ H	INCHES		WEIGHT VOL	
			W	D	LBS	FT ³
EVPB24CPA230	183	30	3	3	8.5	0.31
EVPB24CPA236	227	36	3	3	11.5	0.37
EVPB24CPA242	227	42	3	3	15	0.43

EVPB30CPA • Panel to 30" H Power Beam 2 Way Corner Post



- Connects one panels and one 30" H power beams in 90 degree configuration.
- Post and connecting hardware add 3.25" to power beam run.
- Includes post, panel connectors and power beam connectors, post with trim all around, levelling glide, hardware and trim kit.
- Pass thru only for power beam.

PRODUCT CODE	PRICE	SIZE/ H	INCHES		WEIGHT VOL	
			W	D	LBS	FT ³
EVPB30CPA230	183	30	3	3	8.5	0.31
EVPB30CPA236	227	36	3	3	11.5	0.37
EVPB30CPA242	227	42	3	3	15	0.43

EVPB36CPA • Panel to 36" H Power Beam 2 Way Corner Post



- Connects one panels and one 36" H power beams in 90 degree configuration.
- Post and connecting hardware add 3.25" to power beam run.
- Includes post, panel connectors and power beam connectors, post with trim all around, levelling glide, hardware and trim kit.
- Pass thru only for power beam.

PRODUCT CODE	PRICE	SIZE/ H	INCHES		WEIGHT VOL	
			W	D	LBS	FT ³
EVPB36CPA236	227	36	3	3	11.5	0.37
EVPB36CPA242	227	42	3	3	15	0.43

EVPB24CPSA2 • Panel to 24" H Power Beam 2 Way Corner Post - Slotted



- Connects one panels and one 24" H power beams in 90 degree configuration.
- Post and connecting hardware add 3.25" to the power beam run.
- Includes post, panel connectors, power beam connectors, post with trim all around, levelling glide, hardware and trim kit.
- Pass thru only for power beam, power beam leg slotted.

PRODUCT CODE	PRICE	SIZE/INCHES			WEIGHT VOL	
		H	W	D	LBS	FT ³
EVPB24CPSA230	183	30	3	3	8.5	0.31
EVPB24CPSA236	227	36	3	3	11.5	0.37
EVPB24CPSA242	227	42	3	3	15	0.43

EVPB30CPSA2 • Panel to 30" H Power Beam 2 Way Corner Post - Slotted



- Connects one panels and one 30" H power beams in 90 degree configuration.
- Post and connecting hardware add 3.25" to the power beam run.
- Includes post, panel connectors, power beam connectors, post with trim all around, levelling glide, hardware and trim kit.
- Pass thru only for power beam, power beam leg slotted.

PRODUCT CODE	PRICE	SIZE/INCHES			WEIGHT LBS	VOL FT³
		H	W	D		
EVPB30CPSA230	183	30	3	3	8.5	0.31
EVPB30CPSA236	227	36	3	3	11.5	0.37
EVPB30CPSA242	227	42	3	3	15	0.43

EVPB36CPSA2 • Panel to 36" H Power Beam 2 Way Corner Post - Slotted

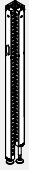

- Connects one panels and one 36" H power beams in 90 degree configuration.
- Post and connecting hardware add 3.25" to the power beam run.
- Includes post, panel connectors, power beam connectors, post with trim all around, levelling glide, hardware and trim kit.
- Pass thru only for power beam, power beam leg slotted.

PRODUCT CODE	PRICE	SIZE/INCHES			WEIGHT LBS	VOL FT³
		H	W	D		
EVPB36CPSA236	227	36	3	3	11.5	0.37
EVPB36CPSA242	227	42	3	3	15	0.43

EVPB24CPA3-P • Panel to two 24" Power Beam 3 Way Corner Post



- Connects two 24" H power beams with panel in T configuration.
- Post and connecting hardware add 3.25" to power beam run.
- Includes post, panel connectors and power beam connectors, post with trim all around, levelling glide, hardware and trim kit.
- Pass thru only for power beam.

PRODUCT CODE	PRICE	SIZE/ INCHES			WEIGHT LBS	VOL FT³
		H	W	D		
EVPB24CPA330P	208	30	3	3	11.8	0.36
EVPB24CPA336P	277	36	3	3	13	0.42
EVPB24CPA342P	277	42	3	3	16.1	0.5

EVPB30CPA3-P • Panel to two 30" Power Beam 3 Way Corner Post



- Connects two 24" H power beams with panel in T configuration.
- Post and connecting hardware add 3.25" to power beam run.
- Includes post, panel connectors and power beam connectors, post with trim all around, levelling glide, hardware and trim kit.
- Pass thru only for power beam.

PRODUCT CODE	PRICE	SIZE/ INCHES			WEIGHT LBS	VOL FT³
		H	W	D		
EVPB30CPA330P	208	30	3	3	11.8	0.36
EVPB30CPA336P	277	36	3	3	13	0.42
EVPB30CPA342P	277	42	3	3	16.1	0.5

EVPB36CPA3-P • Panel to two 36" Power Beam 3 Way Corner Post



- Connects two 24" H power beams with panel in T configuration.
- Post and connecting hardware add 3.25" to power beam run.
- Includes post, panel connectors and power beam connectors, post with trim all around, levelling glide, hardware and trim kit.
- Pass thru only for power beam.

PRODUCT CODE	PRICE	SIZE/ INCHES			WEIGHT LBS	VOL FT³
		H	W	D		
EVPB36CPA336P	277	36	3	3	13	0.42
EVPB36CPA342P	277	42	3	3	16.1	0.5

EVPB24CPSA3-P • Panel to two 24" H Power Beam 3 Way Corner Post



- Connects two 24" H power beams with panel in a T configuration.
- Post and connecting hardware add 3.25" to the power beam run.
- Includes post, panel connectors, power beam connectors, post with trim all around, levelling glide, hardware and trim kit.
- Pass thru only for power beam, power beam leg slotted.

PRODUCT CODE	PRICE	SIZE/INCHES			WEIGHT LBS	VOL FT³
		H	W	D		
EVPB24CPSA330P	208	30	3	3	11.8	0.36
EVPB24CPSA336P	277	36	3	3	13	0.42
EVPB24CPSA342P	277	42	3	3	16.1	0.50

EVPB30CPSA3-P • Panel to two 30" H Power Beam 3 Way Corner Post



- Connects two 30" H power beams with panel in a T configuration.
- Post and connecting hardware add 3.25" to the power beam run.
- Includes post, panel connectors, power beam connectors, post with trim all around, levelling glide, hardware and trim kit.
- Pass thru only for power beam, power beam leg slotted.

PRODUCT CODE	PRICE	SIZE/INCHES			WEIGHT LBS	VOL FT³
		H	W	D		
EVPB30CPSA330P	208	30	3	3	11.8	0.36
EVPB30CPSA336P	277	36	3	3	13	0.42
EVPB30CPSA342P	277	42	3	3	16.1	0.50

EVPB36CPSA3-P • Panel to two 36" H Power Beam 3 Way Corner Post



- Connects two 36" H power beams with panel in a T configuration.
- Post and connecting hardware add 3.25" to the power beam run.
- Includes post, panel connectors, power beam connectors, post with trim all around, levelling glide, hardware and trim kit.
- Pass thru only for power beam, power beam leg slotted.

PRODUCT CODE	PRICE	SIZE/INCHES			WEIGHT LBS	VOL FT³
		H	W	D		
EVPB36CPSA336P	277	36	3	3	13	0.42
EVPB36CPSA342P	277	42	3	3	16.1	0.50

EVPFE • Fabric Panel Extension Module

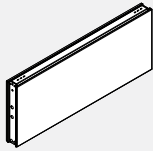

- Attaches on top of a panel.
- Module can be stacked to add privacy or divide space.
- Each side of fabric module may have different fabric within that same grade at no charge. If different grades of fabric are used, the entire module must be priced at highest grade.
- When ordering panel extension modules , additional connectors are required.
- Panel extension modules cannot be installed higher than 42" high above finished floor.

PRODUCT CODE	PRICE		SIZE/ INCHES			WEIGHT		VOL FT ³
	GR 1	GR 2	H	W	D	LBS		
EVPFE0618	153	160	6	18	2.875	4.80	0.21	
EVPFE0624	159	169	6	24	2.875	6.40	0.29	
EVPFE0630	174	183	6	30	2.875	7.40	0.36	
EVPFE0636	195	207	6	36	2.875	8.20	0.43	
EVPFE0642	217	233	6	42	2.875	9.40	0.51	
EVPFE0648	235	248	6	48	2.875	10.20	0.58	
EVPFE0654	253	271	6	54	2.875	14.40	0.65	
EVPFE0660	276	295	6	60	2.875	16.00	0.73	
EVPFE0666	298	317	6	66	2.875	17.6	0.91	
EVPFE0672	318	340	6	72	2.875	18.2	0.99	
EVPFE1218	153	160	12	18	2.875	7.40	0.38	
EVPFE1224	159	168	12	24	2.875	8.60	0.50	
EVPFE1230	174	183	12	30	2.875	9.60	0.63	
EVPFE1236	195	207	12	36	2.875	12.80	0.75	
EVPFE1242	217	231	12	42	2.875	14.80	0.88	
EVPFE1248	235	248	12	48	2.875	15.00	1.00	
EVPFE1254	253	271	12	54	2.875	16.20	1.12	
EVPFE1260	276	295	12	60	2.875	17.80	1.25	
EVPFE1266	298	317	12	66	2.875	19.0	1.37	
EVPFE1272	318	340	12	72	2.875	20.2	1.45	
EVPFE1818	190	201	18	18	2.875	9.01	0.54	
EVPFE1824	197	211	18	24	2.875	10.47	0.72	
EVPFE1830	212	234	18	30	2.875	11.93	0.90	
EVPFE1836	246	268	18	36	2.875	13.39	1.08	
EVPFE1842	274	301	18	42	2.875	14.84	1.26	
EVPFE1848	298	328	18	48	2.875	16.29	1.44	
EVPFE1854	324	355	18	54	2.875	17.76	1.62	
EVPFE1860	352	382	18	60	2.875	19.21	1.80	
EVPFE1866	382	406	18	66	2.875	20.7	1.98	
EVPFE1872	409	435	18	72	2.875	22.2	2.16	

EVPGTE • Tempered Glass Panel Extension Module

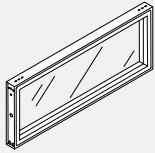

- Attaches on top of a panel.
- Module can be stacked to add privacy or divide space.
- Panel extension module is not load bearing above 66" high.
- Standard in lear (CLR).
- Frosted glass (FRST) upcharge varies. Contact Evolve customer service representative for details.
- When ordering panel extension modules, additional connectors are required.

PRODUCT CODE	PRICE	SIZE/ INCHES			WEIGHT LBS	VOL FT ³
		H	W	D		
EVPGTE0618	305	6	18	2.875	7.60	0.18
EVPGTE0624	328	6	24	2.875	9.24	0.25
EVPGTE0630	397	6	30	2.875	10.78	0.31
EVPGTE0636	412	6	36	2.875	12.32	0.37
EVPGTE0642	508	6	42	2.875	14.10	0.43
EVPGTE0648	567	6	48	2.875	15.80	0.50
EVPGTE0654	621	6	54	2.875	17.42	0.56
EVPGTE0660	666	6	60	2.875	19.28	0.63
EVPGTE0666	714	6	66	2.875	21.1	0.91
EVPGTE0672	766	6	72	2.875	22.9	0.99
EVPGTE1218	305	12	18	2.875	10.06	0.38
EVPGTE1224	328	12	24	2.875	12.08	0.50
EVPGTE1230	397	12	30	2.875	14.10	0.63
EVPGTE1236	412	12	36	2.875	16.12	0.75
EVPGTE1242	508	12	42	2.875	18.24	0.88
EVPGTE1248	567	12	48	2.875	20.56	1.00
EVPGTE1254	621	12	54	2.875	22.66	1.12
EVPGTE1260	666	12	60	2.875	25.00	1.25
EVPGTE1266	714	12	66	2.875	27.4	1.37
EVPGTE1272	766	12	72	2.875	29.9	1.45
EVPGTE1818	459	18	18	2.875	12.00	0.54
EVPGTE1824	473	18	24	2.875	14.93	0.72
EVPGTE1830	505	18	30	2.875	17.77	0.90
EVPGTE1836	551	18	36	2.875	20.57	1.08
EVPGTE1842	627	18	42	2.875	23.31	1.26
EVPGTE1848	701	18	48	2.875	25.94	1.44
EVPGTE1854	762	18	54	2.875	28.51	1.62
EVPGTE1860	819	18	60	2.875	31.28	1.80
EVPGTE1866	874	18	66	2.875	33.9	1.98
EVPGTE1872	935	18	72	2.875	35.7	2.16

EVPW1SE • Write Board Extension Module - One Side

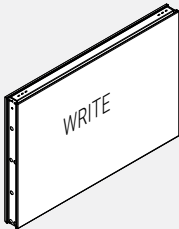

- Attaches on top of a beam.
- Provides writing surface on one side and fabric on the other side.
- Modules can be stacked to add privacy or to divide space.
- Panel Extension Modules cannot install higher than 42" high above finished floor.
- When ordering Beam Extension Modules, additional connectors are required.

PRODUCT CODE	PRICE		SIZE/ INCHES			WEIGHT LBS	VOL FT ³
	GR1	GR2	H	W	D		
EVPW1SE1818	233	237	18	18	2.875	9.44	0.54
EVPW1SE1824	263	270	18	24	2.875	10.90	0.72
EVPW1SE1830	293	303	18	30	2.875	12.35	0.90
EVPW1SE1836	344	355	18	36	2.875	13.81	1.08
EVPW1SE1842	389	405	18	42	2.875	15.27	1.26
EVPW1SE1848	430	448	18	48	2.875	16.72	1.44
EVPW1SE1854	465	483	18	54	2.875	18.18	1.62
EVPW1SE1860	503	520	18	60	2.875	19.64	1.80
EVPW1SE1866	540	557	18	66	2.875	21.70	1.98
EVPW1SE1872	577	593	18	72	2.875	23.30	2.16

EVPW2SE • Write Board Extension Module - Two Side

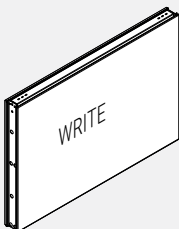

- Attaches on top of a panel.
- Provides writing surface on two sides.
- Modules can be stacked to add privacy or to divide space.
- Panel Extension Modules cannot install higher than 42" h above finished floor
- When ordering Panel Extension Modules, additional connectors are required.

PRODUCT CODE	PRICE	SIZE/ INCHES			WEIGHT LBS	VOL FT ³
		H	W	D		
EVPW2SE1818	279	18	18	2.875	10.29	0.54
EVPW2SE1824	328	18	24	2.875	11.75	0.72
EVPW2SE1830	375	18	30	2.875	13.20	0.90
EVPW2SE1836	446	18	36	2.875	14.66	1.08
EVPW2SE1842	503	18	42	2.875	16.12	1.26
EVPW2SE1848	562	18	48	2.875	17.57	1.44
EVPW2SE1854	622	18	54	2.875	19.03	1.62
EVPW2SE1860	678	18	60	2.875	20.49	1.80
EVPW2SE1866	733	18	66	2.875	21.70	1.98
EVPW2SE1872	792	18	72	2.875	23.30	2.16

EVPH1SE • Laminate Extension Module - One Side

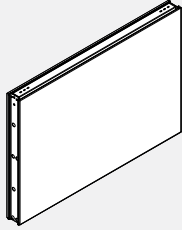

- Attaches on top of a beam.
- Laminate module provides a durable, washable surface on one side and fabric on the other side.
- Modules can be stacked to add privacy or to divide space.
- Panel Extension Modules cannot install higher than 42”h. above finished floor.
- When ordering Panel Extension Modules, additional connectors are required.
- Available in high pressure laminate finishes only.

PRODUCT CODE	PRICE		SIZE/ INCHES			WEIGHT LBS	VOL FT³
	GR 1	GR 2	H	W	D		
EVPH1SE0618	212	217	6	18	2.875	2.77	0.25
EVPH1SE0624	247	259	6	24	2.875	3.20	0.35
EVPH1SE0630	280	284	6	30	2.875	3.63	0.43
EVPH1SE0636	319	327	6	36	2.875	4.06	0.51
EVPH1SE0642	361	367	6	42	2.875	4.49	0.60
EVPH1SE0648	394	404	6	48	2.875	4.91	0.68
EVPH1SE0654	446	454	6	54	2.875	5.34	0.76
EVPH1SE0660	469	477	6	60	2.875	5.77	0.84
EVPH1SE0666	488	500	6	66	3	17.6	0.91
EVPH1SE0672	542	550	6	72	3	18.2	0.99
EVPH1SE1218	212	217	12	18	2.875	5.55	0.51
EVPH1SE1224	247	259	12	24	2.875	6.41	0.71
EVPH1SE1230	280	284	12	30	2.875	7.26	0.87
EVPH1SE1236	319	327	12	36	2.875	8.12	1.03
EVPH1SE1242	361	367	12	42	2.875	8.98	1.20
EVPH1SE1248	394	404	12	48	2.875	9.83	1.36
EVPH1SE1254	446	454	12	54	2.875	10.69	1.53
EVPH1SE1260	469	477	12	60	2.875	11.55	1.69
EVPH1SE1266	488	500	12	66	3	19.0	1.37
EVPH1SE1272	542	550	12	72	3	20.2	1.45
EVPH1SE1818	276	281	18	18	2.875	9.44	0.54
EVPH1SE1824	340	347	18	24	2.875	10.90	0.72
EVPH1SE1830	391	401	18	30	2.875	12.35	0.90
EVPH1SE1836	448	457	18	36	2.875	13.81	1.08
EVPH1SE1842	505	518	18	42	2.875	15.27	1.26
EVPH1SE1848	553	570	18	48	2.875	16.72	1.44
EVPH1SE1854	602	619	18	54	2.875	18.18	1.62
EVPH1SE1860	660	687	18	60	2.875	19.64	1.80
EVPH1SE1866	723	755	18	66	3	20.7	1.98
EVPH1SE1872	770	802	18	72	3	22.2	2.16

EVPH2SE • Laminate Extension Module - Two Sides

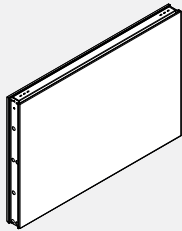

- Attaches on top of a beam.
- Laminate faces on both sides of the module provide durable, washable surfaces
- Modules can be stacked to add privacy or to divide space.
- Panel Extension Modules cannot install higher than 42”h. above finished floor.
- When ordering Panel Extension Modules, additional connectors are required.
- Available in high pressure laminate finishes only.

PRODUCT CODE	PRICE	SIZE/ INCHES			WEIGHT LBS	VOL FT³
		H	W	D		
EVPH2SE0618	234	6	18	2.875	3.03	0.26
EVPH2SE0624	274	6	24	2.875	3.46	0.36
EVPH2SE0630	318	6	30	2.875	3.89	0.44
EVPH2SE0636	364	6	36	2.875	4.32	0.52
EVPH2SE0642	410	6	42	2.875	4.74	0.60
EVPH2SE0648	460	6	48	2.875	5.17	0.69
EVPH2SE0654	535	6	54	2.875	5.60	0.77
EVPH2SE0660	544	6	60	2.875	6.03	0.85
EVPH2SE0666	555	6	66	2.875	21.1	0.91
EVPH2SE0672	627	6	72	2.875	22.9	0.99
EVPH2SE1218	234	12	18	2.875	6.05	0.51
EVPH2SE1224	274	12	24	2.875	6.91	0.71
EVPH2SE1230	318	12	30	2.875	7.77	0.88
EVPH2SE1236	364	12	36	2.875	8.63	1.04
EVPH2SE1242	410	12	42	2.875	9.48	1.20
EVPH2SE1248	460	12	48	2.875	10.34	1.37
EVPH2SE1254	535	12	54	2.875	11.20	1.53
EVPH2SE1260	544	12	60	2.875	12.05	1.70
EVPH2SE1266	555	12	66	2.875	27.4	1.37
EVPH2SE1272	627	12	72	2.875	29.9	1.45
EVPH2SE1818	329	18	18	2.875	10.29	0.54
EVPH2SE1824	404	18	24	2.875	11.75	0.72
EVPH2SE1830	469	18	30	2.875	13.20	0.90
EVPH2SE1836	542	18	36	2.875	14.66	1.08
EVPH2SE1842	614	18	42	2.875	16.12	1.26
EVPH2SE1848	694	18	48	2.875	17.57	1.44
EVPH2SE1854	762	18	54	2.875	19.03	1.62
EVPH2SE1860	823	18	60	2.875	20.49	1.80
EVPH2SE1866	882	18	66	2.875	33.9	1.98
EVPH2SE1872	949	18	72	2.875	35.7	2.16

EVPAE • Air Flow Extension Module

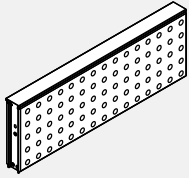

- Metal air flow panel extension.
- Attaches to top of beam.
- Modules can be stacked to add privacy or to divide space.
- Panel Extension Modules cannot install higher than 42”h. above finished floor.
- When ordering Panel Extension Modules, additional connectors are required.

PRODUCT CODE	PRICE	SIZE/ INCHES			WEIGHT LBS	VOL FT ³
		H	W	D		
EVPAE1224	270	12	24	2.875	9.66	0.59
EVPAE1230	318	12	30	2.875	10.93	0.82
EVPAE1236	363	12	36	2.875	12.19	1.00
EVPAE1242	401	12	42	2.875	13.62	1.05
EVPAE1248	452	12	48	2.875	15.18	1.18
EVPAE1260	596	12	60	2.875	18.17	1.32
EVPAE1824	339	18	24	2.875	10.56	0.72
EVPAE1830	394	18	30	2.875	12.11	0.90
EVPAE1836	435	18	36	2.875	13.66	1.08
EVPAE1842	478	18	42	2.875	15.05	1.26
EVPAE1848	547	18	48	2.875	16.35	1.44
EVPAE1860	711	18	60	2.875	19.04	1.80

EVPOE • Open Panel Extension Module

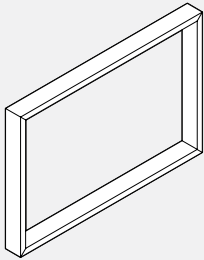

- Attaches to top portion of a beam.
- Modules can be stacked to add privacy or to divide space.
- Panel Extension Modules cannot install higher than 42”h above finished floor.
- When ordering Panel Extension Modules, additional connectors are required.

PRODUCT CODE	PRICE	SIZE/ INCHES			WEIGHT LBS	VOL FT ³
		H	W	D		
EVPOE0618	246	6	18	2.875	6.22	0.26
EVPOE0624	252	6	24	2.875	7.40	0.29
EVPOE0630	307	6	30	2.875	8.48	0.36
EVPOE0636	323	6	36	2.875	9.56	0.43
EVPOE0642	392	6	42	2.875	10.88	0.51
EVPOE0648	442	6	48	2.875	12.12	0.58
EVPOE0654	483	6	54	2.875	13.25	0.65
EVPOE0660	520	6	60	2.875	14.68	0.73
EVPOE1218	246	12	18	2.875	7.30	0.51
EVPOE1224	252	12	24	2.875	8.40	0.59
EVPOE1230	307	12	30	2.875	9.50	0.82
EVPOE1236	323	12	36	2.875	10.60	1.00
EVPOE1242	392	12	42	2.875	11.84	1.00
EVPOE1248	442	12	48	2.875	13.20	1.18
EVPOE1254	483	12	54	2.875	14.38	1.25
EVPOE1260	520	12	60	2.875	15.80	1.32
EVPOE1818	329	18	18	2.875	7.74	0.54
EVPOE1824	369	18	24	2.875	9.18	0.72
EVPOE1830	392	18	30	2.875	10.53	0.90
EVPOE1836	431	18	36	2.875	11.88	1.08
EVPOE1842	485	18	42	2.875	13.09	1.26
EVPOE1848	546	18	48	2.875	14.22	1.44
EVPOE1854	592	18	54	2.875	15.28	1.62
EVPOE1860	638	18	60	2.875	16.56	1.80

EVPMP-GIP • Panel Mount Privacy Glass

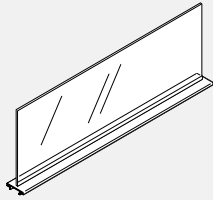

- Attaches on top of Power Beam or extension modules to add privacy or divide space.
- Privacy Glass is integrated into the aluminum top trim.
- Includes aluminum trim with channel and glass tile
- Glass and attachment hardware ship separately.
- Standard in clear (CLR), frosted (FRST) or writeable (WRW) glass.
- Privacy glass modules may stack on top of Power Beam or extension modules at 42" h. to achieve a height up to 54"h. above finished floor

PRODUCT CODE	PRICE			SIZE/ INCHES			WEIGHT LBS	VOL FT ³
	CLR	FRST	WRW	H	W	D		
EVPMP24GI6P	201	251	-	6	24	2.875	2.39	0.25
EVPMP30GI6P	219	276	-	6	30	2.875	2.99	0.32
EVPMP36GI6P	235	291	-	6	36	2.875	3.58	0.37
EVPMP42GI6P	251	313	-	6	42	2.875	4.18	0.43
EVPMP48GI6P	262	327	-	6	48	2.875	4.78	0.50
EVPMP54GI6P	270	338	-	6	54	2.875	5.38	0.56
EVPMP60GI6P	276	343	-	6	60	2.875	5.97	0.63
EVPMP66GI6P	422	562	-	6	66	2.875	6.57	0.69
EVPMP72GI6P	450	587	-	6	72	2.875	7.16	0.76
EVPMP24GI9P	201	251	-	9	24	2.875	3.58	0.38
EVPMP30GI9P	219	276	-	9	30	2.875	4.48	0.47
EVPMP36GI9P	235	291	-	9	36	2.875	5.37	0.56
EVPMP42GI9P	251	313	-	9	42	2.875	6.26	0.65
EVPMP48GI9P	262	327	-	9	48	2.875	7.16	0.75
EVPMP54GI9P	270	338	-	9	54	2.875	8.06	0.84
EVPMP60GI9P	276	343	-	9	60	2.875	8.96	0.94
EVPMP66GI9P	422	562	-	9	66	2.875	9.85	1.04
EVPMP72GI9P	450	587	-	9	72	2.875	10.74	1.13
EVPMP24GIP	201	251	350	12	24	2.875	4.77	0.50
EVPMP30GIP	219	276	357	12	30	2.875	5.97	0.63
EVPMP36GIP	235	291	364	12	36	2.875	7.16	0.75
EVPMP42GIP	251	313	401	12	42	2.875	8.35	0.87
EVPMP48GIP	262	327	439	12	48	2.875	9.55	1.00
EVPMP54GIP	270	338	475	12	54	2.875	10.75	1.12
EVPMP60GIP	276	343	512	12	60	2.875	11.95	1.25
EVPMP66GIP	422	562	701	12	66	2.875	13.05	1.37
EVPMP72GIP	450	587	734	12	72	2.875	14.25	1.51
EVPMP24GI18P	289	363	-	18	24	2.875	7.16	0.75
EVPMP30GI18P	317	397	-	18	30	2.875	8.96	0.94
EVPMP36GI18P	338	420	-	18	36	2.875	10.74	1.13
EVPMP42GI18P	363	453	-	18	42	2.875	12.53	1.31
EVPMP48GI18P	375	471	-	18	48	2.875	14.33	1.50
EVPMP54GI18P	388	485	-	18	54	2.875	16.13	1.69
EVPMP60GI18P	397	496	-	18	60	2.875	17.91	1.88
EVPMP66GI18P	553	733	-	18	66	2.875	19.70	2.06
EVPMP72GI18P	588	766	-	18	72	2.875	21.48	2.25

EVPBSCGD • Power Beam Shared Storage Cabinet with Sliding Glass Door

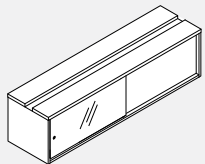

Left Hand Shown

- Inside dimensions 13"high x 13"deep.
- Laminate storage cabinet, available in standard Evolve laminate finishes.
- Available in Tempered frosted glass only, glass with handle.
- Tracks for sliding glass available in Tungsten only.
- To be installed under power beam between T legs.
- Power Beam Storage cabinet attaches to the bottom of the power beam with brackets.
- For ease of installation, levelers in middle included.
- **Note: To be used with 24"h. Power Beam only.**

PRODUCT CODE	PRICE	SIZE/ INCHES			WEIGHT LBS	VOL FT ³
		H	W	D		
EVPBSCGDR60	1786	15	58.75	16	80.46	8.33
EVPBSCGDR72	1950	15	70.75	16	96.60	10.00
EVPBSCGDL60	1786	15	58.75	16	80.46	8.33
EVPBSCGDL72	1950	15	70.75	16	96.60	10.00

EVPBSCGDP • Power Beam Shared Storage Cabinet with Sliding Glass Door and Cable Pass Through

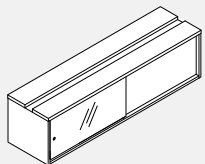

Left Hand Shown

- Inside dimensions 13"high x 13"deep.
- Laminate storage cabinet, available in standard Evolve laminate finishes.
- Available in Tempered frosted glass only, glass with handle.
- Tracks for sliding glass available in Tungsten only.
- To be installed under power beam between T legs.
- Power Beam Storage cabinet attaches to the bottom of the power beam with brackets.
- For ease of installation, levelers in middle included.
- **Note: To be used with 24"h. Power Beam only, EVPBEP-KIT and 60" and 72" widths only.**
- Cabinet with cable pass through in the middle to bring power to power beam above
- Includes metal cover for easy access to wires
- Electrics not included
- Power beam base feed to be ordered separately.
- Power beam kit with electrical cut out in middle to be ordered separately. (EVPBEP-KIT)

PRODUCT CODE	PRICE	SIZE/ INCHES			WEIGHT LBS	VOL FT ³
		H	W	D		
EVPBSCGDPR60	2155	15	58.75	16	80.46	8.33
EVPBSCGDPR72	2279	15	70.75	16	96.60	10.00
EVPBSCGDPL60	2155	15	58.75	16	80.46	8.33
EVPBSCGDPL72	2279	15	70.75	16	96.60	10.00

EVPBSC • Power Beam Shared Storage Cabinet, Open

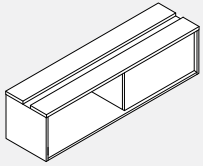

- Inside dimensions 13"high x 13"deep.
- Laminate storage cabinet, without doors, available in standard Evolve laminate finishes.
- To be installed under power beam between T legs.
- Power Beam Storage cabinet attaches to bottom of power beam with brackets.
- For ease of installation, levelers in middle included.
- Note: It can not be converted to cabinet with glass door.
- **Note: To be used with 24" h Power Beam only.**

PRODUCT CODE	PRICE	SIZE/ INCHES			WEIGHT VOL	
		H	W	D	LBS	FT ³
EVPBSCR60	1143	15	58.75	16	80.46	8.33
EVPBSCR72	1167	15	70.75	16	96.6	10.00
EVPBSCCL60	1143	15	58.75	16	80.46	8.33
EVPBSCCL72	1167	15	70.75	16	96.6	10.00

EVPBSCP • Power Beam Shared Storage Cabinet, Open and Cable Pass Through

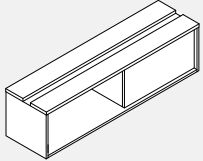

Left Hand Shown

- Inside dimensions 13"high x 13"deep.
- Laminate storage cabinet, without doors, available in standard Evolve laminate finishes.
- To be installed under power beam between T legs.
- Power Beam Storage cabinet attaches to bottom of power beam with brackets.
- For ease of installation, levelers in middle included.
- Note: It can not be converted to cabinet with glass door.
- **Note: To be used with 24" h Power Beam only, EVPBBEP-KIT.**
- Cabinet with cable pass through in the middle to bring power to power beam above.
- Includes metal cover for easy access to wires.
- Electrics not included.
- Power beam base feed to be ordered separately.
- Power beam kit with electrical cut out in middle to be ordered separately. (EVPBEP-KIT).

PRODUCT CODE	PRICE	SIZE/ INCHES			WEIGHT VOL	
		H	W	D	LBS	FT ³
EVPBSCP60	1275	15	58.75	16	80.46	8.33
EVPBSCP72	1345	15	70.75	16	96.6	10.00
EVPBSCPL60	1275	15	58.75	16	80.46	8.33
EVPBSCPL72	1345	15	70.75	16	96.6	10.00

EVSDAOH • Power Beam Dual Access Overhead

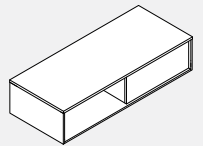

- Inside dimensions 6.5" high x 13"deep.
- Laminate Overhead.
- Available in standard Evolve laminate finishes.
- Power Beam storage cabinet must be installed at the bottom for stability.
- Top mount on power beam.
- Dual Access Overhead Support Brackets to be ordered separately.
- Power Beam legs for storage to be ordered separately.
- Power Beam legs for storage must be used.

PRODUCT CODE	PRICE	SIZE/ INCHES			WEIGHT VOL	
		H	W	D	LBS	FT ³
EVSDAOH60	1137	8.5	60	16	51.5	5.00
EVSDAOH72	1160	8.6	72	16	60.2	6.00

EVSDAOHBRKIT • Brackets for Dual Access Overhead

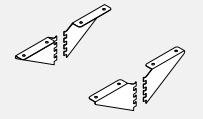

- Brackets support Dual access overhead
- To be used with Power Beam Channel
- Available in standard paint colors
- Brackets and screws included

PRODUCT CODE	PRICE	SIZE/INCHES			WEIGHT LBS	VOL FT ³
		H	W	D		
EVSDAOHBRKIT	133	5	5	1.5	2.00	0.08

EVPBL • 36" Power Beam Connector with Leg for Storage



- Connects 24" h power beams on equal height.
- Includes non slotted connector with leg, glides and connecting hardware.
- Must be used with overhead.

PRODUCT CODE	PRICE	SIZE/ INCHES			WEIGHT VOL	
		H	W	D	LBS	FT ³
EVPBL36S	112	36	18		8.5	0.45

EVPBLERT • End of Run Trim for Connector

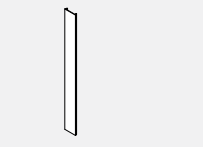

- Specify to match height of beam or total height with extension modules

PRODUCT CODE	PRICE	SIZE/ INCHES			WEIGHT VOL	
		H	W	D	LBS	FT ³
EVPBLERT24	54	21.4	2.875	3	1.0	0.04
EVPBLERT30	61	27.4	2.875	3	1.4	0.04
EVPBLERT36	64	33.4	2.875	3	1.6	0.06
EVPBLERT42	68	39.4	2.875	3	1.8	0.07
EVPBLERT48	71	45.4	2.875	3	2.00	0.08
EVPBLERT54	74	51.4	2.875	3	2.20	0.09
EVPBLERT66	85	63.4	2.875	3	2.60	1.10

EVPBLEP • Laminate End Panel for Power Beam

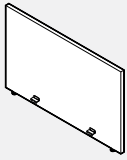

- Connects to a power beam support leg with foot at the end of a run
- Includes brackets to attach to support leg with foot
- Finished in thermally fused laminate. If wood grain is selected, grain runs horizontally
- Laminate End Panel height is inclusive of panel glides extended to their full height
- Laminate end panel must connect to a support leg with foot and will not connect to a support leg with glide
- Must be used with Connectors with T-Leg

PRODUCT CODE	PRICE	SIZE/ INCHES			WEIGHT VOL	
		H	W	D	LBS	FT ³
EVPBLEP2451	327	24	51	1	32.81	0.73
EVPBLEP3051	408	30	51	1	39.38	0.88
EVPBLEP3651	487	36	51	1	45.94	1.02
EVPBLEP4251	731	42	51	1	52.50	1.24
EVPBLEP2463	370	24	63	1	37.50	0.83
EVPBLEP3063	465	30	63	1	45.00	1.00
EVPBLEP3663	557	36	63	1	52.50	1.17
EVPBLEP4263	816	42	63	1	60.00	1.53

EVPBLEP • Laminate End Panel for Power Beam, Single Leg

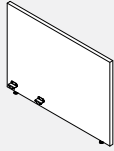

- EVPBLEP - Laminate End Panel for Power Beam.
- Attaches to power beam connector with single leg.
- For one sided Power beam application.
- Includes brackets to attached to attached to leg.
- Finished in thermally fused laminate, if wood grain is selected, grain runs horizontally.
- Laminate End Panel height is inclusive of panel glides extended to their full height.
- EVPBLEP-30 to be used for 24" deep worksurface.
- EVPBLEP-36 to be used for 30" deep worksurfaces

PRODUCT CODE	PRICE	SIZE/ INCHES			WEIGHT VOL	
		H	W	D	LBS	FT ³
EVPBLEP2430	265	24	30	1	19.30	0.42
EVPBLEP3030	287	30	30	1	23.16	0.52
EVPBLEP3630	309	36	30	1	27.02	0.64
EVPBLEP4230	388	42	30	1	30.88	0.74
EVPBLEP2436	312	24	36	1	21.43	0.55
EVPBLEP3036	323	30	36	1	25.71	0.64
EVPBLEP3636	364	36	36	1	30.00	0.75
EVPBLEP4236	465	42	36	1	34.29	0.90

EVE8PD • Power Distribution Housing

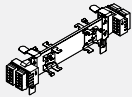

- Power housing is specified per beam size (e.g. EVE8PD36 is for use in a 36" beam).
- 8 wire, 4 circuits (2+2 configuration).
- Accommodates two duplex receptacles per panel side.

PRODUCT CODE	PRICE	SIZE/ INCHES		WEIGHT VOL	
		W	D	LBS	FT ³
EVE8PD24	156	24	9.25	0.83	1.17
EVE8PD30	208	30	15.25	1.28	1.17
EVE8PD36	220	36	21.25	1.62	1.65
EVE8PD42	226	42	27.25	2.00	2.00
EVE8PD48	238	48	33.25	0.18	0.16
EVE8PD54	242	54	39.25	2.66	3.20
EVE8PD60	243	60	45.25	3.04	3.20

EVE8PD • Power Distribution Housing

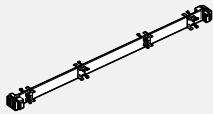

- Power housing is specified per beam size (e.g. EVE8PD72 is for use in a 72" beam).
- 8 wire, 4 circuits (2+2 configuration).
- Provides two duplex receptacle to be plugged directly to power distribution housing and then as option additional two duplex receptacle to be connected to it with "I" connector, per panel size.
- Both duplex receptacles connected by "I" connector must be same circuit.
- Each power distribution housing supports 15-20 amps.
- Duplex receptacles and "I" connectors to be ordered separately.

PRODUCT CODE	PRICE	SIZE/ INCHES		WEIGHT VOL	
		W	D	LBS	FT ³
EVE8PD66	253	66	43.5	3.44	3.30
EVE8PD72	262	72	45.5	3.84	3.40

EVE8CP • Jumper Cable

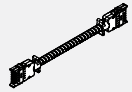

- The EVE8CP16 electrically connects two powered panels positioned side by side.
- The EVE8CP20 electrically connects two powered panels separated by a post.

PRODUCT CODE	PRICE	SIZE/ INCHES	WEIGHT VOL	
			L	LBS FT ³
EVE8CP16	121	16	0.66	1.17
EVE8CP20	142	20	0.78	1.17

EVE8CP18 • Flexible Mesh Jumper Cable

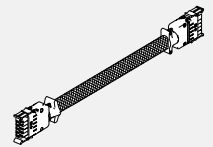

- Electrically connects two powered panels separated by post.
- Used to connect two power distribution housing in Power Beam at 90 degrees.

PRODUCT CODE	PRICE	SIZE/INCHES			WEIGHT VOL	
		H	W	D	LBS	FT ³
EVE8CP18	147			18.5	0.78	1.17

EVE8CP • Pass Through Cable

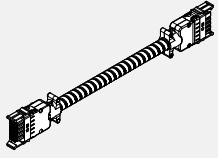

- Flexible metal conduit is used to distribute electrical power through non-powered panels.
- To calculate the length of a Pass-Through Cable, add the widths of the non-powered panels separating the powered panels (panels with distribution housing attached). To this, add 16" (distance from the edge of the panel to the distribution housing x 2). See Technical Information page at the beginning of this section.

PRODUCT CODE	PRICE	SIZE/ INCHES			WEIGHT VOL	
		L			LBS	FT ³
EVE8CP40	164	40			1.44	1.17
EVE8CP46	169	46			1.71	1.17
EVE8CP52	177	52			1.95	1.17
EVE8CP58	188	58			2.21	1.17
EVE8CP64	196	64			2.37	1.17
EVE8CP70	200	70			2.60	1.17
EVE8CP76	204	76			2.81	1.17
EVE8CP82	213	82			3.03	1.17
EVE8CP88	220	88			3.05	1.17
EVE8CP94	228	94			3.92	1.17
EVE8CP100	233	100			3.47	1.17
EVE8CP106	243	106			3.87	1.17
EVE8CP118	257	118			4.08	1.17
EVE8CP130	281	185			4.73	1.17
EVE8CP142	293	142			4.59	1.17

EVE8CPxx-H • Hybrid Pass Through Cables with Wire Mesh

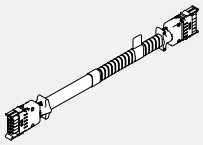

- Flexible metal conduit with wire mesh distributes electrical power through non powered panels.
- To calculate the length of Hybrid Pass Through Cable, add the width of non powered panels separating the powered panels. To this add 16" (distance from edge of the panels to power distribution housing x2).
- Please add an additional 3" when passing through a post. Please see the the beginning of this section.
- Hybrid Pass Through Cables with wire mesh allows connection at 90 degree post and one end for Power Beam.

PRODUCT CODE	PRICE	SIZE/INCHES			WEIGHT VOL	
		H	W	D	LBS	FT ³
EVE8CP40-H	196	40			1.44	1.17
EVE8CP46-H	204	46			1.71	1.17
EVE8CP52-H	212	52			1.95	1.17
EVE8CP58-H	226	58			2.21	1.17
EVE8CP64-H	235	64			2.37	1.17
EVE8CP70-H	240	70			2.60	1.17
EVE8CP76-H	244	76			2.81	1.17
EVE8CP82-H	255	82			3.03	1.17
EVE8CP88-H	264	88			3.05	1.17
EVE8CP94-H	273	94			3.42	1.17
EVE8CP100-H	281	100			3.47	1.17
EVE8CP106-H	292	106			3.87	1.17
EVE8CP118-H	309	118			4.08	1.17
EVE8CP130-H	337	130			4.73	1.17
EVE8CP142-H	351	142			4.89	1.17

EVE8CI-1 • "I" Connector



- Female - Female connector used to connect two Pass-Through Cables.

PRODUCT CODE	PRICE	SIZE/ INCHES			WEIGHT VOL	
		H	W	D	LBS	FT ³
EVE8CI-1	85	15	15	0.75	0.06	0.20

EVE8RD • Duplex Receptacles

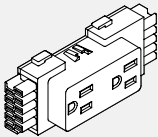

- Up to 6 duplex receptacles per circuit.
- EVE8RD1 = Circuit #1 (utility circuit)
- EVE8RD1 = Circuit #2 (utility circuit)
- EVE8RDA = Circuit #A (dedicated)
- EVE8RDB = Circuit #B (dedicated)

PRODUCT CODE	PRICE	SIZE/ INCHES			WEIGHT VOL	
		H	W	D	LBS	FT ³
EVE8RD1	35	2	4.625	1.25	0.16	0.01
EVE8RD2	35	2	4.625	1.25	0.16	0.01
EVE8RDA	35	2	4.625	1.25	0.16	0.01
EVE8RDB	35	2	4.625	1.25	0.16	0.01

EVEUSB01 • Duplex Receptacles

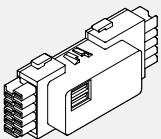

- The USB charging module provides convenient charging power access through dual ports on face of the receptacle.
- Two USB ports.
- 2 Amp output via two USB ports, considered as circuit #1.
- Available in white, black.

PRODUCT CODE	PRICE	SIZE/ INCHES			WEIGHT VOL	
		H	W	D	LBS	FT ³
EVEUSB01WHT	238	2	4.625	1.25	0.16	0.01
EVEUSB01BLK	238	2	4.625	1.25	0.16	0.01

EVE8FR3PB • Floor Power Entry for Power Beam

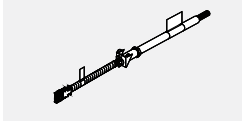

- Snaps into the power distribution housing.
- Includes 84" long flexible vinyl conduit.
- Includes bracket to attach to vertical raceway panel.
- Must be hard wire to source by licenced electrician.

PRODUCT CODE	PRICE	SIZE/ INCHES			WEIGHT VOL	
		H	W	D	LBS	FT ³
EVE8FR3PB	435	3	84	2	3.82	2.00

EVE8EC • Ceiling Power Entry

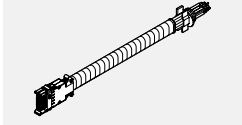

- Snaps into the end of the Power Distribution Housing.
- Flexible metal conduit extends into the ceiling through a corner post and post extension (both ordered separately).
- Must be hard wired to source power by a licensed electrician.
- 4" Junction Box included.

PRODUCT CODE	PRICE	SIZE/ INCHES			WEIGHT VOL	
		L	LBS	FT ³	LBS	FT ³
EVE8EC1	268	132	5.24	2.00		
EVE8EC2	479	144	5.96	2.00		

EVE8FR3PBP • Power Entry for Power Beam for Wall Plate Infeed

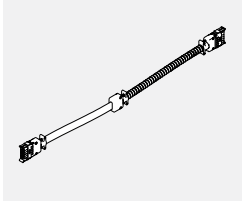

- Snaps into power distribution housing.
- Includes 48" long flexible vinyl conduit with connector.
- Includes bracket to attach to vertical raceway panel
- Power Beam with electrical cut out must be ordered.
- 71" long base feed will work with 24" and 36" H Power Beam.
- Note: EVE8FR3PBP will only work with Wall Plate Infeed EVE8WPIPB.

PRODUCT CODE	PRICE	SIZE/INCHES			WEIGHT VOL	
		H	W	D	LBS	FT ³
EVE8FR3PBP	373	3	71	2	3.82	2.00

EVE8WPIPB • Wall Plate Infeed for Power Beam

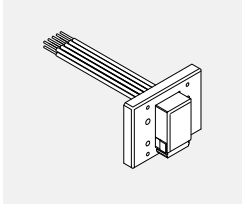

- Wall plate infeed must be installed and hardwired to source by licensed electrician.
- Note: EVE8FR3PBP will only work with Wall Plate Infeed EVE8WPIPB.

PRODUCT CODE	PRICE	SIZE/INCHES			WEIGHT VOL	
		H	W	D	LBS	FT ³
EVE8WPIPB	607	5.25	5.25	1.75	1.00	0.10

EVEJBC1PB • Hardwire Junction Box for Power Beam

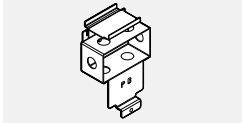

- Can be retrofitted in any size of panel at the receptacle location.
- Gives access from one side only at each location.
- Customer to supply conduit, wiring, receptacle, and face plate 2 per Power Beam.
- A licensed electrician must provide hard wire connection with the junction box.
- For use with Power Beam only.

PRODUCT CODE	PRICE	WEIGHT VOL	
		LBS	FT ³
EVEJBC1PB	105	1.50	0.02

EVDPE • Post Extension Data/Comm Lay-in

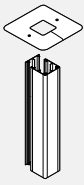

- Attaches to the top of a post to bring power and/or data cables from the ceiling to panel power way.
- Three-sided power pole with snap-on fourth side.
- Post extension can be opened on one side for lay-in for power and/or data cables.
- Made of aluminum and can be field cut.
- Accommodates up to 25 CAT5 cables with electric. Accommodates up to 45 CAT5 cables without electric.

PRODUCT CODE	PRICE	SIZE/ INCHES		WEIGHT LBS	VOL FT ³
		H	W		
EVDPE64	160	64	2.875	3.00	0.70
EVDPE82	197	82	2.875	4.20	0.80
EVDPE88	302	88	2.875	4.50	0.85
EVDPE94	323	94	2.875	4.80	0.92
EVDPE100	344	100	2.875	5.12	0.97

EVDP4E • 45° Post Extension Data/Comm Lay-in

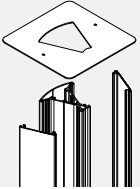

- Attached to the top of the 45° Corner Post to bring power and/or data cables from the ceiling to the panel run through.
- Cable capacity
 - 40 CAT5 cables without electric feed.
 - 10 CAT5 cables with electric feed.

PRODUCT CODE	PRICE	SIZE/ INCHES		WEIGHT LBS	VOL FT ³
		H	W		
EVDP4E64	162	64	3.65	3.00	0.70
EVDP4E82	218	82	3.65	4.20	0.80

EVDP6E • 60° Post Extension Data/Comm Lay-in

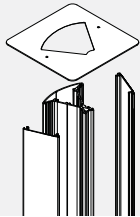

- Attached to the top of the 60° Corner Post to bring power and/or data cables from the ceiling to the panel run through.
- Post extension can be opened on one side for lay-in power and/or data cables.
- Made of aluminum and can be field cut.
- Two sided power pole with snap-on third side.
- Cable capacity
 - 32 CAT5 cables without electric.
 - 15 CAT5 cables with electric

PRODUCT CODE	PRICE	SIZE/ INCHES		WEIGHT LBS	VOL FT ³
		H	W		
EVDP6E64	157	64	2	3.00	0.70
EVDP6E82	192	82	2	4.20	0.80

EVPBECH34 • Wire Manager Kit



- Provides cable management from Power Beam to Height Adjustable Table.
- Includes bracket to attach to bottom trim of Power Beam.
- Cables fit easily.
- Includes a neoprene wire manager sock, bracket and screws.
- Neoprene available in black only.
- Specify bracket paint finish.

PRODUCT CODE	PRICE	SIZE/ INCHES			WEIGHT LBS	VOL FT ³
		H	W	D		
EVPBECH34	421	1	41	2	0.60	0.04

EVPBT01 • Power Beam Tray

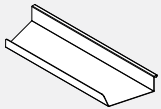

- Power beam tray provides support for wires.
- Can be used with power beam only.
- Available in standard and premium paint finishes.

PRODUCT CODE	PRICE	SIZE/ INCHES			WEIGHT LBS	VOL FT ³
		H	W	D		
EVPBT01	32	12	1.25	3.5	0.60	0.04

EVAFMB01 • Floor Mount Plate

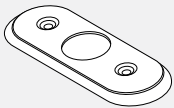

- Attached to floor.
- Secures panel to floor.
- Attachment screws not included.
- Care should be taken to use correct fasteners for type of floor.
- Available in chrome finish only.

PRODUCT CODE	PRICE	SIZE/ INCHES			WEIGHT LBS	VOL FT ³
		H	W	D		
EVAFMB01	72	0.25	5	2.5	0.2	0.02

WORKSURFACES • TECHNICAL INFORMATION

- All worksurfaces have threaded inserts for metal-to-metal connection of support hardware.
- Back edge features scoop detail and sits 3/8" away from the face of a panel for wire management. Scoop depth is 3/4" at centre.
- Communication and electrical wires are routed through the cable scoop at the back of the worksurface.
- Straight or Curvilinear Worksurfaces 48" or less have one scoop while those that are 54" or more have two scoops. All other worksurface shapes have one scoop.

- LP and HP worksurfaces are 3.5 mm edge banded.
- LP worksurfaces are 1" thick particle board with laminate finish.
- HP worksurfaces are 1 1/16" thick particle board with laminate finish overall.
- All support hardware must be ordered separately.
- Wood grain laminates on corner worksurfaces may run diagonal to the adjacent worksurfaces. Specify "WG" at the end of the worksurface code.
- Please use "Wood Grain Direction" chart at the beginning of the price list.

WORKSURFACES • GUIDELINE FOR ORDERING PRODUCT

The price list uses a numbering system with meaningful alphanumeric characters to create a simple-to-understand product number. This makes specifying the product much easier and more accurate.

EXAMPLE OF WORKSURFACE CODE

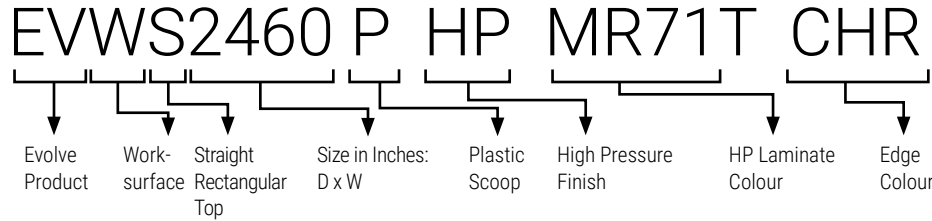

HOW TO SPECIFY

- Specify Evolve worksurface type and size by code.
- Specify type of finish.
- Specify High or LOW Pressure Laminate Colour.
- Specify PVC edge colour.

EVWS • Straight Worksurface

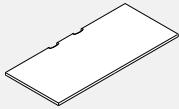

- Straight rectangular worksurfaces are non-handed and can be interchanged on site.
- Please choose from DWT - Designer White, SIL - Silver or BLK - Black for scoop covers.

PRODUCT CODE	PRICE		SIZE/ INCHES			WEIGHT VOL	
	LP	HP	H	W	D	LBS	FT³
EVWS1818P	127	161	1	18	18	12.50	0.37
EVWS1824P	131	174	1	24	18	13.50	0.40
EVWS1830P	138	183	1	30	18	16.50	0.54
EVWS1836P	159	210	1	36	18	19.50	0.63
EVWS1842P	208	278	1	42	18	23.25	0.73
EVWS1848P	249	328	1	48	18	26.25	0.83
EVWS1854P	293	385	1	54	18	29.25	0.93
EVWS1860P	329	422	1	60	18	33.00	1.02
EVWS1866P	344	452	1	66	18	36.75	1.12
EVWS1872P	363	478	1	72	18	39.75	1.21
EVWS1878P	380	503	1	78	18	38.50	1.23
EVWS1884P	417	546	1	84	18	39.75	1.21
EVWS1890P	542	797	1	90	18	48.75	1.53
EVWS1896P	578	852	1	96	18	51.75	1.73
EVWS2418P	131	168	1	18	24	12.00	0.50
EVWS2424P	133	178	1	24	24	18.00	60.00
EVWS2430P	145	190	1	30	24	22.00	0.72
EVWS2436P	161	213	1	36	24	26.00	0.85
EVWS2442P	211	280	1	42	24	31.00	0.98
EVWS2448P	252	339	1	48	24	35.00	1.11
EVWS2454P	299	394	1	54	24	39.00	1.23
EVWS2460P	336	443	1	60	24	44.00	1.36
EVWS2466P	350	462	1	66	24	49.00	1.49
EVWS2472P	366	484	1	72	24	53.00	1.62
EVWS2478P	392	516	1	78	24	57.18	2.16
EVWS2484P	422	553	1	84	24	61.50	2.33
EVWS2490P	542	797	1	90	24	64.50	2.53
EVWS2496P	578	852	1	96	24	68.50	2.73
EVWS3018P	149	192	1	18	30	15.30	0.63
EVWS3024P	159	208	1	24	30	22.00	0.74
EVWS3030P	170	225	1	30	30	28.00	0.90
EVWS3036P	200	264	1	36	30	33.00	1.06
EVWS3042P	283	373	1	42	30	38.00	1.22
EVWS3048P	299	394	1	48	30	44.00	1.38
EVWS3054P	327	420	1	54	30	49.00	1.54
EVWS3060P	350	462	1	60	30	55.00	1.69
EVWS3066P	364	483	1	66	30	60.00	1.85
EVWS3072P	385	510	1	72	30	66.00	2.01
EVWS3078P	410	540	1	78	30	71.48	2.70
EVWS3084P	456	596	1	84	30	76.98	2.92
EVWS3090P	676	998	1	90	30	81.98	3.12
EVWS3096P	722	1064	1	96	30	68.50	3.32
EVWS3672P	544	712	1	72	36	79.20	2.42

EVWS • Straight Worksurface to Span a Post

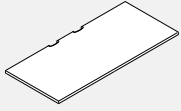

- Straight rectangular worksurfaces are non-handed and can be interchanged on site.
- Worksurface will span the width of a post eliminating a gap between standard sizes.
- Please choose from DWT - Designer White, SIL - Silver or BLK - Black for scoop covers.

PRODUCT CODE	PRICE		SIZE/ INCHES			WEIGHT VOL	
	LP	HP	H	W	D	LBS	FT ³
EVWSP1827P	138	183	1	27	18	16.50	0.54
EVWSP1833P	174	210	1	33	18	19.50	0.53
EVWSP1839P	208	278	1	39	18	23.25	0.73
EVWSP1845P	249	328	1	45	18	26.25	0.83
EVWSP1851P	293	385	1	51	18	29.25	0.93
EVWSP1857P	329	422	1	57	18	33.00	1.02
EVWSP1863P	344	452	1	63	18	36.75	1.12
EVWSP1869P	363	478	1	69	18	39.75	1.21
EVWSP1875P	380	503	1	75	18	42.75	1.33
EVWSP1881P	417	546	1	81	18	45.75	1.43
EVWSP2427P	145	190	1	27	24	22.00	0.72
EVWSP2433P	161	213	1	33	24	26.00	0.85
EVWSP2439P	211	280	1	39	24	31.00	0.98
EVWSP2445P	252	339	1	45	24	35.00	1.11
EVWSP2451P	299	394	1	51	24	39.00	1.23
EVWSP2457P	336	443	1	57	24	44.00	1.36
EVWSP2463P	350	462	1	63	24	49.00	1.49
EVWSP2469P	366	484	1	69	24	53.00	1.62
EVWSP2475P	392	516	1	75	24	57.18	2.16
EVWSP2481P	422	553	1	81	24	61.50	2.33
EVWSP3027P	170	225	1	27	30	28.00	0.90
EVWSP3033P	200	264	1	33	30	33.00	1.06
EVWSP3039P	283	373	1	39	30	38.00	1.22
EVWSP3045P	299	394	1	45	30	44.00	1.38
EVWSP3051P	327	420	1	51	30	49.00	1.54
EVWSP3057P	350	462	1	57	30	55.00	1.69
EVWSP3063P	364	483	1	63	30	60.00	1.85
EVWSP3069P	385	510	1	69	30	66.00	2.01
EVWSP3075P	410	540	1	75	30	71.48	2.70
EVWSP3081P	456	596	1	81	30	76.98	2.92

EVWVL • Curvilinear Worksurface Left

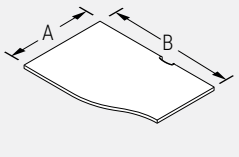

- When deepest end equals 24", the opposite depth is 18".
- When deepest end equals 30", the opposite depth is 24".
- Please choose from DWT - Designer White, SIL - Silver or BLK - Black for scoop covers.

NOTE: EVWV

24	36
A	B
DEPTH	WIDTH

PRODUCT CODE	PRICE		SIZE/ INCHES			WEIGHT VOL	
	LP	HP	H	W	D	LBS	FT ³
EVWVL2424P	172	233	1	24	24	15.00	0.59
EVWVL2430P	182	240	1	30	24	19.00	0.72
EVWVL2436P	217	289	1	36	24	23.00	0.85
EVWVL2442P	252	339	1	42	24	27.00	0.98
EVWVL2448P	289	385	1	48	24	31.00	1.11
EVWVL2454P	327	433	1	54	24	35.00	1.23
EVWVL2460P	354	483	1	60	24	39.00	1.36
EVWVL2466P	392	528	1	66	24	43.00	1.49
EVWVL2472P	420	578	1	72	24	47.00	1.62
EVWVL3024P	174	239	1	24	30	19.00	0.74
EVWVL3030P	192	251	1	30	30	24.00	0.90
EVWVL3036P	229	289	1	36	30	29.00	1.06
EVWVL3042P	312	412	1	42	30	34.00	1.22
EVWVL3048P	327	433	1	48	30	39.00	1.38
EVWVL3054P	364	483	1	54	30	44.00	1.54
EVWVL3060P	391	528	1	60	30	49.00	1.69
EVWVL3066P	420	578	1	66	30	54.00	1.85
EVWVL3072P	451	626	1	72	30	59.00	2.01
EVWVL3078P	653	833	1	78	30	71.48	2.71
EVWVL3084P	833	850	1	84	30	76.98	2.91

EVWVR • Curvilinear Worksurface Right

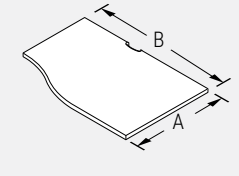

- When deepest end equals 24", the opposite depth is 18".
- When deepest end equals 30", the opposite depth is 24".
- Please choose from DWT - Designer White, SIL - Silver or BLK - Black for scoop covers.

NOTE: EVWV

24	36
A	B
DEPTH	WIDTH

PRODUCT CODE	PRICE		SIZE/ INCHES			WEIGHT VOL	
	LP	HP	H	W	D	LBS	FT ³
EVWVR2424P	172	233	1	24	24	15.00	0.59
EVWVR2430P	182	240	1	30	24	19.00	0.72
EVWVR2436P	217	289	1	36	24	23.00	0.85
EVWVR2442P	252	339	1	42	24	27.00	0.98
EVWVR2448P	289	385	1	48	24	31.00	1.11
EVWVR2454P	327	433	1	54	24	35.00	1.23
EVWVR2460P	354	483	1	60	24	39.00	1.36
EVWVR2466P	392	528	1	66	24	43.00	1.49
EVWVR2472P	420	578	1	72	24	47.00	1.62
EVWVR3024P	174	239	1	24	30	19.00	0.74
EVWVR3030P	192	251	1	30	30	24.00	0.90
EVWVR3036P	229	289	1	36	30	29.00	1.06
EVWVR3042P	312	412	1	42	30	34.00	1.22
EVWVR3048P	327	433	1	48	30	39.00	1.38
EVWVR3054P	364	483	1	54	30	44.00	1.54
EVWVR3060P	391	528	1	60	30	49.00	1.69
EVWVR3066P	420	578	1	66	30	54.00	1.85
EVWVR3072P	451	626	1	72	30	59.00	2.01
EVWVR3078P	653	833	1	78	30	71.48	2.71
EVWVR3084P	757	850	1	84	30	76.98	2.71

EVWNL • Notched Worksurface Left

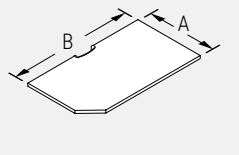

- When deepest end equals 24", the opposite depth is 18".
- When deepest end equals 30", the opposite depth is 24".
- The user edge is 6" shorter than the overall length.
- Please choose from DWT - Designer White, SIL - Silver or BLK - Black for scoop covers.

NOTE: EVWN

24	36
A	B
DEPTH	WIDTH

PRODUCT CODE	PRICE		SIZE/ INCHES			WEIGHT VOL	
	LP	HP	H	W	D	LBS	FT ³
EVWNL2424P	172	233	1	24	24	15.00	0.59
EVWNL2430P	182	240	1	30	24	19.00	0.72
EVWNL2436P	217	289	1	36	24	23.00	0.85
EVWNL2442P	252	339	1	42	24	27.00	0.98
EVWNL2448P	289	385	1	48	24	31.00	1.11
EVWNL2454P	327	433	1	54	24	35.00	1.23
EVWNL2460P	354	483	1	60	24	39.00	1.36
EVWNL2466P	392	528	1	66	24	43.00	1.49
EVWNL2472P	420	578	1	72	24	47.00	1.62
EVWNL3024P	174	239	1	24	30	19.00	0.74
EVWNL3030P	192	251	1	30	30	24.00	0.90
EVWNL3036P	229	289	1	36	30	29.00	1.06
EVWNL3042P	312	412	1	42	30	34.00	1.22
EVWNL3048P	327	433	1	48	30	39.00	1.38
EVWNL3054P	364	483	1	54	30	44.00	1.54
EVWNL3060P	391	528	1	60	30	49.00	1.69
EVWNL3066P	420	578	1	66	30	54.00	1.85
EVWNL3072P	451	626	1	72	30	59.00	2.01
EVWNL3078P	653	833	1	78	30	71.48	2.70
EVWNL3084P	833	850	1	84	30	76.98	2.92

EVWNR • Notched Worksurface Right

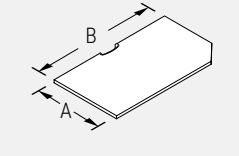

- When deepest end equals 24", the opposite depth is 18".
- When deepest end equals 30", the opposite depth is 24".
- The user edge is 6" shorter than the overall length.
- Please choose from DWT - Designer White, SIL - Silver or BLK - Black for scoop covers.

NOTE: EVWN

24	36
A	B
DEPTH	WIDTH

PRODUCT CODE	PRICE		SIZE/ INCHES			WEIGHT VOL	
	LP	HP	H	W	D	LBS	FT ³
EVWNR2424P	172	233	1	24	24	15.00	0.59
EVWNR2430P	182	240	1	30	24	19.00	0.72
EVWNR2436P	217	289	1	36	24	23.00	0.85
EVWNR2442P	252	339	1	42	24	27.00	0.98
EVWNR2448P	289	385	1	48	24	31.00	1.11
EVWNR2454P	327	433	1	54	24	35.00	1.23
EVWNR2460P	354	483	1	60	24	39.00	1.36
EVWNR2466P	392	528	1	66	24	43.00	1.49
EVWNR2472P	420	578	1	72	24	27.00	1.62
EVWNR3024P	174	239	1	24	24	19.00	0.74
EVWNR3030P	192	251	1	30	30	24.00	0.90
EVWNR3036P	229	289	1	36	30	29.00	1.06
EVWNR3042P	312	412	1	42	30	34.00	1.22
EVWNR3048P	327	433	1	48	30	39.00	1.38
EVWNR3054P	364	483	1	54	30	44.00	1.54
EVWNR3060P	391	528	1	60	30	49.00	1.69
EVWNR3066P	420	578	1	66	30	54.00	1.85
EVWNR3072P	451	626	1	72	30	59.00	2.01
EVWNR3078P	653	833	1	78	30	71.48	2.70
EVWNR3084P	833	850	1	84	30	76.98	2.92

EVWC4C • Corner Curved Worksurface For 45° Post

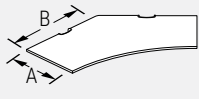

NOTE:
A= 18, 24, 30
B= 24, 30, 36, 42, 48

- "WG" at the end of the code indicates wood grain laminate on the diagonal.
- "WG" worksurface over 42" cannot be done on the diagonal.
- Support hardware must be ordered separately. See the listing in this section.
- Please choose from DWT - Designer White, SIL - Silver or BLK - Black for scoop covers.

PRODUCT CODE	PRICE		SIZE/ H	INCHES		WEIGHT VOL	
	LP	HP		W	D	LBS	FT ³
EVWC4C1824P	397	495	1	24	18	19.38	0.43
EVWC4C1830P	512	638	1	30	18	24.87	0.55
EVWC4C1836P	720	895	1	36	18	30.36	0.67
EVWC4C1842P	1166	1456	1	42	18	35.78	0.80
EVWC4C1848P	1358	1697	1	48	18	41.28	0.92
EVWC4C2424P	411	516	1	24	24	24.04	0.53
EVWC4C2430P	578	723	1	30	24	31.38	0.70
EVWC4C2436P	797	998	1	36	24	38.72	0.86
EVWC4C2442P	1166	1456	1	42	24	46.07	1.02
EVWC4C2448P	1527	1907	1	48	24	53.41	1.19
EVWC4C3024P	431	537	1	24	30	27.94	0.62
EVWC4C3030P	641	802	1	30	30	37.16	0.83
EVWC4C3036P	877	1094	1	36	30	46.38	1.03
EVWC4C3042P	1306	1638	1	42	30	55.60	1.24
EVWC4C3048P	1697	2121	1	48	30	64.82	1.44
EVWC4C1824WGP	595	743	1	24	18	19.38	0.43
EVWC4C1830WGP	768	957	1	30	18	24.87	0.55
EVWC4C1836WGP	1079	1343	1	36	18	30.36	0.67
EVWC4C1842WGP	1749	2184	1	42	18	35.78	0.80
EVWC4C2424WGP	617	774	1	24	24	24.04	0.53
EVWC4C2430WGP	867	1085	1	30	24	31.38	0.70
EVWC4C2436WGP	1197	1498	1	36	24	38.72	0.86
EVWC4C2442WGP	1749	2184	1	42	24	46.07	1.02
EVWC4C3024WGP	646	805	1	24	30	27.94	0.62
EVWC4C3030WGP	960	1203	1	30	30	37.16	0.83
EVWC4C3036WGP	1315	1640	1	36	30	46.38	1.03
EVWC4C3042WGP	1959	2456	1	42	30	55.60	1.24

EVWC4K • Keyboard Corner Worksurface For 45° Post

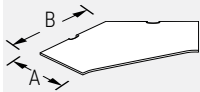

NOTE:
A= 18, 24, 30
B= 24, 30, 36, 42, 48

- "WG" at the end of the code indicates wood grain laminate on the diagonal.
- "WG" worksurface over 42" cannot be done on the diagonal.
- Support hardware must be ordered separately. See the listing in this section.
- Please choose from DWT - Designer White, SIL - Silver or BLK - Black for scoop covers.

PRODUCT CODE	PRICE		SIZE/ H	INCHES		WEIGHT VOL	
	LP	HP		W	D	LBS	FT ³
EVWC4K1824P	422	534	1	24	18	19.38	0.43
EVWC4K1830P	656	819	1	30	18	24.87	0.55
EVWC4K1836P	931	1168	1	36	18	30.36	0.67
EVWC4K1842P	1166	1456	1	42	18	35.78	0.80
EVWC4K1848P	1358	1697	1	48	18	41.28	0.92
EVWC4K2424P	509	636	1	24	24	24.04	0.53
EVWC4K2430P	762	955	1	30	24	31.38	0.70
EVWC4K2436P	1066	1332	1	36	24	38.72	0.86
EVWC4K2442P	1166	1456	1	42	24	46.07	1.02
EVWC4K2448P	1527	1907	1	48	24	53.41	1.19
EVWC4K3024P	593	744	1	24	30	27.94	0.62
EVWC4K3030P	942	1090	1	30	30	37.16	0.83
EVWC4K3036P	1066	1332	1	36	30	46.38	1.03
EVWC4K3042P	1306	1638	1	42	30	55.60	1.24
EVWC4K3048P	1697	2121	1	48	30	64.82	1.44
EVWC4K1824WGP	633	800	1	24	18	19.38	0.43
EVWC4K1830WGP	984	1229	1	30	18	24.87	0.55
EVWC4K1836WGP	1397	1752	1	36	18	30.36	0.67
EVWC4K1842WGP	1749	2184	1	42	18	35.78	0.80
EVWC4K2424WGP	763	954	1	24	24	24.04	0.53
EVWC4K2430WGP	1143	1433	1	30	24	31.38	0.70
EVWC4K2436WGP	1600	1997	1	36	24	38.72	0.86
EVWC4K2442WGP	1749	2184	1	42	24	46.07	1.02
EVWC4K3024WGP	891	1114	1	24	30	27.94	0.62
EVWC4K3030WGP	1414	1635	1	30	30	37.16	0.83
EVWC4K3036WGP	1600	1997	1	36	30	46.38	1.03
EVWC4K3042WGP	1959	2456	1	42	30	55.60	1.24

EVW4T • Corner Transaction Surface For 45° Post

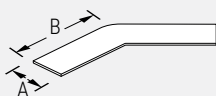

- Support hardware must be ordered separately. See the listing in this section.
- For use with laminate end and middle panels.

NOTE:
A= 15
B= 24, 30, 36, 42, 48

PRODUCT CODE	PRICE		SIZE/ H	INCHES		WEIGHT VOL	
	LP	HP		W	D	LBS	FT ³
EVW4T1524	582	726	1	24	15	19.14	0.43
EVW4T1530	726	909	1	30	15	23.78	0.53
EVW4T1536	1018	1272	1	36	15	28.39	0.63
EVW4T1542	1358	1697	1	42	15	32.99	0.73
EVW4T1548	1456	1817	1	48	15	37.58	0.84

EVWC6C • Corner Curved Worksurface For 60° Post

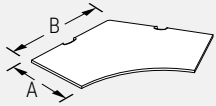

- "WG" at the end of the code indicates wood grain laminate on the diagonal.
- "WG" worksurface over 42" cannot be done on the diagonal.
- Support hardware must be ordered separately. See the listing in this section.
- Please choose from DWT - Designer White, SIL - Silver or BLK - Black for scoop covers.

NOTE:

A= 18, 24, 30

B= 24, 30, 36, 42, 48

PRODUCT CODE	PRICE		SIZE/ INCHES			WEIGHT VOL	
	LP	HP	H	W	D	LBS	FT ³
EVWC6C1824P	341	425	1	24	18	17.76	0.39
EVWC6C1830P	465	581	1	30	18	23.26	0.52
EVWC6C1836P	661	829	1	36	18	28.75	0.64
EVWC6C1842P	975	1073	1	42	18	34.17	0.76
EVWC6C1848P	1330	1464	1	48	18	39.66	0.88
EVWC6C2424P	354	446	1	24	24	21.25	0.47
EVWC6C2430P	508	631	1	30	24	28.59	0.64
EVWC6C2436P	712	892	1	36	24	35.94	0.80
EVWC6C2442P	1223	1340	1	42	24	43.28	0.96
EVWC6C2448P	1330	1464	1	48	24	50.63	1.13
EVWC6C3024P	372	465	1	24	30	23.72	0.53
EVWC6C3030P	544	683	1	30	30	32.94	0.73
EVWC6C3036P	762	954	1	36	30	42.16	0.94
EVWC6C3042P	1223	1340	1	42	30	51.38	1.14
EVWC6C3048P	1330	1464	1	48	30	60.60	1.35
EVWC6C1824WGP	512	638	1	24	18	17.76	0.39
EVWC6C1830WGP	697	871	1	30	18	23.26	0.52
EVWC6C1836WGP	993	1244	1	36	18	28.75	0.64
EVWC6C1842WGP	1464	1610	1	42	18	34.17	0.76
EVWC6C2424WGP	531	670	1	30	24	28.59	0.64
EVWC6C2430WGP	761	947	1	36	24	35.94	0.80
EVWC6C2436WGP	1067	1338	1	42	24	43.28	0.96
EVWC6C2442WGP	1833	2011	1	48	24	50.63	1.13
EVWC6C3024WGP	557	697	1	24	30	23.72	0.53
EVWC6C3030WGP	816	1025	1	30	30	32.94	0.73
EVWC6C3036WGP	1143	1431	1	36	30	42.16	0.94
EVWC6C3042WGP	1833	2011	1	42	30	51.38	1.14

EVWC6K • Keyboard Corner Worksurface For 60° Post

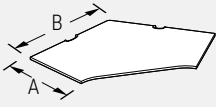

- "WG" at the end of the code indicates wood grain laminate on the diagonal.
- "WG" worksurface over 42" cannot be done on the diagonal.
- Support hardware must be ordered separately. See the listing in this section.
- Please choose from DWT - Designer White, SIL - Silver or BLK - Black for scoop covers.

NOTE:

A= 18, 24, 30

B= 24, 30, 36, 42, 48

PRODUCT CODE	PRICE		SIZE/ INCHES			WEIGHT VOL	
	LP	HP	H	W	D	LBS	FT ³
EVWC6K1824P	333	367	1	24	18	17.76	0.39
EVWC6K1830P	535	586	1	30	18	23.26	0.52
EVWC6K1836P	800	879	1	36	18	28.75	0.64
EVWC6K1842P	975	1073	1	42	18	34.17	0.76
EVWC6K1848P	1330	1464	1	48	18	39.66	0.88
EVWC6K2430P	709	783	1	30	24	28.59	0.64
EVWC6K2436P	800	879	1	36	24	35.94	0.80
EVWC6K2442P	975	1073	1	42	24	43.28	0.96
EVWC6K2448P	1330	1464	1	48	24	50.63	1.13
EVWC6K3030P	709	783	1	30	30	32.94	0.73
EVWC6K3036P	796	1029	1	36	30	42.16	0.94
EVWC6K3042P	1089	1411	1	42	30	51.38	1.14
EVWC6K3048P	1323	1719	1	48	30	60.60	1.35
EVWC6K1824WGP	500	551	1	24	18	17.76	0.39
EVWC6K1830WGP	802	879	1	30	18	23.26	0.52
EVWC6K1836WGP	1200	1317	1	36	18	28.75	0.64
EVWC6K1842WGP	1464	1610	1	42	18	34.17	0.76
EVWC6K2430WGP	1062	1174	1	30	24	28.59	0.64
EVWC6K2436WGP	1200	1317	1	36	24	35.94	0.80
EVWC6K2442WGP	1464	1610	1	42	24	43.28	0.96
EVWC6K3030WGP	1062	1174	1	30	30	32.94	0.73
EVWC6K3036WGP	1195	1543	1	36	30	42.16	0.94
EVWC6K3042WGP	1634	2116	1	42	30	51.38	1.14

EVW6T • Corner Transaction Surface For 60° Post

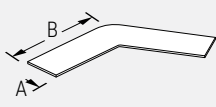

- Support hardware must be ordered separately. See the listing in this section.
- For use with laminate end and middle panels.

NOTE:

A= 15

B= 24, 30, 36, 42, 48

PRODUCT CODE	PRICE		SIZE/ INCHES			WEIGHT VOL	
	LP	HP	H	W	D	LBS	FT ³
EVW6T1518	340	435	1	18	15	14.53	0.32
EVW6T1524	536	691	1	24	15	19.17	0.43
EVW6T1530	694	898	1	30	15	23.78	0.53
EVW6T1536	969	1257	1	36	15	28.39	0.63
EVW6T1542	1055	1366	1	42	15	32.97	0.73
EVW6T1548	1378	1785	1	48	15	34.17	0.76

EVWCC • Corner Curved Worksurface

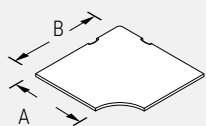

- "WG" at the end of the code indicates wood grain laminate on the diagonal.
- "WG" worksurface over 42" cannot be done on the diagonal.
- Please choose from DWT - Designer White, SIL - Silver or BLK - Black for scoop covers.

NOTE: EVWCC

18	36
A	B
DEPTH	WIDTH

PRODUCT CODE	PRICE		SIZE/ H	INCHES			WEIGHT VOL	
	LP	HP		W	D	LBS	FT ³	
EVWCC3618P	397	495	1	36	18	24.00	1.27	
EVWCC3624P	439	548	1	36	24	30.00	1.47	
EVWCC4224P	591	736	1	42	24	47.00	1.70	
EVWCC4230P	607	759	1	42	30	53.00	1.98	
EVWCC4824P	688	857	1	48	24	53.00	2.67	
EVWCC4830P	688	857	1	48	30	55.00	2.67	
EVWCC3618WGP	441	567	1	36	18	19.80	0.75	
EVWCC3624WGP	485	625	1	36	24	30.00	1.47	
EVWCC4224WGP	657	845	1	42	24	47.00	1.70	
EVWCC4230WGP	712	916	1	42	30	53.00	1.96	

EVWCKK • Corner Worksurface with Curved Keyboard Support

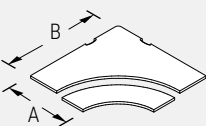

- Keyboard mechanism is included.
- Must be supported with two 24" Cantilevers and 2 Flat Brackets (ordered separately).
- "WG" worksurface over 42" cannot be done on the diagonal.
- "WG" at the end of the code indicates wood grain laminate on the diagonal.
- Keyboard Support is 11" deep, adjusts 6" above and 6" below surface with a positive/negative tilt (+15° to -15°).
- Please choose from DWT - Designer White, SIL - Silver or BLK - Black for scoop covers.

NOTE: EVWCC

24	42
A	B
DEPTH	WIDTH

PRODUCT CODE	PRICE		SIZE/ H	INCHES			WEIGHT VOL	
	LP	HP		W	D	LBS	FT ³	
EVWCKK4224P	1238	1374	1	42	24	38.00	0.95	
EVWCKK4230P	1315	1466	1	42	30	42.00	1.15	
EVWCKK4824P	1389	1560	1	48	24	48.00	1.55	
EVWCKK4830P	1424	1605	1	48	30	50.00	1.65	
EVWCKK4224WGP	1329	1502	1	42	24	38.00	0.95	
EVWCKK4230WGP	1422	1606	1	42	30	42.00	1.15	

EVWCK • Corner Keyboard Worksurface

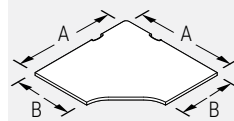

- "WG" at the end of the code indicates wood grain laminate on the diagonal.
- "WG" worksurface over 42" cannot be done on the diagonal.
- Please choose from DWT - Designer White, SIL - Silver or BLK - Black for scoop covers.

NOTE: EVWC

24	36
A	B
DEPTH	WIDTH

PRODUCT CODE	PRICE		SIZE/ H	INCHES			WEIGHT VOL	
	LP	HP		W	D	LBS	FT ³	
EVWCK3618P	388	484	1	36	18	39.59	1.50	
EVWCK3624P	430	536	1	36	24	39.59	1.50	
EVWCK4224P	570	714	1	42	24	53.89	2.04	
EVWCK4230P	589	734	1	42	30	53.89	2.04	
EVWCK4824P	660	827	1	48	24	70.39	2.67	
EVWCK4830P	660	827	1	48	30	70.39	2.67	
EVWCK3618WGP	441	550	1	36	18	34.00	1.27	
EVWCK3624WGP	484	605	1	36	24	45.00	1.69	
EVWCK4224WGP	655	817	1	42	24	47.00	1.70	
EVWCK4230WGP	707	884	1	42	30	58.00	2.12	

EVWCF • Five Sided Worksurface

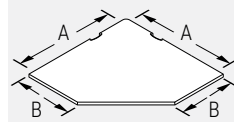

- "WG" at the end of the code indicates wood grain laminate on the diagonal.
- "WG" worksurface over 42" cannot be done on the diagonal.
- Please choose from DWT - Designer White, SIL - Silver or BLK - Black for scoop covers.

NOTE: EVWC

24	36
A	B
DEPTH	WIDTH

PRODUCT CODE	PRICE		SIZE/ H	INCHES			WEIGHT VOL	
	LP	HP		W	D	LBS	FT ³	
EVWCF3012P	259	320	1	30	24	11.00	0.42	
EVWCF3612P	341	425	1	36	24	13.20	0.50	
EVWCF3618P	341	425	1	36	18	19.80	0.75	
EVWCF3624P	354	446	1	36	24	26.40	1.00	
EVWCF4224P	503	627	1	42	24	30.79	1.17	
EVWCF4230P	517	652	1	42	30	38.49	1.46	
EVWCF4824P	567	707	1	48	24	35.19	1.33	
EVWCF4830P	596	747	1	48	30	43.99	1.67	
EVWCF3618WGP	441	567	1	36	18	34.00	1.27	
EVWCF3624WGP	485	625	1	36	24	45.00	1.69	
EVWCF4224WGP	657	845	1	42	24	47.00	1.70	
EVWCF4230WGP	712	916	1	42	30	58.75	2.12	

EVWKKR • Angle Front Edge Worksurface

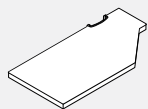

- To be used with EVWCF3012SCP & EVWCF3612SCP Corner Worksurface
- Creates efficient, compact keyboard corner workstation
- For use with flat screen monitors
- Please choose from DWT - Designer White, SIL - Silver or BLK - Black for scoop covers.

PRODUCT CODE	PRICE		SIZE/ INCHES			WEIGHT VOL	
	LP	HP	H	W	D	LBS	FT ³
EVWKKR2448P	251	313	1	48	24	35.00	1.11
EVWKKL2448P	251	313	1	48	24	35.00	1.11
EVWKKR2442P	219	275	1	42	24	31.00	0.98
EVWKKL2442P	219	275	1	42	24	31.00	0.98
EVWKKR2436P	190	236	1	36	24	26.00	0.85
EVWKKL2436P	190	236	1	36	24	26.00	0.85

EVWCC • Non-Symmetrical Corner Curved Worksurface

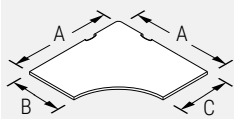

- Please specify starting at the first "A" on the left side and then continuing clockwise.
- "WG" worksurface over 42" cannot be done on the diagonal.
- Please choose from DWT - Designer White, SIL - Silver or BLK - Black for scoop covers.

NOTE: EVWCC

36	36	18	24
A	A	B	C
WIDTH	WIDTH	DEPTH	DEPTH

PRODUCT CODE	PRICE		SIZE/ INCHES			WEIGHT VOL	
	LP	HP	W(A)	D(B)	D(C)	LBS	FT ³
EVWCC36361824P	439	665	36	18	24	30.00	1.47
EVWCC36362418P	439	665	36	24	18	30.00	1.47
EVWCC36362430P	516	699	36	24	30	30.00	1.47
EVWCC36363024P	516	699	36	30	24	30.00	1.47
EVWCC42421824P	591	736	42	18	24	53.89	2.04
EVWCC42422418P	591	736	42	24	18	53.89	2.04
EVWCC42422430P	607	759	42	24	30	53.89	2.04
EVWCC42423024P	607	759	42	30	24	53.89	2.04
EVWCC48482430P	688	857	48	24	30	70.38	2.66
EVWCC48483024P	688	857	48	30	24	70.38	2.66
EVWCC36361824WGP	548	697	36	18	24	30.00	1.47
EVWCC36362418WGP	548	697	36	24	18	30.00	1.47
EVWCC36362430WGP	579	736	36	24	30	30.00	1.47
EVWCC36363024WGP	579	736	36	30	24	30.00	1.47
EVWCC42421824WGP	666	865	42	18	24	53.89	2.04
EVWCC42422418WGP	666	865	42	24	18	53.89	2.04
EVWCC42422430WGP	722	928	42	24	30	53.89	2.04
EVWCC42423024WGP	722	928	42	30	24	53.89	2.04

EVWCK • Non-Symmetrical Corner Keyboard Worksurface

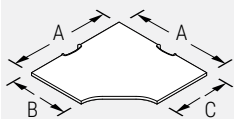

- Please specify starting at the first "A" on the left side and then continuing clockwise
- "WG" worksurface over 42" cannot be done on the diagonal.
- Please choose from DWT - Designer White, SIL - Silver or BLK - Black for scoop covers.

NOTE: EVWCC

36	36	18	24
A	A	B	C
WIDTH	WIDTH	DEPTH	DEPTH

PRODUCT CODE	PRICE		SIZE/INCHES			WEIGHT VOL	
	LP	HP	W(A)	D(B)	D(C)	LBS	FT ³
EVWCK36361824P	450	683	36	18	24	39.59	1.50
EVWCK36362418P	450	683	36	24	24	39.59	1.50
EVWCK42421824P	600	749	42	18	24	53.89	2.04
EVWCK42422418P	600	749	42	24	18	53.89	2.04
EVWCK42422430P	619	773	42	24	30	53.89	2.04
EVWCK42423024P	619	773	42	30	24	53.89	2.04
EVWCK48482430P	694	868	48	24	30	70.38	2.66
EVWCK48483024P	694	868	48	30	24	70.38	2.66
EVWCK36361824WGP	537	755	36	18	24	39.59	1.50
EVWCK36362418WGP	537	755	36	24	24	39.59	1.50
EVWCK42421824WGP	666	865	42	18	24	53.89	2.04
EVWCK42422418WGP	666	865	42	24	18	53.89	2.04
EVWCK42422430WGP	733	952	42	24	30	53.89	2.04
EVWCK42423024WGP	733	952	42	30	24	53.89	2.04

EVWCF • Non-Symmetrical Five Sided Worksurface

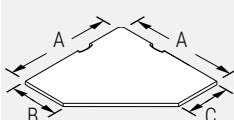

- Please specify starting at the first "A" on the left side and then continuing clockwise.
- "WG" worksurface over 42" cannot be done on the diagonal.
- Please choose from DWT - Designer White, SIL - Silver or BLK - Black for scoop covers.

NOTE: EVWCC

36	36	18	24
A	A	B	C
WIDTH	WIDTH	DEPTH	DEPTH

PRODUCT CODE	PRICE		SIZE/INCHES			WEIGHT VOL	
	LP	HP	W(A)	D(B)	D(C)	LBS	FT ³
EVWCF36361824P	418	638	36	18	24	30.00	1.47
EVWCF36362418P	418	638	36	24	18	30.00	1.47
EVWCF36362430P	439	665	36	24	30	30.00	1.47
EVWCF36363024P	439	665	36	30	24	30.00	1.47
EVWCF42421824P	503	692	42	18	24	53.89	2.04
EVWCF42422418P	503	692	42	24	18	53.89	2.04
EVWCF42422430P	577	754	42	24	30	53.89	2.04
EVWCF42423024P	577	754	42	30	24	53.89	2.04
EVWCF48482430P	629	837	48	24	30	70.38	2.66
EVWCF48483024P	629	837	48	30	24	70.38	2.66
EVWCF36361824WGP	557	723	36	18	24	30.00	1.47
EVWCF36362418WGP	557	723	36	24	18	30.00	1.47
EVWCF36362430WGP	592	780	36	24	30	30.00	1.47
EVWCF36363024WGP	592	780	36	30	24	30.00	1.47
EVWCF42421824WGP	602	779	42	18	24	53.89	2.04
EVWCF42422418WGP	602	779	42	24	18	53.89	2.04
EVWCF42422430WGP	629	817	42	24	30	53.89	2.04
EVWCF42423024WGP	629	817	42	30	24	53.89	2.04

EVWL • “L” Worksurface

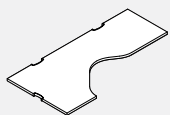

- There are three cable scoops on this worksurface.
- Wood grain laminate not available on the diagonal.
- Must be specified either left or right.
- Please choose from DWT - Designer White, SIL - Silver or BLK - Black for scoop covers.

PRODUCT CODE	PRICE		SIZE/INCHES			WEIGHT VOL	
	LP	HP	H	W	D	LBS	FT ³
EVWLL2472P	737	922	1	72	24	73.00	2.70
EVWLR2472P	737	922	1	72	24	73.00	2.70

EVWBTL • Transition Worksurface

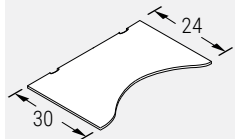

Left Hand Shown

- Support hardware must be ordered separately. See the listing in this section of the price list.
- Opposing side of 30" deep Transition Worksurface has depth of 24".
- Scoops located on back edge only.
- Must be specified as right or left handed.
- Please choose from DWT - Designer White, SIL - Silver or BLK - Black for scoop covers.

PRODUCT CODE	PRICE		SIZE/INCHES			WEIGHT VOL	
	LP	HP	W	D	D2	LBS	FT ³
EVWBTL3060P	561	698	60	30	24	54.99	2.08
EVWBTL3066P	619	770	66	30	24	60.49	2.29
EVWBTL3072P	671	842	72	30	24	65.99	2.50
EVWBTR3060P	561	698	60	30	24	54.99	2.08
EVWBTR3066P	614	770	66	30	24	60.49	2.29
EVWBTR3072P	671	842	72	30	24	60.49	2.29

EVWBTL • Transition Worksurface

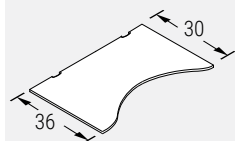

Left Hand Shown

- Support hardware must be ordered separately. See the listing in this section of the price list.
- Opposing side of 36" deep Transition Worksurface has depth of 30".
- Scoops located on back edge only.
- Must be specified as right or left handed.
- Please choose from DWT - Designer White, SIL - Silver or BLK - Black for scoop covers.

PRODUCT CODE	PRICE		SIZE/ INCHES			WEIGHT VOL	
	LP	HP	W	D	D2	LBS	FT ³
EVWBTL3660P	671	857	60	36	30	65.99	2.50
EVWBTL3666P	737	925	66	36	30	72.59	2.75
EVWBTL3672P	805	1007	72	36	30	79.19	3.00
EVWBTR3660P	671	842	60	36	30	65.99	2.50
EVWBTR3666P	737	925	66	36	30	72.59	2.75
EVWBTR3672P	805	1007	72	36	30	79.19	3.00

EVWCEL • Extended Curved Corner - Left

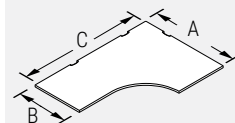

- For 48" wide ("C" dimension) worksurfaces, there are two cable scoops, all others have three.
- Wood grain laminate not available on the diagonal.
- Please choose from DWT - Designer White, SIL - Silver or BLK - Black for scoop covers.

NOTE: EVWCE

36	24	72
A	B	C
DEPTH	DEPTH	WIDTH

PRODUCT CODE	PRICE		SIZE/ INCHES			WEIGHT VOL	
	LP	HP	A	B	C	LBS	FT ³
EVWCEL362448P	600	744	36	24	48	43.92	1.25
EVWCEL362460P	655	816	36	24	60	52.79	1.50
EVWCEL362466P	721	895	36	24	66	57.18	1.62
EVWCEL362472P	796	994	36	24	72	61.58	1.75
EVWCEL362478P	850	1062	36	24	78	65.98	1.87
EVWCEL362484P	917	1143	36	24	84	70.38	2.00
EVWCEL422460P	688	857	42	24	60	57.18	1.63
EVWCEL422466P	758	947	42	24	66	61.58	1.57
EVWCEL422472P	835	1045	42	24	72	65.98	1.87
EVWCEL422478P	893	1117	42	24	78	70.38	2.00
EVWCEL422484P	962	1201	42	24	84	74.78	2.00
EVWCEL423060P	775	970	42	30	60	63.78	1.82
EVWCEL423066P	850	1062	42	30	66	69.28	1.96
EVWCEL423072P	929	1160	42	30	72	74.78	2.12
EVWCEL423078P	996	1243	42	30	78	80.28	2.28
EVWCEL423084P	1062	1326	42	30	84	85.78	2.43
EVWCEL482460P	786	984	48	24	60	65.18	1.90
EVWCEL482466P	874	1092	48	24	66	69.78	3.66
EVWCEL482472P	956	1197	48	24	72	76.18	1.95
EVWCEL482478P	1021	1273	48	24	78	74.78	1.20
EVWCEL482484P	1083	1352	48	24	84	123.17	4.66
EVWCEL483060P	874	1092	48	30	60	68.18	1.93
EVWCEL483066P	956	1197	48	30	66	73.68	2.09
EVWCEL483072P	1021	1273	48	30	72	79.18	2.25
EVWCEL483078P	1083	1352	48	30	78	84.68	2.40
EVWCEL483084P	1158	1450	48	30	84	90.18	2.56

EVWCER • Extended Curved Corner - Right

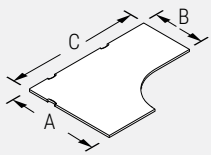

- For 48" wide ("C" dimension) worksurfaces, there are two cable scoops, all others have three finishes.
- Wood grain laminate not available on the diagonal.
- Please choose from DWT - Designer White, SIL - Silver or BLK - Black for scoop covers.

NOTE: EVWCE

36	24	72
A	B	C
DEPTH	DEPTH	WIDTH

PRODUCT CODE	PRICE		SIZE/ INCHES			WEIGHT VOL	
	LP	HP	A	B	C	LBS	FT ³
EVWCER362448P	600	744	36	24	48	43.92	1.25
EVWCER362460P	655	816	36	24	60	52.79	1.50
EVWCER362466P	721	895	36	24	66	57.18	1.62
EVWCER362472P	796	994	36	24	72	61.58	1.75
EVWCER362478P	850	1062	36	24	78	65.98	1.87
EVWCER362484P	917	1143	36	24	84	70.38	2.00
EVWCER422460P	688	857	42	24	60	57.18	1.63
EVWCER422466P	758	947	42	24	66	61.58	1.57
EVWCER422472P	835	1045	42	24	72	65.98	1.87
EVWCER422478P	893	1117	42	24	78	70.38	2.00
EVWCER422484P	962	1201	42	24	84	74.78	2.00
EVWCER423060P	775	970	42	30	60	63.78	1.82
EVWCER423066P	850	1062	42	30	66	69.28	1.96
EVWCER423072P	929	1160	42	30	72	74.78	2.12
EVWCER423078P	996	1243	42	30	78	80.28	2.28
EVWCER423084P	1062	1326	42	30	84	85.78	2.43
EVWCER482460P	786	984	48	24	60	65.18	1.90
EVWCER482466P	874	1092	48	24	66	96.78	3.66
EVWCER482472P	956	1197	48	24	72	76.18	1.95
EVWCER482478P	1021	1273	48	24	78	74.78	1.20
EVWCER482484P	1083	1352	48	24	84	123.17	4.66
EVWCER483060P	874	1092	48	30	60	68.18	1.93
EVWCER483066P	956	1197	48	30	66	73.68	2.09
EVWCER483072P	1021	1273	48	30	72	79.18	2.25
EVWCER483078P	1083	1352	48	30	78	84.68	2.40
EVWCER483084P	1158	1450	48	30	84	90.18	2.56

EVWH • Hatchet Worksurface

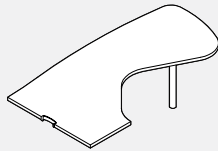

- Cable scoop is in the middle of the 36" wide edge.
- Wood grain laminate not available on the diagonal.
- Must be specified either left or right.
- Includes monoleg.
- Please choose from DWT - Designer White, SIL - Silver or BLK - Black for scoop covers.

Right Hand Shown

PRODUCT CODE	PRICE		SIZE/ INCHES			WEIGHT VOL	
	LP	HP	H	W	D	LBS	FT ³
EVWHL3672P	1079	1299	1	72	30	73.00	2.70
EVWHR3672P	1079	1299	1	72	30	73.00	2.70

EVWSH • Hatchet Worksurface - Straight Front

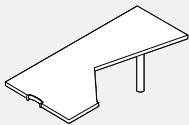

- Cable scoop is in the middle of the 36" wide edge.
- Wood grain laminate not available on the diagonal.
- Support hardware must be ordered separately.
- Must be specified either left or right.
- Includes monoleg.
- Please choose from DWT - Designer White, SIL - Silver or BLK - Black for scoop covers.

Right Hand Shown

PRODUCT CODE	PRICE		SIZE/ INCHES			WEIGHT VOL	
	LP	HP	H	W	D	LBS	FT ³
EVWSHL3672P	1027	1236	1	72	30	73.00	2.70
EVWSHR3672P	1027	1236	1	72	30	73.00	2.70

EVWD • "D" Worksurface

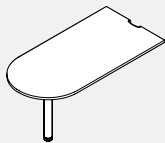

- Cable scoop is at the centre of the end.
- Includes monoleg.
- Please choose from DWT - Designer White, SIL - Silver or BLK - Black for scoop covers.

PRODUCT CODE	PRICE		SIZE/ INCHES			WEIGHT VOL	
	LP	HP	H	W	D	LBS	FT ³
EVWD2442P	569	659	1	42	24	28.00	0.98
EVWD2448P	593	693	1	48	24	32.00	1.11
EVWD2460P	623	725	1	60	24	40.00	1.36
EVWD2472P	661	779	1	72	24	48.00	1.61
EVWD3048P	596	695	1	48	30	39.00	1.37
EVWD3060P	665	780	1	60	30	49.00	1.69
EVWD3072P	731	864	1	72	30	59.00	2.01

EVWPT • “P” Top Worksurface

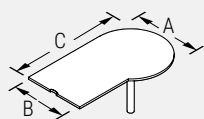

Left Hand Shown

- Cable scoop is at the center of the panel with edge.
- Must be specified either left or right.
- Includes monoleg.
- Please choose from DWT - Designer White, SIL - Silver or BLK - Black for scoop covers.

NOTE: EVWCE

24	60	30
A	B	C
DEPTH	DEPTH	WIDTH

PRODUCT CODE	PRICE		SIZE/ INCHES			WEIGHT VOL	
	LP	HP	H	W	D	LBS	FT ³
EVWPTL245430P	773	938	1	54	24	39.50	1.50
EVWPTL246030P	829	992	1	60	24	54.99	2.08
EVWPTL246630P	846	1074	1	66	24	60.48	2.29
EVWPTL247230P	894	1121	1	72	24	65.98	2.50
EVWPTL306036P	916	1140	1	60	30	65.98	2.50
EVWPTL306636P	992	1182	1	66	30	72.58	2.75
EVWPTL307236P	1034	1236	1	72	30	79.00	2.41
EVWPTR245430P	773	938	1	54	24	39.50	1.50
EVWPTR246030P	829	992	1	60	24	54.99	2.08
EVWPTR246630P	846	1074	1	66	24	60.48	2.29
EVWPTR247230P	894	1121	1	72	24	65.98	2.50
EVWPTR306036P	916	1140	1	60	30	65.98	2.50
EVWPTR306636P	992	1182	1	66	30	72.58	2.75
EVWPTR307236P	1034	1236	1	72	30	79.00	2.41

EVWW • Wedge Worksurface

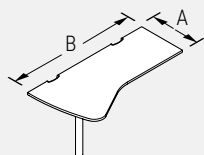

Left Hand Shown

- Two cable scoops on the back side of worksurface.
- Must be specified either left or right.
- Includes monoleg.
- Conference end is 10" wider than "A".
- Please choose from DWT - Designer White, SIL - Silver or BLK - Black for scoop covers.

NOTE: EVWC

18	48
A	B
DEPTH	WIDTH

PRODUCT CODE	PRICE		SIZE/ INCHES			WEIGHT VOL	
	LP	HP	H	W	D	LBS	FT ³
EVWWL2460P	653	761	1	60	24	51.99	1.81
EVWWL2466P	691	812	1	66	24	56.39	1.98
EVWWL2472P	727	863	1	72	24	60.79	2.15
EVWWL2478P	817	1022	1	78	24	65.18	2.31
EVWWL2484P	829	1035	1	84	24	69.58	2.48
EVWWL3060P	752	886	1	60	30	62.99	2.23
EVWWL3066P	800	951	1	66	30	68.44	2.44
EVWWL3072P	851	1012	1	72	30	73.98	2.65
EVWWR2460P	653	761	1	60	24	51.99	1.81
EVWWR2466P	691	812	1	66	24	56.39	1.98
EVWWR2472P	727	863	1	72	24	60.79	2.15
EVWWR2478P	817	1022	1	78	24	65.18	2.31
EVWWR2484P	829	1035	1	84	24	69.58	2.48
EVWWR3060P	752	886	1	60	30	62.99	2.23
EVWWR3066P	800	951	1	66	30	68.44	2.44
EVWWR3072P	851	1012	1	72	30	73.98	2.65

EVWPL • Piano Top Worksurface Left

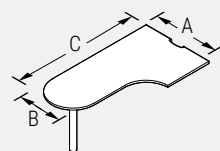

Left Hand Shown

- Cable scoop is at the center of the panel with edge.
- Must be specified either left or right.
- Includes monoleg.
- Works with EVWMP modesty.
- Please choose from DWT - Designer White, SIL - Silver or BLK - Black for scoop covers.

NOTE: EVWP

36	18	48
A	B	C
DEPTH	DEPTH	WIDTH

PRODUCT CODE	PRICE		SIZE/ INCHES			WEIGHT VOL	
	LP	HP	H	W	D	LBS	FT ³
EVWPL361848P	727	863	1	48	36	52.79	2.00
EVWPL361854P	773	916	1	54	36	59.39	2.25
EVWPL361860P	813	969	1	60	36	65.99	2.50
EVWPL361866P	857	1022	1	66	36	72.59	2.75
EVWPL361872P	896	1072	1	72	36	79.18	3.00
EVWPL362448P	736	868	1	48	24	52.79	2.75
EVWPL362454P	778	920	1	54	24	59.39	2.25
EVWPL362460P	823	973	1	60	24	65.58	1.68
EVWPL362466P	863	1026	1	66	24	73.00	2.23
EVWPL362472P	903	1078	1	72	24	79.18	3.00
EVWPL422454P	833	992	1	54	42	69.29	2.63
EVWPL422460P	883	1052	1	60	42	75.58	1.88
EVWPL422466P	930	1112	1	66	42	85.68	3.21
EVWPL422472P	975	1170	1	72	42	92.38	3.51
EVWPL423060P	897	1073	1	60	42	76.99	2.92
EVWPL423066P	952	1139	1	66	42	84.68	3.21
EVWPL423072P	1000	1199	1	72	42	92.38	3.50
EVWPL482460P	1001	1201	1	60	48	87.98	3.33
EVWPL482466P	1062	1275	1	66	48	87.98	3.33
EVWPL482472P	1121	1351	1	72	48	105.58	4.00
EVWPL483066P	1065	1284	1	66	48	96.78	3.66
EVWPL483072P	1125	1355	1	72	48	105.58	4.00

EVWPR • Piano Top Worksurface Right

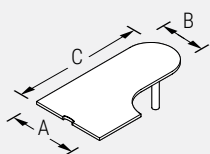

Right Hand Shown

- Cable scoop is at the center of the panel with edge.
- Must be specified either left or right.
- Includes monoleg.
- Works with EVWMP modesty.
- Please choose from DWT - Designer White, SIL - Silver or BLK - Black for scoop covers.

NOTE: EVWP

36	18	48
A	B	C
DEPTH	DEPTH	WIDTH

PRODUCT CODE	PRICE		SIZE/ INCHES			WEIGHT LBS	VOL FT ³
	LP	HP	H	W	D		
EVWPR361848P	727	863	1	48	36	52.79	2.00
EVWPR361854P	773	916	1	54	36	59.39	2.25
EVWPR361860P	813	969	1	60	36	65.99	2.50
EVWPR361866P	857	1022	1	66	36	72.59	2.75
EVWPR361872P	896	1072	1	72	36	79.18	3.00
EVWPR362448P	736	868	1	48	24	52.79	2.75
EVWPR362454P	778	920	1	54	24	59.39	2.25
EVWPR362460P	823	973	1	60	24	65.58	1.68
EVWPR362466P	863	1026	1	66	24	73.00	2.23
EVWPR362472P	903	1078	1	72	24	79.18	3.00
EVWPR422454P	833	992	1	54	42	69.29	2.63
EVWPR422460P	883	1052	1	60	42	75.58	1.88
EVWPR422466P	930	1112	1	66	42	85.68	3.21
EVWPR422472P	975	1170	1	72	42	92.38	2.27
EVWPR423060P	897	1073	1	60	42	76.99	2.92
EVWPR423066P	952	1139	1	66	42	84.68	3.21
EVWPR423072P	1000	1199	1	72	42	92.38	3.50
EVWPR482460P	1001	1201	1	60	48	87.98	2.25
EVWPR482466P	1062	1275	1	66	48	78.00	3.66
EVWPR482472P	1121	1351	1	72	48	105.58	4.00
EVWPR483066P	1065	1284	1	66	48	96.78	3.66
EVWPR483072P	1125	1355	1	72	48	105.58	4.00

EVWQR/L • Quarter Round Panel Worksurface



Left Hand Shown

- The worksurface edge running along the panel face is a slightly different length than that of the worksurface end, causing the surface to be handed.
- The user edge abutting the adjacent worksurface runs straight for 3" before starting to curve.

PRODUCT CODE	PRICE		SIZE/ INCHES			WEIGHT LBS	VOL FT ³
	LP	HP	H	W	D		
EVWQRL1818	139	174	1	18	18	9	0.30
EVWQRL2424	200	247	1	24	24	16	0.52
EVWQRL3030	259	320	1	30	30	25	0.81
EVWQRR1818	139	174	1	18	18	9	0.30
EVWQRR2424	200	247	1	24	24	16	0.52
EVWQRR3030	259	320	1	30	30	25	0.81

EVWQRC • Quarter Round Panel Corner Worksurface



- Wraps around a 90° corner post.
- Putting the adjacent worksurface runs straight for 3" before starting to curve.

PRODUCT CODE	PRICE		SIZE/ INCHES			WEIGHT LBS	VOL FT ³
	LP	HP	H	W	D		
EVWQRC1818	162	202	1	21	21	12.00	0.38
EVWQRC2424	235	293	1	27	27	17.00	0.58
EVWQRC3030	289	364	1	33	33	25.50	0.86

EVWMP • Worksurface Modesty Panel

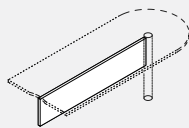

- Modesty panel fastens to the worksurface and Monoleg to provide additional privacy and support.
- Made of cold rolled steel and is epoxy powder coated.
- For "D", Hatchet and Piano Top Worksurfaces only (ordered separately).

PRODUCT CODE	PRICE		SIZE/ INCHES			WEIGHT LBS	VOL FT ³
	LP	HP	H	W	D		
EVWMP1242	134		13	26	1	4.00	0.22
EVWMP1248	151		13	32	1	5.00	0.25
EVWMP1260	174		13	44	1	6.00	0.30
EVWMP1272	225		13	56	1	8.00	2.00

EVWR • Radius Worksurface

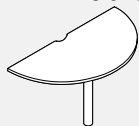

- Rounded worksurface for conferencing provides a radius corner from a worksurface to worksurface.
- 18" and 24" come with one monoleg and 30" comes with two monolegs.
- Radius cut out on the straight edge allows space for trims.
- Please choose from DWT - Designer White, SIL - Silver or BLK - Black for scoop covers.

PRODUCT CODE	PRICE		SIZE/ INCHES			WEIGHT LBS	VOL FT ³
	LP	HP	H	W	D		
EVWR18P	503	578	29	39	19.5	24.00	0.74
EVWR24P	577	668	29	51	25.5	34.00	1.16
EVWR30P	969	1108	29	63	31.5	51.00	1.76

EVTTE • Teardrop Extension Table



- Stand-alone mobile table.

PRODUCT CODE	PRICE		SIZE/ INCHES			WEIGHT LBS	VOL FT ³
	LP	HP	H	W	D		
EVTTE29247	494	579	27	29	29	30.00	15.00
EVTTE34307	542	636	27	34	34	35.00	18.00
EVTTE29249	581	666	29	29	29	30.00	19.00
EVTTE34309	629	724	29	34	34	35.00	19.00

EVWT • Straight Transaction Surface

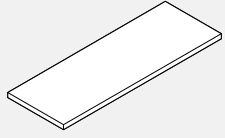

- Support hardware must be ordered separately.
- All tops are thermally fused 1" thick with pilot holes to enable proper alignment with worksurface supports. Wood screws must be used.
- Evolve worksurfaces feature a 3mm edge.

PRODUCT CODE	PRICE		SIZE/ INCHES			WEIGHT VOL	
	LP	HP	H	W	D	LBS	FT ³
EVWT1512	60	77	1	12	15	6.00	0.22
EVWT1518	74	102	1	18	15	8.00	0.30
EVWT1524	93	124	1	24	15	10.00	0.38
EVWT1530	112	146	1	30	15	13.00	0.46
EVWT1536	128	170	1	36	15	15.00	0.54
EVWT1542	146	194	1	42	15	18.00	0.62
EVWT1548	166	217	1	48	15	20.00	0.70
EVWT1554	178	239	1	54	15	23.00	0.78
EVWT1560	199	263	1	60	15	25.00	0.86
EVWT1566	213	284	1	66	15	29.00	0.94
EVWT1572	234	307	1	72	15	30.00	1.02
EVWT1578	249	333	1	78	15	32.00	1.10
EVWT1584	267	353	1	84	15	35.00	1.18

EVWTV • Straight Transaction Surface with Cut-out

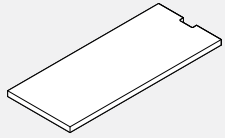

- Used where a transaction surface butts up against a taller panel

PRODUCT CODE	PRICE		SIZE/ INCHES			WEIGHT VOL	
	LP	HP	H	W	D	LBS	FT ³
EVWTV1524	104	134	1	24	15	10.00	0.38
EVWTV1530	126	160	1	30	15	13.00	0.46
EVWTV1536	139	180	1	36	15	15.00	0.54
EVWTV1542	160	204	1	42	15	18.00	0.62
EVWTV1548	176	231	1	48	15	20.57	0.70
EVWTV1554	192	251	1	54	15	22.57	0.75
EVWTV1560	210	275	1	60	15	26.00	0.92
EVWTV1566	229	298	1	66	15	28.00	1.00
EVWTV1572	245	319	1	72	15	30.00	1.08

EVWTCL • "L" Corner Transaction Surface

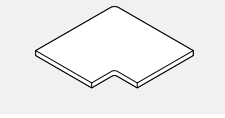

- Used where two panels meet at a 90° angle.
- For Wood Grain Laminate, use code ending with "WG".

PRODUCT CODE	PRICE		SIZE/ INCHES			WEIGHT VOL	
	LP	HP	H	W	D	LBS	FT ³
EVWTCL90	171	212	1	21	15	12.00	0.75
EVWTCL90WG	208	261	1	21	15	12.00	0.75

EVWTCT • "T" Corner Transaction Surface

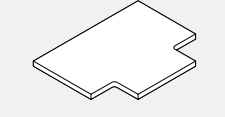

- Used where three panels meet.
- For Wood Grain Laminate, use code ending with "WG".

PRODUCT CODE	PRICE		SIZE/ INCHES			WEIGHT VOL	
	LP	HP	H	W	D	LBS	FT ³
EVWTCT90	171	212	1	27	15	16.00	1.00

EVWTE • End Transaction Surface

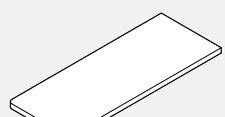

- Surface has rounded corners at one end.

PRODUCT CODE	PRICE		SIZE/ INCHES			WEIGHT VOL	
	LP	HP	H	W	D	LBS	FT ³
EVWTE1512	60	77	1	14	15	12.00	0.54
EVWTE1518	74	102	1	20	15	14.00	0.58
EVWTE1524	104	134	1	26	15	16.00	0.61
EVWTE1530	126	160	1	32	15	20.00	0.69
EVWTE1536	139	180	1	38	15	20.00	0.70
EVWTE1542	160	204	1	44	15	23.00	0.74
EVWTE1548	176	231	1	50	15	26.00	0.77
EVWTE1554	192	251	1	56	15	28.00	0.85
EVWTE1560	210	275	1	62	15	31.00	0.94
EVWTE1566	229	298	1	68	15	34.00	1.02
EVWTE1572	245	319	1	74	15	36.00	1.10

EVWTEV • End Transaction Surface with Cut-out

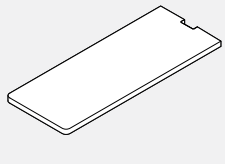

- Used at the end of a panel run where the surface butts up against a taller panel.
- Surface has rounded corners at one end.

PRODUCT CODE	PRICE		SIZE/ INCHES			WEIGHT VOL	
	LP	HP	H	W	D	LBS	FT ³
EVWTEV1524	116	146	1	26	15	16.00	0.61
EVWTEV1530	136	171	1	32	15	18.00	0.65
EVWTEV1536	151	195	1	38	15	20.00	0.69
EVWTEV1542	171	217	1	44	15	23.00	0.74
EVWTEV1548	190	240	1	50	15	32.00	1.22
EVWTEV1554	202	264	1	56	15	36.00	1.32
EVWTEV1560	221	286	1	62	15	36.00	1.30
EVWTEV1566	239	309	1	68	15	30.24	1.14
EVWTEV1572	259	333	1	74	15	40.00	1.38

EVW9TL • Corner Transaction Top for 90 degree Left

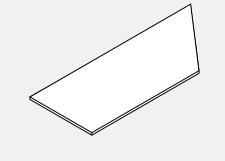

PRODUCT CODE	PRICE		SIZE/ INCHES			WEIGHT VOL	
	LP	HP	H	W	D	LBS	FT ³
EVW9TL1524	394	581	1	33	15	15.00	0.54
EVW9TL1530	475	705	1	39	15	18.00	0.62
EVW9TL1536	551	816	1	45	15	20.00	0.70
EVW9TL1542	631	930	1	51	15	23.00	0.78
EVW9TL1548	712	1050	1	57	15	25.00	0.86

EVW9TR • Corner Transaction Top for 90 degree Right

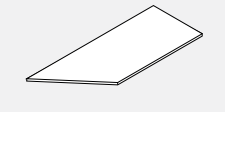

PRODUCT CODE	PRICE		SIZE/ INCHES			WEIGHT VOL	
	LP	HP	H	W	D	LBS	FT ³
EVW9TR1524	394	581	1	33	15	15.00	0.54
EVW9TR1530	475	705	1	39	15	18.00	0.62
EVW9TR1536	551	816	1	45	15	20.00	0.70
EVW9TR1542	631	930	1	51	15	23.00	0.78
EVW9TR1548	712	1050	1	57	15	25.00	0.86

EVWTD • End “D” Transaction Surface

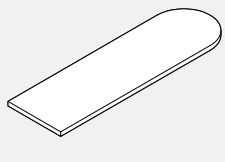

- Used at the end of a panel run where surface can overhang.

PRODUCT CODE	PRICE		SIZE/ INCHES			WEIGHT VOL	
	LP	HP	H	W	D	LBS	FT ³
EVWTD1530	145	190	1	37	15	18.00	0.65
EVWTD1536	153	204	1	43	15	20.00	0.69
EVWTD1542	171	229	1	49	15	23.00	0.74
EVWTD1548	192	251	1	55	15	26.00	0.77
EVWTD1554	207	274	1	61	15	28.00	0.85
EVWTD1560	229	303	1	67	15	31.00	0.94
EVWTD1566	245	323	1	73	15	34.00	1.02
EVWTD1572	265	351	1	79	15	36.00	1.10

EVWTDV • End “D” Transaction Surface with Cut-out

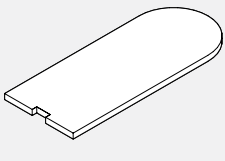

- Used at the end of a panel run where the surface butts up against a taller panel on one end and can overhang at the other.

PRODUCT CODE	PRICE		SIZE/ INCHES			WEIGHT VOL	
	LP	HP	H	W	D	LBS	FT ³
EVWTDV1530	149	201	1	37	15	18.00	0.65
EVWTDV1536	162	217	1	43	15	20.00	0.69
EVWTDV1542	179	239	1	49	15	23.00	0.74
EVWTDV1548	199	264	1	55	15	26.00	0.77
EVWTDV1554	212	284	1	61	15	28.00	0.85
EVWTDV1560	235	312	1	67	15	31.00	0.94

EVWTD • Double “D” Transaction Surface

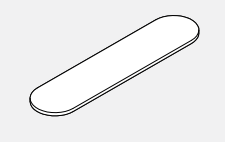

- Support hardware must be ordered separately.
- All tops are thermally fused 1” thick with pilot holes to enable proper alignment with worksurface supports. Wood screws must be used.
- Evolve worksurfaces feature a 3mm edge.

PRODUCT CODE	PRICE		SIZE/ INCHES			WEIGHT VOL	
	LP	HP	H	W	D	LBS	FT ³
EVWTD1548	213	284	1	62	15	28.00	0.85
EVWTD1560	249	333	1	74	15	31.00	0.94
EVWTD1572	289	385	1	86	15	36.00	1.10

EVHEP • End Panel

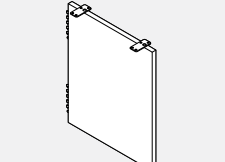

- Attaches a worksurface to a panel connector.
- Provides solid support at the end of a run of worksurfaces.
- Shipped with pedestal brackets and flat brackets.
- Glides are installed.
- Please specify metal colour for brackets.

PRODUCT CODE	PRICE	SIZE/ INCHES			WEIGHT VOL	
		H	W	D	LBS	FT ³
EVHEP2618	187	26	1	18	15.00	0.30
EVHEP2624	239	25	1	24	16.00	0.35
EVHEP2630	280	25	1	30	20.00	0.45
EVHEP2918	197	28	1	18	18.00	0.40
EVHEP2924	239	28	1	24	18.00	0.40
EVHEP2930	280	28	1	30	22.00	0.50

EVHS • Support Leg

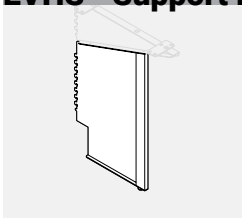

- Used in conjunction with an EVHC Cantilever of the same hand.
- Attaches a worksurface to a panel connector.
- Provides extra support where needed.
- May be used to support two convergent worksurfaces.
- Available in BLK (Black) only.

PRODUCT CODE	PRICE	SIZE/ INCHES			WEIGHT VOL	
		H	W	D	LBS	FT ³
EVHSL2618	126	22	1	10	6.00	0.24
EVHSL2624	126	22	1	10	6.00	0.31
EVHSL2918	133	25	1	10	7.00	0.30
EVHSL2924	133	25	1	10	7.00	0.33
EVHSR2618	126	22	1	10	6.00	0.24
EVHSR2624	126	22	1	10	6.00	0.31
EVHSR2918	133	25	1	10	7.00	0.30
EVHSR2924	133	25	1	10	7.00	0.33

EVHC • Cantilever

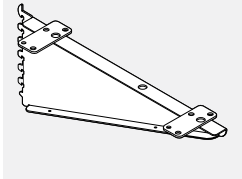

- Attaches a worksurface to a panel connector.
- May be used to support two convergent worksurfaces.
- Priced individually.
- Available in BLK (Black) only.

PRODUCT CODE	PRICE	SIZE/ INCHES			WEIGHT VOL	
		H	W	D	LBS	FT ³
EVHC12L	93	8	1	12	2.00	0.04
EVHC18L	93	8	1	18	2.00	0.04
EVHC24L	104	8	1	24	3.00	0.05
EVHC12R	93	8	1	12	2.00	0.04
EVHC18R	93	8	1	18	2.00	0.04
EVHC24R	104	8	1	24	3.00	0.50

EVHMSL1 • Mid Support Leg

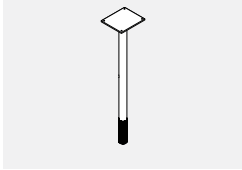

- Provides additional support for worksurface.
- Includes leveling glide, PVC Sleeve and 4.8" x 4.8" attachment plate.
- 1.5 diameter tube.
- Available in standard paint colours.

PRODUCT CODE	PRICE	SIZE/ H	INCHES	WEIGHT VOL	
				LBS	FT ³
EVHMSL1	77	28		3.20	0.37

EVHMSL2 • Mid Support Leg

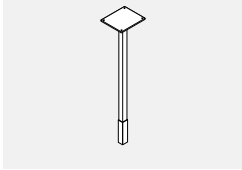

- Provides additional support for worksurface.
- Includes leveling glide, PVC Sleeve and 4.8" x 4.8" attachment plate.
- 1.5" square tube.
- Available in standard paint colours.

PRODUCT CODE	PRICE	SIZE/ H	INCHES	WEIGHT VOL	
				LBS	FT ³
EVHMSL2	77	28		3.20	0.37

EVHMSCL18 • Mid Support Leg with Cantilever Bracket

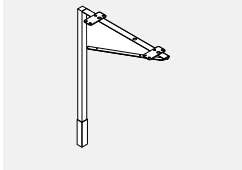

- Provides additional support for worksurface.
- Includes leveling glide, PVC Sleeve and 4.8" x 4.8" attachment plate.
- 1.5" square tube.
- Available in standard paint colours.

PRODUCT CODE	PRICE	SIZE/ INCHES			WEIGHT VOL	
		H	W	D	LBS	FT ³
EVHMSCL18	115	28	18	1.5	5.2	0.55

EVHMEGR - Metal End Gable Round Leg, Non-handed

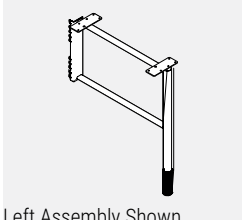

Left Assembly Shown

- **Metal End Gable Leg supports the worksurface and enhances the stability of connected panels.**
- Includes a leveling glide and decorative PVC sleeve to cover the glide.
- Attached to Evolve panel connectors. The mounting bracke is universal and attaches with screws to the back of the leg.
- Please specify standard paint finish.
- NOTE: Cannot be used to support worksurfaces side by side. Please use EVHMSRL12 for supporting adjoining worksurfaces.

PRODUCT CODE	PRICE	SIZE/INCHES			WEIGHT VOL	
		H	W	D	LBS	FT ³
EVHMEGR24	173	29	2	23	6.00	0.73
EVHMEGR30	185	29	2	29	6.80	0.90

EVHMSRL - Metal Mid Support Round Leg

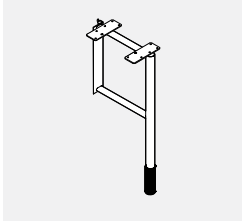

- **Metal Mid Support Leg supports two adjoining worksurfaces and enhances the stability of connected panels.**
- Includes a leveling glide and decorative PVC sleeve to cover the glide.
- Attached to Evolve Panels.
- Please specify standard paint finish.

PRODUCT CODE	PRICE	SIZE/INCHES			WEIGHT VOL	
		H	W	D	LBS	FT ³
EVHMSRL12	149	29	2	11	4.60	0.36

EVHMEGS - Metal End Gable Square Leg, Non-handed

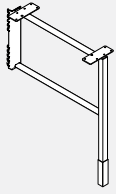

Left Assembly Shown

- **Metal End Gable Leg supports the worksurface and enhances the stability of connected panels.**
- Includes a leveling glide and decorative PVC sleeve to cover the glide.
- Attached to Evolve panel connectors. The mounting bracke is universal and attaches with screws to the back of the leg.
- Please specify standard paint finish.
- NOTE: Cannot be used to support worksurfaces side by side. Please use EVHMSSL12 for supporting adjoining worksurfaces.

PRODUCT CODE	PRICE	SIZE/INCHES			WEIGHT LBS	VOL FT ³
		H	W	D		
EVHMEGS24	177	29	2	23	6.00	0.73
EVHMEGS30	188	29	2	29	6.80	0.90

EVHMSSL - Metal Mid Support Square Leg

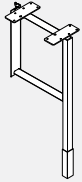

- **Metal Mid Support Leg supports two adjoining worksurfaces and enhances the stability of connected panels.**
- Includes a leveling glide and decorative PVC sleeve to cover the glide.
- Attached to Evolve Panels.
- Please specify standard paint finish.

PRODUCT CODE	PRICE	SIZE/INCHES			WEIGHT LBS	VOL FT ³
		H	W	D		
EVHMSSL12	152	29	2	11	4.60	0.36

EVRTHLEG • Evolve Bridges Leg

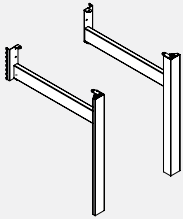

- Leg assembly attaches to panel for application which requires functionality of panels with open enviroment of Bridges tables.
- One leg with horizontal member connects to 1" increment slots in connector.
- Provides support to panel and panel connected 24" & 30" worksurface at end of run-design coordinated with Bridges freestanding tables.
- One leg can support 2 adjoining worksurface by specifying 2 flat brackets.
- Leveling glide is standard.
- Panel cantilever and storage must be for worksurface support.
- One aluminum leg with steel structure - specify left or right and 24" or 30" deep for corresponding worksurface depth.
- Panel bracket, dislodgment clip and worksurface hardware included.
- Anodized aluminum upcharge \$37.
- Please specify paint finish for support.

PRODUCT CODE	PRICE	SIZE/	INCHES		WEIGHT LBS	VOL FT ³
		H	W	D		
EVRTHLEG24LL	353	28	2.5	24	9	1.25
EVRTHLEG24RL	353	28	2.5	24	9	1.25
EVRTHLEG30LL	372	28	2.5	30	11	1.45
EVRTHLEG30RL	372	28	2.5	30	11	1.45

EVHH • High Profile Foot

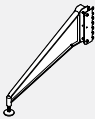

- Provides added support to a panel or worksurface under load.
- Two leveling glides included to adapt to different panel clearances.

PRODUCT CODE	PRICE	SIZE/	INCHES		WEIGHT LBS	VOL FT ³
		H	W	D		
EVHHF01	249	6	1	21	2.80	0.15

EVHML • Monoleg



- Provides support for a worksurface.
- Includes an adjustable foot and an attachment plate.
- 3" diameter.
- 1" Height adjustment range.

PRODUCT CODE	PRICE	SIZE/ H	INCHES W	D	WEIGHT LBS	VOL FT ³
EVHML1	194	28	8	8	8.00	0.15

EVHCB • Corner Bracket

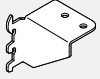

- Attaches the corner of any worksurface to a panel connector.
- Priced per pair.
- Available in BLK (Black) only.

PRODUCT CODE	PRICE	SIZE/ H	INCHES W	D	WEIGHT LBS	VOL FT ³
EVHCB2	26	2	3.5	2.5	0.50	0.02

EVHTB • Transaction Bracket



- Securely attaches a transaction surface to the top of a panel.
- Priced per pair.

PRODUCT CODE	PRICE	SIZE/ H	INCHES W	D	WEIGHT LBS	VOL FT ³
EVHTB2	26	3.5	3.5	2.5	0.50	0.02

EVHFB • Flat Bracket

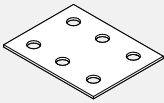

- Must be used in conjunction with cantilevers or transaction brackets to ensure alignment of neighbouring surfaces.

PRODUCT CODE	PRICE	SIZE/ H	INCHES W	D	WEIGHT LBS	VOL FT ³
EVHFB1	21	0.125	3	4	0.50	0.01

EVHZZB • "Z" Bracket



- Used to attach two different worksurface heights with a 3" difference.
- Must be used in conjunction with a cantilever.
- Available in BLK (Black) only.

PRODUCT CODE	PRICE	SIZE/ H	INCHES W	D	WEIGHT LBS	VOL FT ³
EVHZZB1	54	3	17	4	2.00	0.19

EVHPB • Pedestal Bracket



- Attaches to back edge of a pedestal and connects pedestal to panel connector.

PRODUCT CODE	PRICE	SIZE/ H	INCHES W	D	WEIGHT LBS	VOL FT ³
EVHPB1	29	12	1	1	0.50	0.50

EVHWSC • Worksurface Support Channel

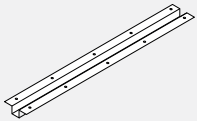

- EVHWSC40 for table 54" wide.
- EVHWSC46 for table 60" wide.
- EVHWSC52 for table 66" wide.
- EVHWSC58 for table 72" wide.
- EVHWSC64 for table 78" wide.
- EVHWSC70 for table 84" wide.
- Tops with post legs should be specified with support channel for structural reinforcement.
- Support channel attaches to underside of worksurface with screws.
- Support channel should be 14" shorter than top length.
- Screws included.
- Painted Black.

PRODUCT CODE	PRICE	SIZE/ H	INCHES W	D	WEIGHT LBS	VOL FT ³
EVHWSC40	58	40	5	4	0.20	
EVHWSC46	64	46	5	6	0.22	
EVHWSC52	68	52	5	7	0.25	
EVHWSC58	78	58	5	8	0.28	
EVHWSC64	88	64	5	9	0.31	
EVHWSC70	94	70	5	10	0.33	

EVHV • Wall Adapter



- A "U" shaped channel used to attach system components to a fixed wall.
- Slots are 1" on centre.
- Sold per pair.
- Care should be taken to mount adapters only to wall studs using correct fasteners.
- Failure to do this may result in collapse of the unit and subsequent possible personal injury.
- Mounting hardware is not included.
- Mounting hardware selection to be based on wall material

PRODUCT CODE	PRICE	SIZE/ H	INCHES W	D	WEIGHT LBS	VOL FT ³
EVHV01	74	60	0.5	0.5	4.00	0.01

EVHOMB • Off Module Worksurface Bracket

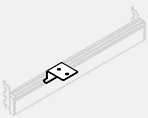

- Supports the worksurface in the work station corner in the case where an adjoining panel is wider than the worksurface.
- Enhances the stability of the worksurface.
- Can be used only in conjunction with the Top Load Bar (EVALB2xx - xx being the panel width - ordered separately)

PRODUCT CODE	PRICE	SIZE/ H	INCHES W	D	WEIGHT LBS	VOL FT ³
EVHOMB1	16	1.6	3	2.73	0.50	0.02

EVLEP • Laminate End Panel

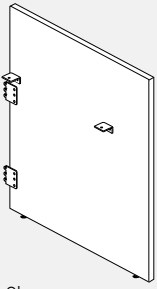

Right Shown

- Attaches to end of run connector.
- Finished in thermally fused laminate.
- Includes attachment flat brackets.
- Includes support brackets to attach worksurface.
- Laminate End Panel height is inclusive of panel glides extended to their full height.
- If wood grain is selected, grain runs vertically.
- Three sides are PVC edged while fourth edge is self-edge. Please choose a PVC edge colour.

PRODUCT CODE	PRICE LP	SIZE/ INCHES		WEIGHT VOL	
		H	W	LBS	FT ³
EVLEPR4224	327	42	24	26.25	0.58
EVLEPR4230	408	42	30	32.81	0.73
EVLEPR4236	487	42	36	39.38	0.88
EVLEPR4242	569	42	42	45.94	1.02
EVLEPR4248	654	42	48	52.50	1.17
EVLEPL4224	327	42	24	30.00	0.67
EVLEPL4230	408	42	30	37.50	0.83
EVLEPL4236	487	42	36	45.00	1.00
EVLEPL4242	569	42	42	52.50	1.17
EVLEPL4248	654	42	48	60.00	1.33
EVLEPR4824	370	48	24	26.25	0.58
EVLEPR4830	465	48	30	32.81	0.73
EVLEPR4836	557	48	36	39.38	0.88
EVLEPR4842	652	48	42	45.94	1.02
EVLEPR4848	744	48	48	52.50	1.17
EVLEPL4824	370	48	24	30.00	0.67
EVLEPL4830	465	48	30	37.50	0.83
EVLEPL4836	557	48	36	45.00	1.00
EVLEPL4842	652	48	42	52.50	1.17
EVLEPL4848	744	48	48	60.00	1.33

EVLMP • Laminate Middle Panel

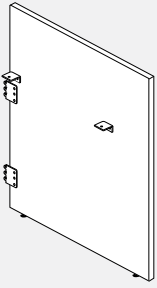

- Attaches to double inline connector.
- Finished in thermally fused laminate.
- Includes attachment flat brackets.
- Includes support brackets to attach worksurfaces on both sides on middle panel.
- Laminate Middle Panel height is inclusive of panel glides extended to their full height.
- If wood grain is selected, grain runs vertically.
- Three sides are PVC edged while fourth edge is self-edge. Please choose a PVC edge colour.

PRODUCT CODE	PRICE LP	SIZE/ INCHES		WEIGHT VOL	
		H	W	LBS	FT ³
EVLMP4224	364	42	24	26.25	0.58
EVLMP4230	442	42	30	32.81	0.73
EVLMP4236	524	42	36	39.38	0.88
EVLMP4242	608	42	42	45.94	1.02
EVLMP4248	694	42	48	52.50	1.17
EVLMP4824	406	48	24	30.00	0.67
EVLMP4830	503	48	30	37.50	0.83
EVLMP4836	595	48	36	45.00	1.00
EVLMP4842	689	48	42	52.50	1.17
EVLMP4848	783	48	48	60.00	1.33

EVLEP-A • Laminate End Panel with Accessory Rail

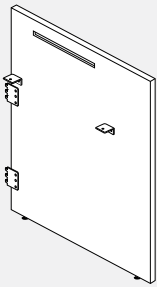

Right Shown

- Attaches to end of run connector.
- Finished in thermally fused laminate.
- Includes attachment flat brackets and accessory rail on inside.
- Includes support brackets to attach worksurface.
- Laminate End Panel height is inclusive of panel glides extended to their full height.
- If wood grain is selected, grain runs vertically.
- Three sides are PVC edged while fourth edge is self-edge. Please choose a PVC edge colour.

PRODUCT CODE	PRICE LP	SIZE/ INCHES		WEIGHT VOL	
		H	W	LBS	FT ³
EVLEPR4224A	370	42	24	26.25	0.58
EVLEPR4230A	450	42	30	32.81	0.73
EVLEPR4236A	535	42	36	39.38	0.88
EVLEPR4242A	614	42	42	45.94	1.02
EVLEPR4248A	699	42	48	52.50	1.17
EVLEPL4224A	370	42	24	30.00	0.67
EVLEPL4230A	450	42	30	37.50	0.83
EVLEPL4236A	535	42	36	45.00	1.00
EVLEPL4242A	614	42	42	52.50	1.17
EVLEPL4248A	699	42	48	60.00	1.33
EVLEPR4824A	411	48	24	26.25	0.58
EVLEPR4830A	501	48	30	32.81	0.73
EVLEPR4836A	565	48	36	39.38	0.88
EVLEPR4842A	644	48	42	45.94	1.02
EVLEPR4848A	790	48	48	52.50	1.17
EVLEPL4824A	411	48	24	30.00	0.67
EVLEPL4830A	501	48	30	37.50	0.83
EVLEPL4836A	565	48	36	45.00	1.00
EVLEPL4842A	644	48	42	52.50	1.17
EVLEPL4848A	790	48	48	60.00	1.33

EVLMP-A • Laminate Middle Panel with Accessory Rail

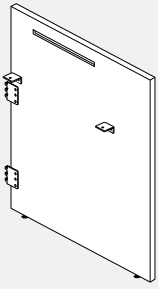

- Attaches to double inline connector.
- Finished in thermally fused laminate.
- Includes accessory rail on both sides of middle panel.
- Includes attachment flat brackets and accessory rail on both sides.
- Includes support brackets to attach worksurfaces on both sides on middle panel.
- Laminate Middle Panel height is inclusive of panel glides extended to their full height.
- If wood grain is selected, grain runs vertically.
- Three sides are PVC edged while fourth edge is self-edge. Please choose a PVC edge colour.

PRODUCT CODE	PRICE LP	SIZE / INCHES		WEIGHT VOL	
		H	W	LBS	FT ³
EVLMP4224A	417	42	24	26.25	0.58
EVLMP4230A	499	42	30	32.81	0.73
EVLMP4236A	582	42	36	39.38	0.88
EVLMP4242A	661	42	42	45.94	1.02
EVLMP4248A	751	42	48	52.50	1.17
EVLMP4824A	456	48	24	30.00	0.67
EVLMP4830A	557	48	30	37.50	0.83
EVLMP4836A	652	48	36	45.00	1.00
EVLMP4842A	744	48	42	52.50	1.17
EVLMP4848A	837	48	48	60.00	1.33

EV4LXP • Laminate Panel Four Way

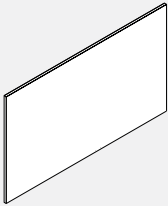

- Panel connects "+" configuration with extension panel
- Finished in thermally fused laminate
- Laminate extension Panel height is inclusive of panel glides extended to their full height
- If wood grain is selected, grain runs horizontally
- Corner connecting brackets to be ordered separately

PRODUCT CODE	PRICE LP	SIZE / INCHES		WEIGHT VOL	
		H	W	LBS	FT ³
EV4LXP4249	535	42	49	53.59	1.19
EV4LXP4261	638	42	61	66.72	1.48
EV4LXP4273	740	42	73	79.84	1.77
EV4LXP4849	607	48	49	61.25	1.36
EV4LXP4861	745	48	61	76.25	1.69
EV4LXP4873	885	48	73	91.25	2.03
EV4LXP5449	678	54	49	68.91	1.53
EV4LXP5461	885	54	61	85.78	1.91
EV4LXP5473	1023	54	73	102.66	2.28

EVLXPML • Laminate Extension Panel

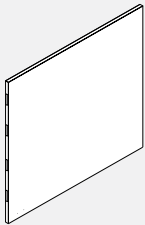

- Locking connection on both sides
- Finished in thermally fused laminate
- Laminate extension Panel height is inclusive of panel glides extended to their full height
- If wood grain is selected, grain runs horizontally
- Bottom connecting brackets to be ordered separately

PRODUCT CODE	PRICE LP	SIZE / INCHES		WEIGHT VOL	
		H	W	LBS	FT ³
EVLXPML4224	284	42	24	26.25	0.58
EVLXPML4230	346	42	30	32.81	0.73
EVLXPML4236	386	42	36	39.38	0.88
EVLXPML4242	435	42	42	45.94	1.02
EVLXPML4248	499	42	48	52.50	1.17
EVLXPMR4224	284	42	24	26.25	0.58
EVLXPMR4230	346	42	30	32.81	0.73
EVLXPMR4236	386	42	36	39.38	0.88
EVLXPMR4242	435	42	42	45.94	1.02
EVLXPMR4248	499	42	48	52.50	1.17
EVLXPML4824	328	48	24	30.00	0.67
EVLXPML4830	378	48	30	37.50	0.83
EVLXPML4836	432	48	36	45.00	1.00
EVLXPML4842	483	48	42	52.50	1.17
EVLXPML4848	535	48	48	60.00	1.33
EVLXPMR4824	328	48	24	30.00	0.67
EVLXPMR4830	378	48	30	37.50	0.83
EVLXPMR4836	432	48	36	45.00	1.00
EVLXPMR4842	483	48	42	52.50	1.17
EVLXPMR4848	535	48	48	60.00	1.33
EVLXPML5424	355	54	24	33.75	0.75
EVLXPML5430	417	54	30	42.19	0.94
EVLXPML5436	477	54	36	50.63	1.13
EVLXPML5442	543	54	42	59.06	1.31
EVLXPML5448	638	54	48	67.50	1.50
EVLXPMR5424	355	54	24	33.75	0.75
EVLXPMR5430	417	54	30	42.19	0.94
EVLXPMR5436	477	54	36	50.63	1.13
EVLXPMR5442	543	54	42	59.06	1.31
EVLXPMR5448	638	54	48	67.50	1.50

EV2LXP • Laminate Extension Panel Two Way

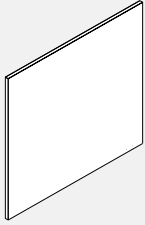

- Panel connects at 90 degree with extension panel
- Finished in thermally fused laminate
- Laminate extension Panel height is inclusive of panel glides extGalleryed to their full height
- If wood grain is selected, grain runs horizontally
- Corner connecting brackets to be ordered separately

PRODUCT CODE	PRICE LP	SIZE / INCHES		WEIGHT LBS	VOL FT ³
		H	W		
EV2LXPL4225	284	42	25	27.34	0.61
EV2LXPL4231	346	42	31	33.91	0.75
EV2LXPL4237	386	42	37	40.47	0.90
EV2LXPL4243	435	42	43	47.03	1.05
EV2LXPL4249	499	42	49	53.59	1.19
EV2LXPR4225	284	42	25	27.34	0.61
EV2LXPR4231	346	42	31	33.91	0.75
EV2LXPR4237	386	42	37	40.47	0.90
EV2LXPR4243	435	42	43	47.03	1.05
EV2LXPR4249	499	42	49	53.59	1.19
EV2LXPL4825	328	48	25	31.25	0.69
EV2LXPL4831	378	48	31	38.75	0.86
EV2LXPL4837	432	48	37	46.25	1.03
EV2LXPL4843	483	48	43	53.75	1.19
EV2LXPL4849	535	48	49	61.25	1.36
EV2LXPR4825	328	48	25	31.25	0.69
EV2LXPR4831	378	48	31	38.75	0.86
EV2LXPR4837	432	48	37	46.25	1.03
EV2LXPR4843	483	48	43	53.75	1.19
EV2LXPR4849	535	48	49	61.25	1.36
EV2LXPL5425	383	54	25	35.16	0.78
EV2LXPL5431	438	54	31	43.59	0.97
EV2LXPL5437	494	54	37	52.03	1.16
EV2LXPL5443	600	54	43	60.47	1.34
EV2LXPL5449	678	54	49	68.91	1.53
EV2LXPR5425	383	54	25	35.16	0.78
EV2LXPR5431	438	54	31	43.59	0.97
EV2LXPR5437	494	54	37	52.03	1.16
EV2LXPR5443	600	54	43	60.47	1.34
EV2LXPR5449	678	54	49	68.91	1.53

EV3LXP • Laminate Extension Panel Three Way

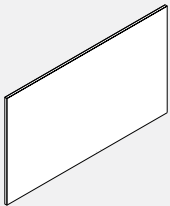

- Panel connects "T" configuration with extension panel
- Finished in thermally fused laminate
- Laminate extension Panel height is inclusive of panel glides extended to their full height
- If wood grain is selected, grain runs horizontally
- Corner connecting brackets to be ordered separately

PRODUCT CODE	PRICE LP	SIZE / INCHES		WEIGHT LBS	VOL FT ³
		H	W		
EV3LXPL4249	535	42	49	53.59	1.19
EV3LXPL4261	638	42	61	66.72	1.48
EV3LXPL4273	740	42	73	79.84	1.77
EV3LXPR4249	535	42	49	53.59	1.19
EV3LXPR4261	638	42	61	66.72	1.48
EV3LXPR4273	740	42	73	79.84	1.77
EV3LXPL4849	607	48	49	61.25	1.36
EV3LXPL4861	745	48	61	76.25	1.69
EV3LXPL4873	885	48	73	91.25	2.03
EV3LXPR4849	607	48	49	61.25	1.36
EV3LXPR4861	745	48	61	76.25	1.69
EV3LXPR4873	885	48	73	91.25	2.03
EV3LXPL5449	678	54	49	68.91	1.53
EV3LXPL5461	885	54	61	85.78	1.91
EV3LXPL5473	1023	54	73	102.66	2.28
EV3LXPR5449	678	54	49	68.91	1.53
EV3LXPR5461	885	54	61	85.78	1.91
EV3LXPR5473	1023	54	73	102.66	2.28

EV4LXPM • Laminate Extension Panel for Four Way Configuration

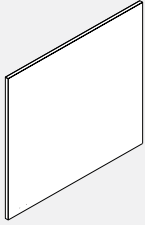

- Locking connection on one side only for four way panel
- Finished in thermally fused laminate
- Universal to be used on both sides of four way laminate panel
- Laminate extension Panel height is inclusive of panel glides extended to their full height
- If wood grain is selected, grain runs horizontally
- Bottom connecting brackets to be ordered separately

PRODUCT CODE	PRICE LP	SIZE / INCHES		WEIGHT LBS	VOL FT ³
		H	W		
EV4LXPM4224	284	42	24	26.25	0.58
EV4LXPM4230	346	42	30	32.81	0.73
EV4LXPM4236	386	42	36	39.38	0.88
EV4LXPM4242	435	42	42	45.94	1.02
EV4LXPM4248	499	42	48	52.50	1.17
EV4LXPM4824	328	48	24	30.00	0.67
EV4LXPM4830	378	48	30	37.50	0.83
EV4LXPM4836	432	48	36	45.00	1.00
EV4LXPM4842	483	48	42	52.50	1.17
EV4LXPM4848	535	48	48	60.00	1.33
EV4LXPM5424	355	54	24	33.75	0.75
EV4LXPM5430	417	54	30	42.19	0.94
EV4LXPM5436	477	54	36	50.63	1.13
EV4LXPM5442	543	54	42	59.06	1.31
EV4LXPM5448	638	54	48	67.50	1.50

EVLXPML-NC - Laminate Extension Panel, No End Connection

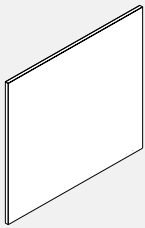

- Locking connection on one sides, no connection at end
- Finished in thermally fused laminate
- Laminate extension Panel height is inclusive of panel glides extended to their full height
- If wood grain is selected, grain runs horizontally
- Bottom connecting brackets to be ordered separately

PRODUCT CODE	PRICE LP	SIZE / INCHES		WEIGHT LBS	VOL FT ³
		H	W		
EVLXPML4224NC	284	42	24	26.25	0.58
EVLXPML4230NC	346	42	30	32.81	0.73
EVLXPML4236NC	386	42	36	39.38	0.88
EVLXPML4242NC	435	42	42	45.94	1.02
EVLXPML4248NC	499	42	48	52.50	1.17
EVLXPMR4224NC	284	42	24	26.25	0.58
EVLXPMR4230NC	346	42	30	32.81	0.73
EVLXPMR4236NC	386	42	36	39.38	0.88
EVLXPMR4242NC	435	42	42	45.94	1.02
EVLXPMR4248NC	499	42	48	52.50	1.17
EVLXPML4824NC	328	48	24	30.00	0.67
EVLXPML4830NC	378	48	30	37.50	0.83
EVLXPML4836NC	432	48	36	45.00	1.00
EVLXPML4842NC	483	48	42	52.50	1.17
EVLXPML4848NC	535	48	48	60.00	1.33
EVLXPMR4824NC	328	48	24	30.00	0.67
EVLXPMR4830NC	378	48	30	37.50	0.83
EVLXPMR4836NC	432	48	36	45.00	1.00
EVLXPMR4842NC	483	48	42	52.50	1.17
EVLXPMR4848NC	535	48	48	60.00	1.33
EVLXPML5424NC	355	54	24	33.75	0.75
EVLXPML5430NC	417	54	30	42.19	0.94
EVLXPML5436NC	477	54	36	50.63	1.13
EVLXPML5442NC	543	54	42	59.06	1.31
EVLXPML5448NC	638	54	48	67.50	1.50
EVLXPMR5424NC	355	54	24	33.75	0.75
EVLXPMR5430NC	417	54	30	42.19	0.94
EVLXPMR5436NC	477	54	36	50.63	1.13
EVLXPMR5442NC	543	54	42	59.06	1.31
EVLXPMR5448NC	638	54	48	67.50	1.50

EVLEPDS • Laminate Gallery Panel

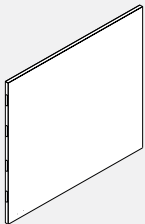

- Attaches to end of run connector with "U" channel
- To be installed at end of panel run
- Finished in thermally fused laminate
- Locking connection both sides
- Laminate Gallery Panel height is inclusive of panel glides extended to their full height
- If wood grain is selected, grain runs horizontally
- End of run connector with "U" channel and bottom connecting brackets to be ordered separately

PRODUCT CODE	PRICE LP	SIZE / INCHES		WEIGHT LBS	VOL FT ³
		H	W		
EVLEPDS4251	535	42	51	55.78	1.24
EVLEPDS4263	695	42	63	68.91	1.53
EVLEPDS4275	857	42	75	82.03	1.82
EVLEPDS4851	607	48	51	63.75	1.42
EVLEPDS4863	773	48	63	78.75	1.75
EVLEPDS4875	937	48	75	93.75	2.08
EVLEPDS5451	678	54	51	71.72	1.59
EVLEPDS5463	885	54	63	88.59	1.97
EVLEPDS5475	1023	54	75	105.47	2.34

EVLEPDC • Laminate Gallery Panel

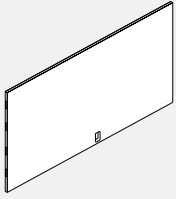

- Attaches in middle of panel run with connector with "U" channel
- To be installed in middle between two panels in straight run
- Finished in thermally fused laminate
- Locking connection both sides
- Laminate Gallery Panel height is inclusive of panel glides extended to their full height
- If wood grain is selected, grain runs horizontally
- End of run connector with "U" channel and bottom connecting brackets to be ordered separately

PRODUCT CODE	PRICE LP	SIZE / INCHES		WEIGHT LBS	VOL FT ³
		H	W		
EVLEPDC4251	535	42	51	55.78	1.24
EVLEPDC4263	695	42	63	68.91	1.53
EVLEPDC4275	857	42	75	82.03	1.82
EVLEPDC4851	607	48	51	63.75	1.42
EVLEPDC4863	773	48	63	78.75	1.75
EVLEPDC4875	937	48	75	93.75	2.08
EVLEPDC5451	678	54	51	71.72	1.59
EVLEPDC5463	885	54	63	88.59	1.97
EVLEPDC5475	1023	54	75	105.47	2.34

EVLEPSSL/R • Laminate Gallery Panel, End Connection on One Side

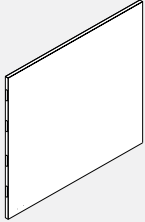

- Attaches to end of run connector with "U" channel
- To be installed at end of panel run on one side
- Finished in thermally fused laminate
- Locking connection on one side
- Laminate Gallery Panel height is inclusive of panel glides extended to their full height
- If wood grain is selected, grain runs horizontally
- End of run connector with "U" channel and bottom connecting brackets to be ordered separately

PRODUCT CODE	PRICE LP	SIZE / INCHES		WEIGHT LBS	VOL FT ³
		H	W		
EVLEPSSL4227	346	42	27	29.53	0.66
EVLEPSSL4233	386	42	33	36.09	0.80
EVLEPSSL4239	435	42	39	42.66	0.95
EVLEPSSL4245	499	42	45	49.22	1.09
EVLEPSSL4251	535	42	51	55.78	1.24
EVLEPSSL4827	378	48	27	33.75	0.75
EVLEPSSL4833	432	48	33	41.25	0.92
EVLEPSSL4839	483	48	39	48.75	1.08
EVLEPSSL4845	535	48	45	56.25	1.25
EVLEPSSL4851	607	48	51	63.75	1.42
EVLEPSSL5427	417	54	27	37.97	0.84
EVLEPSSL5433	477	54	33	46.41	1.03
EVLEPSSL5439	543	54	39	54.84	1.22
EVLEPSSL5445	638	54	45	63.28	1.41
EVLEPSSL5451	678	54	51	71.72	1.59
EVLEPSSR4227	346	42	27	29.53	0.66
EVLEPSSR4233	386	42	33	36.09	0.80
EVLEPSSR4239	435	42	39	42.66	0.95
EVLEPSSR4245	499	42	45	49.22	1.09
EVLEPSSR4251	535	42	51	55.78	1.24
EVLEPSSR4827	378	48	27	33.75	0.75
EVLEPSSR4833	432	48	33	41.25	0.92
EVLEPSSR4839	483	48	39	48.75	1.08
EVLEPSSR4845	535	48	45	56.25	1.25
EVLEPSSR4851	607	48	51	63.75	1.42
EVLEPSSR5427	417	54	27	37.97	0.84
EVLEPSSR5433	477	54	33	46.41	1.03
EVLEPSSR5439	543	54	39	54.84	1.22
EVLEPSSR5445	638	54	45	63.28	1.41
EVLEPSSR5451	678	54	51	71.72	1.59

EVLEPSC • Laminate Gallery Panel

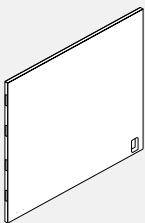

- Attaches in middle of panel run with connector with "U" channel
- To be installed in middle between two panels in straight run on one side
- Cut out for electrics at power beam height
- Finished in thermally fused laminate
- Locking connection on one side
- Laminate Gallery Panel height is inclusive of panel glides extended to their full height
- If wood grain is selected, grain runs horizontally
- End of run connector with "U" channel and bottom connecting brackets to be ordered separately

PRODUCT CODE	PRICE LP	SIZE / INCHES		WEIGHT LBS	VOL FT ³
		H	W		
EVLEPSC4227	346	42	27	29.53	0.66
EVLEPSC4233	386	42	33	36.09	0.80
EVLEPSC4239	435	42	39	42.66	0.95
EVLEPSC4245	499	42	45	49.22	1.09
EVLEPSC4251	535	42	51	55.78	1.24
EVLEPSC4827	378	48	27	33.75	0.75
EVLEPSC4833	432	48	33	41.25	0.92
EVLEPSC4839	483	48	39	48.75	1.08
EVLEPSC4845	535	48	45	56.25	1.25
EVLEPSC4851	607	48	51	63.75	1.42
EVLEPSC5427	417	54	27	37.97	0.84
EVLEPSC5433	477	54	33	46.41	1.03
EVLEPSC5439	543	54	39	54.84	1.22
EVLEPSC5445	638	54	45	63.28	1.41
EVLEPSC5451	678	54	51	71.72	1.59

EVLEPDS-NC • Laminate Gallery Panel, No End Connection at Both Sides

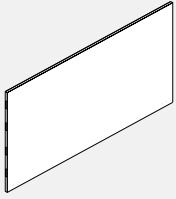

- Attaches to end of run connector with "U" channel
- To be installed at end of panel run
- Finished in thermally fused laminate
- Locking connection both sides
- Laminate Gallery Panel height is inclusive of panel glides extended to their full height
- If wood grain is selected, grain runs horizontally
- End of run connector with "U" channel and bottom connecting brackets to be ordered separately

PRODUCT CODE	PRICE LP	SIZE / INCHES		WEIGHT LBS	VOL FT ³
		H	W		
EVLEPDS4251NC	535	42	51	55.78	1.24
EVLEPDS4263NC	695	42	63	68.91	1.53
EVLEPDS4275NC	857	42	75	82.03	1.82
EVLEPDS4851NC	607	48	51	63.75	1.42
EVLEPDS4863NC	773	48	63	78.75	1.75
EVLEPDS4875NC	937	48	75	93.75	2.08
EVLEPDS5451NC	678	54	51	71.72	1.59
EVLEPDS5463NC	885	54	63	88.59	1.97
EVLEPDS5475NC	1023	54	75	105.47	2.34

EVLEPDC-NC • Laminate Gallery Middle Panel, No End Connection at Both Sides

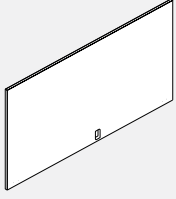

- Attaches in middle of panel run with connector with "U" channel
- To be installed in middle between two panels in straight run
- Finished in thermally fused laminate
- No connection both sides
- Laminate Gallery Panel height is inclusive of panel glides extended to their full height
- If wood grain is selected, grain runs horizontally
- End of run connector with "U" channel and bottom connecting brackets to be ordered separately

PRODUCT CODE	PRICE LP	SIZE / INCHES		WEIGHT LBS	VOL FT ³
		H	W		
EVLEPDC4251NC	535	42	51	55.78	1.24
EVLEPDC4263NC	695	42	63	68.91	1.53
EVLEPDC4275NC	857	42	75	82.03	1.82
EVLEPDC4851NC	607	48	51	63.75	1.42
EVLEPDC4863NC	773	48	63	78.75	1.75
EVLEPDC4875NC	937	48	75	93.75	2.08
EVLEPDC5451NC	678	54	51	71.72	1.59
EVLEPDC5463NC	885	54	63	88.59	1.97
EVLEPDC5475NC	1023	54	75	105.47	2.34

EVLEPSS-NC • Laminate Gallery End Panel, No End Connection at Both Sides

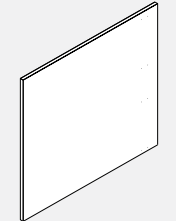

- Attaches in middle of panel run with connector with "U" channel
- To be installed in middle between two panels in straight run
- Finished in thermally fused laminate
- No connection both sides
- Laminate Gallery Panel height is inclusive of panel glides extended to their full height
- If wood grain is selected, grain runs horizontally
- End of run connector with "U" channel and bottom connecting brackets to be ordered separately

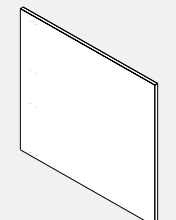

PRODUCT CODE	PRICE LP	SIZE / INCHES		WEIGHT LBS	VOL FT ³
		H	W		
EVLEPSSL4227NC	346	42	27	29.53	0.66
EVLEPSSL4233NC	386	42	33	36.09	0.80
EVLEPSSL4239NC	435	42	39	42.66	0.95
EVLEPSSL4245NC	499	42	45	49.22	1.09
EVLEPSSL4251NC	535	42	51	55.78	1.24
EVLEPSSL4827NC	378	48	27	33.75	0.75
EVLEPSSL4833NC	432	48	33	41.25	0.92
EVLEPSSL4839NC	483	48	39	48.75	1.08
EVLEPSSL4845NC	535	48	45	56.25	1.25
EVLEPSSL4851NC	607	48	51	63.75	1.42
EVLEPSSL5427NC	417	54	27	37.97	0.84
EVLEPSSL5433NC	477	54	33	46.41	1.03
EVLEPSSL5439NC	543	54	39	54.84	1.22
EVLEPSSL5445NC	638	54	45	63.28	1.41
EVLEPSSL5451NC	678	54	51	71.72	1.59
EVLEPSSR4227NC	346	42	27	29.53	0.66
EVLEPSSR4233NC	386	42	33	36.09	0.80
EVLEPSSR4239NC	435	42	39	42.66	0.95
EVLEPSSR4245NC	499	42	45	49.22	1.09
EVLEPSSR4251NC	535	42	51	55.78	1.24
EVLEPSSR4827NC	378	48	27	33.75	0.75
EVLEPSSR4833NC	432	48	33	41.25	0.92
EVLEPSSR4839NC	483	48	39	48.75	1.08
EVLEPSSR4845NC	535	48	45	56.25	1.25
EVLEPSSR4851NC	607	48	51	63.75	1.42
EVLEPSSR5427NC	417	54	27	37.97	0.84
EVLEPSSR5433NC	477	54	33	46.41	1.03
EVLEPSSR5439NC	543	54	39	54.84	1.22
EVLEPSSR5445NC	638	54	45	63.28	1.41
EVLEPSSR5451NC	678	54	51	71.72	1.59

EVLEPSC-NC • Laminate Gallery Middle One Side Panel, No End Connection at Both Sides

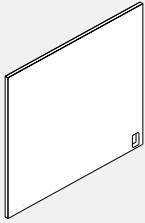

- Attaches in middle of panel run with connector with "U" channel
- To be installed in middle between two panels in straight run on one side
- Cut out for electrics at power beam height
- Finished in thermally fused laminate
- No connection both sides
- Laminate Gallery Panel height is inclusive of panel glides extended to their full height
- If wood grain is selected, grain runs horizontally
- End of run connector with "U" channel and bottom connecting brackets to be ordered separately

PRODUCT CODE	PRICE LP	SIZE / INCHES		WEIGHT LBS	VOL FT ³
		H	W		
EVLEPSC4227NC	346	42	27	29.53	0.66
EVLEPSC4233NC	386	42	33	36.09	0.80
EVLEPSC4239NC	435	42	39	42.66	0.95
EVLEPSC4245NC	499	42	45	49.22	1.09
EVLEPSC4251NC	535	42	51	55.78	1.24
EVLEPSC4827NC	378	48	27	33.75	0.75
EVLEPSC4833NC	432	48	33	41.25	0.92
EVLEPSC4839NC	483	48	39	48.75	1.08
EVLEPSC4845NC	535	48	45	56.25	1.25
EVLEPSC4851NC	607	48	51	63.75	1.42
EVLEPSC5427NC	417	54	27	37.97	0.84
EVLEPSC5433NC	477	54	33	46.41	1.03
EVLEPSC5439NC	543	54	39	54.84	1.22
EVLEPSC5445NC	638	54	45	63.28	1.41
EVLEPSC5451NC	678	54	51	71.72	1.59

EVPBLEPDS • Laminate Gallery Panel for Power Beam, End Connection

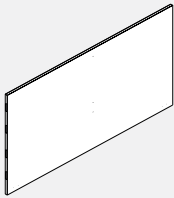

- Attaches to power beam channel
- To be installed at end of power beam run
- Finished in thermally fused laminate
- Locking connection both sides
- Laminate Gallery Panel height is inclusive of panel glides extended to their full height
- If wood grain is selected, grain runs horizontally
- Power beam channel and bottom connecting bracket to be ordered separately

PRODUCT CODE	PRICE LP	SIZE / INCHES		WEIGHT LBS	VOL FT ³
		H	W		
EVPBLEPDS4251	535	42	51	55.78	1.24
EVPBLEPDS4263	695	42	63	68.91	1.53
EVPBLEPDS4275	857	42	75	82.03	1.82
EVPBLEPDS4851	607	48	51	63.75	1.42
EVPBLEPDS4863	773	48	63	78.75	1.75
EVPBLEPDS4875	937	48	75	93.75	2.08
EVPBLEPDS5451	678	54	51	71.72	1.59
EVPBLEPDS5463	885	54	63	88.59	1.97
EVPBLEPDS5475	1023	54	75	105.47	2.34

EVPBLEPDC • Laminate Gallery Panel for Power Beam, Middle Connection

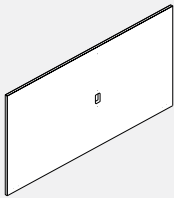

- Attaches to power beam channel
- To be installed in middle between two power beam in straight run
- Cut out for electrics at power beam height
- Finished in thermally fused laminate
- Locking connection both sides
- Laminate Gallery Panel height is inclusive of panel glides extended to their full height
- If wood grain is selected, grain runs horizontally
- Power beam channel and bottom connecting bracket to be ordered separately
- Standard code is for 24" H Power Beam
- Please add at code end "B" for 30"h Power Beam or "C" for 36"h Power Beam

PRODUCT CODE	PRICE LP	SIZE / INCHES		WEIGHT LBS	VOL FT ³
		H	W		
EVPBLEPDC4251	535	42	51	55.78	1.24
EVPBLEPDC4263	695	42	63	68.91	1.53
EVPBLEPDC4275	857	42	75	82.03	1.82
EVPBLEPDC4851	607	48	51	63.75	1.42
EVPBLEPDC4863	773	48	63	78.75	1.75
EVPBLEPDC4875	937	48	75	93.75	2.08
EVPBLEPDC5451	678	48	51	63.75	1.42
EVPBLEPDC5463	885	48	63	78.75	1.75
EVPBLEPDC5475	1023	48	75	93.75	2.08

EVPBLEPSSL/R • Laminate Gallery Panel for Power Beam, End Connection on One Side

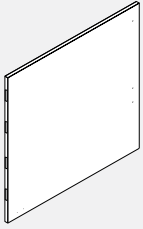

- Attaches to power beam channel
- To be installed at end of power beam run on one side
- Finished in thermally fused laminate
- Locking connection on one side
- Laminate Gallery Panel height is inclusive of panel glides extended to their full height
- If wood grain is selected, grain runs horizontally
- Power beam channel and bottom connecting bracket to be ordered separately

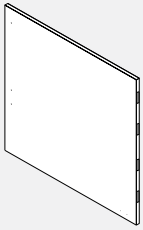

PRODUCT CODE	PRICE LP	SIZE/INCHES		WEIGHT LBS	VOL FT ³
		H	W		
EVPBLEPSSL4227	346	42	27	29.53	0.66
EVPBLEPSSL4233	386	42	33	36.09	0.80
EVPBLEPSSL4239	435	42	39	42.66	0.95
EVPBLEPSSL4245	499	42	45	49.22	1.09
EVPBLEPSSL4251	535	42	51	55.78	1.24
EVPBLEPSSL4827	378	48	27	33.75	0.75
EVPBLEPSSL4833	432	48	33	41.25	0.92
EVPBLEPSSL4839	483	48	39	48.75	1.08
EVPBLEPSSL4845	535	48	45	56.25	1.25
EVPBLEPSSL4851	607	48	51	63.75	1.42
EVPBLEPSSL5427	417	54	27	37.97	0.84
EVPBLEPSSL5433	477	54	33	46.41	1.03
EVPBLEPSSL5439	543	54	39	54.84	1.22
EVPBLEPSSL5445	638	54	45	63.28	1.41
EVPBLEPSSL5451	678	54	51	71.72	1.59
EVPBLEPSSR4227	346	42	27	29.53	0.66
EVPBLEPSSR4233	386	42	33	36.09	0.80
EVPBLEPSSR4239	435	42	39	42.66	0.95
EVPBLEPSSR4245	499	42	45	49.22	1.09
EVPBLEPSSR4251	535	42	51	55.78	1.24
EVPBLEPSSR4827	378	48	27	33.75	0.75
EVPBLEPSSR4833	432	48	33	41.25	0.92
EVPBLEPSSR4839	483	48	39	48.75	1.08
EVPBLEPSSR4845	535	48	45	56.25	1.25
EVPBLEPSSR4851	607	48	51	63.75	1.42
EVPBLEPSSR5427	417	54	27	37.97	0.84
EVPBLEPSSR5433	477	54	33	46.41	1.03
EVPBLEPSSR5439	543	54	39	54.84	1.22
EVPBLEPSSR5445	638	54	45	63.28	1.41
EVPBLEPSSR5451	678	54	51	71.72	1.59

EVPBLEPSC • Laminate Gallery Panel for Power Beam, Middle Connection on One Side

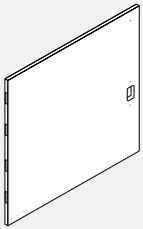

- Attaches to power beam channel
- To be installed in middle between two power beam in straight run on one side
- Cut out for electrics at power beam height
- Finished in thermally fused laminate
- Locking connection on one side
- Laminate Gallery Panel height is inclusive of panel glides extended to their full height
- If wood grain is selected, grain runs horizontally
- Power beam channel and bottom connecting bracket to be ordered separately
- Standard code is for 24" H Power Beam
- Please add at code end "B" for 30"h Power Beam or "C" for 36"h Power Beam

PRODUCT CODE	PRICE LP	SIZE/INCHES		WEIGHT LBS	VOL FT ³
		H	W		
EVPBLEPSC4227	346	42	27	29.53	0.66
EVPBLEPSC4233	386	42	33	36.09	0.80
EVPBLEPSC4239	435	42	39	42.66	0.95
EVPBLEPSC4245	499	42	45	49.22	1.09
EVPBLEPSC4251	535	42	51	55.78	1.24
EVPBLEPSC4827	378	48	27	33.75	0.75
EVPBLEPSC4833	432	48	33	41.25	0.92
EVPBLEPSC4839	483	48	39	48.75	1.08
EVPBLEPSC4845	535	48	45	56.25	1.25
EVPBLEPSC4851	607	48	51	63.75	1.42
EVPBLEPSC5427	417	54	27	37.97	0.84
EVPBLEPSC5433	477	54	33	46.41	1.03
EVPBLEPSC5439	543	54	39	54.84	1.22
EVPBLEPSC5445	638	54	45	63.28	1.41
EVPBLEPSC5451	678	54	51	71.72	1.59

EVPBLEPDS-NC • Laminate Gallery Panel for Power Beam, No End Connection

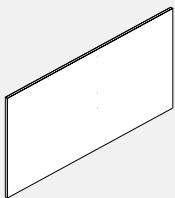

- Attaches to power beam channel
- To be installed at end of power beam run
- Finished in thermally fused laminate
- No connection both sides
- Laminate Gallery Panel height is inclusive of panel glides extended to their full height
- If wood grain is selected, grain runs horizontally
- Power beam channel and bottom connecting bracket to be ordered separately

PRODUCT CODE	PRICE LP	SIZE/INCHES		WEIGHT LBS	VOL FT ³
		H	W		
EVPBLEPDS4251NC	535	42	51	55.78	1.24
EVPBLEPDS4263NC	695	42	63	68.91	1.53
EVPBLEPDS4275NC	857	42	75	82.03	1.82
EVPBLEPDS4851NC	607	48	51	63.75	1.42
EVPBLEPDS4863NC	773	48	63	78.75	1.75
EVPBLEPDS4875NC	937	48	75	93.75	2.08
EVPBLEPDS5451NC	678	54	51	71.72	1.59
EVPBLEPDS5463NC	885	54	63	88.59	1.97
EVPBLEPDS5475NC	1023	54	75	105.47	2.34

EVPBLEPDC-NC • Laminate Gallery Middle Panel for Power Beam, No End Connection at Both Sides

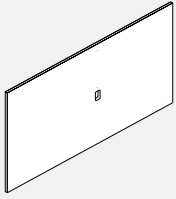

- Attaches to power beam channel
- To be installed in middle between two power beam in straight run
- Cut out for electrics at power beam height
- Finished in thermally fused laminate
- No connection both sides
- Laminate Gallery Panel height is inclusive of panel glides extended to their full height
- If wood grain is selected, grain runs horizontally
- Power beam channel and bottom connecting bracket to be ordered separately
- Standard code is for 24" H Power Beam
- Please add at code end "B" for 30"h Power Beam or "C" for 36"h Power Beam

PRODUCT CODE	PRICE LP	SIZE/INCHES		WEIGHT LBS	VOL FT ³
		H	W		
EVPBLEPDC4251NC	535	42	51	55.78	1.24
EVPBLEPDC4263NC	695	42	63	68.91	1.53
EVPBLEPDC4275NC	857	42	75	82.03	1.82
EVPBLEPDC4851NC	607	48	51	63.75	1.42
EVPBLEPDC4863NC	773	48	63	78.75	1.75
EVPBLEPDC4875NC	937	48	75	93.75	2.08
EVPBLEPDC5451NC	678	48	51	63.75	1.42
EVPBLEPDC5463NC	885	48	63	78.75	1.75
EVPBLEPDC5475NC	1023	48	75	93.75	2.08

EVPBLEPSS-NC • Laminate Gallery End Panel for Power Beam, No End Connection at Both Sides

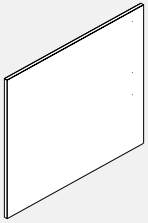

- Attaches to power beam channel
- To be installed at end of power beam run on one side
- Finished in thermally fused laminate
- No connection both sides
- Laminate Gallery Panel height is inclusive of panel glides extended to their full height
- If wood grain is selected, grain runs horizontally
- Power beam channel and bottom connecting bracket to be ordered separately

PRODUCT CODE	PRICE LP	SIZE/INCHES		WEIGHT LBS	VOL FT ³
		H	W		
EVPBLEPSSL4227NC	346	42	27	29.53	0.66
EVPBLEPSSL4233NC	386	42	33	36.09	0.80
EVPBLEPSSL4239NC	435	42	39	42.66	0.95
EVPBLEPSSL4245NC	499	42	45	49.22	1.09
EVPBLEPSSL4251NC	535	42	51	55.78	1.24
EVPBLEPSSL4827NC	378	48	27	33.75	0.75
EVPBLEPSSL4833NC	432	48	33	41.25	0.92
EVPBLEPSSL4839NC	483	48	39	48.75	1.08
EVPBLEPSSL4845NC	535	48	45	56.25	1.25
EVPBLEPSSL4851NC	607	48	51	63.75	1.42
EVPBLEPSSL5427NC	417	54	27	37.97	0.84
EVPBLEPSSL5433NC	477	54	33	46.41	1.03
EVPBLEPSSL5439NC	543	54	39	54.84	1.22
EVPBLEPSSL5445NC	638	54	45	63.28	1.41
EVPBLEPSSL5451NC	678	54	51	71.72	1.59
EVPBLEPSSR4227NC	346	42	27	29.53	0.66
EVPBLEPSSR4233NC	386	42	33	36.09	0.80
EVPBLEPSSR4239NC	435	42	39	42.66	0.95
EVPBLEPSSR4245NC	499	42	45	49.22	1.09
EVPBLEPSSR4251NC	535	42	51	55.78	1.24
EVPBLEPSSR4827NC	378	48	27	33.75	0.75
EVPBLEPSSR4833NC	432	48	33	41.25	0.92
EVPBLEPSSR4839NC	483	48	39	48.75	1.08
EVPBLEPSSR4845NC	535	48	45	56.25	1.25
EVPBLEPSSR4851NC	607	48	51	63.75	1.42
EVPBLEPSSR5427NC	417	54	27	37.97	0.84
EVPBLEPSSR5433NC	477	54	33	46.41	1.03
EVPBLEPSSR5439NC	543	54	39	54.84	1.22
EVPBLEPSSR5445NC	638	54	45	63.28	1.41
EVPBLEPSSR5451NC	678	54	51	71.72	1.59

EVPBLEPSC-NC • Laminate Gallery Middle One Side Panel for Power Beam, No End Connection at Both Sides

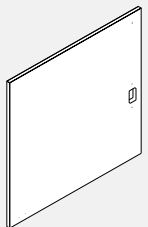

- Attaches to power beam channel
- To be installed in middle between two power beam in straight run on one side
- Cut out for electrics at power beam height
- Finished in thermally fused laminate
- No connection both sides
- Laminate Gallery Panel height is inclusive of panel glides extended to their full height
- If wood grain is selected, grain runs horizontally
- Power beam channel and bottom connecting bracket to be ordered separately
- Standard code is for 24" H Power Beam
- Please add at code end "B" for 30"h Power Beam or "C" for 36"h Power Beam

PRODUCT CODE	PRICE LP	SIZE/INCHES		WEIGHT LBS	VOL FT ³
		H	W		
EVPBLEPSC4227NC	346	42	27	29.53	0.66
EVPBLEPSC4233NC	386	42	33	36.09	0.80
EVPBLEPSC4239NC	435	42	39	42.66	0.95
EVPBLEPSC4245NC	499	42	45	49.22	1.09
EVPBLEPSC4251NC	535	42	51	55.78	1.24
EVPBLEPSC4827NC	378	48	27	33.75	0.75
EVPBLEPSC4833NC	432	48	33	41.25	0.92
EVPBLEPSC4839NC	483	48	39	48.75	1.08
EVPBLEPSC4845NC	535	48	45	56.25	1.25
EVPBLEPSC4851NC	607	48	51	63.75	1.42
EVPBLEPSC5427NC	417	54	27	37.97	0.84
EVPBLEPSC5433NC	477	54	33	46.41	1.03
EVPBLEPSC5439NC	543	54	39	54.84	1.22
EVPBLEPSC5445NC	638	54	45	63.28	1.41
EVPBLEPSC5451NC	678	54	51	71.72	1.59

EVHLPBB01 • Laminate Panel Bracket

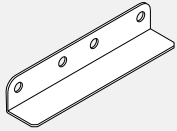

- Laminate panel bottom bracket connects two laminate end panels at bottom with screws
- Available in standard paint colors
- Bracket and screws included

PRODUCT CODE	PRICE	SIZE/INCHES			WEIGHT LBS	VOL FT ³
		H	W	D		
EVHLPBB01	35	1.5	8	1	0.50	0.11

EVHLPCB01 • Laminate Panel Corner Bracket

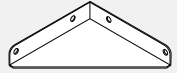

- Laminate panel corner bottom bracket connects two laminate panels at 90 degree
- Available in standard paint colors
- Bracket and screws included

PRODUCT CODE	PRICE	SIZE/INCHES			WEIGHT LBS	VOL FT ³
		H	W	D		
EVHLPCB01	34	1.5	4	4	0.50	0.11

EVPERCH • Connector with U Channel



- U channel attaches with screws to laminate end panel or laminate middle panel
- Evolve panels attaches to connector
- Pass thru at bottom and beltline location for power/data
- U channel is welded to connector
- Includes connector with U channel and hardware

PRODUCT CODE	PRICE	SIZE/INCHES		WEIGHT LBS	VOL FT ³
		H	W		
EVPERCH42	133	42	2.875	4.60	0.14
EVPERCH48	140	48	2.875	5.09	0.18
EVPERCH54	151	54	2.875	6.75	0.22

EVPBIECH • Power Beam Channel



- One piece channel for power beam and extension module above, attaches to laminate panels with screws
- Power beam attaches to channel with clamps and extension module attaches above
- Channel has cut out for power beam electrics to run thru laminate panel

Note

- It is not stackable.
- It can not be stacked with standard extension connector above it.

PRODUCT CODE	PRICE	SIZE/INCHES		WEIGHT LBS	VOL FT ³
		H	W		
EVPBIECH12	38	12	2.875	1.32	0.12
EVPBIECH18	42	18	2.875	1.94	0.18
EVPBIECH24	53	24	2.875	2.60	0.24
EVPBIECH30	56	30	2.875	3.30	0.30
EVPBIECH36	61	36	2.875	4.60	0.36

EVSL12 • Laminated Shelf for Reception Panels

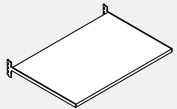

- Laminated Wood Shelf Panel Mounted
- Shelf thickness 1"
- Available in LP
- Includes attachment hardware

PRODUCT CODE	PRICE	SIZE/INCHES			WEIGHT LBS	VOL FT ³
		H	W	D		
EVSL1218	197	1.125	18	12	4.98	0.13
EVSL1224	212	1.125	24	12	6.64	0.17
EVSL1230	226	1.125	30	12	8.3	0.21
EVSL1236	239	1.125	36	12	9.96	0.25
EVSL1242	253	1.125	42	12	11.63	0.29
EVSL1248	268	1.125	48	12	13.29	0.33

EVPTTAU • Connector with U Channel Top Trim Aluminum

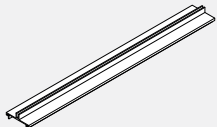

- Aluminum top trim longer by 0.625" to cover width of connector with U channel
- Trim can not span a post
- Available in standard paint colors

PRODUCT CODE	PRICE	SIZE/INCHES		WEIGHT LBS	VOL FT ³
		W	D		
EVPTTAU24	19	24.625	0.19	0.04	
EVPTTAU30	24	30.625	0.24	0.05	
EVPTTAU36	27	36.625	0.28	0.06	
EVPTTAU42	30	42.625	0.33	0.07	
EVPTTAU48	35	48.625	0.37	0.08	
EVPTTAU54	38	54.625	0.42	0.09	
EVPTTAU60	46	60.625	0.46	0.10	
EVPTTAU66	48	66.625	0.51	0.11	
EVPTTAU72	49	72.625	0.56	0.12	
EVPTTAU78	57	78.625	0.60	0.13	
EVPTTAU84	60	84.625	0.65	0.14	

EVPTTA • Aluminum Top Trim for Double Inline Connector (for use with laminate end and middle panels)

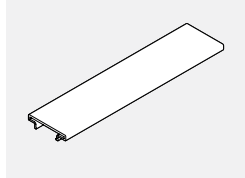

- Used for panels in middle of run of panels with Double Inline Connector.
- Aluminum Top Trim covers panel and one Double Inline Connector.
- Available in standard paint colours.
- Note: Trim can not span a Post Connector.

PRODUCT CODE	PRICE	SIZE/	INCHES		WEIGHT VOL	
			W	LBS	FT ³	
EVPTTA25	19		25.125	0.19	0.04	
EVPTTA31	24		31.125	0.24	0.05	
EVPTTA37	27		37.125	0.28	0.06	
EVPTTA43	30		43.125	0.33	0.07	
EVPTTA49	35		49.125	0.37	0.08	
EVPTTA55	38		55.125	0.42	0.09	
EVPTTA61	46		61.125	0.46	0.10	
EVPTTA67	48		67.125	0.51	0.11	
EVPTTA73	49		73.125	0.56	0.12	
EVPTTA79	57		79.125	0.60	0.13	
EVPTTA85	60		83.125	0.65	0.14	

EVPTTA • Aluminum Top Trim for Double Inline Connector (for use with laminate end and middle panels)

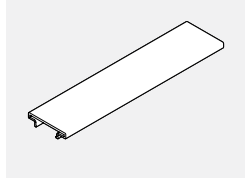

- Used for panels next to end of run trim in run of panels with Double Inline Connector.
- Available in standard paint colours.
- Note: Trim can not span a Post Connector.

PRODUCT CODE	PRICE	SIZE/	INCHES		WEIGHT VOL	
			W	LBS	FT ³	
EVPTTA24	16		24	0.22	0.04	
EVPTTA30	23		30	0.29	0.05	
EVPTTA36	25		36	0.30	0.06	
EVPTTA42	29		42	0.34	0.07	
EVPTTA48	34		48	0.38	0.08	
EVPTTA54	37		54	0.42	0.09	
EVPTTA60	43		60	0.46	0.10	
EVPTTA66	46		66	0.50	0.11	
EVPTTA72	48		72	0.55	0.12	
EVPTTA78	56		78	0.59	0.12	
EVPTTA84	60		84	0.64	0.13	

EVPGDCP • Gallery panel data post

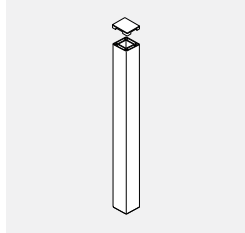

- One way post attaches to Gallery Panel at the end to bring power and/or data cables from ceiling to Evolve panels.
- Accommodates up to 25 CAT 5 cables with electric. Accommodates up to 45 CAT 5 cables without electric.
- Middle Gallery panel with bottom cut out for electrics must be ordered.
- Standard data post extension used above.
- Standard data post extension to be ordered separately.
- Choose standard paint finish.

PRODUCT CODE	PRICE	SIZE/	INCHES		WEIGHT VOL	
			H	W	LBS	FT ³
EVPGDCP42	176		42	3		
EVPGDCP48	208		48	3		
EVPGDCP54	227		54	3		

EVPMP-GI6W • Privacy Glass for 1" Laminate Panels

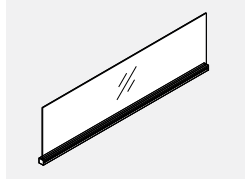

- Privacy glass integrated with aluminum trim.
- Attaches on top of 1" laminate panels to add privacy or divide space.
- Includes aluminum trim with end caps and glass tile.
- Aluminum trim has rail for accessories.
- Standard in clear (CLR), frosted (FRST) or writeable (WRW) glass.
- Glass and attachment hardware to ship separately.

PRODUCT CODE	PRICE			SIZE/INCHES			WEIGHT VOL	
	CL	FRST	WRW	H	W	D	LBS	FT ³
EVPMP24GI6W	201	251	-	6	24	1	2.39	0.25
EVPMP30GI6W	219	276	-	6	30	1	2.99	0.32
EVPMP36GI6W	235	291	-	6	36	1	3.58	0.37
EVPMP42GI6W	251	313	-	6	42	1	4.18	0.43
EVPMP48GI6W	262	327	-	6	48	1	4.78	0.50
EVPMP24GI9W	201	251	-	9	24	1	3.58	0.25
EVPMP30GI9W	219	276	-	9	30	1	4.48	0.32
EVPMP36GI9W	235	291	-	9	36	1	5.37	0.37
EVPMP42GI9W	251	313	-	9	42	1	6.26	0.43
EVPMP48GI9W	262	327	-	9	48	1	7.16	0.50
EVPMP24GIW	201	251	350	12	24	1	4.77	0.50
EVPMP30GIW	219	276	357	12	30	1	5.97	0.63
EVPMP36GIW	235	291	364	12	36	1	7.16	0.75
EVPMP42GIW	251	313	401	12	42	1	8.35	0.87
EVPMP48GIW	262	327	439	12	48	1	9.55	1.00

EVPFDW • Felt divider for 1" Laminate Panels

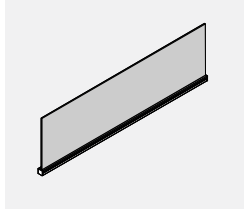

- Privacy Felt Divider integrated with aluminum top trim. Attaches on top of laminate panels to add privacy or divide space.
- Includes aluminum trim with channel and felt tile.
- Felt and attachment hardware to ship separately.
- 9 mm felt material is tackable and comes in 18 different colors. Please specify felt finish.
- Aluminum top trim available in standard paint finishes.

PRODUCT CODE	PRICE	SIZE/INCHES			WEIGHT VOL	
		H	W	D	LBS	FT ³
EVPFD0624W	72	6	24	1	1.42	0.26
EVPFD0630W	88	6	30	1	1.73	0.32
EVPFD0636W	102	6	36	1	2.03	0.37
EVPFD0642W	114	6	42	1	2.34	0.43
EVPFD0648W	170	6	48	1	2.64	0.50
EVPFD0654W	183	6	54	1	2.95	0.56
EVPFD0660W	199	6	60	1	3.25	0.63
EVPFD0666W	210	6	66	1	3.56	0.69
EVPFD0672W	238	6	72	1	3.86	0.76
EVPFD0924W	72	9	24	1	1.63	0.38
EVPFD0930W	88	9	30	1	1.99	0.47
EVPFD0936W	102	9	36	1	2.35	0.56
EVPFD0942W	114	9	42	1	2.70	0.65
EVPFD0948W	170	9	48	1	3.06	0.75
EVPFD0954W	183	9	54	1	3.42	0.84
EVPFD0960W	199	9	60	1	3.78	0.94
EVPFD0966W	210	9	66	1	4.13	1.04
EVPFD0972W	238	9	72	1	4.49	1.13
EVPFD1224W	72	12	24	1	1.84	0.50
EVPFD1230W	88	12	30	1	2.25	0.63
EVPFD1236W	102	12	36	1	2.66	0.75
EVPFD1242W	114	12	42	1	3.07	0.87
EVPFD1248W	170	12	48	1	3.48	1.00
EVPFD1254W	183	12	54	1	3.89	1.12
EVPFD1260W	199	12	60	1	4.30	1.25
EVPFD1266W	210	12	66	1	5.12	1.38
EVPFD1272W	238	12	72	1	5.53	1.51
EVPFD1824W	92	18	24	1	2.26	0.75
EVPFD1830W	108	18	30	1	2.77	0.94
EVPFD1836W	128	18	36	1	3.29	1.13
EVPFD1842W	143	18	42	1	3.80	1.31
EVPFD1848W	212	18	48	1	4.32	1.50
EVPFD1854W	231	18	54	1	4.83	1.69
EVPFD1860W	248	18	60	1	5.35	1.88
EVPFD1866W	262	18	66	1	6.68	2.06
EVPFD1872W	298	18	72	1	7.20	2.25

EVPDIC • Double Inline Panel Connector (for use with Laminate Middle Panels)

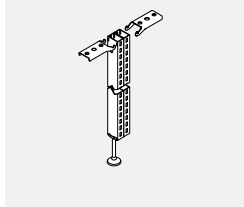

- Used to connect Laminate Middle Panel to panels of equal height in straight run.
- Aluminum Top Trim for Double Inline Connector must be used.
- Provides slotted support for worksurfaces and hang on storage compartments. Includes two slotted post with levelling glide and connection hardware.
- Connectors available without clots as special at no charge. Contact Customer Service.

PRODUCT CODE	PRICE	SIZE/ INCHES		WEIGHT VOL	
		H	W	LBS	FT ³
EVPDIC42	136	42	2	9.20	0.14
EVPDIC48	144	48	2	10.50	0.14

EVPDVTF • Double Connector Trim (for use with Laminate Middle Panels)

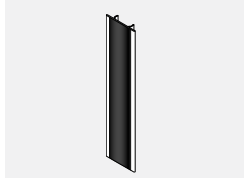

- Attaches to exposed side of double Inline Connector
- Must be ordered separately when Laminate Middle Panel is attached only to one side of Double Inline Connector.

PRODUCT CODE	PRICE	SIZE/ INCHES		WEIGHT VOL	
		H	W	LBS	FT ³
EVPDVTF42	13	42	2	0.52	0.07
EVPDVTF48	21	48	2	0.75	0.09

Technical Information for 9300 Series Pedestals

General Information:

9300 Series Pedestals feature center pull handles (models ending in "C") and full pull handles (models ending in "P"). Freestanding, mobile, and worksurface supporting options available. Quality steel construction. File drawers hold letter or A4 front to back and legal side to side configurations. Products are finished in a highly durable dry epoxy powder coating and drawer body interiors are finished with 100% recycled paint. Counterweights are included in freestanding and mobile pedestals to meet applicable ANSI/BIFMA X5.9.

Features:

- Cold rolled steel construction consisting of 16 ga front and back base with 22 ga case
- Reinforced welded construction
- Inset drawer fronts and flush base
- Double wall construction on all drawer fronts
- Full extension ball bearing slides on file drawers and $\frac{3}{4}$ extension on box drawers
- Rubber bumpers on slides for quietness
- Worksurface supporting option available (includes mounting holes at top of unit)
- 1 pencil tray and 1 drawer divider are included with each unit containing a box drawer
- Each file drawer includes a hanging file bar
- Levelers provide 1" height adjustment
- Counterweights included for freestanding and mobile pedestals
- Includes lock with 2 keys
- Lock is located at the top right of the case above the top drawer
- Keyed alike option available and can be keyed alike to other storage components

Technical Information for Prime Series

General Information:

Prime premium filing and storage products pre-configured to suit your needs; featuring fixed front or receding doors with full pull handles and fully welded seamless tops to deliver strength and clean aesthetics. Premium quality steel construction. File drawers accommodate legal, letter or A4 sizes in back-to-front and side-to-side configurations. Products are finished in a highly durable dry epoxy powder coating and drawer body interiors are finished with 100% recycled paint.

Counterweights are recommended for use in all laterals, pedestals and freestanding files of all widths and heights to meet applicable ANSI/BIFMA X5.9. (Counterweights are offered as an option on all products where required to meet applicable ANSI/BIFMA standard)

Features

- Premium steel construction, 18-22 gauge steel components
- Full welded and reinforced case construction
- Interlock system allows only one drawer to open at a time for safety
- Most products feature full overlay fronts, with some exceptions such as units with receding doors where the front is inset in the case
- Double wall construction on all drawer and door fronts
- Full extension roller bearing glides on all drawers
- Anti-bounce-back safety feature prevents drawers from sliding open
- Receding doors slide into the cabinet and allow the shelf to be pulled out
- All pedestals are equipped with four levelling glides, providing 1.5" of height adjustment
- All other units equipped with four levelling glides providing 1" height adjustment and can be accessed from the interior of the cabinets for ease of adjustment
- On units with drawers and hinged doors, locks are located at the center of the case above the top opening
- Lock position on towers with wardrobes is below the handle when center pull is selected
- Each lock includes 2 keys; locks are standard with removable cores
- Key assignment is random or can be specified for specific key number for key alike applications

Overhead Storage:

- Overhead cabinets - 7 widths in 6" increments
- 14 5/8" high cases with interior clear height of 12"
- 13" deep units have interior clear dimension of 12.7"
- 16" deep units have interior clear dimension of 15.7"
- Open shelves - 7 widths in 6" increments
- Shelves are 12 1/2" deep with 7 1/2" high side gables

Sizes:

- 15" width
- 19", 23", 29" depths
- Interior drawer depths:

19" Deep pedestals
17 1/4" deep box drawers
16 1/16" deep file drawers

23" deep pedestals
20 3/16" deep box drawers
19 7/16" deep file drawers

29" deep pedestals
26 5/16" deep box drawers
26 1/16" deep file drawers

Drawer Heights:

Box drawer fronts are 6"H with 5" interior height
File drawer fronts are 12"H with 10 9/16" interior height

Pedestals:

- Freestanding and worksurface supporting options available
- Worksurface supporting includes mounting holes at top of unit
- 1 pencil tray and 1 drawer divider are included with each unit containing a box drawer
- File drawers hold legal, letter or A4 sizes in back-to-front and side-to-side configurations
- Each file drawer includes a hanging file bar and conversion rails
- Freestanding units BSPF can be specified with optional non-locking casters to convert to a mobile unit
- 15" width x 18", 22", 28" depths

Interior drawer depth is as follows:

- 15" deep drawers for 18" deep pedestals
- 19" deep drawers for 22" deep pedestals
- 25" deep drawers for 28" deep pedestals

File drawer capacity:

- 14 3/8" filing capacity for file drawers in 18" pedestal
- 18 3/8" filing capacity for file drawers in 22" pedestal
- 24 3/8" filing capacity for file drawers in 28" pedestal

Laterals:

- 18" depth with interior depth of 16"
- 30", 36", 42" widths
- Available in 2 to 6 drawer high (28"h – 77.6"h)

File Drawer Capacity:

- 30" wide units
- Letter & legal side-to-side = 26 5/8"
 - Letter front-to-back = 30 1/2"
 - Legal front-to-back = 15 1/4" + 10" side space
- 36" wide units
- Letter & legal side-to-side = 32 5/8"
 - Letter front-to-back = 30 1/2" + 6 1/2" side space
 - Legal front-to-back = 30 1/2"
- 42" wide units
- Letter & legal side-to-side = 58 5/8"
 - Letter front-to-back = 45 3/4"
 - Legal front-to-back = 30 1/2" + 6 1/2" side space

Technical Information for Prime Series

Storage Cabinets:

- 18" depth
- 30", 36", 42" widths
- Available in 2 to 5 high configurations (28"h – 65.6"h)

Towers:

- Include coat rod and shelf to accommodate personal items
- The top of the storage compartment is perforated for ventilation
- Includes locks with 2 keys each
 - Closed storage comes with 3 locks – one of the drawers, one for the cupboard, and one for the wardrobe
 - Side open storage comes with 2 locks – one of the drawers and one for the ward-

robe

- 24" depth
- 24" width
- 50", 54", and 66" nominal heights available to coordinate with Global's panel systems

STORAGE COMPONENTS - GUIDELINES FOR ORDERING PRODUCT

Codes

The price list uses a numbering system with meaningful alphanumeric characters to create a simple-to-understand product number. This makes specifying the product much easier and more accurate.

How to Specify

- Specify storage pedestal type and size by code, including depth.
- Specify metal color (eg. BLK for Black)
- Specify key random, key list provided, or key number (eg. 401)
- Specify worksurface supporting (1 = Yes, 2 = No)
- Specify counterweight if pedestal is not worksurface supporting (NN = No Counterweight)

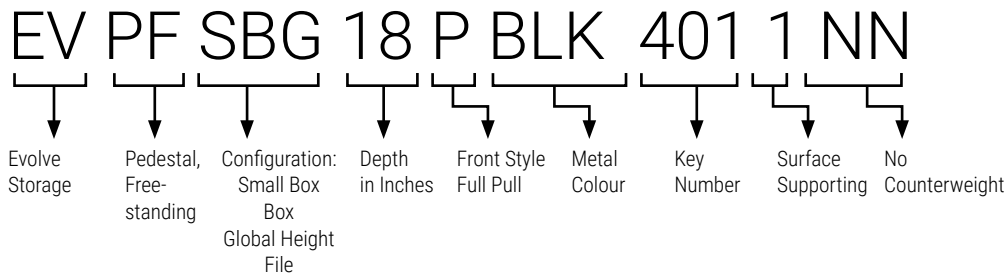

EVSLs • Low Profile Shelf

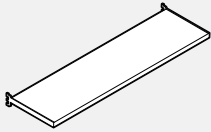

- Laminated Wood Shelf Panel Mounted
- Shelf thickness 1.125".
- Available in LP only.
- Includes attachment hardware.

PRODUCT CODE	PRICE	SIZE/ INCHES			WEIGHT VOL	
		H	W	D	LBS	FT ³
EVSLs0818	210	1.125	18	8.5	3.98	0.09
EVSLs0824	229	1.125	24	8.5	5.31	0.12
EVSLs0830	248	1.125	30	8.5	6.64	0.15
EVSLs0836	264	1.125	36	8.5	7.97	0.18
EVSLs0842	284	1.125	42	8.5	9.30	0.21
EVSLs0848	301	1.125	48	8.5	10.63	0.24

EVKSS • Panel Mount Shelf

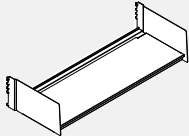

- 14" deep panel mounted storage shelf with backlip.
- Mounting brackets are included.

PRODUCT CODE	PRICE	SIZE/ INCHES			WEIGHT VOL	
		H	W	D	LBS	FT ³
EVKSS24	220	7.45	23.44	14.73	12.8	1.5
EVKSS30	229	7.45	29.44	14.73	14.8	1.9
EVKSS36	244	7.45	35.44	14.73	16.8	2.3
EVKSS42	254	7.45	41.44	14.73	18.8	2.6
EVKSS48	259	7.45	47.44	14.73	20.8	3.0
EVKSS54	293	7.45	53.44	14.73	22.8	3.4
EVKSS60	322	7.45	59.44	14.73	24.8	3.8

EVLSF • Flush Front Overhead Cabinet

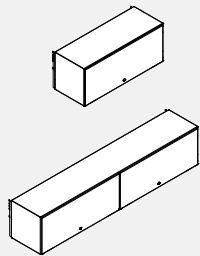

Cabinets 54" and 60" wide come with two doors

- Flush Front Overhead Cabinet is panel mounted lockable storage unit.
- The door retracts inside/within the overhead cabinet.
- Locks can be keyed alike to match other lockable storage components or keyed random to provide a dedicated lock.
- Available in 13" and 16" depths, 24" to 60" widths at 6" increments.
- Cabinets 54" and 60" wide come with two doors.
- Includes mounting hardware as specified, lock and keys.
- Lock secures into bottom shelf.
- Can be mounted at any height, however 66"h panels are recommended.
- Shipped assembled.

PRODUCT CODE	PRICE	SIZE/ INCHES			WEIGHT VOL	
		H	W	D	LBS	FT ³
EVLSF1324MN	869	14.62	23.87	13.5	39.30	2.7
EVLSF1330MN	947	14.62	29.87	13.5	44.3	3.4
EVLSF1336MN	1044	14.62	35.87	13.5	49.3	4.1
EVLSF1342MN	1147	14.62	41.87	13.5	54.3	4.8
EVLSF1348MN	1244	14.62	47.87	13.5	59.3	5.5
EVLSF1354MN	1324	14.62	53.87	13.5	64.3	6.2
EVLSF1360MN	1449	14.62	59.87	13.5	69.3	6.8
EVLSF1624MN	966	14.62	23.87	16.5	38.6	3.4
EVLSF1630MN	1044	14.62	29.87	16.5	43.9	4.2
EVLSF1636MN	1147	14.62	35.87	16.5	49.2	5.0
EVLSF1642MN	1244	14.62	41.87	16.5	54.5	5.8
EVLSF1648MN	1342	14.62	47.87	16.5	59.8	6.7
EVLSF1654MN	1449	14.62	53.87	16.5	65.1	7.5
EVLSF1660MN	1547	14.62	59.87	16.5	70.4	8.4

EVADA-PM • Easy-Up Panel Mounted Overhead Storage Unit - AODA Compliant

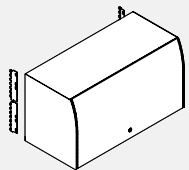

- Meets CSA B651 Barrier Free Design & AODA (Accessibility for Ontarians with Disabilities Act).
- 16" high units accept standard and A4 binders.
- All shelves are reinforced for proper weight distribution.
- Inside dimensions: 14.25" high x 13.4" deep.
- Unit includes attachment hardware, lock and mounting brackets. Back not included.
- Not recommended for use with wall rails.
- Shipped partially assembled.
- Unit can be converted to an Up-Mount Overhead Storage in the field by adding EVADA-KIT.

With opaque acrylic door. The mechanism lifts the door up and stores it out of the way, above the storage unit.

PRODUCT CODE	PRICE	SIZE/ INCHES			WEIGHT VOL	
		H	W	D	LBS	FT ³
EVADA30PM	839	16	30	14.2	27.00	5.30
EVADA36PM	906	16	36	14.2	32.00	6.30
EVADA42PM	970	16	42	14.2	37.00	7.30
EVADA48PM	1037	16	48	14.2	42.00	8.30
EVADA54PM	1101	16	54	14.2	47.00	9.30
EVADA60PM	1167	16	60	14.2	53.00	10.30

EVADAPMKIT • Panel Mount Conversion Kit



- Converts an existing Up-Mount Overhead Storage Unit EVADA-UM to a Panel Mounted Overhead Storage Unit EVADA-PM.
- Kit includes panel mounting brackets.

PRODUCT CODE	PRICE	SIZE/ INCHES			WEIGHT VOL	
		H	W	D	LBS	FT ³
EVADAPMKIT	40	16	0.5	2	2.00	0.01

EVADA-UM • Easy-Up Up-Mount Overhead Storage Unit - AODA Compliant

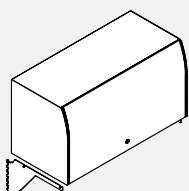

- Meets CSA B651 Barrier Free Design & AODA (Accessibility for Ontarians with Disabilities Act).
- 16" high units accept standard and A4 binders.
- All shelves are reinforced for proper weight distribution.
- Inside dimensions: 14.25" high x 13.4" deep.
- Unit includes attachment hardware, lock, mounting cantilevers and has a finished back.
- Unit can be converted to an Panel Mounted Overhead Storage Unit in the field by adding EVADAPM-KIT.
- Shipped partially assembled.

Up-mounted storage can reduce furniture costs by reducing the height of all panels to 54". Complete 54" panel installations simplify cable routing at one level, below the top cap. Up-mounted cantilevers maintain accessibility and functionality of the panels' top lay-in channel below the top cap.

PRODUCT CODE	PRICE	SIZE/ INCHES			WEIGHT VOL	
		H	W	D	LBS	FT ³
EVADA30UM	999	16	30	14.2	33.00	5.30
EVADA36UM	1046	16	36	14.2	40.00	6.30
EVADA42UM	1105	16	42	14.2	46.00	7.30
EVADA48UM	1166	16	48	14.2	53.00	8.30
EVADA54UM	1222	16	54	14.2	59.00	9.30
EVADA60UM	1293	16	60	14.2	66.00	10.30

EVADA-KIT • Up-Mount Conversion Kit

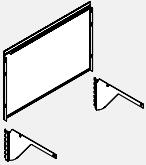

- Converts an existing Panel Mounted Overhead Storage Unit EVADA-PM to an Up-Mounted Overhead Storage Unit EVADA-UM.
- When used on a 54" high panel, the top of the overhead can match the height of 66" high panels.
- Kit includes a back panel for the Overhead and Up-Mount Cantilevers.

PRODUCT CODE	PRICE	SIZE/ INCHES			WEIGHT VOL	
		H	W	D	LBS	FT ³
EVADA30KIT	201	16	30	2	8.00	0.60
EVADA36KIT	210	16	36	2	10.00	0.70
EVADA42KIT	225	16	42	2	11.00	0.80
EVADA48KIT	235	16	48	2	13.00	0.90
EVADA54KIT	247	16	54	2	14.00	1.00
EVADA60KIT	261	16	60	2	15.00	1.10

EVSDAOHL36 • Dual Access Overhead Left

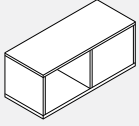

- Inside dimensions 13" high x 13" deep.
- Laminate Overhead.
- Available in standard Evolve laminate finishes.
- Top mount on panels.
- Dual Access Overhead Support Brackets to be ordered separately.

PRODUCT CODE	PRICE	SIZE/ INCHES			WEIGHT VOL	
		H	W	D	LBS	FT ³
EVSDAOHL36	1037	15	36	14.12	46.97	4.40
EVSDAOHL42	1118	15	42	14.12	52.84	5.13
EVSDAOHL48	1164	15	48	14.12	58.90	5.87
EVSDAOHL54	1246	15	54	14.12	64.97	6.61
EVSDAOHL60	1294	15	60	14.12	71.03	7.35

EVSDAOHR36 • Dual Access Overhead Right

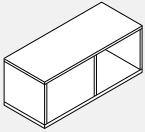

- Inside dimensions 13" high x 13" deep.
- Laminate Overhead.
- Available in standard Evolve laminate finishes.
- Top mount on panels.
- Dual Access Overhead Support Brackets to be ordered separately.

PRODUCT CODE	PRICE	SIZE/ INCHES			WEIGHT VOL	
		H	W	D	LBS	FT ³
EVSDAOHR36	1037	15	36	14.12	46.97	4.40
EVSDAOHR42	1118	15	42	14.12	52.84	5.13
EVSDAOHR48	1164	15	48	14.12	58.90	5.87
EVSDAOHR54	1246	15	54	14.12	64.97	6.61
EVSDAOHR60	1294	15	60	14.12	71.03	7.35

EVSDAOHBKTE • End of run Bracket

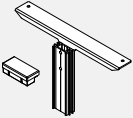

- Bracket supports dual access overhead on one side only.
- Includes one bracket, aluminum insert and end of run plastic cap.
- End of run plastic cap attaches to end of run trim.
- Bracket available in standard Evolve paint finishes.

PRODUCT CODE	PRICE	SIZE/ INCHES			WEIGHT VOL	
		H	W	D	LBS	FT ³
EVSDAOHBKTE	91	6.5	2	12	1	0.09

EVSDAOHBKTS • Inline Single Bracket

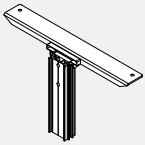

- Bracket supports dual access overhead on one side only.
- Includes one bracket, aluminum insert and inline plastic cap.
- Inline plastic cap and top trim align.
- Bracket available in standard Evolve paint finishes.
- Note: Single clamps must be used when inline single bracket is used.

PRODUCT CODE	PRICE	SIZE/ INCHES			WEIGHT VOL	
		H	W	D	LBS	FT ³
EVSDAOHBKTS	91	6.5	4	12	1.6	0.09

EVSDAOHBKTD • Double Bracket

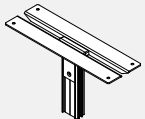

- Double Bracket supports sides of dual access overheads when overhead are side by side.
- Includes two brackets, aluminum insert and plastic caps.
- Plastic caps installed between bracket.
- Brackets available in standard Evolve paint finishes.
- **Note:** Single clamps must be used when double bracket is used.

PRODUCT CODE	PRICE	SIZE/ INCHES			WEIGHT VOL	
		H	W	D	LBS	FT ³
EVSDAOHBKTD	181	6.5	4	12	1.6	0.18

EVSSOHL • Top Mount KD Overhead with Sliding Glass Door Left

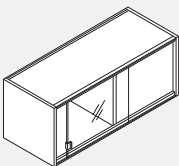

- Inside dimensions 13" high x 13" deep
- Laminate side walls and divider, available in standard laminate finishes
- Metal shelves and back wall, available in standard paint finishes
- Available in tempered frosted glass only
- Tracks for sliding glass available in Tungsten only
- Top mount on panels
- Ready for quick assembly on site
- Top Mount Overhead Support Brackets to be ordered separately.

PRODUCT CODE	PRICE	SIZE/ INCHES			WEIGHT VOL	
		H	W	D	LBS	FT ³
EVSSOHL30	1049	15	30	15	63.00	3.66
EVSSOHL36	1158	15	36	15	64.00	4.40
EVSSOHL42	1276	15	42	15	66.00	5.13
EVSSOHL48	1359	15	48	15	68.00	5.87
EVSSOHL54	1438	15	54	15	70.00	6.61
EVSSOHL60	1571	15	60	15	72.00	7.35

EVSSOHR • Top Mount KD Overhead with Sliding Glass Door Right

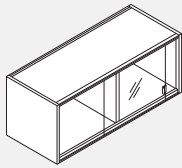

- Inside dimensions 13" high x 13" deep.
- Laminate side walls and divider, available in standard laminate finishes.
- Metal shelves and back wall, available in standard paint finishes.
- Available in tempered frosted glass only.
- Tracks for sliding glass available in Tungsten only.
- Top mount on panels.
- Ready for quick assembly on site .
- Top Mount Overhead Support Brackets to be ordered separately.

PRODUCT CODE	PRICE	SIZE/ H	INCHES W	D	WEIGHT LBS	VOL FT³
EVSSOHR30	1049	15	30	15	63.00	3.66
EVSSOHR36	1158	15	36	15	64.00	4.40
EVSSOHR42	1276	15	42	15	66.00	5.13
EVSSOHR48	1359	15	48	15	68.00	5.87
EVSSOHR54	1438	15	54	15	70.00	6.61
EVSSOHR60	1571	15	60	15	72.00	7.35

EVSSOHBKTE • End of run Top Mount Overhead Bracket

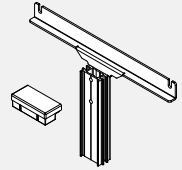

- Bracket supports Top Mount KD overhead on one side only.
- Includes one bracket , aluminum insert and end of run plastic cap.
- End of run plastic cap attaches to end of run trim.
- Bracket available in standard Evolve paint finishes.

PRODUCT CODE	PRICE	SIZE/ H	INCHES W	D	WEIGHT LBS	VOL FT³
EVSSOHBKTE	91	6	2	12	1	0.07

EVSSOHBKTS • Inline Single Top Mount Overhead Bracket

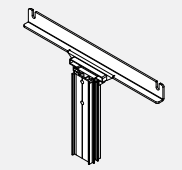

- Bracket supports Top Mount KD overhead on one side only.
- Includes one bracket , aluminum insert and inline plastic cap.
- Inline plastic cap and top trim align.
- Bracket available in standard Evolve paint finishes.
- **Note:** Single clamps must be used when inline single bracket is used.

PRODUCT CODE	PRICE	SIZE/ H	INCHES W	D	WEIGHT LBS	VOL FT³
EVSSOHBKTS	91	15	36	12	1	0.07

EVSSOHBKTD • Double Top Mount Overhead Bracket

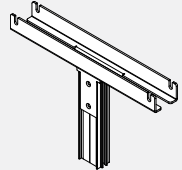

- Double Bracket supports sides of Top Mount KD overheads when overhead are side by side.
- Includes two brackets, aluminum insert and plastic caps.
- Plastic caps installed between brackets.
- Brackets available in standard Evolve paint finishes.
- **Note:** Single clamps must be used when double bracket is used.

PRODUCT CODE	PRICE	SIZE/ H	INCHES W	D	WEIGHT LBS	VOL FT³
EVSSOHBKTD	91	15	36	12	1.6	0.09

EVSODOMB • Overhead Off Module Mount Conversion Kit

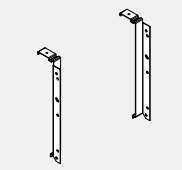

- Converts any existing EVADA overheads to off module installed.
- Allows to install overhead of different widths of Premium Panel.
- Attaches to top horizontal tube of Premium Fabric Panel.
- Brackets allow to install Double Wall Overhead or AODA overhead.
- Kit includes pair of brackets.
- Available in standard paint finishes.

PRODUCT CODE	PRICE	SIZE/ H	INCHES W	D	WEIGHT LBS	VOL FT³
EVSODOMB	95	12.37	1	4.37	0.25	0.09

EV93FPxxBFP • 9300 Series Freestanding Box File Pedestal

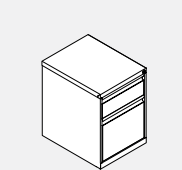

- One box and one file drawer pedestal.
- Freestanding, counterweight included.
- All drawers are locking.
- Box drawer includes pencil tray.

PRODUCT CODE	PRICE	SIZE/ H	INCHES W	D	WEIGHT LBS	VOL FT³
EV93FP19BFP	559	21.31	15	19	50	5.1
EV93FP23BFP	566	21.31	15	23	55	6.0
EV93FP29BFP	678	21.31	15	29	64	7.5

EV93FPxxBBFP • 9300 Series Freestanding Box Box File Pedestal

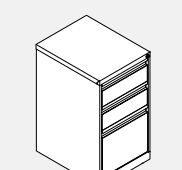

- Two box and one file drawer pedestal.
- Freestanding, counterweight included.
- All drawers are locking.
- Top box drawer includes pencil tray.

PRODUCT CODE	PRICE	SIZE/ H	INCHES W	D	WEIGHT LBS	VOL FT³
EV93FP19BBFP	617	27.87	15	19	55	6.5
EV93FP23BBFP	628	27.87	15	23	68	7.7
EV93FP29BBFP	741	27.87	15	29	78	9.6

EV93FPxxFFP • 9300 Series Freestanding File File Pedestal

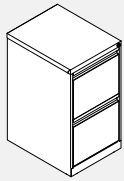

- Two file drawer pedestal.
- Freestanding, counterweight included.
- All drawers are locking.

PRODUCT CODE	PRICE	SIZE/ INCHES			WEIGHT VOL	
		H	W	D	LBS	FT ³
EV93FP19FFP	589	27.87	15	19	53	6.5
EV93FP23FFP	597	27.87	15	23	60	7.7
EV93FP29FFP	699	27.87	15	29	70	9.6

EV93WPxxBBFP • 9300 Series Worksurface Supporting Box Box File Pedestal

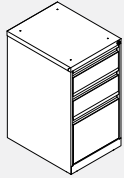

- Two box and one file drawer pedestal.
- Worksurface supporting, includes mounting holes in the top.
- All drawers are locking.
- Top box drawer includes pencil tray.
- To use as a worksurface supporting pedestal, please specify EVHPB6 separately.

PRODUCT CODE	PRICE	SIZE/ INCHES			WEIGHT VOL	
		H	W	D	LBS	FT ³
EV93WP19BBFP	613	27.87	15	19	55	6.5
EV93WP23BBFP	621	27.87	15	23	68	7.7
EV93WP29BBFP	711	27.87	15	29	78	9.6

EV93WPxxFFP • 9300 Series Worksurface Supporting File File Pedestal

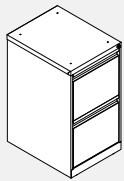

- Two file drawer pedestal.
- Worksurface supporting, includes mounting holes in the top.
- All drawers are locking.
- To use as a worksurface supporting pedestal, please specify EVHPB6 separately.

PRODUCT CODE	PRICE	SIZE/ INCHES			WEIGHT VOL	
		H	W	D	LBS	FT ³
EV93WP19FFP	582	27.87	15	19	53	6.5
EV93WP23FFP	587	27.87	15	23	60	7.7
EV93WP29FFP	700	27.87	15	29	70	9.6

EV93MPxxBFP • 9300 Series Mobile Box File Pedestal

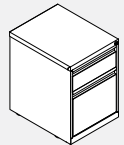

- One box and one file drawer mobile pedestal.
- Casters preinstalled, casters non-locking.
- Counterweight included.
- All drawers locking.
- Box drawer includes pencil tray.
- NOTE: Cannot be used as guest seating.

PRODUCT CODE	PRICE	SIZE/ INCHES			WEIGHT VOL	
		H	W	D	LBS	FT ³
EV93MP19BFP	659	21.87	15	19	66	5.2
EV93MP23BFP	681	21.87	15	23	72	6.2
EV93MP29BFP	730	21.87	15	29	92	7.6

EV93MPxxBBFP • 9300 Series Mobile Box Box File Pedestal

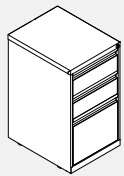

- Two box and one file drawer mobile pedestal.
- Casters preinstalled, casters non-locking.
- Counterweight included.
- All drawers locking.
- Top box drawer includes pencil tray.
- NOTE: Cannot be used as guest seating.

PRODUCT CODE	PRICE	SIZE/ INCHES			WEIGHT VOL	
		H	W	D	LBS	FT ³
EV93MP19BBFP	695	27.93	15	19	76	6.5
EV93MP23BBFP	702	27.93	15	23	85	7.7
EV93MP29BBFP	757	27.93	15	29	94	9.6

EV93MPxxFFP • 9300 Series Mobile File File Pedestal

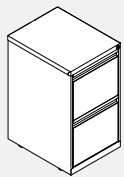

- Two file drawer pedestal.
- Casters preinstalled, casters non-locking.
- Counterweight included.
- All drawers locking.
- NOTE: Cannot be used as guest seating.

PRODUCT CODE	PRICE	SIZE/ INCHES			WEIGHT VOL	
		H	W	D	LBS	FT ³
EV93MP19FFP	654	27.93	15	19	73	6.5
EV93MP23FFP	681	27.93	15	23	81	7.7
EV93MP29FFP	748	27.93	15	29	90	9.6

EVPFOBFxxP • Prime Freestanding Box File Pedestal

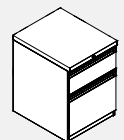

- One box and one file drawer pedestal.
- All drawers are locking.
- Box drawer includes pencil tray.
- For freestanding, to add counterweight (W2 option), add \$50 list.
- For mobile to add casters and counterweight (W1 option), add \$75 list. Adds 0.5" to height.
- NOTE: Cannot be used as guest seating.

PRODUCT CODE	PRICE	SIZE/ INCHES			WEIGHT VOL	
		H	W	D	LBS	FT ³
EVPFOBF18P	722	20.8	15	18	52.4	4.2
EVPFOBF22P	756	20.8	15	22	58.8	5.0
EVPFOBF28P	791	20.8	15	28	68.7	6.3

EVPFSGxxP • Prime Box Box File Pedestal

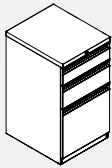

- Two box and one file drawer pedestal.
- All drawers are locking.
- Top box drawer includes pencil tray.
- For freestanding, to add counterweight (W2 option), add \$50 list.
- For mobile to add casters and counterweight (W1 option), add \$75 list. Adds 0.5" to height.
- Top box drawer 4.8"h; middle box drawer 6.4"h; bottom file drawer 13.6"h (interior 12.5"h).
- When worksurface supporting option selected, unit includes pre-drilled top holes for attaching.
- To use as a worksurface supporting pedestal, please specify EVHPB5 separately.

PRODUCT CODE	PRICE	SIZE/ INCHES			WEIGHT VOL	
		H	W	D	LBS	FT ³
EVPFSG18P	834	28	15	18	67.5	5.5
EVPFSG22P	874	28	15	22	75	6.6
EVPFSG28P	913	28	15	28	86.8	8.3

EVPFOFGxxP • Prime File File Pedestal

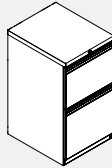

- Two file drawer pedestal.
- All drawers are locking.
- For freestanding, to add counterweight (W2 option), add \$50 list.
- For mobile to add casters and counterweight (W1 option), add \$75 list. Adds 0.5" to height.
- Top file drawer 11.2"h (interior 10.6"h); bottom file drawer 13.6"h (interior 12.5"h).
- When worksurface supporting option selected, unit includes pre-drilled top holes for attaching.
- To use as a worksurface supporting pedestal, please specify EVHPB5 separately.

PRODUCT CODE	PRICE	SIZE/ INCHES			WEIGHT VOL	
		H	W	D	LBS	FT ³
EVPFOFG18P	761	28	15	18	67.5	5.5
EVPFOFG22P	791	28	15	22	75	6.6
EVPFOFG28P	825	28	15	28	86.8	8.3

EVPWOBFxxP • Prime Mobile Box File Pedestal



- Mobile one box and one file drawer pedestal.
- All drawers are locking.
- 60mm casters.
- Front casters are locking.

PRODUCT CODE	PRICE	SIZE/ INCHES			WEIGHT VOL	
		H	W	D	LBS	FT ³
EVPWOBF18P	888	23.3	15	18	73.5	4.6
EVPWOBF22P	917	23.3	15	22	79.1	5.6
EVPWOBF28P	947	23.3	15	28	87.7	7.0

EVPWSSFxxP • Prime Mobile Box Box File Pedestal



- Mobile two box and one file drawer pedestal.
- All drawers are locking.
- 60mm casters.
- Front casters are locking.

PRODUCT CODE	PRICE	SIZE/ INCHES			WEIGHT VOL	
		H	W	D	LBS	FT ³
EVPWSSF18P	1005	26.5	15	18	82.9	5.2
EVPWSSF22P	1044	26.5	15	22	89.3	6.3
EVPWSSF28P	1059	26.5	15	28	99.2	7.9

EVSTC • Pedestal/Lateral Seat Cushion

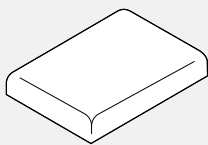

PRODUCT CODE	YRDS	SIZE/ INCHES			WEIGHT VOL	
		H	W	D	LBS	FT ³
EVSTCL1830	1.00	2	18	30	6.00	0.55
EVSTCL1836	1.25	2	18	36	6.00	0.65
EVSTCP1518	0.75	2	15	18	5.00	0.41
EVSTCP1522	1.00	2	15	22	5.25	0.45
EVSTCP1528	1.00	2	15	28	5.50	0.55

• C.O.M. Fabrics are priced as Grade 3.

PRODUCT CODE	PRICE																			
	GR1	GR2	GR3	GR4	GR5	GR6	GR7	GR8	GR9	GR10	GR11	GR12	GR13	GR14	GR15	GR16	GR17	GR18	GR19	GR20
EVSTCL1830	289	328	355	394	450	503	552	603	655	712	783	886	987	1089	1317	1541	1772	1996	2221	2471
EVSTCL1836	343	391	430	475	543	608	673	733	801	869	960	1089	1214	1343	1628	1908	2194	2474	2757	3070
EVSTCP1518	202	233	252	280	323	364	401	435	477	518	574	652	724	802	972	1142	1312	1482	1652	1839
EVSTCP1522	212	240	264	291	333	372	411	448	486	528	582	659	736	813	984	1153	1324	1495	1661	1848
EVSTCP1528	267	305	336	371	426	480	534	579	631	688	759	864	964	1065	1294	1517	1747	1973	2198	2448

EVFELT03BC - Felt Shelf Liner for Cube Pedestals

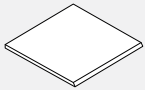

- Felt shelf liner can be added to any closed back shelf.
- Front edge is cut at 45 degree.

PRODUCT CODE	PRICE	SIZE/ H	INCHES W	D	WEIGHT LBS	VOL FT³
EVFTFELT03BC	23	12	12	0.38	0.1	0.03

EVSSPH12BFB • Cube Hanging Pedestal, One File Box and Two Open Boxes

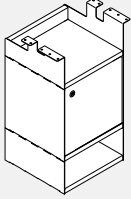

- Hanging pedestal with one file box in the middle and two open boxes, one at the top and one at the bottom.
- Attaches to the underside of a worksurface with supplied screws.
- File box interior dimensions: 11 7/8" h x 11 13/16" w x 10 7/16" d.
- Includes chrome wire divider and optional lock.
- Metal wire divider is chrome and sits 3 7/16" from either side and is interchangeable.
- File door lock, if specified is located on the top right corner for the right pedestal and top left corner for the left pedestal.
- Bottom, middle and top shelves, front door and back are made of 3/4" low pressure laminate.
- Sides are made of powder coated metal.
- Ships knocked-down.

PRODUCT CODE	PRICE	SIZE/ H	INCHES W	D	WEIGHT LBS	VOL FT³
Without Lock						
EVSSPH12BFBR	444	24	12	12	26	2.33
EVSSPH12BFBL	444	24	12	12	26	2.33
With Lock						
EVSSPH12BFBKR	457	24	12	12	26	2.33
EVSSPH12BFBKL	457	24	12	12	26	2.33

EVSSPH12BF • Cube Hanging Pedestal, One File Box

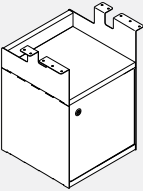

- Hanging pedestal with one file box at the bottom and one open box at the top.
- Attaches to the underside of a worksurface with supplied screws.
- File box interior dimensions: 11 7/8" h x 11 13/16" w x 10 7/16" d.
- Includes chrome wire divider and optional lock.
- Metal wire divider is chrome and sits 3 7/16" from either side and is interchangeable.
- File door lock, if specified is located on the top right corner for the right pedestal and top left corner for the left pedestal.
- Bottom, middle and top shelves, front door and back are made of 3/4" low pressure laminate.
- Sides are made of powder coated metal.
- Ships knocked-down.

PRODUCT CODE	PRICE	SIZE/ H	INCHES W	D	WEIGHT LBS	VOL FT³
Without Lock						
EVSSPH12BFR	334	18.5	12	12	20	1.83
EVSSPH12BFL	334	18.5	12	12	20	1.83
With Lock						
EVSSPH12BFKR	347	18.5	12	12	20	1.83
EVSSPH12BFKL	347	18.5	12	12	20	1.83

EVSSPH12B • Cube Hanging Pedestal Box

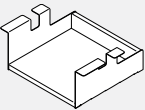

- Hanging pedestal open box.
- Attaches to the underside of a worksurface with supplied screws to create an open box.
- Bottom, middle and top shelves, front door and back are made of 3/4" low pressure laminate.
- Sides are made of powder coated metal.
- Ships knocked-down.

PRODUCT CODE	PRICE	SIZE/ H	INCHES W	D	WEIGHT LBS	VOL FT³
EVSSPH12B	136	6	12	12	6	0.96

EVSSPH12BB • Cube Hanging Pedestal, Two Open Boxes

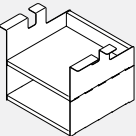

- Hanging pedestal with two open boxes.
- Attaches to the underside of a worksurface with supplied screws.
- Bottom, middle and top shelves, front door and back are made of 3/4" low pressure laminate.
- Sides are made of powder coated metal.
- Ships knocked-down.

PRODUCT CODE	PRICE	SIZE/ H	INCHES W	D	WEIGHT LBS	VOL FT³
EVSSPH12BB	251	11.5	12	12	12	1.42

EVT • Lateral File Tops

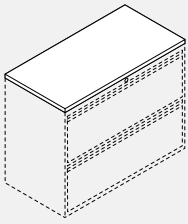

- Made of 1" or 1/16" thick particle board with laminate finish and edged in 3.0 mm edge banding.

PRODUCT CODE	PRICE		SIZE/INCHES			WEIGHT VOL	
	LP	HP	H	W	D	LBS	FT ³
EVT1830	151	213	1.0625	30	18	18.00	0.70
EVT1836	177	239	1.0625	36	18	22.00	0.82
EVT1842	207	318	1.0625	42	18	26.00	0.92
EVT1860	286	486	1.0625	60	18	37.00	1.27
EVT1872	340	550	1.0625	72	18	44.00	1.50
EVT1884	464	625	1.0625	84	18	52.00	1.85
EVT1890	502	682	1.0625	90	18	56.00	1.85
EVT18108	624	853	1.0625	108	18	67.00	2.20

EVLPS0BF18xxP • Prime Box File Lateral

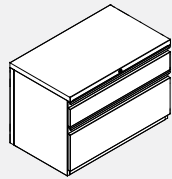

- One and a half height lateral filing cabinet.
- Fixed front drawers, top box drawer front 4.8" bottom file drawer front 13.6" (interior 12.5").
- Locking.
- Side to side hanging bars included.
- To add counterweight (W2 option), add \$410 list.

PRODUCT CODE	PRICE	SIZE/INCHES			WEIGHT VOL	
		H	W	D	LBS	FT ³
EVLPS0BF1830P	1191	20.98	30	18.06	119.96	8.0
EVLPS0BF1836P	1283	20.98	36	18.06	129.86	9.5
EVLPS0BF1842P	1371	20.98	42	18.06	165.45	11.1

EVL20G18xxP • Prime 2 High Lateral File

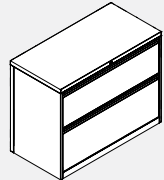

- Two high lateral filing cabinet.
- Fixed front file drawers, top drawer front 11.2" (interior 10.6") bottom drawer front 13.6" (interior 12.5").
- Locking.
- Side to side hanging bars included.
- To add counterweight (W2 option), add \$200 list.

PRODUCT CODE	PRICE	SIZE/INCHES			WEIGHT VOL	
		H	W	D	LBS	FT ³
EVL20G1830P	1279	28	30	18	98.7	10.5
EVL20G1836P	1366	28	36	18	114.4	12.5
EVL20G1842P	1454	28	42	18	129.4	14.5

EVL30G18xxP • Prime 3 High Lateral File

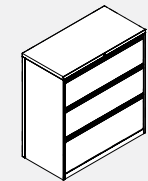

- Three high lateral filing cabinet.
- Fixed front file drawers, top & middle drawer front 11.2" (interior 10.6") bottom drawer front 13.6" (interior 12.5").
- Locking.
- Side to side hanging bars included.
- Will not line up with 42" high panels.
- To add counterweight (W2 option), add \$200 list.

PRODUCT CODE	PRICE	SIZE/INCHES			WEIGHT VOL	
		H	W	D	LBS	FT ³
EVL30G1830P	1747	39.2	30	18	127.9	14.5
EVL30G1836P	1869	39.2	36	18	147.6	17.2
EVL30G1842P	1991	39.2	42	18	167.5	20.0

EVL40H18xxP • Prime 4 High RFFF Lateral File

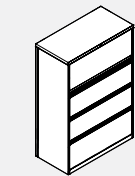

- Four high receding top door and remaining fixed front lateral filing cabinet.
- Top opening receding door + roll out shelf 14.4" front, accepts binder height; fixed front drawers second and third drawers 11.2" (interior 10.6") bottom drawer front 13.6" (interior 12.5").
- Locking.
- Side to side hanging bars included.
- To add counterweight (W2 option), add \$200 list.

PRODUCT CODE	PRICE	SIZE/INCHES			WEIGHT VOL	
		H	W	D	LBS	FT ³
EVL40H1830P	2323	53.6	30	18	171.9	19.6
EVL40H1836P	2474	53.6	36	18	198.2	23.3
EVL40H1842P	2630	53.6	42	18	225.3	27.0

EVL50P18xxP • Prime 5 High RFFFF Lateral File

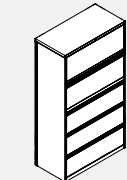

- Five high receding top door and remaining fixed front lateral filing cabinet.
- 13.6" (interior 12.5").
- Locking.
- Side to side hanging bars included.
- Top opening receding door + Roll out shelf 14.4" front, accepts binder height; fixed front drawers below - second and third 11.2" (interior 10.6") bottom drawer front
- To add counterweight (W2 option), add \$200 list.

PRODUCT CODE	PRICE	SIZE/INCHES			WEIGHT VOL	
		H	W	D	LBS	FT ³
EVL50P1830P	2860	65.6	30	18	208.9	23.9
EVL50P1836P	3035	65.6	36	18	239.9	28.4
EVL50P1842P	3221	65.6	42	18	272.7	32.9

EVSC21G18xxP • Prime 2 High Storage Cabinet

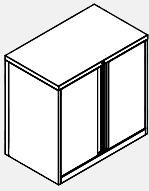

- Two high storage cabinet.
- One adjustable shelf + fixed bottom shelf.
- Locking.

PRODUCT CODE	PRICE	SIZE/INCHES			WEIGHT LBS	VOL FT ³
		H	W	D		
EVSC21G1830P	1005	28	30	18	75.08	10.5
EVSC21G1836P	1074	28	36	18	86.48	12.5
EVSC21G1842P	1142	28	42	18	95.78	14.5

EVSC31G18xxP • Prime 3 High Storage Cabinet

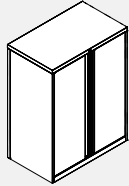

- Three high storage cabinet.
- Two adjustable shelves + fixed bottom shelf.
- Will not line up to 42" high panels.
- Locking.

PRODUCT CODE	PRICE	SIZE/INCHES			WEIGHT LBS	VOL FT ³
		H	W	D		
EVSC31G1830P	1401	39.2	30	18	96.69	14.5
EVSC31G1836P	1493	39.2	36	18	111.59	17.2
EVSC31G1842P	1571	39.2	42	18	124.49	20.0

EVSC41H18xxP • Prime 4 High Storage Cabinet

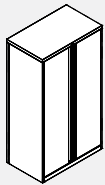

- Four high storage cabinet.
- Three adjustable shelves + fixed bottom shelf.
- Locking.

PRODUCT CODE	PRICE	SIZE/INCHES			WEIGHT LBS	VOL FT ³
		H	W	D		
EVSC41H1830P	1713	53.6	30	18	120.17	19.6
EVSC41H1836P	1825	53.6	36	18	138.27	23.3
EVSC41H1842P	1913	53.6	42	18	154.37	27.0

EVSC51C18xxP • Prime 5 High Storage Cabinet

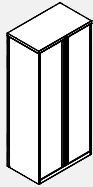

- Five high storage cabinet.
- Four adjustable shelves + fixed bottom shelf.
- Locking.

PRODUCT CODE	PRICE	SIZE/INCHES			WEIGHT LBS	VOL FT ³
		H	W	D		
EVSC51C1830P	1947	65.6	30	18	138.5	23.9
EVSC51C1836P	2069	65.6	36	18	160.4	28.4
EVSC51C1842P	2162	65.6	42	18	180.4	32.9

EVSLFxx24BCPL • Prime Tower, Left Wardrobe, Half Height Door, Box Box File Drawers

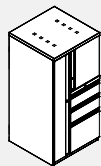

- Left wardrobe tower with half height door and box box file drawers.
- Wardrobe section includes top shelf and coat bar.
- Hinged door compartment of 50"h and 54"h includes one adjustable shelf; 66"h includes two adjustable open shelves.
- Wardrobe section includes top perforations for ventilation.
- Three locks included - wardrobe door, hinged door shelving compartment and drawers.
- To add counterweight (W2 option), add \$105 list.

PRODUCT CODE	PRICE	SIZE/INCHES			WEIGHT LBS	VOL FT ³
		H	W	D		
EVSLF4G24BCPL	3348	49.6	24	24	176.71	19.23
EVSLF4H24BCPL	3348	53.6	24	24	181.63	19.83
EVSLF5024BCPL	3514	65.6	24	24	204.52	25.25

*4G' Tower Shown

EVSLFxx24BCPR • Prime Tower, Right Wardrobe, Half Height Door, Box Box File Drawers

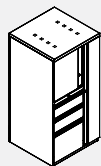

- Right wardrobe tower with half height door and box box file drawers.
- Wardrobe section includes top shelf and coat bar.
- Hinged door compartment of 50"h and 54"h includes one adjustable shelf; 66"h includes two adjustable open shelves.
- Wardrobe section includes top perforations for ventilation.
- Three locks included - wardrobe door, hinged door shelving compartment and drawers.
- To add counterweight (W2 option), add \$105 list.

PRODUCT CODE	PRICE	SIZE/INCHES			WEIGHT LBS	VOL FT ³
		H	W	D		
EVSLF4G24BCPR	3348	49.6	24	24	176.71	19.23
EVSLF4H24BCPR	3348	53.6	24	24	181.63	19.83
EVSLF5024BCPR	3514	65.6	24	24	204.52	25.25

*4G' Tower Shown

EVSLFxx24FCPL • Prime Tower, Left Wardrobe, Half Height Door, File File Drawers

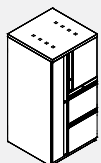

- Left wardrobe tower with half height door and file file drawers.
- Wardrobe section includes top shelf and coat bar.
- Hinged door compartment of 50"h and 54"h includes one adjustable shelf; 66"h includes two adjustable open shelves.
- Wardrobe section includes top perforations for ventilation.
- Three locks included - wardrobe door, hinged door shelving compartment and drawers.
- To add counterweight (W2 option), add \$105 list.

PRODUCT CODE	PRICE	SIZE/INCHES			WEIGHT LBS	VOL FT ³
		H	W	D		
EVSLF4G24FCPL	3260	49.6	24	24	181.05	19.23
EVSLF4H24FCPL	3260	53.6	24	24	186.43	19.83
EVSLF5024FCPL	3431	65.6	24	24	231.53	25.25

*4G' Tower Shown

EVSLFxx24FCPR • Prime Tower, Right Wardrobe, Half Height Door, File File Drawers

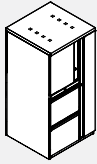

*4G' Tower Shown

- Right wardrobe tower with half height door and file file drawers.
- Wardrobe section includes top shelf and coat bar.
- Hinged door compartment of 50" and 54" includes one adjustable shelf; 66" includes two adjustable open shelves.
- Wardrobe section includes top perforations for ventilation.
- Three locks included - wardrobe door, hinged door shelving compartment and drawers.
- To add counterweight (W2 option), add \$105 list.

PRODUCT CODE	PRICE	SIZE/INCHES			WEIGHT LBS	VOL FT ³
		H	W	D		
EVSLF4G24FCPR	3260	49.6	24	24	181.05	19.23
EVSLF4H24FCPR	3260	53.6	24	24	186.43	19.83
EVSLF5024FCPR	3431	65.6	24	24	231.53	25.25

EVSLSxx2424BOPL • Prime Tower, Left Wardrobe, Side Open Shelf, Box Box File Drawers

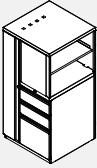

*4G' Tower Shown

- Left wardrobe tower with side open shelving and box box file drawers.
- Wardrobe section includes top shelf and coat bar.
- 50" and 54" include open side shelf with one adjustable shelf; 66" includes open side shelf with two adjustable shelves.
- Wardrobe section includes top perforations for ventilation.
- Two locks included - wardrobe door and drawers.

PRODUCT CODE	PRICE	SIZE/INCHES			WEIGHT LBS	VOL FT ³
		H	W	D		
EVSLS4G2424BOPL	3475	49.6	24	24	186.18	19.23
EVSLS4H2424BOPL	3475	53.6	24	24	186.91	19.83
EVSLS502424BOPL	3684	65.6	24	24	236.34	25.25

EVSLSxx2424BOPR • Prime Tower, Right Wardrobe, Side Open Shelf, Box Box File Drawers

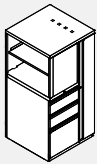

*4G' Tower Shown

- Right wardrobe tower with side open shelving and box box file drawers.
- Wardrobe section includes top shelf and coat bar.
- 50" and 54" include open side shelf with one adjustable shelf; 66" includes open side shelf with two adjustable shelves.
- Wardrobe section includes top perforations for ventilation.
- Two locks included - wardrobe door and drawers.

PRODUCT CODE	PRICE	SIZE/INCHES			WEIGHT LBS	VOL FT ³
		H	W	D		
EVSLS4G2424BOPR	3475	49.6	24	24	186.18	19.23
EVSLS4H2424BOPR	3475	53.6	24	24	186.91	19.83
EVSLS502424BOPR	3684	65.6	24	24	236.34	25.25

EVSLSxx2424FOPL • Prime Tower, Left Wardrobe, Side Open Shelf, File File Drawers

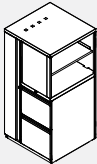

*4G' Tower Shown

- Left wardrobe tower with side open shelving and file file drawers.
- Wardrobe section includes top shelf and coat bar.
- 50" and 54" include open side shelf with one adjustable shelf; 66" includes open side shelf with two adjustable shelves.
- Wardrobe section includes top perforations for ventilation.
- Two locks included - wardrobe door and drawers.

PRODUCT CODE	PRICE	SIZE/INCHES			WEIGHT LBS	VOL FT ³
		H	W	D		
EVSLS4G2424FOPL	3392	49.6	24	24	179.54	19.23
EVSLS4H2424FOPL	3392	53.6	24	24	180.26	19.83
EVSLS502424FOPL	3601	65.6	24	24	232.55	25.25

EVSLSxx2424FOPR • Prime Tower, Right Wardrobe, Side Open Shelf, File File Drawers

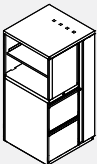

*4G' Tower Shown

- Right wardrobe tower with side open shelving and file file drawers.
- Wardrobe section includes top shelf and coat bar.
- 50" and 54" include open side shelf with one adjustable shelf; 66" includes open side shelf with two adjustable shelves.
- Wardrobe section includes top perforations for ventilation.
- Two locks included - wardrobe door and drawers.

PRODUCT CODE	PRICE	SIZE/INCHES			WEIGHT LBS	VOL FT ³
		H	W	D		
EVSLS4G2424FOPR	3392	49.6	24	24	179.54	19.23
EVSLS4H2424FOPR	3392	53.6	24	24	180.26	19.83
EVSLS502424FOPR	3601	65.6	24	24	232.55	25.25

EVWC51C18xxP • Prime Wardrobe

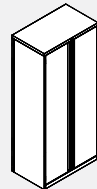

- Wardrobe cabinet.
- 30"W includes full width shelf and side to side coat rod.
- 36" and 42"W are split with shelving on left side, wardrobe on the other.

PRODUCT CODE	PRICE	SIZE/INCHES			WEIGHT LBS	VOL FT ³
		H	W	D		
EVWC51C1830P	1874	65.6	30	18	125.26	23.85
EVWC51C1836P	2294	65.6	36	18	164.97	28.40
EVWC51C1842P	2499	65.6	42	18	180.59	32.94

EVCC31G18xxP • Prime Three High Combination Cabinet

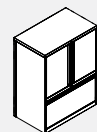

- Multi stor cabinet including hinged door upper section with one adjustable shelf; one fixed front file drawers below.
- Will not line up to 42" high panels.
- Locking.

PRODUCT CODE	PRICE	SIZE/INCHES			WEIGHT LBS	VOL FT ³
		H	W	D		
EVCC31G1830P	1664	39.2	30	18	117.3	14.5
EVCC31G1836P	1767	39.2	36	18	135.5	17.2
EVCC31G1842P	1869	39.2	42	18	152.5	20.0

EVCC41G18xxP • Prime Four High Combination Cabinet

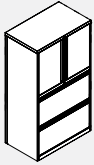

- Multi stor cabinet including hinged door upper section with one adjustable shelf; two fixed front file drawers below, lines up to 50" high panels.
- Locking.
- To add counterweight (W2 option), add \$195 list.

PRODUCT CODE	PRICE	SIZE/INCHES			WEIGHT LBS	VOL FT ³
		H	W	D		
EVCC41G1830P	2064	49.6	30	18	149.96	18.2
EVCC41G1836P	2201	49.6	36	18	172.96	21.6
EVCC41G1842P	2333	49.6	42	18	195.36	25.1

EVCC41H18xxP • Prime Four High Combination Cabinet

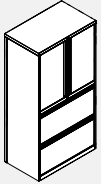

- Multi stor cabinet including hinged door upper section with one adjustable shelf; two fixed front file drawers below, lines up to 54" high panels.
- Locking.
- To add counterweight (W2 option), add \$195 list.

PRODUCT CODE	PRICE	SIZE/INCHES			WEIGHT LBS	VOL FT ³
		H	W	D		
EVCC41H1830P	2133	53.6	30	18	154.54	19.6
EVCC41H1836P	2264	53.6	36	18	178.54	23.3
EVCC41H1842P	2396	53.6	42	18	202.04	27.0

EVCC31C18xxP • Prime Five High Combination Cabinet

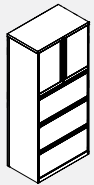

- Multi stor cabinet including hinged door upper section with one adjustable shelf; three fixed front file drawers below.
- Locking.
- To add counterweight (W2 option), add \$195 list.

PRODUCT CODE	PRICE	SIZE/INCHES			WEIGHT LBS	VOL FT ³
		H	W	D		
EVCC51C1830P	2518	65.6	30	18	188.5	23.9
EVCC51C1836P	2679	65.6	36	18	216.9	28.4
EVCC51C1842P	2840	65.6	42	18	245.5	32.9

EVLFA0718 • Prime Front to Back File Bars

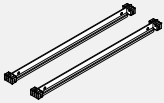

- Package of two, grey finish.

PRODUCT CODE	PRICE	SIZE/INCHES			WEIGHT LBS	VOL FT ³
		H	W	D		
EVLFA0718	45	1	17.3	1	1	0.04

EVLFS • Prime Hanging File Bars

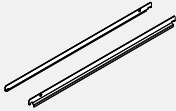

- Package of two, grey finish.

PRODUCT CODE	PRICE	SIZE/INCHES			WEIGHT LBS	VOL FT ³
		H	W	D		
EVLFA01	48	1.3	27.5	0.5	2	0.03
EVLFA02	48	1.3	33.5	0.5	2.4	0.04
EVLFA03	48	1.3	39.5	0.5	2.8	0.05

EVLFA1018 • Prime Plate Dividers

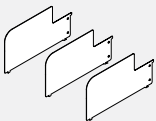

- Package of three, grey finish.

PRODUCT CODE	PRICE	SIZE/INCHES			WEIGHT LBS	VOL FT ³
		H	W	D		
EVLFA1018	49	7.25	13.5	0.2	4	0.07

EVLFA2418 • Prime Half Height Plate Dividers

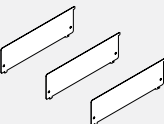

- Package of three, grey finish.

PRODUCT CODE	PRICE	SIZE/INCHES			WEIGHT LBS	VOL FT ³
		H	W	D		
EVLFA2418	49	3.95	13.5	0.2	2.2	0.04

EVLFA2018 • Prime EDP Adapters

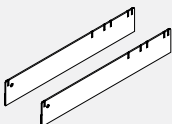

PRODUCT CODE	PRICE	SIZE/INCHES			WEIGHT LBS	VOL FT ³
		H	W	D		
EVLFA2018	49	2.6	16.5	0.15	2.5	0.02

EVEK93/ EVCK093 • Keys and Replacement Lock Core (Profile 9300 Series)

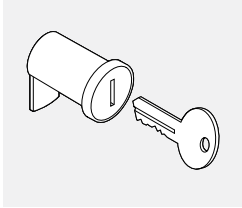

- EVEK93 - Set of two extra keys for existing 9300 Series storage. Specify core #. Key range W401-W550.
- EVCK093 - Includes one lock core and a set of two keys for 9300 Series storage. Specify core #. Key range W401-W550.

PRODUCT CODE	PRICE	SIZE/INCHES			WEIGHT LBS	VOL FT ³
		H	W	D		
EVEK93 EXTRA KEY	19	1.75	0.75	0.2	0.2	0.01
EVCK093 LOCK CORE & KEY	31	2	1	0.5	0.4	0.01

EVKY/EVKC • Keys and Replacement Lock Core (Fileco Prime Series)

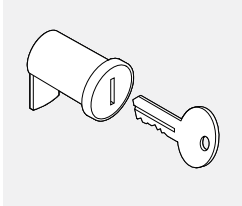

- EVKY - Set of two extra keys for existing Prime storage. Specify core #. Key range W401-W550.
- EVKC - Includes one lock core and a set of two keys for Prime storage. Specify core #. Key range W401-W550.

PRODUCT CODE	PRICE	SIZE/INCHES			WEIGHT LBS	VOL FT ³
		H	W	D		
ESKY EXTRA KEY	13	1.75	0.75	0.2	0.2	0.01
ESKC LOCK CORE & KEY	30	2	1	0.5	0.4	0.01

EVSA • Prime Extra Cabinet Shelves

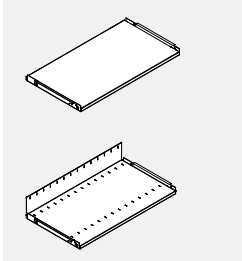

- Shelf, non-slotted.
- Shelf, slotted.

PRODUCT CODE	PRICE	SIZE/INCHES			WEIGHT LBS	VOL FT ³
		H	W	D		
Shelf, non-slotted.						
EVSA011830	83	0.8	28.4	16	7.2	0.4
EVSA011836	93	0.8	34.4	16	8.4	0.5
EVSA011842	98	0.8	40.4	16	9.5	0.6
Shelf, slotted.						
EVSA021830	98	5.25	28.4	16	8.2	1.8
EVSA021836	114	5.25	34.4	16	9.6	2.2
EVSA021842	120	5.25	40.4	16	10.8	2.6

EVHPB6 - Worksurface Supporting 9300 Pedestal Bracket

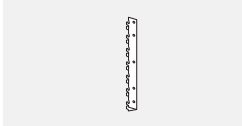

- Attaches to back edge of a pedestal and connects pedestal to panel connector.

PRODUCT CODE	PRICE	SIZE/ H	INCHES		WEIGHT LBS	VOL FT ³
			W	D		
EVHPB6	28	13.5	1	1	0.5	0.5

EVHPB5 - Worksurface Supporting Pedestal Bracket and Filler For Prime

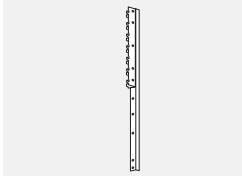

- Attaches to back edge of a pedestal and connects pedestal to panel connector.

PRODUCT CODE	PRICE	SIZE/ H	INCHES		WEIGHT LBS	VOL FT ³
			W	D		
EVHPB5	28	28	1	2	0.5	0.5

EVALB • Load Bar

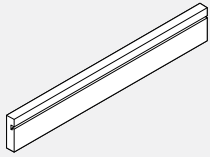

- Enables accessory items to be hung from a panel or wall.
- Includes end caps and mounting brackets.

PRODUCT CODE	PRICE	SIZE/ INCHES		
		H	W	D
EVALB24	133	2.25	24	1
EVALB30	146	2.25	30	1
EVALB36	161	2.25	36	1
EVALB42	187	2.25	42	1
EVALB48	213	2.25	48	1
EVALB54	234	2.25	54	1
EVALB60	247	2.25	60	1

EVALB2 • Ganging Load Bar - Top

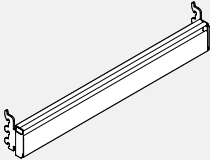

- Enables accessory items to be hung from a panel or wall
- Includes end caps and mounting brackets.
- Can connect to EVALB2-2 and/or EVALB2-3 Load Bars to create a multi-level bar or "Slat Wall" or can be used on its own.

PRODUCT CODE	PRICE	SIZE/ INCHES		
		H	W	D
EVALB224	104	2.25	24	1
EVALB230	112	2.25	30	1
EVALB236	116	2.25	36	1
EVALB242	124	2.25	42	1
EVALB248	131	2.25	48	1
EVALB254	134	2.25	54	1
EVALB260	139	2.25	60	1

EVALB22 • Ganging Load Bar - Middle

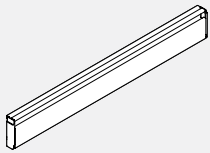

- Enables accessory items to be hung from a panel or wall.
- Includes end caps and is to be used in conjunction with the Ganging Load Bar-Top (EVALB) mounting brackets NOT included.
- Can connect to EVALB2 and/or EVALB2-3 Load Bars to create a multi-level bar or "Slat Wall". Multiples of EVALB2-2 can be joined one below the other to create the "Slat Wall".
- Must be used on conjunction with an EVALB2 or a combination of EVALB2 and EVALB2-3.

PRODUCT CODE	PRICE	SIZE/ INCHES		
		H	W	D
EVALB2-224	69	2.25	24	1
EVALB2-230	77	2.25	30	1
EVALB2-236	81	2.25	36	1
EVALB2-242	90	2.25	42	1
EVALB2-248	94	2.25	48	1
EVALB2-254	102	2.25	54	1
EVALB2-260	106	2.25	60	1

EVALB23 • Ganging Load Bar - Bottom

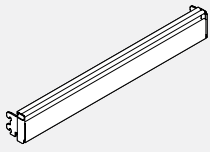

- Enables accessory items to be hung from a panel or wall.
- Includes end caps and mounting brackets.
- Must connect to EVALB2 and/or EVALB2-3 Load Bars to create a multi-level bar or "Slat Wall".
- Must be used on conjunction with an EVALB2 or a combination of EVALB2 and EVALB2-3.

PRODUCT CODE	PRICE	SIZE/ INCHES		
		H	W	D
EVALB2-324	102	2.25	24	1
EVALB2-330	106	2.25	30	1
EVALB2-336	112	2.25	36	1
EVALB2-342	116	2.25	42	1
EVALB2-348	126	2.25	48	1
EVALB2-354	132	2.25	54	1
EVALB2-360	136	2.25	60	1

EVACH01 • Coat Hook

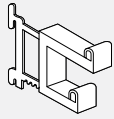

- Panel mounted coat hook.**
- Panel frame finish
 - Not available in Fog (FOG)
 - Not available in Metal Paper Accessory Colours

PRODUCT CODE	PRICE	SIZE/ INCHES			WEIGHT VOL	
		H	W	D	LBS	FT ³
EVACH01	69	3	0.75	3	0.2	0.001

EVACH02 • Panel Coat Hook

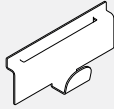

- Panel mounted coat hook.**
- Installed at panel top in groove between module and top trim.
 - Available in standard and premium paint colors.
 - Priced per six piece package.

PRODUCT CODE	PRICE	SIZE/ INCHES			WEIGHT VOL	
		H	W	D	LBS	FT ³
EVACH02	92	1	2.5	0.625	0.8	0.01

EVANP02 • Name Plate

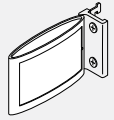

- **Name plate attaches to 1" increment slots of Evolve. It can be set either as a single-sided (parallel to panel surface) or double-sided (perpendicular to panel surface - for aisle applications, displaying name on both sides).**
- Injection molded frame and die-cast base with **black rubberized finish.**
- Steel bracket and fasteners included
- Includes two slide-in name cards.

PRODUCT CODE	PRICE	SIZE/ INCHES			WEIGHT VOL	
		H	W	D	LBS	FT ³
EVANP02	89	3.3	5.3	1.25	0.3	0.013

EVATB • Fabric Tackboard

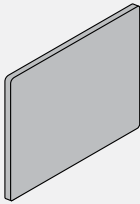

- To provide a tackable surface for notes and memos in a work area. Panel mounted.**
- Includes set of 4 mounting brackets.
 - Class "A" Fire Rated Fabric.

PRODUCT CODE	PRICE		SIZE/ INCHES			WEIGHT VOL	
	GR1	GR2	H	W	D	LBS	FT ³
EVATB1730	261	274	17	30	0.25	3	0.416
EVATB1736	298	312	17	36	0.25	4	0.500
EVATB1742	340	353	17	42	0.25	4	0.583
EVATB1748	378	397	17	48	0.25	5	0.666
EVATB1754	419	441	17	54	0.25	5	0.750
EVATB1760	460	483	17	60	0.25	6	0.833
EVATB2130	261	270	21	30	0.25	3	0.416
EVATB2136	298	307	21	36	0.25	4	0.500
EVATB2142	340	351	21	42	0.25	4	0.583
EVATB2148	378	392	21	48	0.25	5	0.666
EVATB2154	419	439	21	54	0.25	5	0.750
EVATB2160	460	482	21	60	0.25	6	0.833
EVATB2430	261	271	24	30	0.25	3	0.416
EVATB2436	298	312	24	36	0.25	4	0.500
EVATB2442	352	378	24	42	0.25	4	0.583
EVATB2448	394	419	24	48	0.25	5	0.666
EVATB2454	441	509	24	52	0.25	5	0.750
EVATB2460	460	482	24	60	0.25	6	0.833

EVHTVM • TV Mount

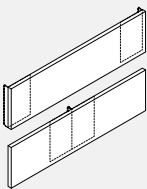

- Laminate panel with two mounting brackets to be installed on Evolve panels.
- TV Mount can be installed on panel of equal width or both brackets can be attached in middle for installing on single connector.
- TV frame not included, TV frame to be ordered separately.
- Note: TV frame must be securely attach to laminate panel. Care should be taken to attach TV frame using correct fasteners.
- Failure to do so may result in collapse of unit and subsequent possible injury.

PRODUCT CODE	PRICE	SIZE/INCHES			WEIGHT LBS	VOL FT ³
		H	W	D		
EVHTVM24	173	11	24	1.0	14.00	0.46
EVHTVM30	190	11	30	1.0	17.00	0.52
EVHTVM36	204	11	36	1.0	19.00	0.60
EVHTVM42	219	11	42	1.0	22.00	0.68

EVPMP542 • Privacy Mesh Divider

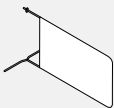

- **Divider attaches to connector.**
- Available with Visionknit mesh only.
- Current available (others available upon request)
 - GRY Grey
 - BOR Burnt Orange
- Wire frame upholstered in Visionknit mesh.
- Visionknit mesh easy to replace.
- Wire frame painted in standard paint finishes.
- For each mesh colour ordered, minimum order must be 25 pcs.
- If mesh colour ordered is less than 25 pcs, there will be upcharge fee \$132 net per each mesh colour.
- Note: Divider can be only used with 42"h. segmented panels (24" bottom and 12" top module configuration only).
- Divider attaches to top 12" module.

PRODUCT CODE	PRICE	SIZE/ INCHES			WEIGHT VOL	
		H	W	D	LBS	FT ³
EVPMP542	157	12	24	0.250	5	0.416

EVAWB • Write Board

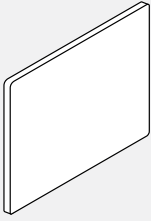

- To provide a writing surface in a work area. Panel mounted.
- Includes set of 4 mounting brackets.
- Black trim only

PRODUCT CODE	PRICE	SIZE/ H	INCHES W	WEIGHT LBS	VOL FT ³
EVAWB2130	293	21	30	3	0.416
EVAWB2136	333	21	36	4	0.500
EVAWB2142	372	21	42	4	0.588
EVAWB2148	433	21	48	5	0.833
EVAWB2430	293	24	30	3	0.416
EVAWB2436	333	24	36	4	0.500
EVAWB2442	372	24	42	4	0.588
EVAWB2448	433	24	48	5	0.833

EVAMT • Marker Tray



- Provides a tray for storage of markers, erasers. etc.
- Attaches to the bottom of the White Marker Board.

PRODUCT CODE	PRICE	SIZE/ H	INCHES W	WEIGHT LBS	VOL FT ³
EVAMT12	16		12	0.5	0.01

EVSOFD • Overhead Divider

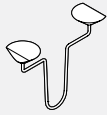

- Attaches to EVS0F12 or EVS0F13 Overhead top shelf inside the overhead.
- Provides a rigid division for books and binders.
- Sold per pair.

PRODUCT CODE	PRICE	SIZE/ H	INCHES W	WEIGHT LBS	VOL FT ³
EVSOFD01	58	10	0.1875	0.8	0.02

EVAOMFD • Dry Erase Marker Board

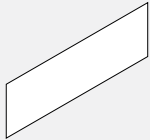

- Adheres magnetically to the door fo a flipper door overhead.

PRODUCT CODE	PRICE	SIZE/ H	INCHES W	D
EVAOMFD24	227	14.4	22.8	0.05
EVAOMFD30	261	14.4	28.8	0.05
EVAOMFD36	299	14.4	34.8	0.05
EVAOMFD42	341	14.4	40.8	0.05
EVAOMFD48	373	14.4	46.8	0.05
EVAOMFD54	391	14.4	52.8	0.05
EVAOMFD60	422	14.4	58.8	0.05

EVAOMBW • Dry Erase Marker Board

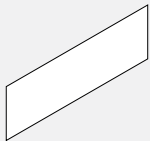

- Adheres magnetically to the back wall of the AODA Overhead.

PRODUCT CODE	PRICE	SIZE/ H	INCHES W	D
EVAOMBW30	261	14.4	29.2	0.05
EVAOMBW36	299	14.4	35.5	0.05
EVAOMBW42	341	14.4	41.2	0.05
EVAOMBW48	373	14.4	47.2	0.05
EVAOMBW54	391	14.4	53.2	0.05
EVAOMBW60	422	14.4	59.2	0.05

EVED50AC • Duo Module with A+C



- The Duo power module is completely integrated with a mounting clamp to attach to the edge of a worksurface.
- Provides two 15 Amp 120 Volt AC Receptacles; 2.4 amp USB-A port and 60 watt USB-C power delivery port.
- 10' long three-prong cord.
- Available in W - White or B - Black as indicated by last letter of model number.

PRODUIT CODE	PRIX	TAILLE/ H	POUCES L	P	POIDS LB	VOLUME PI ³
EVED50ACW	695	3	5.5	3.2	3	0.2
EVED50ACB	695	3	5.5	3.2	3	0.2

EVEDU51AC • Duo Under Module

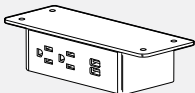

- The Duo under power module comes with a thin flush mounting bracket to attach to the underside of a work surface or above work surface shelves.
- Provides two 15 Amp 120 Volt AC Receptacles; 2.4 amp USB-A port and 60 watt USB-C power delivery port.
- 10' long three-prong cord.
- Available in W - White or B - Black as indicated by last letter of model number.

PRODUIT CODE	PRIX	TAILLE/ H	POUCES L	P	POIDS LB	VOLUME PI ³
EVEDU51ACW	695	1.8	5.5	2.8	3	0.2
EVEDU51ACB	695	1.8	5.5	2.8	3	0.2

EVEDB52AC • Duo Under Module with A+C



- The Duo bezel power module is embedded and flush-mounted in a piece of furniture or a work surface.
- Provides two 15 Amp 120 Volt AC Receptacles; 2.4 amp USB-A port and 60 watt USB-C power delivery port.
- 10' long three-prong cord, silver trim.
- Available in W - White or B - Black as indicated by last letter of model number.
- Will not work on W thick worksurfaces, please contact your Customer Service Representative for specific surface applications.

PRODUCT CODE	PRICE	SIZE/ H	INCHES W	D	WEIGHT LBS	VOL FT ³
EVEDB52ACW	695	4	6.5	3.2	3	0.2
EVEDB52ACB	695	4	6.5	3.2	3	0.2

EVETP53AC • Trio Module with A+C



- The Trio plus power module is completely integrated with a mounting clamp to attach to the edge of a work surface or above work surface shelves.
- Provides two 15 Amp 120 Volt AC Receptacles; 2.4 amp USB-A port and 60 watt USB-C power delivery port and an adapter kit containing blank cover, HDMI, RJ45 or VGA adapter brackets. Note: HDMI, RJ45 and VGA connectors are not included.
- 10' long three-prong cord, silver trim.
- Available in W - White or B - Black as indicated by last letter of model number.

PRODUCT CODE	PRICE	SIZE/ INCHES			WEIGHT VOL	
		H	W	D	LBS	FT ³
EVETP53ACW	735	3	8	3.2	2.5	0.14
EVETP53ACB	735	3	8	3.2	2.5	0.14

EVETB55AC • Trio Plus Module with A+C



- The Trio plus bezel power module is embedded and flush-mounted in a piece of furniture or a work surface.
- Provides two 15 Amp 120 Volt AC Receptacles; 2.4 amp USB-A port and 60 watt USB-C power delivery port and an adapter kit containing blank cover, HDMI, RJ45 or VGA adapter brackets. Note: HDMI, RJ45 and VGA connectors are not included.
- 10' long three-prong cord, silver trim.
- Available in W - White or B - Black as indicated by last letter of model number.
- Will not work on W thick worksurfaces, please contact your Customer Service Representative for specific surface applications.

PRODUCT CODE	PRICE	SIZE/ INCHES			WEIGHT VOL	
		H	W	D	LBS	FT ³
EVETB55ACW	752	4	9	3.2	2.5	0.14
EVETPB55ACB	752	4	9	3.2	2.5	0.14

EVMA1 • Single Clamp Mount Monitor Arm

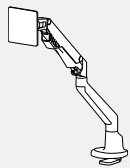

- Finger touch dynamic height adjustment, 12" height range. 4.4 to 19.8 lbs. per monitor loading capacity; accepts screen size 17"-30".
- Maximum monitor width of 34".
- Maximum of 20.5" extension from rear of desk to back of monitor, folds to 4.5".
- Tilt, pan and landscape to portrait rotation; quick release VESA plate, 180 degree lock out.
- Clamp mount and grommet mount options included, accommodates 0.5" to 2" thick tops.
- Accepts mini slide arm GAMS.
- Available in TUN - Tungsten only.

PRODUCT CODE	PRICE	SIZE/ INCHES			WEIGHT VOL	
		H	W	D	LBS	FT ³
EVMA1	418	21		5.5	6.6	0.4

EVMA2 • Double Clamp Mount Monitor Arm

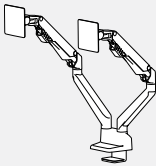

- Finger touch dynamic height adjustment, 12" height range.
- 4.4 to 19.8 lbs. per monitor loading capacity; accepts screen size 17"-30".
- Maximum monitor width of 34".
- Maximum of 20.5" extension from rear of desk to back of monitor, folds to 4.5".
- Tilt, pan and landscape to portrait rotation; quick release VESA plate, 180 degree lock out.
- Clamp mount and grommet mount options included, accommodates 0.5" to 2" thick tops.
- Accepts mini slide arm GAMS.
- Available in TUN - Tungsten only.

PRODUCT CODE	PRICE	SIZE/ INCHES			WEIGHT VOL	
		H	W	D	LBS	FT ³
EVMA2	734	21		5.5	12.8	1

EVAMS • Mini Slide Monitor Arm

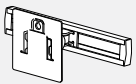

- Works with EVMA1 and EVMA2 monitor arms.
- 9" slide, loading capacity 13.2lbs.
- Quick release VESA plate.
- Available in TUN - Tungsten only.

PRODUCT CODE	PRICE	SIZE/ INCHES			WEIGHT VOL	
		H	W	D	LBS	FT ³
EVAMS	145	4.5	11	6	3.3	0.3

EVELEDVS • LED Single Arm Lamp

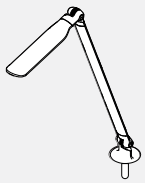

- 7 System watts, 18-fractional LEDs.
- 3500K 250 lumens, 84CRI.
- Soft touch - instant on, fade to off.
- Infinite dimming 100% down to 15%, last state memory.
- Standard 10 hours turn off (ATO).
- 50,000 hour life LEDs.
- 15 watt, 24 volt wall transformer, 6' cord.
- White (WHT)or Black (BLK) - Must specify colour choice.

PRODUCT CODE	PRICE	SIZE/ INCHES			WEIGHT VOL	
		H	W	D	LBS	FT ³
EVELEDVS	616	8	7	33	7.3	0.98
With occupancy sensor						
EVELEDVSO	920	10	9	35	8.3	1.51

- UL, CUL and CSA compliant, ETL Listed.
- Base not included.

EVELEDVD • LED Double Arm Lamp

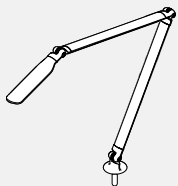

- 7 System watts, 18-fractional LEDs.
- 3500K 250 lumens, 84CRI.
- Double arm articulation with 20" base to head reaches.
- Soft touch - instant on, fade to off.
- Infinite dimming 100% down to 15%, last state memory.
- Standard 10 hours turn off (ATO).
- 50,000 hour life LEDs.
- 15 watt, 24 volt wall transformer, 6' cord.
- White (WHT)or Black (BLK) - Must specify colour choice.

PRODUCT CODE	PRICE	SIZE/ INCHES			WEIGHT VOL	
		H	W	D	LBS	FT ³
EVELEDVD	633	8	7	33	7.6	1.02
With occupancy sensor						
EVELEDVDO	931	10	9	35	8.6	1.57

- UL, CUL and CSA compliant, ETL Listed.
- Base not included.

EVELEDRS • LED Single Arm Lamp

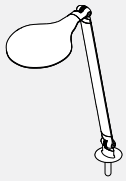

- 7 System watts, 18-fractional LEDs.
- 3500K 250 lumens, 84CRI.
- Soft touch - instant on, fade to off.
- Infinite dimming 100% down to 15%, last state memory.
- Standard 10 hours turn off (ATO).
- 50,000 hour life LEDs.
- 15 watt, 24 volt wall transformer, 6' cord.
- White (WHT) or Black (BLK) - Must specify colour choice.

PRODUCT CODE	PRICE	SIZE/ H	INCHES W	D	WEIGHT LBS	VOL FT ³
EVELEDRS	616	8	7	33	7.3	0.98
With occupancy sensor						
EVELEDRSO	920	10	9	35	8.3	1.51

- UL, CUL and CSA compliant, ETL Listed.
- Base not included.

EVELEDRD • LED Double Arm Lamp

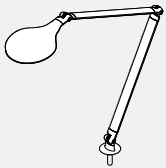

- 7 System watts, 18-fractional LEDs.
- 3500K 250 lumens, 84CRI.
- Double arm articulation with 20" base to head reaches.
- Soft touch - instant on, fade to off.
- Infinite dimming 100% down to 15%, last state memory.
- Standard 10 hours turn off (ATO).
- 50,000 hour life LEDs.
- 15 watt, 24volt wall transformer, 6' cord.
- White (WHT) or Black (BLK) - Must specify colour choice.

PRODUCT CODE	PRICE	SIZE/ H	INCHES W	D	WEIGHT LBS	VOL FT ³
EVELEDRD	633	8	7	33	7.6	1.02
With occupancy sensor						
EVELEDRDO	931	10	9	35	8.6	1.57

- UL, CUL and CSA compliant, ETL Listed.
- Base not included.

Lamp Mounting Options



Grommet Mount

PRODUCT CODE	PRICE	SIZE/ H	INCHES W	D	WEIGHT LBS	VOL FT ³
EVELEDASM	155	3	6	6	3	0.06



Worksurface Mount

PRODUCT CODE	PRICE	SIZE/ H	INCHES W	D	WEIGHT LBS	VOL FT ³
EVELEDACM	155	3	6	6	2	0.04



Slatwall Mount

PRODUCT CODE	PRICE	SIZE/ H	INCHES W	D	WEIGHT LBS	VOL FT ³
EVELEDASW	155	3	6	6	3	0.06



Panel Mount

PRODUCT CODE	PRICE	SIZE/ H	INCHES W	D	WEIGHT LBS	VOL FT ³
EVELEDAPM	155	3	6	6	3	0.06

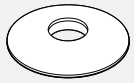

Weighted Base

PRODUCT CODE	PRICE	SIZE/ H	INCHES W	D	WEIGHT LBS	VOL FT ³
EVELEDAFS	173	4	12	12	6	0.50

EVABB01 • Binder Bin



- Load bar/accessory rail mounted metal binder bin.
- Panel frame finish

PRODUCT CODE	PRICE	SIZE/ H	INCHES W	D	WEIGHT LBS	VOL FT ³
EVABB01	58	9	5.75	9.25	1.85	0.21

EVAFS01 • Flip Sorter

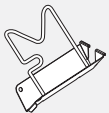

- Load bar/accessory rail mounted metal flip sorter. Comes with nickel plated wire.
- Panel frame finish

PRODUCT CODE	PRICE	SIZE/ H	INCHES W	D	WEIGHT LBS	VOL FT ³
EVAFS01	40	9	3	9	0.6	0.14

EVASS01 • Slant Sorter



Right hand Shown

- Load bar/accessory rail mounted metal slant sorter.
- Panel frame finish

PRODUCT CODE	PRICE	SIZE/ H	INCHES W	D	WEIGHT LBS	VOL FT ³
EVASS01R	35	9.25	2.75	9	1	0.28
EVASS01L	35	9.25	2.75	9	1	0.28

EVALT01 • Letter Tray

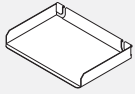

- Load bar/accessory rail mounted metal letter tray.
- Panel frame finish

PRODUCT CODE	PRICE	SIZE/ H	INCHES W	D	WEIGHT LBS	VOL FT ³
EVALT01	43	1.75	12	8.75	0.5	0.15

EVALT02 • Legal Tray

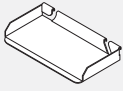

- Load bar/accessory rail mounted metal legal tray.
- Panel frame finish

PRODUCT CODE	PRICE	SIZE/ H	INCHES W	D	WEIGHT LBS	VOL FT ³
EVALT02	58	1.75	14.7	8.75	0.5	0.15

EVAMB01 • Media Bin

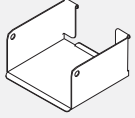

- Load bar/accessory rail mounted.
- Panel frame finish

PRODUCT CODE	PRICE	SIZE/ H	INCHES W	D	WEIGHT LBS	VOL FT ³
EVAMB01	43	3	5.75	5.25	0.8	0.05

EVAUT01 • Utility Tray

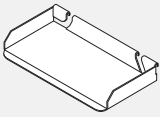

- Load bar/accessory rail mounted metal utility tray.
- Panel frame finish

PRODUCT CODE	PRICE	SIZE/ H	INCHES W	D	WEIGHT LBS	VOL FT ³
EVAUT01	30	1	7.5	3.75	0.5	0.02

EVAPP01 • Mail Box

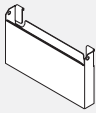

- Load bar/accessory rail mounted.
- Panel frame finish

PRODUCT CODE	PRICE	SIZE/ H	INCHES W	D	WEIGHT LBS	VOL FT ³
EVAPP01	72	7	12	1.75	2	0.25

EVATH01 • Telephone Holder

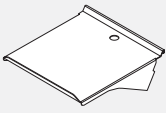

- Load bar/rail mounted telephone holder.
- Panel frame finish

PRODUCT CODE	PRICE	SIZE/ H	INCHES W	D	WEIGHT LBS	VOL FT ³
EVATH01	68	2	8	10	2	0.26

EVSPD1921 • Pencil Drawer

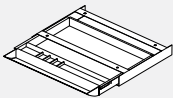

- Provides accommodation for writing instruments and small items at the workspace.
- Attaches to the underside of worksurface with drawer slides.
- Available in Black ABS Only

PRODUCT CODE	PRICE	TAILLE/ H	POUCES L	P	POIDS LB	VOLUME PI ³
EVSPD1921	125	1.9	21.2	16.1	0.5	0.3

EVFPD-WS • Worksurface Felt Divider

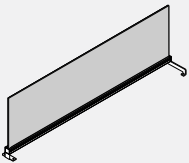

- Privacy felt divider integrated into an aluminum top trim.
- Attaches on top of a worksurface to add privacy or divide space.
- Must be used at connector location.
- Includes aluminum trim with channel, felt tile and brackets.
- 9 mm felt material is tackable and comes in 18 different colors. Please specify felt finish.
- Aluminum extrusion and brackets available in standard paint finishes.
- Felt tile and attachment hardware to ship separately.

PRODUCT CODE	PRICE	SIZE/ H	INCHES W	D	WEIGHT LBS	VOL FT ³
EVFPD1818WS	158	18	18	1	2.26	0.75
EVFPD1824WS	177	18	24	1	2.77	0.94
EVFPD1830WS	199	18	30	1	3.29	1.13
EVFPD1836WS	216	18	36	1	3.8	1.31

PRIVA NOTES

GENERAL INFORMATION

- Priva™ acoustic pods provide a place for personal privacy, focus and online collaboration, away from the commotion of the open office.
- Integrated ventilation (55 cubic feet per minute) and low-voltage LED lighting are motion-sensor activated to reduce energy consumption while providing a comfortable environment for short or longer stays.
- The tempered glass entrance door, in combination with an optional glass back panel, reduces the sense of confinement.

CONSTRUCTION

- Assembles in less than 90 minutes. Once complete, simply plug in and get to work!
- Priva has been tested and complies with all BIFMA mechanical tests.
- Exterior is clad in 3/4" thermally fused laminate with a 10mm tempered glass door and glass (POD1G, POD2G, POD3G) or laminate back panel (POD1L).
- Exterior corner details are made of extruded aluminum
- Internal frame is comprised of 14 gauge steel beams
- Interior is clad in PET (recommended for greater acoustic properties)
- Laminate interior is optional.
- Pod ceiling is Designer White laminate
- Interior carpet flooring is comprised of eco-friendly Nylon fiber, solution dyed with a polypropylene backing.
- Laminate touch-down shelf is standard in Designer White (DWT) laminate.

DIMENSIONS

- Door: 32" w x 88" h
- Shelf: 24" w x 8" d x 40" h
- Electrical cord is 10' long.

Exterior Laminate Finishes

Absolute Acajou	ACJ
Asian Night	ASN
Black	BLK
Brushed Cobalt	BRC
Clear Maple	CMB
Dark Espresso	DES
Designer White	DWT
Noce Biondo	NBL
Noce Grigio	NGL
Noce Leggero	NEL
Noce Medio	NML
Storm Grey	SOG
Walnut Heights	WHE
White Chocolate	WHC
Winter Cherry	WCR

Exterior Frame Finishes

Black	BLK
Charcoal	CHR
Designer White	DWT
Tungsten	TUN

Hardware Finishes (Handle + Hinge)

Black	BK
Silver	SI

Interior Finishes - Select Laminate or PET

PET

Graphite	GPH
Pewter	PWT
Mist	MTS

Laminate

Black	BLK
Designer White	DWT
Storm Grey	SOG

Interior Finish (Laminate or PET)

Always Designers White (DWT) laminate

Hardware Finishes

Exterior Laminate

Exterior Frame

Glass front is standard with Black painted frame

Exterior Dimensions

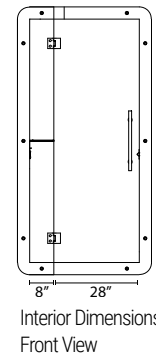
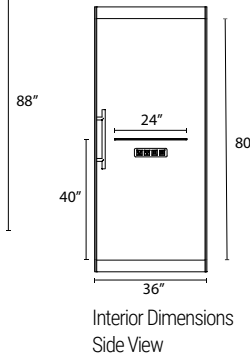
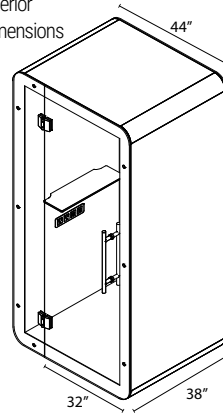

Exterior Dimensions

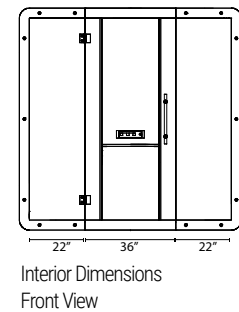
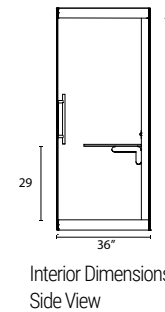
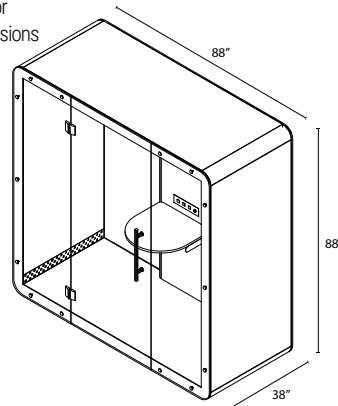

Exterior Dimensions

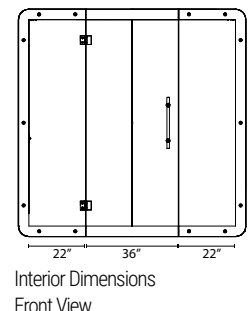
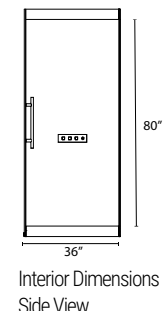
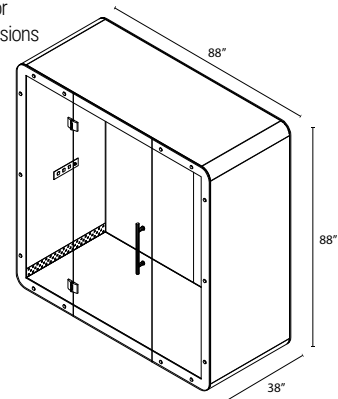

POD1G • Single User Pod - Glass Back Panel

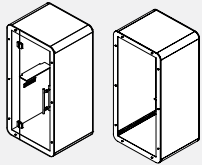

Front View/Rear View

- Acoustic Pod includes laminate exterior with aluminum frame. PET interior provides acoustic privacy.
- Laminate interior optional for easy cleaning. Door is 10mm tempered glass with a glass back panel.
- Power + Connectivity: 2 AC outlets and 2 charging USB-A ports coupled with an occupancy sensor controlling two 12V DC fans and an LED light circuit, ensuring comfort in even the smallest of enclosed spaces, while keeping power consumption at a minimum.
- Acoustic Ratings: NIC-36, STI .07
- Airflow Specifications: CFM 55

PRODUCT CODE	PRICE	SIZE/INCHES			WEIGHT LBS	VOL FT ³
		H	W	D		
POD1G	25852	88	44	38	800	85

POD1L • Single User Pod - Laminate Back Panel

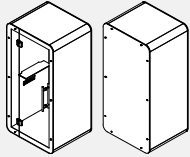

Front View/Rear View

- Acoustic Pod includes laminate exterior with aluminum frame. PET interior provides acoustic privacy.
- Laminate interior optional for easy cleaning. Door is 10mm tempered glass with a laminate back panel.
- Power + Connectivity: 2 AC outlets and 2 charging USB-A ports coupled with an occupancy sensor controlling two 12V DC fans and an LED light circuit, ensuring comfort in even the smallest of enclosed spaces, while keeping power consumption at a minimum.
- Acoustic Ratings: NIC-36, STI .07
- Airflow Specifications: CFM 55

PRODUCT CODE	PRICE	SIZE/INCHES			WEIGHT LBS	VOL FT ³
		H	W	D		
POD1L	25852	88	44	38	800	85

POD2G • Two Person Meeting Pod - Glass/Laminate Back Panel

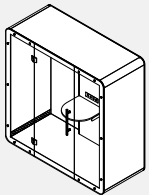

- Acoustic Meeting Pod includes laminate exterior with aluminum frame. PET interior provides acoustic privacy
- Includes D-Shaped Table 22.75" w x 22.75" d x 1" thick.
- Table can be installed at 26h, 28h or 30h
- Door is 10mm tempered glass
- Interior dimensions: 80" w x 36" d x 80" h
- Power + Connectivity: 2 AC outlets, USB-C and USB-A ports coupled with an occupancy sensor controlling two 12V DC fans and two LED lights, ensuring comfort in even the smallest of enclosed spaces, while keeping power consumption at a minimum.
- Acoustic Ratings: NIC-36, STI .07
- Airflow Specifications: CFM 55

PRODUCT CODE	PRICE	SIZE/INCHES			WEIGHT LBS	VOL FT ³
		H	W	D		
POD2G	46522	88	88	38	1200	170

POD3G • Office Pod - Glass Back Panel

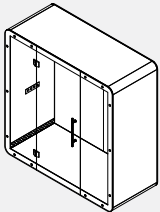

- Acoustic Office Pod includes laminate exterior with aluminum frame. PET interior provides acoustic privacy.
- Full tempered glass back
- Can accommodate a single task chair and small desk 36w x 24d (sold separately)
- Door is 10mm tempered glass
- Interior dimensions: 80" w x 36" d x 80" h
- Power + Connectivity: 2 AC outlets, USB-C and USB-A ports coupled with an occupancy sensor controlling two 12V DC fans and two LED lights, ensuring comfort in even the smallest of enclosed spaces, while keeping power consumption at a minimum.
- Acoustic Ratings: NIC-36, STI .07
- Airflow Specifications: CFM 55

PRODUCT CODE	PRICE	SIZE/INCHES			WEIGHT LBS	VOL FT ³
		H	W	D		
POD3G	43102	88	88	38	1200	170

Why Softpod?

Softpod is where flexibility meets focus bringing a new work style option to the Global family of products. This sleek privacy pod is a cozy, secluded space dedicated to focus. Its multi segmented dividers and hexagon shape offer flexibility for both privacy and space planning.

Divider:

- PET Felt / aluminum composition 1 3/8" thick
- Channel edge allows for add-on privacy
- Acoustic rating of .60 NRC and 13 STC

PET Felt features:

- Tackable acoustic material
- Soft form capability

Electrical:

- Simple interconnect / direct plug-in or
- Hard wire formats

Storage:

- Solution based

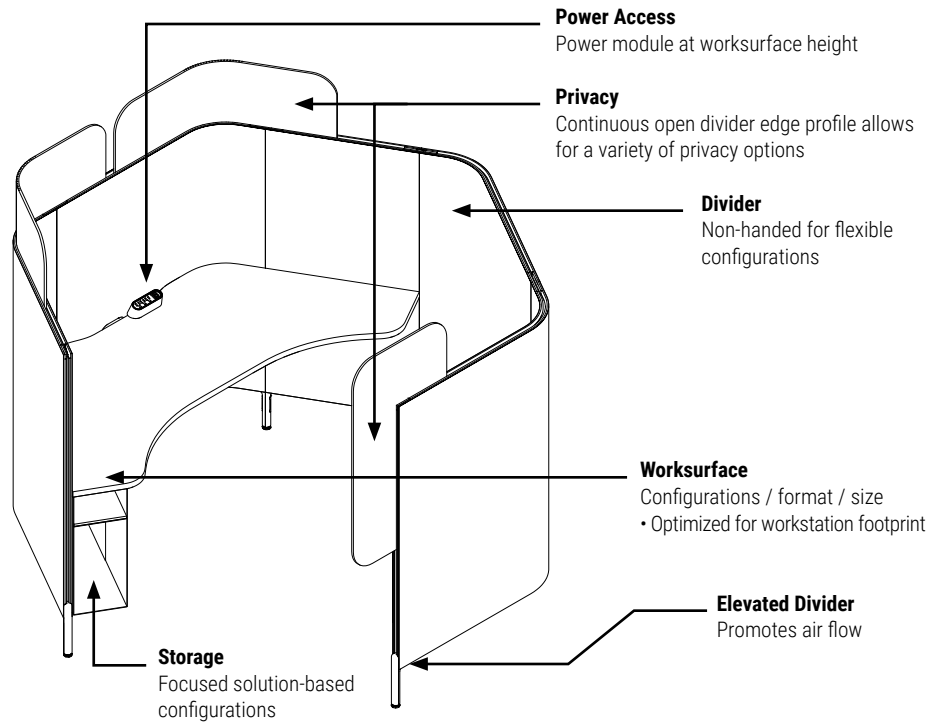

Height Adjustable Pod

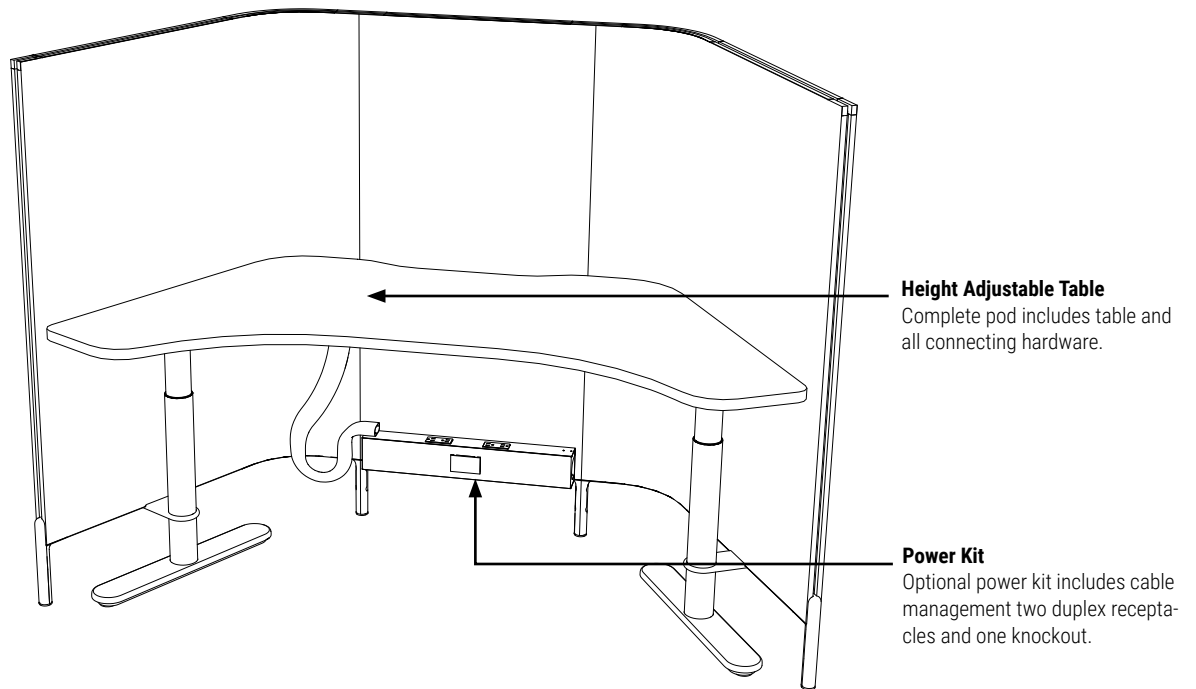

Why Softpod?

Freestanding Lounge Pods

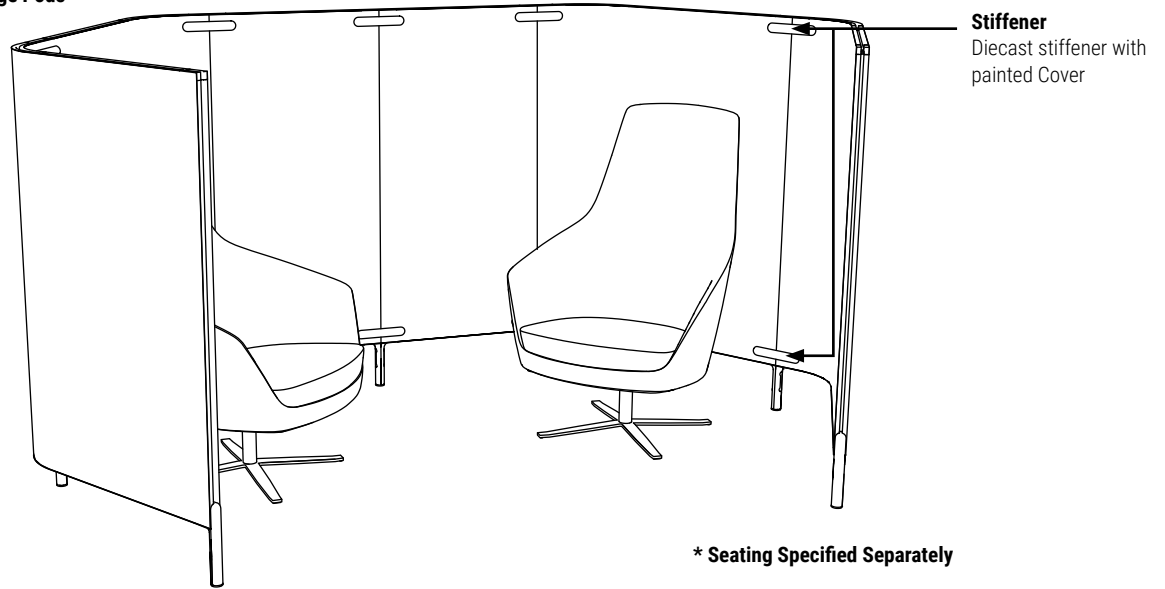

Meeting Pods

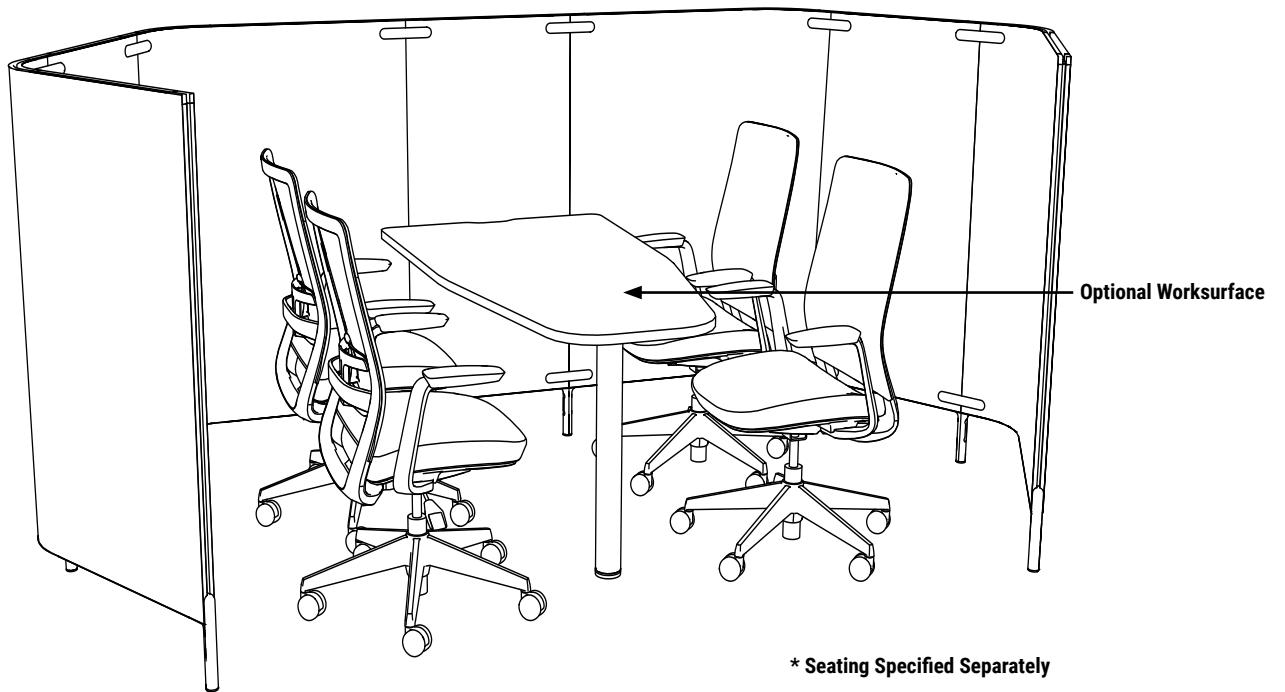

Statement Of Line

Softpods

HX2P5452SW
Softpod with 2 Dividers
and Worksurface

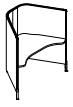

HX2PM5452SW
Mobile Softpod
with 2 Dividers and
Worksurface

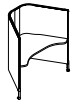

HX3PM5472SW
Mobile Softpod
with 3 Dividers and
Worksurface

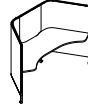

HX3P5472SW
Softpod with
3 Dividers and
Worksurface

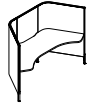

HX4PM5472SW
Mobile Softpod
with 4 Dividers and
Worksurface



HX4P5472R/LW
Softpod with 4 Dividers
and Wrap Around
Worksurface

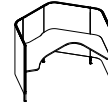

HX4PM5472LW/RW
Mobile Softpod with
4 Dividers and Wrap
Around Worksurface

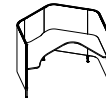

HX5P5472SW
Softpod with 5 Dividers
and Worksurface



HX5P5472R/LW
Softpod with 5 Dividers and
Wrap Around Worksurface

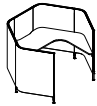

HXP5430
Single J-divider

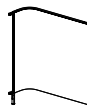

Height Adjustable Tables

HX3PH5472SW
Softpod with 3 Dividers
and Height Adjustable
Worksurface



Freestanding Pods

HX3PF
Freestanding Softpod
with 3 Dividers



HX3PFM
Freestanding Mobile
Softpod with 3 Dividers

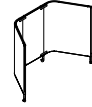

HX4PF
Freestanding Softpod
with 4 Dividers



HX4PFM
Freestanding Mobile
Softpod with 4 Dividers



HX5PF
Freestanding Softpod
with 5 Dividers



HX5PFM
Freestanding Mobile
Softpod with 5 Dividers



HX6PF
Freestanding Softpod
with 6 Dividers



HX7PF
Freestanding Softpod
with 7 Dividers

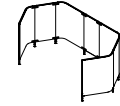

Meeting Pods

HX6PFD
Meeting Pod with 6 Dividers
with D Top Worksurface



HX7PFD
Meeting Pod with 7 Dividers
with D Top Worksurface

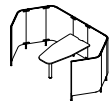

Extensions

HXPAEFE
End PET Felt Extension
Divider Add-on



HXPACFE
Corner PET Felt Extension
Divider Add-on

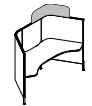

HXPATCFE
Top Corner PET Felt Extension
Divider Add-on

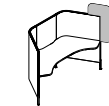

HXPATCFE
PET Felt Extension Divider Add-
on for Softpod with 2 Dividers

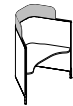

HXPACFE
PET Felt Extension Divider Add-
on for Softpod with 3 Dividers



HXPACFEH
PET Felt Extension Panel Add-on for
Softpod Height Adjustable Table

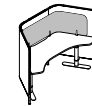

HXPACFES
Corner Semitransparent
Extension Panel Add-on

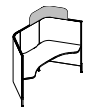

Statement Of Line

Electrical

BRED50AC
Duo Module



HXEUWC
Under Worksurface/
Edge USB
Charger

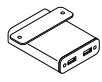

GAADG
Access Door
Module

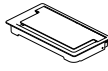

GAADCT
Access Door Module
with Cable Tray

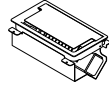

GMSA10
ModPower Starter
Mounted Unit

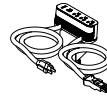

GMDCA3
ModPower Middle
Mounted Unit

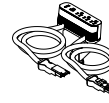

GMDEA3
ModPower End
Mounted Unit

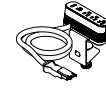

GMDSF10
ModPower In Surface
Starter Unit



GMDCF3
ModPower In
Surface Middle Unit



GMDEF3
ModPower In
Surface End Unit

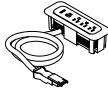

GMDCLIPS
ModPower Man-
agement Clips



GMDJ36BK
ModPower Intercon-
necting Jumper



GMDPC22W
Slim Desktop Power
Module, 2 Duplex



GMDPC32W
Slim Desktop Power
Module, 3 Duplex



HXEPK
Station 2-Circuit
Power Kit



HXECS
Cable Shroud



HXEHP
Height Adjustable
Power Kit



HXEPPJ
Station to Station
Jumper Kit

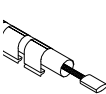

HXEPPJ
Station to Station
Jumper

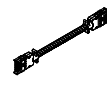

HXECF
Ceiling Feed



HXEBCF
Base Feed



HXECFP
Ceiling Feed Pole



HXEPCGK
Divider Grommet
Kit



HXEPCGS
Divider Grommet
Connector / Spacer



Accessories

BLVELEDVS
LED Single Arm
Lamp



BLVELEDVD
LED Double Arm
Lamp



BLVELEDRS
LED Single Arm
Lamp



BLVELEDRD
LED Double Arm
Lamp

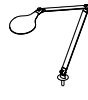

BLVELEDASC
Lamp Mounting
Options



BLVELEDAFS
Lamp Mounting
Options



HXAHS
Hanging Shelf



HXAHSWB
Hanging Shelf with
Dry Erase Board



HXARWS
Rear Wall Shelf



HXACHS
Coat/Bag Hook
for Dividers



HXACTH
Coat/Bag Hook
for Dividers Edge



HXABH
Under Surface
Bag Hook



HXNP
Name Plate

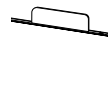

HXPCKIT
Connection Kit

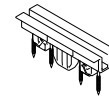

Storage

HXSCSO
Under Work-
surface Casual
Storage Unit

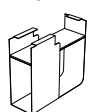

HXSCSO
Under Work-
surface Casual
Storage Unit

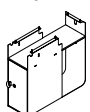

L2PO
Pantry Storage

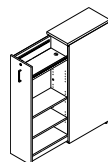

Footprint

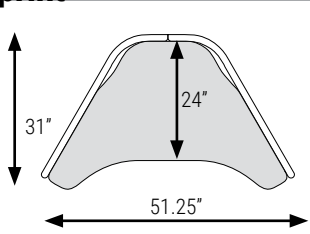

HX2P5452SW
Softpod with 2 Dividers

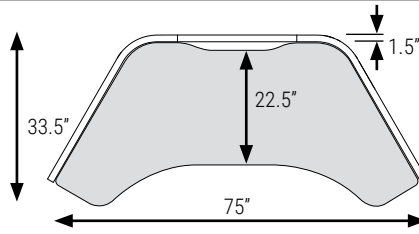

HX3P5472SW
Softpod with 3 Dividers

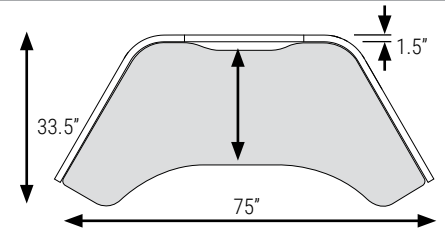

HX3PH5472SW
Height Adjustable Softpod

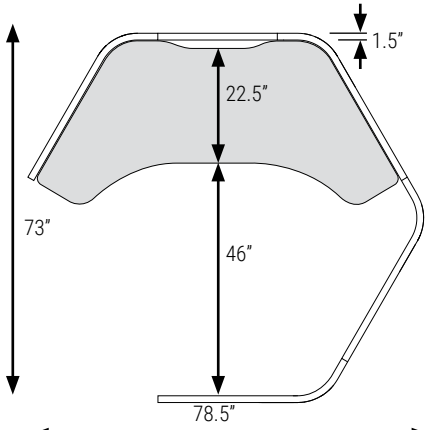

HX5P5472SW Softpod with 5 Dividers

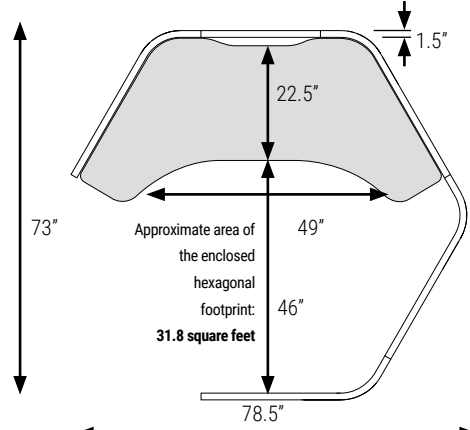

Single Softpod with 5 Dividers

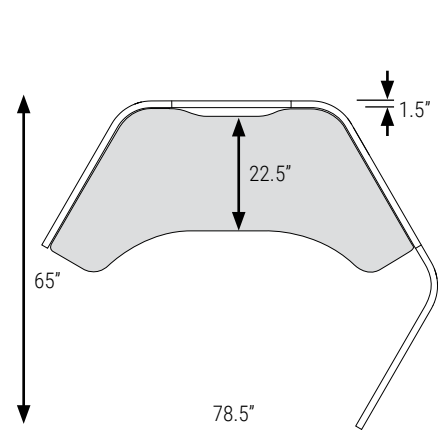

HX4P5472SW
Softpod with 4 Dividers

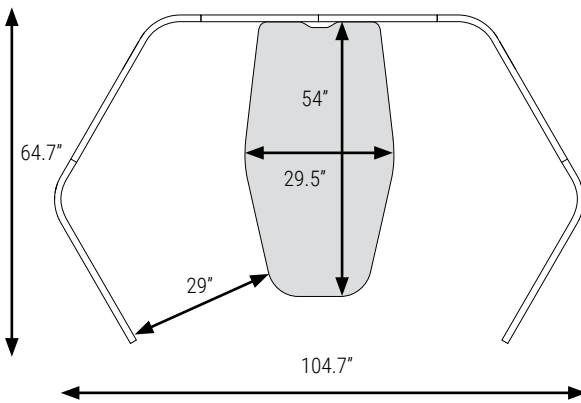

HX6PFD
Softpod with 6 Dividers and D Top Worksurface

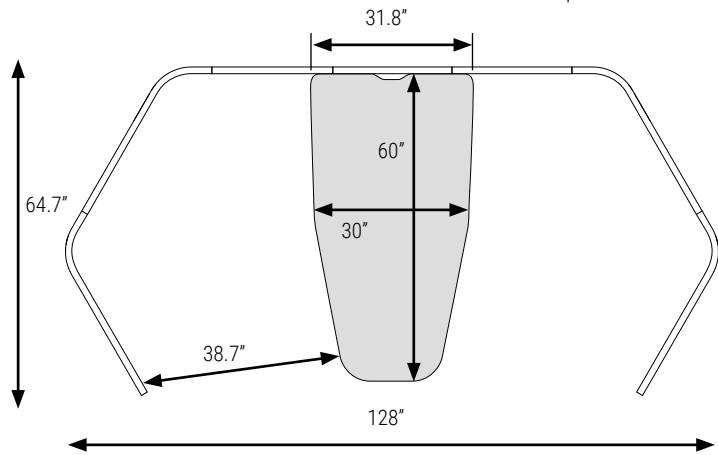

HX7PFD
Softpod with 7 Dividers and D Top Worksurface

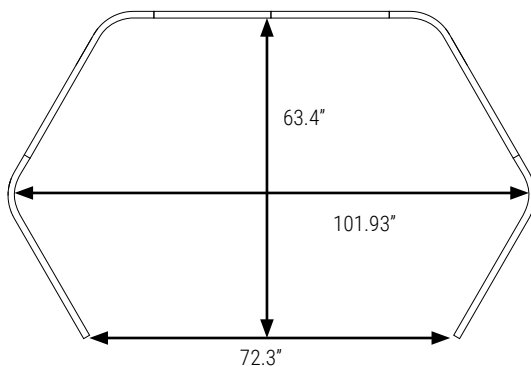

HX6PFD
Softpod with 6 Dividers and D Top Worksurface

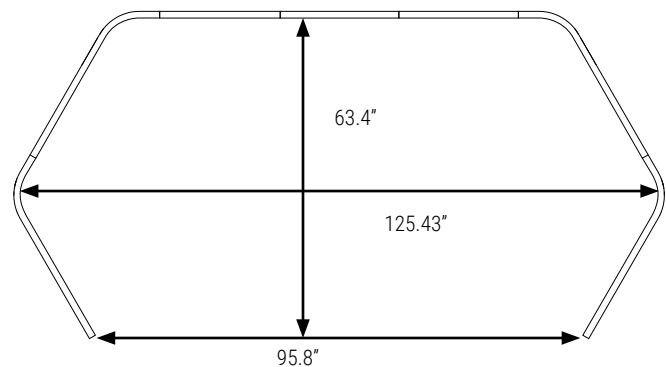

HX7PFD
Softpod with 7 Dividers and D Top Worksurface

Off Grid Planning

The flexible format of Softpod offers a variety of planning options and encourages both on and off grid layouts. From a single or cluster of Softpods this versatile system adapts to your needs.

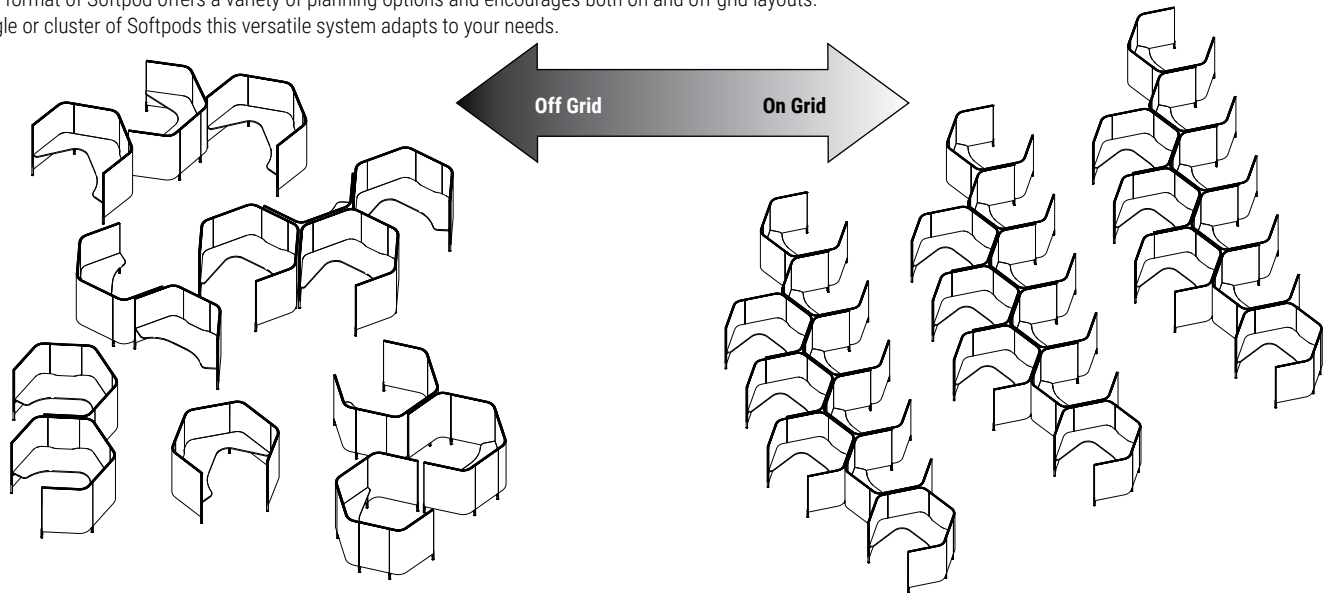

Off Grid Planning

Agile
The freestanding, single Softpod can flex to support any number of employees in a hybrid work environment. The pods can be easily reconfigured and adjusted as needs change. Its small kit of parts and thoughtfully designed features make it easy to specify and keep inventory counts low.

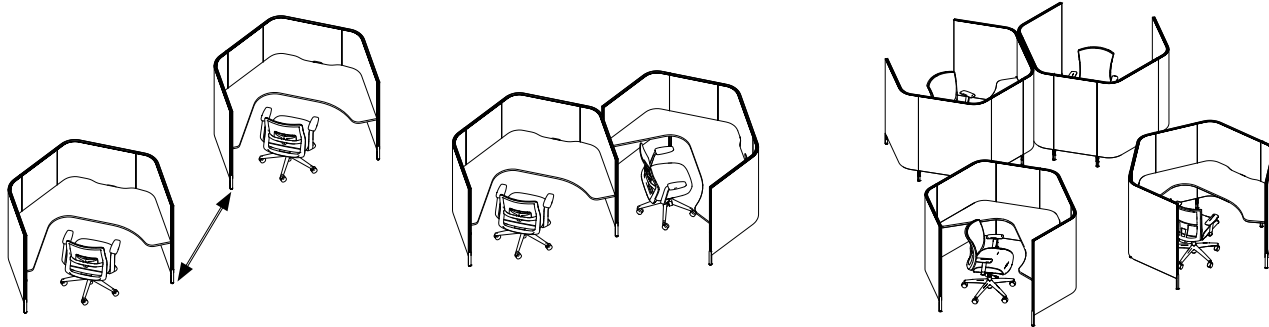

Scalable

The adaptable dividers give the ability to address the level of privacy needed on a station by station basis.

Softpod PRIVACY

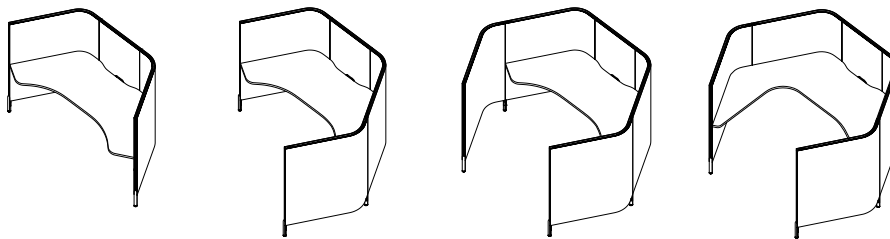

Extensions - PRIVACY

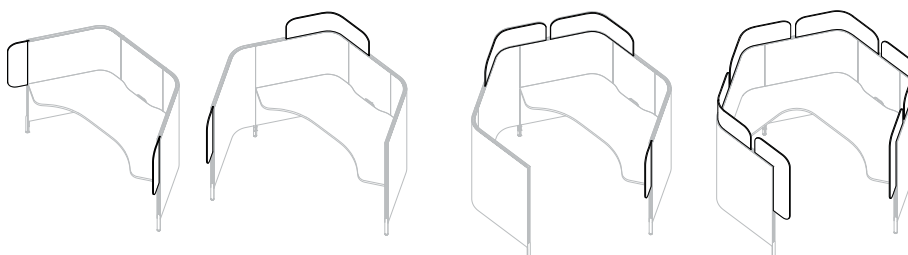

Quick Specification

Softpod's small and complete kits allows for quick and efficient movement of product from time of specification to installation.

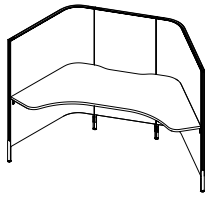

Single Pod with 3 Dividers

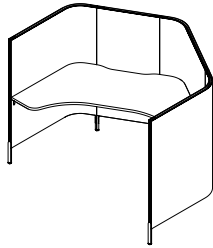

Single Pod with 4 Dividers

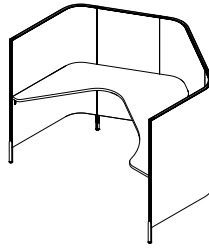

Single Pod with 4 Dividers and Wrap Around Surface

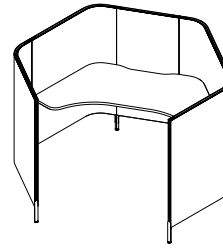

Single Pod with 5 Dividers

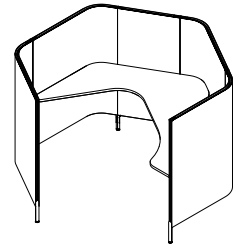

Single Pod with 5 Dividers and Wrap Around Surface

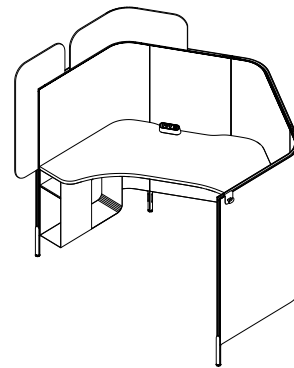
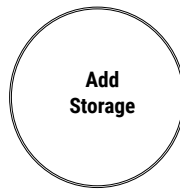
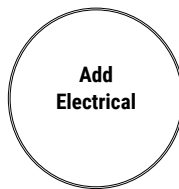

Power Connections

Plug In

Simple casual wire - Direct plug-in or hard wired.

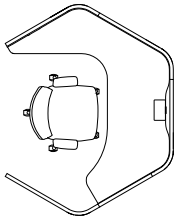

Daisy Chain Interconnect System

Plug-in power supply and interlinked, pre-determined, universal modules. If specified, one module is shipped with the station and interconnected on site.

Integrating additional station (C) requires disconnecting A from B and plugging in the C on site.

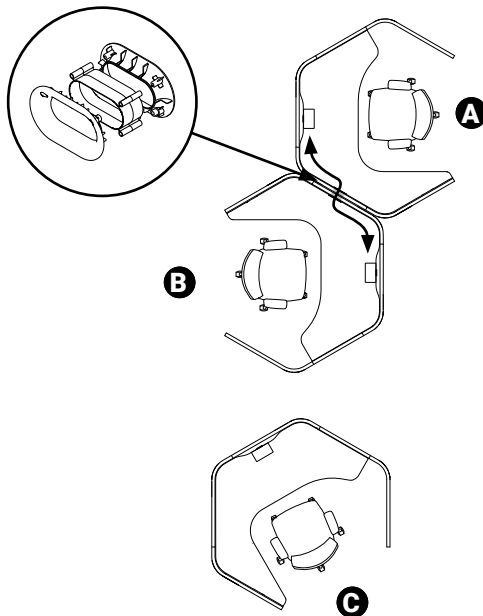

Dual Circuit Power

Outlets mounted below worksurfaces.

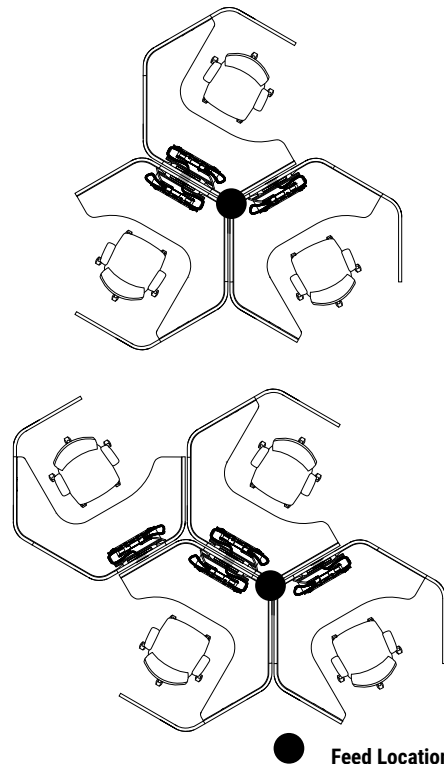

● Feed Location

Space Planning

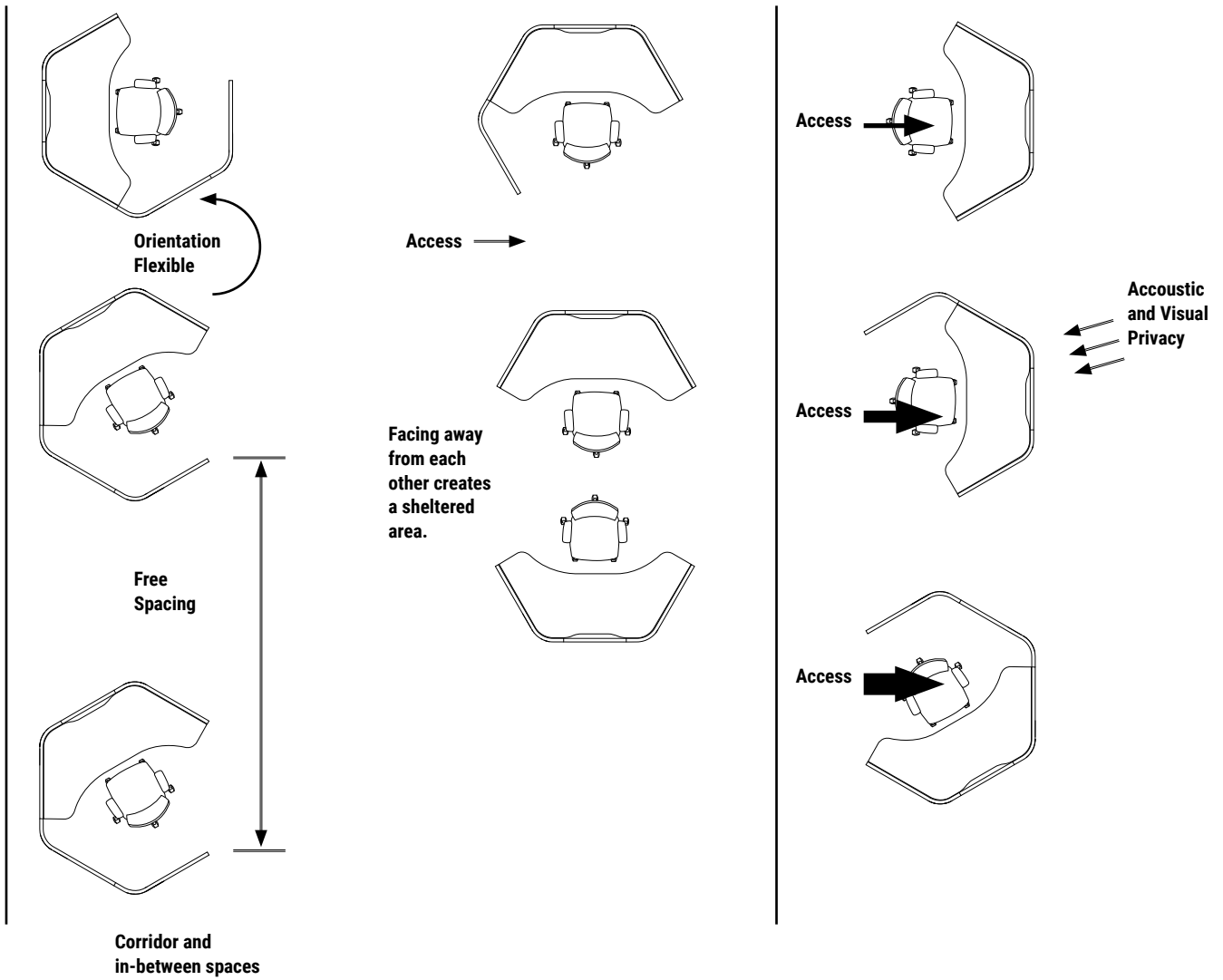

Pod Formats

Align units in cluster plan
Option unit type and orientation

(A) Worksurfaces must have opposing alignment

Flat and curved dividers are non-handed and symmetrical. The addition of the legs determines if the j-dividers becomes LEFT handed or RIGHT handed. Any j-divider can be configured and re-configured LEFT or RIGHT.

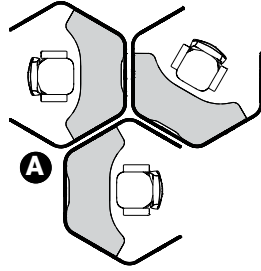

Power/ data is delivered through divider via grommet

Grommet tethers units together

Maximum 4 unit cluster per 2 circuits

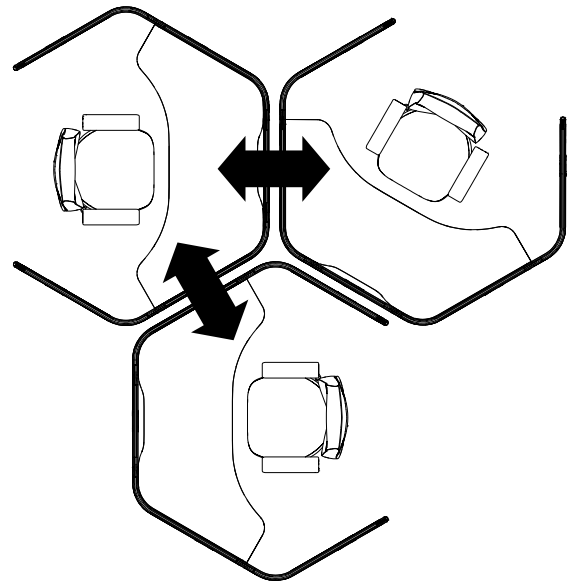
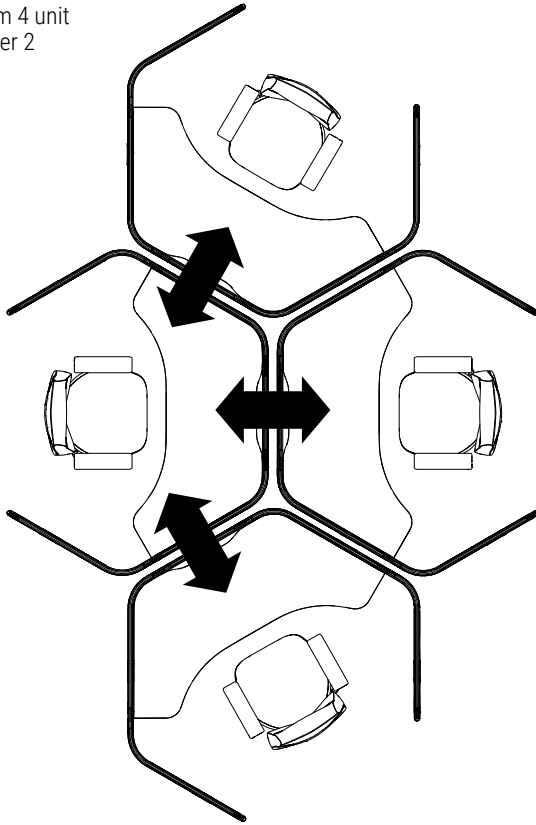

Planning for Single Softpod with 2 Dividers

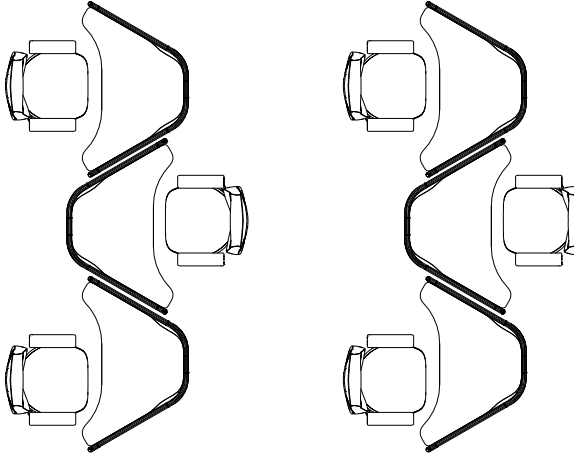

Touchdown

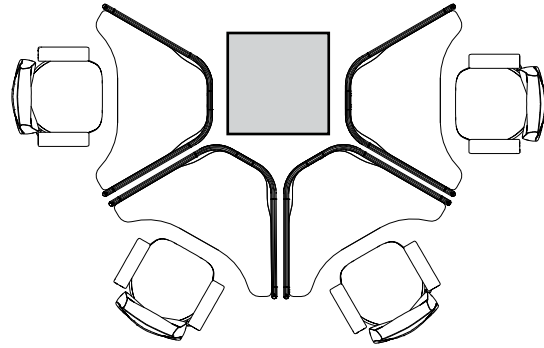

Around Column

Planning for Single Softpod with 3 Dividers

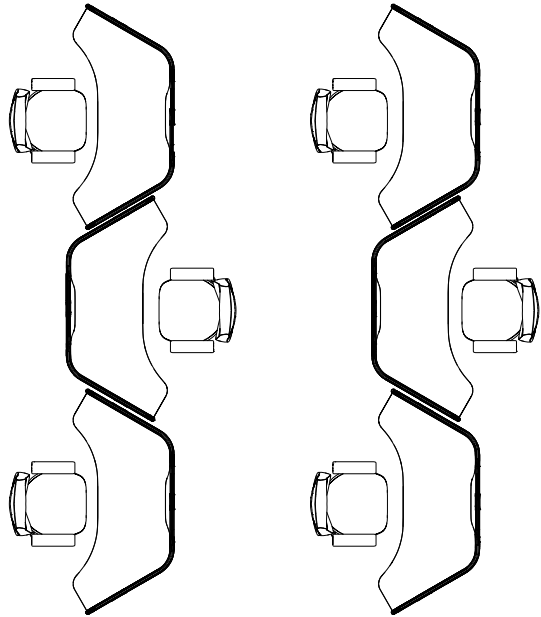

Touchdown

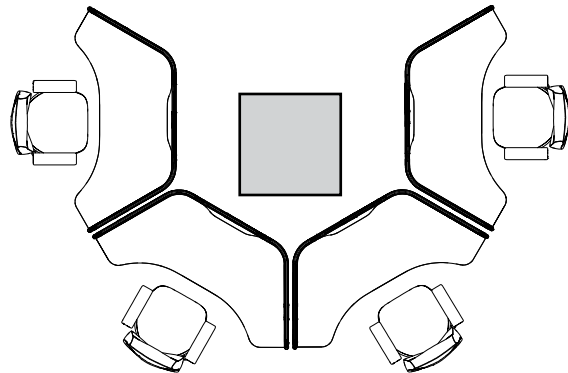

Around Column

Planning for Single Softpod with 4 Dividers

Cluster of 2 Softpods

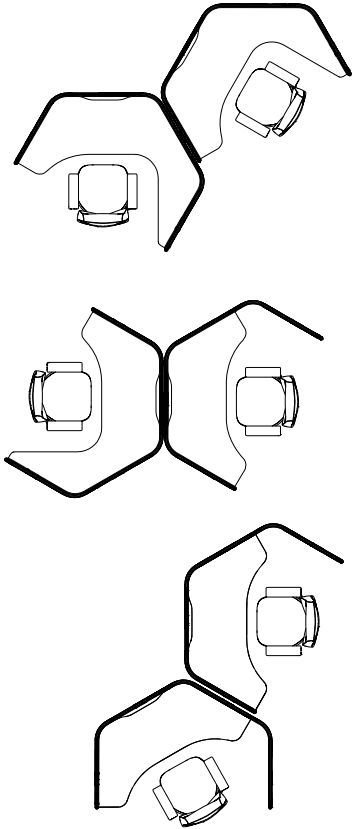

Cluster of 3 Softpods

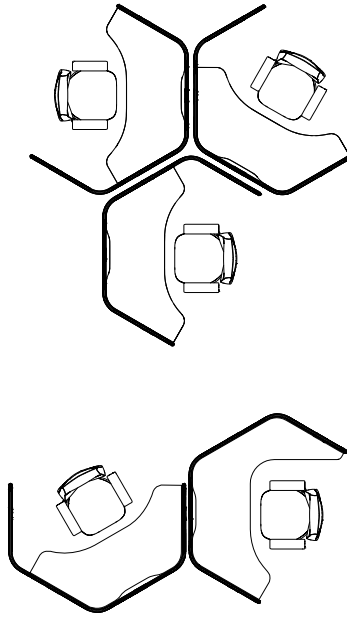

Cluster of 4 Softpods

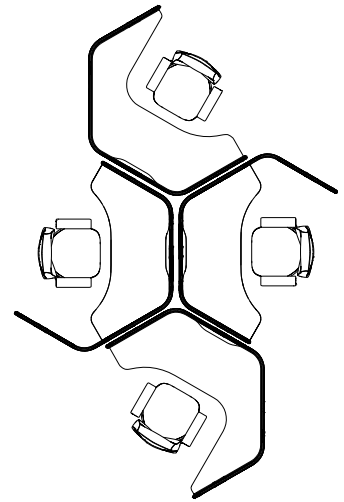

Planning for Single Softpod with 5 Dividers - Center

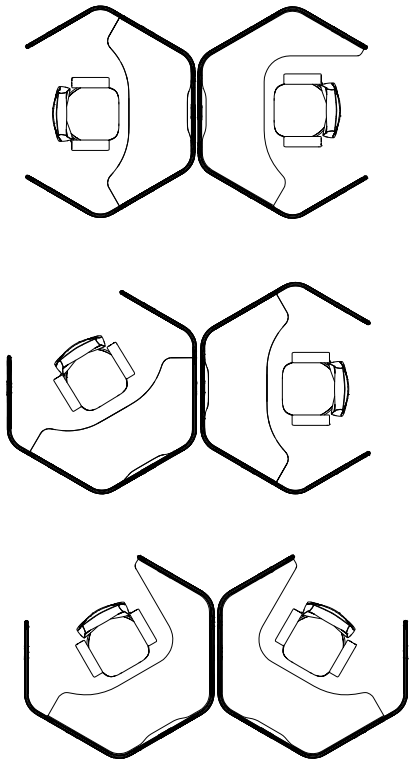

Cluster of 2 Softpods

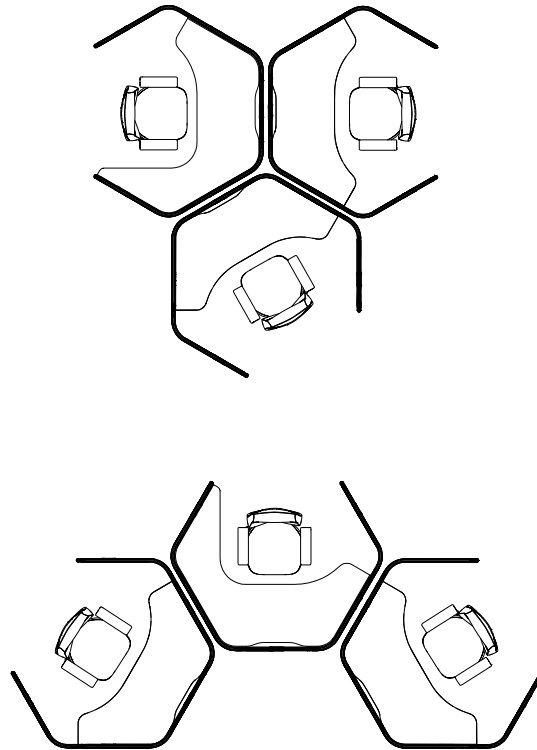

Cluster of 3 Softpods

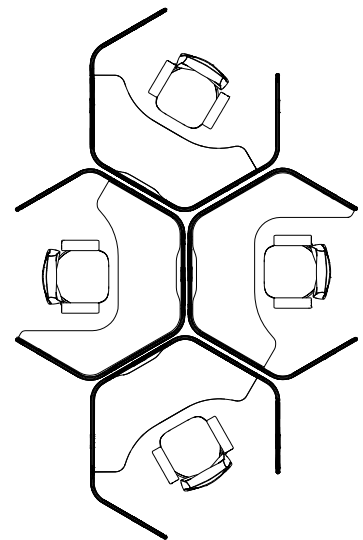

Cluster of 4 Softpods

Planning for Single Softpod with 5 Dividers Left/Right

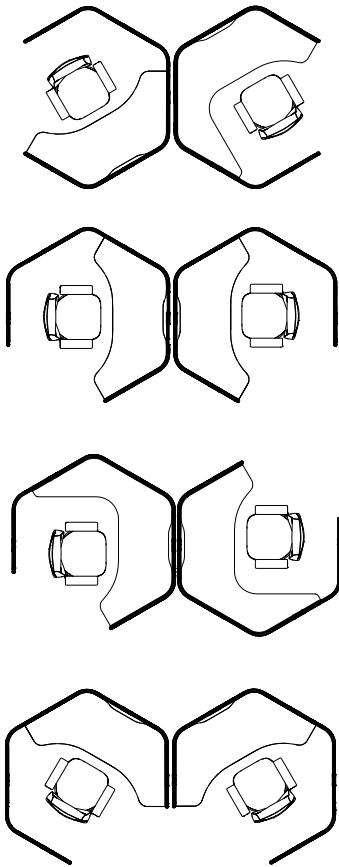

Cluster of 2 Softpods

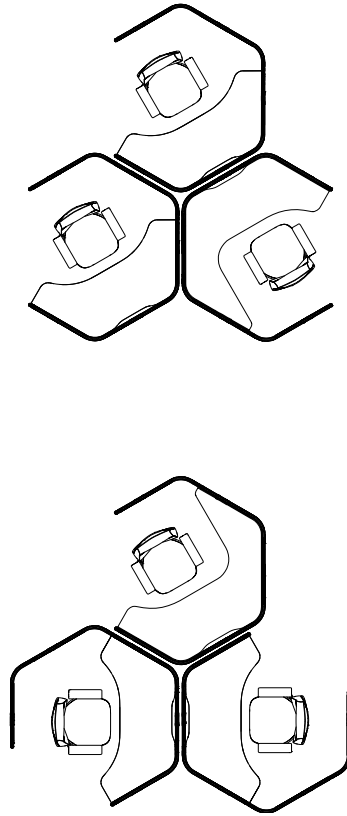

Cluster of 3 Softpods

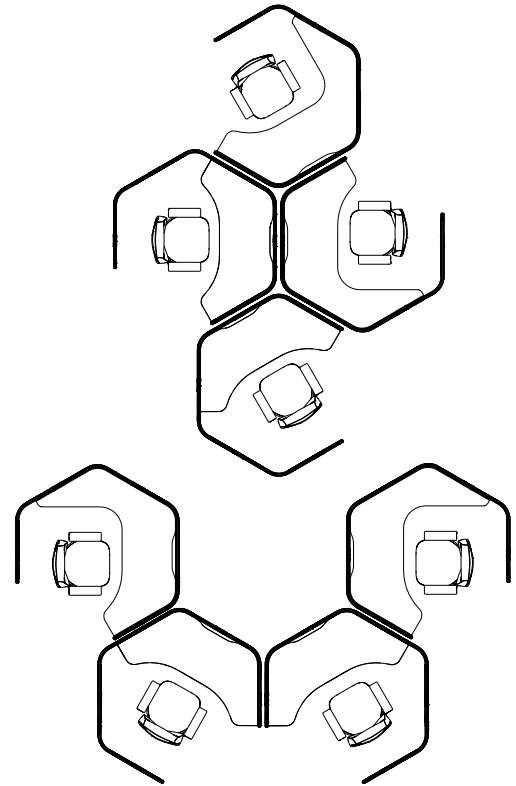

Cluster of 4 Softpods

Planning with Collaboration Pod for Meeting and Lounge Settings

* Seating specified separately

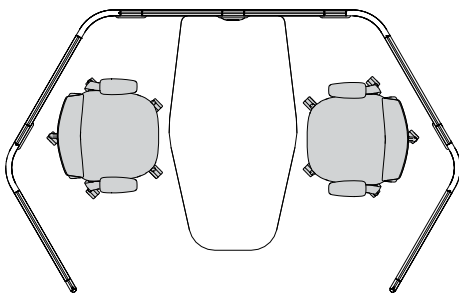

Meeting with D Worksurface

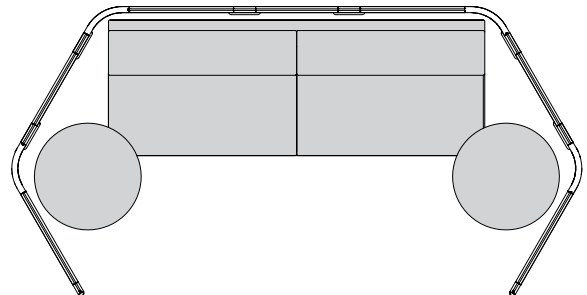

Freestanding Pods for Lounge Settings

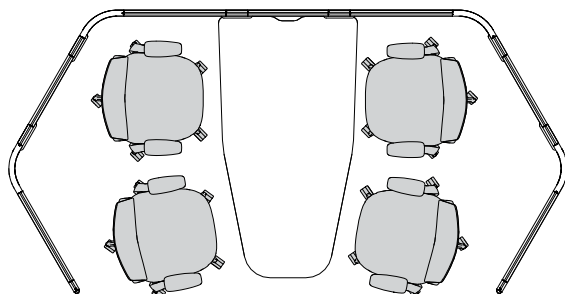

Meeting with D Worksurface

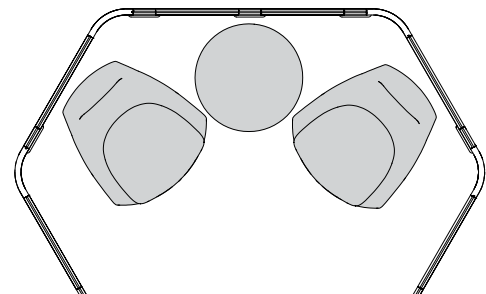

Freestanding Pods for Lounge Settings

End to end connections

Softpod allows for end to end connection to meet a variety of planning needs:

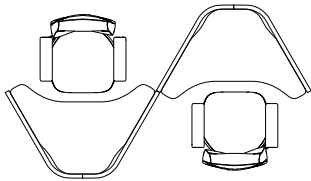

Softpod with 2 Dividers

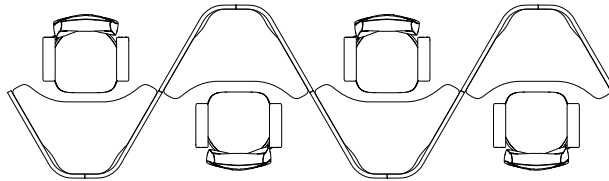

Softpod with 2 Dividers

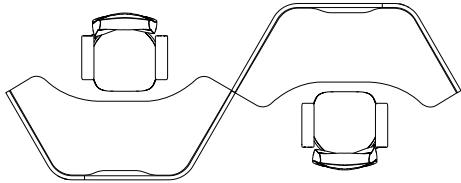

Softpod with 3 Dividers

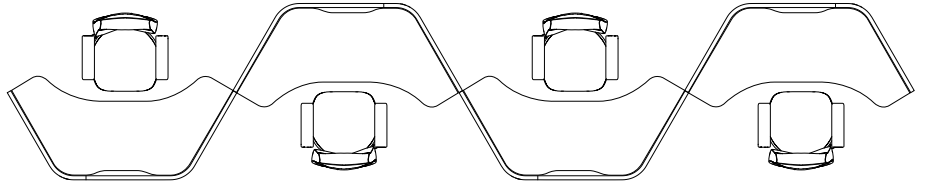

Softpod with 3 Dividers

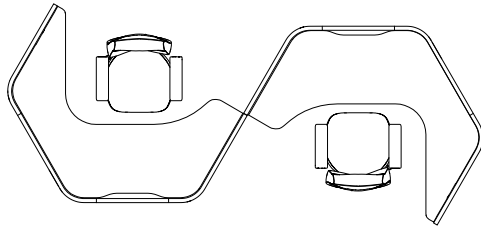

Softpod with 4 Dividers

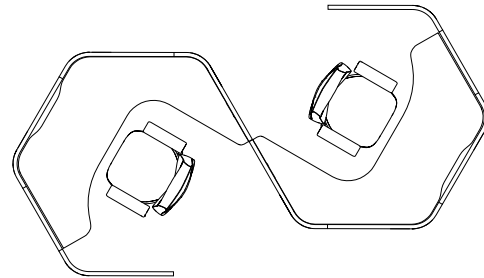

Softpod with 5 Dividers

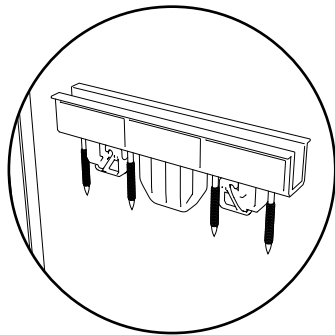

HXPCKIT

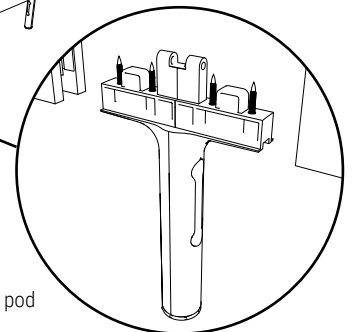
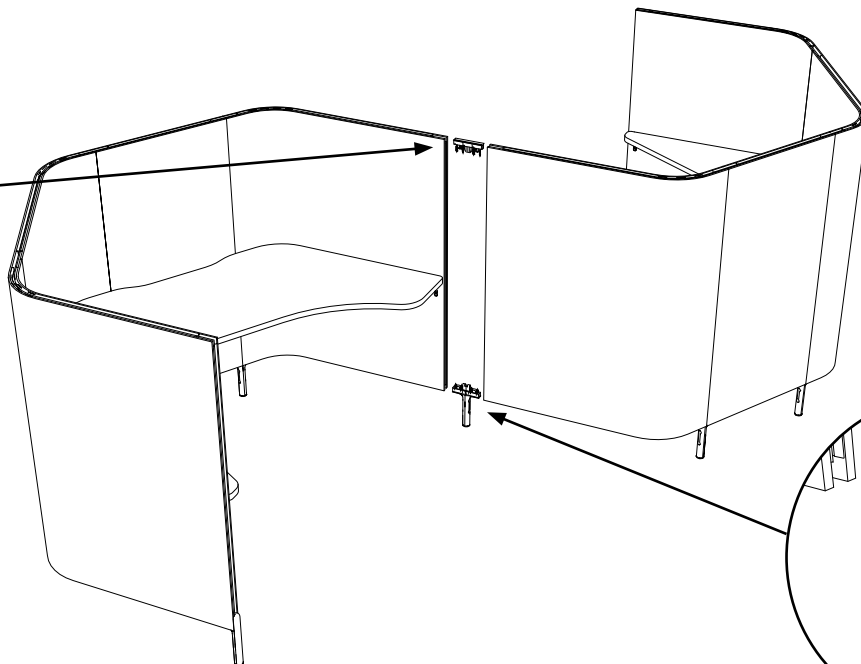

* Reuse leg from existing pod

Privacy Extensions

Flexible privacy extensions can be added to any Softpod workstation to adjust the level of privacy based on the user's needs.

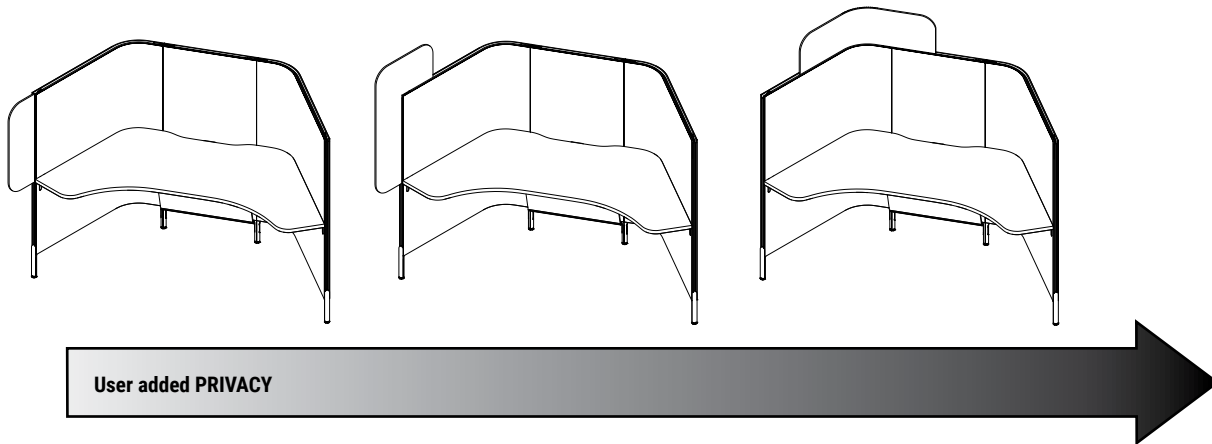

User added PRIVACY

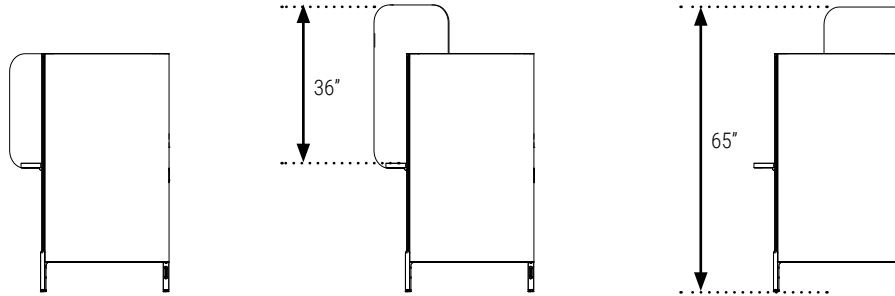

End PET Felt Extension Divider Add-on
 Height: 25.5"
 Depth: 9mm
 Width: 9.5"
 PET Felt
 - solid

Top Corner PET Felt Extension Divider Add-on
 Height: 37"
 Depth: 9mm
 Width: 19.5"
 PET Felt
 - solid
 - perforated

Corner PET Felt Extension Divider Add-on
 Height: 11.5"
 Depth: 9mm
 Width: 38.5"
 PET Felt
 - solid
 - perforated

Corner Semitransparent Extension Panel Add-on
 height: 11.5"
 Depth: 9mm
 Width: 29.5"
 Acrylic
 - Semitransparent

Top PET Felt Extension Divider Add-on for Softpod with 2 Dividers
 Height: 11.5"
 Depth: 9mm
 Width: 55.5"
 PET Felt
 - solid
 - perforated

Top PET Felt Extension Divider Add-on for Softpod with 3 Dividers
 Height: 11.5"
 Depth: 9mm
 Width: 78.3"
 PET Felt
 - solid
 - perforated

Privacy Extensions

PET Felt - Solid

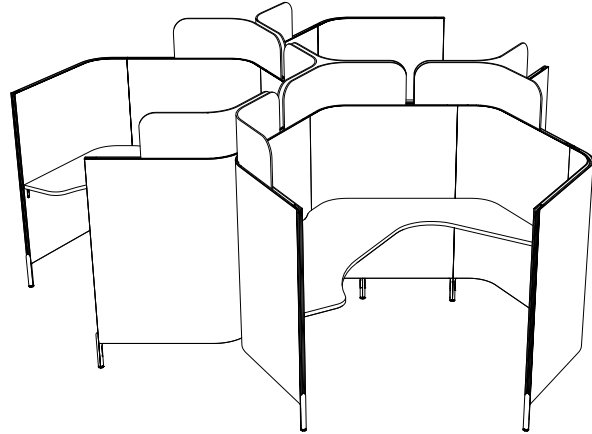
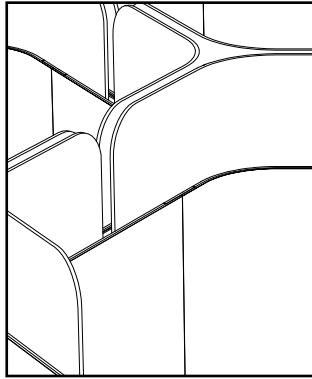

PET Felt - Perforated

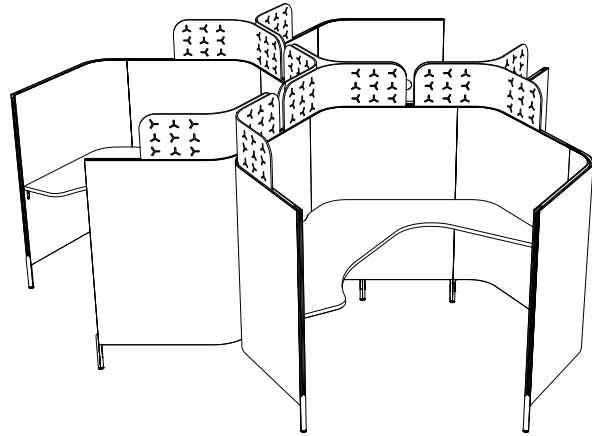
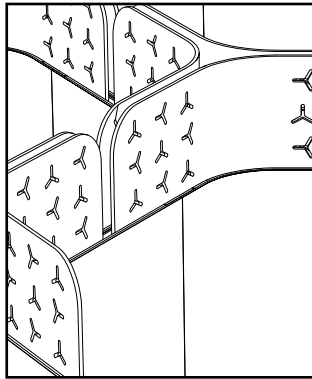

PET Felt Colour Programming

PET Felt finishes may be the same or different for the interior and exterior of the Softpod. Only one finish may be applied to either the interior or exterior of each divider within each Softpod. Extensions may be in any single PET Felt colour to compliment or contrast. Due to variation in the color of felt, we recommend a contrasting or complimentary colour.

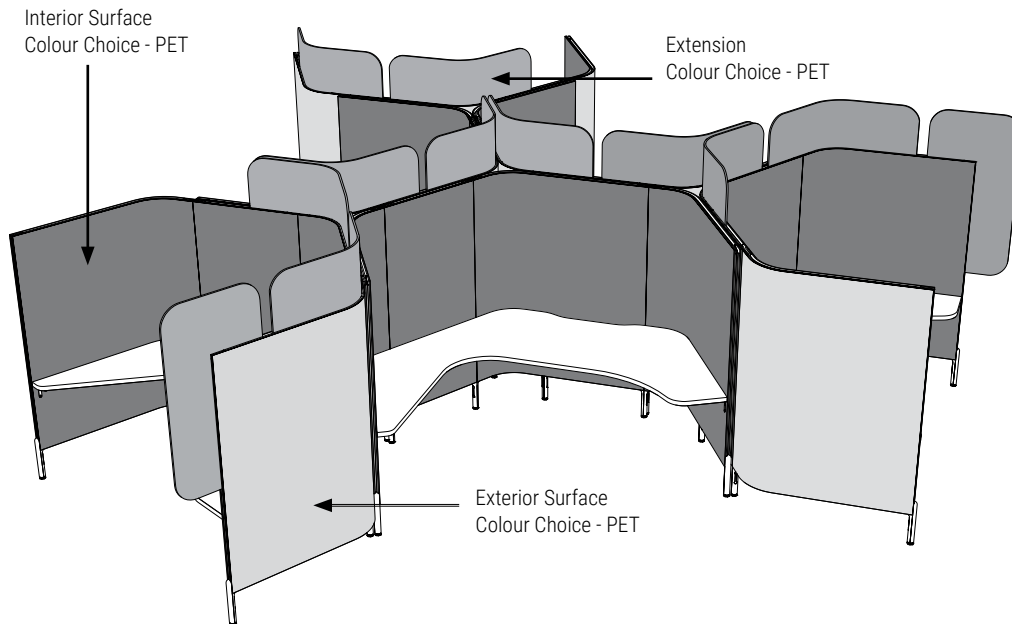

Worksurface Dimensions and Grain Direction

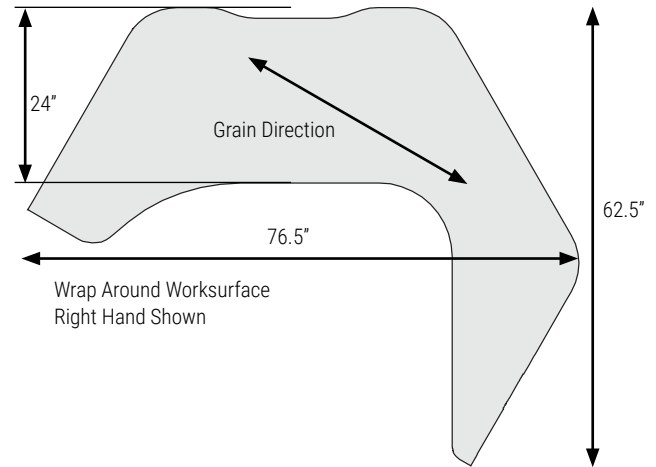
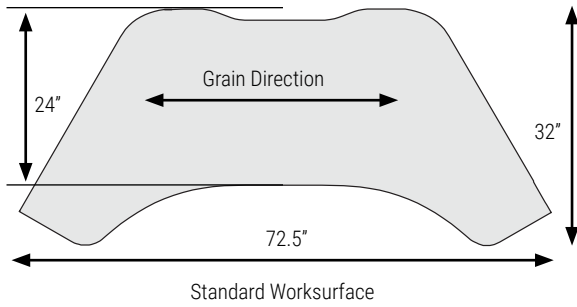

- A single worksurface to be used within Softpod dividers.
- The surface is non handed with pre-determined mounting points.
- Choose from either standard LP - low pressure laminate or HP - high pressure laminate, with PVC edge.

- A single wrap around worksurface to be used within Softpod dividers.
- The surface is handed L -left or R -right with pre-determined mounting points.
- Compatible only with 4 or 5 divider station configurations.
- Choose from either standard LP - low pressure laminate or HP - high pressure laminate, with PVC edge.

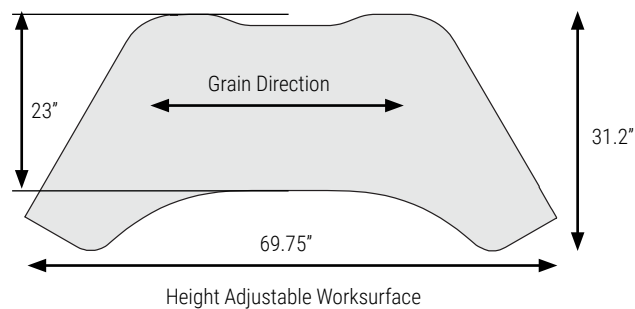
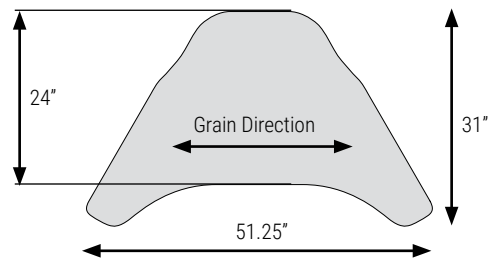
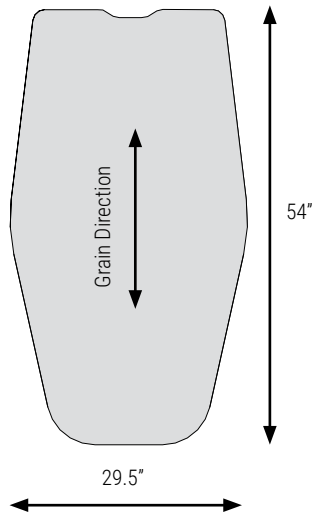
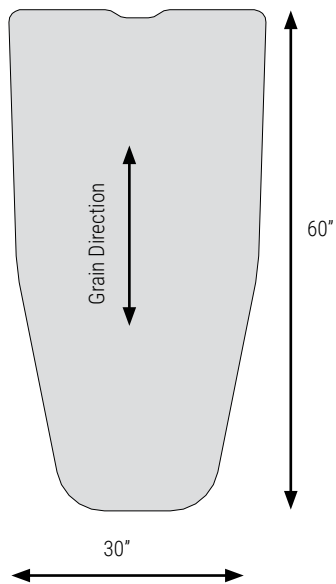

Grommet Location

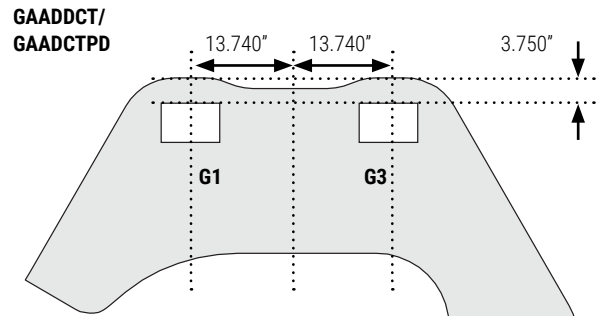
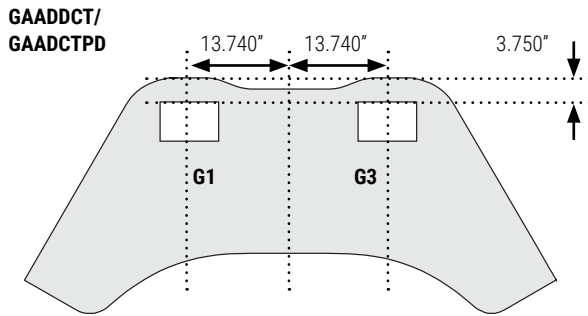

Right Hand Shown

- Grommets must be ordered separately.
- GAAD grommet is not available in combination with HXECS (Cable Shroud) and HXEPK (2 Circuit Power Kit).

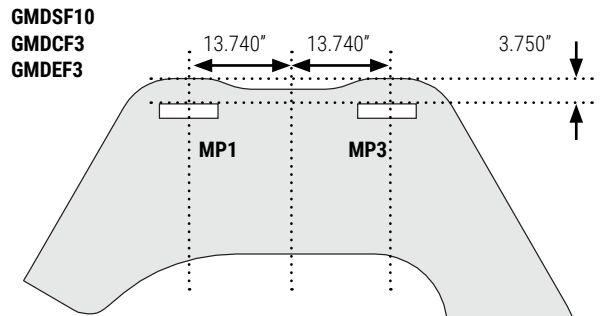
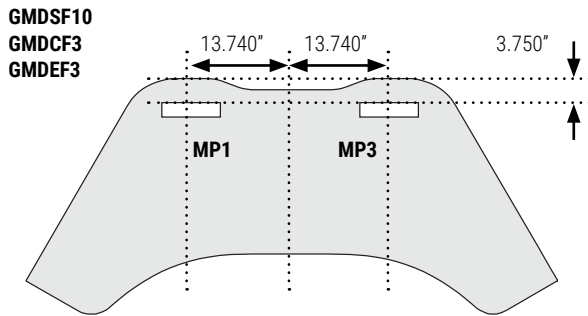
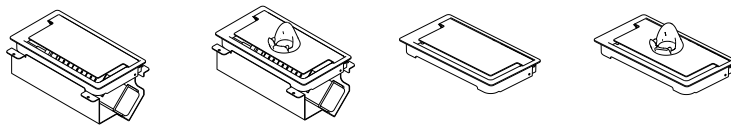

Right Hand Shown

- Grommets must be ordered separately.
- GAAD grommet is not available in combination with HXECS (Cable Shroud) and HXEPK (2 Circuit Power Kit).

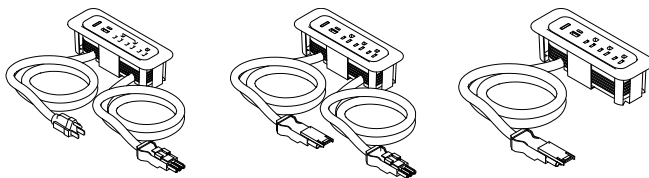

Electrical

Power and data lines can enter Softpod via floor, ceiling, or through grommet in the divider. The grommet opening is built-into every Softpod divider at a specific location, but it is covered by an on-site removable PET plug.

A grommet on a single Softpod can also facilitate cable access to a wall outlet.

Grommets installed on specific dividers facilitate passage of wires through Softpod dividers into adjacent Softpods.

Orientation of worksurfaces plays important role when planning Softpod cluster layouts with the need to pass cables between individual Softpods as the cables are best hidden underneath.

Worksurfaces must have opposing alignment.

Align units in cluster plan option unit type & orientation.

(A) Worksurfaces must have opposing alignment.

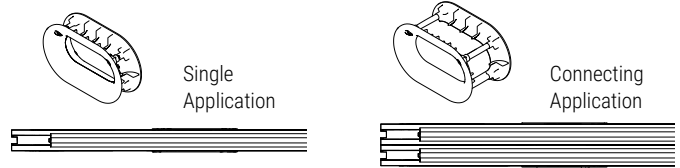
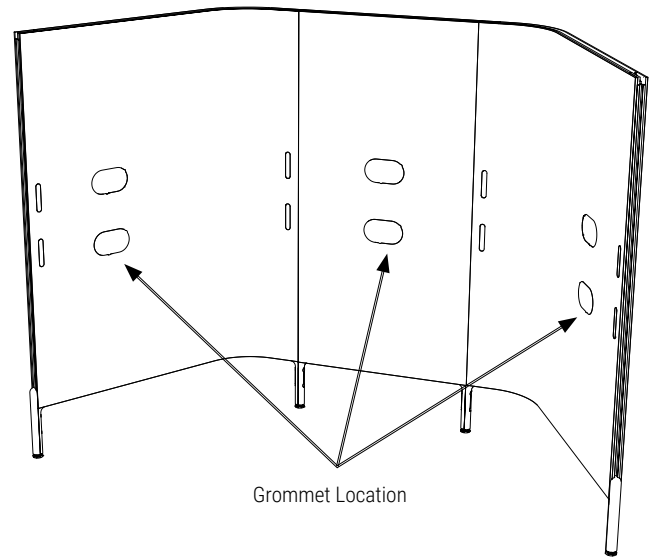
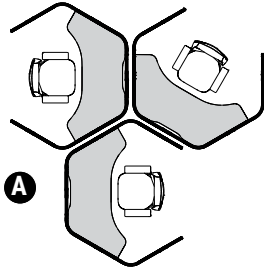

Ceiling pole attaches to the divider grommet under worksurface.

Location of the Ceiling pole on the inside of the Softpod is determined by the contoured recess at the back of worksurface.

White dots below indicate possible ceiling feed pole location within the Pod (must be at the same location as worksurface contoured recess).

Grey dots indicate possible Ceiling fee pole location outside of the POD (because cables pass through the divider grommets and under the worksurface).

Black arrows indicate possible power and data cable passage between Softpods (because cables pass through the divider grommet under the worksurface, through the second divider grommet and into the adjacent Softpod, under worksurface).

In either case, the cables enter or exit the Softpod through the divider grommet.

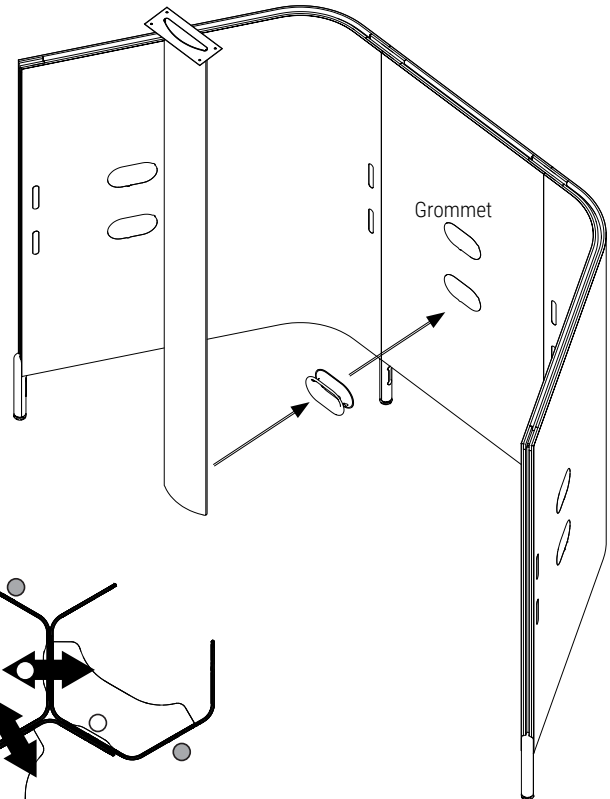

Recommended Maximum 4 unit cluster per 2 circuits.

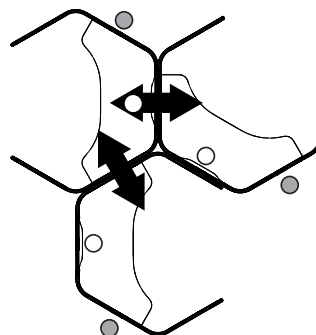
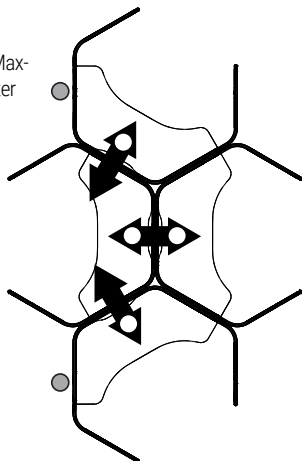

● Ceiling Feed Pole Location

Electrical Options

Direct Plug In

- Direct or floor monument outlet plug-in.

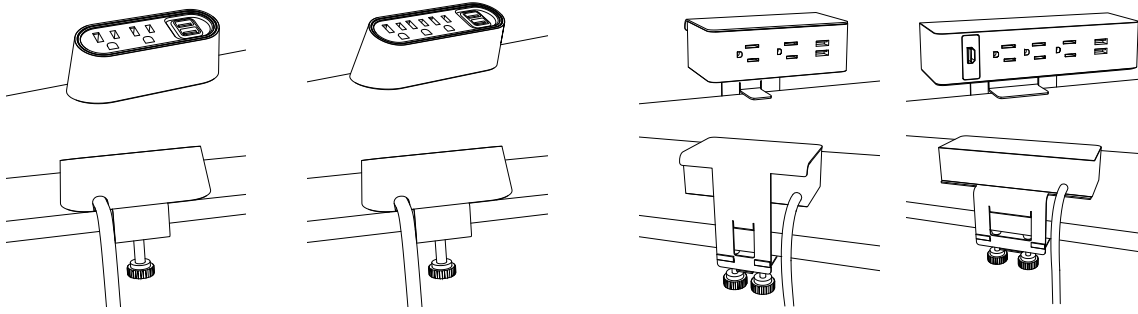

Grommet Application

- In surface.

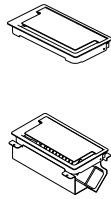
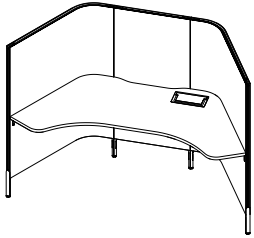

Grommet Application

- In surface Daisy Chain.

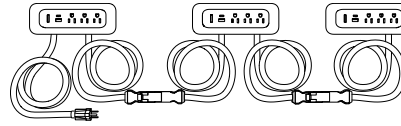
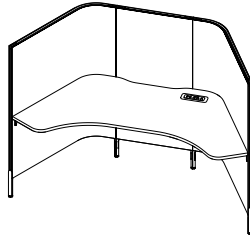

Daisy Chain Interconnect System

- Direct or floor monument outlet plug-in.

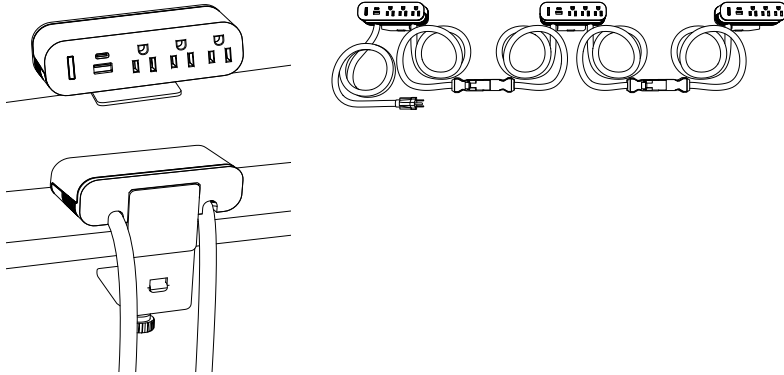

Dual Circuit Power

- Hardwired

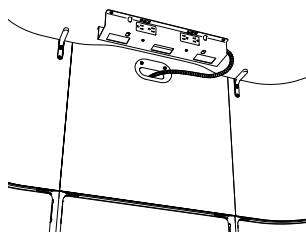
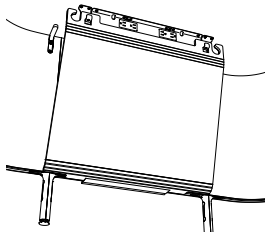

Floor Feed

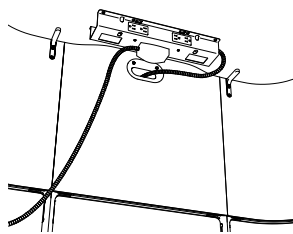

Ceiling Feed

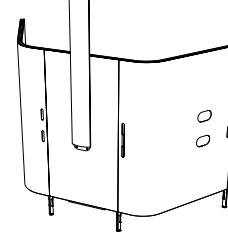

Electrical

2 Circuit, 4 Wire Power Distribution

The 2-circuit, 4-wire electrical components are housed in a metal trough, mounted under worksurface, immediately adjacent to the worksurface contoured recess.

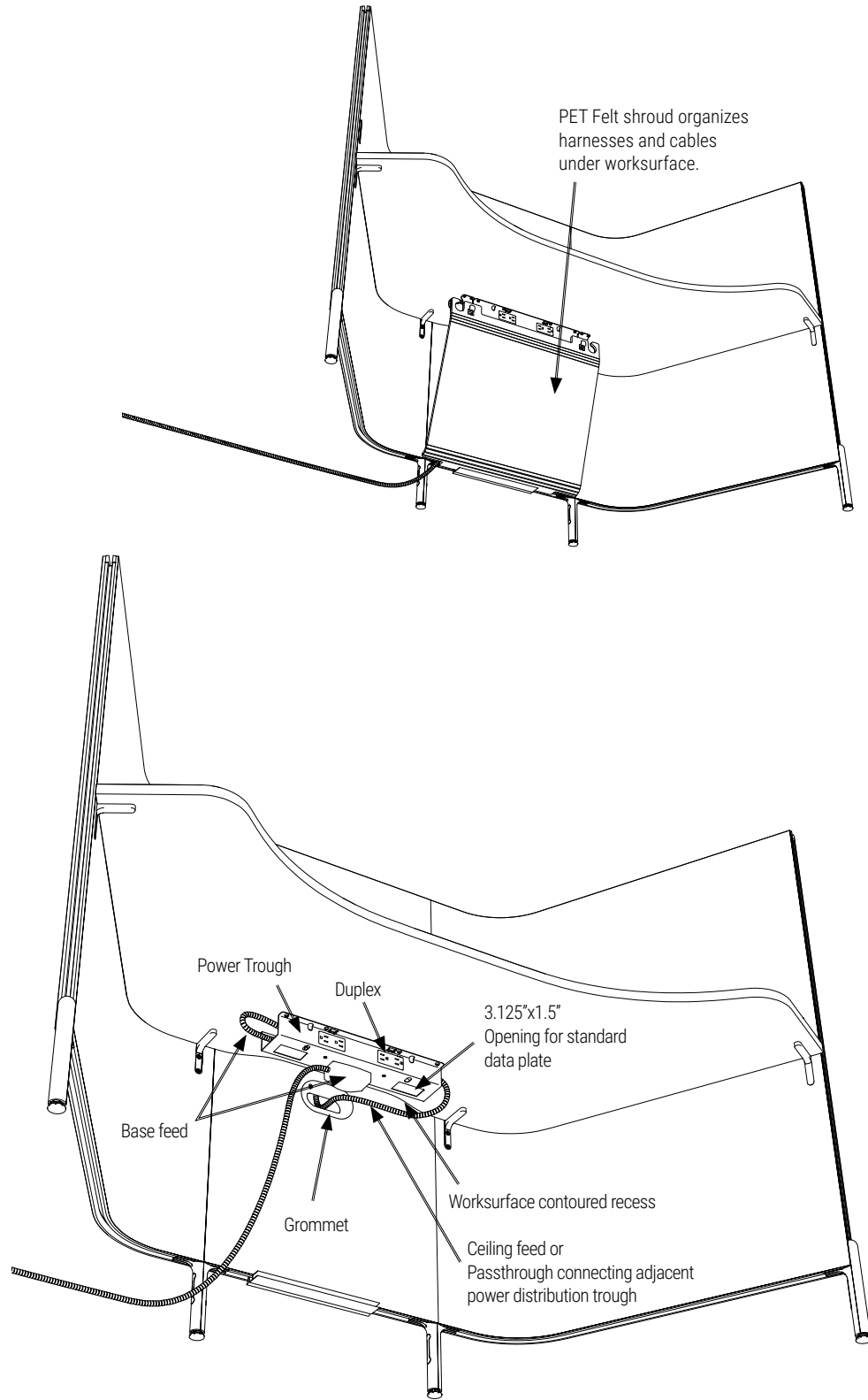

Height Adjustable

HX3PH5472SW

Softpod with 3 Dividers and Height Adjustable Worksurface Complete 3 divider pod consisting of one straight back divider, two side j-dividers and one height adjustable worksurface. Includes all connecting hardware, tubular legs and supporting brackets.

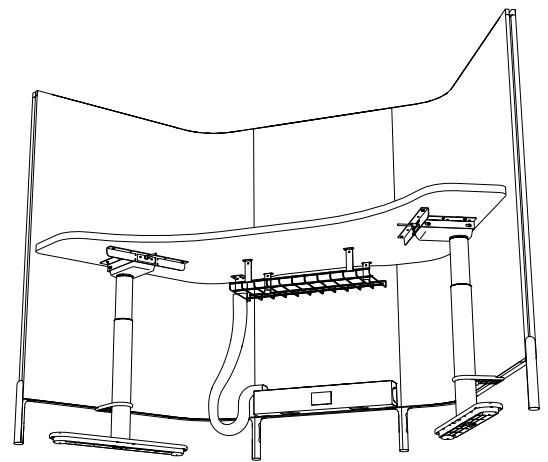
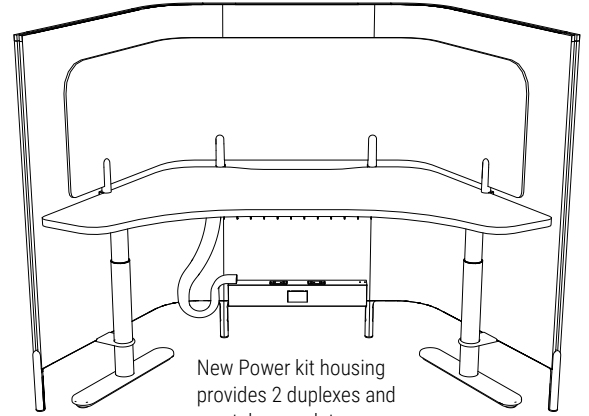
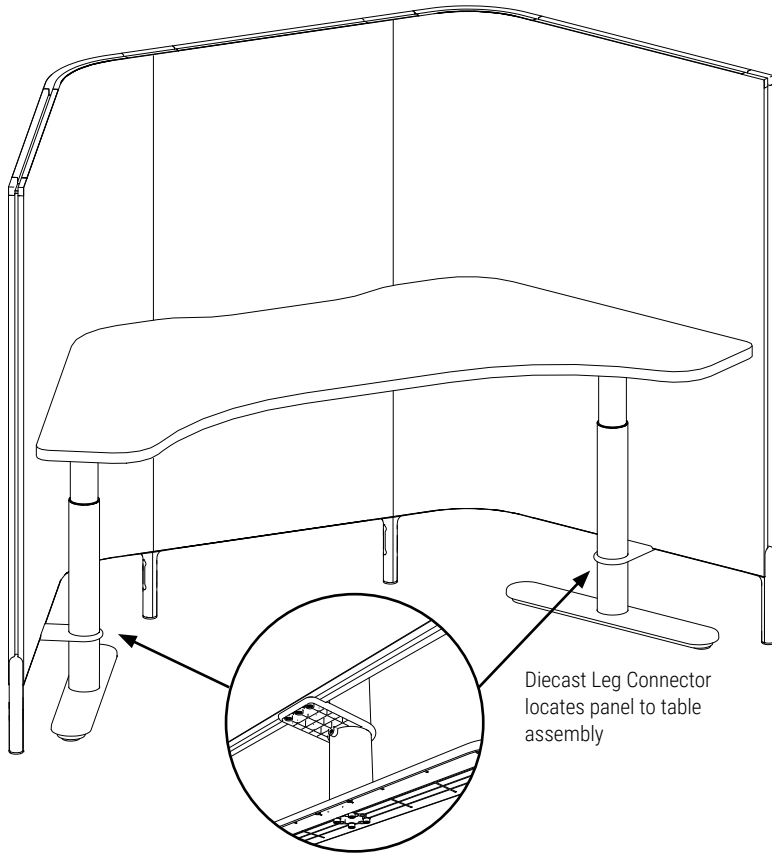

HXEHP

Optional electrical kit for use with height adjustable Softpod, includes electrical housing with receptacles, under worksurface cable basket, and black neoprene sock for wire management

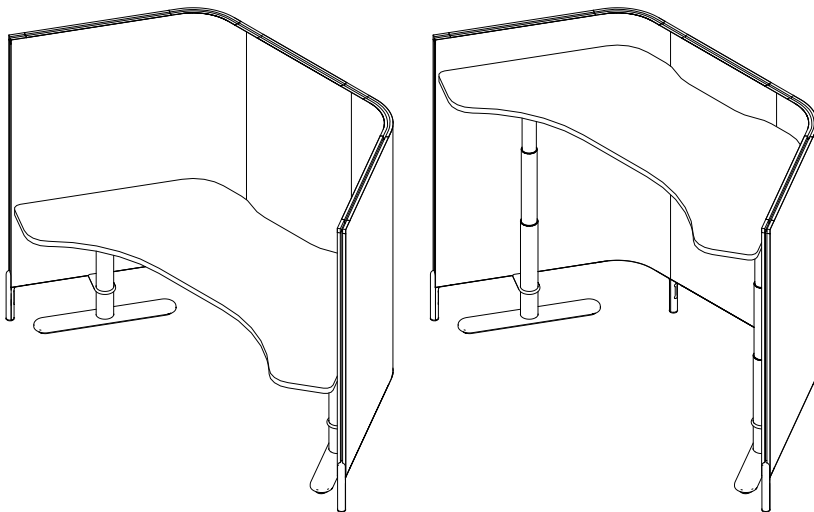

Height Range of 22.5" - 48.9" (Top of Surface)

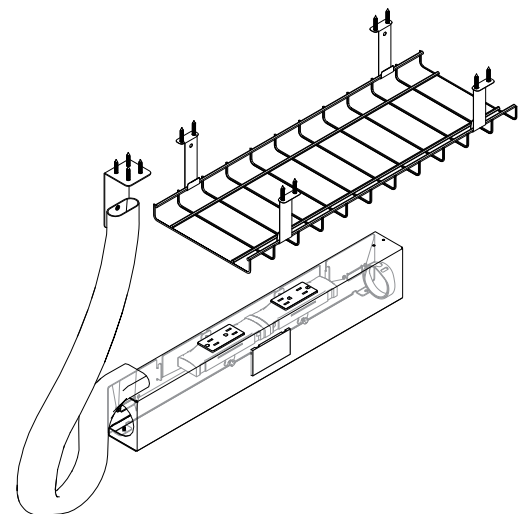

Height Adjustable Base Specification

Construction:

- Leg column size – 70mm
- Leg and foot materials - Steel
- Glide adjustment range – 18mm
- Weight capacity – 1200N/leg
- Operation speed – 35mm/sec
- Anti collision if existent – 6-axis Gyro built into control box
- Warranty – 5-year on electrical/ 10-year on steel
- Certifications - ANSI/BIFMA Compliant. UL component level certification.

Three stage leg design:

- Guide / actuator / motor housing design – Steel/Aluminum/Plastic
- Max. thrust – 800N/leg
- Max. speed – 38mm/sec
- Noise level - <50dB

Control box specs "NE2/N3":

- Voltage – 120V
- Control box specs NE2:
- Size - 11 5/8 x 1 7/8 x 3 3/4
- Weight- 1.14 lbs

Control box specs N3:

- Size - 12 5/8" x 1 15/16" x 3 11/16"
- Weight- 1.54 lbs
- Temperatures - Below 70°C.
- Colour - Black
- Overload protection – Work duty: 2min operation, request 18min rest, otherwise code H01 will show. Current limitations: single port not larger than 7A, total port not larger than 15A.
- Type of plug (two prong / three prong) - Three prong
- Cord length – 1 meter

Handset "K50C":

- Colour - Black
- PVC or PVC-Free – PVC
- Plug style and cord length – RJ45
- Power consumption – < 0.1W
- Certifications – UL component level certification

Height Adjustable Power

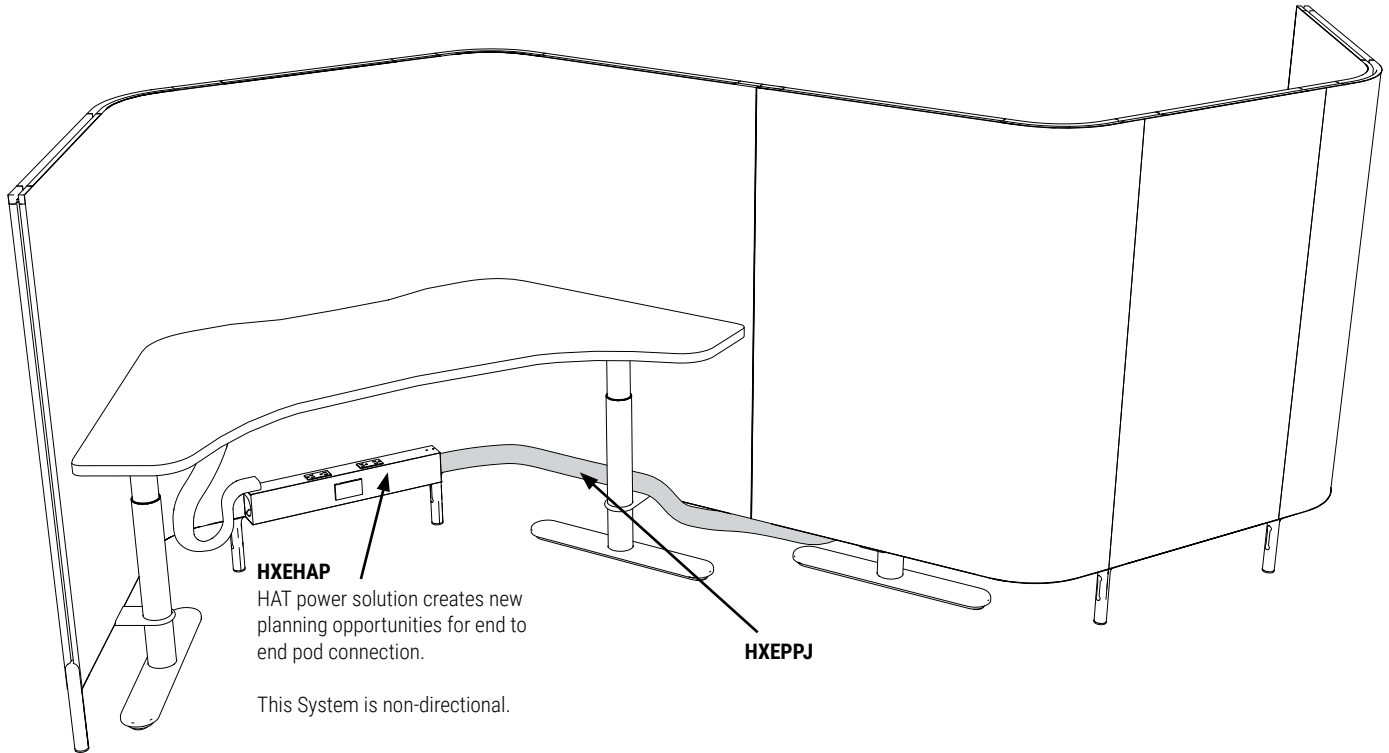

HXEHP
 HAT power solution creates new planning opportunities for end to end pod connection.

HXEPPJ

This System is non-directional.

Side to side

Required jumper length - 36"
 HXEPPJ36

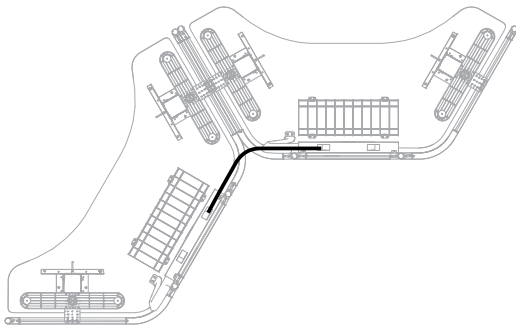

End to end

Required jumper length - 90"
 HXEPPJ72
 HXEPPJ18
 BE8C11

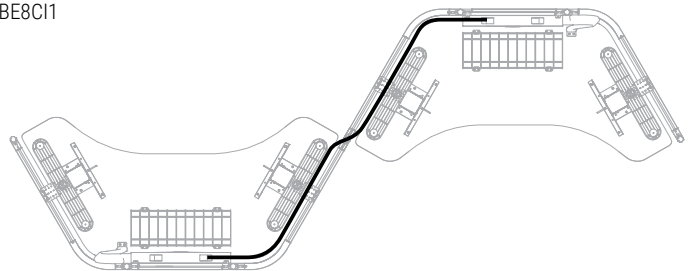

Back to back

Required jumper length - 24"
 HXEPPJ24

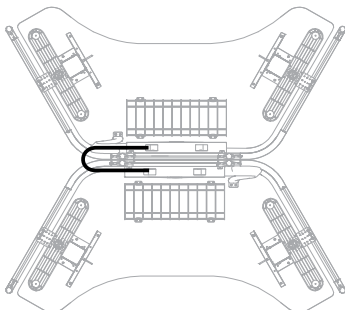

Line

Required jumper length - 72"
 HXEPPJ72

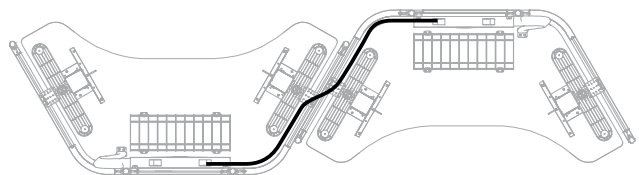

Storage

Hook
For hanging small items like earphones.

Shelf
PET Felt liner with rear hole to direct power cords for charging.

Rear Access
Tuck valuable items out of sight

Bag Drop
Area for storing personal items.

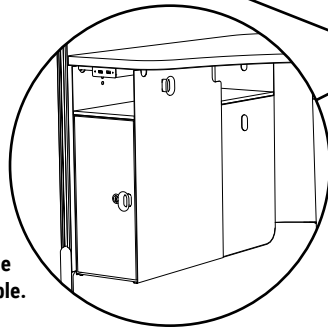

Optional Lockable Door Unit Available.

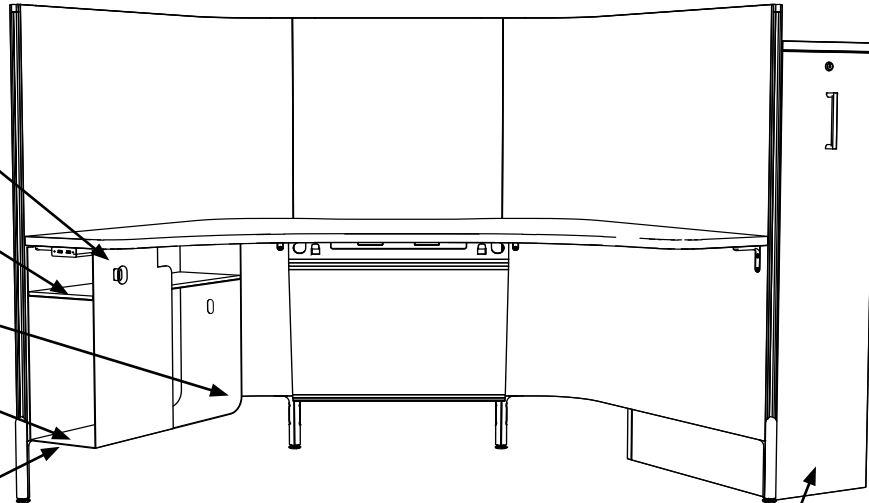

Pantry Storage
Multifunction, customizable storage

Accessories

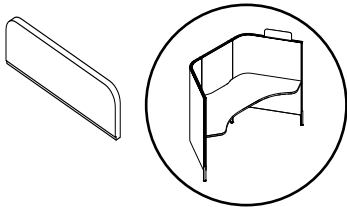

HXNP Name Plate
Height: 3.5"
Depth: 0.5"
Width: 11"
• Two sided white dry erase surface.

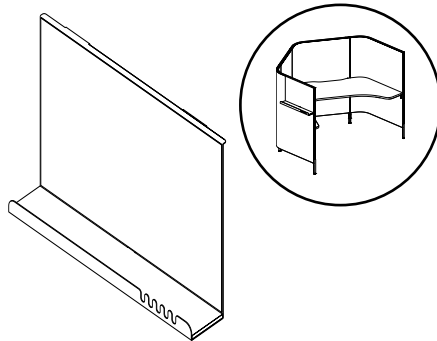

HXAHS Hanging Shelf
Height: 16"
Depth: 3"
Width: 23.5"
• Optional dry erase board available

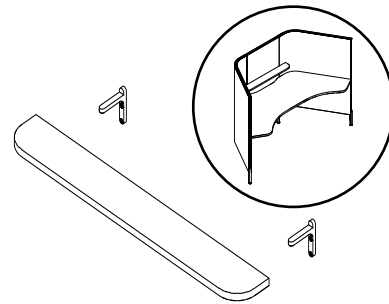

HXARWS Rear Wall Shelf
Height: 3/4"
Depth: 4.5"
Width: 32.5"
• Laminate
NOTE : Not compatible with Ceiling Feed Pole or any monitor mounts.

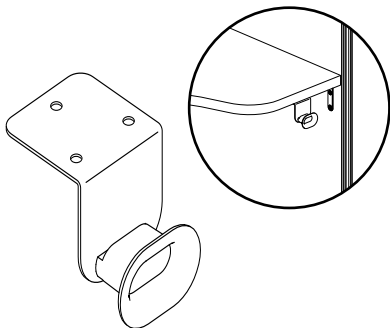

HXABH Under Surface Bag Hook

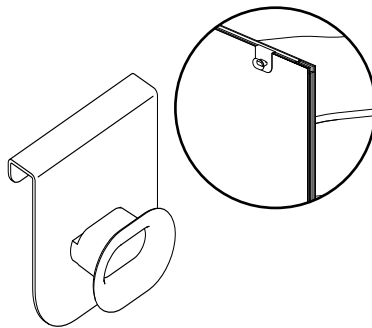

HXACHT Coat, Bag Hook for horizontal divider edge

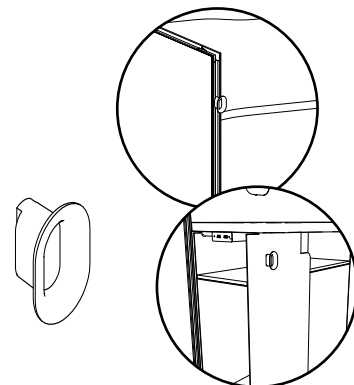

HXACHS Coat, Bag Hook for Dividers

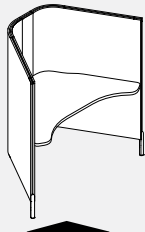
HX2P5452SW • Softpod with 2 Dividers and Worksurface**NEW!**

- Complete 2 divider pod consisting of two j-dividers and one standard worksurface.
- Installed pod measures 54"h from the floor, 25" from top of surface and has a clearance of 6 3/8" at floor level.
- Dividers are surfaced with tackable PET Felt. Please choose any standard PET Felt color. Interior PET Felt color may be different than the outer.
- The divider perimeter reveal trim accepts privacy extensions and is made of polypropylene available only in CHR - Charcoal.
- Surface choice of LP - low pressure or HP - high pressure laminate with PVC edge. Please choose any standard laminate and PVC edge.
- Metal legs are powder coated paint. Please specify standard paint finish.
- Complete pod includes all connecting hardware, tubular legs and supporting brackets.
- Extensions, electrical, storage and accessories are specified separately.

PRODUCT CODE	PRICE		SIZE/INCHES			WEIGHT LBS	VOL FT ³
	LP	HP	H	W	D		
HX2P5452SW	2018	2230	54	49	30	86	17.87

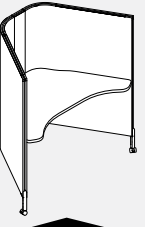
HX2PM5452SW • Mobile Softpod with 2 Dividers and Worksurface**NEW!**

- Complete 2 divider pod consisting of two j-dividers and one standard worksurface.
- Installed pod measures 54"h from the floor, 25" from top of surface and has a clearance of 6 3/8" at floor level.
- Dividers are surfaced with tackable PET Felt. Please choose any standard PET Felt color. Interior PET Felt color may be different than the outer.
- The divider perimeter reveal trim accepts privacy extensions and is made of polypropylene available only in CHR - Charcoal.
- Surface choice of LP - low pressure or HP - high pressure laminate with PVC edge. Please choose any standard laminate and PVC edge.
- Metal legs with casters are powder coated paint. Please specify standard paint finish.
- Complete pod includes all connecting hardware, tubular legs, casters and supporting brackets.
- Extensions, electrical, storage and accessories are specified separately.

PRODUCT CODE	PRICE		SIZE/INCHES			WEIGHT LBS	VOL FT ³
	LP	HP	H	W	D		
HX2PM5452SW	2039	2250	54	49	30	87	17.87

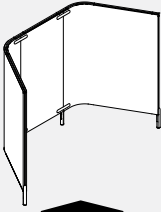
HX3PF • Freestanding Softpod with 3 Dividers**NEW!**

- Complete 3 divider pod consisting of one straight back divider, and two side j-dividers.
- Installed pod measures 54"h from the floor, and has a clearance of 6 3/8" at floor level.
- Dividers are surfaced with tackable PET Felt. Please choose any standard PET Felt color. Interior PET Felt color may be different than the outer.
- The divider perimeter reveal trim accepts privacy extensions and is made of polypropylene available only in CHR - Charcoal.
- Metal legs and stiffeners are powder coated paint. Please specify standard paint finish.
- Complete pod includes all connecting hardware, tubular legs and supporting brackets.
- Extensions, electrical, storage and accessories are specified separately.

PRODUCT CODE	PRICE	SIZE/INCHES			WEIGHT LBS	VOL FT ³
		H	W	D		
HX3PF	2174	54	72	30	85	14.10

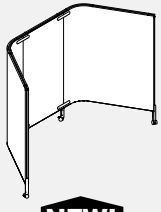
HX3PFM • Freestanding Mobile Softpod with 3 Dividers**NEW!**

- Complete 3 divider pod consisting of one straight back divider, and two side j-dividers.
- Installed pod measures 54"h from the floor, and has a clearance of 6 3/8" at floor level.
- Dividers are surfaced with tackable PET Felt. Please choose any standard PET Felt color. Interior PET Felt color may be different than the outer.
- The divider perimeter reveal trim accepts privacy extensions and is made of polypropylene available only in CHR - Charcoal.
- Metal legs with casters and stiffeners are powder coated paint. Please specify standard paint finish.
- Complete pod includes all connecting hardware, tubular legs, casters and supporting brackets.
- Extensions, electrical, storage and accessories are specified separately.

PRODUCT CODE	PRICE	SIZE/INCHES			WEIGHT LBS	VOL FT ³
		H	W	D		
HX3PFM	2204	54	72	30	85	14.10

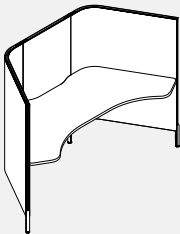
HX3P5472SW • Softpod with 3 Dividers and Worksurface

- Complete 3 divider pod consisting of one straight back divider, two side j-dividers and one standard worksurface.
- Installed pod measures 54"h from the floor, 25" from top of surface and has a clearance of 6 3/8" at floor level.
- Dividers are surfaced with tackable PET Felt. Please choose any standard PET Felt color. Interior PET Felt color may be different than the outer.
- The divider perimeter reveal trim accepts privacy extensions and is made of polypropylene available only in CHR - Charcoal.
- Surface choice of LP - low pressure or HP - high pressure laminate with PVC edge. Please choose any standard laminate and PVC edge.
- Metal legs are powder coated paint. Please specify standard paint finish.
- Complete pod includes all connecting hardware, tubular legs and supporting brackets.
- Extensions, electrical, storage and accessories are specified separately.

PRODUCT CODE	PRICE		SIZE/INCHES			WEIGHT LBS	VOL FT ³
	LP	HP	H	W	D		
HX3P5472SW	2910	3293	54	72	30	127	22.92

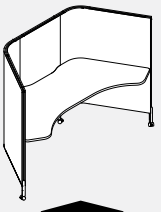
HX3PM5472SW • Mobile Softpod with 3 Dividers and Worksurface**NEW!**

- Complete 3 divider pod consisting of one straight back divider, two side j-dividers and worksurface.
- Installed pod measures 54"h from the floor, 25" from top of surface and has a clearance of 6 3/8" at floor level.
- Dividers are surfaced with tackable PET Felt. Please choose any standard PET Felt color. Interior PET Felt color may be different than the outer.
- The divider perimeter reveal trim accepts privacy extensions and is made of polypropylene available only in CHR - Charcoal.
- Surface choice of LP - low pressure or HP - high pressure laminate with PVC edge. Please choose any standard laminate and PVC edge.
- Metal legs with casters and stiffeners are powder coated paint. Please specify standard paint finish.
- Complete pod includes all connecting hardware, tubular legs, casters and supporting brackets.

PRODUCT CODE	PRICE		SIZE/INCHES			WEIGHT LBS	VOL FT ³
	LP	HP	H	W	D		
HX3PM5472SW	2970	3408	54	72	30	127	22.92

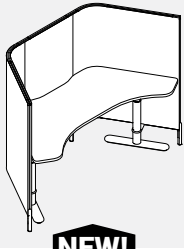
HX3PH5472SW • Softpod with 3 Dividers and Height Adjustable Worksurface

- Complete 3 divider pod consisting of one straight back divider, two side j-dividers and one height adjustable worksurface.
- Installed pod measures 54"h from the floor and has a clearance of 6 3/8" at floor level.
- Dividers are surfaced with tackable PET Felt. Please choose any standard PET Felt color. Interior PET Felt color may be different than the outer.
- The divider perimeter reveal trim accepts privacy extensions and is made of polypropylene available only in CHR - Charcoal.
- Surface choice of LP - low pressure or HP - high pressure laminate with PVC edge. Please choose any standard laminate and PVC edge.
- Panel legs are powder coated paint. Please specify standard paint finish.
- Height adjustable legs are powder coated. Choose from BLK -Black, DWT -Designer White, SIL - Silver . Additional finishes available at an additional 200\$ upcharge. (BZD -Blizzard, CHR -Charcoal, NEV -Nevada, SDT -Stonedust, TPE -Taupe TIN -Ink, TUN - Tungsten)
- Complete pod includes all connecting hardware, tubular legs and supporting brackets.
- Extensions, electrical, storage and accessories are specified separately.

PRODUCT CODE	PRICE		SIZE/INCHES			WEIGHT LBS	VOL FT ³
	LP	HP	H	W	D		
HX3PH5472SW	4463	4901	54	72	30	133	23.48

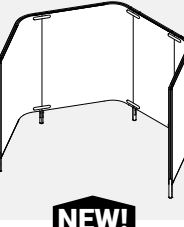
HX4PF • Freestanding Softpod with 4 Dividers

- Complete 4 divider pod consisting of one straight back divider, and three side j-dividers.
- Installed pod measures 54"h from the floor, 25" from top of surface and has a clearance of 6 3/8" at floor level.
- Dividers are surfaced with tackable PET Felt. Please choose any standard PET Felt color. Interior PET Felt color may be different than the outer.
- The divider perimeter reveal trim accepts privacy extensions and is made of polypropylene available only in CHR - Charcoal.
- Metal legs and stiffeners are powder coated paint. Please specify standard paint finish.
- Complete pod includes all connecting hardware, tubular legs and supporting brackets.
- Extensions, electrical, storage and accessories are specified separately.

PRODUCT CODE	PRICE	SIZE/INCHES			WEIGHT LBS	VOL FT ³
		H	W	D		
HX4PF	2971	54	72	30	117	14.10

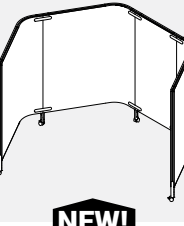
HX4PFM • Freestanding Mobile Softpod with 4 Dividers

- Complete 4 divider pod consisting of one straight back divider, and three side j-dividers.
- Installed pod measures 54"h from the floor, 25" from top of surface and has a clearance of 6 3/8" at floor level.
- Dividers are surfaced with tackable PET Felt. Please choose any standard PET Felt color. Interior PET Felt color may be different than the outer.
- The divider perimeter reveal trim accepts privacy extensions and is made of polypropylene available only in CHR - Charcoal.
- Metal legs with casters and stiffeners are powder coated paint. Please specify standard paint finish.
- Complete pod includes all connecting hardware, tubular legs, casters and supporting brackets.
- Extensions, electrical, storage and accessories are specified separately.

PRODUCT CODE	PRICE	SIZE/INCHES			WEIGHT LBS	VOL FT ³
		H	W	D		
HX4PFM	3009	54	72	30	117	14.10

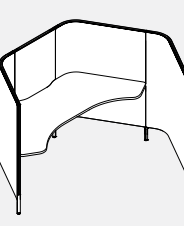
HX4P5472SW • Softpod with 4 Dividers and Worksurface

- Complete 4 divider pod consisting of one straight back divider, three side j-dividers and one standard worksurface.
- Installed pod measures 54"h from the floor, 25" from top of surface and has a clearance of 6 3/8" at floor level.
- Dividers are surfaced with tackable PET Felt. Please choose any standard PET Felt color. Interior PET Felt color may be different than the outer.
- The divider perimeter reveal trim accepts privacy extensions and is made of polypropylene available only in CHR - Charcoal.
- Surface choice of LP - low pressure or HP - high pressure laminate with PVC edge. Please choose any standard laminate and PVC edge.
- Metal legs are powder coated paint. Please specify standard paint finish.
- Complete pod includes all connecting hardware, tubular legs and supporting brackets.
- Wing divider can be installed left or right.
- Extensions, electrical, storage and accessories are specified separately.

PRODUCT CODE	PRICE		SIZE/INCHES			WEIGHT LBS	VOL FT ³
	LP	HP	H	W	D		
HX4P5472SW	3654	4036	54	72	65	170	25.41

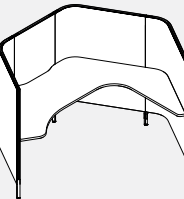
HX4P5472R/LW • Softpod with 4 Dividers and Wrap Around Worksurface

- Complete 4 divider pod consisting of one straight back divider, three side j-dividers and one standard wrap around worksurface.
- Installed pod measures 54"h from the floor, 25" from top of surface and has a clearance of 6 3/8" at floor level.
- Dividers are surfaced with tackable PET Felt. Please choose any standard PET Felt color. Interior PET Felt color may be different than the outer.
- The divider perimeter reveal trim accepts privacy extensions and is made of polypropylene available only in CHR - Charcoal.
- Surface choice of LP - low pressure or HP - high pressure laminate with PVC edge. Please choose any standard laminate and PVC edge.
- Metal legs are powder coated paint. Please specify standard paint finish.
- Complete pod includes all connecting hardware, tubular legs and supporting brackets.
- Extensions, electrical, storage and accessories are specified separately.

PRODUCT CODE	PRICE		SIZE/INCHES			WEIGHT LBS	VOL FT ³
	LP	HP	H	W	D		
HX4P5472RW	3977	4516	54	72	65	185	25.41
HX4P5472LW	3977	4516	54	72	65	185	25.41

Right Hand Shown

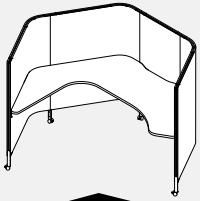
HX4PM5472R/LW • Mobile Softpod with 4 Dividers and Worksurface**NEW!**

- Complete 4 divider pod consisting of one straight back divider, three side j-dividers and one work surface.
- Installed pod measures 54"h from the floor, 25" from top of surface and has a clearance of 6 3/8" at floor level.
- Dividers are surfaced with tackable PET Felt. Please choose any standard PET Felt color. Interior PET Felt color may be different than the outer.
- The divider perimeter reveal trim accepts privacy extensions and is made of polypropylene available only in CHR - Charcoal.
- Surface choice of LP - low pressure or HP - high pressure laminate with PVC edge. Please choose any standard laminate and PVC edge.
- Metal legs with casters and stiffeners are powder coated paint. Please specify standard paint finish.
- Complete pod includes all connecting hardware, tubular legs, casters and supporting brackets.

PRODUCT CODE	PRICE		SIZE/INCHES			WEIGHT		VOL FT ³
	LP	HP	H	W	D	LBS		
HX4PM5472LW	4028	4644	54	72	65	168	25.41	
HX4PM5472RW	4028	4644	54	72	65	168	25.41	

HX5PF • Freestanding Softpod with 5 Dividers**NEW!**

- Complete 5 divider pod consisting of one straight back divider, four side j-dividers.
- Installed pod measures 54"h from the floor and has a clearance of 6 3/8" at floor level.
- Dividers are surfaced with tackable PET Felt. Please choose any standard PET Felt color. Interior PET Felt color may be different than the outer.
- The divider perimeter reveal trim accepts privacy extensions and is made of polypropylene available only in CHR - Charcoal.
- Metal legs and stiffeners are powder coated paint. Please specify standard paint finish.
- Complete pod includes all connecting hardware, tubular legs and supporting brackets.
- Extensions, electrical, storage and accessories are specified separately.

PRODUCT CODE	PRICE	SIZE/INCHES			WEIGHT		VOL FT ³
		H	W	D	LBS		
HX5PF	3767	54	72	65	148	28.24	

HX5PFM • Freestanding Mobile Softpod with 5 Dividers**NEW!**

- Complete 5 divider pod consisting of one straight back divider, four side j-dividers.
- Installed pod measures 54"h from the floor and has a clearance of 6 3/8" at floor level.
- Dividers are surfaced with tackable PET Felt. Please choose any standard PET Felt color. Interior PET Felt color may be different than the outer.
- The divider perimeter reveal trim accepts privacy extensions and is made of polypropylene available only in CHR - Charcoal.
- Metal legs with casters and stiffeners are powder coated paint. Please specify standard paint finish.
- Complete pod includes all connecting hardware, tubular legs, casters and supporting brackets.
- Extensions, electrical, storage and accessories are specified separately.

PRODUCT CODE	PRICE	SIZE/INCHES			WEIGHT		VOL FT ³
		H	W	D	LBS		
HX5PFM	3814	54	72	65	148	28.24	

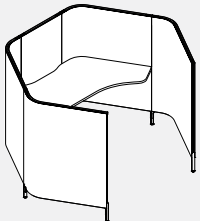
HX5P5472SW • Softpod with 5 Dividers and Worksurface**NEW!**

- Complete 5 divider pod consisting of one straight back divider, four side j-dividers and one standard work surface.
- Installed pod measures 54"h from the floor, 25" from top of surface and has a clearance of 6 3/8" at floor level.
- Dividers are surfaced with tackable PET Felt. Please choose any standard PET Felt color. Interior PET Felt color may be different than the outer.
- The divider perimeter reveal trim accepts privacy extensions and is made of polypropylene available only in CHR - Charcoal.
- Surface choice of LP - low pressure or HP - high pressure laminate with PVC edge. Please choose any standard laminate and PVC edge.
- Metal legs are powder coated paint. Please specify standard paint finish.
- Complete pod includes all connecting hardware, tubular legs and supporting brackets.
- Wing dividers can be installed both on left or right side or one on each side.
- Extensions, electrical, storage and accessories are specified separately.

PRODUCT CODE	PRICE		SIZE/INCHES			WEIGHT		VOL FT ³
	LP	HP	H	W	D	LBS		
HX5P5472SW	4462	4845	54	72	65	198	32.41	

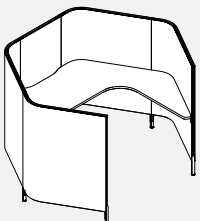
HX5P5472R/LW • Softpod with 5 Dividers and Wrap Around Worksurface

Right Hand Shown

- Complete 5 divider pod consisting of one straight back divider, four side j-dividers and one standard wrap around work surface.
- Installed pod measures 54"h from the floor, 25" from top of surface and has a clearance of 6 3/8" at floor level.
- Dividers are surfaced with tackable PET Felt. Please choose any standard PET Felt color. Interior PET Felt color may be different than the outer.
- The divider perimeter reveal trim accepts privacy extensions and is made of polypropylene available only in CHR - Charcoal.
- Surface choice of LP - low pressure or HP - high pressure laminate with PVC edge. Please choose any standard laminate and PVC edge.
- Metal legs are powder coated paint. Please specify standard paint finish.
- Complete pod includes all connecting hardware, tubular legs and supporting brackets.
- Extra wing divider can be installed on left or right side.
- Extensions, electrical, storage and accessories are specified separately.

PRODUCT CODE	PRICE		SIZE/INCHES			WEIGHT		VOL FT ³
	LP	HP	H	W	D	LBS		
HX5P5472RW	4739	5277	54	72	65	213	32.41	
HX5P5472LW	4739	5277	54	72	65	213	32.41	

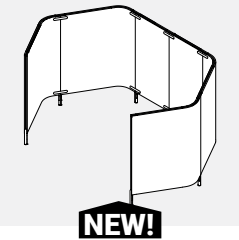
HX6PF • Freestanding Softpod with 6 Dividers**NEW!**

- Complete 6 divider pod consisting of two straight back dividers, and four side j-dividers.
- Installed pod measures 54" h from the floor and has a clearance of 6 3/8" at floor level.
- Dividers are surfaced with tackable PET Felt. Please choose any standard PET Felt color. Interior PET Felt color may be different than the outer.
- The divider perimeter reveal trim accepts privacy extensions and is made of polypropylene available only in CHR - Charcoal.
- Metal legs and stiffeners are powder coated paint. Please choose CHR - Charcoal or DWT - Designer White.
- Complete pod includes all connecting hardware, tubular legs and supporting brackets.
- Extensions, electrical, storage and accessories are specified separately.

PRODUCT CODE	PRICE	SIZE/INCHES			WEIGHT LBS	VOL FT ³
		H	W	D		
HX6PF	4559	54	96	65	171	28.24

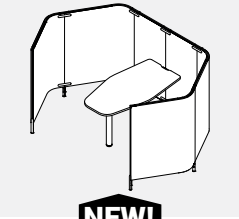
HX6PFD • Softpod with 6 Dividers with D Top Worksurface**NEW!**

- Complete 6 divider pod consisting of two straight back dividers, four side j-dividers, and one collaborative worksurface.
- Installed pod measures 54" h from the floor and has a clearance of 6 3/8" at floor level.
- Dividers are surfaced with tackable PET Felt. Please choose any standard PET Felt color. Interior PET Felt color may be different than the outer.
- The divider perimeter reveal trim accepts privacy extensions and is made of polypropylene available only in CHR - Charcoal.
- Metal legs and stiffeners are powder coated paint. Please specify standard paint finish.
- Worksurface features a scoop to pass through wires.
- Surface choice of LP - low pressure or HP - high pressure laminate with PVC edge. Please choose any standard laminate and PVC edge.
- Complete pod includes all connecting hardware, tubular legs and supporting brackets.
- Extensions, electrical, storage and accessories are specified separately.

PRODUCT CODE	PRICE		SIZE/INCHES			WEIGHT LBS	VOL FT ³
	LP	HP	H	W	D		
HX6PFD	5190	5426	54	96	65	218	30.76

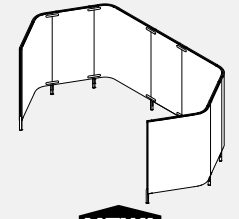
HX7PF • Freestanding Softpod with 7 Dividers**NEW!**

- Complete 7 divider pod consisting of two straight back dividers, and four side j-dividers.
- Installed pod measures 54" h from the floor and has a clearance of 6 3/8" at floor level.
- Dividers are surfaced with tackable PET Felt. Please choose any standard PET Felt color. Interior PET Felt color may be different than the outer.
- The divider perimeter reveal trim accepts privacy extensions and is made of polypropylene available only in CHR - Charcoal.
- Metal legs and stiffeners are powder coated paint. Please specify standard paint finish.
- Complete pod includes all connecting hardware, tubular legs and supporting brackets.
- Extensions, electrical, storage and accessories are specified separately.

PRODUCT CODE	PRICE	SIZE/INCHES			WEIGHT LBS	VOL FT ³
		H	W	D		
HX7PF	5127	54	119	65	194	28.24

HX7PFD • Softpod with 7 Dividers with D Top Worksurface**NEW!**

- Complete 7 divider pod consisting of two straight back dividers, four side j-dividers, and one collaborative worksurface.
- Installed pod measures 54" h from the floor and has a clearance of 6 3/8" at floor level.
- Dividers are surfaced with tackable PET Felt. Please choose any standard PET Felt color. Interior PET Felt color may be different than the outer.
- The divider perimeter reveal trim accepts privacy extensions and is made of polypropylene available only in CHR - Charcoal.
- Metal legs and stiffeners are powder coated paint. Please specify standard paint finish.
- Worksurface features a scoop to pass through wires.
- Surface choice of LP - low pressure or HP - high pressure laminate with PVC edge. Please choose any standard laminate and PVC edge.
- Complete pod includes all connecting hardware, tubular legs and supporting brackets.
- Extensions, electrical, storage and accessories are specified separately.

PRODUCT CODE	PRICE		SIZE/INCHES			WEIGHT LBS	VOL FT ³
	LP	HP	H	W	D		
HX7PFD	5889	6125	54	119	65	25	30.76

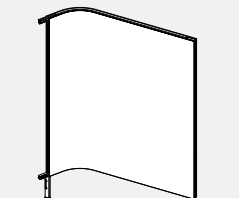
HXP5430 • Single J-divider**NEW!**

- A single divider is curved; non-handed symmetrical along the horizontal axis.
- J-dividers are surfaced with tackable PET Felt. Please choose any standard PET Felt color. Interior PET Felt color may be different than the outer.
- Installed pod measures 54" h from the floor, 25" from top of surface and has a clearance of 6 3/8" at floor level.
- The divider perimeter reveal trim accepts privacy extensions and is made of polypropylene available only in CHR - Charcoal.
- J-divider comes complete with top connector kit, shared leg kit and trim.
- If a Single J-divider is ordered as an add-on to a previous order, the PET Felt finish may or may not match based on dyelot and fading.
- Single J-divider is not intended to be used alone without a complete kit including a work surface due to stability and connectivity constraints.

PRODUCT CODE	PRICE	SIZE/INCHES			WEIGHT LBS	VOL FT ³
		H	W	D		
HXP5430AP	833	54	30	6	28	16.17

HXPCKIT • Connection Kit**NEW!**

- Kit consists of all hardware required to connect two Softpods end-to-end.
- For use in special configurations when a customer wants to link several Softpods together.

PRODUCT CODE	PRICE	SIZE/INCHES			WEIGHT LBS	VOL FT ³
		H	W	D		
HXPCKIT	29	1.81	5.00	0.86	0.18	0.004

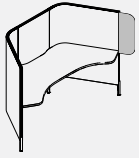
HXPAEFE • End PET Felt Extension Divider Add-on

- Designed to add 8.7" of additional privacy at the end of the divider.
- Fits into the base divider perimeter reveal and placement is user oriented.
- PET Felt divider surface is tackable. Choose from standard PET finishes.
- NOTE : Not available with a perforated pattern.

PRODUCT CODE	PRICE	SIZE/INCHES			WEIGHT LBS	VOL FT ³
		H	W	D		
HXPAEFE	40	25.4	9.3	0.35	0.63	0.05

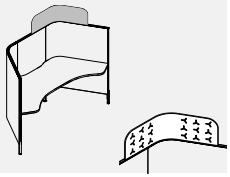
HXPACFE • Corner PET Felt Extension Divider Add-on

- Designed to add 11.1" of additional privacy at the top corner of the divider.
- Fits into the base divider perimeter reveal and placement is user oriented.
- Installed station with Corner PET Felt Extension Divider Add-on installed measures 65" from floor, 36" from top of worksurface.
- PET Felt divider surface is tackable. Choose from standard PET finishes.
- Perforated pattern option available, shown with "P" at the end of the code.

PRODUCT CODE	PRICE	SIZE/INCHES			WEIGHT LBS	VOL FT ³
		H	W	D		
HXPACFE	71	11.687	38.3	0.35	1.16	0.09
HXPACFEP	142	11.687	38.3	0.35	1.16	0.09

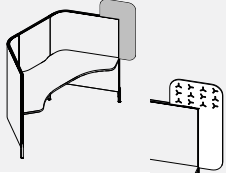
HXPATCFE • Top Corner PET Felt Extension Divider Add-on

- Designed to add 8.7" of additional privacy to the top of the divider and 11.1" at the end of the divider.
- Fits into the base divider perimeter reveal and placement is user oriented.
- Installed station with Corner PET Felt Extension Divider Add-on installed measures 65" from floor, 36" from top of worksurface.
- PET Felt divider surface is tackable. Choose from standard PET finishes.
- Perforated pattern option available, shown with "P" at the end of the code.

PRODUCT CODE	PRICE	SIZE/INCHES			WEIGHT LBS	VOL FT ³
		H	W	D		
HXPATCFE	77	37.1	19.5	0.35	1.25	0.15
HXPATCFEP	154	37.1	19.5	0.35	1.25	0.15

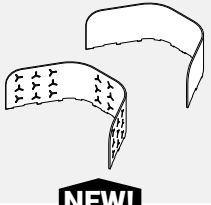
HXPA1CFE • PET Felt Extension Divider Add-on for Softpod with 2 Dividers**NEW!**

- Designed to add 11.1" of additional privacy at the top of the divider assembly.
- Fits into the base divider perimeter reveal and placement is user oriented.
- Installed station with PET Felt Extension Divider Add-on installed measures 65" from floor, 36" from top of worksurface.
- PET Felt divider surface is tackable. Choose from standard PET finishes.
- Perforated option available, shown with "P" at the end of the code.

PRODUCT CODE	PRICE	SIZE/INCHES			WEIGHT LBS	VOL FT ³
		H	W	D		
HXPA1CFE	132	11.687	55.51	0.35	2.30	0.13
HXPA1CFEP	265	11.687	55.51	0.35	2.30	0.13

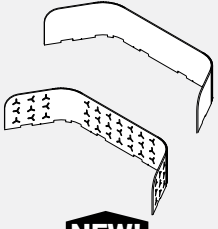
HXPA2CFE • PET Felt Extension Divider Add-on for Softpod with 3 Dividers**NEW!**

- Designed to add 11.1" of additional privacy at the top of the divider assembly.
- Fits into the base divider perimeter reveal and placement is user oriented.
- Installed station with PET Felt Extension Divider Add-on installed measures 65" from floor, 36" from top of worksurface.
- PET Felt divider surface is tackable. Choose from standard PET finishes.
- Perforated option available, shown with "P" at the end of the code.

PRODUCT CODE	PRICE	SIZE/INCHES			WEIGHT LBS	VOL FT ³
		H	W	D		
HXPA2CFE	150	11.687	78.28	0.35	2.60	0.19
HXPA2CFEP	300	11.687	78.28	0.35	2.60	0.19

HXPACFES • Corner Semitransparent Extension Panel Add-on**NEW!**

- Designed to add 11" of additional privacy on top of the height adjustable worksurface.
- Fits into the base divider perimeter reveal and placement is user oriented.
- Installed station with Extension Divider Add-on installed measures 65" from floor, 36" from top of worksurface.
- Divider is frosted for added privacy.
- Choose from 3 colours: TNC - Translucent, TNB - Blue, TNY - Yellow.

PRODUCT CODE	PRICE	SIZE/INCHES			WEIGHT LBS	VOL FT ³
		H	W	D		
HXPACFES	723	11.687	29.50	16.8	1.11	3.35

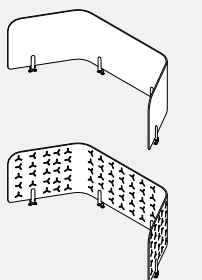
HXPACFEHP • PET Felt Extension Panel Add-on for Softpod Height Adjustable Table**NEW!**

- Designed to add 20" of additional privacy on top of the height adjustable worksurface.
- Aluminum mounting brackets fasten to underside of worksurface.
- Curved PET fits into aluminum mounting brackets.
- Installed station with PET Privacy Screen Add-on installed measures 69" from floor at maximum height, 20" from top of worksurface.
- PET Felt privacy screen surface is tackable. Choose from standard PET finishes.
- Perforated option available, shown with "P" at the end of the code.

PRODUCT CODE	PRICE	SIZE/INCHES			WEIGHT LBS	VOL FT ³
		H	W	D		
HXPACFEH	303	19	63.50	21.70	1.65	5.94
HXPACFEHP	607	19	63.50	21.70	1.65	5.94

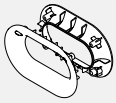
HXEPGK • Divider Grommet Kit

- Divider Grommet Kit facilitates passage of wires through any Softpod divider.
- Can be located either below or above the worksurface.
- Installed on site; no need to order special dividers.
- Powder coated die-cast aluminum divider grommet - specify CHR - Charcoal or WHT (OR DWT)

PRODUCT CODE	PRICE	SIZE/INCHES			WEIGHT LBS	VOL FT ³
		H	W	D		
HXEPGK	29	3.25	5.50	2.75	0.27	0.02

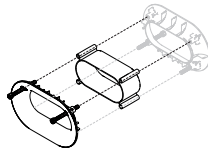
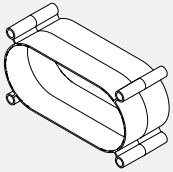
HXEPGCS • Divider Grommet Connector / Spacer

- Divider Grommet Spacer converts any Divider Grommet Kit into a connector.
- Clamps two dividers together through the divider grommet opening.
- Can be located above or below the worksurface at pre-determined locations.
- Specify with the Divider Grommet Kit or use with the Divider Grommet Kit included in the Station 2-Circuit Power Kit.
- Made of injection molded ABS in CHR - Charcoal.
- For Dual Pod connection, only 1 HXEPGK is needed.

PRODUCT CODE	PRICE	SIZE/INCHES			WEIGHT LBS	VOL FT ³
		H	W	D		
HXEPGCS	13	3.25	5.50	2.75	0.04	0.01

GMDPC22W • Slim Desktop Power Module, 2 Simplex

- Desktop power center with two 15A tamper resistant power receptacles, one USB-A and one USB-C (provides 3.1A); 10' power cord.
- Includes three mounting options (i) a screw-in mounting plate for forward facing outlets; or (ii) an under surface mount bracket; or (iii) a clamp mounting kit for 0.5-1.5" thick surfaces.
- Gloss white body with grey face.

PRODUCT CODE	PRICE	SIZE/INCHES			WEIGHT LBS	VOL FT ³
		H	W	D		
GMDPC22W	449	2.25	4.88	2.25	2.5	0.5

GMDPC32W • Slim Desktop Power Module, 3 Simplex

- Desktop power center with three 15A tamper resistant power receptacles, one USB-A and one USB-C (provides 3.1A); 10' power cord.
- Includes three mounting options (i) a screw-in mounting plate for forward facing outlets; or (ii) an under surface mount bracket; or (iii) a clamp mounting kit for 0.5-1.5" thick surfaces.
- Gloss white body with grey face.

PRODUCT CODE	PRICE	SIZE/INCHES			WEIGHT LBS	VOL FT ³
		H	W	D		
GMDPC32W	586	2.25	6.00	2.25	2.6	0.5

BRED50AC • Duo Module with A+C

- **The Duo power module is completely integrated with a mounting clamp to attach to the edge of a worksurface.**
- Provides two 15 Amp 120 Volt AC Receptacles; 2.4 amp USB-A port and 60 watt USB-C power delivery port.
- 10' long three-prong cord.
- Available in W - White or B - Black as indicated by last letter of model number.

PRODUCT CODE	PRICE	SIZE/INCHES			WEIGHT LBS	VOL FT ³
		H	W	D		
BRED50ACW	695	3	5.5	3.2	3	0.2
BRED50ACB	695	3	5.5	3.2	3	0.2

BREDU51AC • Duo Under Module with A+C

- **The Duo under power module comes with a thin flush mounting bracket to attach to the underside of a work surface or above work surface shelves.**
- Provides two 15 Amp 120 Volt AC Receptacles; 2.4 amp USB-A port and 60 watt USB-C power delivery port.
- 10' long three-prong cord.
- Available in W - White or B - Black as indicated by last letter of model number.

PRODUCT CODE	PRICE	SIZE/INCHES			WEIGHT LBS	VOL FT ³
		H	W	D		
BREDU51ACW	695	1.8	5.5	2.8	3	0.2
BREDU51ACB	695	1.8	5.5	2.8	3	0.2

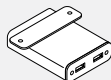
HXEUWC • Under Worksurface/ Edge USB Charger

- Under surface table mounted module - dual USB (A&C) charging ports.
- Consists of one 15 watt USB C charging outlet and one 2.1 amp USB A charging outlet.
- Unit has white housing, white powder coated mounting bracket and white electrical cord.

PRODUCT CODE	PRICE	SIZE/INCHES			WEIGHT LBS	VOL FT ³
		H	W	D		
HXEUWC	367	1	3	4	0.31	0.01

GAADG • Access Door Module

- Soft close door is set back from edge to allow for cable pass thru.
- Available in all standard divider frame finishes.
- GAADGDH includes device holder for most mobilephones or tablets. Holder is only available in white.
- FreeFit can only accommodate one grommet per worksurface.

PRODUCT CODE	PRICE	SIZE/INCHES			WEIGHT LBS	VOL FT ³
		H	D	W		
GAADG	60	1.08	5.54	10.09	2	0.04
GAADGDH	65	1.08	5.54	10.09	2	0.04

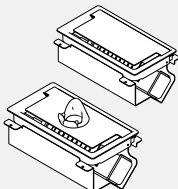
GAADCT • Access Door Module with Cable Tray

- Soft close door is set back from edge to allow for cable pass thru when closed.
- Cable tray comes one standard telcom knock out and a platform to mount a powerbar.
- Sides are open for easy access.
- Available in all standard divider frame finishes.
- GAADCTDH includes device holder for most mobile phones or tablets. Holder is only available in white.
- FreeFit can only accommodate one grommet per worksurface

PRODUCT CODE	PRICE	SIZE/INCHES			WEIGHT LBS	VOL FT ³
		H	D	W		
GAADCT	95	5.07	5.54	10.09	4	0.19
GAADCTDH	103	5.07	5.54	10.09	4	0.19

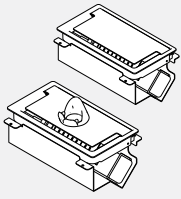
GAADCTPD • Access Door Module with Cable Tray and Power Bar

- Access door module with cable tray and power bar.
- Powerbar with 3 simplex and 2 USB, CSA Certified.
- Soft close door is set back from edge to allow for cable pass thru when closed.
- Sides are open for easy access.
- Cable tray comes one standard telcom knock out and a platform to mount a powerbar.
- Housing Paint Finish - TBD
- GAADCTPDDH includes device holder for most mobile phones or tablets.
- Holder is only available in white.
- One grommet per worksurface.

PRODUCT CODE	PRICE	SIZE/INCHES			WEIGHT LBS	VOL FT ³
		H	D	W		
GAADCTPD	208	6.96	5.54	10.09	4	0.20
GAADCTPDDH	212	6.96	5.54	10.09	4	0.20

ModPower Daisy Chain Solution

- Adds flexible power and USB charging to work surfaces.
- Connects up to four units with a single corded infeed with NEMA plug.
- Begin the run with a starter unit which includes a coded infeed. Add additional middle or end units as required.
- Middle and end units are equipped with connecting cables.
- In-surface modules require table top cut-outs for mounting. Please specify TR - Top Right and/or TL - Top Left.
- ModPower units are sold separately.

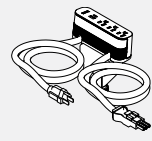
GMDSA10 • ModPower Starter Mounted Unit

- ModPower starter unit includes one 10' cord with a NEMA plug and one 3' connector cord.
- Unit equipped with three 15A tamper resistant receptacles, one USB-A and one USB-C charging ports and a circuit breaker.
- Includes edge clamp and 3 other mounting methods; and 4 cable management cord clips.
- MG at the end of the code indicates a magnesium finish, while WH is a white finish.

PRODUCT CODE	PRICE	H	W	D	WEIGHT LBS	VOL FT ³
GMDSA10WH	631	6.13	1.75	2.5	4.33	1.0

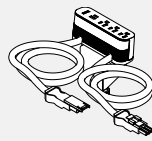
GMDCA3 • ModPower Middle Mounted Unit

- ModPower middle unit includes two 3' connector cords.
- Unit equipped with three 15A rated 12A tamper resistant receptacles, one USB-A and one USB-C charging ports and a circuit breaker.
- Includes edge clamp and 3 other mounting methods; and 4 cable management cord clips.
- MG at the end of the code indicates a magnesium finish, while WH is a white finish.

PRODUCT CODE	PRICE	H	W	D	WEIGHT LBS	VOL FT ³
GMDCA3WH	597	6.13	1.75	2.5	3.33	1.0

GMDEA3 • ModPower End Mounted Unit

- ModPower end unit includes one 3' connector cord.
- Unit equipped with three 15A rated 12A tamper resistant receptacles, one USB-A and one USB-C charging ports and a circuit breaker.
- Includes edge clamp and 3 other mounting methods; and 2 cable management cord clips.
- MG at the end of the code indicates a magnesium finish, while WH is a white finish.

PRODUCT CODE	PRICE	H	W	D	WEIGHT LBS	VOL FT ³
GMDEA3WH	528	6.13	1.75	2.5	2.75	1.0

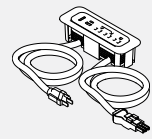
GMDSF10 • ModPower In Surface Starter Unit

- ModPower starter unit includes one 10' cord with a NEMA plug and one 3' connector cord.
- Unit equipped with three 15A tamper resistant receptacles, one USB-A and one USB-C charging ports and a circuit breaker.
- 4 cable management cord clips included.
- MG at the end of the code indicates a magnesium finish, while WH is a white finish.

PRODUCT CODE	PRICE	H	W	D	WEIGHT LBS	VOL FT ³
GMDSF10WH	597	2.63	7.63	2.63	3.44	1.0

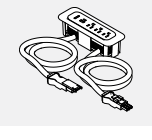
GMDCF3 • ModPower In Surface Middle Unit

- ModPower middle unit includes two 3' connector cords.
- Unit equipped with three 15A rated 12A tamper resistant receptacles, one USB-A and one USB-C charging ports and a circuit breaker.
- 4 cable management cord clips included.
- MG at the end of the code indicates a magnesium finish, while WH is a white finish.

PRODUCT CODE	PRICE	H	W	D	WEIGHT LBS	VOL FT ³
GMDCF3WH	562	2.63	7.63	2.63	2.44	1.0

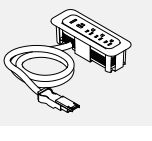
GMDEF3 • ModPower In Surface End Unit

- ModPower end unit includes one 3' connector cord.
- Unit equipped with three 15A rated 12A tamper resistant receptacles, one USB-A and one USB-C charging ports and a circuit breaker.
- 2 cable management cord clips included.
- MG at the end of the code indicates a magnesium finish, while WH is a white finish.

PRODUCT CODE	PRICE	H	W	D	WEIGHT LBS	VOL FT ³
GMDEF3WH	494	2.63	7.63	2.63	1.85	1.0

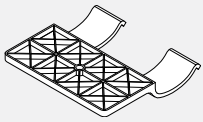
GMDCLIPS • ModPower Management Clips

- Includes 10 clips.

PRODUCT CODE	PRICE	SIZE/INCHES			WEIGHT LBS	VOL FT ³
		H	W	D		
GMDCLIPS	102	2.6	2.5	0.6	0.3	0.2

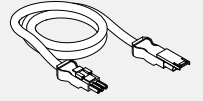
GMDJ36BK • ModPower Interconnecting Jumper

- ModPower interconnecting jumper cord to add an additional 3 feet of cord length between ModPower units.
- Package of 2, each 3 feet with male & female connector.

PRODUCT CODE	PRICE	SIZE/INCHES			WEIGHT LBS	VOL FT ³
		H	W	D		
GMDJ36BK	329	36			1.38	0.9

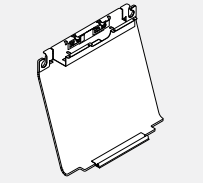
HXEPK • Station 2-Circuit Power Kit

- Station 2-Circuit Power Kit consists of two duplexes, trough, cable shroud and divider grommet.
- Accommodates up to two standard data plates (plates not included).
- Accommodates center mount single or dual screen monitor arm.
- Facilitates 2-circuit power delivery.
- Facilitates interconnection of two stations. Please specify Station to Station Jumper.
- Specify duplex circuit #1, #2 or combination #1+2.
- Ceiling or base feed not included, please specify separately.
- Trough is powder coated metal in CHR - Charcoal.
- Includes all connecting hardware, supporting brackets and through divider grommet.
- PET Felt finish, please chose from any standard PET Felt.
- NOTE: Cannot be used in conjunction with height adjustable tables.

PRODUCT CODE	PRICE	SIZE/INCHES			WEIGHT LBS	VOL FT ³
		H	W	D		
HXEPK11	311	20.85	23.5	9.73	3.92	2.76
HXEPK12	311	20.85	23.5	9.73	3.92	2.76
HXEPK22	311	20.85	23.5	9.73	3.92	2.76

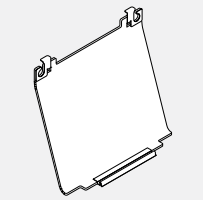
HXECS • Cable Shroud

- Cable shroud secures to the bottom of worksurface and clips to the bottom of straight section of any divider.
- Includes all connecting hardware.
- PET Felt finish, please chose from any standard PET Felt.
- NOTE: Cannot be used in conjunction with height adjustable tables.

PRODUCT CODE	PRICE	SIZE/INCHES			WEIGHT LBS	VOL FT ³
		H	W	D		
HXECS	76	1	22	8	1.62	2.87

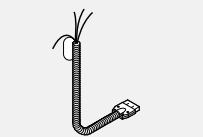
HXECEF • Ceiling Feed

- Ceiling feed plugs into left or right duplex mounted within the 2-Circuit Power Kit.
- 10' long metal conduit, ready to be hardwired to building power supply.
- Strain relief fitting provided; junction box is not included.
- To be used with HXEFCF - Ceiling Feed Pole

PRODUCT CODE	PRICE	SIZE/INCHES			WEIGHT LBS	VOL FT ³
		H	W	D		
HXECEF	178	2.00	144	2.00	5.6	0.06

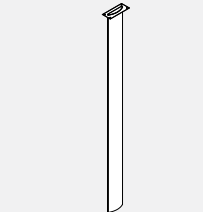
HXEFCF • Ceiling Feed Pole

- Ceiling Feed Pole manages power and data cables between ceiling and worksurface.
- Aluminum extrusion with PVC cover secures to the divider grommet and passes below worksurface through the worksurface contured recess.
- Mounting hardware and ceiling bezel included.
- Hardware for securing the pole above ceiling tile is not included.
- Please specify standard paint finish.
- PVC colour CHR - Charcoal.
- Ceiling Feed HXECEF must be ordered separately.

PRODUCT CODE	PRICE	SIZE/INCHES			WEIGHT LBS	VOL FT ³
		H	W	D		
HXEFCF	150	116	6.00	1.50	5.49	0.38

HXEBF • Base Feed

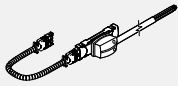

- Base feed provides single power entry from floor into 2-Circuit Power Kit under worksurface.
- 6' long liquid tight whip; ready to be hardwired to building power supply.

PRODUCT CODE	PRICE	SIZE/INCHES			WEIGHT LBS	VOL FT ³
		H	W	D		
HXEBF	354	2	72	2	5.6	0.06

HXEHAP • Height Adjustable Power Kit

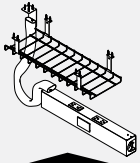

NEW!

- Height Adjustable Circuit Power Kit consists of two duplexes, cable basket, and electrical housing.
- Accommodates one standard data plate (data cover included).
- Facilitates 2-circuit power delivery.
- Specify duplex circuit #1, #2, or combination #1+2.
- Facilitates interconnection of two stations. Please specify Station to Station Jumper.
- Ceiling or base feed not included please specify separately.
- Includes all connecting hardware & supporting brackets.
- Specify standard metal paint finish for the power box.

PRODUCT CODE	PRICE	SIZE/INCHES			WEIGHT LBS	VOL FT ³
		H	W	D		
HXEHAP	563	21.50	22	8.06	4.55	1.00
HXEHAP12	563	21.50	22	8.06	4.55	1.00
HXEHAP22	563	21.50	22	8.06	4.55	1.00

HXEPPJ • Station to Station Jumper Kit

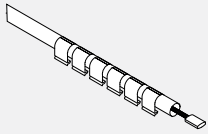

NEW!

- Station to station jumper.
- Facilitates interconnection of two stations (under the worksurface).
- Black neoprene sock of equal length included.
- Mounting clips included (quantity based on length).
- NOTE: Refer to Application Guide for recommended length of jumper kit required.

PRODUCT CODE	PRICE	H	W	D	WEIGHT	
					LBS	FT ³
HXEPPJ18	131	2	18.50	2	0.68	0.04
HXEPPJ24	145	2	24.50	2	0.79	0.06
HXEPPJ30	165	2	30.50	2	0.85	0.07
HXEPPJ36	180	2	36.50	2	1.02	0.08
HXEPPJ48	238	2	48.50	2	1.24	0.11
HXEPPJ60	263	2	60.50	2	1.46	0.14
HXEPPJ72	285	2	72.50	2	1.68	0.17
HXEPPJ78	287	2	78.50	2	1.79	0.18

HXSCSO • Under Worksurface Casual Storage Unit

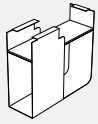

- Open storage with shelf; extension at the back provides side compartment.
- Sheet metal construction with PET liner; 24" deep
- Secured to the bottom of worksurface.
- Choose from standard PET and panel frame finishes.
- Order coat hook HXACHS, attaches to either left or right side of storage unit (sold separately).
- Can not be installed on height adjustable Softpod or two divider pods with surfaces.

PRODUCT CODE	PRICE	SIZE/INCHES			WEIGHT LBS	VOL FT ³
		H	W	D		
HXSCSO	327	21	8	24	20	4.22

HXSCSOL/R • Under Worksurface Lockable Casual Storage Unit

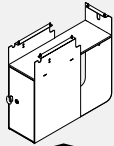

NEW!

- Open storage with shelf, extension at the back provides side compartment.
- Sheet metal construction with PET liner, 24" deep.
- Secured to the bottom of worksurface.
- Choose from standard PET and panel frame finishes.
- Order coat hook HXACHS, attaches to either left or right side of storage unit (sold separately).
- Lockable Cabinet with key - laminate with PVC edge. Please choose any standard laminate and PVC edge.
- Can not be installed on height adjustable Softpod or two divider pods with surfaces.

PRODUCT CODE	PRICE	SIZE/INCHES			WEIGHT LBS	VOL FT ³
		H	W	D		
HXSCSOL	783	21	8	24	37	4.22
HXCSOR	783	21	8	24	37	4.22

L2PO • Pantry Storage

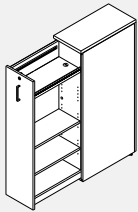

Left Hand Shown

- The pull out cabinet serves as a multifunction, customizable storage unit that both defines space and enhances privacy in an open plan environment.
- Can be used in conjunction with Licence, Bridges, FreeFit and Boulevard.
- Internal organization consists of two fixed shelves top and bottom. The two middle shelves are adjustable. Two accessory rails are standard and will accept GC metal accessories
- Interior cabinet shelves and back are standard in Designer White. Cabinet shell, drawer and top can be specified in any standard laminate.
- L2PO12-NL/R does not fit binders.
- Only available with FA handle.

PRODUCT CODE	PRICE LP	SIZE/INCHES						WEIGHT LBS	VOL FT ³
		B	W	H(LP/B)	H(W)	W	D		
L2PO1224H54NL	1691	1709	1741	53.56	54	12	24	138	9
L2PO1230H54NL	1772	1792	1813	53.56	54	12	30	153	11
L2PO1236H54NL	1853	1878	1904	53.56	54	12	36	167	14
L2PO1824H54NL	1961	1986	2029	53.56	54	18	24	166	14
L2PO1830H54NL	2049	2081	2131	53.56	54	18	30	182	17
L2PO1836H54NL	2137	2173	2233	53.56	54	18	36	197	20
L2PO1224H54NR	1691	1709	1741	53.56	54	12	24	138	9
L2PO1230H54NR	1772	1792	1813	53.56	54	12	30	153	11
L2PO1236H54NR	1853	1878	1904	53.56	54	12	36	167	14
L2PO1824H54NR	1961	1986	2029	53.56	54	18	24	166	14
L2PO1830H54NR	2049	2081	2131	53.56	54	18	30	182	17
L2PO1836H54NR	2137	2173	2233	53.56	54	18	36	197	20

Finish

While the Pantry Storage cabinet walls, top and pull-out drawer front door and back panel finish can be specified, the internal cabinet back and adjustable shelves are standard white. Please specify the cabinet top and pull-out drawer front finish.

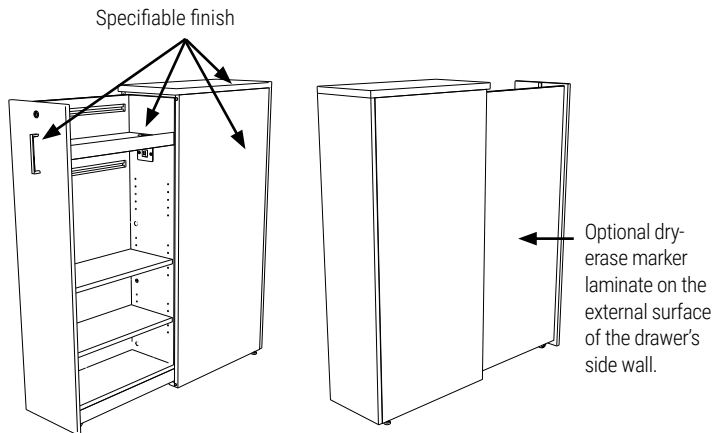

Options

- Dual USB A+C outlet kit - please add "USB" at the end of the code. Add \$388 to the list price
- When you specify dual USB outlet the top shelf will come with grey PET Felt surface and grommet which allows for cable passage from the USB outlet (located below the top shelf). A two-prong power cord exits the cabinet through the floor at the back.
- Dry-erase marker board - Choose "DE" option. Please add \$372 to the list price. If specified the Dry-erase marker laminate will be applied to the external surface of the pull-out drawer side wall.

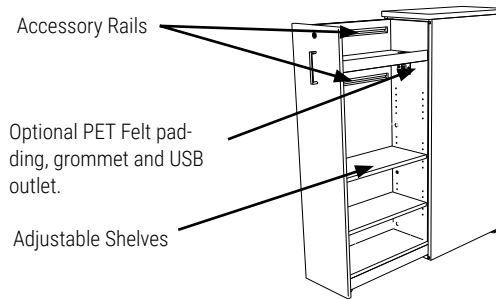

Integrated Accessory rails

Two accessory rails (each 18.25" long) are provided to further enhance customization with Global Contract metal accessories.

Upper Accessory Rail:

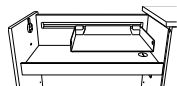

1x BALTO1 or BALTO1GL Letter Ttray

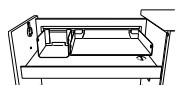

1x BALTO1 Letter Ttray
1x BAMBO1 Media Bin

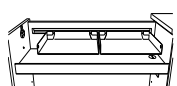

2x BAUTO1 Utility Ttray

Lower Accessory Rail:

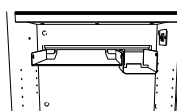

1x BALTO1 Letter Ttray
1x BAMBO1 Media Bin

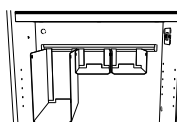

3x BABBO1 Media Bin or 3x BAMBO1 Binder Bin

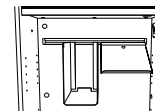

1x BATHO1 Telephone Holder
1x BABBO1 Binder Bin

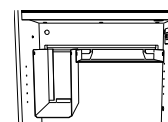

1x BALTO1 Letter Ttray
1x BABBO1 Binder Bin

L2PW • Wardrobe Pantry Storage

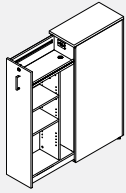

Left Hand Shown

- The pull out cabinet serves as a multifunction, customizable storage unit that both defines space and enhances privacy in an open plan environment.
- Can be used in conjunction with Licence,, FreeFit and Boulevard.
- Internal organization consists of one fixed shelf at the top. The two middle shelves are adjustable. Wardrobe includes coat hook.
- Interior cabinet shelves and back are standard in Designer White. Cabinet shell, drawer and top can be specified in any standard laminate.
- L2PW12-NL/R does not fit binders.
- Only available with FA handle.

Finish

While the Pantry Storage cabinet walls, top and pull-out drawer front door and back panel finish can be specified, the internal cabinet back and adjustable shelves are standard white. Please specify the cabinet top and pull-out drawer front finish.

Options

- Dual USB A+C outlet kit - please add "USB" at the end of the code. Add \$388 to the list price
- When you specify dual USB outlet the top shelf will come with grey felt surface and grommet which allows for cable passage from the USB outlet (located below the top shelf). A two-prong power cord exits the cabinet through the floor at the back.
- Dry-erase marker board - Choose "DE" option. Please add \$372 to the list price. If specified the Dry-erase marker laminate will be applied to the external surface of the pull-out drawer side wall.

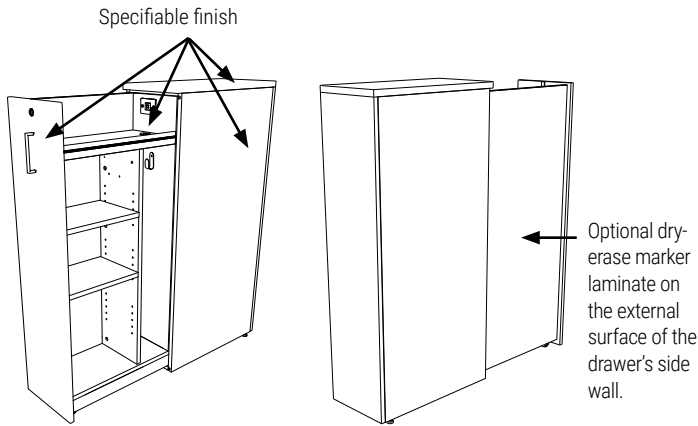

PRODUCT CODE	PRICE LP	SIZE/INCHES				WEIGHT LBS	VOL FT ³		
		B	W	H(LP/B)	H(W)				
L2PW1224H42NL	1680	1698	1735	41.56	42	12	24	128	7
L2PW1230H42NL	1757	1780	1822	41.56	42	12	30	143	9
L2PW1236H42NL	1832	1860	1911	41.56	42	12	36	157	11
L2PW1824H42NL	1946	1975	2022	41.56	42	18	24	156	11
L2PW1830H42NL	2031	2066	2124	41.56	42	18	30	172	13
L2PW1836H42NL	2116	2158	2225	41.56	42	18	36	187	16
L2PW1224NL	1831	1848	1880	49.56	50	12	24	133	8
L2PW1230NL	1912	1945	1971	49.56	50	12	30	148	10
L2PW1236NL	1993	2040	2064	49.56	50	12	36	162	15
L2PW1824NL	2140	2173	2207	49.56	50	18	24	161	12
L2PW1830NL	2227	2281	2310	49.56	50	18	30	177	15
L2PW1836NL	2315	2388	2412	49.56	50	18	36	192	18
L2PW1224H54NL	1866	1884	1916	53.56	54	12	24	138	9
L2PW1230H54NL	1947	1967	1988	53.56	54	12	30	153	11
L2PW1236H54NL	2028	2053	2080	53.56	54	12	36	167	14
L2PW1824H54NL	2182	2206	2250	53.56	54	18	24	166	14
L2PW1830H54NL	2269	2301	2351	53.56	54	18	30	182	17
L2PW1836H54NL	2358	2394	2453	53.56	54	18	36	197	20
L2PW1224H42NR	1680	1698	1735	41.56	42	12	24	128	7
L2PW1230H42NR	1757	1780	1822	41.56	42	12	30	143	9
L2PW1236H42NR	1832	1860	1911	41.56	42	12	36	157	11
L2PW1824H42NR	1946	1975	2022	41.56	42	18	24	156	11
L2PW1830H42NR	2031	2066	2124	41.56	42	18	30	172	13
L2PW1836H42NR	2116	2158	2225	41.56	42	18	36	187	16
L2PW1224NR	1831	1848	1880	49.56	50	12	24	133	8
L2PW1230NR	1912	1945	1971	49.56	50	12	30	148	10
L2PW1236NR	1993	2040	2064	49.56	50	12	36	162	15
L2PW1824NR	2140	2173	2207	49.56	50	18	24	161	12
L2PW1830NR	2227	2281	2310	49.56	50	18	30	177	15
L2PW1836NR	2315	2388	2412	49.56	50	18	36	192	18
L2PW1224H54NR	1866	1884	1916	53.56	54	12	24	138	9
L2PW1230H54NR	1947	1967	1988	53.56	54	12	30	153	11
L2PW1236H54NR	2028	2053	2080	53.56	54	12	36	167	14
L2PW1824H54NR	2182	2206	2250	53.56	54	18	24	166	14
L2PW1830H54NR	2269	2301	2351	53.56	54	18	30	182	17
L2PW1836H54NR	2358	2394	2453	53.56	54	18	36	197	20

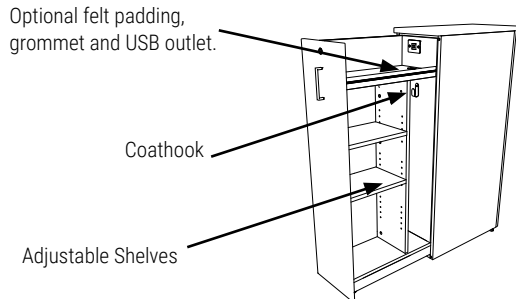

L2PSB • Pantry Felt Storage Bin

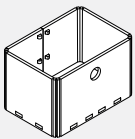

- Crafted from recycled PET felt, felt bins are an intuitive and versatile organization solution within your Pantry unit.
- Felt is 9mm, please choose from our 18 difference finishes.

PRODUCT CODE	PRICE	H	W	D	WEIGHT LBS	VOL FT ³

L2PST • Pantry Felt Storage Tray

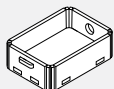

- Crafted from recycled PET felt, felt bins are an intuitive and versatile organization solution within your Pantry unit.
- Felt is 9mm, please choose from our 18 difference finishes.

PRODUCT CODE	PRICE	H	W	D	WEIGHT LBS	VOL FT ³

BLVELEDVS • LED Single Arm Lamp

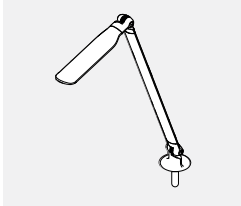

- **7 System watts, 18-fractional LEDs.**
- 3500K 250 lumens, 84 CRI.
- Soft touch - instant on, fade to off.
- Infinite dimming 100% down to 15%, last state memory.
- Standard 10 hours turn off (ATO).
- 50,000 hour life LEDs.
- 15 watt, 24 volt wall transformer, 6' cord.
- White (WHT) Silver (SIL) or Black (BLK) - Must specify colour choice.
- UL, CUL and CSA compliant, ETL Listed.
- Base not included.

PRODUCT CODE	PRICE	SIZE/ H	INCHES W	D	WEIGHT LBS	VOL FT ³
BLVELEDVS	616				3	0.93
With Occupancy Sensor						
BLVELEDVSO	920				3	0.93

BLVELEDVD • LED Double Arm Lamp

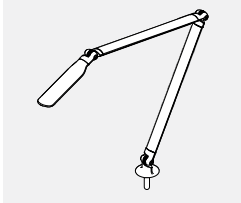

- **7 System watts, 18-fractional LEDs.**
- 3500K 250 lumens, 84 CRI.
- Double arm articulation with 20" base to head reaches.
- Soft touch - instant on, fade to off.
- Infinite dimming 100% down to 15%, last state memory.
- Standard 10 hours turn off (ATO).
- 50,000 hour life LEDs.
- 15 watt, 24 volt wall transformer, 6' cord.
- White (WHT) Silver (SIL) or Black (BLK) - Must specify colour choice.
- UL, CUL and CSA compliant, ETL Listed.
- Base not included.

PRODUCT CODE	PRICE	SIZE/ H	INCHES W	D	WEIGHT LBS	VOL FT ³
BLVELEDVD	646				3	0.93
With Occupancy Sensor						
BLVELEDVDO	931				3	0.93

BLVELEDRS • LED Single Arm Lamp

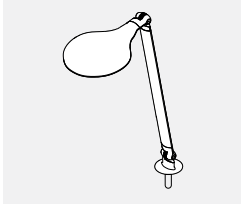

- **7 System watts, 18-fractional LEDs.**
- 3500K 250 lumens, 84 CRI.
- Soft touch - instant on, fade to off.
- Infinite dimming 100% down to 15%, last state memory.
- Standard 10 hours turn off (ATO).
- 50,000 hour life LEDs.
- 15 watt, 24 volt wall transformer, 6' cord.
- White (WHT) Silver (SIL) or Black (BLK) - Must specify colour choice.
- UL, CUL and CSA compliant, ETL Listed.
- Base not included.

PRODUCT CODE	PRICE	SIZE/ H	INCHES W	D	WEIGHT LBS	VOL FT ³
BLVELEDRS	616				3	0.93
With Occupancy Sensor						
BLVELEDRSO	920				3	0.93

BLVELEDRD • LED Double Arm Lamp

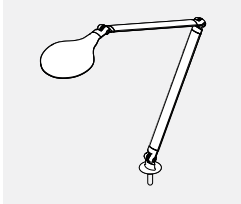

- **7 System watts, 18-fractional LEDs.**
- 3500K 250 lumens, 84 CRI.
- Double arm articulation with 20" base to head reaches.
- Soft touch - instant on, fade to off.
- Infinite dimming 100% down to 15%, last state memory.
- Standard 10 hours turn off (ATO).
- 50,000 hour life LEDs.
- 15 watt, 24 volt wall transformer, 6' cord.
- White (WHT) Silver (SIL) or Black (BLK) - Must specify colour choice.
- UL, CUL and CSA compliant, ETL Listed.
- Base not included.

PRODUCT CODE	PRICE	SIZE/ H	INCHES W	D	WEIGHT LBS	VOL FT ³
BLVELEDRD	633				3	0.93
With Occupancy Sensor						
BLVELEDRDO	931				3	0.93

Lamp Mounting Options

- White (WHT) Silver (SIL) or Black (BLK) - Must specify colour choice.



Worksurface Clamp Mount						
PRODUCT CODE	PRICE	SIZE/ H	INCHES W	D	WEIGHT LBS	VOL FT ³
BLVELEDASCM	155				1	0.05

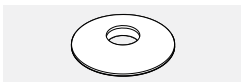

Freestanding Base						
PRODUCT CODE	PRICE	SIZE/ H	INCHES W	D	WEIGHT LBS	VOL FT ³
BLVELEDAFS	173				3	0.5

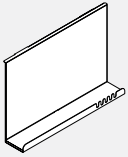
HXAHS • Hanging Shelf

- Hanging Shelf for personal item storage.
- Suspended from the divider's top reveal.
- Installed board measures 16" from top; 9" from top of worksurface.
- Painted metal, choose from standard panel frame finishes.
- Choose a PET Felt finish for the tray insert.
- Must be located away from the stiffeners on freestanding pods.

PRODUCT CODE	PRICE			WEIGHT		VOL FT ³
	H	W	D	LBS		
HXAHS	104	16	23.5	3	8.8	1.91

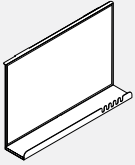
HXAHSWB • Hanging Shelf with Dry Erase Board

- Hanging shelf with, dry-erase marker surface.
- Suspended from the divider's top reveal.
- Installed board measures 16" from top; 9" from top of worksurface.
- White surface, painted metal frame; choose from standard panel frame finishes.
- Choose a PET Felt finish for the tray insert.
- Must be located away from the stiffeners on freestanding pods.

PRODUCT CODE	PRICE			WEIGHT		VOL FT ³
	H	W	D	LBS		
HXAHSWB	398	16	23.5	3	9.57	1.91

HXARWS • Rear Wall Shelf

- Rear wall laminate shelf.
- Made of 3/4" LP- low pressure or HP - high pressure; non-handed, with pre-determined mounting points.
- 2.5" front radii.
- Choose from standard laminate finishes, PVC edge.
- NOTE: Not compatible with Ceiling Feed Pole or any monitor mounts.

PRODUCT CODE	PRICE		WEIGHT			VOL FT ³	
	LP	HP	H	W	D		
HXARWS	106	135	0.75	32.25	4.5	2.80	1.13

HXACHS • Coat/Bag Hook for Dividers

- Coat/Bag Hook can be installed anywhere along the divider perimeter reveal or either side of the Under Surface Casual Storage Unit.
- Made of die-cast aluminum, specify any standard metal paint finish.
- Choose a PET Felt finish for the plug insert.

PRODUCT CODE	PRICE			WEIGHT		VOL FT ³
	H	W	D	LBS		
HXACHS	30	2	1.25	0.75	0.05	0.01

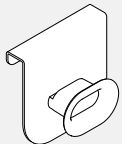
HXACHT • Coat/Bag Hook for Dividers Edge

- Coat/Bag Hook can be installed anywhere along the divider perimeter reveal or either or both sides of any divider.
- Made of die-cast aluminum with steel brackets, specify any standard metal paint finish.
- Choose a PET Felt finish for the plug insert.
- Must be located away from the stiffeners on freestanding pods.

PRODUCT CODE	PRICE			WEIGHT		VOL FT ³
	H	W	D	LBS		
HXACHT	35	2	1.25	0.75	0.23	0.01

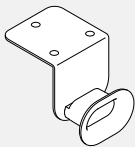
HXABH • Under Surface Bag Hook

- Under Surface Bag Hook can be secured to the bottom of worksurface.
- Made of die-cast aluminum with steel brackets, specify any standard metal paint finish.
- Choose a PET Felt finish for the plug insert.

PRODUCT CODE	PRICE			WEIGHT		VOL FT ³
	H	W	D	LBS		
HXABH	33	2	1.25	0.75	0.18	0.01

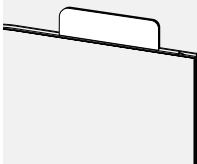
HXNP • Name Plate

- Name Plate sits inside the divider top reveal.
- Two-sided white dry erase surface laminated to 1/2" PET Felt.

PRODUCT CODE	PRICE			WEIGHT		VOL FT ³
	H	W	D	LBS		
HXNP	60	3.625	10.75	0.5		0.01

GCPPVACH • Universal Polypropylene Divider Panels - H Configuration

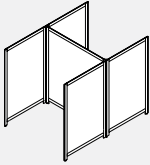

- **Universal Polypropylene Divider Panels dividing space with flexibility.**
- Lightweight and easy to clean partitions.
- Minimal footprint for storage.
- Fluted solid white polypropylene screens surrounded by a 1/2" by 2/5" powder coated aluminum frame in DWT - Designer White or TUN - Tungsten
- Charcoal soft touch radius end trim.
- 7" panel opening at panel bottom for easy cleaning and cable pass-thru.
- Includes all connecting hardware and 1" levelling glide.
- Stations are 60" wide by 42" deep by 66" high.
- Planning stations are preconfigured in a back-to-back H with ability to add stations with a T configuration.

PRODUCT CODE	PRICE	SIZE/INCHES			WEIGHT LBS	VOL FT ³
		H	W	D		
GCPPVACH666085	1945	66	60	85	90	18.74

GCPPVACT • Universal Polypropylene Divider Panels - T Configuration

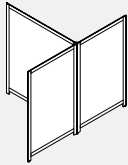

- **Universal Polypropylene Divider Panels dividing space with flexibility.**
- Lightweight and easy to clean partitions.
- Minimal footprint for storage.
- Fluted solid white polypropylene screens surrounded by a 1/2" by 2/5" powder coated aluminum frame in DWT - Designer White or TUN - Tungsten
- Charcoal soft touch radius end trim.
- 7" panel opening at panel bottom for easy cleaning and cable pass-thru.
- Includes all connecting hardware and 1" levelling glide.
- Stations are 60" wide by 42" deep by 66" high.
- Planning stations are preconfigured in a back-to-back H with ability to add stations with a T configuration.

PRODUCT CODE	PRICE	SIZE/INCHES			WEIGHT LBS	VOL FT ³
		H	W	D		
GCPPVACT666085	1238	66	60	85	73	11.82

GCPPVACU • Universal Polypropylene Divider Panels - U Configuration

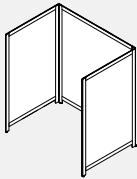

- **Universal Polypropylene Divider Panels dividing space with flexibility.**
- Lightweight and easy to clean partitions.
- Minimal footprint for storage.
- Fluted solid white polypropylene screens surrounded by a 1/2" by 2/5" powder coated aluminum frame in DWT - Designer White or TUN - Tungsten
- Charcoal soft touch radius end trim.
- 7" panel opening at panel bottom for easy cleaning and cable pass-thru.
- Includes all connecting hardware and 1" levelling glide.
- Stations are 60" wide by 42" deep by 66" high.
- Planning stations are preconfigured in a back-to-back U with ability to add stations with an L configuration.

PRODUCT CODE	PRICE	SIZE/INCHES			WEIGHT LBS	VOL FT ³
		H	W	D		
GCPPVACU666043	1241	66	60	43	73	11.82

GCPPVACL • Universal Polypropylene Divider Panels - L Configuration

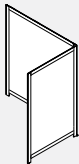

- **Universal Polypropylene Divider Panels dividing space with flexibility.**
- Lightweight and easy to clean partitions.
- Minimal footprint for storage.
- Fluted solid white polypropylene screens surrounded by a 1/2" by 2/5" powder coated aluminum frame in DWT - Designer White or TUN - Tungsten
- Charcoal soft touch radius end trim.
- 7" panel opening at panel bottom for easy cleaning and cable pass-thru.
- Includes all connecting hardware and 1" levelling glide.
- Stations are 60" wide by 42" deep by 66" high.
- Planning stations are preconfigured in a back-to-back U with ability to add stations with an L configuration.

PRODUCT CODE	PRICE	SIZE/INCHES			WEIGHT LBS	VOL FT ³
		H	W	D		
GCPPVACL666043	885	66	60	43	58	8.36

GCUPFSP • Freestanding Divider Polycarbonate Screen With Flat Feet

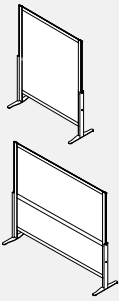

- Provides privacy and room separation.
- Lightweight and easy to clean and move.
- Consists of a powder coated aluminum frame, translucent fluted polycarbonate and steel flat feet.
- Option for 54", 60 and 72" high.
- 72" high by 60" wide divider has a crossbar in the middle.
- Please choose any standard paint finish for frame and feet.

PRODUCT CODE	PRICE	SIZE/INCHES			WEIGHT LBS	VOL FT ³
		H	W	D		
GCUPFSP5424	485	51.75	24	20	15.96	14.38
GCUPFSP5430	534	51.75	30	20	17.96	17.97
GCUPFSP5436	577	51.75	36	20	19.96	21.56
GCUPFSP5442	625	51.75	42	20	21.96	25.16
GCUPFSP5448	632	51.75	48	20	20.96	28.75
GCUPFSP5460	763	51.75	60	20	22.96	35.94
GCUPFSP6024	496	57.75	24	20	17.96	16.04
GCUPFSP6030	543	57.75	30	20	19.96	20.05
GCUPFSP6036	587	57.75	36	20	21.96	24.06
GCUPFSP6042	634	57.75	42	20	23.96	28.07
GCUPFSP6048	644	57.75	48	20	25.96	32.08
GCUPFSP6060	775	57.75	60	20	27.96	40.10
GCUPFSP7230	626	69.75	30	20	21.96	24.22
GCUPFSP7236	683	69.75	36	20	23.96	29.06
GCUPFSP7242	759	69.75	42	20	25.96	33.91
GCUPFSP7248	766	69.75	48	20	27.96	38.75
GCUPFSP7260	884	69.75	60	20	29.96	48.44

GCUPMSP • Freestanding Divider Polycarbonate Screen With Casters

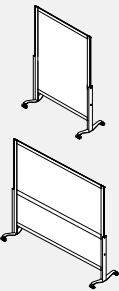

- Provides privacy and room separation.
- Lightweight and easy to clean and move.
- Consists of a powder coated aluminum frame, translucent fluted polycarbonate and steel feet with casters.
- Option for 54", 60 and 72" high.
- 72" high by 60" wide divider has a crossbar in the middle.
- Please choose any standard paint finish for frame and feet.

PRODUCT CODE	PRICE	SIZE/INCHES			WEIGHT LBS	VOL FT ³
		H	W	D		
GCUPMSP5424	718	52.05	24	20	17.13	14.46
GCUPMSP5430	766	52.05	30	20	19.13	18.07
GCUPMSP5436	748	52.05	36	20	21.13	21.69
GCUPMSP5442	794	52.05	42	20	23.13	25.30
GCUPMSP5448	801	52.05	48	20	22.13	28.92
GCUPMSP5460	922	52.05	60	20	24.13	36.15
GCUPMSP6024	675	58.05	24	20	19.13	16.13
GCUPMSP6030	718	58.05	30	20	21.13	20.16
GCUPMSP6036	759	58.05	36	20	23.13	24.19
GCUPMSP6042	803	58.05	42	20	25.13	28.22
GCUPMSP6048	812	58.05	48	20	27.13	32.25
GCUPMSP6060	932	58.05	60	20	29.13	40.31
GCUPMSP7230	918	70.05	30	20	23.13	24.32
GCUPMSP7236	858	70.05	36	20	25.13	29.19
GCUPMSP7242	917	70.05	42	20	27.13	34.05
GCUPMSP7248	925	70.05	48	20	29.13	38.92
GCUPMSP7260	1033	70.05	60	20	31.13	48.65

GCUPSHS • Shared Divider Polycarbonate Screen

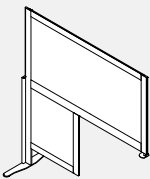

- Provides privacy and divides space for workstations.
- Divider stands on the floor and sits on the worksurface.
- Has no mechanical connection to any surface.
- Lightweight and easy to clean and move.
- Consists of a powder coated aluminum frame, translucent fluted polycarbonate and steel flat foot.
- Option for 54" and 60" high.
- Extends 24" from the worksurface.
- Sits 24" or 30" above worksurface.
- Please choose any standard paint finish for frame and feet.

PRODUCT CODE	PRICE	SIZE/INCHES			WEIGHT LBS	VOL FT ³
		H	W	D		
GCUPSHS5448	499	53.57	48	20	13.45	29.76
GCUPSHS5454	521	53.57	54	20	15.45	33.48
GCUPSHS6048	541	59.57	48	20	17.45	33.09
GCUPSHS6054	568	59.57	54	20	19.45	37.23

GCUPFSF • Freestanding Divider Felt Screen With Flat Feet

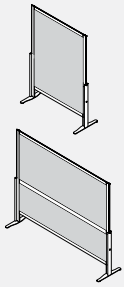

- Provides privacy and room separation.
- Lightweight and easy to clean and move.
- Consists of a powder coated aluminum frame, felt and steel flat feet.
- Option for 54", 60 and 72" high.
- 72" high by 60" wide divider has a crossbar in the middle.
- Please choose any standard paint finish for frame and feet.

PRODUCT CODE	PRICE	SIZE/INCHES			WEIGHT LBS	VOL FT ³
		H	W	D		
GCUPFSF5424	435	51.75	24	20	19.58	14.38
GCUPFSF5430	459	51.75	30	20	20.32	17.97
GCUPFSF5436	468	51.75	36	20	21.06	21.56
GCUPFSF5442	491	51.75	42	20	21.8	25.16
GCUPFSF5448	500	51.75	48	20	22.54	28.75
GCUPFSF5460	614	51.75	60	20	24.03	35.94
GCUPFSF6024	444	57.75	24	20	20.38	16.04
GCUPFSF6030	471	57.75	30	20	21.11	20.05
GCUPFSF6036	478	57.75	36	20	21.84	24.06
GCUPFSF6042	507	57.75	42	20	22.57	28.07
GCUPFSF6048	510	57.75	48	20	23.3	32.08
GCUPFSF6060	623	57.75	60	20	24.87	40.10
GCUPFSF7230	522	69.75	30	20	22.42	24.22
GCUPFSF7236	530	69.75	36	20	23.24	29.06
GCUPFSF7242	621	69.75	42	20	24.06	33.91
GCUPFSF7248	629	69.75	48	20	24.88	38.75
GCUPFSF7260	785	69.75	60	20	29.79	48.44

GCUPMSF • Freestanding Felt Divider Screen With Casters

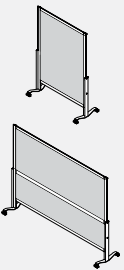

- Provides privacy and room separation.
- Lightweight and easy to clean and move.
- Consists of a powder coated aluminum frame, felt and steel feet with casters.
- Option for 54", 60 and 72" high.
- 72" high by 60" wide divider has a crossbar in the middle.
- Please choose any standard paint finish for frame and feet.

PRODUCT CODE	PRICE	SIZE/INCHES			WEIGHT LBS	VOL FT ³
		H	W	D		
GCUPMSF5424	618	52.05	24	20	20.76	14.46
GCUPMSF5430	641	52.05	30	20	21.5	18.07
GCUPMSF5436	648	52.05	36	20	22.24	21.69
GCUPMSF5442	671	52.05	42	20	22.98	25.30
GCUPMSF5448	678	52.05	48	20	23.72	28.92
GCUPMSF5460	784	52.05	60	20	25.21	36.15
GCUPMSF6024	627	58.05	24	20	21.47	16.13
GCUPMSF6030	650	58.05	30	20	22.23	20.16
GCUPMSF6036	657	58.05	36	20	22.99	24.19
GCUPMSF6042	680	58.05	42	20	23.75	28.22
GCUPMSF6048	688	58.05	48	20	24.51	32.25
GCUPMSF6060	792	58.05	60	20	26.05	40.31
GCUPMSF7230	699	70.05	30	20	23.6	24.32
GCUPMSF7236	709	70.05	36	20	24.42	29.19
GCUPMSF7242	790	70.05	42	20	25.24	34.05
GCUPMSF7248	797	70.05	48	20	26.06	38.92
GCUPMSF7260	942	70.05	60	20	30.97	48.65

GCUPSHF • Shared Divider Felt Screen

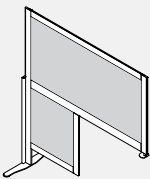

- Provides privacy and divides space for workstations.
- Divider stands on the floor and sits on the worksurface.
- Has no mechanical connection to any surface.
- Lightweight and easy to clean and move.
- Consists of a powder coated aluminum frame, translucent fluted polycarbonate and steel flat foot.
- Option for 54" and 60" high.
- Extends 24" from the worksurface.
- Sits 24" or 30" above worksurface.
- Please choose any standard paint finish for frame and feet.

PRODUCT CODE	PRICE	SIZE/INCHES			WEIGHT LBS	VOL FT ³
		H	W	D		
GCUPSHF5448	411	53.57	48	20	18.06	29.76
GCUPSHF5454	469	53.57	54	20	18.8	33.48
GCUPSHF6048	438	59.57	48	20	18.84	33.09
GCUPSHF6054	578	59.57	54	20	19.6	37.23

GCUPFSG • Freestanding Divider Glass Screen with Flat Feet

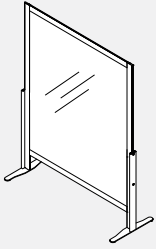

- Provides privacy and room separation.
- Lightweight and easy to clean and move.
- Consists of an aluminum frame, clear glass screen and steel flat feet.
- Please choose any standard panel frame paint finish from Global Contract for all metal parts.
- Option for 54" / 60" high.
- Upcharge for frosted (FRST) glass is 20%.

PRODUCT CODE	PRICE	SIZE/INCHES			WEIGHT LBS	VOL FT ³
		H	W	D		
GCUPFSG5424	570	51.75	24	20	30.83	14.38
GCUPFSG5430	619	51.75	30	20	34.95	17.97
GCUPFSG5436	668	51.75	36	20	39.07	21.56
GCUPFSG5442	717	51.75	42	20	43.19	25.16
GCUPFSG5448	766	51.75	48	20	47.31	28.75
GCUPFSG5460	864	51.75	60	20	55.56	35.94
GCUPFSG6024	604	57.75	24	20	33.11	16.04
GCUPFSG6030	657	57.75	30	20	37.74	20.05
GCUPFSG6036	712	57.75	36	20	42.36	24.06
GCUPFSG6042	765	57.75	42	20	46.99	28.07
GCUPFSG6048	820	57.75	48	20	51.61	32.08
GCUPFSG6060	928	57.75	60	20	60.86	40.10

GCUPMSG • Freestanding Divider Glass Screen with Casters

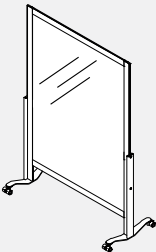

- Provides privacy and room separation.
- Lightweight and easy to clean and move.
- Consists of an aluminum frame, clear glass screen and steel flat feet.
- Please choose any standard panel frame paint finish from Global Contract for all metal parts.
- Option for 54" / 60" high.
- Upcharge for frosted (FRST) glass is 20%.

PRODUCT CODE	PRICE	SIZE/INCHES			WEIGHT LBS	VOL FT ³
		H	W	D		
GCUPMSG5424	817	52.05	24	20	31.99	14.46
GCUPMSG5430	865	52.05	30	20	36.11	18.07
GCUPMSG5436	915	52.05	36	20	40.24	21.69
GCUPMSG5442	963	52.05	42	20	44.36	25.30
GCUPMSG5448	1012	52.05	48	20	48.48	28.92
GCUPMSG5460	1110	52.05	60	20	56.72	36.15
GCUPMSG6024	850	58.05	24	20	34.28	16.13
GCUPMSG6030	904	58.05	30	20	38.9	20.16
GCUPMSG6036	958	58.05	36	20	43.53	24.19
GCUPMSG6042	1011	58.05	42	20	48.15	28.22
GCUPMSG6048	1065	58.05	48	20	52.78	32.25
GCUPMSG6060	1174	58.05	60	20	62.03	40.31

GCUPSHG • Shared Divider Glass Screen

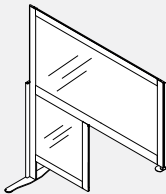

- Provides privacy and divides space for workstations.
- Divider stands on the floor and sits on the worksurface.
- Has no mechanical connection to any surface.
- Lightweight and easy to clean and move.
- Consists of a powder coated aluminum frame, clear glass screen and steel flat foot.
- Option for 54" / 60" high.
- Extends 24" from the worksurface.
- Sits 24" or 30" above worksurface.
- Please choose any standard paint finish for frame and feet.
- Upcharge for frosted (FRST) glass is 20%.

PRODUCT CODE	PRICE	SIZE/INCHES			WEIGHT LBS	VOL FT ³
		H	W	D		
GCUPSHG5448	629	53.57	48	20	36.17	29.76
GCUPSHG5454	657	53.57	54	20	38.51	33.48
GCUPSHG6048	680	59.57	48	20	40.52	33.09
GCUPSHG6054	714	59.57	54	20	43.36	37.23

Bridges Feature List

Our desire was to develop an environment for collaborative teamwork which would facilitate connection, or bridging, of people and ideas. A set of components which would even serve as a catalyst - inviting team members out of their cocooned comfort zones and encouraging them to engage, to co-create.

Flexible building components:

- single tables (freestanding or mobile)
- training rooms
- boardrooms
- library
- 1 person general and private office
- 2 person work station
- 3-person work station
- 4-person work station
- 6+ -person work station
- Storage spine-based work station
- Panel based work station

Easy to customize / reconfigure to fit specific requirements. From the facility manager's perspective, all work stations can be standardized to form a linear worksurface and power/data services, and their respective function, or purpose, can be governed by the type, quantity and placement of adjacent components like dividers, storage cabinets, shelves and accessories. These adjacent components can be easily reconfigured with minimal down time - without having to invite electrical and IT crew.

Compatible with various environments clean, simple, elegant design language with finishes suggesting comfortable, even domestic flavour. Wide range of finished various environments. From understated to some combinations, like anodized aluminum and white that give a hint of subtle sophistication.

Worksurfaces

- Worksurfaces are available in (HP) high pressure laminate and (LP) low pressure laminate.
- Veneer tops available, please contact your Customer Service Representative.
- HP laminate tops are 1 1/16" thick laminate particle board and have a flat 3 mm edge profile on all sides.
- LP laminate tops are 1" thick melamine particle board and have a flat 3 mm edge profile on all side.

Tables

- All single sliding rail tables are standard with casters.
- All multiple linear workstations are standard with levelers.
- Tops square for flush surface-to-surface abutment and to accept desk mounted accessories.
- Worksurfaces provided with pilot holes for alignment purposes.

CODES: The price list uses a numbering system with meaningful alphanumeric characters to

Worksurface Edge Profiles:

HP/LP edge: 

Choice of two functionally and visually differentiated leg supports on casters or levelers: - height-adjustable round legs - fixed height rectangular legs with optional anodized aluminum finish

Various power/data delivery levels to choose from: - wire basket to organize cable excess under worksurface and storage - table leg integrated vertical cable manager - worksurface edge-mounted power/data units (easy to reconfigure, plug into wall/floor outlets) - single and double below worksurface power/data trough (desk top, floor standing computers and office equipment) - worksurface access door (access to below worksurface power outlets and data terminals) - above worksurface power/data trough (laptop / tablet / phone immediate access) - storage integrated power/data unit - horizontal cable management under storage units with optional wire basket - raised storage units for uninterrupted access to panel based floor raceway

Interconnected storage units can form a spine (space division, storage, cable management and worksurface support). Storage leg can be configured to act as a ganging bracket.

Panel integrated storage units can be connected and provide support to panel partitions (space division, storage, cable management, panel power/data delivery access and worksurface support). Panel integrated Bridges leg provides support to panel mounted worksurfaces.

Bridges Collaborative Seating collection consists of seating, privacy screens, tables, tablets and power. It is a versatile modular furniture series which can be configured into many space planning scenarios including corner, in-line, open concept, traditional reception as well as secluded seating with high privacy partitions.

create a simple-to-understand product number. This makes specifying the product much easier and more accurate.

SPECIFICATION EXAMPLE OF A BRIDGES WORKSURFACE

PRODUCT CODE: BRTWS2472HP MR71T CHR
 BRT = Bridges
 WS = Type of Worksurface
 2472 = Size: Depth x Width
 HP = Finish
 MR71T = High Pressure Laminate
 CHR = PVC Edging

How To Specify:

- Specify Bridges product code in appropriate top material.
- Specify top colour - ie. Laminate colour MR71T (Studio White Matrix).
- Specify PVC edge colour - ie. CHR (Charcoal).

30" WIDE UNITS Storage Capacity Chart

SIDE TO SIDE

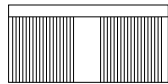

LETTER LETTER

SIDE TO SIDE LETTER/FRONT TO BACK LEGAL

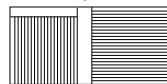

LETTER LEGAL

36" & 42" WIDE UNITS Storage Capacity Chart

SIDE TO SIDE LETTER



LETTER LETTER

FRONT TO BACK LEGAL

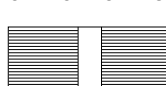

LEGAL LEGAL

SIDE TO SIDE LETTER/FRONT TO BACK LEGAL

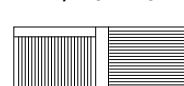

LETTER LEGAL

GRAIN DIRECTION CHART

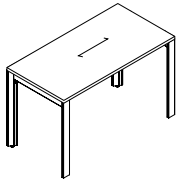

BRTS1P-L

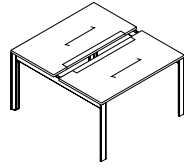

BRTBAR2PA-L

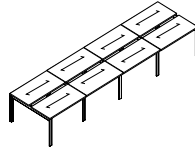

BRTBAR8PA-L

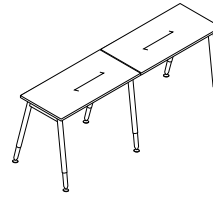

BRTS2P-LR

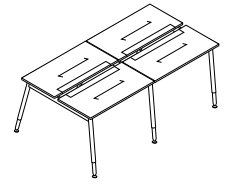

BRTBAR4PA-LR

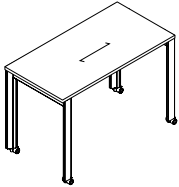

BRTS1P-C

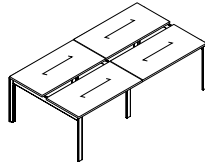

BRTBAR4P-L

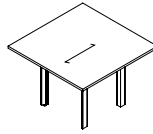

BRTSQ

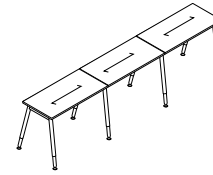

BRTS3P-LR

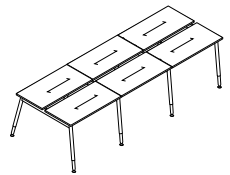

BRTBAR6P-LR

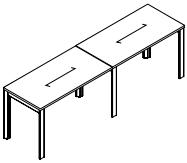

BRTS2P-L

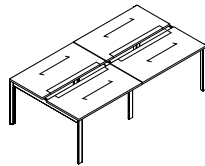

BRTBAR4PA-L

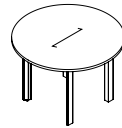

BTRR

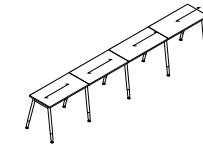

BRTS4P-LR

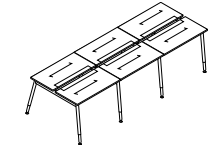

BRTBAR6PA-LR

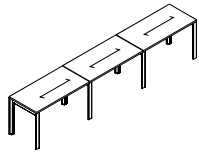

BRTS3P-L

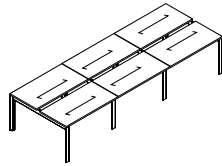

BRTBAR6P-L

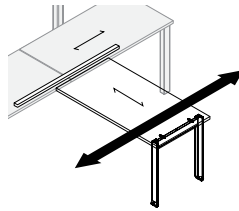

BRTSLDT72C

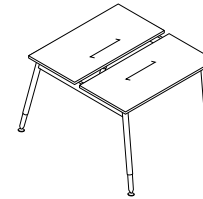

BRTBAR2P-LR

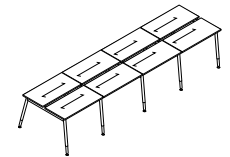

BRTBAR8P-LR

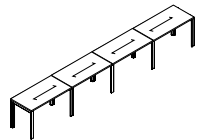

BRTS4P-L

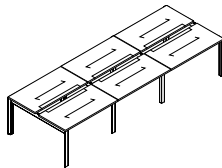

BRTBAR6PA-L

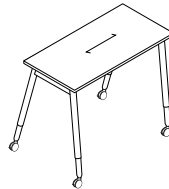

BRTS1P-CR

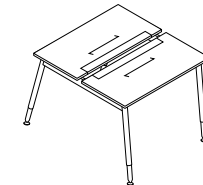

BRTBAR2PA-LR

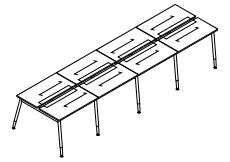

BRTBAR8PA-LR

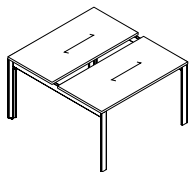

BRTBAR2P-L

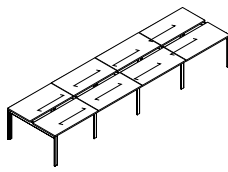

BRTBAR8P-L

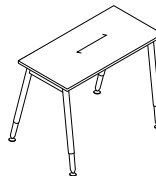

BRTS1P-LR

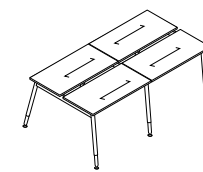

BRTBAR4P-LR

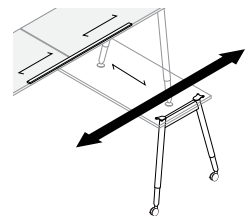

BRTSLDT72CR

GRAIN DIRECTION CHART

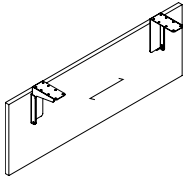

BRTMPS

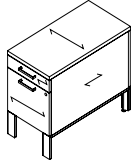

BRT25BF-L

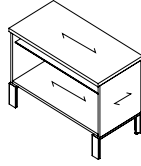

BRT25LO-L

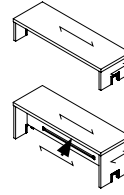

BRTBTS

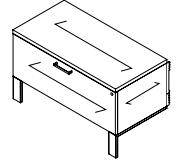

BRTPSL

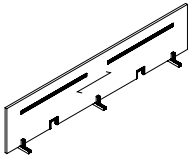

BRTLPPD

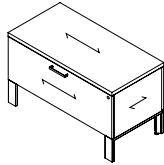

BRT21F-L

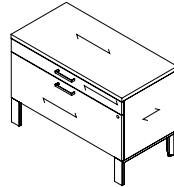

BRT25LBF-L

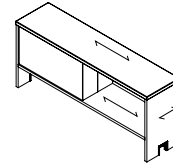

BRTBAS048

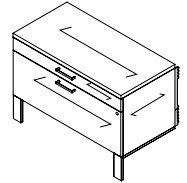

BRTPLBF

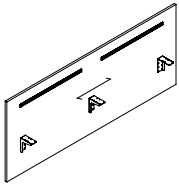

BRTLPPS

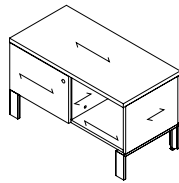

BRT21LS-L

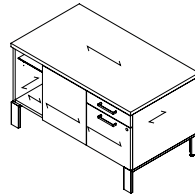

BRT25LBF042L

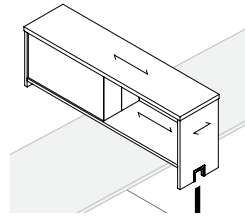

BRTSDS48

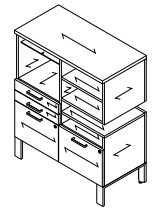

BRTCS45BBFF

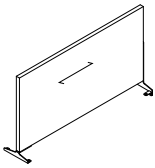

BRTLPPD

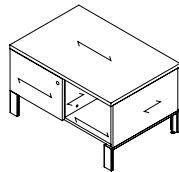

BRT21LSS-L

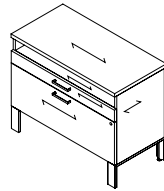

BRT29LOBF-L

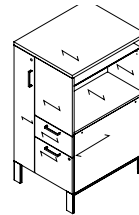

BRTTW50

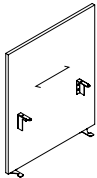

BRTLPEP

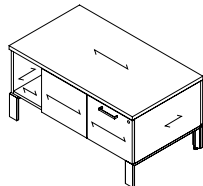

BRT21LS042L

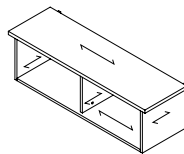

BRTTES

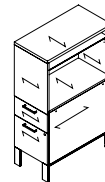

BRTT50

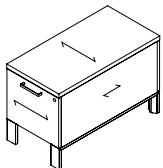

BRT21BF

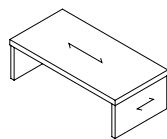

BRTSTS

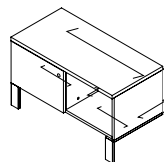

BRTPSLS

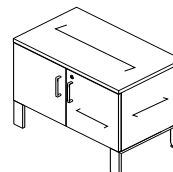

BRT25L2D

Technical Information - Rectangular Leg

Support Leg and Frame

Single and shared worksurface support.

Bridges Rectangular legs are available with:

- Locking casters (BRTLCS)
- Levelers (BRTLVS)
- Casters and Levelers not retrofitable.

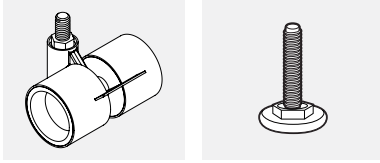

NOTES:

- Levelers have a 2" height range, with 5/16-18 thread.
- Levelers are available in black only.
- 45mm high casters with 8mm thread, available in White Body/Grey Tire combination only.
- Leg frame is available in our (9) standard paint and anodized aluminum finish.
- Paint finish is durable environmentally friendly epoxy powder coating.

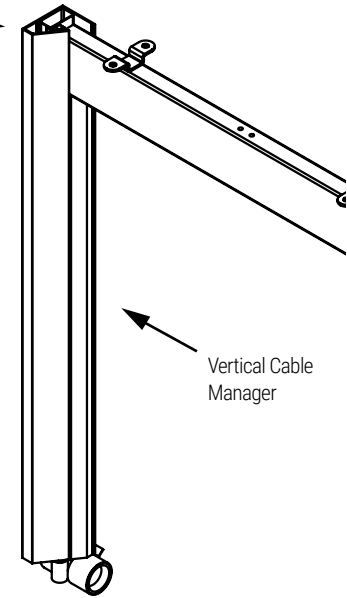

Technical Information - Round Leg

Support Leg and Frame

- Tubular steel legs are adjustable in 1" increments.

Single and shared worksurface support.

Height adjustment allows the user to easily set the height of a table.

Legs have a height adjustment range of 24" - 32" in 1" increments with levelers and 27" - 35" with casters.

Bridges Round legs are available with:

- Locking casters (BRTLCR)
- Levelers (BRTLVR)
- Casters and levelers are retrofitable on site.

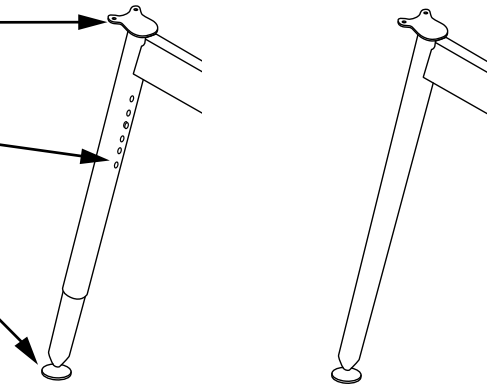

Height Adjustable Leg

Fixed Leg

NOTES:

- Levelers have a 1" height range, with 3/8-16 thread.
- Levelers are available in Chrome only.
- Casters available in Tungsten/Black combination only.
- Casters are 3" diameter with an overall height of 3 3/4", with 3/8-16 thread.
- Inner leg is available in Chrome only.
- Leg frame is available in our (9) standard paint finishes.
- Paint finish is durable environmentally friendly epoxy powder coating.

Technical Information - Handle Options

Optional handle to provide a softer and slimmer alternative to standard Bridges2 storage handles. Radiused corners and edges. Can be retrofitted on site as the drilling hole drawer front pattern remains unchanged.

Finish matches anodized aluminum.

- Centre to centre hole pattern for Bridges 2 handles is 128 mm.

Standard Handle

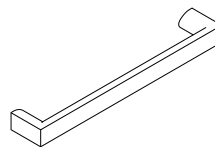

BRH1 - Anodized aluminum
BRH1B - Black

Optional Handle

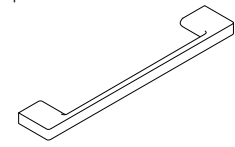

BRH2 - Anodized aluminum

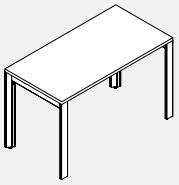
BRTS1P-L • Rectangular Legs - Single Line 1 Person Pod (Levelers)

- **Single Line Table Assemblies consist of one worksurface, two leg assemblies and one horizontal structural beam.**
- Finish option, please choose from:
 - 1) anodized aluminum vertical legs with powder coated steel horizontal structural members.
Anodized aluminum leg upcharge of \$110 for this configuration.
 - 2) powder coated aluminum vertical legs and steel horizontal structural members. Choose from standard metal finishes.
- Worksurface available in HP and LP. For wood veneer tops, please contact your Customer Service Representative.

PRODUCT CODE	PRICE		SIZE/ INCHES			WEIGHT VOL	
	LP	HP	H	W	D	LBS	FT ³
BRTS1P2436L	1011	1069	29	36	24	45	4.00
BRTS1P2442L	1074	1144	29	42	24	48	4.10
BRTS1P2448L	1126	1209	29	48	24	51	4.20
BRTS1P2451L	1157	1245	29	50.5	24	54	4.30
BRTS1P2454L	1189	1286	29	54	24	57	4.40
BRTS1P2460L	1233	1340	29	60	24	60	4.48
BRTS1P2463L	1243	1357	29	62.5	24	63	4.57
BRTS1P2466L	1258	1368	29	66	24	66	4.65
BRTS1P2472L	1269	1397	29	72	24	69	4.73
BRTS1P2478L	1317	1437	29	78	24	72	4.82
BRTS1P2484L	1355	1484	29	84	24	75	4.92
BRTS1P3036L	1089	1154	29	36	30	54	4.20
BRTS1P3042L	1180	1270	29	42	30	57	4.30
BRTS1P3048L	1204	1300	29	48	30	60	4.41
BRTS1P3051L	1227	1326	29	50.5	30	63	4.50
BRTS1P3054L	1254	1343	29	54	30	66	4.60
BRTS1P3060L	1279	1394	29	60	30	69	4.73
BRTS1P3063L	1292	1407	29	62.5	30	72	4.80
BRTS1P3066L	1301	1422	29	66	30	75	4.90
BRTS1P3072L	1332	1458	29	72	30	78	5.01
BRTS1P3078L	1367	1496	29	78	30	81	5.10
BRTS1P3084L	1422	1561	29	84	30	84	5.20

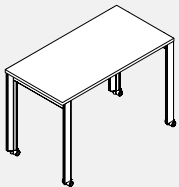
BRTS1P-C • Rectangular Legs - Single Line 1 Person Pod (Casters)

- **Single Line Table Assemblies consist of one worksurface, two leg assemblies and one horizontal structural beam.**
- 40mm white locking casters with grey tires; steel horizontal beams, aluminum legs.
- Finish options, please choose from:
 - 1) anodized aluminum vertical legs with powder coated steel horizontal structural members.
Anodized aluminum leg upcharge of \$110 for this configuration.
 - 2) powder coated aluminum vertical legs and steel horizontal structural members. Choose from standard metal finishes.
- Worksurface available in HP and LP. For wood veneer tops, please contact your Customer Service Representative.

PRODUCT CODE	PRICE		SIZE/ INCHES			WEIGHT VOL	
	LP	HP	H	W	D	LBS	FT ³
BRTS1P2436C	1078	1137	29	36	24	45	4.00
BRTS1P2442C	1142	1210	29	42	24	48	4.10
BRTS1P2448C	1194	1275	29	48	24	51	4.20
BRTS1P2451C	1225	1315	29	50.5	24	54	4.30
BRTS1P2454C	1258	1351	29	54	24	57	4.40
BRTS1P2460C	1299	1407	29	60	24	60	4.48
BRTS1P2463C	1310	1424	29	62.5	24	63	4.57
BRTS1P2466C	1324	1435	29	66	24	66	4.65
BRTS1P2472C	1344	1464	29	72	24	69	4.73
BRTS1P2478C	1382	1504	29	78	24	72	4.82
BRTS1P2484C	1422	1550	29	84	24	75	4.92
BRTS1P3036C	1156	1223	29	36	30	54	4.20
BRTS1P3042C	1245	1338	29	42	30	57	4.30
BRTS1P3048C	1270	1367	29	48	30	60	4.41
BRTS1P3051C	1294	1392	29	50.5	30	63	4.50
BRTS1P3054C	1318	1409	29	54	30	66	4.60
BRTS1P3060C	1348	1460	29	60	30	69	4.73
BRTS1P3063C	1358	1474	29	62.5	30	72	4.90
BRTS1P3066C	1368	1487	29	66	30	75	4.90
BRTS1P3072C	1398	1508	29	72	30	78	5.01
BRTS1P3078C	1434	1561	29	78	30	81	5.10
BRTS1P3084C	1499	1628	29	84	30	84	5.20

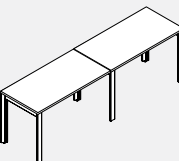
BRTS2P-L • Rectangular Legs - Single Line 2 Person Pod (Levelers)

- **Single Line, 2-person workstation consists of two work-surfaces, three leg assemblies and 2 horizontal structural beams.**
- One leg can be shared by 2 adjoining worksurfaces.
- Finish options, please choose from:
 - 1) anodized aluminum vertical legs with powder coated steel horizontal structural members.
Anodized aluminum leg upcharge of \$164 for this configuration.
 - 2) powder coated aluminum vertical legs and steel horizontal structural members. Choose from standard metal finishes.
- Worksurface available in HP and LP. For wood veneer tops, please contact your Customer Service Representative.

PRODUCT CODE	PRICE		SIZE/ INCHES			WEIGHT VOL	
	LP	HP	H	W	D	LBS	FT ³
BRTS2P2448L	1919	2088	29	96	24	95	6.21
BRTS2P2454L	2047	2234	29	108	24	104	6.45
BRTS2P2460L	2130	2351	29	120	24	113	6.71
BRTS2P2466L	2178	2404	29	132	24	122	6.95
BRTS2P2472L	2223	2463	29	144	24	131	7.13
BRTS2P2478L	2298	2542	29	156	24	140	7.27
BRTS2P2484L	2378	2635	29	168	24	149	7.41
BRTS2P3048L	2061	2252	29	96	30	113	6.57
BRTS2P3054L	2149	2337	29	108	30	122	6.85
BRTS2P3060L	2211	2436	29	120	30	131	7.13
BRTS2P3066L	2256	2495	29	132	30	140	7.41
BRTS2P3072L	2332	2585	29	144	30	155	7.69
BRTS2P3078L	2383	2639	29	156	30	164	7.97
BRTS2P3084L	2495	2774	29	168	30	173	8.25

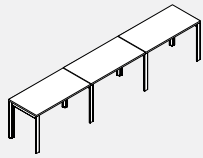
BRTS3P-L • Rectangular Legs - Single Line 3 Person Pod (Levelers)

- **Single Line, 3-person workstation consists of 3 worksurfaces, 4 leg assemblies and 3 horizontal structural beams.**
- Finish options, please choose from:
 - 1) anodized aluminum vertical legs with powder coated steel horizontal structural members.
Anodized aluminum leg upcharge of \$217 for this configuration.
 - 2) powder coated aluminum vertical legs and steel horizontal structural members. Choose from standard metal finishes.
- Worksurface available in HP and LP. For wood veneer tops, please contact your Customer Service Representative.

PRODUCT CODE	PRICE		SIZE/INCHES			WEIGHT VOL	
	LP	HP	H	W	D	LBS	FT ³
BRTS3P2448L	2711	2965	29	144	24	138	8.47
BRTS3P2454L	2900	3186	29	162	24	152	8.68
BRTS3P2460L	3033	3346	29	180	24	165	8.89
BRTS3P2466L	3101	3440	29	198	24	179	9.11
BRTS3P2472L	3169	3527	29	216	24	192	9.32
BRTS3P2478L	3282	3649	29	234	24	206	9.53
BRTS3P2484L	3397	3788	29	252	24	219	9.74
BRTS3P3048L	2918	3199	29	144	30	161	9.01
BRTS3P3054L	3047	3329	29	162	30	178	9.44
BRTS3P3060L	3142	3480	29	180	30	195	9.87
BRTS3P3066L	3206	3565	29	198	30	212	10.30
BRTS3P3072L	3300	3677	29	216	30	229	10.72
BRTS3P3078L	3399	3786	29	234	30	246	11.16
BRTS3P3084L	3565	3985	29	252	30	263	11.59

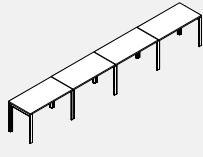
BRTS4P-L • Rectangular Legs - Single Line 4 Person Pod (Levelers)

- **Single Line, 4-person workstation consists of 4 worksurfaces, 5 leg assemblies and 4 horizontal structural beams.**
- Finish options, please choose from:
 - 1) anodized aluminum vertical legs with powder coated steel horizontal structural members.
Anodized aluminum leg upcharge of \$271 for this configuration.
 - 2) powder coated aluminum vertical legs and steel horizontal structural members. Choose from standard metal finishes.
- Worksurface available in HP and LP. For wood veneer tops, please contact your Customer Service Representative.

PRODUCT CODE	PRICE		SIZE/INCHES			WEIGHT VOL	
	LP	HP	H	W	D	LBS	FT ³
BRTS4P2448L	3502	3842	29	192	24	180	10.73
BRTS4P2454L	3758	4135	29	216	24	199	11.22
BRTS4P2460L	3929	4368	29	240	24	217	11.71
BRTS4P2466L	4022	4474	29	264	24	236	12.20
BRTS4P2472L	4142	4625	29	288	24	254	12.69
BRTS4P2478L	4261	4756	29	312	24	273	13.18
BRTS4P2484L	4421	4941	29	336	24	291	13.67
BRTS4P3048L	3773	4153	29	192	30	213	11.45
BRTS4P3054L	3946	4326	29	216	30	235	12.02
BRTS4P3060L	4074	4524	29	240	30	257	12.59
BRTS4P3066L	4158	4641	29	264	30	279	13.16
BRTS4P3072L	4284	4784	29	288	30	301	13.73
BRTS4P3078L	4419	4931	29	312	30	323	14.30
BRTS4P3084L	4641	5195	29	336	30	345	14.87

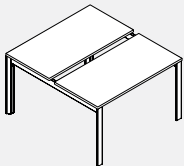
BRTBAR2P-L • Rectangular Legs - Back 2 Back 2 Person Pod (Levelers)

- **Back 2 Back, 2-person workstation consists of 2 worksurfaces, 2 Back 2 Back leg assemblies and 2 horizontal structural beams.**
- Finish options, please choose from:
 - 1) anodized aluminum vertical legs with powder coated steel horizontal structural members.
Anodized aluminum leg upcharge of \$110 for this configuration.
 - 2) powder coated aluminum vertical legs and steel horizontal structural members. Choose from standard metal finishes.
- Worksurface available in HP and LP. For wood veneer tops, please contact your Customer Service Representative.

PRODUCT CODE	PRICE		SIZE/INCHES			WEIGHT VOL	
	LP	HP	H	W	D	LBS	FT ³
BRTBAR2P2460L	1997	2219	29	60	50.5	110	8.56
BRTBAR2P2466L	2047	2269	29	66	50.5	119	8.76
BRTBAR2P2472L	2091	2330	29	72	50.5	128	9.02
BRTBAR2P2478L	2164	2411	29	78	50.5	137	9.20
BRTBAR2P2484L	2244	2502	29	84	50.5	146	9.40
BRTBAR2P3060L	2027	2256	29	60	62.5	130	9.00
BRTBAR2P3066L	2071	2312	29	66	62.5	141	9.25
BRTBAR2P3072L	2138	2383	29	72	62.5	152	9.54
BRTBAR2P3078L	2209	2459	29	78	62.5	163	9.80
BRTBAR2P3084L	2312	2590	29	84	62.5	174	10.4

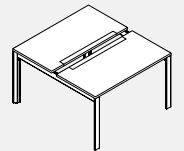
BRTBAR2PA-L • Rectangular Legs - Back 2 Back 2 Person Pod (Levelers) with Access Door

- **Back 2 Back, 2-person workstation consists of 2 worksurfaces, 2 Back 2 Back leg assemblies and 2 horizontal structural beams.**
- Finish options, please choose from:
 - 1) anodized aluminum vertical legs with powder coated steel horizontal structural members.
Anodized aluminum leg upcharge of \$110 for this configuration.
 - 2) powder coated aluminum vertical legs and steel horizontal structural members. Choose from standard metal finishes.
- Anodized aluminum worksurface door provides access to power / data through below worksurface.
- Worksurface with access doors cannot be combined with above worksurface power trough.
- Worksurface available in HP and LP.

PRODUCT CODE	PRICE		SIZE/INCHES			WEIGHT VOL	
	LP	HP	H	W	D	LBS	FT ³
BRTBAR2PA2460L	2080	2393	29	60	50.5	110	8.56
BRTBAR2PA2466L	2160	2508	29	66	50.5	119	8.76
BRTBAR2PA2472L	2244	2644	29	72	50.5	128	9.02
BRTBAR2PA3060L	2244	2644	29	60	62.5	130	9.00
BRTBAR2PA3066L	2361	2791	29	66	62.5	141	9.25
BRTBAR2PA3072L	2443	2926	29	72	62.5	152	9.54

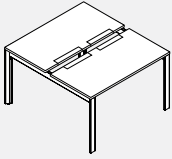
BRTBAR2PDA-L • Rectangular Legs - Back 2 Back 2 Person Pod (Levelers) with Access Doors

- **Back 2 Back, 2-person workstation consists of 2 worksurfaces, 2 Back 2 Back leg assemblies and 2 horizontal structural beams.**

- These tables feature dual access doors providing a central connection point for monitor lifts.
- Finish options, please choose from:
 - 1) anodized aluminum vertical legs with powder coated steel horizontal structural members.
Anodized aluminum leg upcharge of \$110 for this configuration.
 - 2) powder coated aluminum vertical legs and steel horizontal structural members. Choose from standard metal finishes.
- Anodized aluminum worksurface door provides access to power / data through below worksurface.
- Worksurface with access doors cannot be combined with above worksurface power trough.
- Worksurface available in HP and LP.

PRODUCT CODE	PRICE		SIZE/INCHES			WEIGHT		VOL FT ³
	LP	HP	H	W	D	LBS		
BRTBAR2PDA2460L	2244	2586	29	60	50.5	110	8.56	
BRTBAR2PDA2466L	2332	2711	29	66	50.5	119	8.76	
BRTBAR2PDA2472L	2423	2855	29	72	50.5	128	9.02	
BRTBAR2PDA2478L	2476	2927	29	78	50.5	137	9.20	
BRTBAR2PDA2484L	2550	3050	29	84	50.5	146	9.40	
BRTBAR2PDA3060L	2423	2855	29	60	62.5	130	9.00	
BRTBAR2PDA3066L	2550	3015	29	66	62.5	141	9.25	
BRTBAR2PDA3072L	2640	3159	29	72	62.5	152	9.54	
BRTBAR2PDA3078L	2693	3267	29	78	62.5	163	9.80	
BRTBAR2PDA3084L	2783	3394	29	84	62.5	174	10.4	

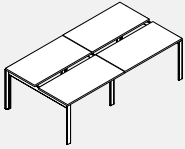
BRTBAR4P-L • Rectangular Legs - Back 2 Back 4 Person Pod (Levelers)

- **Back 2 Back, 4-person workstation consists of 4 worksurfaces, 2 Back 2 Back outer leg assemblies, 1 Back 2 Back narrow leg assembly and 4 horizontal structural beams.**

- Finish options, please choose from:
 - 1) anodized aluminum vertical legs with powder coated steel horizontal structural members.
Anodized aluminum leg upcharge of \$164 for this configuration.
 - 2) powder coated aluminum vertical legs and steel horizontal structural members. Choose from standard metal finishes.
- Worksurface available in HP and LP. For wood veneer tops, please contact your Customer Service Representative.

PRODUCT CODE	PRICE		SIZE/INCHES			WEIGHT		VOL FT ³
	LP	HP	H	W	D	LBS		
BRTBAR4P2460L	3531	3969	29	120	50.5	208	13.82	
BRTBAR4P2466L	3624	4077	29	132	50.5	224	14.28	
BRTBAR4P2472L	3716	4195	29	144	50.5	240	14.74	
BRTBAR4P2478L	3864	4354	29	156	50.5	256	15.20	
BRTBAR4P2484L	4022	4541	29	168	50.5	272	15.66	
BRTBAR4P3060L	3624	4077	29	120	62.5	253	14.70	
BRTBAR4P3066L	3711	4190	29	132	62.5	273	15.24	
BRTBAR4P3072L	3836	4335	29	144	62.5	293	15.78	
BRTBAR4P3078L	3969	4483	29	156	62.5	313	16.32	
BRTBAR4P3084L	4190	4746	29	168	62.5	333	16.86	

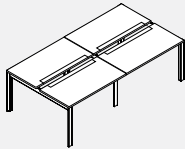
BRTBAR4PA-L • Rectangular Legs - Back 2 Back 4 Person Pod (Levelers) with Access Door

- **Back 2 Back, 4-person workstation consists of 4 worksurfaces, 2 Back 2 Back outer leg assemblies, 1 Back 2 Back narrow leg assembly and 4 horizontal structural beams**

- Finish options, please choose from:
 - 1) anodized aluminum vertical legs with powder coated steel horizontal structural members.
Anodized aluminum leg upcharge of \$164 for this configuration.
 - 2) powder coated aluminum vertical legs and steel horizontal structural members. Choose from standard metal finishes.
- Anodized aluminum worksurface door provides access to power / data through below worksurface.
- Worksurface with access doors cannot be combined with above worksurface power trough.
- Worksurface available in HP and LP.

PRODUCT CODE	PRICE		SIZE/INCHES			WEIGHT		VOL FT ³
	LP	HP	H	W	D	LBS		
BRTBAR4PA2460L	3692	4323	29	120	50.5	208	13.82	
BRTBAR4PA2466L	3855	4555	29	132	50.5	224	14.28	
BRTBAR4PA2472L	4022	4821	29	144	50.5	240	14.74	
BRTBAR4PA3060L	3989	4787	29	120	62.5	253	14.70	
BRTBAR4PA3066L	4221	5087	29	132	62.5	273	15.24	
BRTBAR4PA3072L	4389	5352	29	144	62.5	293	15.78	

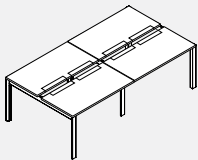
BRTBAR4PDA-L • Rectangular Legs - Back 2 Back 4 Person Pod (Levelers) with Access Doors

- **Back 2 Back, 4-person workstation consists of 4 worksurfaces, 2 Back 2 Back outer leg assemblies, 1 Back 2 Back narrow leg assembly and 4 horizontal structural beams**

- These tables feature dual access doors providing a central connection point for monitor lifts.
- Finish options, please choose from:
 - 1) anodized aluminum vertical legs with powder coated steel horizontal structural members.
Anodized aluminum leg upcharge of \$164 for this configuration.
 - 2) powder coated aluminum vertical legs and steel horizontal structural members. Choose from standard metal finishes.
- Anodized aluminum worksurface door provides access to power / data through below worksurface.
- Worksurface with access doors cannot be combined with above worksurface power trough.
- Worksurface available in HP and LP.

PRODUCT CODE	PRICE		SIZE/INCHES			WEIGHT		VOL FT ³
	LP	HP	H	W	D	LBS		
BRTBAR4PDA2460L	3985	4668	29	120	50.5	208	13.82	
BRTBAR4PDA2466L	4166	4917	29	132	50.5	224	14.28	
BRTBAR4PDA2472L	4342	5207	29	144	50.5	240	14.74	
BRTBAR4PDA2478L	4453	5348	29	156	50.5	256	15.20	
BRTBAR4PDA2484L	4593	5601	29	168	50.5	272	15.66	
BRTBAR4PDA3060L	4308	5169	29	120	62.5	253	14.70	
BRTBAR4PDA3066L	4559	5494	29	132	62.5	273	15.24	
BRTBAR4PDA3072L	4740	5780	29	144	62.5	293	15.78	
BRTBAR4PDA3078L	4848	5996	29	156	62.5	313	16.32	
BRTBAR4PDA3084L	5026	6246	29	168	62.5	333	16.86	

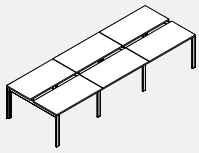
BRTBAR6P-L • Rectangular Legs - Back 2 Back 6 Person Pod (Levelers)

- **Back 2 Back, 6-person workstation consists of 6 worksurfaces, 2 Back 2 Back outer leg assemblies, 2 Back 2 Back narrow leg assemblies and 6 horizontal structural beams.**

- Finish options, please choose from:
 - 1) anodized aluminum vertical legs with powder coated steel horizontal structural members.
Anodized aluminum leg upcharge of \$217 for this configuration.
 - 2) powder coated aluminum vertical legs and steel horizontal structural members. Choose from standard metal finishes.
- Worksurface available in HP and LP. For wood veneer tops, please contact your Customer Service Representative.

PRODUCT CODE	PRICE		SIZE / INCHES			WEIGHT		VOL FT ³
	LP	HP	H	W	D	LBS		
BRTBAR6P2460L	5029	5689	29	180	50.5	308	19.76	
BRTBAR6P2466L	5203	5881	29	198	50.5	329	20.54	
BRTBAR6P2472L	5343	6059	29	216	50.5	359	21.32	
BRTBAR6P2478L	5562	6299	29	234	50.5	409	22.10	
BRTBAR6P2484L	5801	6579	29	252	50.5	434	22.88	
BRTBAR6P3060L	5153	5830	29	180	62.5	369	21.08	
BRTBAR6P3066L	5315	6036	29	198	62.5	400	21.97	
BRTBAR6P3072L	5506	6254	29	216	62.5	431	22.86	
BRTBAR6P3078L	5706	6471	29	234	62.5	462	23.75	
BRTBAR6P3084L	6036	6872	29	252	62.5	493	24.53	

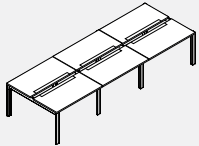
BRTBAR6PA-L • Rectangular Legs - Back 2 Back 6 Person Pod (Levelers) with Access Door

- **Back 2 Back, 6-person workstation consists of 6 worksurfaces, 2 Back 2 Back outer leg assemblies, 2 Back 2 Back narrow leg assemblies and 6 horizontal structural beams.**

- Finish options, please choose from
 - 1) anodized aluminum vertical legs with powder coated steel horizontal structural members.
Anodized aluminum leg upcharge of \$217 for this configuration.
 - 2) powder coated aluminum vertical legs and steel horizontal structural members. Choose from standard metal finishes.
- Anodized aluminum worksurface door provides access to power / data through below worksurface.
- Worksurface with access doors cannot be combined with above worksurface power trough.
- Worksurface available in HP and LP.

PRODUCT CODE	PRICE		SIZE / INCHES			WEIGHT		VOL FT ³
	LP	HP	H	W	D	LBS		
BRTBAR6PA2460L	5269	6216	29	180	50.5	308	19.76	
BRTBAR6PA2466L	5550	6600	29	198	50.5	329	20.54	
BRTBAR6PA2472L	5801	6999	29	216	50.5	359	21.32	
BRTBAR6PA3060L	5702	6899	29	180	62.5	369	21.08	
BRTBAR6PA3066L	6084	7380	29	198	62.5	400	21.97	
BRTBAR6PA3072L	6333	7781	29	216	62.5	431	22.86	

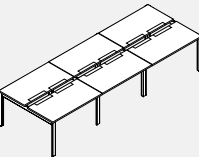
BRTBAR6PDA-L • Rectangular Legs - Back 2 Back 6 Person Pod (Levelers) with Access Doors

- **Back 2 Back, 6-person workstation consists of 6 worksurfaces, 2 Back 2 Back outer leg assemblies, 2 Back 2 Back narrow leg assemblies and 6 horizontal structural beams.**

- These tables feature dual access doors providing a central connection point for monitor lifts.
- Finish options, please choose from
 - 1) anodized aluminum vertical legs with powder coated steel horizontal structural members.
Anodized aluminum leg upcharge of \$217 for this configuration.
 - 2) powder coated aluminum vertical legs and steel horizontal structural members. Choose from standard metal finishes.
- Anodized aluminum worksurface door provides access to power / data through below worksurface.
- Worksurface with access doors cannot be combined with above worksurface power trough.
- Worksurface available in HP and LP.

PRODUCT CODE	PRICE		SIZE / INCHES			WEIGHT		VOL FT ³
	LP	HP	H	W	D	LBS		
BRTBAR6PDA2460L	5691	6715	29	180	50.5	308	19.76	
BRTBAR6PDA2466L	5996	7077	29	198	50.5	329	20.54	
BRTBAR6PDA2472L	6265	7559	29	216	50.5	359	21.32	
BRTBAR6PDA2478L	6427	7774	29	234	50.5	409	22.10	
BRTBAR6PDA2484L	6641	8148	29	252	50.5	434	22.88	
BRTBAR6PDA3060L	6156	7451	29	180	62.5	369	21.08	
BRTBAR6PDA3066L	6570	7971	29	198	62.5	400	21.97	
BRTBAR6PDA3072L	6840	8403	29	216	62.5	431	22.86	
BRTBAR6PDA3078L	7002	8724	29	234	62.5	462	23.75	
BRTBAR6PDA3084L	7272	9102	29	252	62.5	493	24.53	

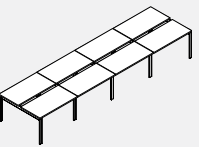
BRTBAR8P-L • Rectangular Legs - Back 2 Back 8 Person Pod (Levelers)

- **Back 2 Back, 8-person workstation consists of 8 worksurfaces, 2 Back 2 Back outer leg assemblies, 3 Back 2 Back narrow leg assemblies and 8 horizontal structural beams.**

- Finish options, please choose from:
 - 1) anodized aluminum vertical legs with powder coated steel horizontal structural members.
Anodized aluminum leg upcharge of \$271 for this configuration.
 - 2) powder coated aluminum vertical legs and steel horizontal structural members. Choose from standard metal finishes.
- Worksurface available in HP and LP. For wood veneer tops, please contact your Customer Service Representative.

PRODUCT CODE	PRICE		SIZE / INCHES			WEIGHT		VOL FT ³
	LP	HP	H	W	D	LBS		
BRTBAR8P2460L	6628	7507	29	240	50.5	412	24.42	
BRTBAR8P2466L	6782	7688	29	264	50.5	448	25.30	
BRTBAR8P2472L	6969	7926	29	288	50.5	484	26.30	
BRTBAR8P2478L	7259	8243	29	312	50.5	520	27.30	
BRTBAR8P2484L	7579	8615	29	336	50.5	556	28.30	
BRTBAR8P3060L	6748	7654	29	240	62.5	492	26.18	
BRTBAR8P3066L	6921	7876	29	264	62.5	536	27.28	
BRTBAR8P3072L	7175	8172	29	288	62.5	581	28.38	
BRTBAR8P3078L	7441	8466	29	312	62.5	625	29.48	
BRTBAR8P3084L	7876	8995	29	336	62.5	669	30.58	

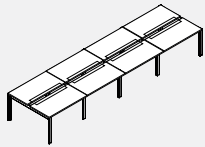
BRTBAR8PA-L • Rectangular Legs - Back 2 Back 8 Person Pod (Levelers) with Access Door

- **Back 2 Back, 8-person workstation consists of 8 worksurfaces, 2 Back 2 Back outer leg assemblies, 3 Back 2 Back narrow leg assemblies and 8 horizontal structural beams.**

- Finish options, please choose from:

- 1) anodized aluminum vertical legs with powder coated steel horizontal structural members.
Anodized aluminum leg upcharge of \$271 for this configuration.
- 2) powder coated aluminum vertical legs and steel horizontal structural members. Choose from standard metal finishes.
- Anodized aluminum worksurface door provides access to power / data through below worksurface.
- Worksurface with access doors cannot be combined with above worksurface power trough.
- Worksurface available in HP and LP.

PRODUCT CODE	PRICE		SIZE/INCHES			WEIGHT LBS	VOL FT ³
	LP	HP	H	W	D		
BRTBAR8PA2460L	6946	8210	29	240	50.5	412	24.42
BRTBAR8PA2466L	7246	8644	29	264	50.5	448	25.30
BRTBAR8PA2472L	7579	9175	29	288	50.5	484	26.30
BRTBAR8PA3060L	7479	9075	29	240	62.5	492	26.18
BRTBAR8PA3066L	7945	9675	29	264	62.5	536	27.28
BRTBAR8PA3072L	8278	10203	29	288	62.5	581	28.38

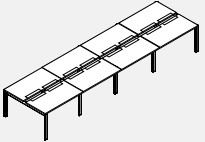
BRTBAR8PDA-L • Rectangular Legs - Back 2 Back 8 Person Pod (Levelers) with Access Doors

- **Back 2 Back, 8-person workstation consists of 8 worksurfaces, 2 Back 2 Back outer leg assemblies, 3 Back 2 Back narrow leg assemblies and 8 horizontal structural beams.**

- These tables feature dual access doors providing a central connection point for monitor lifts.

- Finish options, please choose from:

- 1) anodized aluminum vertical legs with powder coated steel horizontal structural members.
Anodized aluminum leg upcharge of \$271 for this configuration.
- 2) powder coated aluminum vertical legs and steel horizontal structural members. Choose from standard metal finishes.
- Anodized aluminum worksurface door provides access to power / data through below worksurface.
- Worksurface with access doors cannot be combined with above worksurface power trough.
- Worksurface available in HP and LP.

PRODUCT CODE	PRICE		SIZE/INCHES			WEIGHT LBS	VOL FT ³
	LP	HP	H	W	D		
BRTBAR8PDA2460L	7503	8867	29	240	50.5	412	24.42
BRTBAR8PDA2466L	7827	9336	29	264	50.5	448	25.30
BRTBAR8PDA2472L	8187	9911	29	288	50.5	484	26.30
BRTBAR8PDA2478L	8403	10195	29	312	50.5	520	27.30
BRTBAR8PDA2484L	8689	10700	29	336	50.5	556	28.30
BRTBAR8PDA3060L	8077	9803	29	240	62.5	492	26.18
BRTBAR8PDA3066L	8583	10449	29	264	62.5	536	27.28
BRTBAR8PDA3072L	8937	11022	29	288	62.5	581	28.38
BRTBAR8PDA3078L	9155	11454	29	312	62.5	625	29.48
BRTBAR8PDA3084L	9515	11783	29	336	62.5	669	30.58

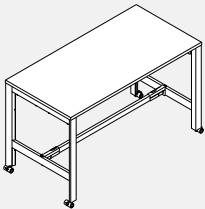
BRT36P-C • Rectangular Legs - 36" High Single Table (Casters)

- **Single table assembly consists of one worksurface, two H leg assemblies and all required beams.**

- 24" deep tables have three (3) beams at the top, and one bottom beam.
- 30" and 36" deep tables have four (4) beams at the top, and one bottom beam.
- 40mm white locking casters with grey tires.
- Finish option, please choose from:
 - 1) anodized aluminum vertical legs with powder coated steel horizontal structural members. Anodized aluminum leg upcharge of \$110 for this configuration.
 - 2) powder coated aluminum vertical legs with steel horizontal structural members. Choose from standard metal finishes.
- Worksurface available in LP and HP.

PRODUCT CODE	PRICE		SIZE/INCHES			WEIGHT LBS	VOL FT ³
	LP	HP	H	W	D		
BRT36P2436C	1948	2001	36	36	24	68.5	4.55
BRT36P2442C	2009	2078	36	42	24	76.0	4.76
BRT36P2448C	2086	2170	36	48	24	81.5	4.98
BRT36P2454C	2194	2289	36	54	24	88.0	5.19
BRT36P2460C	2264	2374	36	60	24	94.6	5.41
BRT36P2466C	2315	2428	36	66	24	101.1	5.62
BRT36P2472C	2364	2482	36	72	24	107.6	5.83
BRT36P2478C	2425	2549	36	78	24	114.1	6.13
BRT36P2484C	2485	2616	36	84	24	120.6	6.42
BRT36P3036C	2243	2306	36	36	30	83.9	5.00
BRT36P3042C	2341	2432	36	42	30	91.0	5.26
BRT36P3048C	2400	2495	36	48	30	99.2	5.53
BRT36P3054C	2505	2602	36	54	30	107.3	5.79
BRT36P3060C	2573	2686	36	60	30	115.5	6.06
BRT36P3066C	2629	2748	36	66	30	123.6	6.32
BRT36P3072C	2696	2818	36	72	30	131.8	6.59
BRT36P3078C	2762	2891	36	78	30	139.9	6.95
BRT36P3084C	2844	2984	36	84	30	148.1	7.32
BRT36P3642C	2538	2625	36	42	36	99.9	6.56
BRT36P3648C	2629	2723	36	48	36	109.0	6.87
BRT36P3654C	2750	2861	36	54	36	118.2	7.18
BRT36P3660C	2841	2959	36	60	36	126.3	7.48
BRT36P3666C	2929	3061	36	66	36	135.5	7.79
BRT36P3672C	3015	3157	36	72	36	144.6	8.10
BRT36P3678C	3102	3255	36	78	36	152.8	8.50
BRT36P3684C	3185	3350	36	84	36	161.9	8.91

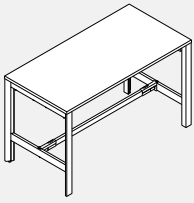
BRT36P-L • Rectangular Legs - 36" High Single Table (Levelers)

- Single table assembly consists of one worksurface, two H leg assemblies and all required beams.
- 24" deep tables have three (3) beams at the top, and one bottom beam.
- 30" and 36" deep tables have four (4) beams at the top, and one bottom beam.
- Finish option, please choose from:
 - 1) anodized aluminum vertical legs with powder coated steel horizontal structural members. Anodized aluminum leg upcharge of \$110 for this configuration
 - 2) powder coated aluminum vertical legs with steel horizontal structural members Choose from standard metal finishes
- Worksurface available in LP and HP.

PRODUCT CODE	PRICE		SIZE/INCHES			WEIGHT LBS	VOL FT ³
	LP	HP	H	W	D		
BRT36P2436L	1867	1919	36	36	24	68.0	4.55
BRT36P2442L	1928	1997	36	42	24	75.5	4.76
BRT36P2448L	2005	2089	36	48	24	81.0	4.98
BRT36P2454L	2115	2209	36	54	24	87.6	5.19
BRT36P2460L	2184	2292	36	60	24	94.1	5.41
BRT36P2466L	2234	2347	36	66	24	100.6	5.62
BRT36P2472L	2285	2403	36	72	24	107.1	5.83
BRT36P2478L	2345	2469	36	78	24	113.6	6.13
BRT36P2484L	2405	2536	36	84	24	120.2	6.42
BRT36P3036L	2161	2227	36	36	30	83.4	5.00
BRT36P3042L	2261	2351	36	42	30	90.5	5.26
BRT36P3048L	2320	2414	36	48	30	98.7	5.53
BRT36P3054L	2425	2521	36	54	30	106.8	5.79
BRT36P3060L	2494	2605	36	60	30	115.0	6.06
BRT36P3066L	2548	2669	36	66	30	123.1	6.32
BRT36P3072L	2614	2738	36	72	30	131.3	6.59
BRT36P3078L	2681	2810	36	78	30	139.4	6.95
BRT36P3084L	2763	2905	36	84	30	147.6	7.32
BRT36P3642L	2459	2545	36	42	36	99.4	6.56
BRT36P3648L	2548	2643	36	48	36	108.5	6.87
BRT36P3654L	2670	2778	36	54	36	117.7	7.18
BRT36P3660L	2760	2878	36	60	36	125.8	7.48
BRT36P3666L	2847	2980	36	66	36	135.0	7.79
BRT36P3672L	2934	3078	36	72	36	144.1	8.10
BRT36P3678L	3021	3175	36	78	36	152.3	8.50
BRT36P3684L	3104	3269	36	84	36	161.4	8.91

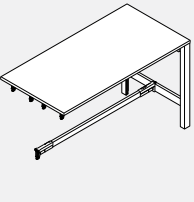
BRT36A-L • Rectangular Legs - 36" High Add-On (Levelers)

- Single table assembly consists of one worksurface, one H leg assembly and all required beams.
- 24" deep tables have three (3) beams at the top, and one bottom beam.
- 30" and 36" deep tables have four (4) beams at the top, and one bottom beam.
- Finish option, please choose from:
 - 1) anodized aluminum vertical legs with powder coated steel horizontal structural members. Anodized aluminum leg upcharge of \$55 for this configuration
 - 2) powder coated aluminum vertical legs with steel horizontal structural members Choose from standard metal finishes
- Worksurface available in LP and HP.

PRODUCT CODE	PRICE		SIZE/INCHES			WEIGHT LBS	VOL FT ³
	LP	HP	H	W	D		
BRT36A2436L	1407	1461	36	36	24	54.2	2.87
BRT36A2442L	1470	1539	36	42	24	61.7	3.08
BRT36A2448L	1545	1630	36	48	24	67.2	3.30
BRT36A2454L	1654	1748	36	54	24	73.7	3.51
BRT36A2460L	1723	1834	36	60	24	80.2	3.73
BRT36A2466L	1776	1888	36	66	24	86.8	3.94
BRT36A2472L	1824	1944	36	72	24	93.3	4.15
BRT36A2478L	1885	2009	36	78	24	99.8	4.45
BRT36A2484L	1947	2076	36	84	24	106.3	4.74
BRT36A3036L	1673	1738	36	36	30	67.5	3.24
BRT36A3042L	1772	1861	36	42	30	74.7	3.50
BRT36A3048L	1830	1923	36	48	30	82.8	3.77
BRT36A3054L	1935	2029	36	54	30	91.0	4.03
BRT36A3060L	2003	2116	36	60	30	99.1	4.30
BRT36A3066L	2059	2178	36	66	30	107.3	4.56
BRT36A3072L	2126	2247	36	72	30	115.4	4.83
BRT36A3078L	2193	2322	36	78	30	123.6	5.19
BRT36A3084L	2275	2415	36	84	30	131.7	5.56
BRT36A3642L	1900	1985	36	42	36	81.6	4.30
BRT36A3648L	1987	2086	36	48	36	90.8	4.61
BRT36A3654L	2112	2220	36	54	36	99.9	4.92
BRT36A3660L	2200	2322	36	60	36	108.1	5.22
BRT36A3666L	2289	2421	36	66	36	117.2	5.53
BRT36A3672L	2377	2519	36	72	36	126.4	5.84
BRT36A3678L	2462	2616	36	78	36	134.5	6.24
BRT36A3684L	2546	2709	36	84	36	143.7	6.65

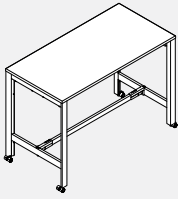
BRT42P-C • Rectangular Legs - 42" High Pod (Casters)

- Single table assembly consists of one worksurface, two H leg assemblies and all required beams.
- 24" deep tables have three (3) beams at the top, and one bottom beam.
- 30" and 36" deep tables have four (4) beams at the top, and one bottom beam.
- 40mm white locking casters with grey tires
- Finish option, please choose from:
 - 1) anodized aluminum vertical legs with powder coated steel horizontal structural members. Anodized aluminum leg upcharge of \$110 for this configuration
 - 2) powder coated aluminum vertical legs with steel horizontal structural members. Choose from standard metal finishes
- Worksurface available in LP and HP.

PRODUCT CODE	PRICE		SIZE / INCHES			WEIGHT		VOL FT ³
	LP	HP	H	W	D	LBS		
BRT42P2436C	1993	2047	42	36	24	70.4	5.11	
BRT42P2442C	2055	2125	42	42	24	77.9	5.32	
BRT42P2448C	2130	2217	42	48	24	83.4	5.54	
BRT42P2454C	2240	2334	42	54	24	89.9	5.75	
BRT42P2460C	2310	2419	42	60	24	96.5	5.97	
BRT42P2466C	2361	2472	42	66	24	103.0	6.18	
BRT42P2472C	2409	2528	42	72	24	109.5	6.39	
BRT42P2478C	2471	2594	42	78	24	116.0	6.69	
BRT42P2484C	2531	2664	42	84	24	122.5	6.98	
BRT42P3036C	2289	2354	42	36	30	85.8	5.60	
BRT42P3042C	2388	2476	42	42	30	92.9	5.86	
BRT42P3048C	2446	2539	42	48	30	101.1	6.13	
BRT42P3054C	2551	2646	42	54	30	109.2	6.39	
BRT42P3060C	2619	2732	42	60	30	117.4	6.66	
BRT42P3066C	2673	2795	42	66	30	125.5	6.92	
BRT42P3072C	2740	2865	42	72	30	133.7	7.19	
BRT42P3078C	2809	2936	42	78	30	141.8	7.55	
BRT42P3084C	2891	3033	42	84	30	150.0	7.92	
BRT42P3642C	2585	2671	42	42	36	101.8	7.34	
BRT42P3648C	2673	2769	42	48	36	110.9	7.65	
BRT42P3654C	2796	2905	42	54	36	120.1	7.96	
BRT42P3660C	2887	3006	42	60	36	128.2	8.26	
BRT42P3666C	2975	3105	42	66	36	137.4	8.57	
BRT42P3672C	3062	3204	42	72	36	146.5	8.88	
BRT42P3678C	3148	3301	42	78	36	154.7	9.28	
BRT42P3684C	3232	3394	42	84	36	163.8	9.69	

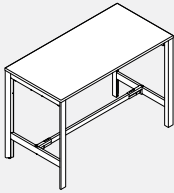
BRT42P-L • Rectangular Legs - 42" High Pod (Levelers)

- Single table assembly consists of one worksurface, two H leg assemblies and all required beams.
- 24" deep tables have three (3) beams at the top, and one bottom beam.
- 30" and 36" deep tables have four (4) beams at the top, and one bottom beam.
- Finish option, please choose from:
 - 1) anodized aluminum vertical legs with powder coated steel horizontal structural members. Anodized aluminum leg upcharge of \$110 for this configuration
 - 2) powder coated aluminum vertical legs with steel horizontal structural members. Choose from standard metal finishes
- Worksurface available in LP and HP.

PRODUCT CODE	PRICE		SIZE / INCHES			WEIGHT		VOL FT ³
	LP	HP	H	W	D	LBS		
BRT42P2436L	1914	1963	42	36	24	69.94	5.11	
BRT42P2442L	1975	2042	42	42	24	77.46	5.32	
BRT42P2448L	2050	2133	42	48	24	82.98	5.54	
BRT42P2454L	2159	2256	42	54	24	89.50	5.75	
BRT42P2460L	2231	2338	42	60	24	96.02	5.97	
BRT42P2466L	2279	2392	42	66	24	102.54	6.18	
BRT42P2472L	2329	2448	42	72	24	109.06	6.39	
BRT42P2478L	2391	2515	42	78	24	115.58	6.69	
BRT42P2484L	2450	2582	42	84	24	122.10	6.98	
BRT42P3036L	2209	2273	42	36	30	85.33	5.60	
BRT42P3042L	2304	2395	42	42	30	92.48	5.86	
BRT42P3048L	2365	2460	42	48	30	100.63	6.13	
BRT42P3054L	2471	2565	42	54	30	108.78	6.39	
BRT42P3060L	2538	2651	42	60	30	116.93	6.66	
BRT42P3066L	2593	2714	42	66	30	125.08	6.92	
BRT42P3072L	2660	2784	42	72	30	133.23	7.19	
BRT42P3078L	2730	2855	42	78	30	141.38	7.55	
BRT42P3084L	2810	2950	42	84	30	149.53	7.92	
BRT42P3642L	2503	2590	42	42	36	101.34	7.34	
BRT42P3648L	2593	2691	42	48	36	110.49	7.65	
BRT42P3654L	2716	2824	42	54	36	119.64	7.96	
BRT42P3660L	2806	2926	42	60	36	127.79	8.26	
BRT42P3666L	2893	3024	42	66	36	136.94	8.57	
BRT42P3672L	2981	3124	42	72	36	146.09	8.88	
BRT42P3678L	3067	3220	42	78	36	154.24	9.28	
BRT42P3684L	3151	3312	42	84	36	163.39	9.69	

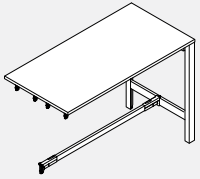
BRT42A-L • Rectangular Legs - 42" High Add-On (Levelers)

- **Single table assembly consists of one worksurface, one H leg assembly and all required beams.**
- 24" deep tables have three (3) beams at the top, and one bottom beam.
- 30" and 36" deep tables have four (4) beams at the top, and one bottom beam.
- Finish option, please choose from:
 - 1) anodized aluminum vertical legs with powder coated steel horizontal structural members. Anodized aluminum leg upcharge of \$55 for this configuration
 - 2) powder coated aluminum vertical legs with steel horizontal structural members.
- Choose from standard metal finishes
- Worksurface available in LP and HP.

PRODUCT CODE	PRICE		SIZE/INCHES			WEIGHT		VOL FT ³
	LP	HP	H	W	D	LBS		
BRT42A2436L	1431	1483	42	36	24	55.15	3.15	
BRT42A2442L	1494	1561	42	42	24	62.67	3.36	
BRT42A2448L	1568	1653	42	48	24	68.19	3.58	
BRT42A2454L	1677	1774	42	54	24	74.71	3.79	
BRT42A2460L	1747	1856	42	60	24	81.23	4.01	
BRT42A2466L	1799	1911	42	66	24	87.75	4.22	
BRT42A2472L	1846	1963	42	72	24	94.27	4.43	
BRT42A2478L	1908	2032	42	78	24	100.79	4.73	
BRT42A2484L	1970	2099	42	84	24	107.31	5.02	
BRT42A3036L	1696	1759	42	36	30	68.52	3.54	
BRT42A3042L	1791	1884	42	42	30	75.67	3.80	
BRT42A3048L	1853	1948	42	48	30	83.82	4.07	
BRT42A3054L	1958	2053	42	54	30	91.97	4.33	
BRT42A3060L	2026	2138	42	60	30	100.12	4.60	
BRT42A3066L	2081	2200	42	66	30	108.27	4.86	
BRT42A3072L	2149	2272	42	72	30	116.42	5.13	
BRT42A3078L	2217	2344	42	78	30	124.57	5.49	
BRT42A3084L	2298	2437	42	84	30	132.72	5.86	
BRT42A3642L	1922	2009	42	42	36	82.60	4.69	
BRT42A3648L	2013	2107	42	48	36	91.75	5.00	
BRT42A3654L	2132	2243	42	54	36	100.90	5.31	
BRT42A3660L	2223	2344	42	60	36	109.05	5.61	
BRT42A3666L	2312	2443	42	66	36	118.20	5.92	
BRT42A3672L	2400	2541	42	72	36	127.35	6.23	
BRT42A3678L	2485	2639	42	78	36	135.50	6.63	
BRT42A3684L	2568	2733	42	84	36	144.65	7.04	

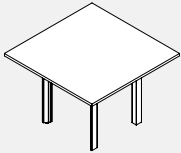
BRTSQ • Rectangular Legs - Meeting Table - Rectangular

- **Rectangular meeting tables; levelers or casters**
- LP or HP tops, 3mm edging.
- Anodized aluminum leg upcharge of \$110 for this configuration.
- Includes top, legs and beam.
- L = Levelers
- C = Casters
- Worksurface available in HP and LP. For wood veneer tops, please contact your Customer Service Representative.

PRODUCT CODE	PRICE		SIZE/INCHES			WEIGHT		VOL FT ³
	LP	HP	H	W	D	LBS		
BRTSQ42L	1258	1389	29	42	42	85	4.20	
BRTSQ42C	1324	1456	29	42	42	85	4.20	

BRTR • Rectangular Legs - Meeting Table - Round

- **Round meeting tables; levelers or casters**
- LP or HP tops, 3mm edging.
- Anodized aluminum leg upcharge of \$110 for this configuration.
- Includes top, legs and beam.
- L = Levelers
- C = Casters
- Worksurface available in HP and LP. For wood veneer tops, please contact your Customer Service Representative.

PRODUCT CODE	PRICE		SIZE/INCHES			WEIGHT		VOL FT ³
	LP	HP	H	W	D	LBS		
BRTR42L	1258	1389	29	42	42	65	3.90	
BRTR42C	1324	1456	29	42	42	65	3.90	

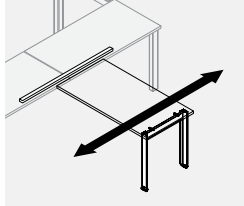
BRTSLDT72C • Rectangular Legs - Rail Sliding Table Kit

- **Includes leg, leg support, sliding bracket hardware, 72" rail and hardware to secure table. Worksurface not included.**
- 40mm dia. locking casters with 8mm thread, white body and grey tires.
- Legs included are for 24" deep worksurfaces.
- Anodized aluminum leg upcharge of \$55 for this configuration.
- Maximum length of the sliding table surface is 48".

PRODUCT CODE	PRICE	SIZE/INCHES			WEIGHT		VOL FT ³
		H	W	D	LBS		
BRTSLDT72C	665	29	48	72	28.5	2.40	

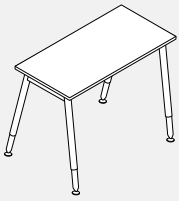
BRTS1P-LR • Round Legs Single Line 1 Person Pod (Levelers)

- Single Line Table Assemblies consist of one worksurface, two leg assemblies and one horizontal structural beam.
- Worksurface available in HP and LP. For wood veneer tops, please contact your Customer Service Representative.

PRODUCT CODE	PRICE		SIZE/INCHES			WEIGHT LBS	VOL FT ³
	LP	HP	H	W	D		
BRTS1P2436LR	1079	1117	29	36	24	45	4.00
BRTS1P2442LR	1117	1169	29	42	24	48	4.10
BRTS1P2448LR	1167	1254	29	48	24	51	4.20
BRTS1P2451LR	1198	1269	29	50.5	24	54	4.30
BRTS1P2454LR	1243	1325	29	54	24	57	4.40
BRTS1P2460LR	1270	1382	29	60	24	60	4.48
BRTS1P2463LR	1288	1396	29	62.5	24	63	4.57
BRTS1P2466LR	1296	1407	29	66	24	66	4.65
BRTS1P2472LR	1320	1437	29	72	24	69	4.73
BRTS1P2478LR	1355	1476	29	78	24	72	4.82
BRTS1P2484LR	1395	1525	29	84	24	75	4.92
BRTS1P3036LR	1050	1112	29	36	30	45	4.00
BRTS1P3042LR	1170	1262	29	42	30	48	4.10
BRTS1P3048LR	1197	1291	29	48	30	51	4.20
BRTS1P3051LR	1234	1330	29	50.5	30	54	4.30
BRTS1P3054LR	1258	1351	29	54	30	57	4.40
BRTS1P3060LR	1289	1383	29	60	30	60	4.48
BRTS1P3063LR	1299	1415	29	62.5	30	63	4.57
BRTS1P3066LR	1306	1429	29	66	30	66	4.65
BRTS1P3072LR	1339	1448	29	72	30	69	4.73
BRTS1P3078LR	1372	1500	29	78	30	72	4.82
BRTS1P3084LR	1429	1568	29	84	30	75	4.92

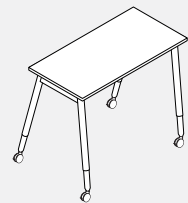
BRTS1P-CR • Round Legs Single Line 1 Person Pod (Casters)

- Single Line Table Assemblies consist of one worksurface, two leg assemblies and one horizontal structural beam.
- Worksurface available in HP and LP. For wood veneer tops, please contact your Customer Service Representative.

PRODUCT CODE	PRICE		SIZE/INCHES			WEIGHT LBS	VOL FT ³
	LP	HP	H	W	D		
BRTS1P2436CR	1158	1197	29	36	24	45	4.00
BRTS1P2442CR	1197	1246	29	42	24	48	4.10
BRTS1P2448CR	1243	1329	29	48	24	51	4.20
BRTS1P2451CR	1275	1351	29	50.5	24	54	4.30
BRTS1P2454CR	1326	1404	29	54	24	57	4.40
BRTS1P2460CR	1352	1461	29	60	24	60	4.48
BRTS1P2463CR	1366	1475	29	62.5	24	63	4.57
BRTS1P2466CR	1374	1487	29	66	24	66	4.65
BRTS1P2472CR	1397	1517	29	72	24	69	4.73
BRTS1P2478CR	1435	1559	29	78	24	72	4.82
BRTS1P2484CR	1474	1605	29	84	24	75	4.92
BRTS1P3036CR	1128	1194	29	36	30	45	4.00
BRTS1P3042CR	1254	1340	29	42	30	48	4.10
BRTS1P3048CR	1273	1369	29	48	30	51	4.20
BRTS1P3051CR	1315	1411	29	50.5	30	54	4.30
BRTS1P3054CR	1333	1430	29	54	30	57	4.40
BRTS1P3060CR	1367	1463	29	60	30	60	4.48
BRTS1P3063CR	1378	1496	29	62.5	30	63	4.57
BRTS1P3066CR	1389	1508	29	66	30	66	4.65
BRTS1P3072CR	1424	1527	29	72	30	69	4.73
BRTS1P3078CR	1454	1581	29	78	30	72	4.82
BRTS1P3084CR	1508	1647	29	84	30	75	4.92

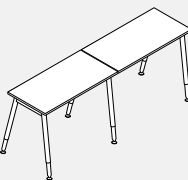
BRTS2P-LR • Round Legs Single Line 2 Person Pod (Levelers)

- Single Line Table Assemblies consists of 2 worksurfaces, 3 leg assemblies and 2 horizontal structural beams.
- Worksurface available in HP and LP. For wood veneer tops, please contact your Customer Service Representative.

PRODUCT CODE	PRICE		SIZE/INCHES			WEIGHT LBS	VOL FT ³
	LP	HP	H	W	D		
BRTS2P2448LR	1981	2149	29	96	24	95	6.21
BRTS2P2454LR	2104	2292	29	108	24	104	6.45
BRTS2P2460LR	2191	2411	29	120	24	113	6.71
BRTS2P2466LR	2244	2463	29	132	24	122	6.95
BRTS2P2472LR	2286	2525	29	144	24	131	7.13
BRTS2P2478LR	2356	2603	29	156	24	140	7.27
BRTS2P2484LR	2449	2696	29	168	24	149	7.41
BRTS2P3048LR	2071	2261	29	96	30	113	6.57
BRTS2P3054LR	2157	2348	29	108	30	122	6.85
BRTS2P3060LR	2221	2447	29	120	30	131	7.13
BRTS2P3066LR	2264	2502	29	132	30	140	7.41
BRTS2P3072LR	2327	2576	29	144	30	155	7.69
BRTS2P3078LR	2393	2651	29	156	30	164	7.97
BRTS2P3084LR	2502	2783	29	168	30	173	8.25

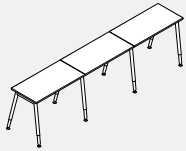
BRTS3P-LR • Round Legs Single Line 3 Person Pod (Levelers)

- Single Line, 3-person workstation consists of 3 worksurfaces, 4 leg assemblies and 3 horizontal structural beams.
- Worksurface available in HP and LP. For wood veneer tops, please contact your Customer Service Representative.

PRODUCT CODE	PRICE		SIZE/INCHES			WEIGHT VOL	
	LP	HP	H	W	D	LBS	FT ³
BRTS3P2448LR	2790	3046	29	144	24	138	8.47
BRTS3P2454LR	2981	3263	29	162	24	152	8.68
BRTS3P2460LR	3111	3440	29	180	24	165	8.89
BRTS3P2466LR	3180	3521	29	198	24	179	9.11
BRTS3P2472LR	3251	3611	29	216	24	192	9.32
BRTS3P2478LR	3357	3730	29	234	24	206	9.53
BRTS3P2484LR	3479	3867	29	252	24	219	9.74
BRTS3P3048LR	2931	3217	29	144	30	161	9.01
BRTS3P3054LR	3062	3346	29	162	30	178	9.44
BRTS3P3060LR	3156	3494	29	180	30	195	9.87
BRTS3P3066LR	3220	3580	29	198	30	212	10.30
BRTS3P3072LR	3316	3689	29	216	30	229	10.72
BRTS3P3078LR	3414	3798	29	234	30	246	11.16
BRTS3P3084LR	3580	3997	29	252	30	263	11.59

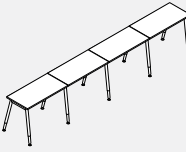
BRTS4P-LR • Round Legs Single Line 4 Person Pod (Levelers)

- Single Line, 4-person workstation consists of 4 worksurfaces, 5 leg assemblies and 3 horizontal structural beams.
- Worksurface available in HP and LP. For wood veneer tops, please contact your Customer Service Representative.

PRODUCT CODE	PRICE		SIZE/INCHES			WEIGHT VOL	
	LP	HP	H	W	D	LBS	FT ³
BRTS4P2448LR	3564	3943	29	192	24	180	10.73
BRTS4P2454LR	3855	4234	29	216	24	199	11.22
BRTS4P2460LR	4015	4468	29	240	24	217	11.71
BRTS4P2466LR	4124	4576	29	264	24	236	12.20
BRTS4P2472LR	4216	4693	29	288	24	254	12.69
BRTS4P2478LR	4363	4852	29	312	24	273	13.18
BRTS4P2484LR	4521	5040	29	336	24	291	13.67
BRTS4P3048LR	3790	4168	29	192	30	213	11.45
BRTS4P3054LR	3961	4341	29	216	30	235	12.02
BRTS4P3060LR	4089	4541	29	240	30	257	12.59
BRTS4P3066LR	4177	4654	29	264	30	279	13.16
BRTS4P3072LR	4302	4800	29	288	30	301	13.73
BRTS4P3078LR	4433	4947	29	312	30	323	14.30
BRTS4P3084LR	4654	5215	29	336	30	345	14.87

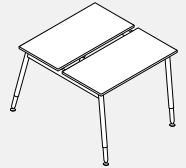
BRTBAR2P-LR • Round Legs Back 2 Back 2 Person Pod (Levelers)

- Back 2 Back, 2-person workstation consists of 2 worksurfaces, 2 Back 2 Back leg assemblies and 2 horizontal structural beams.
- Worksurface available in HP and LP. For wood veneer tops, please contact your Customer Service Representative.

PRODUCT CODE	PRICE		SIZE/INCHES			WEIGHT VOL	
	LP	HP	H	W	D	LBS	FT ³
BRTBAR2P2460LR	2051	2269	29	60	50.5	110	8.56
BRTBAR2P2466LR	2098	2324	29	66	50.5	119	8.76
BRTBAR2P2472LR	2145	2383	29	72	50.5	128	9.02
BRTBAR2P2478LR	2219	2463	29	78	50.5	137	9.20
BRTBAR2P2484LR	2281	2538	29	84	50.5	146	9.40
BRTBAR2P3060LR	1907	2306	29	60	62.5	130	9.00
BRTBAR2P3066LR	2125	2364	29	66	62.5	141	9.25
BRTBAR2P3072LR	2188	2429	29	72	62.5	152	9.54
BRTBAR2P3078LR	2256	2508	29	78	62.5	163	9.80
BRTBAR2P3084LR	2364	2644	29	84	62.5	174	10.4

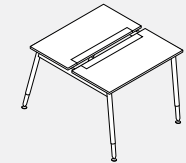
BRTBAR2PA-LR • Round Legs Back 2 Back 2 Person Pod with Access Door (Levelers)

- Back 2 Back, 2-person workstation consists of 2 worksurfaces, 2 Back 2 Back leg assemblies and 2 horizontal structural beams.
- Anodized aluminum worksurface door provides access to power / data through below worksurface.
- Worksurface with access doors cannot be combined with above worksurface power trough.
- Worksurface available in HP and LP.

PRODUCT CODE	PRICE		SIZE/INCHES			WEIGHT VOL	
	LP	HP	H	W	D	LBS	FT ³
BRTBAR2PA2460LR	2130	2447	29	60	50.5	110	8.56
BRTBAR2PA2466LR	2213	2563	29	66	50.5	119	8.76
BRTBAR2PA2472LR	2298	2696	29	72	50.5	128	9.02
BRTBAR2PA3060LR	2264	2664	29	60	62.5	130	9.00
BRTBAR2PA3066LR	2381	2812	29	66	62.5	141	9.25
BRTBAR2PA3072LR	2463	2947	29	72	62.5	152	9.54

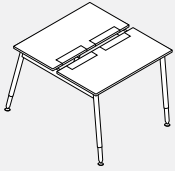
BRTBAR2PDA-LR • Round Legs Back 2 Back 2 Person Pod with Access Door (Levelers)

- Back 2 Back, 2-person workstation consists of 2 worksurfaces, 2 Back 2 Back leg assemblies and 2 horizontal structural beams.
- These tables feature dual access doors providing a central connection point for monitor lifts.
- Anodized aluminum worksurface door provides access to power / data through below worksurface.
- Worksurface with access doors cannot be combined with above worksurface power trough.
- Worksurface available in HP and LP.

PRODUCT CODE	PRICE		SIZE/INCHES			WEIGHT LBS	VOL FT ³
	LP	HP	H	W	D		
BRTBAR2PDA2460LR	2301	2644	29	60	50.5	110	8.56
BRTBAR2PDA2466LR	2392	2768	29	66	50.5	119	8.76
BRTBAR2PDA2472LR	2480	2911	29	72	50.5	128	9.02
BRTBAR2PDA2478LR	2536	2983	29	78	50.5	137	9.20
BRTBAR2PDA2484LR	2589	3092	29	84	50.5	146	9.40
BRTBAR2PDA3060LR	2443	2876	29	60	62.5	130	9.00
BRTBAR2PDA3066LR	2571	3039	29	66	62.5	141	9.25
BRTBAR2PDA3072LR	2659	3183	29	72	62.5	152	9.54
BRTBAR2PDA3078LR	2716	3289	29	78	62.5	163	9.80
BRTBAR2PDA3084LR	2805	3414	29	84	62.5	174	10.4

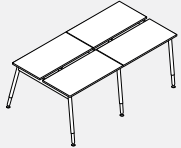
BRTBAR4P-LR • Round Legs Back 2 Back 4 Person Pod (Levelers)

- Back 2 Back, 4-person workstation consists of 4 worksurfaces, 3 Back 2 Back leg assemblies and 4 horizontal structural beams.
- Worksurface available in HP and LP. For wood veneer tops, please contact your Customer Service Representative.

PRODUCT CODE	PRICE		SIZE/INCHES			WEIGHT LBS	VOL FT ³
	LP	HP	H	W	D		
BRTBAR4P2460LR	3645	4081	29	120	50.5	208	13.82
BRTBAR4P2466LR	3736	4190	29	132	50.5	224	14.28
BRTBAR4P2472LR	3829	4308	29	144	50.5	240	14.74
BRTBAR4P2478LR	3978	4468	29	156	50.5	256	15.20
BRTBAR4P2484LR	4135	4654	29	168	50.5	272	15.66
BRTBAR4P3060LR	3736	4190	29	120	62.5	253	14.70
BRTBAR4P3066LR	3758	4234	29	132	62.5	273	15.24
BRTBAR4P3072LR	3917	4415	29	144	62.5	293	15.78
BRTBAR4P3078LR	4048	4561	29	156	62.5	313	16.32
BRTBAR4P3084LR	4269	4826	29	168	62.5	333	16.86

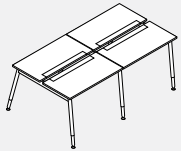
BRTBAR4PA-LR • Round Legs Back 2 Back 4 Person Pod with Access Door (Levelers)

- Back 2 Back, 4-person workstation consists of 4 worksurfaces, 3 Back 2 Back leg assemblies and 4 horizontal structural beams.
- Anodized aluminum worksurface door provides access to power / data through below worksurface.
- Worksurface with access doors cannot be combined with above worksurface power trough.
- Worksurface available in HP and LP.

PRODUCT CODE	PRICE		SIZE/INCHES			WEIGHT LBS	VOL FT ³
	LP	HP	H	W	D		
BRTBAR4PA2460LR	3802	4433	29	120	50.5	208	13.82
BRTBAR4PA2466LR	4044	4742	29	132	50.5	224	14.28
BRTBAR4PA2472LR	4135	4933	29	144	50.5	240	14.74
BRTBAR4PA3060LR	4102	4902	29	120	62.5	253	14.70
BRTBAR4PA3066LR	4368	5165	29	132	62.5	273	15.24
BRTBAR4PA3072LR	4468	5431	29	144	62.5	293	15.78

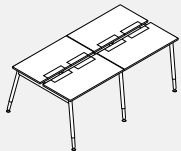
BRTBAR4PDA-LR • Round Legs Back 2 Back 4 Person Pod with Access Door (Levelers)

- Back 2 Back, 4-person workstation consists of 4 worksurfaces, 3 Back 2 Back leg assemblies and 4 horizontal structural beams.
- These tables feature dual access doors providing a central connection point for monitor lifts.
- Anodized aluminum worksurface door provides access to power / data through below worksurface.
- Worksurface with access doors cannot be combined with above worksurface power trough.
- Worksurface available in HP and LP.

PRODUCT CODE	PRICE		SIZE/INCHES			WEIGHT LBS	VOL FT ³
	LP	HP	H	W	D		
BRTBAR4PDA2460LR	4106	4788	29	120	50.5	208	13.82
BRTBAR4PDA2466LR	4366	5122	29	132	50.5	224	14.28
BRTBAR4PDA2472LR	4467	5327	29	144	50.5	240	14.74
BRTBAR4PDA2478LR	4573	5471	29	156	50.5	256	15.20
BRTBAR4PDA2484LR	4716	5722	29	168	50.5	272	15.66
BRTBAR4PDA3060LR	4430	5293	29	120	62.5	253	14.70
BRTBAR4PDA3066LR	4716	5577	29	132	62.5	273	15.24
BRTBAR4PDA3072LR	4825	5866	29	144	62.5	293	15.78
BRTBAR4PDA3078LR	4933	6083	29	156	62.5	313	16.32
BRTBAR4PDA3084LR	5112	6332	29	168	62.5	333	16.86

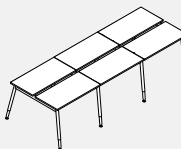
BRTBAR6P-LR • Round Legs Back 2 Back 6 Person Pod (Levelers)

- Back 2 Back, 6-person workstation consists of 6 worksurfaces, 4 Back 2 Back leg assemblies and 6 horizontal structural beams.
- Worksurface available in HP and LP. For wood veneer tops, please contact your Customer Service Representative.

PRODUCT CODE	PRICE		SIZE/INCHES			WEIGHT LBS	VOL FT ³
	LP	HP	H	W	D		
BRTBAR6P2460LR	5235	5906	29	180	50.5	308	19.76
BRTBAR6P2466LR	5375	6053	29	198	50.5	329	20.54
BRTBAR6P2472LR	5515	6234	29	216	50.5	359	21.32
BRTBAR6P2478LR	5735	6471	29	234	50.5	409	22.10
BRTBAR6P2484LR	5974	6751	29	252	50.5	434	22.88
BRTBAR6P3060LR	5325	6005	29	180	62.5	369	21.08
BRTBAR6P3066LR	5456	6175	29	198	62.5	400	21.97
BRTBAR6P3072LR	5644	6392	29	216	62.5	431	22.86
BRTBAR6P3078LR	5846	6612	29	234	62.5	462	23.75
BRTBAR6P3084LR	6182	7011	29	252	62.5	493	24.53

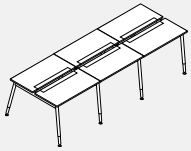
BRTBAR6PA-LR • Round Legs Back 2 Back 6 Person Pod with Access Door (Levelers)

- Back 2 Back, 6-person workstation consists of 6 worksurfaces, 4 Back 2 Back leg assemblies and 6 horizontal structural beams.
- Anodized aluminum worksurface door provides access to power / data through below worksurface.
- Worksurface with access doors cannot be combined with above worksurface power trough.
- Worksurface available in HP and LP.

PRODUCT CODE	PRICE		SIZE/INCHES			WEIGHT VOL	
	LP	HP	H	W	D	LBS	FT ³
BRTBAR6PA2460LR	5477	6424	29	180	50.5	308	19.76
BRTBAR6PA2466LR	5723	6773	29	198	50.5	329	20.54
BRTBAR6PA2472LR	5974	7173	29	216	50.5	359	21.32
BRTBAR6PA3060LR	5876	7071	29	180	62.5	369	21.08
BRTBAR6PA3066LR	6222	7520	29	198	62.5	400	21.97
BRTBAR6PA3072LR	6471	7919	29	216	62.5	431	22.86

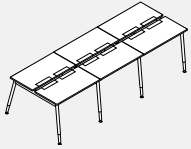
BRTBAR6PDA-LR • Round Legs Back 2 Back 6 Person Pod with Access Door (Levelers)

- Back 2 Back, 6-person workstation consists of 6 worksurfaces, 4 Back 2 Back leg assemblies and 6 horizontal structural beams.
- These tables feature dual access doors providing a central connection point for monitor lifts.
- Anodized aluminum worksurface door provides access to power / data through below worksurface.
- Worksurface with access doors cannot be combined with above worksurface power trough.
- Worksurface available in HP and LP.

PRODUCT CODE	PRICE		SIZE/INCHES			WEIGHT VOL	
	LP	HP	H	W	D	LBS	FT ³
BRTBAR6PDA2460LR	5914	6937	29	180	50.5	308	19.76
BRTBAR6PDA2466LR	6181	7315	29	198	50.5	329	20.54
BRTBAR6PDA2472LR	6454	7746	29	216	50.5	359	21.32
BRTBAR6PDA2478LR	6612	7958	29	234	50.5	409	22.10
BRTBAR6PDA2484LR	6831	8336	29	252	50.5	434	22.88
BRTBAR6PDA3060LR	6345	7635	29	180	62.5	369	21.08
BRTBAR6PDA3066LR	6720	8123	29	198	62.5	400	21.97
BRTBAR6PDA3072LR	6991	8551	29	216	62.5	431	22.86
BRTBAR6PDA3078LR	7151	8873	29	234	62.5	462	23.75
BRTBAR6PDA3084LR	7419	9254	29	252	62.5	493	24.53

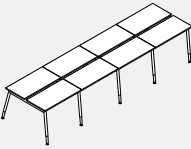
BRTBAR8P-LR • Round Legs Back 2 Back 8 Person Pod (Levelers)

- Back 2 Back, 8-person workstation consists of 8 worksurfaces, 5 Back 2 Back leg assemblies and 8 horizontal structural beams.
- Worksurface available in HP and LP. For wood veneer tops, please contact your Customer Service Representative.

PRODUCT CODE	PRICE		SIZE/INCHES			WEIGHT VOL	
	LP	HP	H	W	D	LBS	FT ³
BRTBAR8P2460LR	6828	7705	29	240	50.5	412	24.42
BRTBAR8P2466LR	7015	7919	29	264	50.5	448	25.30
BRTBAR8P2472LR	7202	8159	29	288	50.5	484	26.30
BRTBAR8P2478LR	7493	8477	29	312	50.5	520	27.30
BRTBAR8P2484LR	7826	8850	29	336	50.5	556	28.30
BRTBAR8P3060LR	6946	7851	29	240	62.5	492	26.18
BRTBAR8P3066LR	7121	8077	29	264	62.5	536	27.28
BRTBAR8P3072LR	7375	8372	29	288	62.5	581	28.38
BRTBAR8P3078LR	7637	8664	29	312	62.5	625	29.48
BRTBAR8P3084LR	8077	9195	29	336	62.5	669	30.58

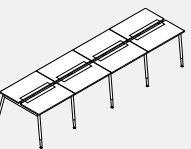
BRTBAR8PA-LR • Round Legs Back 2 Back 8 Person Pod with Access Door (Levelers)

- Back 2 Back, 8-person workstation consists of 8 worksurfaces, 5 Back 2 Back leg assemblies and 8 horizontal structural beams.
- Anodized aluminum worksurface door provides access to power / data through below worksurface.
- Worksurface with access doors cannot be combined with above worksurface power trough.
- Worksurface available in HP and LP.

PRODUCT CODE	PRICE		SIZE/INCHES			WEIGHT VOL	
	LP	HP	H	W	D	LBS	FT ³
BRTBAR8PA2460LR	7148	8411	29	240	50.5	412	24.42
BRTBAR8PA2466LR	7479	8874	29	264	50.5	448	25.30
BRTBAR8PA2472LR	7813	9408	29	288	50.5	484	26.30
BRTBAR8PA3060LR	7680	9275	29	240	62.5	492	26.18
BRTBAR8PA3066LR	8144	9873	29	264	62.5	536	27.28
BRTBAR8PA3072LR	8477	10404	29	288	62.5	581	28.38

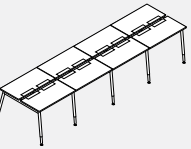
BRTBAR8PDA-LR • Round Legs Back 2 Back 8 Person Pod with Access Door (Levelers)

- Back 2 Back, 8-person workstation consists of 8 worksurfaces, 5 Back 2 Back leg assemblies and 8 horizontal structural beams.
- These tables feature dual access doors providing a central connection point for monitor lifts.
- Anodized aluminum worksurface door provides access to power / data through below worksurface.
- Worksurface with access doors cannot be combined with above worksurface power trough.
- Worksurface available in HP and LP.

PRODUCT CODE	PRICE		SIZE/INCHES			WEIGHT VOL	
	LP	HP	H	W	D	LBS	FT ³
BRTBAR8PDA2460LR	7719	9084	29	240	50.5	412	24.42
BRTBAR8PDA2466LR	8077	9586	29	264	50.5	448	25.30
BRTBAR8PDA2472LR	8439	10161	29	288	50.5	484	26.30
BRTBAR8PDA2478LR	8652	10449	29	312	50.5	520	27.30
BRTBAR8PDA2484LR	8937	10949	29	336	50.5	556	28.30
BRTBAR8PDA3060LR	8295	10017	29	240	62.5	492	26.18
BRTBAR8PDA3066LR	8796	10664	29	264	62.5	536	27.28
BRTBAR8PDA3072LR	9155	11238	29	288	62.5	581	28.38
BRTBAR8PDA3078LR	9370	11668	29	312	62.5	625	29.48
BRTBAR8PDA3084LR	9730	12172	29	336	62.5	669	30.58

BRTSLDT72CR • Sliding Table Kit (Round Legs)

- Includes leg, leg support, sliding bracket hardware, 72" rail and hardware to secure table. Worksurface not included.
- Maximum length of the Sliding Table surface is 48".
- Locking casters are 3" diameter as standard.

PRODUCT CODE	PRICE	SIZE/INCHES			WEIGHT VOL	
		H	W	D	LBS	FT ³
BRTSLDT72CR	665	29	48	72	28.5	2.40

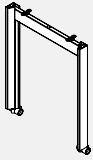
BRTSL-C • Single Leg Assembly (Casters)

- **Two Single Leg Assemblies form the structure of the Bridges series Single Table.**
- 40mm white locking casters with grey tires; steel frame, aluminum legs.
- Anodized aluminum leg upcharge \$55.
- Please specify paint finish for support.

PRODUCT CODE	PRICE	SIZE/INCHES			WEIGHT VOL	
		H	W	D	LBS	FT ³
BRTSL24C	439	28	2.5	24	8	1.34
BRTSL30C	456	28	2.5	30	8	1.41
BRTSL36C	476	28	2.5	36	8	1.81

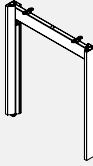
BRTSL-L • Single Leg Assembly (Levelers)

- **Two Single Leg Assemblies form the structure of the Bridges series Single Line Tables.**
- One leg can be shared by 2 adjoining worksurfaces.
- Leveling glides, steel frame, aluminum legs.
- Anodized aluminum leg upcharge \$55.
- Please specify paint finish for support.
- Please specify 2 beams when using BRTSL36L.

PRODUCT CODE	PRICE	SIZE/INCHES			WEIGHT VOL	
		H	W	D	LBS	FT ³
BRTSL24L	399	28	2.5	24	8	1.34
BRTSL30L	417	28	2.5	30	8	1.34
BRTSL36L	435	28	2.5	36	9	1.50

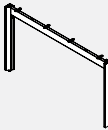
BRTBA-L • Back 2 Back Leg Assembly (Levelers)

- **Two Back 2 Back Leg Assemblies form the structure of the Bridges series Back 2 Back Tables.**
- One double leg can be shared by 4 adjoining worksurfaces.
- Leveling, steel frame, aluminum legs.
- Anodized aluminum leg upcharge \$55.
- Please specify paint finish for support.

PRODUCT CODE	PRICE	SIZE/INCHES			WEIGHT VOL	
		H	W	D	LBS	FT ³
BRTBA34L	399	28	2.5	34	10	2.47
BRTBA51L	433	28	2.5	50.5	12	2.96
BRTBA63L	450	28	2.5	62.5	13	3.21

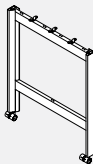
BRTHL-C • Single "H" Leg Assembly (Casters)

- **Two Single Leg Assemblies form the structure of the Bridges series Single Line Tables.**
- Leveling glides, steel frame, aluminum legs.
- Anodized aluminum leg upcharge \$55.
- Please specify paint finish for support.
- Note:
 - 24" deep tables must have three (3) beams at the top, and one beam (BRTBB-C "Bottom Table Beam") at the bottom.
 - 30" and 36" deep tables must have four (4) beams at the top, and one beam (BRTBB-C "Bottom Table Beam") at the bottom.

PRODUCT CODE	PRICE	SIZE/INCHES			WEIGHT VOL	
		H	W	D	LBS	FT ³
BRTHL3624C	500	35	2.5	24	14	1.68
BRTHL3630C	528	35	2.5	30	16	1.76
BRTHL3636C	600	35	2.5	36	18	2.26
BRTHL4224C	522	41	2.5	24	15	1.96
BRTHL4230C	552	41	2.5	30	17	2.06
BRTHL4236C	622	41	2.5	36	19	2.65

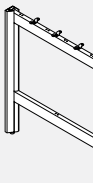
BRTHL-L • Single "H" Leg Assembly (Levelers)

- **Two Single Leg Assemblies form the structure of the Bridges series Single Line Tables.**
- One leg can be shared by 2 adjoining worksurfaces.
- Leveling glides, steel frame, aluminum legs.
- Anodized aluminum leg upcharge \$55.
- Please specify paint finish for support.
- Note:
 - 24" deep tables must have three (3) beams at the top, and one beam (BRTBB-C "Bottom Table Beam") at the bottom.
 - 30" and 36" deep tables must have four (4) beams at the top, and one beam (BRTBB-C "Bottom Table Beam") at the bottom.

PRODUCT CODE	PRICE	SIZE/INCHES			WEIGHT VOL	
		H	W	D	LBS	FT ³
BRTHL3624L	459	35	2.5	24	14	1.68
BRTHL3630L	488	35	2.5	30	16	1.76
BRTHL3636L	557	35	2.5	36	18	2.26
BRTHL4224L	483	41	2.5	24	15	1.96
BRTHL4230L	513	41	2.5	30	17	2.06
BRTHL4236L	581	41	2.5	36	19	2.65

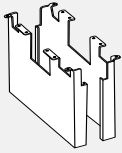
BRTDLSHS34 • 34" Leg Shroud

- A two part steel enclosure creates 5" deep and 30" wide cable management cavity between 34" rectangular table legs.
- Hides floor power feeds as well as data/communication cables rising from floor monuments to the underside of Bridges II tables.
- Secures to BRTBA34L rectangular leg and to underside of worksurfaces.
- Specify paint finish.

PRODUCT CODE	PRICE	SIZE/INCHES			WEIGHT VOL	
		H	W	D	LBS	FT ³
BRTDLSHS34	451	28	30	5	62	5.25

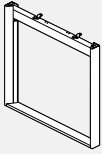
BRTSLL • Single Loop Leg

- Two Single Leg Assemblies form the structure of the Bridges series Single Line Tables.
- One leg can be shared by 2 adjoining worksurfaces.
- Leveling glides, steel frame, aluminum legs.
- Anodized aluminum leg upcharge \$55.
- Please specify paint finish for support.
- Please specify two beams when using BRTSLL36L

PRODUCT CODE	PRICE	SIZE/INCHES			WEIGHT VOL	
		H	W	D	LBS	FT ³
BRTSLL24L	460	28	2.5	24	11.00	1.01
BRTSLL30L	480	28	2.5	30	13.75	1.26
BRTSLL36L	509	28	2.5	36	16.50	1.51

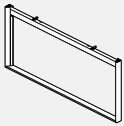
BRTBALL • Back 2 Back Loop Leg

- Two Back 2 Back Leg Assemblies form the structure of the Bridges series Back 2 Back Tables.
- One double leg can be shared by 4 adjoining worksurfaces.
- Leveling glides, steel frame, aluminum legs.
- Anodized aluminum leg upcharge \$55.
- Please specify paint finish for support.

PRODUCT CODE	PRICE	SIZE/INCHES			WEIGHT VOL	
		H	W	D	LBS	FT ³
BRTBALL51L	527	28	2.5	50.5	23.14	2.12
BRTBALL63L	551	28	2.5	62.5	28.64	2.62

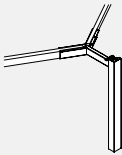
BRT • 120° Corner Leg Kit

- One 120° corner leg kit combined with two single or double Leg Assemblies and support beams form the structure of the Bridges series 120° Tables.
- 120° corner leg kit includes one corner leg and adjacent, telescopic beams to support BRTWAC120 or BRTWAC120A 120° worksurfaces. Telescopic horizontal beams allow single or double Leg Assemblies to be positioned either under the worksurface (end of a run) or to be shared by adjoining worksurfaces. Levelers, steel frame, aluminum legs.
- Anodized aluminum leg upcharge \$30.
- Please specify paint finish for support.

PRODUCT CODE	PRICE	SIZE/INCHES			WEIGHT VOL	
		H	W	D	LBS	FT ³
BRT120L42	763	28	2.5	34	6.6	2.80

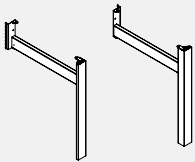
BRTHLEG • Boulevard Leg Assembly

- Boulevard Leg Assembly attaches to a Boulevard panel for applications which require functionality of Boulevard panels with an open environment of Bridges tables.
- One leg with horizontal member connecting to 1" increment slots in panel's vertical frame member. Provides support to panel and panel-connected worksurface at the end of a run; design coordinated with Bridges freestanding tables.
- Supports 24" and 30" deep worksurfaces. By adding 2 BHBF01 flat brackets and 1 BHBC02 corner bracket, a single leg can then support the adjoining worksurface. Leveling glide is standard. No worksurface supporting beams, use panel cantilevers and storage for worksurface support. One aluminum leg with steel structure - specify Left or Right and 24" or 30" deep for corresponding worksurface depths. Panel bracket, dislodgment clip and worksurface hardware included.
- Anodized aluminum leg upcharge \$30.
- Please specify paint finish for support.

PRODUCT CODE	PRICE	SIZE/INCHES			WEIGHT VOL	
		H	W	D	LBS	FT ³
BRTHLEG24LL	317	28	2.5	24	9	1.25
BRTHLEG24RL	317	28	2.5	24	9	1.25
BRTHLEG30LL	333	28	2.5	30	11	1.45
BRTHLEG30RL	333	28	2.5	30	11	1.45

BRTLVS • Leveler for Rectangular Leg Table

- 5/16" thread with black base; leveler has 2" adjustment range.
- Casters and levelers on Rectangular legs cannot be interchanged on site.

PRODUCT CODE	PRICE	SIZE/INCHES			WEIGHT VOL	
		H	W	D	LBS	FT ³
BRTLVS	9	2.5	1	1	0.025	0.001

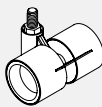
BRTLCS • Locking Caster for Rectangular Leg Tables

- Locking Caster for Rectangular Table
- 40mm dia. locking caster with 8mm thread; white body, light grey tires.
- Casters and levelers on rectangular legs cannot be interchanged on site.

PRODUCT CODE	PRICE	SIZE/INCHES			WEIGHT VOL	
		H	W	D	LBS	FT ³
BRTLCS	27	2.5	2.7	2.6	0.055	0.008

BRTSL • Single Leg Assembly

- **Two Single Leg Assemblies combined with a Single Beam form the supporting structure of the Bridges series Single Line Tables.**
- One leg can be shared by 2 adjoining worksurfaces.
- Leveling glides are standard. Locking casters are available on single tables. Specify 2 casters (BRTLCL) at an upcharge of \$22 each.

PRODUCT CODE	PRICE	SIZE/INCHES			WEIGHT VOL	
		H	W	D	LBS	FT ³
BRTSL	352	28	3	24	8	1.25

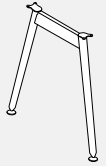
BRTFSL • Fixed Height Single Leg Assembly

- **Two Single Leg Assemblies combined with a Single Beam form the supporting structure of the Bridges series Single Line Tables.**
- One leg can be shared by 2 adjoining worksurfaces.

PRODUCT CODE	PRICE	SIZE/INCHES			WEIGHT VOL	
		H	W	D	LBS	FT ³
BRTFSL	303	28	2.5	24	5	0.97

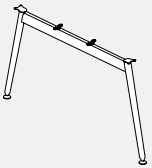
BRTDL • Back 2 Back Leg Assembly

- **Two Back 2 Back Leg Assemblies combined with 2 Single Beams form the supporting structure of the Bridges series Back 2 Back tables.**
- One leg can be shared by 2 adjoining worksurfaces.
- Leveling glides are standard.

PRODUCT CODE	PRICE	SIZE/INCHES			WEIGHT VOL	
		H	W	D	LBS	FT ³
BRTDL	459	28	3	50	12	2.81

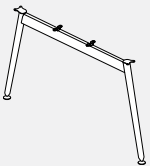
BRTFDL • Fixed Height Back 2 Back Leg Assembly

- **Two Back 2 Back Leg Assemblies combined with 2 Single Beams form the supporting structure of the Bridges series Back 2 Back tables.**
- One leg can be shared by 2 adjoining worksurfaces.
- Leveling glides are standard.

PRODUCT CODE	PRICE	SIZE/INCHES			WEIGHT VOL	
		H	W	D	LBS	FT ³
BRTFDL	411	28	2.5	50	8	2.03

BRTBL • Boulevard Leg Assembly

- **Boulevard Leg Assembly attaches to a Boulevard panel for applications which require functionality of Boulevard panels with an open environment of Bridge 2 tables.**
- Panel bracket secures the leg to the panel in 1" increments, within a 24" to 32" height range.
- Panel mounting bracket is reversible for non-handed applications.
- Supports 24" and 30" deep worksurfaces. By adding 2 BHBF01 flat brackets and 1 BHBC02 corner bracket, a single leg can then support the adjoining worksurface. Leveling glide is standard. No worksurface supporting beams, use panel cantilevers and storage for worksurface support. Panel bracket, dislodgment clip and worksurface hardware included.
- Leveling glide is standard.

PRODUCT CODE	PRICE	SIZE/INCHES			WEIGHT VOL	
		H	W	D	LBS	FT ³
BRTBL	338	28	3	24	12	1.25

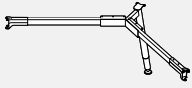
BRTCRL • 120° Corner Leg Kit

- Provides support for worksurfaces connected at 120° Degree.
- Single leg and beam assembly for 120° worksurface planning.
- Works with BRTWAC120 or BRTWAC120A worksurfaces.
- For a single table application two BRTSL (single legs) must be added.
- To join to a Back 2 Back table application, leg assembly will join to existing pod.
- Note: When joining to an existing table, the beam extends to reach the shared leg.

PRODUCT CODE	PRICE	SIZE/INCHES			WEIGHT VOL	
		H	W	D	LBS	FT ³
BRTCRL42	707	28	18	16	15	1.50

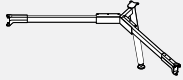
BRTFCRL • 120° Fixed Height Corner Leg Kit

- Provides support for worksurfaces connected at 120° Degree, supported by fixed height legs.
- Single leg and beam assembly for 120° worksurface planning.
- Works with BRTWAC120 or BRTWAC120A worksurfaces.
- For a single table application two BRTFSL (single legs) must be added.
- To join to a Back 2 Back table application, leg assembly will join to existing pod.
- Note: When joining to an existing table, the beam extends to reach the shared leg.

PRODUCT CODE	PRICE	SIZE/INCHES			WEIGHT VOL	
		H	W	D	LBS	FT ³
BRTFCRL42	658	28	18	16	13	1.50

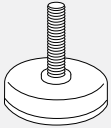
BRTLVR • Levelers for Tables

- Provides an option to casters.
- Leveler is 2 1/8" diameter.
- 1 1/2" long, 3/8" - 16 threaded stem provides 1" height adjustment range.
- Field retrofitable on round leg.

PRODUCT CODE	PRICE	SIZE/INCHES			WEIGHT VOL	
		H	W	D	LBS	FT ³
BRTLVR	9	2	2.125	2.125	0.2	0.002

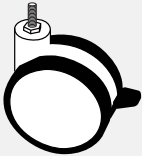
BRTLRCR • Locking Casters for Round Leg Tables

- Provides an option to levelers.
- Caster is 3" diameter wheel and 3/8" - 16 threaded stem.
- Overall height is 3 3/4".
- Field retrofitable on round leg.

PRODUCT CODE	PRICE	SIZE/INCHES			WEIGHT VOL	
		H	W	D	LBS	FT ³
BRTLRCR	27	3.75	3	1.5	0.3	0.002

BRTRL • Round Table Leg Assembly

- Four leg assembly.
- Leveling glides are standard. Locking casters are available. Specify 4 casters (BRTLRCR) at an upcharge of \$17 each.
- Maximum table diameter is 42".
- Includes all connecting hardware.

PRODUCT CODE	PRICE	SIZE/INCHES			WEIGHT VOL	
		H	W	D	LBS	FT ³
BRTRL	726	28	24	24	16	2.33

Beam Applications

Bridges II table legs are connected with supporting beams. Unless there is one beam for a single line of tables while two beams connect Back 2 Back table structures. Adjustable clamps at either end of the beam can be adjusted to accommodate the following applications in both single table as well as Back 2 Back table configurations.

STANDARD TABLE BEAM

Single table beam application bridges two legs to form support for a single table, or two Back 2 Back work surfaces.

Adjustable clamps at either end of the beam are pushed all the way in to allow both table legs to be tucked under the work surface.

End of run table beam application supports one table leg assembly tucked under work surface (one adjustable clamp pushed all the way in), while the other table leg assembly can be shared between two adjacent work surfaces (adjustable clamp pulled out to extend the beam).

Interconnecting table beam application supports both table leg assemblies extended to support adjacent work surfaces on either side. Both adjustable clamps pulled out to extend the beam at either end.

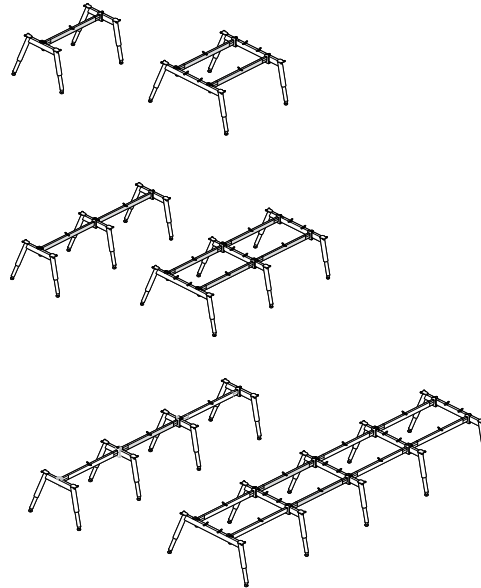

TELESCOPIC TABLE RETURN BEAM

Supports a return connected perpendicularly to a 24" or 30" deep primary work surface. The Telescopic beam is connected to a single or Back 2 Back leg on one side and to any work surface-supporting beam on the opposite side. Telescopic beam clamp allows the table leg to be tucked under worksurface or shared between two adjacent worksurfaces.

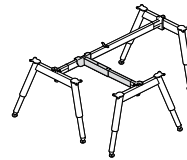

TABLE TO TABLE TELESCOPIC BRIDGE BEAM

Supports a 36" to 84" wide top connected perpendicularly between two freestanding tables. Adjustable brackets on both sides of the beam connect off module to the perpendicular standard beam and can be adjusted to accommodate 24" and 30" deep primary worksurfaces.

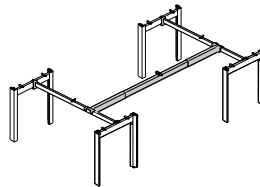
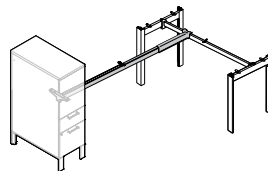

TABLE TO STORAGE TELESCOPIC RETURN BEAM

Supports a return connected perpendicularly to a 24" or 30" deep primary work surface on one end and a storage cabinet on the other. This allows the return worksurface to be layered overtop of storage without the need for an additional leg assembly.



STORAGE TABLE BEAM

The Storage beam is connected to a single or Back 2 Back leg on one side and to the work surface on the opposite side - thus saving one leg (assembly work surface is connected to storage units with included storage brackets). Storage table beam's flexibility allows for a single table application (with the table leg tucked in under the work surface) as well as for a double table installation (two adjacent tables supported by a shared leg in the middle and two storage cabinets at the opposite ends).

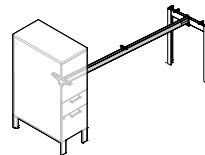

STORAGE TABLE BEAM ADAPTER

Connects to Storage table beam. This assembly allows a work surface to be supported by a leg on one side and a spine (formed by interconnected storage cabinets) on the opposite side.

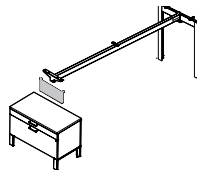

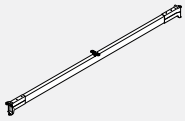
BRTSB-C • Standard Table Beam

- **Standard table beam bridges two legs to form support for a single table, or two Back 2 Back work surfaces. Adjustable clamps at either end of the beam accommodate Standard table beam, end of run and interconnecting table beam applications. Adjustable brackets ship attached to the beam.**
- Specify Single Table Beam size corresponding nominally to the worksurface length. Includes all hardware necessary to connect to legs. Powder coated steel beam and aluminum cast clamps.
- Specify metal finish.
- Distance between bottom of beam and floor of standard height application is 25 3/8".

PRODUCT CODE	PRICE	SIZE/INCHES			WEIGHT VOL	
		H	W	D	LBS	FT ³
BRTSB15C	151	2	10	1	1.28	0.01
BRTSB24C	193	2	19	1	2.03	0.01
BRTSB30C	195	2	25	1	2.70	0.02
BRTSB36C	197	2	31	1	3.31	0.03
BRTSB42C	200	2	37	1	3.59	0.04
BRTSB48C	208	2	43	1	4.60	0.05
BRTSB51C	217	2	45.5	1	4.81	0.05
BRTSB54C	225	2	49	1	4.86	0.06
BRTSB60C	234	2	55	1	5.45	0.07
BRTSB63C	238	2	57.5	1	5.72	0.08
BRTSB66C	240	2	61	1	6.09	0.08
BRTSB72C	249	2	67	1	6.74	0.09
BRTSB78C	260	2	73	1	7.38	0.12
BRTSB84C	265	2	79	1	8.02	0.15

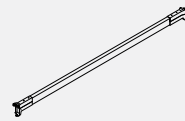
BRTBB-C • Bottom Table Beam

- **Bottom table beam connects to the lower cross beam on the 36" and 42" high "H" leg to create the footrest.**
- One beam required for each table
- Cannot be used as a substitute for the standard table beam.
- Specify the bottom table beam that corresponds to the worksurface length. Includes all hardware necessary to connect to "H" leg. Powder coated steel beam and aluminum cast clamps.
- Specify metal finish

PRODUCT CODE	PRICE	SIZE/INCHES			WEIGHT VOL	
		H	W	D	LBS	FT ³
BRTBB36C	197	2	31	1	3.31	0.03
BRTBB42C	200	2	37	1	3.59	0.04
BRTBB48C	208	2	43	1	4.60	0.05
BRTBB54C	225	2	49	1	4.86	0.06
BRTBB60C	234	2	55	1	5.45	0.07
BRTBB66C	240	2	61	1	6.09	0.08
BRTBB72C	249	2	67	1	6.74	0.09
BRTBB78C	260	2	73	1	7.38	0.12
BRTBB84C	265	2	79	1	8.02	0.15

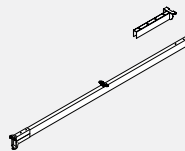
BRTTB-C • Telescopic Table Return Beam

- **Provides support for a worksurface connected perpendicularly to a run of primary tables.**
- Can be adjusted to accommodate 24" and 30" deep primary worksurfaces.
- Adjustable clamp secures the beam to a Leg assembly on one side, while the other side of the beam connects off-module, to the perpendicular Standard Beam.
- The adjustable clamp can also be extended to allow for the leg to be tucked in under the work surface or to be shared by two adjacent work surfaces.
- Includes all hardware necessary to connect to legs.
- Powder coated steel and die-cast aluminum clamp.
- Distance between bottom of beam and floor of standard height application is 25 3/8".

PRODUCT CODE	PRICE	SIZE/INCHES			WEIGHT VOL	
		H	W	D	LBS	FT ³
BRTTB36C	307	2	48.5	1	5.19	0.05
BRTTB42C	324	2	54.5	1	5.83	0.06
BRTTB48C	341	2	60.5	1	6.74	0.07
BRTTB54C	355	2	66.5	1	7.11	0.07
BRTTB60C	373	2	72.5	1	7.75	0.08
BRTTB66C	383	2	78.5	1	8.40	0.09
BRTTB72C	391	2	84.5	1	9.04	0.09
BRTTB78C	399	2	90.5	1	9.68	0.12
BRTTB84C	408	2	96.5	1	10.32	0.15

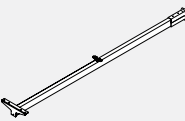
BRTSTB-C • Storage Table Beam

- **Storage Table Beam allows a worksurface to be supported by a leg on one side and storage tower(s) on the opposite side. The Storage beam is connected to a single or Back 2 Back leg on one side and to the worksurface on the opposite side - thus saving one leg assembly. The flexible arrangement of such a leg/beam/clamp assembly allows the leg to be tucked in under the work surface or to be shared by two adjacent work surfaces.**
- Also, applies to multiple, Back 2 Back Assemblies.
- Specify Storage table beam size corresponding nominally to the worksurface length. Includes all hardware necessary to connect to legs.
- Powder coated steel.
- Distance between bottom of beam and floor of standard height application is 25 3/8".

PRODUCT CODE	PRICE	SIZE/INCHES			WEIGHT VOL	
		H	W	D	LBS	FT ³
BRTSTB36C	208	2	32.75	1	3.50	0.03
BRTSTB42C	217	2	38.75	1	4.16	0.04
BRTSTB48C	219	2	44.75	1	4.78	0.05
BRTSTB54C	234	2	50.75	1	5.43	0.05
BRTSTB60C	249	2	54.75	1	5.85	0.06
BRTSTB66C	265	2	62.75	1	6.74	0.07
BRTSTB72C	275	2	68.75	1	7.35	0.08
BRTSTB78C	283	2	74.75	1	7.99	0.08
BRTSTB84C	291	2	80.75	1	8.64	0.09

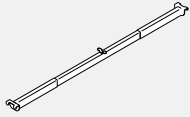
BRT2TTB • Table to Table Telescopic Bridge Beam

- Provides support for a worksurface connected between two primary tables.
- Can be adjusted to accommodate 24" and 30" deep primary worksurfaces.
- Adjustable brackets on both sides of the beam connect off-module to the perpendicular standard beam.
- Includes all hardware necessary to connect to legs.
- Power coated steel. Please specify colour.

PRODUCT CODE	PRICE	SIZE/INCHES			WEIGHT VOL	
		H	W	D	LBS	FT ³
BRT2TTB36	331	2.52	61.3	3.41	8.7	3.5
BRT2TTB42	338	2.52	67.3	3.41	9.3	3.8
BRT2TTB48	343	2.52	73.3	3.41	9.9	4.2
BRT2TTB54	350	2.52	79.3	3.41	10.5	4.6
BRT2TTB60	354	2.52	85.3	3.41	11.1	4.9
BRT2TTB66	364	2.52	91.3	3.41	11.7	5.3
BRT2TTB72	370	2.52	97.3	3.41	12.3	5.6
BRT2TTB78	375	2.52	103.3	3.41	12.9	6.0
BRT2TTB84	382	2.52	109.3	3.41	13.5	6.4

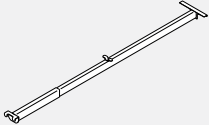
BRT2STTB • Table to Storage Telescopic Return Beam

- Provides support for a return connected a primary work surface on one end and a storage cabinet on the other.
- Can be adjusted to accommodate 24" and 30" deep primary worksurfaces.
- Adjustable clamp secures the beam to a Storage Tower on one side, while the other side of the beam connects off-module, to the perpendicular Standard Beam.
- Includes all hardware necessary to connect to legs.
- Power coated steel. Please specify colour.

PRODUCT CODE	PRICE	SIZE/INCHES			WEIGHT VOL	
		H	W	D	LBS	FT ³
BRT2STTB36	239	2.52	61.3	3.41	8.7	3.5
BRT2STTB42	246	2.52	67.3	3.41	9.3	3.8
BRT2STTB48	251	2.52	73.3	3.41	9.9	4.2
BRT2STTB54	260	2.52	79.3	3.41	10.5	4.6
BRT2STTB60	265	2.52	85.3	3.41	11.1	4.9
BRT2STTB66	271	2.52	91.3	3.41	11.7	5.3
BRT2STTB72	278	2.52	97.3	3.41	12.3	5.6
BRT2STTB78	284	2.52	103.3	3.41	12.9	6.0
BRT2STTB84	289	2.52	109.3	3.41	13.5	6.4

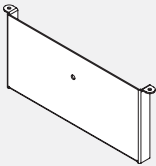
BRTSA • Storage Table Beam Adapter

- Storage table beam adapter allows a worksurface to be supported by a leg on one side and storage spine on the opposite side. A typical Storage spine is formed by series of interconnected 21" or 25" high storage cabinets of corresponding depth.

PRODUCT CODE	PRICE	SIZE/INCHES			WEIGHT VOL	
		H	W	D	LBS	FT ³
BRTSA21	100	6.5	15.2	1	2.15	0.05
BRTSA25	83	2.75	15.2	1	4.3	0.02

- The Storage beam is connected to a single or Back 2 Back leg on one side and to the worksurface on the opposite side - thus saving one leg assembly.
- The 21" or 25" adapters provide structural support - acting as supports between top of the storage cabinet spine and the bottom of perpendicular worksurfaces.
- The flexible leg/beam/adaptor assembly arrangement allows the leg to be tucked in under the worksurface or to be shared by two adjacent worksurfaces. Included hardware connect the adapter to the worksurface and to the Spine storage beam adapter tower.
- Note: Specify Storage Beam nominally 18" shorter than worksurfaces for storage spine support application.
- Specify Storage Spine Adapter BRTSA21 (21") or BRTSA25 adapter (25") - depending on the height of Bridges storage units forming the spine.
- Includes all hardware necessary to connect the adapter to the beam, worksurface and storage spine.

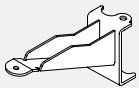
BRTLSC • Leg Support Cantilever

- Provides stability for leg supports.

PRODUCT CODE	PRICE	SIZE/INCHES			WEIGHT VOL	
		H	W	D	LBS	FT ³
BRTLSC	124	3.5	7	2	0.5	0.007

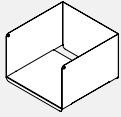
BRTESBBIN • Elevated Shelf Binder Bin

- **Elevated Shelf Binder Bin.**
- Frame finish.
- Not compatible with 16" Deep shared Overhead with Sliding Doors.
- Handy companion to 12" deep BRTBTS Shared Elevated Table Shelves. The bin rests on top surface, provides better utilization of vertical space, binder/book manager, enhanced sense of privacy as well as magnetic board on the opposite side.

PRODUCT CODE	PRICE	SIZE/INCHES			WEIGHT VOL	
		H	W	D	LBS	FT ³
BRTESBBIN	151	8	12	12	6	0.66

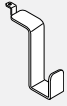
BRTHB • Hanging Bracket

- **A formed steel bracket hooks over Bridges2 table leg. Can be secured either on the inner or outer side of the leg.**
- Frame Finish.

PRODUCT CODE	PRICE	SIZE/INCHES			WEIGHT VOL	
		H	W	D	LBS	FT ³
BRTHB	25	3.5	1.5	3.3	0.2	0.01

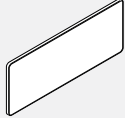
BRTWB • Whiteboard

- **White dry-erase marker board surface on white powder coated steel backer.**
- Fits 16" tall Bridges 2 dividers and single-sided shelves. White dry-erase surface attaches magnetically to the steel backer, when removed the backer can be used as a magnetic board.

PRODUCT CODE	PRICE	SIZE/INCHES			WEIGHT VOL	
		H	W	D	LBS	FT ³
BRTWB0924	207	8.5	24	0.5	1	0.56

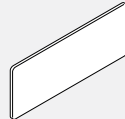
BRTTB • Tackboard

- **Grey tackboard surface on white powder coated steel backer.**
- Fits 16" tall Bridges 2 dividers and single sided shelves.

PRODUCT CODE	PRICE	SIZE/INCHES			WEIGHT VOL	
		H	W	D	LBS	FT ³
BRTTB0924	207	8.5	24	0.5	1	0.56

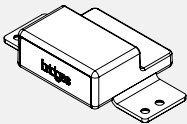
BRTTEGF • Table End Gap Filler

- **Injection molded block fills the gap finishing the end of Back 2 Back table assemblies. Secures to the bottom of two Back 2 Back worksurfaces.**
- Injection molded resin, white.

PRODUCT CODE	PRICE	SIZE/INCHES			WEIGHT VOL	
		H	W	D	LBS	FT ³
BRTTEGF	9	1.1	2.5	4.5	0.025	0.006

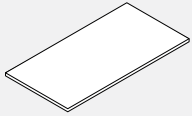
BRTWS • Rectangular Worksurface Top

- **Worksurfaces are available in high pressure laminate (HP 1 1/16" thick) and low pressure laminate (LP 1" thick) with a flat 3 mm edge profile on all sides.**
- Worksurfaces provided with pilot holes for alignment purposes.
- Worksurface available in HP and LP.

PRODUCT CODE	PRICE		SIZE/INCHES			WEIGHT VOL	
	LP	HP	H	W	D	LBS	FT ³
BRTWS2436	161	213	1	36	24	23	0.71
BRTWS2442	211	280	1	42	24	28	0.90
BRTWS2448	252	339	1	48	24	31	1.06
BRTWS2454	299	394	1	54	24	35	1.20
BRTWS2460	336	443	1	60	24	39	1.30
BRTWS2466	350	462	1	66	24	43	1.41
BRTWS2472	366	484	1	72	24	47	1.54
BRTWS2478	392	516	1	78	24	51	1.70
BRTWS2484	422	553	1	84	24	55	1.80
BRTWS3036	200	264	1	36	30	30	1.06
BRTWS3042	283	373	1	42	30	34	1.12
BRTWS3048	299	394	1	48	30	39	1.41
BRTWS3054	327	420	1	54	30	44	1.44
BRTWS3060	350	462	1	60	30	49	1.77
BRTWS3066	364	483	1	66	30	54	1.80
BRTWS3072	385	510	1	72	30	59	2.00
BRTWS3078	410	540	1	78	30	64	2.10
BRTWS3084	456	596	1	84	30	69	2.24
BRTWS3642	343	431	1	42	36	39	2.63
BRTWS3648	389	485	1	48	36	45	3.00
BRTWS3654	433	542	1	54	36	51	3.38
BRTWS3660	480	600	1	60	36	56	3.75
BRTWS3666	523	656	1	66	36	62	4.13
BRTWS3672	569	712	1	72	36	68	4.50
BRTWS3678	612	765	1	78	36	73	4.88
BRTWS3684	658	824	1	84	36	79	5.25

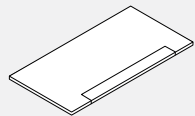
BRTWSA • Rectangular Worksurface Top with Access Door

- **Tables Worksurfaces are available in high pressure laminate (HP: 1 1/16" thick), low pressure laminate (LP: 1" thick), 3 mm edging on all sides.**
- Worksurfaces provided with pilot holes for easier alignment purposes.
- Worksurfaces 42" through 72" have one access door.
- 3.5" deep anodized aluminum door provides access to power / data trough below worksurface.
- Access door is offset 13.5" from either side of worksurface.
- Worksurfaces with access doors cannot be combined with Above Worksurface Power Troughs.
- Worksurface available in HP and LP.

PRODUCT CODE	PRICE		SIZE/INCHES			WEIGHT VOL	
	LP	HP	H	W	D	LBS	FT ³
BRTWSA2442	265	383	1	42	24	23	0.71
BRTWSA2448	299	433	1	48	24	28	0.90
BRTWSA2454	333	483	1	54	24	31	1.06
BRTWSA2460	373	535	1	60	24	35	1.20
BRTWSA2466	408	581	1	66	24	39	1.30
BRTWSA2472	441	639	1	72	24	43	1.41
BRTWSA3042	317	456	1	42	30	30	1.06
BRTWSA3048	355	516	1	48	30	34	1.12
BRTWSA3054	399	581	1	54	30	39	1.41
BRTWSA3060	441	639	1	60	30	44	1.44
BRTWSA3066	490	707	1	66	30	49	1.77
BRTWSA3072	523	763	1	72	30	54	1.80
BRTWSA3642	377	513	1	42	36	39	2.63
BRTWSA3648	449	608	1	48	36	45	3.00
BRTWSA3654	508	701	1	54	36	51	3.38
BRTWSA3660	570	777	1	60	36	56	3.75
BRTWSA3666	655	880	1	66	36	62	4.13
BRTWSA3672	709	964	1	72	36	68	4.50

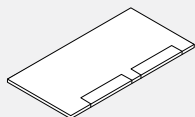
BRTWSAA • Rectangular Worksurface Top with 2 16" Access Doors

- **Tables Worksurfaces are available in high pressure laminate (HP: 1 1/16" thick), low pressure laminate (LP: 1" thick), 3 mm edging on all sides.**
- Worksurfaces provided with pilot holes for easier alignment purposes.
- 3.5" deep anodized aluminum door provides access to power / data trough below worksurface.
- Access door is offset 10" (60" worksurfaces) and 13.5" (worksurfaces 66" and wider) from either side of worksurface.
- Worksurfaces with access doors cannot be combined with Above Worksurface Power Troughs.
- Dimension between doors is 8" for 60" and 66" long surfaces, 14" for 72", 20" for 78" and 26" for 84".
- Worksurface available in HP and LP. F
- Worksurfaces should not be used with Table Mounted Dividers BRPX3P21.

PRODUCT CODE	PRICE		SIZE/INCHES			WEIGHT VOL	
	LP	HP	H	W	D	LBS	FT ³
BRTWSAA2460	405	575	1	60	24	35	1.20
BRTWSAA2466	441	630	1	66	24	39	1.30
BRTWSAA2472	476	692	1	72	24	43	1.41
BRTWSAA2478	480	697	1	78	24	47	1.54
BRTWSAA2484	508	752	1	84	24	51	1.70
BRTWSAA3060	476	692	1	60	30	44	1.44
BRTWSAA3066	534	762	1	66	30	49	1.77
BRTWSAA3072	563	826	1	72	30	54	1.80
BRTWSAA3078	568	846	1	78	30	59	2.00
BRTWSAA3084	603	897	1	84	30	64	2.10
BRTWSAA3660	537	748	1	60	36	56	3.75
BRTWSAA3666	622	854	1	66	36	62	4.13
BRTWSAA3672	670	948	1	72	36	68	4.50
BRTWSAA3678	695	983	1	78	36	73	4.88
BRTWSAA3684	763	1072	1	84	36	79	5.25

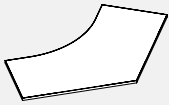
BRTWAC120 • 120° Table Top

- 5-sided worksurface can be used for a single, freestanding table, can form a pod of two or three tables, or can be combined with rectangular worksurfaces to create larger workstations.
- Worksurfaces provided with pilot holes for alignment purposes.

- Worksurface available in HP and LP.

PRODUCT CODE	PRICE		SIZE/INCHES			WEIGHT	VOL
	LP	HP	H	W	D	LBS	FT ³
BRTWAC120424224	757	1003	1	42	24	31	1.06
BRTWAC120424230	824	1073	1	42	30	39	1.41

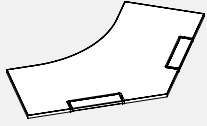
BRTWAC120A • 120° Table Top with Access Door

- 5-sided worksurface can be used for a single, freestanding table, can form a pod of two or three tables, or can be combined with rectangular worksurfaces to create larger workstations.
- 3.5" deep anodized aluminum door provides access to power / data trough below worksurface.
- 120° Worksurface as above with Worksurface access door - anodized aluminum worksurface access door provides access to power / data trough below worksurface.
- Worksurface with access doors cannot be combined with above worksurface power trough.
- Access door is offset 13.5" from either side of worksurface.
- Worksurface available in HP and LP.

PRODUCT CODE	PRICE		SIZE/INCHES			WEIGHT	VOL
	LP	HP	H	W	D	LBS	FT ³
BRTWAC120A424224	804	1072	1	42	24	31	1.06
BRTWAC120A424230	868	1204	1	42	30	39	1.41

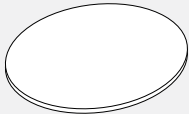
BRTMTR • Round Meeting Table Top

- Round top
- Worksurfaces provided with pilot holes for alignment purposes.
- Worksurface available in HP and LP.

PRODUCT CODE	PRICE		SIZE/INCHES			WEIGHT	VOL
	LP	HP	H	W	D	LBS	FT ³
BRTMTR42	399	499	1	42	42	40	1.76

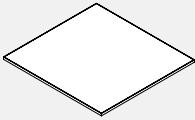
BRTWS • Meeting Table Top

- Can create convenient, flexible extension of the Back 2 Back Bridges table assembly.
- Worksurfaces provided with pilot holes for alignment purposes.
- Meeting table top. 50.5" long side matches 24" deep, Back 2 Back Bridges table assembly
- Meeting table tops 62.5 long side matches 30" deep, Back 2 Back Bridges table assemblies.
- Worksurface available in HP and LP.

PRODUCT CODE	PRICE		SIZE/INCHES			WEIGHT	VOL
	LP	HP	H	W	D	LBS	FT ³
BRTWS2451	299	394	1	50.5	24	31	1.06
BRTWS3051	312	410	1	50.5	30	37	1.41
BRTWS3651	465	542	1	50.5	36	43	1.71
BRTWS4251	514	653	1	50.5	42	48	1.93
BRTWS4851	586	736	1	50.5	48	52	2.07
BRTWS5151	626	770	1	50.5	50.5	55	2.12
BRTWS5451	678	864	1	50.5	54	59	2.19
BRTWS6051	770	962	1	50.5	60	63	2.26
BRTWS2463	342	454	1	62.5	24	39	1.41
BRTWS3063	354	473	1	62.5	30	49	1.77
BRTWS3663	522	656	1	62.5	36	53	1.94
BRTWS4263	626	786	1	62.5	42	57	2.07
BRTWS4863	752	941	1	62.5	48	61	2.13
BRTWS5463	849	1057	1	62.5	54	63	2.21
BRTWS6063	942	1174	1	62.5	60	67	2.34

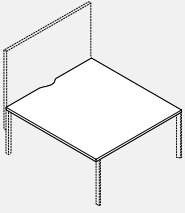
BRTWS-SCP • Display Wall Table Top with Scoop

- Display wall mounts to the end of Bridges Back 2 Back table assembly supported by rectangular legs. As opposed to two separate Back 2 Back work surfaces, the Display Wall table top provides one continuous, uninterrupted surface with a scoop cutout next to the Display Wall (the scoop facilitates cable passage from below the table).
- Worksurfaces provided with pilot holes for alignment purposes.
- Table top: 50.5" long side matches 24" deep, Back 2 Back Bridges table assembly
- Meeting table tops 62.5 long side matches 30" deep, Back 2 Back Bridges table assemblies.
- Worksurface available in HP and LP.

PRODUCT CODE	PRICE		SIZE/INCHES			WEIGHT		VOL FT ³
	LP	HP	H	W	D	LBS		
BRTWS4851SCP	586	736	1	50.5	48	60	1.40	
BRTWS5451SCP	678	864	1	50.5	54	68	1.58	
BRTWS6051SCP	770	962	1	50.5	60	75	1.75	
BRTWS4863SCP	752	941	1	62.5	48	75	1.74	
BRTWS5463SCP	849	1057	1	62.5	54	84	1.95	
BRTWS6063SCP	942	1174	1	62.5	60	93	2.17	

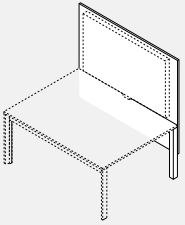
BRTTVFT • Display Wall: Monitor Facing Double Work Station

- Display wall mounts to the end of bridges Back 2 Back table assembly supported by bridges rectangular legs.
- Display faces the double work station - facilitates seated presentation area.
- Includes laminate board, TV/display brackets (black), mounting hardware, vertical cable manager (black). Slim (22mm) bracket capable of supporting displays/TVs up to 50" (resp. 62") wide, up to 80lbs. When installed, top of the 52" x 50.5" (resp. 62.5") wide board reaches 65.5" high.
- 1" LP or HP laminate board with 3mm edging. Different HP laminate finishes expand product functionality. For instance: white dryerase marker board laminate can be specified on "non-display" board surface. Specify laminate finish, HP laminate position (Display side, non-display side) and edging.
- Note: Included vertical cable manager passes through the gap between two Back 2 Back work surfaces. Should you need one continuous, uninterrupted surface specify Display Wall table top with a scoop (listed in the Work surface section of bridges Price List).
- Display wall mounts to the end of Bridges Back 2 Back table assembly supported by rectangular legs or Back 2 Back table structure with BRTWS-SCP Display Wall Table Top with scoop. As opposed to two separate Back 2 Back work surfaces, the BRTWS-SCP Display Wall Table Top provides one continuous, uninterrupted surface with a scoop cutout next to the display wall (the scoop facilitates cable passage from below the table top).
- Please add \$422 for white, dry erase on 51" wide Display Wall and \$576 for 63" wide.

PRODUCT CODE	PRICE		SIZE/INCHES			WEIGHT		VOL FT ³
	LP	HP	H	W	D	LBS		
BRTTVFT51	1426	1900	52	50.5	4	62.00	6.08	
BRTTVFT63	1504	2059	52	62.5	4	74.00	7.52	

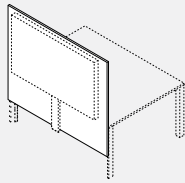
BRTTVBK • Display Wall: Monitor Facing Back of Double Work Station

- Display wall support board mounts to end of bridges Back 2 Back table assembly supported by bridges rectangular legs. Display faces back of the double work station - facilitates standing or seated presentation area (combine with collaborative seating).
- Includes laminate board, TV/display brackets (black), mounting hardware, vertical cable manager (black). Slim (22mm) bracket capable of supporting displays/TVs up to 50" (resp. 62") wide, up to 80lbs.
- When installed, top of the 52" x 50.5" (resp. 62.5") wide board reaches 65.5" high.
- 1" LP or HP laminate board with 3mm edging. Different HP laminate finished expand product functionality. For instance: white dry-erase marker board laminate can be specified on "non-display" board surface. Specify laminate finish, HP laminate position (Display side, non-display side) and edging.
- Display wall mounts to the end of Bridges Back 2 Back table assembly supported by rectangular legs or Back 2 Back table structure with BRTWS-SCP Display Wall Table Top with scoop. As opposed to two separate Back 2 Back work surfaces, the BRTWS-SCP Display Wall Table Top provides one continuous, uninterrupted surface with a scoop cutout next to the display wall (the scoop facilitates cable passage from below the table top).
- Please add \$422 for white, dry erase on 51" wide Display Wall and \$576 for 63" wide.

PRODUCT CODE	PRICE		SIZE/INCHES			WEIGHT		VOL FT ³
	LP	HP	H	W	D	LBS		
BRTTVBK51	1426	1900	52	50.5	4	62.00	6.08	
BRTTVBK63	1504	2059	52	62.5	4	74.00	7.52	

Power delivery / cable management

At the basic level, table and floor based office equipment is serviced by a wall or floor power supply. As the operation grows, there might be a need to organize excessive cable clutter.

Cable Basket (1) connects to the underside of worksurfaces with steel brackets and cables are simply dropped and coiled into them.

Cable Snake(2) installed in proximity of floor monument to manage vertical cable clutter.

Table clamped, single circuit Desk Top Power Data Modules (3) deliver services to desk height, while tapping into wall or floor power supply. Again, the excessive cables can be managed with Cable Baskets.

Ceiling pole BRTCPP (4) manages power and data cables between ceiling and above or below worksurface power troughs.

Above and Below Worksurface Power/Data Troughs (5) can be installed between Back 2 Back tables for extended below and above desk height power/data distribution.

- 8 wire, 4-circuit system.

Single Sided Power/Data Troughs (6) can be installed to the underside of a single table.

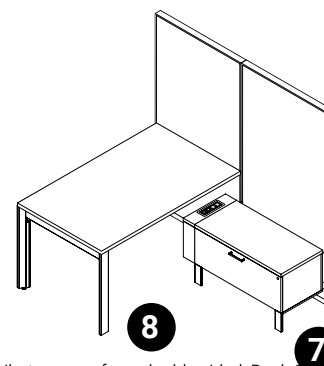
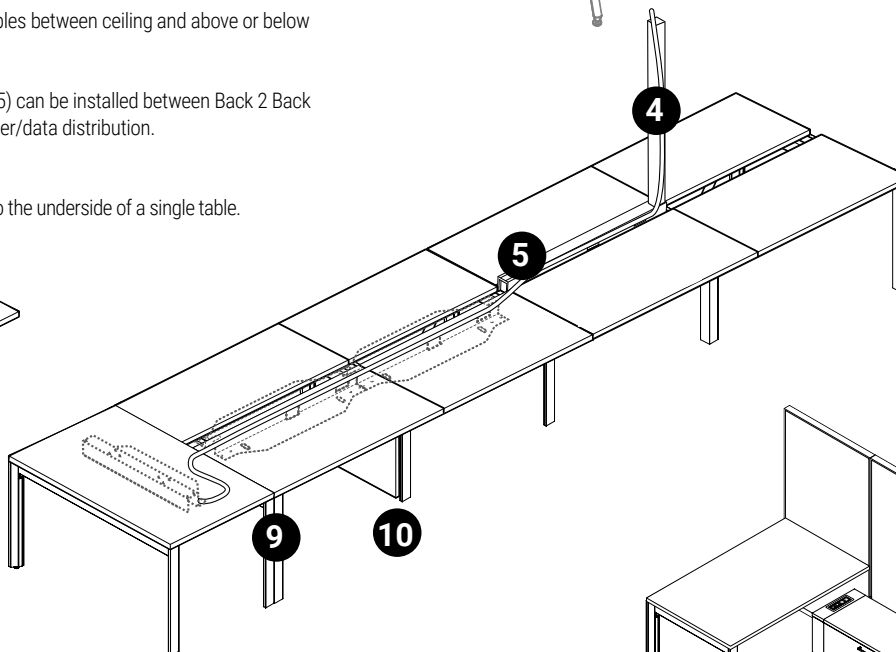
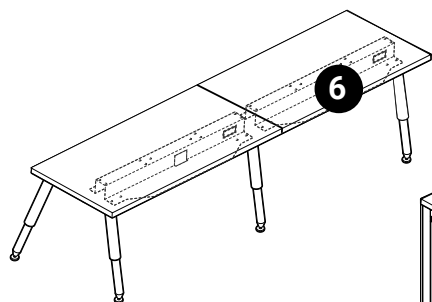
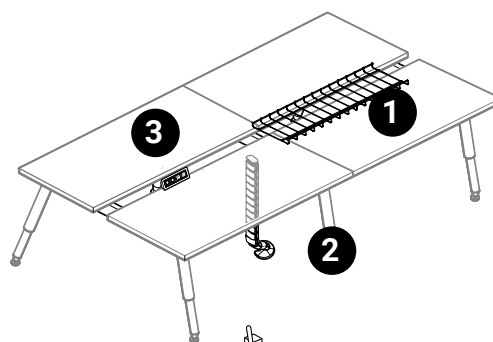

Elevated storage units provide access to floor raceway power duplexes and data terminals (7). 1" gap between panels and storage allow for easy passage of cables.

Some storage units can be connected to panel vertical slots and those allow to open and access panel floor raceway.

Storage power/data box BRTVCM (8) attaches to storage units and provides access to one duplex/data terminal on top storage surface. Integrated single circuit module can be plugged to floor monument under the storage, to a wall outlet or to a panel floor raceway duplex receptacle.

NOTE: Specify BRTHH58 (9) to distribute power from double sided, Back 2 Back below worksurface power trough to a single sided, below work surface power trough at the end of a table run.

Leg shroud (10) attaches to 34" wide legs and manages power floor feed as well as data cables from floor monument.

Electrical system

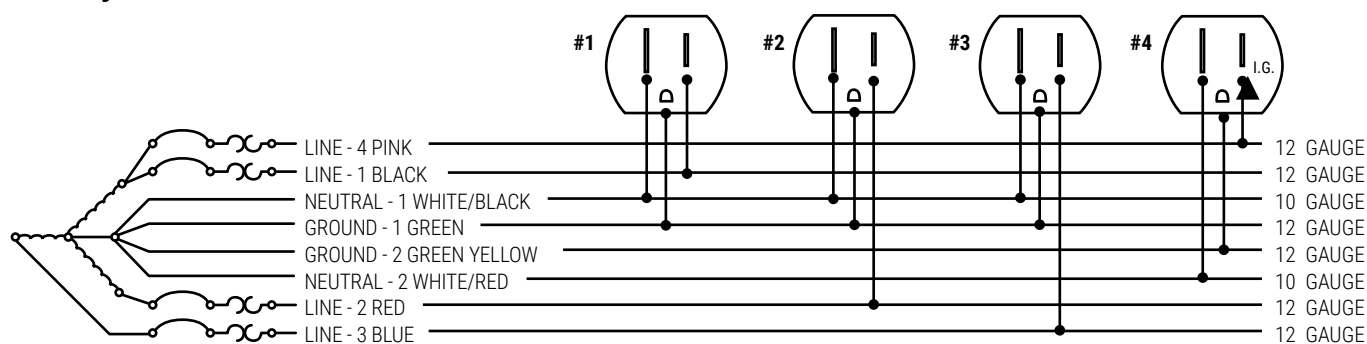

An 8-wire, 4-circuits, 3+1 electrical systems complies with UL 1286

8 Wires
4 Lines (12ga.)
2 Neutrals
2 Grounds (12ga.)

4 Circuits
3 Utility Circuit
1 Isolated Circuit

Receptacles
Duplex - Up to 6 duplex receptacles per circuit

Specifications
120 VAC system rated at 20A (15 CSA)

BRED50AC • Duo Module with A+C

- The Duo power module is completely integrated with a mounting clamp to attach to the edge of a worksurface.
- 10' long three-prong cord.
- Provides two 15 Amp 120 Volt AC Receptacles; 2.4 amp USB-A port and 60 watt USB-C power delivery port.
- Available in W - White or B - Black as indicated by last letter of model number.

PRODUCT CODE	PRICE	SIZE/ INCHES			WEIGHT VOL	
		H	W	D	LBS	FT ³
BRED50ACW	695	3	5.5	3.2	3	0.2
BRED50ACB	695	3	5.5	3.2	3	0.2

BREDU51AC • Duo Under Module with A+C

- The Duo under power module comes with a thin flush mounting bracket to attach to the underside of a work surface or above work surface shelves.
- 10' long three-prong cord.
- Provides two 15 Amp 120 Volt AC Receptacles; 2.4 amp USB-A port and 60 watt USB-C power delivery port.
- Available in W - White or B - Black as indicated by last letter of model number.

PRODUCT CODE	PRICE	SIZE/ INCHES			WEIGHT VOL	
		H	W	D	LBS	FT ³
BREDU51ACW	695	1.8	5.5	2.8	3	0.2
BREDU51ACB	695	1.8	5.5	2.8	3	0.2

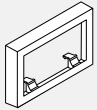
B RTPDS • Data/Comm Spacer

- Data/comm plate spacer extends the depth behind data/comm jacks by 0.6" in order to accommodate larger data/com cable bending radius.
- Black finish.
- "W" indicates White, "S" indicates Silver.

PRODUCT CODE	PRICE	SIZE/INCHES			WEIGHT VOL	
		H	W	D	LBS	FT ³
B RTPDS	46	2.04	4.75	0.6	0.1	0.01
B RTPDSW	46	2.04	4.75	0.6	0.1	0.01
B RTPDSS	46	2.04	4.75	0.6	0.1	0.01

BRACS • Cable Snake

- Flexible cable management trough.
- Two pathways within the snake, one for data/communication and one for routing power cables.
- Clear (CLR) available only.

PRODUCT CODE	PRICE	SIZE/INCHES			WEIGHT VOL	
		H	W	D	LBS	FT ³
BRACS	127	30	8	2	3	0.19
BRACSH	213	49	8	2	5	0.27

B RTCM • Wire Manager

- Replacement wire manager can be added to Bridges. Wire manager neatly organizes and stores electrical and communication cables.
- Two lengths, 46" for tops 60" and under, 58" for tops 72".

PRODUCT CODE	PRICE	SIZE/INCHES			WEIGHT VOL	
		H	W	D	LBS	FT ³
B RTCM43	48	3	5	46	8	0.67
B RTCM55	60	3	5	58	9	0.85

ModPower Power Solution

- Power solutions for flexible spaces. Connect up to four units (in Canada)/six units in the USA from a single infeed with NEMA plug to deliver power and charging ports to the table top. In-surface modules and clamp on modules available.
- Easy to install; code compliant that allows users to optimize any space providing convenient power access. Perfect for training areas, meeting rooms, in-office workstations and more. Units feature tamper-resistant receptacles as well as both USB-A and USB-C charging ports.
- Easy to use connectors that are touch-safe with added latch to prevent unintended separation. Easy push together to connect, and simple press down on latch to disconnect.
- Maximum overall length not to exceed 48.5 feet per infeed. UL listed to UL962A SD, the standard for furniture power distribution units for portable/moveable work space tables.
- Certified to CSA standard C22.2 No. 203-16.
- Will work with Licence, Terina and Bridges Products.

- Surface mounted module ships with a clamp mount that will accommodate any material 1/2" to 1-1/2" thick; additional brackets are also included for screw in mounting options that can accommodate vertical or horizontal positions.

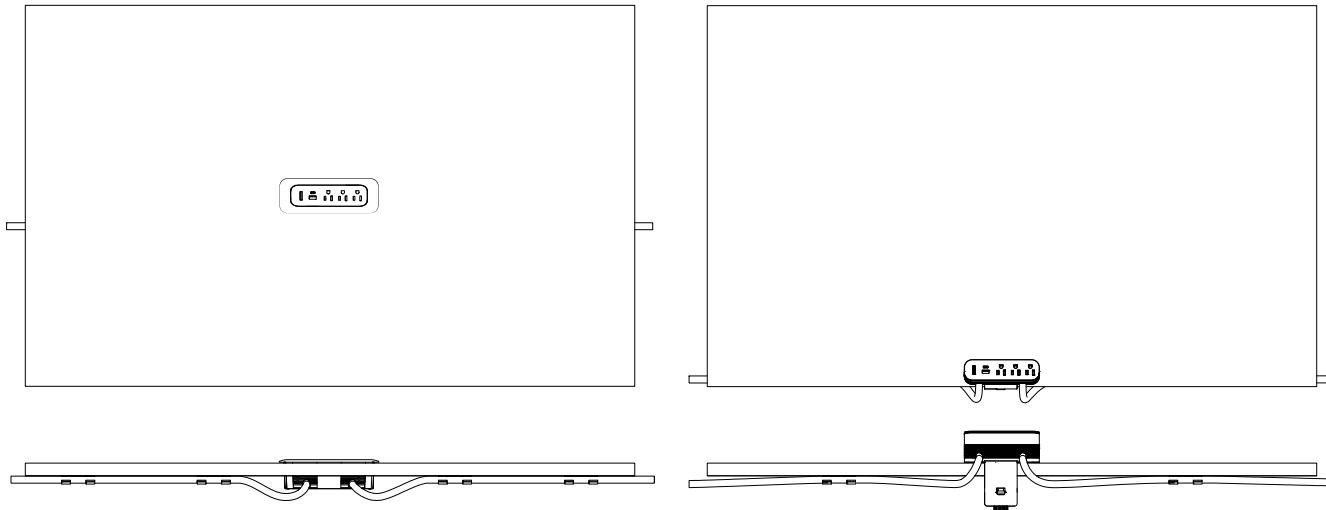
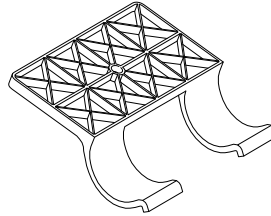

GMDSF10 • ModPower In Surface Starter Unit

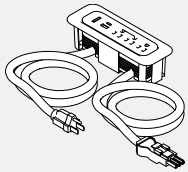

- ModPower starter unit includes one 10' cord with a NEMA plug and one 3' connector cord.
- Unit equipped with three 15A tamper resistant receptacles, one USB-A and one USB-C charging ports and a circuit breaker.
- 4 cable management cord clips included.
- MG at the end of the code indicates a magnesium finish, while WH is a white finish.

PRODUCT CODE	PRICE	DIMENSIONS			WEIGHT		VOL FT ³
		H	W	D	LBS		
GMDSF10MG	597	2.63	7.63	2.63	3.44	1.0	
GMDSF10WH	597	2.63	7.63	2.63	3.44	1.0	

GMDCF3 • ModPower In Surface Middle Unit

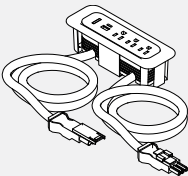

- ModPower middle unit includes two 3' connector cords.
- Unit equipped with three 15A rated 12A tamper resistant receptacles, one USB-A and one USB-C charging ports and a circuit breaker.
- 4 cable management cord clips included.
- MG at the end of the code indicates a magnesium finish, while WH is a white finish.

PRODUCT CODE	PRICE	DIMENSIONS			WEIGHT		VOL FT ³
		H	W	D	LBS		
GMDCF3MG	562	2.63	7.63	2.63	2.44	1.0	
GMDCF3WH	562	2.63	7.63	2.63	2.44	1.0	

GMDEF3 • ModPower In Surface End Unit

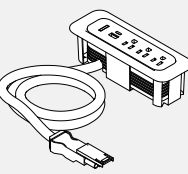

- ModPower end unit includes one 3' connector cord.
- Unit equipped with three 15A rated 12A tamper resistant receptacles, one USB-A and one USB-C charging ports and a circuit breaker.
- 2 cable management cord clips included.
- MG at the end of the code indicates a magnesium finish, while WH is a white finish.

PRODUCT CODE	PRICE	DIMENSIONS			WEIGHT		VOL FT ³
		H	W	D	LBS		
GMDEF3MG	494	2.63	7.63	2.63	1.85	1.0	
GMDEF3WH	494	2.63	7.63	2.63	1.85	1.0	

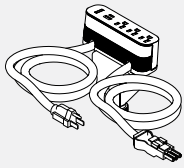
GMDSA10 • ModPower Starter Mounted Unit

- ModPower starter unit includes one 10' cord with a NEMA plug and one 3' connector cord.
- Unit equipped with three 15A tamper resistant receptacles, one USB-A and one USB-C charging ports and a circuit breaker.
- Includes edge clamp and 3 other mounting methods; and 4 cable management cord clips.
- MG at the end of the code indicates a magnesium finish, while WH is a white finish.

PRODUCT CODE	PRICE	PRICE			WEIGHT		VOL FT ³
		H	W	D	LBS	FT ³	
GMDSA10MG	631	2.5	6.13	1.75	4.33	1.0	
GMDSA10WH	631	2.5	6.13	1.75	4.33	1.0	

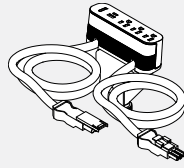
GMDCA3 • ModPower Middle Mounted Unit

- ModPower middle unit includes two 3' connector cords.
- Unit equipped with three 15A rated 12A tamper resistant receptacles, one USB-A and one USB-C charging ports and a circuit breaker.
- Includes edge clamp and 3 other mounting methods; and 4 cable management cord clips.
- MG at the end of the code indicates a magnesium finish, while WH is a white finish.

PRODUCT CODE	PRICE	PRICE			WEIGHT		VOL FT ³
		H	W	D	LBS	FT ³	
GMDCA3MG	597	2.5	6.13	1.75	3.33	1.0	
GMDCA3WH	597	2.5	6.13	1.75	3.33	1.0	

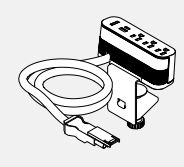
GMDEA3 • ModPower End Mounted Unit

- ModPower end unit includes one 3' connector cord.
- Unit equipped with three 15A rated 12A tamper resistant receptacles, one USB-A and one USB-C charging ports and a circuit breaker.
- Includes edge clamp and 3 other mounting methods; and 2 cable management cord clips.
- MG at the end of the code indicates a magnesium finish, while WH is a white finish.

PRODUCT CODE	PRICE	PRICE			WEIGHT		VOL FT ³
		H	W	D	LBS	FT ³	
GMDEA3MG	528	2.5	6.13	1.75	2.75	1.0	
GMDEA3WH	528	2.5	6.13	1.75	2.75	1.0	

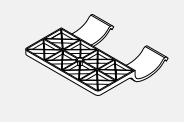
GMDCLIPS • ModPower Management Clips

- Includes 10 clips.

PRODUCT CODE	PRICE	PRICE			WEIGHT		VOL FT ³
		H	W	D	LBS	FT ³	
GMDCLIPS	102	0.6	2.6	2.5	0.3	0.2	

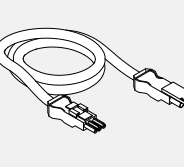
GMDJ36BK • ModPower Interconnecting Jumper

- ModPower interconnecting jumper cord to add an additional 3 feet of cord length between ModPower units.
- Package of 2, each 3 feet with male & female connector.

PRODUCT CODE	PRICE	PRICE			WEIGHT		VOL FT ³
		H	W	D	LBS	FT ³	
GMDJ36BK	329		36		1.38	0.9	

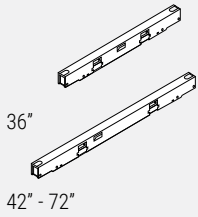
BRTETA-KIT • Above Worksurface Power Trough

- **Above Worksurface Power Trough Kit Facilitates power distribution and data/communication cable management.**
- Formed steel trough is secured between Back 2 Back stations. Not suitable for single table assemblies.
- Power Trough Kits 36-72 consist of one double sided steel trough, Power Distribution Housing, mounting brackets and one charcoal grey extruded Data/Communication cable manager.
- Power Trough Kits 78 and 84 consist of two double sided steel troughs (BRTETA78KIT = BRTETA36 above KIT + BRTETA42KIT + Jumper. BRTETA84KIT = BRTETA42KIT + BRTETA42KIT + Jumper), two Power Distribution Housings, mounting brackets and two charcoal grey extruded Data/Communication cable managers.
- Specify Duplex receptacles separately. 36" trough can house one duplex per side and 42-72" trough can house two duplexes per side, 78" trough can house three duplexes and 84" trough can house four duplexes per side. Specify Jumpers between tables separately.
- Ceiling feed entry through slots at either end; base feed entry at either end.
- Each trough provides two openings 1.37" x 2.68"(one per side) for data/communication terminal plates. A single terminal plate (not supplied) can accommodate up to 4 data/communication plates.
- Data/comm plate spacer BRTPDS available to accommodate larger cable-to-terminal bending radius
- Each trough provides two openings 1.37" x 2.68"(one per side) for data/communication terminal plates. A single terminal plate (not supplied) can accommodate up to 4 data/communication terminals (jacks).
- Painted finish.
- Specify above worksurface power trough end cap BRTETEC to finish open ends of the power trough.
- Each trough includes one black (BRTPDS) data/comm spacer extending the depth behind the data/comm jacks by 0.6". White (BRTPDSW) and Silver (BRTPDSS) are also available as an option. Additional spacers may be purchased individually for \$45 list, see BRTPDS.

PRODUCT CODE	PRICE	SIZE/INCHES			WEIGHT VOL	
		H	W	D	LBS	FT ³
BRTETA36KIT	500	3.5	35.9	2.5	4.06	0.18
BRTETA42KIT	541	3.5	41.9	2.5	4.73	0.21
BRTETA48KIT	574	3.5	47.9	2.5	5.41	0.24
BRTETA54KIT	607	3.5	53.9	2.5	6.09	0.27
BRTETA60KIT	625	3.5	59.9	2.5	6.77	0.30
BRTETA66KIT	672	3.5	65.9	2.5	7.45	0.33
BRTETA72KIT	683	3.5	71.9	2.5	8.12	0.36
BRTETA78KIT	1038	3.5	78	2.5	8.81	0.39
BRTETA84KIT	1083	3.5	84	2.5	9.49	0.42

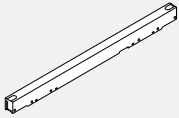
BRTEST-KIT • Back 2 Back Storage Tower Gap Filler Kit

- **Consists of a formed sheet metal cover and four brackets which allow the cover to be mounted at either above worksurface power trough level or below work surface power trough level.**
- Versatile brackets secure the cover trough at corners, to the bottom of Back 2 Back work surface supported by either shared 51 or 63 legs or storage beam and storage towers.
- Note: the Back 2 Back storage tower gap filler is not compatible with single, freestanding tables.
- The BRTEST15kit covers the gap between two Back 2 Back BRRT5024x or BRRT5030x storage towers.
- The BRTEST30kit covers the gap between two pairs of Back 2 Back BRRT5024x or BRRT5030x storage towers.
- The BRTEST24kit covers the gap between two Back 2 Back BRRTW5024x or BRRTW5030x storage towers.
- The BRTEST48kit covers the gap between two pairs of Back 2 Back BRRTW5024x or BRRTW5030x storage towers.
- A corresponding harness is included.

PRODUCT CODE	PRICE	SIZE/INCHES			WEIGHT VOL	
		H	W	D	LBS	FT ³
BRTEST15KIT	441	3.5	2.5	15.5	2	0.078
BRTEST30KIT	510	3.5	2.5	31	3.5	0.157
BRTEST24KIT	478	3.5	2.5	24	2.5	0.122
BRTEST48KIT	563	3.5	2.5	48	4	0.243

BRTETEC • Above Worksurface Power Trough End Cap

- **Covers the ends of the worksurface power trough.**
- Specify two per linear trough assembly.
- Finish white

PRODUCT CODE	PRICE	SIZE/INCHES			WEIGHT VOL	
		H	W	D	LBS	FT ³
BRTETEC	9	3.1	2.25	0.5	0.1	0.002

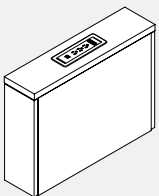
BRTVCM • Vertical Cable Manager

- 6" wide vertical channel which can be secured to an end or in-between 21" or 25" high storage units of corresponding depth.
- Facilitates power / data transfer from a floor monument under storage cabinets or from a panel base raceway to top of storage units.
- The units can join other 18" or 24" deep storage units to form a storage spine.
- Floor clearance allows for access to panel floor raceway duplex outlets.
- Removable top with a Below Worksurface Power/Data Module provides easy access.
- Optional Cable Basket suspends off storage unit's bottoms and manages cables along the horizontal plane.
- 3/4" LP chassis, fronts and back (specify LP finish), 1" top (specify LP or HP finish); unfinished cut-out edges. Universal connecting hardware included.
- Flush-mounted power module included.
- Provides three outlets and two 2.1 amp USB ports and an adapter kit containing blank cover, HDMI, RJ45 or VGA adapter brackets. Note: HDMI, RJ45 and VGA connectors are not included.

PRODUCT CODE	PRICE	SIZE/INCHES			WEIGHT VOL		
		LP	HP	H W D	LBS	FT ³	
BRTVCM2118	930	948	21	6	18	14	1.31
BRTVCM2518	948	963	25	6	18	17	1.56
BRTVCM2124	982	998	21	6	24	17	1.75
BRTVCM2524	998	1015	25	6	24	22	2.08

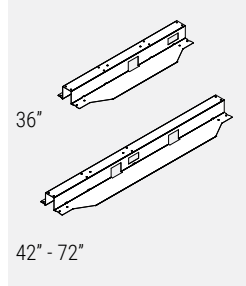
BRTETB-SKIT • Below Worksurface Single Power/Data Trough

- **Below Worksurface Single Power Trough Kit Facilitates power distribution and data/communication cable management.**

- Formed steel trough is secured below a single table worksurface; outlets are facing the rear worksurface edge.
- Not suitable for Back 2 Back tables
- Power Trough Kits 36-72 consist of one single sided steel trough, Power Distribution Housing, mounting brackets and one charcoal grey extruded Data/Communication cable manager.
- Power Trough Kits 78 and 84 consist of two single sided steel troughs (BRTETB78KIT = BRTETB36KIT + BRTETB42KIT + Jumper. BRTETB84KIT = BRTETB42KIT + BRTETB42KIT + Jumper), two Power Distribution Housings, mounting brackets and two charcoal grey extruded Data/Communication cable managers.
- Specify Duplex receptacles separately. 36" trough can house one duplex, 42-72" trough can house two duplexes, 78" through can house three duplexes and 84" trough can house four duplexes per side.
- Specify Jumpers between tables separately.
- Base feed entry at either end; no ceiling feed.
- Each trough provides one opening 1.37" x 2.68" for terminal plate (not supplied). One terminal plate can accommodate up to 4 data/communication terminals (jacks).
- Each trough includes one black (BRTPDS) data/comm spacer extending the depth behind the data/comm jacks by 0.6". White (BRTPDSW) and Silver (BRTPDSS) are also available as an option. Additional spacers may be purchased individually for \$45 list, see BRTPDS.
- Painted finish.
- Note: Please specify BRTETB36SKIT Single Trough Kit for 120° Degree Tables BRTWAC120

PRODUCT CODE	PRICE	SIZE/INCHES			WEIGHT VOL	
		H	W	D	LBS	FT ³
BRTETB36SKIT	441	2.5	30.34	8.5	4.5	0.59
BRTETB42SKIT	483	2.5	36.34	8.5	5.3	0.61
BRTETB48SKIT	523	2.5	42.34	8.5	6.2	0.71
BRTETB54SKIT	548	2.5	48.34	8.5	7.1	0.81
BRTETB60SKIT	557	2.5	54.34	8.5	8.0	0.91
BRTETB66SKIT	581	2.5	60.34	8.5	8.9	1.01
BRTETB72SKIT	600	2.5	66.34	8.5	9.8	1.11
BRTETB78SKIT	922	2.5	72.34	8.5	11.0	1.21
BRTETB84SKIT	963	2.5	78.34	8.5	12.0	1.31

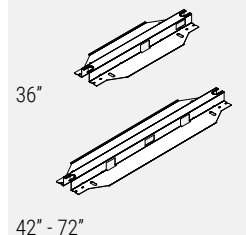
BRTETB-DKIT • Below Worksurface Double Power/Data Trough

- **Below Worksurface Double Power Trough Kit Facilitates power distribution and data/communication cable management.**

- Formed steel trough is secured below worksurfaces, between Back 2 Back stations, supported by Back 2 Back Legs.
- Not suitable for single table assemblies.
- Power Trough Kits 36-72 consist of one double sided steel trough, Power Distribution Housing, mounting brackets and one charcoal grey extruded Data/Communication cable manager.
- Power Trough Kits 78 and 84 consist of two double sided steel troughs (BRTETB78KIT = BRTETB36KIT + BRTETB42KIT + Jumper. BRTETB84KIT = BRTETB42KIT + BRTETB42KIT + Jumper), two Power Distribution Housings, mounting brackets and two charcoal grey extruded Data/Communication cable managers.
- Specify Duplex receptacles separately. 36" trough can house one duplex per side, 42-72" trough can house two duplexes, 78" trough can house three duplexes and 84" trough can house four duplexes per side.
- Specify Jumpers between tables separately.
- Ceiling feed entry through slots at either end; base feed entry at either end.
- Each trough provides two openings 1.37" x 2.68" (one per side) for data/communication terminal plates (not supplied).
- Painted finish.
- Each trough includes one black (BRTPDS) data/comm spacer extending the depth behind the data/comm jacks by 0.6". White (BRTPDSW) and Silver (BRTPDSS) are also available as an option. Additional spacers may be purchased individually for \$45 list, see BRTPDS.

PRODUCT CODE	PRICE	SIZE/INCHES			WEIGHT VOL	
		H	W	D	LBS	FT ³
BRTETB36DKIT	607	2.5	30.3	11.6	3.8	0.37
BRTETB42DKIT	625	2.5	36.3	11.6	4.5	0.44
BRTETB48DKIT	652	2.5	42.3	11.6	5.3	0.52
BRTETB54DKIT	665	2.5	48.3	11.6	6.0	0.59
BRTETB60DKIT	683	2.5	54.3	11.6	6.8	0.66
BRTETB66DKIT	707	2.5	60.3	11.6	7.5	0.74
BRTETB72DKIT	723	2.5	66.3	11.6	8.3	0.81
BRTETB78DKIT	1232	2.5	72.3	11.6	9.0	0.88
BRTETB84DKIT	1245	2.5	78.3	11.6	9.8	0.96

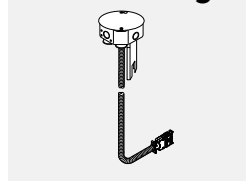
BRTCF • Bridges Ceiling Feed

- **Ceiling feed provides a single power entry from ceiling, through Ceiling pole into Power Trough, into Power Distribution Housing.**

- An 8-wire (4-circuit) metal conduit harness with included metal junction box for hard wiring to the building power supply above ceiling tile.
- Must be hard wired to the building power supply by a licensed electrician.
- Ceiling Pole not included.

PRODUCT CODE	PRICE	SIZE/INCHES			WEIGHT VOL	
		H	W	D	LBS	FT ³
BRTCF120	450	120	6	6	5	2
BRTCF144	501	144	6	6	6	3

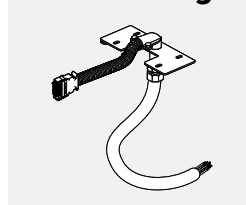
BRTBF • Bridges Base Feed

- **Provides single power entry from floor or wall located building power supply.**

- Connects to Power Distribution Housing.
- Must be hard wired to the building power supply by a licensed electrician.

PRODUCT CODE	PRICE	SIZE/INCHES			WEIGHT VOL	
		H	W	D	LBS	FT ³
BRTBF	494	4	72	6	4	2
BRTBF120	705	4	120	6	6	2
BRTBF144	760	4	144	6	8	2

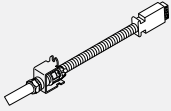
BRTDIVPBF • Bridges Divider Panel Base Feed

- Provides single power entry from floor or wall located building power supply.
- Connects to Power Distribution Housing.
- Must be hard wired to the building power supply by a licensed electrician.

PRODUCT CODE	PRICE	SIZE/INCHES			WEIGHT VOL	
		H	W	D	LBS	FT ³
BRTDIVPBF	473	4	72	6	4	2

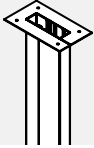
BRTCPP • Bridges Ceiling Pole

- Ceiling pole brings ceiling feed conduit and data cables from the ceiling down to Power troughs at desk height. Accommodates 10' ceiling heights.
- A two part construction allows power/data conduit lay-in.
- Includes mounting hardware and ceiling bezel.
- Painted finish.

PRODUCT CODE	PRICE	SIZE/INCHES			WEIGHT VOL	
		H	W	D	LBS	FT ³
BRTCPP	249	99	4.75	1.5	13	0.48

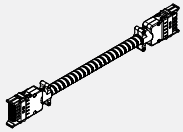
BRTHH • Housing to Housing Harness

- Distributes power between Power Distribution Housings.
- Specify BRTHH58 to distribute power from double sided, Back 2 Back below the worksurface power trough to a single sided, below work surface power trough at the end of a table run.
(Please see Power Delivery page at the beginning of electrical section (item #9)).

PRODUCT CODE	PRICE	SIZE/INCHES			WEIGHT VOL	
		H	W	D	LBS	FT ³
BRTHH28	160	2	28	0.5	1.0	1.17
BRTHH44	190	2	44.5	0.5	1.5	1.17
BRTHH52	201	2	52.5	0.5	2.0	1.17
BRTHH58	208	2	58.5	0.5	2.2	1.17
BRTHH76	233	2	76.5	0.5	2.8	1.17

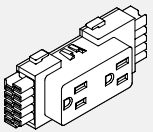
BRT8D • Duplex Receptacles

- Snaps into Power Distribution Housing.
- Up to 6 duplex receptacles per circuit.
- D1 = Circuit #1 (utility circuit)
- D2 = Circuit #2 (utility circuit)
- D3 = Circuit #3 (utility circuit)
- DA - Circuit #A (dedicated circuit)
- XW identifies white colour plastic, all others in standard black.

PRODUCT CODE	PRICE	SIZE/INCHES			WEIGHT VOL	
		H	W	D	LBS	FT ³
BRT8D1	35	2	4.625	1.25	0.10	0.01
BRT8D2	35	2	4.625	1.25	0.10	0.01
BRT8D3	35	2	4.625	1.25	0.10	0.01
BRT8DA	35	2	4.625	1.25	0.10	0.01
BRT8DXW1	52	2	4.625	1.25	0.10	0.01
BRT8DXW2	52	2	4.625	1.25	0.10	0.01
BRT8DXW3	52	2	4.625	1.25	0.10	0.01
BRT8DXWA	52	2	4.625	1.25	0.10	0.01

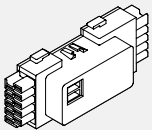
BE8D • USB Receptacles

- Snaps into Power Distribution Housing.
- USB charging module provides convenient charging power access through dual ports on face of receptacles.
- Two USB ports.
- 2 amp output, considered as circuit #1.

PRODUCT CODE	PRICE	SIZE/INCHES			WEIGHT VOL	
		H	W	D	LBS	FT ³
BRT8DU1-W	238	2	4.625	1.25	0.10	0.01
BRT8DU1-B	238	2	4.625	1.25	0.10	0.01

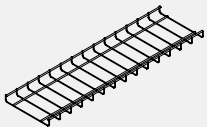
BRTCB • Power/Data Cable Basket

- Shallow, 8" wide basket manages cable excess. If suspended below Back 2 Back worksurfaces, it facilitates the simplest way of electrifying a workstation. The equipment can be plugged directly to a wall or floor monument outlets and the Cable Basket serves to manage cords and cables. It can be easily unclipped from steel brackets (included) to rearrange cable connections from below the worksurface.
- The same steel brackets can suspend the Cable Basket below storage cabinet's bottom where it keeps the cords and cables off the floor and manages them under storage cabinets along the horizontal plane - between panel base raceway outlets, floor monuments and Storage Vertical Cable Manager, for example.
- Tall storage cabinet's legs provide easy access to the Cable Basket where it can be easily unclipped from steel brackets (included) to rearrange cable connections.
- Note: wide Cable Baskets can span under several storage cabinets. As a general rule - specify Cable Basket min. 8" shorter than the storage cabinet spine assembly.
- Steel wire construction, black finish baskets; black steel hanging brackets, fasteners.
- BRTCB76KIT contains 2 pieces BRTCB34.

PRODUCT CODE	PRICE	SIZE/INCHES			WEIGHT VOL	
		H	W	D	LBS	FT ³
BRTCB8	80	1	8	8	0.36	0.03
BRTCB16	89	1	16	8	0.73	0.07
BRTCB22	93	1	22	8	1.01	0.10
BRTCB28	100	1	28	8	1.20	0.13
BRTCB34	114	1	34	8	1.56	0.15
BRTCB40	117	1	40	8	1.80	0.18
BRTCB46	127	1	46	8	2.16	0.21
BRTCB52	133	1	52	8	2.39	0.24
BRTCB58	144	1	58	8	2.66	0.26
BRTCB64	146	1	64	8	2.94	0.29
BRTCB70	159	1	70	8	3.22	0.34
BRTCB76KIT	218	1	34	8	1.56	0.15

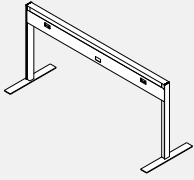
BRPBS • Starter Beam

- Bridges Power Beam divides space, delineates territory, provides power and data to adjacent work spaces.
- Starter Beam can serve as a single, standalone unit or the beginning of a longer run of interconnected beams.
- 30" to 72" wide beams feature knockouts for two electrical duplex and one communication face plate on each side while 24" wide beams accommodate one electrical duplex and one communication face plate on each side.
- The leg expands by approximately 4" in height to compensate for uneven floors and allow for accurate levelling. Feet depth is 24".
- Starter Beam consist of the horizontal channel, raceway covers, two legs, two 24" deep feet, two vertical end trims and corresponding end trim capture strips.
- Specify standard Flat Top Trim (BRPBTC), Glass and Top Trim Kit (BRPBEG) or PET Felt and Top Trim Kit (BRPBEF) separately.
- Specify electrical components separately.
- Specify standard metal paint finish.
- Final built up height is not to exceed 50" high, including over panels.

PRODUCT CODE	PRICE	SIZE/INCHES			WEIGHT LBS	VOL FT ³
		H	W	D		
BRPBS1824	406	18	24	24	20.23	6.00
BRPBS1830	431	18	30	24	21.83	7.50
BRPBS1836	450	18	36	24	23.14	9.00
BRPBS1842	471	18	42	24	24.46	10.50
BRPBS1848	496	18	48	24	25.77	12.00
BRPBS1854	517	18	54	24	27.08	13.50
BRPBS1860	538	18	60	24	28.39	15.00
BRPBS1866	562	18	66	24	29.7	16.50
BRPBS1872	595	18	72	24	31.01	18.00
BRPBS2624	432	26	24	24	21.24	8.67
BRPBS2630	457	26	30	24	22.84	10.83
BRPBS2636	476	26	36	24	24.15	13.00
BRPBS2642	497	26	42	24	25.47	15.17
BRPBS2648	523	26	48	24	26.77	17.33
BRPBS2654	544	26	54	24	28.09	19.50
BRPBS2660	564	26	60	24	29.4	21.67
BRPBS2666	588	26	66	24	30.7	23.83
BRPBS2672	621	26	72	24	32.02	26.00
BRPBS3424	455	34	24	24	22.25	11.33
BRPBS3430	489	34	30	24	23.85	14.17
BRPBS3436	508	34	36	24	25.16	17.00
BRPBS3442	529	34	42	24	26.47	19.83
BRPBS3448	554	34	48	24	27.78	22.67
BRPBS3454	575	34	54	24	29.09	25.50
BRPBS3460	596	34	60	24	30.4	28.33
BRPBS3466	617	34	66	24	31.71	31.17
BRPBS3472	656	34	72	24	33.02	34.00

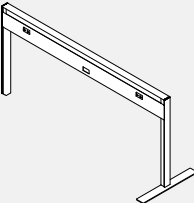
BRPBA • Add-on Beam

- Bridges Power Beam divides space, delineates territory, provides power and data to adjacent work spaces.
- Add-on Beam connects to the Starter Beam and serves to extend the run of Bridges Power Beams as desired.
- 30" to 72" wide beams feature knockouts for two electrical duplex and one communication face plate on each side while 24" wide beams accommodate one electrical duplex and one communication face plate on each side.
- Add-on Beam consist of the horizontal channel, raceway covers, two legs, one foot and a pair of beam-to-beam connecting capture strips.
- The leg expands by approximately 4" in height to compensate for uneven floors and allow for accurate levelling. Feet depth is 24".
- Specify standard Flat Top Trim (BRPBTC), Glass and Top Trim Kit (BRPBEG) or PET Felt and Top Trim Kit (BRPBEF) separately.
- Specify electrical components separately.
- Specify standard metal paint finish.
- Final built up height is not to exceed 50" high, including over panels.

PRODUCT CODE	PRICE	SIZE/INCHES			WEIGHT LBS	VOL FT ³
		H	W	D		
BRPBA1824	298	18	24	24	14.46	6.00
BRPBA1830	323	18	30	24	16.06	7.50
BRPBA1836	342	18	36	24	17.37	9.00
BRPBA1842	363	18	42	24	18.68	10.50
BRPBA1848	389	18	48	24	19.99	12.00
BRPBA1854	410	18	54	24	21.31	13.50
BRPBA1860	430	18	60	24	22.62	15.00
BRPBA1866	451	18	66	24	23.92	16.50
BRPBA1872	487	18	72	24	25.24	18.00
BRPBA2624	325	26	24	24	15.5	8.67
BRPBA2630	350	26	30	24	17.11	10.83
BRPBA2636	369	26	36	24	18.42	13.00
BRPBA2642	389	26	42	24	19.73	15.17
BRPBA2648	415	26	48	24	21.04	17.33
BRPBA2654	436	26	54	24	22.35	19.50
BRPBA2660	456	26	60	24	23.66	21.67
BRPBA2666	477	26	66	24	24.97	23.83
BRPBA2672	513	26	72	24	26.28	26.00
BRPBA3424	356	34	24	24	16.55	11.33
BRPBA3430	381	34	30	24	18.15	14.17
BRPBA3436	400	34	36	24	19.46	17.00
BRPBA3442	421	34	42	24	20.77	19.83
BRPBA3448	447	34	48	24	22.08	22.67
BRPBA3454	468	34	54	24	23.4	25.50
BRPBA3460	488	34	60	24	24.71	28.33
BRPBA3466	509	34	66	24	26.01	31.17
BRPBA3472	545	34	72	24	27.33	34.00

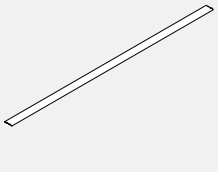
BRPBTC • Flat Top Trim

- Flat Top Trim attaches on top of Bridges Power Beams to add privacy or divide space.
- Flat top trim is made of an aluminum extrusion.
- Specify standard metal paint finish.

PRODUCT CODE	PRICE	SIZE/INCHES			WEIGHT LBS	VOL FT ³
		H	W	D		
BRPBTC24	11	0.2	24	2.61	0.24	0.01
BRPBTC30	14	0.2	30	2.61	0.61	0.01
BRPBTC36	16	0.2	36	2.61	0.73	0.01
BRPBTC42	19	0.2	42	2.61	0.85	0.01
BRPBTC48	21	0.2	48	2.61	0.97	0.01
BRPBTC54	24	0.2	54	2.61	1.1	0.02
BRPBTC60	24	0.2	60	2.61	1.22	0.02
BRPBTC66	27	0.2	66	2.61	1.34	0.02
BRPBTC72	31	0.2	72	2.61	1.47	0.02

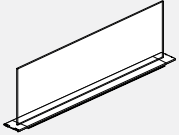
BRPBEG • Embedded Glass and Top Trim Kit

- Embedded Glass and Top Trim Kit attaches on top of beams to add privacy or divide space.
- Embedded Glass Top Trim Kit consist of the extruded aluminum channel, die-cast channel end covers, glass partition, gasket and hardware required to secure the trim to the beam's horizontal channel.
- Specify standard metal paint finish.
- Clear tempered glass is standard.
- NOTE: When specifying an application where two panels are side by side at different heights, a special is required to ensure proper fit.

PRODUCT CODE	PRICE		SIZE/INCHES			WEIGHT LBS	VOL FT ³
	CLR	FRST	H	W	D		
BRPBEG0824	129	213	8	24	2.61	9.42	0.29
BRPBEG0830	137	220	8	30	2.61	11.79	0.36
BRPBEG0836	144	229	8	36	2.61	14.15	0.44
BRPBEG0842	152	237	8	42	2.61	16.52	0.51
BRPBEG0848	168	262	8	48	2.61	18.88	0.58
BRPBEG0854	186	291	8	54	2.61	19.52	0.65
BRPBEG0860	204	320	8	60	2.61	20.58	0.73
BRPBEG0866	221	350	8	66	2.61	21.55	0.80
BRPBEG0872	245	385	8	72	2.61	23.62	0.87
BRPBEG1624	134	218	16	24	2.61	9.891	0.58
BRPBEG1630	165	264	16	30	2.61	12.37	0.73
BRPBEG1636	184	311	16	36	2.61	14.85	0.87
BRPBEG1642	210	357	16	42	2.61	17.346	1.02
BRPBEG1648	236	404	16	48	2.61	19.824	1.16
BRPBEG1654	261	425	16	54	2.61	21.25	1.31
BRPBEG1660	286	496	16	60	2.61	23.62	1.45
BRPBEG1666	312	543	16	66	2.61	25.98	1.60
BRPBEG1672	343	595	16	72	2.61	28.35	1.74

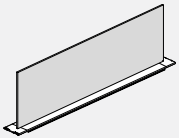
BRPBEF • Embedded PET Felt and Top Trim Kit

- Embedded PET Felt and Top Trim Kit attaches on top of beams to add privacy or divide space.
- Embedded PET Felt Top Trim Kit consist of the extruded aluminum channel, die-cast channel end covers, PET felt partition and hardware required to secure the trim to the beams horizontal channel.
- Specify standard metal paint finish.
- 9mm PET felt material is tackable. Please specify standard finish.
- NOTE: When specifying an application where two panels are side by side at different heights, a special is required to ensure proper fit.

PRODUCT CODE	PRICE	SIZE/INCHES			WEIGHT LBS	VOL FT ³
		H	W	D		
BRPBEF0824	63	8	24	2.61	1.32	0.29
BRPBEF0830	66	8	30	2.61	1.65	0.36
BRPBEF0836	88	8	36	2.61	1.99	0.44
BRPBEF0842	92	8	42	2.61	2.32	0.51
BRPBEF0848	165	8	48	2.61	2.65	0.58
BRPBEF0854	169	8	54	2.61	2.98	0.65
BRPBEF0860	172	8	60	2.61	3.32	0.73
BRPBEF0866	176	8	66	2.61	3.65	0.80
BRPBEF0872	185	8	72	2.61	3.98	0.87
BRPBEF1624	63	16	24	2.61	1.83	0.58
BRPBEF1630	66	16	30	2.61	2.3	0.73
BRPBEF1636	88	16	36	2.61	2.76	0.87
BRPBEF1642	92	16	42	2.61	3.22	1.02
BRPBEF1648	165	16	48	2.61	3.68	1.16
BRPBEF1654	169	16	54	2.61	4.14	1.31
BRPBEF1660	172	16	60	2.61	4.61	1.45
BRPBEF1666	176	16	66	2.61	5.07	1.60
BRPBEF1672	185	16	72	2.61	5.53	1.74

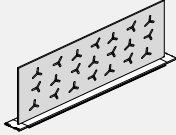
BRPBEPF • Embedded Perforated PET Felt and Top Trim Kit

- Embedded Perforated PET Felt and Top Trim Kit attaches on top of beams to add privacy or divide space.
- Embedded Perforated PET Felt Top Trim Kit consist of the extruded aluminum channel, die-cast channel end covers, perforated PET felt partition and hardware required to secure the trim to the beams horizontal channel.
- Specify standard metal paint finish.
- 9mm PET felt material is tackable. Please specify standard finish.
- NOTE: When specifying an application where two panels are side by side at different heights, a special is required to ensure proper fit.

PRODUCT CODE	PRICE	SIZE/INCHES			WEIGHT LBS	VOL FT ³
		H	W	D		
BRPBEPF0824	126	8	24	2.61	1.32	0.29
BRPBEPF0830	133	8	30	2.61	1.65	0.36
BRPBEPF0836	175	8	36	2.61	1.99	0.44
BRPBEPF0842	182	8	42	2.61	2.32	0.51
BRPBEPF0848	330	8	48	2.61	2.65	0.58
BRPBEPF0854	337	8	54	2.61	2.98	0.65
BRPBEPF0860	345	8	60	2.61	3.32	0.73
BRPBEPF0866	352	8	66	2.61	3.65	0.80
BRPBEPF0872	371	8	72	2.61	3.98	0.87
BRPBEPF1624	126	16	24	2.61	1.83	0.58
BRPBEPF1630	133	16	30	2.61	2.3	0.73
BRPBEPF1636	175	16	36	2.61	2.76	0.87
BRPBEPF1642	182	16	42	2.61	3.22	1.02
BRPBEPF1648	330	16	48	2.61	3.68	1.16
BRPBEPF1654	337	16	54	2.61	4.14	1.31
BRPBEPF1660	345	16	60	2.61	4.61	1.45
BRPBEPF1666	352	16	66	2.61	5.07	1.60
BRPBEPF1672	371	16	72	2.61	5.53	1.74

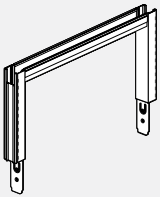
BPX3OP • Over Panel Frame

- **Over Panel Frame attaches on top of beams to add privacy or divide space.**
- Overpanel Extension consists of the extruded aluminum frame and bayonets connecting the frame to the top of the powerBEAM vertical leg.
- Any tile can be attached to either side to enclose the frame.
- Specify standard Flat Top Trim (BRPBTC), Vertical Trims (BA3VT), Glass and Top Trim Kit (BRPBEG) or PET Felt and Top Trim Kit (BRPBEF) separately.
- Specify standard metal paint finish.
- Final built up height is not to exceed 50" high, including over panels.

PRODUCT CODE	PRICE	SIZE/ INCHES			WEIGHT LBS	VOL FT ³
		H	W	D		
BPX3OP0824	102	8	24	2.61	4	0.43
BPX3OP0830	109	8	30	2.61	4	0.65
BPX3OP0836	117	8	36	2.61	4	0.71
BPX3OP0842	131	8	42	2.61	5	0.87
BPX3OP0848	138	8	48	2.61	5	0.93
BPX3OP0854	146	8	54	2.61	6	1.04
BPX3OP0860	156	8	60	2.61	6	1.20
BPX3OP0866	173	8	66	2.61	7	1.31
BPX3OP0872	192	8	72	2.61	8	1.42
BPX3OP1624	102	16	24	2.61	5	0.73
BPX3OP1630	109	16	30	2.61	5	1.09
BPX3OP1636	117	16	36	2.61	5	1.18
BPX3OP1642	131	16	42	2.61	6	1.45
BPX3OP1648	138	16	48	2.61	6	1.55
BPX3OP1654	146	16	54	2.61	7	1.73
BPX3OP1660	156	16	60	2.61	7	2.00
BPX3OP1666	173	16	66	2.61	9	2.16
BPX3OP1672	192	16	72	2.61	10	2.37

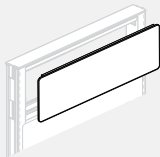
BP3FT • Removeable Face Tile - Fabric or Laminate

- **Attaches to any opening in a Pass-Thru Panel.**
- Tile clips included.
- Easily interchangeable on site.
- Specify two tiles per over panel opening of corresponding width. Tiles can be combined. For example, Fabric Tile on one side and Accessory Tile on the opposite side of the same panel.
- OPT* = Laminate or Whiteboard.

PRODUCT CODE	PRICE			SIZE/ INCHES			WEIGHT LBS	VOL FT ³
	GR1	GR2	OPT*	H	W	D		
BP3FT0824	97	106	113	8	24	0.25	1	0.16
BP3FT0830	106	117	134	8	30	0.25	2	0.20
BP3FT0836	131	144	159	8	36	0.25	2	0.25
BP3FT0842	139	151	169	8	42	0.25	2	0.29
BP3FT0848	145	159	173	8	48	0.25	3	0.33
BP3FT0854	153	169	181	8	54	0.25	3	0.37
BP3FT0860	159	172	187	8	60	0.25	4	0.41
BP3FT0866	180	239	305	8	66	0.25	4	0.46
BP3FT0872	233	307	384	8	72	0.25	4	0.50
BP3FT1624	109	115	124	16	24	0.25	2	0.33
BP3FT1630	116	132	146	16	30	0.25	3	0.41
BP3FT1636	144	157	172	16	36	0.25	3	0.50
BP3FT1642	153	169	181	16	42	0.25	3	0.58
BP3FT1648	161	174	192	16	48	0.25	4	0.66
BP3FT1654	170	181	199	16	54	0.25	4	0.75
BP3FT1660	187	247	205	16	60	0.25	5	0.83
BP3FT1666	205	264	329	16	66	0.25	5	0.92
BP3FT1672	253	336	420	16	72	0.25	6	1.00

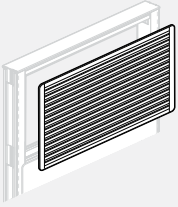
BP3AT • Removable Face Tile - Accessory

- Attaches to any opening in an Over Panel Frame.
- Provides support for accessories.
- Easily interchangeable on site.
- Two tile clips included.
- Specify two tiles per over panel opening of corresponding width. Tiles can be combined. For example, Fabric Tile on one side and Accessory Tile on the opposite side of the same panel.
- Accessory Tile cannot be installed opposite an electrical tile.

PRODUCT CODE	PRICE	SIZE/ INCHES			WEIGHT VOL	
		H	W	D	LBS	FT ³
BP3AT0824	115	08	24	0.25	2.3	0.16
BP3AT0830	127	08	30	0.25	2.9	0.20
BP3AT0836	149	08	36	0.25	3.5	0.25
BP3AT0842	180	08	42	0.25	4.1	0.29
BP3AT0848	211	08	48	0.25	4.7	0.33
BP3AT0854	227	08	54	0.25	5.3	0.37
BP3AT0860	259	08	60	0.25	5.9	0.41
BP3AT0866	279	08	66	0.25	6.5	0.45
BP3AT0872	303	08	72	0.25	7.0	0.50
BP3AT1624	138	16	24	0.25	4.7	0.33
BP3AT1630	147	16	30	0.25	5.7	0.41
BP3AT1636	178	16	36	0.25	7.0	0.50
BP3AT1642	211	16	42	0.25	8.2	0.58
BP3AT1648	245	16	48	0.25	9.4	0.66
BP3AT1654	265	16	54	0.25	10.6	0.75
BP3AT1660	304	16	60	0.25	11.9	0.83
BP3AT1666	336	16	66	0.25	13.0	0.91
BP3AT1672	366	16	72	0.25	14.0	1.00

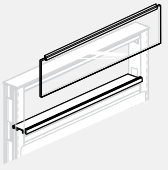
BP3GT • Removable Face Tile - Glazed

- Attaches to any opening in a Pass-Thru Panel.
- 8" or 16" high glazing provides visual accessibility and light transfer.
- Easily interchangeable on site.
- Specify one Glazed Tile for over panel opening of corresponding width.
- Clear tempered glass standard.

PRODUCT CODE	PRICE	FRST/SMK	SIZE/ INCHES			WEIGHT VOL	
			H	W	D	LBS	FT ³
BP3GT0824	115	138	8	24	2.61	3.1	0.16
BP3GT0830	127	151	8	30	2.61	3.9	0.20
BP3GT0836	148	178	8	36	2.61	4.7	0.25
BP3GT0842	173	208	8	42	2.61	5.5	0.29
BP3GT0848	200	238	8	48	2.61	6.3	0.33
BP3GT0854	225	270	8	54	2.61	7.1	0.37
BP3GT0860	249	301	8	60	2.61	7.8	0.41
BP3GT0866	276	331	8	66	2.61	8.6	0.46
BP3GT0872	301	363	8	72	2.61	9.4	0.50
BP3GT1624	125	149	16	24	2.61	5.8	0.33
BP3GT1630	144	172	16	30	2.61	7.2	0.41
BP3GT1636	174	210	16	36	2.61	8.7	0.50
BP3GT1642	204	245	16	42	2.61	10.2	0.58
BP3GT1648	235	280	16	48	2.61	11.6	0.66
BP3GT1654	264	317	16	54	2.61	13.1	0.75
BP3GT1660	295	352	16	60	2.61	14.6	0.83
BP3GT1666	324	372	16	66	2.61	16.0	0.91
BP3GT1672	352	406	16	72	2.61	17.5	1.00

BRP3PS • 90 Degree Post

- Post facilitates splitting of the beam run into up to 4 directions at 90 angle.
- Post kit consist of the extruded aluminum post and four pairs of capture strip connectors.
- Post Vertical Trim must be specified in accordance to your post 2-way, 3-way or 4-way configuration.
- Specify painted metal finish colour.

PRODUCT CODE	PRICE	SIZE/INCHES			WEIGHT LBS	VOL FT ³
		H	W	D		
BRP3PS018	67	18	2.61	2.61	3.00	0.12
BRP3PS026	96	26	2.61	2.61	3.60	0.13
BRP3PS034	126	34	2.61	2.61	4.00	0.14

BRP3PS • 60 Degree Post

- Post facilitates splitting of the beam run into up to 3 directions at 120 angle.
- Post kit consist of the extruded aluminum post and three pairs of capture strip connectors.
- Post Vertical Trim must be specified in accordance to your post 2-way, 3-way or 4-way configuration.
- Specify painted metal finish colour.

PRODUCT CODE	PRICE	SIZE/INCHES			WEIGHT LBS	VOL FT ³
		H	W	D		
BRP3PS60018	67	18	2.61	2.61	3.00	0.12
BRP3PS60026	96	26	2.61	2.61	3.60	0.13
BRP3PS60034	126	34	2.61	2.61	4.00	0.14

BRP3PS • 45 Degree Post

- Post facilitates two beams at 45 angle.
- Post kit consist of the extruded aluminum post and four pairs of capture strip connectors.
- Post Vertical Trim must be specified in accordance to your post 2-way, 3-way or 4-way configuration.
- Specify painted metal finish colour.

PRODUCT CODE	PRICE	SIZE/INCHES			WEIGHT LBS	VOL FT ³
		H	W	D		
BRP3PS45018	67	18	2.61	2.61	3.00	0.12
BRP3PS45026	96	26	2.61	2.61	3.60	0.13
BRP3PS45034	126	34	2.61	2.61	4.00	0.14

BRPVTRF • End Trim

- Attaches to Post
- Consist of the extruded aluminum trim and one pair of capture strip connectors.
- Post Vertical Trim must be specified in accordance to your post 2-way, 3-way or 4-way configuration.
- Specify painted metal finish colour.

PRODUCT CODE	PRICE	SIZE/INCHES			WEIGHT LBS	VOL FT ³
		H	W	D		
BRPVTRF18	23	18	2.61	2.61	0.50	0.01
BRPVTRF26	30	26	2.61	2.61	0.72	0.02
BRPVTRF34	38	34	2.61	2.61	0.94	0.03
BRPVTRF42	46	42	2.61	2.61	1.16	0.04
BRPVTRF50	56	50	2.61	2.61	1.38	0.05

BA3VTEF • Overpanel End Trim

- Attaches to sides of Overpanel Extension frame.
- Overpanel Extension Vertical Trim consist of the extruded aluminum trim, die-cast corner and a pair capture strip connectors.
- Overpanel Extension Vertical Trim must be specified because Overpanel Extensions may not necessarily continue in full length, and single, strategically positioned Overpane Extensions will therefore require their own vertical trims in corresponding locations.
- Specify metal finish colour

PRODUCT CODE	PRICE	SIZE/INCHES			WEIGHT LBS	VOL FT ³
		H	W	D		
BA3VTEF8	11	8	2.61	0.125	0.20	0.01
BA3VTEF16	24	16	2.61	0.125	0.50	0.03
BA3VTEF32	38	32	2.61	0.125	1.00	0.06

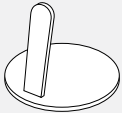
BRPRB • Round Disk Base for Leg

- Attached to the bottom of BRP3PS Post to provide stability at an intersection.
- Round metal plate is 1/4" thick.
- Specify painted metal finish colour.

PRODUCT CODE	PRICE	SIZE/INCHES			WEIGHT LBS	VOL FT ³
		H	W	D		
BRPRB	242	6.5	7.5	7.5	3.67	0.01

BH3PE • Post Extension for Over Panels

- Provides route for ceiling data or electrical cables through the post to the panel.
- Includes 2 "Capture Strip" panel connectors.

PRODUCT CODE	PRICE	SIZE/ INCHES			WEIGHT LBS	VOL FT ³
		H	W	D		
BH3PE008	30	8	2.61	2.61	1	0.03
BH3PE016	54	16	2.61	2.61	2	0.07
BH3PE032	78	32	2.61	2.61	4	0.14
BH3PE45016	54	16	2.61	2.61	2	0.07
BH3PE45032	78	32	2.61	2.61	4	0.14
BH3PE60016	54	16	2.61	2.61	2	0.07
BH3PE60032	78	32	2.61	2.61	4	0.14

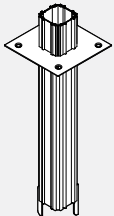
BEPE • Post Extension

- Lightweight aluminum pole to be used to bring power and/or data/communication cables from ceiling to a beam through a post.
- Attaches to ceiling and post.
- Includes connectors, ceiling trim plate and screws.
- Post extension will accept:
 - 75 cables 5.6mm (0.220") dia. data cables
 - 60 cables 5.6mm (0.220") dia. data cables with 1 power feed
 - 45 cables 5.6mm (0.220") dia. data cables with 2 power feeds.
- Ceiling bezel is white only.
- Specify metal finish colour

PRODUCT CODE	PRICE	SIZE/INCHES			WEIGHT LBS	VOL FT ³
		H	W	D		
BEPE81	188	81	2.61	2.61	9	0.43

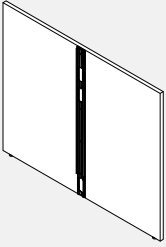
B3LEP-NC • End of Run Gallery Panel in a T configuration, No Connectors for Additional Gallery Panels

- Provides floor standing support while enclosing the end of a panel run on two sides.
- Attaches to the end of a Bridges Power Beam with capture strips to form a T configuration.
- Connection is on the interior face center.
- Includes all attachment hardware and glides.
- Total height is inclusive of panel glides extended to their full height.
- 51" wide gallery panel accommodates two 24" deep surfaces while the 63" wide accommodates two 30" deep surfaces and 75" wide two 36" deep surfaces.
- Please specify LP laminate finish and PVC edge finish.
- If a wood grain laminate is chosen, grain direction run horizontally.
- Edged in PVC on three exposed edges and self edged on bottom.

PRODUCT CODE	PRICE LP	SIZE / INCHES			WEIGHT LBS	VOL FT ³
		H	W	D		
B3LEP4227NC	416	42	26.5	1	29.49	0.64
B3LEP4251NC	653	42	51	1	55.17	1.24
B3LEP4263NC	731	42	63	1	68.01	1.53
B3LEP4275NC	814	42	75	1	80.86	1.82
B3LEP5027NC	485	50	26.5	1	35.25	0.77
B3LEP5051NC	758	50	51	1	65.92	1.48
B3LEP5063NC	854	50	63	1	81.27	1.82
B3LEP5075NC	964	50	75	1	96.62	2.17

B3LSEPL-NC • Left End of Run Single Gallery Panel in L Configuration, No Connectors for Additional Gallery Panels

- Provides floor standing support while enclosing the end of a panel run on one side.
- Attaches to the end of a Bridges Power Beam with capture strips to form an L configuration.
- Connection is on interior face near it's right end.
- Includes all attachment hardware and glides.
- Total height is inclusive of panel glides extended to their full height.
- 27" wide gallery panel accommodates a 24" deep surface while the 33" wide accommodates a 30" deep surface and 39" wide a 36" deep surface.
- Please specify LP laminate finish and PVC edge finish.
- If a wood grain laminate is chosen, grain direction run horizontally.
- Edged in PVC on three exposed edges and self edged on bottom.

PRODUCT CODE	PRICE LP	SIZE / INCHES			WEIGHT LBS	VOL FT ³
		H	W	D		
B3LSEPL4215NC	342	42	14.25	1	16.64	0.35
B3LSEPL4227NC	497	42	27	1	29.47	0.66
B3LSEPL4233NC	537	42	33	1	35.89	0.80
B3LSEPL4239NC	564	42	39	1	42.32	0.95
B3LSEPL5015NC	389	50	14.25	1	19.9	0.41
B3LSEPL5027NC	565	50	27	1	35.23	0.78
B3LSEPL5033NC	613	50	33	1	42.9	0.95
B3LSEPL5039NC	656	50	39	1	50.57	1.13

B3LSEPR-NC • Right End of Run Single Gallery Panel in L Configuration, No Connectors for Additional Gallery Panels

- Provides floor standing support while enclosing the end of a panel run on one side.
- Attaches to the end of a Bridges Power Beam with capture strips to form an L configuration.
- Connection is on interior face near it's right end.
- - Includes all attachment hardware and glides.
- Total height is inclusive of panel glides extended to their full height.
- 27" wide gallery panel accommodates a 24" deep surface while the 33" wide accommodates a 30" deep surface and 39" wide a 36" deep surface.
- Please specify LP laminate finish and PVC edge finish.
- If a wood grain laminate is chosen, grain direction run horizontally.
- Edged in PVC on three exposed edges and self edged on bottom.

PRODUCT CODE	PRICE LP	SIZE / INCHES			WEIGHT LBS	VOL FT ³
		H	W	D		
B3LSEPR4215NC	342	42	14.25	1	16.64	0.35
B3LSEPR4227NC	497	42	27	1	29.47	0.66
B3LSEPR4233NC	537	42	33	1	35.89	0.80
B3LSEPR4239NC	564	42	39	1	42.32	0.95
B3LSEPR5015NC	389	50	14.25	1	19.9	0.41
B3LSEPR5027NC	565	50	27	1	35.23	0.78
B3LSEPR5033NC	613	50	33	1	42.9	0.95
B3LSEPR5039NC	656	50	39	1	50.57	1.13
B3LSEPR5415NC	389	54	14.25	1	21.52	0.45

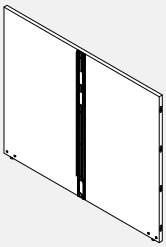
B3LEP • End of Run Gallery Panel in a T configuration, with Connectors for Additional Gallery Panels

- Provides floor standing support while enclosing the end of a panel run.
- Attaches to the end of a Bridges Power Beam with capture strips to form a T configuration.
- Connections at both ends as well as on the middle of interior face.
- The end connections are to connect other Gallery Panels.
- The side right is compatible with right hand Gallery Panels (B3LXPRxxxx and B3LXPRxxxx-NC, B3L2PRxxxx and B3L3PRxxxx) only.
- The left side is compatible with left hand Gallery Panels (B3LXPLxxxx and B3LXPLxxxxNC, B3L2PLxxxx and B3L3PLxxxx) only.
- The middle interior face connections are for Boulevard panels.
- Includes all attachment hardware and glides.
- Total height is inclusive of panel glides extended to their full height.
- 51" wide gallery panel accommodates two 24" deep surface while the 63" wide accommodates two 30" deep surfaces and 75" wide two 36" deep surfaces.
- Please specify LP laminate finish and PVC edge finish.
- If a wood grain laminate is chosen, grain direction run horizontally.
- Gallery panel is edged in PVC on exposed top edge only and self edged on the three other edges.

PRODUCT CODE	PRICE LP	SIZE / INCHES			WEIGHT LBS	VOL FT ³
		H	W	D		
B3LEP4251	667	42	51	1	55.25	1.24
B3LEP4263	745	42	63	1	68.1	1.53
B3LEP4275	828	42	75	1	80.95	1.82
B3LEP5051	773	50	51	1	66.01	1.48
B3LEP5063	868	50	63	1	81.36	1.82
B3LEP5075	979	50	75	1	96.71	2.17

B3LSEPL • Left End of Run Single Gallery Panel in L Configuration, with Connectors for Additional Gallery Panels

- Provides floor standing support while enclosing the end of a panel run.
- Attaches at the end of a Bridges Power Beam with capture strips to form an L configuration.
- Connection to the Boulevard panel is on interior face near it's right end.
- Connections for a Gallery Panel are on the left edge.
- Compatible with left hand Gallery Panels (B3LXPLxxxx and B3LXPLxxxxNC, B3L2PLxxxx and B3L3PLxxxx) only.
- Includes all attachment hardware and glides.
- Total height is inclusive of panel glides extended to their full height.
- 27" wide gallery panel accommodates a 24" deep surface while the 33" wide accommodates a 30" deep surface and 39" wide a 36" deep surface.
- Please specify LP laminate finish and PVC edge finish.
- If a wood grain laminate is chosen, grain direction run horizontally.
- Edged in PVC on two exposed edges, self edged on connecting to gallery panel edge and the bottom.

PRODUCT CODE	PRICE LP	SIZE / INCHES			WEIGHT LBS	VOL FT ³
		H	W	D		
B3LSEPL4227	505	42	27	1	29.51	0.66
B3LSEPL4233	544	42	33	1	35.94	0.80
B3LSEPL4239	571	42	39	1	42.36	0.95
B3LSEPL5027	573	50	27	1	35.27	0.78
B3LSEPL5033	621	50	33	1	42.94	0.95
B3LSEPL5039	664	50	39	1	50.62	1.13

B3LSEPR • Right End of Run Single Gallery Panel in L Configuration, with Connectors for additional Gallery Panels



- Provides floor standing support while enclosing the end of a panel run.
- Attaches at the end of a Bridges Power Beam with capture strips to form an L configuration.
- Connection to the Boulevard panel is on interior face near it's left end.
- Connections for a Gallery Panel are on the right edge.
- Compatible with right hand Gallery Panels (B3LXPRxxxx and B3LXPRxxxxNC, B3L2PRxxxx and B3L3PRxxxx) only.
- Includes all attachment hardware and glides.
- Total height is inclusive of panel glides extended to their full height.
- 27" wide gallery panel accomodates a 24" deep surface while the 33" wide accomodates a 30" deep surface and 39" wide a 36" deep surface.
- Please specify LP laminate finish and PVC edge finish.
- If a wood grain laminate is chosen, grain direction run horizontally.
- Edged in PVC on two exposed edges, self edged on connecting to gallery panel edge and the bottom.

PRODUCT CODE	PRICE LP	SIZE /INCHES			WEIGHT LBS	VOL FT ³
		H	W	D		
B3LSEPR4227	505	42	27	1	29.51	0.66
B3LSEPR4233	544	42	33	1	35.94	0.80
B3LSEPR4239	571	42	39	1	42.36	0.95
B3LSEPR5027	573	50	27	1	35.27	0.78
B3LSEPR5033	621	50	33	1	42.94	0.95
B3LSEPR5039	664	50	39	1	50.62	1.13

B3LXPL • Left Gallery Panel Extension, with Connectors for Additional Gallery Panels

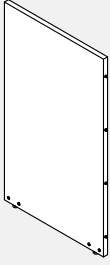

- Provides floor standing support while extending the Gallery Panels run.
- Attaches to the left edge of a Gallery Panel by the pin connectors to allow for additional Gallery Panels to be added on the left side.
- Pin connectors on the right edge and modular connectors on the left edge of the interior face.
- The right side is compatible with Gallery Panels (B3LEPxxx, B3LSEPL, B3LMPxxx, B3LSMP and B3LXPLxxx) only.
- The left side is compatible with left hand Gallery Panels (B3LXPLxxxx and B3LXPLxxxxNC, B3L2PLxxxx and B3L3PLxxxx) only.
- Includes all attachment hardware and glides.
- Total height is inclusive of panel glides extended to their full height.
- Please specify LP laminate finish and PVC edge finish.
- If a wood grain laminate is chosen, grain direction run horizontally.
- Edged in PVC on two exposed edges, self edged on connecting to gallery panel edge and the bottom.
- Edged in PVC on exposed top edge only and self edges on the three other.

PRODUCT CODE	PRICE LP	SIZE /INCHES			WEIGHT LBS	VOL FT ³
		H	W	D		
B3LXPL4224	260	42	24	1	25.83	0.58
B3LXPL4230	299	42	30	1	32.26	0.73
B3LXPL4236	338	42	36	1	38.68	0.88
B3LXPL4242	376	42	42	1	45.11	1.02
B3LXPL4248	415	42	48	1	51.53	1.17
B3LXPL5024	309	50	24	1	30.83	0.69
B3LXPL5030	357	50	30	1	38.51	0.87
B3LXPL5036	406	50	36	1	46.18	1.04
B3LXPL5042	453	50	42	1	53.86	1.22
B3LXPL5048	502	50	48	1	61.53	1.39

B3LXPR • Right Gallery Panel Extension, with Connectors for Additional Gallery Panels



- Provides floor standing support while extending the Gallery Panels run.
- Attaches to the right edge of a Gallery Panel by the pin connectors to allow for additional Gallery Panels to be added on the right side.
- Pin connectors on the right edge and modular connectors on the left edge of the interior face.
- The right side is compatible with right hand Gallery Panels (B3LXPRxxxx and B3LXPRxxxxNC, B3L2PRxxxx and B3L3PRxxxx) only.
- The left side is compatible with Gallery Panels (B3LEPxxx, B3LSEPRxxx, B3LMPxxx and B3LXPRxxx) only.
- Includes all attachment hardware and glides.
- Total height is inclusive of panel glides extended to their full height.
- Please specify LP laminate finish and PVC edge finish.
- If a wood grain laminate is chosen, grain direction run horizontally.
- Edged in PVC on exposed top edge only and self edges on the three other.

PRODUCT CODE	PRICE LP	SIZE /INCHES			WEIGHT LBS	VOL FT ³
		H	W	D		
B3LXPR4224	260	42	24	1	25.83	0.58
B3LXPR4230	299	42	30	1	32.26	0.73
B3LXPR4236	338	42	36	1	38.68	0.88
B3LXPR4242	376	42	42	1	45.11	1.02
B3LXPR4248	415	42	48	1	51.53	1.17
B3LXPR5024	309	50	24	1	30.83	0.69
B3LXPR5030	357	50	30	1	38.51	0.87
B3LXPR5036	406	50	36	1	46.18	1.04
B3LXPR5042	453	50	42	1	53.86	1.22
B3LXPR5048	502	50	48	1	61.53	1.39

B3LXPL-NC • Left Gallery Panel Extension, No Connectors for Additional Gallery Panels



- Provides floor standing support while enclosing the end of a Gallery Panel left run.
- Attached to the left edge of a Gallery Panel by the pin connectors to finish the run.
- Pin connectors are on the right edge of the interior face.
- Compatible with gallery panels (B3LEPxxxx, B3LSEPLxxxx, B3LMPxxxx, B3LSMPxxxx and B3LXPLxxxx) only.
- Includes all attachment hardware and glides.
- Total height is inclusive of panel glides extended to their full height.
- Please specify LP laminate finish and PVC edge finish.
- If a wood grain laminate is chosen, grain direction run horizontally.
- Edged in PVC on two exposed edges, self edged on connecting to gallery panel edge and the bottom.

PRODUCT CODE	PRICE LP	SIZE /INCHES			WEIGHT LBS	VOL FT ³
		H	W	D		
B3LXPL4212NC	142	42	12	1	12.95	0.29
B3LXPL4224NC	252	42	24	1	25.8	0.58
B3LXPL4230NC	291	42	30	1	32.22	0.73
B3LXPL4236NC	330	42	36	1	38.65	0.88
B3LXPL4242NC	370	42	42	1	45.07	1.02
B3LXPL4248NC	408	42	48	1	51.5	1.17
B3LXPL5012NC	177	50	12	1	15.45	0.35
B3LXPL5024NC	303	50	24	1	30.8	0.69
B3LXPL5030NC	350	50	30	1	38.47	0.87
B3LXPL5036NC	398	50	36	1	46.15	1.04
B3LXPL5042NC	448	50	42	1	53.82	1.22
B3LXPL5048NC	495	50	48	1	61.5	1.39

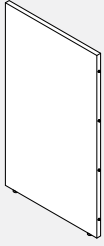
B3LXPR-NC • Right Gallery Panel Extension, No Connectors for Additional Gallery Panels

- Provides floor standing support while enclosing the end of a Gallery Panel right run.
- Attached to the right edge of a Gallery Panel by the pin connectors to finish the run.
- Pin connectors are on the left edge of the interior face.
- Compatible with gallery panels (B3LEPxxxx, B3LSEPRxxxx, B3LMPxxxx and B3LX-PRxxxx) only.
- Includes all attachment hardware and glides.
- Total height is inclusive of panel glides extended to their full height.
- Please specify LP laminate finish and PVC edge finish.
- If a wood grain laminate is chosen, grain direction run horizontally.
- Edged in PVC on two exposed edges, self edged on connecting to gallery panel edge and the bottom.

PRODUCT CODE	PRICE LP	SIZE / INCHES			WEIGHT LBS	VOL FT ³
		H	W	D		
B3LXPR4212NC	142	42	12	1	12.95	0.29
B3LXPR4224NC	252	42	24	1	25.8	0.58
B3LXPR4230NC	291	42	30	1	32.22	0.73
B3LXPR4236NC	330	42	36	1	38.65	0.88
B3LXPR4242NC	370	42	42	1	45.07	1.02
B3LXPR4248NC	408	42	48	1	51.5	1.17
B3LXPR5012NC	177	50	12	1	15.45	0.35
B3LXPR5024NC	303	50	24	1	30.8	0.69
B3LXPR5030NC	350	50	30	1	38.47	0.87
B3LXPR5036NC	398	50	36	1	46.15	1.04
B3LXPR5042NC	448	50	42	1	53.82	1.22
B3LXPR5048NC	495	50	48	1	61.5	1.39

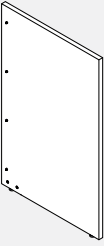
B3L2PR • Right Gallery Panel End of Run Return

- Provides floor standing support while enclosing the end of a Gallery Panel run.
- Attaches at the Gallery Panel right edge with connectors to form an L configuration.
- Connections to Gallery Panel are on the interior face near it's left end.
- Compatible with Gallery Panels (B3LEPxxxx, B3LSEPRxxxx, B3LMPxxxx and B3LX-PRxxxx) only.
- Includes all attachment hardware and glides.
- Total height is inclusive of panel glides extended to their full height.
- 25" wide gallery panel accomodates a 24" deep surface while the 31" wide accomodates a 30" deep surface and 37" wide a 36" deep surface.
- Please specify LP laminate finish and PVC edge finish.
- If a wood grain laminate is chosen, grain direction run horizontally.
- Edged in PVC on three exposed edges and self edged on the bottom edge.

PRODUCT CODE	PRICE LP	SIZE / INCHES			WEIGHT LBS	VOL FT ³
		H	W	D		
B3L2PR4213	153	42	13	1	14.02	0.32
B3L2PR4225	291	42	25	1	26.87	0.61
B3L2PR4231	330	42	31	1	33.29	0.75
B3L2PR4237	357	42	37	1	39.72	0.90
B3L2PR5013	192	50	13	1	16.73	0.38
B3L2PR5025	350	50	25	1	32.08	0.72
B3L2PR5031	398	50	31	1	39.75	0.90
B3L2PR5037	441	50	37	1	47.43	1.07

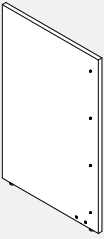
B3L2PL • Left Gallery Panel End of Run Return

- Provides floor standing support while enclosing the end of a gallery panel run.
- Attaches at the Gallery Panel left edge with connectors to form an L configuration.
- Connections to Gallery Panel are on the interior face near it's right end.
- Compatible with Gallery Panels (B3LEPxxxx, B3LSEPLxxxx, B3LMPxxxx, B3LSMPxxxx and B3LXPLxxxx) only.
- Includes all attachment hardware and glides.
- Total height is inclusive of panel glides extended to their full height.
- 25" wide gallery panel accomodates a 24" deep surface while the 31" wide accomodates a 30" deep surface and 37" wide a 36" deep surface.
- Please specify LP laminate finish and PVC edge finish.
- If a wood grain laminate is chosen, grain direction run horizontally.
- Edged in PVC on three exposed edges and self edged on the bottom edge.

PRODUCT CODE	PRICE LP	SIZE / INCHES			WEIGHT LBS	VOL FT ³
		H	W	D		
B3L2PL4213	153	42	13	1	14.02	0.32
B3L2PL4225	291	42	25	1	26.87	0.61
B3L2PL4231	330	42	31	1	33.29	0.75
B3L2PL4237	357	42	37	1	39.72	0.90
B3L2PL5013	192	50	13	1	16.73	0.38
B3L2PL5025	350	50	25	1	32.08	0.72
B3L2PL5031	398	50	31	1	39.75	0.90
B3L2PL5037	441	50	37	1	47.43	1.07

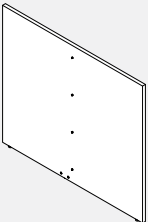
B3L3PL • Left Gallery Panel End of Run 3-Way Return

- Provides floor standing support while enclosing the end of a Gallery Panel run.
- Attaches to the Gallery Panel left edge with connectors to form an T configuration.
- Connections to Gallery Panel are on the interior face in the middle.
- Compatible with Gallery Panels (B3LEPxxxx, B3LSEPLxxxx, B3LMPxxxx, B3LSMPxxxx and B3LXPLxxxx) only.
- Includes all attachment hardware and glides.
- Total height is inclusive of panel glides extended to their full height.
- 49" wide gallery panel accomodates two 24" deep surfaces while the 61" wide accomodates two 30" deep surface and 73" wide two 36" deep surface.
- Please specify LP laminate finish and PVC edge finish.
- If a wood grain laminate is chosen, grain direction run horizontally.
- Edged in PVC on three exposed edges and self edged on the bottom edge.

PRODUCT CODE	PRICE LP	SIZE / INCHES			WEIGHT LBS	VOL FT ³
		H	W	D		
B3L3PL4225	229	42	25	1	26.87	0.61
B3L3PL4249	396	42	49	1	52.57	1.19
B3L3PL4261	524	42	61	1	65.41	1.48
B3L3PL4273	609	42	73	1	78.26	1.77
B3L3PL5025	286	50	25	1	32.08	0.72
B3L3PL5049	543	50	49	1	62.77	1.42
B3L3PL5061	639	50	61	1	78.12	1.77
B3L3PL5073	749	50	73	1	93.47	2.11

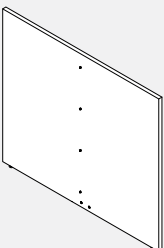
B3L3PR • Right Gallery Panel End of Run 3-Way Return

- Provides floor standing support while enclosing the end of a Gallery Panel run.
- Attaches to the Gallery Panel right edge with connectors to form an T configuration.
- Connections to Gallery Panel are on the interior face in the middle.
- Compatible with gallery panels (B3LEPxxxx, B3LSEPRxxxx, B3LMPxxxx and B3LXPRxxxx) only.
- Includes all attachment hardware and glides.
- Total height is inclusive of panel glides extended to their full height.
- 49" wide gallery panel accomodates two 24" deep surfaces while the 61" wide accomodates two 30" deep surface and 73" wide two 36" deep surface.
- Please specify LP laminate finish and PVC edge finish.
- If a wood grain laminate is chosen, grain direction run horizontally.
- Edged in PVC on three exposed edges and self edged on the bottom edge.

PRODUCT CODE	PRICE LP	SIZE / INCHES			WEIGHT LBS	VOL FT ³
		H	W	D		
B3L3PR4225	229	42	25	1	26.87	0.61
B3L3PR4249	396	42	49	1	52.57	1.19
B3L3PR4261	524	42	61	1	65.41	1.48
B3L3PR4273	609	42	73	1	78.26	1.77
B3L3PR5025	286	50	25	1	32.08	0.72
B3L3PR5049	543	50	49	1	62.77	1.42
B3L3PR5061	639	50	61	1	78.12	1.77
B3L3PR5073	749	50	73	1	93.47	2.11

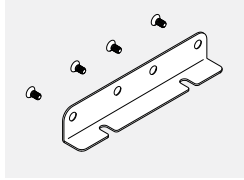
B3HLPBB01 • Gallery Panel Bottom Inline Bracket

- Gallery Panel Bottom Inline Bracket connects two Gallery Panels at the bottom with screws.
- Available in standard paint colors.

PRODUCT CODE	PRICE	SIZE / INCHES			WEIGHT LBS	VOL FT ³
		H	W	D		
B3HLPBB01	35	7	1.5	8	1	0.5

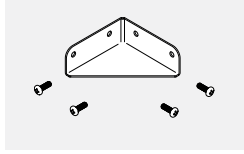
B3HLPCB01 • Gallery Panel Corner Bracket

- Gallery Panel Corner Bottom bracket connects two Gallery Panels at 90 degrees.
- Available in standard paint colors.

PRODUCT CODE	PRICE	SIZE / INCHES			WEIGHT LBS	VOL FT ³
		H	W	D		
B3HLPCB01	34	7	1.5	4	4	0.5

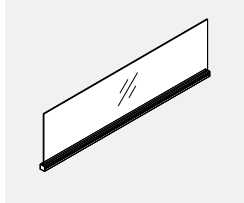
B3PMP-GI-W • Privacy Glass for 1" Laminate Panels

- Privacy glass integrated with aluminum top trim.
- Attaches on top of gallery panels to add privacy or divide space.
- Includes aluminum trim with channel, end caps and glass tile.
- Top rail may also be used to hang accessories.
- Glass and attachment hardware ship separately.
- Please specify standard paint finish for the channel.
- Standard in clear (CLR) or frosted (FRST).

PRODUCT CODE	PRICE		SIZE / INCHES			WEIGHT LBS	VOL FT ³
	CLR	FRST	H	W	D		
B3PMP24GI8W	201	251	8	24	1	4.84	0.11
B3PMP30GI8W	219	276	8	30	1	6.06	0.14
B3PMP36GI8W	235	291	8	36	1	7.28	0.17
B3PMP42GI8W	251	313	8	42	1	8.5	0.19
B3PMP48GI8W	262	327	8	48	1	9.72	0.22
B3PMP24GI16W	201	251	16	24	1	8.92	0.22
B3PMP30GI16W	219	276	16	30	1	11.17	0.28
B3PMP36GI16W	235	291	16	36	1	13.43	0.33
B3PMP42GI16W	251	313	16	42	1	15.68	0.39
B3PMP48GI16W	262	327	16	48	1	17.92	0.44

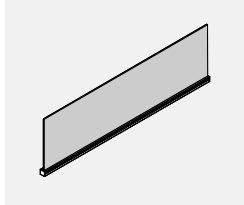
B3PFD-W • Felt divider for 1" Laminate Panels

- Privacy felt integrated with aluminum top trim.
- Attaches on top of gallery panels to add privacy or divide space.
- Includes aluminum trim with channel, end caps and felt tile.
- Top rail may also be used to hang accessories.
- Felt and attachment hardware ship separately.
- Please specify standard paint finish for the channel.
- Please specify standard felt finish.

PRODUCT CODE	PRICE	SIZE / INCHES			WEIGHT LBS	VOL FT ³
		H	W	D		
B3PFD0824W	72	8	24	1	1.32	0.11
B3PFD0830W	88	8	30	1	1.65	0.14
B3PFD0836W	102	8	36	1	1.99	0.17
B3PFD0842W	114	8	42	1	2.32	0.19
B3PFD0848W	170	8	48	1	2.65	0.22
B3PFD0854W	183	8	54	1	2.98	0.25
B3PFD0860W	199	8	60	1	3.32	0.28
B3PFD0866W	210	8	66	1	3.65	0.31
B3PFD0872W	238	8	72	1	3.98	0.33
B3PFD1624W	83	16	24	1	1.83	0.22
B3PFD1630W	98	16	30	1	2.3	0.28
B3PFD1636W	116	16	36	1	2.76	0.33
B3PFD1642W	130	16	42	1	3.22	0.39
B3PFD1648W	193	16	48	1	3.68	0.44
B3PFD1654W	210	16	54	1	4.14	0.50
B3PFD1660W	226	16	60	1	4.61	0.56
B3PFD1666W	238	16	66	1	5.07	0.61
B3PFD1672W	271	16	72	1	5.53	0.67

BE8CI-1 • "I" Connector



- Connects two Pass Thru Cables.
- Inline coupler used to connect two BE8CPxxHH Pass-Thru Cables.

PRODUCT CODE	PRICE	SIZE/ H	INCHES W	D	WEIGHT LBS	VOL FT ³
BE8CI1	85	1.5	1.5	4.625	0.06	0.03

BE8D • Duplex Receptacles

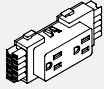

- Snaps into Power Distribution Housing.
- Up to 6 duplex receptacles per circuit.
- BE8D1 = Circuit #1 (utility circuit)
- BE8D2 = Circuit #2 (utility circuit)
- BE8D3 = Circuit #3 (utility circuit)
- BE8DA - Circuit #A (dedicated circuit)

PRODUCT CODE	PRICE	SIZE/ H	INCHES W	D	WEIGHT LBS	VOL FT ³
BE8D1	35	2	4.625	1.25	0.10	0.01
BE8D2	35	2	4.625	1.25	0.10	0.01
BE8D3	35	2	4.625	1.25	0.10	0.01
BE8DA	35	2	4.625	1.25	0.10	0.01

BE8D • USB Receptacles



- Snaps into Power Distribution Housing.
- USB charging module provides convenient charging power access through dual ports on face of receptacles.
- Two USB ports.
- 2 amp output, considered as circuit #1.

PRODUCT CODE	PRICE	SIZE/ H	INCHES W	D	WEIGHT LBS	VOL FT ³
BE8DU1-B	238	2	4.625	1.25	0.10	0.01
BE8DU1-W	238	2	4.625	1.25	0.10	0.01

BE83D • Power Distribution Housing Kit - Beam Raceway

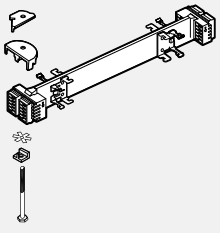

- Provides two duplex receptacles per panel side for all panel widths above 24" wide.
- Power Distribution Housing is specified per panel size. eg. BE83D36 is for use with a 36" panel.
- 24" wide panel allows for only one (1) duplex receptacle per panel side.

PRODUCT CODE	PRICE	SIZE/ H	INCHES L	D	WEIGHT LBS	VOL FT ³
BE83D24	198	2	9.25	2.61	0.83	1.17
BE83D30	208	2	15.25	2.61	1.28	1.17
BE83D36	220	2	21.25	2.61	1.62	1.65
BE83D42	226	2	27.25	2.61	2.00	2.00
BE83D48	238	2	33.25	2.61	2.32	2.54
BE83D54	242	2	39.25	2.61	2.66	3.20
BE83D60	243	2	45.25	2.61	3.04	3.20
BE83D66	310	2	51.25	2.61	3.49	3.25
BE83D72	341	2	57.25	2.61	3.76	3.30

BE8JC • Jumper Cable

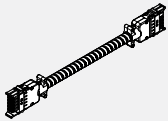

- Electrically connects two Power Distribution Housings.
- The BE8JC16 electrically connects two powered panels positioned side by side.
- The BE8JC20 electrically connects two powered panels separated by a post.
- Wires are concealed in a flexible metal conduit.
- Cannot go through a Boulevard 1 post in a corner application. (Please use the Jumper Cable Mesh)

PRODUCT CODE	PRICE	SIZE/ H	INCHES L	D	WEIGHT LBS	VOL FT ³
BE8JC16	160	2	16.75	0.5	0.66	1.17
BE8JC20	162	2	20.75	0.5	0.78	1.17

BE8JM19 • Jumper Cable Mesh

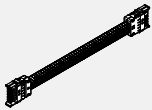

- Electrically connects two Power Distribution Housings in Boulevard 1 panels that are separated by a post in a corner application.
- BE8JM19 - Wires are covered with a durable nylon mesh.
- BE8JMS19 - Wires are concealed in a flexible metal shroud and covered with a durable nylon mesh.
- Used in System 3 Panels at tile position passing through post at corner application.

PRODUCT CODE	PRICE	SIZE/ H	INCHES L	D	WEIGHT LBS	VOL FT ³
BE8JM19	162	2	19	0.5	0.75	1.17
BE8JMS19	184	2	19	0.5	0.75	1.17

BE8CP-HH • Housing-to-Housing Pass-Thru Cable

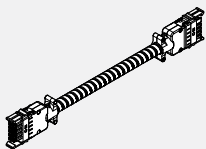

- Electrically connects two Power Distribution Housings in panels separated by one or more non-powered panels.
- Wires are concealed in a flexible metal conduit.
- NOTE: In Boulevard 1 and or System 3 tile position applications, the Housing-to-Housing Pass-Thru Cables can only be used in a straight run.

PRODUCT CODE	PRICE	SIZE/ H	INCHES L	D	WEIGHT LBS	VOL FT ³
BE8CP40HH	161	2	40.5	0.5	1.44	1.17
BE8CP46HH	167	2	46.5	0.5	1.71	1.17
BE8CP52HH	177	2	52.5	0.5	1.95	1.17
BE8CP58HH	184	2	58.5	0.5	2.21	1.17
BE8CP64HH	190	2	64.5	0.5	2.37	1.17
BE8CP70HH	196	2	70.5	0.5	2.6	1.17
BE8CP76HH	204	2	76.5	0.5	2.81	1.17
BE8CP82HH	213	2	82.5	0.5	3.03	1.17
BE8CP88HH	221	2	88.5	0.5	3.05	1.17
BE8CP94HH	226	2	94.5	0.5	3.30	1.17
BE8CP100HH	233	2	100.5	0.5	3.47	1.17
BE8CP106HH	242	2	106.5	0.5	3.87	1.17
BE8CP118HH	256	2	118.5	0.5	4.08	1.17
BE8CP130HH	268	2	130.5	0.5	4.73	1.17
BE8CP142HH	282	2	142.5	0.5	4.99	1.17

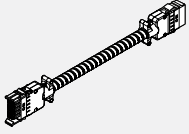
BE8CP-HJ • Housing-to-Jumper Pass-Thru Cable

- Electrically connects a Power Distribution Housing to a Housing connection of a harness.
- Wires are concealed in a flexible metal conduit.
- **NOTE** : In both Boulevard 1 and System 3 Tile Position applications, the Housing-to-Jumper Pass-Thru Cables can only be used in a straight run.

PRODUCT CODE	PRICE	SIZE/ INCHES			WEIGHT VOL	
		H	L	D	LBS	FT ³
BE8CP24HJ	144	2	24	0.5	0.9	1.17
BE8CP30HJ	151	2	30	0.5	1.3	1.17
BE8CP36HJ	156	2	36	0.5	1.44	1.17
BE8CP42HJ	169	2	42	0.5	1.71	1.17
BE8CP48HJ	177	2	48	0.5	1.95	1.17
BE8CP54HJ	188	2	54	0.5	2.21	1.17
BE8CP60HJ	196	2	60	0.5	2.37	1.17
BE8CP72HJ	204	2	72	0.5	2.81	1.17
BE8CP84HJ	220	2	84	0.5	3.05	1.17
BE8CP96HJ	233	2	96	0.5	3.3	1.17
BE8CP108HJ	243	2	108	0.5	3.87	1.17
BE8CP120HJ	257	2	120	0.5	4.08	1.17
BE8CP144HJ	293	2	144	0.5	4.59	1.17

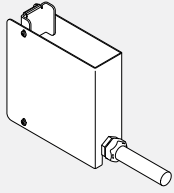
BRBPEFH • Base Feed and Housing for powerBeam

- Floorfeed housing and harness for Bridges Power Beam applications. Specify xx18 baseFEED for 18" high powerBEAMS. xx26 baseFEED for 26" Bridges Power Beam, etc.
- Attaches to inner side of the powerBEAM leg
- Base feed kit consist of two mounting brackets, steel shroud and base feed harness with 72" long liquid-tight conduit hardwired to building power supply.
- **NOTE**: on-site drilling required to secure mounting brackets to the inside of the beam vertical leg
- Post Vertical Trim must be specified in accordance to your post 2-way, 3-way or 4-way configuration.
- Specify metal finish colour

PRODUCT CODE	PRICE	SIZE/ INCHES			WEIGHT VOL	
		H	L	D	LBS	FT ³
BRBPEFH18	576	6.9	6	2.5	2.70	0.06
BRBPEFH26	615	16.9	6	2.5	5.41	0.15
BRBPEFH34	644	22.9	6	2.5	7.03	0.20

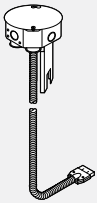
BE8CF-1 • Ceiling Feed - Single

- Provides single power entry from ceiling, through post and into raceway channel.
- Power entry cable penetrates 8" into a panel and plugs into either a Power Distribution Housing or BE8CPxxHJ Pass-Thru Harness.
- Specify Post Extension separately.
- Must be hard wired to power source by a licensed electrician.

PRODUCT CODE	PRICE	SIZE/ INCHES			WEIGHT VOL	
		H	L	D	LBS	FT ³
BE8CF1201	353	6	120	6	5.24	2
BE8CF1441	479	6	144	6	5.96	2

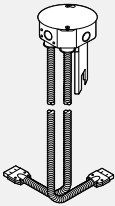
BE8CF-2 • Ceiling Feed - Double

- Provides dual power entry from ceiling, through post and into raceway channel.
- Power entry cable penetrates 8" into a panel and plugs into either a Power Distribution Housing or a BE8CPxxHJ Pass-Thru Harness.
- Use 1) In middle of run to distribute power in two directions.
2) At beginning of run where second Ceiling Feed harness is connected to BE8CPxxHJ and distributes power underneath Power Distribution Housing to pick-up second circuit grouping in long panel run.
- Specify Post Extension separately.
- Must be hard wired to power source by a licensed electrician.

PRODUCT CODE	PRICE	SIZE/ INCHES			WEIGHT VOL	
		H	L	D	LBS	FT ³
BE8CF1202	620	6	120	3	5.24	2
BE8CF1442	701	6	144	3	5.96	2

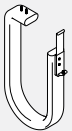
BRTWMS • Wire Manager Kit

- Provides wire management from under the Freefit worksurface to the Power Beam.
- The bracket can be aligned anywhere on the Power Beam.
- Kit includes a neoprene wire manager sock, bracket and screws.
- Please specify bracket paint finish.

PRODUCT CODE	PRICE	SIZE/ INCHES			WEIGHT VOL	
		H	L	D	LBS	FT ³
BRTWMS	112	1.25	42	5.25	1.87	0.4

Applications

Combining **Bridges tables with BRPX3P table mounted dividers** increases power, data capacity, offers optional, integrated desk-height power/data access and enhances sense of privacy with fabric covered panel tiles. Optional Accessory tiles support paper-organizing accessories.

Non-powered BRPX3P dividers combined with BRTETB power troughs. The troughs in this instance provide power/data distribution and access, while the BRPX3P dividers enhance sense of privacy and, with accessory tiles in place, provide support for bridges paper accessories.

Notice that the dividers combined with power troughs do not distribute any power.

Specify quantity and finish of BRA3VTRF22 vertical aluminum flat end trim at either end.

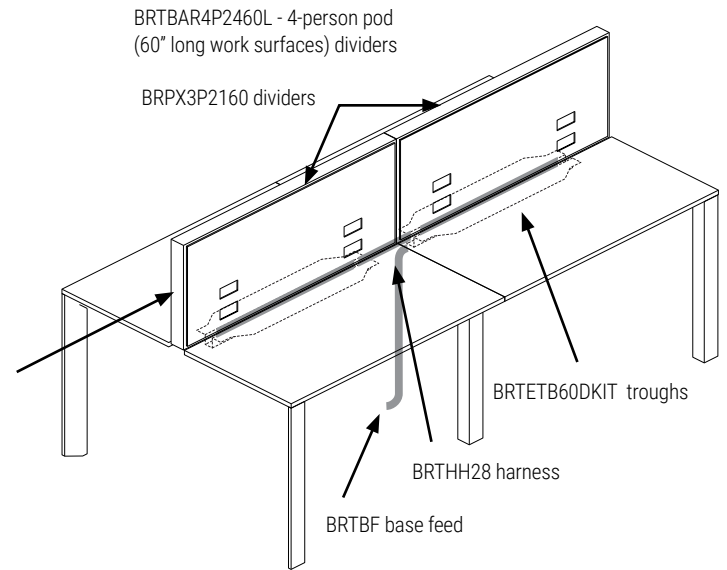

BRPX3P dividers with built-in 8-wire, 4-circuit power distribution system and data.

The BRPX3P dividers provide power/data distribution, desk-height access, while enhancing sense of privacy. When specified, accessory tiles can provide support for Bridges paper accessories.

Note: **Powered BRPX3P dividers cannot be combined with BRTETB power troughs on freestanding Bridges tables.** They both require separate, dedicated base feed, and BRPX3P Divider's base feed would physically interfere with the BRTETB below work surface trough.

BRPX3P dividers and BRTETB below work surface troughs can only be combined if the **power to the BRPX3P dividers is fed horizontally from adjacent Boulevard System 3 panels** (thus preventing base feed's interfering with the troughs). BRTETB below work surface troughs remain powered by BRTDIVPBF base feed.

Under certain conditions **powered BRPX3P dividers can be combined with BRTETB power troughs.** Thus, in addition to enhanced privacy and support for accessories, the BRPX3P/BRTETB electrified combo provides double layered power distribution system (each with 8 wires and 4 circuits) for customers with high power demands. Note that each layer needs its own power supply source base feed power supply.

Note: BRPX3P dividers and BRTETB below work surface troughs can only be combined if the **power to the BRPX3P dividers is fed horizontally from adjacent Boulevard System 3 panels.**

BRPX3P Divider's base feed will physically interfere with the BRTETB below work surface trough. BRTETB below work surface troughs remain powered by BRTDIVPBF base feed. Bridges BRTBF base feed and BRTDIVPBF divider base feed are dedicated, non-interchangeable components.

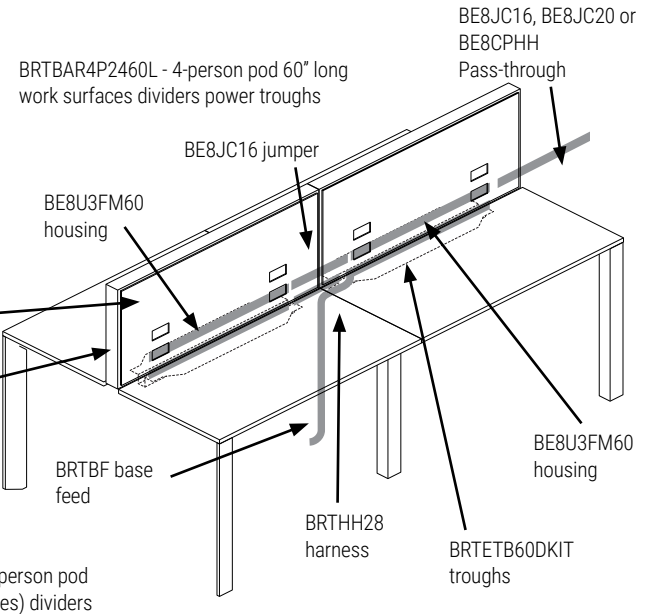
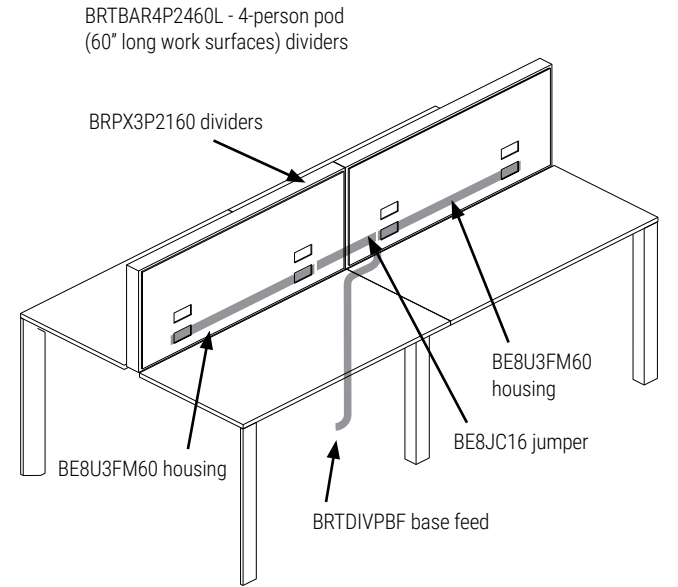

Applications

Bridges table mounted BRPX3P dividers offers can be combined with Boulevard System 3 panels. Table mounted BRPX3P dividers will match in height 50" high Boulevard System 3 floor standing panel.

BRPX3P dividers combined with BOULEVARD System 3 panels.

Power routed through System 3 panels.

This example illustrates power routed from the System 3 panel assembly on the left, through the post and into table mounted BRPX3P dividers. Any 50" high System3 panel can be connected between two independent bridges table assemblies, but if you intend to route power/ data into the next bridges table cluster, specify BPX3PT Pass-through panel so that the cables could cross horizontally into the next table mounted BRPX3P divider on the right.

Specify quantity and finish of BRA3VTRF27 Bridges Divider trims which cover System 3 panel vertical face below Bridges table mounted BRPX3P dividers.

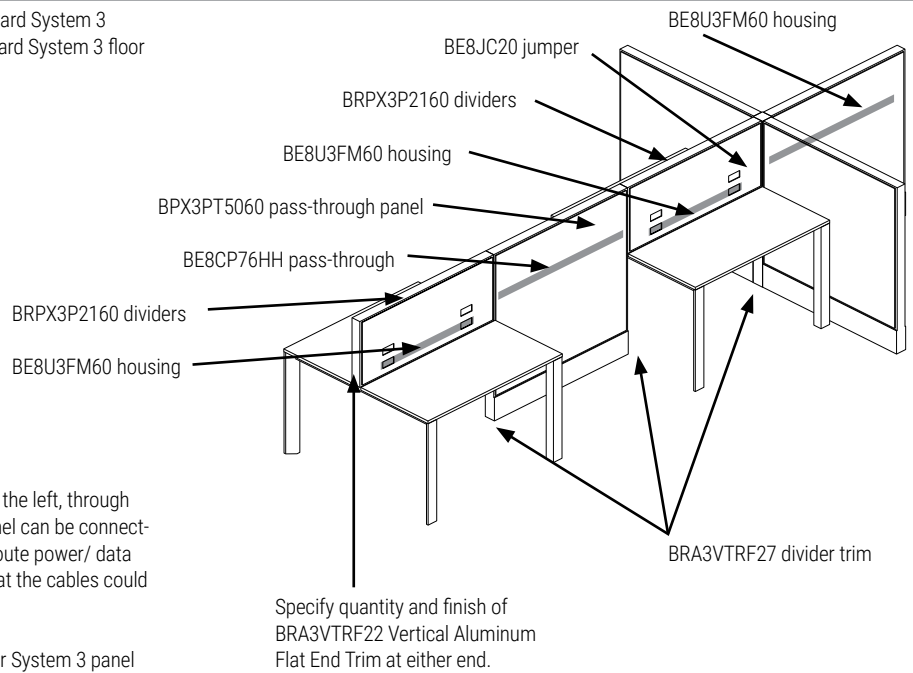

BRPX3P dividers combined with BOULEVARD System 3 panels. Floor feed. While table mounted BRPX3P dividers can be physically connected to 50" high Boulevard System 3 floor standing panels, power/data could be routed from the floor (as illustrated).

There are two ways of facilitating floor feed. 1: Power could enter through the bottom of table mounted BRPX3P divider, into BE8U3FM60 housing and then continues through BPX3PT5060 or BPX3PV5060 pass-through panel into adjacent BRPX3P divider. 2: BE83BF base feed supplies BE8U3FM60 housing within BPX3PV5060 pass-through panel (with integrated vertical channel). BE8CP54HH Pass-through harness then feeds BE8U3FM60 housing within the table mounted BRPX3P divider on the right. BE8CP76HH Pass-through harness then continues through BPX3PV5060 pass-through panel into adjacent BRPX3P divider.

Note: These two examples are for illustration purposes only as **two power feeds must not be connected to one power distribution system!**

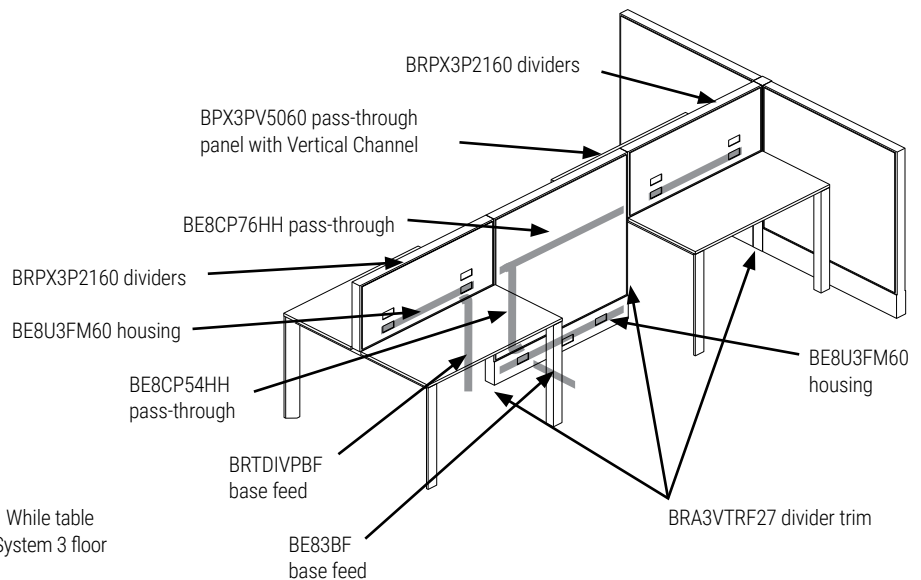

Applications

BRPX3MA25 and BRPXGMA25 Boulevard System 3 dividers facilitate seamless transition from panel-based office to open environment.

BRPX3MA25 and BRPXGMA25 panels combined with BOULEVARD System 3. Power routed through System 3 panels.

The first 50" high panel is furnished with face mount power through its integrated vertical channel.

Any equipment placed on top of the 25" storage cabinets can be plugged into the floor raceway (cables rising through the gap between the panels and the cabinet).

Specify quantity and finish of BRA3VTSF25 bridges-BLVD step down end trims.

BRPXGMA25 panel

BRPXGMA25 panel

The pair of work surface-mounted BRED50AC Duo Modules on the right (plugged into the floor raceway) provide easy access to power at desk height.

Specify quantity and finish of BRA3VTRF25 vertical aluminum flat end trim at the end.

This example illustrates power routed at the floor level from the System 3 panel assembly on the left into BRPX3MA25 and BRPXGMA25 panels.

Combination of **25" high Bridges storage cabinets with BRPX3S storage mounted dividers** forms storage-based linear spine capable of delivering 8-wire, 4-circuit power distribution along the spine.

BRPX3S storage mounted dividers combined with Bridges 25" high storage.

BRPX3S dividers are secured to a storage-based spine formed by back-to-back Bridges storage cabinets of corresponding width (BRPX3S2136 divider secured to BRT25LBF36L, for instance). Optional Accessory tiles support paper-organizing accessories.

Storage mounted dividers reach 46" above the floor to suggest work station boundaries as well as to support paper organizers (with accessory tile installed).

Power enters the spine from the bottom, in-between the back-to-back storage cabinets and is then routed horizontally between the dividers.

Note: This assembly was conceived as a stand-alone application - **not compatible with floor standing Boulevard System 3 panels.**

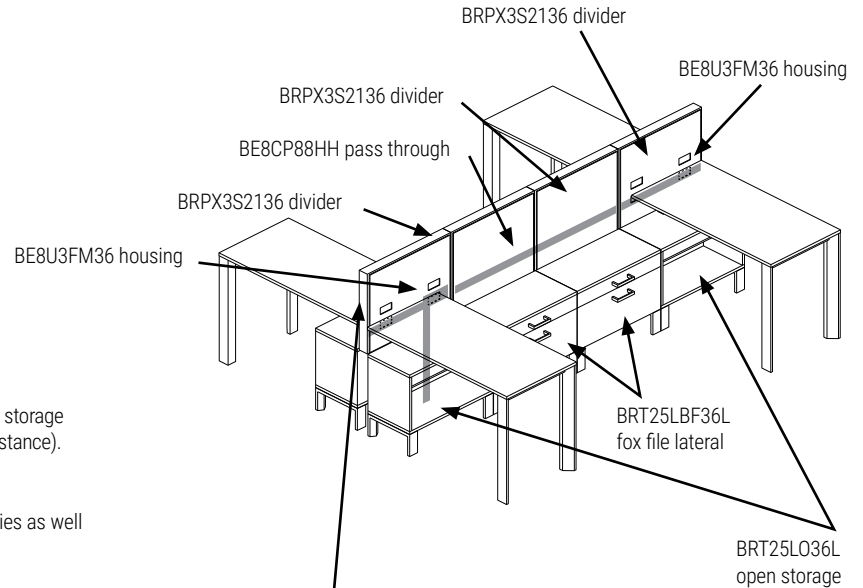

Specify quantity and finish of BRA3VTRF22 Vertical Aluminum Flat End Trim at either end.

Applications

Note: BRPX3S storage mounted dividers combined with Bridges 25" high storage was conceived as a standalone application. It is not compatible with floor standing Boulevard System 3 panels.

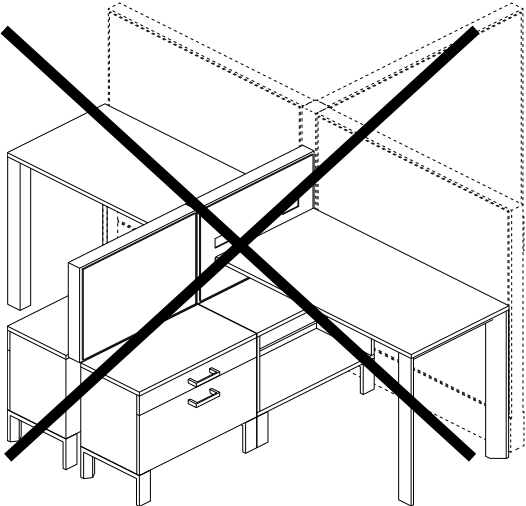

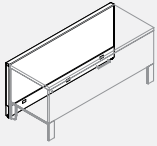
BRPX3MA25 • 25" High System 3 Panel

- 25" high System3 panel facilitates seamless transition from a panel-based, enclosed office to an open one. It can be connected to a cluster of panels on one side and continue with power / data spine distribution into collaborative areas.
- 25" high System3 panel also enables creation of a storage-based spine with full 8-wire, 4-circuit power and data capacity.

PRODUCT CODE	PRICE			SIZE/INCHES			WEIGHT VOL	
	GR1	GR2	OPT	H	W	D	LBS	FT ³
BRPX3MA2530	452	475	495	25	30	2.5	5.00	1.09
BRPX3MA2536	491	537	563	25	36	2.5	6.00	1.30
BRPX3MA2542	537	578	607	25	42	2.5	7.00	1.52

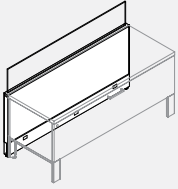
BRPX3GMA25 • 25" High System 3 Panel

- 25" high System3 panel facilitates seamless transition from a panel-based, enclosed office to an open one. It can be connected to a cluster of panels on one side and continue with power / data spine distribution into collaborative areas.
- 25" high System3 panel also enables creation of a storage-based spine with full 8-wire, 4-circuit power and data capacity.
- B3 panel Top trim option provided with embedded, frame-less glass pane rising 8" above the top of the panel. For instance, when installed on 42" high B3 panel, overall height will be 50" high.
- There is 1.25" gap between two adjacent glass panes.
- Glass shipped separately, Allen key to set the glass pane plumb is provided with each panel.
- 5mm tempered glass, acid etched on one side or clear.
- Square corners on glass.
- Integrated adjustable brackets and extruded aluminum trim.
- Cannot be retrofit on-site.

PRODUCT CODE	PRICE			SIZE/INCHES			WEIGHT VOL	
	GR1	GR2	OPT	H	W	D	LBS	FT ³
BRPX3GMA2530	886	908	954	25	30	2.5	5.00	1.09
BRPX3GMA2536	931	973	1023	25	36	2.5	6.00	1.30
BRPX3GMA2542	987	1029	1083	25	42	2.5	7.00	1.52

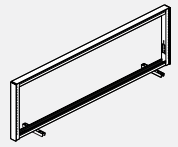
BRPX3P21 • Table Mounted Open Frame Divider

- Aluminum panel frame designed to be secured between two back-2-back bridges work surfaces. When installed, the height of the panel matches the height of 50" high System3 panel. Note: individual panels can be interconnected with 'Capture strips'. The bridges panel is physically compatible with System 3 and can be interconnected using System 3 'Capture strips'.
- Intended to distribute 8-wire / 4-circuit power and data along table-based spine, enhance seated privacy, acoustics and support paper / task accessories. Not suitable for panel mounted Monitor arms. Divider is not slotted.
- Table mounting brackets and capture strips included (individual in-line panels can be interconnected with Capture strips). Specify power distribution harness, duplexes and tiles. End trims not included.
- Tile options: full fabric, full fabric with power/data openings, partial accessory/fabric tile and partial accessory / fabric with power/data openings.
- NOTE: The panel mounts only parallel, between back-2-back work surface. Perpendicular mounting brackets are not available.
- NOTE: Table Mounted Dividers with tiles should not be used with worksurfaces with access doors, BRTWSA & BRTWSAA.

PRODUCT CODE	PRICE	SIZE/INCHES			WEIGHT VOL	
		H	W	D	LBS	FT ³
BRPX3P2130	171	22	30	2.5	5.40	0.95
BRPX3P2136	178	22	36	2.5	6.50	1.15
BRPX3P2142	183	22	42	2.5	7.50	1.34
BRPX3P2148	194	22	48	2.5	8.60	1.53
BRPX3P2154	201	22	54	2.5	9.70	1.72
BRPX3P2160	208	22	60	2.5	10.80	1.91
BRPX3P2166	213	22	66	2.5	11.90	2.10
BRPX3P2172	221	22	72	2.5	13.00	2.29

Application

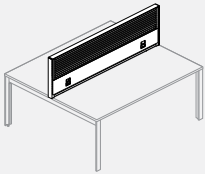
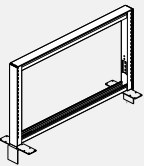
**BRPX3S • Storage Mounted B3 Divider**

- Aluminum panel frame designed to be secured between two back-2-back bridges 21" or 25" high lateral storage units. When installed, top of the panel reaches 42" or 46". Note: individual panels can be interconnected with 'Capture strips'. The bridges panel is physically compatible with System 3 and can be interconnected using System 3 'Capture strips'.
- Intended to distribute 8-wire / 4-circuit power and data along storage-based spine, enhance seated privacy, acoustics and support Paper / task accessories. Not suitable for panel mounted monitor arms. Divider is not slotted.
- Storage mounting brackets and capture strips included (individual in-line panels can be interconnected with capture strips)
- Specify power distribution harness, duplexes and tiles. End trims not included.
- Tile options: full fabric, full fabric with power/data openings, partial accessory/fabric tile and partial accessory fabric with power/data openings.
- NOTE: The panel mounts only parallel, between Back-2-back storage units. Perpendicular mounting brackets are not available.
- Horizontal cable management will not work between storage to table dividers or to panels.
- Cable management must be between dividers on storage only.

PRODUCT CODE	PRICE	SIZE/INCHES			WEIGHT VOL	
		H	W	D	LBS	FT ³
BRPX3S2130	171	22	30	2.5	5.40	0.95
BRPX3S2136	178	22	36	2.5	6.50	1.15
BRPX3S2142	183	22	42	2.5	7.50	1.34

Application

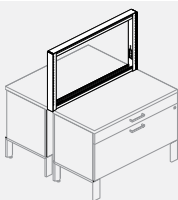

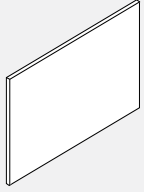
BRPX3FT21 • B3 Bridges Divider Tile

- Full fabric tile. Aluminum frame, fabric stretched around frame's perimeter.

PRODUCT CODE	PRICE			SIZE/INCHES			WEIGHT VOL	
	GR1	GR2	OPT	H	W	D	LBS	FT ³
BRPX3FT2130	82	90	95	22	30	1	2.70	0.38
BRPX3FT2136	90	95	104	22	36	1	3.25	0.46
BRPX3FT2142	102	109	116	22	42	1	3.80	0.53
BRPX3FT2148	112	122	132	22	48	1	4.32	0.61
BRPX3FT2154	124	133	144	22	54	1	4.86	0.69
BRPX3FT2160	134	145	157	22	60	1	5.40	0.76
BRPX3FT2166	146	157	171	22	66	1	5.94	0.84
BRPX3FT2172	157	171	182	22	72	1	6.48	0.92

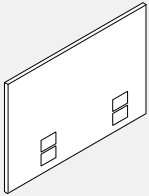
BRPX3NET21 • B3 Bridges Fabric Electrical Tile

- Full fabric tile with openings for power and data. Aluminum frame, fabric stretched around frame's perimeter.
- Includes one data opening blank cover. Specify power distribution module, duplexes.
- Jumpers and power feed harnesses separately.

PRODUCT CODE	PRICE			SIZE/INCHES			WEIGHT VOL	
	GR1	GR2	OPT	H	W	D	LBS	FT ³
BRPX3NET2130	156	169	180	22	30	1	2.70	0.38
BRPX3NET2136	159	172	183	22	36	1	3.25	0.46
BRPX3NET2142	162	176	192	22	42	1	3.80	0.53
BRPX3NET2148	169	179	195	22	48	1	4.32	0.61
BRPX3NET2154	171	182	200	22	54	1	4.86	0.69
BRPX3NET2160	174	190	204	22	60	1	5.40	0.76
BRPX3NET2166	178	194	208	22	66	1	5.94	0.84
BRPX3NET2172	181	199	212	22	72	1	6.48	0.92

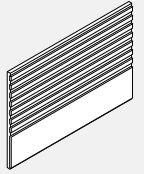
BRPX3ATF21 • B3 Bridges Accessory Fabric Tile

- Partial accessory/fabric tile. The kit consists of a 12" high accessory tile with horizontal slats and an 8" high fabric tile (fabric stretched over aluminum frame).

PRODUCT CODE	PRICE			SIZE/INCHES			WEIGHT VOL	
	GR1	GR2	OPT	H	W	D	LBS	FT ³
BRPX3ATF2130	260	279	303	22	30	1	6.84	0.38
BRPX3ATF2136	268	291	313	22	36	1	8.20	0.46
BRPX3ATF2142	280	303	327	22	42	1	9.57	0.53
BRPX3ATF2148	291	313	340	22	48	1	10.94	0.61
BRPX3ATF2154	303	327	351	22	54	1	12.31	0.69
BRPX3ATF2160	312	339	366	22	60	1	13.68	0.76
BRPX3ATF2166	323	349	377	22	66	1	15.04	0.84
BRPX3ATF2172	333	363	389	22	72	1	16.40	0.92

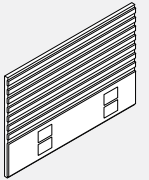
BRPX3ATE21 • B3 Bridges Accessory Electrical Tile

- Partial accessory/fabric power and data tile. The kit consists of a 12" high accessory tile with horizontal slats and an 8" high fabric tile (fabric stretched over aluminum frame).
- Power/data openings in the partial fabric tile section, cover includes one data opening blank cover.
- Specify power distribution module, Duplexes, Jumpers and Power feed harnesses separately.

PRODUCT CODE	PRICE			SIZE/INCHES			WEIGHT VOL	
	GR1	GR2	OPT	H	W	D	LBS	FT ³
BRPX3ATE2130	284	307	333	22	30	1	7.00	0.38
BRPX3ATE2136	298	320	347	22	36	1	8.40	0.46
BRPX3ATE2142	309	333	363	22	42	1	9.80	0.53
BRPX3ATE2148	320	347	373	22	48	1	11.10	0.61
BRPX3ATE2154	333	361	388	22	54	1	12.50	0.69
BRPX3ATE2160	343	372	401	22	60	1	13.90	0.76
BRPX3ATE2166	354	384	417	22	66	1	15.20	0.84
BRPX3ATE2172	369	398	431	22	72	1	16.60	0.92

BRA3VTRF22 • B3 Bridges Divider Trim

- For use with Bridges/System3 Panel/Storage Dividers.
- Table mounted BRPX3P End Trim.
- 25" Boulevard Panel Vertical trim.
- System3 step down panel trim - covers panel's vertical from the bottom of table mounted BRPX3P to the bottom of the adjacent System3 panel.
- System3 step down panel trim - covers panel's vertical from top of BRPX-GMA25 panel to top of adjacent BPX3-34" high System3 panel.
- System3 step down panel trim - covers panel's vertical from top of BRPX-GMA25 panel on top of adjacent BPX3- 42" high System3 panel.
- System3 step down panel trim - covers panel's vertical from top of BRPX-GMA25 panel to top of adjacent BPX3- 50" high System3 panel.

PRODUCT CODE	PRICE	SIZE/INCHES			WEIGHT VOL	
		H	W	D	LBS	FT ³
BRA3VTRF22	29	22	2.61	0.125	0.045	
BRA3VTRF25	34	25	2.61	0.125	0.045	
BRA3VTRF27	41	27	2.61	0.125	0.05	
BRA3VTRF34	46	34	2.61	0.125	0.06	
BRA3VTRF38	54	38	2.61	0.125	0.07	
BRA3VTSF09	21	9	2.61	0.125	0.02	
BRA3VTSF17	24	17	2.61	0.125	0.03	
BRA3VTSF25	34	25	2.61	0.125	0.05	

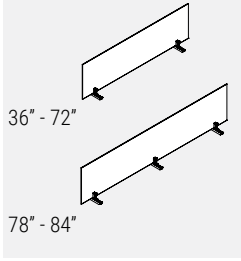
BRTAGDD • Glass Table Mounted Dividers

- **Parallel divider, Back 2 Back tables, glass**
- Secures between two Back 2 Back tables; provides privacy, divides space.
- Installed divider measures 15.7" from the top of the worksurface.
- 36" -72" dividers include 2 support brackets; 78" and 84" dividers include 3 support brackets.
- Tempered glass, acid etched finish on one side (similar to frosted), painted support brackets.

PRODUCT CODE	PRICE	SIZE/INCHES			WEIGHT VOL	
		H	W	D	LBS	FT ³
BRTAGDD36	373	16	33	0.25	12	0.07
BRTAGDD42	417	16	39	0.25	14	0.09
BRTAGDD48	450	16	45	0.25	16	0.10
BRTAGDD54	490	16	51	0.25	18	0.11
BRTAGDD60	516	16	57	0.25	21	0.13
BRTAGDD66	557	16	63	0.25	23	0.14
BRTAGDD72	600	16	69	0.25	25	0.16
BRTAGDD78	697	16	75	0.25	27	0.17
BRTAGDD84	740	16	81	0.25	29	0.18

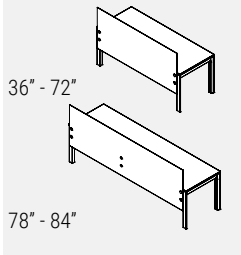
BRTAGDS • Glass Table Mounted Parallel Divider

- **Secures to the rear edge of a single table; provides privacy, divides space while not obstructing available light.**
- 36"-72" dividers include 2 mounting brackets; 78" and 84" dividers include 3 mounting brackets.
- Tempered glass, acid etched on one side (similar to frosted), satin chrome disc fasteners and powder coated steel support brackets.
- Installed divider reaches 15.7" up and 15" down from the top of the worksurface.
- Not recommended for use on tables using 42" high legs.

PRODUCT CODE	PRICE	SIZE/INCHES			WEIGHT VOL	
		H	W	D	LBS	FT ³
BRTAGDS36	707	30.7	33	0.250	23	0.150
BRTAGDS42	774	30.7	39	0.250	27	0.175
BRTAGDS48	840	30.7	45	0.250	31	0.200
BRTAGDS54	907	30.7	51	0.250	35	0.225
BRTAGDS60	972	30.7	57	0.250	39	0.250
BRTAGDS66	1038	30.7	63	0.250	43	0.275
BRTAGDS72	1106	30.7	69	0.250	47	0.300
BRTAGDS78	1324	30.7	75	0.250	51	0.325
BRTAGDS84	1389	30.7	81	0.250	55	0.350

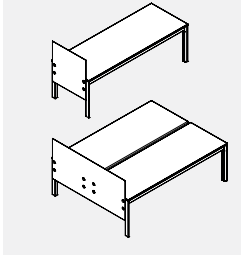
BRTAGED • Glass Perpendicular End of Run Divider

- **Secures to the perpendicular edge of a single or double Back 2 Back table; provides privacy, divides space while not obstructing available light.**
- Installed divider reaches 15.7" up and 15" down from the top of the worksurface.
- 1/2" radius front top corner of 24" and 30" deep glass dividers. 51" and 63" glass dividers for Back 2 Back tables have both top corners 1/2" radius.
- 24" and 30" dividers include 2 mounting brackets.
- 51" and 63" dividers include 4 mounting brackets.
- Tempered glass, acid etched on one side (similar to frosted), satin chrome disc fasteners and powder coated steel support brackets.
- Note: Outside of glass is etched and inside is smooth for left (BRTAGEDL) and right (BRTAGED-R).

PRODUCT CODE	PRICE	SIZE/INCHES			WEIGHT VOL	
		H	W	D	LBS	FT ³
BRTAGED24L	672	30.7	25.4	0.250	23	0.150
BRTAGED24R	672	30.7	25.4	0.250	23	0.150
BRTAGED30L	740	30.7	31.4	0.250	27	0.175
BRTAGED30R	740	30.7	31.4	0.250	27	0.175
BRTAGED51	1324	30.7	50.5	0.250	31	0.200
BRTAGED63	1456	30.7	62.5	0.250	35	0.225

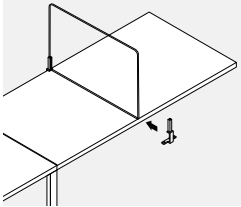
BRTAGPPD-M • Shared Glass Perpendicular Side to Side Divider - Middle

- **Provides privacy, divides space.**
- 24M and 30M kits are designed to be installed on tables with recessed legs (round legs, 34" rectangular legs).
- 24M and 30M kits consist of a rear and front bracket (powder coated steel), tempered glass with rounded top corners (acid etched on one side), bracket-fitting gaskets and mounting screws securing the brackets to the underside of the worksurface.
- Over the seam application would be installed with the wide bracket at the front (thus bypassing the shared leg) and "middle of the work surface" application would be installed with the wide bracket at the back and the narrow at the front".

PRODUCT CODE	PRICE	SIZE/INCHES			WEIGHT VOL	
		H	W	D	LBS	FT ³
BRTAGPPD24M	499	16	24	0.250	9	0.055
BRTAGPPD30M	518	16	30	0.250	11.25	0.069

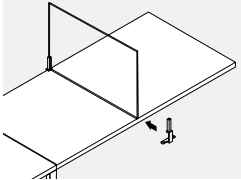
BRTAGPPD-MQ • Shared Glass Perpendicular Side to Side Divider - Middle - Square Corners

- **Provides privacy, divides space.**
- 24M and 30M kits are designed to be installed on tables with recessed legs (round legs, 34" rectangular legs).
- 24M and 30M kits consist of a rear and front bracket (powder coated steel), tempered glass with rounded top corners (acid etched on one side), bracket-fitting gaskets and mounting screws securing the brackets to the underside of the worksurface.
- Over the seam application would be installed with the wide bracket at the front (thus bypassing the shared leg) and "middle of the work surface" application would be installed with the wide bracket at the back and the narrow at the front".

PRODUCT CODE	PRICE	SIZE/INCHES			WEIGHT VOL	
		H	W	D	LBS	FT ³
BRTAGPPD24MQ	421	16	24	0.250	9	0.055
BRTAGPPD30MQ	443	16	30	0.250	11.25	0.069

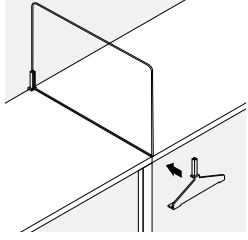
BRTAGPPD-S • Shared Glass Perpendicular Side to Side Divider - Seam

- Provides privacy, divides space.

• 24S and 30S kits are designed to be installed in the middle or over a seam of two adjacent work surfaces supported by a shared, full depth RECTANGULAR leg.

• 24S and 30S kits consist of a rear and front bracket (powder coated steel), tempered glass with rounded top corners (acid etched on one side), bracket-fitting gaskets and mounting screws securing the brackets to the underside of the worksurface.

• Note: Cannot be installed over two, side-by-side rectangular legs. Only one shared or recessed leg.

PRODUCT CODE	PRICE	SIZE/INCHES			WEIGHT VOL	
		H	W	D	LBS	FT ³
BRTAGPPD24S	499	16	24	0.250	9	0.055
BRTAGPPD30S	518	16	30	0.250	11.25	0.069

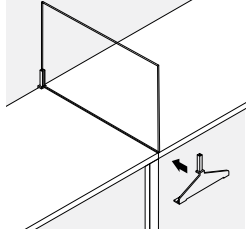
BRTAGPPD-SQ • Shared Glass Perpendicular Side to Side Divider - Seam - Square Corners

- Provides privacy, divides space.

• 24S and 30S kits are designed to be installed in the middle or over a seam of two adjacent work surfaces supported by a shared, full depth RECTANGULAR leg.

• 24S and 30S kits consist of a rear and front bracket (powder coated steel), tempered glass with rounded top corners (acid etched on one side), bracket-fitting gaskets and mounting screws securing the brackets to the underside of the worksurface. Note: Cannot be installed over two, side-by-side rectangular legs. Only one shared or recessed leg.

PRODUCT CODE	PRICE	SIZE/INCHES			WEIGHT VOL	
		H	W	D	LBS	FT ³
BRTAGPPD24SQ	421	16	24	0.250	9	0.055
BRTAGPPD30SQ	443	16	30	0.250	11.25	0.069

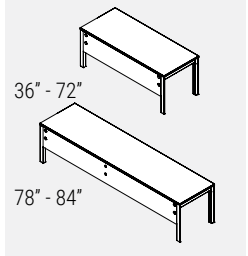
BRTAGMPS • Glass Modesty Panel

- Secures to the rear edge of a single table, between table legs; provides privacy. Installed divider reaches 15" below the worksurface.

• 36"-72" modesty panels include 2 mounting brackets.

• 78"-84" modesty panels include 3 mounting brackets.

• Tempered glass, acid etched on one side (similar to frosted), satin chrome disc fasteners and powder coated steel support brackets.

PRODUCT CODE	PRICE	SIZE/INCHES			WEIGHT VOL	
		H	W	D	LBS	FT ³
BRTAGMPS36	490	13.25	29.75	0.25	9	0.05
BRTAGMPS42	522	13.25	35.75	0.25	11	0.06
BRTAGMPS48	557	13.25	41.75	0.25	13	0.08
BRTAGMPS54	591	13.25	47.75	0.25	15	0.09
BRTAGMPS60	625	13.25	53.75	0.25	17	0.10
BRTAGMPS66	657	13.25	59.75	0.25	19	0.11
BRTAGMPS72	691	13.25	65.75	0.25	20	0.12
BRTAGMPS78	872	13.25	71.75	0.25	22	0.13
BRTAGMPS84	907	13.25	77.75	0.25	24	0.14

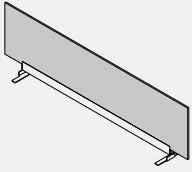
BRTAFDD • Back 2 Back Parallel Felt Divider

- **Secures to the underside of the worksurface.**
- 9mm felt material is tackable and comes in 18 different colours. Please specify colour.
- Installed divider measures 15.7" high from the top of the worksurface.
- Please choose standard metal finish for extrusion and brackets.
- Upcharge of \$96 for anodized extrusion option.

PRODUCT CODE	PRICE	SIZE/INCHES			WEIGHT VOL	
		H	W	D	LBS	FT ³
BRTAFDD36	204	16.88	33	7.5	2.8	0.41
BRTAFDD42	229	16.88	39	7.5	3.2	0.48
BRTAFDD48	260	16.88	45	7.5	3.7	0.55
BRTAFDD54	366	16.88	51	7.5	4.1	0.63
BRTAFDD60	388	16.88	57	7.5	4.6	0.70
BRTAFDD66	410	16.88	63	7.5	5.0	0.77
BRTAFDD72	433	16.88	69	7.5	5.4	0.85
BRTAFDD78	454	16.88	75	7.5	5.9	0.92
BRTAFDD84	477	16.88	81	7.5	6.3	1.00

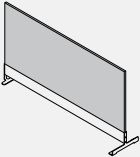
BRTAFPPD-M • Perpendicular Side to Side Off Module Felt Divider

- **1 wide bracket at the back and 1 narrow bracket at the front secure the divider off module to worksurface edges.**
- 9mm felt material is tackable and comes in 18 different colours. Please specify colour.
- Installed divider measures 15.7" high from the top of the worksurface.
- Please choose standard metal finish for extrusion and brackets.
- Upcharge of \$96 for anodized extrusion option.

PRODUCT CODE	PRICE	SIZE/INCHES			WEIGHT VOL	
		H	W	D	LBS	FT ³
BRTAFPPD24M	171	16.85	24.24	6.5	2.1	0.22
BRTAFPPD30M	195	16.85	30.24	6.5	2.6	0.27

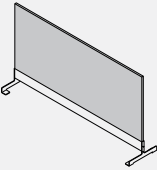
BRTAFPPD-S • Perpendicular Side to Side Felt Divider

- **2 wide bracket secure the divider off module and over the seam of 2 adjacent worksurface.**
- 9mm felt material is tackable and comes in 18 different colours. Please specify colour.
- Installed divider measures 15.7" high from the top of the worksurface.
- Please choose standard metal finish for extrusion and brackets.
- Upcharge of \$96 for anodized extrusion option.

PRODUCT CODE	PRICE	SIZE/INCHES			WEIGHT VOL	
		H	W	D	LBS	FT ³
BRTAFPPD24S	176	16.85	24.24	6.5	2.3	0.22
BRTAFPPD30S	199	16.85	30.24	6.5	2.7	0.27
BRTAFPPD51S	357	16.85	50.81	6.5	4.2	0.46
BRTAFPPD63S	405	16.85	62.81	6.5	5.1	0.57

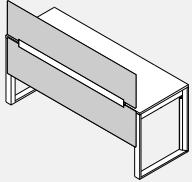
BRTAFDSN • Felt Divider and Modesty Panel Kit

- **Felt divider and modesty panel kit secures to the rear bottom of a single Bridges table and provides privacy above and below the worksurface.**
- 9 mm felt material is tackable and comes in a wide range of colours.
- Installed, the divider measures 15.7 high from the top of the worksurface and 15" high below the top of the worksurface.
- Kit includes two felt dividers, support extrusion and left and right brackets.
- Please choose the finish of the felt and the metal finish for the extrusion and brackets.

PRODUCT CODE	PRICE	SIZE/INCHES			WEIGHT VOL	
		H	W	D	LBS	FT ³
BRTAFDSN48	499	30.68	45	4.05	5.19	38.83
BRTAFDSN54	603	30.68	51	4.05	5.87	44.01
BRTAFDSN60	643	30.68	57	4.05	6.54	49.18
BRTAFDSN66	672	30.68	63	4.05	7.21	54.36
BRTAFDSN72	770	30.68	69	4.05	7.89	59.54
BRTAFDSN78	812	30.68	72	4.05	8.57	62.13
BRTAFDSN84	851	30.68	78	4.05	9.24	67.30

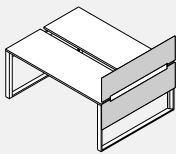
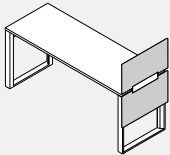
BRTAFEDN • Felt End Divider and Modesty Panel Kit

- **Felt divider and modesty panel kit secures to the side bottom of a single or back to back Bridges table and provides privacy above and below the worksurface.**
- 9 mm felt material is tackable and comes in a wide range of colours.
- Installed, the divider measures 15.7 high from the top of the worksurface and 15" high below the top of the worksurface.
- Kit includes two felt dividers, support extrusion and left and right brackets.
- Please choose the finish of the felt and the metal finish for the extrusion and brackets.

PRODUCT CODE	PRICE	SIZE/ INCHES			WEIGHT VOL	
		H	W	D	LBS	FT ³
BRTAFEDN24	303	30.68	25.46	4.05	3.3	21.97
BRTAFEDN30	341	30.68	31.46	4.05	3.98	27.15
BRTAFEDN51	625	30.68	50.56	4.05	6.22	43.63
BRTAFEDN63	713	30.68	62.56	4.05	7.57	53.98

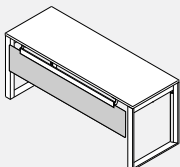
BRTAFMPSN • Felt Modesty Panel

- **Felt modesty panel secures to the rear bottom of a single Bridges table and provides privacy below the worksurface.**
- 9 mm felt material is tackable and comes in a wide range of colours.
- Installed, the divider measures 15" high below the top of the worksurface.
- Kit includes felt modesty, support extrusion and left and right brackets.
- Please choose the finish of the felt and the metal finish for the extrusion and brackets.

PRODUCT CODE	PRICE	SIZE/ INCHES			WEIGHT VOL	
		H	W	D	LBS	FT ³
BRTAFMPSN48	202	13.82	41.76	4.17	3.31	16.71
BRTAFMPSN54	276	13.82	47.76	4.17	3.72	19.11
BRTAFMPSN60	289	13.82	53.76	4.17	4.13	21.51
BRTAFMPSN66	307	13.82	59.76	4.17	4.54	23.92
BRTAFMPSN72	327	13.82	65.76	4.17	4.95	26.32
BRTAFMPSN78	343	13.82	71.76	4.17	5.36	28.72
BRTAFMPSN84	364	13.82	77.76	4.17	5.77	31.12

Single Table Or Single Table Row Application:

Perpendicular laminate side to side divider
BRTLPPD: flush with the front WS edge. Can be installed off-module to the front and back edge of work surface, regardless of type of leg support - supporting brackets can straddle over shared leg."

Parallel laminate table mounted divider
BRTLPPDS for single table or single table row: recessed 1.3" at both ends; mounted to the table with 0.9" gap at the back.

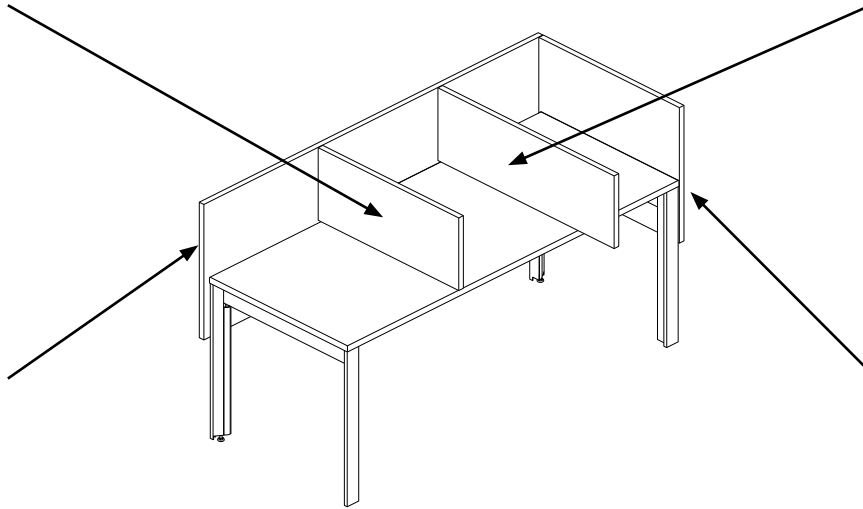

Extended Perpendicular Laminate side to side divider
BRTLPE The extended version protrudes by 6" beyond the front WS edge for added privacy. Can be installed off-module to the front and back edge of work surface, regardless of type of leg support - supporting brackets can straddle over shared leg."

Laminate perpendicular end of run divider
BRTLPE 24, 30 for single table or single table run: flush at the front WS edge; extended back flush with BRTLPPDS divider."

Back-To-Back And Back 2 Back Table Row Application:

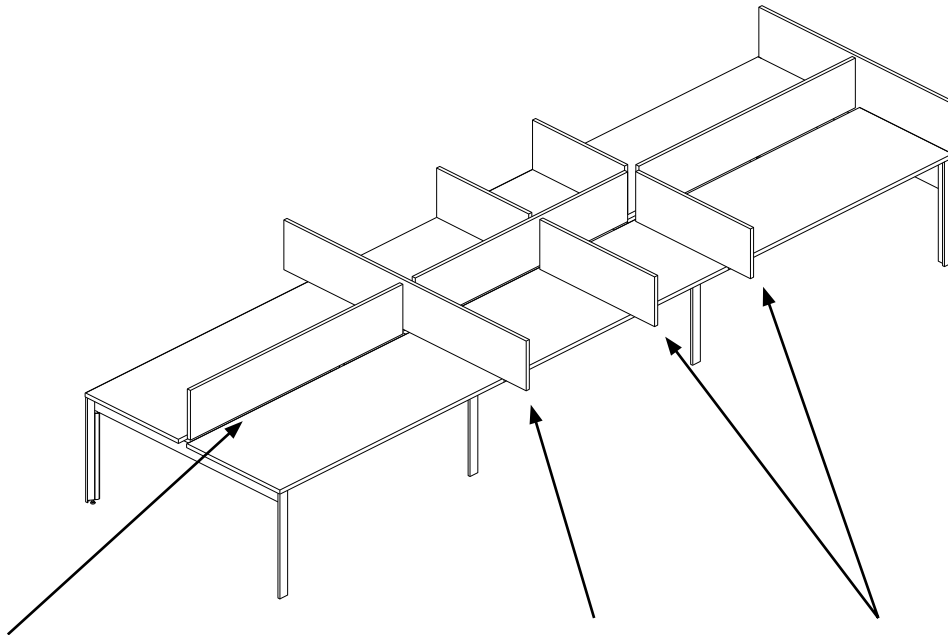

Parallel laminate table mounted divider
BRTLPPD: recessed 1.3" at both ends; mounted between two back-to-back work surfaces."

Extended perpendicular laminate side to side double divider BRTLPESE: this one piece divider spans beyond both back-2-back work surfaces: installs on-module, between two BRTLPPD dividers and is secured to the front edge of both work surfaces, regardless of type of leg support - supporting brackets can straddle over shared leg." Protrudes 6" beyond the front

Extended perpendicular laminate side to side divider BRTLPE. The extended version protrudes by 6" beyond the front WS edge for added privacy. Can be installed off-module or on module to the front and back edge of work surface, regardless of type of leg support - supporting brackets can straddle over shared leg." Shown above in On-module and Off-module application.

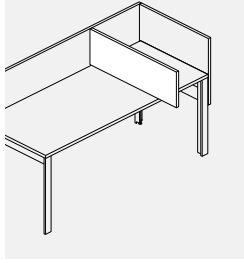
BRTLPESE • Perpendicular Laminate Side to Side Divider - Extended

- Provides privacy, divides spaces.
- Protrudes by 6" beyond the front worksurface edge for added privacy.
- Specify BRTLPESE30 for 24" deep work surfaces and BRTLPESE36 for 30" deep work surfaces.
- Secures off-module or on-module to the front and back edge of work surface, regardless of type of leg support - supporting brackets can straddle over shared leg.
- Includes powder coated steel support brackets. 3/4 LP PVC edge boards, please specify laminate and 3mm PVC edge on order.

PRODUCT CODE	PRICE	SIZE/INCHES			WEIGHT VOL	
		H	W	D	LBS	FT ³
BRTLPESE30	221	16	30	0.75	9.00	0.21
BRTLPESE36	252	16	36	0.75	11.00	0.25

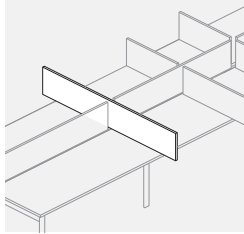
BRTLPESE • Perpendicular Laminate Side to Side Double Divider - Extended

- Provides privacy, divides space. Protrudes 6" beyond the front worksurface edges on either side for added privacy.
- Specify BRTLPESE63 for 24" deep back 2 back work surfaces and BRTLPESE75 for 30" deep back 2 back work surfaces.
- Installs on-module, between two BRTLPESE dividers. It is secured to the front edge of both work surfaces, regardless of type of leg support - supporting brackets can straddle over shared leg.
- NOTE: Can only be installed on-module, between two BRTLPESE dividers.
- Includes powder coated steel support brackets. 3/4 LP PVC edge boards, please specify laminate and 3mm PVC edge on order.

PRODUCT CODE	PRICE	SIZE/INCHES			WEIGHT VOL	
		H	W	D	LBS	FT ³
BRTLPESE63	411	16	63	0.75	18.00	0.44
BRTLPESE75	459	16	75	0.75	22.00	0.52

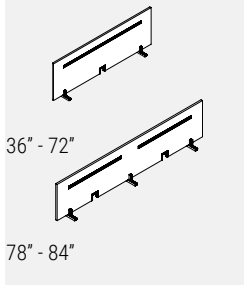
BRTLPESE • Laminate Table Mounted Dividers

- Parallel divider, Back 2 Back tables, LP
- Secures between two Back 2 Back tables; provides privacy, divides space.
- Installed divider measures 15.7" from the top of the worksurface.
- 78" and 84" dividers include 3 support brackets and two pass-through grommets.
- Integrated anodized aluminum accessory rail, white cut out and rail trims; painted support brackets.
- 3/4" LP PVC edged boards, please specify laminate & 3mm PVC edge on order.

PRODUCT CODE	PRICE	SIZE/INCHES			WEIGHT VOL	
		H	W	D	LBS	FT ³
BRTLPESE36	291	16	33	0.75	10	0.22
BRTLPESE42	318	16	39	0.75	12	0.27
BRTLPESE48	347	16	45	0.75	14	0.31
BRTLPESE54	366	16	51	0.75	15	0.35
BRTLPESE60	383	16	57	0.75	17	0.39
BRTLPESE66	401	16	63	0.75	19	0.43
BRTLPESE72	430	16	69	0.75	21	0.47
BRTLPESE78	539	16	75	0.75	23	0.52
BRTLPESE84	555	16	81	0.75	24	0.56

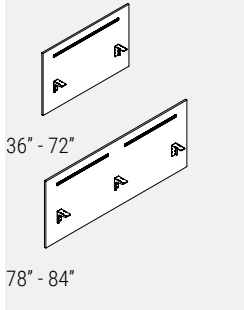
BRTLPESE • High Laminate Table Mounted Divider

- Parallel divider, single tables, LP
- Accessory rail is installed on one side only.
- Secures to the back of a single table; provides privacy, divides space.
- Installed divider reaches 15.7" up and 15" down from the top of the worksurface.
- 36" - 72" dividers include 2 support brackets; 78" and 84" dividers include 3 support brackets.
- Integrated anodized aluminum accessory rail, white cut out and rail trims; powder coat brackets.
- Integrated modesty panel.
- 3/4" LP PVC edged boards, please specify laminate & 3mm PVC edge on order.
- Not recommended for use on tables using 42" high legs.

PRODUCT CODE	PRICE	SIZE/INCHES			WEIGHT VOL	
		H	W	D	LBS	FT ³
BRTLPESE36	410	30.7	33	0.75	22	0.50
BRTLPESE42	501	30.7	39	0.75	25	0.56
BRTLPESE48	539	30.7	45	0.75	29	0.66
BRTLPESE54	567	30.7	51	0.75	32	0.75
BRTLPESE60	610	30.7	57	0.75	36	0.83
BRTLPESE66	645	30.7	63	0.75	40	0.91
BRTLPESE72	683	30.7	69	0.75	43	1.00
BRTLPESE78	837	30.7	75	0.75	47	1.08
BRTLPESE84	874	30.7	81	0.75	50	1.16

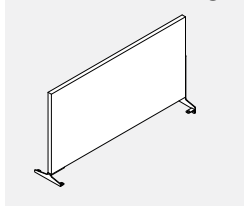
BRTLPESE • High Perpendicular Laminate Side to Side Divider

- **Perpendicular side-to-side divider, 3/4" LP PVC edged board, please specify laminate & 3mm PVC edge finish.**
- Includes powder coated steel support brackets.
- Provides privacy, divides space; secures off-module or on-module to the front and back edge of worksurface, regardless of type of leg support - supporting brackets can straddle over shared leg.
- Installed divider measures 15.7" from the top of the worksurface.

PRODUCT CODE	PRICE	SIZE/INCHES			WEIGHT VOL	
		H	W	D	LBS	FT ³
BRTLPESE24	201	16	24	0.75	7	0.16
BRTLPESE30	218	16	30	0.75	9	0.20

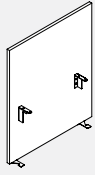
BRTLPEP • Laminate Perpendicular End of a Run Divider

- Secures to the side edge of a table/tables; provides privacy, divides space, LP.
- Installed divider reaches 15.7 up and 15" down from the top of the worksurface.
- Includes powder coated steel support brackets for rectangular legs only.
- Integrated modesty panel.
- 3/4" LP self edged boards, please specify laminate & 3mm PVC edge on order.

PRODUCT CODE	PRICE	SIZE/INCHES			WEIGHT VOL	
		H	W	D	LBS	FT ³
BRTLPEP24	319	30.7	24	0.75	7	0.16
BRTLPEP30	347	30.7	30	0.75	9	0.20
BRTLPEP51	546	30.7	50.5	0.75	15	0.35
BRTLPEP63	621	30.7	62.5	0.75	19	0.43

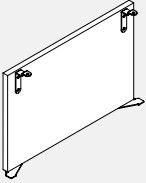
BRTPEG • Laminate Gable for Rectangular Leg

- Perpendicular end of a run gable, LP
- Secures to the side edge of a table/tables and rectangular legs; provides privacy, divides space.
- Includes powder coated steel support brackets.
- 3/4" LP self edged boards.
- 3 Gable heights available:
 - BRTPEG24, 30, 51 and 63 measure 15" below worksurface.
 - BRTPEGH21 lines up with the bottom of storage cabinets.
 - BRTPEGH27 reaches down 1" from the floor.
- Note: BRTPEGH27 will not fit on BRTSLLL Loop Leg.

PRODUCT CODE	PRICE	SIZE/INCHES			WEIGHT VOL	
		H	W	D	LBS	FT ³
BRTPEG24	208	14	24	0.75	6	0.14
BRTPEG24H21	238	20.5	24	0.75	9	0.21
BRTPEG24H27	278	26.5	24	0.75	12	0.26
BRTPEG30	225	14	30	0.75	8	0.18
BRTPEG30H21	252	20.5	30	0.75	12	0.26
BRTPEG30H27	293	26.5	30	0.75	15	0.33
BRTPEG51	367	14	50.5	0.75	13	0.30
BRTPEG51H21	435	20.5	50.5	0.75	20	0.43
BRTPEG51H27	508	26.5	50.5	0.75	26	0.56
BRTPEG63	399	14	62.5	0.75	16	0.38
BRTPEG63H21	469	20.5	62.5	0.75	25	0.53
BRTPEG63H27	540	26.5	62.5	0.75	32	0.69

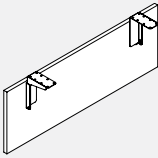
BRTMPS • Laminate Modesty Panel

- Parallel modesty panel, single tables, LP
- Secures to the back edge of a table; provides privacy, divides space.
- Installed divider reaches 15" below worksurface.
- Includes powder coated steel support brackets.
- 3/4" LP self edged boards.
- Flip down for easy access to underside of worksurface.
- Note: actual size of modesty is different than the nominal code.

PRODUCT CODE	PRICE	SIZE/INCHES			WEIGHT VOL	
		H	W	D	LBS	FT ³
BRTMPS36	355	14	30.5	0.75	9	0.21
BRTMPS42	373	14	36.5	0.75	11	0.25
BRTMPS48	391	14	42.5	0.75	13	0.29
BRTMPS54	408	14	48.5	0.75	14	0.32
BRTMPS60	422	14	54.5	0.75	16	0.36
BRTMPS66	441	14	60.5	0.75	17	0.40
BRTMPS72	456	14	66.5	0.75	19	0.43
BRTMPS78	475	14	72.5	0.75	20	0.47
BRTMPS84	490	14	78.5	0.75	22	0.51

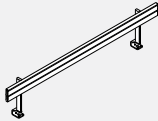
BRLBST • Single Rail Accessory Rail

- Table mounted accessory rail
- Compatible with standard accessories.
- Includes end caps and mounting hardware.
- Please specify paint finish.

PRODUCT CODE	PRICE	SIZE/INCHES			WEIGHT VOL	
		H	W	D	LBS	FT ³
BRLBST36	297	13.5	33	2.95	5.90	0.26
BRLBST42	310	13.5	39	2.95	6.44	0.30
BRLBST48	320	13.5	45	2.95	6.98	0.35
BRLBST54	333	13.5	51	2.95	7.52	0.39
BRLBST60	342	13.5	57	2.95	8.07	0.43
BRLBST66	352	13.5	63	2.95	8.61	0.48
BRLBST72	366	13.5	69	2.95	9.15	0.52
BRLBST78	376	13.5	75	2.95	9.69	0.56
BRLBST84	388	13.5	81	2.95	10.24	0.61

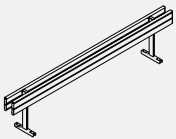
BRLBB2B • Back 2 Back Accessory Rail

- Double sided accessory rail mounts between worksurfaces on back 2 back assembly
- Compatible with standard accessories.
- Includes end caps and mounting hardware.
- Please specify paint finish.

PRODUCT CODE	PRICE	SIZE/INCHES			WEIGHT VOL	
		H	W	D	LBS	FT ³
BRLBB2B36	457	13.5	33	7.50	9.02	0.32
BRLBB2B42	486	13.5	39	7.50	10.10	0.37
BRLBB2B48	510	13.5	45	7.50	11.19	0.42
BRLBB2B54	535	13.5	51	7.50	12.27	0.48
BRLBB2B60	550	13.5	57	7.50	13.36	0.53
BRLBB2B66	574	13.5	63	7.50	14.44	0.58
BRLBB2B72	595	13.5	69	7.50	15.52	0.63
BRLBB2B78	619	13.5	75	7.50	16.61	0.69
BRLBB2B84	643	13.5	81	7.50	17.69	0.74

Single Table Or Single Table Row Application; 16" and 30" high dividers

Table Mounted Framed Divider for single table or single table row; recessed 1.5" at both ends, mounted to the table with 0.6" gap at the back.

BRTMFD/BRTMLD 36" (33" actual) - 66" (63" actual) dividers have 2 mounting brackets.
BRTMFD/BRTMLD 72" (69" actual) - 84" (81" actual) dividers have 3 mounting brackets.

Perpendicular Single Table End of Run Framed Divider;
BREFD/BRELD 24" (21" actual for 24" deep work surfaces),
BREFD/BRELD 30" (27" actual for 30" deep work surfaces),
BREFD/BRELD 36" (33" actual for 36" deep work surfaces),

Two brackets secure the divider to the side edge of work surface. Flush with rear edge, 3" recessed from front work surface edge.

Perpendicular Shared Framed Divider;
BRSFD/BRSLD 24" (21" actual for 24" deep work surfaces),
BRSFD/BRSLD 30" (27" actual for 30" deep work surfaces),
BRSFD/BRSLD 36" (33" actual for 36" deep work surfaces),

Single bracket secures the divider to the rear edge of work surface; Can be mounted off-module or over the seam of two adjacent work surfaces. Flush with the rear edge, 3" recessed from front work surface edge.

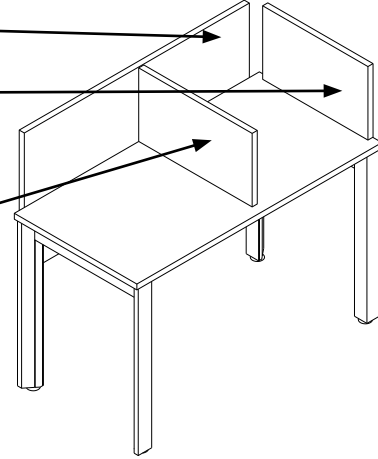

Back 2 Back Table Application; 16" dividers

Perpendicular Back 2 Back Parallel Framed Divider secured between two back-to-back tables; recessed 1.5" at both ends; 0.6" gap between the divider and work surfaces.

BRPFD/BRPLD 36" (33" actual) - 66" (63" actual) dividers have 2 mounting brackets.
BRPFD/BRPLD 72" (69" actual) - 84" (81" actual) dividers have 3 mounting brackets.

Perpendicular Shared Frame Back 2 Back Framed Divider;
BRSDFD/BRSDL 51" (45" actual for 24" deep back-to-back work surfaces)
BRSDFD/BRSDL 63" (57" actual for 30" deep back-to-back work surfaces).
One bracket secures the divider through the gap between work surfaces; two brackets locate top of the divider between two adjacent Parallel dividers.

NOTE: cannot be used on its own without the two Parallel dividers.
3" recessed from front work surface edges.

Perpendicular Back 2 Back End of Run Framed Divider;
BREDFD/BREDLD 51" (45" actual for 24" deep back-to-back work surfaces)
BREDFD/BREDLD 63" (57" actual for 30" deep back-to-back work surfaces).
Three brackets secure the divider to both side edges of work surfaces.
3" recessed from front work surface edges.

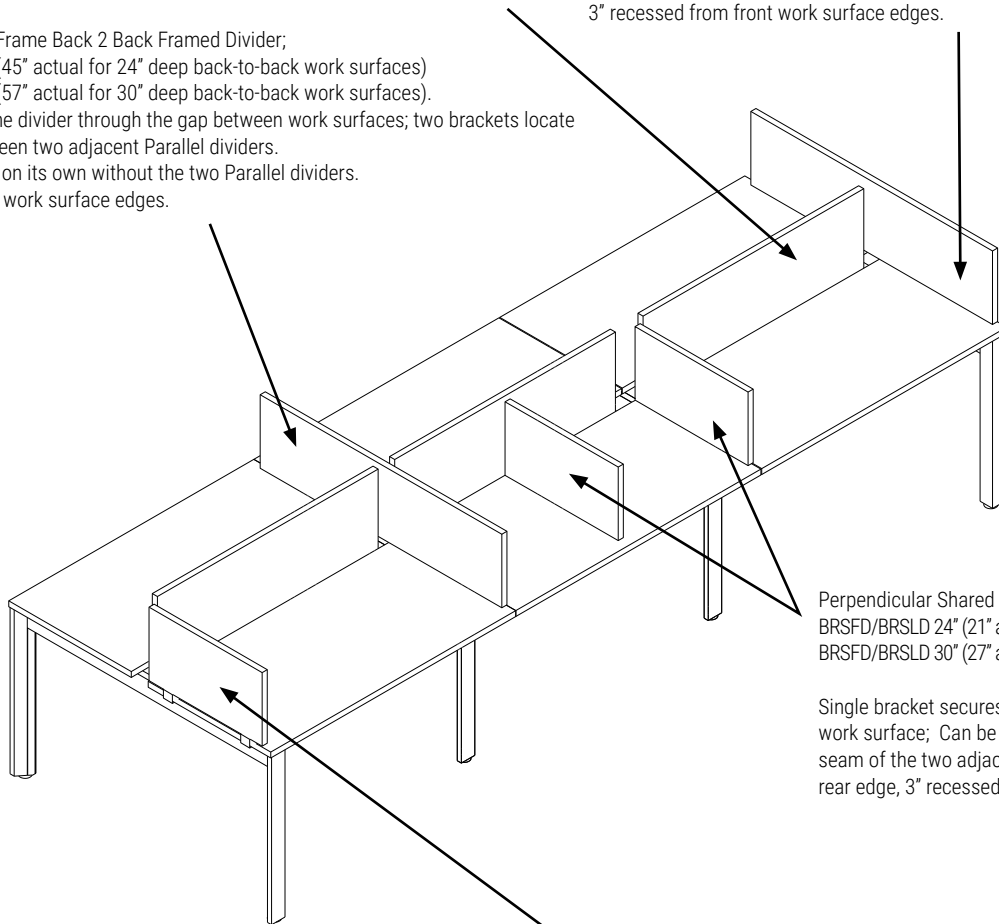

Perpendicular Shared Framed Divider;
BRSFD/BRSLD 24" (21" actual for 24" deep work surfaces).
BRSFD/BRSLD 30" (27" actual for 30" deep work surfaces).

Single bracket secures the divider to the rear edge of work surface; Can be mounted off-module or over the seam of the two adjacent work surfaces. Flush with the rear edge, 3" recessed from front work surfaces edge.

Perpendicular Single Table End of Run Framed Divider;
BREFD/BRELD 24" (21" actual for 24" deep work surfaces).
BREFD/BRELD 30" (27" actual for 30" deep work surfaces).

Two brackets secure the divider to the side edge of work surface. Flush with the rear edge, 3" recessed from front work surface edge.

Note: Do not use framed dividers with glass dividers. Connection hardware will not fit.

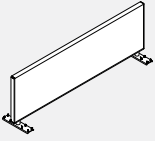
BRPFD/BRPLD • Back 2 Back Parallel Framed Dividers

- **Secures to the underside of the worksurface**
- Divider frame and connecting hardware is painted, please choose from standard metal paint finishes.
- Fabric divider is tackable and always railroaded.
- Divider infill can be specified in fabric, low pressure laminate (LP), high pressure laminate (HP), dry erase whiteboard (DE) or dry erase magnetic whiteboard (DM).
- Installed divider measures 15.7" from top of worksurface.
- 36" to 54" dividers include 2 support brackets. 60" to 84" dividers include 3 support brackets.
- Note 60" - 84" dividers require 3 support brackets and cannot be used with work-surfaces that have a single access door

PRODUCT CODE	PRICE		SIZE/INCHES			WEIGHT VOL	
	GR1	GR2	H	W	D	LBS	FT ³
BRPFD36	351	386	16	33	1.25	13	0.92
BRPFD42	363	396	16	39	1.25	15	1.08
BRPFD48	416	456	16	45	1.25	17	1.25
BRPFD54	434	483	16	51	1.25	19	1.42
BRPFD60	523	574	16	57	1.25	22	1.58
BRPFD66	551	608	16	63	1.25	23	1.75
BRPFD72	569	631	16	69	1.25	25	1.92
BRPFD78	578	643	16	75	1.25	27	2.08
BRPFD84	605	676	16	81	1.25	28	2.25

PRODUCT CODE	PRICE		SIZE/INCHES			LP/HP/DE LBS	MAG LBS	VOL FT ³		
	LP	HP	DE	DM	H				W	D
BRPLD36	259	336	437	731	16	33	1.25	17	20	0.92
BRPLD42	273	357	473	809	16	39	1.25	19	23	1.08
BRPLD48	306	416	543	930	16	45	1.25	21	26	1.25
BRPLD54	357	501	886	1656	16	51	1.25	24	29	1.42
BRPLD60	431	591	935	1709	16	57	1.25	26	32	1.58
BRPLD66	444	645	943	1813	16	63	1.25	30	37	1.75
BRPLD72	459	649	1000	1827	16	69	1.25	33	40	1.92
BRPLD78	465	679	1007	1844	16	75	1.25	35	43	2.08
BRPLD84	475	712	1017	1857	16	81	1.25	37	46	2.25

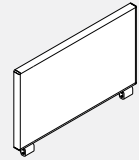
BREFD/BRELD • Perpendicular Single Table End of Run Framed Dividers

- **Connects to the perpendicular end of a single or Back 2 Back table.**
- Divider frame and connecting hardware is painted, please choose from standard metal paint finishes.
- Fabric divider is tackable and always railroaded. Divider infill can be specified in fabric, low pressure laminate (LP), high pressure laminate (HP), dry erase whiteboard (DE) or dry erase magnetic whiteboard (DM) user side only.
- Installed divider measures 15.7" from top of worksurface.
- Divider comes with 2 support brackets.
- When dry erase magnetic whiteboard (DM) is specified it is applied user side ONLY and dry erase whiteboard (DE) is applied on the opposite side.
- Two brackets secure the divider to the side edge of work surface. Flush with the rear edge, 3" recessed from front work surface edge.

PRODUCT CODE	PRICE		SIZE/INCHES			WEIGHT VOL	
	GR1	GR2	H	W	D	LBS	FT ³
BREFD24	271	301	16	21	1.25	9	0.58
BREFD30	280	309	16	27	1.25	11	0.75
BREFD36	306	342	16	33	1.25	12	0.92

PRODUCT CODE	PRICE		SIZE/INCHES			LP/HP/DE LBS	MAG LBS	VOL FT ³		
	LP	HP	DE	DM	H				W	D
BRELD24	194	249	314	378	16	21	1.25	12	14	0.58
BRELD30	214	285	350	431	16	27	1.25	14	17	0.75
BRELD36	221	302	401	501	16	33	1.25	16	20	0.92

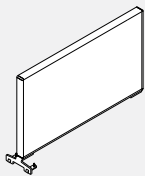
BRSFD/BRSLD • Perpendicular Shared Framed Dividers

- **Connects anywhere along and between worksurfaces to divide space and create privacy.**
- Divider is fastened under the worksurface flush to the back of the table and recessed 3" from the front edge on the user side.
- Divider frame and connecting hardware is painted, please choose from standard metal paint finishes.
- Fabric divider is tackable and always railroaded. Divider infill can be specified in fabric, low pressure laminate (LP), high pressure laminate (HP), dry erase whiteboard (DE) or dry erase magnetic whiteboard (DM).
- Installed divider measures 15.7" from top of worksurface.
- Divider comes with a support bracket at the back and a spacer plate with double sided adhesive at the front.

PRODUCT CODE	PRICE		SIZE/INCHES			WEIGHT VOL	
	GR1	GR2	H	W	D	LBS	FT ³
BRSFD24	262	289	16	21	1.25	9	0.58
BRSFD30	271	301	16	27	1.25	11	0.75
BRSFD36	299	332	16	33	1.25	12	0.92

PRODUCT CODE	PRICE		SIZE/INCHES			LP/HP/DE LBS	MAG LBS	VOL FT ³		
	LP	HP	DE	DM	H				W	D
BRSLD24	194	244	306	501	16	21	1.25	12	14	0.58
BRSLD30	208	279	343	621	16	27	1.25	14	17	0.75
BRSLD36	221	302	401	687	16	33	1.25	16	20	0.92

BREDFD/BRELD • Perpendicular Back 2 Back End of Run Framed Dividers

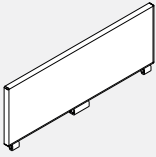

- Connects to the end of run on Back 2 Back tables to create privacy .
- Divider is fastened under the worksurface and recessed 3" from the user edge on the either side.
- Divider frame and connecting hardware is painted, please choose from standard metal paint finishes.
- Fabric divider is tackable and always railroaded.
- Divider infill can be specified in fabric, low pressure laminate (LP) , high pressure laminate (HP), dry erase whiteboard (DE) or dry erase magnetic whiteboard (DM) user side only.
- Installed divider measures 15.7" from top of worksurface.
- Divider comes with 1 large and 2 small support brackets.
- When dry erase magnetic whiteboard (DM) is specified it is applied user side ONLY and dry erase whiteboard (DE) is applied on the opposite side

PRODUCT CODE	PRICE		SIZE/ INCHES			WEIGHT VOL	
	GR1	GR2	H	W	D	LBS	FT³
BREDFD51	422	468	16	45	1.25	18	1.25
BREDFD63	478	527	16	57	1.25	21	1.58

PRODUCT CODE	PRICE				SIZE/INCHES			LP/HP/DE	MAG	VOL
	LP	HP	DE	DM	H	W	D			
BRELD51	314	420	557	679	16	45	1.25	21	26	1.25
BRELD63	386	551	901	1153	16	57	1.25	26	32	1.58

BRSDFD/BRSDLD • Perpendicular Back 2 Back Shared Framed Dividers

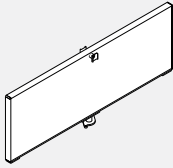

- Connects between parallel framed dividers for Back 2 Back tables to divide space and create privacy.
 - Divider is fastened under the worksurface and recessed 3" from the user edge on the either side.
 - Divider frame and connecting hardware is painted, please choose from standard metal paint finishes.
 - Fabric divider is tackable and always railroaded.
 - Divider infill can be specified in fabric, low pressure laminate (LP) , high pressure laminate (HP), dry erase whiteboard (DE) or dry erase magnetic whiteboard (DM).
 - Installed divider measures 15.7" from top of worksurface.
 - Divider comes with one center support bracket, two spacer plates with adhesive and two top spacer clamps.
- NOTE: cannot be used on its own without the two Parallel dividers.

PRODUCT CODE	PRICE		SIZE/ INCHES			WEIGHT VOL	
	GR1	GR2	H	W	D	LBS	FT³
BRSDFD51	397	439	16	45	1.25	17	1.25
BRSDFD63	451	501	16	57	1.25	20	1.58

PRODUCT CODE	PRICE				SIZE/INCHES			LP/HP/DE	MAG	VOL
	LP	HP	DE	DM	H	W	D			
BRSDLD51	302	408	537	921	16	45	1.25	21	26	1.25
BRSDLD63	372	528	879	1651	16	57	1.25	26	32	1.58

BRTMFD/BRTMLD • Table Mounted Framed Dividers

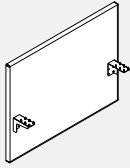

- Parallel divider for single tables.
- Divider frame and connecting hardware is painted, please choose from standard metal paint finishes.
- Fabric divider is tackable and always railroaded.
- Divider infill can be specified in fabric, low pressure laminate (LP) , high pressure laminate (HP), dry erase whiteboard (DE) or dry erase magnetic whiteboard (DM) user side only.
- Fastens to the underside of the worksurface
- 0.6 gap between worksurface and divider allows for cable pass thru.
- Installed divider reaches 15.7 up and 15" down from the top of the worksurface.
- 36" to 66" dividers include 2 support brackets. 72" to 84" dividers include 3 support brackets.
- When dry erase magnetic whiteboard (DM) is specified it is applied user side ONLY and dry erase whiteboard (DE) is applied on the opposite side.
- LAMINATE NOTE: 72" to 84" dividers require 3 support brackets and cannot be used with worksurfaces that have a single access door.
- FABRIC NOTE: 60" to 84" dividers require 3 support brackets and cannot be used with worksurfaces that have a single access door.

PRODUCT CODE	PRICE		SIZE/INCHES			WEIGHT VOL	
	GR1	GR2	H	W	D	LBS	FT³
BRTMFD36	316	350	30	33	1.25	20	1.90
BRTMFD42	378	415	30	39	1.25	22	2.03
BRTMFD48	422	468	30	45	1.25	25	2.34
BRTMFD54	471	520	30	51	1.25	27	2.66
BRTMFD60	534	582	30	57	1.25	30	2.97
BRTMFD66	605	660	30	63	1.25	33	3.28
BRTMFD72	622	687	30	69	1.25	37	3.59
BRTMFD78	649	713	30	75	1.25	40	3.91
BRTMFD84	694	765	30	81	1.25	43	4.22

PRODUCT CODE	PRICE				SIZE/INCHES			LP/HP/DE	MAG	VOL
	LP	HP	DE	DM	H	W	D			
BRTMLD36	376	525	763	1220	30	33	1.25	30	38	1.90
BRTMLD42	391	542	1101	1477	30	39	1.25	34	42	2.03
BRTMLD48	407	556	1107	1573	30	45	1.25	38	48	2.34
BRTMLD54	420	573	2122	2878	30	51	1.25	43	54	2.66
BRTMLD60	444	593	2251	3047	30	57	1.25	48	60	2.97
BRTMLD66	459	673	2257	3062	30	63	1.25	52	66	3.28
BRTMLD72	482	693	2272	3078	30	69	1.25	57	71	3.59
BRTMLD78	956	1273	2287	3091	30	75	1.25	61	77	3.91
BRTMLD84	971	1288	2301	3106	30	81	1.25	66	83	4.22

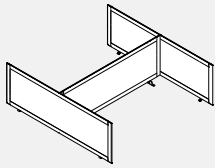
BRTADP-H24 • Back 2 Back Polycarbonate Divider Screen Kit, 24" high

- Provides privacy in an open plan environment.
- Lightweight and easy to clean table mounted partitions.
- Consists of a powder coated aluminum frame, translucent fluted polycarbonate and all hardware to connect. Brackets are painted steel.
- Side dividers extend 6.25" from the front edge of each surface.
- Center divider sits over the gap between the worksurface allowing for the passage of cables to the trough. The gap for each side is approximately 1".
- BRTADP51-H24 are for 24" deep surfaces and BRTADP63-H24 are for 30" deep surfaces.
- Width and depth are nominal sizes representing the sizes of the Bridges configuration. Allow for 1/4" overhang at sides and 6 1/4" at front.
- Please choose any standard paint finish for frame and hardware. End trim cap is available only in CHR - charcoal.

PRODUCT CODE	PRICE	SIZE/INCHES			WEIGHT LBS	VOL FT ³
		H	W	D		
BRTADP5136H24	1102	24.63	36	50.50	33.00	6.31
BRTADP5142H24	1125	24.63	42	50.50	34.50	7.36
BRTADP5148H24	1147	24.63	48	50.50	36.00	8.42
BRTADP5154H24	1170	24.63	54	50.50	37.50	9.47
BRTADP5160H24	1194	24.63	60	50.50	39.00	10.52
BRTADP5166H24	1218	24.63	66	50.50	40.50	11.57
BRTADP5172H24	1238	24.63	72	50.50	42.00	12.63
BRTADP5178H24	1262	24.63	78	50.50	43.50	13.68
BRTADP5184H24	1286	24.63	84	50.50	45.00	14.73
BRTADP6336H24	1193	24.63	36	62.50	46.50	7.81
BRTADP6342H24	1214	24.63	42	62.50	48.00	9.11
BRTADP6348H24	1237	24.63	48	62.50	49.50	10.42
BRTADP6354H24	1261	24.63	54	62.50	51.00	11.72
BRTADP6360H24	1283	24.63	60	62.50	52.50	13.02
BRTADP6366H24	1305	24.63	66	62.50	54.00	14.32
BRTADP6372H24	1329	24.63	72	62.50	55.50	15.63
BRTADP6378H24	1352	24.63	78	62.50	57.00	16.93
BRTADP6384H24	1375	24.63	84	62.50	58.50	18.23

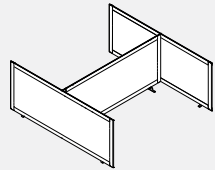
BRTADP-H30 • Back 2 Back Polycarbonate Divider Screen Kit, 30" high

- Provides privacy in an open plan environment.
- Lightweight and easy to clean table mounted partitions.
- Consists of a powder coated aluminum frame, translucent fluted polycarbonate and all hardware to connect. Brackets are painted steel.
- Side dividers extend 6.25" from the front edge of each surface.
- Center divider sits over the gap between the worksurface allowing for the passage of cables to the trough. The gap for each side is approximately 1".
- BRTADP51-H24 are for 24" deep surfaces and BRTADP63-H24 are for 30" deep surfaces.
- Width and depth are nominal sizes representing the sizes of the Bridges configuration. Allow for 1/4" overhang at sides and 6 1/4" at front.
- Please choose any standard paint finish for frame and hardware. End trim cap is available only in CHR - charcoal.

PRODUCT CODE	PRICE	SIZE/INCHES			WEIGHT LBS	VOL FT ³
		H	W	D		
BRTADP5136H30	1223	30.63	36	50.50	35.50	6.31
BRTADP5142H30	1248	30.63	42	50.50	37.00	7.36
BRTADP5148H30	1275	30.63	48	50.50	38.50	8.42
BRTADP5154H30	1302	30.63	54	50.50	40.00	9.47
BRTADP5160H30	1328	30.63	60	50.50	41.50	10.52
BRTADP5166H30	1355	30.63	66	50.50	43.00	11.57
BRTADP5172H30	1381	30.63	72	50.50	44.50	12.63
BRTADP5178H30	1407	30.63	78	50.50	46.00	13.68
BRTADP5184H30	1435	30.63	84	50.50	47.50	14.73
BRTADP6336H30	1372	30.63	36	62.50	49.00	7.81
BRTADP6342H30	1398	30.63	42	62.50	50.50	9.11
BRTADP6348H30	1428	30.63	48	62.50	52.00	10.42
BRTADP6354H30	1451	30.63	54	62.50	53.50	11.72
BRTADP6360H30	1480	30.63	60	62.50	55.00	13.02
BRTADP6366H30	1506	30.63	66	62.50	56.50	14.32
BRTADP6372H30	1533	30.63	72	62.50	58.00	15.63
BRTADP6378H30	1560	30.63	78	62.50	59.50	16.93
BRTADP6384H30	1585	30.63	84	62.50	61.00	18.23

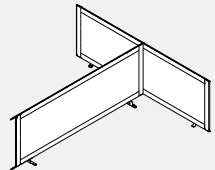
BRTADPE-H24 - Back 2 Back Polycarbonate Divider Screen Kit, 24" high

- Provides an extension for privacy in an open plan environment. Intended to always connect to Back 2 Back Divider Screen Kit
- Lightweight and easy to clean table mounted partitions.
- Consists of a powder coated aluminum frame, translucent fluted polycarbonate and all hardware to connect. Brackets are painted steel.
- Side dividers extend 6.25" from the front edge of each surface.
- Center divider sits over the gap between the worksurface allowing for the passage of cables to the trough. The gap for each side is approximately 1".
- BRTADPE51-H24 are for 24" deep surfaces and BRTADPE63-H24 are for 30" deep surfaces.
- Width and depth are nominal sizes representing the sizes of the Bridges configuration. Allow for 1/4" overhang at sides and 6 1/4" at front.
- Please choose any standard paint finish for frame and hardware. End trim cap is available only in CHR - charcoal.
- Can be used as left or right connection.

PRODUCT CODE	PRICE	SIZE/INCHES			WEIGHT LBS	VOL FT ³
		H	W	D		
BRTADPE5136H24	747	24.63	36	50.50	26.35	6.31
BRTADPE5142H24	767	24.63	42	50.50	27.85	7.36
BRTADPE5148H24	791	24.63	48	50.50	29.35	8.42
BRTADPE5154H24	816	24.63	54	50.50	30.85	9.47
BRTADPE5160H24	839	24.63	60	50.50	32.35	10.52
BRTADPE5166H24	862	24.63	66	50.50	33.85	11.57
BRTADPE5172H24	885	24.63	72	50.50	35.35	12.63
BRTADPE5178H24	907	24.63	78	50.50	36.85	13.68
BRTADPE5184H24	930	24.63	84	50.50	38.35	14.73
BRTADPE6336H24	790	24.63	36	62.50	39.85	7.81
BRTADPE6342H24	814	24.63	42	62.50	41.35	9.11
BRTADPE6348H24	837	24.63	48	62.50	42.85	10.42
BRTADPE6354H24	860	24.63	54	62.50	44.35	11.72
BRTADPE6360H24	884	24.63	60	62.50	45.85	13.02
BRTADPE6366H24	907	24.63	66	62.50	47.35	14.32
BRTADPE6372H24	929	24.63	72	62.50	48.85	15.63
BRTADPE6378H24	952	24.63	78	62.50	50.35	16.93
BRTADPE6384H24	975	24.63	84	62.50	51.85	18.23

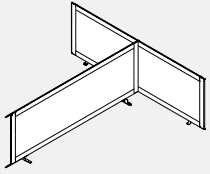
BRTADPE-H30 • Back 2 Back Polycarbonate Divider Screen Kit, 30" high

- Provides an extension for privacy in an open plan environment. Intended to always connect to Back 2 Back Divider Screen Kit
- Lightweight and easy to clean table mounted partitions.
- Consists of a powder coated aluminum frame, translucent fluted polycarbonate and all hardware to connect. Brackets are painted steel.
- Side dividers extend 6.25" from the front edge of each surface.
- Center divider sits over the gap between the worksurface allowing for the passage of cables to the trough. The gap for each side is approximately 1".
- BRTADPE51-H24 are for 24" deep surfaces and BRTADPE63-H24 are for 30" deep surfaces.
- Width and depth are nominal sizes representing the sizes of the Bridges configuration. Allow for 1/4" overhang at sides and 6 1/4" at front.
- Please choose any standard paint finish for frame and hardware. End trim cap is available only in CHR - charcoal.
- Can be used as left or right connection.

PRODUCT CODE	PRICE	SIZE/INCHES			WEIGHT LBS	VOL FT ³
		H	W	D		
BRTADPE5136H30	820	30.63	36	50.50	28.85	6.31
BRTADPE5142H30	849	30.63	42	50.50	30.35	7.36
BRTADPE5148H30	874	30.63	48	50.50	31.85	8.42
BRTADPE5154H30	901	30.63	54	50.50	33.35	9.47
BRTADPE5160H30	928	30.63	60	50.50	34.85	10.52
BRTADPE5166H30	954	30.63	66	50.50	36.35	11.57
BRTADPE5172H30	982	30.63	72	50.50	37.85	12.63
BRTADPE5178H30	1006	30.63	78	50.50	39.35	13.68
BRTADPE5184H30	1033	30.63	84	50.50	40.85	14.73
BRTADPE6336H30	872	30.63	36	62.50	42.35	7.81
BRTADPE6342H30	898	30.63	42	62.50	43.85	9.11
BRTADPE6348H30	926	30.63	48	62.50	45.35	10.42
BRTADPE6354H30	952	30.63	54	62.50	46.85	11.72
BRTADPE6360H30	981	30.63	60	62.50	48.35	13.02
BRTADPE6366H30	1004	30.63	66	62.50	49.85	14.32
BRTADPE6372H30	1033	30.63	72	62.50	51.35	15.63
BRTADPE6378H30	1060	30.63	78	62.50	52.85	16.93
BRTADPE6384H30	1086	30.63	84	62.50	54.35	18.23

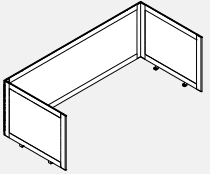
BRTADP-H24 • Single Table Polycarbonate Divider Screen Kit, 24" high

- Provides privacy in an open plan environment.
- Lightweight and easy to clean table mounted partitions.
- Consists of a powder coated aluminum frame, translucent fluted polycarbonate and all hardware to connect. Brackets are painted steel.
- Side dividers extend 6.25" from the front edge of each surface.
- Back divider extends over the back edge of the worksurface by 1 1/2" allowing for the passage of cables to the trough.
- BRTADP24-H24 are for 24" deep surfaces and BRTADP30-H24 are for 30" deep surfaces.
- Width and depth are nominal sizes representing the sizes of the Bridges configuration. Allow for 1/4" overhang at the sides, 1 1/2" at the back and 6 1/4" at the front.
- Please choose any standard paint finish for frame and hardware. End trim cap is available only in CHR - charcoal.

PRODUCT CODE	PRICE	SIZE/INCHES			WEIGHT LBS	VOL FT ³
		H	W	D		
BRTADP2436H24	760	24.63	36	31.75	26.55	3.97
BRTADP2442H24	784	24.63	42	31.75	28.10	4.63
BRTADP2448H24	806	24.63	48	31.75	29.65	5.29
BRTADP2454H24	829	24.63	54	31.75	31.20	5.95
BRTADP2460H24	853	24.63	60	31.75	32.75	6.61
BRTADP2466H24	876	24.63	66	31.75	34.30	7.28
BRTADP2472H24	897	24.63	72	31.75	35.85	7.94
BRTADP2478H24	921	24.63	78	31.75	37.40	8.60
BRTADP2484H24	947	24.63	84	31.75	38.95	9.26
BRTADP3036H24	816	24.63	36	37.75	40.50	4.72
BRTADP3042H24	839	24.63	42	37.75	42.05	5.51
BRTADP3048H24	862	24.63	48	37.75	43.60	6.29
BRTADP3054H24	885	24.63	54	37.75	45.15	7.08
BRTADP3060H24	907	24.63	60	37.75	46.70	7.87
BRTADP3066H24	930	24.63	66	37.75	48.25	8.65
BRTADP3072H24	954	24.63	72	37.75	49.80	9.44
BRTADP3078H24	976	24.63	78	37.75	51.35	10.22
BRTADP3084H24	999	24.63	84	37.75	52.90	11.01

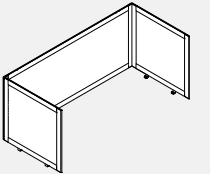
BRTADP-H30 • Single Table Polycarbonate Divider Screen Kit, 30" high

- Provides privacy in an open plan environment.
- Lightweight and easy to clean table mounted partitions.
- Consists of a powder coated aluminum frame, translucent fluted polycarbonate and all hardware to connect. Brackets are painted steel.
- Side dividers extend 6.25" from the front edge of each surface.
- Back divider extends over the back edge of the worksurface by 1 1/2" allowing for the passage of cables to the trough.
- BRTADP24-H24 are for 24" deep surfaces and BRTADP30-H24 are for 30" deep surfaces.
- Width and depth are nominal sizes representing the sizes of the Bridges configuration. Allow for 1/4" overhang at the sides, 1 1/2" at the back and 6 1/4" at the front.
- Please choose any standard paint finish for frame and hardware. End trim cap is available only in CHR - charcoal.

PRODUCT CODE	PRICE	SIZE/INCHES			WEIGHT LBS	VOL FT ³
		H	W	D		
BRTADP2436H30	853	30.63	36	31.75	28.85	3.97
BRTADP2442H30	882	30.63	42	31.75	30.35	4.63
BRTADP2448H30	907	30.63	48	31.75	31.85	5.29
BRTADP2454H30	932	30.63	54	31.75	33.35	5.95
BRTADP2460H30	960	30.63	60	31.75	34.85	6.61
BRTADP2466H30	986	30.63	66	31.75	36.35	7.28
BRTADP2472H30	1015	30.63	72	31.75	37.85	7.94
BRTADP2478H30	1039	30.63	78	31.75	39.35	8.60
BRTADP2484H30	1065	30.63	84	31.75	40.85	9.26
BRTADP3036H30	905	30.63	36	37.75	42.35	4.72
BRTADP3042H30	932	30.63	42	37.75	43.85	5.51
BRTADP3048H30	959	30.63	48	37.75	45.35	6.29
BRTADP3054H30	985	30.63	54	37.75	46.85	7.08
BRTADP3060H30	1012	30.63	60	37.75	48.35	7.87
BRTADP3066H30	1038	30.63	66	37.75	49.85	8.65
BRTADP3072H30	1064	30.63	72	37.75	51.35	9.44
BRTADP3078H30	1091	30.63	78	37.75	52.85	10.22
BRTADP3084H30	1118	30.63	84	37.75	54.35	11.01

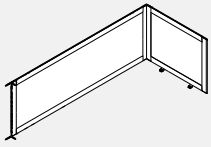
BRTADPE-H24 • Single Table Polycarbonate Divider Screen Extension Kit, 24" high

- Provides an extension for privacy in an open plan environment. Intended to always connect to Single Table Divider Screen Kit
- Lightweight and easy to clean table mounted partitions.
- Can be used as left or right connection.
- Consists of a powder coated aluminum frame, translucent fluted polycarbonate and all hardware to connect. Brackets are painted steel.
- Side dividers extend 6.25" from the front edge of each surface.
- Back divider extends over the back edge of the worksurface by 1 1/2" allowing for the passage of cables to the trough.
- BRTADPE24-H24 are for 24" deep surfaces and BRTADPE30-H24 are for 30" deep surfaces.
- Width and depth are nominal sizes representing the sizes of the Bridges configuration. Allow for 1/4" overhang at the sides, 1 1/2" at the back and 6 1/4" at the front.
- Please choose any standard paint finish for frame and hardware. End trim cap is available only in CHR - charcoal.
- Can be used as left or right connection.

PRODUCT CODE	PRICE	SIZE/INCHES			WEIGHT LBS	VOL FT ³
		H	W	D		
BRTADPE2436H24	570	24.63	36	31.75	21.05	3.97
BRTADPE2442H24	626	24.63	42	31.75	22.60	4.63
BRTADPE2448H24	649	24.63	48	31.75	24.15	5.29
BRTADPE2454H24	672	24.63	54	31.75	25.70	5.95
BRTADPE2460H24	694	24.63	60	31.75	27.25	6.61
BRTADPE2466H24	718	24.63	66	31.75	28.80	7.28
BRTADPE2472H24	741	24.63	72	31.75	30.35	7.94
BRTADPE2478H24	763	24.63	78	31.75	31.90	8.60
BRTADPE2484H24	786	24.63	84	31.75	33.45	9.26
BRTADPE3036H24	592	24.63	36	37.75	35.00	4.72
BRTADPE3042H24	648	24.63	42	37.75	36.55	5.51
BRTADPE3048H24	672	24.63	48	37.75	38.10	6.29
BRTADPE3054H24	694	24.63	54	37.75	39.65	7.08
BRTADPE3060H24	718	24.63	60	37.75	41.20	7.87
BRTADPE3066H24	740	24.63	66	37.75	42.75	8.65
BRTADPE3072H24	762	24.63	72	37.75	44.30	9.44
BRTADPE3078H24	786	24.63	78	37.75	45.85	10.22
BRTADPE3084H24	811	24.63	84	37.75	47.40	11.01

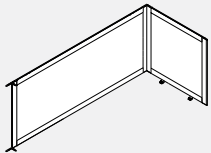
BRTADPE-H30 • Single Table Polycarbonate Divider Screen Extension Kit, 30" high

- Provides an extension for privacy in an open plan environment. Intended to always connect to Single Table Divider Screen Kit
- Lightweight and easy to clean table mounted partitions.
- Can be used as left or right connection.
- Consists of a powder coated aluminum frame, translucent fluted polycarbonate and all hardware to connect. Brackets are painted steel.
- Side dividers extend 6.25" from the front edge of each surface.
- Back divider extends over the back edge of the worksurface by 1 1/2" allowing for the passage of cables to the trough.
- BRTADPE24-H24 are for 24" deep surfaces and BRTADPE30-H24 are for 30" deep surfaces.
- Width and depth are nominal sizes representing the sizes of the Bridges configuration. Allow for 1/4" overhang at the sides, 1 1/2" at the back and 6 1/4" at the front.
- Please choose any standard paint finish for frame and hardware. End trim cap is available only in CHR - charcoal.
- Can be used as left or right connection.

PRODUCT CODE	PRICE	SIZE/INCHES			WEIGHT LBS	VOL FT ³
		H	W	D		
BRTADPE2436H30	627	30.63	36	31.75	22.85	3.97
BRTADPE2442H30	687	30.63	42	31.75	24.40	4.63
BRTADPE2448H30	713	30.63	48	31.75	25.95	5.29
BRTADPE2454H30	739	30.63	54	31.75	27.50	5.95
BRTADPE2460H30	765	30.63	60	31.75	29.05	6.61
BRTADPE2466H30	791	30.63	66	31.75	30.60	7.28
BRTADPE2472H30	818	30.63	72	31.75	32.15	7.94
BRTADPE2478H30	846	30.63	78	31.75	33.70	8.60
BRTADPE2484H30	870	30.63	84	31.75	35.25	9.26
BRTADPE3036H30	654	30.63	36	37.75	36.80	4.72
BRTADPE3042H30	713	30.63	42	37.75	38.35	5.51
BRTADPE3048H30	739	30.63	48	37.75	39.90	6.29
BRTADPE3054H30	763	30.63	54	37.75	41.45	7.08
BRTADPE3060H30	791	30.63	60	37.75	43.00	7.87
BRTADPE3066H30	818	30.63	66	37.75	44.55	8.65
BRTADPE3072H30	845	30.63	72	37.75	46.10	9.44
BRTADPE3078H30	870	30.63	78	37.75	47.65	10.22
BRTADPE3084H30	896	30.63	84	37.75	49.20	11.01

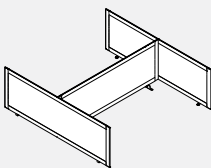
BRTADG-H24 • Back 2 Back Glass Divider Screen Kit, 24" high

- Provides privacy in an open plan environment.
- Easy to clean table mounted partitions.
- Consists of a powder coated aluminum frame, 4mm clear (CLR) glass and all hardware to connect. Brackets are painted steel.
- Side dividers extend 6.25" from the front edge of each surface.
- Center divider sits over the gap between the worksurface allowing for the passage of cables to the trough. The gap for each side is approximately 1".
- BRTADG51-H24 are for 24" deep surfaces and BRTADG63-H24 are for 30" deep surfaces.
- Width and depth are nominal sizes representing the sizes of the Bridges configuration. Allow for 1/4" overhang at sides and 6 1/4" at front.
- Please choose any standard paint finish for frame and hardware. End trim cap is available only in CHR - charcoal.
- Upcharge for frosted (FRST) glass is 20%

PRODUCT CODE	PRICE	SIZE/INCHES			WEIGHT LBS	VOL FT ³
		H	W	D		
BRTADG5136H24	1431	24.60	36	50.50	33.00	6.31
BRTADG5142H24	1464	24.60	42	50.50	34.50	7.36
BRTADG5148H24	1498	24.60	48	50.50	36.00	8.42
BRTADG5154H24	1533	24.60	54	50.50	37.50	9.47
BRTADG5160H24	1565	24.60	60	50.50	39.00	10.52
BRTADG5166H24	1600	24.60	66	50.50	40.50	11.57
BRTADG5172H24	1633	24.60	72	50.50	42.00	12.63
BRTADG5178H24	1667	24.60	78	50.50	43.50	13.68
BRTADG5184H24	1700	24.60	84	50.50	45.00	14.73
BRTADG6336H24	1565	24.60	36	62.50	46.50	7.81
BRTADG6342H24	1599	24.60	42	62.50	48.00	9.11
BRTADG6348H24	1632	24.60	48	62.50	49.50	10.42
BRTADG6354H24	1666	24.60	54	62.50	51.00	11.72
BRTADG6360H24	1698	24.60	60	62.50	52.50	13.02
BRTADG6366H24	1733	24.60	66	62.50	54.00	14.32
BRTADG6372H24	1765	24.60	72	62.50	55.50	15.63
BRTADG6378H24	1800	24.60	78	62.50	57.00	16.93
BRTADG6384H24	1834	24.60	84	62.50	58.50	18.23

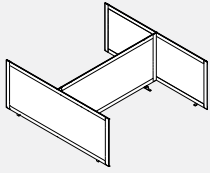
BRTADG-H30 • Back 2 Back Glass Divider Screen Kit, 30" high

- Provides privacy in an open plan environment.
- Easy to clean table mounted partitions.
- Consists of a powder coated aluminum frame, 4mm clear (CLR) glass and all hardware to connect. Brackets are painted steel.
- Side dividers extend 6.25" from the front edge of each surface.
- Center divider sits over the gap between the worksurface allowing for the passage of cables to the trough. The gap for each side is approximately 1".
- BRTADG51-H30 are for 24" deep surfaces and BRTADG63-H30 are for 30" deep surfaces.
- Width and depth are nominal sizes representing the sizes of the Bridges configuration. Allow for 1/4" overhang at sides and 6 1/4" at front.
- Please choose any standard paint finish for frame and hardware. End trim cap is available only in CHR - charcoal.
- Upcharge for frosted (FRST) glass is 20%.

PRODUCT CODE	PRICE	SIZE/INCHES			WEIGHT LBS	VOL FT ³
		H	W	D		
BRTADG5136H30	1511	30.60	36	50.50	35.50	6.31
BRTADG5142H30	1547	30.60	42	50.50	37.00	7.36
BRTADG5148H30	1581	30.60	48	50.50	38.50	8.42
BRTADG5154H30	1615	30.60	54	50.50	40.00	9.47
BRTADG5160H30	1651	30.60	60	50.50	41.50	10.52
BRTADG5166H30	1684	30.60	66	50.50	43.00	11.57
BRTADG5172H30	1706	30.60	72	50.50	44.50	12.63
BRTADG5178H30	1754	30.60	78	50.50	46.00	13.68
BRTADG5184H30	1788	30.60	84	50.50	47.50	14.73
BRTADG6336H30	1696	30.60	36	62.50	49.00	7.81
BRTADG6342H30	1732	30.60	42	62.50	50.50	9.11
BRTADG6348H30	1765	30.60	48	62.50	52.00	10.42
BRTADG6354H30	1801	30.60	54	62.50	53.50	11.72
BRTADG6360H30	1835	30.60	60	62.50	55.00	13.02
BRTADG6366H30	1869	30.60	66	62.50	56.50	14.32
BRTADG6372H30	1890	30.60	72	62.50	58.00	15.63
BRTADG6378H30	1939	30.60	78	62.50	59.50	16.93
BRTADG6384H30	1975	30.60	84	62.50	61.00	18.23

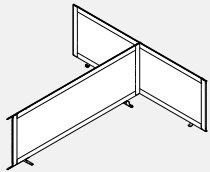
BRTADG-H24 • Back 2 Back Glass Divider Screen Extension Kit, 24" high

- Provides privacy in an open plan environment.
- Easy to clean table mounted partitions.
- Consists of a powder coated aluminum frame, 4mm clear (CLR) glass and all hardware to connect. Brackets are painted steel.
- Side dividers extend 6.25" from the front edge of each surface.
- Center divider sits over the gap between the worksurface allowing for the passage of cables to the trough. The gap for each side is approximately 1".
- BRTADG51-H30 are for 24" deep surfaces and BRTADG63-H30 are for 30" deep surfaces.
- Width and depth are nominal sizes representing the sizes of the Bridges configuration. Allow for 1/4" overhang at sides and 6 1/4" at front.
- Please choose any standard paint finish for frame and hardware. End trim cap is available only in CHR - charcoal.
- Upcharge for frosted (FRST) glass is 20%.
- Can be used as left or right connection.

PRODUCT CODE	PRICE	SIZE/INCHES			WEIGHT LBS	VOL FT ³
		H	W	D		
BRTADGE5136H24	943	24.60	36	50.50	26.35	6.31
BRTADGE5142H24	977	24.60	42	50.50	27.85	7.36
BRTADGE5148H24	1011	24.60	48	50.50	29.35	8.42
BRTADGE5154H24	1045	24.60	54	50.50	30.85	9.47
BRTADGE5160H24	1078	24.60	60	50.50	32.35	10.52
BRTADGE5166H24	1112	24.60	66	50.50	33.85	11.57
BRTADGE5172H24	1146	24.60	72	50.50	35.35	12.63
BRTADGE5178H24	1178	24.60	78	50.50	36.85	13.68
BRTADGE5184H24	1212	24.60	84	50.50	38.35	14.73
BRTADGE6336H24	1011	24.60	36	62.50	39.85	7.81
BRTADGE6342H24	1043	24.60	42	62.50	41.35	9.11
BRTADGE6348H24	1078	24.60	48	62.50	42.85	10.42
BRTADGE6354H24	1109	24.60	54	62.50	44.35	11.72
BRTADGE6360H24	1144	24.60	60	62.50	45.85	13.02
BRTADGE6366H24	1178	24.60	66	62.50	47.35	14.32
BRTADGE6372H24	1211	24.60	72	62.50	48.85	15.63
BRTADGE6378H24	1245	24.60	78	62.50	50.35	16.93
BRTADGE6384H24	1279	24.60	84	62.50	51.85	18.23

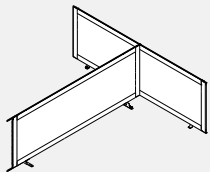
BRTADG-H30 • Back 2 Back Glass Divider Screen Extension Kit, 30" high

- Provides an extension for privacy in an open plan environment. Intended to always connect to Back 2 Back Divider Screen Kit
- Easy to clean table mounted partitions.
- Consists of a powder coated aluminum frame, 4mm clear (CLR) glass and all hardware to connect. Brackets are painted steel.
- Side dividers extend 6.25" from the front edge of each surface.
- Center divider sits over the gap between the worksurface allowing for the passage of cables to the trough. The gap for each side is approximately 1".
- BRTADGE51-H30 are for 24" deep surfaces and BRTADGE63-H30 are for 30" deep surfaces.
- Width and depth are nominal sizes representing the sizes of the Bridges configuration. Allow for 1/4" overhang at sides and 6 1/4" at front.
- Please choose any standard paint finish for frame and hardware. End trim cap is available only in CHR - charcoal.
- Upcharge for frosted (FRST) glass is 20%.
- Can be used as left or right connection.

PRODUCT CODE	PRICE	SIZE/INCHES			WEIGHT LBS	VOL FT ³
		H	W	D		
BRTADGE5136H30	995	30.60	36	50.50	28.85	6.31
BRTADGE5142H30	1029	30.60	42	50.50	30.35	7.36
BRTADGE5148H30	1064	30.60	48	50.50	31.85	8.42
BRTADGE5154H30	1099	30.60	54	50.50	33.35	9.47
BRTADGE5160H30	1133	30.60	60	50.50	34.85	10.52
BRTADGE5166H30	1168	30.60	66	50.50	36.35	11.57
BRTADGE5172H30	1189	30.60	72	50.50	37.85	12.63
BRTADGE5178H30	1237	30.60	78	50.50	39.35	13.68
BRTADGE5184H30	1272	30.60	84	50.50	40.85	14.73
BRTADGE6336H30	1063	30.60	36	62.50	42.35	7.81
BRTADGE6342H30	1099	30.60	42	62.50	43.85	9.11
BRTADGE6348H30	1132	30.60	48	62.50	45.35	10.42
BRTADGE6354H30	1167	30.60	54	62.50	46.85	11.72
BRTADGE6360H30	1201	30.60	60	62.50	48.35	13.02
BRTADGE6366H30	1236	30.60	66	62.50	49.85	14.32
BRTADGE6372H30	1258	30.60	72	62.50	51.35	15.63
BRTADGE6378H30	1305	30.60	78	62.50	52.85	16.93
BRTADGE6384H30	1340	30.60	84	62.50	54.35	18.23

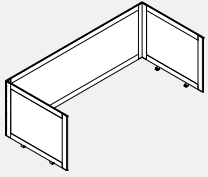
BRTADG-H24 • Single Table Glass Divider Screen Kit, 24" high

- Provides privacy in an open plan environment.
- Easy to clean table mounted partitions.
- Consists of a powder coated aluminum frame, 4mm clear (CLR) glass and all hardware to connect. Brackets are painted steel.
- Side dividers extend 6.25" from the front edge of each surface.
- Back divider extends over the back edge of the worksurface by 1 1/2" allowing for the passage of cables to the trough.
- BRTADG24-H24 are for 24" deep surfaces and BRTADG30-H24 are for 30" deep surfaces.
- Width and depth are nominal sizes representing the sizes of the Bridges configuration. Allow for 1/4" overhang at the sides, 1 1/2" at the back and 6 1/4" at the front.
- Please choose any standard paint finish for frame and hardware. End trim cap is available only in CHR - charcoal.
- Upcharge for frosted (FRST) glass is 20%.

PRODUCT CODE	PRICE	SIZE/INCHES			WEIGHT LBS	VOL FT ³
		H	W	D		
BRTADG2436H24	1033	24.60	36	31.50	26.55	3.94
BRTADG2442H24	1066	24.60	42	31.50	28.10	4.59
BRTADG2448H24	1100	24.60	48	31.50	29.65	5.25
BRTADG2454H24	1133	24.60	54	31.50	31.20	5.91
BRTADG2460H24	1168	24.60	60	31.50	32.75	6.56
BRTADG2466H24	1200	24.60	66	31.50	34.30	7.22
BRTADG2472H24	1235	24.60	72	31.50	35.85	7.88
BRTADG2478H24	1267	24.60	78	31.50	37.40	8.53
BRTADG2484H24	1302	24.60	84	31.50	38.95	9.19
BRTADG3036H24	1096	24.60	36	37.75	40.50	4.72
BRTADG3042H24	1130	24.60	42	37.75	42.05	5.51
BRTADG3048H24	1165	24.60	48	37.75	43.60	6.29
BRTADG3054H24	1198	24.60	54	37.75	45.15	7.08
BRTADG3060H24	1232	24.60	60	37.75	46.70	7.87
BRTADG3066H24	1265	24.60	66	37.75	48.25	8.65
BRTADG3072H24	1299	24.60	72	37.75	49.80	9.44
BRTADG3078H24	1332	24.60	78	37.75	51.35	10.22
BRTADG3084H24	1367	24.60	84	37.75	52.90	11.01

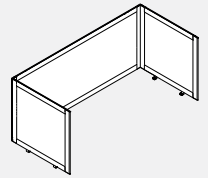
BRTADG-H30 • Single Table Glass Divider Screen Kit, 30" high

- Provides privacy in an open plan environment.
- Easy to clean table mounted partitions.
- Consists of a powder coated aluminum frame, 4mm clear (CLR) glass and all hardware to connect. Brackets are painted steel.
- Side dividers extend 6.25" from the front edge of each surface.
- Back divider extends over the back edge of the worksurface by 1 1/2" allowing for the passage of cables to the trough.
- BRTADG24-H30 are for 24" deep surfaces and BRTADG30-H30 are for 30" deep surfaces.
- Width and depth are nominal sizes representing the sizes of the Bridges configuration. Allow for 1/4" overhang at the sides, 1 1/2" at the back and 6 1/4" at the front.
- Please choose any standard paint finish for frame and hardware. End trim cap is available only in CHR - charcoal.
- Upcharge for frosted (FRST) glass is 20%.

PRODUCT CODE	PRICE	SIZE/INCHES			WEIGHT LBS	VOL FT ³
		H	W	D		
BRTADG2436H30	1073	30.60	36	31.50	28.85	3.94
BRTADG2442H30	1108	30.60	42	31.50	30.40	4.59
BRTADG2448H30	1143	30.60	48	31.50	31.95	5.25
BRTADG2454H30	1178	30.60	54	31.50	33.50	5.91
BRTADG2460H30	1212	30.60	60	31.50	35.05	6.56
BRTADG2466H30	1248	30.60	66	31.50	36.60	7.22
BRTADG2472H30	1267	30.60	72	31.50	38.15	7.88
BRTADG2478H30	1317	30.60	78	31.50	39.70	8.53
BRTADG2484H30	1352	30.60	84	31.50	41.25	9.19
BRTADG3036H30	1143	30.60	36	37.75	42.80	4.72
BRTADG3042H30	1177	30.60	42	37.75	44.35	5.51
BRTADG3048H30	1211	30.60	48	37.75	45.90	6.29
BRTADG3054H30	1246	30.60	54	37.75	47.45	7.08
BRTADG3060H30	1280	30.60	60	37.75	49.00	7.87
BRTADG3066H30	1317	30.60	66	37.75	50.55	8.65
BRTADG3072H30	1336	30.60	72	37.75	52.10	9.44
BRTADG3078H30	1385	30.60	78	37.75	53.65	10.22
BRTADG3084H30	1420	30.60	84	37.75	55.20	11.01

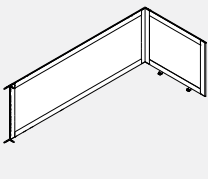
BRTADGE-H24 • Single Table Glass Divider Screen Extension Kit, 24" high

- Provides an extension for privacy in an open plan environment. Intended to always connect to Single Table Divider Screen Kit
- Lightweight and easy to clean table mounted partitions.
- Consists of a powder coated aluminum frame, 4mm clear (CLR) glass and all hardware to connect. Brackets are painted steel.
- Side dividers extend 6.25" from the front edge of each surface.
- Back divider extends over the back edge of the worksurface by 1 1/2" allowing for the passage of cables to the trough.
- BRTADGE24-H24 are for 24" deep surfaces and BRTADGE30-H24 are for 30" deep surfaces.
- Width and depth are nominal sizes representing the sizes of the Bridges configuration. Allow for 1/4" overhang at the sides, 1 1/2" at the back and 6 1/4" at the front.
- Please choose any standard paint finish for frame and hardware. End trim cap is available only in CHR - charcoal.
- Upcharge for frosted (FRST) glass is 20%.
- Can be used as left or right connection.

PRODUCT CODE	PRICE	SIZE/INCHES			WEIGHT LBS	VOL FT ³
		H	W	D		
BRTADGE2436H24	737	24.60	36	31.50	21.05	3.94
BRTADGE2442H24	804	24.60	42	31.50	22.60	4.59
BRTADGE2448H24	839	24.60	48	31.50	24.15	5.25
BRTADGE2454H24	870	24.60	54	31.50	25.70	5.91
BRTADGE2460H24	905	24.60	60	31.50	27.25	6.56
BRTADGE2466H24	937	24.60	66	31.50	28.80	7.22
BRTADGE2472H24	972	24.60	72	31.50	30.35	7.88
BRTADGE2478H24	1004	24.60	78	31.50	31.90	8.53
BRTADGE2484H24	1039	24.60	84	31.50	33.45	9.19
BRTADGE3036H24	777	24.60	36	37.75	35.00	4.72
BRTADGE3042H24	842	24.60	42	37.75	36.55	5.51
BRTADGE3048H24	876	24.60	48	37.75	38.10	6.29
BRTADGE3054H24	909	24.60	54	37.75	39.65	7.08
BRTADGE3060H24	942	24.60	60	37.75	41.20	7.87
BRTADGE3066H24	976	24.60	66	37.75	42.75	8.65
BRTADGE3072H24	1011	24.60	72	37.75	44.30	9.44
BRTADGE3078H24	1043	24.60	78	37.75	45.85	10.22
BRTADGE3084H24	1078	24.60	84	37.75	47.40	11.01

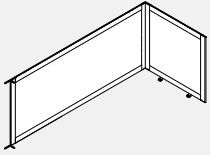
BRTADGE-H30 • Single Table Glass Divider Screen Extension Kit, 30" high

- Provides an extension for privacy in an open plan environment. Intended to always connect to Single Table Divider Screen Kit
- Easy to clean table mounted partitions.
- Consists of a powder coated aluminum frame, 4mm clear (CLR) glass and all hardware to connect. Brackets are painted steel.
- Side dividers extend 6.25" from the front edge of each surface.
- Back divider extends over the back edge of the worksurface by 1 1/2" allowing for the passage of cables to the trough.
- BRTADGE24-H30 are for 24" deep surfaces and BRTADGE30-H30 are for 30" deep surfaces.
- Width and depth are nominal sizes representing the sizes of the Bridges configuration. Allow for 1/4" overhang at the sides, 1 1/2" at the back and 6 1/4" at the front.
- Please choose any standard paint finish for frame and hardware. End trim cap is available only in CHR - charcoal.
- Upcharge for frosted (FRST) glass is 20%.
- Can be used as left or right connection.

PRODUCT CODE	PRICE	SIZE/INCHES			WEIGHT LBS	VOL FT ³
		H	W	D		
BRTADGE2436H30	775	30.60	36	31.50	22.85	3.94
BRTADGE2442H30	843	30.60	42	31.50	24.40	4.59
BRTADGE2448H30	877	30.60	48	31.50	25.95	5.25
BRTADGE2454H30	913	30.60	54	31.50	27.50	5.91
BRTADGE2460H30	948	30.60	60	31.50	29.05	6.56
BRTADGE2466H30	982	30.60	66	31.50	30.60	7.22
BRTADGE2472H30	1000	30.60	72	31.50	32.15	7.88
BRTADGE2478H30	1051	30.60	78	31.50	33.70	8.53
BRTADGE2484H30	1087	30.60	84	31.50	35.25	9.19
BRTADGE3036H30	809	30.60	36	37.75	36.80	4.72
BRTADGE3042H30	877	30.60	42	37.75	38.35	5.51
BRTADGE3048H30	911	30.60	48	37.75	39.90	6.29
BRTADGE3054H30	948	30.60	54	37.75	41.45	7.08
BRTADGE3060H30	982	30.60	60	37.75	43.00	7.87
BRTADGE3066H30	1016	30.60	66	37.75	44.55	8.65
BRTADGE3072H30	1035	30.60	72	37.75	46.10	9.44
BRTADGE3078H30	1086	30.60	78	37.75	47.65	10.22
BRTADGE3084H30	1121	30.60	84	37.75	49.20	11.01

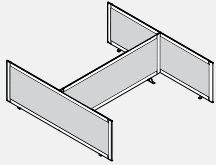
BRTADF-H24 • Back 2 Back Felt Divider Screen Kit, 24" high

- Provides privacy in an open plan environment.
- Consists of a powder coated aluminum frame, 9mm felt and all hardware to connect. Brackets are painted steel.
- Side dividers extend 6.25" from the front edge of each surface.
- Center divider sits over the gap between the worksurface allowing for the passage of • cables to the trough. The gap for each side is approximately 1".
- BRTADF51-H24 are for 24" deep surfaces and BRTADF63-H24 are for 30" deep surfaces.
- Width and depth are nominal sizes representing the sizes of the Bridges configuration. Allow for 1/4" overhang at sides and 6 1/4" at front.
- Please choose any standard paint finish for frame and hardware. End trim cap is available only in CHR - charcoal.
- 9mm felt material is tackable and comes in a variety of colors.

PRODUCT CODE	PRICE	SIZE/INCHES			WEIGHT LBS	VOL FT ³
		H	W	D		
BRTADF5136H24	917	24.60	36	50.50	28.00	6.31
BRTADF5142H24	932	24.60	42	50.50	29.50	7.36
BRTADF5148H24	951	24.60	48	50.50	31.00	8.42
BRTADF5154H24	964	24.60	54	50.50	32.50	9.47
BRTADF5160H24	986	24.60	60	50.50	34.00	10.52
BRTADF5166H24	1003	24.60	66	50.50	35.50	11.57
BRTADF5172H24	1022	24.60	72	50.50	37.00	12.63
BRTADF5178H24	1040	24.60	78	50.50	38.50	13.68
BRTADF5184H24	1074	24.60	84	50.50	40.00	14.73
BRTADF6336H24	986	24.60	36	62.50	41.50	7.81
BRTADF6342H24	1003	24.60	42	62.50	43.00	9.11
BRTADF6348H24	1022	24.60	48	62.50	44.50	10.42
BRTADF6354H24	1039	24.60	54	62.50	46.00	11.72
BRTADF6360H24	1057	24.60	60	62.50	47.50	13.02
BRTADF6366H24	1074	24.60	66	62.50	49.00	14.32
BRTADF6372H24	1092	24.60	72	62.50	50.50	15.63
BRTADF6378H24	1109	24.60	78	62.50	52.00	16.93
BRTADF6384H24	1144	24.60	84	62.50	53.50	18.23

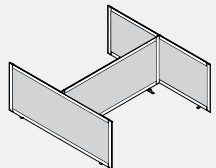
BRTADF-H30 • Back 2 Back Felt Divider Screen Kit, 30" high

- Provides privacy in an open plan environment.
- Consists of a powder coated aluminum frame, 9mm felt and all hardware to connect. Brackets are painted steel.
- Side dividers extend 6.25" from the front edge of each surface.
- Center divider sits over the gap between the worksurface allowing for the passage of • cables to the trough. The gap for each side is approximately 1".
- BRTADF51-H30 are for 24" deep surfaces and BRTADF63-H30 are for 30" deep surfaces.
- Width and depth are nominal sizes representing the sizes of the Bridges configuration. Allow for 1/4" overhang at sides and 6 1/4" at front.
- Please choose any standard paint finish for frame and hardware. End trim cap is available only in CHR - charcoal.
- 9mm felt material is tackable and comes in a variety of colors.

PRODUCT CODE	PRICE	SIZE/INCHES			WEIGHT LBS	VOL FT ³
		H	W	D		
BRTADF5136H30	917	30.60	36	50.50	30.50	6.31
BRTADF5142H30	932	30.60	42	50.50	32.00	7.36
BRTADF5148H30	951	30.60	48	50.50	33.50	8.42
BRTADF5154H30	964	30.60	54	50.50	35.00	9.47
BRTADF5160H30	986	30.60	60	50.50	36.50	10.52
BRTADF5166H30	1003	30.60	66	50.50	38.00	11.57
BRTADF5172H30	1022	30.60	72	50.50	39.50	12.63
BRTADF5178H30	1040	30.60	78	50.50	41.00	13.68
BRTADF5184H30	1074	30.60	84	50.50	42.50	14.73
BRTADF6336H30	986	30.60	36	62.50	44.00	7.81
BRTADF6342H30	1003	30.60	42	62.50	45.50	9.11
BRTADF6348H30	1022	30.60	48	62.50	47.00	10.42
BRTADF6354H30	1039	30.60	54	62.50	48.50	11.72
BRTADF6360H30	1057	30.60	60	62.50	50.00	13.02
BRTADF6366H30	1074	30.60	66	62.50	51.50	14.32
BRTADF6372H30	1092	30.60	72	62.50	53.00	15.63
BRTADF6378H30	1109	30.60	78	62.50	54.50	16.93
BRTADF6384H30	1144	30.60	84	62.50	56.00	18.23

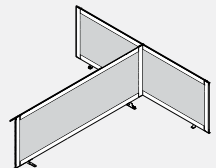
BRTADFE-H24 • Back 2 Back Felt Divider Screen Extension Kit, 24" high

- Provides an extension for privacy in an open plan environment. Intended to always connect to Back 2 Back Divider Screen Kit.
- Consists of a powder coated aluminum frame, 9mm felt and all hardware to connect. Brackets are painted steel.
- Side dividers extend 6.25" from the front edge of each surface.
- Center divider sits over the gap between the worksurface allowing for the passage of • cables to the trough. The gap for each side is approximately 1".
- BRTADFE51-H24 are for 24" deep surfaces and BRTADFE63-H24 are for 30" deep surfaces.
- Width and depth are nominal sizes representing the sizes of the Bridges configuration. Allow for 1/4" overhang at sides and 6 1/4" at front.
- Please choose any standard paint finish for frame and hardware. End trim cap is available only in CHR - charcoal.
- 9mm felt material is tackable and comes in a variety of colors.
- Can be used as left or right connection.

PRODUCT CODE	PRICE	SIZE/INCHES			WEIGHT LBS	VOL FT ³
		H	W	D		
BRTADFE5136H24	623	24.60	36	50.50	23.35	6.31
BRTADFE5142H24	643	24.60	42	50.50	24.85	7.36
BRTADFE5148H24	658	24.60	48	50.50	26.35	8.42
BRTADFE5154H24	678	24.60	54	50.50	27.85	9.47
BRTADFE5160H24	694	24.60	60	50.50	29.35	10.52
BRTADFE5166H24	713	24.60	66	50.50	30.85	11.57
BRTADFE5172H24	731	24.60	72	50.50	32.35	12.63
BRTADFE5178H24	748	24.60	78	50.50	33.85	13.68
BRTADFE5184H24	784	24.60	84	50.50	35.35	14.73
BRTADFE6336H24	657	24.60	36	62.50	36.85	7.81
BRTADFE6342H24	676	24.60	42	62.50	38.35	9.11
BRTADFE6348H24	693	24.60	48	62.50	39.85	10.42
BRTADFE6354H24	712	24.60	54	62.50	41.35	11.72
BRTADFE6360H24	727	24.60	60	62.50	42.85	13.02
BRTADFE6366H24	747	24.60	66	62.50	44.35	14.32
BRTADFE6372H24	763	24.60	72	62.50	45.85	15.63
BRTADFE6378H24	783	24.60	78	62.50	47.35	16.93
BRTADFE6384H24	818	24.60	84	62.50	48.85	18.23

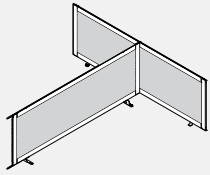
BRTADFE-H30 • Back 2 Back Felt Divider Screen Extension Kit, 30" high

- Provides an extension for privacy in an open plan environment. Intended to always connect to Back 2 Back Divider Screen Kit.
- Consists of a powder coated aluminum frame, 9mm felt and all hardware to connect. Brackets are painted steel.
- Side dividers extend 6.25" from the front edge of each surface.
- Center divider sits over the gap between the worksurface allowing for the passage of • cables to the trough. The gap for each side is approximately 1".
- BRTADFE51-H30 are for 24" deep surfaces and BRTADFE63-H30 are for 30" deep surfaces.
- Width and depth are nominal sizes representing the sizes of the Bridges configuration. Allow for 1/4" overhang at sides and 6 1/4" at front.
- Please choose any standard paint finish for frame and hardware. End trim cap is available only in CHR - charcoal.
- 9mm felt material is tackable and comes in a variety of colors.
- Can be used as left or right connection.

PRODUCT CODE	PRICE	SIZE/INCHES			WEIGHT LBS	VOL FT ³
		H	W	D		
BRTADFE5136H30	623	30.60	36	50.50	25.85	6.31
BRTADFE5142H30	643	30.60	42	50.50	27.35	7.36
BRTADFE5148H30	658	30.60	48	50.50	28.85	7.42
BRTADFE5154H30	678	30.60	54	50.50	30.35	9.47
BRTADFE5160H30	694	30.60	60	50.50	31.85	10.52
BRTADFE5166H30	713	30.60	66	50.50	33.35	11.57
BRTADFE5172H30	731	30.60	72	50.50	34.85	12.63
BRTADFE5178H30	748	30.60	78	50.50	36.35	13.68
BRTADFE5184H30	784	30.60	84	50.50	37.85	14.73
BRTADFE6336H30	657	30.60	36	62.50	39.35	7.81
BRTADFE6342H30	676	30.60	42	62.50	40.85	9.11
BRTADFE6348H30	693	30.60	48	62.50	42.35	10.42
BRTADFE6354H30	712	30.60	54	62.50	43.85	11.72
BRTADFE6360H30	727	30.60	60	62.50	45.35	13.02
BRTADFE6366H30	747	30.60	66	62.50	46.85	14.32
BRTADFE6372H30	763	30.60	72	62.50	48.35	15.63
BRTADFE6378H30	783	30.60	78	62.50	49.85	16.93
BRTADFE6384H30	818	30.60	84	62.50	51.35	18.23

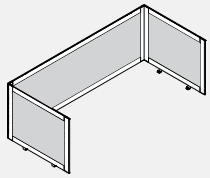
BRTADF-H24 • Single Table Divider Felt Screen Kit, 24" high

- Provides privacy in an open plan environment.
- Consists of a powder coated aluminum frame, 9mm felt and all hardware to connect. Brackets are painted steel.
- Side dividers extend 6.237" from the front edge of each surface.
- Back divider extends over the back edge of the worksurface by 1 1/2" allowing for the passage of cables to the trough.
- BRTADF24-H24 are for 24" deep surfaces and BRTADF30-H24 are for 30" deep surfaces.
- Width and depth are nominal sizes representing the sizes of the FreeFit Table. Allow for 1/4" overhang at the sides, 1 1/2" at the back and 6.237" at the front.
- Please choose any standard paint finish for frame and hardware. End trim cap is available only in CHR - charcoal.
- 9mm felt material is tackable and comes in a variety of colors.

PRODUCT CODE	PRICE	SIZE/INCHES			WEIGHT LBS	VOL FT ³
		H	W	D		
BRTADF2436H24	666	24.60	36	31.50	22.55	3.94
BRTADF2442H24	683	24.60	42	31.50	24.10	4.59
BRTADF2448H24	701	24.60	48	31.50	25.65	5.25
BRTADF2454H24	720	24.60	54	31.50	27.20	5.91
BRTADF2460H24	737	24.60	60	31.50	28.75	6.56
BRTADF2466H24	755	24.60	66	31.50	30.30	7.22
BRTADF2472H24	774	24.60	72	31.50	31.85	7.88
BRTADF2478H24	790	24.60	78	31.50	33.40	8.53
BRTADF2484H24	826	24.60	84	31.50	34.95	9.19
BRTADF3036H24	689	24.60	36	37.75	36.50	4.72
BRTADF3042H24	709	24.60	42	37.75	38.05	5.51
BRTADF3048H24	724	24.60	48	37.75	39.60	6.29
BRTADF3054H24	744	24.60	54	37.75	41.15	7.08
BRTADF3060H24	760	24.60	60	37.75	41.70	7.87
BRTADF3066H24	779	24.60	66	37.75	44.25	8.65
BRTADF3072H24	796	24.60	72	37.75	45.80	9.44
BRTADF3078H24	814	24.60	78	37.75	47.35	10.22
BRTADF3084H24	850	24.60	84	37.75	48.90	11.01

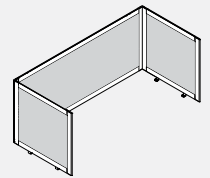
BRTADF-H30 • Single Table Divider Felt Screen Kit, 30" high

- Provides privacy in an open plan environment.
- Consists of a powder coated aluminum frame, 9mm felt and all hardware to connect. Brackets are painted steel.
- Side dividers extend 6.237" from the front edge of each surface.
- Back divider extends over the back edge of the worksurface by 1 1/2" allowing for the passage of cables to the trough.
- BRTADF24-H30 are for 24" deep surfaces and BRTADF30-H30 are for 30" deep surfaces.
- Width and depth are nominal sizes representing the sizes of the FreeFit Table. Allow for 1/4" overhang at the sides, 1 1/2" at the back and 6.237" at the front.
- Please choose any standard paint finish for frame and hardware. End trim cap is available only in CHR - charcoal.
- 9mm felt material is tackable and comes in a variety of colors.

PRODUCT CODE	PRICE	SIZE/INCHES			WEIGHT LBS	VOL FT ³
		H	W	D		
BRTADF2436H30	666	30.60	36	31.50	24.85	3.94
BRTADF2442H30	683	30.60	42	31.50	26.40	4.59
BRTADF2448H30	701	30.60	48	31.50	27.95	5.25
BRTADF2454H30	720	30.60	54	31.50	29.50	5.91
BRTADF2460H30	737	30.60	60	31.50	31.05	6.56
BRTADF2466H30	755	30.60	66	31.50	32.60	7.22
BRTADF2472H30	774	30.60	72	31.50	34.14	7.88
BRTADF2478H30	790	30.60	78	31.50	34.70	8.53
BRTADF2484H30	826	30.60	84	31.50	37.25	9.19
BRTADF3036H30	689	30.60	36	37.75	38.80	4.72
BRTADF3042H30	709	30.60	42	37.75	40.35	5.51
BRTADF3048H30	724	30.60	48	37.75	41.90	6.29
BRTADF3054H30	744	30.60	54	37.75	43.45	7.08
BRTADF3060H30	760	30.60	60	37.75	45.00	7.87
BRTADF3066H30	779	30.60	66	37.75	46.55	8.65
BRTADF3072H30	796	30.60	72	37.75	48.10	9.44
BRTADF3078H30	814	30.60	78	37.75	49.65	10.22
BRTADF3084H30	850	30.60	84	37.75	51.20	11.01

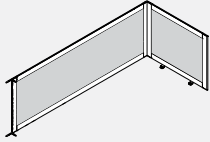
BRTADFE-H24 • Single Table Felt Divider Screen Extension Kit, 24" high

- Provides an extension for privacy in an open plan environment. Intended to always connect to Single Table Divider Screen Kit
- Consists of a powder coated aluminum frame, 9mm felt and all hardware to connect. Brackets are painted steel.
- Side dividers extend 6.237" from the front edge of each surface.
- Back divider extends over the back edge of the worksurface by 1 1/2" allowing for the passage of cables to the trough.
- BRTADFE24-H24 are for 24" deep surfaces and BRTADFE30-H24 are for 30" deep surfaces.
- Width and depth are nominal sizes representing the sizes of the FreeFit Table. Allow for 1/4" overhang at the sides, 1 1/2" at the back and 6.237" at the front.
- Please choose any standard paint finish for frame and hardware. End trim cap is available only in CHR - charcoal.
- 9mm felt material is tackable and comes in a variety of colors.
- Can be used as left or right connection.

PRODUCT CODE	PRICE	SIZE/INCHES			WEIGHT LBS	VOL FT ³
		H	W	D		
BRTADFE2436H24	503	24.60	36	31.50	18.55	3.94
BRTADFE2442H24	552	24.60	42	31.50	20.10	4.59
BRTADFE2448H24	570	24.60	48	31.50	21.65	5.25
BRTADFE2454H24	588	24.60	54	31.50	23.20	5.91
BRTADFE2460H24	607	24.60	60	31.50	24.75	6.56
BRTADFE2466H24	623	24.60	66	31.50	26.30	7.22
BRTADFE2472H24	643	24.60	72	31.50	27.85	7.88
BRTADFE2478H24	658	24.60	78	31.50	29.40	8.53
BRTADFE2484H24	694	24.60	84	31.50	30.95	9.19
BRTADFE3036H24	522	24.60	36	37.75	32.50	4.72
BRTADFE3042H24	573	24.60	42	37.75	34.05	5.51
BRTADFE3048H24	589	24.60	48	37.75	35.60	6.29
BRTADFE3054H24	608	24.60	54	37.75	37.15	7.08
BRTADFE3060H24	625	24.60	60	37.75	38.70	7.87
BRTADFE3066H24	644	24.60	66	37.75	40.25	8.65
BRTADFE3072H24	659	24.60	72	37.75	41.80	9.44
BRTADFE3078H24	679	24.60	78	37.75	43.35	10.22
BRTADFE3084H24	714	24.60	84	37.75	44.90	11.01

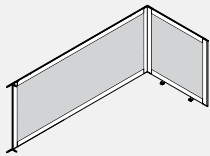
BRTADFE-H30 • Single Table Felt Divider Screen Extension Kit, 30" high

- Provides an extension for privacy in an open plan environment. Intended to always connect to Single Table Divider Screen Kit
- Consists of a powder coated aluminum frame, 9mm felt and all hardware to connect. Brackets are painted steel.
- Side dividers extend 6.237" from the front edge of each surface.
- Back divider extends over the back edge of the worksurface by 1 1/2" allowing for the passage of cables to the trough.
- BRTADFE24-H30 are for 24" deep surfaces and BRTADFE30-H30 are for 30" deep surfaces.
- Width and depth are nominal sizes representing the sizes of the FreeFit Table. Allow for 1/4" overhang at the sides, 1 1/2" at the back and 6.237" at the front.
- Please choose any standard paint finish for frame and hardware. End trim cap is available only in CHR - charcoal.
- 9mm felt material is tackable and comes in a variety of colors.
- Can be used as left or right connection.

PRODUCT CODE	PRICE	SIZE/INCHES			WEIGHT LBS	VOL FT ³
		H	W	D		
BRTADFE2436H30	503	30.60	36	31.50	20.35	3.94
BRTADFE2442H30	552	30.60	42	31.50	21.90	4.59
BRTADFE2448H30	570	30.60	48	31.50	23.45	5.25
BRTADFE2454H30	588	30.60	54	31.50	25.00	5.91
BRTADFE2460H30	607	30.60	60	31.50	26.55	6.56
BRTADFE2466H30	623	30.60	66	31.50	28.10	7.22
BRTADFE2472H30	643	30.60	72	31.50	29.65	7.88
BRTADFE2478H30	658	30.60	78	31.50	31.20	8.53
BRTADFE2484H30	694	30.60	84	31.50	32.75	9.19
BRTADFE3036H30	522	30.60	36	37.75	34.30	4.72
BRTADFE3042H30	573	30.60	42	37.75	35.85	5.51
BRTADFE3048H30	589	30.60	48	37.75	37.40	6.29
BRTADFE3054H30	608	30.60	54	37.75	38.95	7.08
BRTADFE3060H30	625	30.60	60	37.75	40.50	7.87
BRTADFE3066H30	644	30.60	66	37.75	42.05	8.65
BRTADFE3072H30	659	30.60	72	37.75	43.60	9.44
BRTADFE3078H30	679	30.60	78	37.75	45.15	10.22
BRTADFE3084H30	714	30.60	84	37.75	46.70	11.01

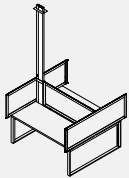
BRTADPCPP4 • Back 2 Back Ceiling Feed Pole Kit

- Ceiling pole brings ceiling feed conduit and data cables from the ceiling to Power Troughs at desk height.
- To be used in conjunction with BRTCF - Bridges Ceiling Feed.
- A two part construction allows for power/data conduit lay-in.
- Includes mounting hardware and ceiling bezel, painted finish.
- Please specify the center divider 6" shorter when using the Ceiling Feed Pole Kit.

PRODUCT CODE	PRICE	SIZE/INCHES			WEIGHT LBS	VOL FT ³
		H	W	D		
BRTADPCPP	283	99	4.75	1.50	13.00	0.48

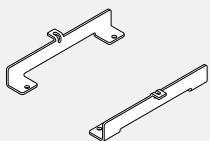
BRTMKIT • Screen Middle Kit

- Kit to be used with Bridges Screen Divider when the End Table Shelf is used.
- During installation, remove the end cap brackets and install th BRTMKIT instead.

PRODUCT CODE	PRICE	SIZE/INCHES			WEIGHT LBS	VOL FT ³
		H	W	D		
BRTMKIT	25	2	2	2	0.50	0.01

Storage Assembly

For a complete storage assembly, one must specify a top, a chassis and legs.

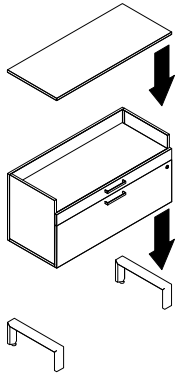

- 1 - BRT29LOBF-U
- 1 - BRTWU
- 2 - BRT-LEGL

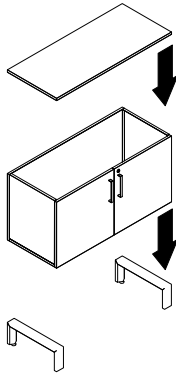

- 1 - BRT29L2D-U
- 1 - BRTWU
- 2 - BRT-LEGL

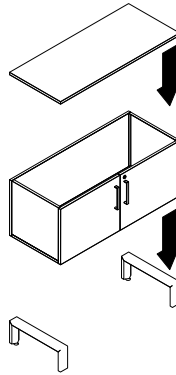

- 1 - BRT25L2D-U
- 1 - BRTWU
- 2 - BRT-LEGL

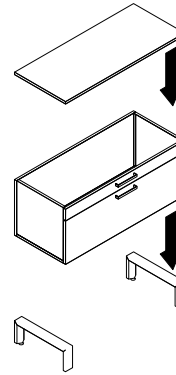

- 1 - BRT25LBF-U
- 1 - BRTWU
- 2 - BRT-LEGL

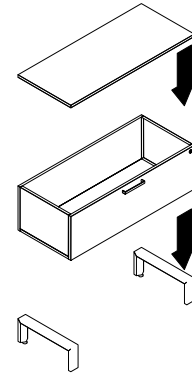

- 1 - BRT21F-U
- 1 - BRTWU
- 2 - BRT-LEGL

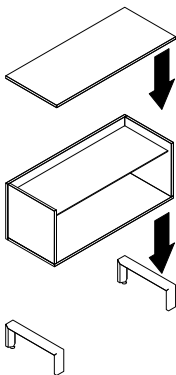
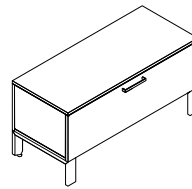
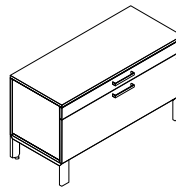
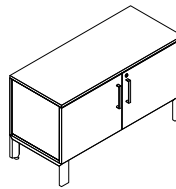
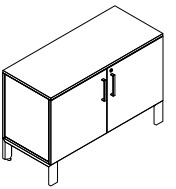
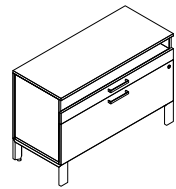

- 1 - BRT25LO-U
- 1 - BRTWU
- 2 - BRT-LEGL

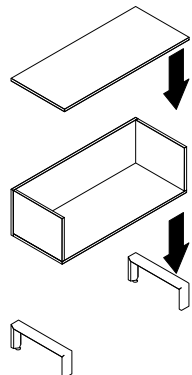

- 1 - BRT21LO-U
- 1 - BRTWU
- 2 - BRT-LEGL

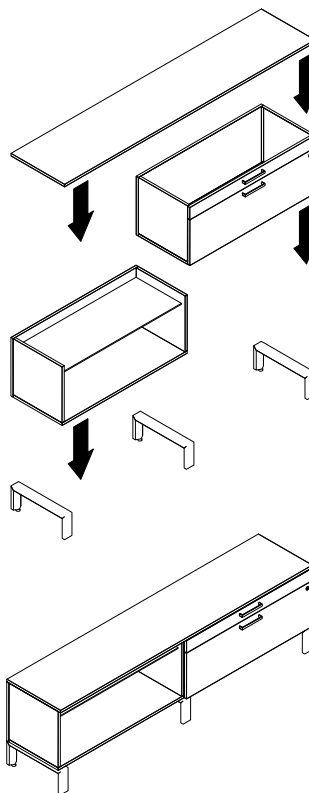

- For larger assemblies, legs may be shared.
- 1 - BRT25LO-U
 - 1 - BRT25LBF-U
 - 1 - BRTWU - ensuring the width of the surface equal the combined width of both storage chassis
 - 3 - BRT-LEGL

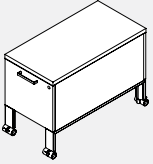
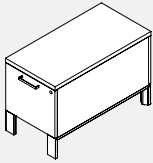
BRT21BF • 21" File Pedestal**• Fits below Bridges tables**

- Can join with other 21" high storage units of corresponding depth to form a spine or slides out on casters to serve as an additional worksurface.
- Floor clearance allows for access to panel floor raceway duplex outlets; units on levelers accommodate installation of an optional Cable Basket to manage cords and data cables under storage spine.
- One file drawer (holds letter, legal and A4 suspended file folders except 18" pedestals).
- Optional Cable Basket suspends off storage unit's bottom and manages cables along the horizontal plane. (NO CASTER models only)
- Fits under table beams even with optional seat cushion.
- LP chassis and drawer fronts (specify LP finish) 1" top (specify LP or HP finish); metal handles, powder coated aluminum or anodized aluminum legs specify 5/16x2" levelers or 40mm white/grey, locking casters.
- Anodized aluminum leg upcharge \$55.
- Optional e-lock available in the vertical position. Please specify V-Vertical and add \$224 list.

PRODUCT CODE	PRICE		SIZE/INCHES			WEIGHT VOL	
	LP	HP	H	W	D	LBS	FT ³
Levelers							
BRT21BF18L	731	783	21	15.5	18	58	3.39
BRT21BF24L	850	896	21	15.5	24	64	4.52
BRT21BF30L	930	998	21	15.5	30	72	5.65
Casters							
BRT21BF18C	731	783	21	15.5	18	58	3.39
BRT21BF24C	850	896	21	15.5	24	64	4.52
BRT21BF30C	930	998	21	15.5	30	72	5.65

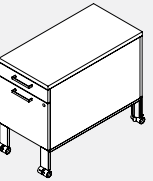
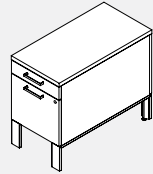
BRT25BF-L • 25" Box/File Pedestal**• Fits below Bridges tables**

- Can join with other 25" high storage units of corresponding depth to form a spine or slides out on casters to serve as an additional worksurface.
- Floor clearance allows for access to panel floor raceway duplex outlets; units on levelers accommodate installation of an optional Cable Basket to manage cords and data cables under storage spine.
- One box drawer, one file drawer (holds letter, legal and A4 suspended file folders except 18" pedestals).
- Optional Cable Basket suspends off storage unit's bottom and manages cables along the horizontal plane. (NO CASTER models only)
- Fits under 30" worksurface table beams as is.
- LP chassis and drawer fronts (specify LP finish) 1" top (specify LP or HP finish); metal handles, powder coated aluminum or anodized aluminum legs specify 5/16x2" levelers or 40mm white/grey, locking casters
- Anodized aluminum leg upcharge \$55.
- Pedestal with cushion will not fit under beam.
- Black injection moulded pencil tray included.
- 25" high Bridges storage should not be used under Back 2 Back Bridges table applications using Below Worksurface Trough. Storage will not fit under the trough.
- Optional e-lock available in the vertical position. Please specify V-Vertical and add \$224 list.

PRODUCT CODE	PRICE		SIZE/INCHES			WEIGHT VOL	
	LP	HP	H	W	D	LBS	FT ³
Levelers							
BRT25BF18L	830	883	25	15.5	18	69	3.89
BRT25BF24L	963	1016	25	15.5	24	74	5.02
BRT25BF30L	1050	1114	25	15.5	30	82	6.15
Casters							
BRT25BF18C	896	949	25	15.5	18	69	3.89
BRT25BF24C	1030	1083	25	15.5	24	74	5.02
BRT25BF30C	1114	1180	25	15.5	30	82	6.15

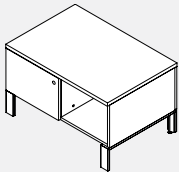
BRT21LS-L/R • 21" Sliding Door Storage

Right Open Shown

• Fits below Bridges tables

- Can join with other 21" high storage units to form a spine.
- Can serve as an additional worksurface or an ad-hoc guest seating with optional cushion.
- Floor clearance allows for access to panel floor raceway duplex outlets and for installation of an optional Cable Basket to manage cords and data cables under storage spine.
- Storage compartment internal height: 12.36"
- Sliding door locks on left side.
- Optional 15.5"x18" cushion.
- Optional Cable Basket suspends off storage unit's bottom and manages cables along the horizontal plane.
- LP chassis and sliding door (specify LP finish), 1" top (specify LP or HP finish); metal handles, powder coated aluminum or anodized aluminum legs.
- Anodized aluminum leg upcharge \$55.

PRODUCT CODE	PRICE		SIZE/INCHES			WEIGHT VOL	
	LP	HP	H	W	D	LBS	FT ³
Left							
BRT21LS30L	797	864	21	30	18	53	6.56
BRT21LS36L	883	949	21	36	18	60	7.87
BRT21LS42L	963	1030	21	42	18	67	9.18
Right							
BRT21LS30R	797	864	21	30	18	53	6.56
BRT21LS36R	883	949	21	36	18	60	7.87
BRT21LS42R	963	1030	21	42	18	67	9.18

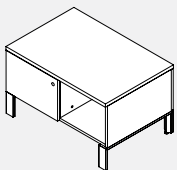
BRT21LSS-L/R • 21" Shared Sliding Door Storage

Right Open Shown

• Shared units offer two 11" deep storage compartments on either side - positioned usually beside Bridges table assembly, between two adjacent workstations.

- The units can join with other 21" high, 24" deep storage units to form a storage spine or to serve as an additional return worksurface or an ad-hoc guest seating with optional cushion.
- Floor clearance allows for installation of an optional Cable Basket to manage cords and data cables under storage spine. Storage compartment internal height: 12.36". Sliding door locks on left side.
- Optional 15.5"x18" cushion.
- Optional Cable Basket suspends off storage unit's bottom and manages cables along the horizontal plane.
- LP chassis and sliding door (specify LP finish) 1" top (specify LP or HP finish); metal handles, powder coated aluminum or anodized aluminum legs.
- Anodized aluminum leg upcharge \$55.

PRODUCT CODE	PRICE		SIZE/INCHES			WEIGHT VOL	
	LP	HP	H	W	D	LBS	FT ³
Left							
BRT21LSS30L	1114	1180	21	30	24	69	8.75
BRT21LSS36L	1212	1298	21	36	24	78	10.50
BRT21LSS42L	1315	1414	21	42	24	87	12.25
Right							
BRT21LSS30R	1114	1180	21	30	24	69	8.75
BRT21LSS36R	1212	1298	21	36	24	78	10.50
BRT21LSS42R	1315	1414	21	42	24	87	12.25

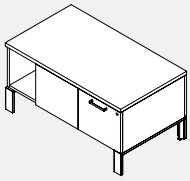
BRT21LSO42L • 21" Shared File/Open Storage

- Shared units offer storage compartments on either side - positioned usually between two adjacent Bridges workstations.

- The units can join with other 21" high, 24" deep storage units to form a storage spine or to serve as an additional return worksurface or an ad-hoc guest seating with optional cushion.
- Floor clearance allows for installation of an optional Cable Basket to manage cords and data cables under storage spine.
- One lockable file drawer, one open compartment per side. Storage compartment internal height without height adjustable glass shelf: 12.360"
- Optional 15.5" x 18" cushion. Optional Cable Basket suspends off storage unit's bottom manages cables along the horizontal plane.
- LP chassis drawer fronts (specify LP finish) 1" top (specify LP or HP finish); metal handles, powder coated aluminum or anodized aluminum legs.
- Anodized aluminum leg upcharge \$55.
- 25" high Bridges storage should not be used under Back 2 Back Bridges table applications using Below Worksurface Trough. Storage will not fit under the trough.
- Optional e-lock available in the vertical position. Please specify V-Vertical and add \$224 list.

PRODUCT CODE	PRICE		SIZE/INCHES			WEIGHT VOL	
	LP	HP	H	W	D	LBS	FT ³
BRT21LSO42L	1497	1613	21	42	24	124	14.0

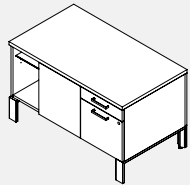
BRT25LBFO42L • 25" Shared Storage

- Shared units offer storage compartments on either side.

- Positioned usually between two adjacent Bridges workstations. The units can join with other 25" high, 24" deep storage units to form a storage spine or to serve as an additional return worksurface.
- Floor clearance allows for installation of an optional Cable Basket to manage cords and data cables under storage spine.
- One lockable file drawer, one box drawer, one open compartment with adjustable glass shelf per side. Storage compartment internal height without height adjustable glass shelf: 16.08". Optional 15.5" x 18" cushion.
- Optional Cable Basket suspends off storage unit's bottom and manages cables along the horizontal plane.
- LP chassis and drawer fronts (specify LP finish) 1" top (specify LP or HP finish); metal handles, powder coated aluminum or anodized aluminum legs.
- Anodized aluminum leg upcharge \$55.
- Black injection moulded pencil tray included.
- 25" high Bridges storage should not be used under Back 2 Back Bridges table applications using Below Worksurface Trough. Storage will not fit under the trough.
- Optional e-lock available in the vertical position. Please specify V-Vertical and add \$224 list.

PRODUCT CODE	PRICE		SIZE/INCHES			WEIGHT VOL	
	LP	HP	H	W	D	LBS	FT ³
BRT25LBFO42L	1878	1981	25	42	24	154	16.66

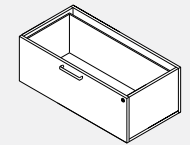
BRT21F-U • 21" High Lateral File Drawer, No Top

- Fits below Bridges tables.

- Can join with other 21" high storage units to form a spine.
- Floor clearance allows for access to panel floor raceway duplex outlets and for installation of an optional Cable Basket to manage cords and data cables under storage spine.
- One file drawer, top and legs to be ordered separately.
- LP chassis and drawer front (specify LP finish); metal handles.
- Optional Cable Basket suspends off storage unit's bottom and manages cables along the horizontal plane.
- Optional e-lock available in the vertical position. Please specify V-Vertical and add \$224 list.

PRODUCT CODE	PRICE		SIZE/INCHES			WEIGHT VOL	
	LP	HP	H	W	D	LBS	FT ³
BRT21F3018U	786		13	30	18	47	4.06
BRT21F3618U	868		13	36	18	51	4.88
BRT21F4218U	1007		13	42	18	56	5.69
BRT21F3024U	804		13	30	24	51	5.42
BRT21F3624U	895		13	36	24	55	6.50
BRT21F4224U	1055		13	42	24	60	7.58

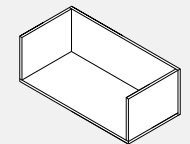
BRT21LO-U • 21" High Open Storage, No Top

- An open storage unit with no top.

- Positioned usually beside Bridges table assembly or between two adjacent workstations.
- Can join with other 21" high storage units to form a spine.
- Floor clearance allows for access to panel floor raceway duplex outlets and for installation of an optional Cable Basket to manage cords and data cables under storage spine.
- One box opening, top and legs to be ordered separately.
- LP chassis (specify LP finish).
- Optional Cable Basket suspends off storage unit's bottom and manages cables along the horizontal plane.
- Unit ships knocked down.

PRODUCT CODE	PRICE		SIZE/INCHES			WEIGHT VOL	
	LP	HP	H	W	D	LBS	FT ³
BRT21LO3018U	247		13	30	18	25	4.06
BRT21LO3618U	369		13	36	18	29	4.88
BRT21LO4218U	399		13	42	18	32	5.69
BRT21LO3024U	259		13	30	24	29	5.42
BRT21LO3624U	382		13	36	24	33	6.50
BRT21LO4224U	415		13	42	24	36	7.58

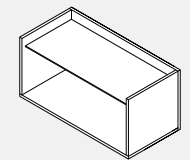
BRT25LO-U • 25" High Open Storage with Glass Shelf, No Top

- An open storage unit with glass shelf and no top.

- Positioned usually beside Bridges table assembly or between two adjacent workstations.
- Can join with other 25" high storage units to form a spine.
- Floor clearance allows for access to panel floor raceway duplex outlets and for installation of an optional Cable Basket to manage cords and data cables under storage spine.
- One box opening with glass shelf, top and legs to be ordered separately.
- LP chassis (specify LP finish).
- Optional Cable Basket suspends off storage unit's bottom and manages cables along the horizontal plane.
- 25" high Bridges storage should not be used under Back 2 Back Bridges table applications using Below Worksurface Trough. Storage will not fit under the trough.
- Unit ships knocked down.

PRODUCT CODE	PRICE		SIZE/INCHES			WEIGHT VOL	
	LP	HP	H	W	D	LBS	FT ³
BRT25LO3018U	366		17	30	18	40	5.31
BRT25LO3618U	501		17	36	18	46	6.38
BRT25LO4218U	518		17	42	18	52	7.44
BRT25LO3024U	391		17	30	24	44	7.08
BRT25LO3624U	521		17	36	24	50	8.50
BRT25LO4224U	544		17	42	24	56	9.92

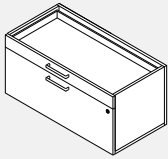
BRT25LBF-U • 25" High Box File Lateral, No Top

- **A box / file storage unit.**
- Positioned usually beside Bridges table assembly or between two adjacent workstations.
- Can join with other 25" high storage units to form a spine.
- Floor clearance allows for access to panel floor raceway duplex outlets and for installation of an optional Cable Basket to manage cords and data cables under storage spine.
- One lockable file drawer, one box drawer, top and legs to be ordered separately.
- LP chassis and drawer fronts (specify LP finish); metal handles.
- Black injection moulded pencil tray included (can be secured inside the drawer anywhere along the perimeter wall).
- 25" high Bridges storage should not be used under Back 2 Back Bridges table applications using Below Worksurface Trough. Storage will not fit under the trough.
- Optional Cable Basket suspends off storage unit's bottom and manages cables along the horizontal plane.
- Optional e-lock available in the vertical position. Please specify V-Vertical and add \$224 list.

PRODUCT CODE	PRICE LP	SIZE/INCHES			WEIGHT LBS	VOL FT ³
		H	W	D		
BRT25LBF3018U	942	17	30	18	58	5.31
BRT25LBF3618U	1094	17	36	18	79	6.38
BRT25LBF4218U	1167	17	42	18	68	7.44
BRT25LBF3024U	981	17	30	24	62	7.08
BRT25LBF3624U	1137	17	36	24	83	8.50
BRT25LBF4224U	1212	17	42	24	72	9.92

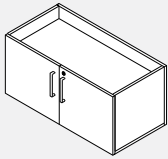
BRT25L2D-U • 25" High Storage Cabinet, No Top

- **A 2 door storage unit.**
- Positioned usually beside Bridges table assembly, between two adjacent workstations.
- The units are level with Bridges tops, can join other 29" high storage units to form a credenza.
- Floor clearance allows for access to panel floor raceway duplex outlets and for installation of an optional Cable Basket to manage cords and data cables under storage spine.
- Two lockable doors, glass shelf included. Top and legs to be ordered separately.
- Storage compartment internal height is 20.5".
- LP chassis and drawer fronts (specify LP finish); metal handles.
- Optional Cable Basket suspends off storage unit's bottom and manages cables along the horizontal plane.
- Optional e-lock available in the horizontal position for the storage cabinet. Please specify HR - Horizontal Right or HL Horizontal Left and add \$224 list.
- Unit ships knocked down.

PRODUCT CODE	PRICE LP	SIZE/INCHES			WEIGHT LBS	VOL FT ³
		H	W	D		
BRT25L2D3018U	695	17	30	18	39	5.31
BRT25L2D3618U	749	17	36	18	45	6.38
BRT25L2D4218U	780	17	42	18	54	7.44
BRT25L2D3024U	812	17	30	24	43	7.08
BRT25L2D3624U	885	17	36	24	49	8.50
BRT25L2D4224U	920	17	42	24	58	9.92

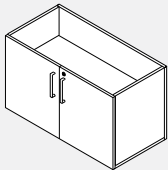
BRT29L2D-U • 29" High Storage Cabinet, No Top

- **A 2 door storage unit.**
- Positioned usually beside Bridges table assembly, between two adjacent workstations.
- The units are level with Bridges tops, can join other 29" high storage units to form a credenza.
- Floor clearance allows for access to panel floor raceway duplex outlets and for installation of an optional Cable Basket to manage cords and data cables under storage spine.
- Two lockable doors, glass shelf included. Top and legs to be ordered separately.
- Storage compartment internal height is 20.5".
- LP chassis and drawer fronts (specify LP finish); metal handles.
- Optional Cable Basket suspends off storage unit's bottom and manages cables along the horizontal plane.
- Optional e-lock available in the horizontal position for the storage cabinet. Please specify HR - Horizontal Right or HL Horizontal Left and add \$224 list.
- Unit ships knocked down.

PRODUCT CODE	PRICE LP	SIZE/INCHES			WEIGHT LBS	VOL FT ³
		H	W	D		
BRT29L2D3018U	796	21	30	18	49	6.56
BRT29L2D3618U	830	21	36	18	55	7.88
BRT29L2D4218U	867	21	42	18	64	9.19
BRT29L2D3024U	935	21	30	24	53	8.75
BRT29L2D3624U	976	21	36	24	59	10.50
BRT29L2D4224U	998	21	42	24	68	12.25

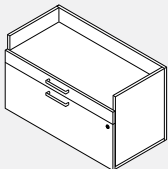
BRT29LOBF-U • 29" High Box File Open Storage, No Top

- **Box/file/shelf unit.**
- Positioned usually beside Bridges table assembly, between two adjacent workstations.
- The units are level with Bridges tops, can join other 29" high storage units to form a credenza.
- Floor clearance allows for access to panel floor raceway duplex outlets and for installation of an optional Cable Basket to manage cords and data cables under storage spine.
- One lockable file drawer, one box drawer, one open compartment. Top and legs to be ordered separately.
- Storage compartment internal height: 3.9"
- Black injection moulded pencil tray included (can be secured inside the drawer anywhere along the perimeter wall).
- LP chassis and drawer fronts (specify LP finish); metal handles.
- Optional Cable Basket suspends off storage unit's bottom and manages cables along the horizontal plane.
- Optional e-lock available in the vertical position. Please specify V-Vertical and add \$224 list.

PRODUCT CODE	PRICE LP	SIZE/INCHES			WEIGHT LBS	VOL FT ³
		H	W	D		
BRT29LOBF3018U	1109	21	30	18	70	6.56
BRT29LOBF3618U	1254	21	36	18	78	7.88
BRT29LOBF4218U	1375	21	42	18	86	9.19
BRT29LOBF3024U	1155	21	30	24	74	8.75
BRT29LOBF3624U	1302	21	36	24	82	10.50
BRT29LOBF4224U	1431	21	42	24	90	12.25

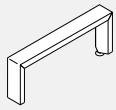
BRT-LEGL • Bridges Leg for Modular Storage

- Two single legs form the structure of the Bridges series modular storage.
- A single can be used at the each end of modular storage units or can be used to support where two modular units meet.
- Leveling glides, steel frame, aluminum legs.
- Please specify paint or anodized finish.
- Anodized aluminum leg upcharge \$55.

PRODUCT CODE	PRICE	SIZE/INCHES			WEIGHT VOL	
		H	W	D	LBS	FT ³
BRT18LEGL	49	8	2.5	18	8	1.34
BRT24LEGL	58	8	2.5	24	8	1.34

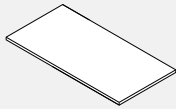
BRTWU • Bridges Worksurface for Modular Storage

- Worksurfaces are available in high pressure laminate (HP 1 1/16" thick) and low pressure laminate (LP 1" thick) with a flat 3 mm edge profile on all sides.
- Worksurfaces provided with pilot holes for alignment purposes.
- Worksurfaces can be used for each modular unit or can span two to three units.

PRODUCT CODE	PRICE		SIZE/INCHES			WEIGHT VOL	
	LP	HP	H	W	D	LBS	FT ³
BRTWU1830	138	183	1	30	18	15	0.50
BRTWU1836	159	210	1	36	18	18	0.59
BRTWU1842	208	278	1	42	18	21	0.68
BRTWU1860	329	422	1	60	18	29	0.97
BRTWU1866	344	452	1	66	18	32	1.10
BRTWU1872	363	478	1	72	18	35	1.20
BRTWU1878	380	503	1	78	18	38	1.30
BRTWU1884	417	546	1	84	18	41	1.40
BRTWU1890	434	568	1	90	18	44	1.50
BRTWU1896	450	590	1	96	18	47	1.60
BRTWU2430	145	190	1	30	24	20	0.65
BRTWU2436	161	213	1	36	24	24	0.78
BRTWU2442	211	280	1	42	24	28	0.90
BRTWU2460	336	443	1	60	24	39	1.30
BRTWU2466	350	462	1	66	24	43	1.41
BRTWU2472	366	484	1	72	24	47	1.54
BRTWU2478	392	516	1	78	24	51	1.70
BRTWU2484	422	553	1	84	24	55	1.80
BRTWU2490	441	578	1	90	24	59	1.90
BRTWU2496	457	600	1	96	24	63	2.00

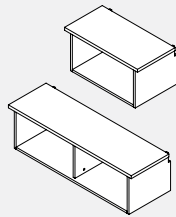
BRTTES • Table Mounted End Shelf

- Single or double open shelf / extended worksurface.
- Secured to the end of single or Back 2 Back Bridges table; supported by rectangular legs, all mounting hardware included.
- Storage compartment internal height: 13.25"
- LP chassis (specify LP finish) 1" top (specify LP or HP finish).
- NOTE: not compatible with round legs.
- 25" high Bridges storage should not be used under Back 2 Back Bridges table applications using Below Worksurface Trough. Storage will not fit under the trough.

PRODUCT CODE	PRICE		SIZE/INCHES			WEIGHT VOL	
	LP	HP	H	W	D	LBS	FT ³
BRTTES24	614	665	15	24	15.5	29	3.22
BRTTES30	672	731	15	30	15.5	34	4.03
BRTTES51	1114	1224	15	50.5	15.5	57	6.79
BRTTES63	1224	1363	15	62.5	15.5	68	8.4

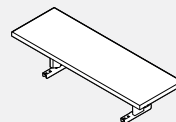
BRTCMS • Centre Mount Shelf

- Open, shared Centre mount shelf 'floats' 6.750" above the gap formed by two back-to-back work surfaces. 12" deep x 30" or 36" laminate shelf surface accepts BRTESBBIN Elevated Shelf Binder Bin - The 30" wide shelf accommodates two, while 36" shelf accommodates up to three BRTESBBIN bins. Shelves overhang the support structure by 6" on either side.
- Aluminum / die cast structure attaches to the underside of both work surfaces.
- Note: Not compatible with BRTETA Above Work Surface Power Trough and Work Surfaces with Access Doors.
- Specify high pressure laminate shelf (HP 1 1/16" thick) or low pressure laminate shelf (LP 1" thick).
- Specify support structure metal finish.
- Anodized support structure finish up charge \$55.

PRODUCT CODE	PRICE		SIZE/INCHES			WEIGHT VOL	
	LP	HP	H	W	D	LBS	FT ³
BRTCMS30	221	252	6.75	30	12	12.60	1.41
BRTCMS36	317	349	6.75	36	12	15.20	1.69

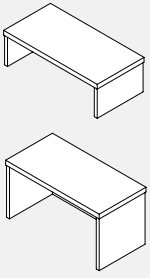
BRTSTS • Single Sided Elevated Table Shelf

- **Single sided elevated shelf.**

- Secured perpendicularly to the single or Back 2 Back Bridges tables. Integrated anodized aluminum accessory rail. White cut out and accessory rail trims.

- Optional Elevated Shelf Binder Bin rests on top surface - better utilization of vertical space, enhanced sense of privacy.

- Three heights available:

- 8" high provides additional storage space without obstructing view; reaches 16" module height when combined with 8" high Binder Shelf. Internal height 6.6".

- 13" high lines up with 42" floor-standing panels.

- 16" high lines up with top of 16" table dividers

- (15.8"). Specify 12" narrower Shared Elevated Shelf immediately adjacent to the perpendicular elevated shelf. Internal height 14.6".

- NOTE: In order to prevent interference ensure that the Shared Elevated Shelves immediately adjacent to the perpendicular elevated shelf which are of equal or bigger height are specified 12" narrower than the supporting worksurface.

- Optional Elevated Shelf Binder Bin (BRTESBBIN) rests on top surface - better utilization of vertical space, enhanced sense of privacy.

- See Accessory compatibility chart.

PRODUCT CODE	PRICE		SIZE/INCHES			WEIGHT VOL	
	LP	HP	H	W	D	LBS	FT ³
BRTSTS0824	217	283	8	24	12	14	1.33
BRTSTS0830	249	317	8	30	12	16	1.66
BRTSTS0851	399	500	8	50.5	12	25	2.80
BRTSTS0863	450	600	8	62.5	12	28	3.47
BRTSTS1324	234	299	13	24	12	18	2.16
BRTSTS1330	265	333	13	30	12	21	2.70
BRTSTS1351	399	500	13	50.5	12	32	4.55
BRTSTS1363	465	600	13	62.5	12	38	5.64
BRTSTS1624	265	333	16	24	12	19	2.66
BRTSTS1630	317	383	16	30	12	29	3.33
BRTSTS1651	465	581	16	50.5	12	33	5.61
BRTSTS1663	535	683	16	62.5	12	39	6.94

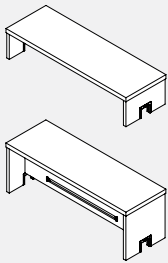
BRTBTS • Shared Elevated Table Shelf

- **Shared, Back 2 Back elevated shelf; rests on Back 2 Back Bridges tables.**

- Cut-outs in both supporting side gables allow placement over Above Worksurface Power/data troughs. Integrated anodized aluminum accessory rail. White cut out and accessory rail trims.

- Three heights available:

- 8" high provides additional storage space without obstructing view; reaches 16" module height when combined with 8" high Binder Shelf. Internal height 6.6".

- 13" high lines up with 42" floor-standing panels.

- 16" high lines up with top of 16" table dividers (15.8"). Specify 12" narrower Shared Elevated Shelf immediately adjacent to the perpendicular elevated shelf. Internal height 14.6".

- NOTE: In order to prevent interference ensure that the Shared Elevated Shelves immediately adjacent to the perpendicular elevated shelf which are of equal or bigger height are specified 12" narrower than the supporting worksurface.

- Optional Elevated Shelf Binder Bin (BRTESBBIN) rests on top surface - better utilization of vertical space, binder/book manager, enhanced sense of privacy, magnetic board on the opposite side.

- LP chassis (specify LP finish); 1" top (specify LP or HP finish).

PRODUCT CODE	PRICE		SIZE/INCHES			WEIGHT VOL	
	LP	HP	H	W	D	LBS	FT ³
BRTBTS0836	333	399	8	36	12	16	2.00
BRTBTS0842	367	433	8	42	12	19	2.33
BRTBTS0848	399	500	8	48	12	21	2.66
BRTBTS0854	417	535	8	54	12	23	3.00
BRTBTS0860	465	600	8	60	12	26	3.33
BRTBTS0866	500	652	8	66	12	28	3.66
BRTBTS0872	535	683	8	72	12	30	4.00
BRTBTS0878	567	731	8	78	12	32	4.33
BRTBTS0884	600	783	8	84	12	35	4.66
BRTBTS1336	399	483	13	36	12	22	3.25
BRTBTS1342	450	535	13	42	12	25	3.79
BRTBTS1348	483	600	13	48	12	28	4.33
BRTBTS1354	535	652	13	54	12	30	4.87
BRTBTS1360	581	697	13	60	12	33	5.86
BRTBTS1366	567	763	13	66	12	36	6.45
BRTBTS1372	665	830	13	72	12	39	6.50
BRTBTS1378	717	883	13	78	12	42	7.04
BRTBTS1384	763	949	13	84	12	44	7.58
BRTBTS1636	417	483	16	36	12	25	4.00
BRTBTS1642	465	567	16	42	12	28	4.66
BRTBTS1648	516	614	16	48	12	31	5.33
BRTBTS1654	548	683	16	54	12	34	6.00
BRTBTS1660	600	731	16	60	12	38	6.66
BRTBTS1666	652	783	16	66	12	41	7.33
BRTBTS1672	697	850	16	72	12	44	8.00
BRTBTS1678	731	896	16	78	12	47	8.66
BRTBTS1684	783	963	16	84	12	50	9.33

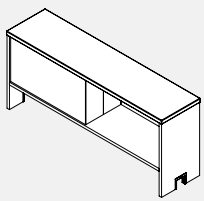
BRTBAS048 • Table Supported Shared Overhead

- **One compartment per side; white magnetic back wall; lines up with 50" high floor standing storage.**

- Integrated anodized aluminum accessory rail below the shelves.

- Fits over the gap between two parallel Back 2 Back Bridges tables.

- Fits over above worksurface power/data trough.

- Storage compartment internal height: 12.25".

- Optional Elevated Shelf Binder Bin rests on top surface - better utilization of vertical space, enhanced sense of privacy.

- LP chassis (specify LP finish), white powder-coated steel central partition and backs; 1" top (specify LP or HP finish).

PRODUCT CODE	PRICE		SIZE/INCHES			WEIGHT VOL	
	LP	HP	H	W	D	LBS	FT ³
BRTBAS048	665	763	21	48	12	54	7.00

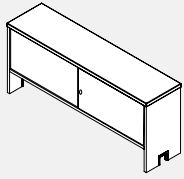
BRTBASL • Shared Elevated Overhead with Sliding Laminate Doors

- **Two compartments facing in opposite direction can be locked with sliding laminate doors. Storage compartment internal height: 12.25**
- Shared elevated overhead fits over the gap between two parallel Bridges Back 2 Back tables.
- Integrated anodized aluminum accessory rail below the storage compartments. Fits over Above Worksurface Power/Data Troughs.
- NOTE: In order to prevent duplex outlet and work surface access door interference, please specify overhead of the same width as the width of the supporting worksurface.

To prevent interference with ceiling feed pole please specify overhead 6" shorter in order width corresponding with the length of the supporting work surface. Elevated Shelf Binder Bins DO NOT work with this overhead. Bottom accessory rail accepts BALTO1 Letter Tray, BAMB01 Media Bin, BAUT01 Utility Tray and BVATH01 Telephone holder.
LP chassis (specify LP finish); 1" top (specify LP or HP finish), satin lock.

PRODUCT CODE	PRICE		SIZE/INCHES			WEIGHT VOL	
	LP	HP	H	W	D	LBS	FT ³
BRTBASL36	1891	2015	21	36	16	23.5	6.56
BRTBASL42	2023	2176	21	42	16	27.5	7.65
BRTBASL48	2128	2309	21	48	16	31.4	8.75
BRTBASL54	2289	2477	21	54	16	35.3	9.84
BRTBASL60	2414	2613	21	60	16	39.3	10.93
BRTBASL66	2725	2954	21	66	16	43.2	12.03
BRTBASL72	2869	3126	21	72	16	47.1	13.12
BRTBASL78	3020	3296	21	78	16	51.0	14.21
BRTBASL84	3059	3440	21	84	16	55.0	15.31

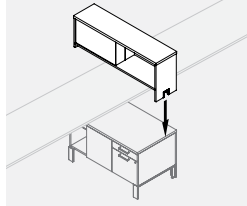
BRTSDS48 • 45" High Shared Storage Divider

- **Divides side-2-side workstations; two shared open shelves**
- One compartment per side; white magnetic back wall. Rests on top of shared 25" box/file/open and Back 2 Back worksurface.
- Top of the unit is 15.7" from the top of the worksurface.
- Storage compartment internal height: 12.8".
- Optional Elevated Shelf Binder Bin (BRTSEBBIN) rests on top surface - better utilization of vertical space, enhanced sense of privacy.
- LP chassis (specify LP finish), white powder-coated steel central partition and backs; 1" top (specify LP or HP finish).

PRODUCT CODE	PRICE		SIZE/INCHES			WEIGHT VOL	
	LP	HP	H	W	D	LBS	FT ³
BRTSDS48	535	631	16	48	12	54	5.33

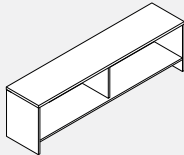
BRT21HO • Open Single Sided Storage

- **Table supported single sided open storage**
- Storage compartment internal height: 14"
- LP chassis (specify LP finish); 1" top (specify LP or HP finish).
- NOTE: Cannot be used in conjunction with above worksurface power trough.
- In order to prevent duplex outlet and work surface access door interference, please specify overhead of the same width as the width of the supporting worksurface.
- To prevent interference with ceiling feed pole please specify overhead 6" shorter width corresponding with the length of the supporting work surface.

PRODUCT CODE	PRICE		SIZE/INCHES			WEIGHT VOL	
	LP	HP	H	W	D	LBS	FT ³
BRT21HO3616	835	947	21	36	16	81	9
BRT21HO4216	897	1027	21	42	16	96	10.5
BRT21HO4816	958	1102	21	48	16	100	12
BRT21HO5416	1017	1180	21	54	16	124	13.5
BRT21HO6016	1086	1266	21	60	16	134	15
BRT21HO6616	1154	1354	21	66	16	144	16.5
BRT21HO7216	1197	1424	21	72	16	152	18
BRT21HO7816	1288	1524	21	78	16	161	19.5
BRT21HO8416	1339	1592	21	84	16	168	21

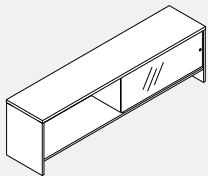
BRT21GS • Open Single Sided Storage with One Sliding Glass Door

- **Table supported single sided open storage, single sliding glass door with recessed pull**
- Storage compartment internal height: 14"
- LP chassis (specify LP finish); 1" top (specify LP or HP finish).
- Not locking.
- Glass is clear.
- NOTE: Cannot be used in conjunction with above worksurface power trough.
- In order to prevent duplex outlet and work surface access door interference, please specify overhead of the same width as the width of the supporting worksurface.
- To prevent interference with ceiling feed pole please specify overhead 6" shorter width corresponding with the length of the supporting work surface.

PRODUCT CODE	PRICE		SIZE/INCHES			WEIGHT VOL	
	LP	HP	H	W	D	LBS	FT ³
BRT21GS3616	1317	1428	21	36	16	87	9
BRT21GS4216	1383	1511	21	42	16	103	10.5
BRT21GS4816	1442	1587	21	48	16	108	12
BRT21GS5416	1721	1885	21	54	16	133	13.5
BRT21GS6016	1788	1972	21	60	16	144	15
BRT21GS6616	1876	2076	21	66	16	155	16.5
BRT21GS7216	1936	2155	21	72	16	164	18
BRT21GS7816	2040	2276	21	78	16	174	19.5
BRT21GS8416	2100	2356	21	84	16	181	21

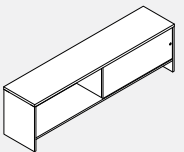
BRT21LS • Open Single Sided Storage with One Sliding Laminate Door

- **Table supported single sided open storage, single sliding laminate door with recessed pull**
- Storage compartment internal height: 14"
- LP chassis (specify LP finish); 1" top (specify LP or HP finish).
- Not locking.
- NOTE: Cannot be used in conjunction with above worksurface power trough.
- In order to prevent duplex outlet and work surface access door interference, please specify overhead of the same width as the width of the supporting worksurface.
- To prevent interference with ceiling feed pole please specify overhead 6" shorter width corresponding with the length of the supporting work surface.

PRODUCT CODE	PRICE		SIZE/INCHES			WEIGHT VOL	
	LP	HP	H	W	D	LBS	FT ³
BRT21LS3616	1278	1434	21	36	16	94	9
BRT21LS4216	1341	1522	21	42	16	111	10.5
BRT21LS4816	1401	1606	21	48	16	117	12
BRT21LS5416	1460	1691	21	54	16	143	13.5
BRT21LS6016	1688	1947	21	60	16	155	15
BRT21LS6616	1758	2040	21	66	16	167	16.5
BRT21LS7216	1810	2118	21	72	16	177	18
BRT21LS7816	1891	2225	21	78	16	188	19.5
BRT21LS8416	1944	2301	21	84	16	198	21

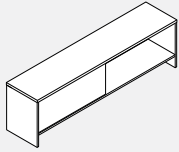
BRT21HDO • Open Double Sided Storage

- **Table supported double sided open storage.**
- Fits over the gap between two parallel Bridges Back 2 Back tables.
- Storage compartment internal height: 14"
- LP chassis (specify LP finish); 1" top (specify LP or HP finish)
- NOTE: Cannot be used in conjunction with above worksurface power trough
- In order to prevent duplex outlet and work surface access door interference, please specify overhead of the same width as the width of the supporting worksurface.
- To prevent interference with ceiling feed pole please specify overhead 6" shorter width corresponding with the length of the supporting work surface.

PRODUCT CODE	PRICE		SIZE/INCHES			WEIGHT VOL	
	LP	HP	H	W	D	LBS	FT ³
BRT21HDO3616	867	976	21	36	16	81	9
BRT21HDO4216	917	1043	21	42	16	96	10.5
BRT21HDO4816	959	1106	21	48	16	100	12
BRT21HDO5416	1034	1198	21	54	16	124	13.5
BRT21HDO6016	1088	1267	21	60	16	134	15
BRT21HDO6616	1170	1370	21	66	16	144	16.5
BRT21HDO7216	1208	1428	21	72	16	152	18
BRT21HDO7816	1303	1541	21	78	16	161	19.5
BRT21HDO8416	1340	1595	21	84	16	168	21

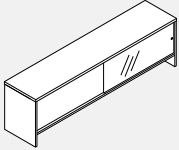
BRT21GDS • Double Sided Storage with Sliding Glass Door

- **Table supported double sided storage with sliding glass doors and recessed pull.**
- Fits over the gap between two parallel Bridges Back 2 Back tables.
- Storage compartment internal height: 14"
- LP chassis (specify LP finish); 1" top (specify LP or HP finish).
- Not Locking
- NOTE: Cannot be used in conjunction with above worksurface power trough
- In order to prevent duplex outlet and work surface access door interference, please specify overhead of the same width as the width of the supporting worksurface.
- To prevent interference with ceiling feed pole please specify overhead 6" shorter width corresponding with the length of the supporting work surface.

PRODUCT CODE	PRICE		SIZE/INCHES			WEIGHT VOL	
	LP	HP	H	W	D	LBS	FT ³
BRT21GDS3616	1711	1819	21	36	16	94	9
BRT21GDS4216	1789	1918	21	42	16	111	10.5
BRT21GDS4816	1831	1976	21	48	16	117	12
BRT21GDS5416	2367	2531	21	54	16	143	13.5
BRT21GDS6016	2411	2593	21	60	16	155	15
BRT21GDS6616	2572	2773	21	66	16	167	16.5
BRT21GDS7216	2629	2845	21	72	16	177	18
BRT21GDS7816	2735	2971	21	78	16	188	19.5
BRT21GDS8416	2911	3167	21	84	16	196	21

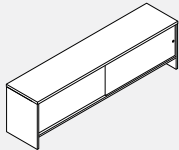
BRT21LDS • Double sided Storage with Sliding Laminate Door

- **Table supported double sided storage with sliding laminate doors and recessed pull.**
- Fits over the gap between two parallel Bridges Back 2 Back tables.
- Storage compartment internal height: 14"
- LP chassis (specify LP finish); 1" top (specify LP or HP finish).
- Not Locking
- NOTE: Cannot be used in conjunction with above worksurface power trough
- In order to prevent duplex outlet and work surface access door interference, please specify overhead of the same width as the width of the supporting worksurface.
- To prevent interference with ceiling feed pole please specify overhead 6" shorter width corresponding with the length of the supporting work surface.

PRODUCT CODE	PRICE		SIZE/INCHES			WEIGHT VOL	
	LP	HP	H	W	D	LBS	FT ³
BRT21LDS3616	1680	1788	21	36	16	106	9
BRT21LDS4216	1786	1915	21	42	16	126	10.5
BRT21LDS4816	1824	1970	21	48	16	134	12
BRT21LDS5416	2278	2442	21	54	16	162	13.5
BRT21LDS6016	2320	2501	21	60	16	176	15
BRT21LDS6616	2473	2674	21	66	16	190	16.5
BRT21LDS7216	2511	2731	21	72	16	203	18
BRT21LDS7816	2606	2842	21	78	16	216	19.5
BRT21LDS8416	2762	3016	21	84	16	227	21

BRTTW50-L/R • Storage Tower with Coat Storage

Left Shown

- Provides storage and privacy at the end of a table
- Box+file drawers; open compartment with adjustable glass shelf (50" high); coat storage with hinged door.
- Specify Left or Right handed.
- Capable of supporting worksurface on one side (built-in threaded inserts to secure dedicated worksurface supporting beam).
- Open side storage compartment internal height: 19.6".
- Optional Cable Basket suspends off storage unit's bottom and manages cables along the horizontal plane.
- LP chassis (specify LP finish), 1" top (specify LP or HP finish); metal handles; powder coated aluminum or anodized aluminum legs (specify paint finish).
- Anodized aluminum leg upcharge \$55.
- Black injection moulded pencil tray included.
- Optional e-lock available in the vertical position for the box, file drawer. Please specify V-Vertical and add \$224 list.
- Optional e-lock available in the horizontal position for the wardrobe. Please specify HR-Horizontal Right or HL-Horizontal Left and add \$224 list.

PRODUCT CODE	PRICE		SIZE/INCHES			WEIGHT VOL	
	LP	HP	H	W	D	LBS	FT ³
BRTTW5024L	1812	1928	50	24	24	142	16.66
BRTTW5024R	1812	1928	50	24	24	142	16.66
BRTTW5030L	2014	2128	50	24	30	163	20.83
BRTTW5030R	2014	2128	50	24	30	163	20.83

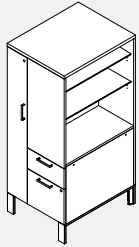
BRTTW66-L/R • Storage Tower with Coat Storage

Left Shown

- Provides storage and privacy at the end of a table
- Box+file drawers; open compartment with adjustable glass shelf (66" high); coat storage with hinged door.
- Specify Left or Right handed.
- Capable of supporting worksurface on one side (built-in threaded inserts to secure dedicated worksurface supporting beam).
- Open side storage compartment internal height: 35.6".
- Optional Cable Basket suspends off storage unit's bottom and manages cables along the horizontal plane.
- LP chassis (specify LP finish), 1" top (specify LP or HP finish); metal handles; powder coated aluminum or anodized aluminum legs (specify paint finish).
- Anodized aluminum leg upcharge \$55.
- Black injection moulded pencil tray included.
- Optional e-lock available in the vertical position for the box, file drawer. Please specify V-Vertical and add \$224 list.
- Optional e-lock available in the horizontal position for the wardrobe. Please specify HR-Horizontal Right or HL-Horizontal Left and add \$224 list.

PRODUCT CODE	PRICE		SIZE/INCHES			WEIGHT VOL	
	LP	HP	H	W	D	LBS	FT ³
BRTTW6624L	2356	2506	66	24	24	170	22
BRTTW6624R	2356	2506	66	24	24	170	22
BRTTW6630L	2616	2765	66	24	30	195	27.5
BRTTW6630R	2616	2765	66	24	30	195	27.5

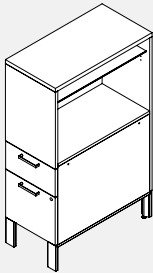
BRTT50-L/R • 50" High Storage Tower

Left Shown

- Provides storage and privacy at the end of a table
- Box+file drawers; open compartment with adjustable glass shelf.
- Specify Left or Right handed.
- Capable of supporting worksurface on one side (built-in threaded inserts to secure dedicated worksurface supporting beam).
- Open side storage compartment internal height: 19.6"
- Optional Cable Basket suspends off storage unit's bottoms and manages cables along the horizontal plane.
- LP chassis (specify LP finish), 1" top (specify LP or HP finish); metal handles; powder coated aluminum or anodized aluminum legs (specify paint finish).
- Anodized aluminum leg upcharge \$55.
- Black injection moulded pencil tray included.
- Optional e-lock available in the vertical position. Please specify V-Vertical and add \$224 list.

PRODUCT CODE	PRICE		SIZE/INCHES			WEIGHT VOL	
	LP	HP	H	W	D	LBS	FT ³
BRTT5024L	1348	1430	50	15.5	24	88	10.76
BRTT5024R	1348	1430	50	15.5	24	88	10.76
BRTT5030L	1481	1579	50	15.5	30	101	13.45
BRTT5030R	1481	1579	50	15.5	30	101	13.45

BRTT66-L/R • 66" High Storage Tower

Left Shown

- Provides storage and privacy at the end of a table
- Box+file drawers; open compartment with 2 adjustable glass shelf.
- Specify Left or Right handed.
- Capable of supporting worksurface on one side (built-in threaded inserts to secure dedicated worksurface supporting beam).
- Open side storage compartment internal height: 35.6"
- Optional Cable Basket suspends off storage unit's bottoms and manages cables along the horizontal plane.
- LP chassis (specify LP finish), 1" top (specify LP or HP finish); metal handles; powder coated aluminum or anodized aluminum legs (specify paint finish).
- Anodized aluminum leg upcharge \$55.
- Black injection moulded pencil tray included.
- Optional e-lock available in the vertical position. Please specify V-Vertical and add \$224 list.

PRODUCT CODE	PRICE		SIZE/INCHES			WEIGHT VOL	
	LP	HP	H	W	D	LBS	FT ³
BRTT6624L	1751	1859	66	15.5	24	106	12.91
BRTT6624R	1751	1859	66	15.5	24	106	12.91
BRTT6630L	1925	2055	66	15.5	30	121	16.14
BRTT6630R	1925	2055	66	15.5	30	121	16.14

BRTTW2D50-L/R - 50" High Two Door Storage Tower

Left Shown

- **Provides storage and privacy at the end of a table**

- Box+file drawers; closed compartment with one adjustable laminate shelf and hinged door; coat storage with hinged door.
- Specify Left or Right handed.
- Closed side storage compartment internal height: 20.3"
- Optional Cable Basket suspends off storage unit's bottoms and manages cables along the horizontal plane.
- LP chassis (specify LP finish), 1" top (specify LP or HP finish); metal handles; powder coated aluminum or anodized aluminum legs (specify paint finish).
- Anodized aluminum leg upcharge \$55.
- Black injection moulded pencil tray included.
- Optional e-lock available in the vertical position for the box, file drawer. Please specify V-Vertical and add \$224 list.
- Optional e-lock available in the horizontal position for the wardrobe. Please specify HR-Horizontal Right or HL-Horizontal Left and add \$224 list.
- Optional e-lock available in the horizontal position for the closed compartment. Please specify HR-Horizontal Right or HL-Horizontal Left and add \$224 list.

PRODUCT CODE	PRICE		SIZE/INCHES			WEIGHT VOL	
	LP	HP	H	W	D	LBS	FT ³
BRTTW2D5018L	1677	1766	50	24	18	121	12.50
BRTTW2D5018R	1677	1766	50	24	18	121	12.50
BRTTW2D5024L	1881	1996	50	24	24	142	16.67
BRTTW2D5024R	1881	1996	50	24	24	142	16.67
BRTTW2D5030L	2082	2196	50	24	30	163	20.83
BRTTW2D5030R	2082	2196	50	24	30	163	20.83

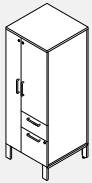
BRTTW2D66-L/R - 66" High Two Door Storage Tower

Left Shown

- **Provides storage and privacy at the end of a table**

- Box+file drawers; closed compartment with two adjustable laminate shelves and hinged door; coat storage with hinged door.
- Specify Left or Right handed.
- Closed side storage compartment internal height: 36.3"
- Anodized aluminum leg upcharge \$55.
- Optional Cable Basket suspends off storage unit's bottoms and manages cables along the horizontal plane.
- LP chassis (specify LP finish), 1" top (specify LP or HP finish); metal handles; powder coated aluminum or anodized aluminum legs (specify paint finish).
- Black injection moulded pencil tray included.
- Optional e-lock available in the vertical position for the box, file drawer. Please specify V-Vertical and add \$224 list.
- Optional e-lock available in the horizontal position for the wardrobe. Please specify HR-Horizontal Right or HL-Horizontal Left and add \$224 list.
- Optional e-lock available in the horizontal position for the closed compartment. Please specify HR-Horizontal Right or HL-Horizontal Left and add \$224 list.

PRODUCT CODE	PRICE		SIZE/INCHES			WEIGHT VOL	
	LP	HP	H	W	D	LBS	FT ³
BRTTW2D6618L	2144	2254	66	24	18	145	16.50
BRTTW2D6618R	2144	2254	66	24	18	145	16.50
BRTTW2D6624L	2425	2574	66	24	24	170	22.00
BRTTW2D6624R	2425	2574	66	24	24	170	22.00
BRTTW2D6630L	2685	2834	66	24	30	195	27.50
BRTTW2D6630R	2685	2834	66	24	30	195	27.50

BRTT1D50-L/R - 50" High Hinged Door Storage Tower

Right Shown

- **Provides storage and privacy at the end of a table**

- Box+file drawers; closed compartment with one adjustable laminate shelf and hinged door.
- Specify Left or Right handed.
- Closed side storage compartment internal height: 20.3"
- Optional Cable Basket suspends off storage unit's bottoms and manages cables along the horizontal plane.
- LP chassis (specify LP finish), 1" top (specify LP or HP finish); metal handles; powder coated aluminum or anodized aluminum legs (specify paint finish).
- Anodized aluminum leg upcharge \$55.
- Black injection moulded pencil tray included.
- Optional e-lock available in the vertical position for the box, file drawer. Please specify V-Vertical and add \$224 list.
- Optional e-lock available in the horizontal position for the closed compartment. Please specify HR-Horizontal Right or HL-Horizontal Left and add \$224 list.

PRODUCT CODE	PRICE		SIZE/INCHES			WEIGHT VOL	
	LP	HP	H	W	D	LBS	FT ³
BRTT1D5018L	1235	1298	50	15.5	18	110	8.07
BRTT1D5018R	1235	1298	50	15.5	18	110	8.07
BRTT1D5024L	1416	1498	50	15.5	24	131	10.76
BRTT1D5024R	1416	1498	50	15.5	24	131	10.76
BRTT1D5030L	1549	1647	50	15.5	30	152	13.45
BRTT1D5030R	1549	1647	50	15.5	30	152	13.45

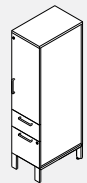
BRTT1D66-L/R - 66" High Hinged Door Storage Tower

Right Shown

- **Provides storage and privacy at the end of a table**

- Box+file drawers; closed compartment with two adjustable laminate shelves and hinged door.
- Specify Left or Right handed.
- Closed side storage compartment internal height: 36.3"
- Optional Cable Basket suspends off storage unit's bottoms and manages cables along the horizontal plane.
- LP chassis (specify LP finish), 1" top (specify LP or HP finish); metal handles; powder coated aluminum or anodized aluminum legs (specify paint finish).
- Anodized aluminum leg upcharge \$55.
- Black injection moulded pencil tray included.
- Optional e-lock available in the vertical position for the box, file drawer. Please specify V-Vertical and add \$224 list.
- Optional e-lock available in the horizontal position for the closed compartment. Please specify HR-Horizontal Right or HL-Horizontal Left and add \$224 list.

PRODUCT CODE	PRICE		SIZE/INCHES			WEIGHT VOL	
	LP	HP	H	W	D	LBS	FT ³
BRTT1D6618L	1579	1669	66	15.5	18	134	10.66
BRTT1D6618R	1579	1669	66	15.5	18	134	10.66
BRTT1D6624L	1819	1928	66	15.5	24	159	14.21
BRTT1D6624R	1819	1928	66	15.5	24	159	14.21
BRTT1D6630L	1994	2125	66	15.5	30	184	17.76
BRTT1D6630R	1994	2125	66	15.5	30	184	17.76

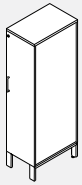
BRTW1D-L/R - Hinged Door Wardrobe Tower

Right Shown

- Provides wardrobe and privacy at the end of a table.
- Specify Left or Right handed.
- Optional Cable Basket suspends off storage unit's bottoms and manages cables along the horizontal plane.
- LP chassis (specify LP finish), 1" top (specify LP or HP finish); metal handles; powder coated aluminum or anodized aluminum legs (specify paint finish).
- Anodized aluminum leg upcharge \$55.
- Optional e-lock available in the horizontal position for the wardrobe. Please specify HR-Horizontal Right or HL-Horizontal Left and add \$224 list.
- 18" unit has coat hooks, 24" and 30" units have a coat rod.

PRODUCT CODE	PRICE		SIZE/INCHES			WEIGHT VOL	
	LP	HP	H	W	D	LBS	FT ³
BRTW1D5018L	952	1012	50	15.5	18	105	8.07
BRTW1D5018R	952	1012	50	15.5	18	105	8.07
BRTW1D5024L	1078	1157	50	15.5	24	126	10.76
BRTW1D5024R	1078	1157	50	15.5	24	126	10.76
BRTW1D5030L	1209	1309	50	15.5	30	147	13.45
BRTW1D5030R	1209	1309	50	15.5	30	147	13.45
BRTW1D6618L	1204	1265	66	15.5	18	129	10.66
BRTW1D6618R	1204	1265	66	15.5	18	129	10.66
BRTW1D6624L	1363	1441	66	15.5	24	154	14.21
BRTW1D6624R	1363	1441	66	15.5	24	154	14.21
BRTW1D6630L	1525	1622	66	15.5	30	179	17.76
BRTW1D6630R	1525	1622	66	15.5	30	179	17.76

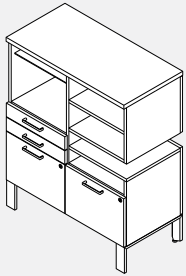
BRTCS45BBFF • Cantilever Storage Open Box, Box, File, Open, File

Left Shown

- Provides storage and privacy anywhere along the length of the bench.
- The middle opening of the cabinet allows the upper portion to cantilever above the worksurface
- Two locking file drawers.
- Two pencil drawers not locking.
- Open compartment with adjustable glass shelf, internal dimension of 15.9"
- Three fixed open compartments two above worksurfaces (6.7" interior dimension), one below (3.7" interior dimension)
- Specify Left or Right handed.
- Optional Cable Basket suspends off storage unit's bottoms and manages cables along the horizontal plane.
- LP chassis (specify LP finish), 1" top (specify LP or HP finish); metal handles; powder coated aluminum or anodized aluminum legs (specify paint finish).
- Anodized aluminum leg upcharge \$55.
- Optional e-lock available in the vertical position. Please specify V-Vertical and add \$224 list each.
- Cantilever storage requires two e-locks.

PRODUCT CODE	PRICE		SIZE/INCHES			WEIGHT VOL	
	LP	HP	H	W	D	LBS	FT ³
BRTCS45BBFFL	2037	2141	45	36	18	256	24
BRTCS45BBFFR	2037	2141	45	36	18	256	24

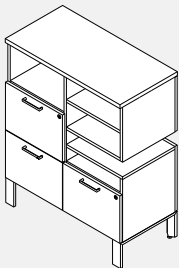
BRTCS45FFFO • Cantilever Storage Open, File, Open, File, Open

Left Shown

- Provides storage and privacy anywhere along the length of the bench.
- The middle opening of the cabinet allows the upper portion to cantilever above the worksurface
- Three locking file drawers with two locks.
- Open compartment (10.3" interior dimension)
- Three fixed open compartments two above worksurface (6.7" interior dimension), one below (3.7" interior dimension).
- Specify Left or Right handed.
- Optional Cable Basket suspends off storage unit's bottoms and manages cables along the horizontal plane.
- LP chassis (specify LP finish), 1" top (specify LP or HP finish); metal handles; powder coated aluminum or anodized aluminum legs (specify paint finish).
- Anodized aluminum leg upcharge \$55.
- Optional e-lock available in the vertical position. Please specify V-Vertical and add \$224 list each.
- Cantilever storage requires two e-locks.

PRODUCT CODE	PRICE		SIZE/INCHES			WEIGHT VOL	
	LP	HP	H	W	D	LBS	FT ³
BRTCS45FFFO L	2087	2188	45	36	18	256	24
BRTCS45FFFO R	2087	2188	45	36	18	256	24

BRTCS45BBFOO • Cantilever Storage Open, Box, Box, File, Open

Left Shown

- Provides storage and privacy anywhere along the length of the bench.
- The middle opening of the cabinet allows the upper portion to cantilever above the worksurface
- Locking file drawer.
- Two pencil drawers not locking.
- Open compartment (10.3" interior dimension) with adjustable glass shelf.
- Four fixed open compartments two above worksurface (6.7" interior dimension), two below (lower 12.2" interior dimension and upper 3.3" interior dimension)
- Specify Left or Right handed.
- Optional Cable Basket suspends off storage unit's bottoms and manages cables along the horizontal plane.
- LP chassis (specify LP finish), 1" top (specify LP or HP finish); metal handles; powder coated aluminum or anodized aluminum legs (specify paint finish).
- Anodized aluminum leg upcharge \$55.
- Optional e-lock available in the vertical position. Please specify V-Vertical and add \$224 list each.
- Cantilever storage requires one e-lock.

PRODUCT CODE	PRICE		SIZE/INCHES			WEIGHT VOL	
	LP	HP	H	W	D	LBS	FT ³
BRTCS45BBFOO L	1991	2093	45	36	18	256	24
BRTCS45BBFOO R	1991	2093	45	36	18	256	24

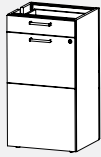
BRTDS2B2F • Pier Storage unit Box/File, Box/File

- Supports SideXSide divider with Box File on opposite sides for SideXSide application.
- Two lockable file drawers, two box drawers.
- Black injection moulded pencil tray included (can be secured inside the drawer anywhere along the perimeter wall).
- Optional e-lock available in the vertical position. Please specify V-Vertical and add \$446 list.

PRODUCT CODE	PRICE	SIZE/INCHES			WEIGHT VOL	
		H	W	D	LBS	FT ³
BRTDS2B2F	1309	36	18	16	85	14

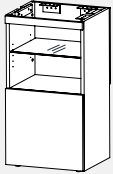
BRTDSOP • Pier Storage unit Open with Two glass adjustable shelves

- Supports SideXSide divider with Box File on opposite sides for SideXSide application.
- Storage compartment internal height without height adjustable glass shelf: 15"

PRODUCT CODE	PRICE	SIZE/INCHES			WEIGHT VOL	
		H	W	D	LBS	FT ³
BRTDSOP	868	36	18	16	75	14

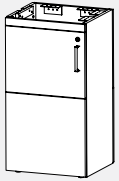
BRTDS2D • Pier Storage unit Hinged Door with Two glass adjustable shelves

- Supports SideXSide divider with hinged lockable door on opposite sides for SideX-Side application.
- Storage compartment internal height without height adjustable shelf: 15"
- Optional e-lock available in the vertical position. Please specify HL HR- Horizontal Left and Right add \$446 list.

PRODUCT CODE	PRICE	SIZE/INCHES			WEIGHT VOL	
		H	W	D	LBS	FT ³
BRTDS2D	1169	36	18	16	79	14

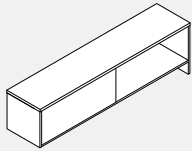
BRT21PHDO • SideXSide Storage - Open Double Sided

- Pier and Table supported SideXSide double sided open storage.
- Divides space and provides storage anywhere along bench or table.
- Storage compartment internal height: 14".
- LP chassis (specify LP finish); 1" top (specify LP or HP finish).

PRODUCT CODE	PRICE		SIZE/INCHES			WEIGHT VOL	
	LP	HP	H	W	D	LBS	FT ³
BRT21PHDO4216	755	884	21	42	16	96	10.5
BRT21PHDO4816	804	951	21	48	16	100	12
BRT21PHDO5416	883	1045	21	54	16	124	13.5
BRT21PHDO6016	930	1113	21	60	16	134	15
BRT21PHDO6616	1009	1209	21	66	16	144	16.5
BRT21PHDO7216	1064	1283	21	72	16	152	18

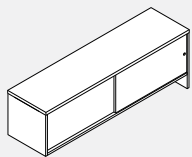
BRT21PLDS • SideXSide Storage - Sliding Laminate Double Sided

- Pier and Table supported SideXSide double sided storage with sliding laminate doors and recessed pull.
- Divides space and provides storage anywhere along bench or table.
- Storage compartment internal height: 14".
- LP chassis (specify LP finish); 1" top (specify LP or HP finish).
- Not Locking

PRODUCT CODE	PRICE		SIZE/INCHES			WEIGHT VOL	
	LP	HP	H	W	D	LBS	FT ³
BRT21PLDS4216	1754	1883	21	42	16	126	11
BRT21PLDS4816	1790	1936	21	48	16	134	12
BRT21PLDS5416	2246	2411	21	54	16	162	14
BRT21PLDS6016	2288	2470	21	60	16	176	15
BRT21PLDS6616	2442	2643	21	66	16	190	17
BRT21PLDS7216	2480	2698	21	72	16	203	18

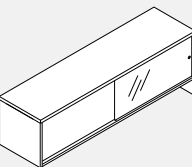
BRT21PGDS • SideXSide Storage - Sliding Glass Double Sided

- Pier and Table supported SideXSide double sided storage with sliding glass doors and recessed pull.
- Divides space and provides storage anywhere along bench or table.
- Storage compartment internal height: 14".
- LP chassis (specify LP finish); 1" top (specify LP or HP finish).

PRODUCT CODE	PRICE		SIZE/INCHES			WEIGHT VOL	
	LP	HP	H	W	D	LBS	FT ³
BRT21PGDS4216	1774	1898	21	42	16	110	10.5
BRT21PGDS4816	1811	1956	21	48	16	116	12
BRT21PGDS5416	2349	2514	21	54	16	141	13.5
BRT21PGDS6016	2392	2573	21	60	16	153	15
BRT21PGDS6616	2551	2751	21	66	16	165	16.5
BRT21PGDS7216	2608	2827	21	72	16	175	18

Panel supporting laterals

- Provide storage and panel support. Full access to Boulevard System 3 bottom raceway cover and power/data outlets. Feet support the front of the unit while a set of brackets (included) secures the unit to Boulevard panels.
- Panel mounting brackets leave 1" deep space between the storage and the panel allowing for easy cable passage behind the storage. Note: that the brackets bring the total depth to 19" (18" deep storage units) from the panel and 24" (23" deep storage units).
- Optional Cable Basket suspends off storage unit's bottom and manages cables along the horizontal plane.
- LP chassis (specify LP finish); 1" top (specify LP or HP finish); metal handles; powder coated aluminum or anodized aluminum legs (specify finish).

BRTPSLS • Panel Supporting Lateral Sliding Door

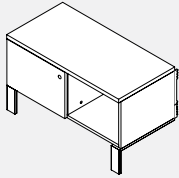

- Fits below Bridges tables, can join with other 21" high, 18" and 23" deep storage units along the panel. Can serve as an additional work-surface or an ad-hoc guest seating with optional cushion.
- Storage compartment internal height: 12.36".
- Sliding door locks on left side.
- Anodized aluminum leg upcharge \$55.

PRODUCT CODE	PRICE		SIZE/INCHES			WEIGHT VOL	
	LP	HP	H	W	D	LBS	FT ³
BRTPSLS30	1016	1083	21	30	19	53	6.56
BRTPSLS36	1096	1166	21	36	19	60	7.87
BRTPSLS42	1180	1245	21	42	19	67	9.18
BRTPSLS2330	1352	1441	21	30	24	61	8.39
BRTPSLS2336	1463	1550	21	36	24	70	10.06
BRTPSLS2342	1574	1664	21	42	24	79	11.74

BRTPSL • Panel Supporting Lateral File Drawer

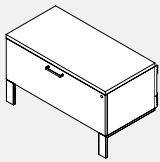

- Fits below Bridges tables, can join with other 21" high, 18" and 23" deep storage units along the panel. Can serve as an additional work-surface or an ad-hoc guest seating with optional cushion.
- One file drawer (holds letter, legal and A4 suspended file folders).
- Anodized aluminum leg upcharge \$55.
- Optional e-lock available in the vertical position. Please specify V-Vertical and add \$224 list.

PRODUCT CODE	PRICE		SIZE/INCHES			WEIGHT VOL	
	LP	HP	H	W	D	LBS	FT ³
BRTPSL30	1050	1064	21	30	19	77	6.56
BRTPSL36	1147	1212	21	36	19	84	7.87
BRTPSL42	1264	1329	21	42	19	92	9.18
BRTPSL2330	1396	1417	21	30	24	86	8.39
BRTPSL2336	1529	1617	21	36	24	95	10.06
BRTPSL2342	1691	1775	21	42	24	104	11.74

BRTP25LO-L • Panel Supporting Open Storage

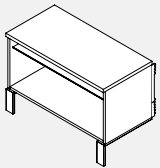

- Fits below Bridges tables, can join with other 25" high, 18" and 23" deep storage units along the panel. Can serve as an additional work-surface or an ad-hoc guest seating with optional cushion.
- Open compartment with glass adjustable glass shelf. Storage compartment internal height without height adjustable glass shelf: 15.8"
- Anodized aluminum leg upcharge \$55.

PRODUCT CODE	PRICE		SIZE/INCHES			WEIGHT VOL	
	LP	HP	H	W	D	LBS	FT ³
BRTP25LO30L	581	697	25	30	19	49	7.81
BRTP25LO36L	731	797	25	36	19	55	9.37
BRTP25LO42L	797	883	25	42	19	62	10.93
BRTP25LO2330L	778	930	25	30	24	59	10.42
BRTP25LO2336L	975	1064	25	36	24	66	12.50
BRTP25LO2342L	1064	1174	25	42	24	72	14.58

BRTPLBF • Panel Supporting Lateral Box/File

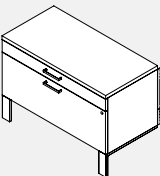

- Fits below Bridges tables, can join with other 25" high, 18" and 23" deep storage units along the panel.
- One lockable file drawer (holds letter, legal and A4 suspended file folders), one box drawer.
- Anodized aluminum leg upcharge \$55.
- Black injection moulded pencil tray included (can be secured inside the drawer anywhere along the perimeter wall).
- Optional e-lock available in the vertical position. Please specify V-Vertical and add \$224 list.

PRODUCT CODE	PRICE		SIZE/INCHES			WEIGHT VOL	
	LP	HP	H	W	D	LBS	FT ³
BRTPLBF30	1131	1198	25	30	19	88	7.81
BRTPLBF36	1298	1363	25	36	19	96	9.37
BRTPLBF42	1414	1497	25	42	19	104	10.93
BRTPLBF2330	1586	1664	25	30	24	98	10.42
BRTPLBF2336	1730	1816	25	36	24	107	12.50
BRTPLBF2342	1885	1994	25	42	24	116	14.58

BRTP25L2D • Panel Supporting Lateral w/hinged doors

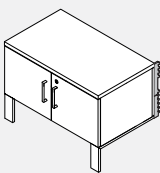

- Fits below Bridges tables, can join with other 25" high, 18" or 23" deep storage units along the panel.
- Can serve as an additional worksurface or an ad-hoc guest seating with optional cushion.
- Two lockable doors
- LP chassis and door fronts (specify LP finish)
- 1" top (specify LP or HP finish); metal handles, powder coated aluminum or anodized aluminum legs. Anodized aluminum leg upcharge \$55.

PRODUCT CODE	PRICE		SIZE/INCHES			WEIGHT VOL	
	LP	HP	H	W	D	LBS	FT ³
BRTP25L2D30	896	984	25	30	19	69	7.81
BRTP25L2D36	969	1069	25	36	19	78	9.38
BRTP25L2D42	1017	1135	25	42	19	90	10.94
BRTP25L2D3024	1027	1142	25	30	24	75	10.42
BRTP25L2D3624	1113	1250	25	36	24	84	12.50
BRTP25L2D4224	1197	1317	25	42	24	96	14.58

BRTC • Cushion

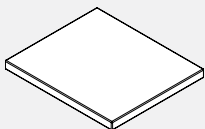

- Optional seat cushion may be added to any storage component.

PRODUCT CODE	PRICE		SIZE/ INCHES							WEIGHT VOL	
	GR1	GR2	H	W	D	LBS	FT ³	GR8	GR9	GR10	
BRTC	193	227	252	286	339	384	433	478	524	577	
BRTC	644	740	830	925	1132	1338	1547	1753	1959	2190	

Bridges Collaborative Seating

Bridges collaborative seating collection consists of seating, privacy screens, tables, tablets and power. It is a versatile modular furniture series which can be configured into many space planning scenarios including corner, in-line, open concept, traditional reception as well as secluded seating with high privacy partitions.

Furniture pieces can be used as stand alone items or can be mechanically linked together to form a variety of seating configurations.

Seat and backrest can be integrated with Bridges tables, as well as Boulevard panels.

Corner tables and in-line 6" table modules double as power delivery centers.

Dedicated seat backrests feature dual USB charging port.

Some Inline 6" table modules are furnished with grommets to support tablets.

Legs are available in standard Bridges metal painted finishes and anodized aluminum finish.

Bridges Collaborative Seating upholstery features a single stitch, thick white thread around the edges. The white, wide stitch along with crisp corners are part of its distinctive personality. In order to achieve crisp edges and to minimize "pillow" effect caused by taut fabric, the upholstery material has been applied deliberately loose, which may, over time, produce puckering of the upholstery surface material. This can be easily corrected by stretching the fabric by hand or during vacuuming.

In order to efficiently utilize fabric yield all 60" seats and backs feature a seam in the middle. The double stitch seam is sewn with a thin thread, closely matching the upholstery material in colour.

Some complicated fabric patterns prevent pattern matching and will be upholstered without the seam at the discretion of the factory.

Should you require no middle seam by cutting into the roll, please specify "NO SEAM" at time of your order.

• COM yardage is an estimate only. More accurate yardage will be dependent on the width of the fabric and on the repeat pattern.

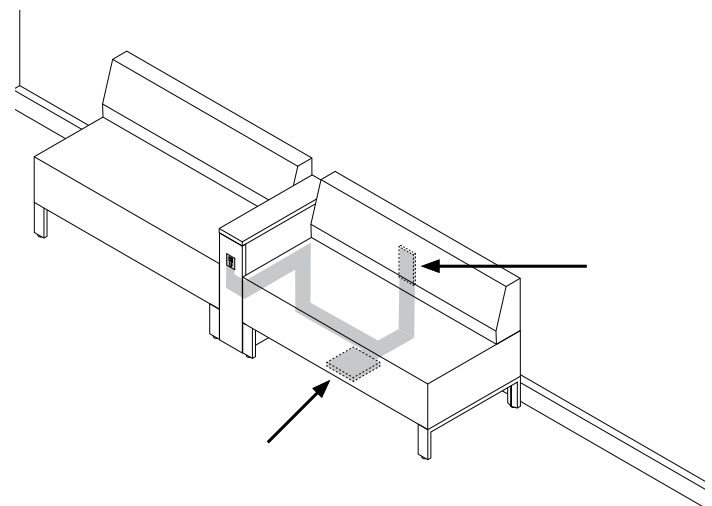
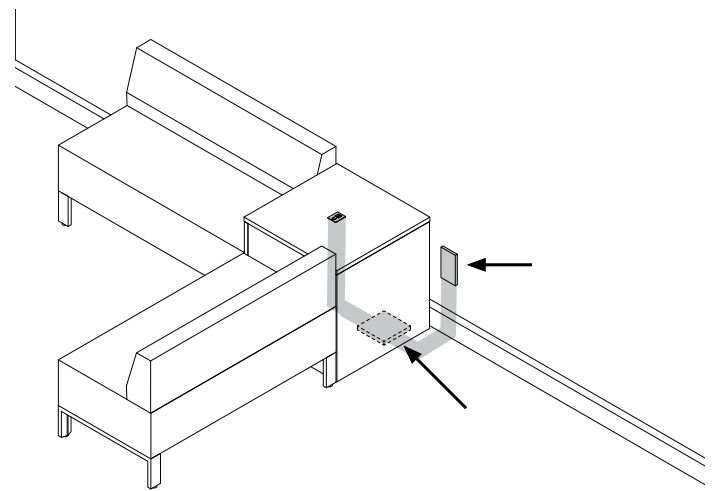
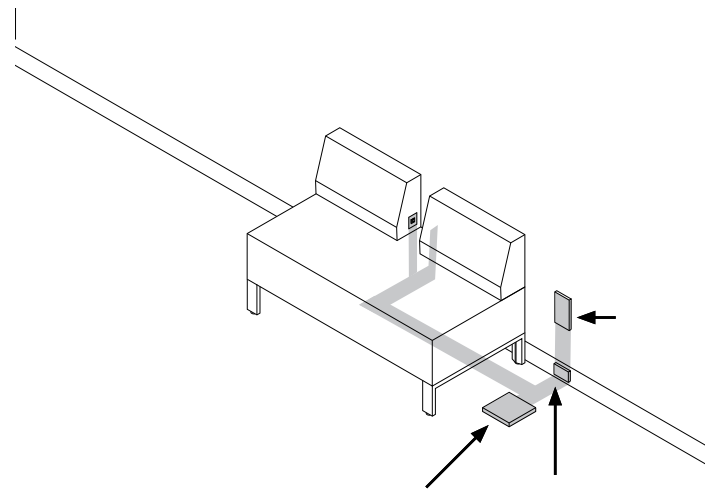

BRTST24-F • Low Table

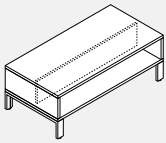

- **Freestanding 17" high tables.**
- Central partition divides space under top surface into two 11" deep compartments. All LP chassis w/ HP or LP top (3mm edging). Bridges storage aluminum leg.
- Specify chassis and top finish, specify metal leg finish. Add \$57 for anodized aluminum leg finish.
- To convert to mobile, please add \$37 list and an "M" at the end of the product code.

PRODUCT CODE	PRICE		SIZE/INCHES			WEIGHT	VOL
	LP	HP	H	W	D	LBS	FT ³
BRTST2424F	476	553	17	24	24	40.7	5.67
BRTST2448F	672	870	17	48	24	69.0	11.33
BRTST2460F	752	1029	17	60	24	83.6	14.17

BRTSE-NB • Lounge Seat

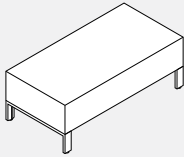

- **Fully upholstered armless lounge seat with metal base.**
- Seats can be freestanding or linked with optional interlocking bracket kit.
- Specify seating fabric and leg finish.
- Add \$57 for anodized aluminum leg finish.

PRODUCT CODE	PRICE	SIZE/INCHES			WEIGHT	VOL	YRDS
		H	W	D	LBS	FT ³	(COM)
BRTSE24NB	672	17	24	24	22.7	5.57	1.25
BRTSE48NB	1227	17	48	24	36.9	11.33	2.00
BRTSE60NB	1419	17	60	24	47.0	14.17	2.50

PRODUCT CODE	PRICE	GR1	GR2	GR3	GR4	GR5	GR6	GR7	GR8	GR9	GR10
BRTSE24NB	672	718	754	797	864	926	987	1045	1108	1174	
BRTSE48NB	1227	1300	1357	1428	1533	1632	1731	1820	1923	2028	
BRTSE60NB	1419	1511	1583	1670	1803	1927	2050	2164	2291	2423	

PRODUCT CODE	PRICE	GR11	GR12	GR13	GR14	GR15	GR16	GR17	GR18	GR19	GR20
BRTSE24NB	1261	1383	1504	1627	1895	2164	2435	2705	2973	3270	
BRTSE48NB	2168	2364	2559	2750	3185	3613	4046	4478	4907	5382	
BRTSE60NB	2598	2842	3082	3324	3867	4403	4946	5484	6020	6614	

BRTSE-B • Lounge Seat with Backrest

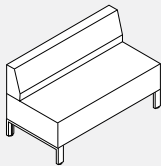

- **Fully upholstered armless lounge seat with full backrest and metal base.**
- Backrests are permanently secured to the seats and cannot be reconfigured on site.
- Seats can be freestanding or linked with optional interlocking bracket kit.
- Specify seating fabric and leg finish.
- Add \$57 for anodized aluminum leg finish.

PRODUCT CODE	PRICE	SIZE/INCHES			WEIGHT	VOL	YRDS
		H	W	D	LBS	FT ³	(COM)
BRTSE2424B	1061	29	24	24	33.0	9.57	2.25
BRTSE4848B	1958	29	48	24	55.5	19.33	3.50
BRTSE6060B	2269	29	60	24	70.0	24.17	4.50

PRODUCT CODE	PRICE	GR1	GR2	GR3	GR4	GR5	GR6	GR7	GR8	GR9	GR10
BRTSE2424B	1061	1142	1205	1286	1405	1515	1628	1730	1844	1961	
BRTSE4848B	1958	2086	2187	2309	2494	2667	2841	2998	3179	3364	
BRTSE6060B	2269	2434	2563	2720	2956	3182	3406	3610	3839	4077	

PRODUCT CODE	PRICE	GR11	GR12	GR13	GR14	GR15	GR16	GR17	GR18	GR19	GR20
BRTSE2424B	2118	2341	2559	2775	3262	3742	4232	4716	5197	5735	
BRTSE4848B	3607	3950	4285	4624	5386	6132	6893	7649	8398	9231	
BRTSE6060B	4389	4828	5263	5697	6673	7636	8614	9585	10548	11621	

BRTSE-BL/R • Lounge Seat, Single 24" Offset Backrest

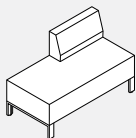

Right Hand Shown

- **Fully upholstered armless lounge seat with one backrest and metal base.**
- Specify backrest as either Left or Right side. Backrests are permanently secured to the bench and cannot be reconfigured on site.
- Seats can be freestanding or linked with optional interlocking bracket kit.
- Specify seating fabric and leg finish.
- Add \$57 for anodized aluminum leg finish.

PRODUCT CODE	PRICE	SIZE/INCHES			WEIGHT	VOL	YRDS
		H	W	D	LBS	FT ³	(COM)
BRTSE2448BL	1615	29	48	24	46.10	19.33	3.00
BRTSE2448BR	1615	29	48	24	46.10	19.33	3.00

PRODUCT CODE	PRICE	GR1	GR2	GR3	GR4	GR5	GR6	GR7	GR8	GR9	GR10
BRTSE2448BL	1615	1722	1810	1914	2072	2221	2370	2505	2659	2817	
BRTSE2448BR	1615	1722	1810	1914	2072	2221	2370	2505	2659	2817	

PRODUCT CODE	PRICE	GR11	GR12	GR13	GR14	GR15	GR16	GR17	GR18	GR19	GR20
BRTSE2448BL	3024	3321	3611	3899	4550	5192	5845	6491	7134	7848	
BRTSE2448BR	3024	3321	3611	3899	4550	5192	5845	6491	7134	7848	

BRTSE-BODL/R • Lounge Seat, Two 24" Offset Backrest

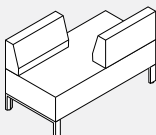

Left Hand Shown

- **Fully upholstered armless lounge seat with two offset backrests and metal base.**
- Specify either Left or Right backrest configuration. Backrests are permanently secured to the bench and cannot be reconfigured on site.
- Seats can be freestanding or linked with optional interlocking bracket kit.
- Specify seating fabric and leg finish.
- Add \$57 for anodized aluminum leg finish.

PRODUCT CODE	PRICE	SIZE/INCHES			WEIGHT	VOL	YRDS
		H	W	D	LBS	FT ³	(COM)
BRTSE2448BODL	2002	29	48	24	46.10	19.33	4.00
BRTSE2448BODR	2002	29	48	24	46.10	19.33	4.00

PRODUCT CODE	PRICE	GR1	GR2	GR3	GR4	GR5	GR6	GR7	GR8	GR9	GR10
BRTSE2448BODL	2002	2148	2262	2401	2612	2810	3010	3191	3395	3607	
BRTSE2448BODR	2002	2148	2262	2401	2612	2810	3010	3191	3395	3607	

PRODUCT CODE	PRICE	GR11	GR12	GR13	GR14	GR15	GR16	GR17	GR18	GR19	GR20
BRTSE2448BODL	3884	4276	4663	5048	5915	6773	7640	8504	9360	10311	
BRTSE2448BODR	3884	4276	4663	5048	5915	6773	7640	8504	9360	10311	

BRTSE-EBL/R • Lounge Seat, Single 21" Wide Backrest with USB

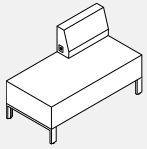

Right Hand Shown

- Fully upholstered armless lounge seat with one backrest and metal base.
- 21" wide backrest come with embedded dual USB port in its side.
Note: the side mounted power/USB outlets always point to the centre of the seat. Each USB outlet offers 2 amps. AC/DC transformer plugs into the wall or floor monument (approximately 4' long cable available from the bottom of the seat). Transformer power consumption: 0.68 amps.
- Specify either Left or Right backrest configuration. Backrests are permanently secured to the bench and cannot be reconfigured on site.
- Seats can be freestanding or linked with optional interlocking bracket kit.
- White USB outlets.
- Specify seating fabric and leg finish.
- Add \$57 for anodized aluminum leg finish.

PRODUCT CODE	SIZE/INCHES			WEIGHT LBS	VOL FT ³	YRDS (COM)
	H	W	D			
BRTSE2148EBL	29	48	24	46.10	19.33	3.00
BRTSE2148EBR	29	48	24	46.10	19.33	3.00

PRODUCT CODE	PRICE										
	GRADE	GR1	GR2	GR3	GR4	GR5	GR6	GR7	GR8	GR9	GR10
BRTSE2148EBL	1870	1981	2065	2170	2327	2476	2627	2762	2916	3074	
BRTSE2148EBR	1870	1981	2065	2170	2327	2476	2627	2762	2916	3074	
GRADE	GR11	GR12	GR13	GR14	GR15	GR16	GR17	GR18	GR19	GR20	
BRTSE2148EBL	3283	3578	3866	4156	4806	5449	6099	6745	7388	8103	
BRTSE2148EBR	3283	3578	3866	4156	4806	5449	6099	6745	7388	8103	

BRTSE-E2B • Lounge Seat, two 21" Wide Backrests with USB

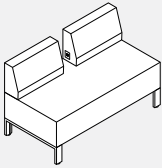

- Fully upholstered armless lounge seat with two backrests, each with dual USB outlet and metal base.
- Both 21" wide backrests come with embedded dual USB port in its side.
Note: the side mounted power/USB outlets always point to the centre of the seat. Each USB outlet offers 2 amps. AC/DC transformer plugs into the wall or floor monument (about 52" long cable available from the bottom of the seat). Transformer power consumption: 0.68 amps.
- Backrests are permanently secured to the bench and cannot be reconfigured on site.
- Seats can be freestanding or linked with optional interlocking bracket kit.
- Specify seating fabric and leg finish.
- USB outlets are white.
- Add \$57 for anodized aluminum leg finish.

PRODUCT CODE	SIZE/INCHES			WEIGHT LBS	VOL FT ³	YRDS (COM)
	H	W	D			
BRTSE2148E2B	29	48	24	57.00	19.33	4.00

PRODUCT CODE	PRICE										
	GRADE	GR1	GR2	GR3	GR4	GR5	GR6	GR7	GR8	GR9	GR10
BRTSE2148E2B	2515	2659	2775	2913	3125	3323	3523	3703	3908	4117	
GRADE	GR11	GR12	GR13	GR14	GR15	GR16	GR17	GR18	GR19	GR20	
BRTSE2148E2B	4396	4788	5175	5561	6428	7285	8152	9017	9872	10824	

BRTSE-EBODL/R • Lounge Seat Two USB backrests Offset

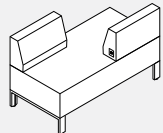

Left Hand Shown

- Fully upholstered armless lounge seat with two offset backrests, each with dual USB outlet and metal base.
- Both 21" wide backrests come with embedded dual USB port in its side.
Note: the side mounted power/USB outlets always point to the centre of the seat. Each USB outlet offers 2 amps. AC/DC transformer plugs into the wall or floor monument (about 52" long cable available from the bottom of the seat). Transformer power consumption: 0.68 amps.
- Backrests are permanently secured to the bench and cannot be reconfigured on site.
- Seats can be freestanding or linked with optional interlocking bracket kit.
- Specify seating fabric and leg finish.
- USB outlets are white.
- Add \$57 for anodized aluminum leg finish.

PRODUCT CODE	SIZE/INCHES			WEIGHT LBS	VOL FT ³	YRDS (COM)
	H	W	D			
BRTSE2148EBODL	29	48	24	57.00	19.33	4.00
BRTSE2148EBODR	29	48	24	57.00	19.33	4.00

PRODUCT CODE	PRICE										
	GRADE	GR1	GR2	GR3	GR4	GR5	GR6	GR7	GR8	GR9	GR10
BRTSE2148EBODL	2515	2659	2775	2913	3125	3323	3523	3703	3908	4117	
BRTSE2148EBODR	2515	2659	2775	2913	3125	3323	3523	3703	3908	4117	
GRADE	GR11	GR12	GR13	GR14	GR15	GR16	GR17	GR18	GR19	GR20	
BRTSE2148EBODL	4396	4788	5175	5561	6428	7285	8152	9017	9872	10824	
BRTSE2148EBODR	4396	4788	5175	5561	6428	7285	8152	9017	9872	10824	

BRTSE-EBL/R • Single Seat, Single 21" Wide Backrest with USB

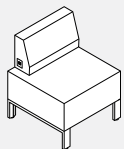

Right Hand Shown

- Fully upholstered armless lounge seat with one backrests, with dual USB outlet and metal base.
- 21" wide backrest come with embedded dual USB port in its side.
Note: Each USB outlet offers 2 amps. AC/DC transformer plugs into the wall or floor monument (about 52" long cable available from the bottom of the seat). Transformer power consumption: 0.68 amps.
- Backrests are permanently secured to the bench and cannot be reconfigured on site.
- Seats can be freestanding or linked with optional interlocking bracket kit.
- Specify seating fabric and leg finish.
- USB outlets are white.
- Add \$57 for anodized aluminum leg finish.

PRODUCT CODE	SIZE/INCHES			WEIGHT LBS	VOL FT ³	YRDS (COM)
	H	W	D			
BRTSE2124EBL	29	24	24	33.00	9.67	2.25
BRTSE2124EBR	29	24	24	33.00	9.67	2.25

PRODUCT CODE	PRICE										
	GRADE	GR1	GR2	GR3	GR4	GR5	GR6	GR7	GR8	GR9	GR10
BRTSE2124EBL	1317	1397	1463	1541	1660	1774	1883	1985	2100	2220	
BRTSE2124EBR	1317	1397	1463	1541	1660	1774	1883	1985	2100	2220	
GRADE	GR11	GR12	GR13	GR14	GR15	GR16	GR17	GR18	GR19	GR20	
BRTSE2124EBL	2375	2595	2812	3033	3521	3999	4487	4973	5456	5993	
BRTSE2124EBR	2375	2595	2812	3033	3521	3999	4487	4973	5456	5993	

BRTSPI • Boulevard Integrated Lounge Seat

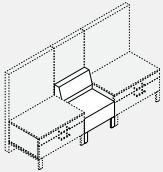

- **Fully upholstered armless lounge seat with full width backrest and special metal legs.**
- The single backrest is permanently secured to the bench and cannot be reconfigured on site.
- The seat brackets connect on-module to panel's vertical slots; **On-module applications only.** The seat width must be equal to panel width. The seat is **NOT** capable of supporting the panel.
- Seats and storage units can be interconnected with shared leg. Special leg support allows access to panel raceway cavity under the seat as well as access to panel-distributed duplex outlets.
- Backrests are permanently secured to the bench and cannot be reconfigured on site.
- Panels and storage units not included.
- Add \$57 for anodized aluminum leg finish.

PRODUCT CODE	SIZE/INCHES			WEIGHT LBS	VOL FT ³	YRDS (COM)
	H	W	D			
BRTSPI2424	29	24	24	33.00	9.67	2.25
BRTSPI4848	29	48	24	55.50	19.33	3.50
BRTSPI6060	29	60	24	69.00	24.17	4.50

PRODUCT CODE	PRICE											
GRADE	GR1	GR2	GR3	GR4	GR5	GR6	GR7	GR8	GR9	GR10	GR11	GR12
BRTSPI2424	1061	1142	1205	1286	1405	1515	1628	1730	1844	1961		
BRTSPI4848	1958	2086	2187	2309	2494	2667	2841	2998	3179	3364		
BRTSPI6060	2269	2434	2563	2720	2956	3182	3406	3610	3839	4077		
GRADE	GR11	GR12	GR13	GR14	GR15	GR16	GR17	GR18	GR19	GR20		
BRTSPI2424	2118	2341	2559	2775	3262	3742	4232	4716	5197	5735		
BRTSPI4848	3607	3950	4285	4624	5386	6132	6893	7649	8398	9231		
BRTSPI6060	4389	4828	5263	5697	6673	7636	8614	9585	10548	11621		

BRTSPI-L/R • Boulevard integrated Single Seat with USB

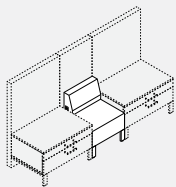

Right Hand Shown

- **Fully upholstered armless lounge seat with 21" wide backrest with dual USB outlets and special metal legs.**
- The single backrest is permanently secured to the bench and cannot be reconfigured on site.
- The seat brackets connect on-module to panel's vertical slots; **On-module applications only.** The seat width must be equal to panel width. The seat is **NOT** capable of supporting the panel.
- Seats and storage units can be interconnected with shared leg. Special leg support allows access to panel raceway cavity under the seat as well as access to panel-distributed duplex outlets.
- Note: Each USB outlet offers 2 amps. AC/DC transformer plugs into the wall or floor monument (about 52" long cable available from the bottom of the seat). Transformer power consumption:0.68 amps.
- Panels and storage units not included.
- USB outlets are white.
- Specify seating fabric and leg finish. Add \$57 for anodized aluminum leg finish.

PRODUCT CODE	SIZE/INCHES			WEIGHT LBS	VOL FT ³	YRDS (COM)
	H	W	D			
BRTSPI2124L	29	24	24	33.00	9.67	2.25
BRTSPI2124R	29	24	24	55.50	19.33	2.25

PRODUCT CODE	PRICE											
GRADE	GR1	GR2	GR3	GR4	GR5	GR6	GR7	GR8	GR9	GR10	GR11	GR12
BRTSPI2124L	1317	1397	1463	1541	1660	1774	1883	1985	2100	2220		
BRTSPI2124R	1317	1397	1463	1541	1660	1774	1883	1985	2100	2220		
GRADE	GR11	GR12	GR13	GR14	GR15	GR16	GR17	GR18	GR19	GR20		
BRTSPI2124L	2375	2595	2812	3033	3521	3999	4487	4973	5456	5993		
BRTSPI2124R	2375	2595	2812	3033	3521	3999	4487	4973	5456	5993		

BRTSPI-B2 • Boulevard integrated Lounge Seat Two 21" Backrests with USB

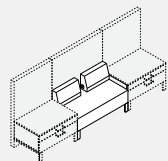

- **Fully upholstered armless lounge seat with 21" wide backrest with dual USB outlets and special metal legs.**
- The single backrest is permanently secured to the bench and cannot be reconfigured on site.
- The seat brackets connect on-module to panel's vertical slots; **On-module applications only.** The seat width must be equal to panel width. The seat is **NOT** capable of supporting the panel.
- Seats and storage units can be interconnected with shared leg. Special leg support allows access to panel raceway cavity under the seat as well as access to panel-distributed duplex outlets.
- Note: Each USB outlet offers 2 amps. AC/DC transformer plugs into the wall or floor monument (about 52" long cable available from the bottom of the seat). Transformer power consumption:0.68 amps.
- Panels and storage units not included.
- USB outlets are white.
- Specify seating fabric and leg finish. Add \$57 for anodized aluminum leg finish.

PRODUCT CODE	SIZE/INCHES			WEIGHT LBS	VOL FT ³	YRDS (COM)
	H	W	D			
BRTSPI2148B2	29	48	24	33.00	9.67	4.00

PRODUCT CODE	PRICE											
GRADE	GR1	GR2	GR3	GR4	GR5	GR6	GR7	GR8	GR9	GR10	GR11	GR12
BRTSPI2148B2	2515	2659	2775	2913	3125	3323	3523	3703	3908	4117		
GRADE	GR11	GR12	GR13	GR14	GR15	GR16	GR17	GR18	GR19	GR20		
BRTSPI2148B2	4396	4788	5175	5561	6428	7285	8152	9017	9872	10824		

BRTSINT-S • Bridges Integrated Lounge Seat Single Sided

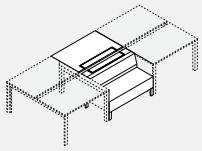

- Fully upholstered armless lounge seat with full width backrest and metal legs
- Integrated into Bridges 62.5" deep Back 2 Back linear table assembly.
- The Single-sided kit consists of 24"x48" or 24"x60" seat, full width back, three-sided below work surface enclosure, 6" deep work surface module with access door, 30"x48" or 30"x60" wide work surface with access door and supporting hardware.

PRODUCT CODE	SIZE/INCHES			WEIGHT LBS	VOL FT ³	YRDS (COM)
	H	W	D			
BRTSINT48S	29	48	24	126.00	19.33	3.50
BRTSINT60S	29	60	24	155.00	24.17	4.50

- **Note: Only compatible with Back 2 Back 30" deep work surfaces (62.5" total depth) supported by Bridges rectangular legs.**

PRODUCT CODE	PRICE											
	GRADE	GR1	GR2	GR3	GR4	GR5	GR6	GR7	GR8	GR9	GR10	
BRTSINT48SLP	4289	4364	4420	4489	4593	4695	4795	4885	4986	5091		
BRTSINT60SLP	4484	4574	4646	4734	4864	4992	5114	5227	5356	5488		
BRTSINT48SHP	4518	4589	4646	4715	4822	4919	5021	5112	5215	5320		
BRTSINT60SHP	4710	4800	4874	4960	5090	5218	5340	5454	5581	5714		
GRADE	GR11	GR12	GR13	GR14	GR15	GR16	GR17	GR18	GR19	GR20		
BRTSINT48SLP	5232	5428	5620	5812	6247	6674	7111	7543	7969	8445		
BRTSINT60SLP	5663	5906	6148	6388	6931	7466	8009	8549	9084	9678		
BRTSINT48SHP	5458	5654	5847	6039	6473	6902	7337	7768	8195	8674		
BRTSINT60SHP	5887	6131	6372	6613	7155	7692	8235	8776	9309	9906		

- **Connecting Back 2 Back table beams, legs and worksurface need to be specified separately.**

- Not compatible with Bridges round legs, 24" deep work surfaces; not compatible with single line table assemblies 24" and 30" deep. The kit cannot be used at the end of a table run, nor can it be used as a standalone, freestanding configuration. It must always be supported by Back 2 Back Bridges table assemblies on either side.
- Note: the seat module accommodates continuation of power and data distribution services below work surfaces (specify Below Work surface Power Troughs and power components separately).
- The 6" deep work surface module with access door provides access to Below Work Surface Power Trough.
- Backrests are permanently secured to the bench and cannot be reconfigured on site.
- Tables not included.
- Specify seating fabric and leg finish. Add \$55 for anodized aluminum leg finish

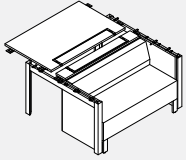

BRTSINT-D • Bridges Integrated Lounge Double Sided

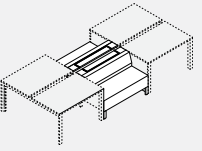

- Fully upholstered armless lounge bench with backrests and metal legs integrated into Bridges 62.5" deep Back 2 Back linear table assembly.
- The Double-sided kit consists of two 24"x48" or 24"x60" seats, full width backs, three-sided below work surface enclosures, 6" deep work surface modules with access doors and supporting hardware.

PRODUCT CODE	SIZE/INCHES			WEIGHT LBS	VOL FT ³	YRDS (COM)
	H	W	D			
BRTSINT48D	29	48	24	182.00	19.33	3.50
BRTSINT60D	29	60	24	220.00	24.17	4.50

- Note: Only compatible with Back 2 Back 30" deep work surfaces (62.5" total depth) supported by Bridges rectangular legs. Not compatible with Bridges round legs, 24" deep work surfaces; not compatible with single line table assemblies 24" and 30" deep.

PRODUCT CODE	PRICE											
	GRADE	GR1	GR2	GR3	GR4	GR5	GR6	GR7	GR8	GR9	GR10	
BRTSINT48DLP	5275	5526	5731	5973	6341	6692	7037	7353	7715	8084		
BRTSINT60DLP	5899	6222	6483	6797	7271	7719	8166	8573	9034	9509		
BRTSINT48DHP	5499	5754	5955	6200	6568	6915	7263	7581	7938	8309		
BRTSINT60DHP	6124	6451	6709	7023	7496	7945	8390	8798	9259	9737		
GRADE	GR11	GR12	GR13	GR14	GR15	GR16	GR17	GR18	GR19	GR20		
BRTSINT48DLP	8569	9255	9928	10605	12124	13622	15143	16653	18152	19818		
BRTSINT60DLP	10133	11015	11884	12752	14705	16632	18585	20528	22455	24599		
BRTSINT48DHP	8795	9479	10155	10830	12350	13847	15370	16881	18379	20045		
BRTSINT60DHP	10362	11240	12110	12977	14932	16858	18812	20753	22681	24823		

- The kit cannot be used at the end of a table run nor as a standalone, freestanding configuration. It must always be supported by Back 2 Back Bridges table assemblies on either side.
- Note: the seat module accommodates continuation of power and data distribution services below work surfaces (specify Below Work Surface Power Troughs and power components separately).
- The 6" deep work surface module with access door provides access to Below Work Surface Power Trough.
- Backrests are permanently secured to the bench and cannot be reconfigured on site.
- Tables not included.
- Specify seating fabric, LP laminate finish (enclosure), work surface and leg finish.
- Specify seating fabric and leg finish. Add \$57 for anodized aluminum leg finish.

BRTPP-L1 • Seat Partitions

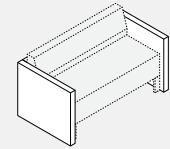

- Fully upholstered, 2.5" thick, 3-part, low level partition kit wraps around 24" or 48" bridges seat.
- The seat front is recessed by 2.5". The kit is secured to seats on-site (brackets connecting seat legs to the inner side of the partition are included).
- Upholsterd kits consist of 2" hollow core boards, 1/4 foam, fabric, levelers and connecting hardware. Specify panel fabric finish.
- Note: Seats and backrests are not included.

PRODUCT CODE	PRICE		SIZE/INCHES			WEIGHT LBS	VOL FT ³	YRDS (COM)
	GR1	GR2	H	W	D			
BRTPP2424L1	1131	1243	25	29	28.7	32.00	12.04	2.50
BRTPP2448L1	1508	1664	25	53	28.7	41.00	22.01	3.25

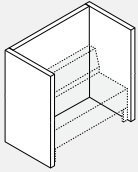
BRTPP-L2 • Seat Privacy Partitions

- Fully upholstered, 2.5" thick, 3-part, Two tier partition kit wraps around 24" or 48" bridges seat. The 50" high assembly provides seated visual privacy.
- 2.5" thick, upholstered partitions improve acoustic privacy for focused time away from the team or for a quiet phone call. Recessed seat extends the partition at the front by 2.5" for enhanced sense of privacy.
- The kit is secured to seats on-site (brackets connecting seat legs to the inner side of the partition are included).
- Upholstered kits consist of 2" hollow core boards, 1/4" foam, fabric, levelers and connecting hardware. Specify panel fabric finish.
- Note: Seats and backrests are not included.

PRODUCT CODE	PRICE		SIZE/INCHES			WEIGHT		VOL		YRDS (COM)
	GR1	GR2	H	W	D	LBS	FT ³			
BRTPP2424L2	1658	1885	50	29	28.7	38.00	24.08	5.00		
BRTPP2448L2	2187	2413	50	53	28.7	48.00	44.01	6.50		

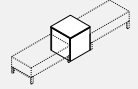
BRTS-B • Square Table Block

- Freestanding 25" high, 24" square table block serves as a visual anchor whenever bridges seat needs to turn corner, or split into two, three or four directions.
- BRTS2424BP can be positioned directly over a floor monument, which will supply power to the top-mounted Power module. This option includes 24"x24" block chassis and flush-mounted Duo power module included (two outlets and two 2.1 amp USB ports, white face plate, outlets and bezel, 72" long three prong black cord).
- The square table block can function as a self-supporting, freestanding unit or it can be secured permanently to adjacent Bridges seats with optional interconnecting brackets listed below.
- Specify LP laminate chassis, 1" LP or HP laminate surface.
- 2 Square Table Ganging Brackets Kits included.
- Powered Square Table Block has optional side panel grommet as needed. Please specify GRMTRS for right side and GRMTLS for left side.

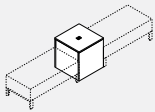

PRODUCT CODE	PRICE		SIZE/INCHES			WEIGHT		VOL	
	LP	HP	H	W	D	LBS	FT ³		
BRTS2424B	527	604	25	24	24	57.00	8.33		
BRTS2424BP	1056	1131	25	24	24	59.30	8.33		

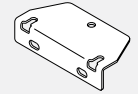
BRTSTBG • Square Table Block Ganging Bracket Kit

- Two Square Table Block Ganging Brackets connect seat legs permanently to the side of the 24" square table block on site. The kit employs machine screws connecting legs to seats and ships with wood screws which provide permanent connection to the Square Table Block.
- Includes 2 brackets and screws; Black powdercoat finish.

PRODUCT CODE	PRICE	SIZE/INCHES		WEIGHT		VOL	
		H	W	D	LBS	FT ³	
BRTSTBG	37	1.1	5	2.4	0.50	0.01	

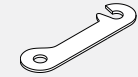
BRTSTSB • Ganging Bracket Kit

- Two ganging brackets connect seat temporarily to adjacent in-line seat or 24" deep bridges storage.
- Black powder coat finish.

PRODUCT CODE	PRICE	SIZE/INCHES		WEIGHT		VOL	
		H	W	D	LBS	FT ³	
BRTSTSB	18	.1	6	1.3	0.3	0.00	

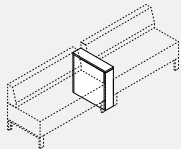
BRTS-Bx • Inline 6" Block

- Multifunctional In-line 6" table block divides seating areas, serves as a utility surface, can support tablet arms, lamps and double as a power delivery centre.
- It is permanently secured between two Bridges seats and cannot be placed at the end of a run. Two Square Table Block Ganging Brackets BRTSTBG connect seat legs permanently to the side of the in-line table block on site. The included kit employs machine screws connecting legs to seats and ships with wood screws which provide permanent connection to the Inline 6" Block. Black powder coat finish.
- The chassis is available without Power Module, with one Power Module or with two vertically embedded Power Modules.
- Vertical-panel flush-mounted Duo module provides two outlets and two 2.1 amp USB ports; 72" cord exits through the bottom and plugs into a floor monument under seats, white face plate and bezel.
- BRTS2406BT and BRTS2406BPT include 9.5" x 14.5" swivel tablet.
- Specify LP laminate chassis, 1" LP or HP laminate surface. If top is specified in LP the tablet will be manufactured in LP as well. If top is specified in HP the tablet will be manufactured in HP.
- 2 Square Table Ganging Bracket Kits included.

PRODUCT CODE	PRICE		SIZE/INCHES			WEIGHT		VOL	
	LP	HP	H	W	D	LBS	FT ³		
BRTS2406B	452	488	25	6	24	21.00	2.08		
BRTS2406BP	982	1018	25	6	24	23.30	2.08		
BRTS2406B2P	1508	1545	25	6	24	24.30	2.08		
BRTS2406BT	867	905	25	6	24	25.60	2.08		
BRTS2406BPT	1395	1434	25	6	24	24.30	2.08		

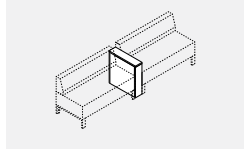
BRTS2406B

Inline table (without power module and swivel arm).

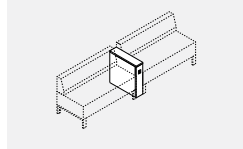
BRTS2406BP

Inline table with front power module

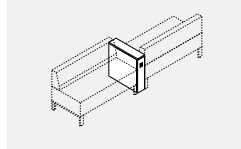
BRTS2406B2P

Inline table with front and rear power module.

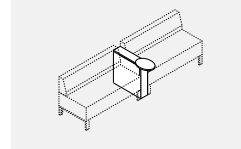
BRTS2406BT

Inline table with swivel tablet arm.

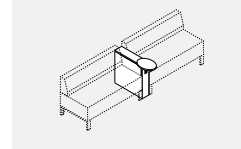
BRTS2406BPT

Inline table with front power module and swivel tablet arm.

Statement of Line

Tables - Work Height Tables



SCTWDxxxx

Core Collaboration Table
Small Radius
Corner Levelers

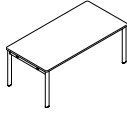

SCTWSLxxxx

Standard Collaboration Table
Small Radius
Corner Levelers

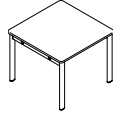

SCTSWSLxxxx

Workshop Table
Small Radius
Corners Levelers

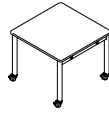

SCTSWSCxxxx

Workshop Table
Small Radius
Corners Casters

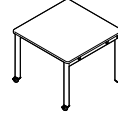

SCTSWSXxxxx

Workshop Table
Small Radius
Corners Levelers/Casters

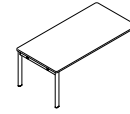

SCTLWSLxxxx

Large Collaboration Table
Small Radius
Corners Levelers

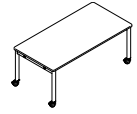

SCTLWSCxxxx

Large Collaboration Table
Small Radius
Corners Casters

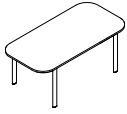

SCTLWLLxxxx

Large Collaboration Table
Large Radius
Corners Levelers

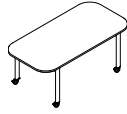

SCTLWLCxxxx

Large Collaboration Table
Large Radius
Corners Casters

Tables - Cafe Height Tables

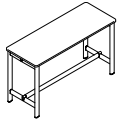

SCTCSLxxxx

Standard Collaboration Table
Small Radius
Corner Levelers



SCTSCSLxxxx

Workshop Table
Small Radius
Corners Levelers

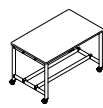

SCTSCSCxxxx

Workshop Table
Small Radius
Corners Casters

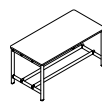

SCTLCSLxxxx

Large Collaboration Table
Small Radius
Corners Levelers

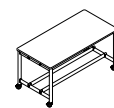

SCTL CSCxxxx

Large Collaboration Table
Small Radius
Corners Casters

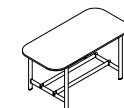

SCTLCLLxxxx

Large Collaboration Table
Large Radius
Corners Levelers



SCTLCLCxxxx

Large Collaboration Table
Large Radius
Corners Casters

Tables - Bar Height Tables

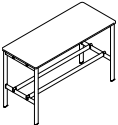

SCTBSLxxxx

Standard Collaboration Table
Small Radius
Corner Levelers

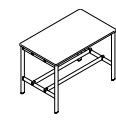

SCTBSLxxxx

Workshop Table
Small Radius
Corners Levelers

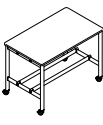

SCTBSCLxxxx

Workshop Table
Small Radius
Corners Casters

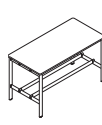

SCTLBSLxxxx

Large Collaboration Table
Small Radius
Corners Levelers

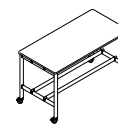

SCTLBSCxxxx

Large Collaboration Table
Small Radius
Corners Casters

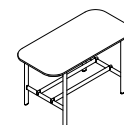

SCTLBLLxxxx

Large Collaboration Table
Large Radius
Corners Levelers



SCTLBLCxxxx

Large Collaboration Table
Large Radius
Corners Casters

Tables - Occasional, Coffee Tables (17"H)

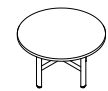

SCOCRxxxx

Coffee Table
Round Top

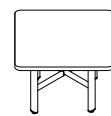

SCOCSxxxx

Coffee Table
Square Top
Small Radius Corner

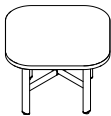

SCOCSLxxxx

Coffee Table
Square Top
Large Radius Corner



SCOCCxxxx

Coffee Table
Racetrack Top



SCORxxxx

Side Table
Round Top

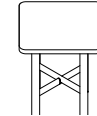

SCOCxxxx

Side Table
Square Top
Small Radius Corner

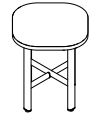

SCOCLxxxx

Side Table
Square Top
Large Radius Corner

Tables - Laptop Tables



SCLCCxxxx

Laptop Table
Racetrack Top
Wheel + Foot Base

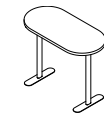

SCLCBxxxx

Laptop Table
Racetrack Top
Foot Base

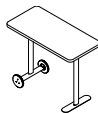

SCLTCxxxx

Laptop Table
Rectangular Top
Wheel + Foot Base

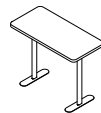

SCLTBxxxx

Laptop Table
Rectangular Top
Foot Base

Tables - Laptop Tables

Statement of Line

Table - Accessories

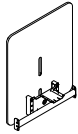

SCTAMxx
Collaboration Table
Media Unit

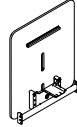

SCTAMTxx
Collaboration Table
Media Unit with TV Mount



SCTALxx
Table Leg
Cable Organizer

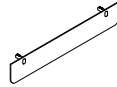

SCTAPxx
PET Felt
Modesty Panel

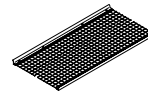

SCTATxxxx
Wire Mesh
Storage Tray



SCTAH
Table Mounted
Bag Hook

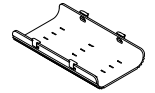

SCTACT
PET Felt Wire
Manager

Table Power - Accessories



SCTAPExx
Nik Edge/Clamp
Power Module



SCTAPsx
Nik In-Surface
Power Module



SCTAPBx
Nik Below Surface
Power Module



SCTAPPBx
Below Surface
Power Bar

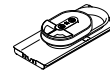

SCAPTx
Collaborative
Spaces Power Tray



SCTAOTx
Collaborative Spaces
Organizer Tray



SCTAPRx
Collaborative Spaces
Recessed Power Tray

Team - Carts

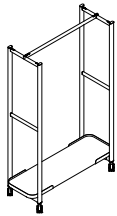

SCRRxx
Coat Rack
Cart

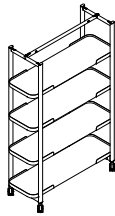

SCSSxxxx
Shelf Cart

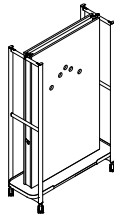

SCCMxxxxxx
Media Cart

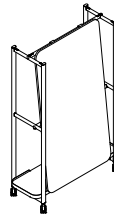

SCCSWxxxx
Single Sided
Writeboard Cart



SCCDWxxxx
Double Sided
Writeboard Cart

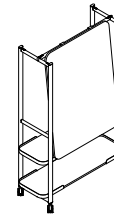

SCCCWxxxx
Combo Writeboard Cart

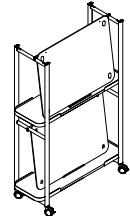

SCCRWxxxx
Removable Writeboard Cart

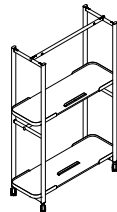

SCCEWxxxx
Empty Removeable
Writeboard Cart



SCHCxxxx
Hospitality Cart

Team Cart - Accessories

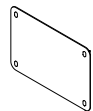

SCCAPPxxxx
Cart Mounted PET Privacy
Panel

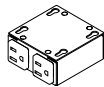

SCCAMP
Concealed Power
Unit
(for Media Cart)

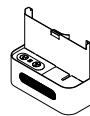

SCCAMTxx
Media Tray
(for Media Cart)



SCCAC
Accessory Cup



SCCAH
Accessory Hook

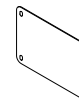

SCCAWBxxxx
Writeboard

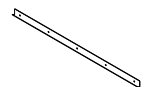

SCCAWBRxx
Writeboard
Wall Rail



SCCALSxxxx
Laptop Shelf

Information

Three table heights

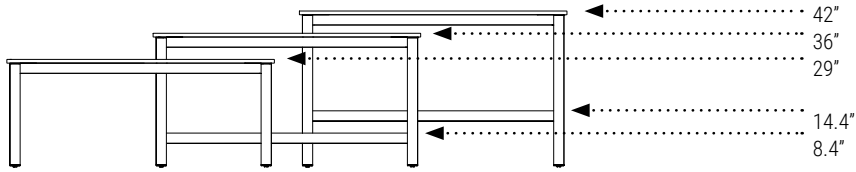

Table Corner Radius Detail

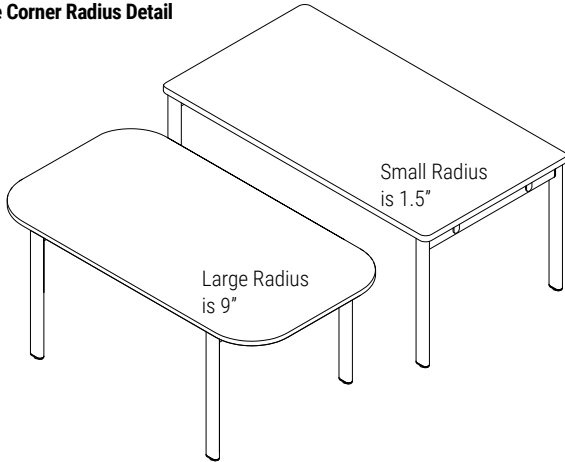
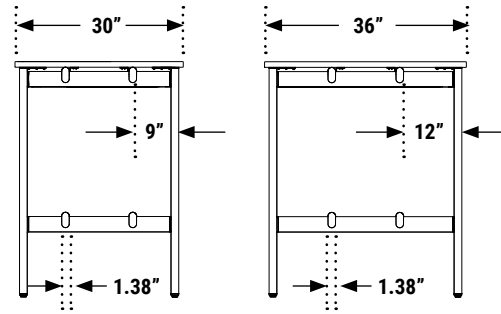
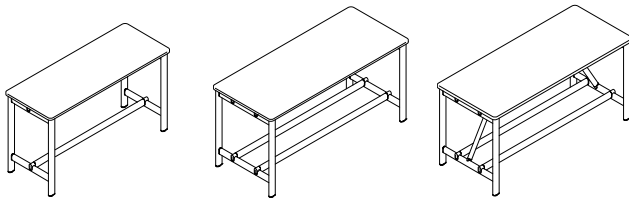

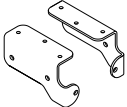

Table End Leg Detail



Support Beam Detail



Beam Support

WIDTH RANGE	DEPTH RANGE	HEIGHT RANGE	BEAM SUPPORT - Y/N 	STANCHION - Y/N 
36", 42"	18" to 48" (ALL)	WORK, CAFÉ, BAR	NO	NO
48" to 72"	18" to 48"	WORK, CAFÉ, BAR	YES	NO
78" to 96"	30" to 48"	WORK	YES	NO
78" to 96"	30" to 48"	CAFÉ, BAR (Small Radius)	YES	YES

Grommet Locations

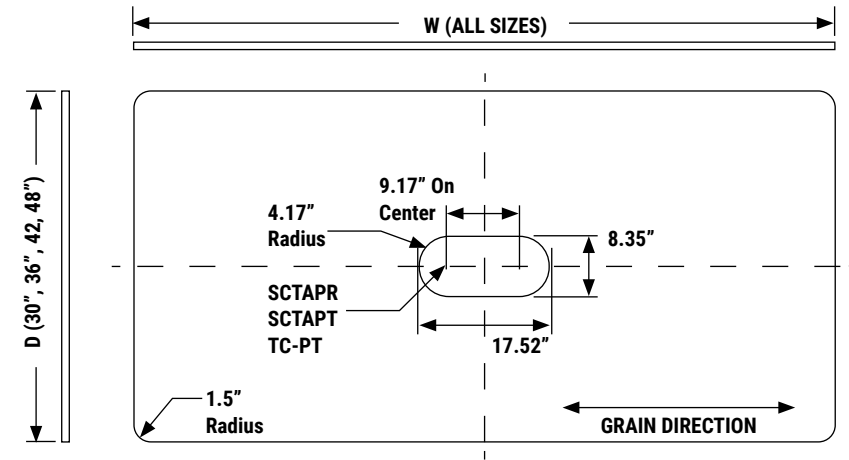

NOTES:

1. Cutout not available for 18" and 24" Deep Tables.
2. Cutout Position TC available only.
3. These rules apply to both Small and Large Radius Table Tops. Small Radius Top Shown.

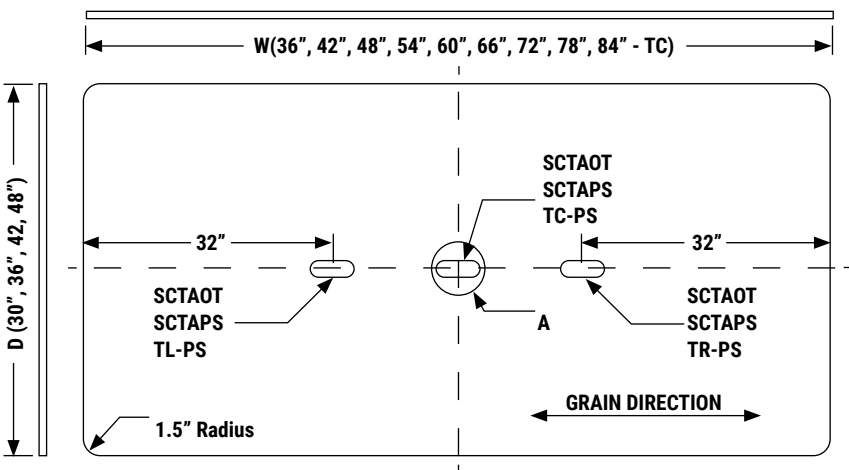

NOTES:

1. Cutout not available for 18" and 24" Deep Tables.
2. SCTAOT/SCTAPS/TL TR Available only for 90" & 96" WIDE TABLES.
3. These rules apply to both Small and Large Radius Table Tops. Small Radius Top Shown.

Power Module Planning

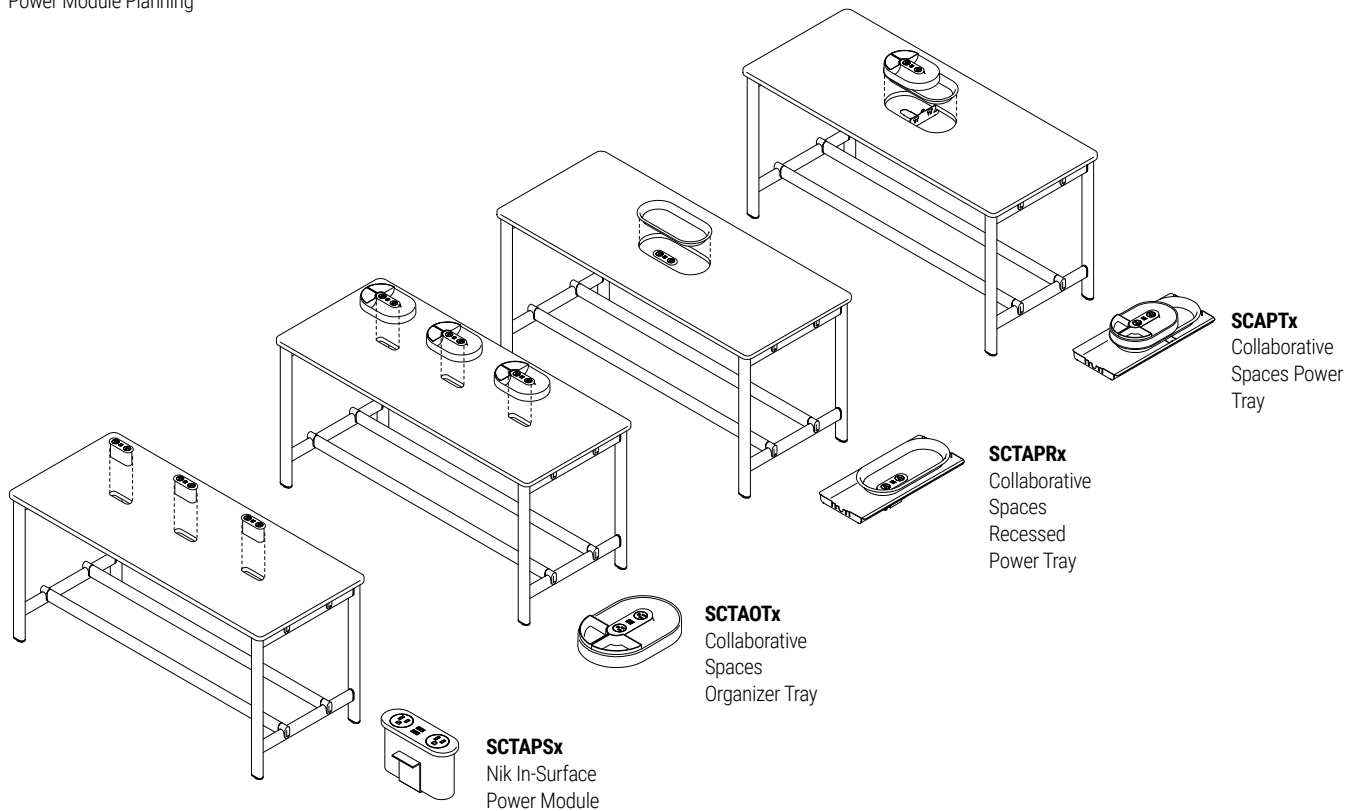

Planning

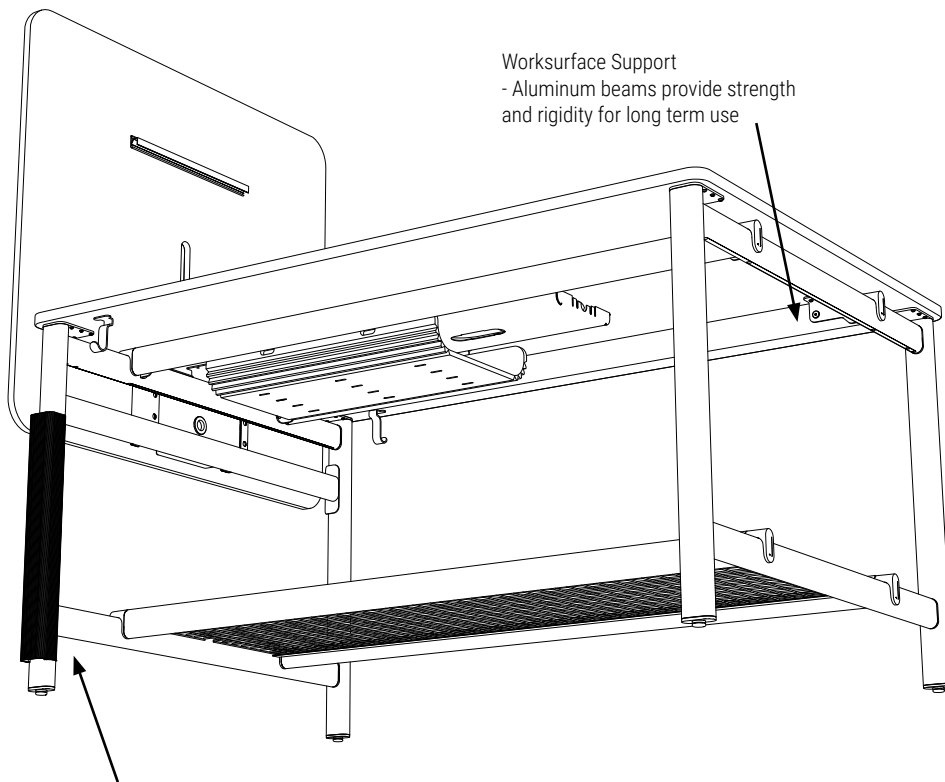
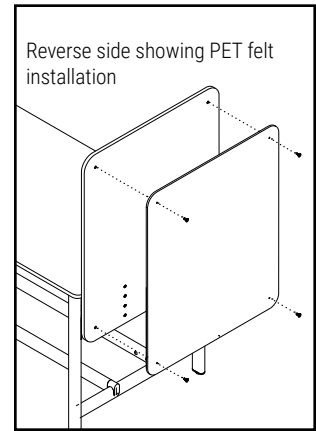
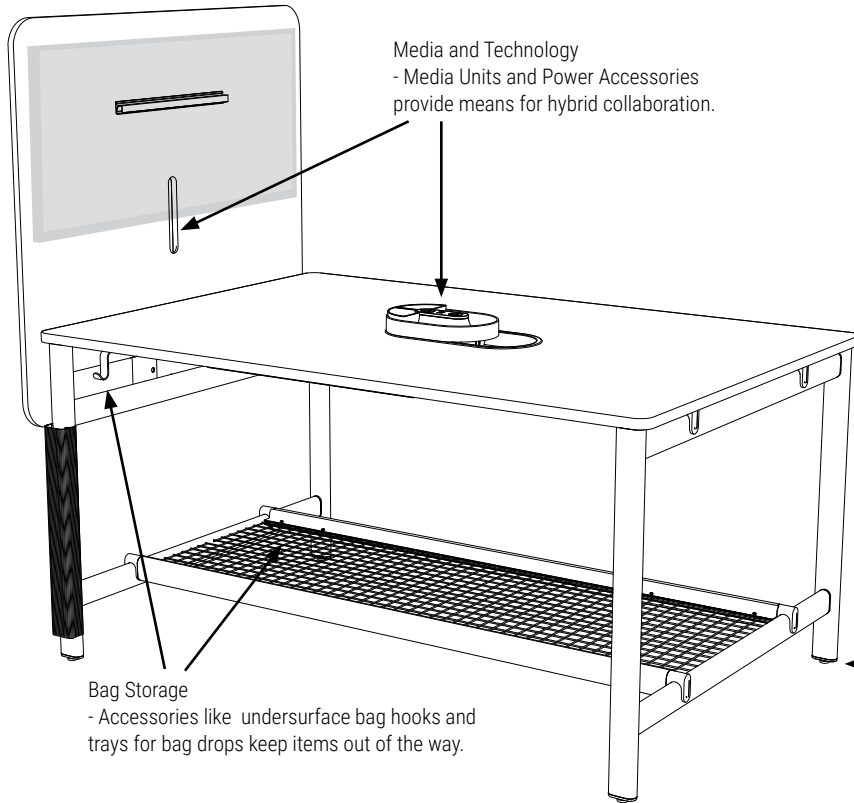

Planning

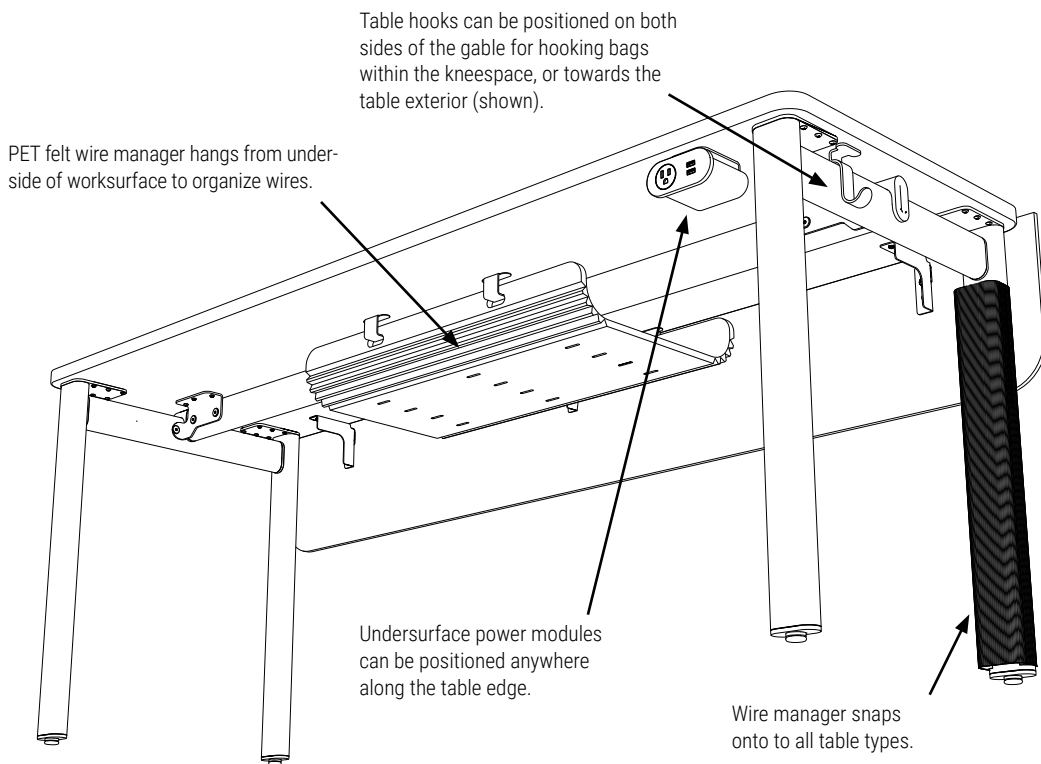
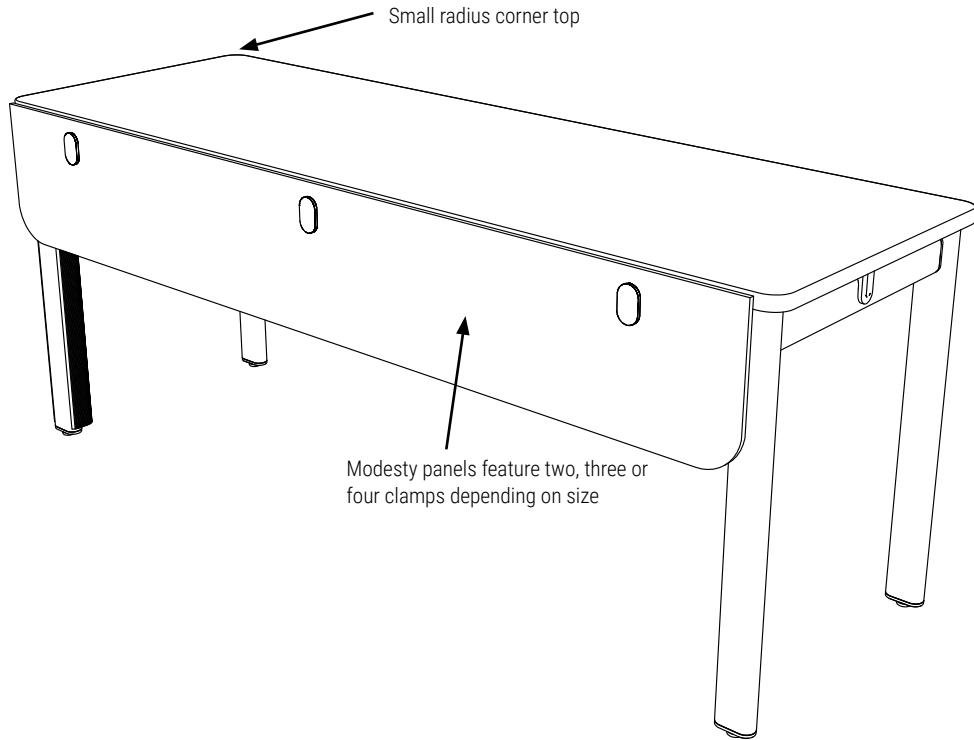

Planning

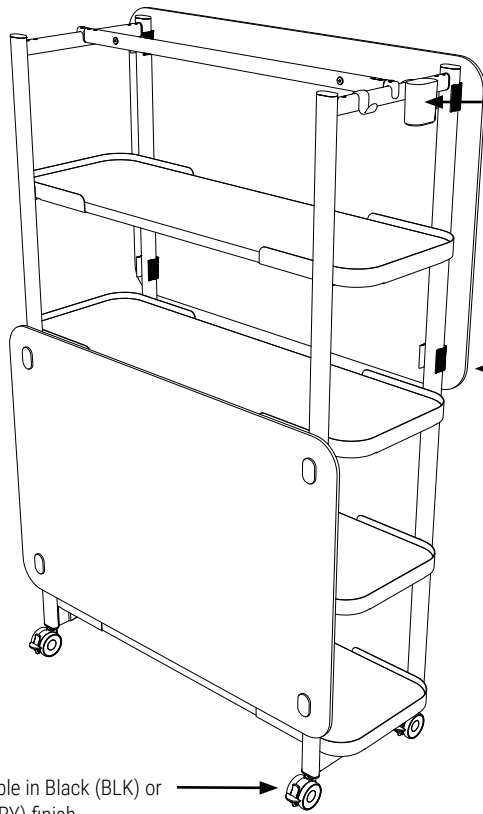

Accessorize
- Small side rails accept hooks and accessory cups

Privacy
- PET Felt screens provide privacy and some acoustic properties while dividing space.

Casters
- Available in Black (BLK) or Grey (GRY) finish

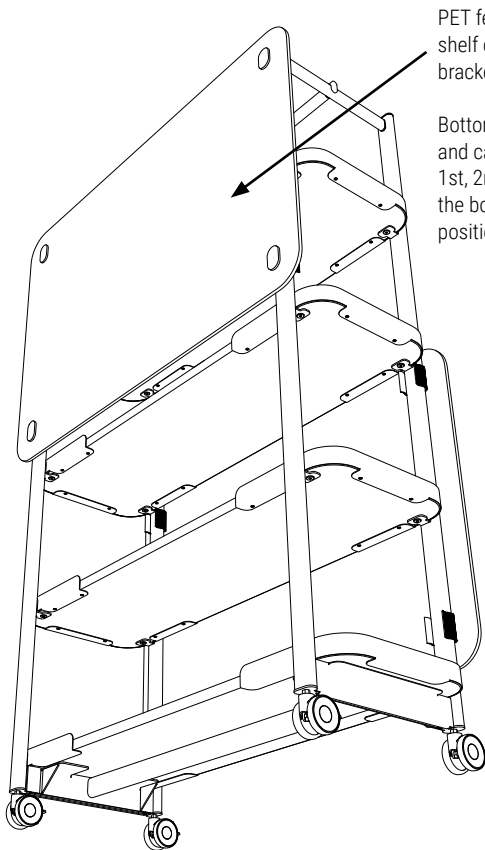

PET felt screens clip onto shelf carts with included brackets.

Bottom clip rests on shelves and can be placed at the 1st, 2nd or 3rd shelf from the bottom (1st and 3rd position shown).

Planning

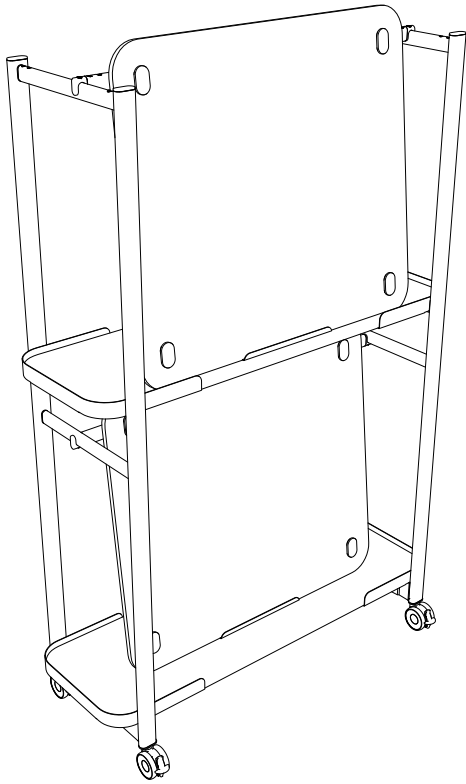

Writeboard on a wall (Wall rails are sold separately)

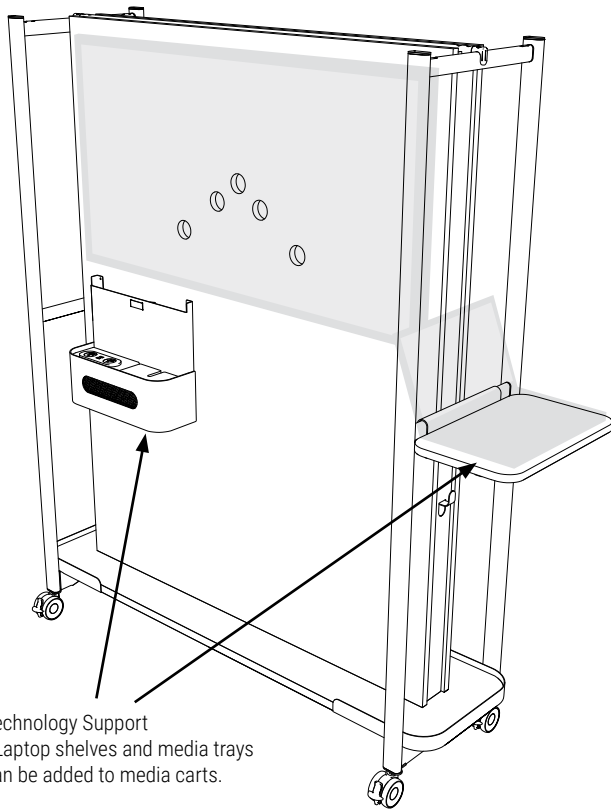
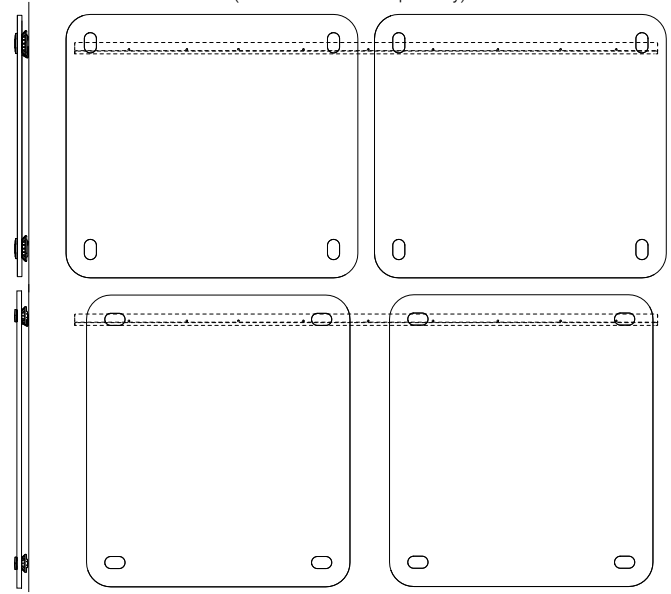

Technology Support
- Laptop shelves and media trays
can be added to media carts.

Planning

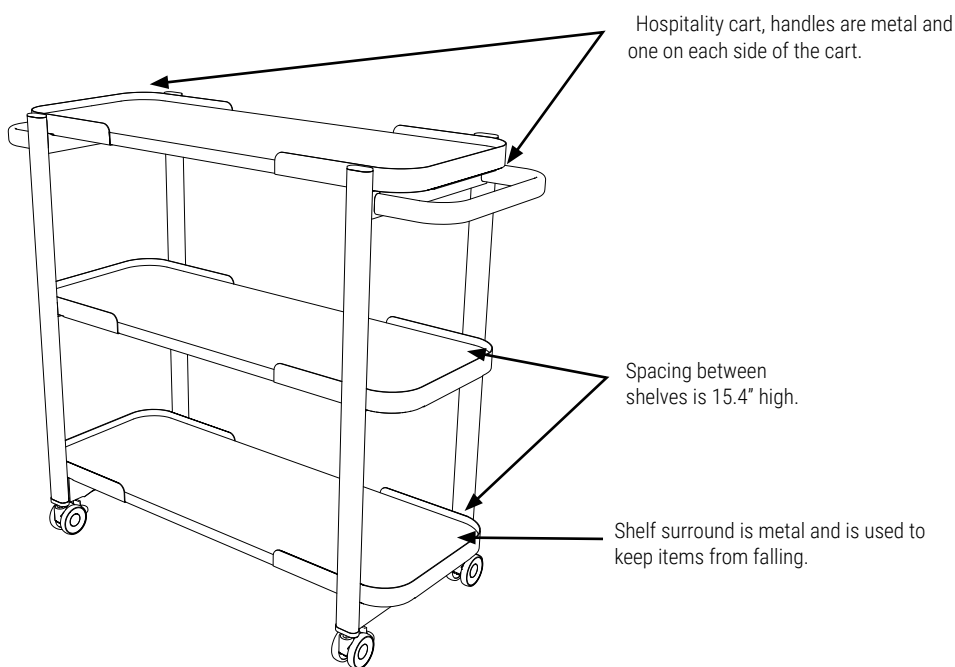
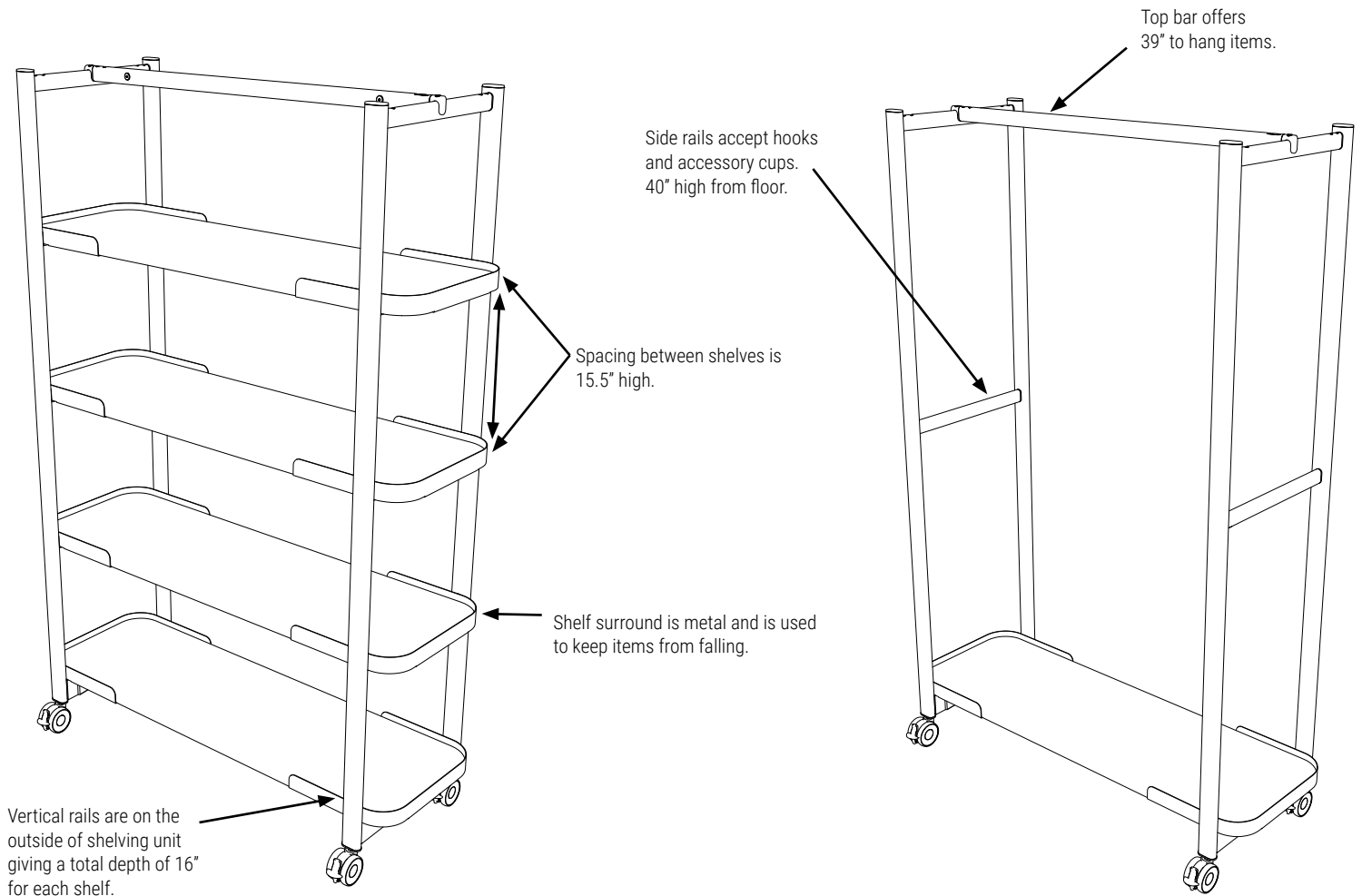

Planning

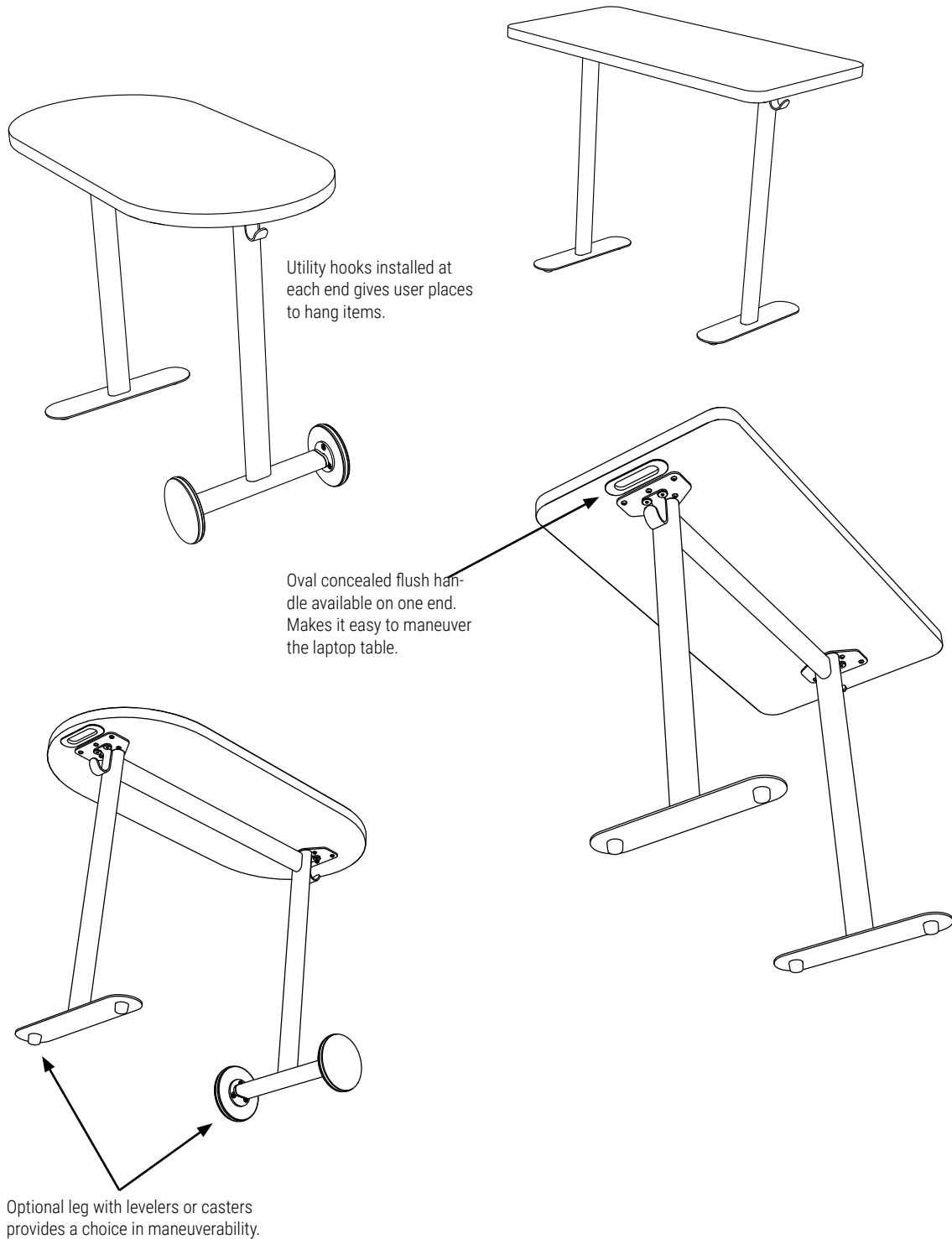

Please contact your Global Contract Service Representative at 416-739-5000 for any questions or concerns.

NOTE: Any alterations to listed components will void the manufacturer's warranty. The manufacturer will not be responsible for any damage or bodily harm caused by alterations in accordance with national or local electrical codes and manufacturer's speci-

fications. In accordance with the manufacturer's policy of continual product improvement, the product presented in this document is subject to change without notice or obligation.

COLLABORATIVE SPACES

Technical Notes

- All tables are available in HP - High Pressure Laminate (1-1/16" thick) or LP - Low Pressure Laminate (1" thick) with flat edge.
- Surfaces constructed of 45lb. density particleboard substructure with low pressure laminate or optional high pressure laminate.
- All tables are PVC 3mm edge banded.
- Grommet location must be specified at the time of order or it will default to a no grommet option.
- Power modules and grommets are not included, they must be specified separately.
- Table legs and bases are painted aluminum finish.
- Tables are shipped knocked down and must be assembled on site.
- Cart shelf load capacities : 120 lbs for 42" wide (Hospitality Cart), 140 lbs for 48" wide and 175 lbs for 60" wide.
- Casters cannot be used with TV Mount units and wire basket for tables larger than 78" long.

DIMENSIONS

Corner radius for small radius table tops is 1.5".

Corner radius for large radius tables tops is 9".

Top end overhang for large tables is 10.5"

Worksurface support beams and footrests (where applicable) are centered for tables 18" and 24" deep.

Worksurface support beams and footrests (where applicable) are 9" from the outside table edges for tables 30" deep.

Worksurface support beams and footrests (where applicable) are 12" from the outside table edges for tables 36 to 48" deep.

GENERAL NOTES

- GREENGUARD certified (www.greenguard.org)
- Carb compliant
- Level3™ certified (www.levelcertified.org)
- Tested to meet or exceed ANSI/BIFMA X5.9.2019 , ANSI/ BIFMA X5.5.2021 and CAN/CGSB 44-227-2008
- Plant is ISO 9001:2015 (Quality) certified
- Plant is ISO 14001:2015 (Environmental) certified
- Plant is OHSAS 18001:2007 (Health and Safety) certified
- 100% made in Canada
- Lifetime Warranty

STORAGE AND WORKSURFACE FINISHES

Metal Storage Colors - Panel Frame

Matches	
Black	BLK
Blizzard	BZD
Charcoal	CHR
Designer White	DWT
Ink	TIN
Nevada	NEV
Silver	SIL
Stonedust	SDT
Taupe	TPE
Tungsten	TUN

PVC Edge Finishes - Panel Frame

Matches	
Black	BLK
Blizzard	BZD
Brushed Cobalt	BRC
Charcoal	CHR
Designer White	DWE
Nevada	NEV
Silver	SIL
Stonedust	SDT
Taupe	TPE
Tungsten	TUN

Worksurface PVC Edge Trim - Wood

Grain Matches			
Absolute Acajou	AAE	Noce Leggero	NEL
Asian Night	ASE	Noce Medio	NML
Avant Cherry	ACE	Quartered Mahogany	QTM
Avant Honey	AHE	Sheer Beauty	SBY
Clear Maple	CME	Walnut Heights	WHE
Dark Espresso	DEE	White Chocolate	CBE
Fashionista	FAS	Winter Cherry	WCE
First Class	FCL		
Noce Biondo	NBL		
Noce Grigio	NGL		

Low Pressure Laminates (LP) Panel Frame Matches

Black	BLKLP
Blizzard	BZDLP
Brushed Cobalt (Tungsten)	BRCLP
Custom Grey (Silver)	CGYLP
Designer White	DWTLP
Hayden Grey (Taupe)	HGTLP
Stonedust	SDTLP
Storm Grey (Charcoal)	SOGLP
String (Nevada)	STGLP

Low Pressure Laminates (LP) Solids and Patterns

Blizzard Matrix	BMXLP
Grey Matrix	GRXLP
Hayden Linen	HLNLP
Stone Linen	SLNLP
Studio White Matrix	SWXLP

Low Pressure Laminates (LP) Wood Grain Laminates

Absolute Acajou	ACJLP	Noce Leggero	NELLP
Asian Night	ASNLP	Noce Medio	NMLLP
Avant Cherry	AWCLP	Quartered Mahogany	QTM LP
Avant Honey	AWHLP	Sheer Beauty	SBYLP
Clear Maple	CMBLP	Walnut Heights	WHELP
Dark Espresso	DESLP	White Chocolate	WHCLP
Fashionista	FASLP	Winter Cherry	WCRLP
First Class	FCLLP		
Noce Biondo	NBLLP		
Noce Grigio	NGLLP		

High Pressure Laminates (HP) Panel Frame Matches

Black	BLKHP
Blizzard	BZDHP
Brushed Cobalt (Tungsten)	BRCHP
Custom Grey (Silver)	CGYHP
Designer White	DWTHP
Hayden Grey (Taupe)	HGTHP
Stonedust	SDTHP
Storm Grey (Charcoal)	SOGHP
String (Nevada)	STGHP

High Pressure Laminates (HP) Solids and Patterns

Blizzard Matrix	BMXHP
Grey Matrix	GRXHP
Hayden Linen	HLNHP
Stone Linen	SLNHP
Studio White Matrix	SWXHP

High Pressure Laminates (HP) Wood Grain Laminates

Absolute Acajou	ACJHP	Noce Leggero	NELHP
Asian Night	ASNHP	Noce Medio	NMLHP
Avant Cherry	AWCHP	Quartered Mahogany	QTMHP
Avant Honey	AWHHP	Sheer Beauty	SBYHP
Clear Maple	CMBHP	Walnut Heights	WHEHP
Dark Espresso	DESHP	White Chocolate	WHCHP
Fashionista	FASHP	Winter Cherry	WCRHP
First Class	FCLHP		
Noce Biondo	NBLHP		
Noce Grigio	NGLHP		

Caster Finish

Black	BLK
Grey	GRC

COLLABORATIVE SPACES

Spaces Collaborative Specifications

HOW TO SPECIFY :

Example: SCTWSL2472

SC	Space Collaborative	
T	Table	
W	Work Height Table - 29"	Other Options: C - Café Height Table - 36" B - Bar Height Table - 42"
S	Small Radius - 1.5"	Other Options: L - Large Radius - 9"
L	Levelers	Other Options: C - Casters - Available in BLK - Black or GRC - Grey
24	Depth	
72	Width	
LP	Low Pressure Laminate	Other Options: HP - High Pressure

Choose: Laminate Finish
Edging
Paint
Grommet location as per chart

COLLABORATIVE SPACES

SCTWD • Core Collaboration Table, 29" Work Height, Small Radius, Levelers

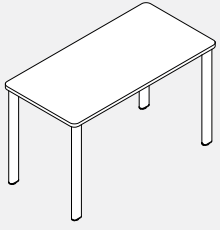

- Core Work Height Collaboration Tables on levelers consist of four individual legs and one surface with a small 1.5" radius at each corner.
- Surface available in LP - Low Pressure or HP - High Pressure laminates.
- Legs are painted extruded aluminum. Levelers have 1" adjustment for leveling.
- Tables from 48" to 72" include a center worksurface support beam
- Center worksurface support beam eliminates the possibility of a grommet cutout.

PRODUCT CODE	PRICE		SIZE/INCHES			WEIGHT LBS	VOL FT ³
	LP	HP	H	W	D		
SCTWD1836	587	658	29	36	18	35.54	2.33
SCTWD1842	612	695	29	42	18	38.52	2.52
SCTWD1848	676	771	29	48	18	47.06	2.71
SCTWD1854	708	815	29	54	18	50.88	2.90
SCTWD1860	734	896	29	60	18	54.70	3.08
SCTWD1866	769	946	29	66	18	58.52	3.27
SCTWD1872	803	997	29	72	18	62.34	3.46
SCTWD2436	631	725	29	36	24	41.51	3.11
SCTWD2442	662	772	29	42	24	45.49	3.36
SCTWD2448	732	858	29	48	24	55.02	3.61
SCTWD2454	770	912	29	54	24	59.83	3.86
SCTWD2460	802	1015	29	60	24	64.65	4.11
SCTWD2466	843	1077	29	66	24	69.46	4.36
SCTWD2472	884	1138	29	72	24	74.27	4.61
SCTWD3036	674	792	29	36	30	47.47	3.89
SCTWD3042	712	850	29	42	30	52.45	4.20
SCTWD3048	788	945	29	48	30	62.98	4.51
SCTWD3054	832	1010	29	54	30	68.78	4.83
SCTWD3060	871	1134	29	60	30	74.59	5.14
SCTWD3066	918	1207	29	66	30	80.40	5.45
SCTWD3072	964	1280	29	72	30	86.20	5.76

SCTWSL • Standard Collaboration Table, 29" Work Height, Small Radius, Levelers

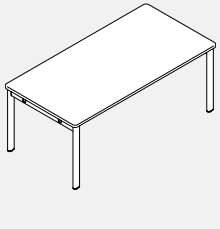

- Work Height Collaboration Tables on levelers consist of two leg assemblies, worksurface support beams and one worksurface with a small 1.5" radius at each corner.
- Surface available in LP - Low Pressure or HP - High Pressure laminates.
- Legs are painted extruded aluminum. Levelers have 1" adjustment for leveling.
- Cutouts for power modules are limited to specific sizes/configurations, please see Grommet Location Chart.
- 18" and 24" deep tables feature one worksurface support beam.
- 30" deep tables feature two worksurface support beams.

PRODUCT CODE	PRICE		SIZE/INCHES			WEIGHT LBS	VOL FT ³
	LP	HP	H	W	D		
SCTWSL1836	899	970	29	36	18	40.05	2.33
SCTWSL1842	957	1040	29	42	18	43.65	2.52
SCTWSL1848	1140	1235	29	48	18	50.15	2.71
SCTWSL1854	1166	1272	29	54	18	53.75	2.90
SCTWSL1860	1213	1331	29	60	18	57.34	3.08
SCTWSL1866	1239	1368	29	66	18	60.93	3.27
SCTWSL1872	1301	1443	29	72	18	64.52	3.46
SCTWSL1878	1326	1480	29	78	18	68.12	3.65
SCTWSL1884	1352	1517	29	84	18	71.71	3.83
SCTWSL1890	1451	1628	29	90	18	75.31	4.02
SCTWSL1896	1476	1665	29	96	18	78.90	4.21
SCTWSL2436	967	1062	29	36	24	43.05	3.11
SCTWSL2442	1032	1142	29	42	24	46.65	3.36
SCTWSL2448	1221	1347	29	48	24	53.15	3.61
SCTWSL2454	1252	1394	29	54	24	56.75	3.86
SCTWSL2460	1306	1463	29	60	24	60.34	4.11
SCTWSL2466	1337	1511	29	66	24	63.93	4.36
SCTWSL2472	1406	1595	29	72	24	67.52	4.61
SCTWSL2478	1437	1642	29	78	24	71.12	4.86
SCTWSL2484	1469	1689	29	84	24	74.71	5.11
SCTWSL2490	1574	1810	29	90	24	78.31	5.36
SCTWSL2496	1606	1857	29	96	24	81.90	5.61
SCTWSL3036	1162	1280	29	36	30	46.05	3.89
SCTWSL3042	1266	1404	29	42	30	49.65	4.20
SCTWSL3048	1483	1641	29	48	30	56.15	4.51
SCTWSL3054	1521	1698	29	54	30	59.75	4.83
SCTWSL3060	1603	1800	29	60	30	63.34	5.14
SCTWSL3066	1641	1857	29	66	30	66.93	5.45
SCTWSL3072	1752	1988	29	72	30	70.52	5.76
SCTWSL3078	1808	2064	29	78	30	74.12	6.08
SCTWSL3084	1845	2121	29	84	30	77.71	6.70
SCTWSL3090	2030	2326	29	90	30	81.31	6.39
SCTWSL3096	2068	2383	29	96	30	84.90	7.01

COLLABORATIVE SPACES

SCTCSL • Standard Collaboration Table, 36" Café Height, Small Radius, Levelers

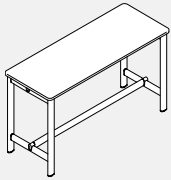

For 18" and 24" deep surfaces

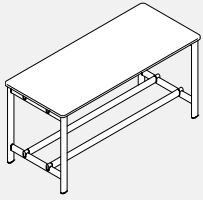

For 30" deep tables, 36" to 72" wide

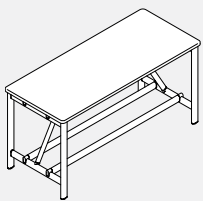

For 30" deep tables, 78" to 96" wide

- Café Height Collaboration Tables on levelers consist of two leg assemblies, worksurface support beam(s), footrest(s) and one worksurface with a small 1.5" radius at each corner.
- Surface available in LP - Low Pressure or HP - High Pressure laminates.
- Legs are painted extruded aluminum.
- Levelers have 1" adjustment for leveling.
- Cutouts for power modules are limited to specific sizes/configurations, please see Grommet Location Chart.
- Tables 18" and 24" deep feature one worksurface support beam and one footrest.
- Tables 30" deep feature two worksurface support beams and two footrests.
- Tables 30" deep and 78" wide and greater include a reinforcement cantilever for added stability.

PRODUCT CODE	PRICE		SIZE/INCHES			WEIGHT LBS	VOL FT ³
	LP	HP	H	W	D		
SCTCSL1836	1277	1348	36	36	18	50.14	2.33
SCTCSL1842	1369	1452	36	42	18	54.34	2.52
SCTCSL1848	1551	1645	36	48	18	61.46	2.71
SCTCSL1854	1576	1682	36	54	18	65.66	2.90
SCTCSL1860	1646	1764	36	60	18	69.87	3.08
SCTCSL1866	1671	1801	36	66	18	74.07	3.27
SCTCSL1872	1770	1912	36	72	18	78.28	3.46
SCTCSL1878	1796	1949	36	78	18	82.48	3.65
SCTCSL1884	1821	1987	36	84	18	86.69	3.83
SCTCSL1890	1994	2171	36	90	18	90.90	4.02
SCTCSL1896	2019	2208	36	96	18	95.10	4.21
SCTCSL2436	1370	1465	36	36	24	67.83	3.11
SCTCSL2442	1468	1578	36	42	24	74.58	3.36
SCTCSL2448	1656	1782	36	48	24	84.23	3.61
SCTCSL2454	1687	1829	36	54	24	90.98	3.86
SCTCSL2460	1763	1921	36	60	24	97.73	4.11
SCTCSL2466	1795	1968	36	66	24	104.48	4.36
SCTCSL2472	1900	2089	36	72	24	111.23	4.61
SCTCSL2478	1931	2136	36	78	24	117.98	4.86
SCTCSL2484	1963	2183	36	84	24	124.73	5.11
SCTCSL2490	2142	2378	36	90	24	131.48	5.36
SCTCSL2496	2173	2425	36	96	24	138.23	5.61
SCTCSL3036	1717	1835	36	36	30	86.09	3.89
SCTCSL3042	1887	2025	36	42	30	95.44	4.20
SCTCSL3048	2081	2239	36	48	30	107.70	4.51
SCTCSL3054	2119	2296	36	54	30	117.05	4.83
SCTCSL3060	2245	2442	36	60	30	126.41	5.14
SCTCSL3066	2282	2499	36	66	30	135.76	5.45
SCTCSL3072	2468	2704	36	72	30	145.11	5.76
SCTCSL3078	2651	2906	36	78	30	156.91	6.08
SCTCSL3084	2688	2964	36	84	30	166.26	6.70
SCTCSL3090	3021	3316	36	90	30	175.62	6.39
SCTCSL3096	3058	3373	36	96	30	184.97	7.01

COLLABORATIVE SPACES

SCTBSL • Standard Collaboration Table, 42" Bar Height, Small Radius, Levelers

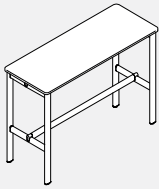

For 18" and 24" deep surfaces

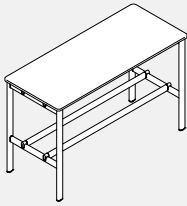

For 30" deep tables, 36" to 72" wide

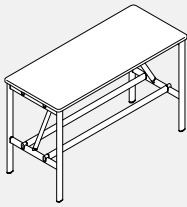

For 30" deep tables, 78" to 96" wide

- Bar Height Collaboration Tables on levelers consist of two leg assemblies, worksurface support beam(s), footrest(s) and one worksurface with a small 1.5" radius at each corner.
- Surface available in LP - Low Pressure or HP - High Pressure laminates.
- Legs are painted extruded aluminum. Levelers have 1" adjustment for leveling.
- Cutouts for power modules are limited to specific sizes/configurations, please see Grommet Location Chart.
- Tables 18" and 24" deep feature one worksurface support beam and one footrest.
- Tables 30" deep feature two worksurface support beams and two footrests.
- Tables 30" deep and 78" wide and greater include a reinforcement cantilever for added stability.

PRODUCT CODE	PRICE		SIZE/INCHES			WEIGHT		VOL FT ³
	LP	HP	H	W	D	LBS		
SCTBSL1836	1378	1449	42	36	18	52.58	2.33	
SCTBSL1842	1470	1553	42	42	18	56.79	2.52	
SCTBSL1848	1652	1746	42	48	18	63.90	2.71	
SCTBSL1854	1677	1784	42	54	18	68.11	2.90	
SCTBSL1860	1747	1865	42	60	18	72.31	3.08	
SCTBSL1866	1772	1902	42	66	18	76.52	3.27	
SCTBSL1872	1871	2013	42	72	18	80.72	3.46	
SCTBSL1878	1897	2050	42	78	18	84.93	3.65	
SCTBSL1884	1922	2088	42	84	18	89.13	3.83	
SCTBSL1890	2095	2272	42	90	18	93.34	4.02	
SCTBSL1896	2121	2310	42	96	18	97.55	4.21	
SCTBSL2436	1471	1566	42	36	24	70.28	3.11	
SCTBSL2442	1569	1679	42	42	24	77.02	3.36	
SCTBSL2448	1757	1883	42	48	24	86.68	3.61	
SCTBSL2454	1789	1930	42	54	24	93.43	3.86	
SCTBSL2460	1864	2022	42	60	24	100.18	4.11	
SCTBSL2466	1896	2069	42	66	24	106.93	4.36	
SCTBSL2472	2001	2190	42	72	24	113.68	4.61	
SCTBSL2478	2033	2237	42	78	24	120.43	4.86	
SCTBSL2484	2064	2285	42	84	24	127.18	5.11	
SCTBSL2490	2243	2479	42	90	24	133.93	5.36	
SCTBSL2496	2275	2527	42	96	24	140.67	5.61	
SCTBSL3036	1818	1936	42	36	30	88.53	3.89	
SCTBSL3042	1988	2126	42	42	30	97.89	4.20	
SCTBSL3048	2182	2340	42	48	30	110.14	4.51	
SCTBSL3054	2220	2397	42	54	30	117.05	4.83	
SCTBSL3060	2346	2543	42	60	30	126.41	5.14	
SCTBSL3066	2384	2600	42	66	30	135.76	5.45	
SCTBSL3072	2569	2805	42	72	30	145.11	5.76	
SCTBSL3078	2752	3008	42	78	30	159.35	6.08	
SCTBSL3084	2789	3065	42	84	30	168.71	6.40	
SCTBSL3090	3122	3417	42	90	30	178.06	6.71	
SCTBSL3096	3160	3474	42	96	30	187.41	7.01	

SCTSWSL • Workshop Table, 29" Work Height, Small Radius, Levelers

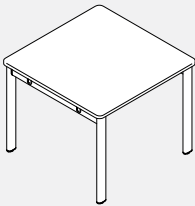

- Work Height Workshop Tables on levelers consist of two leg assemblies, two worksurface support beams and a one worksurface with a small 1.5" radius at each corner.
- Surface available in LP - Low Pressure or HP - High Pressure laminates.
- Legs are painted extruded aluminum. Levelers have 1" adjustment for leveling.
- Cutouts for power modules are limited to specific sizes/configurations, please see Grommet Location Chart.

PRODUCT CODE	PRICE		SIZE/INCHES			WEIGHT		VOL FT ³
	LP	HP	H	W	D	LBS		
SCTSWSL3636	1235	1377	29	36	36	79.31	4.67	
SCTSWSL3642	1390	1555	29	42	36	88.83	5.04	
SCTSWSL3648	1567	1756	29	48	36	101.24	5.42	
SCTSWSL3654	1611	1824	29	54	36	110.76	5.79	
SCTSWSL3660	1699	1935	29	60	36	120.27	6.17	
SCTSWSL4242	1416	1609	29	42	42	99.72	5.88	
SCTSWSL4248	1644	1865	29	48	42	113.52	6.32	
SCTSWSL4254	1694	1942	29	54	42	124.41	6.76	
SCTSWSL4260	1788	2064	29	60	42	135.31	7.19	
SCTSWSL4848	1730	1982	29	48	48	125.80	7.22	
SCTSWSL4854	1786	2069	29	54	48	138.07	7.72	
SCTSWSL4860	1886	2201	29	60	48	150.35	8.22	

COLLABORATIVE SPACES

SCTSWSC • Workshop Table, 29" Work Height, Small Radius, Casters

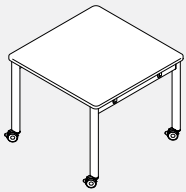

- Work Height Workshop Tables on casters consist of two leg assemblies, two worksurface support beams and a one worksurface with a small 1.5" radius at each corner.
- Surface available in LP - Low Pressure or HP - High Pressure laminates.
- Legs are painted extruded aluminum. Casters are lockable, in a choice of two finishes.
- Cutouts for power modules are limited to specific sizes/configurations, please see Grommet Location Chart.

PRODUCT CODE	PRICE		SIZE/INCHES			WEIGHT LBS	VOL FT ³
	LP	HP	H	W	D		
SCTSWSC3636	1451	1593	29	36	36	79.40	4.67
SCTSWSC3642	1561	1727	29	42	36	88.92	5.04
SCTSWSC3648	1739	1928	29	48	36	101.33	5.42
SCTSWSC3654	1783	1996	29	54	36	110.85	5.79
SCTSWSC3660	1871	2107	29	60	36	120.36	6.17
SCTSWSC4242	1632	1825	29	42	42	99.81	5.88
SCTSWSC4248	1816	2037	29	48	42	113.61	6.32
SCTSWSC4254	1866	1942	29	54	42	124.50	6.76
SCTSWSC4260	1960	2236	29	60	42	135.40	7.19
SCTSWSC4848	1902	2154	29	48	48	125.89	7.22
SCTSWSC4854	1958	2241	29	54	48	138.16	7.72
SCTSWSC4860	2058	2373	29	60	48	150.44	8.22

SCTWSX • Workshop Table, 29" Work Height, Small Radius, Casters/Levelers

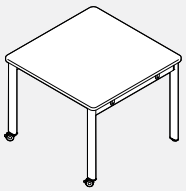

- Work Height Workshop Tables consist of one leg assembly with casters, one leg assembly with levelers, two worksurface support beams and a one worksurface with a small 1.5" radius at each corner.
- Surface available in LP - Low Pressure or HP - High Pressure laminates.
- Legs are painted extruded aluminum. Levelers have 1" adjustment for leveling. Casters are lockable, in a choice of 2 finishes.
- Cutouts for power modules are limited to specific sizes/configurations, please see Grommet Location Chart.

PRODUCT CODE	PRICE		SIZE/INCHES			WEIGHT LBS	VOL FT ³
	LP	HP	H	W	D		
SCTWSX3636	1343	1485	29	36	36	79.36	4.67
SCTWSX3642	1453	1619	29	42	36	88.87	5.04
SCTWSX3648	1653	1842	29	48	36	101.29	5.42
SCTWSX3654	1697	1910	29	54	36	110.80	5.79
SCTWSX3660	1785	2021	29	60	36	120.31	6.17
SCTWSX4242	1524	1717	29	42	42	99.77	5.88
SCTWSX4248	1730	1951	29	48	42	113.56	6.32
SCTWSX4254	1780	2028	29	54	42	124.46	6.76
SCTWSX4260	1874	2150	29	60	42	135.36	7.19
SCTWSX4848	1816	2068	29	48	48	125.71	7.22
SCTWSX4854	1872	2155	29	54	48	137.99	7.72
SCTWSX4860	1972	2287	29	60	48	150.27	8.22

SCTLWSL • Large Collaboration Table, 29" Work Height, Small Radius, Levelers

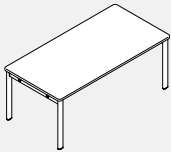

- Large Work Height Collaboration Tables on levelers consist of two leg assemblies, two worksurface support beams and a one worksurface with a small 1.5" radius at each corner.
- Surface available in LP - Low Pressure or HP - High Pressure laminates.
- Legs are painted extruded aluminum. Levelers have 1" adjustment for leveling.
- Cutouts for power modules are limited to specific sizes/configurations, please see Grommet Location Chart.

PRODUCT CODE	PRICE		SIZE/INCHES			WEIGHT LBS	VOL FT ³
	LP	HP	H	W	D		
SCTLWSL3666	1743	2003	29	66	36	129.78	6.54
SCTLWSL3672	1860	2144	29	72	36	139.30	6.92
SCTLWSL3678	1922	2229	29	78	36	148.81	7.29
SCTLWSL3684	1966	2297	29	84	36	158.32	7.67
SCTLWSL3690	2157	2512	29	90	36	167.84	8.04
SCTLWSL3696	2201	2579	29	96	36	177.35	8.42
SCTLWSL4266	1838	2141	29	66	42	146.21	7.63
SCTLWSL4272	1962	2293	29	72	42	127.10	8.07
SCTLWSL4278	2030	2388	29	78	42	168.00	8.51
SCTLWSL4284	2080	2466	29	84	42	178.89	8.94
SCTLWSL4290	2277	2690	29	90	42	189.79	9.38
SCTLWSL4296	2327	2768	29	96	42	200.68	9.82
SCTLWSL4866	1942	2288	29	66	48	162.63	8.72
SCTLWSL4872	2072	2450	29	72	48	174.91	9.22
SCTLWSL4878	2146	2555	29	78	48	187.18	9.72
SCTLWSL4884	2202	2643	29	84	48	199.46	10.22
SCTLWSL4890	2405	2878	29	90	48	211.74	10.72
SCTLWSL4896	2461	2965	29	96	48	224.01	11.22

COLLABORATIVE SPACES

SCTLWLL • Large Collaboration Table, 29" Work Height, Large Radius, Levelers

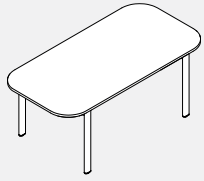

- Large Work Height Collaboration Tables on levelers consist of two leg assemblies, two worksurface support beams and a one worksurface with a large 9" radius at each corner with 10.5" overhang on each end.
- Surface available in LP - Low Pressure or HP - High Pressure laminates.
- Legs are painted extruded aluminum. Levelers have 1" adjustment for leveling.
- Cutouts for power modules are limited to specific sizes/configurations, please see Grommet Location Chart.
- Note: Large radius tables are not compatible with SCTAMxx and SCTAMTxx Media Units.

PRODUCT CODE	PRICE		SIZE/INCHES			WEIGHT LBS	VOL FT ³
	LP	HP	H	W	D		
SCTLWLL3666	1699	1958	29	66	36	123.52	6.54
SCTLWLL3672	1742	2026	29	72	36	133.03	6.92
SCTLWLL3672	1830	2137	29	78	36	142.55	7.29
SCTLWLL3684	1874	2205	29	84	36	152.06	7.67
SCTLWLL3690	1992	2346	29	90	36	161.57	8.04
SCTLWLL3696	2054	2431	29	96	36	171.09	8.42
SCTLWLL4266	1794	2097	29	66	42	139.94	7.63
SCTLWLL4272	1844	2175	29	72	42	150.84	8.07
SCTLWLL4278	1938	2296	29	78	42	161.73	8.51
SCTLWLL4284	1988	2374	29	84	42	172.63	8.94
SCTLWLL4290	2111	2525	29	90	42	183.52	9.38
SCTLWLL4296	2158	2599	29	96	42	194.42	9.82
SCTLWLL4866	1898	2244	29	66	48	156.37	8.72
SCTLWLL4872	1954	2332	29	72	48	168.64	9.22
SCTLWLL4878	2054	2463	29	78	48	180.92	9.72
SCTLWLL4884	2110	2551	29	84	48	193.20	10.22
SCTLWLL4890	2240	2712	29	90	48	205.48	10.72
SCTLWLL4896	2314	2818	29	96	48	217.75	11.22

SCTLWSC • Large Collaboration Table, 29" Work Height, Small Radius, Casters

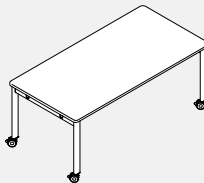

- Large Work Height Collaboration Tables on casters consist of two leg assemblies, two worksurface support beams and a one worksurface with a small 1.5" radius at each corner.
- Surface available in LP - Low Pressure or HP - High Pressure laminates.
- Legs are painted extruded aluminum. Casters are lockable, in a choice of two finishes.
- Cutouts for power modules are limited to specific sizes/configurations, please see Grommet Location Chart.

PRODUCT CODE	PRICE		SIZE/INCHES			WEIGHT LBS	VOL FT ³
	LP	HP	H	W	D		
SCTLWSC3666	1915	2175	29	66	36	129.87	6.54
SCTLWSC3672	2032	2316	29	72	36	139.39	6.92
SCTLWSC3678	2094	2401	29	78	36	148.90	7.29
SCTLWSC3684	2138	2469	29	84	36	158.41	7.67
SCTLWSC3690	2329	2683	29	90	36	167.93	8.04
SCTLWSC3696	2373	2751	29	96	36	177.44	8.42
SCTLWSC4266	2010	2313	29	66	42	146.30	7.63
SCTLWSC4272	2134	2464	29	72	42	157.19	8.07
SCTLWSC4278	2202	2560	29	78	42	168.09	8.51
SCTLWSC4284	2252	2637	29	84	42	178.98	8.94
SCTLWSC4290	2449	2862	29	90	42	189.88	9.38
SCTLWSC4296	2306	2747	29	96	42	200.77	9.82
SCTLWSC4866	2114	2460	29	66	48	162.72	8.72
SCTLWSC4872	2244	2621	29	72	48	175.00	9.22
SCTLWSC4878	2318	2727	29	78	48	187.27	9.72
SCTLWSC4884	2374	2815	29	84	48	199.55	10.22
SCTLWSC4890	2577	3050	29	90	48	211.83	10.72
SCTLWSC4896	2633	3137	29	96	48	224.10	11.22

SCTLWLC • Large Collaboration Table, 29" Work Height, Large Radius, Casters

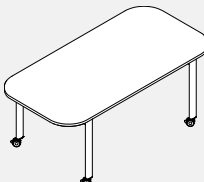

- Large Work Height Collaboration Tables on casters consist of two leg assemblies, two worksurface support beams and a one worksurface with a large 9" radius at each corner with 10.5" overhang on each end.
- Surface available in LP - Low Pressure or HP - High Pressure laminates.
- Legs are painted extruded aluminum. Casters are lockable, in a choice of two finishes.
- Cutouts for power modules are limited to specific sizes/configurations, please see Grommet Location Chart.
- Note: Large radius tables are not compatible with SCTAMxx and SCTAMTxx Media Units.

PRODUCT CODE	PRICE		SIZE/INCHES			WEIGHT LBS	VOL FT ³
	LP	HP	H	W	D		
SCTLWLC3666	1871	2130	29	66	36	123.61	6.54
SCTLWLC3672	1914	2198	29	72	36	133.12	6.92
SCTLWLC3678	2002	2309	29	78	36	142.64	7.29
SCTLWLC3684	2046	2377	29	84	36	152.15	7.67
SCTLWLC3690	2163	2518	29	90	36	161.66	8.04
SCTLWLC3696	2225	2603	29	96	36	171.18	8.42
SCTLWLC4266	1966	2269	29	66	42	140.03	7.63
SCTLWLC4272	2016	2346	29	72	42	150.93	8.07
SCTLWLC4278	2110	2468	29	78	42	161.82	8.51
SCTLWLC4284	2160	2545	29	84	42	172.72	8.94
SCTLWLC4290	2283	2697	29	90	42	183.62	9.38
SCTLWLC4296	2351	2792	29	96	42	194.51	9.82
SCTLWLC4866	2070	2416	29	66	48	156.46	8.72
SCTLWLC4872	2126	2503	29	72	48	168.73	9.22
SCTLWLC4878	2226	2635	29	78	48	181.01	9.72
SCTLWLC4884	2282	2723	29	84	48	193.29	10.22
SCTLWLC4890	2411	2884	29	90	48	205.57	10.72
SCTLWLC4896	2486	2989	29	96	48	217.84	11.22

COLLABORATIVE SPACES

SCTSCSL • Workshop Table, 36" Café Height, Small Radius, Levelers

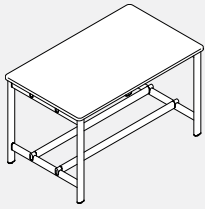

- Café Height Workshop Tables on levelers consist of two leg assemblies, two worksurface support beams, dual footrests and a one worksurface with a small 1.5" radius at each corner.
- Surface available in LP - Low Pressure or HP - High Pressure laminates.
- Legs are painted extruded aluminum. Levelers have 1" adjustment for leveling.
- Cutouts for power modules are limited to specific sizes/configurations, please see Grommet Location Chart.

PRODUCT CODE	PRICE		SIZE/INCHES			WEIGHT LBS	VOL FT ³
	LP	HP	H	W	D		
SCTSCSL3636	1817	1959	36	36	36	96.82	5.67
SCTSCSL3642	1993	2159	36	42	36	107.56	6.21
SCTSCSL3648	2193	2382	36	48	36	121.20	6.75
SCTSCSL3654	2237	2450	36	54	36	131.93	7.29
SCTSCSL3660	2369	2605	36	60	36	142.67	7.83
SCTSCSL4242	2043	2236	36	42	42	119.68	7.05
SCTSCSL4248	2291	2512	36	48	42	134.70	7.65
SCTSCSL4254	2341	2589	36	54	42	146.81	8.26
SCTSCSL4260	2480	2755	36	60	42	158.93	8.86
SCTSCSL4848	2406	2658	36	48	48	148.20	8.56
SCTSCSL4854	2462	2746	36	54	48	161.70	9.22
SCTSCSL4860	2607	2922	36	60	48	175.20	9.89

SCTSCSC • Workshop Table, 36" Café Height, Small Radius, Casters

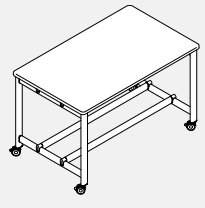

- Café Height Workshop Tables on casters consist of two leg assemblies, two worksurface support beams, dual footrests and a one worksurface with a small 1.5" radius at each corner.
- Surface available in LP - Low Pressure or HP - High Pressure laminates.
- Legs are painted extruded aluminum. Casters are lockable, in a choice of two finishes.
- Cutouts for power modules are limited to specific sizes/configurations, please see Grommet Location Chart.

PRODUCT CODE	PRICE		SIZE/INCHES			WEIGHT LBS	VOL FT ³
	LP	HP	H	W	D		
SCTSCSC3636	2013	2155	36	36	36	96.66	5.67
SCTSCSC3642	2190	2355	36	42	36	107.39	6.21
SCTSCSC3648	2390	2579	36	48	36	121.03	6.75
SCTSCSC3654	2433	2646	36	54	36	131.77	7.29
SCTSCSC3660	2566	2802	36	60	36	142.50	7.83
SCTSCSC4242	2282	2475	36	42	42	119.51	7.05
SCTSCSC4248	2488	2708	36	48	42	134.53	7.65
SCTSCSC4254	2538	2786	36	54	42	146.65	8.26
SCTSCSC4296	2676	2952	36	60	42	158.77	8.86
SCTSCSC4848	2603	2855	36	48	48	148.03	8.56
SCTSCSC4854	2659	2942	36	54	48	161.53	9.22
SCTSCSC4860	2803	3118	36	60	48	175.03	9.89

SCTLCSL • Large Collaboration Table, 36" Café Height, Small Radius, Levelers



For 66" and 72" wide tables



For 78" to 96" wide tables

- Large Café Height Collaboration Tables on levelers consist of two leg assemblies, two worksurface support beams, dual footrests and a one worksurface with a small 1.5" radius at each corner.
- Surface available in LP - Low Pressure or HP - High Pressure laminates.
- Legs are painted extruded aluminum. Levelers have 1" adjustment for leveling.
- Cutouts for power modules are limited to specific sizes/configurations, please see Grommet Location Chart.
- Tables 78" wide and greater include a reinforcement cantilever for added stability.

PRODUCT CODE	PRICE		SIZE/INCHES			WEIGHT LBS	VOL FT ³
	LP	HP	H	W	D		
SCTLCSL3666	2413	2673	36	66	36	153.40	8.38
SCTLCSL3672	2604	2888	36	72	36	164.14	8.92
SCTLCSL3678	2793	3100	36	78	36	177.32	9.46
SCTLCSL3684	2837	3168	36	84	36	188.05	10.00
SCTLCSL3690	3176	3530	36	90	36	198.79	10.54
SCTLCSL3696	3219	3597	36	96	36	209.52	11.08
SCTLCSL4266	2529	2832	36	66	42	171.05	9.47
SCTLCSL4272	2727	3057	36	72	42	183.17	10.07
SCTLCSL4278	2922	3280	36	78	42	197.73	10.67
SCTLCSL4284	2972	3358	36	84	42	209.84	11.28
SCTLCSL4290	3317	3730	36	90	42	221.96	11.88
SCTLCSL4296	3366	3807	36	96	42	234.08	12.49
SCTLCSL4866	2663	3009	36	66	48	188.69	10.56
SCTLCSL4872	2866	3244	36	72	48	202.19	11.22
SCTLCSL4878	3067	3477	36	78	48	218.14	11.89
SCTLCSL4884	3123	3564	36	84	48	231.63	12.56
SCTLCSL4890	3474	3947	36	90	48	245.13	13.22
SCTLCSL4896	3530	4034	36	96	48	258.63	13.89

COLLABORATIVE SPACES

SCTLCLL • Large Collaboration Table, 36" Café Height, Large Radius, Levelers

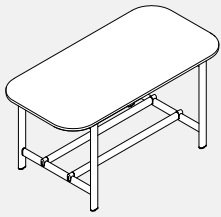

For 66" to 90" wide tables

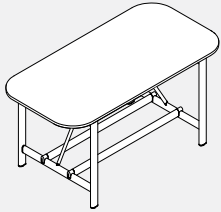

For 96" wide tables

- Large Café Height Collaboration Tables on levelers consist of two leg assemblies, two worksurface support beams and a one worksurface with a large 9" radius at each corner with 10.5" overhang on each end.
- Surface available in LP - Low Pressure or HP - High Pressure laminates.
- Legs are painted extruded aluminum. Levelers have 1" adjustment for leveling.
- Cutouts for power modules are limited to specific sizes/configurations, please see Grommet Location Chart.
- Tables 78" wide and greater include a reinforcement cantilever for added stability.
- Note: Large radius tables are not compatible with SCTAMxx and SCTAMTx Media Units.

PRODUCT CODE	PRICE		SIZE/INCHES			WEIGHT LBS	VOL FT ³
	LP	HP	H	W	D		
SCTLCLL3666	2324	2584	36	66	36	143.48	8.38
SCTLCLL3672	2368	2652	36	72	36	154.21	8.92
SCTLCLL3678	2500	2807	36	78	36	164.95	9.46
SCTLCLL3684	2544	2875	36	84	36	175.68	10.00
SCTLCLL3690	2735	3090	36	90	36	186.42	10.54
SCTLCLL3696	2924	3302	36	96	36	199.60	11.08
SCTLCLL4266	2441	2744	36	66	42	161.12	9.47
SCTLCLL4272	2491	2821	36	72	42	173.24	10.07
SCTLCLL4278	2629	2987	36	78	42	185.36	10.67
SCTLCLL4284	2679	3065	36	84	42	197.47	11.28
SCTLCLL4290	2876	3290	36	90	42	209.59	11.88
SCTLCLL4296	2724	3165	36	96	42	224.15	12.49
SCTLCLL4866	2574	2921	36	66	48	178.77	10.56
SCTLCLL4872	2630	3008	36	72	48	192.27	11.22
SCTLCLL4878	2775	3184	36	78	48	205.77	11.89
SCTLCLL4884	2830	3271	36	84	48	219.26	12.56
SCTLCLL4890	3034	3506	36	90	48	232.76	13.22
SCTLCLL4896	3235	3739	36	96	48	248.71	13.89

SCTL CSC • Large Collaboration Table, 36" Café Height, Small Radius, Casters

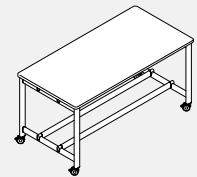

For 66" to 90" wide tables

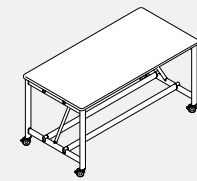

For 96" wide tables

- Large Café Height Collaboration Tables on casters consist of two leg assemblies, two worksurface support beams, dual footrests and a one worksurface with a small 1.5" radius at each corner.
- Surface available in LP - Low Pressure or HP - High Pressure laminates.
- Legs are painted extruded aluminum. Casters are lockable, in a choice of two finishes.
- Cutouts for power modules are limited to specific sizes/configurations, please see Grommet Location Chart.
- Tables 78" wide and greater include a reinforcement cantilever for added stability.

PRODUCT CODE	PRICE		SIZE/INCHES			WEIGHT LBS	VOL FT ³
	LP	HP	H	W	D		
SCTL CSC3666	2609	2869	36	66	36	153.24	8.38
SCTL CSC3672	2801	3084	36	72	36	163.97	8.92
SCTL CSC3678	2990	3297	36	78	36	177.15	9.46
SCTL CSC3684	3033	3364	36	84	36	187.89	10.00
SCTL CSC3690	3372	3726	36	90	36	198.62	10.54
SCTL CSC3696	3416	3794	36	96	36	209.36	11.08
SCTL CSC4266	2726	3029	36	66	42	170.88	9.47
SCTL CSC4272	2923	3254	36	72	42	183.00	10.07
SCTL CSC4278	3118	3477	36	78	42	197.56	10.67
SCTL CSC4284	3168	3554	36	84	42	209.68	11.28
SCTL CSC4290	3513	3926	36	90	42	221.80	11.88
SCTL CSC4296	3563	4004	36	96	42	233.91	12.49
SCTL CSC4866	2859	3205	36	66	48	188.53	10.56
SCTL CSC4872	3062	3440	36	72	48	202.03	11.22
SCTL CSC4878	3264	3673	36	78	48	217.97	11.89
SCTL CSC4884	3320	3761	36	84	48	231.47	12.56
SCTL CSC4890	3671	4143	36	90	48	244.97	13.22
SCTL CSC4896	3727	4231	36	96	48	258.47	13.89

SCTLCLC • Large Collaboration Table, 36" Café Height, Large Radius, Casters

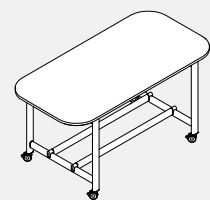

For 66" to 90" wide tables

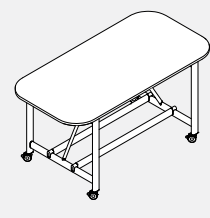

For 96" wide tables

- Large Café Height Collaboration Tables on casters consist of two leg assemblies, two worksurface support beams and a one worksurface with a large 9" radius at each corner with 10.5" overhang on each end.
- Surface available in LP - Low Pressure or HP - High Pressure laminates.
- Legs are painted extruded aluminum. Casters are lockable, in a choice of two finishes.
- Cutouts for power modules are limited to specific sizes/configurations, please see Grommet Location Chart.
- Tables 78" wide and greater include a reinforcement cantilever for added stability.
- Note: Large radius tables are not compatible with SCTAMxx and SCTAMTx Media Units.

PRODUCT CODE	PRICE		SIZE/INCHES			WEIGHT LBS	VOL FT ³
	LP	HP	H	W	D		
SCTLCLC3666	2521	2781	36	66	36	143.31	8.38
SCTLCLC3672	2565	2848	36	72	36	154.05	8.92
SCTLCLC3678	2697	3004	36	78	36	164.78	9.46
SCTLCLC3684	2741	3071	36	84	36	175.52	10.00
SCTLCLC3690	2932	3286	36	90	36	186.25	10.54
SCTLCLC3696	3121	3499	36	96	36	199.43	11.08
SCTLCLC4266	2637	2940	36	66	42	160.96	9.47
SCTLCLC4272	2687	3018	36	72	42	173.07	10.07
SCTLCLC4278	2825	3184	36	78	42	185.19	10.67
SCTLCLC4284	2875	3261	36	84	42	197.31	11.28
SCTLCLC4290	3073	3486	36	90	42	209.43	11.88
SCTLCLC4296	3268	3709	36	96	42	223.98	12.49
SCTLCLC4866	2771	3117	42	66	48	178.60	10.56
SCTLCLC4872	2826	3204	42	72	48	192.10	11.22
SCTLCLC4878	2971	3380	42	78	48	205.60	11.89
SCTLCLC4884	3027	3468	42	84	48	219.10	12.56
SCTLCLC4890	3230	3703	42	90	48	232.60	13.22
SCTLCLC4896	3432	3936	42	96	48	248.54	13.89

COLLABORATIVE SPACES

SCTSBSL • Workshop Table, 42" Bar Height, Small Radius, Levelers

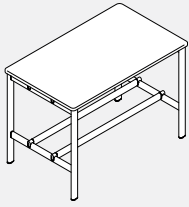

- Bar Height Workshop Tables on levelers consist of two leg assemblies, two worksurface support beams, dual footrests and a one worksurface with a small 1.5" radius at each corner.
- Surface available in LP - Low Pressure or HP - High Pressure laminates.
- Legs are painted extruded aluminum. Levelers have 1" adjustment for leveling.
- Cutouts for power modules are limited to specific sizes/configurations, please see Grommet Location Chart.

PRODUCT CODE	PRICE		SIZE/INCHES			WEIGHT LBS	VOL FT ³
	LP	HP	H	W	D		
SCTSBSL3636	1918	2060	42	36	36	99.27	5.67
SCTSBSL3642	2094	2260	42	42	36	110.00	6.21
SCTSBSL3648	2294	2483	42	48	36	123.64	6.75
SCTSBSL3654	2338	2551	42	54	36	134.38	7.29
SCTSBSL3660	2470	2707	42	60	36	145.11	7.83
SCTSBSL4242	2186	2379	42	42	42	122.12	7.05
SCTSBSL4248	2392	2613	42	48	42	137.14	7.65
SCTSBSL4254	2442	2690	42	54	42	149.26	8.26
SCTSBSL4260	2581	2856	42	60	42	161.38	8.86
SCTSBSL4848	2507	2759	42	48	48	150.64	8.56
SCTSBSL4854	2563	2847	42	54	48	164.14	9.22
SCTSBSL4860	2708	3023	42	60	48	177.64	9.89

SCTSBSC • Workshop Table, 42" Bar Height, Small Radius, Casters

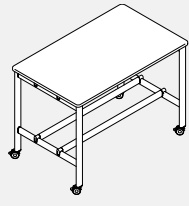

- Bar Height Workshop Tables on casters consist of two leg assemblies, two worksurface support beams, dual footrests and a one worksurface with a small 1.5" radius at each corner.
- Surface available in LP - Low Pressure or HP - High Pressure laminates.
- Legs are painted extruded aluminum. Levelers have 1" adjustment for leveling.
- Cutouts for power modules are limited to specific sizes/configurations, please see Grommet Location Chart.

PRODUCT CODE	PRICE		SIZE/INCHES			WEIGHT LBS	VOL FT ³
	LP	HP	H	W	D		
SCTSBSC3636	2055	2197	42	36	36	99.10	5.67
SCTSBSC3642	2232	2397	42	42	36	109.84	6.21
SCTSBSC3648	2432	2621	42	48	36	123.48	6.75
SCTSBSC3654	2476	2688	42	54	36	134.21	7.29
SCTSBSC3660	2608	2844	42	60	36	144.95	7.83
SCTSBSC4242	2324	2517	42	42	42	121.95	7.05
SCTSBSC4248	2530	2750	42	48	42	136.98	7.65
SCTSBSC4254	2580	2828	42	54	42	149.09	8.26
SCTSBSC4260	2718	2994	42	60	42	161.21	8.86
SCTSBSC4848	2645	2897	42	48	48	150.47	8.56
SCTSBSC4854	2701	2984	42	54	48	163.97	9.22
SCTSBSC4860	2845	3160	42	60	48	177.47	9.89

SCTLBSL • Large Collaboration Table, 42" Bar Height, Small Radius, Levelers

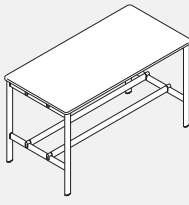

- Large Bar Height Collaboration Tables on levelers consist of two leg assemblies, two worksurface support beams, dual footrests and a one worksurface with a small 1.5" radius at each corner.
- Surface available in LP - Low Pressure or HP - High Pressure laminates.
- Legs are painted extruded aluminum. Levelers have 1" adjustment for leveling.
- Cutouts for power modules are limited to specific sizes/configurations, please see Grommet Location Chart.
- Tables 78" wide and greater include a reinforcement cantilever for added stability.

PRODUCT CODE	PRICE		SIZE/INCHES			WEIGHT LBS	VOL FT ³
	LP	HP	H	W	D		
SCTLBSL3666	2514	2774	42	66	36	155.85	8.38
SCTLBSL3672	2705	2989	42	72	36	166.58	8.92
SCTLBSL3678	2917	3224	42	78	36	179.76	9.46
SCTLBSL3684	2960	3291	42	84	36	190.50	10.00
SCTLBSL3690	3299	3653	42	90	36	201.23	10.54
SCTLBSL3696	3343	3721	42	96	36	211.97	11.08
SCTLBSL4266	2630	2934	42	66	42	173.49	9.47
SCTLBSL4272	2828	3158	42	72	42	185.61	10.07
SCTLBSL4278	3045	3403	42	78	42	200.17	10.67
SCTLBSL4284	3095	3481	42	84	42	212.29	11.28
SCTLBSL4290	3440	3853	42	90	42	224.41	11.88
SCTLBSL4296	3490	3931	42	96	42	236.52	12.49
SCTLBSL4866	2764	3110	42	66	48	191.14	10.56
SCTLBSL4872	2967	3345	42	72	48	204.64	11.22
SCTLBSL4878	3191	3600	42	78	48	220.58	11.89
SCTLBSL4884	3247	3687	42	84	48	234.08	12.56
SCTLBSL4890	3597	4070	42	90	48	247.58	13.22
SCTLBSL4896	3653	4157	42	96	48	261.08	13.89

For 66" and 72" wide tables

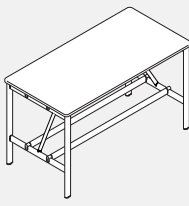

For 78" to 96" wide tables

COLLABORATIVE SPACES

SCTLBLL • Large Collaboration Table, 42" Bar Height, Large Radius, Levelers

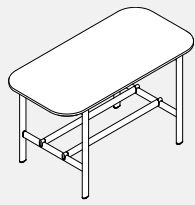

For 66" to 90" wide tables

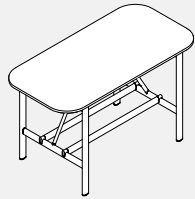

For 96" wide tables

- Large Bar Height Collaboration Tables on levelers consist of two leg assemblies, two worksurface support beams and a one worksurface with a large 9" radius at each corner with 10.5" overhang on each end.
- Surface available in LP - Low Pressure or HP - High Pressure laminates.
- Legs are painted extruded aluminum. Levelers have 1" adjustment for leveling.
- Cutouts for power modules are limited to specific sizes/configurations, please see Grommet Location Chart.
- Tables 78" wide and greater include a reinforcement cantilever for added stability.
- Note: Large radius tables are not compatible with SCTAMxx and SCTAMTx Media Units.

PRODUCT CODE	PRICE		SIZE/INCHES			WEIGHT LBS	VOL FT ³
	LP	HP	H	W	D		
SCTLBLL3666	2426	2685	42	66	36	145.92	8.38
SCTLBLL3672	2469	2753	42	72	36	156.66	8.92
SCTLBLL3678	2729	3036	42	78	36	167.39	9.46
SCTLBLL3684	2772	2976	42	84	36	178.13	10.00
SCTLBLL3690	2964	3191	42	90	36	188.86	10.54
SCTLBLL3696	3026	3403	42	96	36	202.04	11.08
SCTLBLL4266	2542	2845	42	66	42	163.57	9.47
SCTLBLL4272	2592	2922	42	72	42	175.68	10.07
SCTLBLL4278	2857	3088	42	78	42	187.80	10.67
SCTLBLL4284	2907	3166	42	84	42	199.92	11.28
SCTLBLL4290	3104	3391	42	90	42	212.04	11.88
SCTLBLL4296	3173	3613	42	96	42	226.60	12.49
SCTLBLL4866	2675	3022	42	66	48	181.21	10.56
SCTLBLL4872	2731	3109	42	72	48	194.71	11.22
SCTLBLL4878	3003	3285	42	78	48	208.21	11.89
SCTLBLL4884	3059	3372	42	84	48	221.71	12.56
SCTLBLL4890	3262	3607	42	90	48	235.21	13.22
SCTLBLL4896	3336	3840	42	96	48	251.15	13.89

SCTLBSC • Large Collaboration Table, 42" Bar Height, Small Radius, Casters

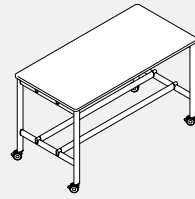

For 66" and 72" wide tables

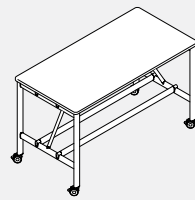

For 78" to 96" wide tables

- Large Bar Height Collaboration Tables on casters consist of two leg assemblies, two worksurface support beams and a one worksurface with a small 1.5" radius at each corner.
- Surface available in LP - Low Pressure or HP - High Pressure laminates.
- Legs are painted extruded aluminum. Casters are lockable, in a choice of two finishes.
- Cutouts for power modules are limited to specific sizes/configurations, please see Grommet Location Chart.
- Tables 78" wide and greater include a reinforcement cantilever for added stability.

PRODUCT CODE	PRICE		SIZE/INCHES			WEIGHT LBS	VOL FT ³
	LP	HP	H	W	D		
SCTLBSC3666	2652	2911	42	66	36	155.68	8.38
SCTLBSC3672	2843	3126	42	72	36	166.42	8.92
SCTLBSC3678	3054	3361	42	78	36	179.60	9.46
SCTLBSC3684	3098	3428	42	84	36	190.33	10.00
SCTLBSC3690	3436	3791	42	90	36	201.07	10.54
SCTLBSC3696	3480	3858	42	96	36	211.80	11.08
SCTLBSC4266	2768	3071	42	66	42	173.33	9.47
SCTLBSC4272	2965	3296	42	72	42	185.45	10.07
SCTLBSC4278	3183	3541	42	78	42	200.00	10.67
SCTLBSC4284	3232	3618	42	84	42	212.12	11.28
SCTLBSC4290	3577	3991	42	90	42	224.24	11.88
SCTLBSC4296	3627	4068	42	96	42	236.36	12.49
SCTLBSC4866	2901	3248	42	66	48	190.97	10.56
SCTLBSC4872	3105	3483	42	72	48	204.47	11.22
SCTLBSC4878	3328	3737	42	78	48	220.41	11.89
SCTLBSC4884	3384	3825	42	84	48	233.91	12.56
SCTLBSC4890	3735	4207	42	90	48	247.41	13.22
SCTLBSC4896	3791	4295	42	96	48	260.91	13.89

SCTLBLC • Large Collaboration Table, 42" Bar Height, Large Radius, Casters

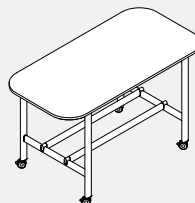

For 66" to 90" wide tables

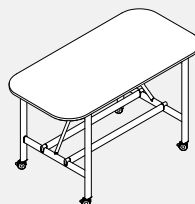

For 96" wide tables

- Large Bar Height Collaboration Tables on casters consist of two leg assemblies, two worksurface support beams and a one worksurface with a large 9" radius at each corner with 10.5" overhang on each end.
- Surface available in LP - Low Pressure or HP - High Pressure laminates.
- Legs are painted extruded aluminum. Casters are lockable, in a choice of two finishes.
- Cutouts for power modules are limited to specific sizes/configurations, please see Grommet Location Chart.
- Tables 96" wide include a reinforcement cantilever for added stability.
- Note: Large radius tables are not compatible with SCTAMxx and SCTAMTx Media Units.

PRODUCT CODE	PRICE		SIZE/INCHES			WEIGHT LBS	VOL FT ³
	LP	HP	H	W	D		
SCTLBLC3666	2563	2823	42	66	36	145.75	8.38
SCTLBLC3672	2607	2890	42	72	36	156.49	8.92
SCTLBLC3678	2739	3046	42	78	36	167.23	9.46
SCTLBLC3684	2783	3113	42	84	36	177.96	10.00
SCTLBLC3690	2974	3328	42	90	36	188.70	10.54
SCTLBLC3696	3163	3541	42	96	36	201.87	11.08
SCTLBLC4266	2679	2983	42	66	42	163.40	9.47
SCTLBLC4272	2729	3060	42	72	42	175.52	10.07
SCTLBLC4278	2868	3226	42	78	42	187.63	10.67
SCTLBLC4284	2917	3303	42	84	42	199.75	11.28
SCTLBLC4290	3115	3528	42	90	42	211.87	11.88
SCTLBLC4296	3310	3751	42	96	42	226.43	12.49
SCTLBLC4866	2813	3159	42	66	48	181.04	10.56
SCTLBLC4872	2869	3247	42	72	48	197.54	11.22
SCTLBLC4878	3013	3422	42	78	48	208.04	11.89
SCTLBLC4884	3069	3510	42	84	48	221.54	12.56
SCTLBLC4890	3272	3745	42	90	48	235.04	13.22
SCTLBLC4896	3474	3978	42	96	48	250.98	13.89

SCTAM • Collaboration Table Media Unit

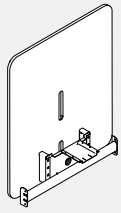

- Collaboration Table Media Unit can be affixed to all small radius tables of the same nominal width. User side is thermally fused laminate to accept TV mounts. Side facing away from users features a tackable PET panel affixed to the thermally fused laminate with a 0.5" inset.
- Surface available in LP - Low Pressure Laminate.
- Felt backer available in all standard finishes.
- Brackets and reinforcement bar is painted metal.
- TV mount not included.
- Units 36" wide can accept TV's up to 40", not exceeding 50 lbs.
- Units 42" wide can accept TV's up to 43", not exceeding 50 lbs.
- Units 48" wide can accept TV's up to 55", not exceeding 50 lbs.

PRODUCT CODE	PRICE LP	SIZE/INCHES			WEIGHT VOL	
		H	W	D	LBS	FT ³
SCTAM36	748	43	36	11.25	46.28	10.08
SCTAM42	767	43	42	11.25	52.50	11.76
SCTAM48	826	43	48	11.25	58.83	13.44

SCTAMT • Collaboration Table Media Unit with TV Mount

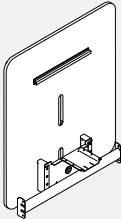

- Collaboration Table Media Unit with TV Mount can be affixed to all small radius tables of the same nominal width. User side is thermally fused laminate and includes a TV mount. Side facing away from users features a tackable PET panel affixed to the thermally fused laminate with a 0.5" inset.
- Surface available in LP - Low Pressure Laminate.
- Felt backer available in all standard finishes.
- Brackets and reinforcement bar is painted metal.
- Units 36" wide can accept TV's up to 40", not exceeding 50 lbs.
- Units 42" wide can accept TV's up to 43", not exceeding 50 lbs.
- Units 48" wide can accept TV's up to 55", not exceeding 50 lbs.

PRODUCT CODE	PRICE LP	SIZE/INCHES			WEIGHT VOL	
		H	W	D	LBS	FT ³
SCTAMT36	942	43	36	11.25	47.58	10.08
SCTAMT42	961	43	42	11.25	53.80	11.76
SCTAMT48	1020	43	48	11.25	60.13	13.44

SCTAL • Table Leg Cable Organizer



- Table Leg Cable organizer snaps on to any leg to manage wires vertically. Black only.

PRODUCT CODE	PRICE	SIZE/INCHES			WEIGHT VOL	
		H	W	D	LBS	FT ³
SCTAL21	29	21	2.965	2.21	0.60	0.09
SCTAL23	33	23	2.965	2.21	0.60	0.09

SCTAP • PET Felt Modesty Panel

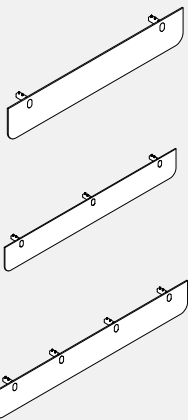

- PET Felt modesty panel with metal brackets for use on Core, Standard and Workshop tables.
- Modesty panels 36" to 54" include two brackets.
- Modesty panels 60" to 90" include three brackets.
- Modesty panels 96" include four brackets.
- Specify matching nominal width to table.
- PET Felt available in standard finishes.

PRODUCT CODE	PRICE	SIZE/INCHES			WEIGHT VOL	
		H	W	D	LBS	FT ³
SCTAP36	75	11	33	4.75	1.78	1.00
SCTAP42	81	11	39	4.75	1.99	1.18
SCTAP48	81	11	45	4.75	2.14	1.36
SCTAP54	85	11	51	4.75	2.38	1.54
SCTAP60	114	11	57	4.75	2.53	1.72
SCTAP66	118	11	63	4.75	2.68	1.90
SCTAP72	122	11	69	4.75	2.87	2.09
SCTAP78	126	11	75	4.75	3.05	2.27
SCTAP84	137	11	81	4.75	3.23	2.45
SCTAP90	149	11	87	4.75	3.41	2.63
SCTAP96	162	11	93	4.75	3.59	2.81

SCTAT • Wire Mesh Storage Tray

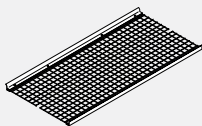

- Steel storage tray is attached between dual stretchers on tables 48"d x 48"w and larger.
- Specify matching nominal width to table.
- Can be combined with SCTAM/SCTAMT Media Units on any size table noted above with levelers and up to table sizes 48" d x 78" w on casters.
- Cannot be combined with SCTAM/SCTAMT Media Units on tables on casters over 78" w.

PRODUCT CODE	PRICE	SIZE/INCHES			WEIGHT VOL	
		H	W	D	LBS	FT ³
SCTAT4848	204	1.6	42	22	7.85	0.98
SCTAT4854	229	1.6	48	22	8.97	1.10
SCTAT4860	260	1.6	54	22	10.09	1.22
SCTAT4866	294	1.6	60	22	11.19	1.34
SCTAT4872	392	1.6	66	22	12.29	1.47
SCTAT4878	403	1.6	72	22	13.40	1.59
SCTAT4884	417	1.6	78	22	14.52	1.71
SCTAT4890	481	1.6	84	22	15.62	1.83
SCTAT4896	495	1.6	90	22	16.72	1.96

SCTAH • Table Mounted Bag Hook

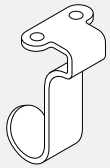

- Steel hook for use on Collaborative tables.
- Specify standard metal paint finish.
- Maximum capacity of 10 lbs.

PRODUCT CODE	PRICE	SIZE/INCHES			WEIGHT VOL	
		H	W	D	LBS	FT ³
SCTAH	16	3.5	1.5	0.65	0.30	

SCTAPE • Nik Edge/Clamp Mount Power Module

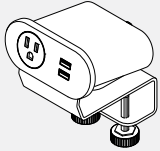

- Nik Edge/Clamp Mount Power Module in black with black receptacles, 10ft cord.
- Specify configuration, last letter of the code represents the following:
 - A = 1 AC, 1 USB-A 1.5A charge port, 1 USB-A 2.4A quick charge port
 - B = 2 AC
 - C = 2 AC, 1 USB-A 1.5A charge port, 1 USB-A 2.4A quick charge port
 - D = 1 AC, 1 USB-A 1.5A charge port, 1 USB-A 2.4A quick charge port, 1 60W USB-C charge port
 - E = 3 AC

PRODUCT CODE	PRICE	SIZE/INCHES			WEIGHT VOL	
		H	W	D	LBS	FT ³
SCTAPEA	516	3.7	6	2.10	4.00	
SCTAPEB	491	3.7	6	2.10	4.00	
SCTAPEC	569	3.7	6	2.10	4.00	
SCTAPED	672	3.7	6	2.10	4.00	
SCTAPEE	502	3.7	6	2.10	4.00	

SCTAPS • Nik In-Surface Power Module

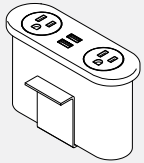

- Nik In-Surface Power Module in black with black receptacles, 10ft cord.
- Specify configuration, last letter of the code represents the following:
 - C = 2 AC, 1 USB-A 1.5A charge port, 1 USB-A 2.4A quick charge port
 - D = 1 AC, 1 USB-A 1.5A charge port, 1 USB-A 2.4A quick charge port, 1 60W USB-C charge port
 - E = 3 AC

PRODUCT CODE	PRICE	SIZE/INCHES			WEIGHT VOL	
		H	W	D	LBS	FT ³
SCTAPSC	578	3.7	6	2.10	4.00	0.03
SCTAPSD	718	3.7	6	2.10	4.00	0.03
SCTAPSE	509	3.7	6	2.10	4.00	0.03

SCTAPB • Nik Below Surface Power Module

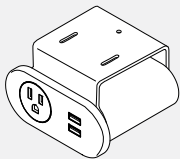

- Nik Below Surface Power Module in black with black receptacles, 10ft cord.
- Specify configuration, last letter of the code represents the following:
 - A = 1 AC, 1 USB-A 1.5A charge port, 1 USB-A 2.4A quick charge port
 - B = 2 AC
 - C = 2 AC, 1 USB-A 1.5A charge port, 1 USB-A 2.4A quick charge port
 - D = 1 AC, 1 USB-A 1.5A charge port, 1 USB-A 2.4A quick charge port, 1 60W USB-C charge port
 - E = 3 AC

PRODUCT CODE	PRICE	SIZE/INCHES			WEIGHT VOL	
		H	W	D	LBS	FT ³
SCTAPBA	562	3.7	6	2.10	4.00	0.03
SCTAPBB	512	3.7	6	2.10	4.00	0.03
SCTAPBC	596	3.7	6	2.10	4.00	0.03
SCTAPBD	741	3.7	6	2.10	4.00	0.03
SCTAPBE	524	3.7	6	2.10	4.00	0.03

SCTAPPB • Below Surface Power Bar

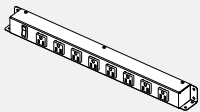

SCTAPPBS

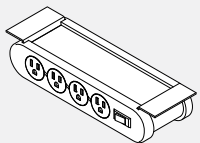

SCTAPPBD

- Below surface power bar is black only.
- Single (SCTAPPBS) includes 8 outlets on a single side.
- Double (SCTAPPBD) includes 4 outlets on each side of the bar. Built-in circuit breaker (shown).
- Cord length is 10'.

PRODUCT CODE	PRICE	SIZE/INCHES			WEIGHT VOL	
		H	W	D	LBS	FT ³
SCTAPPBS	436	1.95	21	1.95	2.70	0.06
SCTAPPBD	1069	2.3	10.6	4.00	4.00	0.05

SCTAPT • Collaborative Spaces Power Tray

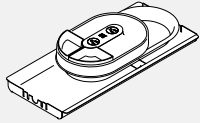

- Black plastic power tray with removable grey accessory trays. Top tray is offset for cable storage underneath. Recessed tray sits 3.7" below surface to keep cables out of sight.
- Specify configuration, last letter of the code represents the following.
- 10ft cord.
- C = 2 AC, 1 USB-A 1.5A charge port, 1 USB-A 2.4A quick charge port
- D = 1 AC, 1 USB-A 1.5A charge port, 1 USB-A 2.4A quick charge port, 1 60W USB-C charge port
- E = 3 AC

PRODUCT CODE	PRICE	SIZE/INCHES			WEIGHT VOL	
		H	W	D	LBS	FT ³
SCTAPTC	858	4.53	23.26	10.51	7.73	0.64
SCTAPTD	999	4.53	23.26	10.51	7.73	0.64
SCTAPTE	789	4.53	23.26	10.51	7.73	0.64

SCTAOT • Collaborative Spaces Organizer Tray

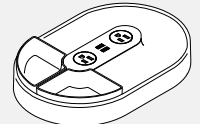

- Black plastic power tray with removable grey accessory trays.
- Specify configuration, last letter of the code represents the following:
- 10ft cord.
- C = 2 AC, 1 USB-A 1.5A charge port, 1 USB-A 2.4A quick charge port
- D = 1 AC, 1 USB-A 1.5A charge port, 1 USB-A 2.4A quick charge port, 1 60W USB-C charge port
- E = 3 AC

PRODUCT CODE	PRICE	SIZE/INCHES			WEIGHT VOL	
		H	W	D	LBS	FT ³
SCTAOTC	639	4.28	12.40	8.32	1.50	0.26
SCTAOTD	779	4.28	12.40	8.32	1.50	0.26
SCTAOTE	570	4.28	12.40	8.32	1.50	0.26

SCTAPR • Collaborative Spaces Recessed Power Tray

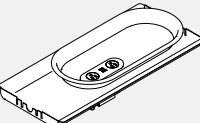

- Black plastic power tray. Recessed tray sits 3.7" below surface to keep cables out of sight.
- Specify configuration, last letter of the code represents the following:
- 10ft cord.
- C = 2 AC, 1 USB-A 1.5A charge port, 1 USB-A 2.4A quick charge port
- D = 1 AC, 1 USB-A 1.5A charge port, 1 USB-A 2.4A quick charge port, 1 60W USB-C charge port
- E = 3 AC

PRODUCT CODE	PRICE	SIZE/INCHES			WEIGHT VOL	
		H	W	D	LBS	FT ³
SCTAPRC	760	6.4	23.26	10.51	6.06	0.91
SCTAPRD	900	6.4	23.26	10.51	6.06	0.91
SCTAPRE	691	6.4	23.26	10.51	6.06	0.91

SCTACT • Collaborative Spaces PET Felt Wire Manager

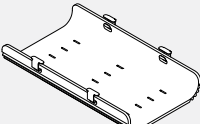

- PET Felt Wire Manager hangs from four brackets under the surface.
- Includes black painted metal brackets.
- PET Felt available in standard finishes.

PRODUCT CODE	PRICE	SIZE/INCHES			WEIGHT VOL	
		H	W	D	LBS	FT ³
SCTACT	80	4	11	26	1.10	0.66

SCCR • Coat Rack Cart

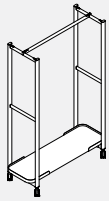

- Cart includes side rails for compatible accessories and a single top rail for hanging coats, jackets, etc.
- Shelf available in LP - Low Pressure laminate.
- Painted aluminum frame available in standard paint finishes.
- Casters are lockable, in a choice of two finishes.

PRODUCT CODE	PRICE LP	SIZE/INCHES			WEIGHT LBS	VOL FT ³
		H	W	D		
SCCR1848	1818	72	48	18	56.82	36.04
SCCR1860	1876	72	60	18	62.77	45.05

SCCS • Shelf Cart

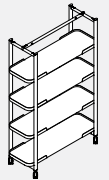

- Cart includes four fixed shelves with metal trim detail. Vertical rails accept PET privacy panels (sold separately) to create space division within open areas.
- Horizontal top rail accepts compatible accessories.
- Shelves available in LP - Low Pressure laminate.
- Painted aluminum frame available in standard paint finishes.
- Casters are lockable, in a choice of two finishes.

PRODUCT CODE	PRICE LP	SIZE/INCHES			WEIGHT LBS	VOL FT ³
		H	W	D		
SCCS1848	3400	72	48	18	123.88	36.04

SCCM • Media Cart

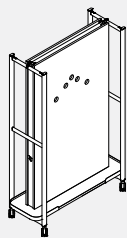

- Media Cart includes a bottom shelf and thermally fused laminate TV board. Short side panels feature small cutout for wire pass thru and hook for wire management.
- Side rails accept compatible accessories.
- Shelf available in LP - Low Pressure laminate.
- Back panel is removeable for access to cavity for cable management. Back panel is whiteboard laminate.
- SCCMEP models include a power bar (SCCAMP) mounted internally.
- SCCMNE models do not include any power.
- Units 48" wide can accept TV's up to 55", not exceeding 50lbs.
- Units 60" wide can accept TV's up to 60", not exceeding 50lbs.
- Painted aluminum frame available in standard paint finishes.
- Casters are lockable, in a choice of two finishes.
- Note: TV mount included. TV and video conferencing units are not included.

PRODUCT CODE	PRICE LP	SIZE/INCHES			WEIGHT LBS	VOL FT ³
		H	W	D		
SCCMEP1848	3515	72	48	18	171.42	36.04
SCCMEP1860	3945	72	60	18	214.23	45.05
SCCMNE1848	3343	72	48	18	170.92	36.04
SCCMNE1860	3772	72	60	18	213.73	45.05

SCCSW • Single Sided Whiteboard Cart

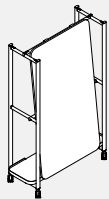

- Cart includes one fixed shelf with metal trim detail, accessible from behind whiteboard.
- Front of vertical whiteboard panel is whiteboard only.
- Side rails accept compatible accessories.
- Back of vertical whiteboard panel is DWTLPL - Designer White laminate with DWE - Designer White edging.
- Shelf available in LP - Low Pressure laminate.
- Painted aluminum frame available in standard paint finishes.
- Casters are lockable, in a choice of two finishes.

PRODUCT CODE	PRICE LP	SIZE/INCHES			WEIGHT LBS	VOL FT ³
		H	W	D		
SCCSW1848	3011	72	48	18	106.37	36.04
SCCSW1860	3531	72	60	18	191.07	45.05

SCCDW • Double Side Whiteboard Cart

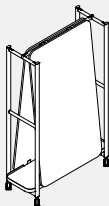

- Cart includes one fixed shelf with metal trim detail, accessible from behind whiteboard.
- Front of vertical whiteboard panels are whiteboard only.
- Side rails accept compatible accessories.
- Back of vertical whiteboard panels are DWTLPL - Designer White laminate with DWE - Designer White edging.
- Shelf available in LP - Low Pressure laminate.
- Painted aluminum frame available in standard paint finishes.
- Casters are lockable, in a choice of two finishes.

PRODUCT CODE	PRICE LP	SIZE/INCHES			WEIGHT LBS	VOL FT ³
		H	W	D		
SCCDW1848	4061	72	48	18	153.96	36.04
SCCDW1860	5027	72	60	18	191.07	45.05

SCCCW • Combo Whiteboard Cart

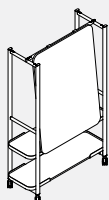

- Cart includes two fixed shelves with metal trim detail. Bottom shelf is accessible from both sides of cart, top shelf accessible from behind whiteboard.
- Front of vertical whiteboard panel is whiteboard only.
- Side rails accept compatible accessories.
- Back of vertical whiteboard panel is DWTLPL - Designer White laminate with DWE - Designer White edging.
- Shelves available in LP - Low Pressure laminate.
- Painted aluminum frame available in standard paint finishes.
- Casters are lockable, in a choice of two finishes.

PRODUCT CODE	PRICE LP	SIZE/INCHES			WEIGHT LBS	VOL FT ³
		H	W	D		
SCCCW1848	3250	72	48	18	115.66	36.04
SCCCW1860	3736	72	60	18	150.33	45.05

SCCRW • Removable Whiteboard Cart

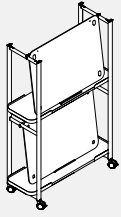

- Cart includes two fixed shelves with spacers for removeable whiteboards.
- Includes five lightweight removeable whiteboard panels.
- One whiteboard can be stored at the top and four at the bottom.
- Cart accepts five lightweight removeable whiteboard panels maximum.
- Whiteboards feature whiteboard front and DWTHP - Designer White laminate back with DWE - Designer White edge.
- Hanging bracket finish matches the cart frame finish.
- Shelves available in LP - Low Pressure laminate.
- Side rails accept compatible accessories.
- Painted aluminum frame available in standard paint finishes.
- Casters are lockable, in a choice of two finishes.

PRODUCT CODE	PRICE LP	SIZE/INCHES			WEIGHT VOL	
		H	W	D	LBS	FT ³
SCCRW1848	5013	72	48	18	188	42.05
SCCRW1860	5724	72	60	18	245.61	52.56

SCCEW • Empty Removeable Whiteboard/Privacy Cart

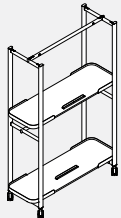

- Cart includes two fixed shelves with spacers for removeable whiteboards.
- Cart accepts five lightweight removeable whiteboard panels maximum.
- One whiteboard can be stored at the top and four at the bottom.
- To order Removeable Whiteboard, specify SCCAWB3336 for the 48" wide cart and SCCAWB3348 for the 60" wide cart.
- Hanging bracket finish matches the cart frame finish.
- Shelves available in LP - Low Pressure laminate.
- Side rails accept compatible accessories.
- Painted aluminum frame available in standard paint finishes.
- Casters are lockable, in a choice of two finishes.

PRODUCT CODE	PRICE LP	SIZE/INCHES			WEIGHT VOL	
		H	W	D	LBS	FT ³
SCCEW1848	2455	72	48	18	82.31	42.05
SCCEW1860	2597	72	60	18	105.70	52.56

SCHC • Hospitality Cart

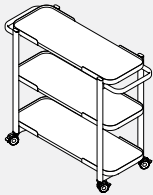

- Hospitality Cart includes three fixed shelves with metal trim.
- Surfaces available in LP - Low Pressure laminate.
- Legs and handles are painted aluminum available in standard paint finishes.
- Note: size is inclusive of handles, shelf sizing is approximately 10" shorter.

PRODUCT CODE	PRICE LP	SIZE/INCHES			WEIGHT VOL	
		H	W	D	LBS	FT ³
SCHC2233	2653	41	43	18	81.31	15.39
SCHC2239	2763	41	49	18	95	17.96

SCCAPP • Cart Mounted PET Felt Privacy Panels

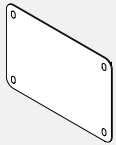

- Lightweight removeable PET Felt panels, specify SCCAPP3248 for the 48" w cart and SCCAPP3260 for the 60" w cart.
- Snaps onto (SCCEWxxxx) vertical rails at various shelf heights to create space division and privacy.
- Cover caps painted metal finish should be specified to match the cart finish.
- PET Felt available in standard finishes.

PRODUCT CODE	PRICE	SIZE/INCHES			WEIGHT VOL	
		H	W	D	LBS	FT ³
SCCAPP3248	223	32	48	0.5	4.16	0.32
SCCAPP3260	331	32	60	0.5	5.16	0.40

SCCAMP • Concealed Power Unit

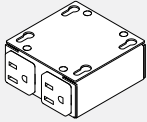

- Provided inside SCCMEPxxxx media units, can be added to SCCNMExxxx in field.
- Includes two AC outlets.
- Compatible with Mobile Media Carts only.
- BLK - Black finish only.

PRODUCT CODE	PRICE	SIZE/INCHES			WEIGHT VOL	
		H	W	D	LBS	FT ³
SCCAMP	251	1.5	3	3.00	0.50	0.01

SCCAMT • Media Tray

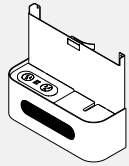

- Attaches to the front of the SCCMEPxxxx/SCCNMExxxx to provide a wire catch, wireless receiver area and easily accessible power at the front of the media carts.
- Compatible with Mobile Media Carts only.
- Tray is painted metal with a PET Felt insert.
- PET Felt available in 18 standard finishes.
- SCCAMT is empty and has no power capabilities.
- Specify configuration, last letter of the code represents the following:
 • C = 2 AC, 1 USB-A 1.5A charge port, 1 USB-A 2.4A quick charge port
 • D = 1 AC, 1 USB-A 1.5A charge port, 1 USB-A 2.4A quick charge port, 1 60W USB-C charge port
 • E = 3 AC

PRODUCT CODE	PRICE	SIZE/INCHES			WEIGHT VOL	
		H	W	D	LBS	FT ³
SCCAMT	611	13.80	14.57	5.60	12	0.65
SCCAMTPC	1189	13.80	14.57	5.60	12	0.65
SCCAMTPD	1329	13.80	14.57	5.60	12	0.65
SCCAMTPE	1120	13.80	14.57	5.60	12	0.65

SCCAC • Accessory Cup



- Hangs onto any team cart horizontal top or side rail. Black only.

PRODUCT CODE	PRICE	SIZE/INCHES			WEIGHT VOL	
		H	W	D	LBS	FT ³
SCCAC	9	3.7	3.3	3.00	0.15	0.02

SCCAH • Hook for Team Cart



- Hangs onto any team cart horizontal top or side rail.
- Black only
- Maximum capacity of 10 lbs.

PRODUCT CODE	PRICE	SIZE/INCHES			WEIGHT VOL	
		H	W	D	LBS	FT ³
SCCAH	6	1.8	1.3	0.65	0.10	

SCCAWB • Whiteboard

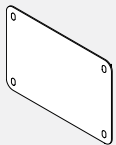

- Lightweight removeable whiteboard panels.
- Specify SCCAWB3336 for the 48" w cart and SCCAWB3348 for the 60" w cart.
- Back of whiteboard is DWT - Designer White with DWE - Designer White edging.
- Cover caps painted metal finish should be specified to match the cart finish.
- Horizontal and vertical mounting on wall rail(s).

PRODUCT CODE	PRICE	SIZE/INCHES			WEIGHT VOL	
		H	W	D	LBS	FT ³
SCCAWB3336	501	33	36	0.50	17.62	0.34
SCCAWB3348	620	33	48	0.50	23.32	0.46

SCCAWBR • Whiteboard Wall Rail

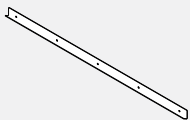

- Wall rail for whiteboards.
- Accepts SCCAWBxxxx.
- Metal extrusion in BLK - Black only.

PRODUCT CODE	PRICE	SIZE/INCHES			WEIGHT VOL	
		H	W	D	LBS	FT ³
SCCAWBR36	51	2	36	1	1.27	0.04
SCCAWBR48	63	2	48	1	1.71	0.05
SCCAWBR72	102	2	72	1.00	2.54	0.08
SCCAWBR96	126	2	96	1.00	3.42	0.11

SCCALSL • Laptop Shelf



- Laminate laptop shelf with dual bracket.
- Can be flipped vertically to store when cart is not in use.
- Shelf available in LP - Low Pressure laminate.
- Bracket included is painted metal finish and should be specified to match the cart finish.

PRODUCT CODE	PRICE	SIZE/INCHES			WEIGHT VOL	
		H	W	D	LBS	FT ³
SCCALSL1219	243	3	19	12	11.07	

SCOR • Occasional Side Table, Round Top

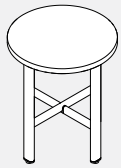

- Occasional End Table includes leg assembly, cross beams and one worksurface.
- Surface available in LP - Low Pressure laminate.
- Legs and cross beam are painted aluminum available in standard paint finishes.

PRODUCT CODE	PRICE LP	SIZE/INCHES			WEIGHT LBS	VOL FT ³
		H	W	D		
SCOR1818	514	21	18	18	18.52	3.94
SCOR2424	584	21	24	24	26.53	7.01

SCOC • Occasional Side Table, Square Top

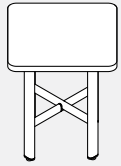

- Occasional End Table includes leg assembly, cross beams and one worksurface with a small 1.5" radius at each corner.
- Surface available in LP - Low Pressure laminate.
- Legs and cross beam are painted aluminum available in standard paint finishes.

PRODUCT CODE	PRICE LP	SIZE/INCHES			WEIGHT LBS	VOL FT ³
		H	W	D		
SCOC1818	514	21	18	18	21.12	3.94
SCOC2424	584	21	24	24	31.20	7.01

SCOCL • Occasional Side Table, Square Top, Larger Radius

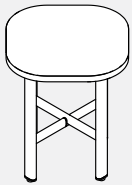

- Occasional End Table includes leg assembly, cross beams and one worksurface with a larger 9" radius at each corner.
- Surface available in LP - Low Pressure laminate.
- Legs and cross beam are painted aluminum available in standard paint finishes.

PRODUCT CODE	PRICE LP	SIZE/INCHES			WEIGHT LBS	VOL FT ³
		H	W	D		
SCOCL1818	550	21	18	18	21.12	3.94
SCOCL2424	648	21	24	24	31.20	7.01

SCOCR • Occasional Coffee Table, Round Top

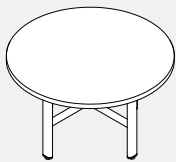

- Occasional End Table includes leg assembly, cross beams and one worksurface.
- Surface available in LP - Low Pressure laminate.
- Legs and cross beam are painted aluminum available in standard paint finishes.

PRODUCT CODE	PRICE LP	SIZE/INCHES			WEIGHT LBS	VOL FT ³
		H	W	D		
SCOCR2424	563	17	24	24	25.55	5.67
SCOCR3030	643	17	30	30	35.76	8.86
SCOCR3636	739	17	36	36	48.13	12.76

SCOCS • Occasional Coffee Table, Square Top

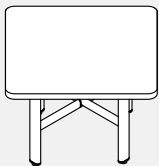

- Occasional Coffee Table includes leg assembly, cross beams and one worksurface with a small 1.5" radius at each corner.
- Surface available in LP - Low Pressure laminate.
- Legs and cross beam are painted aluminum available in standard paint finishes.

PRODUCT CODE	PRICE LP	SIZE/INCHES			WEIGHT LBS	VOL FT ³
		H	W	D		
SCOCS2424	563	17	24	24	30.22	5.67
SCOCS3030	643	17	30	30	43.10	8.86

SCOCSL • Occasional Coffee Table, Square Top, Larger Radius

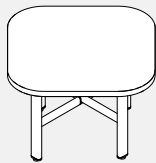

- Occasional Coffee Table includes leg assembly, cross beams and one worksurface with a larger 9" radius at each corner.
- Surface available in LP - Low Pressure laminate.
- Legs and cross beam are painted aluminum available in standard paint finishes.

PRODUCT CODE	PRICE LP	SIZE/INCHES			WEIGHT LBS	VOL FT ³
		H	W	D		
SCOCSL2424	563	17	24	24	29.11	5.67
SCOCSL3030	643	17	30	30	41.99	8.86

SCOCC • Occasional Coffee Table, Racetrack Top

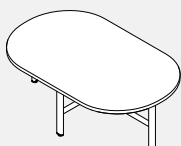

- Occasional Coffee Table includes leg assembly, cross beams and one racetrack worksurface.
- Surface available in LP - Low Pressure laminate.
- Legs and cross beam are painted aluminum available in standard paint finishes.

PRODUCT CODE	PRICE LP	SIZE/INCHES			WEIGHT LBS	VOL FT ³
		H	W	D		
SCOCC2442	676	17	24	42	42.78	9.93
SCOCC3048	777	17	30	48	57.13	14.18

SCLCC • Laptop Table, Racetrack Top, Wheel and Foot Base



- Laptop Table includes leg assembly and two wheels with rubber trim, one leg assembly with a foot and one racetrack worksurface.
- Two bag hooks included, one on the exterior of each leg, mounted just under the surface for easy access.
- Each bag hook accepts up to 10 lbs, and painted to match the legs.
- Legs, beams and hook are painted aluminum available in standard paint finishes.
- Wheel insert is painted to match the legs and beams.
- Surface available in LP - Low Pressure laminate.

PRODUCT CODE	PRICE LP	SIZE/INCHES			WEIGHT		VOL FT ³
		H	W	D	LBS		
SCLCC1633	901	26	33	16	25.60	6.51	

SCLCB • Laptop Table, Racetrack Top, Foot Base



- Laptop Table includes two leg assemblies a foot and one racetrack worksurface.
- Two bag hooks included, one on the exterior of each leg, mounted just under the surface for easy access.
- Each bag hook accepts up to 10 lbs, and painted to match the legs.
- Legs and beams are painted aluminum available in standard paint finishes.
- Surface available in LP - Low Pressure laminate.

PRODUCT CODE	PRICE LP	SIZE/INCHES			WEIGHT		VOL FT ³
		H	W	D	LBS		
SCLCB1633	516	26	33	16	23.85	6.51	

SCLTC • Laptop Table, Rectangular Top, Small Radius, Wheel and Foot Base

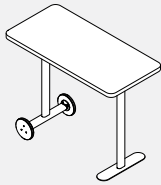

- Laptop Table includes leg assembly and two wheels with rubber trim, one leg assembly with a foot and one rectangular worksurface with a small 1.5" radius at each corner.
- Two bag hooks included, one on the exterior of each leg, mounted just under the surface for easy access.
- Each bag hook accepts up to 10 lbs, and painted to match the legs.
- Legs and beams are painted aluminum available in standard paint finishes.
- Wheel insert is painted to match the legs and beams.
- Surface available in LP - Low Pressure laminate.

PRODUCT CODE	PRICE LP	SIZE/INCHES			WEIGHT		VOL FT ³
		H	W	D	LBS		
SCLTC1633	901	26	33	16	27.64	6.51	

SCLTB • Laptop Table, Rectangular Top, Base

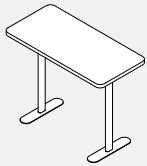

- Laptop Table includes two leg assemblies a foot and one rectangular worksurface with a small 1.5" radius at each corner.
- Two bag hooks included, one on the exterior of each leg, mounted just under the surface for easy access.
- Each bag hook accepts up to 10 lbs, and painted to match the legs.
- Legs and beams are painted aluminum available in standard paint finishes.
- Surface available in LP - Low Pressure laminate.

PRODUCT CODE	PRICE LP	SIZE/INCHES			WEIGHT		VOL FT ³
		H	W	D	LBS		
SCLTB1633	516	26	33	16	25.88	6.51	

Guideline for Ordering Product

CODES: The price list uses a numbering system with meaningful alphanumeric characters to create a simple-to-understand product number. This makes specifying the product much easier and more accurate.

SPECIFICATION EXAMPLE OF A HEIGHT ADJUSTABLE TABLE

Ordered as components, please order:

1, BASE

PRODUCT CODE:

FT - FreeFit
 5 - Standard Range Legs
 2 - Leg Quantity
 SF - Small Frame
 24 - Depth
 CL - C-leg Style
 S - Standard Controller



OPTIONS:

Frame Style: 5 - Standard Range Frame 27.5" to 47"
 6 - Extended Range Frame 22.5" to 48.5"

Leg Quantity: 1 - 1 Leg for return Kit
 2 - 2 Leg table Kit
 3 - 3 Leg Table Kit
 4 - 4 Leg Table Kit

Frame Size: SF - Small Frame, for 42" to 60" wide Tables
 LF - Large Frame, for 66" to 84" wide Tables

Worksurface Depth: 24 - For 23" deep worksurfaces
 30 - For 29" and 35" deep worksurfaces

Leg Style: CL - C Shaped Table Leg
 TL - T Shaped Table Leg

Controller Style: S - Standard Controller
 D - Display Controller

Base Finish: BLK - Black
 DWT - Designer White
 TUN - Tungsten
 The following finishes are available for minimum orders of 72 legs for special projects. For customer who request the finishes below, and do not meet the 72 legs threshold, a 30% surcharge will apply to the base and an extended lead time of 6 weeks.

BZD - Blizzard SIL - Silver
 CHR - Charcoal FOG - Steel
 NEV - Nevada TPE - Taupe
 SDT - Stonedust

2, TOP

PRODUCT CODE:

FTWR2436

Top: LP = LP (Low Pressure Laminate) Thickness 1"
 HP = HP (High Pressure Laminate) Thickness 1 1/16"

Top Finish Laminate: Choose Colour

Top PVC Edging: Choose Colour

3, ACCESSORIES

PRODUCT CODE:

FTAEC12

Base Finish: BLK - Black
 DWT - Designer White
 TUN - Tungsten
 The following finishes are available for minimum orders of 72 legs for special projects. For customer who request the finishes below, and do not meet the 72 legs threshold, a 30% surcharge will apply to the base and an extended lead time of 6 weeks.

BZD - Blizzard SIL - Silver
 CHR - Charcoal FOG - Steel
 NEV - Nevada TPE - Taupe
 SDT - Stonedust

Height Adjustable Tables • Product Map

C-Leg Base
Standard and Extended Range

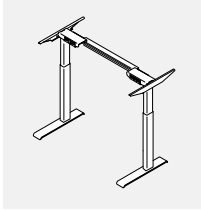

90 Degree Retrofit Kit with C-Leg
Standard and Extended Range

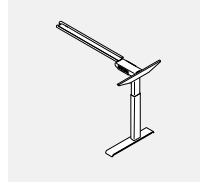

Single Frame
Standard and Extended Range

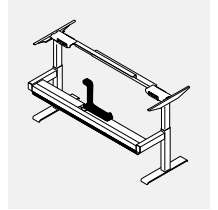

T-Leg Base
Standard and Extended Range

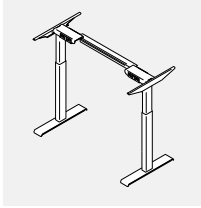

90 Degree Retrofit Kit with T-Leg
Standard and Extended Range

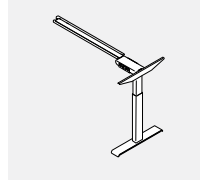

Single End of Run Frame
Standard and Extended Range

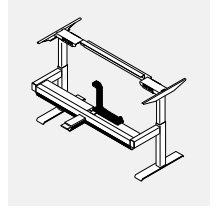

90 Degree Table Base, Equal Sides
Standard and Extended Range

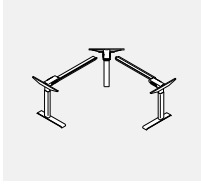

120 Degree Table Base
Standard and Extended Range

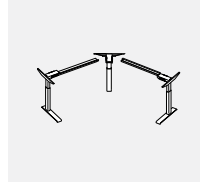

Media Table Frame
Standard and Extended Range



90 Degree Table Base, Unequal Sides
Standard and Extended Range

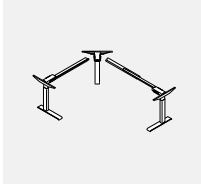

Back to Back Frame
Standard and Extended Range



FREEFIT GROMMET LOCATION

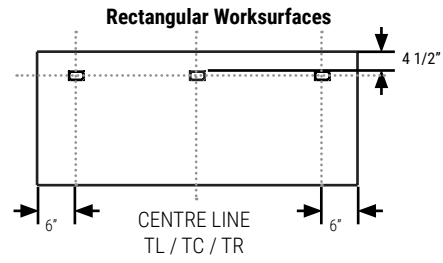
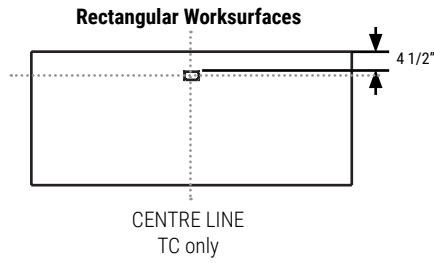

120° Corner Table Top

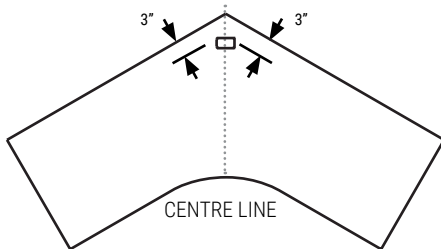

90° Extended Corner Worksurface

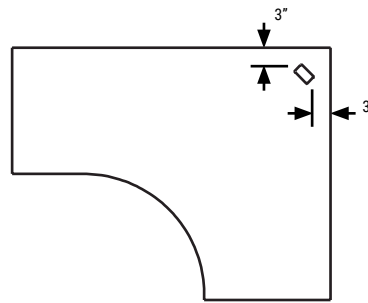

For FTWR worksurfaces 64" and larger, TL/TR, TL/TC and TC/TR are also available.

GAADxx Grommets Rectangular Worksurface TL

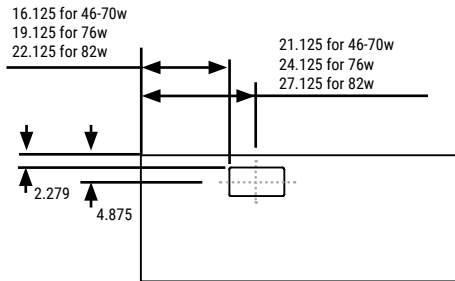

GAADxx Grommets Rectangular Worksurface TR

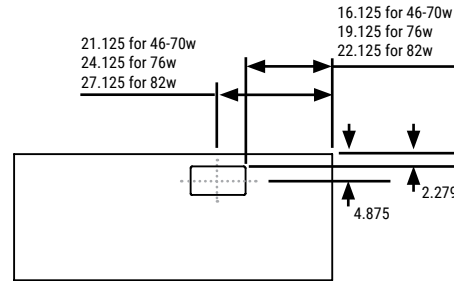

For Back to Back Tables and Freestanding Tables only. Not available for return table tops.

Media Table Tops

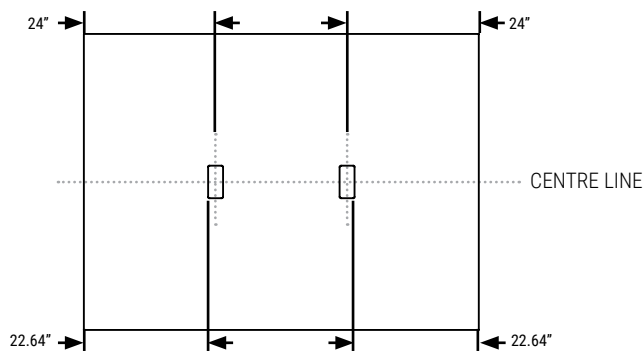

General Specification

FEATURES

- Table frames feature 80 X 50 mm rectangular outer leg with the large tube attached to the foot.
- Open base design with ample room for chair and user's legs.
- Flat foot design includes adjustable (10mm) glides.
- All table frames include expandable width upper crossbars to create a variety of size tables.
- Tables have no lower crossbars.
- All table frames are easy to assemble with few parts.
- Tables are designed so that the paint will never mar on the leg during operation.
- Steel construction of the leg assembly tubing, feet and upper structure assemblies.
- Powder coat finishes for bases standard in (DWT) Designer White, (BLK) Black and (TUN) Tungsten.
- All standard Global Contract laminate finishes are available.
- Sizes of tops are "nominal". Unless otherwise stated, actual depth is 1" less and actual width is 2" less than "nominal" size.
- Additional Finishes available minimum quantity of 72 legs (36 - 2 leg tables, 24 - 3 leg tables or 18 B2B Tables) Blizzard, Charcoal, Nevada, Silver, Steel, Stonedust, and Taupe
- All bases lift 350 lbs on two leg tables.
- All bases operate at 1.5" per second.
- Standard Range Frame adjusts from 27.5" to 47" including the worksurface.
- Extended Range Frame adjusts from 22.5" to 48.5" including the worksurface.
- Tops are warranted for lifetime and bases are warranted for 7 years.

CERTIFICATIONS

Products are fully compliant with ANSI/BIFMA X5.5 – 2014, CAN/CGSB-44.227 - 2017; EN 60335-1 and UL962

All Global Contract Extended Range tables meet the BIFMA G1-2013 Ergonomic Guideline for "recommended adjustment range".

EXTENDED RANGE COLUMNS

The 3-part construction ensures a short installation dimension combined with a long stroke length making the Extended Range Column the optimum choice no matter the height of the person using it. The middle profile of the column moves synchronously so the profiles are always in the same height optimising the desk design and the stability.

- Compact design where guide and actuator functions are an integrated unit
- Reinforced column and optimised motor housing design for extra strength and stability
- Maximum load 350 lbs. for 2 legged configurations, 525 lbs. for 3 legged configurations.
- Max. speed 38 mm/s unloaded
- Installation dimension: 560 mm 518 mm (BIFMA)
- Stroke length: 650 mm 665 mm (BIFMA)
- Dimensions column: 50 x 80 mm (outer profile), 43.5 x 73.5 mm (middle profile) and 37 x 67 mm (inner profile)
- Low noise level
- No visible gliding pads

STANDARD RANGE COLUMNS

The 2-part lifting column is a perfect choice for a wide range of different desk applications in the office.

- Compact design where guide and actuator functions are an integrated unit
- Reinforced column and optimised motor housing design for extra strength and stability
- Maximum load 350 lbs. for 2 legged configurations, 525 lbs. for 3 legged configurations
- Max. speed: 38 mm/s unloaded
- Standard installation dimension 645 mm
- Standard stroke length 500 mm
- Dimensions column: 50 x 80 mm (outer profile) and 43.5 x 73.5 mm (inner profile)
- Dimension motor housing: 177 x 97 x 46 mm
- Low noise level
- No visible gliding pads

FOOT

Freefit offers two foot styles either a "T" or "C".

The feet are available in two different lengths (560 mm and 710 mm). The foot offers a recessed connection for the column and connects from the bottom with 4 bolts. Adjustable glides are standard

DESK MOUNT FRAME

- Can be specified in two lengths Short Frame (SF) for tables 42" – 60" in length. Long Frames (LF) for tables 66"– 84" in length
 - All metal parts Black
 - Cantilever length: 550 mm
 - Central or off-centre placement of columns (T-desk and C-desk)
- Includes all connecting hardware

CONTROL BOX

Two leg tables come standard with a 200 W Control Box

- Mains voltage 230 VAC, 50 Hz, or 120 VAC, 60 Hz
- Ultra-compact; length 210 mm length
- Lightweight control box; weight only approx. 400 g

Three Leg Tables come standard with a 300 W Control Box

- can be connected up to 4 columns
- Mains voltage 100-240 VAC, 50-60 Hz (universal)
- Ultra-compact; length 265 mm length
- Lightweight control box; weight only approx. 500 g

Common features for the (200 W and 300 W):

- Ultra-low; height only 38 mm
- Environment: Operation Storage
- Ambient temperature: 5 to 40 °C -10 to +50 °C
- Relative humidity: 20 to 80 % at 30 °C 20 to 80 % at 30 °C
- Atmospheric pressure: 700 to 1060 hPa 700 to 1060 hPa
- Compact high-power SMPS (Switch Mode Power Supply)
- Colour: black
- Protection against overload (EOP), by individual current limitation
- The control box is designed with a soft start/stop function
- Autodetection of the number and type of columns connected
- Cable grooves at the bottom to optimise cable management
- White plugs for easy recognition when mounting/dismounting
- PVC-Free™
- Low standby power consumption – only 0.1 W.
- Exchangeable standard mains cable

STANDARD UP/DOWN CONTROLLER

Features Bluetooth® connection, two favourite positions and a reminder via an LED to remind the users to use their desk. The Controller is activated by tilting the desk panel in the same direction as the desk is intended to drive. Via pulsating green and orange lights, the LED reminds the users to change positions. Using the integrated Bluetooth® and downloading the Desk Control™ App the user can also be reminded via notifications on computers and smart devices.

- Colour: Black
- Black cable with RJ45 modular plug, 1700 mm straight
- PVC-Free™
- Featuring ZERO™: Very low power consumption in standby mode
- Approved according to EN 60335-1
- Approved according to UL962

NOTE: All grommets must be specified separately.

DISPLAY UP/DOWN CONTROLLER

Features Bluetooth® connection, four favourite positions, a display to guide the users and a reminder via a light strip to remind the users to use their desks. The Controller is activated by tilting the desk panel in the same direction as the desk is intended to drive. The Display Controller features a modern discreet design with a glossy surface and an integrated display to ensure a clean and minimalist design. The display provides guidance to the users when operating the desk. Via pulsating green and orange lights, the light strip reminds the users to change positions. Using the integrated Bluetooth® and downloading the Desk Control™ App the users can also be reminded via notifications on smart devices.

- Colour: Black
- Black cable with RJ45 modular plug, 1700 mm straight
- PVC-Free™
- Featuring ZERO™: Very low power consumption in standby mode
- Approved according to EN 60335-1
- Approved according to UL962

ANTI COLLISION SENSOR

Features enhanced Anti-Collision protection which can limit material damage to a desk or an object if a collision occurs during driving of the desk. The sensor is a compact plug-in adapter based on gyroscope-technology, and it detects even little tilting of the desk when the desk is driving up or down. Upon detected tilting, the system stops and drives in the opposite direction to avoid collision and damage to the desk or the object. The sensor can detect both hard and soft obstacles. The Anti-Collision Sensor is standard on all desks.

- Reacts to angle changes bigger than 0.7° per second
- Just plug it in – no mounting required
- ZERO™ Power capable
- PVC-Free

BATTERY BOX

A high-performance lithium-Ion battery with a capacity of 2.15 Ah. On a full charge the table can cycle from 35 to 45 stroke lengths based upon the range of column selected and load on the table.

- Compact unit for easy handling and installation
- Battery alarm (audio) when charging is needed
- Battery charging indicator (LED light bars) indicating the capacity level
- Thermal switch protection, overcurrent protection
- Colour: black
- Battery capacity: 2.15 Ah / 52 Wh
- Nominal voltage: 24 V DC
- Discharge current: 9 A (max)
- Maximum charging voltage: 40 V DC
- Charging current: 0.5 A
- Weight: 600 g

USAGE

- Ambient temperature: 5 to 40 °C
- Storage temperature: 0 to 45 °C
- Approved according to:
 - EN 62133 (Battery safety testing)
 - UL 1642 (Lithium cells, standard test)
 - UN 38.3 (transportation of Lithium batteries)
 - UL 2054 (Household and commercial batteries)
 - EN 60335-1 with CBH Advanced

FT52-CL • Standard Range Base with C-Legs

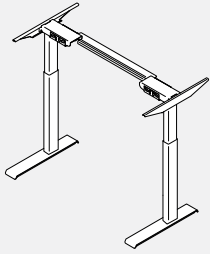

- Kit includes one beam, two cantilevers, two standard range columns and two C styled feet.
- BF indicates a smaller frame for 30" to 42" tables.
- SF indicates small frame for 48" to 60" tables.
- LF indicates large frame: 66" to 84" tables.
- For 23" deep worksurfaces, use 24" CL leg.
- For 29" and 35" deep worksurface, use 30" CL leg.
- For enhanced collision detection an Anti Collision Desk Sensor included with every base.
- For Standard Up/Down Controller add (S) at the end of the code. For Display Controller, please add at "D" at the end of the product code and \$78 to the list price.
- Specify paint finish: BLK-Black, DWT-Designer White, TUN-Tungsten.

PRODUCT CODE	PRICE	HEIGHT MIN/MAX	WIDTH MIN/MAX	DEPTH MIN/MAX	WEIGHT LBS	VOL FT ³
FT52BF24CL	1778	27.5" - 47"	30" - 42"	24" - 24"	56.12	2.3
FT52BF30CL	1791	27.5" - 47"	30" - 42"	30" - 30"	56.12	2.3
FT52SF24CL	1806	27.5" - 47"	48" - 60"	24" - 24"	56.12	2.3
FT52SF30CL	1821	27.5" - 47"	48" - 60"	30" - 36"	56.12	2.3
FT52LF24CL	1815	27.5" - 47"	66" - 84"	24" - 24"	59.3	2.3
FT52LF30CL	1827	27.5" - 47"	66" - 84"	30" - 36"	59.3	2.3

FT52-TL • Standard Range Base with T-Legs

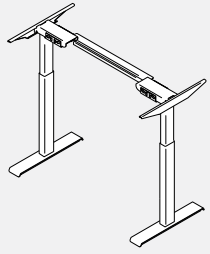

- Kit includes one beam, two cantilevers, two standard range columns and two T styled feet.
- BF indicates a smaller frame for 30" to 42" tables.
- SF indicates small frame for 48" to 60" tables.
- LF indicates large frame: 66" to 84" tables.
- For 23" deep worksurfaces, use 24" TL leg.
- For 29" deep worksurface, use 30" TL leg.
- For enhanced collision detection an Anti Collision Desk Sensor included with every base.
- For Standard Up/Down Controller add (S) at the end of the code. For Display Controller, please add at "D" at the end of the product code and \$78 to the list price.
- Specify paint finish: BLK-Black, DWT-Designer White, TUN-Tungsten.

PRODUCT CODE	PRICE	HEIGHT MIN/MAX	WIDTH MIN/MAX	DEPTH MIN/MAX	WEIGHT LBS	VOL FT ³
FT52BF24TL	1734	27.5" - 47"	30" - 42"	24" - 24"	56.12	2.3
FT52BF30TL	1748	27.5" - 47"	30" - 42"	30" - 30"	56.12	2.3
FT52SF24TL	1763	27.5" - 47"	48" - 60"	24" - 24"	56.12	2.3
FT52SF30TL	1778	27.5" - 47"	48" - 60"	30" - 36"	56.12	2.3
FT52LF24TL	1769	27.5" - 47"	66" - 84"	24" - 24"	59.3	2.3
FT52LF30TL	1784	27.5" - 47"	66" - 84"	30" - 36"	59.3	2.3

FT62-CL • Extended Range Base with C-Legs

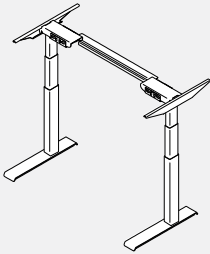

- Kit includes one beam, two cantilevers, two extended range columns and two C styled feet.
- BF indicates a smaller frame for 30" to 42" tables.
- SF indicates small frame for 48" to 60" tables.
- LF indicates large frame: 66" to 84" tables.
- For 23" deep worksurfaces, use 24" CL leg.
- For 29" and 35" deep worksurface, use 30" CL leg.
- For enhanced collision detection an Anti Collision Desk Sensor included with every base.
- For Standard Up/Down Controller add (S) at the end of the code. For Display Controller, please add at "D" at the end of the product code and \$78 to the list price.
- Specify paint finish: BLK-Black, DWT-Designer White, TUN-Tungsten.

PRODUCT CODE	PRICE	HEIGHT MIN/MAX	WIDTH MIN/MAX	DEPTH MIN/MAX	WEIGHT LBS	VOL FT ³
FT62BF24CL	1896	22.5" - 48.5"	30" - 42"	24" - 24"	56.12	2.3
FT62BF30CL	1911	22.5" - 48.5"	30" - 42"	30" - 30"	56.12	2.3
FT62SF24CL	1927	22.5" - 48.5"	48" - 60"	24" - 24"	59.3	2.3
FT62SF30CL	1941	22.5" - 48.5"	48" - 60"	30" - 36"	59.3	2.3
FT62LF24CL	1932	22.5" - 48.5"	66" - 84"	24" - 24"	64.7	2.3
FT62LF30CL	1947	22.5" - 48.5"	66" - 84"	30" - 36"	64.7	2.3

FT62-TL • Extended Range Base with T-Legs

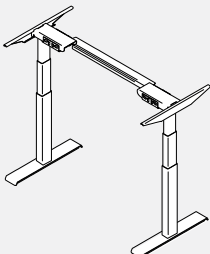

- Kit includes one beam, two cantilevers, two extended range columns and two T styled feet.
- BF indicates a smaller frame for 30" to 42" tables.
- SF indicates small frame for 48" to 60" tables.
- LF indicates large frame: 66" to 84" tables.
- For 23" deep worksurfaces, use 24" TL leg.
- For 29" deep worksurface, use 30" TL leg.
- For enhanced collision detection an Anti Collision Desk Sensor included with every base.
- For Standard Up/Down Controller add (S) at the end of the code. For Display Controller, please add at "D" at the end of the product code and \$78 to the list price.
- Specify paint finish: BLK-Black, DWT-Designer White, TUN-Tungsten.

PRODUCT CODE	PRICE	HEIGHT MIN/MAX	WIDTH MIN/MAX	DEPTH MIN/MAX	WEIGHT LBS	VOL FT ³
FT62BF24TL	1854	22.5" - 48.5"	30" - 42"	24" - 24"	56.12	2.3
FT62BF30TL	1868	22.5" - 48.5"	30" - 42"	30" - 30"	56.12	2.3
FT62SF24TL	1884	22.5" - 48.5"	48" - 60"	24" - 24"	59.3	2.3
FT62SF30TL	1895	22.5" - 48.5"	48" - 60"	30" - 36"	59.3	2.3
FT62LF24TL	1890	22.5" - 48.5"	66" - 84"	24" - 24"	64.7	2.3
FT62LF30TL	1905	22.5" - 48.5"	66" - 84"	30" - 36"	64.7	2.3

FT539F-CL • Standard Range 90 Degree Table Base, Equal Sides

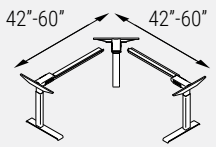

FS Base

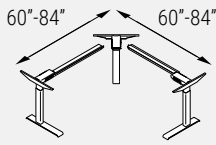

FL Base

- Kit includes two equal length beams, three cantilevers, one standard range corner column, two standard range columns and two C styled feet.
- FS indicates small base for 54" to 60" sided tables.
- FL indicates large base for 66" to 84" sided tables.
- For 23" deep worksurfaces, use 24" CL leg.
- For 29" and 35" deep worksurface, use 30" CL leg.

PRODUCT CODE	PRICE	HEIGHT MIN/MAX	WIDTH MIN/MAX	DEPTH MIN/MAX	WEIGHT LBS	VOL FT ³
FT539FS24CL	2629	27.5" - 47"	42" - 60"	42" - 60"	79.1	4.7
FT539FS30CL	2644	27.5" - 47"	42" - 60"	42" - 60"	79.1	4.7
FT539FL24CL	2678	27.5" - 47"	66" - 84"	66" - 84"	59.3	4.7
FT539FL30CL	2690	27.5" - 47"	66" - 84"	66" - 84"	59.3	4.7

- For enhanced collision detection an Anti Collision Desk Sensor included with every base.
- For Standard Up/Down Controller add (S) at the end of the code. For Display Controller, please add at "D" at the end of the product code and \$78 to the list price.
- Specify paint finish: BLK-Black, DWT-Designer White, TUN-Tungsten.

FT539FSL-CL • Standard Range 90 Degree Table Base, Unequal Sides

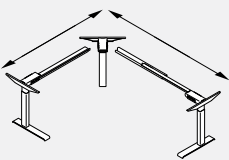

- Kit includes two beams (one small and one large), three cantilevers, one standard range corner column, two standard range columns and two C styled feet.
- For 23" deep worksurfaces, use 24" CL leg.
- For 29" and 35" deep worksurface, use 30" CL leg.

PRODUCT CODE	PRICE	HEIGHT MIN/MAX	WIDTH MIN/MAX	DEPTH MIN/MAX	WEIGHT LBS	VOL FT ³
FT539FSL24CL	2652	27.5" - 47"	42" - 60"	66" - 84"	85.4	4.7
FT539FSL30CL	2666	27.5" - 47"	42" - 60"	66" - 84"	85.4	4.7

- For enhanced collision detection an Anti Collision Desk Sensor included with every base.
- For Standard Up/Down Controller add (S) at the end of the code. For Display Controller, please add at "D" at the end of the product code and \$78 to the list price.
- Specify paint finish: BLK-Black, DWT-Designer White, TUN-Tungsten.

FT639F-CL • Extended Range 90 Degree Table Base, Equal Sides

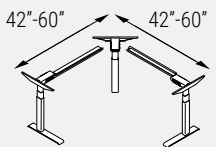

FS Base

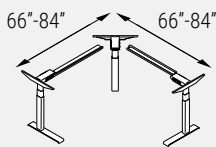

FL Base

- Kit includes two equal length beams, three cantilevers, one extended range corner column, two extended range columns and two C styled feet.
- FS indicates small base for 54" to 60" sided tables.
- FL indicates large base for 66" to 84" sided tables.
- For 23" deep worksurfaces, use 24" CL leg.
- For 29" and 35" deep worksurface, use 30" CL leg.

PRODUCT CODE	PRICE	HEIGHT MIN/MAX	WIDTH MIN/MAX	DEPTH MIN/MAX	WEIGHT LBS	VOL FT ³
FT639FS24CL	2808	22.5" - 48.5"	42" - 60"	42" - 60"	76.5	4.7
FT639FS30CL	2822	22.5" - 48.5"	42" - 60"	42" - 60"	76.5	4.7
FT639FL24CL	2855	22.5" - 48.5"	66" - 84"	66" - 84"	82.7	4.7
FT639FL30CL	2869	22.5" - 48.5"	66" - 84"	66" - 84"	82.7	4.7

- For enhanced collision detection an Anti Collision Desk Sensor included with every base.
- For Standard Up/Down Controller add (S) at the end of the code. For Display Controller, please add at "D" at the end of the product code and \$78 to the list price.
- Specify paint finish: BLK-Black, DWT-Designer White, TUN-Tungsten.

FT639FSL-CL • Extended Range 90 Degree Table Base, Unequal Sides

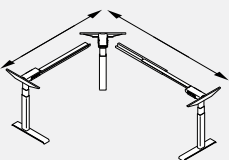

- Kit includes two beams (one small and one large), three cantilevers, one extended range corner column, two extended range columns and two C styled feet.
- For 23" deep worksurfaces, use 24" CL leg.
- For 29" and 35" deep worksurface, use 30" CL leg.

PRODUCT CODE	PRICE	HEIGHT MIN/MAX	WIDTH MIN/MAX	DEPTH MIN/MAX	WEIGHT LBS	VOL FT ³
FT639FSL24CL	2832	22.5" - 48.5"	42" - 60"	48" - 84"	85.4	4.7
FT639FSL30CL	2845	22.5" - 48.5"	42" - 60"	48" - 84"	85.4	4.7

- For enhanced collision detection an Anti Collision Desk Sensor included with every base.
- For Standard Up/Down Controller add (S) at the end of the code. For Display Controller, please add at "D" at the end of the product code and \$78 to the list price.
- Specify paint finish: BLK-Black, DWT-Designer White, TUN-Tungsten.

FT51-R-CL • Standard Range 90 Degree Table Retrofit Kit with with C-Leg

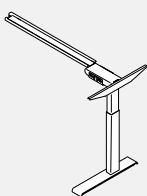

- Kit includes one beam, one cantilever, one standard range column and one C styled foot.
- SR indicates short returns.
- LR indicates long returns.
- For 23" deep worksurfaces, use 24" CL leg.
- For 29" and 35" deep worksurface, use 30" CL leg.
- Specify paint finish: BLK-Black, DWT-Designer White, TUN-Tungsten.

PRODUCT CODE	PRICE	HEIGHT MIN/MAX	WIDTH MIN/MAX	DEPTH MIN/MAX	WEIGHT LBS	VOL FT ³
FT51SR24CL	1195	27.5" - 47"	24" - 48"	24" - 24"	24.9	4.7
FT51LR24CL	1219	27.5" - 47"	54" - 72"	24" - 24"	26.9	4.7
FT51SR30CL	1203	27.5" - 47"	24" - 48"	30" - 36"	24.9	4.7
FT51LR30CL	1225	27.5" - 47"	54" - 72"	30" - 36"	26.9	4.7

FT51-R-TL • Standard Range 90 Degree Table Retrofit Kit with with T-Leg

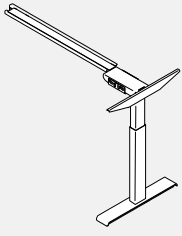

- Kit includes one beam, one cantilever, one standard range column and one T styled foot.
- SR indicates short returns.
- LR indicates long returns.
- For 23" deep worksurfaces, use 24" TL leg.
- For 29" and 35" deep worksurface, use 30" TL leg.
- Specify paint finish: BLK-Black, DWT-Designer White, TUN-Tungsten.

PRODUCT CODE	PRICE	HEIGHT MIN/MAX	WIDTH MIN/MAX	DEPTH MIN/MAX	WEIGHT LBS	VOL FT ³
FT51SR24TL	1176	27.5" - 47"	24" - 48"	24" - 24"	24.9	2.3
FT51LR24TL	1197	27.5" - 47"	54" - 72"	24" - 24"	26.9	2.3
FT51SR30TL	1181	27.5" - 47"	24" - 48"	30" - 36"	24.9	2.3
FT51LR30TL	1204	27.5" - 47"	54" - 72"	30" - 36"	26.9	2.3

FT61-R-CL • Extended Range 90 Degree Table Retrofit Kit with with C-Leg

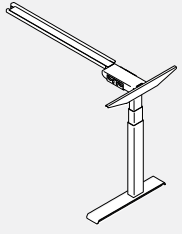

- Kit includes one beam, one cantilever, one extended range column and one C styled foot.
- SR indicates short returns.
- LR indicates long returns.
- For 23" deep worksurfaces, use 24" CL leg.
- For 29" and 35" deep worksurface, use 30" CL leg.
- Specify paint finish: BLK-Black, DWT-Designer White, TUN-Tungsten.

PRODUCT CODE	PRICE	HEIGHT MIN/MAX	WIDTH MIN/MAX	DEPTH MIN/MAX	WEIGHT LBS	VOL FT ³
FT61SR24CL	1255	22.5" - 48.5"	24" - 48"	24" - 24"	27.6	4.7
FT61LR24CL	1279	22.5" - 48.5"	54" - 72"	24" - 24"	30.7	4.7
FT61SR30CL	1262	22.5" - 48.5"	24" - 48"	30" - 36"	27.6	4.7
FT61LR30CL	1286	22.5" - 48.5"	54" - 72"	30" - 36"	30.7	4.7

FT61-R-TL • Extended Range 90 Degree Table Retrofit Kit with with T-Leg

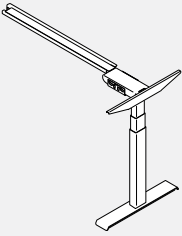

- Kit includes one beam, one cantilever, one extended range column and one T styled foot.
- SR indicates short returns.
- LR indicates long returns.
- For 23" deep worksurfaces, use 24" TL leg.
- For 29" and 35" deep worksurface, use 30" TL leg.
- Specify paint finish: BLK-Black, DWT-Designer White, TUN-Tungsten.

PRODUCT CODE	PRICE	HEIGHT MIN/MAX	WIDTH MIN/MAX	DEPTH MIN/MAX	WEIGHT LBS	VOL FT ³
FT61SR24TL	1234	22.5" - 48.5"	24" - 48"	24" - 24"	27.6	2.3
FT61LR24TL	1257	22.5" - 48.5"	54" - 72"	24" - 24"	30.7	2.3
FT61SR30TL	1241	22.5" - 48.5"	24" - 48"	30" - 36"	27.6	2.3
FT61LR30TL	1265	22.5" - 48.5"	54" - 72"	30" - 36"	30.7	2.3

FT531F-CL • Standard Range 120 Degree Table Base, Equal Sides

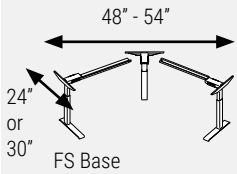

- Kit includes two beams, three cantilevers, one standard range corner column, two standard range columns and two C styled feet.
- FS indicates small base for 48" to 54" sided tables.
- FL indicates large base for 60" to 66" sided tables.
- For 23" deep worksurfaces, use 24" CL leg.
- For 29" and 35" deep worksurface, use 30" CL leg.
- For enhanced collision detection an Anti Collision Desk Sensor included with every base.

PRODUCT CODE	PRICE	HEIGHT MIN/MAX	WIDTH MIN/MAX	DEPTH MIN/MAX	WEIGHT LBS	VOL FT ³
FT531FS24CL	2629	27.5" - 47"	48" - 54"	48" - 54"	59.7	4.7
FT531FS30CL	2644	27.5" - 47"	48" - 54"	48" - 54"	59.7	4.7
FT531FL24CL	2678	27.5" - 47"	60" - 66"	60" - 66"	59.7	4.7
FT531FL30CL	2690	27.5" - 47"	60" - 66"	60" - 66"	59.7	4.7

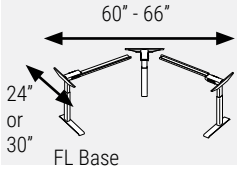

- For Standard Up/Down Controller add (S) at the end of the code. For Display Controller, please add at "D" at the end of the product code and \$78 to the list price.
- Specify paint finish: BLK-Black, DWT-Designer White, TUN-Tungsten.

FT631F-CL • Extended Range 120 Degree Table Base, Equal Sides

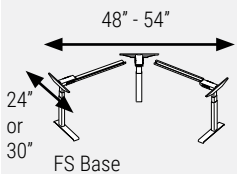

- Kit includes two beams, three cantilevers, one extended range corner column, two extended range columns and two C styled feet.
- FS indicates small base for 48" to 54" sided tables.
- FL indicates large base for 60" to 66" sided tables.
- For 23" deep worksurfaces, use 24" CL leg.
- For 29" and 35" deep worksurface, use 30" CL leg.
- For enhanced collision detection an Anti Collision Desk Sensor included with every base.

PRODUCT CODE	PRICE	HEIGHT MIN/MAX	WIDTH MIN/MAX	DEPTH MIN/MAX	WEIGHT LBS	VOL FT ³
FT631FS24CL	2808	22.5" - 48.5"	48" - 54"	48" - 54"	59.7	4.7
FT631FS30CL	2822	22.5" - 48.5"	48" - 54"	48" - 54"	59.7	4.7
FT631FL24CL	2855	22.5" - 48.5"	60" - 66"	60" - 66"	59.7	4.7
FT631FL30CL	2869	22.5" - 48.5"	60" - 66"	60" - 66"	59.7	4.7

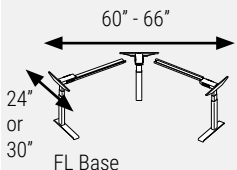

- For Standard Up/Down Controller add (S) at the end of the code. For Display Controller, please add at "D" at the end of the product code and \$78 to the list price.
- Specify paint finish: BLK-Black, DWT-Designer White, TUN-Tungsten.

FT5B2B • Back to Back Standard Range Base

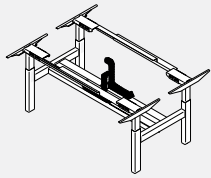

- Kit includes two beams, four cantilevers, four standard range columns and one power trough assembly with two energy chains.
- For 50.5" depth, use two x 23" deep worksurfaces.
- For 62.5" depth, use two x 29" deep worksurfaces.
- 30" or larger depth worksurfaces cannot be used with Back to Back bases.
- Duplex receptacles are not included, please specify separately.
- For enhanced collision detection an Anti Collision Desk Sensor included with every base.
- For Standard Up/Down Controller add (S) at the end of the code. For Display Controller, please add at "D" at the end of the product code and \$165 to the list price.
- Specify paint finish: BLK-Black, DWT-Designer White, TUN-Tungsten.

PRODUCT CODE	PRICE	HEIGHT MIN/MAX	WIDTH MIN/MAX	DEPTH MIN/MAX	WEIGHT LBS	VOL FT ³
FT5B2B48	4977	27.5" - 47"	48" - 48"	50.5" - 62.5"	129	4.7
FT5B2B54	5014	27.5" - 47"	54" - 54"	50.5" - 62.5"	129	4.7
FT5B2B60	5066	27.5" - 47"	60" - 60"	50.5" - 62.5"	129	4.7
FT5B2B66	5104	27.5" - 47"	66" - 66"	50.5" - 62.5"	129	4.7
FT5B2B72	5117	27.5" - 47"	72" - 84"	50.5" - 62.5"	129	4.7

FT6B2B • Back to Back Extended Range Base



- Kit includes two beams, four cantilevers, four extended range columns and one power trough assembly with two energy chains.
- For 50.5" depth, use two x 23" deep worksurfaces.
- For 62.5" depth, use two x 29" deep worksurfaces.
- 30" or larger depth worksurfaces cannot be used with Back to Back bases.
- Duplex receptacles are not included, please specify separately.
- For enhanced collision detection an Anti Collision Desk Sensor included with every base.
- For Standard Up/Down Controller add (S) at the end of the code. For Display Controller, please add at "D" at the end of the product code and \$165 to the list price.
- Specify paint finish: BLK-Black, DWT-Designer White, TUN-Tungsten.

PRODUCT CODE	PRICE	HEIGHT MIN/MAX	WIDTH MIN/MAX	DEPTH MIN/MAX	WEIGHT LBS	VOL FT ³
FT6B2B48	5204	22.5" - 48.5"	48" - 48"	50.5" - 62.5"	129	4.7
FT6B2B54	5241	22.5" - 48.5"	54" - 54"	50.5" - 62.5"	129	4.7
FT6B2B60	5294	22.5" - 48.5"	60" - 60"	50.5" - 62.5"	129	4.7
FT6B2B66	5331	22.5" - 48.5"	66" - 66"	50.5" - 62.5"	129	4.7
FT6B2B72	5343	22.5" - 48.5"	72" - 84"	50.5" - 62.5"	129	4.7

FT5SGL-T • Standard Range Single Frame

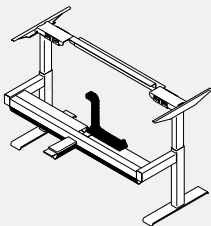

- Kit includes one beam, two cantilevers, two standard range columns, two T styled feet and one power trough assembly with one energy chains.
- For T24 leg, use 23" deep worksurfaces.
- For T30 leg, use 29" deep worksurfaces.
- 30" or larger depth worksurfaces cannot be used with Back to Back bases.
- Duplex receptacles are not included, please specify separately.
- For enhanced collision detection an Anti Collision Desk Sensor included with every base.
- For Standard Up/Down Controller add (S) at the end of the code. For Display Controller, please add at "D" at the end of the product code and \$78 to the list price.
- Specify paint finish: BLK-Black, DWT-Designer White, TUN-Tungsten.

PRODUCT CODE	PRICE	HEIGHT MIN/MAX	WIDTH MIN/MAX	DEPTH MIN/MAX	WEIGHT LBS	VOL FT ³
FT5SGL48T24	2915	27.5" - 47"	48" - 48"	24" - 24"	75	2.3
FT5SGL54T24	2949	27.5" - 47"	54" - 54"	24" - 24"	75	2.3
FT5SGL60T24	2988	27.5" - 47"	60" - 60"	24" - 24"	75	2.3
FT5SGL66T24	3017	27.5" - 47"	66" - 66"	24" - 24"	75	2.3
FT5SGL72T24	3042	27.5" - 47"	72" - 84"	24" - 24"	75	2.3
FT5SGL48T30	2930	27.5" - 47"	48" - 48"	30" - 30"	75	2.3
FT5SGL54T30	2964	27.5" - 47"	54" - 54"	30" - 30"	75	2.3
FT5SGL60T30	3003	27.5" - 47"	60" - 60"	30" - 30"	75	2.3
FT5SGL66T30	3033	27.5" - 47"	66" - 66"	30" - 30"	75	2.3
FT5SGL72T30	3057	27.5" - 47"	72" - 84"	30" - 30"	75	2.3

FT6SGL-T • Extended Range Single Frame

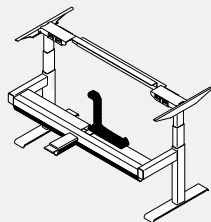

- Kit includes one beam, two cantilevers, two extended range columns, two (C or T) styled feet and one power trough assembly with one energy chain for single sided HA benching applications
- For T24 leg, use 23" deep worksurfaces.
- For T30 leg, use 29" deep worksurfaces.
- 30" or larger depth worksurfaces cannot be used with Back to Back bases.
- Duplex receptacles are not included, please specify separately.
- For enhanced collision detection an Anti Collision Desk Sensor included with every base.
- For Standard Up/Down Controller add (S) at the end of the code. For Display Controller, please add at "D" at the end of the product code and \$78 to the list price.
- Specify paint finish: BLK-Black, DWT-Designer White, TUN-Tungsten.

PRODUCT CODE	PRICE	HEIGHT MIN/MAX	WIDTH MIN/MAX	DEPTH MIN/MAX	WEIGHT LBS	VOL FT ³
FT6SGL48T24	3029	22.5" - 48.5"	48" - 48"	24" - 24"	75	2.3
FT6SGL54T24	3063	22.5" - 48.5"	54" - 54"	24" - 24"	75	2.3
FT6SGL60T24	3103	22.5" - 48.5"	60" - 60"	24" - 24"	75	2.3
FT6SGL66T24	3132	22.5" - 48.5"	66" - 66"	24" - 24"	75	2.3
FT6SGL72T24	3157	22.5" - 48.5"	72" - 84"	24" - 24"	75	2.3
FT6SGL48T30	3043	22.5" - 48.5"	48" - 48"	30" - 30"	75	2.3
FT6SGL54T30	3076	22.5" - 48.5"	54" - 54"	30" - 30"	75	2.3
FT6SGL60T30	3115	22.5" - 48.5"	60" - 60"	30" - 30"	75	2.3
FT6SGL66T30	3146	22.5" - 48.5"	66" - 66"	30" - 30"	75	2.3
FT6SGL72T30	3170	22.5" - 48.5"	72" - 84"	30" - 30"	75	2.3

FT5SGL-T • Standard Range End of Run Single Frame

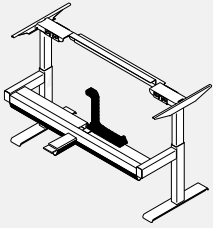

- Kit includes one beam, two cantilevers, two standard range columns, two T styled feet and one power trough assembly with one energy chains.

PRODUCT CODE	PRICE	HEIGHT MIN/MAX	WIDTH MIN/MAX	DEPTH MIN/MAX	WEIGHT LBS	VOL FT ³
FT5SGL51T24	3178	27.5" - 47"	51" - 62"	24" - 24"	75	2.3
FT5SGL51T30	3194	27.5" - 47"	51" - 62"	30" - 30"	75	2.3

- For T24 leg, use 23" deep worksurfaces.
- For T30 leg, use 29" deep worksurfaces.
- 30" or larger depth worksurfaces cannot be used with Back to Back bases.
- Duplex receptacles are not included, please specify separately.
- For enhanced collision detection an Anti Collision Desk Sensor included with every base.
- For Standard Up/Down Controller add (S) at the end of the code. For Display Controller, please add at "D" at the end of the product code and \$78 to the list price.
- Specify paint finish: BLK-Black, DWT-Designer White, TUN-Tungsten.

FT6SGL-T • Extended Range End of Run Single Frame

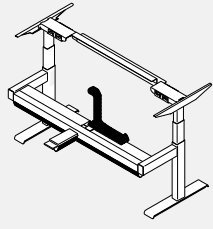

- Kit includes one beam, two cantilevers, two extended range columns, two T styled feet and one power trough assembly with one energy chains.

PRODUCT CODE	PRICE	HEIGHT MIN/MAX	WIDTH MIN/MAX	DEPTH MIN/MAX	WEIGHT LBS	VOL FT ³
FT6SGL51T24	3293	22.5" - 48.5"	51" - 62"	24" - 24"	75	2.3
FT6SGL51T30	3306	22.5" - 48.5"	51" - 62"	30" - 30"	75	2.3

- For T24 leg, use 23" deep worksurfaces.
- For T30 leg, use 29" deep worksurfaces.
- 30" or larger depth worksurfaces cannot be used with Back to Back bases.
- Duplex receptacles are not included, please specify separately.
- For enhanced collision detection an Anti Collision Desk Sensor included with every base.
- For Standard Up/Down Controller add (S) at the end of the code. For Display Controller, please add at "D" at the end of the product code and \$78 to the list price.
- Specify paint finish: BLK-Black, DWT-Designer White, TUN-Tungsten.

FTM5B2B-F • Standard Range Media Table Base

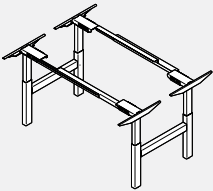

- Kit includes two beams, four cantilevers, four standard range columns and two controllers.

PRODUCT CODE	PRICE	HEIGHT MIN/MAX	WIDTH MIN/MAX	DEPTH MIN/MAX	WEIGHT LBS	VOL FT ³
FTM5B2BSF	4067	27.5" - 47"	60" - 60"	54" - 60"	129	4.7
FTM5B2BLF	4081	27.5" - 47"	66" - 96"	54" - 60"	129	4.7

- SF indicates small base for 60" sided tables.
- LF indicates large base for 66" to 96" sided tables.
- For enhanced collision detection an Anti Collision Desk Sensor included with every base.
- For Standard Up/Down Controller add (S) at the end of the code. For Display Controller, please add at "D" at the end of the product code and \$165 to the list price.
- Specify paint finish: BLK-Black, DWT-Designer White, TUN-Tungsten.

FTM6B2B-F • Extended Range Media Table Base

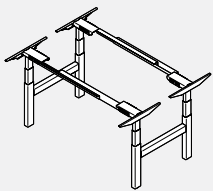

- Kit includes two beams, four cantilevers, four extended range columns and two controllers.

PRODUCT CODE	PRICE	HEIGHT MIN/MAX	WIDTH MIN/MAX	DEPTH MIN/MAX	WEIGHT LBS	VOL FT ³
FTM6B2BSF	4294	22.5" - 48.5"	60" - 60"	54" - 60"	129	4.7
FTM6B2BLF	4308	22.5" - 48.5"	66" - 96"	54" - 60"	129	4.7

- SF indicates small base for 60" sided tables.
- LF indicates large base for 66" to 96" sided tables.
- For enhanced collision detection an Anti Collision Desk Sensor included with every base.
- For Standard Up/Down Controller add (S) at the end of the code. For Display Controller, please add at "D" at the end of the product code and \$165 to the list price.
- Specify paint finish: BLK-Black, DWT-Designer White, TUN-Tungsten.

FTWR - Rectangular Worksurface

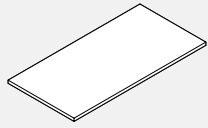

- Rectangular worksurfaces are non-handed and can be interchanged on site.
- Specify laminate finish and PVC edge finish.
- Grommet option for surfaces less than 64" is TC - Top Center only.
- Specification:
- For 23" deep worksurfaces, use FT52(S/L)F24CL/TL standard range or FT62(S/L)F24CL/TL extended range base.
- For 29" deep worksurfaces, use FT52(S/L)F30CL/TL standard range or FT62(S/L)F30CL/TL extended range base.
- For 35" deep worksurfaces, use FT5(S/L)F30CL/TL standard range or FT6(S/L)F30CL/TL extended range base.
- The 35" deep worksurfaces cannot be used with Back to Back Bases.
- For Back to Back bases, please use the following chart:

FTW(23/29)46, FT(5/6)B2B48
 FTW(23/29)52, FT(5/6)B2B54
 FTW(23/29)58, FT(5/6)B2B60
 FTW(23/29)64, FT(5/6)B2B66
 FTW(23/29)72, FT(5/6)B2B72
 FTW(23/29)76, FT(5/6)B2B72
 FTW(23/29)82, FT(5/6)B2B72

PRODUCT CODE	PRICE		SIZE/INCHES			WEIGHT LBS	VOL FT ³
	LP	HP	H	W	D		
FTWR2328	149	191	1	28	23	20	1.16
FTWR2334	165	215	1	34	23	24	1.40
FTWR2340	212	279	1	40	23	28	1.64
FTWR2346	245	329	1	46	23	31	1.84
FTWR2352	290	383	1	52	23	36	2.08
FTWR2358	326	430	1	58	23	40	2.32
FTWR2364	340	449	1	64	23	44	2.56
FTWR2370	355	470	1	70	23	48	3.80
FTWR2376	381	501	1	76	23	52	3.03
FTWR2382	410	537	1	82	23	56	3.27
FTWR2928	173	227	1	28	29	25	1.46
FTWR2934	202	265	1	34	29	30	1.76
FTWR2940	283	371	1	40	29	35	2.06
FTWR2946	290	383	1	46	29	40	2.32
FTWR2952	317	408	1	52	29	45	2.62
FTWR2958	340	449	1	58	29	50	2.92
FTWR2964	353	469	1	64	29	55	3.22
FTWR2970	374	495	1	70	29	60	3.52
FTWR2976	398	524	1	76	29	65	3.83
FTWR2982	443	579	1	82	29	71	4.13
FTWR3528	178	234	1	28	35	30	2.00
FTWR3534	210	275	1	34	35	35	2.00
FTWR3540	295	385	1	40	35	40	2.50
FTWR3546	378	471	1	46	35	48	2.80
FTWR3552	420	526	1	52	35	54	3.16
FTWR3558	466	583	1	58	35	60	3.52
FTWR3564	508	637	1	64	35	67	3.89
FTWR3570	552	691	1	70	35	73	4.25
FTWR3576	594	743	1	76	35	79	4.62
FTWR3582	639	800	1	82	35	85	4.98

FTWRR - Rectangular Return Worksurface

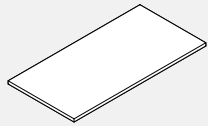

- Rectangular return worksurfaces are non-handed and can be interchanged on site.
- Specify laminate finish and PVC edge finish.
- Includes two flat brackets for connection.
- Specification:
- For 23" deep worksurfaces, use FT51SR24CL/TL standard range or FT61SR24CL/TL extended range base.
- For 29" deep worksurfaces, use FT51SR30CL/TL standard range or FT61SR30CL/TL extended range base.

PRODUCT CODE	PRICE		SIZE/INCHES			WEIGHT LBS	VOL FT ³
	LP	HP	H	W	D		
FTWRR2329	149	191	1	29	23	20	1.16
FTWRR2335	165	215	1	35	23	24	1.40
FTWRR2341	212	279	1	41	23	28	1.64
FTWRR2347	254	336	1	47	23	32	1.88
FTWRR2353	297	392	1	53	23	36	2.12
FTWRR2359	333	438	1	59	23	40	2.36
FTWRR2929	173	227	1	29	29	25	1.46
FTWRR2935	202	265	1	35	29	30	1.76
FTWRR2941	283	371	1	41	29	35	2.06
FTWRR2947	297	392	1	47	29	40	2.36
FTWRR2953	323	418	1	53	29	46	2.67
FTWRR2959	347	458	1	59	29	51	2.97

FTWR - Rectangular End of Run Worksurface

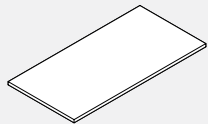

- Rectangular end of run worksurfaces are non-handed and can be interchanged on site.
- Specify laminate finish and PVC edge finish.
- Specification:
- For 23" deep worksurfaces, use FT52(S/F)L24CL/TL standard range or FT62(S/F)L24CL/TL extended range base.
- For 29" deep worksurfaces, use FT52(S/F)L30CL/TL standard range or FT62(S/F)L30CL/TL extended range base.
- For Back to Back bases, please use the following chart:
- FTWR(23/29)51, FT(5/6)B2B60
- FTWR(23/29)62, FT(5/6)B2B66

PRODUCT CODE	PRICE		SIZE/INCHES			WEIGHT LBS	VOL FT ³
	LP	HP	H	W	D		
FTWR2351	326	430	1	51	23	40	2.02
FTWR2362	340	449	1	62	23	44	2.5
FTWR2951	340	449	1	51	29	50	2.54
FTWR2962	353	528	1	62	29	55	3.15

• LP = Thermally Fused Laminate, HP = High Pressure Laminate.

FTWCC - 90 Degree Corner Worksurface

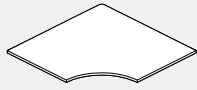

- 90 Degree Corner Worksurface.
- Specify laminate finish and PVC edge finish.
- Specification:
- For tables that connect with 23" deep worksurfaces, use FT539FS-24CL standard range or FT539FS24CL extended range base.
- For table that connect with 29" deep worksurfaces, use FT539FS-30CL standard range or FT639FS30CL extended range base.

PRODUCT CODE	FINISH		SIZE / INCHES			WEIGHT LBS	VOL FT ³
	LP	HP	H	W	D		
FTWCC234023	549	603	1	40	40	70	1.50
FTWCC234623	565	620	1	46	46	75	2.00
FTWCC235223	647	712	1	52	52	80	4.69
FTWCC235823	828	910	1	58	58	100	5.84
FTWCC294029	549	603	1	40	40	70	1.50
FTWCC294629	549	603	1	46	46	75	3.67
FTWCC295229	647	712	1	52	52	80	4.69
FTWCC295829	828	910	1	58	58	100	5.84

FTWEC - Left Extended 90 Degree Corner Worksurface

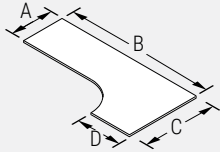

- Left Extended 90 Degree Corner Worksurface.
- Specify laminate finish and PVC edge finish.
- Specification:
- For tables that connect with 23" deep (A and D) worksurfaces, use FT539F(S/L)24CL standard range or FT639F(S/L)24CL extended range base.
- For table that connect with 29" deep (A and D) worksurfaces, use FT539F(S/L)30CL standard range or FT639F(S/L)30CL extended range base.

NOTE: FTWEC

A	B	C	D
DEPTH	LENGTH	WIDTH	DEPTH

PRODUCT CODE	FINISH		SIZE / INCHES			WEIGHT LBS	VOL FT ³
	LP	HP	H	W	D		
FTWEC23584023	741	927	1	58	40	115	2.55
FTWEC23644023	824	1030	1	64	40	127	2.81
FTWEC23704023	901	1128	1	70	40	138	3.07
FTWEC23764023	963	1200	1	76	40	150	3.34
FTWEC23824023	1020	1275	1	82	40	162	3.60
FTWEC23584623	763	955	1	58	46	115	2.55
FTWEC23644623	849	1060	1	64	46	127	2.81
FTWEC23704623	928	1162	1	70	46	138	3.07
FTWEC23764623	991	1236	1	76	46	150	3.34
FTWEC23824623	1051	1313	1	82	46	162	3.60
FTWEC23585223	787	985	1	58	52	130	2.88
FTWEC23645223	872	1093	1	64	52	143	3.18
FTWEC23705223	956	1197	1	70	52	156	3.48
FTWEC23765223	1020	1273	1	76	52	170	3.77
FTWEC23825223	1082	1353	1	82	52	183	4.07
FTWEC23645823	901	1125	1	64	58	160	3.54
FTWEC23705823	986	1232	1	70	58	174	3.88
FTWEC23765823	1051	1312	1	76	58	189	4.21
FTWEC23825823	1114	1394	1	82	58	204	4.54
FTWEC29584029	771	965	1	58	40	115	2.55
FTWEC29644029	858	1071	1	64	40	127	2.81
FTWEC29704029	936	1173	1	70	40	138	3.07
FTWEC29764029	1000	1247	1	76	40	150	3.34
FTWEC29824029	1060	1327	1	82	40	162	3.60
FTWEC29584629	794	993	1	58	46	115	2.55
FTWEC29644629	883	1102	1	64	46	127	2.81
FTWEC29704629	966	1208	1	70	46	138	3.07
FTWEC29764629	1031	1286	1	76	46	150	3.34
FTWEC29824629	1093	1366	1	82	46	162	3.60
FTWEC29585229	818	1024	1	58	52	130	2.88
FTWEC29645229	908	1136	1	64	52	143	3.18
FTWEC29705229	994	1243	1	70	52	156	3.48
FTWEC29765229	1060	1324	1	76	52	170	3.77
FTWEC29825229	1125	1407	1	82	52	183	4.07
FTWEC29645829	935	1170	1	64	58	160	3.54
FTWEC29705829	1025	1282	1	70	58	174	3.88
FTWEC29765829	1093	1365	1	76	58	189	4.21
FTWEC29825829	1159	1451	1	82	58	204	4.54

• LP = Thermally Fused Laminate, HP = High Pressure Laminate.

FTWEC • Right Extended 90 Degree Corner Worksurface

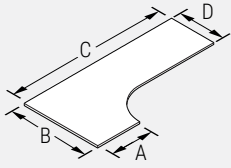

- Right Extended 90 Degree Corner Worksurface.
- Specify laminate finish and PVC edge finish.
- Specification:
- For tables that connect with 23" deep (A and D) worksurfaces, use FT539F(S/L)24CL standard range or FT639F(S/L)24CL extended range base.
- For table that connect with 29" deep (A and D) worksurfaces, use FT539F(S/L)30CL standard range or FT639F(S/L)30CL extended range base.

NOTE: FTWEC

A	B	C	D
DEPTH	WIDTH	LENGTH	DEPTH

PRODUCT CODE	FINISH		SIZE/INCHES			WEIGHT LBS	VOL FT ³
	LP	HP	H	W	D		
FTWEC23405823	741	927	1	58	40	115	2.55
FTWEC23406423	824	1030	1	64	40	127	2.81
FTWEC23407023	901	1128	1	70	40	138	3.07
FTWEC23407623	963	1200	1	76	40	150	3.34
FTWEC23408223	1020	1275	1	82	40	162	3.60
FTWEC23465823	763	955	1	58	46	115	2.55
FTWEC23466423	849	1060	1	64	46	127	2.81
FTWEC23467023	928	1162	1	70	46	138	3.07
FTWEC23467623	991	1236	1	76	46	150	3.34
FTWEC23468223	1051	1313	1	82	46	162	3.6
FTWEC23525823	787	985	1	58	52	130	2.88
FTWEC23526423	872	1093	1	64	52	143	3.18
FTWEC23527023	956	1197	1	70	52	156	3.48
FTWEC23527623	1020	1273	1	76	52	170	3.77
FTWEC23528223	1082	1353	1	82	52	183	4.07
FTWEC23586423	901	1125	1	64	58	160	3.54
FTWEC23587023	986	1232	1	70	58	174	3.88
FTWEC23587623	1051	1312	1	76	58	189	4.21
FTWEC23588223	1114	1394	1	82	58	204	4.54
FTWEC29405829	771	965	1	58	40	115	2.55
FTWEC29406429	858	1071	1	64	40	127	2.81
FTWEC29407029	936	1173	1	70	40	138	3.07
FTWEC29407629	1000	1247	1	76	40	150	3.34
FTWEC29408229	1060	1327	1	82	40	162	3.60
FTWEC29465829	794	993	1	58	46	115	2.55
FTWEC29466429	883	1102	1	64	46	127	2.81
FTWEC29467029	966	1208	1	70	46	138	3.07
FTWEC29467629	1031	1286	1	76	46	150	3.34
FTWEC29468229	1093	1366	1	82	46	162	3.6
FTWEC29525829	818	1024	1	58	52	130	2.88
FTWEC29526429	908	1136	1	64	52	143	3.18
FTWEC29527029	994	1243	1	70	52	156	3.48
FTWEC29527629	1060	1324	1	76	52	170	3.77
FTWEC29528229	1125	1407	1	82	52	183	4.07
FTWEC29586429	935	1170	1	64	58	160	3.54
FTWEC29587029	1025	1282	1	70	58	174	3.88
FTWEC29587629	1093	1365	1	76	58	189	4.21
FTWEC29588229	1159	1451	1	82	58	204	4.54

FTWRE • Rectangular Extension Return Worksurface

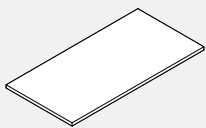

- **Worksurfaces to be used only with Extended 90 Degree Corner Worksurfaces.**
- Rectangular Extension Return Worksurface.
- Specify laminate finish and PVC edge finish.
- Includes 2 flat brackets for connection.
- Specification:
- FTWRE23 to be used with FTWEC23xxxx23.
- FTWRE29 to be used with FTWEC29xxxx29.

PRODUCT CODE	FINISH		SIZE/INCHES			WEIGHT LBS	VOL FT ³
	LP	HP	H	W	D		
FTWRE2324	136	180	1	24	23	16	0.96
FTWRE2330	149	191	1	30	23	20	1.20
FTWRE2336	165	215	1	36	23	25	1.44
FTWRE2924	163	209	1	24	29	21	1.21
FTWRE2930	173	227	1	30	29	26	1.51
FTWRE2936	202	265	1	36	29	31	1.81

FTWTC • 120 Degree Corner Worksurface

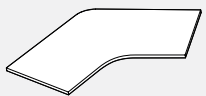

- 120 Degree Corner Worksurface.
- Specify laminate finish and PVC edge finish.
- Specification:
- For tables that connect with 23" deep (A and C) worksurfaces, use FT531F(S/L)24CL standard range or FT531F(S/L)24CL extended range base.
- For table that connect with 29" deep (A and C) worksurfaces, use FT531F(S/L)30CL standard range or FT631F(S/L)30CL extended range.
- Inside radius is 17.5".

PRODUCT CODE	FINISH		SIZE/INCHES			WEIGHT LBS	VOL FT ³
	LP	HP	H	W	D		
FTWTC234623	773	1077	1	46	23	165	3.67
FTWTC235223	773	1077	1	52	23	211	4.69
FTWTC235823	1389	1961	1	58	23	263	5.84
FTWTC236423	1389	1961	1	64	23	320	7.11
FTWTC294629	773	1077	1	46	29	165	3.67
FTWTC295229	773	1077	1	52	29	211	4.69
FTWTC295829	1389	1961	1	58	29	263	5.84
FTWTC296429	1389	1961	1	64	29	320	7.10

• LP = Thermally Fused Laminate, HP = High Pressure Laminate.

FTWMR • Media Table Top

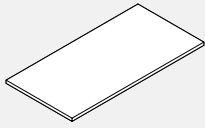

- Media Table Top.
- Specify laminate finish and PVC edge finish.
- Specification:
- For tables FTWMR5a460 and 6060, use FTM5B2BSF standard range or FTM6B2BSF extended range base.
- For all other tables, use FTM5B2BLF standard range or FTM6B-2BLF extended range base.

PRODUCT CODE	FINISH LP	HP	SIZE / INCHES			WEIGHT LBS	VOL FT ³
			H	W	D		
FTWMR5460	557	769	1	60	54	96	5.63
FTWMR5466	607	842	1	66	54	106	6.19
FTWMR5472	658	915	1	72	54	115	6.75
FTWMR5478	706	987	1	78	54	125	7.31
FTWMR5484	758	1058	1	84	54	135	7.88
FTWMR5490	807	1131	1	90	54	144	8.44
FTWMR5496	859	1201	1	96	54	154	9.00
FTWMR6060	611	850	1	60	60	107	6.25
FTWMR6066	667	930	1	66	60	118	6.88
FTWMR6072	723	1009	1	72	60	128	7.50
FTWMR6078	778	1088	1	78	60	139	8.13
FTWMR6084	833	1166	1	84	60	150	8.75
FTWMR6090	890	1247	1	90	60	160	9.38
FTWMR6096	944	1327	1	96	60	171	10.00

FTMT5145 • TV Mount

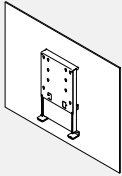

- TV Mount for FreeFit Media Tables.
- Includes the TV/Display bracket and mounting hardware.
- Maximum TV size is 50".
- Back panel is made of PET Felt.

PRODUCT CODE	FINISH LP	SIZE / INCHES			WEIGHT LBS	VOL FT ³
		H	W	D		
FTMT5145	616	40.5	51	4	16.82	4.8

FTB-L • Laminate Leg Shroud for C-Leg, Left

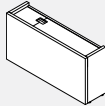

- Laminate shroud for a FreeFit C-Leg on the left side.
- Includes a felt liner at the top.
- Short side panel is removable to access interior.
- Please specify low pressure laminate, PVC edge and felt finishes.
- NOTE: When integrating FreeFit height adjustable tables with casegoods, it is recommended to only use 2 stage bases (codes starting with FT5).

PRODUCT CODE	FINISH LP	SIZE / INCHES			WEIGHT LBS	VOL FT ³
		H	W	D		
FTB23L	510	18	23	9	47	2
FTB29L	534	18	29	9	55	3
FTB35L	556	18	35	9	67	3

FTB-R • Laminate Leg Shroud for C-Leg, Right

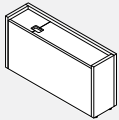

- Laminate shroud for a FreeFit C-Leg on the right side.
- Includes a felt liner at the top.
- Short side panel is removable to access interior.
- Please specify low pressure laminate, PVC edge and felt finishes.
- NOTE: When integrating FreeFit height adjustable tables with casegoods, it is recommended to only use 2 stage bases (codes starting with FT5).

PRODUCT CODE	FINISH LP	SIZE / INCHES			WEIGHT LBS	VOL FT ³
		H	W	D		
FTB23R	510	18	23	9	47	2
FTB29R	534	18	29	9	55	3
FTB35R	556	18	35	9	67	3

FTB • Laminate Housing for T-Leg

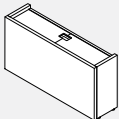

- Laminate Leg Shroud for T-Leg.
- Includes a felt liner at the top.
- Short side panel is removable to access interior.
- Please specify low pressure laminate, PVC edge and felt finishes.
- NOTE: When integrating FreeFit height adjustable tables with casegoods, it is recommended to only use 2 stage bases (codes starting with FT5).

PRODUCT CODE	FINISH LP	SIZE / INCHES			WEIGHT LBS	VOL FT ³
		H	W	D		
FTB23	510	18	23	9	47	2
FTB29	534	18	29	9	55	3
FTB35	556	18	35	9	67	3

FTB • Laminate Leg Shroud for Media Bases

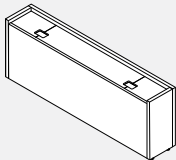

- Includes a felt liner at the top.
- Side panel is removable to access the interior.
- Please specify low pressure laminate, PVC edging and felt finish.
- NOTE: When integrating FreeFit height adjustable tables with casegoods, it is recommended to only use 2 stage bases (codes starting with FT5).

PRODUCT CODE	FINISH LP	SIZE / INCHES			WEIGHT LBS	VOL FT ³
		H	W	D		
FTB54	802	18	54	9	110	5
FTB60	930	18	60	9	134	6

• LP = Thermally Fused Laminate, HP = High Pressure Laminate.

FTCRBFO • Credenza, BF / Open

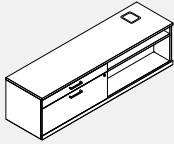

- Credenza storage with grommet to accommodate a FreeFit C leg base.
- Recommended for use with the standard range bases only.
- One lock included
- One adjustable Shelf
- Select any standard Licence2 handle
- Optional E-lock available in the vertical position. Please specify V - Vertical and add \$224.00 list.
- Grommet available only in BLK - Black
- Back of the unit where the leg is located is open the unit is intended to be within a panel surround or against a wall.

PRODUCT CODE	FINISH LP	B	W	SIZE/INCHES				WEIGHT LBS	VOL FT³
				H(LP/B)	H(W)	W	D		
FTCRBFO2060	1912	2093	2167	19.94	20.5	60	20	202	20
FTCRBFO2066	1969	2166	2247	19.94	20.5	66	20	220	22
FTCRBFO2072	2072	2286	2374	19.94	20.5	72	20	254	24
FTCRBFO2460	1987	2175	2254	19.94	20.5	60	24	202	20
FTCRBFO2466	2049	2254	2338	19.94	20.5	66	24	220	22
FTCRBFO2472	2155	2377	2469	19.94	20.5	72	24	254	24

• NOTE: When integrating FreeFit height adjustable tables with casegoods, it is recommended to only use 2 stage bases (codes starting with FT5).

FTCROBF • Credenza, Open / BF

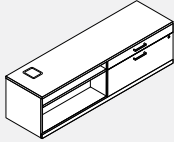

- Credenza storage with grommet to accommodate a FreeFit C leg base.
- Recommended for use with the standard range bases only.
- One lock included
- One adjustable Shelf
- Select any standard Licence2 handle
- Optional E-lock available in the vertical position. Please specify V - Vertical and add \$224.00 list.
- Grommet available only in BLK - Black
- Back of the unit where the leg is located is open the unit is intended to be within a panel surround or against a wall.

PRODUCT CODE	FINISH LP	B	W	SIZE/INCHES				WEIGHT LBS	VOL FT³
				H(LP/B)	H(W)	W	D		
FTCROBF2060	1912	2093	2167	19.94	20.5	60	20	202	20
FTCROBF2066	1969	2166	2247	19.94	20.5	66	20	220	22
FTCROBF2072	2072	2286	2374	19.94	20.5	72	20	254	24
FTCROBF2460	1987	2175	2254	19.94	20.5	60	24	202	20
FTCROBF2466	2049	2254	2338	19.94	20.5	66	24	220	22
FTCROBF2472	2155	2377	2469	19.94	20.5	72	24	254	24

• NOTE: When integrating FreeFit height adjustable tables with casegoods, it is recommended to only use 2 stage bases (codes starting with FT5).

FTCRBFO-T • Credenza, BF / Open

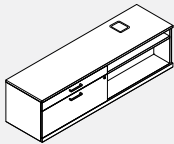

- Credenza storage with grommet to accommodate a FreeFit T-leg base.
- Recommended for use with the standard range bases only.
- One lock included
- One adjustable Shelf
- Select any standard Licence2 handle
- Optional E-lock available in the vertical position. Please specify V - Vertical and add \$224.00 list.
- Grommet available only in BLK - Black
- Back of the unit where the leg is located is open the unit is intended to be within a panel surround or against a wall.

PRODUCT CODE	FINISH LP	B	W	SIZE/INCHES				WEIGHT LBS	VOL FT³
				H(LP/B)	H(W)	W	D		
FTCRBFO2060T	1912	2093	2167	19.94	20.5	60	20	202	20
FTCRBFO2066T	1969	2166	2247	19.94	20.5	66	20	220	22
FTCRBFO2072T	2072	2286	2374	19.94	20.5	72	20	254	24
FTCRBFO2460T	1987	2175	2254	19.94	20.5	60	24	202	20
FTCRBFO2466T	2049	2254	2338	19.94	20.5	66	24	220	22
FTCRBFO2472T	2155	2377	2469	19.94	20.5	72	24	254	24

• NOTE: When integrating FreeFit height adjustable tables with casegoods, it is recommended to only use 2 stage bases (codes starting with FT5).

FTCROBF-T • Credenza, Open / BF

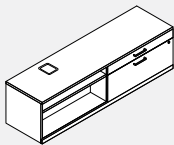

- Credenza storage with grommet to accommodate a FreeFit T-leg base.
- Recommended for use with the standard range bases only.
- One lock included
- One adjustable Shelf
- Select any standard Licence2 handle
- Optional E-lock available in the vertical position. Please specify V - Vertical and add \$224.00 list.
- Grommet available only in BLK - Black
- Back of the unit where the leg is located is open the unit is intended to be within a panel surround or against a wall.

PRODUCT CODE	FINISH LP	B	W	SIZE/INCHES				WEIGHT LBS	VOL FT³
				H(LP/B)	H(W)	W	D		
FTCROBF2060T	1912	2093	2167	19.94	20.5	60	20	202	20
FTCROBF2066T	1969	2166	2247	19.94	20.5	66	20	220	22
FTCROBF2072T	2072	2286	2374	19.94	20.5	72	20	254	24
FTCROBF2460T	1987	2175	2254	19.94	20.5	60	24	202	20
FTCROBF2466T	2049	2254	2338	19.94	20.5	66	24	220	22
FTCROBF2472T	2155	2377	2469	19.94	20.5	72	24	254	24

• NOTE: When integrating FreeFit height adjustable tables with casegoods, it is recommended to only use 2 stage bases (codes starting with FT5).

FTSSPH12BFB • Cube Hanging Pedestal, One File Box and Two Open Boxes

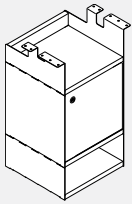

- Hanging pedestal with one file box in the middle and two open boxes, one at the top and one at the bottom.
- Attaches to the underside of a worksurface with supplied screws.
- File box interior dimensions: 11 7/8" h x 11 13/16" w x 10 7/16" d.
- Includes chrome wire divider and optional lock.
- Metal wire divider is chrome and sits 3 7/16" from either side and is interchangeable.
- File door lock, if specified is located on the top right corner for the right pedestal and top left corner for the left pedestal.
- Bottom, middle and top shelves, front door and back are made of 3/4" low pressure laminate.
- Sides are made of powder coated metal.
- Ships knocked-down.
- NOTE: To be used with Standard Range FreeFit Bases (FT5 and FTM5) only.

PRODUCT CODE	PRICE	SIZE/ INCHES			WEIGHT VOL	
		H	W	D	LBS	FT ³
Without Lock						
FTSSPH12BFBR	444	24	12	12	26	2.33
FTSSPH12BFBL	444	24	12	12	26	2.33
With Lock						
FTSSPH12BFBKR	457	24	12	12	26	2.33
FTSSPH12BFBKL	457	24	12	12	26	2.33

FTSSPH12BF • Cube Hanging Pedestal, One File Box

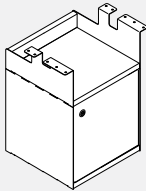

- Hanging pedestal with one file box at the bottom and one open box at the top.
- Attaches to the underside of a worksurface with supplied screws.
- File box interior dimensions: 11 7/8" h x 11 13/16" w x 10 7/16" d.
- Includes chrome wire divider and optional lock.
- Metal wire divider is chrome and sits 3 7/16" from either side and is interchangeable.
- File door lock, if specified is located on the top right corner for the right pedestal and top left corner for the left pedestal.
- Bottom, middle and top shelves, front door and back are made of 3/4" low pressure laminate.
- Sides are made of powder coated metal.
- Ships knocked-down.

PRODUCT CODE	PRICE	SIZE/ INCHES			WEIGHT VOL	
		H	W	D	LBS	FT ³
Without Lock						
FTSSPH12BFR	334	18.5	12	12	20	1.83
FTSSPH12BFL	334	18.5	12	12	20	1.83
With Lock						
FTSSPH12BFKR	347	18.5	12	12	20	1.83
FTSSPH12BFKL	347	18.5	12	12	20	1.83

FTSSPH12B • Cube Hanging Pedestal Box

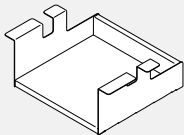

- Hanging pedestal open box.
- Attaches to the underside of a worksurface with supplied screws to create an open box.
- Bottom, middle and top shelves, front door and back are made of 3/4" low pressure laminate.
- Sides are made of powder coated metal.
- Ships knocked-down.

PRODUCT CODE	PRICE	SIZE/ INCHES			WEIGHT VOL	
		H	W	D	LBS	FT ³
FTSSPH12B	136	6	12	12	6	0.96

FTSSPH12BB • Cube Hanging Pedestal, Two Open Boxes

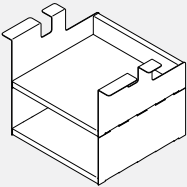

- Hanging pedestal with two open boxes.
- Attaches to the underside of a worksurface with supplied screws.
- Bottom, middle and top shelves, front door and back are made of 3/4" low pressure laminate.
- Sides are made of powder coated metal.
- Ships knocked-down.

PRODUCT CODE	PRICE	SIZE/ INCHES			WEIGHT VOL	
		H	W	D	LBS	FT ³
FTSSPH12BB	251	11.5	12	12	12	1.42

FTFELT03BC • Felt Shelf Liner for Cube Pedestals

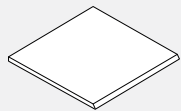

- Felt shelf liner can be added to any closed back shelf.
- Front edge is cut at 45 degree.

PRODUCT CODE	PRICE	SIZE/ INCHES			WEIGHT VOL	
		H	W	D	LBS	FT ³
FTFELT03BC	23	12	12	0.38	0.1	0.03

BRT8D • Duplex Receptacles

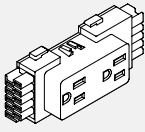

- Snaps into Power Distribution Housing.
- Up to 6 duplex receptacles per circuit.
- xxxD1 = Circuit #1 (utility circuit)
- xxxD2 = Circuit #2 (utility circuit)
- xxxD3 = Circuit #3 (utility circuit)
- xxxDA - Circuit #A (dedicated circuit)
- XW identifies white colour plastic, all others in standard black.

PRODUCT CODE	PRICE	SIZE/ INCHES		WEIGHT		VOL FT ³
		H	D	LBS	FT ³	
BRT8D1	35	2	4.625	1.25	0.10	0.01
BRT8D2	35	2	4.625	1.25	0.10	0.01
BRT8D3	35	2	4.625	1.25	0.10	0.01
BRT8DA	35	2	4.625	1.25	0.10	0.01
BRT8DXW1	52	2	4.625	1.25	0.10	0.01
BRT8DXW2	52	2	4.625	1.25	0.10	0.01
BRT8DXW3	52	2	4.625	1.25	0.10	0.01
BRT8DXWA	52	2	4.625	1.25	0.10	0.01

GAADG • Access Door Module

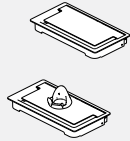

- Soft close door is set back from edge to allow for cable pass thru.
- Available in all standard panel frame finishes.
- GAADGDH includes device holder for most mobile phones or tablets. Holder is only available in white.
- FreeFit can only accomodate one grommet per worksurface.

PRODUCT CODE	PRICE	SIZE/INCHES			WEIGHT LBS	VOL FT ³
		H	D	W		
GAADG	60	1.08	5.54	10.09	2	0.04
GAADGDH	65	1.08	5.54	10.09	2	0.04

GAADCT • Access Door Module with Cable Tray

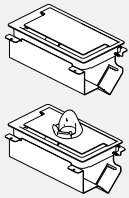

- Soft close door is set back from edge to allow for cable pass thru when closed.
- Cable tray comes one standard telcom knock out and a platform to mount a powerbar.
- Sides are open for easy access.
- Available in all standard panel frame finishes.
- GAADCTDH includes device holder for most mobile phones or tablets. Holder is only available in white.
- FreeFit can only accomodate one grommet per worksurface.

PRODUCT CODE	PRICE	SIZE/INCHES			WEIGHT LBS	VOL FT ³
		H	D	W		
GAADCT	95	5.07	5.54	10.09	4	0.19
GAADCTDH	103	5.07	5.54	10.09	4	0.19

GAADCTPD • Access Door Module with Cable Tray and Power Bar

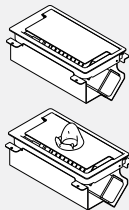

- Powerbar with 3 simplex and 2 USB, CSA Certified.
- Soft close door is set back from edge to allow for cable pass thru when closed.
- Cable tray comes one standard telcom knock out and a platform to mount a powerbar.
- Sides are open for easy access.
- Available in all standard panel frame finishes.
- GAADCTPDDH includes device holder for most mobile phones or tablets. Holder is only available in white.
- FreeFit can only accomodate one grommet per worksurface.

PRODUCT CODE	PRICE	SIZE/INCHES			WEIGHT LBS	VOL FT ³
		H	D	W		
GAADCTPD	208	6.96	5.54	10.09	4	0.20
GAADCTPDDH	212	6.96	5.54	10.09	4	0.20

BWAEGC00158GC • Power Bar with USB

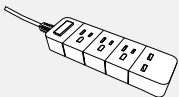

- Power Bar with 3 receptacles + 2 USB and power switch.
- Standard with 6' cord.
- Rating 15A, 125V, AC 60Hz, 1875W.
- USB output 5V, 2.6A (max.)
- White case, white cord.

PRODUCT CODE	PRICE	SIZE/ INCHES			WEIGHT LBS	VOL FT ³
		H	W	D		
BWAEGC00158GC	99	1.3	2.3	1	1	0.02

BG5 • Rectangular Grommet

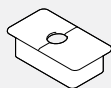

- Option (BLK) Black Plastic (GRY) Grey Plastic (WHT) White Plastic

PRODUCT CODE	PRICE	SIZE/ INCHES			WEIGHT LBS	VOL FT ³
		H	W	D		
BG5	36		3.5	2		

MSPDM • 1 Duplex, 2 Data



- Includes one duplex and 2 data jacks (both RJ45, Cat 6)
- Black plastic

PRODUCT CODE	PRICE	SIZE/ INCHES			WEIGHT LBS	VOL FT ³
		H	W	D		
MSPDM	276	2.75	6.5	3.5	2	0.1

BWAEFC • Ceiling Feed Post

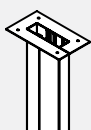

- Ceiling pole brings ceiling feed conduit and data cables from the ceiling down to Power troughs height. Accommodates 9'-3" ceiling heights.
- A two part construction allows power/data conduit lay-in.
- Includes mounting hardware and ceiling bezel.
- Painted finish.

PRODUCT CODE	PRICE	SIZE/INCHES			WEIGHT LBS	VOL FT ³
		H	D	W		
BWAEFC	312	99.32	2.5	4.74	13	0.48

BWAECFH • Ceiling Feed Harness



- Ceiling feed provides a single power entry from ceiling, through Ceiling pole into Power Trough, into Power Distribution Housing.
- An 8-wire (4-circuit) metal conduit harness with included metal junction box for hard wiring to the building power supply above ceiling tile.
- Must be hard wired to the building power supply by a licensed electrician.
- Ceiling Pole not included.

PRODUCT CODE	PRICE	SIZE/INCHES			WEIGHT LBS	VOL FT ³
		H	D	W		
BWAECFH120	410	120	6	6.00	5.00	2
BWAECFH144	459	144	6	6.00	6.00	3

FTAEC • Table to Table Connector

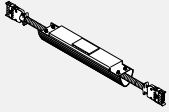

- Connects Freefit back2back legs and trough provide power data/ communication pass thru
- Connector kit consist of formed steel housing, mounting brackets,
- Housing to housing harness and one charcoal grey extruded Data/ Communication cable manager
- For table to table up to 72" w (with no storage in between tables), use FTAEC12.
- For table to table 78" w (when no storage in between), use FTAEC18.
- For table to table 84" w (when no storage in between), use FTAEC24.
- For table to table up to 72" w with a Pantry Storage is in between, use FTAEC24.

PRODUCT CODE	PRICE	SIZE/INCHES			WEIGHT LBS	VOL FT ³
		H	D	W		
FTAEC12	259	3	16	2.3	6.00	0.12
FTAEC18	278	3	22	2.3	8.00	0.15
FTAEC24	294	3	28	2.3	9.00	0.18
FTAEC30	310	3	34	2.3	10.60	0.22
FTAEC36	324	3	40	2.3	12.00	0.24
FTAEC42	348	3	46	2.3	11.60	0.28
FTAEC48	372	3	52	2.3	14.00	0.30

FTABRC • Table to Bridges Connector

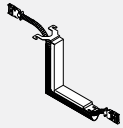

- Connects FreeFit back2back benching to Bridges 29H table with below surface power trough.
- Please specify paint colour on bracket. Wire manager is always charcoal.

PRODUCT CODE	PRICE	SIZE/INCHES			WEIGHT LBS	VOL FT ³
		H	D	W		
FTABRC	219	13	13	2.3	2.4	0.28

FTACCL • Leg Wire Manager

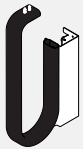

- Provides wire management from under FreeFit worksurface, down the leg and to the floor.
- Can only be used for FreeFit Regular and Media tables. Not for use on FreeFit Back to Back tables.
- Kit includes wire manager housing, magnets, screws and cable chain.
- Magnetically fastens to the Freefit leg and cable chain is screwed to work surface.
- Please specify housing paint finish.

PRODUCT CODE	PRICE	SIZE/INCHES			WEIGHT LBS	VOL FT ³
		H	D	W		
FTACCL	388	13	3.2	2	0.06	0.06

FTAEFF • Floor Feed

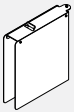

- Floor feed housing for FreeFit benching applications only
- Liquitite whip 72"
- Must be hard wired to power source by a licenced technician
- Please choose paint colour for housing.

PRODUCT CODE	PRICE	SIZE/INCHES			WEIGHT LBS	VOL FT ³
		H	D	W		
FTAEFF	574	10.8	8.75	2	7	0.23

FFTCB • Under Worksurface Cable Basket

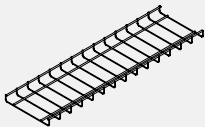

- Shallow 8" wide basket manages cable excess.
- It can be easily unclipped from steel brackets (included) to rear-range cable connections from below work surface.
- As a general rule- specify cable basket 30" shorter that the Freefit work surface.
- Steel wire construction, black painted finish, black steel hanging brackets and fasteners.

PRODUCT CODE	PRICE	SIZE/ INCHES	H	W	D	WEIGHT LBS	VOL FT ³
FFTCB48	86	1	16	8	0.73	0.07	
FFTCB54	90	1	22	8	1.01	0.10	
FFTCB60	97	1	28	8	1.20	0.13	
FFTCB66	111	1	34	8	1.56	0.15	
FFTCB72	114	1	40	8	1.80	0.18	
FFTCB78	123	1	46	8	2.16	0.21	
FFTCB84	129	1	52	8	2.39	0.24	

BRACS • Cable Snake



- **Flexible cable management trough.**
- Two pathways within the snake, one for data/communication and one for routing power cables.
- Clear (CLR) available only.

PRODUCT CODE	PRICE	SIZE/ INCHES	H	W	D	WEIGHT LBS	VOL FT ³
BRACSH	213	49	8	2	5	0.27	

FTBATT • Battery and Charger

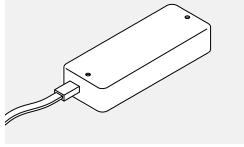

- Battery Pak with charging cable mounts to the underside of the worksurface
- Features LED bars indicating capacity level and audio alarm when it needs to be charged.
- On a full charge the table can cycle from 35 to 45 stroke lengths based upon the range of column selected and load on the table.

PRODUCT CODE	PRICE	SIZE/INCHES			WEIGHT		VOL FT ³
		H	D	W	LBS		
FTBATT	859	1.5	8	3	1.54	0.02	

FTACDS • Anti Collision Desk Sensor USB Plug

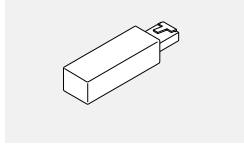

- Provides enhanced anti-collision detection.
- Plugs directly into leg column.
- Only one USB plug required for table assembly.
- This is a replacement part. The sensor ships stand with every table.

PRODUCT CODE	PRICE	SIZE/INCHES			WEIGHT		VOL FT ³
		H	D	W	LBS		
FTACDS	72	0.5	2.36	0.6	0.01	0.01	

FTDPG1C • Display + Bluetooth + Reminder Controller

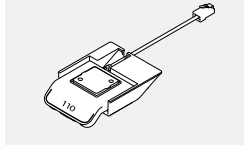

- Up/down drive with 4 memory positions.
- LED Light strip reminder, table height display.
- Bluetooth enabled connects to Desk Control App.

PRODUCT CODE	PRICE	SIZE/INCHES			WEIGHT		VOL FT ³
		H	D	W	LBS		
FTDPG1C	166	1	3	4.3	0.4	0.01	

FTDPG1M • Memory + Bluetooth + Diode Reminder Controller

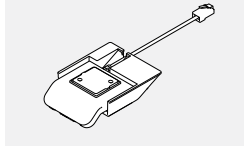

- Up/down drive with 2 memory positions.
- Bluetooth enabled connects to Desk Control App.
- This is a replacement part. Every base comes standard with a controller.

PRODUCT CODE	PRICE	SIZE/INCHES			WEIGHT		VOL FT ³
		H	D	W	LBS		
FTDPG1M	66	1	3	4.3	0.4	0.01	

FTCD2DUSB • Desk2Device USB Charger

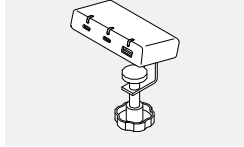

- Charge virtually any USB device directly from your FreeFit desk. Reduce cable clutter and get better power access.
- The charger is powered directly by the control box of a FreeFit table, no additional power outlet is required.
- Features one USB Type-A port (output 7.5w), two USB Type-C ports (output 50w if one port is used, 25w if both are used).
- Housing is white in color and the mounts are in black.
- Can be mounted on top of the table surface or underneath the surface (horizontal or slightly tilted).
- Includes two different mounts and a rubber (silicone) pad to secure placement on a smooth desk surface.
- Low standby power consumption of only 0.1w.
- LED diodes indicate either charging or that an active device is connected.
- PVC-Free (TM).

PRODUCT CODE	PRICE	SIZE/INCHES			WEIGHT		VOL FT ³
		H	D	W	LBS		
FTCD2DUSB	422	0.85	3.77	1.96	0.187	0.004	

FreeFit • Single Table; 21' high dividers

- FreeFit table mounted dividers for single table or single table row, recessed 6.5" at both ends (for example - 72" (70" actual) FreeFit table mounted divider measures 57").
- The centre of all dividers is always mounted 2.250" from work surface's rear edge. Please note the gap between the divider and the work surface therefore varies, depending on the divider thickness (1.250" framed dividers. 0.750" frame-less LP and 0.250" frame-less glass).
- 48" (33" actual) - 66" (51" actual) dividers have 2 mounting brackets.
- 72" (57" actual) dividers have 3 mounting brackets.

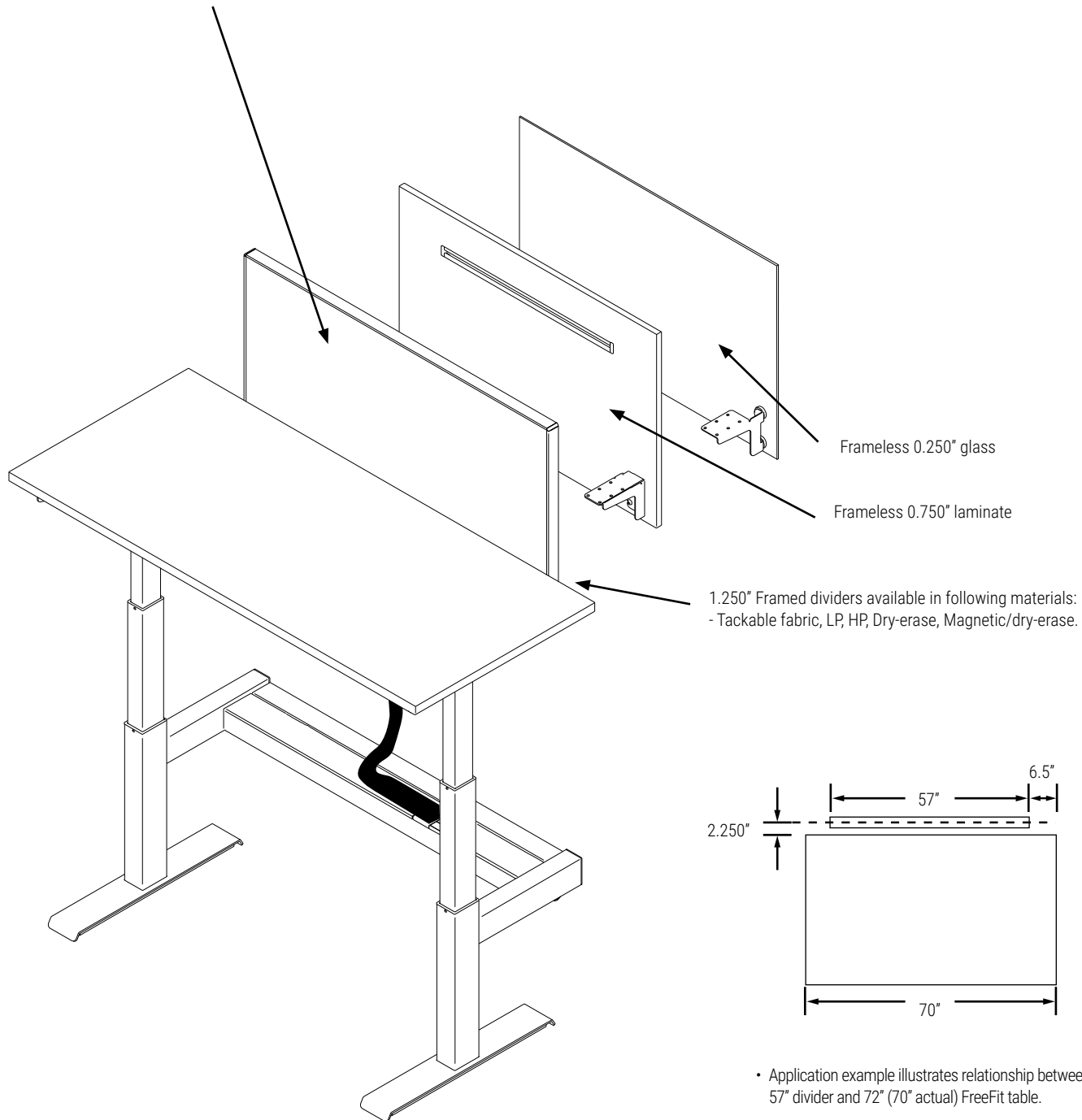

- Application example illustrates relationship between 57" divider and 72" (70" actual) FreeFit table.
- Example Order:
 BWATMFD72
 (actual dimension of 57") for
 BWA2D3072A8
 (actual dimension of 70").

FreeFit • Back 2 Back Table; 37" high dividers

FreeFit Back 2 Back stationary dividers; stationary, shared, secured to table structure; recessed 6.5" at both ends (for example - 72" (70" actual) FreeFit table mounted divider measures 57").

The centre of all dividers is always mounted 2.250" from work surface's rear edge. Please note the gap between the divider and the worksurface therefore varies, depending on the divider thickness (1.250" Framed dividers, 0.750" frame-less LP and 0.250" frame-less glass).

- 48" (33" actual) divider for 48" (46" actual) table
- 54" (39" actual) divider for 54" (52" actual) table
- 60" (45" actual) divider for 60" (58" actual) table
- 66" (51" actual) divider for 66" (64" actual) table
- 72" (57" actual) divider for 72" (70" actual) table

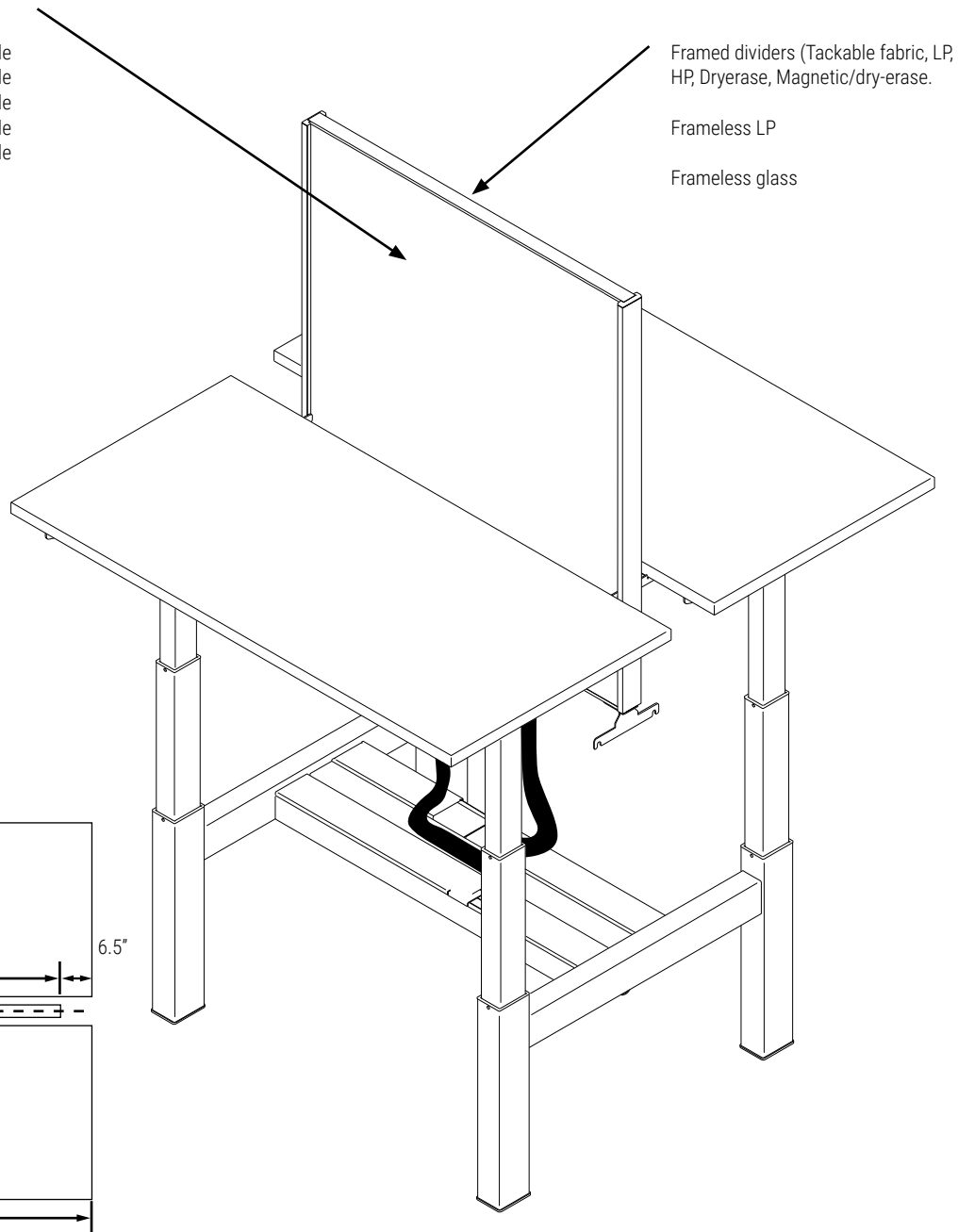

Application example illustrates relationship between 57" shared divider and 72" (70" actual) FreeFit Back 2 Back table.

- Example Order:
 BWASFD72
 (actual dimension of 57") for
 BWA2D6072A8
 (actual dimension of 70").

BWATMFD/BWATMLD • Table Mounted Framed Dividers

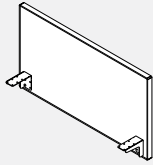

- **Connects parallel on Freefit single and back 2 back tables.**
- Divider frame and connecting hardware is painted, please choose from standard metal paint finishes.
- Fabric divider is tackable.
- Divider infill can be specified in fabric, low pressure laminate (LP), high pressure laminate (HP), dry erase whiteboard (DE) or dry erase magnetic whiteboard (DM) user side only.
- Fastens to the underside of the worksurface
- 1.625" gap between worksurface and divider allows for cable pass thru
- Installed divider measures 15.7" from top of worksurface and 5.75" below the worksurface.
- 48" to 66" dividers include 2 support brackets. 72" divider includes 3 support brackets.
- When dry erase magnetic whiteboard (DM) is specified it is applied user side ONLY and dry erase whiteboard (DE) is applied on the opposite side

TACKABLE FABRIC

PRODUCT CODE	PRICE		SIZE/ INCHES			WEIGHT LBS	VOL FT ³
	GR1	GR2	H	W	D		
BWATMFD48	333	370	21.5	33	1.25	16	1.23
BWATMFD54	357	392	21.5	39	1.25	18	1.46
BWATMFD60	388	432	21.5	45	1.25	20	1.68
BWATMFD66	434	483	21.5	51	1.25	22	1.90
BWATMFD72	478	527	21.5	57	1.25	26	2.13

LAMINATE

PRODUCT CODE	PRICE				SIZE/ INCHES			WEIGHT LBS	VOL FT ³
	LP	HP	DE	DM	H	W	D		
BWATMLD48	208	330	494	645	21.5	33	1.25	35	1.23
BWATMLD54	237	392	591	786	21.5	39	1.25	39	1.46
BWATMLD60	279	444	655	865	21.5	45	1.25	44	1.68
BWATMLD66	320	551	1107	1485	21.5	51	1.25	48	1.90
BWATMLD72	350	580	1130	1507	21.5	57	1.25	52	2.13

BWASFD/BWASLD • Stationary Framed Dividers

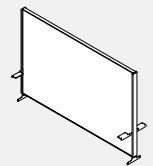

- **Provides a stationary framed divider between back 2 back height adjustable tables**
- Divider frame and connecting hardware is painted, please choose from standard metal paint finishes.
- Fabric divider is tackable.
- Divider infill can be specified in fabric, low pressure laminate (LP), high pressure laminate (HP), dry erase whiteboard (DE) or dry erase magnetic whiteboard (DM).
- Divider is anchored to the base and captured between two aluminum upright tracks. The uprights have sliding brackets that connect the worksurfaces to the divider providing continuous support as it travels up and down.
- 1.625" gap between worksurface and divider allows for cable pass thru
- Installed divider measures 54" from floor.

TACKABLE FABRIC

PRODUCT CODE	PRICE		SIZE/ INCHES			WEIGHT LBS	VOL FT ³
	GR1	GR2	H	W	D		
BWASFD48	660	695	37.2	33	2	25	2.13
BWASFD54	678	712	37.2	39	2	28	2.52
BWASFD60	692	734	37.2	45	2	31	2.91
BWASFD66	732	781	37.2	51	2	34	3.29
BWASFD72	949	997	37.2	57	2	37	3.68

LAMINATE

PRODUCT CODE	PRICE				SIZE/ INCHES			WEIGHT LBS	VOL FT ³
	LP	HP	DE	DM	H	W	D		
BWASLD48	573	886	1288	2446	37.2	33	2	58	2.13
BWASLD54	616	956	1369	2587	37.2	39	2	66	2.52
BWASLD60	631	971	1383	2603	37.2	45	2	73	2.91
BWASLD66	665	1043	2306	4623	37.2	51	2	81	3.29
BWASLD72	865	1430	2446	4882	37.2	57	2	88	3.68

BWATMLLD • Table Mounted Laminate Dividers

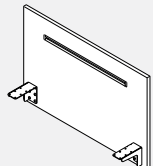

- **Connects parallel on Freefit single and back 2 back tables.**
- Laminate divider with integrated accessory rail, installed one side only.
- Integrated anodized aluminum accessory rail, white cut out and rail trims; white powder coat brackets.
- 3/4" LP PVC edged boards, please specify laminate & 3mm PVC edge.
- Fastens to the underside of the worksurface.
- 1.88 gap between worksurface and divider allows for cable pass thru.
- Installed divider measures 15.7" from top of worksurface and 5.75" below the worksurface.
- 48" to 66" dividers include 2 support brackets. 72" divider includes 3 support brackets.

LAMINATE

PRODUCT CODE	PRICE	SIZE/ INCHES			WEIGHT LBS	VOL FT ³
		H	W	D		
BWATMLLD48	249	21.5	33	0.75	16	1.23
BWATMLLD54	265	21.5	39	0.75	19	1.46
BWATMLLD60	280	21.5	45	0.75	21	1.68
BWATMLLD66	416	21.5	51	0.75	24	1.90
BWATMLLD72	431	21.5	57	0.75	27	2.13

BWASLLD • Stationary Laminate Dividers

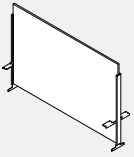

- Provides a stationary laminate divider between back 2 back height adjustable tables
- Divider uprights and connecting hardware is painted, please choose from standard metal paint finishes.
- Please specify laminate (LP) finish.
- Divider is anchored to the base and captured between two aluminum upright tracks. The uprights have sliding brackets that connect the worksurfaces to the divider providing continuous support as it travels up and down.
- 1.88" gap between worksurface and divider allows for cable pass thru.
- Installed divider measures 54" from floor.

LAMINATE PRODUCT CODE	PRICE	SIZE/ H	INCHES W	D	WEIGHT LBS	VOL FT ³
BWASLLD48	508	37.2	33	2	28	2.13
BWASLLD54	522	37.2	39	2	33	2.52
BWASLLD60	539	37.2	45	2	37	2.91
BWASLLD66	816	37.2	51	2	41	3.29
BWASLLD72	829	37.2	57	2	46	3.68

BWATMGD • Table Mounted Glass Dividers

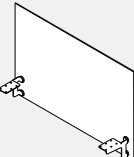

- Frameless glass divider connects parallel on single and back 2 back tables.
- Tempered glass, acid etched on one side (similar to frosted), satin chrome disc fasteners and powder coated steel support brackets.
- Fastens to the underside of the worksurface.
- 2.13 gap between worksurface and divider allows for cable pass thru.
- Installed divider measures 15.7" from top of worksurface and 4.75" below the worksurface.
- 54" to 66" dividers include 2 support brackets. 72" divider includes 3 support brackets.
- 1/2" radius on all four corners.

GLASS PRODUCT CODE	PRICE	SIZE/ H	INCHES W	D	WEIGHT LBS	VOL FT ³
BWATMGD48	537	21.5	33	0.25	16	1.23
BWATMGD54	578	21.5	39	0.25	19	1.46
BWATMGD60	619	21.5	45	0.25	22	1.68
BWATMGD66	656	21.5	51	0.25	24	1.90
BWATMGD72	697	21.5	57	0.25	28	2.13

BWASGD • Stationary Glass Dividers

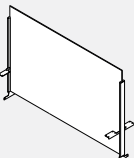

- Provides a stationary glass divider between back 2 back height adjustable tables.
- Tempered glass, acid etched on one side (similar to frosted), satin chrome disc fasteners and white powdercoated steel support brackets.
- Divider is anchored to the base and captured between two aluminum upright tracks. The uprights have sliding brackets that connect the worksurfaces to the divider providing continuous support as it travels up and down.
- 2.13 gap between worksurface and divider allows for cable pass thru.
- 1/2" radius on top two corners.

GLASS PRODUCT CODE	PRICE	SIZE/ H	INCHES W	D	WEIGHT LBS	VOL FT ³
BWASGD48	476	37.2	33	2	30	2.13
BWASGD54	542	37.2	39	2	34	2.52
BWASGD60	614	37.2	45	2	39	2.91
BWASGD66	680	37.2	51	2	43	3.29
BWASGD72	747	37.2	57	2	48	3.68

BWAFWR • Felt Wrap Around Divider for FreeFit Table

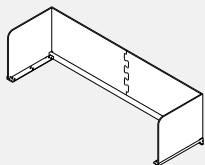

Single

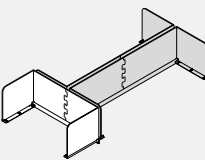

End of Run

- Wraps around FreeFit table to provide privacy.
- 9mm Felt material is tackable and comes in 18 different colours. Please specify colour.
- Installed divider measures 15.7" high from top of the worksurface.
- Please choose standard metal finish for extrusion and brackets.
- Upcharge of \$83 for anodized extrusion option.
- Divider extends by 1.5" at the back.
- For sizes 2346, 2351 and 2352, the felt will be manufactured in one pieces, while all others will be manufactured in two pieces as shown.
- Note: Cannot use ceiling feed option with this divider.

PRODUCT CODE	PRICE	SIZE/ H	INCHES W	D	WEIGHT LBS	VOL FT ³
BWAFWR2346	392	18.24	46.84	18.46	26.58	1.07
BWAFWR2352	416	18.24	52.84	18.46	28.40	1.21
BWAFWR2358	438	18.24	58.84	18.46	30.22	1.34
BWAFWR2364	580	18.24	64.84	18.46	32.02	0.74
BWAFWR2370	618	18.24	70.84	18.46	33.84	0.81
BWAFWR2946	444	18.24	46.84	24.46	30.74	1.07
BWAFWR2952	587	18.24	52.84	24.46	32.55	0.60
BWAFWR2958	625	18.24	58.84	24.46	34.37	0.67
BWAFWR2964	661	18.24	64.84	24.46	36.19	0.74
BWAFWR2970	703	18.24	70.84	24.46	38.00	0.81
End of Run						
BWAFWR2351	398	18.24	51.34	27.94	27.94	1.05
BWAFWR2951	586	18.24	51.34	32.09	32.09	0.62
BWAFWR2363	579	18.24	63.34	31.57	31.57	1.50
BWAFWR2963	660	18.24	63.34	35.73	35.73	0.87

BWAFPN • Parallel Felt Divider

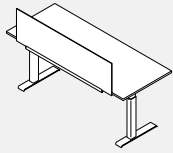

- **Felt divider connects parallel on a single or Back to Back FreeFit table.**
- 9 mm felt material is tackable and comes in a wide range of colours.
- Installed, the divider measures 15.7" high from the top of the worksurface.
- Kit includes felt divider, support extrusion and left and right brackets.
- Please choose the finish of the felt and the metal finish for the extrusion and brackets.

PRODUCT CODE	PRICE	SIZE/INCHES			WEIGHT LBS	VOL FT ³
		H	W	D		
BWAFPN36	136	18.24	21	5.86	2.21	1.30
BWAFPN42	152	18.24	27	5.86	2.77	1.67
BWAFPN48	208	18.24	33	5.86	2.82	2.04
BWAFPN54	234	18.24	39	5.86	3.29	2.41
BWAFPN60	264	18.24	45	5.86	3.75	2.78
BWAFPN66	372	18.24	51	5.86	4.22	3.15
BWAFPN72	397	18.24	57	5.86	4.69	3.53

BWAFMPSN • Modesty Felt Divider

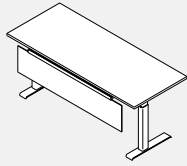

- **Felt modesty panel secures to the rear bottom of a regular FreeFit table and provides privacy below the worksurface.**
- 9 mm felt material is tackable and comes in a wide range of colours.
- Installed, the divider measures 15" high below the top of the worksurface.
- Kit includes felt modesty, support extrusion and left and right brackets.
- Please choose the finish of the felt and the metal finish for the extrusion and brackets.

PRODUCT CODE	PRICE	SIZE/INCHES			WEIGHT LBS	VOL FT ³
		H	W	D		
BWAFMPSN36	128	13.94	21	4.17	1.84	0.71
BWAFMPSN42	139	13.94	27	4.17	2.32	0.91
BWAFMPSN48	195	13.94	33	4.17	2.44	1.11
BWAFMPSN54	217	13.94	39	4.17	2.86	1.31
BWAFMPSN60	246	13.94	45	4.17	3.27	1.51
BWAFMPSN66	347	13.94	51	4.17	3.68	1.72
BWAFMPSN72	370	13.94	57	4.17	4.09	1.92

BWAFPDN • Parallel Above & Below Felt Divider

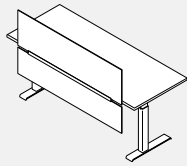

- **Felt divider and modesty panel kit secures to the rear bottom of a regular FreeFit table and provides privacy above and below the worksurface.**
- 9 mm felt material is tackable and comes in a wide range of colours.
- Installed, the divider measures 15.7 high from the top of the worksurface and 15" high below the top of the worksurface.
- Kit includes two felt dividers, support extrusion and left and right brackets.
- Please choose the finish of the felt and the metal finish for the extrusion and brackets.

PRODUCT CODE	PRICE	SIZE/INCHES			WEIGHT LBS	VOL FT ³
		H	W	D		
BWAFPDN36	201	30.68	21	5.86	2.79	2.18
BWAFPDN42	219	30.68	27	5.86	3.56	2.81
BWAFPDN48	312	30.68	33	5.86	3.82	3.43
BWAFPDN54	346	30.68	39	5.86	4.5	4.06
BWAFPDN60	405	30.68	45	5.86	5.17	4.68
BWAFPDN66	618	30.68	51	5.86	5.85	5.31
BWAFPDN72	656	30.68	57	5.86	6.53	5.93

BW AFC • Corner Wrap Felt Divider

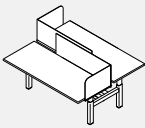
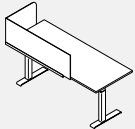

- **Felt Corner Wrap secures to the side and rear bottom of a FreeFit table, wraps around one side and provides limited privacy.**
- 9 mm felt material is tackable and comes in a wide range of colours.
- Installed, the divider measures 15.7 high from the top of the worksurface..
- Kit includes felt dividers, support extrusion and large and small handed brackets.
- Please choose the finish of the felt and the metal finish for the extrusion and brackets.

PRODUCT CODE	PRICE	SIZE/INCHES			WEIGHT LBS	VOL FT ³
		H	W	D		
BW AFC2432L	283	18.24	32.46	18.52	4.99	6.35
BW AFC2432R	283	18.24	32.46	18.52	4.99	6.35
BW AFC2438L	323	18.24	38.46	18.52	5.46	7.52
BW AFC2438R	323	18.24	38.46	18.52	5.46	7.52
BW AFC2448L	347	18.24	47.46	18.52	6.16	9.28
BW AFC2448R	347	18.24	47.46	18.52	6.16	9.28
BW AFC3032L	319	18.24	32.46	24.52	5.72	8.40
BW AFC3032R	319	18.24	32.46	24.52	5.72	8.40
BW AFC3038L	343	18.24	38.46	24.52	6.19	9.95
BW AFC3038R	343	18.24	38.46	24.52	6.19	9.95
BW AFC3048L	369	18.24	47.46	24.52	6.89	12.28
BW AFC3048R	369	18.24	47.46	24.52	6.89	12.28

FFTDP-H24 • Height Adjustable Table Polycarbonate Divider Screen Kit, 24" high

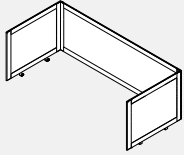

- Provides privacy in an open plan environment.
- Lightweight and easy to clean table mounted partitions.
- Consists of a powder coated aluminum frame, translucent fluted polycarbonate and all hardware to connect. Brackets are painted steel.
- Side dividers extend 6.237" from the front edge of each surface.
- Back divider extends over the back edge of the worksurface by 1 1/2" allowing for the passage of cables to the trough.
- FFTDP24xxH24 are for 23" deep surfaces and FFTDP30xxH24 are for 29" deep surfaces.
- Width and depth are nominal sizes representing the sizes of the FreeFit Table. Allow for 1/4" overhang at the sides, 1 1/2" at the back and 6.237" at the front.
- Please choose any standard paint finish for frame and hardware. End trim cap is available only in CHR - charcoal.

PRODUCT CODE	PRICE	SIZE/ INCHES			WEIGHT LBS	VOL FT³
		H	W	D		
FFTDP2436H24	760	24.63	34	31.75	26.55	3.94
FFTDP2442H24	784	24.63	40	31.75	28.10	4.59
FFTDP2448H24	806	24.63	46	31.75	29.65	5.25
FFTDP2454H24	829	24.63	52	31.75	31.20	5.91
FFTDP2460H24	853	24.63	58	31.75	32.75	6.56
FFTDP2466H24	876	24.63	60	31.75	34.30	7.22
FFTDP2472H24	897	24.63	70	31.75	35.85	7.88
FFTDP2478H24	921	24.63	76	31.75	37.40	8.53
FFTDP2484H24	947	24.63	82	31.75	38.95	9.19
FFTDP3036H24	816	24.63	34	37.75	40.50	4.72
FFTDP3042H24	839	24.63	40	37.75	42.05	5.51
FFTDP3048H24	862	24.63	46	37.75	43.60	6.29
FFTDP3054H24	885	24.63	52	37.75	45.15	7.08
FFTDP3060H24	907	24.63	58	37.75	46.70	7.87
FFTDP3066H24	930	24.63	60	37.75	48.25	8.65
FFTDP3072H24	954	24.63	70	37.75	49.80	9.44
FFTDP3078H24	976	24.63	76	37.75	51.35	10.22
FFTDP3084H24	999	24.63	82	37.75	52.90	11.01

FFTDP-H30 • Height Adjustable Table Polycarbonate Divider Screen Kit, 30" high

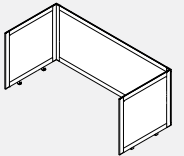

- Provides privacy in an open plan environment.
- Lightweight and easy to clean table mounted partitions.
- Consists of a powder coated aluminum frame, translucent fluted polycarbonate and all hardware to connect. Brackets are painted steel.
- Side dividers extend 6.237" from the front edge of each surface.
- Back divider extends over the back edge of the worksurface by 1 1/2" allowing for the passage of cables to the trough.
- FFTDP24xxH24 are for 23" deep surfaces and FFTDP30xxH24 are for 29" deep surfaces.
- Width and depth are nominal sizes representing the sizes of the FreeFit Table. Allow for 1/4" overhang at the sides, 1 1/2" at the back and 6.237" at the front.
- Please choose any standard paint finish for frame and hardware. End trim cap is available only in CHR - charcoal.

PRODUCT CODE	PRICE	SIZE/ INCHES			WEIGHT LBS	VOL FT³
		H	W	D		
FFTDP2436H30	853	30.63	34	31.75	26.55	3.94
FFTDP2442H30	882	30.63	40	31.75	28.10	4.59
FFTDP2448H30	907	30.63	46	31.75	29.65	5.25
FFTDP2454H30	932	30.63	52	31.75	31.20	5.91
FFTDP2460H30	960	30.63	58	31.75	32.75	6.56
FFTDP2466H30	986	30.63	60	31.75	34.30	7.22
FFTDP2472H30	1015	30.63	70	31.75	35.85	7.88
FFTDP2478H30	1039	30.63	76	31.75	37.40	8.53
FFTDP2484H30	1065	30.63	82	31.75	38.95	9.19
FFTDP3036H30	905	30.63	34	37.75	40.50	4.72
FFTDP3042H30	932	30.63	40	37.75	42.05	5.51
FFTDP3048H30	959	30.63	46	37.75	43.60	6.29
FFTDP3054H30	985	30.63	52	37.75	45.15	7.08
FFTDP3060H30	1012	30.63	58	37.75	46.70	7.87
FFTDP3066H30	1038	30.63	60	37.75	48.25	8.65
FFTDP3072H30	1064	30.63	70	37.75	49.80	9.44
FFTDP3078H30	1091	30.63	76	37.75	51.35	10.22
FFTDP3084H30	1118	30.63	82	37.75	52.90	11.01

FFTDG-H24 • Height Adjustable Table Glass Divider Screen Kit, 24" high

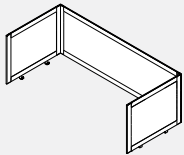

- Provides privacy in an open plan environment.
- Easy to clean table mounted partitions.
- Consists of a powder coated aluminum frame, 4mm clear (CLR) glass and all hardware to connect. Brackets are painted steel.
- Side dividers extend 6.237" from the front edge of each surface.
- Back divider extends over the back edge of the worksurface by 1 1/2" allowing for the passage of cables to the trough.
- FFTDG24xxH24 are for 23" deep surfaces and FFTDG30xxH24 are for 29" deep surfaces.
- Width and depth are nominal sizes representing the sizes of the FreeFit Table. Allow for 1/4" overhang at the sides, 1 1/2" at the back and 6.237" at the front.
- Please choose any standard paint finish for frame and hardware. End trim cap is available only in CHR - charcoal.
- Upcharge for frosted (FRST) glass is 20%.

PRODUCT CODE	PRICE	SIZE/ INCHES			WEIGHT LBS	VOL FT³
		H	W	D		
FFTDG2436H24	1024	24.60	34	31.50	26.55	3.94
FFTDG2442H24	1060	24.60	40	31.50	28.10	4.59
FFTDG2448H24	1091	24.60	46	31.50	29.65	5.25
FFTDG2454H24	1126	24.60	52	31.50	31.20	5.91
FFTDG2460H24	1159	24.60	58	31.50	32.75	6.56
FFTDG2466H24	1193	24.60	60	31.50	34.30	7.22
FFTDG2472H24	1226	24.60	70	31.50	35.85	7.88
FFTDG2478H24	1260	24.60	76	31.50	37.40	8.53
FFTDG2484H24	1294	24.60	82	31.50	38.95	9.19
FFTDG3036H24	1089	24.60	34	37.75	40.50	4.72
FFTDG3042H24	1122	24.60	40	37.75	42.05	5.51
FFTDG3048H24	1156	24.60	46	37.75	43.60	6.29
FFTDG3054H24	1191	24.60	52	37.75	45.15	7.08
FFTDG3060H24	1223	24.60	58	37.75	46.70	7.87
FFTDG3066H24	1258	24.60	60	37.75	48.25	8.65
FFTDG3072H24	1291	24.60	70	37.75	49.80	9.44
FFTDG3078H24	1325	24.60	76	37.75	51.35	10.22
FFTDG3084H24	1358	24.60	82	37.75	52.90	11.01

FFTDG-H30 • Height Adjustable Table Glass Divider Screen Kit, 30" high

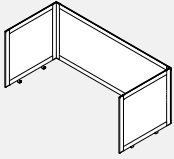

- Provides privacy in an open plan environment.
- Easy to clean table mounted partitions.
- Consists of a powder coated aluminum frame, 4mm clear (CLR) glass and all hardware to connect. Brackets are painted steel.
- Side dividers extend 6.237" from the front edge of each surface.
- Back divider extends over the back edge of the worksurface by 1 1/2" allowing for the passage of cables to the trough.
- FTDG24xxH30 are for 23" deep surfaces and FTDG30xxH30 are for 29" deep surfaces.
- Width and depth are nominal sizes representing the sizes of the FreeFit Table. Allow for 1/4" overhang at the sides, 1 1/2" at the back and 6.237" at the front.
- Please choose any standard paint finish for frame and hardware. End trim cap is available only in CHR - charcoal.
- Upcharge for frosted (FRST) glass is 20%.

PRODUCT CODE	PRICE	SIZE/ INCHES			WEIGHT LBS	VOL FT³
		H	W	D		
FFTDG2436H30	1073	30.60	34	31.50	28.85	3.94
FFTDG2442H30	1107	30.60	40	31.50	30.40	4.59
FFTDG2448H30	1143	30.60	46	31.50	31.95	5.25
FFTDG2454H30	1177	30.60	52	31.50	33.50	5.91
FFTDG2460H30	1211	30.60	58	31.50	35.05	6.56
FFTDG2466H30	1246	30.60	60	31.50	36.60	7.22
FFTDG2472H30	1267	30.60	70	31.50	38.15	7.88
FFTDG2478H30	1317	30.60	76	31.50	39.70	8.53
FFTDG2484H30	1351	30.60	82	31.50	41.25	9.19
FFTDG3036H30	1142	30.60	34	37.75	42.80	4.72
FFTDG3042H30	1175	30.60	40	37.75	44.35	5.51
FFTDG3048H30	1211	30.60	46	37.75	45.90	6.29
FFTDG3054H30	1245	30.60	52	37.75	47.45	7.08
FFTDG3060H30	1279	30.60	58	37.75	49.00	7.87
FFTDG3066H30	1315	30.60	60	37.75	50.55	8.65
FFTDG3072H30	1336	30.60	70	37.75	52.10	9.44
FFTDG3078H30	1385	30.60	76	37.75	53.65	10.22
FFTDG3084H30	1419	30.60	82	37.75	55.20	11.01

FFTDF-H24 • Height Adjustable Table Felt Divider Screen Kit, 24" high

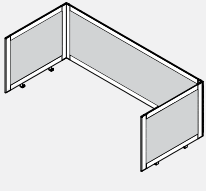

- Provides privacy in an open plan environment.
- Consists of a powder coated aluminum frame, 9mm felt and all hardware to connect. Brackets are painted steel.
- Side dividers extend 6.237" from the front edge of each surface.
- Back divider extends over the back edge of the worksurface by 1 1/2" allowing for the passage of cables to the trough.
- FFTDF24xxH24 are for 23" deep surfaces and FFTDF30xxH24 are for 29" deep surfaces.
- Width and depth are nominal sizes representing the sizes of the FreeFit Table. Allow for 1/4" overhang at the sides, 1 1/2" at the back and 6.237" at the front.
- Please choose any standard paint finish for frame and hardware. Select also a felt finish. End trim cap is available only in CHR - charcoal.
- 9mm felt material is tackable and comes in a variety of colors.

PRODUCT CODE	PRICE	SIZE/INCHES			WEIGHT LBS	VOL FT³
		H	W	D		
FFTDF2436H24	666	24.60	34	31.50	22.55	3.94
FFTDF2442H24	683	24.60	40	31.50	24.10	4.59
FFTDF2448H24	701	24.60	46	31.50	25.65	5.25
FFTDF2454H24	720	24.60	52	31.50	27.20	5.91
FFTDF2460H24	737	24.60	58	31.50	28.75	6.56
FFTDF2466H24	757	24.60	60	31.50	30.30	7.22
FFTDF2472H24	774	24.60	70	31.50	31.85	7.80
FFTDF2478H24	790	24.60	76	31.50	33.40	8.53
FFTDF2484H24	826	24.60	82	31.50	34.95	9.19
FFTDF3036H24	689	24.60	34	37.75	36.50	4.72
FFTDF3042H24	709	24.60	40	37.75	38.05	5.51
FFTDF3048H24	724	24.60	46	37.75	39.60	6.29
FFTDF3054H24	744	24.60	52	37.75	41.15	7.08
FFTDF3060H24	760	24.60	58	37.75	41.70	7.87
FFTDF3066H24	779	24.60	60	37.75	44.25	8.65
FFTDF3072H24	796	24.60	70	37.75	45.80	9.44
FFTDF3078H24	814	24.60	76	37.75	47.35	10.22
FFTDF3084H24	850	24.60	82	37.75	48.90	11.01

FFTDF-H30 • Height Adjustable Table Felt Divider Screen Kit, 30" high

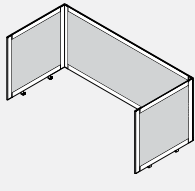

- Provides privacy in an open plan environment.
- Consists of a powder coated aluminum frame, 9mm felt and all hardware to connect. Brackets are painted steel.
- Side dividers extend 6.237" from the front edge of each surface.
- Back divider extends over the back edge of the worksurface by 1 1/2" allowing for the passage of cables to the trough.
- FFTDF24xxH30 are for 23" deep surfaces and FFTDF30xxH30 are for 29" deep surfaces.
- Width and depth are nominal sizes representing the sizes of the FreeFit Table. Allow for 1/4" overhang at the sides, 1 1/2" at the back and 6.237" at the front.
- Please choose any standard paint finish for frame and hardware. Select also a felt finish. End trim cap is available only in CHR - charcoal.
- 9mm felt material is tackable and comes in a variety of colors.

PRODUCT CODE	PRICE	SIZE/INCHES			WEIGHT LBS	VOL FT³
		H	W	D		
FFTDF2436H30	660	30.60	34	31.50	24.85	3.94
FFTDF2442H30	679	30.60	40	31.50	26.40	4.59
FFTDF2448H30	694	30.60	46	31.50	27.95	5.25
FFTDF2454H30	712	30.60	52	31.50	29.50	5.91
FFTDF2460H30	726	30.60	58	31.50	31.05	6.56
FFTDF2466H30	745	30.60	60	31.50	32.60	7.22
FFTDF2472H30	760	30.60	70	31.50	34.15	7.88
FFTDF2478H30	778	30.60	76	31.50	35.70	8.53
FFTDF2484H30	817	30.60	82	31.50	37.25	9.19
FFTDF3036H30	693	30.60	34	37.75	38.80	4.72
FFTDF3042H30	711	30.60	40	37.75	40.35	5.51
FFTDF3048H30	725	30.60	46	37.75	41.90	6.29
FFTDF3054H30	744	30.60	52	37.75	43.45	7.08
FFTDF3060H30	760	30.60	58	37.75	45.00	7.87
FFTDF3066H30	778	30.60	60	37.75	46.55	8.65
FFTDF3072H30	792	30.60	70	37.75	48.10	9.44
FFTDF3078H30	811	30.60	76	37.75	49.65	10.22
FFTDF3084H30	849	30.60	82	37.75	51.20	11.01

FTATB • Boulevard Connector Kit

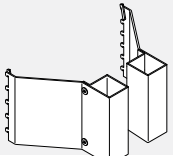

- FreeFit to Boulevard kit secures FreeFit height adjustable freestanding tables to parallel Boulevard panels.
- It provides panel/table alignment, preventing moving parts from rubbing against panel vertical surfaces and maintains 1" clearance around table surface perimeter.
- Standard metal finishes.
- All hardware included.
- Sold as a pair.
- Note: - Kit connects to C style base only.

PRODUCT CODE	PRICE	SIZE/ INCHES			WEIGHT VOL	
		H	W	D	LBS	FT ³
FTATB	140	10	6.5	10	7.00	0.50

FTAEG • Back to Back End Gable

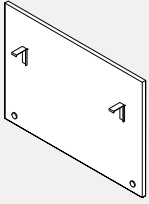

- Optional Back to Back Freefit End Gable is intended to be installed at the end of Freefit Back to Back table run.
- Made out of 3/4" PL Laminate, it enhances Freefit table assembly aesthetics by reducing number of visible elements below work surface.
- Two heights available.
- The End Gable connects to Freefit H-frame crossbar; compatible with Floor Feed.
- Please specify LP finish.
- Please specify paint finish for the brackets.

PRODUCT CODE	PRICE	SIZE/INCHES			WEIGHT VOL	
		H	D	W	LBS	FT ³
FTAEG18H	311	18	30	0.75	10.00	0.24
FTAEG22H	337	23	30	0.75	13.00	0.30

FTACPU • CPU Holder

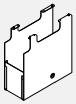

- Accepts tower CPU's with a width range from 7.6" to 2.25" and a maximum height of 18"
- Durable sheet metal construction
- Please specify paint finish.

PRODUCT CODE	PRICE	SIZE/INCHES			WEIGHT VOL	
		H	D	W	LBS	FT ³
FTACPU	281	21	21	8	3.57	2.04

BRTLCS • Locking Caster for Rectangular Leg Tables



- Locking Caster for Rectangular Table.
- 40mm dia. locking caster with 8mm thread; whitebody, light grey tires.

PRODUCT CODE	PRICE	SIZE/INCHES			WEIGHT VOL	
		H	D	W	LBS	FT ³
BRTLCS	27	2.5	2.7	2.6	0.06	0.01

FTFOOT-TL • T-foot

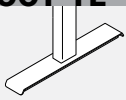

- Replacement single "T" foot.
- Includes attachment hardware.

PRODUCT CODE	PRICE	SIZE/INCHES			WEIGHT VOL	
		H	D	W	LBS	FT ³
FTFOOT24TL	83	1.16	23	3	4.4	0.25
FTFOOT30TL	89	1.16	29	3	4.85	0.31

FTFOOT-CL • C-foot

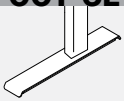

- Replacement single "C" foot.
- Includes attachment hardware.

PRODUCT CODE	PRICE	SIZE/INCHES			WEIGHT VOL	
		H	D	W	LBS	FT ³
FTFOOT24CL	107	1.16	23	3	4.4	0.25
FTFOOT30CL	116	1.16	29	3	4.85	0.31

FTSETGLIDE • Set of Glides



- Replacement Glides a set of two with 1/2" adjustment

PRODUCT CODE	PRICE	SIZE/INCHES			WEIGHT VOL	
		H	D	W	LBS	FT ³
FTSETGLIDE	12	1	1.5	1.5	0.06	0.01

BRLBST • Single Table Accessory Rail

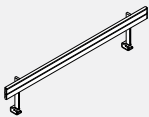

- **Table mounted accessory rail.**
- Compatible with standard Bins, Trays and Sorters.
- Includes end caps and mounting hardware.
- Please specify paint finish
- To ensure proper connection and clearance on tables 46" wide and up, choose accessory rail 13" smaller than the actual table width (70" wide table gets 57" wide rail).
- Tables 40" wide and smaller use 33" wide accessory rail.

PRODUCT CODE	PRICE	SIZE/ INCHES			WEIGHT VOL	
		H	W	D	LBS	FT ³
BRLBST36	297	16	33	2.95	5.9	0.26
BRLBST42	310	16	39	2.95	6.44	0.30
BRLBST48	320	16	45	2.95	6.98	0.35
BRLBST54	333	16	51	2.95	7.52	0.39
BRLBST60	342	16	57	2.95	8.07	0.43
BRLBST66	352	16	63	2.95	8.61	0.48
BRLBST72	366	16	69	2.95	9.15	0.52
BRLBST78	376	16	75	2.95	9.69	0.56
BRLBST84	388	16	81	2.95	10.24	0.61

Technical Information - Tables

Common

- Tables up to and including 96" long are manufactured in one piece, 108" to 168" long are manufactured in two pieces and over 192" are manufactured in three pieces. If wood grain laminate or wood veneer is chosen, the wood grain may not line up for any tables longer than 10 feet.
- Tables in 2 or 3 pieces will have the joining edge finished, hardware will be shipped for assembly.
- Grommet locations must be specified at the time of order or it will default to "no grommet" option.
- Tables are pre-drilled with factory installed inserts for easy metal to metal base connection.

Edge Options B & W

- "LKD" Rectangular shape tables with edge B and W have 1" radius at each corner. For tables with square corners, please add "NR" at the end of the product code, no upcharge required.
- The "NR" option is available only with the B and W edge profiles.
- All table surfaces are High Pressure Laminate in "B" (1 1/16") or "W" (1 7/16") thickness.

Edge Options KL/FV/KV

- LKD" Rectangular shape tables have 90 degree corners. There is no radius corner option.
- All table surfaces are 1 3/16" thickness.
- KL is a high pressure laminate top with 3mm perimeter PVC edging with a 2" undercut knife profile.
- FV is a veneer top with a flat 3mm perimeter hardwood edge.
- KV is a veneer top with 3mm perimeter hardwood edge with a 2" undercut knife profile.

Tables • Guidelines For Ordering Product

CODES: The price list uses a numbering system with meaningful alphanumeric characters to create a simple-to-understand product number. This makes specifying the product much easier and more accurate.

SPECIFICATION EXAMPLE OF A TABLE UNIT

PRODUCT CODE:

LKD3636
 L = Licence
 KD = Kadin Tables
 3636 = Size: Depth x Width

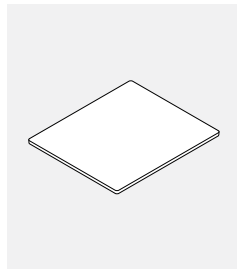

Edge Options:

"B" Edges

Laminate surface with PVC edge

HP (B) 1.062" Thickness

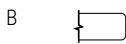

"W" Edges

Laminate surface with PVC edge

HP (W) 1.437" Thickness

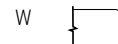

"KL" Edges

Laminate surface with PVC edge

HP (KL) 1.187" Thickness

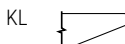

"FV" Edges

Veneer surface with Hardwood edge

(FV) 1.187" Thickness

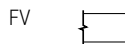

"KV" Edges

Veneer surface with Hardwood edge

(KV) 1.187" Thickness

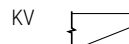

LKD Grommet locations

Square Table (TC Grommet Only)

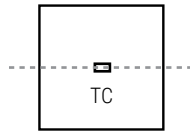

- LKD3636 accepts BG5.
- LKD4242, LKD4848, LKD5454 and LKD6060 accept all grommets and modules.
- LKD4248, LKD4254, LKD4854
- Note: Also accepts GCSRTMCD6xx

Round Table (TC Grommet Only)

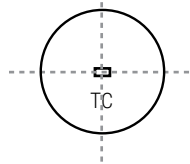

- LKD36DIA accepts BG5.
- LKD42DIA, LKD48DIA, LKD54DIA and LKD60DIA accept BG5 and MSPDM.

Rectangular Table

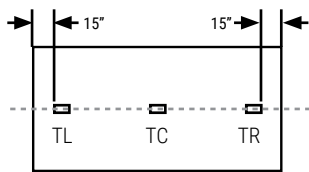

TC GROMMET ONLY

- LKD3648
- LKD3654
- LKD4248
- LKD4254
- LKD4854
- LKD4248, LKD4254 and LKD4854 also accepts GCRTMCD602, GCRTMCD622 and GCRTMCD642.

ONE GROMMET CHOICE ONLY - TL,TC OR TR

- LKD3660, LKD3666, LKD3672
- LKD4260, LKD4266, LKD4272

(Accept BG5, MSPDM, GCRTMCS401, GCRTMCS421)

UP TO 3 GROMMETS IN TL,TC AND/OR TR

- LKD3678, LKD3684, LKD3696
- LKD4278, LKD4284, LKD4296
- LKD4878, LKD4884, LKD4896

Rectangular Table, 2 Piece Top

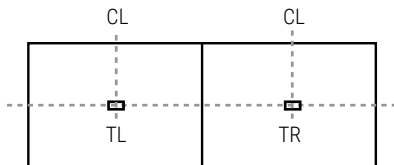

UP TO 2 GROMMETS IN TL, AND/OR TR

LKD
All sizes

Rectangular Table, 3 Piece Top

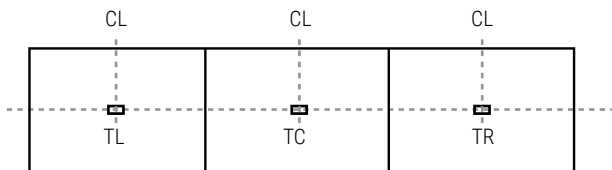

UP TO 3 GROMMETS IN TL,TC AND/OR TR

LKD
All sizes

Note: Grommet orientation follows the length of table.

ModPower Power Solution

- Power solutions for flexible spaces. Connect up to four units (in Canada)/six units in the USA from a single infeed with NEMA plug to deliver power and charging ports to the table top. In-surface modules and clamp on modules available.
- Easy to install; code compliant that allows users to optimize any space providing convenient power access. Perfect for training areas, meeting rooms, in-office workstations and more. Units feature tamper-resistant receptacles as well as both USB-A and USB-C charging ports.
- Easy to use connectors that are touch-safe with added latch to prevent unintended separation. Easy push together to connect, and simple press down on latch to disconnect.
- Maximum overall length not to exceed 48.5 feet per infeed. UL listed to UL962A SD, the standard for furniture power distribution units for portable/moveable work space tables.
- Certified to CSA standard C22.2 No. 203-16.
- Will work with Licence, Terina and Bridges Products.

- Surface mounted module ships with a clamp mount that will accommodate any material 1/2" to 1-1/2" thick; additional brackets are also included for screw in mounting options that can accommodate vertical or horizontal positions.
- Modules can be integrated into surfaces but the surface must be specified as a special.

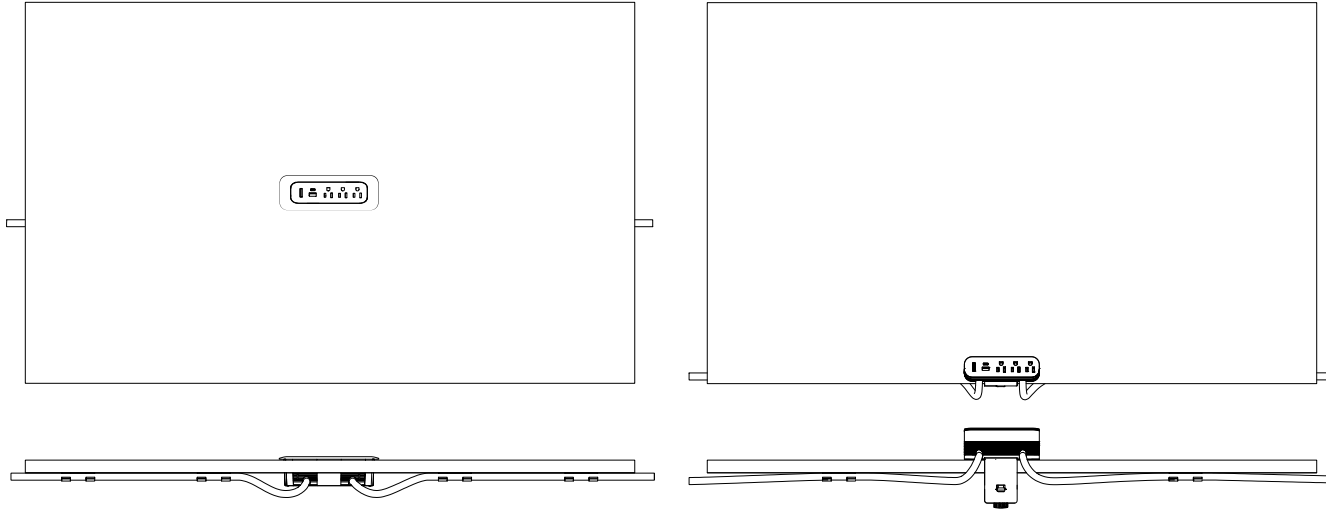
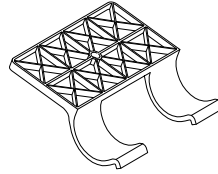

GMDSF10 • ModPower In Surface Starter Unit

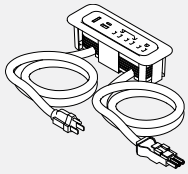

- ModPower starter unit includes one 10' cord with a NEMA plug and one 3' connector cord.
- Unit equipped with three 15A tamper resistant receptacles, one USB-A and one USB-C charging ports and a circuit breaker.
- 4 cable management cord clips included.
- MG at the end of the code indicates a magnesium finish, while WH is a white finish.

PRODUCT CODE	PRICE	DIMENSIONS			WEIGHT		VOL FT ³
		H	W	D	LBS		
GMDSF10MG	597	2.63	7.63	2.63	3.44	1.0	
GMDSF10WH	597	2.63	7.63	2.63	3.44	1.0	

GMDCF3 • ModPower In Surface Middle Unit

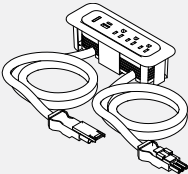

- ModPower middle unit includes two 3' connector cords.
- Unit equipped with three 15A rated 12A tamper resistant receptacles, one USB-A and one USB-C charging ports and a circuit breaker.
- 4 cable management cord clips included.
- MG at the end of the code indicates a magnesium finish, while WH is a white finish.

PRODUCT CODE	PRICE	DIMENSIONS			WEIGHT		VOL FT ³
		H	W	D	LBS		
GMDCF3MG	562	2.63	7.63	2.63	2.44	1.0	
GMDCF3WH	562	2.63	7.63	2.63	2.44	1.0	

GMDEF3 • ModPower In Surface End Unit

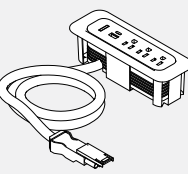

- ModPower end unit includes one 3' connector cord.
- Unit equipped with three 15A rated 12A tamper resistant receptacles, one USB-A and one USB-C charging ports and a circuit breaker.
- 2 cable management cord clips included.
- MG at the end of the code indicates a magnesium finish, while WH is a white finish.

PRODUCT CODE	PRICE	DIMENSIONS			WEIGHT		VOL FT ³
		H	W	D	LBS		
GMDEF3MG	494	2.63	7.63	2.63	1.85	1.0	
GMDEF3WH	494	2.63	7.63	2.63	1.85	1.0	

GMDSA10 • ModPower Starter Mounted Unit

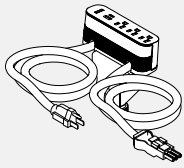

- ModPower starter unit includes one 10' cord with a NEMA plug and one 3' connector cord.
- Unit equipped with three 15A tamper resistant receptacles, one USB-A and one USB-C charging ports and a circuit breaker.
- Includes edge clamp and 3 other mounting methods; and 4 cable management cord clips.
- MG at the end of the code indicates a magnesium finish, while WH is a white finish.

PRODUCT CODE	PRICE	DIMENSIONS			WEIGHT	
		H	W	D	LBS	FT ³
GMDSA10MG	631	2.5	6.13	1.75	4.33	1.0
GMDSA10WH	631	2.5	6.13	1.75	4.33	1.0

GMDCA3 • ModPower Middle Mounted Unit

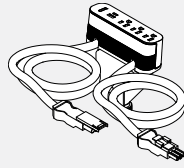

- ModPower middle unit includes two 3' connector cords.
- Unit equipped with three 15A rated 12A tamper resistant receptacles, one USB-A and one USB-C charging ports and a circuit breaker.
- Includes edge clamp and 3 other mounting methods; and 4 cable management cord clips.
- MG at the end of the code indicates a magnesium finish, while WH is a white finish.

PRODUCT CODE	PRICE	DIMENSIONS			WEIGHT	
		H	W	D	LBS	FT ³
GMDCA3MG	597	2.5	6.13	1.75	3.33	1.0
GMDCA3WH	597	2.5	6.13	1.75	3.33	1.0

GMDEA3 • ModPower End Mounted Unit

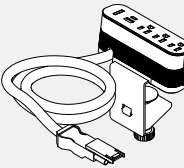

- ModPower end unit includes one 3' connector cord.
- Unit equipped with three 15A rated 12A tamper resistant receptacles, one USB-A and one USB-C charging ports and a circuit breaker.
- Includes edge clamp and 3 other mounting methods; and 2 cable management cord clips.
- MG at the end of the code indicates a magnesium finish, while WH is a white finish.

PRODUCT CODE	PRICE	DIMENSIONS			WEIGHT	
		H	W	D	LBS	FT ³
GMDEA3MG	528	2.5	6.13	1.75	2.75	1.0
GMDEA3WH	528	2.5	6.13	1.75	2.75	1.0

GMDCLIPS • ModPower Management Clips

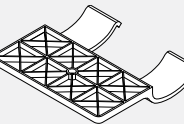

- Includes 10 clips.

PRODUCT CODE	PRICE	DIMENSIONS			WEIGHT	
		H	W	D	LBS	FT ³
GMDCLIPS	102	0.6	2.6	2.5	0.3	0.2

GMDJ36BK • ModPower Interconnecting Jumper

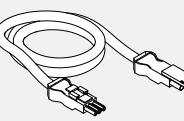

- ModPower interconnecting jumper cord to add an additional 3 feet of cord length between ModPower units.
- Package of 2, each 3 feet with male & female connector.

PRODUCT CODE	PRICE	DIMENSIONS			WEIGHT	
		H	W	D	LBS	FT ³
GMDJ36BK	329		36		1.38	0.9

LKD • Square Table

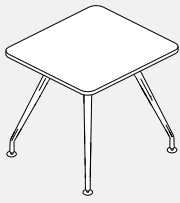

- Leg finish option, chrome or paint.
- Beam finish, paint only.

PRODUCT CODE	PRICE		SIZE/INCHES						WEIGHT		VOL FT ³
	B	W	KL	FV	KV	H(B)	H(W)	W	D	LBS	
LKD3636	1193	1339	1544	1760	1821	29	29.5	36	36	73	4
LKD4242	1363	1503	1803	2097	2182	29	29.5	42	42	86	4
LKD4848	1600	1769	2097	2482	2594	29	29.5	48	48	107	5
LKD5454	1763	1968	2522	3009	3150	29	29.5	54	54	120	5
LKD6060	1943	2187	2891	3490	3667	29	29.5	60	60	135	6

LKD • Round Table

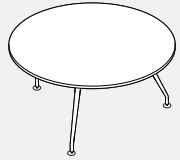

- Leg finish option, chrome or paint.
- Beam finish, paint only.

PRODUCT CODE	PRICE		SIZE/INCHES						WEIGHT		VOL FT ³
	B	W	KL	FV	KV	H(B)	H(W)	W	D	LBS	
LKD36DIA	962	1111	1310	1580	1656	29	29.5	36	36	66	3
LKD42DIA	1131	1272	1624	1989	2093	29	29.5	42	42	78	3
LKD48DIA	1344	1520	1976	2451	2592	29	29.5	48	48	99	4
LKD54DIA	1507	1717	2430	3030	3206	29	29.5	54	54	111	4
LKD60DIA	1684	1938	2873	3624	3835	29	29.5	60	60	126	5

LKD4 • Round Table with 4 Legs



- Leg finish option, chrome or paint.
- Beam finish, paint only.

PRODUCT CODE	PRICE		SIZE/INCHES						WEIGHT		VOL FT ³
	B	W	KL	FV	KV	H(B)	H(W)	W	D	LBS	
LKD436DIA	1193	1339	1458	1726	1804	29	29.5	36	36	66	3
LKD442DIA	1363	1503	1779	2146	2248	29	29.5	42	42	78	3
LKD448DIA	1600	1769	2162	2638	2780	29	29.5	48	48	99	4
LKD454DIA	1763	1968	2573	3176	3348	29	29.5	54	54	111	4
LKD460DIA	1943	2187	3035	3785	3996	29	29.5	60	60	126	5

LKD • Rectangular Table

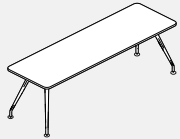

- Leg finish option, chrome or paint.
- Beam finish, paint only.

PRODUCT CODE	PRICE		SIZE/INCHES						WEIGHT		VOL FT ³
	B	W	KL	FV	KV	H(B)	H(W)	W	D	LBS	
LKD3648	1411	1559	1784	2074	2156	29	29.5	48	36	75	4
LKD3654	1472	1637	1951	2274	2369	29	29.5	54	36	81	4
LKD3660	1536	1717	2068	2432	2536	29	29.5	60	36	88	5
LKD3666	1600	1798	2190	2588	2702	29	29.5	66	36	95	5
LKD3672	1660	1876	2308	2741	2869	29	29.5	72	36	101	5
LKD3678	1723	1952	2427	2898	3038	29	29.5	78	36	105	5
LKD3684	1788	2032	2549	3054	3200	29	29.5	84	36	108	5
LKD3696	1914	2190	2786	3366	3532	29	29.5	96	36	115	6
LKD4248	1512	1658	1942	2277	2376	29	29.5	48	42	87	4
LKD4254	1586	1747	2124	2503	2614	29	29.5	54	42	90	5
LKD4260	1659	1836	2263	2682	2808	29	29.5	60	42	94	5
LKD4266	1736	1926	2402	2867	2999	29	29.5	66	42	101	5
LKD4272	1808	2014	2539	3045	3193	29	29.5	72	42	106	5
LKD4278	1884	2103	2677	3225	3384	29	29.5	78	42	110	6
LKD4284	1955	2192	2815	3408	3577	29	29.5	84	42	113	6
LKD4296	2104	2370	3092	3766	3962	29	29.5	96	42	129	6
LKD4854	1721	1900	2301	2735	2858	29	29.5	54	48	94	5
LKD4860	1804	2001	2457	2937	3077	29	29.5	60	48	99	5
LKD4866	1887	2098	2613	3142	3295	29	29.5	66	48	107	6
LKD4872	1970	2197	2768	3347	3515	29	29.5	72	48	114	6
LKD4878	2052	2297	2928	3553	3735	29	29.5	78	48	120	6
LKD4884	2136	2396	3083	3757	3954	29	29.5	84	48	125	6
LKD4896	2300	2595	3397	4169	4390	29	29.5	96	48	149	7

LKD • Rectangular Table, 2 Piece Top



- Leg finish option, chrome or paint.
- Beam finish, paint only.

PRODUCT CODE	PRICE					SIZE / INCHES				WEIGHT		VOL FT ³
	B	W	KL	FV	KV	H(B)	H(W)	W	D	LBS		
LKD36108	2634	2839	3510	4159	4346	29	29.5	108	36	154	7	
LKD36120	2767	2995	3748	4473	4681	29	29.5	120	36	164	8	
LKD42108	2809	3042	3855	4612	4832	29	29.5	108	42	124	8	
LKD42120	2959	3214	4132	4973	5217	29	29.5	120	42	141	9	
LKD48108	3020	3272	4200	5066	5317	29	29.5	108	48	127	9	
LKD48120	3191	3474	4515	5475	5757	29	29.5	120	48	151	9	
LKD48132	3356	3663	4827	5886	6194	29	29.5	132	48	164	10	
LKD48144	3399	3713	5140	6295	6632	29	29.5	144	48	181	10	
LKD48156	3687	4045	5453	6705	7068	29	29.5	156	48	191	11	
LKD48168	3852	4234	5767	7116	7505	29	29.5	168	48	206	11	
LKD48180	4141	4566	6082	7525	7942	29	29.5	180	48	220	12	
LKD54144	3798	4160	5643	6943	7320	29	29.5	144	54	193	11	
LKD54168	4161	4581	6344	7858	8301	29	29.5	168	54	214	12	
LKD60144	4020	4417	6098	7542	7963	29	29.5	144	60	206	12	
LKD60168	4420	4874	6874	8558	9047	29	29.5	168	60	227	13	

LKD • Rectangular Table, 3 Piece Top



- Leg finish option, chrome or paint.
- Beam finish, paint only.

PRODUCT CODE	PRICE					SIZE / INCHES				WEIGHT		VOL FT ³
	B	W	KL	FV	KV	H(B)	H(W)	W	D	LBS		
LKD48192	4657	5089	6881	8423	8870	29	29.5	192	48	279	14	
LKD54192	5005	5478	7537	9268	9773	29	29.5	192	54	288	15	
LKD54216	5368	5897	8239	10185	10751	29	29.5	216	54	270	16	
LKD54240	5732	6317	8938	11102	11733	29	29.5	240	54	298	17	
LKD60192	5300	5814	8145	10070	10630	29	29.5	192	60	257	16	
LKD60216	5699	6272	8921	11085	11714	29	29.5	216	60	283	17	
LKD60240	6097	6729	9693	12100	12797	29	29.5	240	60	311	18	

LICENCE 2 SPECIFICATIONS

- Greenguard certified (www.greenguard.org)
- Carb compliant
- Level3™ certified (www.levelcertified.org)
- Tested to meet or exceed ANSI/BIFMA X5.9.2004 , ANSI/BIFMA X5.5.2008 and CAN/CGSB 44-227-2008
- Plant is ISO 9001:2015 (Quality) certified
- Plant is ISO 14001: 2015 (Environmental) certified
- Plant is OHSAS 18001:2007 (Health and Safety) certified
- 100% made in Canada
- Lifetime Warranty
- Over 6500 standard components
- Custom units available in 5 weeks lead time
- Over 24 standard laminate finishes available
- Edge colour can be specified - select from 20 colours and patterns
- Desk shells and rectangular returns non handed
- Panel end style with top over side panel design
- Tops available in 1" thick Low Pressure Laminate
- Tops available in 1-1/16" or 1-7/16" thick High Pressure Laminate
- Tops available in one edge style: Boulevard (S)
- Surfaces constructed of 45lb. density particleboard substructure with high performance thermally fused laminate or optional high pressure laminate
- Chassis constructed from 45lb. density particleboard substructure with thermally fused laminate
- 3mm edges surround all tops, end panels, drawers and door fronts
- Laminate full modesty and 10" partial modesty available as standard
- Anodized Aluminum framed frosted glazed doors available, no handles included.
- Box drawers mounted on full extension premium ball bearing slides
- File drawers mounted on premium full extension progressive ball bearing slides
- File drawers accommodate letter and/or legal hanging files (see file drawer capacity page G.2)
- Locks are standard on all units. Available in black or silver finish
- All lateral files feature a drawer interlocking mechanism
- Desk drawers open with pulls as standard
- Drawer bottoms are routed into the drawer sides
- Drawer fronts are edged on all four sides with matching 3mm edge
- All drawers locking as standard
- Key alike available
- Pedestals available in 15-1/2" width and 18, 20, 23, 24, 29, 30, 36 depth, include one pencil tray
- All mobile pedestals have option for a counterweight
- Storage modules feature levellers 5/16" x 1" easily accessible from outside the unit. All others feature 5/16" x 2" levellers.
- Monopost legs available in 3 different options, 2.5" or 3" square, 3" round and 6" round
- 6 handle options
- Storage modules available in 4 heights 29", 50", 65.8", 72.8"
- Lateral modules available in 3 widths 30", 36", 42"
- Rectangular grommets are standard and can be specified in a variety of locations as standard (see Grommet Location page A.10)
- Several Power Grommets style and configurations available.
- Drawers/Door fronts are available in a different finish than that of the chassis. Please specify option. Note that the kick plate will match the drawer front finish unless otherwise noted.

FREESTANDING - TECHNICAL INFORMATION

Worksurfaces

- Worksurfaces are offered in LP (1"), B (1 1/16") or W (1 7/16").
- All worksurfaces are drilled to accept connectors in a desk configuration.
- Worksurfaces are available in the following shapes: rectangular, bow, wedge and swerve.

Worksurface Edge trim

- Available in 1 1/16" ("B" thickness), 1 7/16" ("W" thickness) or 1" ("LP" thickness).
- Wood grain PVC edge trim, available in Boulevard (S) edge "B" and "W" thickness only.

Edge Options

Boulevard (S) Edge

"LP"

Thickness



HP "B"

Thickness



HP "W"

Thickness



Hardware

All attachment hardware is included.

Modesty Panels

- Available in full panel 27 5/8" high or half panel ("H" option) 10" high.
- Modesty panels are flush mounted with 24", 30" and 36" deep end gables.
- Modesty panels are available recessed for 30" and 36" deep end gables.
- All recessed modesty panels are inset 6" from the edge.
- Only flush modesty panels are used for extended shell and bridge.
- Only full modesty panels are used for "L2D" desks: Rectangular, Bow, and Wedge worksurfaces.
- All exposed edges are edge banded.

Panel and Gables

- The term "end gable" or "narrow gable" is used to configure a shell, single pedestal or return.
- The term "end panel" or "narrow panel" is used to configure a table desk with shaped worksurfaces such as "D", "P", or profiles.
- All end gables are interchangeable for left or right hand use.

- End gables 24", 30" and 36" deep are drilled to accept full or half modesty panels that are flush mounted.
- End gables 30" and 36" are used for full or half modesty panels that are recessed.
- All panels and end gables are 1" thick and 27 5/8" high.
- All panels and end gables are finished in low pressure laminate.
- End gables are used in shells and single pedestal desks.
- Narrow end gables are used in shells, single pedestal desks, "T", or "L" bases.
- Narrow panels are routed to accept modular connectors for "T" or "L" applications.
- All panels and gables are predrilled to accept levelers at the bottom and connectors at the top.
- All panels or gables are 3mm edge banded at the exposed edge .
- All narrow gables are routed at the top to allow cables to pass through and come with a connecting flat bracket.
- All bottom edges are edge banded.

Handles

- Handles are offered in 4 styles.
- Options are as follows:

BB = Bow Matte Black
BC = Bow Matte Chrome

UB = "U"Dull Black
UC = "U"Dull Chrome

FA = Flat Aluminum

RN = Round Nickel

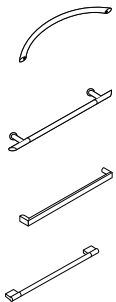

- Span dimension between drilling locations is 192mm.
- e-lock

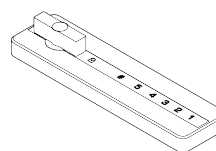

WOOD GRAIN (WG) LAMINATE DIRECTION

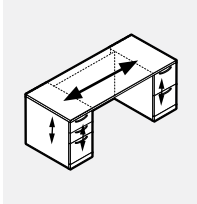

Double Pedestal Desks

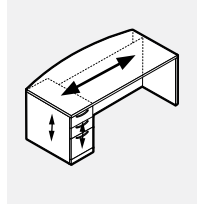

Single Pedestal Desks

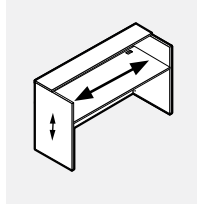

Reception Desks

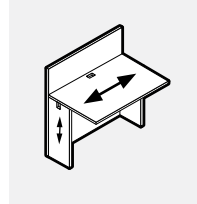

Surround Bridges

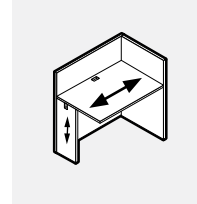

Right Hand Surround Bridges

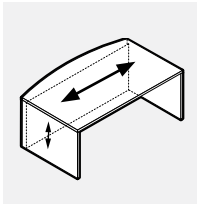

Shells

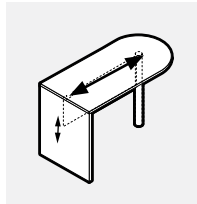

"D" Shaped Tables

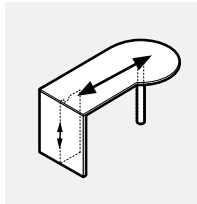

"P" Shaped Tables

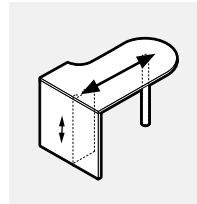

Profile Corner Round Tables

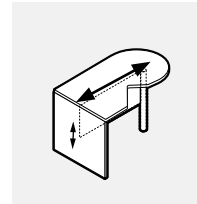

Profile Corner Cut Tables

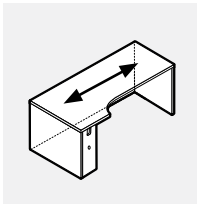

Profile Corner Desks

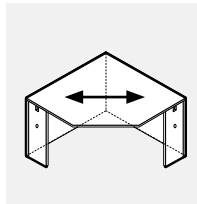

All Corner Desks 42" and Smaller

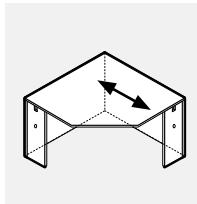

All Corner Desks Larger than 42"

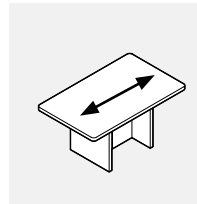

Occasional Tables

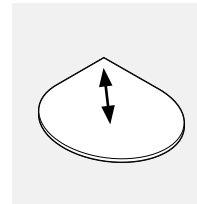

Teardrop Table Tops

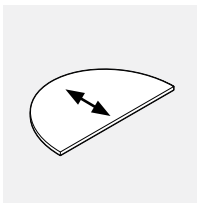

Half Moon Table Tops

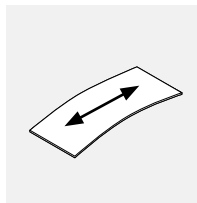

All Other Table Tops

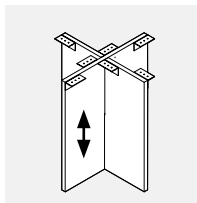

Bases

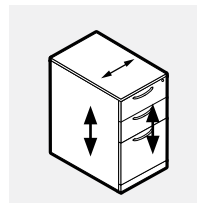

All Pedestals

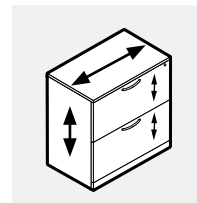

All Laterals

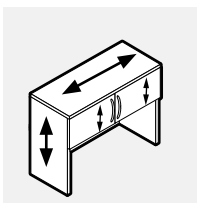

All Hinged Door Hutches

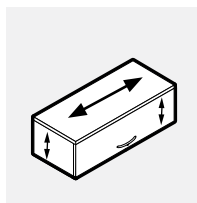

All Flip-Up Door Overheads

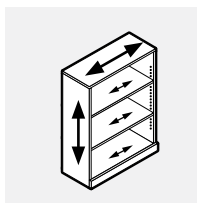

All Bookcases

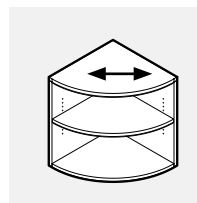

All Corner Bookcases

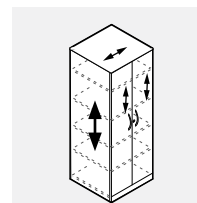

All Towers

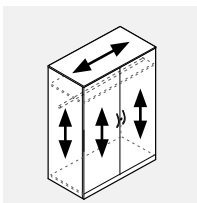

All Cabinets

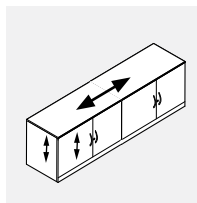

All Credenzas

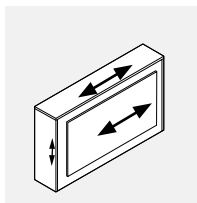

Gallery Desk

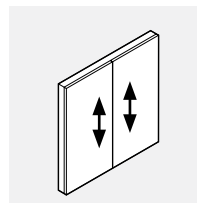

Visual Board

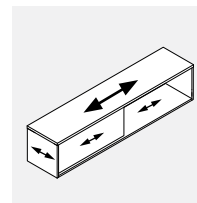

Overhead Divider Storage

GROMMET LOCATION

Notes

- All worksurfaces are standard with rectangular grommets # BG5.
- Worksurfaces 54" wide and under are standard with 1 grommet.

- Worksurfaces over 54" wide are standard with 2 grommets.
- Grommet location must be specified at time of order or it will default to "no grommet" option.

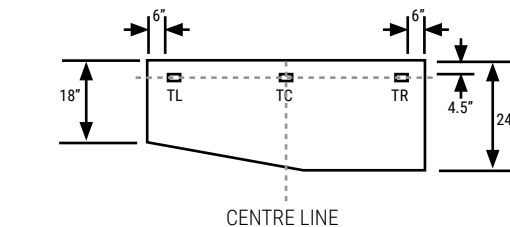
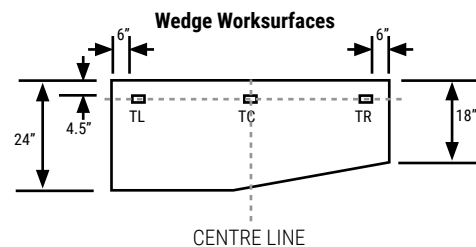
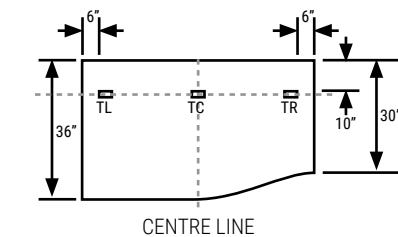
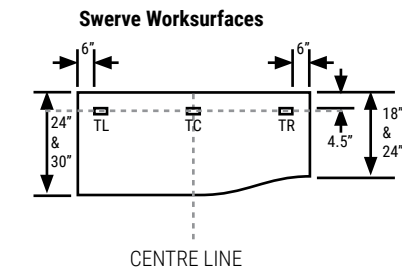
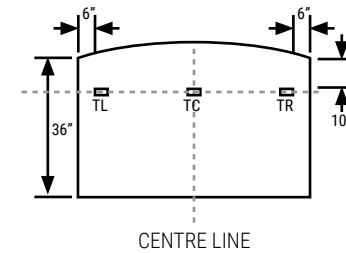
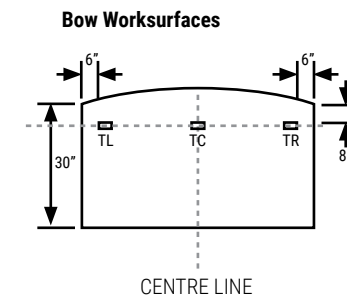
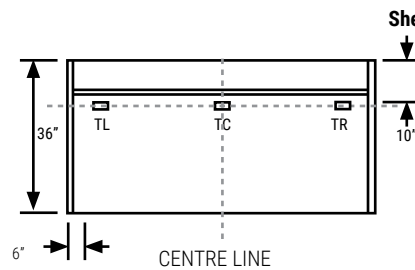
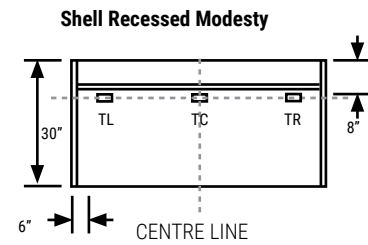
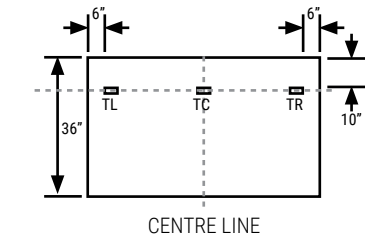
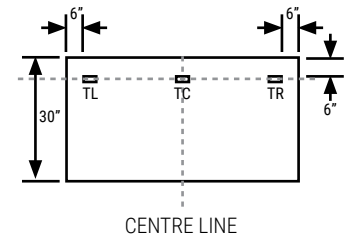
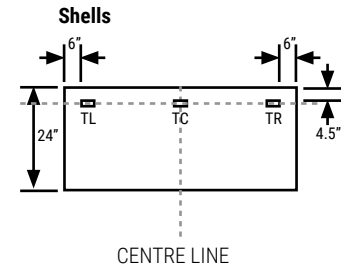
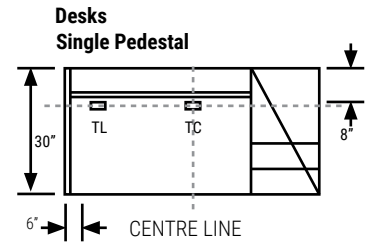
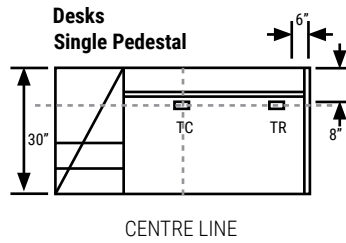
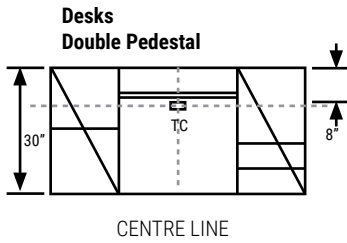

GROMMET LOCATION

"P" Shaped Tables "L2T"

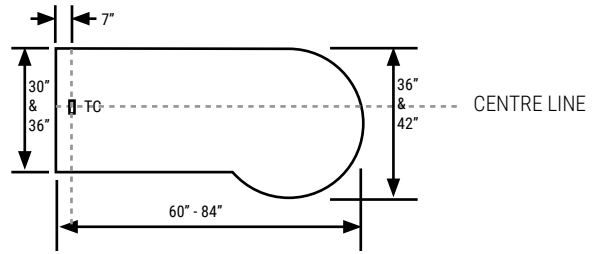
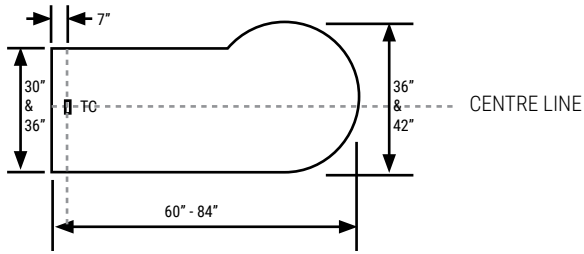

Extended "D" - L2TED

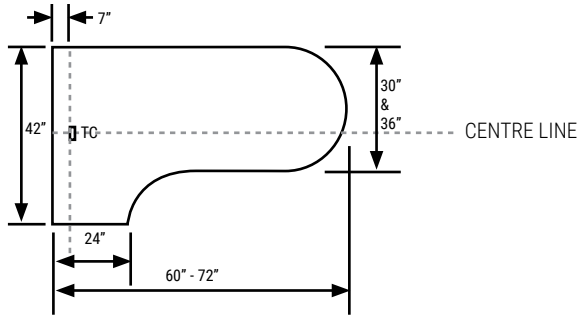

"D" Shaped Tables

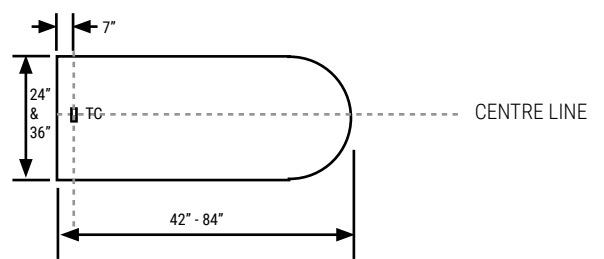

Extended Corner "L2EC"

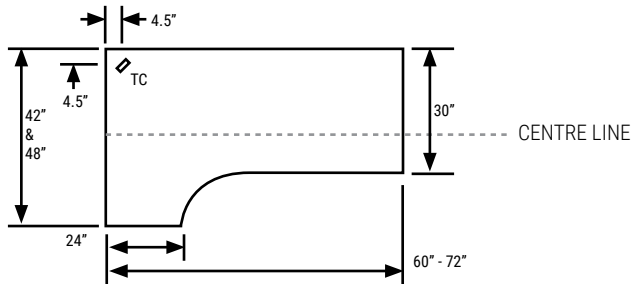

Extended "D" Cut Out "L2TEDCO"

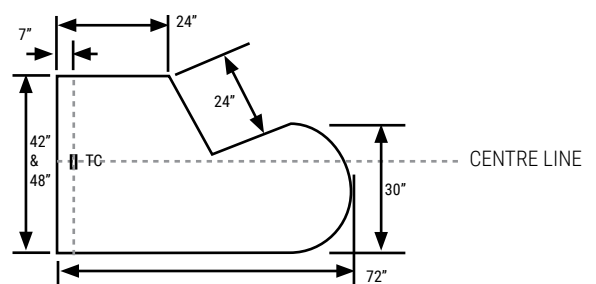

Extended Corner Recessed Modesty

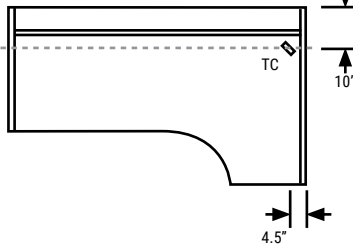

Wedge Shell Recessed Modesty

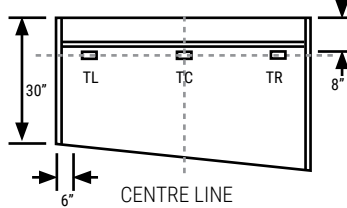

Corner Worksurfaces - 1 Piece

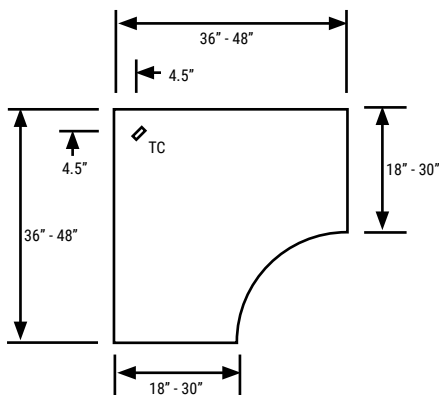

Split Corner Worksurfaces - 2 Piece

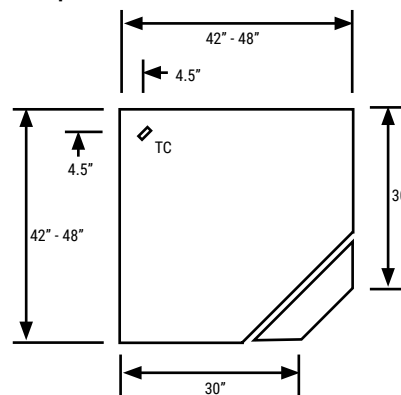

GROMMET LOCATION

Hockey Shaped Tables "L2TH"

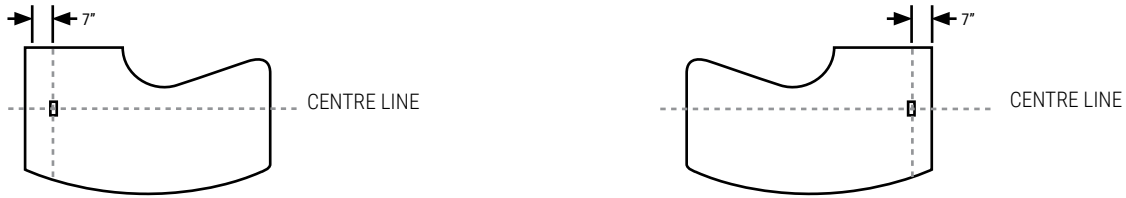

Floating Tops "L2F"

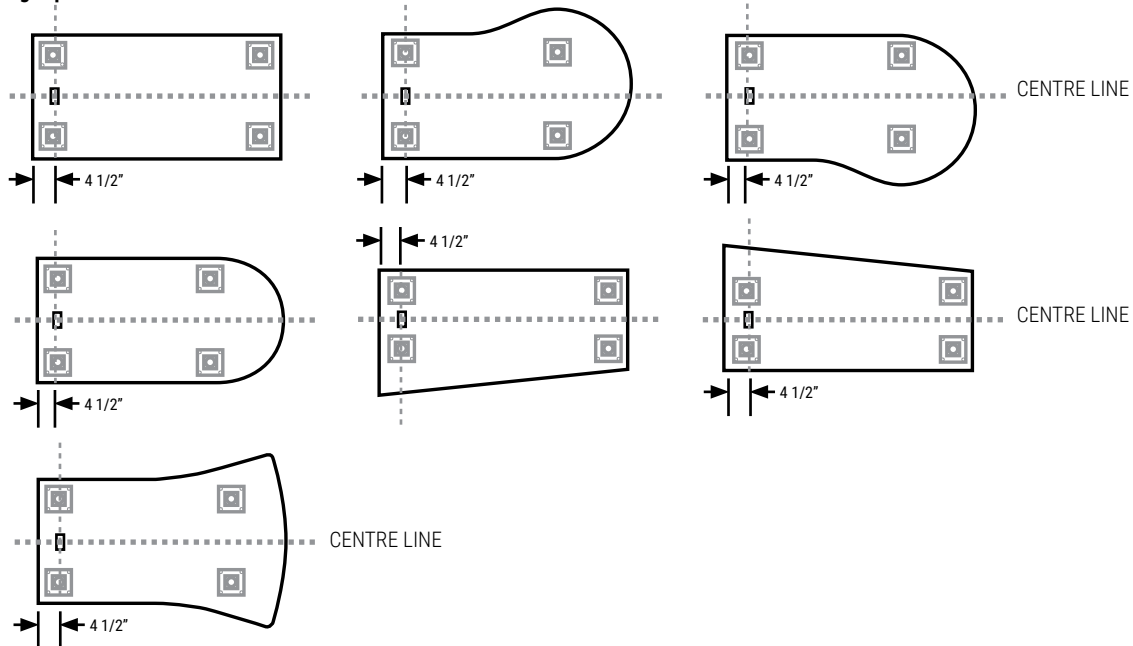

Runoff Tops "L2TC"

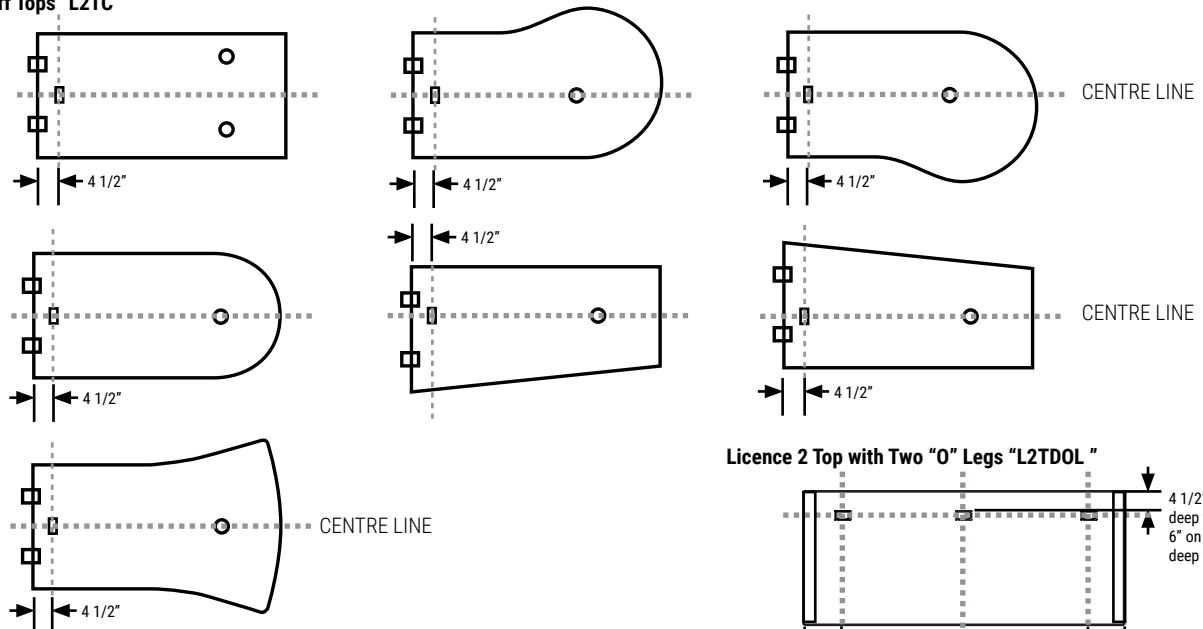

Floating Tops "L2FFL"

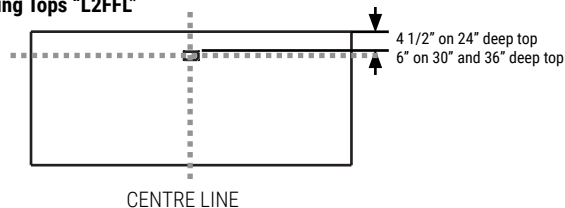

Licence 2 Top with Two "O" Legs "L2TDOL"

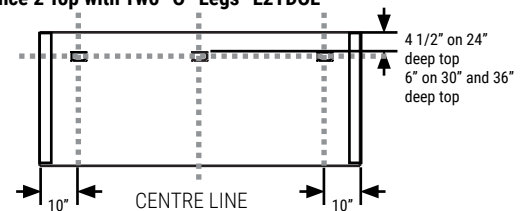

Technical Information

Double Pedestal Desk/ Single Pedestal Desk

- All desks are Shipped knocked down (KD).
- Pedestals are shipped assembled
- Pedestals are LP all over
- Non Interlocking mechanism Pedestals
- Half modesty available on all Double Pedestal Desks, specify 'H' Before size eg. L2DRH3060FB
- Half modesty available on Single Pedestal Desks, specify "H" before size eg. L2DRH3060BR
- All desks have modesty recessed 6"

Executive Return Desk

- All desks are Shipped knocked down (KD).
- This typed of desk must be connected at open end to adjoining worksurface with flat brackets.
- Half modesty available on all Single Pedestal Returns, specify "H" before size eg. L2RH2036FL

Single Pedestal Returns

- All desks are Shipped knocked down (KD).
- This type of desk must be connected at open end to adjoining worksurface with flat brackets.

DESKS • GUIDELINES FOR ORDERING PRODUCT

CODES: The price list uses a numbering system with meaningful alphanumeric characters to create a simple-to-understand product number. This makes specifying the product much easier and more accurate.

SPECIFICATION EXAMPLE OF A DESK UNIT

PRODUCT CODE:

L2DR3060FB
 L2 = New Licence
 D = Desk
 R = Rectangular
 3060 = Size: Depth x Width
 FB = PED FF LEFT / PED BBF RIGHT

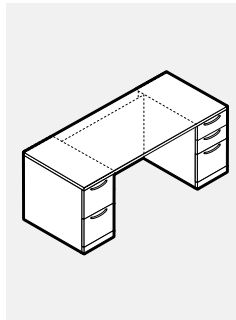

OPTIONS:

Top: LP - LP (Low Pressure Laminate) Thickness 1"
 HP B - B Thickness 1 1/16"
 HP W - W Thickness 1 7/16"

Top Finish Laminate: Choose Colour

Top PVC Edging: Choose Colour

Chassis Laminate: Choose Colour

Chassis PVC Edging: Choose Colour

Handle Style: **BC - Bow Matte Chrome (DEFAULT)**

- BB - Bow Matt Black
- UB - "U" Dull Black
- UC - "U" Dull Chrome
- FA - Flat Aluminum
- RN - Round Nickel

Grommet Location: **N - No grommet (DEFAULT)**

Double Pedestal desk: TC - Top Centre Only

Single Right Pedestal Desk: TC - Top Centre
 TL - Top Left

Single Left Pedestal Desk: TC - Top Centre
 TR - Top Right

L2 • Keys

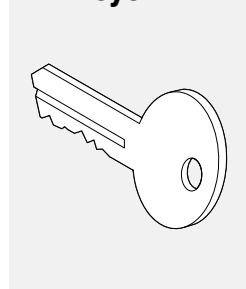

- Additional key (specify at time of order).
- Please choose black or silver.

PRODUCT CODE	PRICE	SIZE/ H	INCHES W	D	WEIGHT LBS	VOL FT ³
Master key:						
L2MK	30					
Extra key for existing cabinet:						
L2EK	13					
Core key:						
L2CK	15					
Core & Key:						
L2LOCKKEY	32					

L2DR-FB • Double Pedestal Desk, FF Left, BBF Right, Recessed Modesty

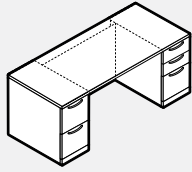

• Optional e-lock available for each pedestal in the vertical position. Please specify V-Vertical and add \$231 list for each.

PRODUCT CODE	FINISH LP	B	W	SIZE/INCHES				D	WEIGHT LBS	VOL FT ³
				H(LP/B)	H(W)	W	D			
L2DR3060FB	2359	2499	2627	29	29.5	60	30	224	24	
L2DR3066FB	2403	2556	2696	29	29.5	66	30	234	25	
L2DR3072FB	2447	2614	2765	29	29.5	72	30	244	25	
L2DR3078FB	2493	2671	2835	29	29.5	78	30	272	26	
L2DR3084FB	2537	2733	2907	29	29.5	84	30	299	26	
L2DR3672FB	2572	2774	2947	29	29.5	72	36	272	26	
L2DR3678FB	2620	2839	3023	29	29.5	78	36	299	28	
L2DR3684FB	2671	2905	3104	29	29.5	84	36	327	28	

L2DR-BF • Double Pedestal Desk, FF Right, BBF Left, Recessed Modesty

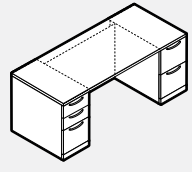

• Optional e-lock available for each pedestal in the vertical position. Please specify V-Vertical and add \$231 list for each.

PRODUCT CODE	FINISH LP	B	W	SIZE/INCHES				D	WEIGHT LBS	VOL FT ³
				H(LP/B)	H(W)	W	D			
L2DR3060BF	2359	2499	2627	29	29.5	60	30	224	24	
L2DR3066BF	2403	2556	2696	29	29.5	66	30	234	25	
L2DR3072BF	2447	2614	2765	29	29.5	72	30	244	25	
L2DR3078BF	2493	2671	2835	29	29.5	78	30	272	26	
L2DR3084BF	2537	2733	2907	29	29.5	84	30	299	26	
L2DR3672BF	2572	2774	2947	29	29.5	72	36	272	26	
L2DR3678BF	2620	2839	3023	29	29.5	78	36	299	28	
L2DR3684BF	2671	2905	3104	29	29.5	84	36	327	28	

L2DRH-FB • Double Pedestal Desk, FF Left, BBF Right Recessed Half Modesty

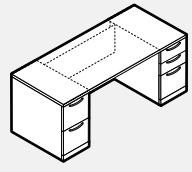

• Optional e-lock available for each pedestal in the vertical position. Please specify V-Vertical and add \$231 list for each.

PRODUCT CODE	FINISH LP	B	W	SIZE/INCHES				D	WEIGHT LBS	VOL FT ³
				H(LP/B)	H(W)	W	D			
L2DRH3060FB	2301	2440	2571	29	29.5	60	30	224	24	
L2DRH3066FB	2337	2493	2630	29	29.5	66	30	234	25	
L2DRH3072FB	2370	2536	2689	29	29.5	72	30	244	25	
L2DRH3078FB	2404	2585	2748	29	29.5	78	30	272	26	
L2DRH3084FB	2439	2633	2810	29	29.5	84	30	299	26	
L2DRH3672FB	2496	2696	2869	29	29.5	72	36	272	26	
L2DRH3678FB	2534	2750	2934	29	29.5	78	36	299	28	
L2DRH3684FB	2573	2808	3007	29	29.5	84	36	327	28	

L2DRH-BF • Double Pedestal Desk, BBF Left, FF Right Recessed Half Modesty

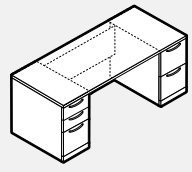

• Optional e-lock available for each pedestal in the vertical position. Please specify V-Vertical and add \$231 list for each.

PRODUCT CODE	FINISH LP	B	W	SIZE/INCHES				D	WEIGHT LBS	VOL FT ³
				H(LP/B)	H(W)	W	D			
L2DRH3060BF	2301	2440	2571	29	29.5	60	30	224	24	
L2DRH3066BF	2337	2493	2630	29	29.5	66	30	234	25	
L2DRH3072BF	2370	2536	2689	29	29.5	72	30	244	25	
L2DRH3078BF	2404	2585	2748	29	29.5	78	30	272	26	
L2DRH3084BF	2439	2633	2810	29	29.5	84	30	299	26	
L2DRH3672BF	2496	2696	2869	29	29.5	72	36	272	26	
L2DRH3678BF	2534	2750	2934	29	29.5	78	36	299	28	
L2DRH3684BF	2573	2808	3007	29	29.5	84	36	327	28	

L2DB-FB • Bowfront Double Pedestal Desk, FF Left, BBF Right, Recessed Modesty

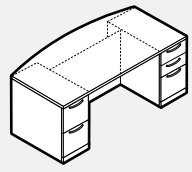

• Optional e-lock available for each pedestal in the vertical position. Please specify V-Vertical and add \$231 list for each.

PRODUCT CODE	FINISH LP	B	W	SIZE/INCHES				D	WEIGHT LBS	VOL FT ³
				H(LP/B)	H(W)	W	D			
L2DB3060FB	2414	2582	2725	29	29.5	60	36	374	25	
L2DB3066FB	2462	2646	2803	29	29.5	66	36	383	26	
L2DB3072FB	2508	2710	2879	29	29.5	72	36	395	26	
L2DB3078FB	2560	2775	2955	29	29.5	78	36	422	28	
L2DB3084FB	2610	2843	3036	29	29.5	84	36	450	28	
L2DB3672FB	2635	2869	3059	29	29.5	72	42	422	28	
L2DB3678FB	2689	2941	3143	29	29.5	78	42	450	29	
L2DB3684FB	2744	3015	3232	29	29.5	84	42	477	29	

L2DB-BF • Bowfront Double Pedestal Desk, FF Right, BBF Left, Recessed Modesty

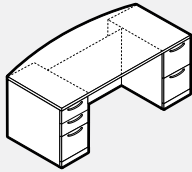

• Optional e-lock available for each pedestal in the vertical position. Please specify V-Vertical and add \$231 list for each.

PRODUCT CODE	FINISH LP	B	W	SIZE/INCHES				D	WEIGHT LBS	VOL FT ³
				H(LP/B)	H(W)	W	D			
L2DB3060BF	2414	2582	2725	29	29.5	60	36	374	25	
L2DB3066BF	2462	2646	2803	29	29.5	66	36	383	26	
L2DB3072BF	2508	2710	2879	29	29.5	72	36	395	26	
L2DB3078BF	2560	2775	2955	29	29.5	78	36	422	28	
L2DB3084BF	2610	2843	3036	29	29.5	84	36	450	28	
L2DB3672BF	2635	2869	3059	29	29.5	72	42	422	28	
L2DB3678BF	2689	2941	3143	29	29.5	78	42	450	29	
L2DB3684BF	2744	3015	3232	29	29.5	84	42	477	29	

L2DBH-FB • Bowfront Double Pedestal Desk, FF Left, BBF Right Recessed Half Modesty

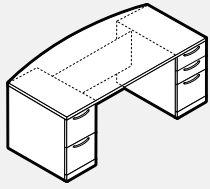

• Optional e-lock available for each pedestal in the vertical position. Please specify V-Vertical and add \$231 list for each.

PRODUCT CODE	FINISH LP	B	W	SIZE/INCHES			D	WEIGHT LBS	VOL FT ³
				H (LP/B)	H (W)	W			
L2DBH3060FB	2359	2526	2670	29	29.5	60	36	374	25
L2DBH3066FB	2394	2582	2735	29	29.5	66	36	383	26
L2DBH3072FB	2434	2632	2803	29	29.5	72	36	395	26
L2DBH3078FB	2470	2689	2868	29	29.5	78	36	422	28
L2DBH3084FB	2511	2745	2936	29	29.5	84	36	450	28
L2DBH3672FB	2560	2791	2981	29	29.5	72	42	422	28
L2DBH3678FB	2601	2853	3055	29	29.5	78	42	450	29
L2DBH3684FB	2647	2918	3133	29	29.5	84	42	477	29

L2DBH-BF • Bowfront Double Pedestal Desk, BBF Left, FF Right Recessed Half Modesty

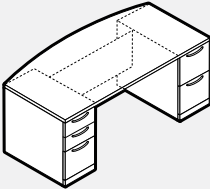

• Optional e-lock available for each pedestal in the vertical position. Please specify V-Vertical and add \$231 list for each.

PRODUCT CODE	FINISH LP	B	W	SIZE/INCHES			D	WEIGHT LBS	VOL FT ³
				H (LP/B)	H (W)	W			
L2DBH3060BF	2359	2526	2670	29	29.5	60	36	374	25
L2DBH3066BF	2394	2582	2735	29	29.5	66	36	383	26
L2DBH3072BF	2434	2632	2803	29	29.5	72	36	395	26
L2DBH3078BF	2470	2689	2868	29	29.5	78	36	422	28
L2DBH3084BF	2511	2745	2936	29	29.5	84	36	450	28
L2DBH3672BF	2560	2791	2981	29	29.5	72	42	422	28
L2DBH3678BF	2601	2853	3055	29	29.5	78	42	450	29
L2DBH3684BF	2647	2918	3133	29	29.5	84	42	477	29

L2DR-BR • Single Pedestal Desk, BBF Right, Recessed Modesty

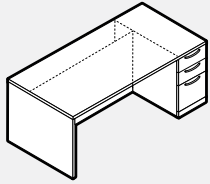

• Optional e-lock available for the pedestal in the vertical position. Please specify V-Vertical and add \$231 list.

PRODUCT CODE	FINISH LP	B	W	SIZE/INCHES			D	WEIGHT LBS	VOL FT ³
				H (LP/B)	H (W)	W			
L2DR3060BR	1638	1776	1904	29	29.5	60	30	224	14
L2DR3066BR	1681	1834	1973	29	29.5	66	30	234	15
L2DR3072BR	1724	1892	2042	29	29.5	72	30	244	15
L2DR3078BR	1762	1942	2106	29	29.5	78	30	272	17
L2DR3084BR	1816	2014	2187	29	29.5	84	30	299	17
L2DR3672BR	1835	2034	2209	29	29.5	72	36	272	17
L2DR3678BR	1876	2092	2281	29	29.5	78	36	299	18
L2DR3684BR	1934	2166	2367	29	29.5	84	36	327	18

L2DR-BL • Single Pedestal Desk, BBF Left, Recessed Modesty

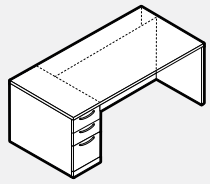

• Optional e-lock available for the pedestal in the vertical position. Please specify V-Vertical and add \$231 list.

PRODUCT CODE	FINISH LP	B	W	SIZE/INCHES			D	WEIGHT LBS	VOL FT ³
				H (LP/B)	H (W)	W			
L2DR3060BL	1638	1776	1904	29	29.5	60	30	224	14
L2DR3066BL	1681	1834	1973	29	29.5	66	30	234	15
L2DR3072BL	1724	1892	2042	29	29.5	72	30	244	15
L2DR3078BL	1762	1942	2106	29	29.5	78	30	272	17
L2DR3084BL	1816	2014	2187	29	29.5	84	30	299	17
L2DR3672BL	1835	2034	2209	29	29.5	72	36	272	17
L2DR3678BL	1876	2092	2281	29	29.5	78	36	299	18
L2DR3684BL	1934	2166	2367	29	29.5	84	36	327	18

L2DRH-BR • Single Pedestal Desk, BBF Right Recessed Half Modesty

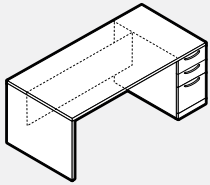

• Optional e-lock available for the pedestal in the vertical position. Please specify V-Vertical and add \$231 list.

PRODUCT CODE	FINISH LP	B	W	SIZE/INCHES			D	WEIGHT LBS	VOL FT ³
				H (LP/B)	H (W)	W			
L2DRH3060BR	1530	1669	1800	29	29.5	60	30	224	14
L2DRH3066BR	1564	1718	1857	29	29.5	66	30	234	15
L2DRH3072BR	1599	1764	1918	29	29.5	72	30	244	15
L2DRH3078BR	1632	1812	1973	29	29.5	78	30	272	17
L2DRH3084BR	1668	1862	2037	29	29.5	84	30	299	17
L2DRH3672BR	1708	1907	2083	29	29.5	72	36	272	17
L2DRH3678BR	1746	1960	2149	29	29.5	78	36	299	18
L2DRH3684BR	1785	2020	2220	29	29.5	84	36	327	18

L2DRH-BL • Single Pedestal Desk, BBF Left Recessed Half Modesty

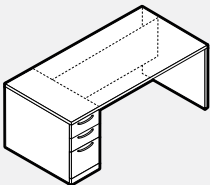

• Optional e-lock available for the pedestal in the vertical position. Please specify V-Vertical and add \$231 list.

PRODUCT CODE	FINISH LP	B	W	SIZE/INCHES			D	WEIGHT LBS	VOL FT ³
				H (LP/B)	H (W)	W			
L2DRH3060BL	1530	1669	1800	29	29.5	60	30	224	14
L2DRH3066BL	1564	1718	1857	29	29.5	66	30	234	15
L2DRH3072BL	1599	1764	1918	29	29.5	72	30	244	15
L2DRH3078BL	1632	1812	1973	29	29.5	78	30	272	17
L2DRH3084BL	1668	1862	2037	29	29.5	84	30	299	17
L2DRH3672BL	1708	1907	2083	29	29.5	72	36	272	17
L2DRH3678BL	1746	1960	2149	29	29.5	78	36	299	18
L2DRH3684BL	1785	2020	2220	29	29.5	84	36	327	18

L2DB-BR • Bowfront Single Pedestal Desk, BBF Right, Recessed Modesty

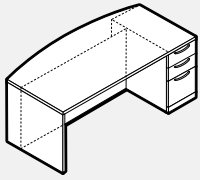

• Optional e-lock available for the pedestal in the vertical position. Please specify V-Vertical and add \$231 list.

PRODUCT CODE	FINISH LP	B	W	SIZE/INCHES				WEIGHT		VOL FT ³
				H (LP/B)	H (W)	W	D	LBS	FT ³	
L2DB3060BR	1691	1859	2003	29	29.5	60	36	264	14	
L2DB3066BR	1741	1923	2083	29	29.5	66	36	274	15	
L2DB3072BR	1788	1987	2157	29	29.5	72	36	286	15	
L2DB3078BR	1831	2048	2227	29	29.5	78	36	314	17	
L2DB3084BR	1890	2121	2315	29	29.5	84	36	338	17	
L2DB3672BR	1898	2130	2322	29	29.5	72	42	310	17	
L2DB3678BR	1947	2197	2400	29	29.5	78	42	338	18	
L2DB3684BR	2006	2279	2495	29	29.5	84	42	362	18	

L2DB-BL • Bowfront Single Pedestal Desk, BBF Left, Recessed Modesty

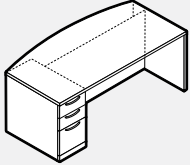

• Optional e-lock available for the pedestal in the vertical position. Please specify V-Vertical and add \$231 list.

PRODUCT CODE	FINISH LP	B	W	SIZE/INCHES				WEIGHT		VOL FT ³
				H (LP/B)	H (W)	W	D	LBS	FT ³	
L2DB3060BL	1691	1859	2003	29	29.5	60	36	264	14	
L2DB3066BL	1741	1923	2083	29	29.5	66	36	274	15	
L2DB3072BL	1788	1987	2157	29	29.5	72	36	286	15	
L2DB3078BL	1831	2048	2227	29	29.5	78	36	314	17	
L2DB3084BL	1890	2121	2315	29	29.5	84	36	338	17	
L2DB3672BL	1898	2130	2322	29	29.5	72	42	310	17	
L2DB3678BL	1947	2197	2400	29	29.5	78	42	338	18	
L2DB3684BL	2006	2279	2495	29	29.5	84	42	362	18	

L2DBH-BR • Bowfront Single Pedestal Desk, BBF Right Recessed Half Modesty

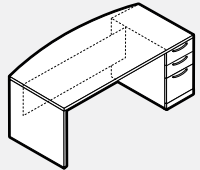

• Optional e-lock available for the pedestal in the vertical position. Please specify V-Vertical and add \$231 list.

PRODUCT CODE	FINISH LP	B	W	SIZE/INCHES				WEIGHT		VOL FT ³
				H (LP/B)	H (W)	W	D	LBS	FT ³	
L2DBH3060BR	1586	1752	1895	29	29.5	60	36	264	14	
L2DBH3066BR	1622	1806	1961	29	29.5	66	36	274	15	
L2DBH3072BR	1660	1861	2028	29	29.5	72	36	286	15	
L2DBH3078BR	1697	1917	2093	29	29.5	78	36	314	17	
L2DBH3084BR	1740	1972	2164	29	29.5	84	36	338	17	
L2DBH3672BR	1772	2003	2193	29	29.5	72	42	310	17	
L2DBH3678BR	1812	2063	2266	29	29.5	78	42	338	18	
L2DBH3684BR	1857	2129	2347	29	29.5	84	42	362	18	

L2DBH-BL • Bowfront Single Pedestal Desk, BBF Left Recessed Half Modesty

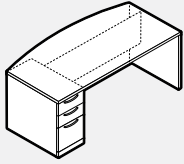

- Optional e-lock available for the pedestal in the vertical position. Please specify V-Vertical and add \$231 list.

PRODUCT CODE	FINISH LP	B	W	SIZE/INCHES				WEIGHT LBS	VOL FT ³
				H(LP/B)	H(W)	W	D		
L2DBH3060BL	1586	1752	1895	29	29.5	60	36	264	14
L2DBH3066BL	1622	1806	1961	29	29.5	66	36	274	15
L2DBH3072BL	1660	1861	2028	29	29.5	72	36	286	15
L2DBH3078BL	1697	1917	2093	29	29.5	78	36	314	17
L2DBH3084BL	1740	1972	2164	29	29.5	84	36	338	17
L2DBH3672BL	1772	2003	2193	29	29.5	72	42	310	17
L2DBH3678BL	1812	2063	2266	29	29.5	78	42	338	18
L2DBH3684BL	1857	2129	2347	29	29.5	84	42	362	18

L2DRA-FB • Double Desk, FF Left BBF Right Recessed, Glazed Full Modesty

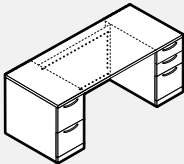

- Modesty is aluminum framed.
- Glazing is frosted acrylic.
- Optional e-lock available for each pedestal in the vertical position. Please specify V-Vertical and add \$231 list for each.

PRODUCT CODE	FINISH LP	B	W	SIZE/INCHES				WEIGHT LBS	VOL FT ³
				H(LP/B)	H(W)	W	D		
L2DRA3060FB	2795	2931	3056	29.06	29.5	60	30	204	22
L2DRA3066FB	2881	3033	3168	29.06	29.5	66	30	213	23
L2DRA3072FB	2968	3130	3278	29.06	29.5	72	30	222	23
L2DRA3078FB	3051	3232	3389	29.06	29.5	78	30	247	24
L2DRA3084FB	3143	3334	3505	29.06	29.5	84	30	272	24
L2DRA3672FB	3091	3286	3456	29.06	29.5	72	36	247	24
L2DRA3678FB	3180	3392	3577	29.06	29.5	78	36	272	25
L2DRA3684FB	3275	3502	3698	29.06	29.5	84	36	297	25

L2DRA-BF • Double Desk, FF Right BBF Left Recessed, Glazed Full Modesty

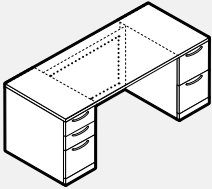

- Modesty is aluminum framed.
- Glazing is frosted acrylic.
- Optional e-lock available for each pedestal in the vertical position. Please specify V-Vertical and add \$231 list for each.

PRODUCT CODE	FINISH LP	B	W	SIZE/INCHES				WEIGHT LBS	VOL FT ³
				H(LP/B)	H(W)	W	D		
L2DRA3060BF	2795	2931	3056	29.06	29.5	60	30	204	22
L2DRA3066BF	2881	3033	3168	29.06	29.5	66	30	213	23
L2DRA3072BF	2968	3130	3278	29.06	29.5	72	30	222	23
L2DRA3078BF	3051	3232	3389	29.06	29.5	78	30	247	24
L2DRA3084BF	3143	3334	3505	29.06	29.5	84	30	272	24
L2DRA3672BF	3091	3286	3456	29.06	29.5	72	36	247	24
L2DRA3678BF	3180	3392	3577	29.06	29.5	78	36	272	25
L2DRA3684BF	3275	3502	3698	29.06	29.5	84	36	297	25

L2DBA-FB • Bowfront Double Desk, FF Left BBF Right Recessed, Glazed Full Modesty

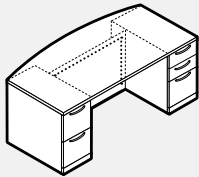

- Modesty is aluminum framed.
- Glazing is frosted acrylic.
- Optional e-lock available for each pedestal in the vertical position. Please specify V-Vertical and add \$231 list for each.

PRODUCT CODE	FINISH LP	B	W	SIZE/INCHES				WEIGHT LBS	VOL FT ³
				H(LP/B)	H(W)	W	D		
L2DBA3060FB	2847	3012	3153	29.06	29.5	60	36	340	23
L2DBA3066FB	2937	3118	3270	29.06	29.5	66	36	348	24
L2DBA3072FB	3033	3224	3389	29.06	29.5	72	36	359	24
L2DBA3078FB	3122	3329	3508	29.06	29.5	78	36	384	25
L2DBA3084FB	3216	3442	3629	29.06	29.5	84	36	409	25
L2DBA3672FB	3153	3380	3564	29.06	29.5	72	42	384	25
L2DBA3678FB	3248	3494	3692	29.06	29.5	78	42	409	26
L2DBA3684FB	3346	3612	3822	29.06	29.5	84	42	434	26

L2DBA-BF • Bowfront Double Desk, FF Right BBF Left Recessed, Glazed Full Modesty

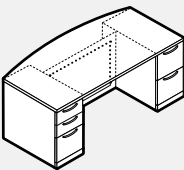

- Modesty is aluminum framed.
- Glazing is frosted acrylic.
- Optional e-lock available for each pedestal in the vertical position. Please specify V-Vertical and add \$231 list for each.

PRODUCT CODE	FINISH LP	B	W	SIZE/INCHES				WEIGHT LBS	VOL FT ³
				H(LP/B)	H(W)	W	D		
L2DBA3060BF	2847	3012	3153	29.06	29.5	60	36	340	23
L2DBA3066BF	2937	3118	3270	29.06	29.5	66	36	348	24
L2DBA3072BF	3033	3224	3389	29.06	29.5	72	36	359	24
L2DBA3078BF	3122	3329	3508	29.06	29.5	78	36	384	25
L2DBA3084BF	3216	3442	3629	29.06	29.5	84	36	409	25
L2DBA3672BF	3153	3380	3564	29.06	29.5	72	42	384	25
L2DBA3678BF	3248	3494	3692	29.06	29.5	78	42	409	26
L2DBA3684BF	3346	3612	3822	29.06	29.5	84	42	434	26

L2DRAH-FB • Double Pedestal Desk, FF Left BBF Right Recessed, Half Glazed Modesty

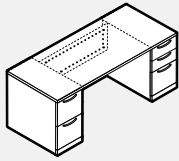

- Modesty is aluminum framed.
- Glazing is frosted acrylic.
- Optional e-lock available for each pedestal in the vertical position. Please specify V-Vertical and add \$231 list for each.

PRODUCT CODE	FINISH LP	B	W	SIZE/INCHES		W	D	WEIGHT LBS	VOL FT ³
				H(LP/B)	H(W)				
L2DRAH3060FB	2646	2782	2908	29.06	29.5	60	30	204	22
L2DRAH3066FB	2717	2866	3005	29.06	29.5	66	30	213	23
L2DRAH3072FB	2778	2942	3091	29.06	29.5	72	30	222	23
L2DRAH3078FB	2842	3016	3177	29.06	29.5	78	30	247	24
L2DRAH3084FB	2908	3100	3269	29.06	29.5	84	30	272	24
L2DRAH3672FB	2903	3099	3265	29.06	29.5	72	36	247	24
L2DRAH3678FB	2968	3180	3363	29.06	29.5	78	36	272	25
L2DRAH3684FB	3039	3265	3460	29.06	29.5	84	36	297	25

L2DRAH-BF • Double Pedestal Desk, BBF Left FF Right Recessed, Half Glazed Modesty

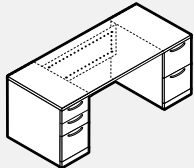

- Modesty is aluminum framed.
- Glazing is frosted acrylic.
- Optional e-lock available for each pedestal in the vertical position. Please specify V-Vertical and add \$231 list for each.

PRODUCT CODE	FINISH LP	B	W	SIZE/INCHES		W	D	WEIGHT LBS	VOL FT ³
				H(LP/B)	H(W)				
L2DRAH3060BF	2646	2782	2908	29.06	29.5	60	30	204	22
L2DRAH3066BF	2717	2866	3005	29.06	29.5	66	30	213	23
L2DRAH3072BF	2778	2942	3091	29.06	29.5	72	30	222	23
L2DRAH3078BF	2842	3016	3177	29.06	29.5	78	30	247	24
L2DRAH3084BF	2908	3100	3269	29.06	29.5	84	30	272	24
L2DRAH3672BF	2903	3099	3265	29.06	29.5	72	36	247	24
L2DRAH3678BF	2968	3180	3363	29.06	29.5	78	36	272	25
L2DRAH3684BF	3039	3265	3460	29.06	29.5	84	36	297	25

L2DBAH-FB • Bowfront Double Desk, FF Left BBF Right Recessed, Half Glazed Modesty

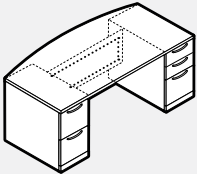

- Modesty is aluminum framed.
- Glazing is frosted acrylic.
- Optional e-lock available for each pedestal in the vertical position. Please specify V-Vertical and add \$231 list for each.

PRODUCT CODE	FINISH LP	B	W	SIZE/INCHES		W	D	WEIGHT LBS	VOL FT ³
				H(LP/B)	H(W)				
L2DBAH3060FB	2699	2863	3005	29.06	29.5	60	36	340	23
L2DBAH3066FB	2775	2953	3105	29.06	29.5	66	36	348	24
L2DBAH3072FB	2841	3037	3199	29.06	29.5	72	36	359	24
L2DBAH3078FB	2907	3118	3296	29.06	29.5	78	36	384	25
L2DBAH3084FB	2979	3206	3394	29.06	29.5	84	36	409	25
L2DBAH3672FB	2963	3192	3376	29.06	29.5	72	42	384	25
L2DBAH3678FB	3036	3283	3478	29.06	29.5	78	42	409	26
L2DBAH3684FB	3106	3375	3584	29.06	29.5	84	42	434	26

L2DBAH-BF • Bowfront Double Desk, BBF Left FF Right Recessed, Half Glazed Modesty

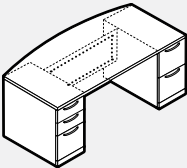

- Modesty is aluminum framed.
- Glazing is frosted acrylic.
- Optional e-lock available for each pedestal in the vertical position. Please specify V-Vertical and add \$231 list for each.

PRODUCT CODE	FINISH LP	B	W	SIZE/INCHES		W	D	WEIGHT LBS	VOL FT ³
				H(LP/B)	H(W)				
L2DBAH3060BF	2699	2863	3005	29.06	29.5	60	36	340	23
L2DBAH3066BF	2775	2953	3105	29.06	29.5	66	36	348	24
L2DBAH3072BF	2841	3037	3199	29.06	29.5	72	36	359	24
L2DBAH3078BF	2907	3118	3296	29.06	29.5	78	36	384	25
L2DBAH3084BF	2979	3206	3394	29.06	29.5	84	36	409	25
L2DBAH3672BF	2963	3192	3376	29.06	29.5	72	42	384	25
L2DBAH3678BF	3036	3283	3478	29.06	29.5	78	42	409	26
L2DBAH3684BF	3106	3375	3584	29.06	29.5	84	42	434	26

L2ER-FL • Executive Return with FF Pedestal Left

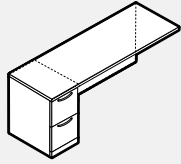

• Optional e-lock available for the pedestal in the vertical position. Please specify V-Vertical and add \$231 list.

PRODUCT CODE	FINISH LP	B	W	SIZE/INCHES				WEIGHT LBS	VOL FT ³
				H (LP/B)	H (W)	W	D		
L2ER2036FL	1169	1235	1302	29	29.5	36	20	151	12
L2ER2042FL	1209	1290	1367	29	29.5	42	20	172	12
L2ER2048FL	1257	1340	1430	29	29.5	48	20	179	12
L2ER2054FL	1296	1395	1491	29	29.5	54	20	184	13
L2ER2436FL	1214	1286	1357	29	29.5	36	24	151	12
L2ER2442FL	1260	1339	1422	29	29.5	42	24	172	12
L2ER2448FL	1302	1395	1485	29	29.5	48	24	179	13
L2ER2454FL	1348	1451	1550	29	29.5	54	24	184	13

L2ER-FR • Executive Return with FF Pedestal Right

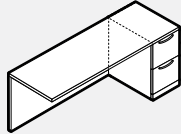

• Optional e-lock available for the pedestal in the vertical position. Please specify V-Vertical and add \$231 list.

PRODUCT CODE	FINISH LP	B	W	SIZE/INCHES				WEIGHT LBS	VOL FT ³
				H (LP/B)	H (W)	W	D		
L2ER2036FR	1169	1235	1302	29	29.5	36	20	151	12
L2ER2042FR	1209	1290	1367	29	29.5	42	20	172	12
L2ER2048FR	1257	1340	1430	29	29.5	48	20	179	12
L2ER2054FR	1296	1395	1491	29	29.5	54	20	184	13
L2ER2436FR	1214	1286	1357	29	29.5	36	24	151	12
L2ER2442FR	1260	1339	1422	29	29.5	42	24	172	12
L2ER2448FR	1302	1395	1485	29	29.5	48	24	179	13
L2ER2454FR	1348	1451	1550	29	29.5	54	24	184	13

L2ERH-FL • Executive Return with FF Pedestal Left and Half Modesty

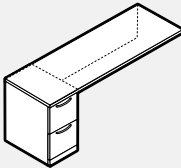

• Optional e-lock available for the pedestal in the vertical position. Please specify V-Vertical and add \$231 list.

PRODUCT CODE	FINISH LP	B	W	SIZE/INCHES				WEIGHT LBS	VOL FT ³
				H (LP/B)	H (W)	W	D		
L2ERH2036FL	1117	1182	1255	29	29.5	36	20	151	12
L2ERH2042FL	1147	1226	1302	29	29.5	42	20	172	12
L2ERH2048FL	1175	1266	1354	29	29.5	48	20	179	12
L2ERH2054FL	1205	1304	1404	29	29.5	54	20	184	13
L2ERH2436FL	1160	1232	1301	29	29.5	36	24	151	12
L2ERH2442FL	1194	1272	1355	29	29.5	42	24	172	12
L2ERH2448FL	1225	1318	1407	29	29.5	48	24	179	13
L2ERH2454FL	1258	1360	1460	29	29.5	54	24	184	13

L2ERH-FR • Executive Return with FF Pedestal Right and Half Modesty

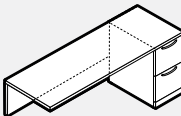

• Optional e-lock available for the pedestal in the vertical position. Please specify V-Vertical and add \$231 list.

PRODUCT CODE	FINISH LP	B	W	SIZE/INCHES				WEIGHT LBS	VOL FT ³
				H (LP/B)	H (W)	W	D		
L2ERH2036FR	1117	1182	1255	29	29.5	36	20	151	12
L2ERH2042FR	1147	1226	1302	29	29.5	42	20	172	12
L2ERH2048FR	1175	1266	1354	29	29.5	48	20	179	12
L2ERH2054FR	1205	1304	1404	29	29.5	54	20	184	13
L2ERH2436FR	1160	1232	1301	29	29.5	36	24	151	12
L2ERH2442FR	1194	1272	1355	29	29.5	42	24	172	12
L2ERH2448FR	1225	1318	1407	29	29.5	48	24	179	13
L2ERH2454FR	1258	1360	1460	29	29.5	54	24	184	13

L2ER-BL • Executive Return with BBF Pedestal Left

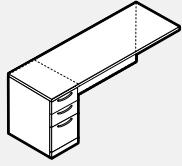

• Optional e-lock available for the pedestal in the vertical position. Please specify V-Vertical and add \$231 list.

PRODUCT CODE	FINISH LP	B	W	SIZE/INCHES				WEIGHT		VOL FT ³
				H (LP/B)	H (W)	W	D	LBS		
L2ER2036BL	1232	1298	1367	29	29.5	36	20	151	12	
L2ER2042BL	1272	1352	1430	29	29.5	42	20	172	12	
L2ER2048BL	1317	1405	1491	29	29.5	48	20	179	12	
L2ER2054BL	1358	1458	1554	29	29.5	54	20	184	13	
L2ER2436BL	1279	1351	1422	29	29.5	36	24	151	12	
L2ER2442BL	1325	1405	1485	29	29.5	42	24	172	12	
L2ER2448BL	1368	1461	1550	29	29.5	48	24	179	13	
L2ER2454BL	1414	1516	1616	29	29.5	54	24	184	13	

L2ER-BR • Executive Return with BBF Pedestal Right

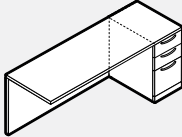

• Optional e-lock available for the pedestal in the vertical position. Please specify V-Vertical and add \$231 list.

PRODUCT CODE	FINISH LP	B	W	SIZE/INCHES				WEIGHT		VOL FT ³
				H (LP/B)	H (W)	W	D	LBS		
L2ER2036BR	1232	1298	1367	29	29.5	36	20	151	12	
L2ER2042BR	1272	1352	1430	29	29.5	42	20	172	12	
L2ER2048BR	1317	1405	1491	29	29.5	48	20	179	12	
L2ER2054BR	1358	1458	1554	29	29.5	54	20	184	13	
L2ER2436BR	1279	1351	1422	29	29.5	36	24	151	12	
L2ER2442BR	1325	1405	1485	29	29.5	42	24	172	12	
L2ER2448BR	1368	1461	1550	29	29.5	48	24	179	13	
L2ER2454BR	1414	1516	1616	29	29.5	54	24	184	13	

L2ERH-BL • Executive Return with BBF Pedestal Left and Half Modesty

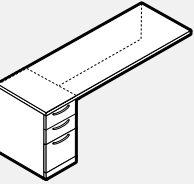

• Optional e-lock available for the pedestal in the vertical position. Please specify V-Vertical and add \$231 list.

PRODUCT CODE	FINISH LP	B	W	SIZE/INCHES				WEIGHT		VOL FT ³
				H (LP/B)	H (W)	W	D	LBS		
L2ERH2036BL	1177	1243	1317	29	29.5	36	20	151	12	
L2ERH2042BL	1208	1289	1366	29	29.5	42	20	172	12	
L2ERH2048BL	1238	1328	1416	29	29.5	48	20	179	12	
L2ERH2054BL	1269	1369	1466	29	29.5	54	20	184	13	
L2ERH2436BL	1226	1296	1367	29	29.5	36	24	151	12	
L2ERH2442BL	1259	1338	1419	29	29.5	42	24	172	12	
L2ERH2448BL	1290	1382	1473	29	29.5	48	24	179	13	
L2ERH2454BL	1323	1426	1525	29	29.5	54	24	184	13	

L2ERH-BR • Executive Return with BBF Pedestal Right and Half Modesty

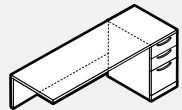

• Optional e-lock available for the pedestal in the vertical position. Please specify V-Vertical and add \$231 list.

PRODUCT CODE	FINISH LP	B	W	SIZE/INCHES				WEIGHT		VOL FT ³
				H (LP/B)	H (W)	W	D	LBS		
L2ERH2036BR	1177	1243	1317	29	29.5	36	20	151	12	
L2ERH2042BR	1208	1289	1366	29	29.5	42	20	172	12	
L2ERH2048BR	1238	1328	1416	29	29.5	48	20	179	12	
L2ERH2054BR	1269	1369	1466	29	29.5	54	20	184	13	
L2ERH2436BR	1226	1296	1367	29	29.5	36	24	151	12	
L2ERH2442BR	1259	1338	1419	29	29.5	42	24	172	12	
L2ERH2448BR	1290	1382	1473	29	29.5	48	24	179	13	
L2ERH2454BR	1323	1426	1525	29	29.5	54	24	184	13	

Technical Information

Technical Information

Reception Desk:

- All desks are shipped KD.
- Centre desk reception transaction top is available in "LP", "B" or "W" thickness to match the thickness and profile of worksurface edge.
- All other exposed edges are banded with 3mm PVC.
- Center unit is freestanding and can be connected on one or both sides with a return or bridge.
- **Bridge unit is connected to the centre unit to extend the return on either side. This unit must be connected on both ends and nonhanded.**
- Left or right hand unit is designed to extend the centre unit. This unit must be connected on one end.
- **Can be used as a freestanding unit or connected with surrounding bridge or corner surround.**
- **Comes with transaction top.**

DESKS • GUIDELINES FOR ORDERING PRODUCT

CODES: The price list uses a numbering system with meaningful alphanumeric characters to create a simple-to-understand product number. This makes specifying the product much easier and more accurate.

SPECIFICATION EXAMPLE OF A GALLERY RECEPTION DESK UNIT

PRODUCT CODE:

L2GR66
 L2 = New Licence
 G = Gallery
 R = Reception
 66 = Size: Width

OPTIONS:

Top: LP - LP (Low Pressure Laminate) Thickness 1"
 HP B - B Thickness 1 1/16"
 HP W - W Thickness 1 7/16"

Top Finish Laminate: Choose Colour

Top PVC Edging: Choose Colour

Chassis Laminate: Choose Colour

Chassis PVC Edging: Choose Colour

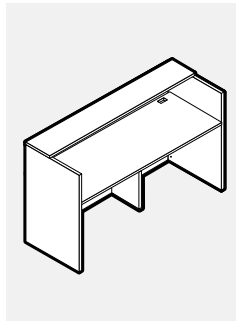

L2GR • Gallery Reception Desk

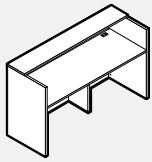

- Two grommets installed TL/TR.

PRODUCT CODE	FINISH			SIZE/INCHES				WEIGHT LBS	VOL FT ³
	LP	B	W	H (LP/B)	H(W)	W	D		
L2GR66	1352	1696	1889	42.315	42.750	66	25	149	15
L2GR72	1422	1797	2001	42.315	42.750	72	25	163	17
L2GR78	1490	1892	2117	42.315	42.750	78	25	166	18
L2GR84	1560	1990	2231	42.315	42.750	84	25	171	20
L2GR96	1697	2187	2461	42.315	42.750	96	25	178	23

L2GB • Gallery Bridge

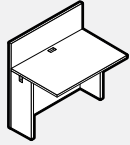

- One grommet installed TC.

PRODUCT CODE	FINISH			SIZE/INCHES				WEIGHT LBS	VOL FT ³
	LP	B	W	H (LP/B)	H(W)	W	D		
L2GB42	603	737	801	41.315	41.315	42	25	79	10
L2GB48	658	812	885	41.315	41.315	48	25	86	12
L2GB54	714	885	966	41.315	41.315	54	25	95	13
L2GB60	766	956	1051	41.315	41.315	60	25	101	14

L2GR-L • Gallery Left Return

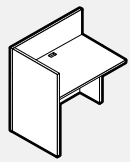

- One grommet installed TC.

PRODUCT CODE	FINISH			SIZE/INCHES				WEIGHT LBS	VOL FT ³
	LP	B	W	H (LP/B)	H(W)	W	D		
L2GR36L	672	796	854	41.315	41.315	36	25	90	9
L2GR42L	726	868	937	41.315	41.315	42	25	97	11
L2GR48L	785	942	1022	41.315	41.315	48	25	106	13
L2GR54L	840	1017	1103	41.315	41.315	54	25	119	14
L2GR60L	894	1089	1186	41.315	41.315	60	25	132	16

L2GR-R • Gallery Right Return

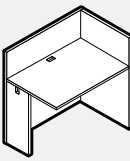

- One grommet installed TC.

PRODUCT CODE	FINISH			SIZE/INCHES				WEIGHT LBS	VOL FT ³
	LP	B	W	H (LP/B)	H(W)	W	D		
L2GR36R	672	796	854	41.315	41.315	36	25	90	9
L2GR42R	726	868	937	41.315	41.315	42	25	97	11
L2GR48R	785	942	1022	41.315	41.315	48	25	106	13
L2GR54R	840	1017	1103	41.315	41.315	54	25	119	14
L2GR60R	894	1089	1186	41.315	41.315	60	25	132	16

L2GD • Gallery Desk Decorative Panel

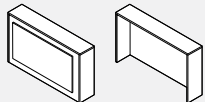

Front Back

- To be used in conjunction with a 66", 72" or 84" rectangular desk shell.
- Decorative Panel is high pressure laminate.

PRODUCT CODE	FINISH			SIZE/INCHES				WEIGHT LBS	VOL FT ³
	LP	B	W	H (LP/B)	H(W)	W	D		
L2GD66	1667	1810	1963	42.315	42.750	68.25	12	99	20
L2GD72	1892	2059	2236	42.315	42.750	74.25	12	113	22
L2GD84	2029	2213	2414	42.315	42.750	86.25	12	117	25

L2GDP • Gallery Desk with Pigeon Holes and Decorative Panel

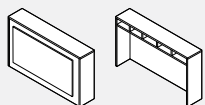

Front Back

- To be used in conjunction with a 66", 72" or 84" rectangular desk shell.
- Decorative Panel is high pressure laminate.

PRODUCT CODE	FINISH			SIZE/INCHES				WEIGHT LBS	VOL FT ³
	LP	B	W	H (LP/B)	H(W)	W	D		
L2GDP66	1732	1919	2076	42.315	42.750	68.25	12	99	20
L2GDP72	1963	2183	2367	42.315	42.750	74.25	12	113	22
L2GDP84	2117	2356	2563	42.315	42.750	86.25	12	117	25

L2GRKIT • Reception Kit Gallery

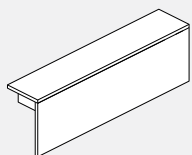

- Unit to be placed on L2DR or L2CRS Desk Shell

PRODUCT CODE	FINISH			SIZE/INCHES				WEIGHT LBS	VOL FT ³
	LP	B	W	H (LP/B)	H(W)	W	D		
L2GRKIT36H36	418	442	459	18.37	18.75	36	12	68	1.50
L2GRKIT42H36	456	485	507	18.37	18.75	42	12	79	1.75
L2GRKIT48H36	495	534	551	18.37	18.75	48	12	90	2.00
L2GRKIT54H36	537	574	600	18.37	18.75	54	12	101	2.25
L2GRKIT60H36	575	619	645	18.37	18.75	60	12	113	2.50
L2GRKIT36H42	462	509	524	24.37	24.75	36	12	68	1.50
L2GRKIT42H42	510	563	581	24.37	24.75	42	12	79	1.75
L2GRKIT48H42	555	614	639	24.37	24.75	48	12	90	2.00
L2GRKIT54H42	604	670	694	24.37	24.75	54	12	101	2.25
L2GRKIT60H42	652	723	752	24.37	24.75	60	12	113	2.50

Technical Information

- All Desks and connecting shells are Shipped knocked down (KD).
- All connecting units must be connected to an adjoining worksurface where there is either no end gable or a narrow gable with flat brackets.
- Gables & partial gables are interchangeable.
- All bottom edges are edge banded.
- Each shell allows for grommet (BG5) to be specified at no upcharge. Please see general information (Section A) for location.

DESKS • GUIDELINES FOR ORDERING PRODUCT

CODES: The price list uses a numbering system with meaningful alphanumeric characters to create a simple-to-understand product number. This makes specifying the product much easier and more accurate.

SPECIFICATION EXAMPLE OF A DESK UNIT

PRODUCT CODE: L2DR3060
 L2 = New Licence
 D = Desk
 R = Rectangular
 3060 = Size: Depth x Width

OPTIONS:
 Top: LP - LP (Low Pressure Laminate) Thickness 1"
 HP B - B Thickness 1 1/16"
 HP W - W Thickness 1 7/16"

Top Finish Laminate: Choose Colour
 Top PVC Edging: Choose Colour
 Chassis Laminate: Choose Colour
 Chassis PVC Edging: Choose Colour

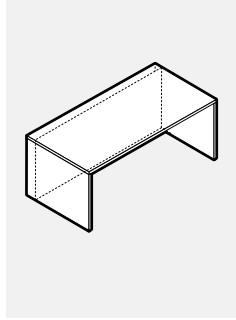

SPECIFICATION EXAMPLE OF A CONNECTING RETURN UNIT

PRODUCT CODE: L2RCH2030R
 L2 = New Licence
 R = Return
 C = Connecting
 H = Half Back Panel
 2030 = Size: Depth x Width
 R = Connecting on Right

OPTIONS:
 Top: LP - LP (Low Pressure Laminate) Thickness 1"
 HP B - B Thickness 1 1/16"
 HP W - W Thickness 1 7/16"

Top Finish Laminate: Choose Colour
 Top PVC Edging: Choose Colour
 Chassis Laminate: Choose Colour
 Chassis PVC Edging: Choose Colour

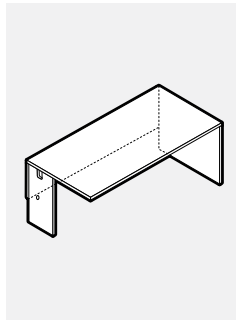

L2DR • Rectangular Desk, Recessed Modesty

• All recessed modesties are inset 6" from the visitor edge.

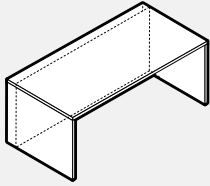

PRODUCT CODE	FINISH LP	B	W	SIZE/INCHES				WEIGHT		VOL FT ³
				H (LP/B)	H (W)	W	D	LBS		
L2DR3060	879	1072	1204	29	29.5	60	30	136	6	
L2DR3066	925	1135	1284	29	29.5	66	30	145	7	
L2DR3072	971	1200	1357	29	29.5	72	30	155	7	
L2DR3078	1018	1264	1431	29	29.5	78	30	175	9	
L2DR3084	1069	1332	1515	29	29.5	84	30	185	10	
L2DR3660	977	1205	1360	29	29.5	60	36	155	7	
L2DR3666	1029	1276	1443	29	29.5	66	36	165	9	
L2DR3672	1083	1351	1529	29	29.5	72	36	176	9	
L2DR3678	1131	1422	1615	29	29.5	78	36	197	11	
L2DR3684	1188	1499	1704	29	29.5	84	36	208	12	

L2DB • Bowfront Desk, Recessed Modesty

• All recessed modesties are inset 6" from the visitor edge.

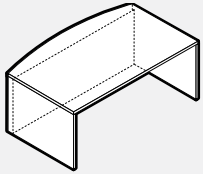

PRODUCT CODE	FINISH LP	B	W	SIZE/INCHES				WEIGHT		VOL FT ³
				H (LP/B)	H (W)	W	D	LBS		
L2DB3060	936	1166	1325	29	29.5	60	36	155	7	
L2DB3066	987	1235	1407	29	29.5	66	36	165	9	
L2DB3072	1037	1304	1495	29	29.5	72	36	176	9	
L2DB3078	1089	1378	1577	29	29.5	78	36	197	11	
L2DB3084	1144	1457	1669	29	29.5	84	36	208	12	
L2DB3660	1037	1299	1476	29	29.5	60	42	155	7	
L2DB3666	1092	1378	1573	29	29.5	66	42	165	9	
L2DB3672	1147	1457	1667	29	29.5	72	42	176	9	
L2DB3678	1201	1538	1758	29	29.5	78	42	197	11	
L2DB3684	1264	1620	1861	29	29.5	84	42	208	12	

L2CRS • Credenza Shell, Full End Gables on Both Sides and Flush Back

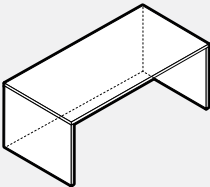

PRODUCT CODE	FINISH LP	B	W	SIZE/INCHES				WEIGHT		VOL FT ³
				H (LP/B)	H (W)	W	D	LBS		
L2CRS2024	518	592	644	29	29.5	24	20	68	3	
L2CRS2030	562	652	712	29	29.5	30	20	77	3	
L2CRS2036	604	701	779	29	29.5	36	20	87	3	
L2CRS2042	644	759	845	29	29.5	42	20	94	3	
L2CRS2048	688	817	911	29	29.5	48	20	102	4	
L2CRS2054	726	872	976	29	29.5	54	20	109	4	
L2CRS2060	779	936	1052	29	29.5	60	20	118	4	
L2CRS2066	823	994	1118	29	29.5	66	20	127	6	
L2CRS2072	863	1051	1182	29	29.5	72	20	135	6	
L2CRS2078	905	1106	1254	29	29.5	78	20	151	7	
L2CRS2084	954	1169	1325	29	29.5	84	20	160	8	
L2CRS2424	540	614	671	29	29.5	24	24	68	3	
L2CRS2430	582	672	740	29	29.5	30	24	77	3	
L2CRS2436	627	731	811	29	29.5	36	24	87	3	
L2CRS2442	670	791	879	29	29.5	42	24	94	3	
L2CRS2448	717	851	949	29	29.5	48	24	102	4	
L2CRS2454	758	908	1017	29	29.5	54	24	109	4	
L2CRS2460	811	973	1094	29	29.5	60	24	118	4	
L2CRS2466	853	1033	1165	29	29.5	66	24	127	6	
L2CRS2472	896	1090	1233	29	29.5	72	24	135	6	
L2CRS2478	941	1152	1300	29	29.5	78	24	151	7	
L2CRS2484	992	1214	1375	29	29.5	84	24	160	8	
L2CRS3030	639	746	820	29	29.5	30	30	90	3	
L2CRS3036	687	811	895	29	29.5	36	30	99	3	
L2CRS3042	731	872	971	29	29.5	42	30	109	4	
L2CRS3048	779	936	1050	29	29.5	48	30	119	4	
L2CRS3054	825	1000	1122	29	29.5	54	30	127	6	
L2CRS3060	879	1072	1204	29	29.5	60	30	136	6	
L2CRS3066	925	1135	1284	29	29.5	66	30	145	7	
L2CRS3072	971	1200	1357	29	29.5	72	30	155	7	
L2CRS3078	1018	1264	1431	29	29.5	78	30	175	9	
L2CRS3084	1069	1332	1515	29	29.5	84	30	185	10	

L2CRSH • Credenza Shell, Flush Back, Cut Out Modesty, Full End Gables on Both Sides

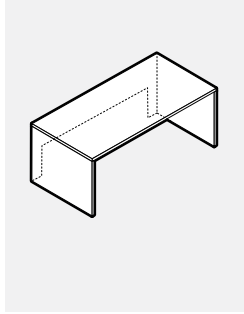

PRODUCT CODE	FINISH LP	B	W	SIZE / INCHES				WEIGHT LBS	VOL FT³
				H (LP/B)	H (W)	W	D		
L2CRSH2030	562	652	712	29	29.5	30	20	77	3
L2CRSH2036	604	701	779	29	29.5	36	20	87	3
L2CRSH2042	644	759	845	29	29.5	42	20	94	3
L2CRSH2048	688	817	911	29	29.5	48	20	102	4
L2CRSH2054	726	872	976	29	29.5	54	20	109	4
L2CRSH2060	779	936	1052	29	29.5	60	20	118	4
L2CRSH2066	823	994	1118	29	29.5	66	20	127	6
L2CRSH2072	863	1051	1182	29	29.5	72	20	135	6
L2CRSH2078	905	1106	1254	29	29.5	78	20	151	7
L2CRSH2084	954	1169	1325	29	29.5	84	20	160	8
L2CRSH2430	582	672	740	29	29.5	30	24	77	3
L2CRSH2436	627	731	811	29	29.5	36	24	87	3
L2CRSH2442	670	791	879	29	29.5	42	24	94	3
L2CRSH2448	717	851	949	29	29.5	48	24	102	4
L2CRSH2454	758	908	1017	29	29.5	54	24	109	4
L2CRSH2460	811	973	1094	29	29.5	60	24	118	4
L2CRSH2466	853	1033	1165	29	29.5	66	24	127	6
L2CRSH2472	896	1090	1233	29	29.5	72	24	135	6
L2CRSH2478	941	1152	1300	29	29.5	78	24	151	7
L2CRSH2484	992	1214	1375	29	29.5	84	24	160	8
L2CRSH3030	639	746	820	29	29.5	30	30	90	3
L2CRSH3036	687	811	895	29	29.5	36	30	99	3
L2CRSH3042	731	872	971	29	29.5	42	30	109	4
L2CRSH3048	779	936	1050	29	29.5	48	30	119	4
L2CRSH3054	825	1000	1122	29	29.5	54	30	127	6
L2CRSH3060	879	1072	1204	29	29.5	60	30	139	6
L2CRSH3066	925	1135	1284	29	29.5	66	30	145	7
L2CRSH3072	971	1200	1357	29	29.5	72	30	155	7
L2CRSH3078	992	1264	1431	29	29.5	78	30	175	9
L2CRSH3084	1069	1332	1515	29	29.5	84	30	185	10

L2RC-R • Return, Connecting Right, Full Gable on Right and Narrow Gable on Left

• Units are non-handed. They can be configured as either lefts or rights.

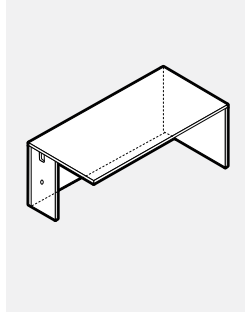

PRODUCT CODE	FINISH			SIZE/INCHES				WEIGHT		VOL FT ³
	LP	B	W	H (LP/B)	H (W)	W	D	LBS		
L2RC2024R	486	561	610	29	29.5	24	20	64	3	
L2RC2030R	535	619	683	29	29.5	30	20	69	3	
L2RC2036R	577	676	752	29	29.5	36	20	79	3	
L2RC2042R	623	736	820	29	29.5	42	20	86	3	
L2RC2048R	666	794	891	29	29.5	48	20	95	4	
L2RC2054R	712	854	959	29	29.5	54	20	102	4	
L2RC2060R	766	926	1040	29	29.5	60	20	110	4	
L2RC2066R	816	986	1109	29	29.5	66	20	119	6	
L2RC2072R	863	1051	1182	29	29.5	72	20	128	6	
L2RC2078R	908	1108	1257	29	29.5	78	20	143	7	
L2RC2084R	954	1168	1325	29	29.5	84	20	152	8	
L2RC2424R	507	579	636	29	29.5	24	24	64	3	
L2RC2430R	553	641	709	29	29.5	30	24	69	3	
L2RC2436R	602	701	783	29	29.5	36	24	79	3	
L2RC2442R	645	763	853	29	29.5	42	24	86	3	
L2RC2448R	693	826	926	29	29.5	48	24	95	4	
L2RC2454R	740	891	998	29	29.5	54	24	102	4	
L2RC2460R	800	963	1084	29	29.5	60	24	110	4	
L2RC2466R	846	1026	1156	29	29.5	66	24	119	6	
L2RC2472R	896	1090	1233	29	29.5	72	24	128	6	
L2RC2478R	943	1153	1302	29	29.5	78	24	143	7	
L2RC2484R	992	1214	1375	29	29.5	84	24	152	8	
L2RC3030R	604	707	784	29	29.5	30	30	83	3	
L2RC3036R	654	775	862	29	29.5	36	30	91	3	
L2RC3042R	699	842	938	29	29.5	42	30	101	4	
L2RC3048R	751	908	1018	29	29.5	48	30	111	4	
L2RC3054R	800	973	1095	29	29.5	54	30	119	6	
L2RC3060R	862	1055	1189	29	29.5	60	30	129	6	
L2RC3066R	911	1121	1266	29	29.5	66	30	138	7	
L2RC3072R	963	1194	1349	29	29.5	72	30	147	7	
L2RC3078R	1012	1260	1508	29	29.5	78	30	167	9	
L2RC3084R	1063	1326	1590	29	29.5	84	30	177	10	
L2RC3660R	930	1158	1309	29	29.5	60	36	145	7	
L2RC3666R	986	1234	1397	29	29.5	66	36	157	9	
L2RC3672R	1041	1310	1490	29	29.5	72	36	169	9	
L2RC3678R	1095	1385	1577	29	29.5	78	36	190	11	
L2RC3684R	1148	1460	1667	29	29.5	84	36	201	12	

L2RCH-R • Half Modesty Return, Connecting Right, Full Gable on Right and Narrow Gable on Left

• Units are non-handed. They can be configured as either lefts or rights.

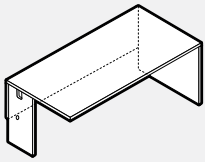

PRODUCT CODE	FINISH LP	B	W	SIZE/INCHES				WEIGHT LBS	VOL FT ³
				H (LP/B)	H (W)	W	D		
L2RCH2024R	433	501	555	29	29.5	24	20	55	3
L2RCH2030R	464	546	609	29	29.5	30	20	57	3
L2RCH2036R	499	593	666	29	29.5	36	20	65	3
L2RCH2042R	528	638	723	29	29.5	42	20	69	3
L2RCH2048R	562	687	779	29	29.5	48	20	76	4
L2RCH2054R	593	727	833	29	29.5	54	20	81	4
L2RCH2060R	636	790	905	29	29.5	60	20	86	4
L2RCH2066R	670	833	959	29	29.5	66	20	92	6
L2RCH2072R	705	885	1021	29	29.5	72	20	99	6
L2RCH2078R	736	930	1074	29	29.5	78	20	112	7
L2RCH2084R	770	975	1132	29	29.5	84	20	119	8
L2RCH2424R	450	520	577	29	29.5	24	24	56	3
L2RCH2430R	483	569	634	29	29.5	30	24	57	3
L2RCH2436R	517	619	693	29	29.5	36	24	65	3
L2RCH2442R	550	661	752	29	29.5	42	24	69	3
L2RCH2448R	582	712	811	29	29.5	48	24	76	4
L2RCH2454R	619	759	867	29	29.5	54	24	81	4
L2RCH2460R	661	823	938	29	29.5	60	24	86	4
L2RCH2466R	695	867	998	29	29.5	66	24	92	6
L2RCH2472R	733	920	1062	29	29.5	72	24	99	6
L2RCH2478R	765	969	1119	29	29.5	78	24	112	7
L2RCH2484R	800	1017	1175	29	29.5	84	24	119	8
L2RCH3030R	537	636	712	29	29.5	30	30	77	3
L2RCH3036R	573	691	778	29	29.5	36	30	83	3
L2RCH3042R	608	744	842	29	29.5	42	30	87	4
L2RCH3048R	644	796	908	29	29.5	48	30	92	4
L2RCH3054R	683	851	972	29	29.5	54	30	98	6
L2RCH3060R	727	917	1052	29	29.5	60	30	105	6
L2RCH3066R	765	971	1117	29	29.5	66	30	111	7
L2RCH3072R	805	1027	1182	29	29.5	72	30	119	7
L2RCH3078R	843	1083	1320	29	29.5	78	30	136	9
L2RCH3084R	880	1134	1388	29	29.5	84	30	144	10
L2RCH3660R	800	1022	1173	29	29.5	60	36	123	7
L2RCH3666R	842	1084	1245	29	29.5	66	36	129	9
L2RCH3672R	885	1147	1326	29	29.5	72	36	141	9
L2RCH3678R	926	1205	1398	29	29.5	78	36	154	11
L2RCH3684R	966	1216	1473	29	29.5	84	36	162	12

L2RC-L • Return, Connecting Left, Full Gable on Left and Narrow Gable on Right

• Units are non-handed. They can be configured as either lefts or rights.

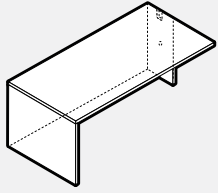

PRODUCT CODE	FINISH			SIZE/INCHES				WEIGHT LBS	VOL FT ³
	LP	B	W	H (LP/B)	H (W)	W	D		
L2RC2024L	486	561	610	29	29.5	24	20	64	3
L2RC2030L	535	619	683	29	29.5	30	20	69	3
L2RC2036L	577	676	752	29	29.5	36	20	79	3
L2RC2042L	623	736	820	29	29.5	42	20	86	3
L2RC2048L	666	794	891	29	29.5	48	20	95	4
L2RC2054L	712	854	959	29	29.5	54	20	102	4
L2RC2060L	766	926	1040	29	29.5	60	20	110	4
L2RC2066L	816	986	1109	29	29.5	66	20	119	6
L2RC2072L	863	1051	1182	29	29.5	72	20	128	6
L2RC2078L	908	1108	1257	29	29.5	78	20	143	7
L2RC2084L	954	1168	1325	29	29.5	84	20	152	8
L2RC2424L	507	579	636	29	29.5	24	24	64	3
L2RC2430L	553	641	709	29	29.5	30	24	69	3
L2RC2436L	602	701	783	29	29.5	36	24	79	3
L2RC2442L	645	763	853	29	29.5	42	24	86	3
L2RC2448L	693	826	926	29	29.5	48	24	95	4
L2RC2454L	740	891	998	29	29.5	54	24	102	4
L2RC2460L	800	963	1084	29	29.5	60	24	110	4
L2RC2466L	846	1026	1156	29	29.5	66	24	119	6
L2RC2472L	896	1090	1233	29	29.5	72	24	128	6
L2RC2478L	943	1153	1302	29	29.5	78	24	143	7
L2RC2484L	992	1214	1375	29	29.5	84	24	152	8
L2RC3030L	604	707	784	29	29.5	30	30	83	3
L2RC3036L	654	775	862	29	29.5	36	30	91	3
L2RC3042L	699	842	938	29	29.5	42	30	101	4
L2RC3048L	751	908	1018	29	29.5	48	30	111	4
L2RC3054L	800	973	1095	29	29.5	54	30	119	6
L2RC3060L	862	1055	1189	29	29.5	60	30	129	6
L2RC3066L	911	1121	1266	29	29.5	66	30	138	7
L2RC3072L	963	1194	1349	29	29.5	72	30	147	7
L2RC3078L	1012	1260	1508	29	29.5	78	30	167	9
L2RC3084L	1063	1326	1590	29	29.5	84	30	177	10
L2RC3660L	930	1158	1309	29	29.5	60	36	145	7
L2RC3666L	986	1234	1397	29	29.5	66	36	157	9
L2RC3672L	1041	1310	1490	29	29.5	72	36	169	9
L2RC3678L	1095	1385	1577	29	29.5	78	36	190	11
L2RC3684L	1148	1460	1667	29	29.5	84	36	201	12

L2RCH-L • Half Modesty Return, Connecting Left, Full Gable on Left and Narrow Gable on Right

• Units are non-handed. They can be configured as either lefts or rights.

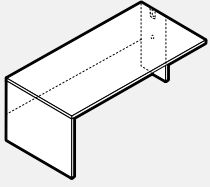

PRODUCT CODE	FINISH LP	B	W	SIZE/INCHES			D	WEIGHT LBS	VOL FT ³
				H (LP/B)	H (W)	W			
L2RCH2024L	433	501	555	29	29.5	24	20	55	3
L2RCH2030L	464	546	609	29	29.5	30	20	57	3
L2RCH2036L	499	593	666	29	29.5	36	20	65	3
L2RCH2042L	528	638	723	29	29.5	42	20	69	3
L2RCH2048L	562	687	779	29	29.5	48	20	76	4
L2RCH2054L	593	727	833	29	29.5	54	20	81	4
L2RCH2060L	636	790	905	29	29.5	60	20	86	4
L2RCH2066L	670	833	959	29	29.5	66	20	92	5
L2RCH2072L	705	885	1021	29	29.5	72	20	99	5
L2RCH2078L	736	930	1074	29	29.5	78	20	112	6
L2RCH2084L	770	975	1132	29	29.5	84	20	119	7
L2RCH2424L	450	520	577	29	29.5	24	24	56	3
L2RCH2430L	483	569	634	29	29.5	30	24	57	3
L2RCH2436L	517	619	693	29	29.5	36	24	65	3
L2RCH2442L	550	661	752	29	29.5	42	24	69	3
L2RCH2448L	582	712	811	29	29.5	48	24	76	4
L2RCH2454L	619	759	867	29	29.5	54	24	81	4
L2RCH2460L	661	823	938	29	29.5	60	24	86	4
L2RCH2466L	695	867	998	29	29.5	66	24	92	5
L2RCH2472L	733	920	1062	29	29.5	72	24	99	5
L2RCH2478L	765	969	1119	29	29.5	78	24	112	6
L2RCH2484L	800	1017	1175	29	29.5	84	24	119	7
L2RCH3030L	537	636	712	29	29.5	30	30	77	3
L2RCH3036L	573	691	778	29	29.5	36	30	83	3
L2RCH3042L	608	744	842	29	29.5	42	30	87	4
L2RCH3048L	644	796	908	29	29.5	48	30	92	4
L2RCH3054L	683	851	972	29	29.5	54	30	98	5
L2RCH3060L	727	917	1052	29	29.5	60	30	105	5
L2RCH3066L	765	971	1117	29	29.5	66	30	111	6
L2RCH3072L	805	1027	1182	29	29.5	72	30	119	6
L2RCH3078L	843	1083	1320	29	29.5	78	30	136	8
L2RCH3084L	880	1134	1388	29	29.5	84	30	144	9
L2RCH3660L	800	1022	1173	29	29.5	60	36	123	6
L2RCH3666L	842	1084	1245	29	29.5	66	36	129	8
L2RCH3672L	885	1147	1326	29	29.5	72	36	141	8
L2RCH3678L	926	1205	1398	29	29.5	78	36	154	10
L2RCH3684L	966	1216	1473	29	29.5	84	36	162	11

L2RC-C • Return, Connecting Narrow Gables on Both Sides

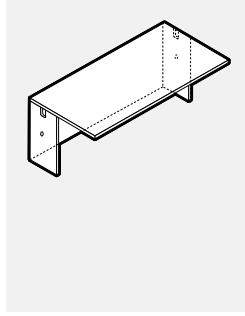

PRODUCT CODE	FINISH LP	B	W	SIZE/INCHES			D	WEIGHT LBS	VOL FT ³
				H (LP/B)	H (W)	W			
L2RC2024C	433	503	555	29	29.5	24	20	56	3
L2RC2030C	477	540	602	29	29.5	30	20	62	3
L2RC2036C	522	593	666	29	29.5	36	20	72	3
L2RC2042C	568	653	731	29	29.5	42	20	78	3
L2RC2048C	610	707	797	29	29.5	48	20	87	4
L2RC2054C	657	761	863	29	29.5	54	20	95	4
L2RC2060C	717	830	941	29	29.5	60	20	102	4
L2RC2066C	759	886	1006	29	29.5	66	20	111	6
L2RC2072C	809	947	1078	29	29.5	72	20	120	6
L2RC2078C	853	1001	1142	29	29.5	78	20	135	7
L2RC2084C	896	1060	1208	29	29.5	84	20	144	8
L2RC2424C	451	522	577	29	29.5	24	24	56	3
L2RC2430C	499	562	626	29	29.5	30	24	62	3
L2RC2436C	543	621	693	29	29.5	36	24	72	3
L2RC2442C	591	676	761	29	29.5	42	24	78	3
L2RC2448C	636	734	829	29	29.5	48	24	87	4
L2RC2454C	686	792	896	29	29.5	54	24	95	4
L2RC2460C	744	864	977	29	29.5	60	24	102	4
L2RC2466C	790	922	1050	29	29.5	66	24	111	6
L2RC2472C	842	985	1121	29	29.5	72	24	120	6
L2RC2478C	888	1041	1189	29	29.5	78	24	135	7
L2RC2484C	935	1101	1259	29	29.5	84	24	144	8
L2RC3030C	557	658	733	29	29.5	30	30	75	3
L2RC3036C	605	724	812	29	29.5	36	30	84	3
L2RC3042C	655	791	892	29	29.5	42	30	94	4
L2RC3048C	701	820	926	29	29.5	48	30	103	4
L2RC3054C	754	884	999	29	29.5	54	30	116	6
L2RC3060C	816	959	1088	29	29.5	60	30	121	6
L2RC3066C	864	1022	1160	29	29.5	66	30	130	7
L2RC3072C	918	1089	1237	29	29.5	72	30	140	7
L2RC3078C	966	1153	1315	29	29.5	78	30	160	9
L2RC3084C	1017	1212	1389	29	29.5	84	30	169	10

L2RCH-C • Half Modesty Return, Connecting Narrow Gables on Both Sides

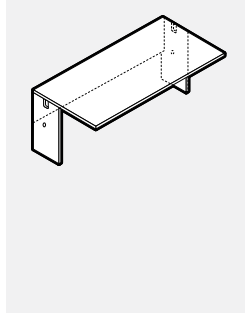

PRODUCT CODE	FINISH LP	B	W	SIZE/INCHES				WEIGHT LBS	VOL FT³
				H(LP/B)	H(W)	W	D		
L2RCH2024C	377	443	500	29	29.5	24	20	46	3
L2RCH2030C	410	490	553	29	29.5	30	20	50	3
L2RCH2036C	442	539	609	29	29.5	36	20	57	3
L2RCH2042C	475	581	666	29	29.5	42	20	62	3
L2RCH2048C	508	629	722	29	29.5	48	20	68	4
L2RCH2054C	522	672	779	29	29.5	54	20	74	4
L2RCH2060C	568	733	850	29	29.5	60	20	78	4
L2RCH2066C	602	779	903	29	29.5	66	20	85	6
L2RCH2072C	634	827	962	29	29.5	72	20	91	6
L2RCH2078C	666	874	1021	29	29.5	78	20	105	7
L2RCH2084C	698	920	1074	29	29.5	84	20	111	8
L2RCH2424C	394	462	518	29	29.5	24	24	46	3
L2RCH2430C	430	510	577	29	29.5	30	24	50	3
L2RCH2436C	460	557	634	29	29.5	36	24	57	3
L2RCH2442C	494	605	693	29	29.5	42	24	62	3
L2RCH2448C	527	655	752	29	29.5	48	24	68	4
L2RCH2454C	543	699	811	29	29.5	54	24	74	4
L2RCH2460C	591	761	883	29	29.5	60	24	78	4
L2RCH2466C	625	811	938	29	29.5	66	24	85	6
L2RCH2472C	659	862	1000	29	29.5	72	24	91	6
L2RCH2478C	693	909	1060	29	29.5	78	24	105	7
L2RCH2484C	725	956	1118	29	29.5	84	24	111	8
L2RCH3030C	487	590	661	29	29.5	30	30	72	3
L2RCH3036C	524	639	725	29	29.5	36	30	80	3
L2RCH3042C	562	693	791	29	29.5	42	30	85	4
L2RCH3048C	600	749	857	29	29.5	48	30	90	4
L2RCH3054C	634	801	922	29	29.5	54	30	95	6
L2RCH3060C	686	867	1000	29	29.5	60	30	97	6
L2RCH3066C	721	921	1066	29	29.5	66	30	103	7
L2RCH3072C	759	977	1135	29	29.5	72	30	111	7
L2RCH3078C	796	1033	1200	29	29.5	78	30	129	9
L2RCH3084C	831	1087	1265	29	29.5	84	30	136	10

L2RCS • Return Connecting Swerve Left

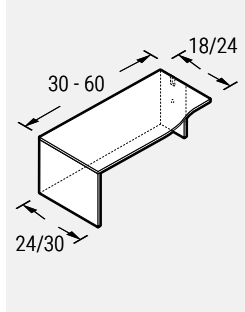

PRODUCT CODE	FINISH LP	B	W	SIZE/INCHES				WEIGHT LBS	VOL FT³
				H(LP/B)	H(W)	W	D		
L2RCS243018	586	672	784	29	29.5	30	24	70	2
L2RCS243618	630	733	853	29	29.5	36	24	79	3
L2RCS244218	673	792	922	29	29.5	42	24	88	3
L2RCS244818	721	852	992	29	29.5	48	24	97	4
L2RCS245418	763	911	1062	29	29.5	54	24	106	4
L2RCS246018	824	984	1143	29	29.5	60	24	114	4
L2RCS303024	638	746	864	29	29.5	30	30	81	3
L2RCS303624	688	812	942	29	29.5	36	30	91	3
L2RCS304224	736	879	1022	29	29.5	42	30	109	4
L2RCS304824	786	943	1101	29	29.5	48	30	119	4
L2RCS305424	833	1011	1177	29	29.5	54	30	127	6
L2RCS306024	885	1079	1259	29	29.5	60	30	136	6

L2RCS • Return Connecting Swerve Right

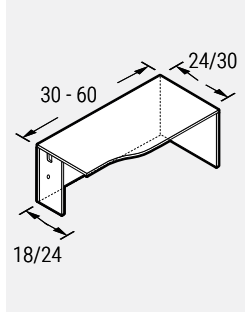

PRODUCT CODE	FINISH LP	B	W	SIZE/INCHES				WEIGHT LBS	VOL FT³
				H(LP/B)	H(W)	W	D		
L2RCS183024	586	672	784	29	29.5	30	24	70	2
L2RCS183624	630	733	853	29	29.5	36	24	79	3
L2RCS184224	673	792	922	29	29.5	42	24	88	3
L2RCS184824	721	852	992	29	29.5	48	24	97	4
L2RCS185424	763	911	1062	29	29.5	54	24	106	4
L2RCS186024	824	984	1143	29	29.5	60	24	114	4
L2RCS243030	638	746	864	29	29.5	30	30	81	3
L2RCS243630	688	812	942	29	29.5	36	30	91	3
L2RCS244230	736	879	1022	29	29.5	42	30	109	4
L2RCS244830	786	943	1101	29	29.5	48	30	119	4
L2RCS245430	833	1011	1177	29	29.5	54	30	127	6
L2RCS246030	885	1079	1259	29	29.5	60	30	136	6

L2RCSH • Return Connecting Swerve Left with Half Modesty Panel

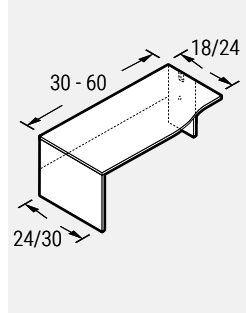

PRODUCT CODE	FINISH LP	B	W	SIZE / INCHES				WEIGHT LBS	VOL FT ³
				H (LP/B)	H (W)	W	D		
L2RCSH243018	518	604	714	29	29.5	30	24	61	2
L2RCSH243618	550	652	766	29	29.5	36	24	65	3
L2RCSH244218	581	694	825	29	29.5	42	24	72	3
L2RCSH244818	614	741	883	29	29.5	48	24	77	4
L2RCSH245418	645	786	936	29	29.5	54	24	84	4
L2RCSH246018	692	846	1004	29	29.5	60	24	90	4
L2RCSH303024	570	672	794	29	29.5	30	30	78	3
L2RCSH303624	607	725	860	29	29.5	36	30	88	3
L2RCSH304224	643	780	925	29	29.5	42	30	105	4
L2RCSH304824	680	833	988	29	29.5	48	30	114	4
L2RCSH305424	718	888	1055	29	29.5	54	30	121	5
L2RCSH306024	754	941	1119	29	29.5	60	30	130	5

L2RCSH • Return Connecting Swerve Right with Half Modesty Panel

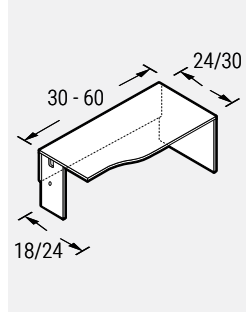

PRODUCT CODE	FINISH LP	B	W	SIZE / INCHES				WEIGHT LBS	VOL FT ³
				H (LP/B)	H (W)	W	D		
L2RCSH183024	518	604	714	29	29.5	30	24	61	2
L2RCSH183624	550	652	766	29	29.5	36	24	65	3
L2RCSH184224	581	694	825	29	29.5	42	24	72	3
L2RCSH184824	614	741	883	29	29.5	48	24	77	4
L2RCSH185424	645	786	936	29	29.5	54	24	84	4
L2RCSH186024	692	846	1004	29	29.5	60	24	90	4
L2RCSH243030	570	672	794	29	29.5	30	30	78	3
L2RCSH243630	607	725	860	29	29.5	36	30	88	3
L2RCSH244230	643	780	925	29	29.5	42	30	105	4
L2RCSH244830	680	833	988	29	29.5	48	30	114	4
L2RCSH245430	718	888	1055	29	29.5	54	30	121	6
L2RCSH246030	754	941	1119	29	29.5	60	30	130	6

L2RCW • Return Connecting Wedge Left

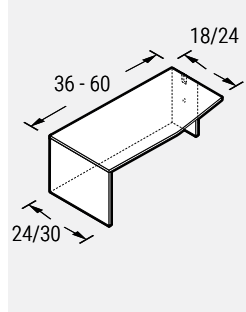

PRODUCT CODE	FINISH LP	B	W	SIZE / INCHES				WEIGHT LBS	VOL FT ³
				H (LP/B)	H (W)	W	D		
L2RCW243018	586	672	784	29	29.5	30	24	70	2
L2RCW243618	630	733	853	29	29.5	36	24	79	3
L2RCW244218	673	792	922	29	29.5	42	24	88	3
L2RCW244818	721	852	992	29	29.5	48	24	97	4
L2RCW245418	763	911	1062	29	29.5	54	24	106	4
L2RCW246018	824	984	1143	29	29.5	60	24	114	4
L2RCW303024	638	746	864	29	29.5	30	30	81	3
L2RCW303624	688	812	942	29	29.5	36	30	91	3
L2RCW304224	736	879	1022	29	29.5	42	30	109	4
L2RCW304824	786	943	1101	29	29.5	48	30	119	4
L2RCW305424	833	1011	1177	29	29.5	54	30	127	6
L2RCW306024	885	1079	1259	29	29.5	60	30	136	6

L2RCW • Return Connecting Wedge Right

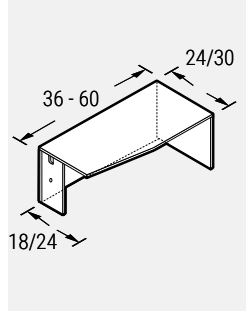

PRODUCT CODE	FINISH LP	B	W	SIZE / INCHES				WEIGHT LBS	VOL FT ³
				H (LP/B)	H (W)	W	D		
L2RCW183024	586	672	784	29	29.5	30	24	70	2
L2RCW183624	630	733	853	29	29.5	36	24	79	3
L2RCW184224	673	792	922	29	29.5	42	24	88	3
L2RCW184824	721	852	992	29	29.5	48	24	97	4
L2RCW185424	763	911	1062	29	29.5	54	24	106	4
L2RCW186024	824	984	1143	29	29.5	60	24	114	4
L2RCW243030	638	746	864	29	29.5	30	30	81	3
L2RCW243630	688	812	942	29	29.5	36	30	91	3
L2RCW244230	736	879	1022	29	29.5	42	30	109	4
L2RCW244830	786	943	1101	29	29.5	48	30	119	4
L2RCW245430	833	1011	1177	29	29.5	54	30	127	6
L2RCW246030	885	1079	1259	29	29.5	60	30	136	6

L2RCWH • Return Connecting Wedge Left with Half Modesty

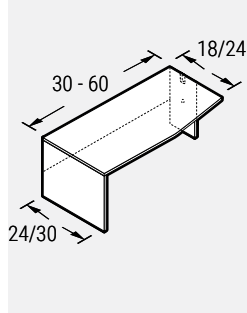

PRODUCT CODE	FINISH LP	B	W	SIZE / INCHES				WEIGHT		VOL FT ³
				H (LP/B)	H (W)	W	D	LBS		
L2RCWH243018	518	604	714	29	29.5	30	24	61	2	
L2RCWH243618	550	652	766	29	29.5	36	24	65	3	
L2RCWH244218	581	694	825	29	29.5	42	24	72	3	
L2RCWH244818	614	741	883	29	29.5	48	24	77	4	
L2RCWH245418	645	786	936	29	29.5	54	24	84	4	
L2RCWH246018	692	846	1004	29	29.5	60	24	90	4	
L2RCWH303024	570	672	794	29	29.5	30	30	78	3	
L2RCWH303624	607	725	860	29	29.5	36	30	88	3	
L2RCWH304224	643	780	925	29	29.5	42	30	105	4	
L2RCWH304824	680	833	988	29	29.5	48	30	114	4	
L2RCWH305424	718	888	1055	29	29.5	54	30	121	6	
L2RCWH306024	754	941	1119	29	29.5	60	30	130	6	

L2RCWH • Return Connecting Wedge Right with Half Modesty

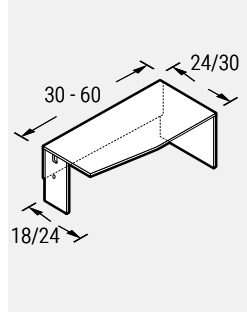

PRODUCT CODE	FINISH LP	B	W	SIZE / INCHES				WEIGHT		VOL FT ³
				H (LP/B)	H (W)	W	D	LBS		
L2RCWH183024	518	604	714	29	29.5	30	24	61	2	
L2RCWH183624	550	652	766	29	29.5	36	24	65	3	
L2RCWH184224	581	694	825	29	29.5	42	24	72	3	
L2RCWH184824	614	741	883	29	29.5	48	24	77	4	
L2RCWH185424	645	786	936	29	29.5	54	24	84	4	
L2RCWH186024	692	846	1004	29	29.5	60	24	90	4	
L2RCWH243030	570	672	794	29	29.5	30	30	78	3	
L2RCWH243630	607	725	860	29	29.5	36	30	88	3	
L2RCWH244230	643	780	925	29	29.5	42	30	105	4	
L2RCWH244830	680	833	988	29	29.5	48	30	114	4	
L2RCWH245430	718	888	1055	29	29.5	54	30	121	6	
L2RCWH246030	754	941	1119	29	29.5	60	30	130	6	

L2ER-L • Executive Return Left

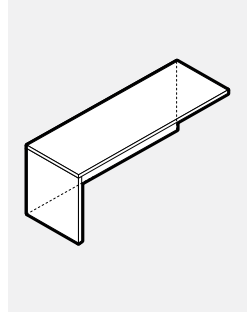

• Units are non-handed. They can be configured as either lefts or rights.

PRODUCT CODE	FINISH LP	B	W	SIZE / INCHES				WEIGHT		VOL FT ³
				H (LP/B)	H (W)	W	D	LBS		
L2ER2024L	389	455	508	29	29.5	24	20	25	3	
L2ER2030L	434	516	577	29	29.5	30	20	29	3	
L2ER2036L	483	578	656	29	29.5	36	20	32	3	
L2ER2042L	536	644	727	29	29.5	42	20	35	3	
L2ER2048L	578	701	800	29	29.5	48	20	37	4	
L2ER2054L	625	762	868	29	29.5	54	20	40	4	
L2ER2060L	683	833	954	29	29.5	60	20	44	4	
L2ER2066L	725	894	1022	29	29.5	66	20	46	6	
L2ER2072L	773	955	1094	29	29.5	72	20	50	6	
L2ER2424L	405	475	527	29	29.5	24	24	25	3	
L2ER2430L	451	537	600	29	29.5	30	24	29	3	
L2ER2436L	503	603	683	29	29.5	36	24	32	3	
L2ER2442L	555	670	759	29	29.5	42	24	35	3	
L2ER2448L	603	731	830	29	29.5	48	24	37	4	
L2ER2454L	652	792	905	29	29.5	54	24	40	4	
L2ER2460L	709	867	988	29	29.5	60	24	44	4	
L2ER2466L	755	930	1063	29	29.5	66	24	46	6	
L2ER2472L	801	994	1139	29	29.5	72	24	50	6	

L2ERH-L • Executive Return Left, Half Modesty

• Units are non-handed. They can be configured as either lefts or rights.

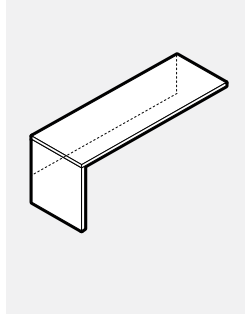

PRODUCT CODE	FINISH			SIZE / INCHES				WEIGHT LBS	VOL FT ³
	LP	B	W	H (LP/B)	H (W)	W	D		
L2ERH2024L	336	399	451	29	29.5	24	20	25	3
L2ERH2030L	367	443	507	29	29.5	30	20	29	3
L2ERH2036L	409	501	577	29	29.5	36	20	32	3
L2ERH2042L	441	546	633	29	29.5	42	20	35	3
L2ERH2048L	473	593	691	29	29.5	48	20	37	4
L2ERH2054L	507	638	746	29	29.5	54	20	40	4
L2ERH2060L	550	697	816	29	29.5	60	20	44	4
L2ERH2066L	581	744	868	29	29.5	66	20	46	6
L2ERH2072L	612	790	929	29	29.5	72	20	50	6
L2ERH2424L	347	412	471	29	29.5	24	24	25	3
L2ERH2430L	380	462	524	29	29.5	30	24	29	3
L2ERH2436L	425	520	602	29	29.5	36	24	32	3
L2ERH2442L	459	569	658	29	29.5	42	24	35	3
L2ERH2448L	491	619	718	29	29.5	48	24	37	4
L2ERH2454L	524	665	775	29	29.5	54	24	40	4
L2ERH2460L	573	724	846	29	29.5	60	24	44	4
L2ERH2466L	605	774	905	29	29.5	66	24	46	6
L2ERH2472L	638	823	969	29	29.5	72	24	50	6

L2ER-R • Executive Return Right

• Units are non-handed. They can be configured as either lefts or rights.

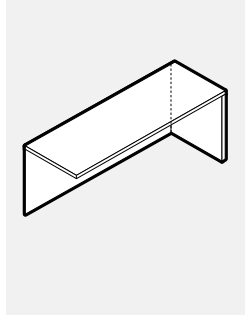

PRODUCT CODE	FINISH			SIZE / INCHES				WEIGHT LBS	VOL FT ³
	LP	B	W	H (LP/B)	H (W)	W	D		
L2ER2024R	389	455	508	29	29.5	24	20	55	3
L2ER2030R	434	516	577	29	29.5	30	20	63	3
L2ER2036R	483	578	656	29	29.5	36	20	70	3
L2ER2042R	536	644	727	29	29.5	42	20	77	3
L2ER2048R	578	701	800	29	29.5	48	20	87	4
L2ER2054R	625	762	868	29	29.5	54	20	92	4
L2ER2060R	683	833	954	29	29.5	60	20	102	4
L2ER2066R	725	894	1022	29	29.5	66	20	110	6
L2ER2072R	773	955	1094	29	29.5	72	20	119	6
L2ER2424R	405	475	527	29	29.5	24	24	55	3
L2ER2430R	451	537	600	29	29.5	30	24	63	3
L2ER2436R	503	603	683	29	29.5	36	24	70	3
L2ER2442R	555	670	759	29	29.5	42	24	77	3
L2ER2448R	603	731	830	29	29.5	48	24	87	4
L2ER2454R	652	792	905	29	29.5	54	24	92	4
L2ER2460R	709	867	988	29	29.5	60	24	102	4
L2ER2466R	755	930	1063	29	29.5	66	24	110	6
L2ER2472R	801	994	1139	29	29.5	72	24	119	6

L2ERH-R • Executive Return Right, Half Modesty

• Units are non-handed. They can be configured as either lefts or rights.

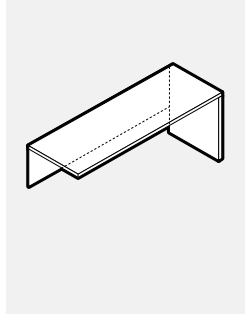

PRODUCT CODE	FINISH			SIZE / INCHES				WEIGHT LBS	VOL FT ³
	LP	B	W	H (LP/B)	H (W)	W	D		
L2ERH2024R	336	399	451	29	29.5	24	20	45	3
L2ERH2030R	367	443	507	29	29.5	30	20	53	3
L2ERH2036R	409	501	577	29	29.5	36	20	62	3
L2ERH2042R	441	546	633	29	29.5	42	20	67	3
L2ERH2048R	473	593	691	29	29.5	48	20	77	4
L2ERH2054R	507	638	746	29	29.5	54	20	83	4
L2ERH2060R	550	697	816	29	29.5	60	20	94	4
L2ERH2066R	581	744	868	29	29.5	66	20	101	6
L2ERH2072R	612	790	929	29	29.5	72	20	110	6
L2ERH2424R	347	412	471	29	29.5	24	24	45	3
L2ERH2430R	380	462	524	29	29.5	30	24	53	3
L2ERH2436R	425	520	602	29	29.5	36	24	62	3
L2ERH2442R	459	569	658	29	29.5	42	24	67	3
L2ERH2448R	491	619	718	29	29.5	48	24	77	4
L2ERH2454R	524	665	775	29	29.5	54	24	83	4
L2ERH2460R	573	724	846	29	29.5	60	24	94	4
L2ERH2466R	605	774	905	29	29.5	66	24	101	6
L2ERH2472R	638	823	969	29	29.5	72	24	110	6

L2B • Bridge with Flush Mounted Modesty

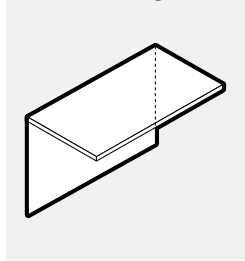

PRODUCT CODE	FINISH			SIZE / INCHES				WEIGHT LBS	VOL FT ³
	LP	B	W	H (LP/B)	H (W)	W	D		
L2B2024	267	328	383	29	29.5	24	20	39	2
L2B2030	312	388	452	29	29.5	30	20	42	3
L2B2036	363	452	527	29	29.5	36	20	68	3
L2B2042	406	510	596	29	29.5	42	20	77	3
L2B2048	451	570	666	29	29.5	48	20	86	4
L2B2054	495	630	736	29	29.5	54	20	94	4
L2B2424	278	341	398	29	29.5	24	24	39	2
L2B2430	324	404	472	29	29.5	30	24	44	3
L2B2436	375	471	548	29	29.5	36	24	68	3
L2B2442	421	535	623	29	29.5	42	24	77	3
L2B2448	471	593	693	29	29.5	48	24	86	4
L2B2454	516	656	763	29	29.5	54	24	94	4

L2BH • Bridge with Flush Mounted Half Modesty

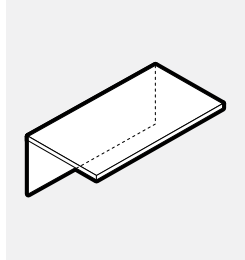

PRODUCT CODE	FINISH			SIZE / INCHES				WEIGHT LBS	VOL FT ³
	LP	B	W	H (LP/B)	H (W)	W	D		
L2BH2024	212	271	327	29	29.5	24	20	36	2
L2BH2030	245	318	380	29	29.5	30	20	36	2
L2BH2036	280	369	443	29	29.5	36	20	54	3
L2BH2042	312	412	501	29	29.5	42	20	61	3
L2BH2048	344	459	555	29	29.5	48	20	66	4
L2BH2054	377	507	610	29	29.5	54	20	72	4
L2BH2424	221	283	339	29	29.5	24	24	36	2
L2BH2430	253	329	397	29	29.5	30	24	42	3
L2BH2436	293	383	462	29	29.5	36	24	54	3
L2BH2442	327	432	520	29	29.5	42	24	61	3
L2BH2448	361	477	578	29	29.5	48	24	66	4
L2BH2454	392	524	636	29	29.5	54	24	72	4

L2EC-R • Extended Corner Desk with 10" End Panel on Left, Full Modesty & Full Gable on Right

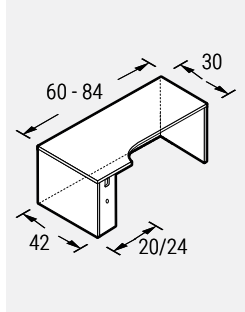

PRODUCT CODE	FINISH			SIZE / INCHES				WEIGHT LBS	VOL FT ³
	LP	B	W	H (LP/B)	H (W)	W	D		
For 20" Return Connection									
L2EC20426030R	1109	1374	1561	29	29.5	60	42	187	8
L2EC20426630R	1167	1456	1655	29	29.5	66	42	209	9
L2EC20427230R	1223	1533	1748	29	29.5	72	42	231	10
L2EC20427830R	1273	1613	1842	29	29.5	78	42	253	11
L2EC20428430R	1329	1690	1935	29	29.5	84	42	275	12
For 24" Return Connection									
L2EC24426030R	1109	1374	1561	29	29.5	60	42	187	8
L2EC24426630R	1167	1456	1655	29	29.5	66	42	209	9
L2EC24427230R	1223	1533	1748	29	29.5	72	42	231	10
L2EC24427830R	1273	1613	1842	29	29.5	78	42	253	11
L2EC24428430R	1329	1690	1935	29	29.5	84	42	275	12

L2EC-L • Extended Corner Desk with 10" End Panel on Right, Full Modesty & Full Gable on Left

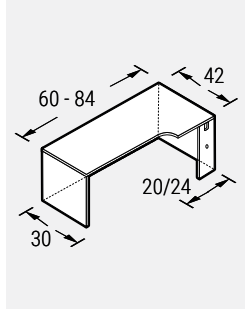

PRODUCT CODE	FINISH			SIZE / INCHES				WEIGHT LBS	VOL FT ³
	LP	B	W	H (LP/B)	H (W)	W	D		
For 20" Return Connection									
L2EC30604220L	1109	1374	1561	29	29.5	60	42	187	8
L2EC30664220L	1167	1456	1655	29	29.5	66	42	209	9
L2EC30724220L	1223	1533	1748	29	29.5	72	42	231	10
L2EC30784220L	1273	1613	1842	29	29.5	78	42	253	11
L2EC30844220L	1329	1690	1935	29	29.5	84	42	275	12
For 24" Return Connection									
L2EC30604224L	1109	1374	1561	29	29.5	60	42	187	8
L2EC30664224L	1167	1456	1655	29	29.5	66	42	209	9
L2EC30724224L	1223	1533	1748	29	29.5	72	42	231	10
L2EC30784224L	1273	1613	1842	29	29.5	78	42	253	11
L2EC30844224L	1329	1690	1935	29	29.5	84	42	275	12

L2EC-R • Extended Corner Desk with 10" End Panel on Left, Full Modesty & Full Gable on Right

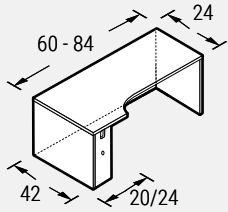

PRODUCT CODE	FINISH LP	B	W	SIZE / INCHES				WEIGHT LBS	VOL FT ³
				H (LP/B)	H (W)	W	D		
For 20" Return Connection									
L2EC20426024R	1088	1352	1539	29	29.5	60	42	187	8
L2EC20426624R	1142	1431	1632	29	29.5	66	42	209	9
L2EC20427224R	1198	1509	1724	29	29.5	72	42	231	10
L2EC20427824R	1255	1588	1817	29	29.5	78	42	253	11
L2EC20428424R	1304	1668	1914	29	29.5	84	42	275	12
For 24" Return Connection									
L2EC24426024R	1088	1352	1539	29	29.5	60	42	187	8
L2EC24426624R	1142	1431	1632	29	29.5	66	42	209	9
L2EC24427224R	1198	1509	1724	29	29.5	72	42	231	10
L2EC24427824R	1255	1588	1817	29	29.5	78	42	253	11
L2EC24428424R	1304	1668	1914	29	29.5	84	42	275	12

L2EC-L • Extended Corner Desk with 10" End Panel on Left, Full Modesty & Full Gable on Right

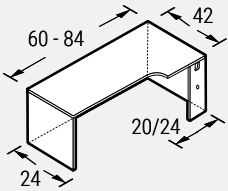

PRODUCT CODE	FINISH LP	B	W	SIZE / INCHES				WEIGHT LBS	VOL FT ³
				H (LP/B)	H (W)	W	D		
For 20" Return Connection									
L2EC24604220L	1088	1352	1539	29	29.5	60	42	187	8
L2EC24664220L	1142	1431	1632	29	29.5	66	42	209	9
L2EC24724220L	1198	1509	1724	29	29.5	72	42	231	10
L2EC24784220L	1255	1588	1817	29	29.5	78	42	253	11
L2EC24844220L	1304	1668	1914	29	29.5	84	42	275	12
For 24" Return Connection									
L2EC24604224L	1088	1352	1539	29	29.5	60	42	187	8
L2EC24664224L	1142	1431	1632	29	29.5	66	42	209	9
L2EC24724224L	1198	1509	1724	29	29.5	72	42	231	10
L2EC24784224L	1255	1588	1817	29	29.5	78	42	253	11
L2EC24844224L	1304	1668	1914	29	29.5	84	42	275	12

L2DEC-R • Extended Corner Desk with 10" End Panel on Left, Full Modesty and Full Gable Right

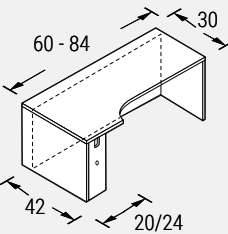

• All recessed modesties are inset 6" from the visitor edge.

PRODUCT CODE	FINISH LP	B	W	SIZE / INCHES				WEIGHT LBS	VOL FT ³
				H (LP/B)	H (W)	W	D		
For 20" Connection									
L2DEC20426030R	1109	1374	1561	29	29.5	60	42	187	8
L2DEC20426630R	1167	1456	1655	29	29.5	66	42	209	9
L2DEC20427230R	1223	1533	1748	29	29.5	72	42	231	10
L2DEC20427830R	1273	1613	1842	29	29.5	78	42	253	11
L2DEC20428430R	1329	1690	1935	29	29.5	84	42	275	12
For 24" Connection									
L2DEC24426030R	1109	1374	1561	29	29.5	60	42	187	8
L2DEC24426630R	1167	1456	1655	29	29.5	66	42	209	9
L2DEC24427230R	1223	1533	1748	29	29.5	72	42	231	10
L2DEC24427830R	1273	1613	1842	29	29.5	78	42	253	11
L2DEC24428430R	1329	1690	1935	29	29.5	84	42	275	12

L2DEC-L • Extended Corner Desk with 10" End Panel on Right, Full Modesty and Full Gable Left

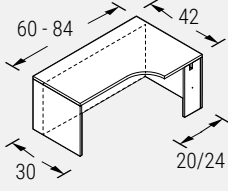

• All recessed modesties are inset 6" from the visitor edge.

PRODUCT CODE	FINISH LP	B	W	SIZE / INCHES				WEIGHT LBS	VOL FT ³
				H (LP/B)	H (W)	W	D		
For 20" Connection									
L2DEC30604220L	1109	1374	1561	29	29.5	60	42	187	8
L2DEC30664220L	1167	1456	1655	29	29.5	66	42	209	9
L2DEC30724220L	1223	1533	1748	29	29.5	72	42	231	10
L2DEC30784220L	1273	1613	1842	29	29.5	78	42	253	11
L2DEC30844220L	1329	1690	1935	29	29.5	84	42	275	12
For 24" Connection									
L2DEC30604224L	1109	1374	1561	29	29.5	60	42	187	8
L2DEC30664224L	1167	1456	1655	29	29.5	66	42	209	9
L2DEC30724224L	1223	1533	1748	29	29.5	72	42	231	10
L2DEC30784224L	1273	1613	1842	29	29.5	78	42	253	11
L2DEC30844224L	1329	1690	1935	29	29.5	84	42	275	12

L2DEC-R • Extended Corner Desk with 10" End Panel on Left, Full Modesty and Full Gable Right

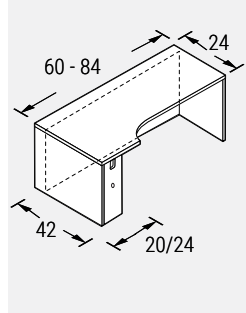

• All recessed modesties are inset 6" from the visitor edge.

PRODUCT CODE	FINISH LP	B	W	SIZE / INCHES				WEIGHT LBS	VOL FT ³
				H (LP/B)	H (W)	W	D		
For 20" Conection									
L2DEC20426024R	1088	1352	1539	29	29.5	60	42	187	8
L2DEC20426624R	1142	1431	1632	29	29.5	66	42	209	9
L2DEC20427224R	1198	1509	1724	29	29.5	72	42	231	10
L2DEC20427824R	1255	1588	1817	29	29.5	78	42	253	11
L2DEC20428424R	1304	1668	1914	29	29.5	84	42	275	12
For 24" Conection									
L2DEC24426024R	1088	1352	1539	29	29.5	60	42	187	8
L2DEC24426624R	1142	1431	1632	29	29.5	66	42	209	9
L2DEC24427224R	1198	1509	1724	29	29.5	72	42	231	10
L2DEC24427824R	1255	1588	1817	29	29.5	78	42	253	11
L2DEC24428424R	1304	1668	1914	29	29.5	84	42	275	12

L2DEC-L • Extended Corner Desk with 10" End Panel on Right, Full Modesty and Full Gable Left

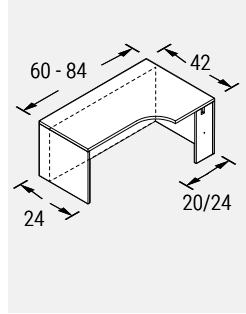

• All recessed modesties are inset 6" from the visitor edge.

PRODUCT CODE	FINISH LP	B	W	SIZE / INCHES				WEIGHT LBS	VOL FT ³
				H (LP/B)	H (W)	W	D		
For 20" Conection									
L2DEC24604220L	1088	1352	1539	29	29.5	60	42	187	8
L2DEC24664220L	1142	1431	1632	29	29.5	66	42	209	9
L2DEC24724220L	1198	1509	1724	29	29.5	72	42	231	10
L2DEC24784220L	1255	1588	1817	29	29.5	78	42	253	11
L2DEC24844220L	1304	1668	1914	29	29.5	84	42	275	12
For 24" Conection									
L2DEC24604224L	1088	1352	1539	29	29.5	60	42	187	8
L2DEC24664224L	1142	1431	1632	29	29.5	66	42	209	9
L2DEC24724224L	1198	1509	1724	29	29.5	72	42	231	10
L2DEC24784224L	1255	1588	1817	29	29.5	78	42	253	11
L2DEC24844224L	1304	1668	1914	29	29.5	84	42	275	12

L2CS • Corner with Straight Front, Full Back Panel & Narrow End Gables

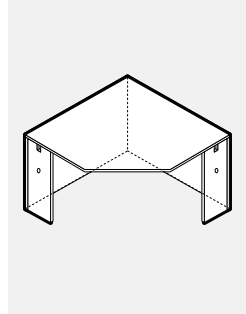

• For grain direction on surfaces larger than 42", please see grain direction chart at beginning of the Price List

PRODUCT CODE	FINISH LP	B	W	SIZE / INCHES				WEIGHT LBS	VOL FT ³
				H (LP/B)	H (W)	W	D		
L2CS183618	888	1095	1369	29	29.5	36	36	79	3
L2CS183620	911	1122	1405	29	29.5	36	36	84	3
L2CS183624	911	1122	1405	29	29.5	36	36	84	3
L2CS203618	911	1122	1405	29	29.5	36	36	84	3
L2CS203620	949	1182	1524	29	29.5	36	36	88	3
L2CS203624	970	1209	1559	29	29.5	36	36	88	3
L2CS243618	911	1122	1405	29	29.5	36	36	84	3
L2CS243620	970	1209	1559	29	29.5	36	36	88	3
L2CS243624	970	1209	1559	29	29.5	36	36	88	3
L2CS184218	972	1203	1496	29	29.5	42	42	87	4
L2CS184220	999	1234	1533	29	29.5	42	42	92	4
L2CS184224	999	1234	1533	29	29.5	42	42	92	4
L2CS204218	999	1234	1533	29	29.5	42	42	92	4
L2CS204220	999	1234	1533	29	29.5	42	42	97	4
L2CS204224	1024	1264	1617	29	29.5	42	42	97	4
L2CS244218	999	1234	1533	29	29.5	42	42	92	4
L2CS244220	1024	1264	1617	29	29.5	42	42	97	4
L2CS244224	1024	1264	1617	29	29.5	42	42	97	4
L2CS184818	1030	1262	1552	29	29.5	48	48	97	6
L2CS184820	1057	1292	1590	29	29.5	48	48	101	6
L2CS184824	1057	1292	1590	29	29.5	48	48	101	6
L2CS204818	1057	1292	1590	29	29.5	48	48	101	6
L2CS204820	1057	1292	1590	29	29.5	48	48	107	6
L2CS204824	1084	1324	1675	29	29.5	48	48	107	6
L2CS244818	1057	1292	1590	29	29.5	48	48	101	6
L2CS244820	1084	1324	1675	29	29.5	48	48	107	6
L2CS244824	1084	1324	1675	29	29.5	48	48	107	6

L2CSH • Corner with Straight Front, Cut Out Back Panel & Narrow End Gables

- For grain direction on surfaces larger than 42", please see grain direction chart at beginning of the Price List

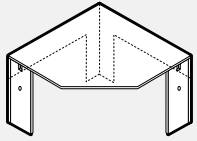

PRODUCT CODE	FINISH LP	B	W	SIZE / INCHES				WEIGHT LBS	VOL FT ³
				H (LP/B)	H (W)	W	D		
L2CSH183618	918	1126	1398	29	29.5	36	36	51	3
L2CSH183620	942	1154	1436	29	29.5	36	36	55	3
L2CSH183624	942	1154	1436	29	29.5	36	36	55	3
L2CSH203618	942	1154	1436	29	29.5	36	36	55	3
L2CSH203620	977	1212	1554	29	29.5	36	36	59	3
L2CSH203624	1000	1239	1588	29	29.5	36	36	59	3
L2CSH243618	942	1154	1436	29	29.5	36	36	55	3
L2CSH243620	1000	1239	1588	29	29.5	36	36	59	3
L2CSH243624	1000	1239	1588	29	29.5	36	36	59	3
L2CSH184218	1006	1237	1529	29	29.5	42	42	57	4
L2CSH184220	1034	1267	1570	29	29.5	42	42	63	4
L2CSH184224	1034	1267	1570	29	29.5	42	42	63	4
L2CSH204218	1034	1267	1570	29	29.5	42	42	63	4
L2CSH204220	1034	1267	1570	29	29.5	42	42	68	4
L2CSH204224	1060	1300	1654	29	29.5	42	42	68	4
L2CSH244218	1034	1267	1570	29	29.5	42	42	63	4
L2CSH244220	1060	1300	1654	29	29.5	42	42	68	4
L2CSH244224	1060	1300	1654	29	29.5	42	42	68	4
L2CSH184818	1065	1298	1587	29	29.5	48	48	65	6
L2CSH184820	1092	1327	1628	29	29.5	48	48	70	6
L2CSH184824	1092	1327	1628	29	29.5	48	48	70	6
L2CSH204818	1092	1327	1628	29	29.5	48	48	70	6
L2CSH204820	1092	1327	1628	29	29.5	48	48	76	6
L2CSH204824	1118	1358	1713	29	29.5	48	48	76	6
L2CSH244818	1092	1327	1628	29	29.5	48	48	70	6
L2CSH244820	1118	1358	1713	29	29.5	48	48	76	6
L2CSH244824	1118	1358	1713	29	29.5	48	48	76	6

L2CC • Corner with Curved Front, Full Back Panel & Narrow End Gables

- For grain direction on surfaces larger than 42", please see grain direction chart at beginning of the Price List

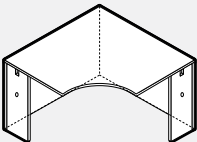

PRODUCT CODE	FINISH LP	B	W	SIZE / INCHES				WEIGHT LBS	VOL FT ³
				H (LP/B)	H (W)	W	D		
L2CC183618	898	1114	1396	29	29.5	36	36	79	3
L2CC183620	925	1142	1434	29	29.5	36	36	84	3
L2CC183624	925	1142	1434	29	29.5	36	36	84	3
L2CC203618	925	1142	1434	29	29.5	36	36	84	3
L2CC203620	962	1204	1554	29	29.5	36	36	88	3
L2CC203624	985	1233	1588	29	29.5	36	36	88	3
L2CC243618	925	1142	1434	29	29.5	36	36	84	3
L2CC243620	985	1233	1588	29	29.5	36	36	88	3
L2CC243624	985	1233	1588	29	29.5	36	36	88	3
L2CC184218	987	1225	1525	29	29.5	42	42	87	4
L2CC184220	1012	1258	1564	29	29.5	42	42	92	4
L2CC184224	1012	1258	1564	29	29.5	42	42	92	4
L2CC204218	1012	1258	1564	29	29.5	42	42	92	4
L2CC204220	1012	1258	1564	29	29.5	42	42	97	4
L2CC204224	1038	1289	1652	29	29.5	42	42	97	4
L2CC244218	1012	1258	1564	29	29.5	42	42	92	4
L2CC244220	1038	1289	1652	29	29.5	42	42	97	4
L2CC244224	1038	1289	1652	29	29.5	42	42	97	4
L2CC184818	1045	1284	1583	29	29.5	48	48	97	6
L2CC184820	1069	1315	1622	29	29.5	48	48	101	6
L2CC184824	1069	1315	1622	29	29.5	48	48	101	6
L2CC204818	1069	1315	1622	29	29.5	48	48	101	6
L2CC204820	1069	1315	1622	29	29.5	48	48	107	6
L2CC204824	1096	1344	1710	29	29.5	48	48	107	6
L2CC244818	1069	1315	1622	29	29.5	48	48	101	6
L2CC244820	1096	1344	1710	29	29.5	48	48	107	6
L2CC244824	1096	1344	1710	29	29.5	48	48	107	6

L2CCH • Corner with Curved Front, Cut Out Back Panel & Narrow End Gables

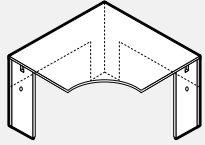

• For grain direction on surfaces larger than 42", please see grain direction chart at beginning of the Price List

PRODUCT CODE	FINISH LP	B	W	SIZE / INCHES				WEIGHT LBS	VOL FT ³
				H (LP/B)	H (W)	W	D		
L2CCH183618	930	1143	1526	29	29.5	36	36	51	3
L2CCH183620	956	1173	1530	29	29.5	36	36	55	3
L2CCH183624	956	1173	1530	29	29.5	36	36	55	3
L2CCH203618	956	1173	1530	29	29.5	36	36	55	3
L2CCH203620	994	1235	1656	29	29.5	36	36	59	3
L2CCH203624	1017	1264	1656	29	29.5	36	36	59	3
L2CCH243618	956	1173	1530	29	29.5	36	36	55	3
L2CCH243620	1017	1264	1656	29	29.5	36	36	59	3
L2CCH243624	1017	1264	1656	29	29.5	36	36	59	3
L2CCH184218	1023	1260	1560	29	29.5	42	42	57	4
L2CCH184220	1051	1291	1601	29	29.5	42	42	63	4
L2CCH184224	1051	1291	1601	29	29.5	42	42	63	4
L2CCH204218	1051	1291	1601	29	29.5	42	42	63	4
L2CCH204220	1051	1291	1601	29	29.5	42	42	68	4
L2CCH204224	1073	1324	1686	29	29.5	42	42	68	4
L2CCH244218	1051	1291	1601	29	29.5	42	42	63	4
L2CCH244220	1073	1324	1686	29	29.5	42	42	68	4
L2CCH244224	1073	1324	1686	29	29.5	42	42	68	4
L2CCH184818	1083	1318	1617	29	29.5	48	48	65	6
L2CCH184820	1107	1349	1656	29	29.5	48	48	70	6
L2CCH184824	1107	1349	1656	29	29.5	48	48	70	6
L2CCH204818	1107	1349	1656	29	29.5	48	48	70	6
L2CCH204820	1107	1349	1656	29	29.5	48	48	76	6
L2CCH204824	1132	1381	1744	29	29.5	48	48	76	6
L2CCH244818	1107	1349	1656	29	29.5	48	48	70	6
L2CCH244820	1132	1381	1744	29	29.5	48	48	76	6
L2CCH244824	1132	1381	1744	29	29.5	48	48	76	6

L2CK • Split Corner Desk w/Curved Front Keyboard, Full Back Panel & Narrow End Gables

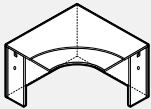

• For grain direction on surfaces larger than 42", please see grain direction chart at beginning of the Price List

PRODUCT CODE	FINISH LP	B	W	SIZE / INCHES				WEIGHT LBS	VOL FT ³
				H (LP/B)	H (W)	W	D		
L2CK244224	1769	2074	2461	29	29.5	42	42	97	4
L2CK244824	1826	2131	2521	29	29.5	48	48	107	6

L2CHK • Split Corner Desk w/Curved Front Keyboard, Cut Out Back Panel & Narrow End Gables

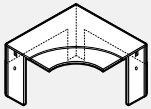

• For grain direction on surfaces larger than 42", please see grain direction chart at beginning of the Price List

PRODUCT CODE	FINISH LP	B	W	SIZE / INCHES				WEIGHT LBS	VOL FT ³
				H (LP/B)	H (W)	W	D		
L2CHK244224	1803	2091	2477	29	29.5	42	42	68	4
L2CHK244824	1861	2151	2536	29	29.5	48	48	76	6

Technical Information

- All Shaped tables are Shipped knocked down (KD).
- Monoleg or square leg ships in a separate box.
- All Units must be connected to an adjoining unit with flat brackets.
- For 24" deep returns that connect to an adjoining unit with included flat brackets.
- For 24" deep returns that connect to the corner units, the narrow panel is 10" and for 30" deep returns, the narrow panel is 14".
- All bottom edges are edge banded.
- Monolegs are drilled to accept shoulder screws to attach to the modesty.
- Modesty are offered 10" high only.
- Top plate with cut-out for 3" monoleg will accept modesty panel 1" thick.
- 8 x 8" plate is attached to surface with #10 3/4 wood screws, included.
- 1" height adjustment range.

TABLES • GUIDELINES FOR ORDERING PRODUCT

CODES: The price list uses a numbering system with meaningful alphanumeric characters to create a simple-to-understand product number. This makes specifying the product much easier and more accurate.

SPECIFICATION EXAMPLE OF A SHAPED TABLE

- PRODUCT CODE:** L2TDH3060
 L2 = New Licence
 T = Table
 D = D Shape Worksurface
 H = Half Modesty (10"High)
 3060 = Size: Depth x Width
- OPTIONS:**
- Top: LP - LPL (Low Pressure Laminate) Thickness 1"
 HP B - B Thickness 1 1/16"
 HP W - W Thickness 1 7/16"
- Leg Option: L2BHML03 (DEFAULT) Round Monoleg
 L2LSQ3X3 - Square Leg
- Top Finish Laminate: Choose Colour
- Top PVC Edging: Choose Colour
- Chassis Laminate: Choose Colour
- Chassis PVC Edging: Choose Colour
- Metal Leg Finish: Choose Colour

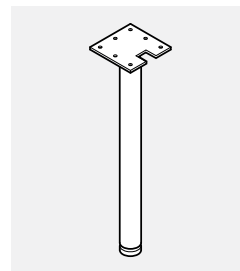

L2BHML03

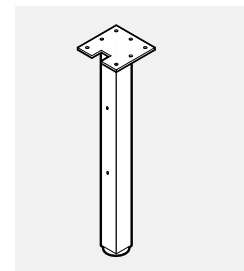

L2LSQ3X3

L2TD • D-Shaped Top with T-Base & Leg

• Add \$118 to list price for chrome leg option.

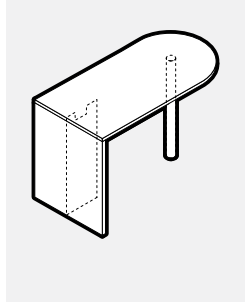

PRODUCT CODE	FINISH		SIZE/INCHES					D	WEIGHT LBS	VOL FT ³
	LP	B	W	H (LP/B)	H (W)	W				
L2TD2442	783	903	994	29	29.5	42	24	64	3	
L2TD2448	802	937	1037	29	29.5	48	24	68	3	
L2TD2454	826	973	1086	29	29.5	54	24	72	3	
L2TD2460	850	1011	1131	29	29.5	60	24	76	4	
L2TD2466	870	1045	1174	29	29.5	66	24	79	4	
L2TD2472	893	1084	1224	29	29.5	72	24	84	4	
L2TD2478	917	1118	1266	29	29.5	78	24	87	6	
L2TD2484	937	1154	1315	29	29.5	84	24	91	6	
L2TD3054	896	1078	1204	29	29.5	54	30	97	4	
L2TD3060	925	1121	1261	29	29.5	60	30	107	7	
L2TD3066	954	1166	1317	29	29.5	66	30	117	8	
L2TD3072	977	1205	1369	29	29.5	72	30	127	9	
L2TD3078	1004	1254	1426	29	29.5	78	30	136	9	
L2TD3084	1033	1294	1481	29	29.5	84	30	146	10	
L2TD3654	963	1173	1320	29	29.5	54	36	107	4	
L2TD3660	996	1226	1383	29	29.5	60	36	111	10	
L2TD3666	1026	1275	1448	29	29.5	66	36	116	9	
L2TD3672	1057	1327	1511	29	29.5	72	36	153	10	
L2TD3678	1089	1378	1575	29	29.5	78	36	165	11	
L2TD3684	1119	1429	1639	29	29.5	84	36	176	12	

L2TDH • D-Shaped Top with Half Modesty & Leg

• Add \$118 to list price for chrome leg option.

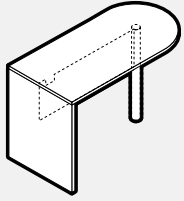

PRODUCT CODE	FINISH			SIZE/INCHES				WEIGHT LBS	VOL FT ³
	LP	B	W	H(LP/B)	H(W)	W	D		
L2TDH2442	763	886	975	29	29.5	42	24	63	3
L2TDH2448	797	931	1030	29	29.5	48	24	69	3
L2TDH2454	829	976	1088	29	29.5	54	24	75	3
L2TDH2460	862	1024	1143	29	29.5	60	24	81	4
L2TDH2466	894	1067	1199	29	29.5	66	24	87	4
L2TDH2472	926	1117	1258	29	29.5	72	24	94	4
L2TDH2478	958	1160	1310	29	29.5	78	24	99	6
L2TDH2484	988	1205	1367	29	29.5	84	24	106	6
L2TDH3054	897	1078	1204	29	29.5	54	30	95	4
L2TDH3060	935	1131	1269	29	29.5	60	30	102	7
L2TDH3066	971	1186	1333	29	29.5	66	30	112	8
L2TDH3072	1006	1237	1398	29	29.5	72	30	122	9
L2TDH3078	1043	1292	1464	29	29.5	78	30	132	9
L2TDH3084	1083	1344	1530	29	29.5	84	30	142	10
L2TDH3654	963	1174	1323	29	29.5	54	36	145	4
L2TDH3660	1004	1235	1394	29	29.5	60	36	151	10
L2TDH3666	1035	1289	1458	29	29.5	66	36	154	9
L2TDH3672	1078	1348	1530	29	29.5	72	36	156	10
L2TDH3678	1118	1407	1606	29	29.5	78	36	161	11
L2TDH3684	1158	1470	1681	29	29.5	84	36	172	12

L2TR • Rectangular Top with T-Base & Mono Leg

• Add \$118 to list price for chrome leg option.

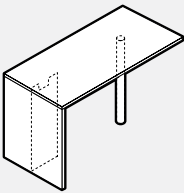

PRODUCT CODE	FINISH			SIZE/INCHES				WEIGHT LBS	VOL FT ³
	LP	B	W	H(LP/B)	H(W)	W	D		
L2TR2442	783	903	994	29	29.5	42	24	64	3
L2TR2448	802	937	1037	29	29.5	48	24	68	3
L2TR2454	826	973	1086	29	29.5	54	24	72	3
L2TR2460	850	1011	1131	29	29.5	60	24	76	4
L2TR2466	870	1045	1174	29	29.5	66	24	79	4
L2TR2472	893	1084	1224	29	29.5	72	24	84	4
L2TR2478	917	1118	1266	29	29.5	78	24	87	6
L2TR2484	937	1154	1315	29	29.5	84	24	91	6
L2TR3054	896	1078	1204	29	29.5	54	30	97	4
L2TR3060	925	1121	1261	29	29.5	60	30	107	7
L2TR3066	954	1166	1317	29	29.5	66	30	112	8
L2TR3072	977	1205	1369	29	29.5	72	30	127	9
L2TR3078	1004	1254	1426	29	29.5	78	30	136	9
L2TR3084	1033	1294	1481	29	29.5	84	30	146	10
L2TR3654	963	1173	1320	29	29.5	54	36	107	4
L2TR3660	996	1226	1383	29	29.5	60	36	111	7
L2TR3666	1026	1275	1448	29	29.5	66	36	116	8
L2TR3672	1057	1327	1511	29	29.5	72	36	153	9
L2TR3678	1089	1378	1575	29	29.5	78	36	165	9
L2TR3684	1119	1429	1639	29	29.5	84	36	176	10

L2TRH • Rectangular Top with Half Modesty & Mono Leg

• Add \$118 to list price for chrome leg option.

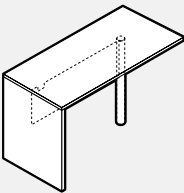

PRODUCT CODE	FINISH			SIZE/INCHES				WEIGHT LBS	VOL FT ³
	LP	B	W	H(LP/B)	H(W)	W	D		
L2TRH2442	763	886	975	29	29.5	42	24	63	3
L2TRH2448	797	931	1040	29	29.5	48	24	69	3
L2TRH2454	829	976	1088	29	29.5	54	24	75	3
L2TRH2460	862	1024	1143	29	29.5	60	24	81	4
L2TRH2466	894	1067	1199	29	29.5	66	24	87	4
L2TRH2472	926	1117	1258	29	29.5	72	24	94	4
L2TRH2478	958	1160	1310	29	29.5	78	24	99	6
L2TRH2484	988	1205	1367	29	29.5	84	24	100	6
L2TRH3054	897	1078	1204	29	29.5	54	30	95	4
L2TRH3060	935	1131	1269	29	29.5	60	30	102	7
L2TRH3066	971	1186	1333	29	29.5	66	30	112	8
L2TRH3072	1006	1237	1398	29	29.5	72	30	132	9
L2TRH3078	1043	1292	1464	29	29.5	78	30	142	9
L2TRH3084	1083	1344	1530	29	29.5	84	30	145	10
L2TRH3654	963	1174	1323	29	29.5	54	36	145	4
L2TRH3660	1004	1235	1394	29	29.5	60	36	151	7
L2TRH3666	1035	1289	1458	29	29.5	66	36	154	8
L2TRH3672	1078	1348	1530	29	29.5	72	36	156	9
L2TRH3678	1118	1407	1606	29	29.5	78	36	161	9
L2TRH3684	1158	1470	1681	29	29.5	84	36	172	10

L2TA • Axe Shaped Top with T-Base & Leg

• Add \$118 to list price for chrome leg option.

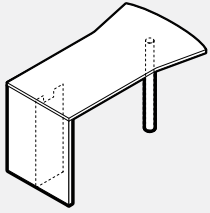

PRODUCT CODE	FINISH LP	B	W	SIZE/INCHES				D	WEIGHT LBS	VOL FT ³
				H (LP/B)	H (W)	W	D			
L2TA3060	1026	1290	1470	29	29.50	60	42	131	10	
L2TA3066	1063	1348	1542	29	29.50	66	42	140	11	
L2TA3072	1096	1405	1616	29	29.50	72	42	149	12	
L2TA3078	1132	1463	1688	29	29.50	78	42	157	12	
L2TA3084	1168	1520	1762	29	29.50	84	42	166	13	
L2TA3672	1174	1525	1757	29	29.50	72	48	153	13	
L2TA3678	1214	1590	1840	29	29.50	78	48	163	14	
L2TA3684	1258	1655	1922	29	29.50	84	48	173	15	

L2TAH • Axe Shaped Top with Half Modesty & Leg

• Add \$118 to list price for chrome leg option.

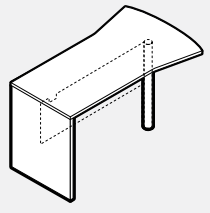

PRODUCT CODE	FINISH LP	B	W	SIZE/INCHES				D	WEIGHT LBS	VOL FT ³
				H (LP/B)	H (W)	W	D			
L2TAH3060	1035	1299	1481	29	29.50	60	42	127	10	
L2TAH3066	1083	1367	1563	29	29.50	66	42	135	11	
L2TAH3072	1126	1435	1646	29	29.50	72	42	144	12	
L2TAH3078	1170	1504	1730	29	29.50	78	42	153	12	
L2TAH3084	1214	1573	1812	29	29.50	84	42	162	13	
L2TAH3672	1197	1543	1777	29	29.50	72	48	149	13	
L2TAH3678	1243	1620	1869	29	29.50	78	48	158	14	
L2TAH3684	1294	1697	1960	29	29.50	84	48	168	15	

L2TP-L • P-Shaped Top Left with T-Base & Leg

• Add \$118 to list price for chrome leg option.

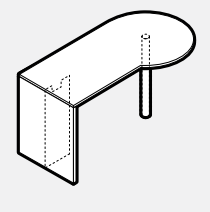

PRODUCT CODE	FINISH LP	B	W	SIZE/INCHES				D	WEIGHT LBS	VOL FT ³
				H (LP/B)	H (W)	W	D			
L2TP3060L	976	1205	1369	29	29.50	60	36	121	9	
L2TP3066L	1007	1260	1434	29	29.50	66	36	135	9	
L2TP3072L	1040	1306	1498	29	29.50	72	36	150	10	
L2TP3078L	1069	1360	1561	29	29.50	78	36	164	11	
L2TP3084L	1102	1411	1627	29	29.50	84	36	178	12	
L2TP3672L	1119	1429	1639	29	29.50	72	42	188	12	
L2TP3678L	1156	1485	1713	29	29.50	78	42	202	12	
L2TP3684L	1193	1547	1785	29	29.50	84	42	217	13	

L2TP-R • P-Shaped Top Right with T-Base & Leg

• Add \$118 to list price for chrome leg option.

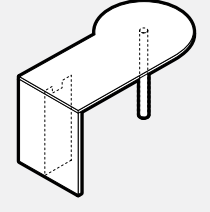

PRODUCT CODE	FINISH LP	B	W	SIZE/INCHES				D	WEIGHT LBS	VOL FT ³
				H (LP/B)	H (W)	W	D			
L2TP3060R	976	1205	1369	29	29.50	60	36	121	9	
L2TP3066R	1007	1260	1434	29	29.50	66	36	135	9	
L2TP3072R	1040	1306	1498	29	29.50	72	36	150	10	
L2TP3078R	1069	1360	1561	29	29.50	78	36	164	11	
L2TP3084R	1102	1411	1627	29	29.50	84	36	178	12	
L2TP3672R	1119	1429	1639	29	29.50	72	42	188	12	
L2TP3678R	1156	1485	1713	29	29.50	78	42	202	12	
L2TP3684R	1193	1547	1785	29	29.50	84	42	217	13	

L2TPH-L • P-Shaped Top Left with Half Modesty & Leg

• Add \$118 to list price for chrome leg option.

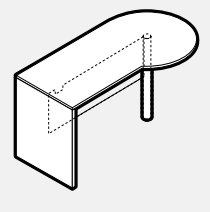

PRODUCT CODE	FINISH LP	B	W	SIZE/INCHES				D	WEIGHT LBS	VOL FT ³
				H (LP/B)	H (W)	W	D			
L2TPH3060L	987	1216	1378	29	29.50	60	36	117	9	
L2TPH3066L	1027	1275	1454	29	29.50	66	36	131	9	
L2TPH3072L	1067	1338	1526	29	29.50	72	36	145	10	
L2TPH3078L	1108	1398	1602	29	29.50	78	36	160	11	
L2TPH3084L	1152	1460	1675	29	29.50	84	36	174	12	
L2TPH3672L	1137	1448	1656	29	29.50	72	42	184	12	
L2TPH3678L	1181	1516	1743	29	29.50	78	42	198	12	
L2TPH3684L	1227	1585	1826	29	29.50	84	42	212	13	

L2TPH-R • P-Shaped Top Right with Half Modesty & Leg

• Add \$118 to list price for chrome leg option.

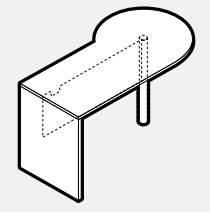

PRODUCT CODE	FINISH LP	B	W	SIZE/INCHES				D	WEIGHT LBS	VOL FT ³
				H (LP/B)	H (W)	W	D			
L2TPH3060R	987	1216	1378	29	29.50	60	36	117	9	
L2TPH3066R	1027	1275	1454	29	29.50	66	36	131	9	
L2TPH3072R	1067	1338	1526	29	29.50	72	36	145	10	
L2TPH3078R	1108	1398	1602	29	29.50	78	36	160	11	
L2TPH3084R	1152	1460	1675	29	29.50	84	36	174	12	
L2TPH3672R	1137	1448	1656	29	29.50	72	42	184	12	
L2TPH3678R	1181	1516	1743	29	29.50	78	42	198	12	
L2TPH3684R	1227	1585	1826	29	29.50	84	42	212	13	

L2TH-L • Hockey Shaped Top Left with T-Base & Leg

• Add \$118 to list price for chrome leg option.

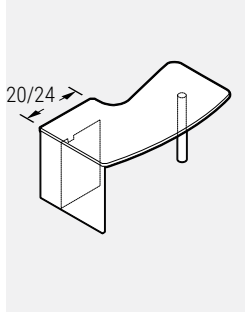

PRODUCT CODE	FINISH LP	B	W	SIZE/INCHES			D	WEIGHT LBS	VOL FT ³
				H(LP/B)	H(W)	W			
For 20" Return Connection									
L2TH203060L	1018	1255	1430	29	29.50	60	36	121	9
L2TH203066L	1051	1302	1496	29	29.50	66	36	135	9
L2TH203072L	1083	1355	1560	29	29.50	72	36	150	10
L2TH203078L	1112	1406	1627	29	29.50	78	36	164	11
L2TH203084L	1143	1460	1690	29	29.50	84	36	178	12
L2TH203660L	1089	1358	1556	29	29.50	60	42	188	10
L2TH203666L	1126	1417	1632	29	29.50	66	42	202	11
L2TH203672L	1165	1476	1706	29	29.50	72	42	217	12
L2TH203678L	1199	1539	1780	29	29.50	78	42	220	12
L2TH203684L	1234	1599	1856	29	29.50	84	42	237	13
For 24" Return Connection									
L2TH3060L	1018	1255	1430	29	29.50	60	36	121	9
L2TH3066L	1051	1302	1496	29	29.50	66	36	135	9
L2TH3072L	1083	1355	1560	29	29.50	72	36	150	10
L2TH3078L	1112	1406	1627	29	29.50	78	36	164	11
L2TH3084L	1143	1460	1690	29	29.50	84	36	178	12
L2TH3660L	1089	1358	1556	29	29.50	60	42	188	10
L2TH3666L	1126	1417	1632	29	29.50	66	42	202	11
L2TH3672L	1165	1476	1706	29	29.50	72	42	217	12
L2TH3678L	1199	1539	1780	29	29.50	78	42	220	12
L2TH3684L	1234	1599	1856	29	29.50	84	42	237	13

L2TH-R • Hockey Shaped Top Right with T-Base & Leg

• Add \$118 to list price for chrome leg option.

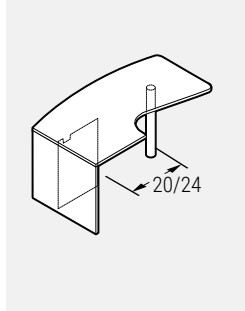

PRODUCT CODE	FINISH LP	B	W	SIZE/INCHES			D	WEIGHT LBS	VOL FT ³
				H(LP/B)	H(W)	W			
For 20" Return Connection									
L2TH203060R	1018	1255	1430	29	29.50	60	36	121	9
L2TH203066R	1051	1302	1496	29	29.50	66	36	135	9
L2TH203072R	1083	1355	1560	29	29.50	72	36	150	10
L2TH203078R	1112	1406	1627	29	29.50	78	36	164	11
L2TH203084R	1143	1460	1690	29	29.50	84	36	178	12
L2TH203660R	1089	1358	1556	29	29.50	60	42	188	10
L2TH203666R	1126	1417	1632	29	29.50	66	42	202	11
L2TH203672R	1165	1476	1706	29	29.50	72	42	217	12
L2TH203678R	1199	1539	1780	29	29.50	78	42	220	12
L2TH203684R	1234	1599	1856	29	29.50	84	42	237	13
For 24" Return Connection									
L2TH3060R	1018	1255	1430	29	29.50	60	36	121	9
L2TH3066R	1051	1302	1496	29	29.50	66	36	135	9
L2TH3072R	1083	1355	1560	29	29.50	72	36	150	10
L2TH3078R	1112	1406	1627	29	29.50	78	36	164	11
L2TH3084R	1143	1460	1690	29	29.50	84	36	178	12
L2TH3660R	1089	1358	1556	29	29.50	60	42	188	10
L2TH3666R	1126	1417	1632	29	29.50	66	42	202	11
L2TH3672R	1165	1476	1706	29	29.50	72	42	217	12
L2TH3678R	1199	1539	1780	29	29.50	78	42	220	12
L2TH3684R	1234	1599	1856	29	29.50	84	42	237	13

L2THH-L • Hockey Shaped Top Left with Half Modesty & Leg

• Add \$118 to list price for chrome leg option.

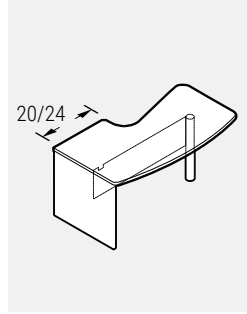

PRODUCT CODE	FINISH LP	B	W	SIZE/INCHES			D	WEIGHT LBS	VOL FT ³
				H(LP/B)	H(W)	W			
For 20" Return Connection									
L2THH203060L	1027	1262	1438	29	29.50	60	36	117	9
L2THH203066L	1067	1325	1516	29	29.50	66	36	131	9
L2THH203072L	1109	1388	1590	29	29.50	72	36	145	10
L2THH203078L	1153	1448	1668	29	29.50	78	36	160	11
L2THH203084L	1196	1511	1743	29	29.50	84	36	174	12
L2THH203660L	1090	1358	1556	29	29.50	60	42	184	10
L2THH203666L	1135	1429	1640	29	29.50	66	42	198	11
L2THH203672L	1181	1498	1724	29	29.50	72	42	212	12
L2THH203678L	1231	1568	1812	29	29.50	78	42	220	12
L2THH203684L	1272	1639	1895	29	29.50	84	42	237	13
For 24" Return Connection									
L2THH3060L	1027	1262	1438	29	29.50	60	36	117	9
L2THH3066L	1067	1325	1516	29	29.50	66	36	131	9
L2THH3072L	1109	1388	1590	29	29.50	72	36	145	10
L2THH3078L	1153	1448	1668	29	29.50	78	36	160	11
L2THH3084L	1196	1511	1743	29	29.50	84	36	174	12
L2THH3660L	1090	1358	1556	29	29.50	60	42	184	10
L2THH3666L	1135	1429	1640	29	29.50	66	42	198	11
L2THH3672L	1181	1498	1724	29	29.50	72	42	212	12
L2THH3678L	1231	1568	1812	29	29.50	78	42	220	12
L2THH3684L	1272	1639	1895	29	29.50	84	42	237	13

L2THH-R • Hockey Shaped Top Right with Half Modesty & Leg

• Add \$118 to list price for chrome leg option.

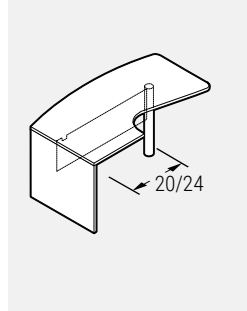

PRODUCT CODE	FINISH LP	B	W	SIZE/INCHES			D	WEIGHT LBS	VOL FT ³
				H(LP/B)	H(W)	W			
For 20" Return Connection									
L2THH203060R	1027	1262	1438	29	29.50	60	36	117	9
L2THH203066R	1067	1325	1516	29	29.50	66	36	131	9
L2THH203072R	1109	1388	1590	29	29.50	72	36	145	10
L2THH203078R	1153	1448	1668	29	29.50	78	36	160	11
L2THH203084R	1196	1511	1743	29	29.50	84	36	174	12
L2THH203660R	1090	1358	1556	29	29.50	60	42	184	10
L2THH203666R	1135	1429	1640	29	29.50	66	42	198	11
L2THH203672R	1181	1498	1724	29	29.50	72	42	212	12
L2THH203678R	1231	1568	1812	29	29.50	78	42	220	12
L2THH203684R	1272	1639	1895	29	29.50	84	42	237	13
For 24" Return Connection									
L2THH3060R	1027	1262	1438	29	29.50	60	36	117	9
L2THH3066R	1067	1325	1516	29	29.50	66	36	131	9
L2THH3072R	1109	1388	1590	29	29.50	72	36	145	10
L2THH3078R	1153	1448	1668	29	29.50	78	36	160	11
L2THH3084R	1196	1511	1743	29	29.50	84	36	174	12
L2THH3660R	1090	1358	1556	29	29.50	60	42	184	10
L2THH3666R	1135	1429	1640	29	29.50	66	42	198	11
L2THH3672R	1181	1498	1724	29	29.50	72	42	212	12
L2THH3678R	1231	1568	1812	29	29.50	78	42	220	12
L2THH3684R	1272	1639	1895	29	29.50	84	42	237	13

L2TEDH-L • Extended “D” with Half Modesty & Leg

• Add \$118 to list price for chrome leg option.

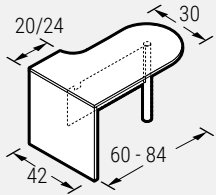

PRODUCT CODE	FINISH LP	B	W	SIZE/INCHES			D	WEIGHT LBS	VOL FT ³
				H(LP/B)	H(W)	W			
For 20" Return Connection									
L2TEDH603020L	1114	1327	1519	29	29.50	60	42	110	8
L2TEDH663020L	1160	1394	1602	29	29.50	66	42	121	9
L2TEDH723020L	1205	1461	1684	29	29.50	72	42	132	10
L2TEDH783020L	1257	1529	1766	29	29.50	78	42	143	11
L2TEDH843020L	1299	1599	1848	29	29.50	84	42	154	12
For 24" Return Connection									
L2TEDH603024L	1114	1327	1519	29	29.50	60	42	110	8
L2TEDH663024L	1160	1394	1602	29	29.50	66	42	121	9
L2TEDH723024L	1205	1461	1684	29	29.50	72	42	132	10
L2TEDH783024L	1257	1529	1766	29	29.50	78	42	143	11
L2TEDH843024L	1299	1599	1848	29	29.50	84	42	154	12

L2TED-L • Extended “D” with T-Base & Leg

• Add \$118 to list price for chrome leg option.

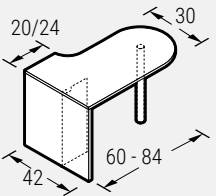

PRODUCT CODE	FINISH LP	B	W	SIZE/INCHES			D	WEIGHT LBS	VOL FT ³
				H(LP/B)	H(W)	W			
For 20" Return Connection									
L2TED603020L	1102	1301	1491	29	29.50	60	42	110	8
L2TED663020L	1139	1358	1563	29	29.50	66	42	121	9
L2TED723020L	1174	1416	1635	29	29.50	72	42	132	10
L2TED783020L	1210	1473	1708	29	29.50	78	42	143	11
L2TED843020L	1246	1529	1779	29	29.50	84	42	154	12
For 24" Return Connection									
L2TED603024L	1102	1301	1491	29	29.50	60	42	110	8
L2TED663024L	1139	1358	1563	29	29.50	66	42	121	9
L2TED723024L	1174	1416	1635	29	29.50	72	42	132	10
L2TED783024L	1210	1473	1708	29	29.50	78	42	143	11
L2TED843024L	1246	1529	1779	29	29.50	84	42	154	12

L2TEDH-R • Extended “D” with Half Modesty & Leg

• Add \$118 to list price for chrome leg option.

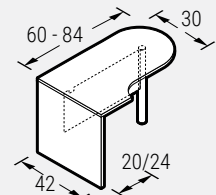

PRODUCT CODE	FINISH LP	B	W	SIZE/INCHES			D	WEIGHT LBS	VOL FT ³
				H(LP/B)	H(W)	W			
For 20" Return Connection									
L2TEDH603020R	1114	1327	1519	29	29.50	60	42	110	8
L2TEDH663020R	1160	1394	1602	29	29.50	66	42	121	9
L2TEDH723020R	1205	1461	1684	29	29.50	72	42	132	10
L2TEDH783020R	1257	1529	1766	29	29.50	78	42	143	11
L2TEDH843020R	1299	1599	1848	29	29.50	84	42	154	12
For 24" Return Connection									
L2TEDH603024R	1114	1327	1519	29	29.50	60	42	110	8
L2TEDH663024R	1160	1394	1602	29	29.50	66	42	121	9
L2TEDH723024R	1205	1461	1684	29	29.50	72	42	132	10
L2TEDH783024R	1257	1529	1766	29	29.50	78	42	143	11
L2TEDH843024R	1299	1599	1848	29	29.50	84	42	154	12

L2TED-R • Extended “D” with T-Base & Leg

• Add \$118 to list price for chrome leg option.

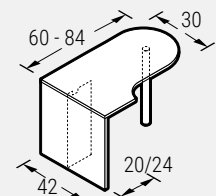

PRODUCT CODE	FINISH LP	B	W	SIZE/INCHES			D	WEIGHT LBS	VOL FT ³
				H(LP/B)	H(W)	W			
For 20" Return Connection									
L2TED603020R	1102	1301	1491	29	29.50	60	42	110	8
L2TED663020R	1139	1358	1563	29	29.50	66	42	121	9
L2TED723020R	1174	1416	1635	29	29.50	72	42	132	10
L2TED783020R	1210	1473	1708	29	29.50	78	42	143	11
L2TED843020R	1246	1529	1779	29	29.50	84	42	154	12
For 24" Return Connection									
L2TED603024R	1102	1301	1491	29	29.50	60	42	110	8
L2TED663024R	1139	1358	1563	29	29.50	66	42	121	9
L2TED723024R	1174	1416	1635	29	29.50	72	42	132	10
L2TED783024R	1210	1473	1708	29	29.50	78	42	143	11
L2TED843024R	1246	1529	1779	29	29.50	84	42	154	12

L2TROL • Licence 2 Top with “O” Leg and T base

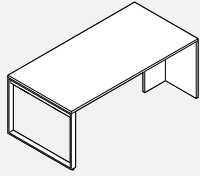

- Includes worksurface, loop leg and laminate T base.
- BG5 grommet please specify TC only.
- Loop leg is painted please specify standard paint colour.

PRODUCT CODE	FINISH		SIZE / INCHES					WEIGHT		VOL FT ³
	LP	B	W	H (LP/B)	H (W)	D	W	LBS		
L2TROL2442	916	982	1072	29	29.5	24	42	138	5	
L2TROL2448	955	1035	1119	29	29.5	24	48	153	5	
L2TROL2454	998	1089	1166	29	29.5	24	54	168	6	
L2TROL2460	1033	1135	1211	29	29.5	24	60	183	6	
L2TROL2466	1046	1155	1258	29	29.5	24	66	198	6	
L2TROL2472	1062	1174	1304	29	29.5	24	72	213	7	
L2TROL2478	1088	1204	1346	29	29.5	24	78	228	7	
L2TROL2484	1118	1241	1392	29	29.5	24	84	243	7	
L2TROL3042	1072	1158	1236	29	29.5	30	42	168	7	
L2TROL3048	1088	1177	1246	29	29.5	30	48	187	7	
L2TROL3054	1113	1203	1346	29	29.5	30	54	206	8	
L2TROL3060	1135	1243	1404	29	29.5	30	60	225	8	
L2TROL3066	1147	1262	1460	29	29.5	30	66	243	8	
L2TROL3072	1170	1289	1514	29	29.5	30	72	262	9	
L2TROL3078	1194	1315	1568	29	29.5	30	78	281	9	
L2TROL3084	1237	1371	1626	29	29.5	30	84	300	10	
L2TROL3642	1177	1260	1392	29	29.5	36	42	200	7	
L2TROL3648	1222	1312	1461	29	29.5	36	48	222	8	
L2TROL3654	1262	1367	1529	29	29.5	36	54	245	8	
L2TROL3660	1306	1419	1601	29	29.5	36	60	267	9	
L2TROL3666	1349	1474	1669	29	29.5	36	66	290	9	
L2TROL3672	1392	1526	1738	29	29.5	36	72	312	10	
L2TROL3678	1434	1579	1806	29	29.5	36	78	335	10	
L2TROL3684	1476	1634	1876	29	29.5	36	84	357	11	

L2TCROL • Licence 2 Return with “O” Leg

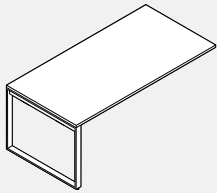

- Includes worksurface, loop leg and connecting brackets and connecting flat brackets
- HAT channel is standard on all tops except 42 and 48 wide
- BG5 grommet please specify TL,TC,TR
- Loop leg is painted please specify standard paint colour
- Worksurface supporting pedestals and laterals will not fit due to the metal channel under the surface.

PRODUCT CODE	FINISH		SIZE / INCHES					WEIGHT		VOL FT ³
	LP	B	W	H (LP/B)	H (W)	D	W	LBS		
L2TCROL2442	682	748	840	29	29.5	24	42	110	4	
L2TCROL2448	722	802	886	29	29.5	24	48	125	5	
L2TCROL2454	828	919	996	29	29.5	24	54	140	5	
L2TCROL2460	870	975	1052	29	29.5	24	60	155	5	
L2TCROL2466	894	1001	1103	29	29.5	24	66	170	6	
L2TCROL2472	918	1030	1160	29	29.5	24	72	185	6	
L2TCROL2478	952	1068	1211	29	29.5	24	78	200	6	
L2TCROL2484	988	1114	1264	29	29.5	24	84	215	7	
L2TCROL3042	814	898	977	29	29.5	30	42	137	6	
L2TCROL3048	828	919	988	29	29.5	30	48	156	6	
L2TCROL3054	918	1007	1153	29	29.5	30	54	175	7	
L2TCROL3060	950	1057	1216	29	29.5	30	60	194	7	
L2TCROL3066	970	1086	1280	29	29.5	30	66	212	8	
L2TCROL3072	1000	1119	1344	29	29.5	30	72	231	8	
L2TCROL3078	1033	1155	1407	29	29.5	30	78	250	8	
L2TCROL3084	1086	1218	1471	29	29.5	30	84	269	9	
L2TCROL3642	919	1000	1132	29	29.5	36	42	164	7	
L2TCROL3648	962	1055	1201	29	29.5	36	48	186	7	
L2TCROL3654	1066	1170	1333	29	29.5	36	54	209	8	
L2TCROL3660	1121	1234	1412	29	29.5	36	60	231	8	
L2TCROL3666	1171	1298	1491	29	29.5	36	66	254	9	
L2TCROL3672	1223	1357	1568	29	29.5	36	72	276	9	
L2TCROL3678	1272	1417	1645	29	29.5	36	78	299	10	
L2TCROL3684	1325	1481	1721	29	29.5	36	84	321	10	

L2TDOL • Licence 2 Top with Two “O” Legs

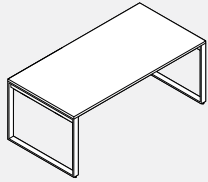

- Includes worksurface, 2 loop legs
- HAT channel is standard on all tops except 42 and 48 wide
- BG5 grommet please specify TL,TC,TR
- Loop leg is painted please specify standard paint colour
- Worksurface supporting pedestals and laterals will not fit due to the metal channel under the surface.

PRODUCT CODE	FINISH			SIZE / INCHES				WEIGHT		VOL FT ³
	LP	B	W	H (LP/B)	H (W)	D	W	LBS		
L2TDOL2442	1087	1153	1243	29	29.5	24	42	115	6	
L2TDOL2448	1126	1205	1290	29	29.5	24	48	130	7	
L2TDOL2454	1233	1324	1398	29	29.5	24	54	145	7	
L2TDOL2460	1275	1378	1456	29	29.5	24	60	160	7	
L2TDOL2466	1299	1406	1508	29	29.5	24	66	175	8	
L2TDOL2472	1323	1435	1566	29	29.5	24	72	190	8	
L2TDOL2478	1355	1473	1615	29	29.5	24	78	205	8	
L2TDOL2484	1394	1517	1668	29	29.5	24	84	220	9	
L2TDOL3042	1280	1368	1443	29	29.5	30	42	143	9	
L2TDOL3048	1296	1385	1457	29	29.5	30	48	162	9	
L2TDOL3054	1383	1474	1617	29	29.5	30	54	181	10	
L2TDOL3060	1415	1524	1683	29	29.5	30	60	200	10	
L2TDOL3066	1436	1550	1747	29	29.5	30	66	218	11	
L2TDOL3072	1469	1585	1811	29	29.5	30	72	237	11	
L2TDOL3078	1499	1620	1874	29	29.5	30	78	256	11	
L2TDOL3084	1550	1684	1936	29	29.5	30	84	275	12	
L2TDOL3642	1434	1515	1646	29	29.5	36	42	170	10	
L2TDOL3648	1475	1568	1717	29	29.5	36	48	192	10	
L2TDOL3654	1581	1684	1848	29	29.5	36	54	215	11	
L2TDOL3660	1634	1747	1927	29	29.5	36	60	237	11	
L2TDOL3666	1686	1811	2005	29	29.5	36	66	260	12	
L2TDOL3672	1736	1870	2083	29	29.5	36	72	282	12	
L2TDOL3678	1786	1933	2159	29	29.5	36	78	305	13	
L2TDOL3684	1839	1994	2235	29	29.5	36	84	327	13	

Technical Information

- All units must be connected to an adjoining unit with flat brackets included.
- Grommet option for Runoff tables are "TC" only.
- NOTE: All Runoff tables includes HAT CHANNEL support.

OPTIONS:

Top: LP - LPL (Low Pressure Laminate) Thickness 1"
 HP B - B Thickness 1 1/16"
 HP W - W Thickness 1 7/16"

Leg Option: BHML03 (DEFAULT) Round Monoleg
 LLSQ3X3H28 - Square Leg

Top Finish Laminate: Choose Colour

Top PVC Edging: Choose Colour

Metal Leg Finish: Choose Colour

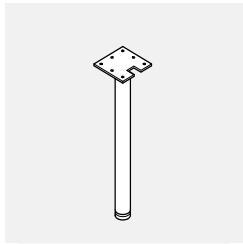

BHML03

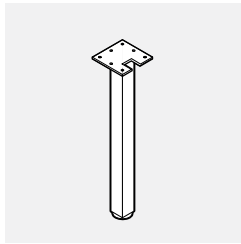

LLSQ3X3H28

L2TCD • "D" Shaped Runoff with Leg

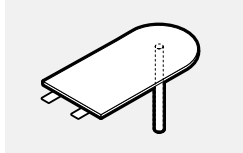

• Add \$118 to list price for chrome leg option.

PRODUCT CODE	FINISH			SIZE / INCHES				WEIGHT LBS	VOL FT ³
	LP	B	W	H (LP/B)	H (W)	W	D		
L2TCD3060	734	922	975	29	29.5	60	30	97	4
L2TCD3066	780	985	1052	29	29.5	66	30	106	6
L2TCD3660	800	1022	1101	29	29.5	60	36	97	4
L2TCD3666	835	1078	1167	29	29.5	66	36	106	6

L2TCR1L • Rectangular Shaped Runoff

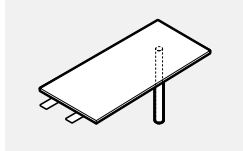

• Add \$118 to list price for chrome leg option.

PRODUCT CODE	FINISH			SIZE / INCHES				WEIGHT LBS	VOL FT ³
	LP	B	W	H (LP/B)	H (W)	W	D		
L2TCR1L3060	711	888	947	29	29.5	60	30	97	4
L2TCR1L3066	740	935	998	29	29.5	66	30	106	6
L2TCR1L3660	758	970	1043	29	29.5	60	36	97	4
L2TCR1L3666	792	1023	1106	29	29.5	66	36	106	6

L2TCA1L • Axe Shaped Runoff

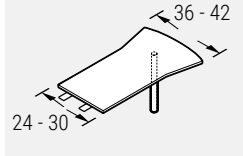

• Add \$118 to list price for chrome leg option.

PRODUCT CODE	FINISH			SIZE / INCHES				WEIGHT LBS	VOL FT ³
	LP	B	W	H (LP/B)	H (W)	W	D		
L2TCA1L2460	761	972	1053	29	29.5	60	36	119	4
L2TCA1L2466	796	1026	1113	29	29.5	66	36	130	6
L2TCA1L3060	809	1051	1147	29	29.5	60	42	119	4
L2TCA1L3066	849	1109	1216	29	29.5	66	42	130	6

L2TCP • "P" Shaped Runoff with Leg

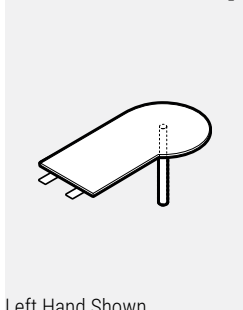

• Add \$118 to list price for chrome leg option.

PRODUCT CODE	FINISH			SIZE / INCHES				WEIGHT LBS	VOL FT ³
	LP	B	W	H (LP/B)	H (W)	W	D		
Right									
L2TCP3060R	797	1018	1101	29	29.5	60	36	119	4
L2TCP3066R	833	1074	1167	29	29.5	66	36	130	6
L2TCP3660R	851	1103	1204	29	29.5	60	42	119	4
L2TCP3666R	892	1168	1276	29	29.5	66	42	130	6
Left									
L2TCP3060L	797	1018	1101	29	29.5	60	36	119	4
L2TCP3066L	833	1074	1167	29	29.5	66	36	130	6
L2TCP3660L	851	1103	1204	29	29.5	60	42	119	4
L2TCP3666L	892	1168	1276	29	29.5	66	42	130	6

Left Hand Shown

L2TCW • Wedge Shaped Runoff with Leg

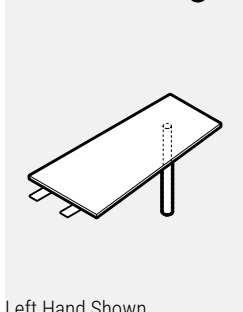

• Add \$118 to list price for chrome leg option.

PRODUCT CODE	FINISH			SIZE / INCHES				WEIGHT LBS	VOL FT ³
	LP	B	W	H (LP/B)	H (W)	W	D		
Right									
L2TCW3060R	755	942	1011	29	29.5	60	30	119	4
L2TCW3066R	788	994	1065	29	29.5	66	30	130	6
L2TCW3660R	809	1029	1117	29	29.5	60	36	119	4
L2TCW3666R	845	1087	1177	29	29.5	66	36	130	6
Left									
L2TCW3060L	755	942	1011	29	29.5	60	30	119	4
L2TCW3066L	788	994	1065	29	29.5	66	30	130	6
L2TCW3660L	809	1029	1117	29	29.5	60	36	119	4
L2TCW3666L	845	1087	1177	29	29.5	66	36	130	6

Left Hand Shown

Floating Tops

- Monolegs and Support channel ships in a separate box.
- Floating tops are not pre-drilled to accept monolegs or spacers.
- Grommet locations (TC only) must be specified at the time of order or it will default to "No Grommet" option.
- Floating top must be placed on top of 1H credenza or 1H lateral open.
- Grommet Option **TC** only
- All Floating tables include HAT CHANNEL support.

LLSQ3X3 • "Spacer" Leg



PRODUCT CODE	PRICE	CHROME OPT	SIZE/INCHES			WEIGHT LBS	VOL FT ³
			H	W	D		
LLSQ3X3	149	253	8	3	3	4	0.09

LLSQ3X3H28 • Square Leg

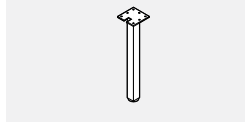

PRODUCT CODE	PRICE	CHROME OPT	SIZE/INCHES			WEIGHT LBS	VOL FT ³
			H	W	D		
LLSQ3X3H28	281	372	28	3	3	4	0.17

L2FD • Floating "D" Shaped with Legs and Spacers

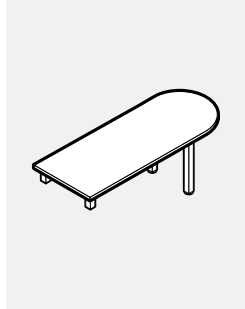

- Add \$469 to list price for chrome leg option.

PRODUCT CODE	FINISH LP	B	W	SIZE/INCHES				WEIGHT LBS	VOL FT ³
				H (LP/B)	H (W)	W	D		
L2FD3060	969	1167	1186	29	29.5	60	30	53	7
L2FD3066	1000	1214	1237	29	29.5	66	30	57	7
L2FD3072	1033	1264	1292	29	29.5	72	30	62	8
L2FD3078	1067	1320	1344	29	29.5	78	30	64	8
L2FD3084	1114	1381	1396	29	29.5	84	30	68	9
L2FD3660	1017	1272	1368	29	29.5	60	36	57	8
L2FD3666	1053	1330	1435	29	29.5	66	36	63	8
L2FD3672	1089	1391	1499	29	29.5	72	36	68	9
L2FD3678	1131	1454	1566	29	29.5	78	36	70	9
L2FD3684	1177	1524	1633	29	29.5	84	36	75	10

L2FR • Floating Rectangular Shaped with Legs and Spacers

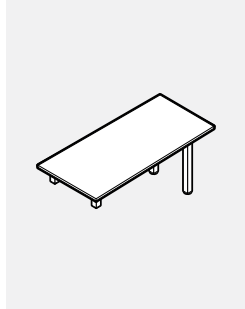

- Add \$469 to list price for chrome leg option.

PRODUCT CODE	FINISH LP	B	W	SIZE/INCHES				WEIGHT LBS	VOL FT ³
				H (LP/B)	H (W)	W	D		
L2FR2460	917	1083	1108	29	29.5	60	24	51	6
L2FR2466	943	1125	1154	29	29.5	66	24	55	6
L2FR2472	973	1167	1199	29	29.5	72	24	59	7
L2FR2478	1004	1210	1241	29	29.5	78	24	62	7
L2FR2484	1045	1265	1290	29	29.5	84	24	66	8
L2FR3060	963	1165	1208	29	29.5	60	30	53	7
L2FR3066	998	1210	1262	29	29.5	66	30	57	7
L2FR3072	1030	1262	1318	29	29.5	72	30	62	8
L2FR3078	1066	1317	1369	29	29.5	78	30	64	8
L2FR3084	1109	1375	1424	29	29.5	84	30	68	9
L2FR3660	1012	1241	1336	29	29.5	60	36	57	8
L2FR3666	1051	1300	1398	29	29.5	66	36	63	8
L2FR3672	1088	1358	1464	29	29.5	72	36	68	9
L2FR3678	1128	1417	1529	29	29.5	78	36	70	9
L2FR3684	1175	1487	1594	29	29.5	84	36	75	10

L2FA • Floating Axe Shaped with Legs and Spacers

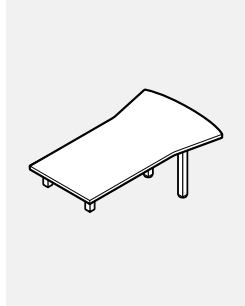

- Add \$469 to list price for chrome leg option.

PRODUCT CODE	FINISH LP	B	W	SIZE/INCHES				WEIGHT LBS	VOL FT ³
				H (LP/B)	H (W)	W	D		
L2FA3060	1067	1332	1419	29	29.5	60	42	77	8
L2FA3066	1109	1397	1491	29	29.5	66	42	81	8
L2FA3072	1153	1463	1564	29	29.5	72	42	84	9
L2FA3078	1198	1530	1635	29	29.5	78	42	88	9
L2FA3084	1254	1607	1708	29	29.5	84	42	95	10
L2FA3660	1139	1436	1552	29	29.5	60	48	83	9
L2FA3666	1182	1508	1634	29	29.5	66	48	88	9
L2FA3672	1232	1581	1717	29	29.5	72	48	90	10
L2FA3678	1276	1656	1798	29	29.5	78	48	95	11
L2FA3684	1336	1741	1876	29	29.5	84	48	101	11

L2FP • Floating “P” Shaped with Legs and Spacers

• Add \$469 to list price for chrome leg option.

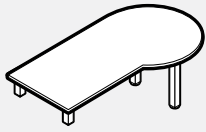

Left Hand Shown

PRODUCT CODE	FINISH		SIZE/INCHES						WEIGHT LBS	VOL FT ³
	LP	B	W	H (LP/B)	H (W)	W	D			
Right										
L2FP3060R	1034	1265	1340	29	29.5	60	36	66	8	
L2FP3066R	1069	1325	1405	29	29.5	66	36	70	8	
L2FP3072R	1108	1381	1469	29	29.5	72	36	75	9	
L2FP3078R	1148	1441	1529	29	29.5	78	36	77	9	
L2FP3084R	1198	1511	1592	29	29.5	84	36	81	10	
L2FP3660R	1087	1351	1443	29	29.5	60	42	70	9	
L2FP3666R	1126	1415	1516	29	29.5	66	42	76	9	
L2FP3672R	1168	1481	1588	29	29.5	72	42	81	10	
L2FP3678R	1212	1548	1660	29	29.5	78	42	84	11	
L2FP3684R	1265	1626	1735	29	29.5	84	42	88	11	
Left										
L2FP3060L	1034	1265	1340	29	29.5	60	36	66	8	
L2FP3066L	1069	1325	1405	29	29.5	66	36	70	8	
L2FP3072L	1108	1381	1469	29	29.5	72	36	75	9	
L2FP3078L	1148	1441	1529	29	29.5	78	36	77	9	
L2FP3084L	1198	1511	1592	29	29.5	84	36	81	10	
L2FP3660L	1087	1351	1443	29	29.5	60	42	70	9	
L2FP3666L	1126	1415	1516	29	29.5	66	42	76	9	
L2FP3672L	1168	1481	1588	29	29.5	72	42	81	10	
L2FP3678L	1212	1548	1660	29	29.5	78	42	84	11	
L2FP3684L	1265	1626	1735	29	29.5	84	42	88	11	

L2FW • Floating Wedge Shaped with Legs and Spacers

• Add \$469 to list price for chrome leg option.

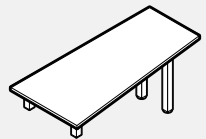

Left Hand Shown

PRODUCT CODE	FINISH		SIZE/INCHES						WEIGHT LBS	VOL FT ³
	LP	B	W	H (LP/B)	H (W)	W	D			
Right										
L2FW3060R	969	1167	1210	29	29.5	60	30	53	7	
L2FW3066R	1000	1214	1266	29	29.5	66	30	57	7	
L2FW3072R	1033	1264	1323	29	29.5	72	30	62	8	
L2FW3078R	1067	1320	1374	29	29.5	78	30	64	8	
L2FW3084R	1114	1381	1429	29	29.5	84	30	68	9	
L2FW3660R	1012	1241	1306	29	29.5	60	36	57	8	
L2FW3666R	1051	1300	1369	29	29.5	66	36	63	8	
L2FW3672R	1088	1358	1434	29	29.5	72	36	68	9	
L2FW3678R	1128	1417	1497	29	29.5	78	36	70	9	
L2FW3684R	1175	1487	1560	29	29.5	84	36	75	10	
Left										
L2FW3060L	969	1167	1210	29	29.5	60	30	53	7	
L2FW3066L	1000	1214	1266	29	29.5	66	30	57	7	
L2FW3072L	1033	1264	1323	29	29.5	72	30	62	8	
L2FW3078L	1067	1320	1374	29	29.5	78	30	64	8	
L2FW3084L	1114	1381	1429	29	29.5	84	30	68	9	
L2FW3660L	1012	1241	1306	29	29.5	60	36	57	8	
L2FW3666L	1051	1300	1369	29	29.5	66	36	63	8	
L2FW3672L	1088	1358	1434	29	29.5	72	36	68	9	
L2FW3678L	1128	1417	1497	29	29.5	78	36	70	9	
L2FW3684L	1175	1487	1560	29	29.5	84	36	75	10	

L2FBR • Floating top Rectangular with Legs / SPACERS SOLD SEPARATELY

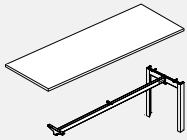

- Anodized aluminum leg upcharge \$55.
- Due to beam location, grommet is only available as a special request, please contact your customer service representative.
- Worksurface supporting pedestals and laterals will not fit due to the metal channel under the surface.

PRODUCT CODE	FINISH LP	B	W	SIZE/INCHES				WEIGHT		VOL FT ³
				H (LP/B)	H (W)	W	D	LBS	FT ³	
L2FBR2466	853	982	1084	1	1.44	66	24	51	6	
L2FBR2472	880	1017	1128	1	1.44	72	24	55	6	
L2FBR2478	915	1063	1181	1	1.44	78	24	59	7	
L2FBR2484	954	1113	1239	1	1.44	84	24	62	7	
L2FBR3066	922	1080	1201	1	1.44	66	30	53	8	
L2FBR3072	952	1125	1257	1	1.44	72	30	57	8	
L2FBR3078	992	1175	1318	1	1.44	78	30	62	9	
L2FBR3084	1034	1235	1385	1	1.44	84	30	64	9	

L2SPBOX • Laminate Spacers with Glass Shelf

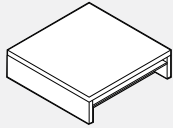

- Glazing is clear.

PRODUCT CODE	PRICE LP	SIZE/INCHES			WEIGHT		VOL FT ³
		H	W	D	LBS	FT ³	
L2SPBOX1620	563	8	16	20	15	1	
L2SPBOX1626	630	8	16	26	18	2	
L2SPBOX1634	717	8	16	34	22	5	

L2FFL • Licence Floating Tops with "O" Leg

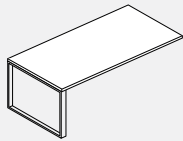

- Kit includes a worksurface, "O" leg and channel.
- Option for grommet - BG5, TC only.
- Painted loop leg, please specify standard paint colour.
- Worksurface supporting pedestals and laterals will not fit due to the metal channel under the surface.

PRODUCT CODE	FINISH LP	B	W	SIZE/INCHES				WEIGHT		VOL FT ³
				H (LP/B)	H (W)	W	D	LBS	FT ³	
L2FFL2466	829	937	1039	1	1.44	66	24	55	6	
L2FFL2472	851	963	1094	1	1.44	72	24	59	7	
L2FFL2478	883	999	1137	1	1.44	78	24	62	7	
L2FFL2484	919	1043	1193	1	1.44	84	24	66	8	
L2FFL3066	905	1021	1216	1	1.44	66	30	57	7	
L2FFL3072	933	1052	1276	1	1.44	72	30	62	8	
L2FFL3078	962	1086	1338	1	1.44	78	30	64	8	
L2FFL3084	1015	1147	1401	1	1.44	84	30	68	9	
L2FFL3666	1107	1233	1428	1	1.44	66	36	63	8	
L2FFL3672	1155	1290	1499	1	1.44	72	36	68	9	
L2FFL3678	1201	1348	1575	1	1.44	78	36	70	9	
L2FFL3684	1255	1409	1652	1	1.44	84	36	75	10	

L2HGAMP • Hanging Aluminum Framed Frosted Glazing Modesty

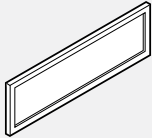

- Framed is anodize aluminum.
- Glazing is frosted acrylic.
- Hanging brackets are included.

PRODUCT CODE	PRICE	SIZE/INCHES			WEIGHT		VOL FT ³
		H	W	D	LBS	FT ³	
L2HGAMP36	505	14	35.50	0.75	12	1	
L2HGAMP42	542	14	41.50	0.75	13	1	
L2HGAMP48	579	14	47.50	0.75	14	1	
L2HGAMP54	619	14	53.50	0.75	16	1	

L2HGMP • Hanging Laminate Modesty

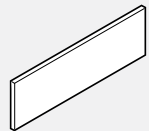

- Hanging brackets are included.

PRODUCT CODE	PRICE LP	SIZE/INCHES			WEIGHT		VOL FT ³
		H	W	D	LBS	FT ³	
L2HGMP36	295	14	36	0.75	9	1	
L2HGMP42	303	14	42	0.75	11	1	
L2HGMP48	314	14	48	0.75	13	1	
L2HGMP54	320	14	54	0.75	14	1	

General Notes

Pedestals

Pedestals are shipped assembled.

- Pedestals are offered in three types of applications: Worksurface Supporting, Freestanding, and Mobile.
- Pedestal front width is 15-1/2" with a deep size variation 18" 23" 24" 29" 30" 36"
- If specifying a pedestal for a desk or credenza, please ensure you specify next depth lower ie. 23" deep pedestal for a 24" deep credenza or desk.
- Worksurface supporting Pedestals are 28"high
- Freestanding pedestals come with the choice of "LP", "B" for 29"high or "W" thickness top for 29.5"high
- Pedestals Freestanding are on adjustable levelers
- Mobile pedestals come with a top with the choice of "LP", "B" for 29"high or "W" thickness top for 29.5"high and have front locking casters to support the pedestal.
- Pencil tray included in the top box drawer of each pedestal.
- Box drawers mounted on full extension ball bearing slides
- File drawers mounted on full extension ball bearing slides
- All file drawers come with adjustable rails for legal or letter size hanging folders. See File Drawer Capacity chart page G2.
- Pull out shelf for CPU and printer units can support 75 lbs. per shelf and has telescopic extension.
- CPU and printer units have ventilation grommet on back panel.
- Interior clearance of printer shelf is 11".
- Printer pedestals have 2 pull out shelves and the back panel has four round grommets.
- CPU pedestals have 1 pull out shelf and the back panel has two round grommets.
- Both CPU and printer units must be installed under a worksurface to prevent tipping.
- All pedestals with a door, include 1 adjustable shelf.
- Cases and fronts are finished in low pressure laminate.
- Specify thickness of the top to match the thickness of the worksurface.
- Locks are standard on all units. Available in black or silver finish. The lock will match the handle finish.

Hutches and Overheads

Hutches and overheads are shipped assembled.

- Hutches and overheads are offered in "LP" and "W" thickness with three option heights . See Storage Technical Info page G3.
- Specify thickness of hutch or overhead top to match the thickness of the worksurface.
- Cases and fronts are finished in low pressure laminate.
- Hutches and overheads with hinged doors (laminate or aluminum), flip up fronts have no handle option.
- Hutches with pigeon holes come with touch latch mechanism.
- Hutches and overheads with sliding laminate doors have standard handle options
- Hutches and overheads with sliding glass doors are offered with recessed handle only. The recessed handle is in chrome finish
- Hutches and wall mounted overheads are offered in 4 styles: Open storage, Hinged doors - laminate or anodized aluminum frame doors with the option for glazing : frosted or clear, sliding doors are laminate or glass doors and flip-up doors.
- Once installed, the bottom of the flip-up door overhead will not line up with the bottom of the open or hinged door overhead.
- Wall mounted storage cabinets must be securely attached to wall studs.
- Panel mounted overheads include attachment brackets for Boulevard panels.
- Back panels on hutches comes with a center round grommet for wire access.
- Top on hutch and overhead storage cabinets with flip-up doors is 3/4" thick Low Pressure Laminate. Doors slides on top of the unit.
- Inside dimension for hutches and wall mounted units with flip-up doors is 13 1/4" high x 14 1/2" deep
- Inside dimension for hutches and wall mounted with hinged doors is 12 3/4" high x 15 1/4" deep
- Inside dimension for open hutches and wall mounted is 12 3/4" high x 15 1/4" deep
- Inside dimension for hutches and wall mounted with sliding doors is 12-3/4"high x 13" deep
- Use double sided tape to attach hutches to worksurface.
- Locks are standard on all units. Available in black or silver finish. The lock will match the handle finish.
- Recommended to be installed against and fixed to a wall using appropriate hardware (not included).

Credenzas

Credenzas are shipped assembled.

- Credenza model # L2CR2H2H or L2CR1H1H must be ordered with counterweights to avoid tipping.
- Credenza come with the choice of "LP", "B" or "W" thickness top
- Credenzas are offered with the choice of "LP", "B" for 20"h. or 29"high and "W" thickness top for 20.5"h or 29.5"high
- Credenza come with hinged doors, laminate or anodized aluminum frame doors with the option for glazing : frosted or clear
- Locks are standard on all units. Available in black or silver finish. The lock will match the handle finish.

Bookcases

Bookcases are Shipped knocked down (KD).

- Available in 30" or 36" widths and 12.685" and 16.685"depths dimension at baseboard with range in height from 29" to 72" with 12" clearance between shelves.
- Bottom shelf is fixed and all other shelves are adjustable.
- Specify thickness of the top to match the thickness and profile of the worksurface.
- Tops are offered "LP" or "B" or "W".
- Up to 42"h, Bookcases are offered in "LP", "B", "W".
- 54"h. and up are offered in "LP" and "W".
- Recommended to be installed against and fixed to a wall using appropriate hardware (not included).

Laterals

Laterals are shipped assembled.

- Laterals are available in three widths, 30" 36", 42" with a height variation of 28" to 54" and a depth of 20" and 24".
- Tops are offered LP, B or W
- Worksurface supporting units do not come with a top.
- Up to 42"h, laterals are offered in "LP", "B", "W".
- 54"h and up are offered in "LP" and "W".
- Cases and fronts are finished in low pressure laminate.
- Laterals with hinged doors, laminate or anodized aluminum frame doors with the option for glazing: frosted or clear
- Lateral files are offered in 2 types of applications: Worksurface Supporting and Freestanding.
- All lateral files feature a drawer interlocking mechanism
- Up to 42"h, Laterals are offered in "LP", "B", "W".
- 54"h, and up are offered in "LP" and "W".
- All file drawer come with adjustable rails for legal or letter size hanging folders.
- Counterweights must be specified in a lateral configurations except worksurface supporting.
- "C" combo lateral have a pencil drawer included in the box drawer. The penciltray is parallel with the depth of the drawer.
- In "C" combo lateral, only one side can be locked.
- All laterals with a door, include 1 adjustable shelf.
- File drawers mounted on full extension ball bearing slides
- Locks are standard on all units. Available in black or silver finish. The lock will match the handle finish.

Towers and cabinets

Towers and cabinets are shipped assembled.

- Towers offered 24"w and cabinets 30"w and 36"w are offered in "LP" and "W".
- Cases are finished in low pressure laminate.
- Towers or cabinets are offered with hinged doors, laminate or anodized aluminum frame with the option for glazing: frosted or clear
- Towers or cabinets with anodized aluminum doors are offered without handles. Touch latch mechanism is included.
- Storage tower with the cupboard above FF or BBF and wardrobe will lock only the wardrobe and drawers.
- Storage tower with the wardrobe include a coat rod.
- Locks are standard on all units. Available in black or silver finish. The lock will match the handle finish.
- Counterweights must be specified for units 20" deep by 60" to 72" high with 2H2D or 2H/ Open, please order 2 x LACWB for each unit.

LATERAL FILE DRAWERS

Lateral File Drawer:

36W & 42W
Legal Filing - front to back

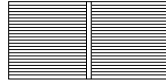

- Drawer file with plastic rail
- 30"W Size 9.44"H x 25.75"W x 16"L
- 36"W Size 9.44"H x 31.75"W x 16"L
- 42"W Size 9.44"H x 37.75"W x 16"L

Lateral File Drawer:

36W & 42W
Legal Filing - side to side
Letter Filing - front to back

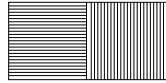

Lateral File Drawer:

30W, 36W & 42W
Letter Filing - front to back



Lateral File Drawer:

36W & 42W
Letter & Legal Filing - front to back



Lateral File Drawer:

30W, 36W & 42W
Legal Filing - side to side

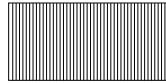

PEDESTAL DRAWERS

Box Drawer:

15.5W
Legal Filing - side to side



- 18"D Drawer Box Size 3.93"H x 13"W x 16"L
- 20.23.24.29.30.36"D Drawer Box Size 3.93"H x 13"W x 20"L

File Drawer:

15.5W
Letter Filing - front to back



- 18"D Drawer File with plastic rail Size 9.4"H x 13"W x 16"L
- 20"D and up Drawer File with plastic rail Size 9.4"H x 13"W x 20"L

File Drawer:

15.5W
Legal Filing - side to side



- 18"D Drawer File with plastic rail Size 9.4"H x 13"W x 16"L
- 20"D and up Drawer File with plastic rail Size 9.4"H x 13"W x 20"L

COMBO LATERAL FILE DRAWERS

- For 30" wide units: Drawer width is 11 3/4" and can accommodate only side to side legal or letter filing.
- For 36" wide units: Drawer width is 14 3/4" and can accommodate only side to side legal or letter filing.

STORAGE TECHNICAL INFORMATION

1" LPL TOP
LP HUTCH
LP DESK 29H
LP CABINET

1-1/16" HPL TOP
LP HUTCH
B TOP DESK 29H
LP CABINET

1-7/16" HPL TOP
W TOP HUTCH
W TOP DESK 29.5H
W CABINET

NO TACKBOARD
LTB
50" High

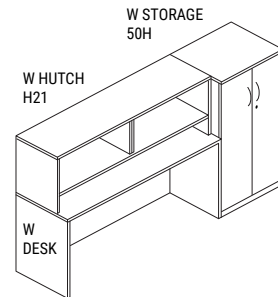
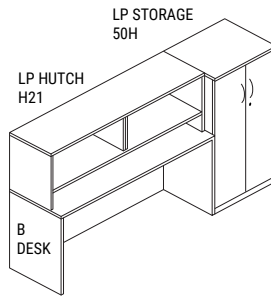
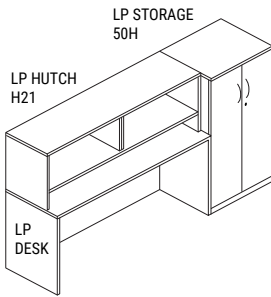

TACKBOARD
LTB21
66" High

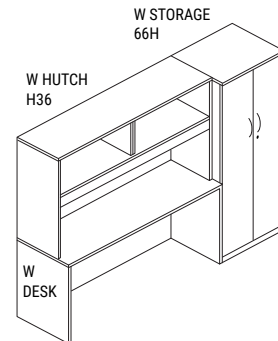
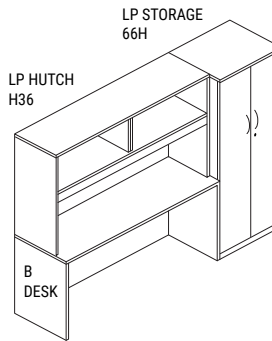
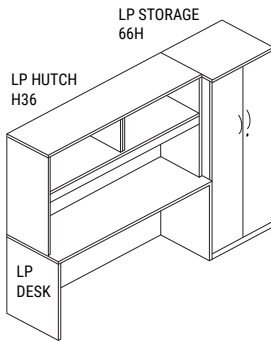

TACKBOARD
LTB27
72" High

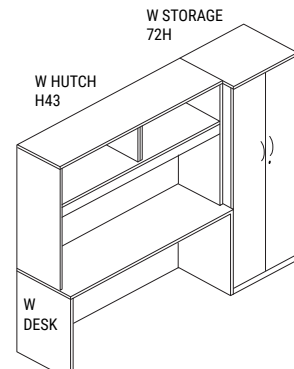
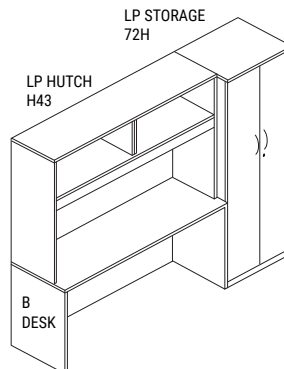
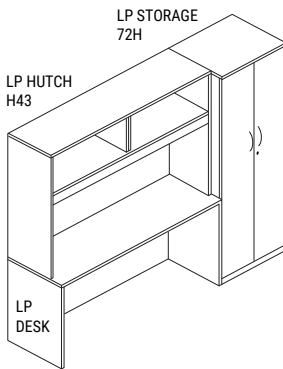

STACK ON TWO HEIGHT CABINET IS TO BE PLACED ON 1H CREDENZA

50" High
Only

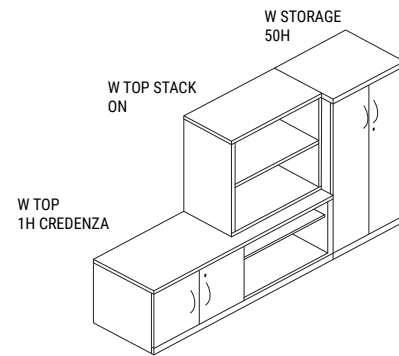
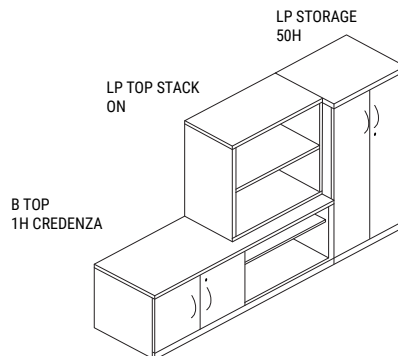
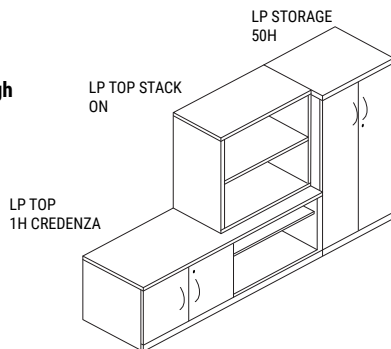

L2PBBF • Worksurface Supporting Box, Box, File Pedestal

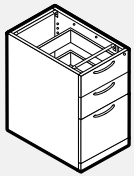

- One lock included.
- Optional e-lock available in the vertical position. Please specify V - Vertical and add \$231 list.
- Counter weight must be ordered separately.

PRODUCT CODE	PRICE LP	SIZE/INCHES			WEIGHT LBS	VOL FT ³
		H	W	D		
L2PBBF18	821	28	15.5	18	94	8
L2PBBF20	895	28	15.5	20	94	8
L2PBBF23	909	28	15.5	23	94	8
L2PBBF24	909	28	15.5	24	99	10
L2PBBF29	943	28	15.5	29	105	10
L2PBBF30	943	28	15.5	30	110	10
L2PBBF36	991	28	15.5	36	116	11

L2PFF • Worksurface Supporting File, File Pedestal

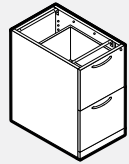

- One lock included.
- Optional e-lock available in the vertical position. Please specify V - Vertical and add \$231 list.

PRODUCT CODE	PRICE LP	SIZE/INCHES			WEIGHT LBS	VOL FT ³
		H	W	D		
L2PFF18	748	28	15.5	18	94	8
L2PFF20	837	28	15.5	20	94	8
L2PFF23	847	28	15.5	23	94	8
L2PFF24	847	28	15.5	24	99	8
L2PFF29	891	28	15.5	29	105	10
L2PFF30	891	28	15.5	30	110	10
L2PFF36	927	28	15.5	36	116	11

L2P1D • Worksurface Supporting 1 Door Pedestal

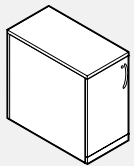

- Includes one adjustable shelf.
- One lock included.
- Optional e-lock available in the horizontal position. Please specify HL - Horizontal Left and add \$231 list.

PRODUCT CODE	PRICE LP	SIZE/INCHES			WEIGHT LBS	VOL FT ³
		H	W	D		
L2P1D18	645	28	15.5	18	66	8
L2P1D20	695	28	15.5	20	74	8
L2P1D23	714	28	15.5	23	74	8
L2P1D24	714	28	15.5	24	75	10
L2P1D29	784	28	15.5	29	84	10
L2P1D30	784	28	15.5	30	85	10

L2PBBF-F • Freestanding Box, Box, File Pedestal

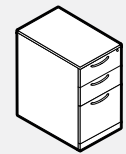

- One lock included.
- Optional e-lock available in the vertical position. Please specify V - Vertical and add \$231 list.
- Counter weight must be ordered separately.

PRODUCT CODE	FINISH LP	B	W	SIZE/INCHES				WEIGHT LBS	VOL FT ³
				H (LP/B)	H (W)	W	D		
L2PBBF20F	972	1000	1038	29	29.5	15.5	20	94	8
L2PBBF24F	987	1015	1055	29	29.5	15.5	24	99	8
L2PBBF30F	1029	1062	1106	29	29.5	15.5	30	105	10
L2PBBF36F	1077	1120	1168	29	29.5	15.5	36	116	11

L2PFF-F • Freestanding File, File Pedestal

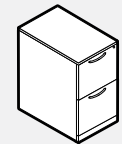

- One lock included.
- Optional e-lock available in the vertical position. Please specify V - Vertical and add \$231 list.
- Counter weight must be ordered separately.

PRODUCT CODE	FINISH LP	B	W	SIZE/INCHES				WEIGHT LBS	VOL FT ³
				H (LP/B)	H (W)	W	D		
L2PFF20F	882	909	972	29	29.5	15.5	20	99	8
L2PFF24F	894	923	988	29	29.5	15.5	24	99	8
L2PFF30F	969	1003	1043	29	29.5	15.5	30	110	10
L2PFF36F	1054	1095	1109	29	29.5	15.5	36	116	11

L2P1D-F • Freestanding 1 Door Pedestal

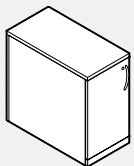

- Includes one adjustable shelf.
- One lock included.
- Optional e-lock available in the horizontal position. Please specify HL - Horizontal Left and add \$231 list.
- Counter weight must be ordered separately.

PRODUCT CODE	FINISH LP	B	W	SIZE/INCHES				WEIGHT LBS	VOL FT ³
				H (LP/B)	H (W)	W	D		
L2P1D20F	775	827	864	29	29.5	15.5	20	78	8
L2P1D24F	786	840	877	29	29.5	15.5	24	98	8
L2P1D30F	864	930	973	29	29.5	15.5	30	103	10
L2P1D36F	949	1027	1078	29	29.5	15.5	36	110	11

L2PBBF-MIT • Mobile Box, Box, File Pedestal to fit under Worksurface

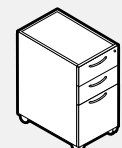

- One lock included.
- Optional e-lock available in the vertical position. Please specify V - Vertical and add \$231 list.
- Counter weight must be ordered separately.
- 18" deep mobile pedestal has a fifth caster at center bottom.

PRODUCT CODE	PRICE LP	SIZE/INCHES			WEIGHT LBS	VOL FT ³
		H	W	D		
L2PBBF18MIT	1187	28	15.5	18	99	8
L2PBBF23MIT	1254	28	15.5	23	105	8
L2PBBF29MIT	1316	28	15.5	29	110	10

L2PBBF-M • Mobile Box, Box, File Pedestal with Standard Top



- One lock included.
- Optional e-lock available in the vertical position. Please specify V - Vertical and add \$231 list.
- Counter weight must be ordered separately.
- 20" deep mobile pedestal has a fifth caster at center bottom.

PRODUCT CODE	FINISH LP	B	W	SIZE/INCHES				WEIGHT LBS	VOL FT³
				H (LP/B)	H (W)	W	D		
L2PBBF20M	1280	1287	1348	29	29.5	15.5	20	99	8
L2PBBF24M	1299	1309	1366	29	29.5	15.5	24	99	8
L2PBBF30M	1327	1356	1400	29	29.5	15.5	30	105	10
L2PBBF36M	1381	1417	1458	29	29.5	15.5	36	110	11

L2PFF-MIT • Mobile File, File Pedestal to fit under Worksurface

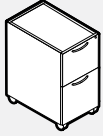

- One lock included.
- Optional e-lock available in the vertical position. Please specify V - Vertical and add \$231 list.
- Counter weight must be ordered separately.
- 18" deep mobile pedestal has a fifth caster at center bottom.

PRODUCT CODE	PRICE LP	SIZE/INCHES				WEIGHT LBS	VOL FT³
		H	W	D	D		
L2PFF18MIT	1011	28	15.5	18	99	8	
L2PFF23MIT	1076	28	15.5	23	105	8	
L2PFF29MIT	1133	28	15.5	29	110	10	

L2PFF-M • Mobile File, File Pedestal with Standard Top

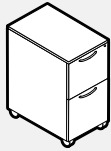

- One lock included.
- Optional e-lock available in the vertical position. Please specify V - Vertical and add \$231 list.
- Counter weight must be ordered separately.
- 20" deep mobile pedestal has a fifth caster at center bottom.

PRODUCT CODE	FINISH LP	B	W	SIZE/INCHES				WEIGHT LBS	VOL FT³
				H (LP/B)	H (W)	W	D		
L2PFF20M	1084	1109	1141	29	29.5	15.5	20	99	8
L2PFF24M	1099	1126	1162	29	29.5	15.5	24	99	8
L2PFF30M	1139	1169	1230	29	29.5	15.5	30	105	10
L2PFF36M	1198	1233	1280	29	29.5	15.5	36	110	11

L2PBF-M • Mobile Box, File Pedestal with Standard Top

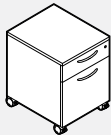

- One lock included.
- Optional e-lock available in the vertical position. Please specify V - Vertical and add \$231 list.
- Counter weight must be ordered separately.
- 20" deep mobile pedestal has a fifth caster at center bottom.

PRODUCT CODE	FINISH LP	B	W	SIZE/INCHES				WEIGHT LBS	VOL FT³
				H (LP/B)	H (W)	W	D		
L2PBF20M	944	972	1026	22.69	23.15	15.5	20	78	7
L2PBF24M	957	987	1038	22.69	23.15	15.5	24	80	7
L2PBF30M	991	1025	1064	22.69	23.15	15.5	30	90	9

L2PBF-MIT • Mobile Box, File Pedestal with Inset Top

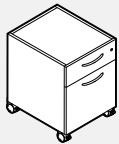

- One lock included.
- Optional e-lock available in the vertical position. Please specify V - Vertical and add \$231 list.
- Counter weight must be ordered separately.
- 18" deep mobile pedestal has a fifth caster at center bottom.

PRODUCT CODE	PRICE LP	SIZE/INCHES				WEIGHT LBS	VOL FT³
		H	W	D	D		
L2PBF18MIT	884	22	15.5	18	99	8	
L2PBF23MIT	941	22	15.5	23	99	8	
L2PBF24MIT	941	22	15.5	24	105	8	
L2PBF29MIT	994	22	15.5	29	105	8	
L2PBF30MIT	994	22	15.5	30	110	10	

L2PU • Printer Unit with 2 Pull Out Shelves

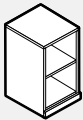

PRODUCT CODE	PRICE LP	SIZE/INCHES				WEIGHT LBS	VOL FT³
		H (LP/B)	W	D	D		
L2PU18	931	28	22	18	83	8	
L2PU22	1016	28	22	22	88	9	
L2PU24	1060	28	22	24	94	10	

L2L2H • Worksurface Supporting File, File Lateral for 18" deep and 22" deep units

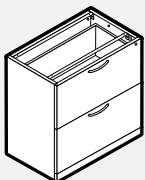

- One lock included.
- Optional e-lock available in the vertical position. Please specify V - Vertical and add \$231 list.

PRODUCT CODE	PRICE LP	SIZE/INCHES				WEIGHT LBS	VOL FT³
		H (LP/B)	W	D	D		
L2L2H1830	1241	28	30	18	189	12	
L2L2H1836	1324	28	36	18	209	14	
L2L2H1842	1374	28	42	18	216	20	
L2L2H2230	1275	28	30	22	189	12	
L2L2H2236	1360	28	36	22	209	14	
L2L2H2242	1456	28	42	22	216	20	

L2L2D • Worksurface Supporting 2 Door Storage Lateral with 1 Adjustable Shelf

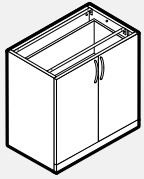

- One lock included.
- Optional e-lock available in the horizontal position. Please specify HR - Horizontal Right and add \$231 list.

PRODUCT CODE	PRICE LP	SIZE/INCHES			WEIGHT LBS	VOL FT ³
		H (LP/B)	W	D		
L2L2D1830	867	28	30	18	171	12
L2L2D1836	916	28	36	18	178	14
L2L2D1842	1003	28	42	18	180	20
L2L2D2230	937	28	30	22	171	12
L2L2D2236	963	28	36	22	178	14
L2L2D2242	1109	28	42	22	180	20

L2L2AD • Worksurface Supporting 2 Aluminum Door Storage Lateral with 1 Adjustable Shelf

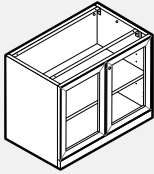

- One lock included.
- E-lock not available for aluminum framed glass doors.

PRODUCT CODE	PRICE LP	SIZE/INCHES			WEIGHT LBS	VOL FT ³
		H (LP/B)	W	D		
L2L2AD1830	1475	28	30	18	165	12
L2L2AD1836	1581	28	36	18	172	14
L2L2AD1842	1726	28	42	18	174	20
L2L2AD2230	1545	28	30	22	165	12
L2L2AD2236	1632	28	36	22	172	14
L2L2AD2242	1834	28	42	22	174	20

L2LCR • Worksurface Supporting Lateral File Combo

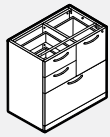

- One lock included.
- Optional e-lock available in the vertical position. Please specify V - Vertical and add \$231 list.

PRODUCT CODE	PRICE LP	SIZE/INCHES			WEIGHT LBS	VOL FT ³
		H (LP/B)	W	D		
L2LCR1830	1524	28	30	18	204	12
L2LCR1836	1779	28	36	18	215	14
L2LCR2230	1774	28	30	22	204	12
L2LCR2236	1862	28	36	22	215	14

L2LCL • Worksurface Supporting Lateral File Combo

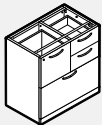

- One lock included.
- E-lock not available.

PRODUCT CODE	PRICE LP	SIZE/INCHES			WEIGHT LBS	VOL FT ³
		H (LP/B)	W	D		
L2LCL1830	1524	28	30	18	204	12
L2LCL1836	1779	28	36	18	215	14
L2LCL2230	1774	28	30	22	204	12
L2LCL2236	1862	28	36	22	215	14

L2LCR • Lateral File Combo with Top

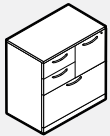

- One lock included.
- Optional e-lock available in the vertical position. Please specify V - Vertical and add \$231 list.

PRODUCT CODE	FINISH LP	B	W	SIZE/INCHES				WEIGHT LBS	VOL FT ³
				H (LP/B)	H (W)	W	D		
L2LCR2030	1882	1925	1973	29	29.5	30	20	204	12
L2LCR2036	1972	1998	2100	29	29.5	36	20	215	14
L2LCR2430	1957	2001	2055	29	29.5	30	24	204	12
L2LCR2436	2051	2081	2187	29	29.5	36	24	215	14

L2LCL • Lateral File Combo with Top

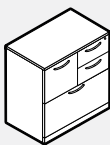

- One lock included.
- E-lock not available.

PRODUCT CODE	FINISH LP	B	W	SIZE/INCHES				WEIGHT LBS	VOL FT ³
				H (LP/B)	H (W)	W	D		
L2LCL2030	1882	1925	1973	29	29.5	30	20	204	12
L2LCL2036	1972	1998	2100	29	29.5	36	20	215	14
L2LCL2430	1957	2001	2055	29	29.5	30	24	204	12
L2LCL2436	2051	2081	2187	29	29.5	36	24	215	14

L2LO • Freestanding 1 High Open Unit

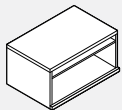

PRODUCT CODE	FINISH LP	B	W	SIZE/INCHES				WEIGHT LBS	VOL FT ³
				H (LP/B)	H (W)	W	D		
L2LO2030	671	762	827	19.94	20.4	30	20	75	11
L2LO2036	796	907	942	19.94	20.4	36	20	86	13
L2LO2430	697	792	862	19.94	20.4	30	24	75	11
L2LO2436	829	942	983	19.94	20.4	36	24	86	13

L2L2D-H20 • Freestanding 2 Doors, 1 High Unit

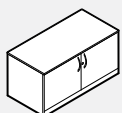

- One lock included.
- Includes one adjustable shelf.
- Optional e-lock available in the horizontal position. Please specify HR - Horizontal Right and add \$231 list.

PRODUCT CODE	FINISH LP	B	W	SIZE/INCHES				WEIGHT LBS	VOL FT ³
				H (LP/B)	H (W)	W	D		
L2L2D2030H20	921	1001	1053	19.94	20.4	30	20	95	11
L2L2D2036H20	1001	1099	1156	19.94	20.4	36	20	106	13
L2L2D2430H20	959	1041	1095	19.94	20.4	30	24	95	11
L2L2D2436H20	1041	1142	1201	19.94	20.4	36	24	106	13

L2L2AD • Freestanding 2 Aluminum Doors, 1 High

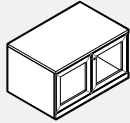

- One lock included.
- Includes one adjustable shelf.
- E-lock not available for aluminum framed glass doors.

PRODUCT CODE	FINISH LP	B	W	SIZE / INCHES				WEIGHT LBS	VOL FT ³
				H (LP/B)	H (W)	W	D		
L2L2AD2030H20	1411	1491	1542	19.5	20	30	20	86	10
L2L2AD2036H20	1533	1629	1686	19.5	20	36	20	96	12
L2L2AD2430H20	1448	1530	1585	19.5	20	30	24	86	10
L2L2AD2436H20	1573	1672	1732	19.5	20	36	24	96	12

L2L2D • Freestanding 2 Doors, 2 High Unit

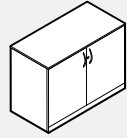

- One lock included.
- Includes one adjustable shelf.
- Optional e-lock available in the horizontal position. Please specify HR - Horizontal Right and add \$231 list.

PRODUCT CODE	FINISH LP	B	W	SIZE / INCHES				WEIGHT LBS	VOL FT ³
				H (LP/B)	H (W)	W	D		
L2L2D2030	1017	1129	1158	29	29.5	30	20	171	12
L2L2D2036	1121	1216	1273	29	29.5	36	20	178	14
L2L2D2042	1257	1367	1430	29	29.5	42	20	208	20
L2L2D2430	1056	1174	1204	29	29.5	30	24	171	12
L2L2D2436	1167	1266	1326	29	29.5	36	24	178	14
L2L2D2442	1302	1419	1487	29	29.5	42	24	208	20

L2L2AD • Freestanding 2 Aluminum Doors, 2 High Unit

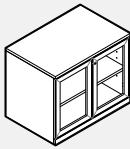

- One lock included.
- Includes one adjustable shelf.
- E-lock not available for aluminum framed glass doors.

PRODUCT CODE	FINISH LP	B	W	SIZE / INCHES				WEIGHT LBS	VOL FT ³
				H (LP/B)	H (W)	W	D		
L2L2AD2030	1626	1738	1769	29	29.5	30	20	165	12
L2L2AD2036	1786	1885	1941	29	29.5	36	20	172	14
L2L2AD2042	1978	2089	2153	29	29.5	42	20	174	20
L2L2AD2430	1666	1782	1812	29	29.5	30	24	165	12
L2L2AD2436	1832	1933	1991	29	29.5	36	24	172	14
L2L2AD2442	2026	2144	2211	29	29.5	42	24	174	20

L2L1H • Freestanding 1 High Lateral

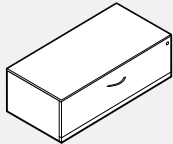

- One lock included.
- Optional e-lock available in the vertical position. Please specify V - Vertical and add \$231 list.

PRODUCT CODE	FINISH LP	B	W	SIZE / INCHES				WEIGHT LBS	VOL FT ³
				H (LP/B)	H (W)	W	D		
L2L1H2030	917	966	1000	19.94	20.4	30	20	105	11
L2L1H2036	977	1038	1094	19.94	20.4	36	20	114	13
L2L1H2042	1060	1128	1193	19.94	20.4	42	20	133	15
L2L1H2430	954	1003	1040	19.94	20.4	30	24	105	11
L2L1H2436	1021	1083	1137	19.94	20.4	36	24	114	13
L2L1H2442	1101	1171	1236	19.94	20.4	42	24	133	15

L2LBFH20 • Freestanding Box File Lateral

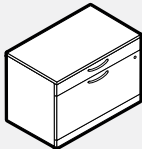

- One lock included.
- Optional e-lock available in the vertical position. Please specify V - Vertical and add \$231 list.

PRODUCT CODE	FINISH LP	B	W	SIZE / INCHES				WEIGHT LBS	VOL FT ³
				H (LP/B)	H (W)	W	D		
L2LBF2030H20	1237	1270	1337	19.94	20	30	20	108	11
L2LBF2036H20	1332	1370	1447	19.94	20	36	20	117	13
L2LBF2042H20	1418	1462	1549	19.94	20	42	20	136	15
L2LBF2430H20	1282	1315	1382	19.94	20	30	24	108	11
L2LBF2436H20	1377	1415	1492	19.94	20	36	24	117	13
L2LBF2442H20	1464	1507	1594	19.94	20	42	24	136	15

L2L2H • Freestanding 2 High Lateral

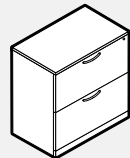

- One lock included.
- Optional e-lock available in the vertical position. Please specify V - Vertical and add \$231 list.

PRODUCT CODE	FINISH LP	B	W	SIZE / INCHES				WEIGHT LBS	VOL FT ³
				H (LP/B)	H (W)	W	D		
L2L2H2030	1388	1435	1485	29	29.5	30	20	189	12
L2L2H2036	1484	1541	1599	29	29.5	36	20	209	14
L2L2H2042	1595	1664	1719	29	29.5	42	20	242	20
L2L2H2430	1442	1491	1547	29	29.5	30	24	189	12
L2L2H2436	1542	1604	1660	29	29.5	36	24	209	14
L2L2H2442	1658	1730	1788	29	29.5	42	24	242	20

L2L3H • Freestanding 3 High Lateral

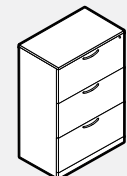

- One lock included.
- Optional e-lock available in the vertical position. Please specify V - Vertical and add \$231 list.

PRODUCT CODE	FINISH LP	B	W	SIZE / INCHES				WEIGHT LBS	VOL FT ³
				H (LP/B)	H (W)	W	D		
L2L3H2030	1893	1941	1993	41.75	42.18	30	20	252	18
L2L3H2036	2039	2095	2108	41.75	42.18	36	20	264	21
L2L3H2430	1970	2019	2072	41.75	42.18	30	24	252	18
L2L3H2436	2121	2182	2194	41.75	42.18	36	24	264	21

L2L4H • Freestanding 4 High Lateral

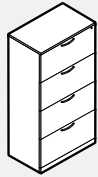

- One lock included.
- Optional e-lock available in the vertical position. Please specify V - Vertical and add \$231 list.

PRODUCT CODE	FINISH		SIZE / INCHES				WEIGHT LBS	VOL FT ³
	LP	W	H (LP/B)	H (W)	W	D		
L2L4H2030	2448	2550	54.5	54.94	30	20	315	23
L2L4H2036	2571	2720	54.5	54.94	36	20	336	28
L2L4H2430	2545	2651	54.5	54.94	30	24	315	23
L2L4H2436	2673	2827	54.5	54.94	36	24	336	28

L2B2H • Bookcase 1 Adjustable Shelf

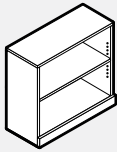

- Shipped knocked down (KD).

PRODUCT CODE	FINISH			SIZE / INCHES				WEIGHT LBS	VOL FT ³
	LP	B	W	H (LP/B)	H (W)	W	D		
L2B2H3012	542	592	638	29	29.5	30	12	95	8
L2B2H3612	629	689	749	29	29.5	36	12	106	9
L2B2H30	645	720	792	29	29.5	30	17	95	11
L2B2H36	747	804	864	29	29.5	36	17	106	13

L2B3H • Bookcase 2 Adjustable Shelves

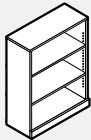

- Shipped knocked down (KD).

PRODUCT CODE	FINISH			SIZE / INCHES				WEIGHT LBS	VOL FT ³
	LP	B	W	H (LP/B)	H (W)	W	D		
L2B3H3012	693	744	775	41.75	42.18	30	12	160	9
L2B3H3612	761	835	874	41.75	42.18	36	12	171	12
L2B3H30	863	935	996	41.75	42.18	30	17	160	15
L2B3H36	972	1057	1117	41.75	42.18	36	17	171	18

L2B4H • Bookcase 3 Adjustable Shelves

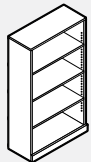

- Shipped knocked down (KD).

PRODUCT CODE	FINISH		SIZE / INCHES				WEIGHT LBS	VOL FT ³
	LP	W	H (LP/B)	H (W)	W	D		
L2B4H3012	827	942	54.5	54.94	30	12	178	13
L2B4H3612	929	1062	54.5	54.94	36	12	189	15
L2B4H30	1055	1174	54.5	54.94	30	17	178	19
L2B4H36	1153	1264	54.5	54.94	36	17	189	22

L2B5H • Bookcase 4 Adjustable Shelves

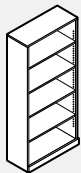

- Shipped knocked down (KD).

PRODUCT CODE	FINISH		SIZE / INCHES				WEIGHT LBS	VOL FT ³
	LP	W	H (LP/B)	H (W)	W	D		
L2B5H3012	998	1063	65.81	66.25	30	12	193	15
L2B5H3612	1089	1225	65.81	66.25	36	12	204	19
L2B5H30	1181	1276	65.81	66.25	30	17	193	23
L2B5H36	1324	1464	65.81	66.25	36	17	204	28

L2B6H • Bookcase 5 Adjustable Shelves

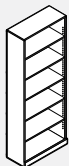

- Shipped knocked down (KD).

PRODUCT CODE	FINISH		SIZE / INCHES				WEIGHT LBS	VOL FT ³
	LP	W	H (LP/B)	H (W)	W	D		
L2B6H3012	1074	1189	72.81	73.24	30	12	237	17
L2B6H3612	1204	1339	72.81	73.24	36	12	248	20
L2B6H30	1210	1336	72.81	73.24	30	17	242	25
L2B6H36	1448	1656	72.81	73.24	36	17	253	30

L2BC • Corner Bookcase 20”D x 20”W /24”D x 24”W

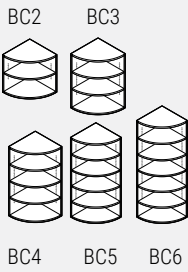

- Shipped knocked down (KD).

PRODUCT CODE	FINISH			SIZE/INCHES				WEIGHT		VOL FT ³
	LP	B	W	H(LP/B)	H(W)	W	D	LBS		
L2BC2H20	872	1024	1062	29.00	29.50	20	20	90	11	
L2BC2H24	908	1065	1102	29.00	29.50	24	24	90	11	
L2BC3H20	1106	1259	1299	41.75	42.18	20	20	125	15	
L2BC3H24	1152	1304	1351	41.75	42.18	24	24	125	15	
L2BC4H20	1340	-	1539	54.50	54.94	20	20	158	20	
L2BC4H24	1395	-	1601	54.50	54.94	24	24	158	20	
L2BC5H20	1575	-	1777	65.81	66.25	20	20	188	24	
L2BC5H24	1639	-	1848	65.81	66.25	24	24	188	24	
L2BC6H20	1772	-	1985	72.81	73.24	20	20	218	26	
L2BC6H24	1842	-	2062	72.81	73.24	24	24	218	26	

L2TW2D-D • Storage Tower with 2 Doors and 4 Adjustable Shelves

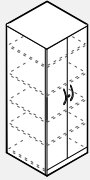

- 50” High Tower comes with 3 adjustable shelves.
- One lock on right door included.
- Optional e-lock available in the horizontal position. Please specify HR - Horizontal Right and add \$231 list.

PRODUCT CODE	FINISH			SIZE/INCHES				WEIGHT		VOL FT ³
	LP	W	D	H(LP/B)	H(W)	W	D	LBS		
L2TW2D50H20D	1524	1634	20	49.56	50.00	24	20	211	22	
L2TW2D66H20D	1684	1835	20	65.81	66.25	24	20	268	24	
L2TW2D72H20D	1757	1902	20	72.81	73.24	24	20	283	26	
L2TW2D50H24D	1581	1697	24	49.56	50.00	24	24	211	22	
L2TW2D66H24D	1748	1906	24	65.81	66.25	24	24	268	24	
L2TW2D72H24D	1826	1973	24	72.81	73.24	24	24	283	26	

L2TW2DCS-D • Storage Tower with 2 Doors, Coat Rod and Hat Shelf

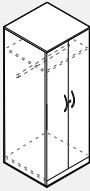

- 50” High Tower comes with one shelf.
- One lock on right door included.
- Optional e-lock available in the horizontal position. Please specify HR - Horizontal Right and add \$231 list.

PRODUCT CODE	FINISH			SIZE/INCHES				WEIGHT		VOL FT ³
	LP	W	D	H(LP/B)	H(W)	W	D	LBS		
L2TW2DCS50H20D	1362	1519	20	49.56	50.00	24	20	178	22	
L2TW2DCS66H20D	1541	1654	20	65.81	66.25	24	20	268	24	
L2TW2DCS72H20D	1607	1720	20	72.81	73.24	24	20	284	26	
L2TW2DCS50H24D	1415	1577	24	49.56	50.00	24	24	178	22	
L2TW2DCS66H24D	1602	1718	24	65.81	66.25	24	24	268	24	
L2TW2DCS72H24D	1670	1785	24	72.81	73.24	24	24	284	26	

L2TW2H2D-D • Storage Tower with a 3 High Cupboard over a 2 High Lateral

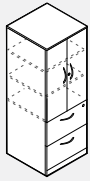

- 50” High Tower comes with one adjustable shelf.
- Two locks included.
- Optional e-lock available in the vertical position for the file drawers. Please specify V - Vertical and add \$231 list.
- Optional e-lock available in the horizontal position for the upper storage cabinet. Please specify HR- Horizontal Right and add \$231 list.

PRODUCT CODE	FINISH			SIZE/INCHES				WEIGHT		VOL FT ³
	LP	W	D	H(LP/B)	H(W)	W	D	LBS		
L2TW2H2D50H20D	2061	2104	20	49.56	50.00	24	20	222	22	
L2TW2H2D66H20D	2290	2327	20	65.81	66.25	24	20	279	24	
L2TW2H2D72H20D	2356	2521	20	72.81	73.24	24	20	295	26	
L2TW2H2D50H24D	2145	2190	24	49.56	50.00	24	24	222	22	
L2TW2H2D66H24D	2383	2419	24	65.81	66.25	24	24	279	24	
L2TW2H2D72H24D	2450	2619	24	72.81	73.24	24	24	295	26	

L2TW3H2D-D • Storage Tower with a 2 High Cupboard over a 3 High Lateral

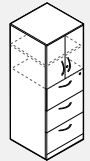

- Two locks included.
- Optional e-lock available in the vertical position for the file drawers. Please specify V - Vertical and add \$231 list.
- Optional e-lock available in the horizontal position for the upper storage cabinet. Please specify HR- Horizontal Right and add \$231 list.

PRODUCT CODE	FINISH			SIZE/INCHES				WEIGHT		VOL FT ³
	LP	W	D	H(LP/B)	H(W)	W	D	LBS		
L2TW3H2D66H20D	2526	2635	20	65.81	66.25	24	20	296	24	
L2TW3H2D72H20D	2602	2681	20	72.81	73.24	24	20	311	26	
L2TW3H2D66H24D	2627	2740	24	65.81	66.25	24	24	296	24	
L2TW3H2D72H24D	2704	2789	24	72.81	73.24	24	24	311	26	

L2TW4H2D-D • Tower with a 2 Door Storage Cabinet over a 4 High Lateral

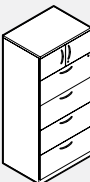

- Two locks included.
- Lock on cupboard is not available for UB, UC or RN handles.
- Optional e-lock available in the vertical position for the file drawers. Please specify V - Vertical and add \$231 list.
- Optional e-lock available in the horizontal position for the upper storage cabinet. Please specify HR- Horizontal Right and add \$231 list.

PRODUCT CODE	FINISH			SIZE/INCHES				WEIGHT		VOL FT ³
	LP	W	D	H(LP/B)	H(W)	W	D	LBS		
L2TW4H2D66H20D	2868	2981	20	65.81	66.25	24	20	307	24	
L2TW4H2D72H20D	2958	2995	20	72.81	73.24	24	20	322	26	
L2TW4H2D66H24D	2982	3101	24	65.81	66.25	24	24	307	24	
L2TW4H2D72H24D	3079	3114	24	72.81	73.24	24	24	322	26	

L2TWBBF2DL • Storage Tower with a 3 High Cupboard, BBF Drawers and Wardrobe

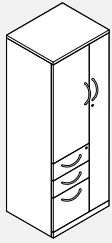

Right Hand Shown

- Storage compartment includes 1 adjustable shelves for 50”h. unit and 2 adjustable shelves for 66”h. and 72”h. units
- Two locks included.
- Optional e-lock available in the vertical position for the box, box, file drawers. Please specify V - Vertical and add \$231 list.
- Optional e-lock available in the horizontal position for the wardrobe. Please specify HR - Horizontal Right or HL - Horizontal Left and add \$231 list.

PRODUCT CODE	FINISH		SIZE/INCHES				WEIGHT LBS	VOL FT³
	LP	W	H (LP/B)	H (W)	W	D		
Left								
L2TWBBF2DL50H20D	2108	2265	49.56	50.00	24	20	288	20
L2TWBBF2DL66H20D	2348	2457	65.81	66.25	24	20	348	22
L2TWBBF2DL72H20D	2434	2541	72.81	73.25	24	20	378	24
L2TWBBF2DL50H24D	2193	2355	49.5	50.00	24	24	288	20
L2TWBBF2DL66H24D	2440	2555	65.81	66.25	24	24	348	22
L2TWBBF2DL72H24D	2529	2644	72.81	73.25	24	24	378	24
Right								
L2TWBBF2DR50H20D	2108	2265	49.56	50.00	24	20	288	20
L2TWBBF2DR66H20D	2348	2457	65.81	66.25	24	20	348	22
L2TWBBF2DR72H20D	2434	2541	72.81	73.25	24	20	378	24
L2TWBBF2DR50H24D	2193	2355	49.5	50.00	24	24	288	20
L2TWBBF2DR66H24D	2440	2555	65.81	66.25	24	24	348	22
L2TWBBF2DR72H24D	2529	2644	72.81	73.25	24	24	378	24

L2TW2F2D-D • Storage Tower with a 3 High Cupboard, FF Drawers and Wardrobe

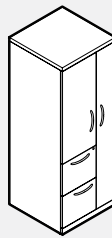

Right Hand Shown

- Wardrobe has a coat rod.
- Two locks included.
- Optional e-lock available in the vertical position for the file drawers. Please specify V - Vertical and add \$231 list.
- Optional e-lock available in the horizontal position for the wardrobe. Please specify HR - Horizontal Right or HL - Horizontal Left and add \$231 list.

PRODUCT CODE	FINISH		SIZE/INCHES				WEIGHT LBS	VOL FT³
	LP	W	H (LP/B)	H (W)	W	D		
Left								
L2TW2F2DL50H20D	1983	2141	49.56	50.00	24	20	222	22
L2TW2F2DL66H20D	2221	2329	65.81	66.25	24	20	279	24
L2TW2F2DL72H20D	2306	2415	72.81	73.24	24	20	295	26
L2TW2F2DL50H24D	2061	2223	49.56	50.00	24	24	222	22
L2TW2F2DL66H24D	2312	2422	65.81	66.25	24	24	279	24
L2TW2F2DL72H24D	2401	2511	72.81	73.24	24	24	295	26
Right								
L2TW2F2DR50H20D	1983	2141	49.56	50.00	24	20	222	22
L2TW2F2DR66H20D	2221	2329	65.81	66.25	24	20	279	24
L2TW2F2DR72H20D	2306	2415	72.81	73.24	24	20	295	26
L2TW2F2DR50H24D	2061	2223	49.56	50.00	24	24	222	22
L2TW2F2DR66H24D	2312	2422	65.81	66.25	24	24	279	24
L2TW2F2DR72H24D	2401	2511	72.81	73.24	24	24	295	26

L2TW3F2D-D • Storage Tower with a 2 High Cupboard, FFF Drawers and Wardrobe

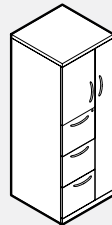

Right Hand Shown

- Two locks included.
- Optional e-lock available in the vertical position for the file drawers. Please specify V - Vertical and add \$231 list.
- Optional e-lock available in the horizontal position for the wardrobe. Please specify HR - Horizontal Right or HL - Horizontal Left and add \$231 list.

PRODUCT CODE	FINISH		SIZE/INCHES				WEIGHT LBS	VOL FT³
	LP	W	H (LP/B)	H (W)	W	D		
Left								
L2TW3F2DL66H20D	2349	2466	65.81	66.25	24	20	296	24
L2TW3F2DL72H20D	2435	2527	72.81	73.24	24	20	311	26
L2TW3F2DL66H24D	2443	2564	65.81	66.25	24	24	296	24
L2TW3F2DL72H24D	2534	2629	72.81	73.24	24	24	311	26
Right								
L2TW3F2DR66H20D	2349	2466	65.81	66.25	24	20	296	24
L2TW3F2DR72H20D	2435	2527	72.81	73.24	24	20	311	26
L2TW3F2DR66H24D	2443	2564	65.81	66.25	24	24	296	24
L2TW3F2DR72H24D	2534	2629	72.81	73.24	24	24	311	26

L2TWBBFD0 • Storage Tower with 3 High Side Open Cupboard, BBF Drawers and Wardrobe

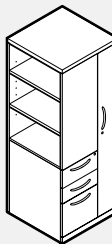

Right Hand Shown

- Open bookcase compartment includes 1 adjustable shelves for 50”h unit and 2 adjustable shelves for 66”h and 72”h units
- Two locks included.
- Optional e-lock available in the vertical position for the box, box, file drawers. Please specify V - Vertical and add \$231 list.
- Optional e-lock available in the horizontal position for the wardrobe. Please specify HR - Horizontal Right or HL - Horizontal Left and add \$231 list.

PRODUCT CODE	FINISH		SIZE/INCHES				WEIGHT LBS	VOL FT³
	LP	W	H (LP/B)	H (W)	W	D		
Left								
L2TWBBFDOL50H20D	1960	2085	49.50	50.00	24	20	285	20
L2TWBBFDOL66H20D	2170	2240	65.81	66.25	24	20	345	22
L2TWBBFDOL72H20D	2242	2309	72.81	73.25	24	20	375	24
L2TWBBFDOL50H24D	2040	2166	49.50	50.00	24	24	285	20
L2TWBBFDOL66H24D	2257	2330	65.81	66.25	24	24	345	22
L2TWBBFDOL72H24D	2331	2401	72.81	73.25	24	24	375	24
Right								
L2TWBBFDOR50H20D	1960	2085	49.50	50.00	24	20	285	20
L2TWBBFDOR66H20D	2170	2240	65.81	66.25	24	20	345	22
L2TWBBFDOR72H20D	2242	2309	72.81	73.25	24	20	375	24
L2TWBBFDOR50H24D	2040	2166	49.50	50.00	24	24	285	20
L2TWBBFDOR66H24D	2257	2330	65.81	66.25	24	24	345	22
L2TWBBFDOR72H24D	2331	2401	72.81	73.25	24	24	375	24

L2TW2FDO-D • Storage Tower with a 3 High Side Open Cupboard, FF Drawers and Wardrobe

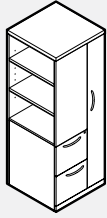

Right Hand Shown

- 50" High Tower comes with one adjustable shelf.
- Two locks included.
- Optional e-lock available in the vertical position for the file drawers. Please specify V - Vertical and add \$231 list.
- Optional e-lock available in the horizontal position for the wardrobe. Please specify HR - Horizontal Right or HL - Horizontal Left and add \$231 list.

PRODUCT CODE	FINISH		SIZE/INCHES				WEIGHT LBS	VOL FT³
	LP	W	H (LP/B)	H (W)	W	D		
Left								
L2TW2FDOL50H20D	1835	1957	49.56	50.00	24	20	211	22
L2TW2FDOL66H20D	2042	2115	65.81	66.25	24	20	268	24
L2TW2FDOL72H20D	2116	2182	72.81	73.24	24	20	284	26
L2TW2FDOL50H24D	1907	2034	49.56	50.00	24	24	211	22
L2TW2FDOL66H24D	2125	2197	65.81	66.25	24	24	268	24
L2TW2FDOL72H24D	2198	2268	72.81	73.24	24	24	284	26
Right								
L2TW2FDOR50H20D	1835	1957	49.56	50.00	24	20	211	22
L2TW2FDOR66H20D	2042	2115	65.81	66.25	24	20	268	24
L2TW2FDOR72H20D	2116	2182	72.81	73.24	24	20	284	26
L2TW2FDOR50H24D	1907	2034	49.56	50.00	24	24	211	22
L2TW2FDOR66H24D	2125	2197	65.81	66.25	24	24	268	24
L2TW2FDOR72H24D	2198	2268	72.81	73.24	24	24	284	26

L2TW3FDO-D • Storage Tower with a 2 High Side Open Cupboard, FFF Drawers and Wardrobe

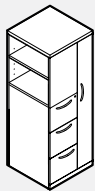

Right Hand Shown

- Two locks included.
- Optional e-lock available in the vertical position for the file drawers. Please specify V - Vertical and add \$231 list.
- Optional e-lock available in the horizontal position for the wardrobe. Please specify HR - Horizontal Right or HL - Horizontal Left and add \$231 list.

PRODUCT CODE	FINISH		SIZE/INCHES				WEIGHT LBS	VOL FT³
	LP	W	H (LP/B)	H (W)	W	D		
Left								
L2TW3FDOL66H20D	2207	2315	65.81	66.25	24	20	285	24
L2TW3FDOL72H20D	2345	2361	72.81	73.24	24	20	300	26
L2TW3FDOL66H24D	2292	2405	65.81	66.25	24	24	285	24
L2TW3FDOL72H24D	2436	2454	72.81	73.24	24	24	300	26
Right								
L2TW3FDOR66H20D	2207	2315	65.81	66.25	24	20	285	24
L2TW3FDOR72H20D	2345	2361	72.81	73.24	24	20	300	26
L2TW3FDOR66H24D	2292	2405	65.81	66.25	24	24	285	24
L2TW3FDOR72H24D	2436	2454	72.81	73.24	24	24	300	26

L2TWA2DCS • Storage Tower with 2 Aluminum Doors, Coat Rod and Hat Shelf

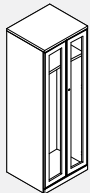

- 50" High Tower comes with 1 shelf above hang rod.
- One lock included.
- E-locks not available for aluminum framed glass doors.

PRODUCT CODE	FINISH		SIZE/INCHES				WEIGHT LBS	VOL FT³
	LP	W	H (LP/B)	H (W)	W	D		
L2TWA2DCS50H20D	2200	2359	49.56	50.00	24	20	162	20
L2TWA2DCS66H20D	2565	2680	65.81	66.25	24	20	244	22
L2TWA2DCS72H20D	2703	2816	72.81	73.25	24	20	258	24
L2TWA2DCS50H24D	2256	2415	49.56	50.00	24	24	162	20
L2TWA2DCS66H24D	2627	2744	65.81	66.25	24	24	244	22
L2TWA2DCS72H24D	2765	2881	72.81	73.25	24	24	258	24

L2TWA2D • Storage Tower with 2 Aluminum Doors and 4 Adjustable Shelves

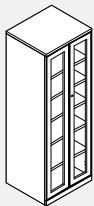

- 50" High Tower comes with 3 adjustable shelves.
- One lock included.
- E-locks not available for aluminum framed glass doors.

PRODUCT CODE	FINISH		SIZE/INCHES				WEIGHT LBS	VOL FT³
	LP	W	H (LP/B)	H (W)	W	D		
L2TWA2D50H20D	2363	2472	49.56	50.00	24	20	192	20
L2TWA2D66H20D	2710	2862	65.81	66.25	24	20	244	22
L2TWA2D72H20D	2852	2997	72.81	73.25	24	20	257	24
L2TWA2D50H24D	2419	2536	49.56	50.00	24	24	192	20
L2TWA2D66H24D	2776	2932	65.81	66.25	24	24	244	22
L2TWA2D72H24D	2920	3070	72.81	73.25	24	24	257	24

L2TWA2H2D • Storage Tower with a 3 High Cupboard over a 2 High Lateral

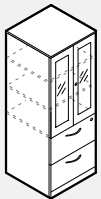

- 50" High Tower comes with 1 adjustable shelf.
- Lock is on the upper drawer.
- Two locks included.
- Optional e-lock available in the vertical position. Please specify V - Vertical and add \$231 list.
- E-locks not available for aluminum framed glass doors.

PRODUCT CODE	FINISH		SIZE/INCHES				WEIGHT LBS	VOL FT³
	LP	W	H (LP/B)	H (W)	W	D		
L2TWA2H2D50H20D	2574	2619	49.56	50.00	24	20	202	20
L2TWA2H2D66H20D	2989	3026	65.81	66.25	24	20	254	22
L2TWA2H2D72H20D	3127	3288	72.81	73.25	24	20	258	24
L2TWA2H2D50H24D	2659	2704	49.56	50.00	24	24	202	20
L2TWA2H2D66H24D	3082	3122	65.81	66.25	24	24	254	22
L2TWA2H2D72H24D	3221	3388	72.81	73.25	24	24	258	24

L2TWA3H2D • Storage Tower with a 2 High Cupboard with Aluminum Doors over a 3 High Lateral

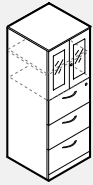

- Lock is on the upper drawer.
- Two locks included.
- Optional e-lock available in the vertical position. Please specify V - Vertical and add \$231 list.
- E-locks not available for aluminum framed glass doors.

PRODUCT CODE	FINISH		SIZE/INCHES				WEIGHT LBS	VOL FT³
	LP	W	H (LP/B)	H (W)	W	D		
L2TWA3H2D66H20D	3078	3190	65.81	66.25	24	20	269	22
L2TWA3H2D72H20D	3222	3304	72.81	73.25	24	20	283	24
L2TWA3H2D66H24D	3179	3292	65.81	66.25	24	24	269	22
L2TWA3H2D72H24D	3326	3412	72.81	73.25	24	24	283	24

L2TWA4H2D • Storage Tower with Cupboard with Aluminum Doors over a 4 High Lateral

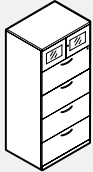

- Lock is on the upper drawer.
- Two locks included.
- Optional e-lock available in the vertical position. Please specify V - Vertical and add \$231 list.
- E-locks not available for aluminum framed glass doors.

PRODUCT CODE	FINISH		SIZE/INCHES				WEIGHT LBS	VOL FT³
	LP	W	H (LP/B)	H (W)	W	D		
L2TWA4H2D66H20D	3217	3328	65.81	66.25	24	20	279	22
L2TWA4H2D72H20D	3388	3424	72.81	73.25	24	20	293	24
L2TWA4H2D66H24D	3329	3447	65.81	66.25	24	24	293	22
L2TWA4H2D72H24D	3508	3545	72.81	73.25	24	24	293	24

L2TWA2F2D • Storage Tower with a 3 High Cupboard, FF Drawers and Wardrobe

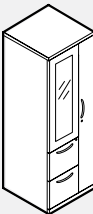

Right Hand Shown

- Storage compartment includes 1 adjustable shelves for 50" unit and 2 adjustable shelves for 66" and 72" units
- Two locks included.
- Optional e-lock available in the vertical position for the file drawers. Please specify V - Vertical and add \$231 list.
- Optional e-lock available in the horizontal position for the wardrobe. Please specify HR - Horizontal Right or HL - Horizontal Left and add \$231 list.
- E-locks not available for aluminum framed glass doors.

PRODUCT CODE	FINISH		SIZE/INCHES				WEIGHT LBS	VOL FT³
	LP	W	H (LP/B)	H (W)	W	D		
L2TWA2F2DR50H20D	2242	2400	49.56	50.00	24	20	219	20
L2TWA2F2DR66H20D	2591	2699	65.81	66.25	24	20	276	22
L2TWA2F2DR72H20D	2719	2827	72.81	73.25	24	20	292	24
L2TWA2F2DR50H24D	2322	2482	49.56	50.00	24	24	219	20
L2TWA2F2DR66H24D	2681	2791	65.81	66.25	24	24	276	22
L2TWA2F2DR72H24D	2811	2924	72.81	73.25	24	24	292	24
L2TWA2F2DL50H20D	2242	2400	49.56	50.00	24	20	219	20
L2TWA2F2DL66H20D	2591	2699	65.81	66.25	24	20	276	22
L2TWA2F2DL72H20D	2719	2827	72.81	73.25	24	20	292	24
L2TWA2F2DL50H24D	2322	2482	49.56	50.00	24	24	219	20
L2TWA2F2DL66H24D	2681	2791	65.81	66.25	24	24	276	22
L2TWA2F2DL72H24D	2811	2924	72.81	73.25	24	24	292	24

L2TWABBF2D • Storage Tower with a 3 High Cupboard, BBF Drawers and Wardrobe

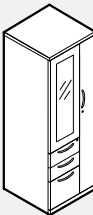

Right Hand Shown

- Storage compartment includes 1 adjustable shelves for 50" unit and 2 adjustable shelves for 66" and 72" units
- Two locks included.
- Optional e-lock available in the vertical position for the box, box, file drawers. Please specify V - Vertical and add \$231 list.
- Optional e-lock available in the horizontal position for the wardrobe. Please specify HR - Horizontal Right or HL - Horizontal Left and add \$231 list.
- E-locks not available for aluminum framed glass doors.

PRODUCT CODE	FINISH		SIZE/INCHES				WEIGHT LBS	VOL FT³
	LP	W	H (LP/B)	H (W)	W	D		
L2TWABBF2DL50H20D	2369	2526	49.56	50.00	24	20	288	20
L2TWABBF2DL66H20D	2719	2825	65.81	66.25	24	20	348	22
L2TWABBF2DL72H20D	2844	2954	72.81	73.25	24	20	378	24
L2TWABBF2DL50H24D	2447	2610	49.56	50.00	24	24	288	20
L2TWABBF2DL66H24D	2809	2919	65.81	66.25	24	24	348	22
L2TWABBF2DL72H24D	2937	3049	72.81	73.25	24	24	378	24
L2TWABBF2DR50H20D	2369	2526	49.56	50.00	24	20	288	20
L2TWABBF2DR66H20D	2719	2825	65.81	66.25	24	20	348	22
L2TWABBF2DR72H20D	2844	2954	72.81	73.25	24	20	378	24
L2TWABBF2DR50H24D	2447	2610	49.56	50.00	24	24	288	20
L2TWABBF2DR66H24D	2809	2919	65.81	66.25	24	24	348	22
L2TWABBF2DR72H24D	2937	3049	72.81	73.25	24	24	378	24

L2TW3F2D-D • Storage Tower with a 2 High Cupboard, FFF Drawers and Wardrobe

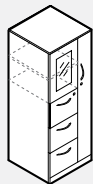

- Lock is on the upper drawer.
- Storage compartment includes 1 adjustable shelf.
- Two locks included.
- Optional e-lock available in the vertical position for the file drawers. Please specify V - Vertical and add \$231 list.
- Optional e-lock available in the horizontal position for the wardrobe. Please specify HR - Horizontal Right or HL - Horizontal Left and add \$231 list.
- E-locks not available for aluminum framed glass doors.

PRODUCT CODE	FINISH		SIZE/INCHES				WEIGHT LBS	VOL FT³
	LP	W	H (LP/B)	H (W)	W	D		
L2TWA3F2DR66H20D	2654	2773	65.81	66.25	24	20	340	22
L2TWA3F2DR72H20D	2778	2870	72.81	73.25	24	20	370	24
L2TWA3F2DR66H24D	2750	2870	65.81	66.25	24	24	340	22
L2TWA3F2DR72H24D	2876	2973	72.81	73.25	24	24	370	24
L2TWA3F2DL66H20D	2654	2773	65.81	66.25	24	20	340	22
L2TWA3F2DL72H20D	2778	2870	72.81	73.25	24	20	370	24
L2TWA3F2DL66H24D	2750	2870	65.81	66.25	24	24	340	22
L2TWA3F2DL72H24D	2876	2973	72.81	73.25	24	24	370	24

L2CB • Storage Cabinet with 2 Doors and 4 Adjustable Shelves

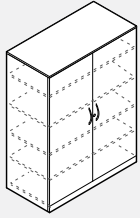

- 50"h. cabinet comes with 3 adjustable shelves.
- 66"h. and 72"h. Cabinet comes with 4 adjustable shelves.
- One lock included.
- Optional e-lock available in the horizontal position. Please specify HR - Horizontal Right and add \$231 list.

PRODUCT CODE	FINISH LP	W	SIZE/INCHES				D	WEIGHT LBS	VOL FT ³
			H (LP/B)	H (W)	W	D			
L2CB20302D50H	1735	1876	49.56	50.00	30	20	245	21	
L2CB20362D50H	1857	2023	49.56	50.00	36	20	281	25	
L2CB20302D66H	1970	2108	65.81	66.25	30	20	310	28	
L2CB20362D66H	2118	2279	65.81	66.25	36	20	354	33	
L2CB20302D72H	2048	2184	72.81	73.24	30	20	327	30	
L2CB20362D72H	2197	2356	72.81	73.24	36	20	372	36	
L2CB24302D50H	1804	1953	49.56	50.00	30	24	245	25	
L2CB24362D50H	1930	2102	49.56	50.00	36	24	281	30	
L2CB24302D66H	2050	2194	65.81	66.25	30	24	310	33	
L2CB24362D66H	2202	2370	65.81	66.25	36	24	354	39	
L2CB24302D72H	2129	2272	72.81	73.24	30	24	327	36	
L2CB24362D72H	2287	2450	72.81	73.24	36	24	372	43	

L2CB • Storage Cabinet with 2 Doors Coat Rod and 1 Fixed Shelf

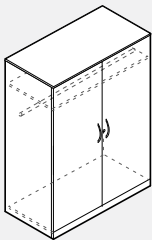

- One lock included.
- Optional e-lock available in the horizontal position. Please specify HR - Horizontal Right and add \$231 list.

PRODUCT CODE	FINISH LP	W	SIZE/INCHES				D	WEIGHT LBS	VOL FT ³
			H (LP/B)	H (W)	W	D			
L2CB20302DCS50H	1586	1718	49.56	50.00	30	20	204	21	
L2CB20362DCS50H	1674	1834	49.56	50.00	36	20	231	25	
L2CB20302DCS66H	1740	1904	65.81	66.25	30	20	249	28	
L2CB20362DCS66H	1831	1991	65.81	66.25	36	20	281	33	
L2CB20302DCS72H	1814	2086	72.81	73.24	30	20	265	30	
L2CB20362DCS72H	1914	2074	72.81	73.24	36	20	298	36	
L2CB24302DCS50H	1649	1786	49.56	50.00	30	24	204	25	
L2CB24362DCS50H	1741	1906	49.56	50.00	36	24	231	30	
L2CB24302DCS66H	1809	1983	65.81	66.25	30	24	249	33	
L2CB24362DCS66H	1903	2069	65.81	66.25	36	24	281	39	
L2CB24302DCS72H	1890	2166	72.81	73.24	30	24	265	36	
L2CB24362DCS72H	1990	2157	72.81	73.24	36	24	298	43	

L2CB • Storage Cabinet with 3 High Cupboard, 2 Adjustable Shelves over a 2 High Lateral

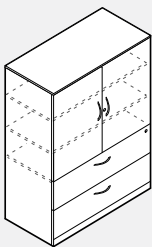

- 50"h. cabinet comes with one adjustable shelf.
- 66" and 72" Cabinet comes with 2 adjustable shelves.
- Two locks included.
- Optional e-lock available for the file drawers vertical position. Please specify V - Vertical and add \$231 list.
- Optional e-lock available in the horizontal position for upper storage cabinet. Please specify HR - Horizontal Right and add \$231 list.

PRODUCT CODE	FINISH LP	W	SIZE/INCHES				D	WEIGHT LBS	VOL FT ³
			H (LP/B)	H (W)	W	D			
L2CB20302H2D50H	2256	2381	49.56	50.00	30	20	256	21	
L2CB20362H2D50H	2394	2508	49.56	50.00	36	20	292	25	
L2CB20302H2D66H	2525	2652	65.81	66.25	30	20	321	28	
L2CB20362H2D66H	2689	2839	65.81	66.25	36	20	365	33	
L2CB20302H2D72H	2603	2732	72.81	73.24	30	20	338	30	
L2CB20362H2D72H	2745	2874	72.81	73.24	36	20	383	36	
L2CB24302H2D50H	2345	2473	49.56	50.00	30	24	256	25	
L2CB24362H2D50H	2494	2610	49.56	50.00	36	24	292	30	
L2CB24302H2D66H	2625	2757	65.81	66.25	30	24	321	33	
L2CB24362H2D66H	2796	2953	65.81	66.25	36	24	365	39	
L2CB24302H2D72H	2708	2840	72.81	73.24	30	24	338	36	
L2CB24362H2D72H	2853	2989	72.81	73.24	36	24	383	43	

L2CB • Storage Cabinet with a 2 High Cupboard, 1 Adjustable Shelf over a 3 High Lateral

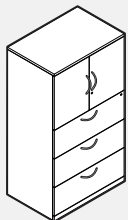

- One lock on right door.
- Two locks included.
- Optional e-lock available for the file drawers vertical position. Please specify V - Vertical and add \$231 list.
- Optional e-lock available in the horizontal position for upper storage cabinet. Please specify HR - Horizontal Right and add \$231 list.

PRODUCT CODE	FINISH LP	W	SIZE/INCHES				D	WEIGHT LBS	VOL FT ³
			H (LP/B)	H (W)	W	D			
L2CB20303H2D66H	2646	2775	65.81	66.25	30	20	337	28	
L2CB20363H2D66H	2811	2963	65.81	66.25	36	20	381	33	
L2CB20303H2D72H	2750	2879	72.81	73.25	30	20	354	30	
L2CB20363H2D72H	2915	3071	72.81	73.25	36	20	399	36	
L2CB24303H2D66H	2751	2884	65.81	66.25	30	24	337	28	
L2CB24363H2D66H	2924	3081	65.81	66.25	36	24	381	33	
L2CB24303H2D72H	2862	2994	72.81	73.25	30	24	354	30	
L2CB24363H2D72H	3034	3194	72.81	73.25	36	24	399	36	

L2CB • Storage Cabinet with a 2 Door Storage Cupboard above a 4 High Lateral

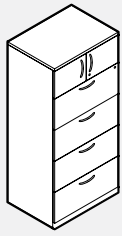

- Two locks included.
- Lock on cupboard is not available for UB, UC or RN handles.
- Optional e-lock available for the file drawers vertical position. Please specify V - Vertical and add \$231 list.
- Optional e-lock available in the horizontal position for upper storage cabinet. Please specify HR - Horizontal Right and add \$231 list.

PRODUCT CODE	FINISH LP	W	SIZE/INCHES				WEIGHT LBS	VOL FT ³
			H (LP/B)	H (W)	W	D		
L2CB20304H2D66H	3046	3199	65.81	66.25	30	20	343	28
L2CB20364H2D66H	3285	3445	65.81	66.25	36	20	387	33
L2CB20304H2D72H	3126	3260	72.81	73.24	30	20	360	30
L2CB20364H2D72H	3319	3476	72.81	73.24	36	20	405	36
L2CB24304H2D66H	3168	3328	65.81	66.25	30	24	278	33
L2CB24364H2D66H	3417	3583	65.81	66.25	36	24	314	39
L2CB24304H2D72H	3251	3390	72.81	73.24	30	24	343	36
L2CB24364H2D72H	3448	3615	72.81	73.24	36	24	387	43

L2CB • Storage Cabinet with Open Bookcase and 2 Adjustable Shelves & 2 Door Cupboard

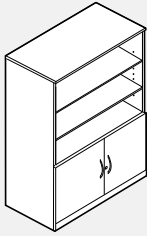

- 50"h. cabinet comes with one adjustable shelf.
- 66"h. and 72"h. Cabinet comes with 2 adjustable Shelves.
- One lock included.
- Optional e-lock available in the horizontal position. Please specify HR - Horizontal Right and add \$231 list.

PRODUCT CODE	FINISH LP	W	SIZE/INCHES				WEIGHT LBS	VOL FT ³
			H (LP/B)	H (W)	W	D		
L2CB20302D050H	1456	1649	49.56	50.00	30	20	212	21
L2CB20362D050H	1554	1826	49.56	50.00	36	20	248	25
L2CB20302D066H	1633	1878	65.81	66.25	30	20	277	28
L2CB20362D066H	2002	2130	65.81	66.25	36	20	321	33
L2CB20302D072H	1687	1955	72.81	73.24	30	20	294	30
L2CB20362D072H	1840	2209	72.81	73.24	36	20	339	36
L2CB24302D050H	1527	1731	49.56	50.00	30	24	212	25
L2CB24362D050H	1633	1918	49.56	50.00	36	24	248	30
L2CB24302D066H	1714	1972	65.81	66.25	30	24	277	33
L2CB24362D066H	1849	2236	65.81	66.25	36	24	321	39
L2CB24302D072H	1772	2050	72.81	73.24	30	24	294	36
L2CB24362D072H	1930	2322	72.81	73.24	36	24	339	43

L2CB • Storage Cabinet with Open Bookcase and 2 Adjustable Shelves over a 2 High Lateral

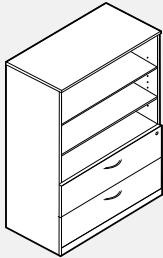

- 50"h. cabinet comes with one adjustable shelf.
- 66"h. and 72"h. Cabinet comes with 2 adjustable Shelves.
- One lock included.
- Optional e-lock available in the vertical position. Please specify V - Vertical and add \$231 list.

PRODUCT CODE	FINISH LP	W	SIZE/INCHES				WEIGHT LBS	VOL FT ³
			H (LP/B)	H (W)	W	D		
L2CB20302H050H	1757	1888	49.56	50.00	30	20	226	21
L2CB20362H050H	1845	1983	49.56	50.00	36	20	261	25
L2CB20302H066H	1935	2063	65.81	66.25	30	20	290	28
L2CB20362H066H	2092	2176	65.81	66.25	36	20	334	33
L2CB20302H072H	2014	2049	72.81	73.24	30	20	307	30
L2CB20362H072H	2148	2230	72.81	73.24	36	20	352	36
L2CB24302H050H	1843	1982	49.56	50.00	30	24	226	25
L2CB24362H050H	1935	2083	49.56	50.00	36	24	261	30
L2CB24302H066H	2032	2166	65.81	66.25	30	24	290	33
L2CB24362H066H	2197	2286	65.81	66.25	36	24	334	39
L2CB24302H072H	2114	2152	72.81	73.24	30	24	307	36
L2CB24362H072H	2256	2341	72.81	73.24	36	24	352	43

L2CBA • Storage Cabinet with 2 Doors and 4 Adjustable Shelves

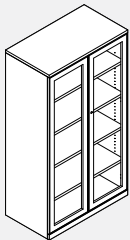

- One lock included.
- Door frame is anodized aluminum.
- Glazing is frosted acrylic.
- Doors standard with no handles.
- E-locks not available for aluminum framed glass doors.

PRODUCT CODE	FINISH LP	W	SIZE/INCHES				WEIGHT LBS	VOL FT ³
			H (LP/B)	H (W)	W	D		
L2CBA20302D50H	2672	2813	49.56	50.00	30	20	235	21
L2CBA20362D50H	2893	3062	49.56	50.00	36	20	281	25
L2CBA20302D66H	3122	3260	65.81	66.25	30	20	300	28
L2CBA20362D66H	3395	3558	65.81	66.25	36	20	344	33
L2CBA20302D72H	3278	3417	72.81	73.25	30	20	317	30
L2CBA20362D72H	3565	3726	72.81	73.25	36	20	362	36
L2CBA24302D50H	2743	2891	49.56	50.00	30	24	235	21
L2CBA24362D50H	2968	3138	49.56	50.00	36	24	281	25
L2CBA24302D66H	3199	3346	65.81	66.25	30	24	300	28
L2CBA24362D66H	3479	3647	65.81	66.25	36	24	344	33
L2CBA24302D72H	3361	3502	72.81	73.25	30	24	317	30
L2CBA24362D72H	3652	3821	72.81	73.25	36	24	362	36

L2CBA • Storage Cabinet with 2 Doors, Coat Rod and 1 Adjustable Shelf

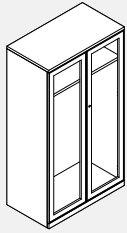

- One lock included.
- Door frame is anodized aluminum.
- Glazing is frosted acrylic.
- Doors standard with no handles.
- E-locks not available for aluminum framed glass doors.

PRODUCT CODE	FINISH LP	W	SIZE/INCHES				WEIGHT		VOL FT ³
			H(LP/B)	H(W)	W	D	LBS		
L2CBA20302DCS50H	2526	2657	49.56	50.00	30	20	195	21	
L2CBA20362DCS50H	2710	2870	49.56	50.00	36	20	221	25	
L2CBA20302DCS66H	2890	3055	65.81	66.25	30	20	239	28	
L2CBA20362DCS66H	3106	3269	65.81	66.25	36	20	271	33	
L2CBA20302DCS72H	3047	3318	72.81	73.25	30	20	255	30	
L2CBA20362DCS72H	3283	3442	72.81	73.25	36	20	288	36	
L2CBA24302DCS50H	2589	2725	49.56	50.00	30	24	195	21	
L2CBA24362DCS50H	2777	2944	49.56	50.00	36	24	221	25	
L2CBA24302DCS66H	2958	3133	65.81	66.25	30	24	239	28	
L2CBA24362DCS66H	3180	3349	65.81	66.25	36	24	271	33	
L2CBA24302DCS72H	3122	3397	72.81	73.25	30	24	255	30	
L2CBA24362DCS72H	3356	3525	72.81	73.25	36	24	288	36	

L2CBA • Storage Cabinet with 3 High Cupboard, 2 Adjustable Shelves over a 2 High Lateral

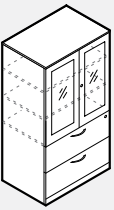

- Cabinet 2h2d.
- One lock on right door.
- One lock on upper drawer.
- Door frame is anodized aluminum with lock(s).
- Glazing is frosted acrylic.
- Doors standard with no handles.
- Two locks included.
- Optional e-lock available in the vertical position. Please specify V - Vertical and add \$231 list.
- E-locks not available for aluminum framed glass doors.

PRODUCT CODE	FINISH LP	W	SIZE/INCHES				WEIGHT		VOL FT ³
			H(LP/B)	H(W)	W	D	LBS		
L2CBA20302H2D50H	2822	2948	49.56	50.00	30	20	233	19	
L2CBA20362H2D50H	3013	3129	49.56	50.00	36	20	265	22	
L2CBA20302H2D66H	3303	3430	65.81	66.25	30	20	292	25	
L2CBA20362H2D66H	3547	3696	65.81	66.25	36	20	332	29	
L2CBA20302H2D72H	3460	3589	72.81	73.25	30	20	307	27	
L2CBA20362H2D72H	3693	3821	72.81	73.25	36	20	348	32	
L2CBA24302H2D50H	2911	3041	49.56	50.00	30	24	233	22	
L2CBA24362H2D50H	3108	3226	49.56	50.00	36	24	265	27	
L2CBA24302H2D66H	3406	3536	65.81	66.25	30	24	292	29	
L2CBA24362H2D66H	3652	3809	65.81	66.25	36	24	332	35	
L2CBA24302H2D72H	3565	3697	72.81	73.25	30	24	307	32	
L2CBA24362H2D72H	3800	3936	72.81	73.25	36	24	348	38	

L2CBA • Storage Cabinet with 2 High Cupboard, 1 Adjustable Shelves over a 3 High Lateral

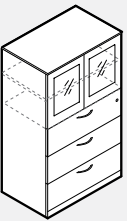

- Cabinet 3h2d.
- One lock on right door.
- One lock on upper drawer.
- Door frame is anodized aluminum with lock(s).
- Glazing is frosted acrylic.
- Doors standard with no handles.
- Two locks included.
- Optional e-lock available in the vertical position. Please specify V - Vertical and add \$231 list.
- E-locks not available for aluminum framed glass doors.

PRODUCT CODE	FINISH LP	W	SIZE/INCHES				WEIGHT		VOL FT ³
			H(LP/B)	H(W)	W	D	LBS		
L2CBA20303H2D66H	3255	3384	65.81	66.25	30	20	337	28	
L2CBA20363H2D66H	3478	3629	65.81	66.25	36	20	381	33	
L2CBA20303H2D72H	3441	3567	72.81	73.25	30	20	354	30	
L2CBA20363H2D72H	3671	3827	72.81	73.25	36	20	399	36	
L2CBA24303H2D66H	3361	3494	65.81	66.25	30	24	337	28	
L2CBA24363H2D66H	3590	3748	65.81	66.25	36	24	381	33	
L2CBA24303H2D72H	3549	3682	72.81	73.25	30	24	354	30	
L2CBA24363H2D72H	3788	3953	72.81	73.25	36	24	399	36	

L2CBA • Storage Cabinet with 2 Aluminum Door Storage Cupboard above a 4 high Lateral

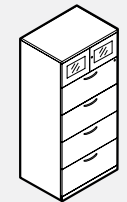

- Two locks included.
- Door frame is anodized aluminum.
- Glazing is frosted acrylic.
- Doors standard with no handles.
- One lock on right door.
- One lock on upper drawer.
- Optional e-lock available in the vertical position. Please specify V - Vertical and add \$231 list.
- E-locks not available for aluminum framed glass doors.

PRODUCT CODE	FINISH LP	W	SIZE/INCHES				WEIGHT		VOL FT ³
			H(LP/B)	H(W)	W	D	LBS		
L2CBA20304H2D66H	3463	3617	65.81	66.25	30	20	343	28	
L2CBA20364H2D66H	3807	3968	65.81	66.25	36	20	387	33	
L2CBA20304H2D72H	3630	3765	72.81	73.25	30	20	360	30	
L2CBA20364H2D72H	3868	4026	72.81	73.25	36	20	345	36	
L2CBA24304H2D66H	3586	3746	65.81	66.25	30	24	343	28	
L2CBA24364H2D66H	3939	4105	65.81	66.25	36	24	387	33	
L2CBA24304H2D72H	3758	3896	72.81	73.25	30	24	360	30	
L2CBA24364H2D72H	3999	4167	72.81	73.25	36	24	345	36	

L2HH • Hutch with Hinged Doors

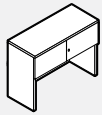

30" - 42" units

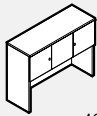

48" units

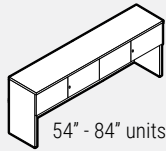

54" - 84" units

- 30" - 42" units come with one lock.
- 48" - 84" units come with two locks.
- Optional e-lock available in the horizontal position. Please specify HR - Horizontal Right and add \$231 list.
- Hutches 48" or longer require two e-locks.

PRODUCT CODE	FINISH		SIZE/INCHES				WEIGHT		VOL FT ³
	LP	W	H(LP)	H(W)	W	D	LBS		
L2HH30H36	877	983	36.81	37.25	30	16	138	17	
L2HH36H36	926	1045	36.81	37.25	36	16	145	18	
L2HH42H36	1003	1153	36.81	37.25	42	16	163	19	
L2HH48H36	1267	1422	36.81	37.25	48	16	180	22	
L2HH54H36	1500	1656	36.81	37.25	54	16	208	26	
L2HH60H36	1533	1726	36.81	37.25	60	16	216	29	
L2HH66H36	1615	1832	36.81	37.25	66	16	233	30	
L2HH72H36	1658	1891	36.81	37.25	72	16	251	32	
L2HH78H36	1753	2048	36.81	37.25	78	16	264	46	
L2HH84H36	1804	2072	36.81	37.25	84	16	277	50	
L2HH30H43	942	1038	43.81	44.25	30	16	158	19	
L2HH36H43	973	1094	43.81	44.25	36	16	166	20	
L2HH42H43	1074	1233	43.81	44.25	42	16	175	22	
L2HH48H43	1325	1475	43.81	44.25	48	16	191	24	
L2HH54H43	1540	1719	43.81	44.25	54	16	209	31	
L2HH60H43	1594	1788	43.81	44.25	60	16	227	32	
L2HH66H43	1681	1898	43.81	44.25	66	16	249	33	
L2HH72H43	1759	1994	43.81	44.25	72	16	259	36	
L2HH78H43	1826	2118	43.81	44.25	78	16	272	48	
L2HH84H43	1874	2152	43.81	44.25	84	16	285	53	

L2HH-A • Hutch with Aluminum Hinged Doors

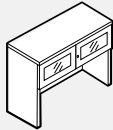

30" - 42" units

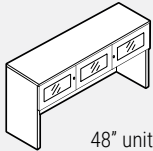

48" units

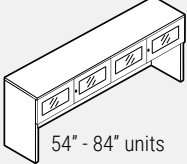

54" - 84" units

- 30" - 42" units come with one lock.
- 48" - 84" units come with two locks.
- Door frame is anodized aluminum.
- Glazing is frosted acrylic.
- Doors standard with no handles.
- E-locks not available for aluminum framed glass doors.

PRODUCT CODE	FINISH		SIZE/INCHES				WEIGHT		VOL FT ³
	LP	W	H(LP)	H(W)	W	D	LBS		
L2HH30H36A	1392	1495	36.81	37.25	30	16	138	17	
L2HH36H36A	1473	1592	36.81	37.25	36	16	145	18	
L2HH42H36A	1568	1684	36.81	37.25	42	16	163	19	
L2HH48H36A	2057	2209	36.81	37.25	48	16	180	22	
L2HH54H36A	2505	2664	36.81	37.25	54	16	208	26	
L2HH60H36A	2571	2765	36.81	37.25	60	16	216	29	
L2HH66H36A	2665	2692	36.81	37.25	66	16	233	30	
L2HH72H36A	2735	2967	36.81	37.25	72	16	251	32	
L2HH78H36A	2831	3126	36.81	37.25	78	16	264	46	
L2HH84H36A	2911	3194	36.81	37.25	84	16	277	50	
L2HH30H43A	1457	1554	43.81	44.25	30	16	158	19	
L2HH36H43A	1524	1642	43.81	44.25	36	16	166	20	
L2HH42H43A	1639	1800	43.81	44.25	42	16	175	22	
L2HH48H43A	2114	2264	43.81	44.25	48	16	191	24	
L2HH54H43A	2565	2725	43.81	44.25	54	16	209	31	
L2HH60H43A	2633	2829	43.81	44.25	60	16	227	32	
L2HH66H43A	2731	2852	43.81	44.25	66	16	249	33	
L2HH72H43A	2843	3079	43.81	44.25	72	16	259	36	
L2HH78H43A	2904	3195	43.81	44.25	78	16	272	48	
L2HH84H43A	2987	3262	43.81	44.25	84	16	285	53	

L2HO • Open Hutch

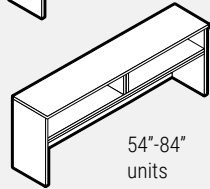
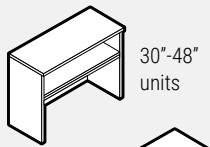
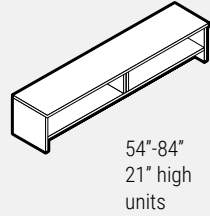
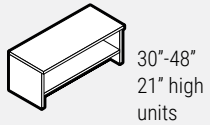

PRODUCT CODE	FINISH LP	W	SIZE/INCHES				WEIGHT LBS	VOL FT ³
			H(LP)	H(W)	W	D		
L2HO30H21	486	596	20.56	21	30	16	73	11
L2HO36H21	534	623	20.56	21	36	16	81	13
L2HO42H21	592	749	20.56	21	42	16	96	15
L2HO48H21	658	823	20.56	21	48	16	100	18
L2HO54H21	792	959	20.56	21	54	16	124	20
L2HO60H21	820	1027	20.56	21	60	16	134	22
L2HO66H21	874	1107	20.56	21	66	16	144	24
L2HO72H21	908	1156	20.56	21	72	16	152	26
L2HO78H21	960	1205	20.56	21	78	16	161	29
L2HO84H21	1006	1300	20.56	21	84	16	169	31
L2HO30H36	593	701	36.81	37.25	30	16	91	18
L2HO36H36	645	774	36.81	37.25	36	16	109	19
L2HO42H36	712	867	36.81	37.25	42	16	127	22
L2HO48H36	823	985	36.81	37.25	48	16	131	24
L2HO54H36	930	1096	36.81	37.25	54	16	145	29
L2HO60H36	963	1171	36.81	37.25	60	16	138	31
L2HO66H36	1026	1262	36.81	37.25	66	16	142	33
L2HO72H36	1072	1323	36.81	37.25	72	16	149	36
L2HO78H36	1129	1441	36.81	37.25	78	16	154	46
L2HO84H36	1188	1474	36.81	37.25	84	16	158	50
L2HO30H43	661	701	43.81	44.25	30	16	99	22
L2HO36H43	697	774	43.81	44.25	36	16	108	26
L2HO42H43	825	867	43.81	44.25	42	16	122	31
L2HO48H43	880	985	43.81	44.25	48	16	127	35
L2HO54H43	1001	1096	43.81	44.25	54	16	151	40
L2HO60H43	1095	1171	43.81	44.25	60	16	161	44
L2HO66H43	1160	1262	43.81	44.25	66	16	171	48
L2HO72H43	1245	1323	43.81	44.25	72	16	178	53
L2HO78H43	1270	1441	43.81	44.25	78	16	187	57
L2HO84H43	1332	1474	43.81	44.25	84	16	196	62

L2HF • Hutch with Flip Up Doors

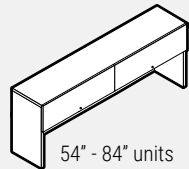
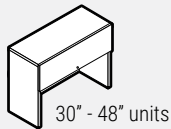

- 30" - 48" units come with one lock.
- 54" - 84" units come with two locks.
- Optional e-lock available in the horizontal position. Please specify HR - Horizontal Right and add \$231 list.
- Hutches 48" or longer require two e-locks.

PRODUCT CODE	FINISH LP	W	SIZE/INCHES				WEIGHT LBS	VOL FT ³
			H(LP)	H(W)	W	D		
L2HF30H36	883	917	36.81	37.25	30	16	142	18
L2HF36H36	941	977	36.81	37.25	36	16	146	19
L2HF42H36	1012	1053	36.81	37.25	42	16	158	22
L2HF48H36	1018	1060	36.81	37.25	48	16	180	24
L2HF54H36	1527	1587	36.81	37.25	54	16	182	29
L2HF60H36	1620	1686	36.81	37.25	60	16	220	31
L2HF66H36	1696	1764	36.81	37.25	66	16	253	33
L2HF72H36	1747	1817	36.81	37.25	72	16	259	36
L2HF78H36	1827	1900	36.81	37.25	78	16	264	46
L2HF84H36	1894	1970	36.81	37.25	84	16	275	50
L2HF30H43	971	1007	43.81	44.25	30	16	150	22
L2HF36H43	976	1018	43.81	44.25	36	16	154	26
L2HF42H43	1052	1092	43.81	44.25	42	16	166	31
L2HF48H43	1126	1170	43.81	44.25	48	16	188	35
L2HF54H43	1543	1606	43.81	44.25	54	16	194	40
L2HF60H43	1668	1735	43.81	44.25	60	16	232	44
L2HF66H43	1753	1825	43.81	44.25	66	16	265	48
L2HF72H43	1801	1870	43.81	44.25	72	16	271	53
L2HF78H43	1934	2015	43.81	44.25	78	16	276	57
L2HF84H43	2006	2087	43.81	44.25	84	16	287	62

L2HHP • Hutch with Laminate Doors and Pigeon Holes

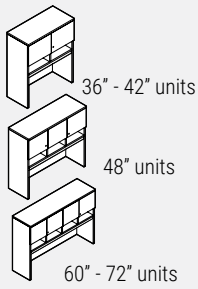

- For tackboards, please use LTB21xx.
- 36" - 42" units come with one lock.
- 48" - 72" units come with two locks.
- Optional e-lock available in the horizontal position. Please specify HR - Horizontal Right or HL - Horizontal Left for the 48" wide unit and add \$231 list.
- Hutches 48" or longer require two e-locks.

PRODUCT CODE	FINISH		SIZE/INCHES				WEIGHT		VOL FT ³
	LP	W	H(LP)	H(W)	W	D	LBS		
L2HHP36	1125	1239	43.81	44.25	36	16	145	17	
L2HHP42	1194	1328	43.81	44.25	42	16	163	19	
L2HHP48	1608	1766	43.81	44.25	48	16	180	22	
L2HHP60	1947	2130	43.81	44.25	60	16	216	26	
L2HHP66	2007	2234	43.81	44.25	66	16	233	30	
L2HHP72	2091	2322	43.81	44.25	72	16	251	32	

L2HHP-A • Hutch with Aluminum Hinged Doors and Pigeon Holes

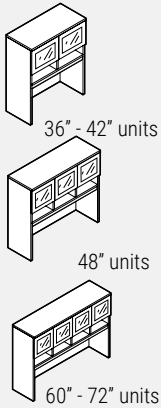

- For tackboards, please use LTB21xx.
- 36" - 42" units come with one lock.
- 48" - 72" units come with two locks.
- Door frame is anodized aluminum.
- Glazing is frosted acrylic.
- Doors standard with no handles.
- E-locks not available for aluminum framed glass doors.

PRODUCT CODE	FINISH		SIZE/INCHES				WEIGHT		VOL FT ³
	LP	W	H(LP)	H(W)	W	D	LBS		
L2HHP36A	1577	1695	43.81	37.25	36	16.8	132	15	
L2HHP42A	1720	1857	43.81	37.25	42	16.8	148	17	
L2HHP48A	2306	2463	43.81	37.25	48	16.8	164	20	
L2HHP60A	2851	3037	43.81	37.25	60	16.8	196	24	
L2HHP66A	2950	3177	43.81	37.25	66	16.8	212	27	
L2HHP72A	3072	3303	43.81	37.25	72	16.8	228	29	

L2HSD • Hutch with Sliding Laminate Doors

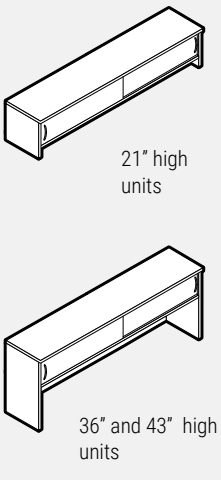

- One lock included.

PRODUCT CODE	FINISH		SIZE/INCHES				WEIGHT		VOL FT ³
	LP	W	H(LP)	H(W)	W	D	LBS		
L2HSD48H21	1094	1262	20.56	21	48	16	122	18	
L2HSD54H21	1200	1389	20.56	21	54	16	146	20	
L2HSD60H21	1241	1451	20.56	21	60	16	156	22	
L2HSD66H21	1324	1554	20.56	21	66	16	166	24	
L2HSD72H21	1362	1586	20.56	21	72	16	174	26	
L2HSD78H21	1429	1721	20.56	21	78	16	183	29	
L2HSD84H21	1471	1759	20.56	21	84	16	191	31	
L2HSD48H36	1355	1529	36.81	37.25	48	16	141	24	
L2HSD54H36	1498	1670	36.81	37.25	54	16	165	29	
L2HSD60H36	1533	1748	36.81	37.25	60	16	175	31	
L2HSD66H36	1626	1867	36.81	37.25	66	16	185	33	
L2HSD72H36	1668	1906	36.81	37.25	72	16	193	36	
L2HSD78H36	1757	2087	36.81	37.25	78	16	201	46	
L2HSD84H36	1797	2117	36.81	37.25	84	16	210	50	
L2HSD48H43	1436	1609	43.81	44.25	48	16	149	35	
L2HSD54H43	1586	1751	43.81	44.25	54	16	173	40	
L2HSD60H43	1628	1843	43.81	44.25	60	16	183	44	
L2HSD66H43	1722	1962	43.81	44.25	66	16	193	48	
L2HSD72H43	1816	2057	43.81	44.25	72	16	200	53	
L2HSD78H43	1866	2191	43.81	44.25	78	16	209	57	
L2HSD84H43	1925	2223	43.81	44.25	84	16	218	62	

L2HGSD • Hutch with Sliding Glass Doors

- One lock included.
- Glass is frosted tempered.

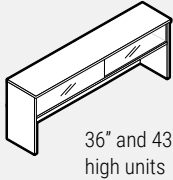
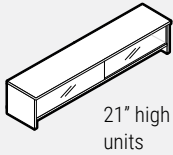

PRODUCT CODE	FINISH LP	W	SIZE/INCHES		W	D	WEIGHT VOL	
			H(LP)	H(W)			LBS	FT ³
L2HGSD48H21	2349	2525	20.56	21	48	16	139	18
L2HGSD54H21	2476	2671	20.56	21	54	16	163	20
L2HGSD60H21	2526	2740	20.56	21	60	16	184	22
L2HGSD66H21	2619	2862	20.56	21	66	16	194	24
L2HGSD72H21	2680	2936	20.56	21	72	16	201	26
L2HGSD78H21	2779	3081	20.56	21	78	16	210	29
L2HGSD84H21	2847	3147	20.56	21	84	16	219	31
L2HGSD48H36	2497	2671	36.81	37.25	48	16	157	24
L2HGSD54H36	2653	2825	36.81	37.25	54	16	182	29
L2HGSD60H36	2692	2907	36.81	37.25	60	16	202	31
L2HGSD66H36	2795	3037	36.81	37.25	66	16	212	33
L2HGSD72H36	2862	3142	36.81	37.25	72	16	220	36
L2HGSD78H36	2977	3300	36.81	37.25	78	16	229	46
L2HGSD84H36	3055	3354	36.81	37.25	84	16	238	50
L2HGSD48H43	2555	2803	43.81	44.25	48	16	165	35
L2HGSD54H43	2692	2961	43.81	44.25	54	16	189	40
L2HGSD60H43	2755	3046	43.81	44.25	60	16	210	44
L2HGSD66H43	2862	3142	43.81	44.25	66	16	220	48
L2HGSD72H43	2936	3288	43.81	44.25	72	16	228	53
L2HGSD78H43	3049	3428	43.81	44.25	78	16	237	57
L2HGSD84H43	3133	3505	43.81	44.25	84	16	245	62

L2DSH • Double Sided Hutch with Laminate Doors

- Two locks included.

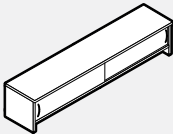

PRODUCT CODE	FINISH LP	W	SIZE/INCHES		W	D	WEIGHT VOL	
			H(LP)	H(W)			LBS	FT ³
L2DSH60H21	1306	1516	20.56	21	60	16	156	22
L2DSH66H21	1391	1622	20.56	21	66	16	166	24
L2DSH72H21	1434	1633	20.56	21	72	16	201	26
L2DSH78H21	1508	1800	20.56	21	78	16	210	29
L2DSH84H21	1554	1840	20.56	21	84	16	219	31

LTB27 • Tackboards for 43" High Hutches

- Provides a tackable surface for notes and memos.
- Velcro for installation is included.
- Tackboards for hutches are 3" shorter than the overall size of the hutch.

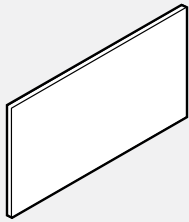

PRODUCT CODE	FABRIC		SIZE/INCHES			WEIGHT LBS	VOL FT ³
	GR1	GR2	H	W	D		
LTB2727	307	324	27	27	1	7	0.46
LTB2733	333	354	27	33	1	7	0.57
LTB2739	363	389	27	39	1	7	0.67
LTB2745	411	441	27	45	1	8	0.78
LTB2751	473	501	27	51	1	8	0.88
LTB2757	527	555	27	57	1	9	0.98
LTB2763	581	610	27	63	1	9	1.09
LTB2769	639	672	27	69	1	10	1.19
LTB2775	717	752	27	75	1	10	1.30
LTB2781	800	835	27	81	1	11	1.40

LTB21 • Tackboards for 36" High Hutches

- Provides a tackable surface for notes and memos.
- Velcro for installation is included.
- Tackboards for hutches are 3" shorter than the overall size of the hutch.

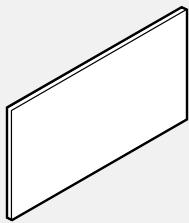

PRODUCT CODE	FABRIC		SIZE/INCHES			WEIGHT LBS	VOL FT ³
	GR1	GR2	H	W	D		
LTB2127	240	260	21	27	1	4	0.38
LTB2133	261	281	21	33	1	4	0.42
LTB2139	283	312	21	39	1	4	0.49
LTB2145	323	351	21	45	1	5	0.56
LTB2151	370	383	21	51	1	5	0.63
LTB2157	411	441	21	57	1	6	0.69
LTB2163	455	488	21	63	1	6	0.76
LTB2169	501	528	21	69	1	7	0.83
LTB2175	561	589	21	75	1	7	0.89
LTB2181	626	655	21	81	1	8	0.96

L2HC • Corner Curved Bookcase

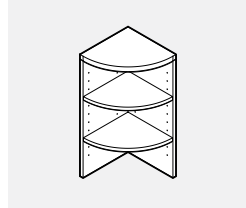

- Shipped knocked down (KD).

PRODUCT CODE	FINISH LP	W	SIZE/INCHES				WEIGHT LBS	VOL FT ³
			H(LP)	H(W)	W	D		
L2HC1637	636	733	36.81	37.25	16.87	16.87	57	7
L2HC1644	676	775	43.81	44.25	16.87	16.87	63	8

L2HBK • Open Hutch Bookcase

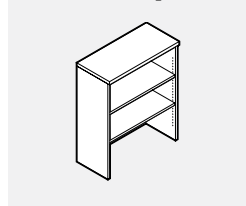

- Shipped knocked down (KD).

PRODUCT CODE	FINISH LP	W	SIZE/INCHES				WEIGHT LBS	VOL FT ³
			H(LP)	H(W)	W	D		
L2HBK303	746	870	36.81	37.25	30	16.875	109	12
L2HBK363	805	956	43.81	44.25	36	16.875	123	14
L2HBK304	817	942	36.81	37.25	30	16.875	119	13
L2HBK364	862	1011	43.81	44.25	36	16.875	135	17

L2WHO • Wall Mounted Open Storage

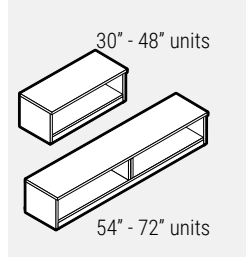

PRODUCT CODE	FINISH LP	W	SIZE/INCHES				WEIGHT LBS	VOL FT ³
			H(LP/B)	H(W)	W	D		
L2WHO30	536	636	16.75	17.18	30	16	69	7
L2WHO36	570	717	16.75	17.18	36	16	78	8
L2WHO42	658	800	16.75	17.18	42	16	87	9
L2WHO48	698	856	16.75	17.18	48	16	97	10
L2WHO54	755	952	16.75	17.18	54	16	106	11
L2WHO60	942	1063	16.75	17.18	60	16	117	12
L2WHO66	988	1096	16.75	17.18	66	16	125	13
L2WHO72	1033	1205	16.75	17.18	72	16	139	14

L2WHH • Wall Mounted Hinged Door

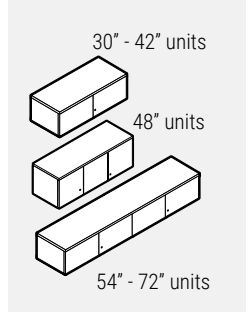

- 30" - 42" units come with one lock.
- 48" - 72" units come with two locks.
- Optional e-lock available in the horizontal position. Please specify HR - Horizontal Right or HL - Horizontal Left for the 48" wide unit and add \$231 list.
- Hutches 48" or longer require two e-locks.

PRODUCT CODE	FINISH LP	W	SIZE/INCHES				WEIGHT LBS	VOL FT ³
			H(LP/B)	H(W)	W	D		
L2WHH30	722	800	16.75	17.18	30	16	120	7
L2WHH36	775	867	16.75	17.18	36	16	139	8
L2WHH42	846	960	16.75	17.18	42	16	143	9
L2WHH48	1060	1182	16.75	17.18	48	16	145	10
L2WHH54	1257	1395	16.75	17.18	54	16	155	11
L2WHH60	1300	1409	16.75	17.18	60	16	165	12
L2WHH66	1360	1487	16.75	17.18	66	16	175	13
L2WHH72	1417	1606	16.75	17.18	72	16	187	14

L2WHF • Wall Mounted Flip-up Door

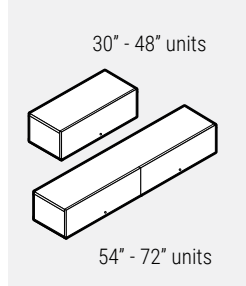

- 30" - 48" units come with one lock.
- 54" - 72" units come with two locks.
- Optional e-lock available in the horizontal position. Please specify HR - Horizontal Right or HL - Horizontal Left add \$231 list.
- Hutches 54" or longer require two e-locks.

PRODUCT CODE	FINISH LP	W	SIZE/INCHES				WEIGHT LBS	VOL FT ³
			H(LP/B)	H(W)	W	D		
L2WHF30	805		17.63	17.63	30	16	94	7
L2WHF36	854		17.63	17.63	36	16	103	8
L2WHF42	930		17.63	17.63	42	16	113	9
L2WHF48	976		17.63	17.63	48	16	123	10
L2WHF54	1441		17.63	17.63	54	16	130	11
L2WHF60	1484		17.63	17.63	60	16	141	12
L2WHF66	1573		17.63	17.63	66	16	151	13
L2WHF72	1613		17.63	17.63	72	16	163	14

L2WHH • Wall Mounted Unit with Aluminum Doors

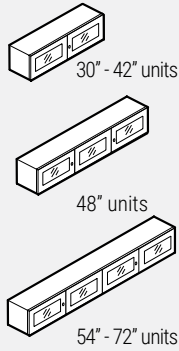

- Horizontal wall rails included.
- 30" - 42" units come with one lock.
- 48" - 72" units come with two locks.
- Door frame is anodized aluminum.
- Glazing is frosted acrylic.
- Doors standard with no handles.
- E-locks not available for aluminum framed glass doors.

PRODUCT CODE	FINISH LP	W	SIZE/INCHES		W	D	WEIGHT LBS	VOL FT ³
			H(LP/B)	H(W)				
L2WHH30A	1201	1278	16.75	17.19	30	16	109	6
L2WHH36A	1296	1389	16.75	17.19	36	16	126	7
L2WHH42A	1407	1524	16.75	17.19	42	16	130	8
L2WHH48A	1800	1923	16.75	17.19	48	16	132	9
L2WHH54A	2173	2313	16.75	17.19	54	16	141	10
L2WHH60A	2259	2369	16.75	17.19	60	16	150	11
L2WHH66A	2347	2473	16.75	17.19	66	16	159	12
L2WHH72A	2461	2647	16.75	17.19	72	16	170	13

L2WSD • Wall Mounted Unit with Sliding Laminate Doors

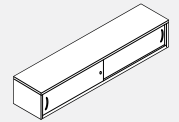

- Wall mounting horizontal rails included.
- One lock included.

PRODUCT CODE	FINISH LP	W	SIZE/INCHES		W	D	WEIGHT LBS	VOL FT ³
			H(LP/B)	H(W)				
L2WSD36	1055	1186	16.75	17.19	36	16	128	7
L2WSD42	1152	1304	16.75	17.19	42	16	130	8
L2WSD48	1194	1348	16.75	17.19	48	16	132	9
L2WSD54	1323	1508	16.75	17.19	54	16	141	10
L2WSD60	1379	1585	16.75	17.19	60	16	150	11
L2WSD66	1473	1711	16.75	17.19	66	16	159	12
L2WSD72	1515	1769	16.75	17.19	72	16	170	13

L2WGSD • Wall Mounted Unit with Sliding Glass Doors

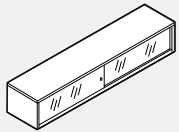

- Wall mounting horizontal rails included.
- Standard recessed chrome pull.
- Lock is included and must be installed at time of manufacturing, please specify key number.
- Frosted tempered glass.

PRODUCT CODE	FINISH LP	W	SIZE/INCHES		W	D	WEIGHT LBS	VOL FT ³
			H(LP/B)	H(W)				
L2WGSD36	1959	2272	16.75	17.19	36	16	128	7
L2WGSD42	2290	2449	16.75	17.19	42	16	130	8
L2WGSD48	2347	2521	16.75	17.19	48	16	132	9
L2WGSD54	2454	2647	16.75	17.19	54	16	141	10
L2WGSD60	2519	2732	16.75	17.19	60	16	150	11
L2WGSD66	2625	2869	16.75	17.19	66	16	159	12
L2WGSD72	2725	2983	16.75	17.19	72	16	170	13

LTB20 • Tackboards for Wall Mounted Units

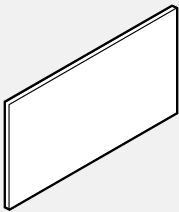

- Please specify wall rails BHV01 and BHV02 separately, see Boulevard Price List.
- Provides a tackable surface for notes and memos.
- Mounting brackets for installation included.
- Tackboards for Wall Mounted Unit. Wall Rails (BHV01 and BHV02) must be ordered separately.
- For tackboards longer than 60", please include an additional BHV01 at the centre.

PRODUCT CODE	FABRIC		SIZE/INCHES			WEIGHT LBS	VOL FT ³
	GR1	GR2	H	W	D		
LTB2030	240	264	19.5	30	1	4	0.38
LTB2036	261	284	19.5	36	1	4	0.42
LTB2042	283	298	19.5	42	1	4	0.49
LTB2048	323	339	19.5	48	1	5	0.56
LTB2054	370	380	19.5	54	1	5	0.63
LTB2060	411	433	19.5	60	1	6	0.69
LTB2066	455	483	19.5	66	1	6	0.76
LTB2072	501	528	19.5	72	1	7	0.83
LTB2078	561	595	19.5	78	1	7	0.89
LTB2084	626	670	19.5	84	1	8	0.96

BHV • Component Wall Adapter - Single and Double

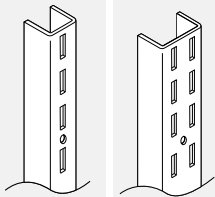

- Used to attach system components to fixed wall.
- Panel frame finish.
- The vertical wall adapter is a "U" shaped channel with a vertical row of slots with 1" centers.
- The double Component Wall Adapter has a double row of slots with 1" centers.
- Comes in 60" length only.
- Care should be taken to mount adapters only to wall studs using correct fasteners.
- Does not include mounting hardware. Mounting hardware selection to be based on wall material.
- Failure to do this may result in collapse of the unit and subsequent possible personal injury.
- Sold in pairs.

PRODUCT CODE	PRICE	SIZE/INCHES			WEIGHT LBS	VOL FT ³
		H	W	D		
BHV01	102	60	0.75	0.5	4	0.009
BHV02	117	60	1.50	0.5	5	0.026

L2PHH • Boulevard Panel Mounted Unit with Aluminum Doors

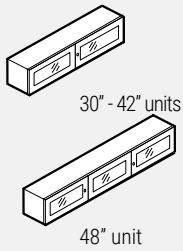

- 30" - 42" units comes with one lock
- 48" Unit comes with two locks.
- Door frame is anodized aluminum.
- Glazing is frosted acrylic.
- Doors standard with no handles.
- E-locks not available for aluminum framed glass doors.

PRODUCT CODE	FINISH LP	W	SIZE/INCHES				WEIGHT		VOL FT ³
			H(LP/B)	H(W)	W	D	LBS		
L2PHH30A	1339	1473	16.75	17.19	30	14.75	111	6	
L2PHH36A	1426	1585	16.75	17.19	36	14.75	128	7	
L2PHH42A	1529	1712	16.75	17.19	42	14.75	132	8	
L2PHH48A	1906	2154	16.75	17.19	48	14.75	134	9	

L2PSD • Boulevard Panel Mounted Unit with Sliding Laminate Doors

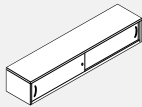

- Hardware included to mount the unit on the panel.
- One lock included.

PRODUCT CODE	FINISH LP	W	SIZE/INCHES				WEIGHT		VOL FT ³
			H(LP/B)	H(W)	W	D	LBS		
L2PSD36	1112	1237	16.75	17.19	36	14.75	123	7	
L2PSD42	1188	1343	16.75	17.19	42	14.75	132	8	
L2PSD48	1214	1370	16.75	17.19	48	14.75	141	9	

L2PGSD • Boulevard Panel Mounted Unit with Sliding Glass Doors

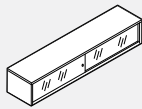

- Hardware included to mount the unit on the panel.
- One lock included.
- Standard recessed chrome pull.

PRODUCT CODE	FINISH LP	W	SIZE/INCHES				WEIGHT		VOL FT ³
			H(LP/B)	H(W)	W	D	LBS		
L2PGSD36	2236	2363	16.75	17.19	36	14.75	123	7	
L2PGSD42	2329	2491	16.75	17.19	42	14.75	132	8	
L2PGSD48	2371	2542	16.75	17.19	48	14.75	141	9	

L2PHO • Boulevard Panel Mounted Unit Open Overhead

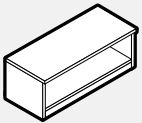

- Hardware included to mount the unit on the panel.

PRODUCT CODE	FINISH LP	W	SIZE/INCHES				WEIGHT		VOL FT ³
			H(LP/B)	H(W)	W	D	LBS		
L2PHO30	557	641	16.75	17.18	30	14.75	72	7	
L2PHO36	592	723	16.75	17.18	36	14.75	80	8	
L2PHO42	608	784	16.75	17.18	42	14.75	89	9	
L2PHO48	643	852	16.75	17.18	48	14.75	99	10	

L2PHH • Boulevard Panel Mounted Hinged Door Overhead

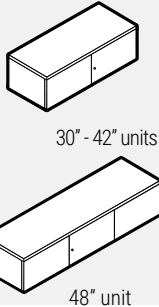

- Hardware included to mount the unit on the panel.
- One lock included.
- Optional e-lock available in the horizontal position. Please specify HR - Horizontal Right or HL - Horizontal Left for the 48" wide unit and add \$231 list.
- Hatches 48" or longer require two e-locks.

PRODUCT CODE	FINISH LP	W	SIZE/INCHES				WEIGHT		VOL FT ³
			H(LP/B)	H(W)	W	D	LBS		
L2PHH30	860	994	16.75	17.18	30	14.75	122	7	
L2PHH36	905	1064	16.75	17.18	36	14.75	141	8	
L2PHH42	969	1148	16.75	17.18	42	14.75	145	9	
L2PHH48	1168	1415	16.75	17.18	48	14.75	147	10	

L2PHF • Boulevard Panel Mounted Flip-up Door Overhead

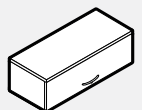

- Hardware included to mount the unit on the panel.
- One lock included.
- Optional e-lock available in the horizontal position. Please specify HR - Horizontal Right and add \$231 list.

PRODUCT CODE	FINISH LP	SIZE/INCHES			WEIGHT		VOL FT ³
		H(LP)	W	D	LBS		
L2PHF30	877	17.63	30	16	94	7	
L2PHF36	920	17.63	36	16	103	8	
L2PHF42	971	17.63	42	16	113	9	
L2PHF48	1023	17.63	48	16	123	10	

L2SOHD • Stack On 2H Cabinet with Hinged Doors & Adjustable Shelf for 1H Storage

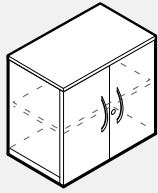

- One lock included.
- Optional e-lock available in the horizontal position. Please specify HR - Horizontal Right and add \$231 list.

PRODUCT CODE	FINISH		SIZE/INCHES				WEIGHT LBS	VOL FT ³
	LP	W	H(LP)	H(W)	W	D		
one door								
L2SOHDL15	645	718	29.63	29.63	15	16	95	7
L2SOHDR15	645	718	29.63	29.63	15	16	95	7
L2SOHDL18	661	734	29.63	29.63	18	16	99	9
L2SOHDR18	661	734	29.63	29.63	18	16	99	9
double door								
L2SOHD30	928	1037	29.63	29.63	30	16	171	11
L2SOHD36	1034	1168	29.63	29.63	36	16	178	13

L2SOALD • Stack On 2H Cabinet with Aluminum Hinged Doors & Adjustable Shelf for 1H Storage

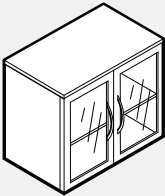

- No lock available for the one door units, one lock included for the double door units.
- Door frame is anodized aluminum.
- Glazing is frosted acrylic.
- Doors standard with no handles.
- E-locks not available for aluminum framed glass doors.

PRODUCT CODE	FINISH		SIZE/INCHES				WEIGHT LBS	VOL FT ³
	LP	W	H(LP)	H(W)	W	D		
one door								
L2SOALDL15	1074	1144	29.63	29.63	15	16	88	7
L2SOALDR15	1074	1144	29.63	29.63	15	16	88	7
L2SOALDL18	1122	1194	29.63	29.63	18	16	94	9
L2SOALDR18	1122	1194	29.63	29.63	18	16	94	9
double door								
L2SOALD30	1817	1928	29.63	29.63	30	16	164	11
L2SOALD36	1970	2099	29.63	29.63	36	16	172	13

L2S00 • Stack On 2H Cabinet with Adjustable Shelf for 1H Storage

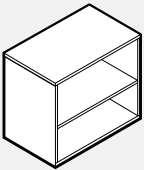

PRODUCT CODE	FINISH		SIZE/INCHES				WEIGHT LBS	VOL FT ³
	LP	W	H(LP)	H(W)	W	D		
L2S0015	473	548	29.63	29.63	15	16	61	7
L2S0018	484	562	29.63	29.63	18	16	72	8
L2S0030	622	741	29.63	29.63	30	16	88	14
L2S0036	725	870	29.63	29.63	36	16	94	19

L2SOSD • Stack On 2H Cabinet with Sliding Door, Divider & Adjustable Shelves for 1H Storage

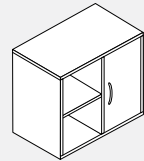

- Includes one sliding door.
- Lock not included.

PRODUCT CODE	FINISH		SIZE/INCHES				WEIGHT LBS	VOL FT ³
	LP	W	H(LP)	H(W)	W	D		
L2SOSD30	952	1062	29.63	29.63	30	16	116	14
L2SOSD36	1119	1255	29.63	29.63	36	16	121	19

L2SOGSD • Stack On 2H Cabinet with Sliding Glass Doors & Adjustable Shelf for 1H Storage

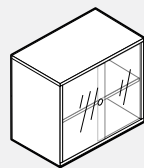

- One lock included.
- Standard recessed chrome pull.
- Glass is frosted tempered.

PRODUCT CODE	FINISH		SIZE/INCHES				WEIGHT LBS	VOL FT ³
	LP	W	H(LP)	H(W)	W	D		
L2SOGSD30	2240	2337	29.63	29.63	30	16	116	14
L2SOGSD36	2450	2568	29.63	29.63	36	16	121	19

L2CR1H1H • Credenza, 1 High File / File

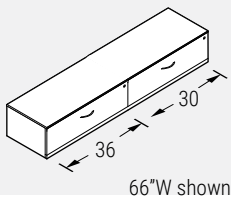

66"W shown

- Two locks included.
- Optional e-lock available in the vertical position. Please specify V - Vertical and add \$231 list.
- Hutches 48" or longer require two e-locks.

PRODUCT CODE	FINISH			SIZE/INCHES				WEIGHT LBS	VOL FT ³
	LP	B	W	H(LP/B)	H(W)	W	D		
L2CR1H1H2060	1714	1803	1842	19.94	20.5	60	20	189	22
L2CR1H1H2066	1797	1892	1933	19.94	20.5	66	20	209	24
L2CR1H1H2072	1822	1928	1973	19.94	20.5	72	20	246	26
L2CR1H1H2460	1782	1874	1918	19.94	20.5	60	24	189	22
L2CR1H1H2466	1867	1963	2014	19.94	20.5	66	24	209	24
L2CR1H1H2472	1894	2006	2053	19.94	20.5	72	24	246	26

L2CR2DO • Credenza, 1 High 2 Doors / Open Shelf

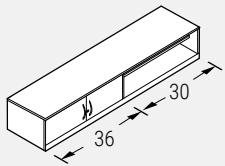

66"W shown

- One lock included.
- One height adjustable shelf included.
- Optional e-lock available in the horizontal position. Please specify HR - Horizontal Right and add \$231 list.

PRODUCT CODE	FINISH LP	B	W	SIZE/INCHES				D	WEIGHT LBS	VOL FT ³
				H(LP/B)	H(W)	W	D			
L2CR2DO2060	1469	1629	1718	19.94	20.5	60	20	169	22	
L2CR2DO2066	1533	1711	1805	19.94	20.5	66	20	180	24	
L2CR2DO2072	1601	1797	1900	19.94	20.5	72	20	191	26	
L2CR2DO2460	1526	1695	1785	19.94	20.5	60	24	169	22	
L2CR2DO2466	1594	1779	1878	19.94	20.5	66	24	180	24	
L2CR2DO2472	1666	1866	1976	19.94	20.5	72	24	191	26	

L2CRO2D • Credenza, 1 High Open Shelf / 2 Doors

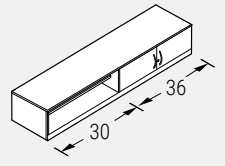

66"W shown

- One lock included.
- One height adjustable shelf included.
- Optional e-lock available in the horizontal position. Please specify HR - Horizontal Right and add \$231 list.

PRODUCT CODE	FINISH LP	B	W	SIZE/INCHES				D	WEIGHT LBS	VOL FT ³
				H(LP/B)	H(W)	W	D			
L2CRO2D2060	1469	1629	1718	19.94	20.5	60	20	169	22	
L2CRO2D2066	1533	1711	1805	19.94	20.5	66	20	180	24	
L2CRO2D2072	1601	1797	1900	19.94	20.5	72	20	191	26	
L2CRO2D2460	1526	1695	1785	19.94	20.5	60	24	169	22	
L2CRO2D2466	1594	1779	1878	19.94	20.5	66	24	180	24	
L2CRO2D2472	1666	1866	1976	19.94	20.5	72	24	191	26	

L2CR2ADO • Credenza, 2 Aluminum Doors / 1 High Open Shelf

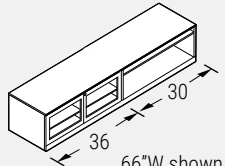

66"W shown

- One lock included.
- One height adjustable shelf included.
- Door frame is anodized aluminum.
- Glazing is frosted acrylic.
- Doors standard with no handles.

PRODUCT CODE	FINISH LP	B	W	SIZE/INCHES				D	WEIGHT LBS	VOL FT ³
				H(LP/B)	H(W)	W	D			
L2CR2ADO2060	1957	2118	2208	19.94	20.5	60	20	154	20	
L2CR2ADO2066	2062	2240	2334	19.94	20.5	66	20	164	22	
L2CR2ADO2072	2129	2324	2432	19.94	20.5	72	20	174	24	
L2CR2ADO2460	2016	2183	2275	19.94	20.5	60	24	154	20	
L2CR2ADO2466	2125	2310	2409	19.94	20.5	66	24	164	22	
L2CR2ADO2472	2194	2394	2503	19.94	20.5	72	24	174	24	

L2CRO2AD • Credenza, 1 High Open Shelf / 2 Aluminum Doors

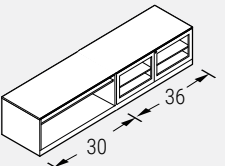

66"W shown

- One lock included.
- One height adjustable shelf included.
- Door frame is anodized aluminum.
- Glazing is frosted acrylic.
- Doors standard with no handles.

PRODUCT CODE	FINISH LP	B	W	SIZE/INCHES				D	WEIGHT LBS	VOL FT ³
				H(LP/B)	H(W)	W	D			
L2CRO2AD2060	1957	2118	2208	19.94	20.5	60	20	154	20	
L2CRO2AD2066	2062	2240	2334	19.94	20.5	66	20	164	22	
L2CRO2AD2072	2129	2324	2432	19.94	20.5	72	20	174	24	
L2CRO2AD2460	2016	2183	2275	19.94	20.5	60	24	154	20	
L2CRO2AD2466	2125	2310	2409	19.94	20.5	66	24	164	22	
L2CRO2AD2472	2194	2394	2503	19.94	20.5	72	24	174	24	

L2CR1HO • Credenza, 1 High File / Open Shelf

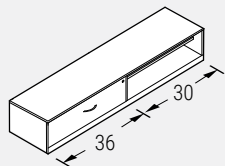

66"W shown

- One lock included.
- One height adjustable shelf included.
- Optional e-lock available in the vertical position. Please specify V - Vertical and add \$231 list.

PRODUCT CODE	FINISH LP	B	W	SIZE/INCHES				D	WEIGHT LBS	VOL FT ³
				H(LP/B)	H(W)	W	D			
L2CR1HO2060	1491	1622	1717	19.94	20.5	60	20	179	22	
L2CR1HO2066	1554	1696	1809	19.94	20.5	66	20	189	24	
L2CR1HO2072	1668	1825	1914	19.94	20.5	72	20	200	26	
L2CR1HO2460	1550	1687	1783	19.94	20.5	60	24	179	22	
L2CR1HO2466	1616	1762	1879	19.94	20.5	66	24	189	24	
L2CR1HO2472	1735	1895	1990	19.94	20.5	72	24	200	26	

L2CRO1H • Credenza, Open Shelf / 1 High File

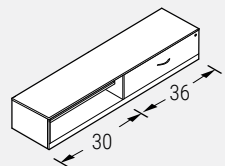

66"W shown

- One lock included.
- One height adjustable shelf included.
- Optional e-lock available in the vertical position. Please specify V - Vertical and add \$231 list.

PRODUCT CODE	FINISH LP	B	W	SIZE/INCHES				D	WEIGHT LBS	VOL FT ³
				H(LP/B)	H(W)	W	D			
L2CRO1H2060	1491	1622	1717	19.94	20.5	60	20	179	22	
L2CRO1H2066	1554	1696	1809	19.94	20.5	66	20	189	24	
L2CRO1H2072	1668	1825	1914	19.94	20.5	72	20	200	26	
L2CRO1H2460	1550	1687	1783	19.94	20.5	60	24	179	22	
L2CRO1H2466	1616	1762	1879	19.94	20.5	66	24	189	24	
L2CRO1H2472	1735	1895	1990	19.94	20.5	72	24	200	26	

L2CRO1H • Credenza, 1 High File / 2 Door

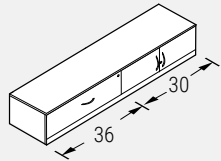

66"W shown

- Two locks included.
- Optional e-lock available in the vertical position for the file drawer. Please specify V - Vertical and add \$231 list.
- Optional e-lock available in the horizontal position. Please specify HR - Horizontal Right and add \$231 list.

PRODUCT CODE	FINISH			SIZE/INCHES				WEIGHT		VOL FT ³
	LP	B	W	H(LP/B)	H(W)	W	D	LBS		
L2CR1H2D2060	1814	1906	2029	19.94	20.5	60	20	199	22	
L2CR1H2D2066	1832	1936	2193	19.94	20.5	66	20	209	24	
L2CR1H2D2072	1947	2142	2246	19.94	20.5	72	20	220	26	
L2CR1H2D2460	1889	1984	2115	19.94	20.5	60	24	199	22	
L2CR1H2D2466	1904	2017	2281	19.94	20.5	66	24	209	24	
L2CR1H2D2472	2021	2227	2334	19.94	20.5	72	24	220	26	

L2CR2D1H • Credenza, 2 Door / 1 High File

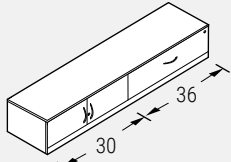

66"W shown

- Two locks included.
- Optional e-lock available in the vertical position for the file drawer. Please specify V - Vertical and add \$231 list.
- Optional e-lock available in the horizontal position. Please specify HR - Horizontal Right and add \$231 list.

PRODUCT CODE	FINISH			SIZE/INCHES				WEIGHT		VOL FT ³
	LP	B	W	H(LP/B)	H(W)	W	D	LBS		
L2CR2D1H2060	1814	1906	2029	19.94	20.5	60	20	199	22	
L2CR2D1H2066	1832	1936	2193	19.94	20.5	66	20	209	24	
L2CR2D1H2072	1947	2142	2246	19.94	20.5	72	20	220	26	
L2CR2D1H2460	1889	1984	2115	19.94	20.5	60	24	199	22	
L2CR2D1H2466	1904	2017	2281	19.94	20.5	66	24	209	24	
L2CR2D1H2472	2021	2227	2334	19.94	20.5	72	24	220	26	

L2CR1H2AD • Credenza, 1 High File / 2 Aluminum Door

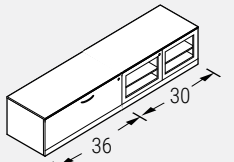

66"W shown

- Two locks included.
- One height adjustable shelf included.
- Door frame is anodized aluminum.
- Glazing is frosted acrylic.
- Doors standard with no handles.
- Optional e-lock available in the vertical position. Please specify V - Vertical and add \$231 list.
- E-locks not available for aluminum framed glass doors.

PRODUCT CODE	FINISH			SIZE/INCHES				WEIGHT		VOL FT ³
	LP	B	W	H(LP/B)	H(W)	W	D	LBS		
L2CR1H2AD2060	2303	2394	2522	19.94	20.5	60	20	181	20	
L2CR1H2AD2066	2363	2469	2722	19.94	20.5	66	20	190	22	
L2CR1H2AD2072	2474	2671	2777	19.94	20.5	72	20	200	24	
L2CR1H2AD2460	2377	2472	2603	19.94	20.5	60	24	181	20	
L2CR1H2AD2466	2435	2546	2811	19.94	20.5	66	24	190	22	
L2CR1H2AD2472	2552	2757	2866	19.94	20.5	72	24	200	24	

L2CR2AD1H • Credenza, 2 Aluminum Door / 1 High File

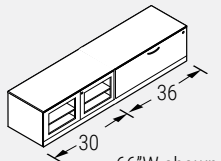

66"W shown

- Two locks included.
- One height adjustable shelf included.
- Door frame is anodized aluminum.
- Glazing is frosted acrylic.
- Doors standard with no handles.
- Optional e-lock available in the vertical position. Please specify V - Vertical and add \$231 list.
- E-locks not available for aluminum framed glass doors.

PRODUCT CODE	FINISH			SIZE/INCHES				WEIGHT		VOL FT ³
	LP	B	W	H(LP/B)	H(W)	W	D	LBS		
L2CR2AD1H2060	2303	2394	2522	19.94	20.5	60	20	181	20	
L2CR2AD1H2066	2363	2469	2722	19.94	20.5	66	20	190	22	
L2CR2AD1H2072	2474	2671	2777	19.94	20.5	72	20	200	24	
L2CR2AD1H2460	2377	2472	2603	19.94	20.5	60	24	181	20	
L2CR2AD1H2466	2435	2546	2811	19.94	20.5	66	24	190	22	
L2CR2AD1H2472	2552	2757	2866	19.94	20.5	72	24	200	24	

L2DSCR1H • Double Sided 1H Credenza Lateral

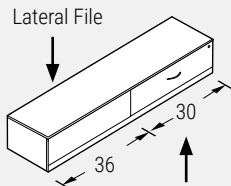

Lateral File
66"W shown

- Two locks included.
- Optional e-lock available in the vertical position. Please specify V - Vertical and add \$231 list.
- Credenzas require two e-locks.

PRODUCT CODE	FINISH			SIZE/INCHES				WEIGHT		VOL FT ³
	LP	B	W	H(LP/B)	H(W)	W	D	LBS		
L2DSCR1H2060	2020	2118	2188	19.94	20.5	60	20	196	22	
L2DSCR1H2066	2085	2191	2281	19.94	20.5	66	20	206	24	
L2DSCR1H2072	2148	2264	2374	19.94	20.5	72	20	217	26	
L2DSCR1H2460	2100	2202	2275	19.94	20.5	60	24	196	22	
L2DSCR1H2466	2165	2279	2371	19.94	20.5	66	24	206	24	
L2DSCR1H2472	2233	2354	2469	19.94	20.5	72	24	217	26	

L2CRBFBF • Credenza, BF / BF

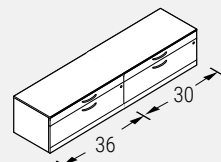

66"W shown

- Two locks included.
- Optional e-lock available in the vertical position. Please specify V - Vertical and add \$231 list.
- Credenzas require two e-locks.

PRODUCT CODE	FINISH			SIZE/INCHES				WEIGHT		VOL FT ³
	LP	B	W	H(LP/B)	H(W)	W	D	LBS		
L2CRBFBF2060	2292	2381	2419	19.94	20.5	60	20	218	20	
L2CRBFBF2066	2383	2481	2525	19.94	20.5	66	20	228	22	
L2CRBFBF2072	2423	2529	2574	19.94	20.5	72	20	239	24	
L2CRBFBF2460	2363	2454	2497	19.94	20.5	60	24	218	20	
L2CRBFBF2466	2459	2559	2603	19.94	20.5	66	24	228	22	
L2CRBFBF2472	2497	2606	2654	19.94	20.5	72	24	239	24	

L2CRBFO • Credenza, BF / Open

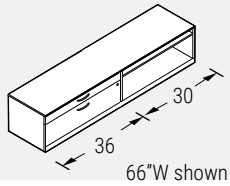

- One lock included.
- One height adjustable shelf included.
- Optional e-lock available in the vertical position. Please specify V - Vertical and add \$231 list.

PRODUCT CODE	FINISH			SIZE/INCHES				WEIGHT LBS	VOL FT ³
	LP	B	W	H(LP/B)	H(W)	W	D		
L2CRBFO2060	1780	1912	2006	19.94	20.5	60	20	202	20
L2CRBFO2066	1856	1996	2108	19.94	20.5	66	20	220	22
L2CRBFO2072	1969	2125	2213	19.94	20.5	72	20	254	24
L2CRBFO2460	1853	1987	2087	19.94	20.5	60	24	202	20
L2CRBFO2466	1929	2076	2193	19.94	20.5	66	24	220	22
L2CRBFO2472	2048	2210	2302	19.94	20.5	72	24	254	24

L2CROBF • Credenza, Open / BF

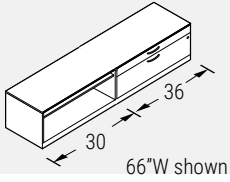

- One lock included.
- One height adjustable shelf included.
- Optional e-lock available in the vertical position. Please specify V - Vertical and add \$231 list.

PRODUCT CODE	FINISH			SIZE/INCHES				WEIGHT LBS	VOL FT ³
	LP	B	W	H(LP/B)	H(W)	W	D		
L2CROBF2060	1780	1912	2006	19.94	20.5	60	20	202	20
L2CROBF2066	1856	1996	2108	19.94	20.5	66	20	220	22
L2CROBF2072	1969	2125	2213	19.94	20.5	72	20	254	24
L2CROBF2460	1853	1987	2087	19.94	20.5	60	24	202	20
L2CROBF2466	1929	2076	2193	19.94	20.5	66	24	220	22
L2CROBF2472	2048	2210	2302	19.94	20.5	72	24	254	24

L2CRBF • Credenza, Box File / 2 Doors

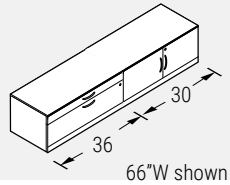

- Two locks included.
- One height adjustable shelf included.
- Optional e-lock available in the vertical position for the file drawer. Please specify V - Vertical and add \$231 list.
- Optional e-lock available in the horizontal position. Please specify HR - Horizontal Right and add \$231 list.

PRODUCT CODE	FINISH			SIZE/INCHES				WEIGHT LBS	VOL FT ³
	LP	B	W	H(LP/B)	H(W)	W	D		
L2CRBF2D2060	2106	2195	2322	19.94	20.5	60	20	214	20
L2CRBF2D2066	2131	2238	2495	19.94	20.5	66	20	224	22
L2CRBF2D2072	2246	2440	2546	19.94	20.5	72	20	235	24
L2CRBF2D2460	2190	2285	2414	19.94	20.5	60	24	214	20
L2CRBF2D2466	2219	2329	2593	19.94	20.5	66	24	224	22
L2CRBF2D2472	2337	2538	2648	19.94	20.5	72	24	235	24

L2CR2DBF • Credenza, 2 Doors / Box File

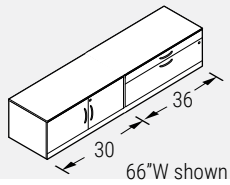

- Two locks included.
- One height adjustable shelf included.
- Optional e-lock available in the vertical position for the file drawer. Please specify V - Vertical and add \$231 list.
- Optional e-lock available in the horizontal position. Please specify HR - Horizontal Right and add \$231 list.

PRODUCT CODE	FINISH			SIZE/INCHES				WEIGHT LBS	VOL FT ³
	LP	B	W	H(LP/B)	H(W)	W	D		
L2CR2DBF2060	2106	2195	2322	19.94	20.5	60	20	214	20
L2CR2DBF2066	2131	2238	2495	19.94	20.5	66	20	224	22
L2CR2DBF2072	2246	2440	2546	19.94	20.5	72	20	235	24
L2CR2DBF2460	2190	2285	2414	19.94	20.5	60	24	214	20
L2CR2DBF2466	2219	2329	2593	19.94	20.5	66	24	224	22
L2CR2DBF2472	2337	2538	2648	19.94	20.5	72	24	235	24

L2CRBF2AD • Credenza, Box File / 2 Aluminum Door

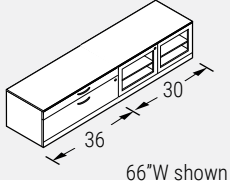

- Two locks included.
- One height adjustable shelf included.
- Door frame is anodized aluminum.
- Glazing is frosted acrylic.
- Doors standard with no handles.
- Optional e-lock available in the vertical position. Please specify V - Vertical and add \$231 list.
- E-locks not available for aluminum framed glass doors.

PRODUCT CODE	FINISH			SIZE/INCHES				WEIGHT LBS	VOL FT ³
	LP	B	W	H(LP/B)	H(W)	W	D		
L2CRBF2AD2060	2594	2686	2810	19.94	20.5	60	20	214	20
L2CRBF2AD2066	2664	2768	3023	19.94	20.5	66	20	224	22
L2CRBF2AD2072	2777	2973	3078	19.94	20.5	72	20	235	24
L2CRBF2AD2460	2697	2790	2921	19.94	20.5	60	24	214	20
L2CRBF2AD2466	2773	2879	3146	19.94	20.5	66	24	224	22
L2CRBF2AD2472	2888	3091	3199	19.94	20.5	72	24	235	24

L2CR2ADBF • Credenza, 2 Aluminum Doors, Box File

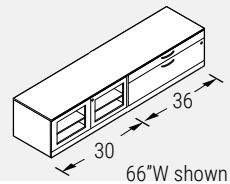

- Two locks included.
- One height adjustable shelf included.
- Door frame is anodized aluminum.
- Glazing is frosted acrylic.
- Doors standard with no handles.
- Optional e-lock available in the vertical position. Please specify V - Vertical and add \$231 list.
- E-locks not available for aluminum framed glass doors.

PRODUCT CODE	FINISH			SIZE/INCHES				WEIGHT LBS	VOL FT ³
	LP	B	W	H(LP/B)	H(W)	W	D		
L2CR2ADBF2060	2594	2686	2810	19.94	20.5	60	20	214	20
L2CR2ADBF2066	2664	2768	3023	19.94	20.5	66	20	224	22
L2CR2ADBF2072	2777	2973	3078	19.94	20.5	72	20	235	24
L2CR2ADBF2460	2697	2790	2921	19.94	20.5	60	24	214	20
L2CR2ADBF2466	2773	2879	3146	19.94	20.5	66	24	224	22
L2CR2ADBF2472	2888	3091	3199	19.94	20.5	72	24	235	24

L2CR2H2D • Credenza, 2 High File / 2 Door

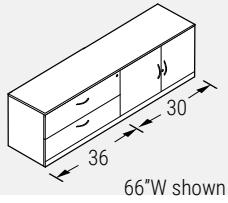

- Two locks included.
- Optional e-lock available in the vertical position for the file drawer. Please specify V - Vertical and add \$231 list.
- Optional e-lock available in the horizontal position. Please specify HR - Horizontal Right and add \$231 list.

PRODUCT CODE	FINISH			SIZE / INCHES				WEIGHT		VOL FT ³
	LP	B	W	H (LP/B)	H (W)	W	D	LBS		
L2CR2H2D2060	2365	2527	2605	29	29.5	60	20	363	24	
L2CR2H2D2066	2462	2632	2719	29	29.5	66	20	374	26	
L2CR2H2D2072	2565	2721	2835	29	29.5	72	20	396	30	
L2CR2H2D2460	2460	2629	2711	29	29.5	60	24	363	24	
L2CR2H2D2466	2561	2737	2827	29	29.5	66	24	374	26	
L2CR2H2D2472	2670	2829	2948	29	29.5	72	24	396	30	

L2CR2D2H • Credenza, 2 Door / 2 High File

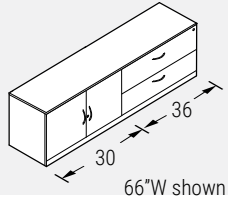

- Two locks included.
- Optional e-lock available in the vertical position for the file drawer. Please specify V - Vertical and add \$231 list.
- Optional e-lock available in the horizontal position. Please specify HR - Horizontal Right and add \$231 list.

PRODUCT CODE	FINISH			SIZE / INCHES				WEIGHT		VOL FT ³
	LP	B	W	H (LP/B)	H (W)	W	D	LBS		
L2CR2D2H2060	2365	2527	2605	29	29.5	60	20	363	24	
L2CR2D2H2066	2462	2632	2719	29	29.5	66	20	374	26	
L2CR2D2H2072	2565	2721	2835	29	29.5	72	20	396	30	
L2CR2D2H2460	2460	2629	2711	29	29.5	60	24	363	24	
L2CR2D2H2466	2561	2737	2827	29	29.5	66	24	374	26	
L2CR2D2H2472	2670	2829	2948	29	29.5	72	24	396	30	

L2CR2H2H • Credenza, 2 High File / File

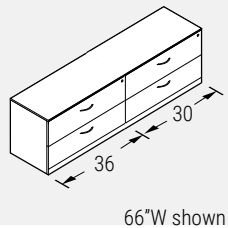

- Two locks included.
- Optional e-lock available in the vertical position. Please specify V - Vertical and add \$231 list.
- Credenzas require two e-locks.

PRODUCT CODE	FINISH			SIZE / INCHES				WEIGHT		VOL FT ³
	LP	B	W	H (LP/B)	H (W)	W	D	LBS		
L2CR2H2H2060	2744	2839	2941	29	29.5	60	20	385	24	
L2CR2H2H2066	2840	2946	3050	29	29.5	66	20	407	26	
L2CR2H2H2072	2934	3049	3164	29	29.5	72	20	418	30	
L2CR2H2H2460	2852	2950	3059	29	29.5	60	24	385	24	
L2CR2H2H2466	2953	3063	3171	29	29.5	66	24	407	26	
L2CR2H2H2472	3051	3171	3289	29	29.5	72	24	418	30	

L2CR2D2D • Credenza, 2 High 4 Doors

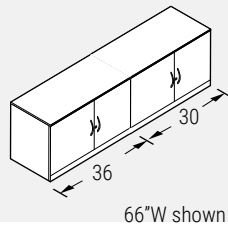

- Two locks included.
- Optional e-lock available in the horizontal position. Please specify HR - Horizontal Right and add \$231 list.
- Credenzas require two e-locks.

PRODUCT CODE	FINISH			SIZE / INCHES				WEIGHT		VOL FT ³
	LP	B	W	H (LP/B)	H (W)	W	D	LBS		
L2CR2D2D2060	1993	2221	2281	29	29.5	60	20	341	24	
L2CR2D2D2066	2098	2309	2394	29	29.5	66	20	352	26	
L2CR2D2D2072	2204	2398	2511	29	29.5	72	20	363	30	
L2CR2D2D2460	2072	2312	2370	29	29.5	60	24	341	24	
L2CR2D2D2466	2183	2403	2494	29	29.5	66	24	352	26	
L2CR2D2D2472	2291	2495	2613	29	29.5	72	24	363	30	

L2CR4AD • Credenza, 2 High 4 Aluminum Doors

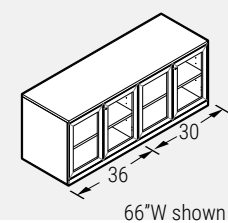

- Two locks included.
- Door frame is anodized aluminum.
- Glazing is frosted acrylic.
- Doors standard with no handles.
- E-lock not available for aluminum framed glass doors.

PRODUCT CODE	FINISH			SIZE / INCHES				WEIGHT		VOL FT ³
	LP	B	W	H (LP/B)	H (W)	W	D	LBS		
L2CR4AD2060	3209	3440	3499	29	29.5	60	20	336	24	
L2CR4AD2066	3429	3639	3729	29	29.5	66	20	347	26	
L2CR4AD2072	3650	3842	3958	29	29.5	72	20	358	30	
L2CR4AD2460	3289	3527	3587	29	29.5	60	24	336	24	
L2CR4AD2466	3514	3734	3824	29	29.5	66	24	347	26	
L2CR4AD2472	3738	3940	4059	29	29.5	72	24	358	30	

LPSTC/LLSTC • Pedestal/Lateral Seat Cushion

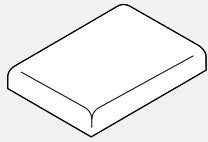

PRODUCT CODE	YRDS	SIZE/ INCHES			WEIGHT VOL	
		H	W	D	LBS	FT ³
LPSTC1518	0.75	2	15.5	18	2	0.34
LPSTC1520	0.75	2	15.5	20	2	0.40
LPSTC1523	0.75	2	15.5	23	3	0.44
LPSTC1524	0.75	2	15.5	24	3	0.46
LPSTC1529	1.00	2	15.5	29	3	0.55
LPSTC1530	1.00	2	15.5	30	3	0.24
LLSTC2030	1.00	2	20	30	5	0.76
LLSTC2036	1.25	2	20	36	6	0.91
LLSTC2230	1.00	2	22	30	6	0.84
LLSTC2236	1.25	2	22	36	7	1.01
LLSTC2430	1.00	2	24	30	6	0.91
LLSTC2436	1.25	2	24	36	7	1.10

PRODUCT CODE	PRICE																			
	GR1	GR2	GR3	GR4	GR5	GR6	GR7	GR8	GR9	GR10	GR11	GR12	GR13	GR14	GR15	GR16	GR17	GR18	GR19	GR20
LPSTC1518	202	233	252	280	323	364	401	435	477	518	574	652	724	802	972	1142	1312	1482	1652	1839
LPSTC1520	208	237	261	286	329	369	408	442	483	523	579	656	731	809	977	1147	1318	1487	1656	1844
LPSTC1523	212	240	264	291	333	372	411	448	486	528	582	659	736	813	984	1153	1324	1495	1661	1848
LPSTC1524	218	247	270	298	340	378	418	452	491	537	590	666	744	819	988	1157	1328	1499	1668	1855
LPSTC1529	267	305	336	371	426	480	534	579	631	688	759	864	964	1065	1294	1517	1747	1973	2198	2448
LPSTC1530	274	310	341	377	433	485	539	584	638	693	765	869	971	1072	1300	1525	1753	1981	2204	2454
LLSTC2030	289	328	355	394	450	503	552	603	655	712	783	886	987	1089	1317	1541	1772	1996	2221	2471
LLSTC2036	343	391	430	475	543	608	673	733	801	869	960	1089	1214	1343	1628	1908	2194	2474	2757	3070
LLSTC2230	295	332	364	398	454	508	557	607	658	715	786	892	994	1092	1323	1545	1776	2001	2225	2474
LLSTC2236	350	397	434	480	548	613	681	740	806	877	966	1094	1223	1348	1633	1916	2199	2481	2763	3077
LLSTC2430	298	336	366	401	456	510	562	609	660	718	790	894	996	1095	1325	1548	1778	2003	2230	2477
LLSTC2436	354	404	441	485	553	621	687	746	813	883	972	1101	1227	1354	1639	1921	2207	2490	2769	3081

LACWB • Counterweight Balance for use in Licence Storage Units

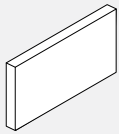

PRODUCT CODE	PRICE	SIZE/INCHES			WEIGHT VOL	
		H	W	D	LBS	FT ³
LACWB	95	0.5	11.62	11.62	10	0.07

BHTP01 • Bracket to connect Licence Towers to Boulevard Panels

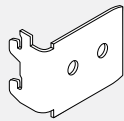

• Panel Frame Finish

PRODUCT CODE	PRICE	SIZE/ INCHES			WEIGHT VOL	
		H	W	D	LBS	FT ³
BHTP01	27	2	2.5	1	2	0.05

L2PO • Pantry Storage

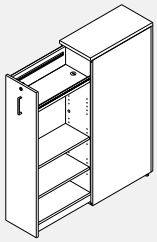

Left Hand Shown

- The pull out cabinet serves as a multifunction, customizable storage unit that both defines space and enhances privacy in an open plan environment.
- Can be used in conjunction with Licence, Bridges, FreeFit and Boulevard.
- Internal organization consists of two fixed shelves top and bottom. The two middle shelves are adjustable. Two accessory rails are standard and will accept GC metal accessories
- Interior cabinet shelves and back are standard in Designer White. Cabinet shell, drawer and top can be specified in any standard laminate.
- L2PO12-NL/R does not fit binders.
- Only available with FA handle.

Finish

While the Pantry Storage cabinet walls, top and pull-out drawer front door and back panel finish can be specified, the internal cabinet back and adjustable shelves are standard white. Please specify the cabinet top and pull-out drawer front finish.

Options

- Dual USB A+C outlet kit - please add "USB" at the end of the code. Add \$388 to the list price
- When you specify dual USB outlet the top shelf will come with grey felt surface and grommet which allows for cable passage from the USB outlet (located below the top shelf). A two-prong power cord exits the cabinet through the floor at the back.
- Dry-erase marker board - Choose "DE" option. Please add \$372 to the list price. If specified the Dry-erase marker laminate will be applied to the external surface of the pull-out drawer side wall.

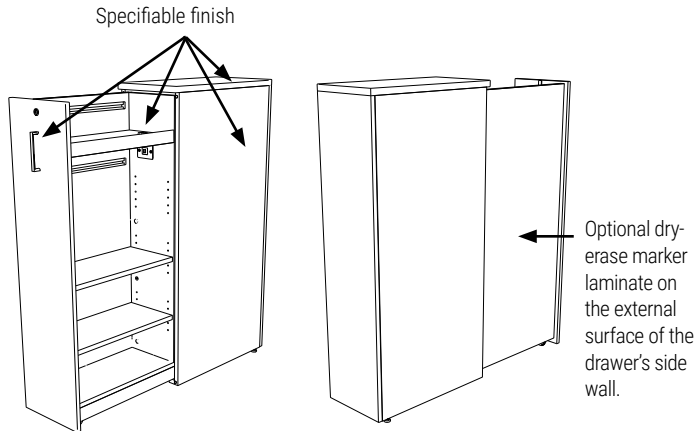

PRODUCT CODE	PRICE			SIZE/INCHES				WEIGHT LBS	VOL FT³
	LP	B	W	H(LP/B)	H(W)	W	D		
L2PO1224H42NL	1538	1556	1592	41.56	42	12	24	128	7
L2PO1230H42NL	1615	1638	1680	41.56	42	12	30	143	9
L2PO1236H42NL	1690	1718	1769	41.56	42	12	36	157	11
L2PO1824H42NL	1767	1796	1844	41.56	42	18	24	156	11
L2PO1830H42NL	1853	1888	1946	41.56	42	18	30	172	13
L2PO1836H42NL	1937	1980	2047	41.56	42	18	36	187	16
L2PO1224NL	1673	1689	1721	49.56	50	12	24	133	8
L2PO1230NL	1753	1786	1813	49.56	50	12	30	148	10
L2PO1236NL	1834	1882	1906	49.56	50	12	36	162	15
L2PO1824NL	1942	1975	2009	49.56	50	18	24	161	12
L2PO1830NL	2028	2083	2112	49.56	50	18	30	177	15
L2PO1836NL	2117	2189	2213	49.56	50	18	36	192	18
L2PO1224H54NL	1691	1709	1741	53.56	54	12	24	138	9
L2PO1230H54NL	1772	1792	1813	53.56	54	12	30	153	11
L2PO1236H54NL	1853	1878	1904	53.56	54	12	36	167	14
L2PO1824H54NL	1961	1986	2029	53.56	54	18	24	166	14
L2PO1830H54NL	2049	2081	2131	53.56	54	18	30	182	17
L2PO1836H54NL	2137	2173	2233	53.56	54	18	36	197	20
L2PO1224H42NR	1538	1556	1592	41.56	42	12	24	128	7
L2PO1230H42NR	1615	1638	1680	41.56	42	12	30	143	9
L2PO1236H42NR	1690	1718	1769	41.56	42	12	36	157	11
L2PO1824H42NR	1767	1796	1844	41.56	42	18	24	156	11
L2PO1830H42NR	1853	1888	1946	41.56	42	18	30	172	13
L2PO1836H42NR	1937	1980	2047	41.56	42	18	36	187	16
L2PO1224NR	1673	1689	1721	49.56	50	12	24	133	8
L2PO1230NR	1753	1786	1813	49.56	50	12	30	148	10
L2PO1236NR	1834	1882	1906	49.56	50	12	36	162	15
L2PO1824NR	1942	1975	2009	49.56	50	18	24	161	12
L2PO1830NR	2028	2083	2112	49.56	50	18	30	177	15
L2PO1836NR	2117	2189	2213	49.56	50	18	36	192	18
L2PO1224H54NR	1691	1709	1741	53.56	54	12	24	138	9
L2PO1230H54NR	1772	1792	1813	53.56	54	12	30	153	11
L2PO1236H54NR	1853	1878	1904	53.56	54	12	36	167	14
L2PO1824H54NR	1961	1986	2029	53.56	54	18	24	166	14
L2PO1830H54NR	2049	2081	2131	53.56	54	18	30	182	17
L2PO1836H54NR	2137	2173	2233	53.56	54	18	36	197	20

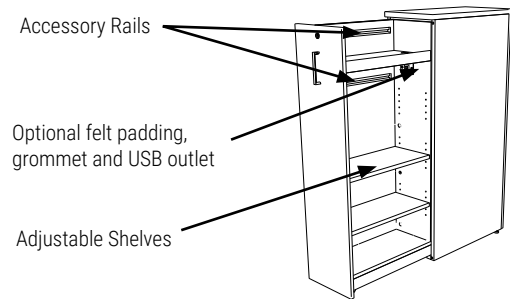

Integrated Accessory rails

Two accessory rails (each 18.25" long) are provided to further enhance customization with Global Contract metal accessories.

Upper Accessory Rail:

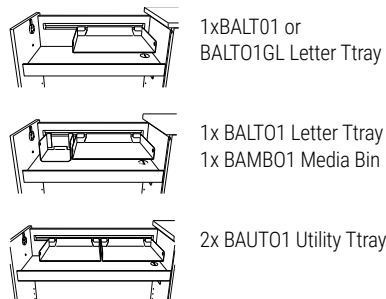

Lower Accessory Rail:

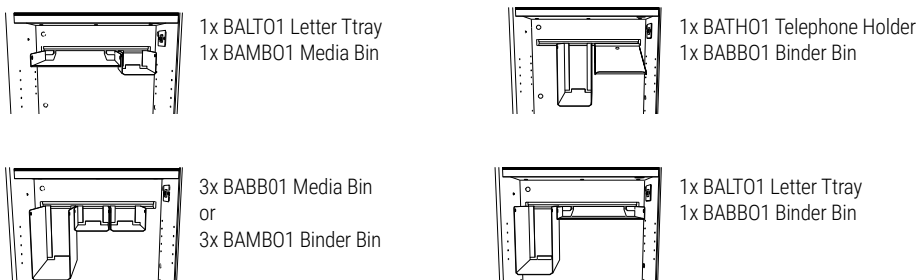

L2PW • Wardrobe Pantry Storage

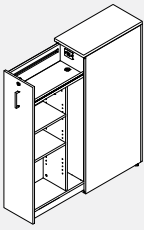

Left Hand Shown

- The pull out cabinet serves as a multifunction, customizable storage unit that both defines space and enhances privacy in an open plan environment.
- Can be used in conjunction with Licence,, FreeFit and Boulevard.
- Internal organization consists of one fixed shelf at the top. The two middle shelves are adjustable. Wardrobe includes coat hook.
- Interior cabinet shelves and back are standard in Designer White. Cabinet shell, drawer and top can be specified in any standard laminate.
- L2PW12-NL/R does not fit binders.
- Only available with FA handle.

Finish

While the Pantry Storage cabinet walls, top and pull-out drawer front door and back panel finish can be specified, the internal cabinet back and adjustable shelves are standard white. Please specify the cabinet top and pull-out drawer front finish.

Options

- Dual USB A+C outlet kit - please add "USB" at the end of the code. Add \$388 to the list price
- When you specify dual USB outlet the top shelf will come with grey felt surface and grommet which allows for cable passage from the USB outlet (located below the top shelf). A two-prong power cord exits the cabinet through the floor at the back.
- Dry-erase marker board - Choose "DE" option. Please add \$372 to the list price. If specified the Dry-erase marker laminate will be applied to the external surface of the pull-out drawer side wall.

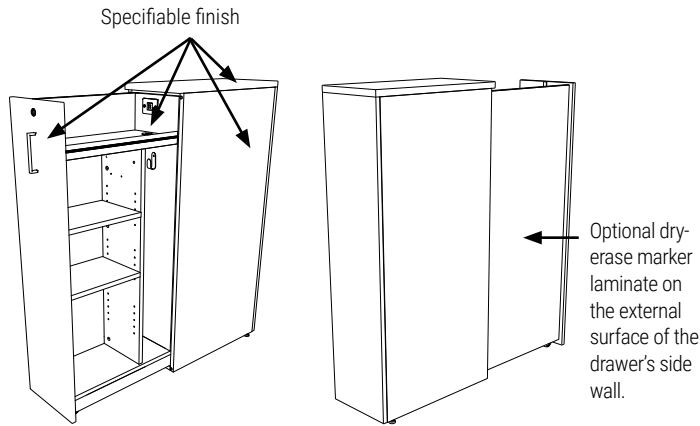

PRODUCT CODE	PRICE LP	SIZE/INCHES				WEIGHT LBS	VOL FT³		
		B	W	H (LP/B)	H (W)				
L2PW1224H42NL	1680	1698	1735	41.56	42	12	24	128	7
L2PW1230H42NL	1757	1780	1822	41.56	42	12	30	143	9
L2PW1236H42NL	1832	1860	1911	41.56	42	12	36	157	11
L2PW1824H42NL	1946	1975	2022	41.56	42	18	24	156	11
L2PW1830H42NL	2031	2066	2124	41.56	42	18	30	172	13
L2PW1836H42NL	2116	2158	2225	41.56	42	18	36	187	16
L2PW1224NL	1831	1848	1880	49.56	50	12	24	133	8
L2PW1230NL	1912	1945	1971	49.56	50	12	30	148	10
L2PW1236NL	1993	2040	2064	49.56	50	12	36	162	15
L2PW1824NL	2140	2173	2207	49.56	50	18	24	161	12
L2PW1830NL	2227	2281	2310	49.56	50	18	30	177	15
L2PW1836NL	2315	2388	2412	49.56	50	18	36	192	18
L2PW1224H54NL	1866	1884	1916	53.56	54	12	24	138	9
L2PW1230H54NL	1947	1967	1988	53.56	54	12	30	153	11
L2PW1236H54NL	2028	2053	2080	53.56	54	12	36	167	14
L2PW1824H54NL	2182	2206	2250	53.56	54	18	24	166	14
L2PW1830H54NL	2269	2301	2351	53.56	54	18	30	182	17
L2PW1836H54NL	2358	2394	2453	53.56	54	18	36	197	20
L2PW1224H42NR	1680	1698	1735	41.56	42	12	24	128	7
L2PW1230H42NR	1757	1780	1822	41.56	42	12	30	143	9
L2PW1236H42NR	1832	1860	1911	41.56	42	12	36	157	11
L2PW1824H42NR	1946	1975	2022	41.56	42	18	24	156	11
L2PW1830H42NR	2031	2066	2124	41.56	42	18	30	172	13
L2PW1836H42NR	2116	2158	2225	41.56	42	18	36	187	16
L2PW1224NR	1831	1848	1880	49.56	50	12	24	133	8
L2PW1230NR	1912	1945	1971	49.56	50	12	30	148	10
L2PW1236NR	1993	2040	2064	49.56	50	12	36	162	15
L2PW1824NR	2140	2173	2207	49.56	50	18	24	161	12
L2PW1830NR	2227	2281	2310	49.56	50	18	30	177	15
L2PW1836NR	2315	2388	2412	49.56	50	18	36	192	18
L2PW1224H54NR	1866	1884	1916	53.56	54	12	24	138	9
L2PW1230H54NR	1947	1967	1988	53.56	54	12	30	153	11
L2PW1236H54NR	2028	2053	2080	53.56	54	12	36	167	14
L2PW1824H54NR	2182	2206	2250	53.56	54	18	24	166	14
L2PW1830H54NR	2269	2301	2351	53.56	54	18	30	182	17
L2PW1836H54NR	2358	2394	2453	53.56	54	18	36	197	20

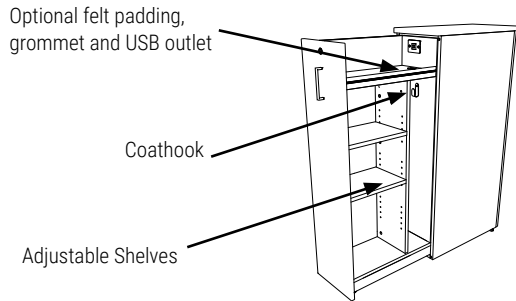

L2PSB • Pantry Felt Storage Bin

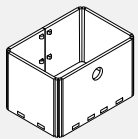

- Crafted from recycled PET felt, felt bins are an intuitive and versatile organization solution within your Pantry unit.
- Felt is 9mm, please choose from our 18 difference finishes.

PRODUCT CODE	PRICE	H	W	D	WEIGHT	VOL
					LBS	FT³
L2PSB0912	47	7.5	11.8	8.6	0.30	0.44

L2PST • Pantry Felt Storage Tray

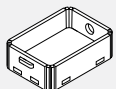

- Crafted from recycled PET felt, felt bins are an intuitive and versatile organization solution within your Pantry unit.
- Felt is 9mm, please choose from our 18 difference finishes.

PRODUCT CODE	PRICE	H	W	D	WEIGHT	VOL
					LBS	FT³
L2PST0609	18	2.6	8.6	5.9	0.28	0.08

L2CT • Collaboration Tables with Integrated Wire Management

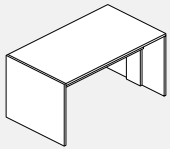

- Units Shipped knocked down (KD)
- Footrest to be ordered separately.
- Add "FR" to the end of the code for a footrail and add \$1,890 to the list price.
- Foot rail kit will include a quantity of two 2" diameter rails and 4 flanges.
- "W" thick (1 7/16") top and gables.
- Low pressure modesty panel.

Standard Grommet Location:

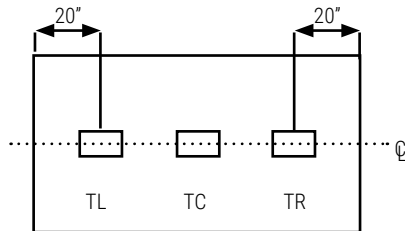

Please see Accessories Section for power grommets.

Half Modesty at 15" high.

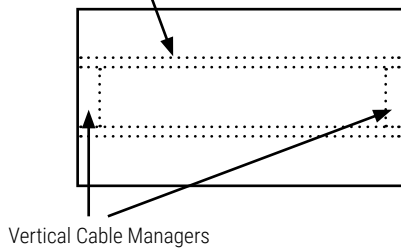

PRODUCT CODE	FINISH "W"	H(W)	W	D	WEIGHT LBS	VOL FT³
L2CT3060H29	1741	29.5	60	30	171	13
L2CT3066H29	1814	29.5	66	30	180	14
L2CT3072H29	1891	29.5	72	30	189	15
L2CT3078H29	1962	29.5	78	30	198	16
L2CT3084H29	2040	29.5	84	30	207	18
L2CT3096H29	2190	29.5	96	30	216	20
L2CT3060H36	1845	36	60	30	176	19
L2CT3066H36	1922	36	66	30	185	21
L2CT3072H36	1996	36	72	30	194	23
L2CT3078H36	2071	36	78	30	203	24
L2CT3084H36	2148	36	84	30	212	26
L2CT3096H36	2298	36	96	30	221	30
L2CT3060H42	1994	42	60	30	181	25
L2CT3066H42	2071	42	66	30	190	28
L2CT3072H42	2145	42	72	30	199	30
L2CT3078H42	2221	42	78	30	208	33
L2CT3084H42	2297	42	84	30	217	35
L2CT3096H42	2446	42	96	30	226	40
L2CT3660H29	1953	29.5	60	36	180	15
L2CT3666H29	2037	29.5	66	36	189	17
L2CT3672H29	2120	29.5	72	36	198	18
L2CT3678H29	2204	29.5	78	36	207	20
L2CT3684H29	2287	29.5	84	36	216	21
L2CT3696H29	2454	29.5	96	36	225	24
L2CT3660H36	2081	36	60	36	185	23
L2CT3666H36	2161	36	66	36	194	25
L2CT3672H36	2246	36	72	36	203	27
L2CT3678H36	2330	36	78	36	212	29
L2CT3684H36	2414	36	84	36	221	32
L2CT3696H36	2582	36	96	36	230	36
L2CT3660H42	2251	42	60	36	190	30
L2CT3666H42	2332	42	66	36	199	33
L2CT3672H42	2416	42	72	36	208	36
L2CT3678H42	2500	42	78	36	217	39
L2CT3684H42	2585	42	84	36	226	42
L2CT3696H42	2751	42	96	36	235	48
L2CT4260H29	2165	29.5	60	42	189	18
L2CT4266H29	2258	29.5	66	42	198	19
L2CT4272H29	2349	29.5	72	42	207	21
L2CT4278H29	2440	29.5	78	42	216	23
L2CT4284H29	2534	29.5	84	42	225	25
L2CT4296H29	2717	29.5	96	42	234	28
L2CT4260H36	2313	36	60	42	194	26
L2CT4266H36	2405	36	66	42	203	29
L2CT4272H36	2497	36	72	42	212	32
L2CT4278H36	2589	36	78	42	221	34
L2CT4284H36	2681	36	84	42	230	37
L2CT4296H36	2866	36	96	42	239	42
L2CT4260H42	2503	42	60	42	199	35
L2CT4266H42	2595	42	66	42	208	39
L2CT4272H42	2689	42	72	42	217	42
L2CT4278H42	2779	42	78	42	226	46
L2CT4284H42	2871	42	84	42	235	49
L2CT4296H42	3055	42	96	42	244	56

L2CTV • Collaboration Tables with Media Wall Integrated Wire Management

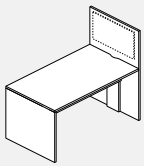

- Units Shipped knocked down (KD)
- Footrest to be ordered separately.
- Add "FR" to the end of the code for a foot rail and add \$1,890 to the list price.
- Foot rail kit will include a quantity of two 2" diameter rails and 4 flanges.
- Unit includes TV/Display bracket & mounting hardware.
- "W" thick (1 7/16") top and gables.
- Low pressure modesty panel.

Standard Grommet Location:

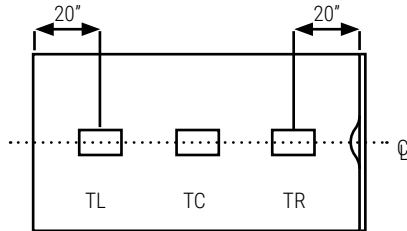

Please see Accessories Section for power grommets.

Half Modesty at 15" high.

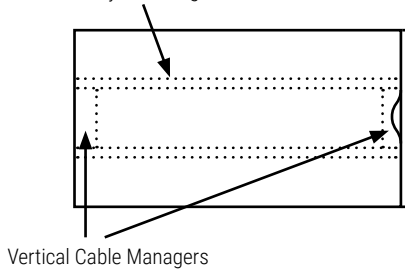

PRODUCT CODE	FINISH "W"	H (W)	W	D	WEIGHT LBS	VOL FT ³
L2CTV4260H29H66	3203	29.5	60	42	192	18
L2CTV4266H29H66	3295	29.5	66	42	201	19
L2CTV4272H29H66	3387	29.5	72	42	210	21
L2CTV4278H29H66	3478	29.5	78	42	219	23
L2CTV4284H29H66	3568	29.5	84	42	228	25
L2CTV4296H29H66	3757	29.5	96	42	237	28
L2CTV4860H29H66	3478	29.5	60	48	198	20
L2CTV4866H29H66	3579	29.5	66	48	207	22
L2CTV4872H29H66	3679	29.5	72	48	216	24
L2CTV4878H29H66	3779	29.5	78	48	225	26
L2CTV4884H29H66	3882	29.5	84	48	234	28
L2CTV4896H29H66	4079	29.5	96	48	243	32
L2CTV4260H36H72	3351	36	60	42	197	26
L2CTV4266H36H72	3443	36	66	42	206	29
L2CTV4272H36H72	3535	36	72	42	215	32
L2CTV4278H36H72	3627	36	78	42	224	34
L2CTV4284H36H72	3717	36	84	42	233	37
L2CTV4296H36H72	3902	36	96	42	242	42
L2CTV4860H36H72	3646	36	60	48	203	30
L2CTV4866H36H72	3746	36	66	48	212	33
L2CTV4872H36H72	3849	36	72	48	221	36
L2CTV4878H36H72	3950	36	78	48	230	39
L2CTV4884H36H72	4047	36	84	48	239	42
L2CTV4896H36H72	3741	36	96	48	248	48
L2CTV4260H42H72	3468	42	60	42	202	35
L2CTV4266H42H72	3559	42	66	42	211	39
L2CTV4272H42H72	3650	42	72	42	220	42
L2CTV4278H42H72	3776	42	78	42	229	46
L2CTV4284H42H72	3836	42	84	42	238	49
L2CTV4296H42H72	4052	42	96	42	247	56
L2CTV4860H42H72	3773	42	60	48	208	40
L2CTV4866H42H72	3873	42	66	48	217	44
L2CTV4872H42H72	3975	42	72	48	226	48
L2CTV4878H42H72	4075	42	78	48	235	52
L2CTV4884H42H72	4177	42	84	48	244	56
L2CTV4896H42H72	4375	42	96	48	253	64

Technical Information - Tables

Tables

- All table surfaces are High Pressure Laminate in "B" or "W" thickness.
- All tables have "T" mold edge band, unless otherwise indicated.
- Tables up to and including 96" long are manufactured in one piece, 120" to 192" long are manufactured in two pieces and over 216" are manufactured in three pieces. If wood grain laminate is chosen, the wood grain pattern will not line up.
- Tables in 2 or 3 pieces will have the joining edge finished with PVC edge (0.5mm), hardware will be shipped for assembly.
- Grommet locations must be specified at the time of order or it will default to "no grommet" option.
- Power modules and grommets are not included, they must be specified separately.
- Positions for drop in power and data grommets are intended for use on tops with the following bases: LR, LSQ, LDRUM, TELRS, TELRR, TELBS, TELBR. For any other base, please consult Customer Service Representative.
- Tables are not pre-drilled to accept legs or bases.
- "LTR" Rectangular shape tables with edge B and W have a 1" radius at each corner.
- For table tops with square corners, please add "NR" at the end of the product code, no upcharge required. The "NR" option is available only with the B and W edge profiles.
- "LBT" Boat shape tables are 6" narrower at the ends. The nominal size is identified at the centre.
- "LBTB" Boat shape tables with bow ends are 12" narrower at the ends. The nominal size is identified at the centre.
- Trapezoid tables can be used in several combinations.
- Power modules and grommets are not included, they must be specified separately.

Bases

- Available in variety of materials metal, high pressure laminate or low pressure laminate, please refer to specific base in price list
- "LR" Rectangular and "LSQ" square bases come standard with removable access door and cut out on the bottom of the base for pass-thru cables.
- "TELRS / TELBS" square and "TELRR / TELBR" rectangular bases come standard with cut out on the bottom of the base for pass-thru cables. Hinged access doors are optional and must be specified with an "HD" at the end of the code. There will be an upcharge of \$122 to the list price.
- Drum bases are finished in high pressure only and comes with a full bottom and notch at the top. Sand bag included. Access door is not an option.
- Drum, rectangular and square bases are shipped assembled.

Folding Legs

- Legs are folded by pressing the lever. Once folded, the legs are held securely by the interlocking springs.
- Includes adjustable levelers offering 12mm (1/2") of adjustment.
- Minimum special sizing for tables is 54" in length and 25" in depth.
- Sold per pair.

Flip Top Training Tables

- "GFT" Rectangular Flip tables with edge B and W edge have straight corners.

Visual Board

- Unit offered in high pressure laminate (B) comes with 2 high pressure laminate doors
- Cork board included on one inside door.
- Unit closes with a touch latch mechanism, but no lock option.
- "MG" indicates a magnetic white board.

Tables • Guidelines For Ordering Product

CODES: The price list uses a numbering system with meaningful alphanumeric characters to create a simple-to-understand product number. This makes specifying the product much easier and more accurate.

SPECIFICATION EXAMPLE OF A TABLE UNIT

PRODUCT CODE: LTS2424
 L = Licence
 T = Table
 S = Square
 2424 = Size: Depth x Width

Edge Options: **"B" Edges** **"W" Edges**
 HP (B) 1.062" Thickness HP (W) 1.437" Thickness

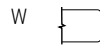

Base Specification Guide (See Installation Manual For Examples).

- Tables up to 96" in length require 2 T bases
- Tables 108" to 144" in length require 3 T bases
- Tables 156" to 192" in length require 4 T bases
- Tables 216" to 240" in length require 6 T bases

FLAT BAR 3 PRONG "TTFL"

BASE SPREAD	TOP WIDTH
18"	24W
22"	30W
24"	36W
30"	42W
36"	48W
36"	54W

LLT/LLTT W/BULLNOSE ENDS

BASE SPREAD	TOP WIDTH
18"	24W
26"	30W
26"	36W
30"	42W
36"	48W
36"	54W
42"	60W

TTFLT FLAT BAR "T"

BASE SPREAD	TOP WIDTH
18"	24W
22"	30W
24"	36W
30"	42W
36"	48W
36"	54W

LD DRUM

BASE SPREAD	ROUND TOP SIZE
18" dia	30" dia
18" dia	36" dia
24" dia	42" dia
24" dia	48" dia
30" dia	54" dia
30" dia	60" dia

LSQ, TELRS & TELBS SQUARE

BASE SPREAD	TOP SIZE
18"	30x30
18"	36x36
24"	42x42
24"	48x48
30"	54x54
30"	60x60

LCT CROSS BASE

BASE SPREAD	TOP SIZE
18"	24x24
24"	30x30
24"	36x36
30"	42x42
30"	48x48
36"	54x54
42"	60x60

- 1 Piece Tables up to 96" in length require 2 bases
- Tables 108" to 192" in length require 3 bases
- Tables 216" to 240" in length require 4 bases

LR, LSQ, TELRS, TELRR, TELBS, TELBR

BASE SPREAD	TOP WIDTH
18"	30
18"	36
24"	42
24"	48
30"	54
30"	60

LELBA

BASE SPREAD	TOP WIDTH
18"	30
18"	36
24"	42
30"	48
36"	54
36"	60

TRUMPET 28H

BASE SPREAD	TOP SIZE
18"	24x24
24"	30x30
24"	36x36
30"	42x42
30"	48x48

FLAT SQUARE

BASE SPREAD	TOP SIZE
18"	24x24
18"	30x30
23"	36x36
23"	42x42
30"	48x48

FLAT DISC 28H

BASE SPREAD	TOP SIZE
18"	24x24
18"	30x30
24"	36x36
30"	42x42
30"	48x48
36"	54x54

FLATBAR X

BASE SPREAD	TOP SIZE
18"	24x24
18"	30x30
24"	36x36
24"	42x42
30"	48x48
36"	54x54

TRUMPET 40.5H

BASE SPREAD	TOP SIZE
18"	24x24
24"	30x30
24"	36x36

FLAT SQUARE 40.5H

BASE SPREAD	TOP SIZE
18"	24x24
23"	30x30

FLAT DISC 40.5H

BASE SPREAD	TOP SIZE
18"	24x24
22"	30x30
24"	36x36

FLATBAR X 40.5H

BASE SPREAD	TOP SIZE
18"	24x24
22"	30x30

LL4S W/BULLNOSE ENDS

BASE SPREAD	TOP SIZE
18"	24x24
26"	30x30
26"	36x36
26"	42x42
30"	48x48
36"	54x54

LHC HAT CHANNEL

- LHC40 For Table 54" Wide
- LHC46 For Table 60" Wide
- LHC52 For Table 66" Wide
- LHC58 For Table 72" Wide
- LHC64 For Table 78" Wide
- LHC70 For Table 84" Wide

LL4S W/BULLNOSE ENDS 40.5H

BASE SPREAD	TOP SIZE
26"	30x30
30"	36x36
36"	42x42

Tops with post legs must be specified with HAT Channels for structural reinforcement.

Grommet Cut Dimensions (inches)

BG5

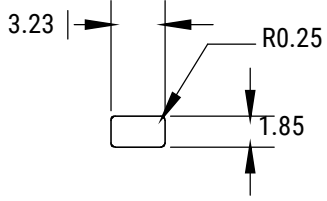
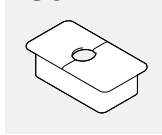

MSPDM

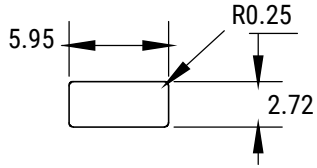
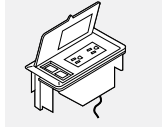

GAAD

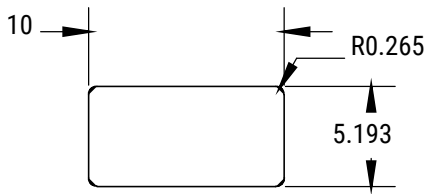
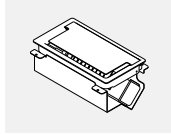

GCRTMCS4xx

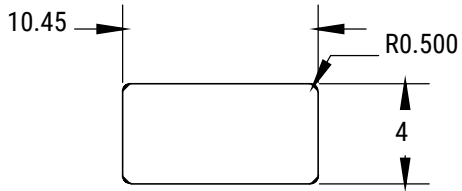
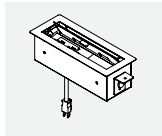

GCSRTMCD6xx

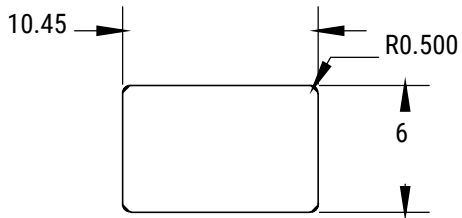
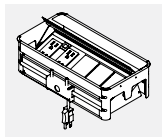
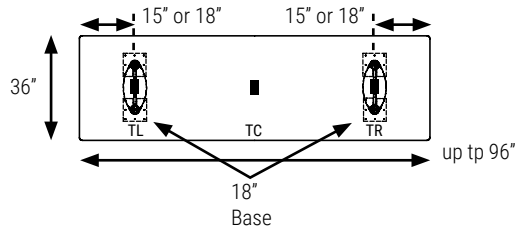

Table Dimension Chart & Grommet Location

LELBA - Elliptical Base

For One Piece Top

LELBA BASE SPREAD	TOP WIDTH
18"	30
18"	36
24"	42
30"	48
36"	54
36"	60



*15" for table widths between 60" and 72" and 18" for table widths between 78" and 96"

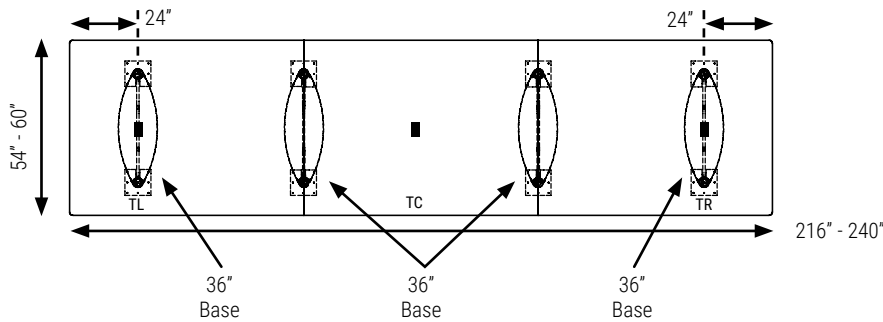
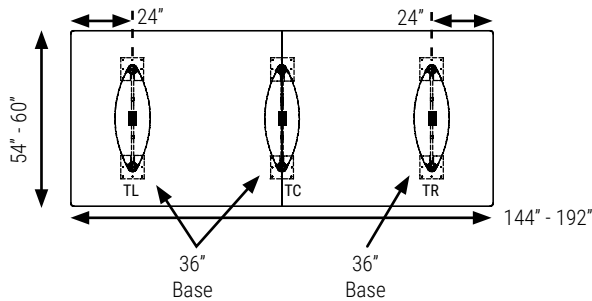
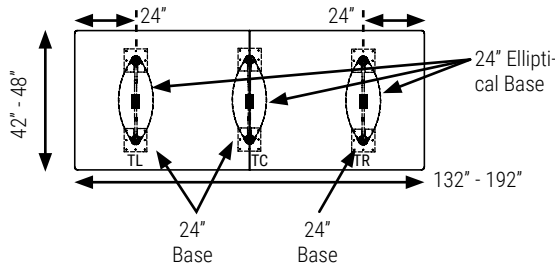
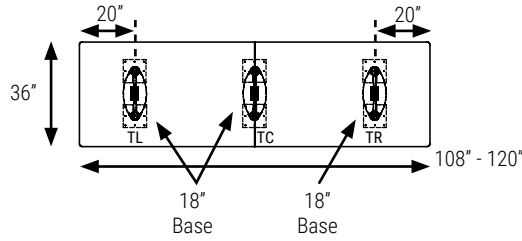

Note: Grommet orientation is perpendicular to the length of table.

Table Dimension Chart & Grommet Location

LR - Rectangular Base

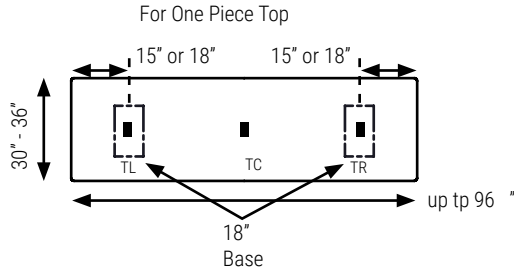

*15" for table widths between 60" and 72" and 18" for table widths between 78" and 96"

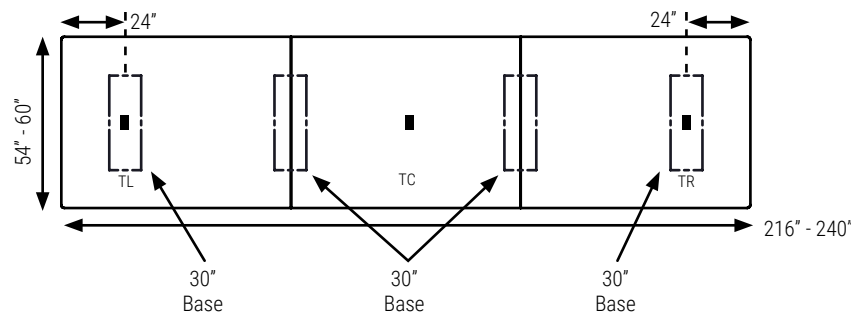
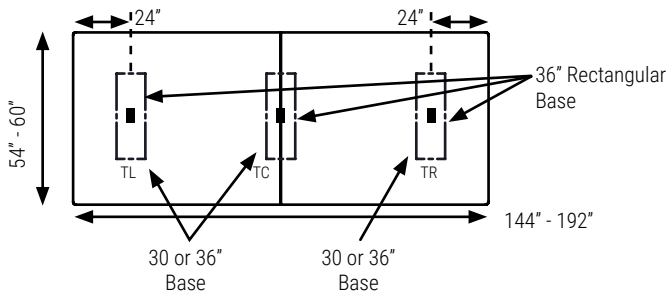
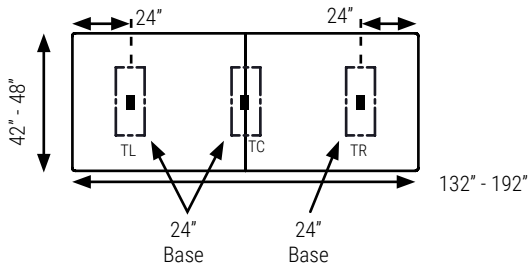
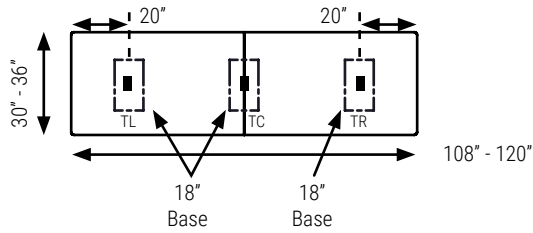

Note: Grommet orientation is perpendicular to the length of table.

Table Dimension Chart & Grommet Location

For One Piece Top

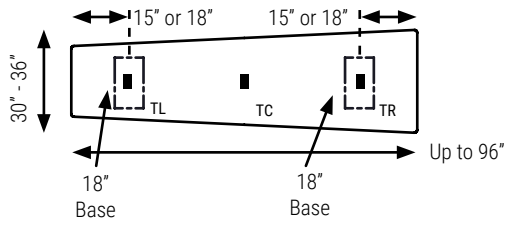

*15" for table widths between 60" and 72" and 18" for table widths between 78" and 96"

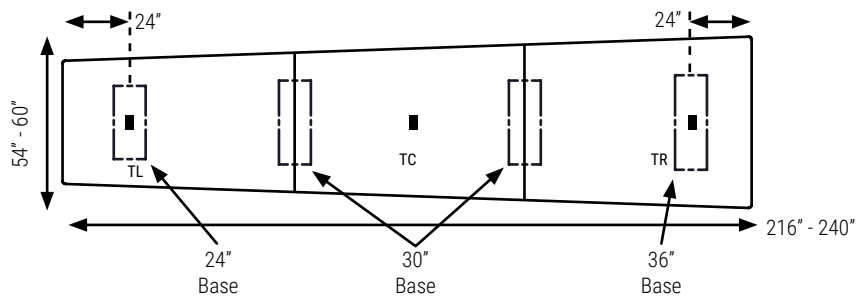
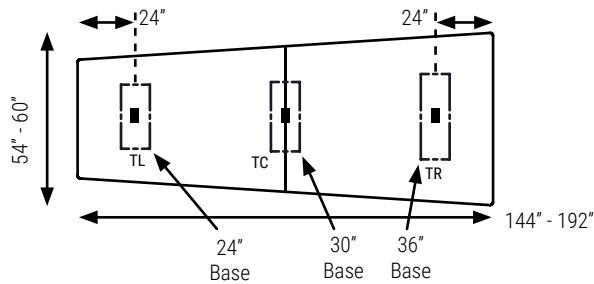
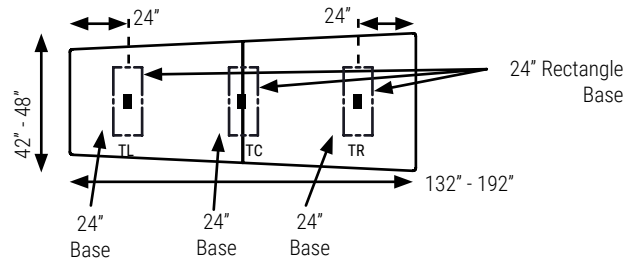
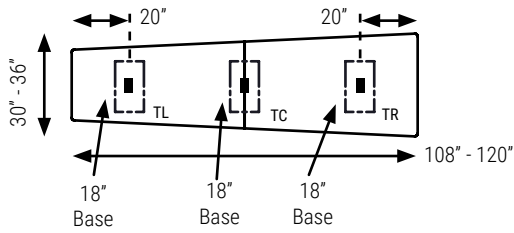

Note: Grommet orientation is perpendicular to the length of table.

Table Dimension Chart & Grommet Location

LELBA - Elliptical Base

For One Piece Top

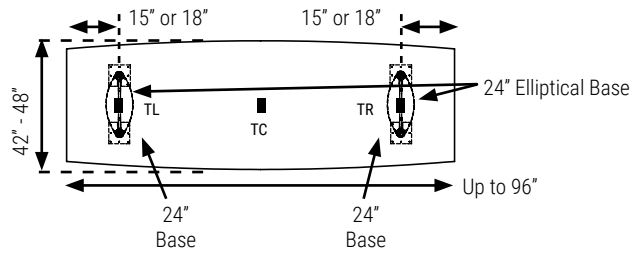

*15" for table widths between 60" and 72" and 18" for table widths between 78" and 96"

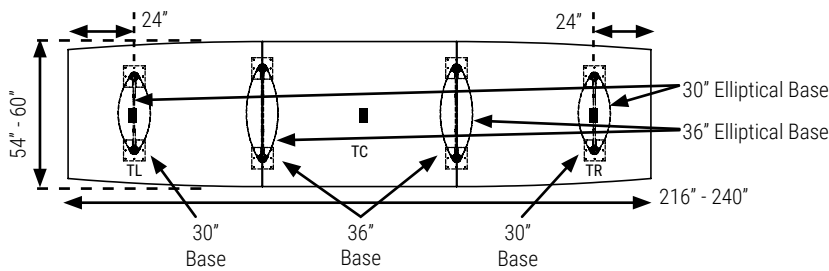
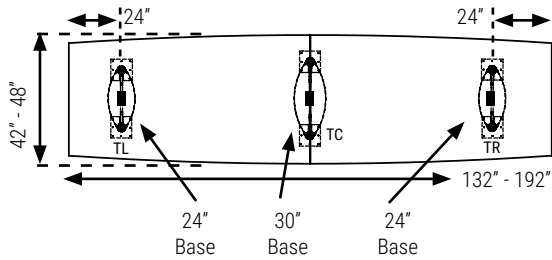
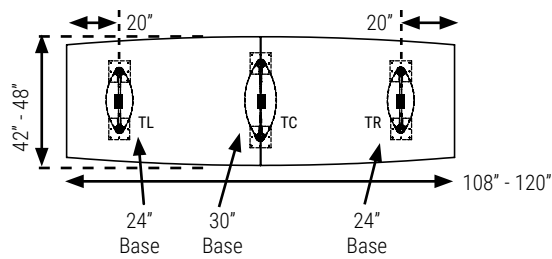

Note: Grommet orientation is perpendicular to the length of table.

Table Dimension Chart & Grommet Location

LELBA - Rectangular Base

For One Piece Top

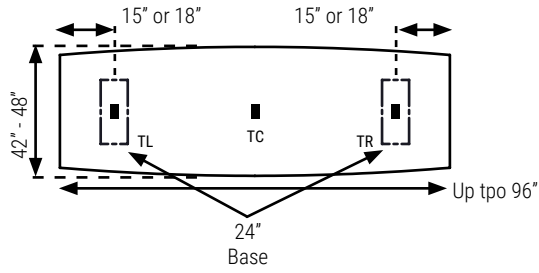

*15" for table widths between 60" and 72" and 18" for table widths between 78" and 96"

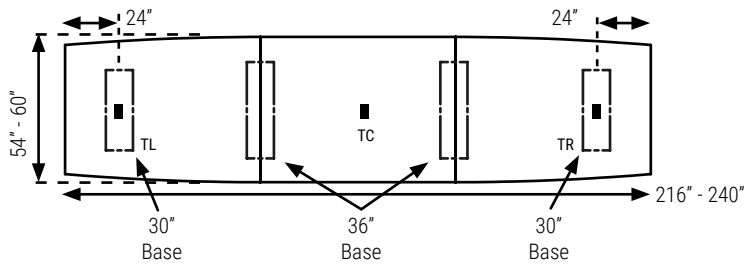
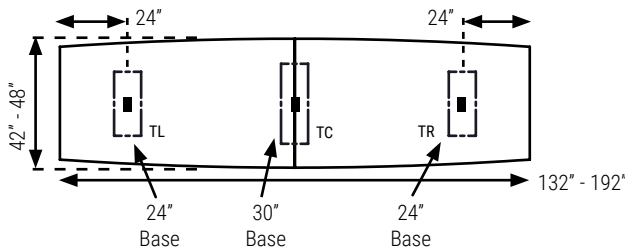
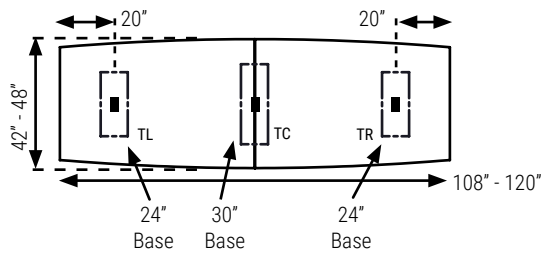

Note: Grommet orientation is perpendicular to the length of table.

Table Dimension Chart & Grommet Location

LR - Elliptical Base

For One Piece Top

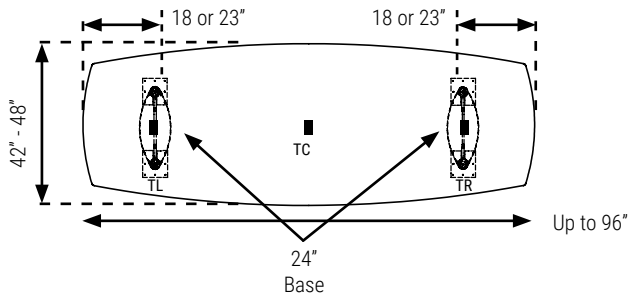

*18" for table widths between 60" and 72" and 23" for table widths between 78" and 96"

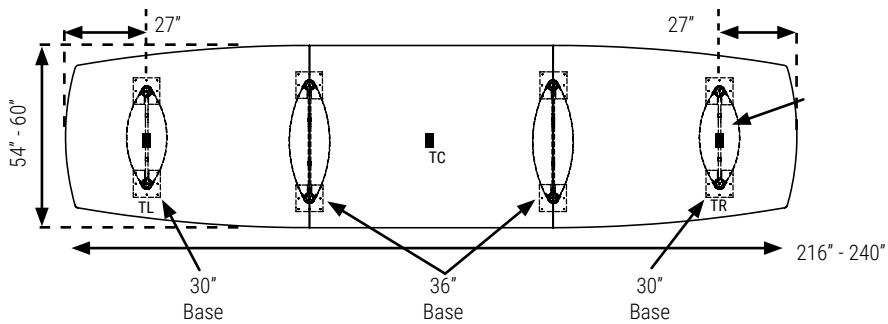
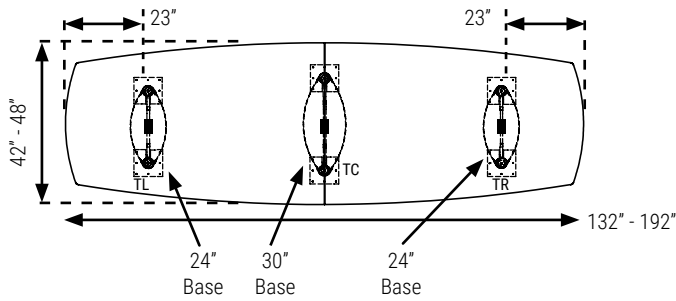
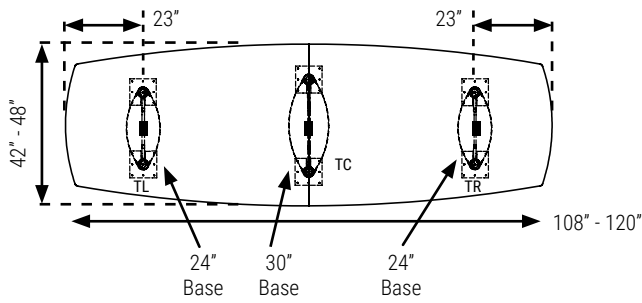

Note: Grommet orientation is perpendicular to the length of table.

Table Dimension Chart

LR - Rectangular Base

For One Piece Top

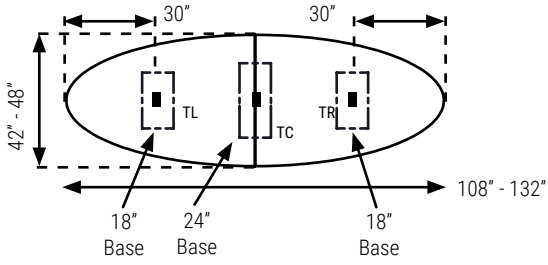
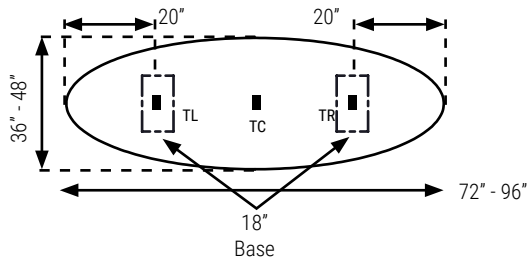

*15" for table widths between 60" and 72" and 18" for table widths between 78" and 96"

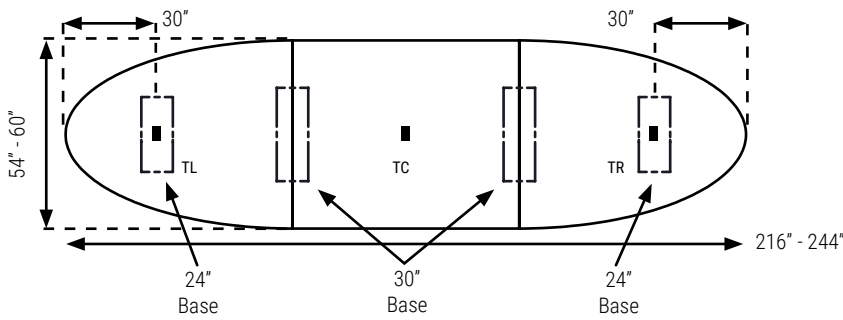
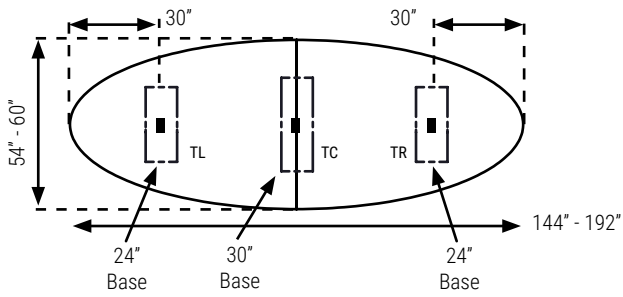

Note: Grommet orientation is perpendicular to the length of table.

Table Dimension Chart

LR - Rectangular Base

For One Piece Top

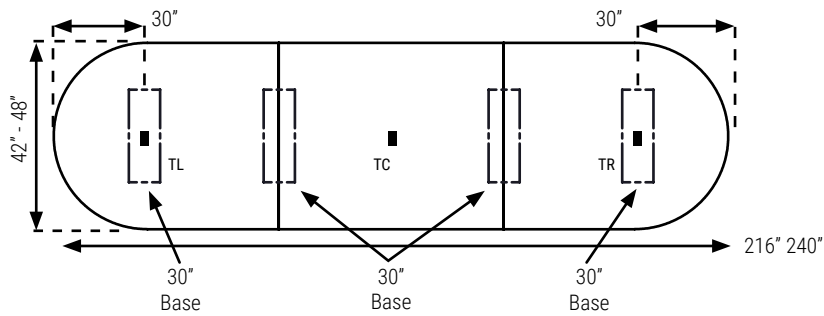
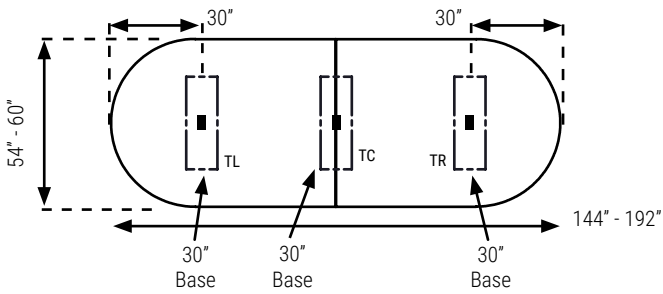
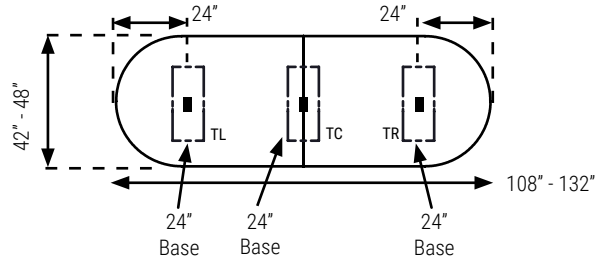
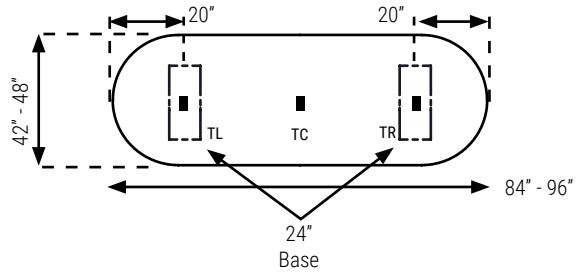

Note: Grommet orientation is perpendicular to the length of table.

LTS • Square Table Top

• Tops with Band W thickness have 1" radius corners.

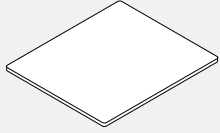

PRODUCT CODE	EDGE		SIZE/INCHES				WEIGHT LBS	VOL FT ³
	B	W	H(B)	H(W)	W	D		
LTS2424	178	260	1	1.5	24	24	29	3
LTS3030	225	372	1	1.5	30	30	32	3
LTS3636	324	476	1	1.5	36	36	46	4
LTS4242	483	626	1	1.5	42	42	57	6
LTS4848	621	792	1	1.5	48	48	75	7
LTS5454	770	984	1	1.5	54	54	86	10
LTS6060	937	1194	1	1.5	60	60	99	12

L-DIA • Circle Table Top

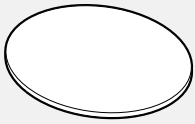

PRODUCT CODE	EDGE		SIZE/INCHES				WEIGHT LBS	VOL FT ³
	B	W	H(B)	H(W)	W	D		
L24DIA	182	265	1	1.5	24 dia	24 dia	29	3
L30DIA	233	384	1	1.5	30	30	32	3
L36DIA	333	487	1	1.5	36	36	46	4
L42DIA	499	643	1	1.5	42	42	57	6
L48DIA	636	819	1	1.5	48	48	75	7
L54DIA	792	1012	1	1.5	54	54	86	10
L60DIA	966	1231	1	1.5	60	60	99	12

LTR • Rectangle Table Top

• Tops with B and W thickness have 1" radius corners.

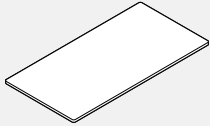

PRODUCT CODE	EDGE		SIZE/INCHES				WEIGHT LBS	VOL FT ³
	B	W	H(B)	H(W)	W	D		
LTR2430	190	286	1	1.5	30	24	26	2
LTR2436	213	331	1	1.5	36	24	31	2
LTR2442	280	377	1	1.5	42	24	33	3
LTR2448	339	425	1	1.5	48	24	35	3
LTR2454	394	475	1	1.5	54	24	40	3
LTR2460	443	522	1	1.5	60	24	42	4
LTR2466	462	570	1	1.5	66	24	47	4
LTR2472	484	622	1	1.5	72	24	53	4
LTR3036	264	398	1	1.5	36	30	31	2
LTR3042	373	455	1	1.5	42	30	35	2
LTR3048	394	513	1	1.5	48	30	40	3
LTR3054	420	573	1	1.5	54	30	44	3
LTR3060	462	630	1	1.5	60	30	48	3
LTR3066	483	689	1	1.5	66	30	53	3
LTR3072	510	747	1	1.5	72	30	57	3
LTR3078	540	804	1	1.5	78	30	59	4
LTR3084	596	863	1	1.5	84	30	62	4
LTR3096	692	977	1	1.5	96	30	66	4
LTR3642	431	569	1	1.5	42	36	42	2
LTR3648	485	641	1	1.5	48	36	46	2
LTR3654	542	714	1	1.5	54	36	51	2
LTR3660	600	786	1	1.5	60	36	57	3
LTR3666	656	860	1	1.5	66	36	63	3
LTR3672	712	930	1	1.5	72	36	68	3
LTR3678	765	1003	1	1.5	78	36	72	3
LTR3684	824	1078	1	1.5	84	36	74	4
LTR3696	936	1224	1	1.5	96	36	79	4
LTR4248	581	734	1	1.5	48	42	57	3
LTR4254	653	819	1	1.5	54	42	59	3
LTR4260	720	898	1	1.5	60	42	62	3
LTR4266	786	985	1	1.5	66	42	68	3
LTR4272	853	1066	1	1.5	72	42	73	3
LTR4278	921	1152	1	1.5	78	42	76	3
LTR4284	988	1234	1	1.5	84	42	78	3
LTR4296	1125	1398	1	1.5	96	42	92	4
LTR4854	736	921	1	1.5	54	48	62	3
LTR4860	813	1017	1	1.5	60	48	66	3
LTR4866	891	1108	1	1.5	66	48	73	3
LTR4872	966	1201	1	1.5	72	48	79	3
LTR4878	1041	1298	1	1.5	78	48	84	3
LTR4884	1119	1391	1	1.5	84	48	88	4
LTR4896	1270	1577	1	1.5	96	48	110	4

LTR • Rectangle Table Top 2 Piece

- Tables larger than 192" long are manufactured in 3 pieces.
- Tops with B and W thickness have 1" radius corners.

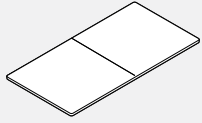

PRODUCT CODE	EDGE		SIZE/INCHES				WEIGHT LBS	VOL FT ³
	B	W	H(B)	H(W)	W	D		
LTR36108	1201	1415	1	1.5	108	36	105	4
LTR36120	1325	1561	1	1.5	120	36	114	4
LTR42108	1370	1613	1	1.5	108	42	108	6
LTR42120	1508	1774	1	1.5	120	42	123	6
LTR48108	1530	1797	1	1.5	108	48	110	6
LTR48120	1690	1984	1	1.5	120	48	132	7
LTR48132	1843	2161	1	1.5	132	48	143	7
LTR48144	1869	2195	1	1.5	144	48	158	8
LTR48156	2151	2524	1	1.5	156	48	167	8
LTR48168	2301	2699	1	1.5	168	48	176	9
LTR48180	2584	3024	1	1.5	180	48	189	10
LTR48192	2610	3059	1	1.5	192	48	201	10
LTR54144	2268	2646	1	1.5	144	54	169	10
LTR54168	2610	3045	1	1.5	168	54	187	10
LTR54192	2953	3443	1	1.5	192	54	212	13
LTR54216	3292	3841	1	1.5	216	54	234	18
LTR54240	3636	4242	1	1.5	240	54	259	20
LTR60144	2490	2895	1	1.5	144	60	180	11
LTR60168	2864	3334	1	1.5	168	60	198	13
LTR60192	3242	3773	1	1.5	192	60	223	18
LTR60216	3617	4213	1	1.5	216	60	245	22
LTR60240	3996	4651	1	1.5	240	60	270	24

LTRB • Rectangle Table Top with Bow Ends

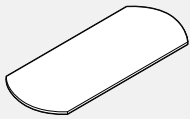

PRODUCT CODE	EDGE		SIZE/INCHES				WEIGHT LBS	VOL FT ³
	B	W	H(B)	H(W)	W	D		
LTRB4284	1021	1269	1	1.5	84	42	78	3
LTRB4296	1158	1441	1	1.5	96	42	92	4
LTRB4884	1153	1431	1	1.5	84	48	88	4
LTRB4896	1309	1626	1	1.5	96	48	110	4

LTRB • Rectangle Table Top with Bow Ends 2 Piece

- Tables larger than 192" long are manufactured in 3 pieces.

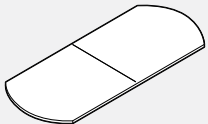

PRODUCT CODE	EDGE		SIZE/INCHES				WEIGHT LBS	VOL FT ³
	B	W	H(B)	H(W)	W	D		
LTRB42108	1414	1660	1	1.5	108	42	108	6
LTRB42120	1552	1826	1	1.5	120	42	123	6
LTRB48108	1577	1846	1	1.5	108	48	110	6
LTRB48120	1741	2042	1	1.5	120	48	132	7
LTRB48132	1898	2227	1	1.5	132	48	143	7
LTRB48144	1927	2262	1	1.5	144	48	158	8
LTRB48156	2213	2595	1	1.5	156	48	167	8
LTRB48168	2371	2782	1	1.5	168	48	176	9
LTRB48180	2659	3116	1	1.5	180	48	189	10
LTRB48192	2689	3153	1	1.5	192	48	201	10
LTRB54144	2337	2722	1	1.5	144	54	169	10
LTRB54168	2691	3134	1	1.5	168	54	187	10
LTRB54192	3040	3547	1	1.5	192	54	212	13
LTRB54216	3392	3956	1	1.5	216	54	234	18
LTRB54240	3745	4366	1	1.5	240	54	259	20
LTRB60144	2562	2982	1	1.5	144	60	180	11
LTRB60168	2950	3433	1	1.5	168	60	198	13
LTRB60192	3339	3887	1	1.5	192	60	223	18
LTRB60216	3729	4339	1	1.5	216	60	245	22
LTRB60240	4115	4790	1	1.5	240	60	270	24

LRT • Racetrack Table Top

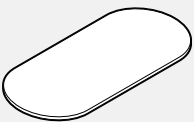

PRODUCT CODE	EDGE		SIZE/INCHES				WEIGHT LBS	VOL FT ³
	B	W	H(B)	H(W)	W	D		
LRT4284	1021	1269	1	1.5	84	42	78	3
LRT4296	1158	1441	1	1.5	96	42	92	4
LRT4884	1153	1431	1	1.5	84	48	88	4
LRT4896	1309	1626	1	1.5	96	48	110	4

LRT • Racetrack Table Top 2 Piece

• Tables larger than 192" long are manufactured in 3 pieces.

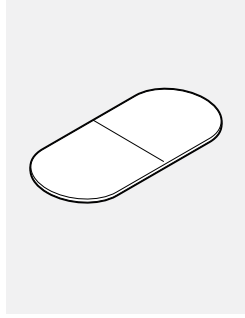

PRODUCT CODE	EDGE		SIZE / INCHES				WEIGHT		VOL FT ³
	B	W	H (B)	H (W)	W	D	LBS		
LRT42108	1414	1660	1	1.5	108	42	108	6	
LRT42120	1552	1826	1	1.5	120	42	123	6	
LRT48108	1577	1846	1	1.5	108	48	110	6	
LRT48120	1741	2042	1	1.5	120	48	132	7	
LRT48132	1898	2227	1	1.5	132	48	143	7	
LRT48144	1927	2262	1	1.5	144	48	158	8	
LRT48156	2213	2595	1	1.5	156	48	167	8	
LRT48168	2371	2782	1	1.5	168	48	176	9	
LRT48180	2659	3116	1	1.5	180	48	189	10	
LRT48192	2689	3153	1	1.5	192	48	201	10	
LRT54144	2337	2722	1	1.5	144	54	169	10	
LRT54168	2691	3134	1	1.5	168	54	187	10	
LRT54192	3040	3547	1	1.5	192	54	204	10	
LRT54216	3392	3956	1	1.5	216	54	226	11	
LRT54240	3745	4366	1	1.5	240	54	253	11	
LRT60144	2562	2982	1	1.5	144	60	180	11	
LRT60168	2950	3433	1	1.5	168	60	198	13	
LRT60192	3339	3887	1	1.5	192	60	223	18	
LRT60216	3729	4339	1	1.5	216	60	245	22	
LRT60240	4115	4790	1	1.5	240	60	270	24	

LO • Oval Table Top

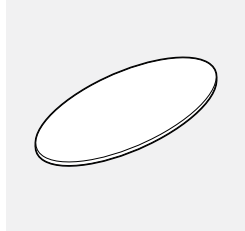

PRODUCT CODE	EDGE		SIZE / INCHES				WEIGHT		VOL FT ³
	B	W	H (B)	H (W)	W	D	LBS		
LO3672	731	959	1	1.5	72	36	68	3	
LO3684	850	1108	1	1.5	84	36	74	3	
LO3696	963	1260	1	1.5	96	36	79	3	
LO4284	1021	1269	1	1.5	84	42	78	3	
LO4296	1158	1441	1	1.5	96	42	92	4	
LO4884	1153	1431	1	1.5	84	48	88	4	
LO4896	1309	1626	1	1.5	96	48	110	4	

LBT • Boat Table Top

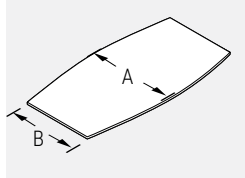

A	B
42	36
48	42

PRODUCT CODE	EDGE		SIZE / INCHES				WEIGHT		VOL FT ³
	B	W	H (B)	H (W)	W	D	LBS		
LBT4284	1021	1269	1	1.5	84	42	78	3	
LBT4296	1158	1441	1	1.5	96	42	92	4	
LBT4884	1153	1431	1	1.5	84	48	99	4	
LBT4896	1309	1626	1	1.5	96	48	110	4	

LBT • Boat Table Top 2 Piece

• Tables larger than 192" long are manufactured in 3 pieces.
 • 6" narrower at the ends.

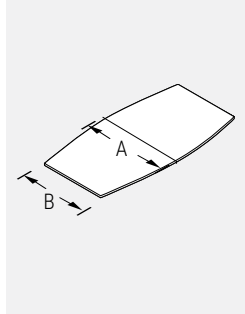

A	B
42	36
48	42
54	48
60	54

PRODUCT CODE	EDGE		SIZE / INCHES				WEIGHT		VOL FT ³
	B	W	H (B)	H (W)	W	D	LBS		
LBT42108	1414	1660	1	1.5	108	42	108	6	
LBT42120	1552	1826	1	1.5	120	42	123	6	
LBT48108	1577	1846	1	1.5	108	48	110	6	
LBT48120	1741	2042	1	1.5	120	48	132	7	
LBT48132	1898	2227	1	1.5	132	48	143	7	
LBT48144	1927	2262	1	1.5	144	48	158	8	
LBT48156	2213	2595	1	1.5	156	48	167	8	
LBT48168	2371	2782	1	1.5	168	48	176	9	
LBT48180	2659	3116	1	1.5	180	48	189	10	
LBT48192	2689	3153	1	1.5	192	48	201	10	
LBT54144	2337	2722	1	1.5	144	54	169	10	
LBT54168	2691	3134	1	1.5	168	54	187	10	
LBT54192	3040	3547	1	1.5	192	54	212	13	
LBT54216	3392	3956	1	1.5	216	54	234	18	
LBT54240	3745	4366	1	1.5	240	54	259	20	
LBT60144	2562	2982	1	1.5	144	60	180	11	
LBT60168	2950	3433	1	1.5	168	60	198	13	
LBT60192	3339	3887	1	1.5	192	60	223	18	
LBT60216	3729	4339	1	1.5	216	60	245	22	
LBT60240	4115	4790	1	1.5	240	60	270	24	

LBTB • Boat Table Top with Bow Ends

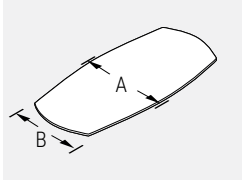

A	B
42	30
48	36

PRODUCT CODE	EDGE		SIZE / INCHES				WEIGHT LBS	VOL FT ³
	B	W	H(B)	H(W)	W	D		
LBTB4284	1021	1269	1	1.5	84	42	78	3
LBTB4296	1158	1441	1	1.5	96	42	92	4
LBTB4884	1153	1431	1	1.5	84	48	88	4
LBTB4896	1309	1626	1	1.5	96	48	110	4

LBTB • Boat Table Top with Bow Ends 2 Piece

• Tables larger than 192" long are manufactured in 3 pieces.

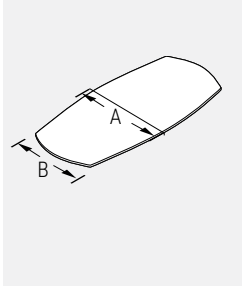

A	B
60	48
54	42
48	36
42	30

PRODUCT CODE	EDGE		SIZE / INCHES				WEIGHT LBS	VOL FT ³
	B	W	H(B)	H(W)	W	D		
LBTB42108	1414	1660	1	1.5	108	42	108	6
LBTB42120	1552	1826	1	1.5	120	42	123	6
LBTB48108	1577	1846	1	1.5	108	48	110	6
LBTB48120	1741	2042	1	1.5	120	48	132	7
LBTB48132	1898	2227	1	1.5	132	48	143	7
LBTB48144	1927	2262	1	1.5	144	48	158	8
LBTB48156	2213	2595	1	1.5	156	48	167	8
LBTB48168	2371	2782	1	1.5	168	48	176	9
LBTB48180	2659	3116	1	1.5	180	48	189	10
LBTB48192	2689	3153	1	1.5	192	48	204	11
LBTB54144	2337	2722	1	1.5	144	54	176	9
LBTB54168	2691	3134	1	1.5	168	54	187	10
LBTB54192	3040	3547	1	1.5	192	54	212	13
LBTB54216	3392	3956	1	1.5	216	54	234	18
LBTB54240	3745	4366	1	1.5	240	54	259	20
LBTB60144	2562	2982	1	1.5	144	60	180	11
LBTB60168	2950	3433	1	1.5	168	60	198	13
LBTB60192	3339	3887	1	1.5	192	60	223	18
LBTB60216	3729	4339	1	1.5	216	60	245	22
LBTB60240	4115	4790	1	1.5	240	60	270	24

LTW • Wedge Table Top

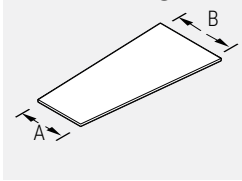

A	B
36	48

PRODUCT CODE	EDGE		SIZE / INCHES				WEIGHT LBS	VOL FT ³
	B	W	H(B)	H(W)	W	D		
LTW4896	1309	1626	1	1.5	96	48	110	4

LTW • Wedge Table Top 2 Piece

• Tables larger than 192" long are manufactured in 3 pieces.

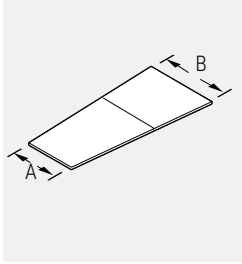

A	B
36	48
42	54
48	60

PRODUCT CODE	EDGE		SIZE / INCHES				WEIGHT LBS	VOL FT ³
	B	W	H(B)	H(W)	W	D		
LTW48108	1577	1846	1	1.5	108	48	110	6
LTW48120	1741	2042	1	1.5	120	48	132	7
LTW48132	1898	2227	1	1.5	132	48	143	7
LTW48144	1927	2262	1	1.5	144	48	158	8
LTW48156	2213	2595	1	1.5	156	48	167	8
LTW48168	2371	2782	1	1.5	168	48	176	9
LTW48180	2659	3116	1	1.5	180	48	189	10
LTW48192	2689	3153	1	1.5	192	48	201	10
LTW54144	2337	2722	1	1.5	144	54	169	10
LTW54168	2691	3134	1	1.5	168	54	187	10
LTW54192	3040	3547	1	1.5	192	54	212	13
LTW54216	3392	3956	1	1.5	216	54	234	18
LTW54240	3745	4366	1	1.5	240	54	259	20
LTW60144	2562	2982	1	1.5	144	60	180	11
LTW60168	2950	3433	1	1.5	168	60	198	13
LTW60192	3339	3887	1	1.5	192	60	223	18
LTW60216	3729	4339	1	1.5	216	60	245	22
LTW60240	4115	4790	1	1.5	240	60	270	24

LTW... first dash is B, and the second dash is the length. A is not included in the code and is the smaller end.

LTWB • Wedge Table Top with Bow Ends

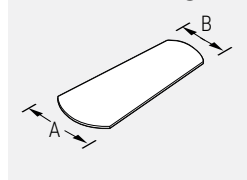

A	B
48	36

PRODUCT CODE	EDGE						WEIGHT		VOL FT ³
	B	W	H(B)	H(W)	W	D	LBS		
LTWB4896	1309	1626	1	1.5	96	48	110	4	

LTWB • Wedge Table Top with Bow Ends 2 Piece

• Tables larger than 192" long are manufactured in 3 pieces.

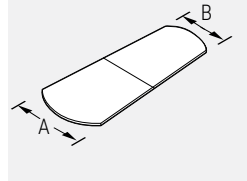

A	B
48	36
54	42
60	48

PRODUCT CODE	EDGE						WEIGHT		VOL FT ³
	B	W	H(B)	H(W)	W	D	LBS		
LTWB48108	1577	1846	1	1.5	108	48	110	6	
LTWB48120	1741	2042	1	1.5	120	48	132	7	
LTWB48132	1898	2227	1	1.5	132	48	143	7	
LTWB48144	1927	2262	1	1.5	144	48	158	8	
LTWB48156	2213	2595	1	1.5	156	48	167	8	
LTWB48168	2371	2782	1	1.5	168	48	176	9	
LTWB48180	2659	3116	1	1.5	180	48	189	10	
LTWB48192	2689	3153	1	1.5	192	48	198	11	
LTWB54144	2337	2722	1	1.5	144	54	178	9	
LTWB54168	2691	3134	1	1.5	168	54	187	10	
LTWB54192	3040	3547	1	1.5	192	54	212	13	
LTWB54216	3392	3956	1	1.5	216	54	234	18	
LTWB54240	3745	4366	1	1.5	240	54	259	20	
LTWB60144	2562	2982	1	1.5	144	60	180	11	
LTWB60168	2950	3433	1	1.5	168	60	198	13	
LTWB60192	3339	3887	1	1.5	192	60	223	18	
LTWB60216	3729	4339	1	1.5	216	60	245	22	
LTWB60240	4115	4790	1	1.5	240	60	270	24	

LHM • Halfmoon Table Top

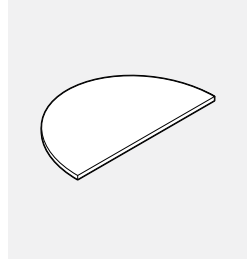

PRODUCT CODE	EDGE						WEIGHT		VOL FT ³
	B	W	H(B)	H(W)	W	D	LBS		
LHM2424	182	265	1	1.5	24	24	29	3	
LHM2448	347	439	1	1.5	48	24	35	3	
LHM2460	456	540	1	1.5	60	24	42	4	
LHM2472	500	638	1	1.5	72	24	53	6	
LHM3030	233	384	1	1.5	30	30	32	3	
LHM3048	406	528	1	1.5	48	30	40	4	
LHM3060	476	652	1	1.5	60	30	48	6	
LHM3072	524	770	1	1.5	72	30	57	7	

LTZ • Trapezoid Table Top

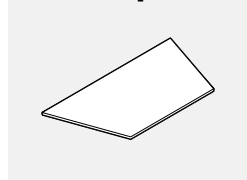

PRODUCT CODE	EDGE						WEIGHT		VOL FT ³
	B	W	H(B)	H(W)	W	D	LBS		
LTZ2460	456	540	1	1.5	60	24	42	4	
LTZ2472	500	638	1	1.5	72	24	53	6	
LTZ3060	476	652	1	1.5	60	30	48	6	
LTZ3072	524	770	1	1.5	72	30	57	7	

LW • Wave Table Top

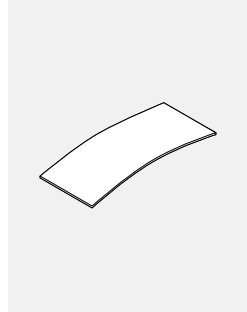

PRODUCT CODE	EDGE						WEIGHT		VOL FT ³
	B	W	H(B)	H(W)	W	D	LBS		
LW2448	347	439	1	1.5	48	24	35	3	
LW2460	456	540	1	1.5	60	24	42	4	
LW2466	476	590	1	1.5	66	24	47	6	
LW2472	500	638	1	1.5	72	24	53	6	
LW3060	476	652	1	1.5	60	30	48	6	
LW3066	499	709	1	1.5	66	30	53	7	
LW3072	524	770	1	1.5	72	30	64	8	
LW3660	614	811	1	1.5	60	36	53	7	
LW3666	672	885	1	1.5	66	36	63	8	
LW3672	731	959	1	1.5	72	36	68	9	

LCT • Cross Base for Table Tops

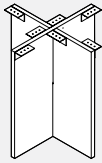

PRODUCT CODE	PRICE	SIZE/INCHES			WEIGHT LBS	VOL FT ³
		H	W	D		
LCT18	516	28	18	18	29	6
LCT24	516	28	24	24	39	4
LCT30	579	28	30	30	48	6
LCT36	664	28	36	36	57	8
LCT42	745	28	42	42	62	9

LR • Rectangular Base for Table Tops

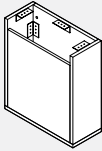

- Short side panel is removable for full wire access.

PRODUCT CODE	PRICE	SIZE/INCHES			WEIGHT LBS	VOL FT ³
		H	W	D		
LR18	447	28	18	10	39	3
LR24	505	28	24	10	46	4
LR30	558	28	30	10	54	6
LR36	622	28	36	10	66	8
LR42	715	28	42	10	83	9

LSQ • Square Base for Table Tops

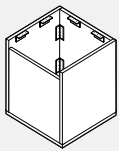

- Short side panel is removable for full wire access.

PRODUCT CODE	PRICE	SIZE/INCHES			WEIGHT LBS	VOL FT ³
		H	W	D		
LSQ18	560	28	18	18	50	7
LSQ24	686	28	24	24	66	11
LSQ30	818	28	30	30	83	17

LDRUM • Drum Base for Table Tops

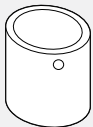

- Drum bases are finished in high pressure only and come with a full bottom.
- A 2" hole at the top to run the cables from the floor to the table top.
- Sand bag included.
- Access door is not an option.

PRODUCT CODE	PRICE	SIZE/INCHES			WEIGHT LBS	VOL FT ³
		H	W	D		
LDRUM18	909	28	18	18	32	8
LDRUM24	969	28	24	24	43	11
LDRUM30	993	28	30	30	54	14

LV • "V" Base for Table Tops

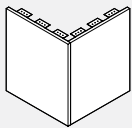

PRODUCT CODE	PRICE	SIZE/INCHES			WEIGHT LBS	VOL FT ³
		H	W	D		
LV1818	298	28	18	18	29	3
LV2424	341	28	24	24	39	4
LV3030	400	28	30	30	48	6

LELBA • Elliptical Base with Aluminum Extrusion

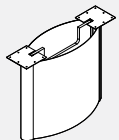

- Laminate side panels are removable for full wire access.
- Standard in metal paint finishes.
- Optional anodized aluminum finish available, please add \$50 list.

PRODUCT CODE	PRICE	SIZE/INCHES			WEIGHT LBS	VOL FT ³
		H	W	D		
LELBA18	1266	28	18	9	33	2
LELBA24	1348	28	24	10	44	2
LELBA30	1511	28	30	12	55	4
LELBA36	1679	28	36	13	66	7
LELBA42	1841	28	42	14	77	9

TELRR • Rectangular Panel Base with Anodized Aluminum Radius Corner Detail

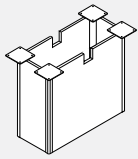

Single hinged access door is optional. Add "HD" to the end of the code. Add \$122 to list price.

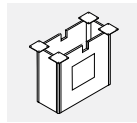

PRODUCT CODE	PRICE	SIZE/INCHES			WEIGHT LBS	VOL FT ³
		H	W	D		
TELRR18	757	28	18	12	66	7
TELRR24	800	28	24	12	72	9
TELRR30	844	28	30	12	105	11
TELRR36	887	28	36	12	129	13
TELRR42	930	28	42	12	129	15

TELBR • Rectangular Base with Rectangular Anodized Aluminum Corner Detail

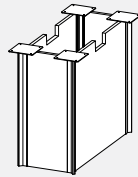

Single hinged access door is optional. Add "HD" to the end of the code. Add \$122 to list price.

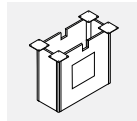

PRODUCT CODE	PRICE	SIZE/INCHES			WEIGHT LBS	VOL FT ³
		H	W	D		
TELBR18	781	28	18	12	66	7
TELBR24	826	28	24	12	72	9
TELBR30	868	28	30	12	105	11
TELBR36	912	28	36	12	129	13
TELBR42	956	28	42	12	129	15

TELSR • Square Panel Base with Anodized Aluminum Radius Corner Detail

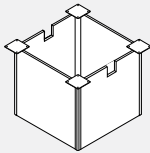

Single hinged access door is optional. Add "HD" to the end of the code. Add \$122 to list price.

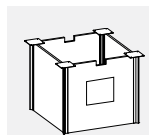

PRODUCT CODE	PRICE	SIZE/INCHES			WEIGHT LBS	VOL FT ³
		H	W	D		
TELSR18	811	28	18	18	77	7
TELSR24	894	28	24	24	83	9
TELSR30	979	28	30	30	117	20
TELSR36	1064	28	36	36	140	24
TELSR42	1146	28	42	42	140	24

TELBS • Square Base with Rectangular Anodized Aluminum End Detail

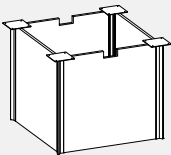

Single hinged access door is optional. Add "HD" to the end of the code. Add \$122 to list price.

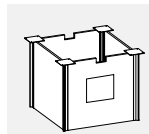

PRODUCT CODE	PRICE	SIZE/INCHES			WEIGHT LBS	VOL FT ³
		H	W	D		
TELBS18	837	28	18	18	77	7
TELBS24	936	28	24	24	83	9
TELBS30	1040	28	30	30	117	20
TELBS36	1156	28	36	36	140	24
TELBS42	1275	28	42	42	140	24

TRUM • Trumpet Column Base

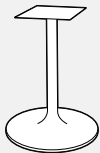

PRODUCT CODE	PRICE		SIZE/INCHES			WEIGHT LBS	VOL FT ³
	PAINTED	CHROME	H	W	D		
TRUM18	473	618	28	18	18	15	9
TRUM24	542	686	28	24	24	18	13
TRUM30	880	1024	28	30	30	20	15
TRUM18BH	699	842	40.5	18	18	26	18
TRUM24BH	799	944	40.5	24	24	29	15

TTFD • Flat Disk Column Base

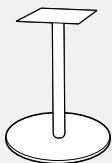

PRODUCT CODE	PRICE		SIZE/INCHES			WEIGHT LBS	VOL FT ³
	PAINTED	CHROME	H	W	D		
TTFD18	845	1007	28	18	18	50	9
TTFD22	912	1073	28	22	22	55	13
TTFD24	980	1140	28	24	24	66	14
TTFD30	1423	1492	28	30	30	88	15
TTFD36	1895	2054	28	36	36	110	15
TTFD18BH	1036	1197	40.5	18	18	72	11
TTFD22BH	1103	1263	40.5	22	22	77	15
TTFD24BH	1169	1330	40.5	24	24	110	17

TTSQ • Flat Square Column Base

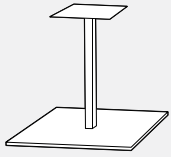

Plate size: (18"-30" 11"x11"), (36" 14"x14").
Column size: (18"-24" 2.1/2"), (30"-36" 3")

PRODUCT CODE	PRICE		SIZE/INCHES			WEIGHT LBS	VOL FT ³
	PAINTED	CHROME	H	W	D		
TTSQ18	1184	1328	28	18	18	50	9
TTSQ23	1319	1463	28	23	23	61	13
TTSQ30	1691	1836	28	30	30	88	15
TTSQ18BH	1375	1519	40.5	18	18	72	11
TTSQ23BH	1508	1653	40.5	23	23	83	15

TTFLTX • Flat Bar "X" Column Base

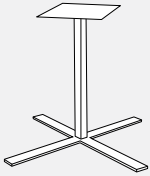

Plate size: (18"-30" 11"x11"), (36" 14"x14").
Column size: (18"-24" 2.1/2"), (30"-36" 3")

PRODUCT CODE	PRICE		SIZE/INCHES			WEIGHT LBS	VOL FT ³
	PAINTED	CHROME	H	W	D		
TTFLTX18	1251	1476	28	18	18	15	9
TTFLTX22	1268	1493	28	22	22	17	11
TTFLTX24	1285	1510	28	24	24	18	13
TTFLTX30	1319	1511	28	30	30	20	15
TTFLTX36	1352	1576	28	36	36	22	24
TTFLTX18BH	1441	1668	40.5	18	18	26	11
TTFLTX22BH	1459	1682	40.5	22	22	28	13
TTFLTX24BH	1508	1737	40.5	24	24	29	15

TTFLT • Flat Bar "T" Column Base

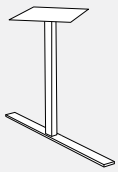

Plate size: (18"-30" 11"x11"), (36" 14"x14").
Column size: (18"-24" 2.1/2"), (30"-36" 3")

PRODUCT CODE	PRICE		SIZE/INCHES			WEIGHT LBS	VOL FT ³
	PAINTED	CHROME	H	W	D		
TTFLT18	946	1108	28		18	9	2
TTFLT22	965	1126	28		22	10	2
TTFLT24	980	1140	28		24	11	3
TTFLT30	1015	1176	28		30	13	3
TTFLT36	1049	1209	28		36	15	3

TTFL3P • Flat Bar 3 Prong Column Base



Plate size: (18"-30" 11"x11"), (36" 14"x14").
Column size: (18"-24" 2.1/2"), (30"-36" 3")

PRODUCT CODE	PRICE		SIZE/INCHES			WEIGHT LBS	VOL FT ³
	PAINTED	CHROME	H	W	D		
TTFL3P18	1184	1410	28		18	11	7
TTFL3P22	1201	1427	28		22	12	13
TTFL3P24	1218	1443	28		24	13	15
TTFL3P30	1251	1476	28		30	15	15
TTFL3P36	1268	1493	28		36	18	24

LL4S • 4 Star Table Leg with Bullnose End

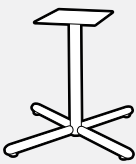

- Leg Plate is 11"x11" for 26" and 30" spread and 14"x14" for 36" spread.
- For the caster option specify "CS" at the end of the code with a \$77 upcharge

PRODUCT CODE	PRICE		SIZE/INCHES			WEIGHT LBS	VOL FT ³
	PAINTED	CHROME	H	W	D		
LL4S18	481	608	28	18	18	15	7
LL4S26	571	699	28	26	26	18	15
LL4S30	607	736	28	30	30	20	15
LL4S36	668	796	28	36	36	22	24

LL4S-42 • Bistro Leg with Bullnose End



- Leg Plate is 11"x11" for 26" and 30" spread.

PRODUCT CODE	PRICE		SIZE/INCHES			WEIGHT LBS	VOL FT ³
	PAINTED	CHROME	H	W	D		
LL4S2642	651	781	40.5	26	26	22	18
LL4S3042	696	825	40.5	30	30	24	23
LL4S3642	760	887	40.5	36	36	26	28

LLT • "T" Table Leg with Bullnose End

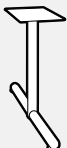

- Leg Plate is 11"x11"
- For the caster option specify "CS" at the end of the code with a \$37 upcharge

PRODUCT CODE	PRICE		SIZE/INCHES			WEIGHT LBS	VOL FT ³
	PAINTED	CHROME	H	W	D		
LLT18	295	424	28	18	6	9	2
LLT26	312	440	28	26	6	11	3
LLT30	325	451	28	30	6	13	3
LLT36	601	728	28	36	6	15	3

LLTT • “TT” Table Leg with Bullnose End



- Leg Plate is 11”x 24”
- For the caster option specify “CS” at the end of the code with a \$37 upcharge

PRODUCT CODE	PRICE		SIZE/INCHES			WEIGHT		VOL FT ³
	PAINTED	CHROME	H	W	D	LBS		
LLTT18	492	653	28	18	6	13	2	
LLTT26	518	679	28	26	6	20	3	
LLTT30	534	696	28	30	6	24	3	
LLTT36	769	928	28	36	6	26	3	
LLTT42	899	1062	28	42	6	31	4	

LLSQ • Square Post Leg

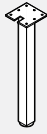

- 2.5” x 2.5” square tubular leg provides support for worksurfaces.
- Top plate welded to leg.
- 8” x 8” plate attached with #10 3/4” wood screws included.
- 1” height adjustment range.

PRODUCT CODE	PRICE		SIZE/INCHES			WEIGHT		VOL FT ³
	PAINTED	CHROME	H	W	D	LBS		
LLSQ25X25H28	240	367	28	2.5	2.5	9	0.17	

LATBL • Tapered Leg



- Tapered leg provides support for worksurfaces.
- Top plate welded to leg.
- 8” x 8” plate attached with #10 3/4” wood screws included.
- 1” height adjustment range.
- Bottom of leg tube is a 1” diameter and top is 2 3/8” diameter.

PRODUCT CODE	PRICE		SIZE/INCHES			WEIGHT		VOL FT ³
	PAINTED	CHROME	H	W	D	LBS		
LATBL28	195	331	28	3	3	9	0.17	

BHML • Monoleg



- 3” diameter Monoleg provides support for worksurfaces.
- Top plate welded to leg.
- 8” x 8” plate attached with #10 3/4” wood screws included.
- 1” height adjustment range.

PRODUCT CODE	PRICE		SIZE/INCHES			WEIGHT		VOL FT ³
	PAINTED	CHROME	H	W	D	LBS		
BHML03	207	334	28	3	3	9	0.17	

L2BHML • Monoleg

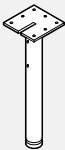

- 3” diameter Monoleg provides support for worksurfaces.
- Cut-out top plate welded to leg. Cut-out accepts 3/4” modesty panel.
- 8” x 8” plate attached with #10 3/4” wood screws included.
- 1” height adjustment range.

PRODUCT CODE	PRICE		SIZE/INCHES			WEIGHT		VOL FT ³
	PAINTED	CHROME	H	W	D	LBS		
L2BHML03	207	334	28	3	3	9	0.17	

LBHML06 • 6” Monoleg



- 6” diameter Monoleg provides support for worksurfaces.
- Top plate welded to leg flush.
- 8” x 8” plate attached with #10 3/4” wood screws, included.
- 1” height adjustment range.
- Leg is offset flush to edge.

PRODUCT CODE	PRICE		SIZE/INCHES			WEIGHT		VOL FT ³
	PAINTED	CHROME	H	W	D	LBS		
LBHML06	398	559	28	6	6	9	0.17	

FOLDLEG • Folding Leg



- Sold as a set of two.
- Available in only in (SIL) Silver or (BLK) Black.

PRODUCT CODE	PRICE	SIZE/INCHES			WEIGHT		VOL FT ³
		H	W	D	LBS		
FOLDLEG	460	28	24.625	3	11	7	

LHC • HAT Channel for Conference Tables

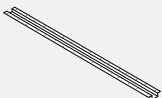

- See chart on page H.2

PRODUCT CODE	PRICE	SIZE/INCHES			WEIGHT		VOL FT ³
		H	W	D	LBS		
LHC40	58	1.4	40	5	4	0.20	
LHC46	64	1.4	46	5	6	0.22	
LHC52	68	1.4	52	5	7	0.25	
LHC58	78	1.4	58	5	8	0.28	
LHC64	88	1.4	64	5	9	0.31	
LHC70	94	1.4	70	5	10	0.33	

LVB • Visual Board

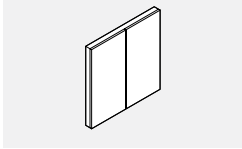

• See page H.1 for technical information.

PRODUCT CODE	FINISH		SIZE/INCHES			WEIGHT		VOL FT ³
	LP/B	HP/B	H (LP/B)	W	D	LBS		
LVB48	1579	1748	48	48	8	154	10	
LVB48MG	2457	2708	48	48	8	154	10	

MSPDM • 1 Duplex, 2 Data



- Includes one duplex and 2 data jacks (both RJ45, Cat 6)
- Black plastic

PRODUCT CODE	PRICE	PRICE			WEIGHT		VOL FT ³
		H	W	D	LBS		
MSPDM	276	2.75	6.5	3.5	2	0.1	

ModPower Power Solution

- Power solutions for flexible spaces. Connect up to four units (in Canada)/six units in the USA from a single infeed with NEMA plug to deliver power and charging ports to the table top. In-surface modules and clamp on modules available.
- Easy to install; code compliant that allows users to optimize any space providing convenient power access. Perfect for training areas, meeting rooms, in-office workstations and more. Units feature tamper-resistant receptacles as well as both USB-A and USB-C charging ports.
- Easy to use connectors that are touch-safe with added latch to prevent unintended separation. Easy push together to connect, and simple press down on latch to disconnect.
- Maximum overall length not to exceed 48.5 feet per infeed. UL listed to UL962A SD, the standard for furniture power distribution units for portable/moveable work space tables.
- Certified to CSA standard C22.2 No. 203-16.
- Will work with Licence, Terina and Bridges Products.
- Surface mounted module ships with a clamp mount that will accommodate any material 1/2" to 1-1/2" thick; additional brackets are also included for screw in mounting options that

- can accommodate vertical or horizontal positions.
- Modules can be integrated into surfaces but the surface must be specified as a special.

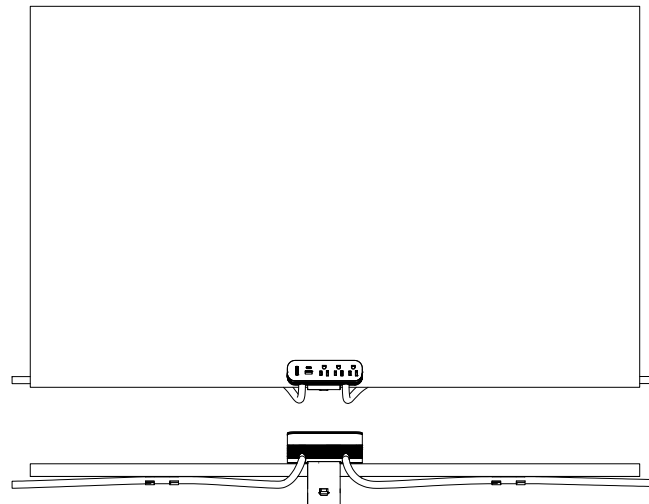
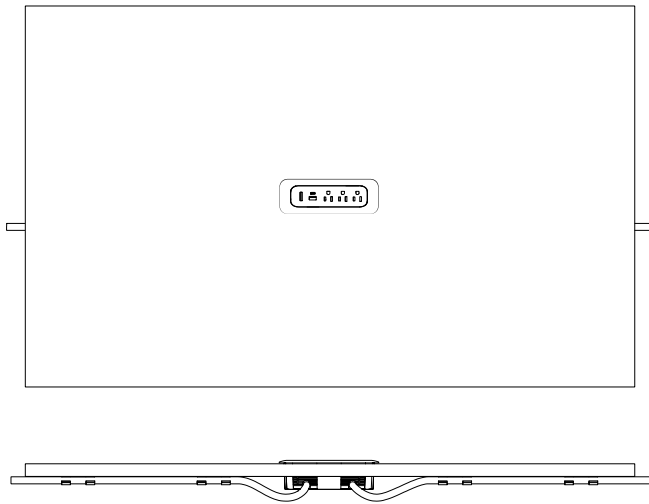
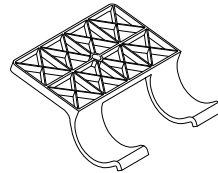

GMDSF10 • ModPower In Surface Starter Unit

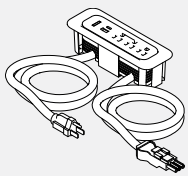

- ModPower starter unit includes one 10' cord with a NEMA plug and one 3' connector cord.
- Unit equipped with three 15A tamper resistant receptacles, one USB-A and one USB-C charging ports and a circuit breaker.
- 4 cable management cord clips included.
- MG at the end of the code indicates a magnesium finish, while WH is a white finish.

PRODUCT CODE	PRICE	PRICE			WEIGHT		VOL FT ³
		H	W	D	LBS		
GMDSF10MG	597	7.63	2.75	2.63	3.44	1.0	
GMDSF10WH	597	7.63	2.75	2.63	3.44	1.0	

GMDCF3 • ModPower In Surface Middle Unit

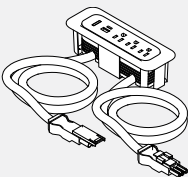

- ModPower middle unit includes two 3' connector cords.
- Unit equipped with three 15A rated 12A tamper resistant receptacles, one USB-A and one USB-C charging ports and a circuit breaker.
- 4 cable management cord clips included.
- MG at the end of the code indicates a magnesium finish, while WH is a white finish.

PRODUCT CODE	PRICE	PRICE			WEIGHT		VOL FT ³
		H	W	D	LBS		
GMDCF3MG	562	7.63	2.75	2.63	2.44	1.0	
GMDCF3WH	562	7.63	2.75	2.63	2.44	1.0	

GMDEF3 • ModPower In Surface End Unit

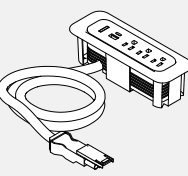

- ModPower end unit includes one 3' connector cord.
- Unit equipped with three 15A rated 12A tamper resistant receptacles, one USB-A and one USB-C charging ports and a circuit breaker.
- 2 cable management cord clips included.
- MG at the end of the code indicates a magnesium finish, while WH is a white finish.

PRODUCT CODE	PRICE	PRICE			WEIGHT		VOL FT ³
		H	W	D	LBS		
GMDEF3MG	494	7.63	2.75	2.63	1.85	1.0	
GMDEF3WH	494	7.63	2.75	2.63	1.85	1.0	

GMDSA10 • ModPower Starter Mounted Unit

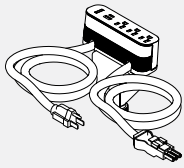

- ModPower starter unit includes one 10' cord with a NEMA plug and one 3' connector cord.
- Unit equipped with three 15A tamper resistant receptacles, one USB-A and one USB-C charging ports and a circuit breaker.
- Includes edge clamp and 3 other mounting methods; and 4 cable management cord clips.
- MG at the end of the code indicates a magnesium finish, while WH is a white finish.

PRODUCT CODE	PRICE	PRICE			WEIGHT		VOL	
		H	W	D	LBS	FT ³		
GMDSA10MG	631	6.13	1.75	2.5	4.33	1.0		
GMDSA10WH	631	6.13	1.75	2.5	4.33	1.0		

GMDCA3 • ModPower Middle Mounted Unit

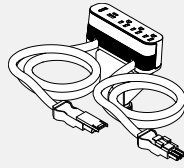

- ModPower middle unit includes two 3' connector cords.
- Unit equipped with three 15A rated 12A tamper resistant receptacles, one USB-A and one USB-C charging ports and a circuit breaker.
- Includes edge clamp and 3 other mounting methods; and 4 cable management cord clips.
- MG at the end of the code indicates a magnesium finish, while WH is a white finish.

PRODUCT CODE	PRICE	PRICE			WEIGHT		VOL	
		H	W	D	LBS	FT ³		
GMDCA3MG	597	6.13	1.75	2.5	3.33	1.0		
GMDCA3WH	597	6.13	1.75	2.5	3.33	1.0		

GMDEA3 • ModPower End Mounted Unit

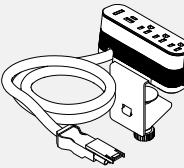

- ModPower end unit includes one 3' connector cord.
- Unit equipped with three 15A rated 12A tamper resistant receptacles, one USB-A and one USB-C charging ports and a circuit breaker.
- Includes edge clamp and 3 other mounting methods; and 2 cable management cord clips.
- MG at the end of the code indicates a magnesium finish, while WH is a white finish.

PRODUCT CODE	PRICE	PRICE			WEIGHT		VOL	
		H	W	D	LBS	FT ³		
GMDEA3MG	528	6.13	1.75	2.5	2.75	1.0		
GMDEA3WH	528	6.13	1.75	2.5	2.75	1.0		

GMDCLIPS • ModPower Management Clips

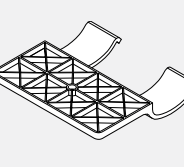

- Includes 10 clips.

PRODUCT CODE	PRICE	PRICE			WEIGHT		VOL	
		H	W	D	LBS	FT ³		
GMDCLIPS	102	2.6	2.5	0.6	0.3	0.2		

GMDJ36BK • ModPower Interconnecting Jumper

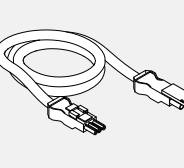

- ModPower interconnecting jumper cord to add an additional 3 feet of cord length between ModPower units.
- Package of 2, each 3 feet with male & female connector.

PRODUCT CODE	PRICE	PRICE			WEIGHT		VOL	
		H	W	D	LBS	FT ³		
GMDJ36BK	329	36			1.38	0.9		

BG5 • Rectangular Grommet

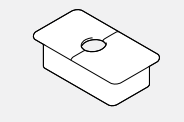

- Option
(BLK) Black Plastic
(GRY) Grey Plastic
(WHT) White Plastic

PRODUCT CODE	PRICE	PRICE			WEIGHT		VOL	
		H	W	D	LBS	FT ³		
BG5	36		3.5	2				

Telecom Plates



PRODUCT CODE	PRICE
Black telecom plate with 2 RJ45 cat 6 data ABLBB	252



PRODUCT CODE	PRICE
Black telecom plate with 3 RJ45 cat 6 data ABLBBB	372



PRODUCT CODE	PRICE
Black telecom plate with 4 RJ45 cat 6 data ABLBBBB	490

GCRTMCS401 • Recessed Power Block, 1 Duplex, 1 Data Knock-outs, 1 Power Duplex

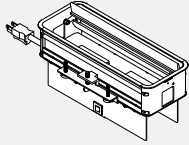

- Single sided recessed power block with 1 regular duplex and 1 data knock-out on top, 1 power duplex on bottom.
- 10 ft power cord with straight plug.
- Telecom plates ordered separately.
- Available in Black - B, Tungsten - T or Designer White - W as indicated by last letter of model number; duplexes always grey.
- Not approved for daisy-chain applications.

PRODUCT CODE	PRICE	H	W	D	WEIGHT LBS	VOL FT ³
GCRTMCS401B	578	4.86	10.78	4.22	4.3	0.51
GCRTMCS401T	578	4.86	10.78	4.22	4.3	0.51
GCRTMCS401W	578	4.86	10.78	4.22	4.3	0.51

GCRTMCS421 • Recessed Power Block, 1 Power including USB A+C, 1 Data Knock-outs, 1 Power Duplex

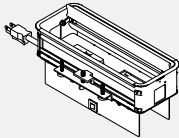

- Single sided recessed power block with 1 power and USB A+C duplex and 1 data knock-out on top, 1 power duplex on bottom.
- USB Type A port charges maximum 2.4 amps at 5V and Type C port charges maximum 3 amps at 5V.
- 10 ft power cord with straight plug.
- Telecom plates ordered separately.
- Available in Black - B, Tungsten - T or Designer White - W as indicated by last letter of model number; duplexes always grey.
- Not approved for daisy-chain applications.

PRODUCT CODE	PRICE	H	W	D	WEIGHT LBS	VOL FT ³
GCRTMCS421B	759	4.86	10.78	4.22	4.3	0.51
GCRTMCS421T	759	4.86	10.78	4.22	4.3	0.51
GCRTMCS421W	759	4.86	10.78	4.22	4.3	0.51

GCRTMCD602 • Recessed Power Block, 2 Duplex, 2 Data Knock-outs, 1 Power Duplex

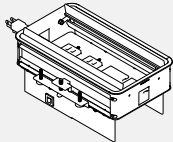

- Double sided recessed power block with 2 regular duplex and 2 data knock-outs on top, 1 power duplex on bottom.
- 10 ft power cord with straight plug.
- Telecom plates ordered separately.
- Available in Black - B, Tungsten - T or Designer White - W as indicated by last letter of model number; duplexes always grey.
- Not approved for daisy-chain applications.

PRODUCT CODE	PRICE	H	W	D	WEIGHT LBS	VOL FT ³
GCRTMCD602B	660	4.86	10.78	6.22	5.9	0.51
GCRTMCD602T	660	4.86	10.78	6.22	5.9	0.51
GCRTMCD602W	660	4.86	10.78	6.22	5.9	0.51

GCRTMCD622 • Recessed Power Block, 1 Duplex, 1 Power including USB A+C, 2 Data Knockouts, Power Duplex

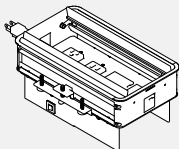

- Double sided recessed power block with 1 regular duplex, 1 power and USB A+C and 2 data knock-outs on top, 1 power duplex on bottom.
- USB Type A port charges maximum 2.4 amps at 5V and Type C port charges maximum 3 amps at 5V.
- 10 ft power cord with straight plug.
- Telecom plates ordered separately.
- Available in Black - B, Tungsten - T or Designer White - W as indicated by last letter of model number; duplexes always grey.
- Not approved for daisy-chain applications.

PRODUCT CODE	PRICE	H	W	D	WEIGHT LBS	VOL FT ³
GCRTMCD622B	831	4.86	10.78	6.22	6.1	0.51
GCRTMCD622T	831	4.86	10.78	6.22	6.1	0.51
GCRTMCD622W	831	4.86	10.78	6.22	6.1	0.51

GCRTMCD642 • Recessed Power Block, 2 Power including USB A+C, 2 Data Knock-outs, 1 Power Duplex

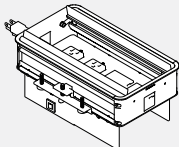

- Double sided recessed power block with 2 power and USB A+C and 2 data knock-outs on top, 1 power duplex on bottom.
- USB Type A port charges maximum 2.4 amps at 5V and Type C port charges maximum 3 amps at 5V.
- 10 ft power cord with straight plug.
- Telecom plates ordered separately.
- Available in Black - B, Tungsten - T or Designer White - W as indicated by last letter of model number; duplexes always grey.
- Not approved for daisy-chain applications.

PRODUCT CODE	PRICE	H	W	D	WEIGHT LBS	VOL FT ³
GCRTMCD642B	1001	4.86	10.78	6.22	6.3	0.51
GCRTMCD642T	1001	4.86	10.78	6.22	6.3	0.51
GCRTMCD642W	1001	4.86	10.78	6.22	6.3	0.51

Terina Tables

Terina™ is a multi-purpose table that allows you to quickly adapt your space to suit your needs. The simple flip-top mechanism is designed for single-handed operation. Tables nest in an upright position to minimize storage space.

Worksurfaces

Laminate surfaces (B) are 1-1/16" thick tops constructed of 45lb. density particle board with high pressure laminate and finished on the underside of the surface with a kraft paper backing. Veneer (V) surfaces are 1-3/16" thick tops constructed of 45 lb. density particle board and are balanced on the underside with veneer (unfinished). Worksurfaces are pre-drilled for alignment of the Terina base.

Base

Tables feature an aluminum leg, cross beam and die-cast foot. Legs and cross beam are available in all standard panel frame painted finishes. Die-cast foot is always in polished aluminum finish. Foot span is 23". Stacking depth of 9".

Casters

Casters are standard on all tables. 2-3/8" dual wheel casters with manual lock. Full 360° swivel. Suggested for carpeted surfaces. Available in grey only.

Ganging Plates

Ganging plates are available for ganging adjoining tables together. Ganging plates are black epoxy coated steel plates with two thumbscrews.

Wire Management

Wire management option is a snap-in channel that fits on the interior of the leg or on the understand of the flip-top cross beam.

Modesty Panels

10" Modesty panel affixes to the top and base, articulating when it folds down. available in all standard LP laminate and veneer finishes.

GFT-R • Rectangular Flip Top Training Table

- B and V edge tops have square corners



PRODUCT CODE	PRICE					WEIGHT LBS	VOL FT³
	B	V	H	W	D		
GFT2448R	1212	2055	29	48	24	48	6
GFT2454R	1262	2206	29	54	24	53	6
GFT2460R	1312	2237	29	60	24	55	7
GFT2466R	1331	2279	29	66	24	61	7
GFT2472R	1349	2317	29	72	24	66	7
GFT3048R	1262	2103	29	48	30	53	6
GFT3054R	1290	2265	29	54	30	55	6
GFT3060R	1331	2305	29	60	30	61	7
GFT3066R	1347	2395	29	66	30	66	7
GFT3072R	1377	2478	29	72	30	68	7

GFT-M • Folding Modesty Panel

- Includes hardware to connect to Terina Tables.
- Woodgrain modesty panels over 60" will have the woodgrain run horizontally, whereas others will run vertically.
- Due to location of the modesty panel, only MSPDM and GMDSF10 grommets can be used on Terina tables with modesty panels.

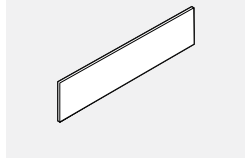

PRODUCT CODE	PRICE					WEIGHT LBS	VOL FT³
	LP	V	H	W	D		
GFT48M	299	518	10	46	0.75	11	1
GFT54M	311	581	10	52	0.75	13	1
GFT60M	323	643	10	58	0.75	15	1
GFT66M	334	702	10	64	0.75	18	2
GFT72M	349	764	10	70	0.75	20	2

GFTCM • Wire Manager

- Set of four
- Each piece is 10" long

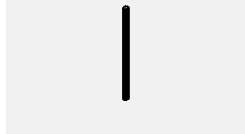

PRODUCT CODE	PRICE				WEIGHT LBS	VOL FT³
	H	W	D			
GFTCM04BLK	37	2	10	2	1	1

GFCNGFP • Ganging Flush Plate

- Please specify application so that inserts may be added to surface.

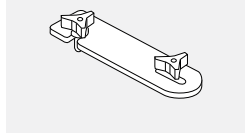

PRODUCT CODE	PRICE			WEIGHT LBS	VOL FT³
	H	W	D		
GFCNGFP	37	2.5	5	0.1	0.01

Technical Information - Vice Versa Tables

Tables

- All worksurfaces have threaded inserts for metal-to-metal connection of support hardware.
- 60" and 72" tables come standard with wire manager.
- HP tops are 1 1/16" thick laminate particle board.

HP Top with T-Mould Edge

- Rectangular mobile table made of 1 1/16" thick particle board with High Pressure laminate finish. HP tops have 3.5mm PVC edge.

Viceversa Leg

- Universal mounting plate can be used to gang 2 tables simply by rotating 45° to span 2 table tops without metal skirts.

- Table legs have a wire management channel that neatly organizes electrical and communication cables running from the worksurfaces to the floor.

- The channel is covered by a clear PVC snap-on cover.

- The Viceversa leg features a push button height adjustment mechanism. This mechanism allows the user to easily set the height of a table.

Legs have a height range of 23.5" – 30.5" in 1" increments for levelers and 25"-33" with casters.

Viceversa legs are available with:

- Levelers
- Locking casters.

NOTES:

- Levelers have a 0.5" height range.
- Levelers available in Charcoal Grey only.
- Casters available in grey with black only.
- Legs are available in our (6) standard finishes.
- Finish is durable environmentally friendly paint.

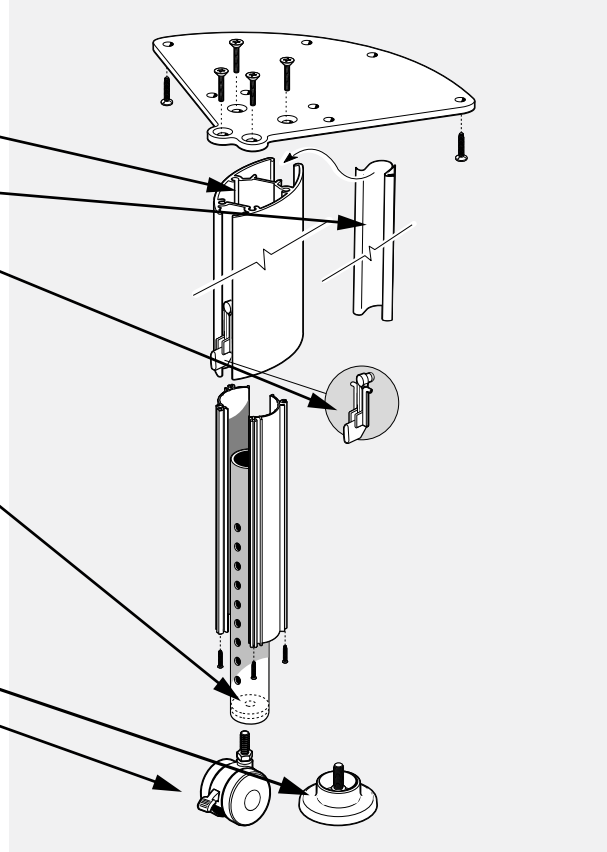

VVRT • Rectangular Tables with 4 Legs

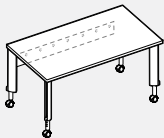

- **Tables are designed to work individually or as a group. They can be moved to meet the changing needs of an individual or group.**
- Tables come standard with 4 locking casters. Optional levelers available, please specify.
- 6" metal skirt provides strength and stability.
- Modesty Panel, Pong Panel or 6" metal skirt cannot be used on tables with 2 legs or shared tables.

PRODUCT CODE	PRICE HP	SIZE/ INCHES			WEIGHT VOL	
		H	D	W	LBS	FT³
VVRT2448HP4	927	26-32	24	48	63	7.11
VVRT2460HP4	1019	26-32	24	60	71	7.36
VVRT2472HP4	1067	26-32	24	72	78	7.62
VVRT3060HP4	1113	26-32	30	60	80	7.69
VVRT3072HP4	1158	26-32	30	72	90	8.01

VVS • Square Tables with 4 Legs

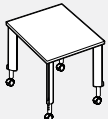

- **Square tables are designed to work individually or as a grouping. They can be moved to meet the changing needs of an individual or group.**
- Tables come standard with 4 locking casters. Optional levelers available, please specify.

PRODUCT CODE	PRICE HP	SIZE/ INCHES			WEIGHT VOL	
		H	D	W	LBS	FT³
VVS30HP4	1019	26-32	30	30	71	7.2
VVS36HP4	1067	26-32	36	36	76	7.6
VVS42HP4	1113	26-32	42	42	82	8.0
VVS48HP4	1208	26-32	48	48	88	8.4

VVR • Round Tables with 4 Legs



- **Round tables are designed to work individually or as a group. They can be moved to meet the changing needs of an individual or group.**
- Tables come standard with 4 locking casters. Optional levelers available, please specify.

PRODUCT CODE	PRICE HP	SIZE/ INCHES			WEIGHT VOL	
		H	D	W	LBS	FT³
VVR30HP4	975	26-32	30	30	57	6.8
VVR36HP4	1019	26-32	36	36	64	7
VVR42HP4	1067	26-32	42	42	71	7.2
VVR48HP4	1158	26-32	48	48	79	7.6

Global offices in Canada

Head Office

560 Supertest Road
Toronto, Ontario
M3J 2M6
T (416) 650-6500

Toronto Sales Office

1350 Flint Road
Toronto, Ontario
M3J 2J7
T (416) 661-3660

Moncton

268 Coverdale Road
Riverview, New Brunswick
E1B 3J2
T (506) 858-8383

Showrooms

Calgary

237 8 Avenue SE, Suite 302
Calgary, Alberta
T2G 5C3
T (403) 250-7770

Montreal

1010 Sainte-Catherine Street West
Mezzanine 2
Montreal, Quebec
H3B 1E7T
(514) 866-4331

Ottawa

251 Laurier Avenue West, Suite 400
Ottawa, Ontario
K1P 5J6
T (613) 234-2881
Please call ahead to book an appointment.

Edmonton

10158 103 Street NW, Suite 201
Edmonton, Alberta
T5J 0X6
T (780) 444-8922

Toronto

1350 Flint Road
Toronto, Ontario
M3J 2J7
T (416) 661-3660

Vancouver

675 West Hastings Street, Suite 1000
Vancouver, British Columbia
V6B 1N2
T (604) 432-1701

Halifax

1061 Marginal Road, Suite 120
Halifax, Nova Scotia
B3H 4P7
T (902) 422-7434

Toronto - The Blueprint

(MetroCentre)
200 Wellington Street West, Suite 1602
Toronto, Ontario
M5V 3C7

Winnipeg

111 Lombard Avenue, Suite 220
Winnipeg, Manitoba
R3B 0T4
T (204) 925-3350