

## Bridges Feature List

Our desire was to develop an environment for collaborative teamwork which would facilitate connection, or bridging, of people and ideas. A set of components which would even serve as a catalyst - inviting team members out of their cocooned comfort zones and encouraging them to engage, to co-create.

**Flexible building components:**

- single tables (freestanding or mobile)
- training rooms
- boardrooms
- library
- 1 person general and private office
- 2 person work station
- 3-person work station
- 4-person work station
- 6+ -person work station
- Storage spine-based work station
- Panel based work station

**Easy to customize / reconfigure** to fit specific requirements. From the facility manager's perspective, all work stations can be standardized to form a linear worksurface and power/data services, and their respective function, or purpose, can be governed by the type, quantity and placement of adjacent components like dividers, storage cabinets, shelves and accessories. These adjacent components can be easily reconfigured with minimal down time - without having to invite electrical and IT crew.

**Compatible with various environments** clean, simple, elegant design language with finishes suggesting comfortable, even domestic flavour. Wide range of finished various environments. From understated to some combinations, like anodized aluminum and white that give a hint of subtle sophistication.

## Worksurfaces

- Worksurfaces are available in (HP) high pressure laminate and (LP) low pressure laminate.
- Veneer tops available, please contact your Customer Service Representative.
- HP laminate tops are 1 1/16" thick laminate particle board and have a flat 3 mm edge profile on all sides.
- LP laminate tops are 1" thick melamine particle board and have a flat 3 mm edge profile on all side.

### Tables

- All single sliding rail tables are standard with casters.
- All multiple linear workstations are standard with levelers.
- Tops square for flush surface-to-surface abutment and to accept desk mounted accessories.
- Worksurfaces provided with pilot holes for alignment purposes.

**CODES:** The price list uses a numbering system with meaningful alphanumeric characters to

### Worksurface Edge Profiles:

HP/LP edge: 

**Choice of two functionally and visually differentiated leg supports** on casters or levelers: - height-adjustable round legs - fixed height rectangular legs with optional anodized aluminum finish

**Various power/data delivery levels to choose from:** - wire basket to organize cable excess under worksurface and storage - table leg integrated vertical cable manager - worksurface edge-mounted power/data units (easy to reconfigure, plug into wall/floor outlets) - single and double below worksurface power/data trough (desk top, floor standing computers and office equipment) - worksurface access door (access to below worksurface power outlets and data terminals) - above worksurface power/data trough (laptop / tablet / phone immediate access) - storage integrated power/data unit - horizontal cable management under storage units with optional wire basket - raised storage units for uninterrupted access to panel based floor raceway

**Interconnected storage units** can form a spine (space division, storage, cable management and worksurface support). Storage leg can be configured to act as a ganging bracket.

**Panel integrated storage units** can be connected and provide support to panel partitions (space division, storage, cable management, panel power/data delivery access and worksurface support). Panel integrated Bridges leg provides support to panel mounted worksurfaces.

**Bridges Collaborative Seating** collection consists of seating, privacy screens, tables, tablets and power. It is a versatile modular furniture series which can be configured into many space planning scenarios including corner, in-line, open concept, traditional reception as well as secluded seating with high privacy partitions.

create a simple-to-understand product number. This makes specifying the product much easier and more accurate.

### SPECIFICATION EXAMPLE OF A BRIDGES WORKSURFACE

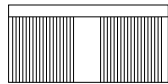
**PRODUCT CODE:** BRTWS2472HP MR71T CHR  
 BRT = Bridges  
 WS = Type of Worksurface  
 2472 = Size: Depth x Width  
 HP = Finish  
 MR71T = High Pressure Laminate  
 CHR = PVC Edging

### How To Specify:

- Specify Bridges product code in appropriate top material.
- Specify top colour - ie. Laminate colour MR71T (Studio White Matrix).
- Specify PVC edge colour - ie. CHR (Charcoal).

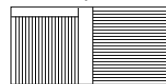
## 30" WIDE UNITS Storage Capacity Chart

SIDE TO SIDE



LETTER LETTER

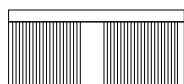
SIDE TO SIDE LETTER/FRONT TO BACK LEGAL



LETTER LEGAL

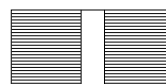
## 36" & 42" WIDE UNITS Storage Capacity Chart

SIDE TO SIDE LETTER



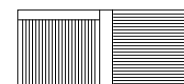
LETTER LETTER

FRONT TO BACK LEGAL



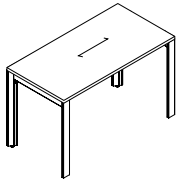
LEGAL LEGAL

SIDE TO SIDE LETTER/FRONT TO BACK LEGAL

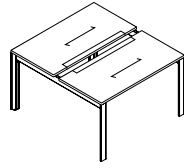


LETTER LEGAL

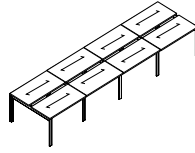
GRAIN DIRECTION CHART



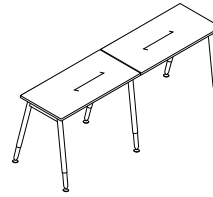
BRTS1P-L



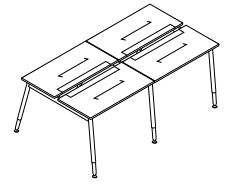
BRTBAR2PA-L



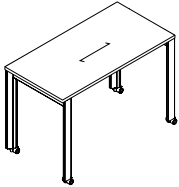
BRTBAR8PA-L



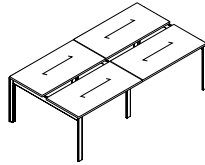
BRTS2P-LR



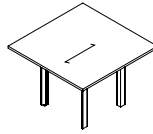
BRTBAR4PA-LR



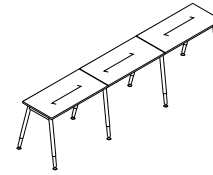
BRTS1P-C



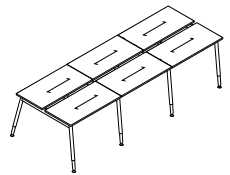
BRTBAR4P-L



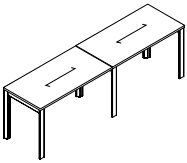
BRTSQ



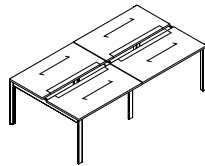
BRTS3P-LR



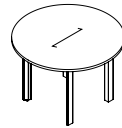
BRTBAR6P-LR



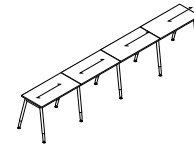
BRTS2P-L



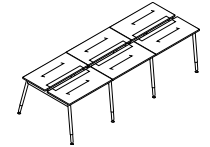
BRTBAR4PA-L



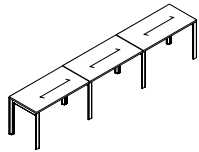
BTRR



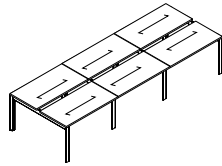
BRTS4P-LR



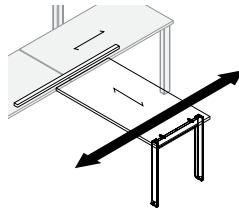
BRTBAR6PA-LR



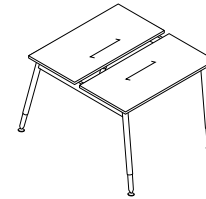
BRTS3P-L



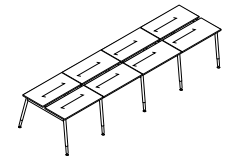
BRTBAR6P-L



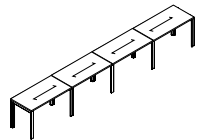
BRTSLDT72C



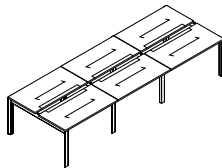
BRTBAR2P-LR



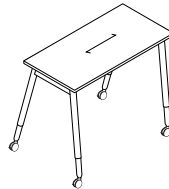
BRTBAR8P-LR



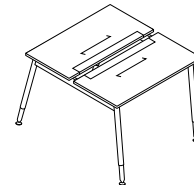
BRTS4P-L



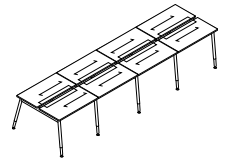
BRTBAR6PA-L



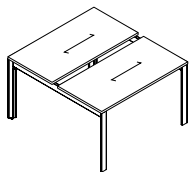
BRTS1P-CR



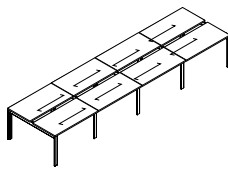
BRTBAR2PA-LR



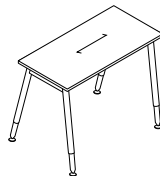
BRTBAR8PA-LR



BRTBAR2P-L



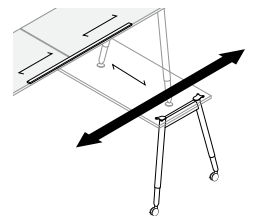
BRTBAR8P-L



BRTS1P-LR

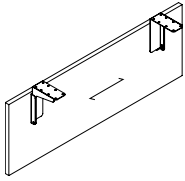


BRTBAR4P-LR

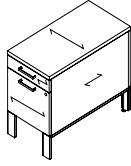


BRTSLDT72CR

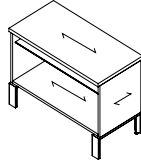
## GRAIN DIRECTION CHART



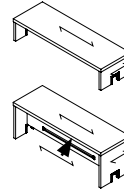
**BRTMPS**



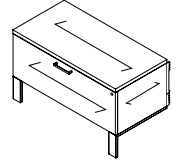
**BRT25BF-L**



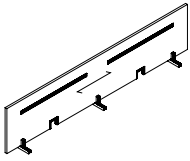
**BRT25LO-L**



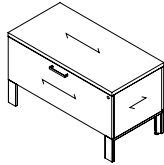
**BRTBTS**



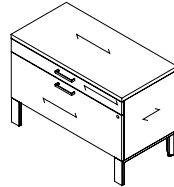
**BRTPSL**



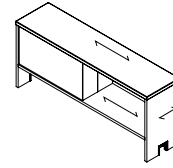
**BRTLPPD**



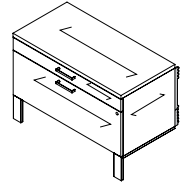
**BRT21F-L**



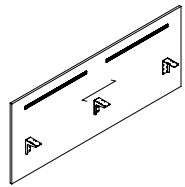
**BRT25LBF-L**



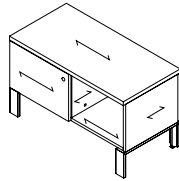
**BRTBAS048**



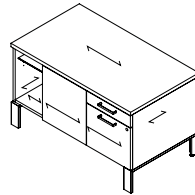
**BRTPLBF**



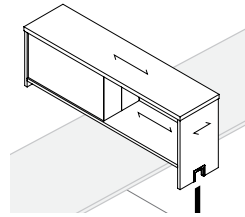
**BRTLPPS**



**BRT21LS-L**



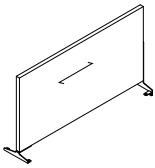
**BRT25LBF042L**



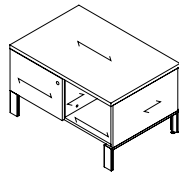
**BRTSDS48**



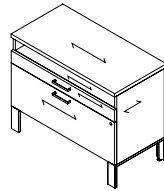
**BRTCS45BBFF**



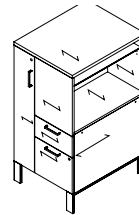
**BRTLPPD**



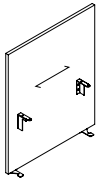
**BRT21LSS-L**



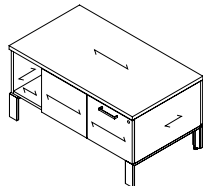
**BRT29LOBF-L**



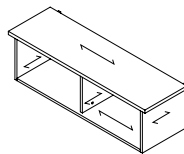
**BRTTW50**



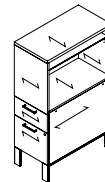
**BRTLPEP**



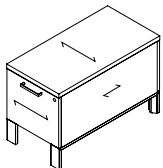
**BRT21LS042L**



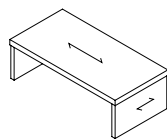
**BRTTES**



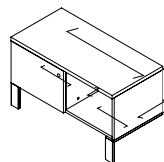
**BRTT50**



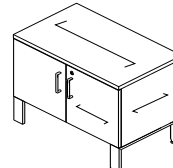
**BRT21BF**



**BRTSTS**



**BRTPSLS**



**BRT25L2D**

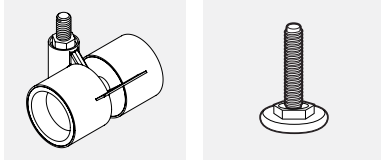
## Technical Information - Rectangular Leg

### Support Leg and Frame

Single and shared worksurface support.

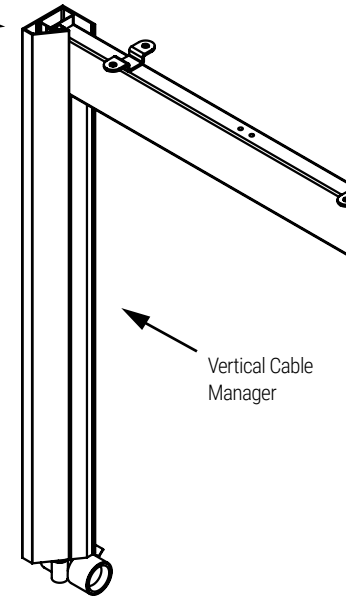
Bridges Rectangular legs are available with:

- Locking casters (BRTLCS)
- Levelers (BRTLVS)
- Casters and Levelers not retrofitable.



### NOTES:

- Levelers have a 2" height range, with 5/16-18 thread.
- Levelers are available in black only.
- 45mm high casters with 8mm thread, available in White Body/Grey Tire combination only.
- Leg frame is available in our (9) standard paint and anodized aluminum finish.
- Paint finish is durable environmentally friendly epoxy powder coating.



Vertical Cable Manager

## Technical Information - Round Leg

### Support Leg and Frame

- Tubular steel legs are adjustable in 1" increments.

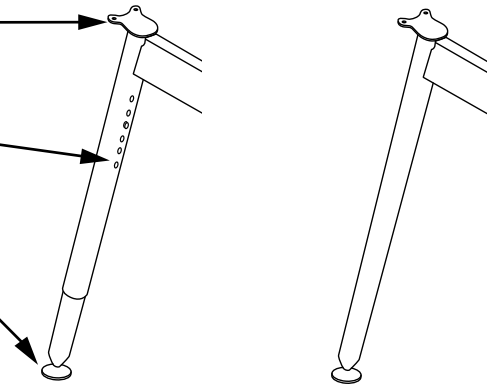
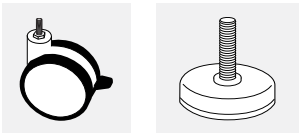
Single and shared worksurface support.

Height adjustment allows the user to easily set the height of a table.

Legs have a height adjustment range of 24" - 32" in 1" increments with levelers and 27" - 35" with casters.

Bridges Round legs are available with:

- Locking casters (BRTLCR)
- Levelers (BRTLVR)
- Casters and levelers are retrofitable on site.



Height Adjustable Leg

Fixed Leg

### NOTES:

- Levelers have a 1" height range, with 3/8-16 thread.
- Levelers are available in Chrome only.
- Casters available in Tungsten/Black combination only.
- Casters are 3" diameter with an overall height of 3 3/4", with 3/8-16 thread.
- Inner leg is available in Chrome only.
- Leg frame is available in our (9) standard paint finishes.
- Paint finish is durable environmentally friendly epoxy powder coating.

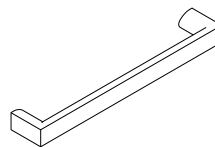
## Technical Information - Handle Options

Optional handle to provide a softer and slimmer alternative to standard Bridges2 storage handles. Radiused corners and edges. Can be retrofitted on site as the drilling hole drawer front pattern remains unchanged.

Finish matches anodized aluminum.

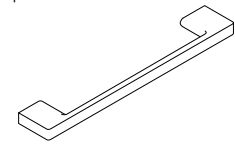
- Centre to centre hole pattern for Bridges 2 handles is 128 mm.

Standard Handle



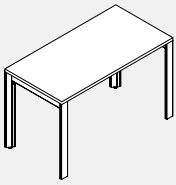
BRH1 - Anodized aluminum  
BRH1B - Black

Optional Handle



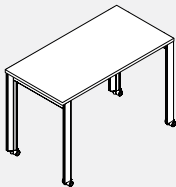
BRH2 - Anodized aluminum



**BRTS1P-L • Rectangular Legs - Single Line 1 Person Pod (Levelers)**

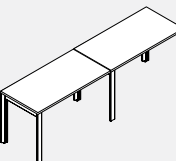
- **Single Line Table Assemblies consist of one worksurface, two leg assemblies and one horizontal structural beam.**
- Finish option, please choose from:
  - 1) anodized aluminum vertical legs with powder coated steel horizontal structural members.  
Anodized aluminum leg upcharge of \$110 for this configuration.
  - 2) powder coated aluminum vertical legs and steel horizontal structural members. Choose from standard metal finishes.
- Worksurface available in HP and LP. For wood veneer tops, please contact your Customer Service Representative.

PRODUCT CODE	PRICE		SIZE/ INCHES			WEIGHT VOL	
	LP	HP	H	W	D	LBS	FT <sup>3</sup>
BRTS1P2436L	1011	1069	29	36	24	45	4.00
BRTS1P2442L	1074	1144	29	42	24	48	4.10
BRTS1P2448L	1126	1209	29	48	24	51	4.20
BRTS1P2451L	1157	1245	29	50.5	24	54	4.30
BRTS1P2454L	1189	1286	29	54	24	57	4.40
BRTS1P2460L	1233	1340	29	60	24	60	4.48
BRTS1P2463L	1243	1357	29	62.5	24	63	4.57
BRTS1P2466L	1258	1368	29	66	24	66	4.65
BRTS1P2472L	1269	1397	29	72	24	69	4.73
BRTS1P2478L	1317	1437	29	78	24	72	4.82
BRTS1P2484L	1355	1484	29	84	24	75	4.92
BRTS1P3036L	1089	1154	29	36	30	54	4.20
BRTS1P3042L	1180	1270	29	42	30	57	4.30
BRTS1P3048L	1204	1300	29	48	30	60	4.41
BRTS1P3051L	1227	1326	29	50.5	30	63	4.50
BRTS1P3054L	1254	1343	29	54	30	66	4.60
BRTS1P3060L	1279	1394	29	60	30	69	4.73
BRTS1P3063L	1292	1407	29	62.5	30	72	4.80
BRTS1P3066L	1301	1422	29	66	30	75	4.90
BRTS1P3072L	1332	1458	29	72	30	78	5.01
BRTS1P3078L	1367	1496	29	78	30	81	5.10
BRTS1P3084L	1422	1561	29	84	30	84	5.20

**BRTS1P-C • Rectangular Legs - Single Line 1 Person Pod (Casters)**

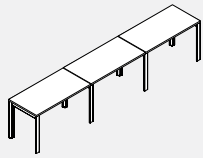
- **Single Line Table Assemblies consist of one worksurface, two leg assemblies and one horizontal structural beam.**
- 40mm white locking casters with grey tires; steel horizontal beams, aluminum legs.
- Finish options, please choose from:
  - 1) anodized aluminum vertical legs with powder coated steel horizontal structural members.  
Anodized aluminum leg upcharge of \$110 for this configuration.
  - 2) powder coated aluminum vertical legs and steel horizontal structural members. Choose from standard metal finishes.
- Worksurface available in HP and LP. For wood veneer tops, please contact your Customer Service Representative.

PRODUCT CODE	PRICE		SIZE/ INCHES			WEIGHT VOL	
	LP	HP	H	W	D	LBS	FT <sup>3</sup>
BRTS1P2436C	1078	1137	29	36	24	45	4.00
BRTS1P2442C	1142	1210	29	42	24	48	4.10
BRTS1P2448C	1194	1275	29	48	24	51	4.20
BRTS1P2451C	1225	1315	29	50.5	24	54	4.30
BRTS1P2454C	1258	1351	29	54	24	57	4.40
BRTS1P2460C	1299	1407	29	60	24	60	4.48
BRTS1P2463C	1310	1424	29	62.5	24	63	4.57
BRTS1P2466C	1324	1435	29	66	24	66	4.65
BRTS1P2472C	1344	1464	29	72	24	69	4.73
BRTS1P2478C	1382	1504	29	78	24	72	4.82
BRTS1P2484C	1422	1550	29	84	24	75	4.92
BRTS1P3036C	1156	1223	29	36	30	54	4.20
BRTS1P3042C	1245	1338	29	42	30	57	4.30
BRTS1P3048C	1270	1367	29	48	30	60	4.41
BRTS1P3051C	1294	1392	29	50.5	30	63	4.50
BRTS1P3054C	1318	1409	29	54	30	66	4.60
BRTS1P3060C	1348	1460	29	60	30	69	4.73
BRTS1P3063C	1358	1474	29	62.5	30	72	4.90
BRTS1P3066C	1368	1487	29	66	30	75	4.90
BRTS1P3072C	1398	1508	29	72	30	78	5.01
BRTS1P3078C	1434	1561	29	78	30	81	5.10
BRTS1P3084C	1499	1628	29	84	30	84	5.20

**BRTS2P-L • Rectangular Legs - Single Line 2 Person Pod (Levelers)**

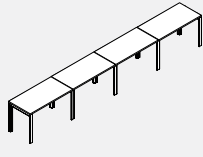
- **Single Line, 2-person workstation consists of two work-surfaces, three leg assemblies and 2 horizontal structural beams.**
- One leg can be shared by 2 adjoining worksurfaces.
- Finish options, please choose from:
  - 1) anodized aluminum vertical legs with powder coated steel horizontal structural members.  
Anodized aluminum leg upcharge of \$164 for this configuration.
  - 2) powder coated aluminum vertical legs and steel horizontal structural members. Choose from standard metal finishes.
- Worksurface available in HP and LP. For wood veneer tops, please contact your Customer Service Representative.

PRODUCT CODE	PRICE		SIZE/ INCHES			WEIGHT VOL	
	LP	HP	H	W	D	LBS	FT <sup>3</sup>
BRTS2P2448L	1919	2088	29	96	24	95	6.21
BRTS2P2454L	2047	2234	29	108	24	104	6.45
BRTS2P2460L	2130	2351	29	120	24	113	6.71
BRTS2P2466L	2178	2404	29	132	24	122	6.95
BRTS2P2472L	2223	2463	29	144	24	131	7.13
BRTS2P2478L	2298	2542	29	156	24	140	7.27
BRTS2P2484L	2378	2635	29	168	24	149	7.41
BRTS2P3048L	2061	2252	29	96	30	113	6.57
BRTS2P3054L	2149	2337	29	108	30	122	6.85
BRTS2P3060L	2211	2436	29	120	30	131	7.13
BRTS2P3066L	2256	2495	29	132	30	140	7.41
BRTS2P3072L	2332	2585	29	144	30	155	7.69
BRTS2P3078L	2383	2639	29	156	30	164	7.97
BRTS2P3084L	2495	2774	29	168	30	173	8.25

**BRTS3P-L • Rectangular Legs - Single Line 3 Person Pod (Levelers)**

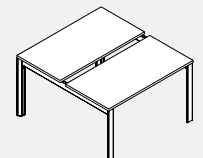
- **Single Line, 3-person workstation consists of 3 worksurfaces, 4 leg assemblies and 3 horizontal structural beams.**
- Finish options, please choose from:
  - 1) anodized aluminum vertical legs with powder coated steel horizontal structural members.  
Anodized aluminum leg upcharge of \$217 for this configuration.
  - 2) powder coated aluminum vertical legs and steel horizontal structural members. Choose from standard metal finishes.
- Worksurface available in HP and LP. For wood veneer tops, please contact your Customer Service Representative.

PRODUCT CODE	PRICE		SIZE/INCHES			WEIGHT VOL	
	LP	HP	H	W	D	LBS	FT <sup>3</sup>
BRTS3P2448L	2711	2965	29	144	24	138	8.47
BRTS3P2454L	2900	3186	29	162	24	152	8.68
BRTS3P2460L	3033	3346	29	180	24	165	8.89
BRTS3P2466L	3101	3440	29	198	24	179	9.11
BRTS3P2472L	3169	3527	29	216	24	192	9.32
BRTS3P2478L	3282	3649	29	234	24	206	9.53
BRTS3P2484L	3397	3788	29	252	24	219	9.74
BRTS3P3048L	2918	3199	29	144	30	161	9.01
BRTS3P3054L	3047	3329	29	162	30	178	9.44
BRTS3P3060L	3142	3480	29	180	30	195	9.87
BRTS3P3066L	3206	3565	29	198	30	212	10.30
BRTS3P3072L	3300	3677	29	216	30	229	10.72
BRTS3P3078L	3399	3786	29	234	30	246	11.16
BRTS3P3084L	3565	3985	29	252	30	263	11.59

**BRTS4P-L • Rectangular Legs - Single Line 4 Person Pod (Levelers)**

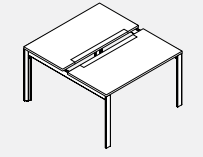
- **Single Line, 4-person workstation consists of 4 worksurfaces, 5 leg assemblies and 4 horizontal structural beams.**
- Finish options, please choose from:
  - 1) anodized aluminum vertical legs with powder coated steel horizontal structural members.  
Anodized aluminum leg upcharge of \$271 for this configuration.
  - 2) powder coated aluminum vertical legs and steel horizontal structural members. Choose from standard metal finishes.
- Worksurface available in HP and LP. For wood veneer tops, please contact your Customer Service Representative.

PRODUCT CODE	PRICE		SIZE/INCHES			WEIGHT VOL	
	LP	HP	H	W	D	LBS	FT <sup>3</sup>
BRTS4P2448L	3502	3842	29	192	24	180	10.73
BRTS4P2454L	3758	4135	29	216	24	199	11.22
BRTS4P2460L	3929	4368	29	240	24	217	11.71
BRTS4P2466L	4022	4474	29	264	24	236	12.20
BRTS4P2472L	4142	4625	29	288	24	254	12.69
BRTS4P2478L	4261	4756	29	312	24	273	13.18
BRTS4P2484L	4421	4941	29	336	24	291	13.67
BRTS4P3048L	3773	4153	29	192	30	213	11.45
BRTS4P3054L	3946	4326	29	216	30	235	12.02
BRTS4P3060L	4074	4524	29	240	30	257	12.59
BRTS4P3066L	4158	4641	29	264	30	279	13.16
BRTS4P3072L	4284	4784	29	288	30	301	13.73
BRTS4P3078L	4419	4931	29	312	30	323	14.30
BRTS4P3084L	4641	5195	29	336	30	345	14.87

**BRTBAR2P-L • Rectangular Legs - Back 2 Back 2 Person Pod (Levelers)**

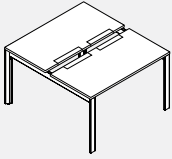
- **Back 2 Back, 2-person workstation consists of 2 worksurfaces, 2 Back 2 Back leg assemblies and 2 horizontal structural beams.**
- Finish options, please choose from:
  - 1) anodized aluminum vertical legs with powder coated steel horizontal structural members.  
Anodized aluminum leg upcharge of \$110 for this configuration.
  - 2) powder coated aluminum vertical legs and steel horizontal structural members. Choose from standard metal finishes.
- Worksurface available in HP and LP. For wood veneer tops, please contact your Customer Service Representative.

PRODUCT CODE	PRICE		SIZE/INCHES			WEIGHT VOL	
	LP	HP	H	W	D	LBS	FT <sup>3</sup>
BRTBAR2P2460L	1997	2219	29	60	50.5	110	8.56
BRTBAR2P2466L	2047	2269	29	66	50.5	119	8.76
BRTBAR2P2472L	2091	2330	29	72	50.5	128	9.02
BRTBAR2P2478L	2164	2411	29	78	50.5	137	9.20
BRTBAR2P2484L	2244	2502	29	84	50.5	146	9.40
BRTBAR2P3060L	2027	2256	29	60	62.5	130	9.00
BRTBAR2P3066L	2071	2312	29	66	62.5	141	9.25
BRTBAR2P3072L	2138	2383	29	72	62.5	152	9.54
BRTBAR2P3078L	2209	2459	29	78	62.5	163	9.80
BRTBAR2P3084L	2312	2590	29	84	62.5	174	10.4

**BRTBAR2PA-L • Rectangular Legs - Back 2 Back 2 Person Pod (Levelers) with Access Door**

- **Back 2 Back, 2-person workstation consists of 2 worksurfaces, 2 Back 2 Back leg assemblies and 2 horizontal structural beams.**
- Finish options, please choose from:
  - 1) anodized aluminum vertical legs with powder coated steel horizontal structural members.  
Anodized aluminum leg upcharge of \$110 for this configuration.
  - 2) powder coated aluminum vertical legs and steel horizontal structural members. Choose from standard metal finishes.
- Anodized aluminum worksurface door provides access to power / data through below worksurface.
- Worksurface with access doors cannot be combined with above worksurface power trough.
- Worksurface available in HP and LP.

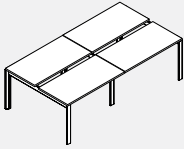
PRODUCT CODE	PRICE		SIZE/INCHES			WEIGHT VOL	
	LP	HP	H	W	D	LBS	FT <sup>3</sup>
BRTBAR2PA2460L	2080	2393	29	60	50.5	110	8.56
BRTBAR2PA2466L	2160	2508	29	66	50.5	119	8.76
BRTBAR2PA2472L	2244	2644	29	72	50.5	128	9.02
BRTBAR2PA3060L	2244	2644	29	60	62.5	130	9.00
BRTBAR2PA3066L	2361	2791	29	66	62.5	141	9.25
BRTBAR2PA3072L	2443	2926	29	72	62.5	152	9.54

**BRTBAR2PDA-L • Rectangular Legs - Back 2 Back 2 Person Pod (Levelers) with Access Doors**

- **Back 2 Back, 2-person workstation consists of 2 worksurfaces, 2 Back 2 Back leg assemblies and 2 horizontal structural beams.**

- These tables feature dual access doors providing a central connection point for monitor lifts.
- Finish options, please choose from:
  - 1) anodized aluminum vertical legs with powder coated steel horizontal structural members.  
Anodized aluminum leg upcharge of \$110 for this configuration.
  - 2) powder coated aluminum vertical legs and steel horizontal structural members. Choose from standard metal finishes.
- Anodized aluminum worksurface door provides access to power / data through below worksurface.
- Worksurface with access doors cannot be combined with above worksurface power trough.
- Worksurface available in HP and LP.

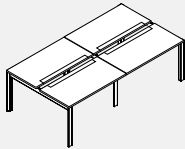
PRODUCT CODE	PRICE		SIZE/INCHES			WEIGHT		VOL FT <sup>3</sup>
	LP	HP	H	W	D	LBS		
BRTBAR2PDA2460L	2244	2586	29	60	50.5	110	8.56	
BRTBAR2PDA2466L	2332	2711	29	66	50.5	119	8.76	
BRTBAR2PDA2472L	2423	2855	29	72	50.5	128	9.02	
BRTBAR2PDA2478L	2476	2927	29	78	50.5	137	9.20	
BRTBAR2PDA2484L	2550	3050	29	84	50.5	146	9.40	
BRTBAR2PDA3060L	2423	2855	29	60	62.5	130	9.00	
BRTBAR2PDA3066L	2550	3015	29	66	62.5	141	9.25	
BRTBAR2PDA3072L	2640	3159	29	72	62.5	152	9.54	
BRTBAR2PDA3078L	2693	3267	29	78	62.5	163	9.80	
BRTBAR2PDA3084L	2783	3394	29	84	62.5	174	10.4	

**BRTBAR4P-L • Rectangular Legs - Back 2 Back 4 Person Pod (Levelers)**

- **Back 2 Back, 4-person workstation consists of 4 worksurfaces, 2 Back 2 Back outer leg assemblies, 1 Back 2 Back narrow leg assembly and 4 horizontal structural beams.**

- Finish options, please choose from:
  - 1) anodized aluminum vertical legs with powder coated steel horizontal structural members.  
Anodized aluminum leg upcharge of \$164 for this configuration.
  - 2) powder coated aluminum vertical legs and steel horizontal structural members. Choose from standard metal finishes.
- Worksurface available in HP and LP. For wood veneer tops, please contact your Customer Service Representative.

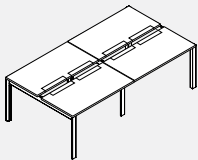
PRODUCT CODE	PRICE		SIZE/INCHES			WEIGHT		VOL FT <sup>3</sup>
	LP	HP	H	W	D	LBS		
BRTBAR4P2460L	3531	3969	29	120	50.5	208	13.82	
BRTBAR4P2466L	3624	4077	29	132	50.5	224	14.28	
BRTBAR4P2472L	3716	4195	29	144	50.5	240	14.74	
BRTBAR4P2478L	3864	4354	29	156	50.5	256	15.20	
BRTBAR4P2484L	4022	4541	29	168	50.5	272	15.66	
BRTBAR4P3060L	3624	4077	29	120	62.5	253	14.70	
BRTBAR4P3066L	3711	4190	29	132	62.5	273	15.24	
BRTBAR4P3072L	3836	4335	29	144	62.5	293	15.78	
BRTBAR4P3078L	3969	4483	29	156	62.5	313	16.32	
BRTBAR4P3084L	4190	4746	29	168	62.5	333	16.86	

**BRTBAR4PA-L • Rectangular Legs - Back 2 Back 4 Person Pod (Levelers) with Access Door**

- **Back 2 Back, 4-person workstation consists of 4 worksurfaces, 2 Back 2 Back outer leg assemblies, 1 Back 2 Back narrow leg assembly and 4 horizontal structural beams**

- Finish options, please choose from:
  - 1) anodized aluminum vertical legs with powder coated steel horizontal structural members.  
Anodized aluminum leg upcharge of \$164 for this configuration.
  - 2) powder coated aluminum vertical legs and steel horizontal structural members. Choose from standard metal finishes.
- Anodized aluminum worksurface door provides access to power / data through below worksurface.
- Worksurface with access doors cannot be combined with above worksurface power trough.
- Worksurface available in HP and LP.

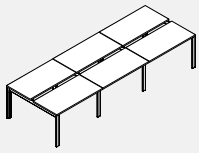
PRODUCT CODE	PRICE		SIZE/INCHES			WEIGHT		VOL FT <sup>3</sup>
	LP	HP	H	W	D	LBS		
BRTBAR4PA2460L	3692	4323	29	120	50.5	208	13.82	
BRTBAR4PA2466L	3855	4555	29	132	50.5	224	14.28	
BRTBAR4PA2472L	4022	4821	29	144	50.5	240	14.74	
BRTBAR4PA3060L	3989	4787	29	120	62.5	253	14.70	
BRTBAR4PA3066L	4221	5087	29	132	62.5	273	15.24	
BRTBAR4PA3072L	4389	5352	29	144	62.5	293	15.78	

**BRTBAR4PDA-L • Rectangular Legs - Back 2 Back 4 Person Pod (Levelers) with Access Doors**

- **Back 2 Back, 4-person workstation consists of 4 worksurfaces, 2 Back 2 Back outer leg assemblies, 1 Back 2 Back narrow leg assembly and 4 horizontal structural beams**

- These tables feature dual access doors providing a central connection point for monitor lifts.
- Finish options, please choose from:
  - 1) anodized aluminum vertical legs with powder coated steel horizontal structural members.  
Anodized aluminum leg upcharge of \$164 for this configuration.
  - 2) powder coated aluminum vertical legs and steel horizontal structural members. Choose from standard metal finishes.
- Anodized aluminum worksurface door provides access to power / data through below worksurface.
- Worksurface with access doors cannot be combined with above worksurface power trough.
- Worksurface available in HP and LP.

PRODUCT CODE	PRICE		SIZE/INCHES			WEIGHT		VOL FT <sup>3</sup>
	LP	HP	H	W	D	LBS		
BRTBAR4PDA2460L	3985	4668	29	120	50.5	208	13.82	
BRTBAR4PDA2466L	4166	4917	29	132	50.5	224	14.28	
BRTBAR4PDA2472L	4342	5207	29	144	50.5	240	14.74	
BRTBAR4PDA2478L	4453	5348	29	156	50.5	256	15.20	
BRTBAR4PDA2484L	4593	5601	29	168	50.5	272	15.66	
BRTBAR4PDA3060L	4308	5169	29	120	62.5	253	14.70	
BRTBAR4PDA3066L	4559	5494	29	132	62.5	273	15.24	
BRTBAR4PDA3072L	4740	5780	29	144	62.5	293	15.78	
BRTBAR4PDA3078L	4848	5996	29	156	62.5	313	16.32	
BRTBAR4PDA3084L	5026	6246	29	168	62.5	333	16.86	

**BRTBAR6P-L • Rectangular Legs - Back 2 Back 6 Person Pod (Levelers)**

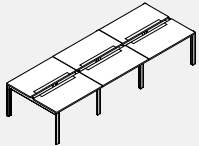
- **Back 2 Back, 6-person workstation consists of 6 worksurfaces, 2 Back 2 Back outer leg assemblies, 2 Back 2 Back narrow leg assemblies and 6 horizontal structural beams.**

- Finish options, please choose from:

- 1) anodized aluminum vertical legs with powder coated steel horizontal structural members.  
Anodized aluminum leg upcharge of \$217 for this configuration.
- 2) powder coated aluminum vertical legs and steel horizontal structural members. Choose from standard metal finishes.

- Worksurface available in HP and LP. For wood veneer tops, please contact your Customer Service Representative.

PRODUCT CODE	PRICE		SIZE / INCHES			WEIGHT		VOL FT <sup>3</sup>
	LP	HP	H	W	D	LBS		
BRTBAR6P2460L	5029	5689	29	180	50.5	308	19.76	
BRTBAR6P2466L	5203	5881	29	198	50.5	329	20.54	
BRTBAR6P2472L	5343	6059	29	216	50.5	359	21.32	
BRTBAR6P2478L	5562	6299	29	234	50.5	409	22.10	
BRTBAR6P2484L	5801	6579	29	252	50.5	434	22.88	
BRTBAR6P3060L	5153	5830	29	180	62.5	369	21.08	
BRTBAR6P3066L	5315	6036	29	198	62.5	400	21.97	
BRTBAR6P3072L	5506	6254	29	216	62.5	431	22.86	
BRTBAR6P3078L	5706	6471	29	234	62.5	462	23.75	
BRTBAR6P3084L	6036	6872	29	252	62.5	493	24.53	

**BRTBAR6PA-L • Rectangular Legs - Back 2 Back 6 Person Pod (Levelers) with Access Door**

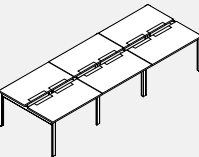
- **Back 2 Back, 6-person workstation consists of 6 worksurfaces, 2 Back 2 Back outer leg assemblies, 2 Back 2 Back narrow leg assemblies and 6 horizontal structural beams.**

- Finish options, please choose from

- 1) anodized aluminum vertical legs with powder coated steel horizontal structural members.  
Anodized aluminum leg upcharge of \$217 for this configuration.
- 2) powder coated aluminum vertical legs and steel horizontal structural members. Choose from standard metal finishes.

- Anodized aluminum worksurface door provides access to power / data through below worksurface.
- Worksurface with access doors cannot be combined with above worksurface power trough.
- Worksurface available in HP and LP.

PRODUCT CODE	PRICE		SIZE / INCHES			WEIGHT		VOL FT <sup>3</sup>
	LP	HP	H	W	D	LBS		
BRTBAR6PA2460L	5269	6216	29	180	50.5	308	19.76	
BRTBAR6PA2466L	5550	6600	29	198	50.5	329	20.54	
BRTBAR6PA2472L	5801	6999	29	216	50.5	359	21.32	
BRTBAR6PA3060L	5702	6899	29	180	62.5	369	21.08	
BRTBAR6PA3066L	6084	7380	29	198	62.5	400	21.97	
BRTBAR6PA3072L	6333	7781	29	216	62.5	431	22.86	

**BRTBAR6PDA-L • Rectangular Legs - Back 2 Back 6 Person Pod (Levelers) with Access Doors**

- **Back 2 Back, 6-person workstation consists of 6 worksurfaces, 2 Back 2 Back outer leg assemblies, 2 Back 2 Back narrow leg assemblies and 6 horizontal structural beams.**

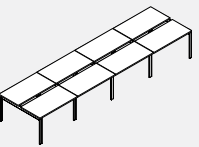
- These tables feature dual access doors providing a central connection point for monitor lifts.

- Finish options, please choose from

- 1) anodized aluminum vertical legs with powder coated steel horizontal structural members.  
Anodized aluminum leg upcharge of \$217 for this configuration.
- 2) powder coated aluminum vertical legs and steel horizontal structural members. Choose from standard metal finishes.

- Anodized aluminum worksurface door provides access to power / data through below worksurface.
- Worksurface with access doors cannot be combined with above worksurface power trough.
- Worksurface available in HP and LP.

PRODUCT CODE	PRICE		SIZE / INCHES			WEIGHT		VOL FT <sup>3</sup>
	LP	HP	H	W	D	LBS		
BRTBAR6PDA2460L	5691	6715	29	180	50.5	308	19.76	
BRTBAR6PDA2466L	5996	7077	29	198	50.5	329	20.54	
BRTBAR6PDA2472L	6265	7559	29	216	50.5	359	21.32	
BRTBAR6PDA2478L	6427	7774	29	234	50.5	409	22.10	
BRTBAR6PDA2484L	6641	8148	29	252	50.5	434	22.88	
BRTBAR6PDA3060L	6156	7451	29	180	62.5	369	21.08	
BRTBAR6PDA3066L	6570	7971	29	198	62.5	400	21.97	
BRTBAR6PDA3072L	6840	8403	29	216	62.5	431	22.86	
BRTBAR6PDA3078L	7002	8724	29	234	62.5	462	23.75	
BRTBAR6PDA3084L	7272	9102	29	252	62.5	493	24.53	

**BRTBAR8P-L • Rectangular Legs - Back 2 Back 8 Person Pod (Levelers)**

- **Back 2 Back, 8-person workstation consists of 8 worksurfaces, 2 Back 2 Back outer leg assemblies, 3 Back 2 Back narrow leg assemblies and 8 horizontal structural beams.**

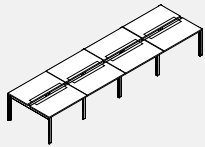
- Finish options, please choose from:

- 1) anodized aluminum vertical legs with powder coated steel horizontal structural members.  
Anodized aluminum leg upcharge of \$271 for this configuration.
- 2) powder coated aluminum vertical legs and steel horizontal structural members. Choose from standard metal finishes.

- Worksurface available in HP and LP. For wood veneer tops, please contact your Customer Service Representative.

PRODUCT CODE	PRICE		SIZE / INCHES			WEIGHT		VOL FT <sup>3</sup>
	LP	HP	H	W	D	LBS		
BRTBAR8P2460L	6628	7507	29	240	50.5	412	24.42	
BRTBAR8P2466L	6782	7688	29	264	50.5	448	25.30	
BRTBAR8P2472L	6969	7926	29	288	50.5	484	26.30	
BRTBAR8P2478L	7259	8243	29	312	50.5	520	27.30	
BRTBAR8P2484L	7579	8615	29	336	50.5	556	28.30	
BRTBAR8P3060L	6748	7654	29	240	62.5	492	26.18	
BRTBAR8P3066L	6921	7876	29	264	62.5	536	27.28	
BRTBAR8P3072L	7175	8172	29	288	62.5	581	28.38	
BRTBAR8P3078L	7441	8466	29	312	62.5	625	29.48	
BRTBAR8P3084L	7876	8995	29	336	62.5	669	30.58	



**BRTBAR8PA-L • Rectangular Legs - Back 2 Back 8 Person Pod (Levelers) with Access Door**

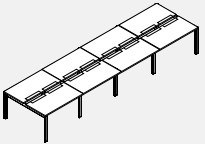
- **Back 2 Back, 8-person workstation consists of 8 worksurfaces, 2 Back 2 Back outer leg assemblies, 3 Back 2 Back narrow leg assemblies and 8 horizontal structural beams.**

- Finish options, please choose from:

- 1) anodized aluminum vertical legs with powder coated steel horizontal structural members.  
Anodized aluminum leg upcharge of \$271 for this configuration.
- 2) powder coated aluminum vertical legs and steel horizontal structural members. Choose from standard metal finishes.

- Anodized aluminum worksurface door provides access to power / data through below worksurface.
- Worksurface with access doors cannot be combined with above worksurface power trough.
- Worksurface available in HP and LP.

PRODUCT CODE	PRICE		SIZE/INCHES			WEIGHT LBS	VOL FT <sup>3</sup>
	LP	HP	H	W	D		
BRTBAR8PA2460L	6946	8210	29	240	50.5	412	24.42
BRTBAR8PA2466L	7246	8644	29	264	50.5	448	25.30
BRTBAR8PA2472L	7579	9175	29	288	50.5	484	26.30
BRTBAR8PA3060L	7479	9075	29	240	62.5	492	26.18
BRTBAR8PA3066L	7945	9675	29	264	62.5	536	27.28
BRTBAR8PA3072L	8278	10203	29	288	62.5	581	28.38

**BRTBAR8PDA-L • Rectangular Legs - Back 2 Back 8 Person Pod (Levelers) with Access Doors**

- **Back 2 Back, 8-person workstation consists of 8 worksurfaces, 2 Back 2 Back outer leg assemblies, 3 Back 2 Back narrow leg assemblies and 8 horizontal structural beams.**

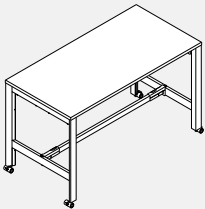
- These tables feature dual access doors providing a central connection point for monitor lifts.

- Finish options, please choose from:

- 1) anodized aluminum vertical legs with powder coated steel horizontal structural members.  
Anodized aluminum leg upcharge of \$271 for this configuration.
- 2) powder coated aluminum vertical legs and steel horizontal structural members. Choose from standard metal finishes.

- Anodized aluminum worksurface door provides access to power / data through below worksurface.
- Worksurface with access doors cannot be combined with above worksurface power trough.
- Worksurface available in HP and LP.

PRODUCT CODE	PRICE		SIZE/INCHES			WEIGHT LBS	VOL FT <sup>3</sup>
	LP	HP	H	W	D		
BRTBAR8PDA2460L	7503	8867	29	240	50.5	412	24.42
BRTBAR8PDA2466L	7827	9336	29	264	50.5	448	25.30
BRTBAR8PDA2472L	8187	9911	29	288	50.5	484	26.30
BRTBAR8PDA2478L	8403	10195	29	312	50.5	520	27.30
BRTBAR8PDA2484L	8689	10700	29	336	50.5	556	28.30
BRTBAR8PDA3060L	8077	9803	29	240	62.5	492	26.18
BRTBAR8PDA3066L	8583	10449	29	264	62.5	536	27.28
BRTBAR8PDA3072L	8937	11022	29	288	62.5	581	28.38
BRTBAR8PDA3078L	9155	11454	29	312	62.5	625	29.48
BRTBAR8PDA3084L	9515	11783	29	336	62.5	669	30.58

**BRT36P-C • Rectangular Legs - 36" High Single Table (Casters)**

- **Single table assembly consists of one worksurface, two H leg assemblies and all required beams.**

- 24" deep tables have three (3) beams at the top, and one bottom beam.
- 30" and 36" deep tables have four (4) beams at the top, and one bottom beam.

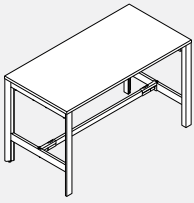
- 40mm white locking casters with grey tires.

- Finish option, please choose from:

- 1) anodized aluminum vertical legs with powder coated steel horizontal structural members. Anodized aluminum leg upcharge of \$110 for this configuration.
- 2) powder coated aluminum vertical legs with steel horizontal structural members. Choose from standard metal finishes.

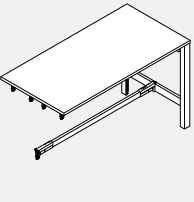
- Worksurface available in LP and HP.

PRODUCT CODE	PRICE		SIZE/INCHES			WEIGHT LBS	VOL FT <sup>3</sup>
	LP	HP	H	W	D		
BRT36P2436C	1948	2001	36	36	24	68.5	4.55
BRT36P2442C	2009	2078	36	42	24	76.0	4.76
BRT36P2448C	2086	2170	36	48	24	81.5	4.98
BRT36P2454C	2194	2289	36	54	24	88.0	5.19
BRT36P2460C	2264	2374	36	60	24	94.6	5.41
BRT36P2466C	2315	2428	36	66	24	101.1	5.62
BRT36P2472C	2364	2482	36	72	24	107.6	5.83
BRT36P2478C	2425	2549	36	78	24	114.1	6.13
BRT36P2484C	2485	2616	36	84	24	120.6	6.42
BRT36P3036C	2243	2306	36	36	30	83.9	5.00
BRT36P3042C	2341	2432	36	42	30	91.0	5.26
BRT36P3048C	2400	2495	36	48	30	99.2	5.53
BRT36P3054C	2505	2602	36	54	30	107.3	5.79
BRT36P3060C	2573	2686	36	60	30	115.5	6.06
BRT36P3066C	2629	2748	36	66	30	123.6	6.32
BRT36P3072C	2696	2818	36	72	30	131.8	6.59
BRT36P3078C	2762	2891	36	78	30	139.9	6.95
BRT36P3084C	2844	2984	36	84	30	148.1	7.32
BRT36P3642C	2538	2625	36	42	36	99.9	6.56
BRT36P3648C	2629	2723	36	48	36	109.0	6.87
BRT36P3654C	2750	2861	36	54	36	118.2	7.18
BRT36P3660C	2841	2959	36	60	36	126.3	7.48
BRT36P3666C	2929	3061	36	66	36	135.5	7.79
BRT36P3672C	3015	3157	36	72	36	144.6	8.10
BRT36P3678C	3102	3255	36	78	36	152.8	8.50
BRT36P3684C	3185	3350	36	84	36	161.9	8.91

**BRT36P-L • Rectangular Legs - 36" High Single Table (Levelers)**

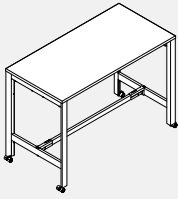
- Single table assembly consists of one worksurface, two H leg assemblies and all required beams.
- 24" deep tables have three (3) beams at the top, and one bottom beam.
- 30" and 36" deep tables have four (4) beams at the top, and one bottom beam.
- Finish option, please choose from:
  - 1) anodized aluminum vertical legs with powder coated steel horizontal structural members. Anodized aluminum leg upcharge of \$110 for this configuration
  - 2) powder coated aluminum vertical legs with steel horizontal structural members Choose from standard metal finishes
- Worksurface available in LP and HP.

PRODUCT CODE	PRICE		SIZE/INCHES			WEIGHT LBS	VOL FT <sup>3</sup>
	LP	HP	H	W	D		
BRT36P2436L	1867	1919	36	36	24	68.0	4.55
BRT36P2442L	1928	1997	36	42	24	75.5	4.76
BRT36P2448L	2005	2089	36	48	24	81.0	4.98
BRT36P2454L	2115	2209	36	54	24	87.6	5.19
BRT36P2460L	2184	2292	36	60	24	94.1	5.41
BRT36P2466L	2234	2347	36	66	24	100.6	5.62
BRT36P2472L	2285	2403	36	72	24	107.1	5.83
BRT36P2478L	2345	2469	36	78	24	113.6	6.13
BRT36P2484L	2405	2536	36	84	24	120.2	6.42
BRT36P3036L	2161	2227	36	36	30	83.4	5.00
BRT36P3042L	2261	2351	36	42	30	90.5	5.26
BRT36P3048L	2320	2414	36	48	30	98.7	5.53
BRT36P3054L	2425	2521	36	54	30	106.8	5.79
BRT36P3060L	2494	2605	36	60	30	115.0	6.06
BRT36P3066L	2548	2669	36	66	30	123.1	6.32
BRT36P3072L	2614	2738	36	72	30	131.3	6.59
BRT36P3078L	2681	2810	36	78	30	139.4	6.95
BRT36P3084L	2763	2905	36	84	30	147.6	7.32
BRT36P3642L	2459	2545	36	42	36	99.4	6.56
BRT36P3648L	2548	2643	36	48	36	108.5	6.87
BRT36P3654L	2670	2778	36	54	36	117.7	7.18
BRT36P3660L	2760	2878	36	60	36	125.8	7.48
BRT36P3666L	2847	2980	36	66	36	135.0	7.79
BRT36P3672L	2934	3078	36	72	36	144.1	8.10
BRT36P3678L	3021	3175	36	78	36	152.3	8.50
BRT36P3684L	3104	3269	36	84	36	161.4	8.91

**BRT36A-L • Rectangular Legs - 36" High Add-On (Levelers)**

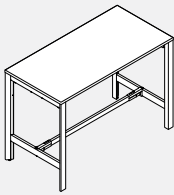
- Single table assembly consists of one worksurface, one H leg assembly and all required beams.
- 24" deep tables have three (3) beams at the top, and one bottom beam.
- 30" and 36" deep tables have four (4) beams at the top, and one bottom beam.
- Finish option, please choose from:
  - 1) anodized aluminum vertical legs with powder coated steel horizontal structural members. Anodized aluminum leg upcharge of \$55 for this configuration
  - 2) powder coated aluminum vertical legs with steel horizontal structural members Choose from standard metal finishes
- Worksurface available in LP and HP.

PRODUCT CODE	PRICE		SIZE/INCHES			WEIGHT LBS	VOL FT <sup>3</sup>
	LP	HP	H	W	D		
BRT36A2436L	1407	1461	36	36	24	54.2	2.87
BRT36A2442L	1470	1539	36	42	24	61.7	3.08
BRT36A2448L	1545	1630	36	48	24	67.2	3.30
BRT36A2454L	1654	1748	36	54	24	73.7	3.51
BRT36A2460L	1723	1834	36	60	24	80.2	3.73
BRT36A2466L	1776	1888	36	66	24	86.8	3.94
BRT36A2472L	1824	1944	36	72	24	93.3	4.15
BRT36A2478L	1885	2009	36	78	24	99.8	4.45
BRT36A2484L	1947	2076	36	84	24	106.3	4.74
BRT36A3036L	1673	1738	36	36	30	67.5	3.24
BRT36A3042L	1772	1861	36	42	30	74.7	3.50
BRT36A3048L	1830	1923	36	48	30	82.8	3.77
BRT36A3054L	1935	2029	36	54	30	91.0	4.03
BRT36A3060L	2003	2116	36	60	30	99.1	4.30
BRT36A3066L	2059	2178	36	66	30	107.3	4.56
BRT36A3072L	2126	2247	36	72	30	115.4	4.83
BRT36A3078L	2193	2322	36	78	30	123.6	5.19
BRT36A3084L	2275	2415	36	84	30	131.7	5.56
BRT36A3642L	1900	1985	36	42	36	81.6	4.30
BRT36A3648L	1987	2086	36	48	36	90.8	4.61
BRT36A3654L	2112	2220	36	54	36	99.9	4.92
BRT36A3660L	2200	2322	36	60	36	108.1	5.22
BRT36A3666L	2289	2421	36	66	36	117.2	5.53
BRT36A3672L	2377	2519	36	72	36	126.4	5.84
BRT36A3678L	2462	2616	36	78	36	134.5	6.24
BRT36A3684L	2546	2709	36	84	36	143.7	6.65

**BRT42P-C • Rectangular Legs - 42" High Pod (Casters)**

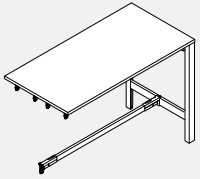
- Single table assembly consists of one worksurface, two H leg assemblies and all required beams.
- 24" deep tables have three (3) beams at the top, and one bottom beam.
- 30" and 36" deep tables have four (4) beams at the top, and one bottom beam.
- 40mm white locking casters with grey tires
- Finish option, please choose from:
  - 1) anodized aluminum vertical legs with powder coated steel horizontal structural members. Anodized aluminum leg upcharge of \$110 for this configuration
  - 2) powder coated aluminum vertical legs with steel horizontal structural members. Choose from standard metal finishes
- Worksurface available in LP and HP.

PRODUCT CODE	PRICE		SIZE / INCHES			WEIGHT		VOL FT <sup>3</sup>
	LP	HP	H	W	D	LBS		
BRT42P2436C	1993	2047	42	36	24	70.4	5.11	
BRT42P2442C	2055	2125	42	42	24	77.9	5.32	
BRT42P2448C	2130	2217	42	48	24	83.4	5.54	
BRT42P2454C	2240	2334	42	54	24	89.9	5.75	
BRT42P2460C	2310	2419	42	60	24	96.5	5.97	
BRT42P2466C	2361	2472	42	66	24	103.0	6.18	
BRT42P2472C	2409	2528	42	72	24	109.5	6.39	
BRT42P2478C	2471	2594	42	78	24	116.0	6.69	
BRT42P2484C	2531	2664	42	84	24	122.5	6.98	
BRT42P3036C	2289	2354	42	36	30	85.8	5.60	
BRT42P3042C	2388	2476	42	42	30	92.9	5.86	
BRT42P3048C	2446	2539	42	48	30	101.1	6.13	
BRT42P3054C	2551	2646	42	54	30	109.2	6.39	
BRT42P3060C	2619	2732	42	60	30	117.4	6.66	
BRT42P3066C	2673	2795	42	66	30	125.5	6.92	
BRT42P3072C	2740	2865	42	72	30	133.7	7.19	
BRT42P3078C	2809	2936	42	78	30	141.8	7.55	
BRT42P3084C	2891	3033	42	84	30	150.0	7.92	
BRT42P3642C	2585	2671	42	42	36	101.8	7.34	
BRT42P3648C	2673	2769	42	48	36	110.9	7.65	
BRT42P3654C	2796	2905	42	54	36	120.1	7.96	
BRT42P3660C	2887	3006	42	60	36	128.2	8.26	
BRT42P3666C	2975	3105	42	66	36	137.4	8.57	
BRT42P3672C	3062	3204	42	72	36	146.5	8.88	
BRT42P3678C	3148	3301	42	78	36	154.7	9.28	
BRT42P3684C	3232	3394	42	84	36	163.8	9.69	

**BRT42P-L • Rectangular Legs - 42" High Pod (Levelers)**

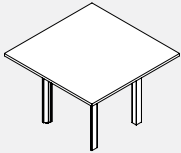
- Single table assembly consists of one worksurface, two H leg assemblies and all required beams.
- 24" deep tables have three (3) beams at the top, and one bottom beam.
- 30" and 36" deep tables have four (4) beams at the top, and one bottom beam.
- Finish option, please choose from:
  - 1) anodized aluminum vertical legs with powder coated steel horizontal structural members. Anodized aluminum leg upcharge of \$110 for this configuration
  - 2) powder coated aluminum vertical legs with steel horizontal structural members. Choose from standard metal finishes
- Worksurface available in LP and HP.

PRODUCT CODE	PRICE		SIZE / INCHES			WEIGHT		VOL FT <sup>3</sup>
	LP	HP	H	W	D	LBS		
BRT42P2436L	1914	1963	42	36	24	69.94	5.11	
BRT42P2442L	1975	2042	42	42	24	77.46	5.32	
BRT42P2448L	2050	2133	42	48	24	82.98	5.54	
BRT42P2454L	2159	2256	42	54	24	89.50	5.75	
BRT42P2460L	2231	2338	42	60	24	96.02	5.97	
BRT42P2466L	2279	2392	42	66	24	102.54	6.18	
BRT42P2472L	2329	2448	42	72	24	109.06	6.39	
BRT42P2478L	2391	2515	42	78	24	115.58	6.69	
BRT42P2484L	2450	2582	42	84	24	122.10	6.98	
BRT42P3036L	2209	2273	42	36	30	85.33	5.60	
BRT42P3042L	2304	2395	42	42	30	92.48	5.86	
BRT42P3048L	2365	2460	42	48	30	100.63	6.13	
BRT42P3054L	2471	2565	42	54	30	108.78	6.39	
BRT42P3060L	2538	2651	42	60	30	116.93	6.66	
BRT42P3066L	2593	2714	42	66	30	125.08	6.92	
BRT42P3072L	2660	2784	42	72	30	133.23	7.19	
BRT42P3078L	2730	2855	42	78	30	141.38	7.55	
BRT42P3084L	2810	2950	42	84	30	149.53	7.92	
BRT42P3642L	2503	2590	42	42	36	101.34	7.34	
BRT42P3648L	2593	2691	42	48	36	110.49	7.65	
BRT42P3654L	2716	2824	42	54	36	119.64	7.96	
BRT42P3660L	2806	2926	42	60	36	127.79	8.26	
BRT42P3666L	2893	3024	42	66	36	136.94	8.57	
BRT42P3672L	2981	3124	42	72	36	146.09	8.88	
BRT42P3678L	3067	3220	42	78	36	154.24	9.28	
BRT42P3684L	3151	3312	42	84	36	163.39	9.69	

**BRT42A-L • Rectangular Legs - 42" High Add-On (Levelers)**

- **Single table assembly consists of one worksurface, one H leg assembly and all required beams.**
- 24" deep tables have three (3) beams at the top, and one bottom beam.
- 30" and 36" deep tables have four (4) beams at the top, and one bottom beam.
- Finish option, please choose from:
  - 1) anodized aluminum vertical legs with powder coated steel horizontal structural members. Anodized aluminum leg upcharge of \$55 for this configuration
  - 2) powder coated aluminum vertical legs with steel horizontal structural members. Choose from standard metal finishes
- Worksurface available in LP and HP.

PRODUCT CODE	PRICE		SIZE/INCHES			WEIGHT VOL	
	LP	HP	H	W	D	LBS	FT <sup>3</sup>
BRT42A2436L	1431	1483	42	36	24	55.15	3.15
BRT42A2442L	1494	1561	42	42	24	62.67	3.36
BRT42A2448L	1568	1653	42	48	24	68.19	3.58
BRT42A2454L	1677	1774	42	54	24	74.71	3.79
BRT42A2460L	1747	1856	42	60	24	81.23	4.01
BRT42A2466L	1799	1911	42	66	24	87.75	4.22
BRT42A2472L	1846	1963	42	72	24	94.27	4.43
BRT42A2478L	1908	2032	42	78	24	100.79	4.73
BRT42A2484L	1970	2099	42	84	24	107.31	5.02
BRT42A3036L	1696	1759	42	36	30	68.52	3.54
BRT42A3042L	1791	1884	42	42	30	75.67	3.80
BRT42A3048L	1853	1948	42	48	30	83.82	4.07
BRT42A3054L	1958	2053	42	54	30	91.97	4.33
BRT42A3060L	2026	2138	42	60	30	100.12	4.60
BRT42A3066L	2081	2200	42	66	30	108.27	4.86
BRT42A3072L	2149	2272	42	72	30	116.42	5.13
BRT42A3078L	2217	2344	42	78	30	124.57	5.49
BRT42A3084L	2298	2437	42	84	30	132.72	5.86
BRT42A3642L	1922	2009	42	42	36	82.60	4.69
BRT42A3648L	2013	2107	42	48	36	91.75	5.00
BRT42A3654L	2132	2243	42	54	36	100.90	5.31
BRT42A3660L	2223	2344	42	60	36	109.05	5.61
BRT42A3666L	2312	2443	42	66	36	118.20	5.92
BRT42A3672L	2400	2541	42	72	36	127.35	6.23
BRT42A3678L	2485	2639	42	78	36	135.50	6.63
BRT42A3684L	2568	2733	42	84	36	144.65	7.04

**BRTSQ • Rectangular Legs - Meeting Table - Rectangular**

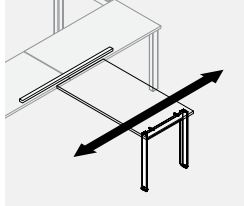
- **Rectangular meeting tables; levelers or casters**
- LP or HP tops, 3mm edging.
- Anodized aluminum leg upcharge of \$110 for this configuration.
- Includes top, legs and beam.
- L = Levelers
- C = Casters
- Worksurface available in HP and LP. For wood veneer tops, please contact your Customer Service Representative.

PRODUCT CODE	PRICE		SIZE/INCHES			WEIGHT VOL	
	LP	HP	H	W	D	LBS	FT <sup>3</sup>
BRTSQ42L	1258	1389	29	42	42	85	4.20
BRTSQ42C	1324	1456	29	42	42	85	4.20

**BRTR • Rectangular Legs - Meeting Table - Round**

- **Round meeting tables; levelers or casters**
- LP or HP tops, 3mm edging.
- Anodized aluminum leg upcharge of \$110 for this configuration.
- Includes top, legs and beam.
- L = Levelers
- C = Casters
- Worksurface available in HP and LP. For wood veneer tops, please contact your Customer Service Representative.

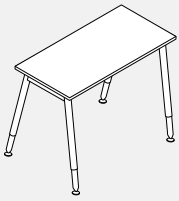
PRODUCT CODE	PRICE		SIZE/INCHES			WEIGHT VOL	
	LP	HP	H	W	D	LBS	FT <sup>3</sup>
BRTR42L	1258	1389	29	42	42	65	3.90
BRTR42C	1324	1456	29	42	42	65	3.90

**BRTSLDT72C • Rectangular Legs - Rail Sliding Table Kit**

- **Includes leg, leg support, sliding bracket hardware, 72" rail and hardware to secure table. Worksurface not included.**
- 40mm dia. locking casters with 8mm thread, white body and grey tires.
- Legs included are for 24" deep worksurfaces.
- Anodized aluminum leg upcharge of \$55 for this configuration.
- Maximum length of the sliding table surface is 48".

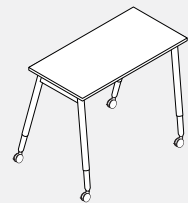
PRODUCT CODE	PRICE	SIZE/INCHES			WEIGHT VOL	
		H	W	D	LBS	FT <sup>3</sup>
BRTSLDT72C	665	29	48	72	28.5	2.40



**BRTS1P-LR • Round Legs Single Line 1 Person Pod (Levelers)**

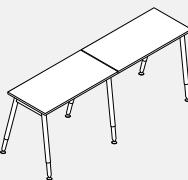
- Single Line Table Assemblies consist of one worksurface, two leg assemblies and one horizontal structural beam.
- Worksurface available in HP and LP. For wood veneer tops, please contact your Customer Service Representative.

PRODUCT CODE	PRICE		SIZE/INCHES			WEIGHT LBS	VOL FT <sup>3</sup>
	LP	HP	H	W	D		
BRTS1P2436LR	1079	1117	29	36	24	45	4.00
BRTS1P2442LR	1117	1169	29	42	24	48	4.10
BRTS1P2448LR	1167	1254	29	48	24	51	4.20
BRTS1P2451LR	1198	1269	29	50.5	24	54	4.30
BRTS1P2454LR	1243	1325	29	54	24	57	4.40
BRTS1P2460LR	1270	1382	29	60	24	60	4.48
BRTS1P2463LR	1288	1396	29	62.5	24	63	4.57
BRTS1P2466LR	1296	1407	29	66	24	66	4.65
BRTS1P2472LR	1320	1437	29	72	24	69	4.73
BRTS1P2478LR	1355	1476	29	78	24	72	4.82
BRTS1P2484LR	1395	1525	29	84	24	75	4.92
BRTS1P3036LR	1050	1112	29	36	30	45	4.00
BRTS1P3042LR	1170	1262	29	42	30	48	4.10
BRTS1P3048LR	1197	1291	29	48	30	51	4.20
BRTS1P3051LR	1234	1330	29	50.5	30	54	4.30
BRTS1P3054LR	1258	1351	29	54	30	57	4.40
BRTS1P3060LR	1289	1383	29	60	30	60	4.48
BRTS1P3063LR	1299	1415	29	62.5	30	63	4.57
BRTS1P3066LR	1306	1429	29	66	30	66	4.65
BRTS1P3072LR	1339	1448	29	72	30	69	4.73
BRTS1P3078LR	1372	1500	29	78	30	72	4.82
BRTS1P3084LR	1429	1568	29	84	30	75	4.92

**BRTS1P-CR • Round Legs Single Line 1 Person Pod (Casters)**

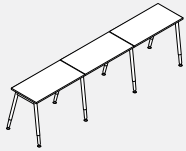
- Single Line Table Assemblies consist of one worksurface, two leg assemblies and one horizontal structural beam.
- Worksurface available in HP and LP. For wood veneer tops, please contact your Customer Service Representative.

PRODUCT CODE	PRICE		SIZE/INCHES			WEIGHT LBS	VOL FT <sup>3</sup>
	LP	HP	H	W	D		
BRTS1P2436CR	1158	1197	29	36	24	45	4.00
BRTS1P2442CR	1197	1246	29	42	24	48	4.10
BRTS1P2448CR	1243	1329	29	48	24	51	4.20
BRTS1P2451CR	1275	1351	29	50.5	24	54	4.30
BRTS1P2454CR	1326	1404	29	54	24	57	4.40
BRTS1P2460CR	1352	1461	29	60	24	60	4.48
BRTS1P2463CR	1366	1475	29	62.5	24	63	4.57
BRTS1P2466CR	1374	1487	29	66	24	66	4.65
BRTS1P2472CR	1397	1517	29	72	24	69	4.73
BRTS1P2478CR	1435	1559	29	78	24	72	4.82
BRTS1P2484CR	1474	1605	29	84	24	75	4.92
BRTS1P3036CR	1128	1194	29	36	30	45	4.00
BRTS1P3042CR	1254	1340	29	42	30	48	4.10
BRTS1P3048CR	1273	1369	29	48	30	51	4.20
BRTS1P3051CR	1315	1411	29	50.5	30	54	4.30
BRTS1P3054CR	1333	1430	29	54	30	57	4.40
BRTS1P3060CR	1367	1463	29	60	30	60	4.48
BRTS1P3063CR	1378	1496	29	62.5	30	63	4.57
BRTS1P3066CR	1389	1508	29	66	30	66	4.65
BRTS1P3072CR	1424	1527	29	72	30	69	4.73
BRTS1P3078CR	1454	1581	29	78	30	72	4.82
BRTS1P3084CR	1508	1647	29	84	30	75	4.92

**BRTS2P-LR • Round Legs Single Line 2 Person Pod (Levelers)**

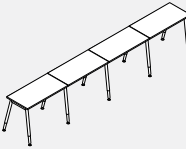
- Single Line Table Assemblies consists of 2 worksurfaces, 3 leg assemblies and 2 horizontal structural beams.
- Worksurface available in HP and LP. For wood veneer tops, please contact your Customer Service Representative.

PRODUCT CODE	PRICE		SIZE/INCHES			WEIGHT LBS	VOL FT <sup>3</sup>
	LP	HP	H	W	D		
BRTS2P2448LR	1981	2149	29	96	24	95	6.21
BRTS2P2454LR	2104	2292	29	108	24	104	6.45
BRTS2P2460LR	2191	2411	29	120	24	113	6.71
BRTS2P2466LR	2244	2463	29	132	24	122	6.95
BRTS2P2472LR	2286	2525	29	144	24	131	7.13
BRTS2P2478LR	2356	2603	29	156	24	140	7.27
BRTS2P2484LR	2449	2696	29	168	24	149	7.41
BRTS2P3048LR	2071	2261	29	96	30	113	6.57
BRTS2P3054LR	2157	2348	29	108	30	122	6.85
BRTS2P3060LR	2221	2447	29	120	30	131	7.13
BRTS2P3066LR	2264	2502	29	132	30	140	7.41
BRTS2P3072LR	2327	2576	29	144	30	155	7.69
BRTS2P3078LR	2393	2651	29	156	30	164	7.97
BRTS2P3084LR	2502	2783	29	168	30	173	8.25

**BRTS3P-LR • Round Legs Single Line 3 Person Pod (Levelers)**

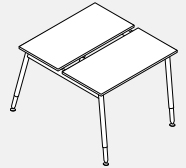
- Single Line, 3-person workstation consists of 3 worksurfaces, 4 leg assemblies and 3 horizontal structural beams.
- Worksurface available in HP and LP. For wood veneer tops, please contact your Customer Service Representative.

PRODUCT CODE	PRICE		SIZE/INCHES			WEIGHT VOL	
	LP	HP	H	W	D	LBS	FT <sup>3</sup>
BRTS3P2448LR	2790	3046	29	144	24	138	8.47
BRTS3P2454LR	2981	3263	29	162	24	152	8.68
BRTS3P2460LR	3111	3440	29	180	24	165	8.89
BRTS3P2466LR	3180	3521	29	198	24	179	9.11
BRTS3P2472LR	3251	3611	29	216	24	192	9.32
BRTS3P2478LR	3357	3730	29	234	24	206	9.53
BRTS3P2484LR	3479	3867	29	252	24	219	9.74
BRTS3P3048LR	2931	3217	29	144	30	161	9.01
BRTS3P3054LR	3062	3346	29	162	30	178	9.44
BRTS3P3060LR	3156	3494	29	180	30	195	9.87
BRTS3P3066LR	3220	3580	29	198	30	212	10.30
BRTS3P3072LR	3316	3689	29	216	30	229	10.72
BRTS3P3078LR	3414	3798	29	234	30	246	11.16
BRTS3P3084LR	3580	3997	29	252	30	263	11.59

**BRTS4P-LR • Round Legs Single Line 4 Person Pod (Levelers)**

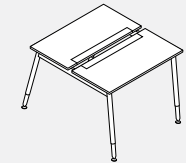
- Single Line, 4-person workstation consists of 4 worksurfaces, 5 leg assemblies and 3 horizontal structural beams.
- Worksurface available in HP and LP. For wood veneer tops, please contact your Customer Service Representative.

PRODUCT CODE	PRICE		SIZE/INCHES			WEIGHT VOL	
	LP	HP	H	W	D	LBS	FT <sup>3</sup>
BRTS4P2448LR	3564	3943	29	192	24	180	10.73
BRTS4P2454LR	3855	4234	29	216	24	199	11.22
BRTS4P2460LR	4015	4468	29	240	24	217	11.71
BRTS4P2466LR	4124	4576	29	264	24	236	12.20
BRTS4P2472LR	4216	4693	29	288	24	254	12.69
BRTS4P2478LR	4363	4852	29	312	24	273	13.18
BRTS4P2484LR	4521	5040	29	336	24	291	13.67
BRTS4P3048LR	3790	4168	29	192	30	213	11.45
BRTS4P3054LR	3961	4341	29	216	30	235	12.02
BRTS4P3060LR	4089	4541	29	240	30	257	12.59
BRTS4P3066LR	4177	4654	29	264	30	279	13.16
BRTS4P3072LR	4302	4800	29	288	30	301	13.73
BRTS4P3078LR	4433	4947	29	312	30	323	14.30
BRTS4P3084LR	4654	5215	29	336	30	345	14.87

**BRTBAR2P-LR • Round Legs Back 2 Back 2 Person Pod (Levelers)**

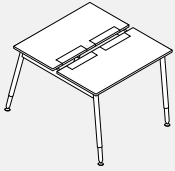
- Back 2 Back, 2-person workstation consists of 2 worksurfaces, 2 Back 2 Back leg assemblies and 2 horizontal structural beams.
- Worksurface available in HP and LP. For wood veneer tops, please contact your Customer Service Representative.

PRODUCT CODE	PRICE		SIZE/INCHES			WEIGHT VOL	
	LP	HP	H	W	D	LBS	FT <sup>3</sup>
BRTBAR2P2460LR	2051	2269	29	60	50.5	110	8.56
BRTBAR2P2466LR	2098	2324	29	66	50.5	119	8.76
BRTBAR2P2472LR	2145	2383	29	72	50.5	128	9.02
BRTBAR2P2478LR	2219	2463	29	78	50.5	137	9.20
BRTBAR2P2484LR	2281	2538	29	84	50.5	146	9.40
BRTBAR2P3060LR	1907	2306	29	60	62.5	130	9.00
BRTBAR2P3066LR	2125	2364	29	66	62.5	141	9.25
BRTBAR2P3072LR	2188	2429	29	72	62.5	152	9.54
BRTBAR2P3078LR	2256	2508	29	78	62.5	163	9.80
BRTBAR2P3084LR	2364	2644	29	84	62.5	174	10.4

**BRTBAR2PA-LR • Round Legs Back 2 Back 2 Person Pod with Access Door (Levelers)**

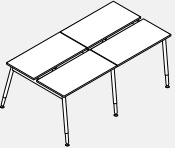
- Back 2 Back, 2-person workstation consists of 2 worksurfaces, 2 Back 2 Back leg assemblies and 2 horizontal structural beams.
- Anodized aluminum worksurface door provides access to power / data through below worksurface.
- Worksurface with access doors cannot be combined with above worksurface power trough.
- Worksurface available in HP and LP.

PRODUCT CODE	PRICE		SIZE/INCHES			WEIGHT VOL	
	LP	HP	H	W	D	LBS	FT <sup>3</sup>
BRTBAR2PA2460LR	2130	2447	29	60	50.5	110	8.56
BRTBAR2PA2466LR	2213	2563	29	66	50.5	119	8.76
BRTBAR2PA2472LR	2298	2696	29	72	50.5	128	9.02
BRTBAR2PA3060LR	2264	2664	29	60	62.5	130	9.00
BRTBAR2PA3066LR	2381	2812	29	66	62.5	141	9.25
BRTBAR2PA3072LR	2463	2947	29	72	62.5	152	9.54

**BRTBAR2PDA-LR • Round Legs Back 2 Back 2 Person Pod with Access Door (Levelers)**

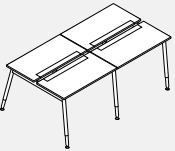
- Back 2 Back, 2-person workstation consists of 2 worksurfaces, 2 Back 2 Back leg assemblies and 2 horizontal structural beams.
- These tables feature dual access doors providing a central connection point for monitor lifts.
- Anodized aluminum worksurface door provides access to power / data through below worksurface.
- Worksurface with access doors cannot be combined with above worksurface power trough.
- Worksurface available in HP and LP.

PRODUCT CODE	PRICE		SIZE/INCHES			WEIGHT LBS	VOL FT <sup>3</sup>
	LP	HP	H	W	D		
BRTBAR2PDA2460LR	2301	2644	29	60	50.5	110	8.56
BRTBAR2PDA2466LR	2392	2768	29	66	50.5	119	8.76
BRTBAR2PDA2472LR	2480	2911	29	72	50.5	128	9.02
BRTBAR2PDA2478LR	2536	2983	29	78	50.5	137	9.20
BRTBAR2PDA2484LR	2589	3092	29	84	50.5	146	9.40
BRTBAR2PDA3060LR	2443	2876	29	60	62.5	130	9.00
BRTBAR2PDA3066LR	2571	3039	29	66	62.5	141	9.25
BRTBAR2PDA3072LR	2659	3183	29	72	62.5	152	9.54
BRTBAR2PDA3078LR	2716	3289	29	78	62.5	163	9.80
BRTBAR2PDA3084LR	2805	3414	29	84	62.5	174	10.4

**BRTBAR4P-LR • Round Legs Back 2 Back 4 Person Pod (Levelers)**

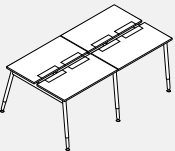
- Back 2 Back, 4-person workstation consists of 4 worksurfaces, 3 Back 2 Back leg assemblies and 4 horizontal structural beams.
- Worksurface available in HP and LP. For wood veneer tops, please contact your Customer Service Representative.

PRODUCT CODE	PRICE		SIZE/INCHES			WEIGHT LBS	VOL FT <sup>3</sup>
	LP	HP	H	W	D		
BRTBAR4P2460LR	3645	4081	29	120	50.5	208	13.82
BRTBAR4P2466LR	3736	4190	29	132	50.5	224	14.28
BRTBAR4P2472LR	3829	4308	29	144	50.5	240	14.74
BRTBAR4P2478LR	3978	4468	29	156	50.5	256	15.20
BRTBAR4P2484LR	4135	4654	29	168	50.5	272	15.66
BRTBAR4P3060LR	3736	4190	29	120	62.5	253	14.70
BRTBAR4P3066LR	3758	4234	29	132	62.5	273	15.24
BRTBAR4P3072LR	3917	4415	29	144	62.5	293	15.78
BRTBAR4P3078LR	4048	4561	29	156	62.5	313	16.32
BRTBAR4P3084LR	4269	4826	29	168	62.5	333	16.86

**BRTBAR4PA-LR • Round Legs Back 2 Back 4 Person Pod with Access Door (Levelers)**

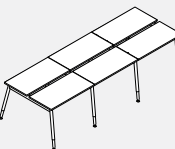
- Back 2 Back, 4-person workstation consists of 4 worksurfaces, 3 Back 2 Back leg assemblies and 4 horizontal structural beams.
- Anodized aluminum worksurface door provides access to power / data through below worksurface.
- Worksurface with access doors cannot be combined with above worksurface power trough.
- Worksurface available in HP and LP.

PRODUCT CODE	PRICE		SIZE/INCHES			WEIGHT LBS	VOL FT <sup>3</sup>
	LP	HP	H	W	D		
BRTBAR4PA2460LR	3802	4433	29	120	50.5	208	13.82
BRTBAR4PA2466LR	4044	4742	29	132	50.5	224	14.28
BRTBAR4PA2472LR	4135	4933	29	144	50.5	240	14.74
BRTBAR4PA3060LR	4102	4902	29	120	62.5	253	14.70
BRTBAR4PA3066LR	4368	5165	29	132	62.5	273	15.24
BRTBAR4PA3072LR	4468	5431	29	144	62.5	293	15.78

**BRTBAR4PDA-LR • Round Legs Back 2 Back 4 Person Pod with Access Door (Levelers)**

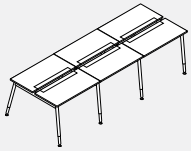
- Back 2 Back, 4-person workstation consists of 4 worksurfaces, 3 Back 2 Back leg assemblies and 4 horizontal structural beams.
- These tables feature dual access doors providing a central connection point for monitor lifts.
- Anodized aluminum worksurface door provides access to power / data through below worksurface.
- Worksurface with access doors cannot be combined with above worksurface power trough.
- Worksurface available in HP and LP.

PRODUCT CODE	PRICE		SIZE/INCHES			WEIGHT LBS	VOL FT <sup>3</sup>
	LP	HP	H	W	D		
BRTBAR4PDA2460LR	4106	4788	29	120	50.5	208	13.82
BRTBAR4PDA2466LR	4366	5122	29	132	50.5	224	14.28
BRTBAR4PDA2472LR	4467	5327	29	144	50.5	240	14.74
BRTBAR4PDA2478LR	4573	5471	29	156	50.5	256	15.20
BRTBAR4PDA2484LR	4716	5722	29	168	50.5	272	15.66
BRTBAR4PDA3060LR	4430	5293	29	120	62.5	253	14.70
BRTBAR4PDA3066LR	4716	5577	29	132	62.5	273	15.24
BRTBAR4PDA3072LR	4825	5866	29	144	62.5	293	15.78
BRTBAR4PDA3078LR	4933	6083	29	156	62.5	313	16.32
BRTBAR4PDA3084LR	5112	6332	29	168	62.5	333	16.86

**BRTBAR6P-LR • Round Legs Back 2 Back 6 Person Pod (Levelers)**

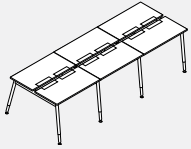
- Back 2 Back, 6-person workstation consists of 6 worksurfaces, 4 Back 2 Back leg assemblies and 6 horizontal structural beams.
- Worksurface available in HP and LP. For wood veneer tops, please contact your Customer Service Representative.

PRODUCT CODE	PRICE		SIZE/INCHES			WEIGHT LBS	VOL FT <sup>3</sup>
	LP	HP	H	W	D		
BRTBAR6P2460LR	5235	5906	29	180	50.5	308	19.76
BRTBAR6P2466LR	5375	6053	29	198	50.5	329	20.54
BRTBAR6P2472LR	5515	6234	29	216	50.5	359	21.32
BRTBAR6P2478LR	5735	6471	29	234	50.5	409	22.10
BRTBAR6P2484LR	5974	6751	29	252	50.5	434	22.88
BRTBAR6P3060LR	5325	6005	29	180	62.5	369	21.08
BRTBAR6P3066LR	5456	6175	29	198	62.5	400	21.97
BRTBAR6P3072LR	5644	6392	29	216	62.5	431	22.86
BRTBAR6P3078LR	5846	6612	29	234	62.5	462	23.75
BRTBAR6P3084LR	6182	7011	29	252	62.5	493	24.53

**BRTBAR6PA-LR • Round Legs Back 2 Back 6 Person Pod with Access Door (Levelers)**

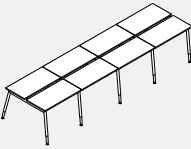
- Back 2 Back, 6-person workstation consists of 6 worksurfaces, 4 Back 2 Back leg assemblies and 6 horizontal structural beams.
- Anodized aluminum worksurface door provides access to power / data through below worksurface.
- Worksurface with access doors cannot be combined with above worksurface power trough.
- Worksurface available in HP and LP.

PRODUCT CODE	PRICE		SIZE/INCHES			WEIGHT VOL	
	LP	HP	H	W	D	LBS	FT <sup>3</sup>
BRTBAR6PA2460LR	5477	6424	29	180	50.5	308	19.76
BRTBAR6PA2466LR	5723	6773	29	198	50.5	329	20.54
BRTBAR6PA2472LR	5974	7173	29	216	50.5	359	21.32
BRTBAR6PA3060LR	5876	7071	29	180	62.5	369	21.08
BRTBAR6PA3066LR	6222	7520	29	198	62.5	400	21.97
BRTBAR6PA3072LR	6471	7919	29	216	62.5	431	22.86

**BRTBAR6PDA-LR • Round Legs Back 2 Back 6 Person Pod with Access Door (Levelers)**

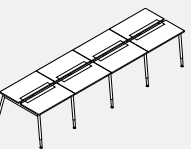
- Back 2 Back, 6-person workstation consists of 6 worksurfaces, 4 Back 2 Back leg assemblies and 6 horizontal structural beams.
- These tables feature dual access doors providing a central connection point for monitor lifts.
- Anodized aluminum worksurface door provides access to power / data through below worksurface.
- Worksurface with access doors cannot be combined with above worksurface power trough.
- Worksurface available in HP and LP.

PRODUCT CODE	PRICE		SIZE/INCHES			WEIGHT VOL	
	LP	HP	H	W	D	LBS	FT <sup>3</sup>
BRTBAR6PDA2460LR	5914	6937	29	180	50.5	308	19.76
BRTBAR6PDA2466LR	6181	7315	29	198	50.5	329	20.54
BRTBAR6PDA2472LR	6454	7746	29	216	50.5	359	21.32
BRTBAR6PDA2478LR	6612	7958	29	234	50.5	409	22.10
BRTBAR6PDA2484LR	6831	8336	29	252	50.5	434	22.88
BRTBAR6PDA3060LR	6345	7635	29	180	62.5	369	21.08
BRTBAR6PDA3066LR	6720	8123	29	198	62.5	400	21.97
BRTBAR6PDA3072LR	6991	8551	29	216	62.5	431	22.86
BRTBAR6PDA3078LR	7151	8873	29	234	62.5	462	23.75
BRTBAR6PDA3084LR	7419	9254	29	252	62.5	493	24.53

**BRTBAR8P-LR • Round Legs Back 2 Back 8 Person Pod (Levelers)**

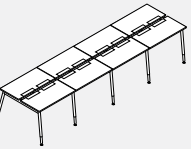
- Back 2 Back, 8-person workstation consists of 8 worksurfaces, 5 Back 2 Back leg assemblies and 8 horizontal structural beams.
- Worksurface available in HP and LP. For wood veneer tops, please contact your Customer Service Representative.

PRODUCT CODE	PRICE		SIZE/INCHES			WEIGHT VOL	
	LP	HP	H	W	D	LBS	FT <sup>3</sup>
BRTBAR8P2460LR	6828	7705	29	240	50.5	412	24.42
BRTBAR8P2466LR	7015	7919	29	264	50.5	448	25.30
BRTBAR8P2472LR	7202	8159	29	288	50.5	484	26.30
BRTBAR8P2478LR	7493	8477	29	312	50.5	520	27.30
BRTBAR8P2484LR	7826	8850	29	336	50.5	556	28.30
BRTBAR8P3060LR	6946	7851	29	240	62.5	492	26.18
BRTBAR8P3066LR	7121	8077	29	264	62.5	536	27.28
BRTBAR8P3072LR	7375	8372	29	288	62.5	581	28.38
BRTBAR8P3078LR	7637	8664	29	312	62.5	625	29.48
BRTBAR8P3084LR	8077	9195	29	336	62.5	669	30.58

**BRTBAR8PA-LR • Round Legs Back 2 Back 8 Person Pod with Access Door (Levelers)**

- Back 2 Back, 8-person workstation consists of 8 worksurfaces, 5 Back 2 Back leg assemblies and 8 horizontal structural beams.
- Anodized aluminum worksurface door provides access to power / data through below worksurface.
- Worksurface with access doors cannot be combined with above worksurface power trough.
- Worksurface available in HP and LP.

PRODUCT CODE	PRICE		SIZE/INCHES			WEIGHT VOL	
	LP	HP	H	W	D	LBS	FT <sup>3</sup>
BRTBAR8PA2460LR	7148	8411	29	240	50.5	412	24.42
BRTBAR8PA2466LR	7479	8874	29	264	50.5	448	25.30
BRTBAR8PA2472LR	7813	9408	29	288	50.5	484	26.30
BRTBAR8PA3060LR	7680	9275	29	240	62.5	492	26.18
BRTBAR8PA3066LR	8144	9873	29	264	62.5	536	27.28
BRTBAR8PA3072LR	8477	10404	29	288	62.5	581	28.38

**BRTBAR8PDA-LR • Round Legs Back 2 Back 8 Person Pod with Access Door (Levelers)**

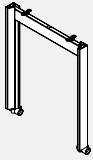
- Back 2 Back, 8-person workstation consists of 8 worksurfaces, 5 Back 2 Back leg assemblies and 8 horizontal structural beams.
- These tables feature dual access doors providing a central connection point for monitor lifts.
- Anodized aluminum worksurface door provides access to power / data through below worksurface.
- Worksurface with access doors cannot be combined with above worksurface power trough.
- Worksurface available in HP and LP.

PRODUCT CODE	PRICE		SIZE/INCHES			WEIGHT VOL	
	LP	HP	H	W	D	LBS	FT <sup>3</sup>
BRTBAR8PDA2460LR	7719	9084	29	240	50.5	412	24.42
BRTBAR8PDA2466LR	8077	9586	29	264	50.5	448	25.30
BRTBAR8PDA2472LR	8439	10161	29	288	50.5	484	26.30
BRTBAR8PDA2478LR	8652	10449	29	312	50.5	520	27.30
BRTBAR8PDA2484LR	8937	10949	29	336	50.5	556	28.30
BRTBAR8PDA3060LR	8295	10017	29	240	62.5	492	26.18
BRTBAR8PDA3066LR	8796	10664	29	264	62.5	536	27.28
BRTBAR8PDA3072LR	9155	11238	29	288	62.5	581	28.38
BRTBAR8PDA3078LR	9370	11668	29	312	62.5	625	29.48
BRTBAR8PDA3084LR	9730	12172	29	336	62.5	669	30.58

**BRTSLDT72CR • Sliding Table Kit (Round Legs)**

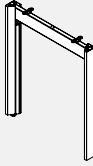
- Includes leg, leg support, sliding bracket hardware, 72" rail and hardware to secure table. Worksurface not included.
- Maximum length of the Sliding Table surface is 48".
- Locking casters are 3" diameter as standard.

PRODUCT CODE	PRICE	SIZE/INCHES			WEIGHT VOL	
		H	W	D	LBS	FT <sup>3</sup>
BRTSLDT72CR	665	29	48	72	28.5	2.40

**BRTSL-C • Single Leg Assembly (Casters)**

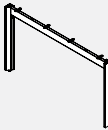
- **Two Single Leg Assemblies form the structure of the Bridges series Single Table.**
- 40mm white locking casters with grey tires; steel frame, aluminum legs.
- Anodized aluminum leg upcharge \$55.
- Please specify paint finish for support.

PRODUCT CODE	PRICE	SIZE/INCHES			WEIGHT VOL	
		H	W	D	LBS	FT <sup>3</sup>
BRTSL24C	439	28	2.5	24	8	1.34
BRTSL30C	456	28	2.5	30	8	1.41
BRTSL36C	476	28	2.5	36	8	1.81

**BRTSL-L • Single Leg Assembly (Levelers)**

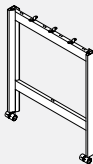
- **Two Single Leg Assemblies form the structure of the Bridges series Single Line Tables.**
- One leg can be shared by 2 adjoining worksurfaces.
- Leveling glides, steel frame, aluminum legs.
- Anodized aluminum leg upcharge \$55.
- Please specify paint finish for support.
- Please specify 2 beams when using BRTSL36L.

PRODUCT CODE	PRICE	SIZE/INCHES			WEIGHT VOL	
		H	W	D	LBS	FT <sup>3</sup>
BRTSL24L	399	28	2.5	24	8	1.34
BRTSL30L	417	28	2.5	30	8	1.34
BRTSL36L	435	28	2.5	36	9	1.50

**BRTBA-L • Back 2 Back Leg Assembly (Levelers)**

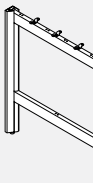
- **Two Back 2 Back Leg Assemblies form the structure of the Bridges series Back 2 Back Tables.**
- One double leg can be shared by 4 adjoining worksurfaces.
- Leveling, steel frame, aluminum legs.
- Anodized aluminum leg upcharge \$55.
- Please specify paint finish for support.

PRODUCT CODE	PRICE	SIZE/INCHES			WEIGHT VOL	
		H	W	D	LBS	FT <sup>3</sup>
BRTBA34L	399	28	2.5	34	10	2.47
BRTBA51L	433	28	2.5	50.5	12	2.96
BRTBA63L	450	28	2.5	62.5	13	3.21

**BRTHL-C • Single "H" Leg Assembly (Casters)**

- **Two Single Leg Assemblies form the structure of the Bridges series Single Line Tables.**
- Leveling glides, steel frame, aluminum legs.
- Anodized aluminum leg upcharge \$55.
- Please specify paint finish for support.
- Note:
  - 24" deep tables must have three (3) beams at the top, and one beam (BRTBB-C "Bottom Table Beam") at the bottom.
  - 30" and 36" deep tables must have four (4) beams at the top, and one beam (BRTBB-C "Bottom Table Beam") at the bottom.

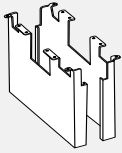
PRODUCT CODE	PRICE	SIZE/INCHES			WEIGHT VOL	
		H	W	D	LBS	FT <sup>3</sup>
BRTHL3624C	500	35	2.5	24	14	1.68
BRTHL3630C	528	35	2.5	30	16	1.76
BRTHL3636C	600	35	2.5	36	18	2.26
BRTHL4224C	522	41	2.5	24	15	1.96
BRTHL4230C	552	41	2.5	30	17	2.06
BRTHL4236C	622	41	2.5	36	19	2.65

**BRTHL-L • Single "H" Leg Assembly (Levelers)**

- **Two Single Leg Assemblies form the structure of the Bridges series Single Line Tables.**
- One leg can be shared by 2 adjoining worksurfaces.
- Leveling glides, steel frame, aluminum legs.
- Anodized aluminum leg upcharge \$55.
- Please specify paint finish for support.
- Note:
  - 24" deep tables must have three (3) beams at the top, and one beam (BRTBB-C "Bottom Table Beam") at the bottom.
  - 30" and 36" deep tables must have four (4) beams at the top, and one beam (BRTBB-C "Bottom Table Beam") at the bottom.

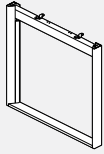
PRODUCT CODE	PRICE	SIZE/INCHES			WEIGHT VOL	
		H	W	D	LBS	FT <sup>3</sup>
BRTHL3624L	459	35	2.5	24	14	1.68
BRTHL3630L	488	35	2.5	30	16	1.76
BRTHL3636L	557	35	2.5	36	18	2.26
BRTHL4224L	483	41	2.5	24	15	1.96
BRTHL4230L	513	41	2.5	30	17	2.06
BRTHL4236L	581	41	2.5	36	19	2.65



**BRTDLSHS34 • 34" Leg Shroud**

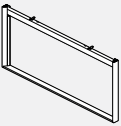
- A two part steel enclosure creates 5" deep and 30" wide cable management cavity between 34" rectangular table legs.
- Hides floor power feeds as well as data/communication cables rising from floor monuments to the underside of Bridges II tables.
- Secures to BRTBA34L rectangular leg and to underside of worksurfaces.
- Specify paint finish.

PRODUCT CODE	PRICE	SIZE/INCHES			WEIGHT VOL	
		H	W	D	LBS	FT <sup>3</sup>
BRTDLSHS34	451	28	30	5	62	5.25

**BRTSLL • Single Loop Leg**

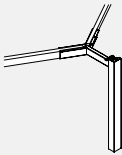
- Two Single Leg Assemblies form the structure of the Bridges series Single Line Tables.
- One leg can be shared by 2 adjoining worksurfaces.
- Leveling glides, steel frame, aluminum legs.
- Anodized aluminum leg upcharge \$55.
- Please specify paint finish for support.
- Please specify two beams when using BRTSLL36L

PRODUCT CODE	PRICE	SIZE/INCHES			WEIGHT VOL	
		H	W	D	LBS	FT <sup>3</sup>
BRTSLL24L	460	28	2.5	24	11.00	1.01
BRTSLL30L	480	28	2.5	30	13.75	1.26
BRTSLL36L	509	28	2.5	36	16.50	1.51

**BRTBALL • Back 2 Back Loop Leg**

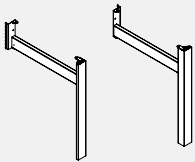
- Two Back 2 Back Leg Assemblies form the structure of the Bridges series Back 2 Back Tables.
- One double leg can be shared by 4 adjoining worksurfaces.
- Leveling glides, steel frame, aluminum legs.
- Anodized aluminum leg upcharge \$55.
- Please specify paint finish for support.

PRODUCT CODE	PRICE	SIZE/INCHES			WEIGHT VOL	
		H	W	D	LBS	FT <sup>3</sup>
BRTBALL51L	527	28	2.5	50.5	23.14	2.12
BRTBALL63L	551	28	2.5	62.5	28.64	2.62

**BRT • 120° Corner Leg Kit**

- One 120° corner leg kit combined with two single or double Leg Assemblies and support beams form the structure of the Bridges series 120° Tables.
- 120° corner leg kit includes one corner leg and adjacent, telescopic beams to support BRTWAC120 or BRTWAC120A 120° worksurfaces. Telescopic horizontal beams allow single or double Leg Assemblies to be positioned either under the work surface (end of a run) or to be shared by adjoining worksurfaces. Levelers, steel frame, aluminum legs.
- Anodized aluminum leg upcharge \$30.
- Please specify paint finish for support.

PRODUCT CODE	PRICE	SIZE/INCHES			WEIGHT VOL	
		H	W	D	LBS	FT <sup>3</sup>
BRT120L42	763	28	2.5	34	6.6	2.80

**BRTHLEG • Boulevard Leg Assembly**

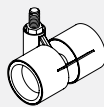
- Boulevard Leg Assembly attaches to a Boulevard panel for applications which require functionality of Boulevard panels with an open environment of Bridges tables.
- One leg with horizontal member connecting to 1" increment slots in panel's vertical frame member. Provides support to panel and panel-connected work surface at the end of a run; design coordinated with Bridges freestanding tables.
- Supports 24" and 30" deep worksurfaces. By adding 2 BHBF01 flat brackets and 1 BHBC02 corner bracket, a single leg can then support the adjoining work surface. Leveling glide is standard. No work surface supporting beams, use panel cantilevers and storage for work surface support. One aluminum leg with steel structure - specify Left or Right and 24" or 30" deep for corresponding work surface depths. Panel bracket, dislodgment clip and work surface hardware included.
- Anodized aluminum leg upcharge \$30.
- Please specify paint finish for support.

PRODUCT CODE	PRICE	SIZE/INCHES			WEIGHT VOL	
		H	W	D	LBS	FT <sup>3</sup>
BRTHLEG24LL	317	28	2.5	24	9	1.25
BRTHLEG24RL	317	28	2.5	24	9	1.25
BRTHLEG30LL	333	28	2.5	30	11	1.45
BRTHLEG30RL	333	28	2.5	30	11	1.45

**BRTLVS • Leveler for Rectangular Leg Table**

- 5/16" thread with black base; leveler has 2" adjustment range.
- Casters and levelers on Rectangular legs cannot be interchanged on site.

PRODUCT CODE	PRICE	SIZE/INCHES			WEIGHT VOL	
		H	W	D	LBS	FT <sup>3</sup>
BRTLVS	9	2.5	1	1	0.025	0.001

**BRTLCS • Locking Caster for Rectangular Leg Tables**

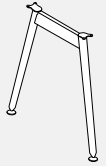
- Locking Caster for Rectangular Table
- 40mm dia. locking caster with 8mm thread; white body, light grey tires.
- Casters and levelers on rectangular legs cannot be interchanged on site.

PRODUCT CODE	PRICE	SIZE/INCHES			WEIGHT VOL	
		H	W	D	LBS	FT <sup>3</sup>
BRTLCS	27	2.5	2.7	2.6	0.055	0.008

**BRTSL • Single Leg Assembly**

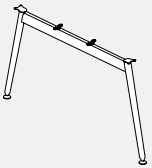
- **Two Single Leg Assemblies combined with a Single Beam form the supporting structure of the Bridges series Single Line Tables.**
- One leg can be shared by 2 adjoining worksurfaces.
- Leveling glides are standard. Locking casters are available on single tables. Specify 2 casters (BRTLCL) at an upcharge of \$22 each.

PRODUCT CODE	PRICE	SIZE/INCHES			WEIGHT VOL	
		H	W	D	LBS	FT <sup>3</sup>
BRTSL	352	28	3	24	8	1.25

**BRTFSL • Fixed Height Single Leg Assembly**

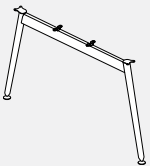
- **Two Single Leg Assemblies combined with a Single Beam form the supporting structure of the Bridges series Single Line Tables.**
- One leg can be shared by 2 adjoining worksurfaces.

PRODUCT CODE	PRICE	SIZE/INCHES			WEIGHT VOL	
		H	W	D	LBS	FT <sup>3</sup>
BRTFSL	303	28	2.5	24	5	0.97

**BRTDL • Back 2 Back Leg Assembly**

- **Two Back 2 Back Leg Assemblies combined with 2 Single Beams form the supporting structure of the Bridges series Back 2 Back tables.**
- One leg can be shared by 2 adjoining worksurfaces.
- Leveling glides are standard.

PRODUCT CODE	PRICE	SIZE/INCHES			WEIGHT VOL	
		H	W	D	LBS	FT <sup>3</sup>
BRTDL	459	28	3	50	12	2.81

**BRTFDL • Fixed Height Back 2 Back Leg Assembly**

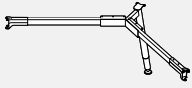
- **Two Back 2 Back Leg Assemblies combined with 2 Single Beams form the supporting structure of the Bridges series Back 2 Back tables.**
- One leg can be shared by 2 adjoining worksurfaces.
- Leveling glides are standard.

PRODUCT CODE	PRICE	SIZE/INCHES			WEIGHT VOL	
		H	W	D	LBS	FT <sup>3</sup>
BRTFDL	411	28	2.5	50	8	2.03

**BRTBL • Boulevard Leg Assembly**

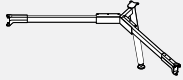
- **Boulevard Leg Assembly attaches to a Boulevard panel for applications which require functionality of Boulevard panels with an open environment of Bridge 2 tables.**
- Panel bracket secures the leg to the panel in 1" increments, within a 24" to 32" height range.
- Panel mounting bracket is reversible for non-handed applications.
- Supports 24" and 30" deep worksurfaces. By adding 2 BHBF01 flat brackets and 1 BHBC02 corner bracket, a single leg can then support the adjoining worksurface. Leveling glide is standard. No worksurface supporting beams, use panel cantilevers and storage for worksurface support. Panel bracket, dislodgment clip and worksurface hardware included.
- Leveling glide is standard.

PRODUCT CODE	PRICE	SIZE/INCHES			WEIGHT VOL	
		H	W	D	LBS	FT <sup>3</sup>
BRTBL	338	28	3	24	12	1.25

**BRTCRL • 120° Corner Leg Kit**

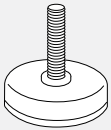
- Provides support for worksurfaces connected at 120° Degree.
- Single leg and beam assembly for 120° worksurface planning.
- Works with BRTWAC120 or BRTWAC120A worksurfaces.
- For a single table application two BRTSL (single legs) must be added.
- To join to a Back 2 Back table application, leg assembly will join to existing pod.
- Note: When joining to an existing table, the beam extends to reach the shared leg.

PRODUCT CODE	PRICE	SIZE/INCHES			WEIGHT VOL	
		H	W	D	LBS	FT <sup>3</sup>
BRTCRL42	707	28	18	16	15	1.50

**BRTFCRL • 120° Fixed Height Corner Leg Kit**

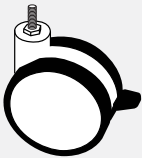
- Provides support for worksurfaces connected at 120° Degree, supported by fixed height legs.
- Single leg and beam assembly for 120° worksurface planning.
- Works with BRTWAC120 or BRTWAC120A worksurfaces.
- For a single table application two BRTFSL (single legs) must be added.
- To join to a Back 2 Back table application, leg assembly will join to existing pod.
- Note: When joining to an existing table, the beam extends to reach the shared leg.

PRODUCT CODE	PRICE	SIZE/INCHES			WEIGHT VOL	
		H	W	D	LBS	FT <sup>3</sup>
BRTFCRL42	658	28	18	16	13	1.50

**BRTLVR • Levelers for Tables**

- Provides an option to casters.
- Leveler is 2 1/8" diameter.
- 1 1/2" long, 3/8" - 16 threaded stem provides 1" height adjustment range.
- Field retrofitable on round leg.

PRODUCT CODE	PRICE	SIZE/INCHES			WEIGHT VOL	
		H	W	D	LBS	FT <sup>3</sup>
BRTLVR	9	2	2.125	2.125	0.2	0.002

**BRTLRCR • Locking Casters for Round Leg Tables**

- Provides an option to levelers.
- Caster is 3" diameter wheel and 3/8" - 16 threaded stem.
- Overall height is 3 3/4".
- Field retrofitable on round leg.

PRODUCT CODE	PRICE	SIZE/INCHES			WEIGHT VOL	
		H	W	D	LBS	FT <sup>3</sup>
BRTLRCR	27	3.75	3	1.5	0.3	0.002

**BRTRL • Round Table Leg Assembly**

- Four leg assembly.
- Leveling glides are standard. Locking casters are available. Specify 4 casters (BRTLRCR) at an upcharge of \$17 each.
- Maximum table diameter is 42".
- Includes all connecting hardware.

PRODUCT CODE	PRICE	SIZE/INCHES			WEIGHT VOL	
		H	W	D	LBS	FT <sup>3</sup>
BRTRL	726	28	24	24	16	2.33



## Beam Applications

Bridges II table legs are connected with supporting beams. Unless there is one beam for a single line of tables while two beams connect Back 2 Back table structures. Adjustable clamps at either end of the beam can be adjusted to accommodate the following applications in both single table as well as Back 2 Back table configurations.

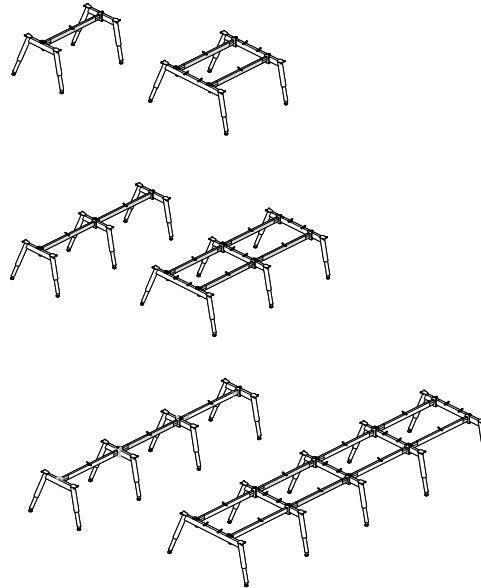
### STANDARD TABLE BEAM

**Single table beam application** bridges two legs to form support for a single table, or two Back 2 Back work surfaces.

Adjustable clamps at either end of the beam are pushed all the way in to allow both table legs to be tucked under the work surface.

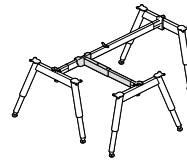
**End of run table beam application** supports one table leg assembly tucked under work surface (one adjustable clamp pushed all the way in), while the other table leg assembly can be shared between two adjacent work surfaces (adjustable clamp pulled out to extend the beam).

**Interconnecting table beam application** supports both table leg assemblies extended to support adjacent work surfaces on either side. Both adjustable clamps pulled out to extend the beam at either end.



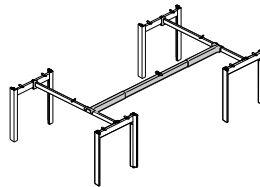
### TELESCOPIC TABLE RETURN BEAM

Supports a return connected perpendicularly to a 24" or 30" deep primary work surface. The Telescopic beam is connected to a single or Back 2 Back leg on one side and to any work surface-supporting beam on the opposite side. Telescopic beam clamp allows the table leg to be tucked under worksurface or shared between two adjacent worksurfaces.



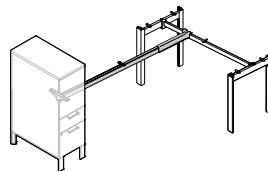
### TABLE TO TABLE TELESCOPIC BRIDGE BEAM

Supports a 36" to 84" wide top connected perpendicularly between two freestanding tables. Adjustable brackets on both sides of the beam connect off module to the perpendicular standard beam and can be adjusted to accommodate 24" and 30" deep primary worksurfaces.



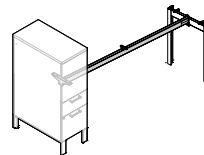
### TABLE TO STORAGE TELESCOPIC RETURN BEAM

Supports a return connected perpendicularly to a 24" or 30" deep primary work surface on one end and a storage cabinet on the other. This allows the return worksurface to be layered otop of storage without the need for an additional leg assembly.



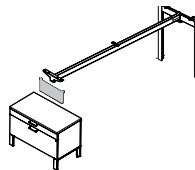
### STORAGE TABLE BEAM

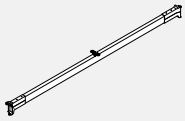
The Storage beam is connected to a single or Back 2 Back leg on one side and to the work surface on the opposite side - thus saving one leg (assembly work surface is connected to storage units with included storage brackets). Storage table beam's flexibility allows for a single table application (with the table leg tucked in under the work surface) as well as for a double table installation (two adjacent tables supported by a shared leg in the middle and two storage cabinets at the opposite ends).



### STORAGE TABLE BEAM ADAPTER

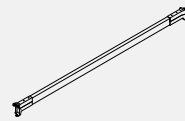
Connects to Storage table beam. This assembly allows a work surface to be supported by a leg on one side and a spine (formed by interconnected storage cabinets) on the opposite side.



**BRTSB-C • Standard Table Beam**

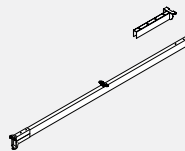
- **Standard table beam bridges two legs to form support for a single table, or two Back 2 Back work surfaces. Adjustable clamps at either end of the beam accommodate Standard table beam, end of run and interconnecting table beam applications. Adjustable brackets ship attached to the beam.**
- Specify Single Table Beam size corresponding nominally to the worksurface length. Includes all hardware necessary to connect to legs. Powder coated steel beam and aluminum cast clamps.
- Specify metal finish.
- Distance between bottom of beam and floor of standard height application is 25 3/8".

PRODUCT CODE	PRICE	SIZE/INCHES			WEIGHT VOL	
		H	W	D	LBS	FT <sup>3</sup>
BRTSB15C	151	2	10	1	1.28	0.01
BRTSB24C	193	2	19	1	2.03	0.01
BRTSB30C	195	2	25	1	2.70	0.02
BRTSB36C	197	2	31	1	3.31	0.03
BRTSB42C	200	2	37	1	3.59	0.04
BRTSB48C	208	2	43	1	4.60	0.05
BRTSB51C	217	2	45.5	1	4.81	0.05
BRTSB54C	225	2	49	1	4.86	0.06
BRTSB60C	234	2	55	1	5.45	0.07
BRTSB63C	238	2	57.5	1	5.72	0.08
BRTSB66C	240	2	61	1	6.09	0.08
BRTSB72C	249	2	67	1	6.74	0.09
BRTSB78C	260	2	73	1	7.38	0.12
BRTSB84C	265	2	79	1	8.02	0.15

**BRTBB-C • Bottom Table Beam**

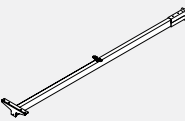
- **Bottom table beam connects to the lower cross beam on the 36" and 42" high "H" leg to create the footrest.**
- One beam required for each table
- Cannot be used as a substitute for the standard table beam.
- Specify the bottom table beam that corresponds to the worksurface length. Includes all hardware necessary to connect to "H" leg. Powder coated steel beam and aluminum cast clamps.
- Specify metal finish

PRODUCT CODE	PRICE	SIZE/INCHES			WEIGHT VOL	
		H	W	D	LBS	FT <sup>3</sup>
BRTBB36C	197	2	31	1	3.31	0.03
BRTBB42C	200	2	37	1	3.59	0.04
BRTBB48C	208	2	43	1	4.60	0.05
BRTBB54C	225	2	49	1	4.86	0.06
BRTBB60C	234	2	55	1	5.45	0.07
BRTBB66C	240	2	61	1	6.09	0.08
BRTBB72C	249	2	67	1	6.74	0.09
BRTBB78C	260	2	73	1	7.38	0.12
BRTBB84C	265	2	79	1	8.02	0.15

**BRTTB-C • Telescopic Table Return Beam**

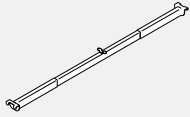
- **Provides support for a worksurface connected perpendicularly to a run of primary tables.**
- Can be adjusted to accommodate 24" and 30" deep primary worksurfaces.
- Adjustable clamp secures the beam to a Leg assembly on one side, while the other side of the beam connects off-module, to the perpendicular Standard Beam.
- The adjustable clamp can also be extended to allow for the leg to be tucked in under the work surface or to be shared by two adjacent work surfaces.
- Includes all hardware necessary to connect to legs.
- Powder coated steel and die-cast aluminum clamp.
- Distance between bottom of beam and floor of standard height application is 25 3/8".

PRODUCT CODE	PRICE	SIZE/INCHES			WEIGHT VOL	
		H	W	D	LBS	FT <sup>3</sup>
BRTTB36C	307	2	48.5	1	5.19	0.05
BRTTB42C	324	2	54.5	1	5.83	0.06
BRTTB48C	341	2	60.5	1	6.74	0.07
BRTTB54C	355	2	66.5	1	7.11	0.07
BRTTB60C	373	2	72.5	1	7.75	0.08
BRTTB66C	383	2	78.5	1	8.40	0.09
BRTTB72C	391	2	84.5	1	9.04	0.09
BRTTB78C	399	2	90.5	1	9.68	0.12
BRTTB84C	408	2	96.5	1	10.32	0.15

**BRTSTB-C • Storage Table Beam**

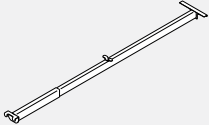
- **Storage Table Beam allows a worksurface to be supported by a leg on one side and storage tower(s) on the opposite side. The Storage beam is connected to a single or Back 2 Back leg on one side and to the worksurface on the opposite side - thus saving one leg assembly. The flexible arrangement of such a leg/beam/clamp assembly allows the leg to be tucked in under the work surface or to be shared by two adjacent work surfaces.**
- Also, applies to multiple, Back 2 Back Assemblies.
- Specify Storage table beam size corresponding nominally to the worksurface length. Includes all hardware necessary to connect to legs.
- Powder coated steel.
- Distance between bottom of beam and floor of standard height application is 25 3/8".

PRODUCT CODE	PRICE	SIZE/INCHES			WEIGHT VOL	
		H	W	D	LBS	FT <sup>3</sup>
BRTSTB36C	208	2	32.75	1	3.50	0.03
BRTSTB42C	217	2	38.75	1	4.16	0.04
BRTSTB48C	219	2	44.75	1	4.78	0.05
BRTSTB54C	234	2	50.75	1	5.43	0.05
BRTSTB60C	249	2	54.75	1	5.85	0.06
BRTSTB66C	265	2	62.75	1	6.74	0.07
BRTSTB72C	275	2	68.75	1	7.35	0.08
BRTSTB78C	283	2	74.75	1	7.99	0.08
BRTSTB84C	291	2	80.75	1	8.64	0.09

**BRT2TTB • Table to Table Telescopic Bridge Beam**

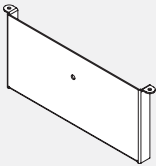
- Provides support for a worksurface connected between two primary tables.
- Can be adjusted to accommodate 24" and 30" deep primary worksurfaces.
- Adjustable brackets on both sides of the beam connect off-module to the perpendicular standard beam.
- Includes all hardware necessary to connect to legs.
- Power coated steel. Please specify colour.

PRODUCT CODE	PRICE	SIZE/INCHES			WEIGHT VOL	
		H	W	D	LBS	FT <sup>3</sup>
BRT2TTB36	331	2.52	61.3	3.41	8.7	3.5
BRT2TTB42	338	2.52	67.3	3.41	9.3	3.8
BRT2TTB48	343	2.52	73.3	3.41	9.9	4.2
BRT2TTB54	350	2.52	79.3	3.41	10.5	4.6
BRT2TTB60	354	2.52	85.3	3.41	11.1	4.9
BRT2TTB66	364	2.52	91.3	3.41	11.7	5.3
BRT2TTB72	370	2.52	97.3	3.41	12.3	5.6
BRT2TTB78	375	2.52	103.3	3.41	12.9	6.0
BRT2TTB84	382	2.52	109.3	3.41	13.5	6.4

**BRT2STTB • Table to Storage Telescopic Return Beam**

- Provides support for a return connected a primary work surface on one end and a storage cabinet on the other.
- Can be adjusted to accommodate 24" and 30" deep primary worksurfaces.
- Adjustable clamp secures the beam to a Storage Tower on one side, while the other side of the beam connects off-module, to the perpendicular Standard Beam.
- Includes all hardware necessary to connect to legs.
- Power coated steel. Please specify colour.

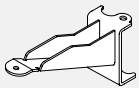
PRODUCT CODE	PRICE	SIZE/INCHES			WEIGHT VOL	
		H	W	D	LBS	FT <sup>3</sup>
BRT2STTB36	239	2.52	61.3	3.41	8.7	3.5
BRT2STTB42	246	2.52	67.3	3.41	9.3	3.8
BRT2STTB48	251	2.52	73.3	3.41	9.9	4.2
BRT2STTB54	260	2.52	79.3	3.41	10.5	4.6
BRT2STTB60	265	2.52	85.3	3.41	11.1	4.9
BRT2STTB66	271	2.52	91.3	3.41	11.7	5.3
BRT2STTB72	278	2.52	97.3	3.41	12.3	5.6
BRT2STTB78	284	2.52	103.3	3.41	12.9	6.0
BRT2STTB84	289	2.52	109.3	3.41	13.5	6.4

**BRTSA • Storage Table Beam Adapter**

- Storage table beam adapter allows a worksurface to be supported by a leg on one side and storage spine on the opposite side. A typical Storage spine is formed by series of interconnected 21" or 25" high storage cabinets of corresponding depth.

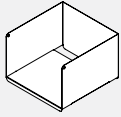
PRODUCT CODE	PRICE	SIZE/INCHES			WEIGHT VOL	
		H	W	D	LBS	FT <sup>3</sup>
BRTSA21	100	6.5	15.2	1	2.15	0.05
BRTSA25	83	2.75	15.2	1	4.3	0.02

- The Storage beam is connected to a single or Back 2 Back leg on one side and to the worksurface on the opposite side - thus saving one leg assembly.
- The 21" or 25" adapters provide structural support - acting as supports between top of the storage cabinet spine and the bottom of perpendicular worksurfaces.
- The flexible leg/beam/adaptor assembly arrangement allows the leg to be tucked in under the worksurface or to be shared by two adjacent worksurfaces. Included hardware connect the adapter to the worksurface and to the Spine storage beam adapter tower.
- Note: Specify Storage Beam nominally 18" shorter than worksurfaces for storage spine support application.
- Specify Storage Spine Adapter BRTSA21 (21") or BRTSA25 adapter (25") - depending on the height of Bridges storage units forming the spine.
- Includes all hardware necessary to connect the adapter to the beam, worksurface and storage spine.

**BRTLSC • Leg Support Cantilever**

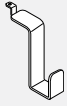
- Provides stability for leg supports.

PRODUCT CODE	PRICE	SIZE/INCHES			WEIGHT VOL	
		H	W	D	LBS	FT <sup>3</sup>
BRTLSC	124	3.5	7	2	0.5	0.007

**BRTESBBIN • Elevated Shelf Binder Bin**

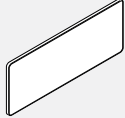
- **Elevated Shelf Binder Bin.**
- Frame finish.
- Not compatible with 16" Deep shared Overhead with Sliding Doors.
- Handy companion to 12" deep BRTBTS Shared Elevated Table Shelves. The bin rests on top surface, provides better utilization of vertical space, binder/ book manager, enhanced sense of privacy as well as magnetic board on the opposite side.

PRODUCT CODE	PRICE	SIZE/INCHES			WEIGHT VOL	
		H	W	D	LBS	FT <sup>3</sup>
BRTESBBIN	151	8	12	12	6	0.66

**BRTHB • Hanging Bracket**

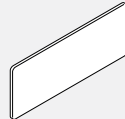
- **A formed steel bracket hooks over Bridges2 table leg. Can be secured either on the inner or outer side of the leg.**
- Frame Finish.

PRODUCT CODE	PRICE	SIZE/INCHES			WEIGHT VOL	
		H	W	D	LBS	FT <sup>3</sup>
BRTHB	25	3.5	1.5	3.3	0.2	0.01

**BRTWB • Whiteboard**

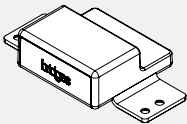
- **White dry-erase marker board surface on white powder coated steel backer.**
- Fits 16" tall Bridges 2 dividers and single-sided shelves. White dry-erase surface attaches magnetically to the steel backer, when removed the backer can be used as a magnetic board.

PRODUCT CODE	PRICE	SIZE/INCHES			WEIGHT VOL	
		H	W	D	LBS	FT <sup>3</sup>
BRTWB0924	207	8.5	24	0.5	1	0.56

**BRTTB • Tackboard**

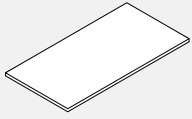
- **Grey tackboard surface on white powder coated steel backer.**
- Fits 16" tall Bridges 2 dividers and single sided shelves.

PRODUCT CODE	PRICE	SIZE/INCHES			WEIGHT VOL	
		H	W	D	LBS	FT <sup>3</sup>
BRTTB0924	207	8.5	24	0.5	1	0.56

**BRTTEGF • Table End Gap Filler**

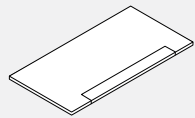
- **Injection molded block fills the gap finishing the end of Back 2 Back table assemblies. Secures to the bottom of two Back 2 Back worksurfaces.**
- Injection molded resin, white.

PRODUCT CODE	PRICE	SIZE/INCHES			WEIGHT VOL	
		H	W	D	LBS	FT <sup>3</sup>
BRTTEGF	9	1.1	2.5	4.5	0.025	0.006

**BRTWS • Rectangular Worksurface Top**

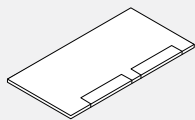
- **Worksurfaces are available in high pressure laminate (HP 1 1/16" thick) and low pressure laminate (LP 1" thick) with a flat 3 mm edge profile on all sides.**
- Worksurfaces provided with pilot holes for alignment purposes.
- Worksurface available in HP and LP.

PRODUCT CODE	PRICE		SIZE/INCHES			WEIGHT VOL	
	LP	HP	H	W	D	LBS	FT <sup>3</sup>
BRTWS2436	161	213	1	36	24	23	0.71
BRTWS2442	211	280	1	42	24	28	0.90
BRTWS2448	252	339	1	48	24	31	1.06
BRTWS2454	299	394	1	54	24	35	1.20
BRTWS2460	336	443	1	60	24	39	1.30
BRTWS2466	350	462	1	66	24	43	1.41
BRTWS2472	366	484	1	72	24	47	1.54
BRTWS2478	392	516	1	78	24	51	1.70
BRTWS2484	422	553	1	84	24	55	1.80
BRTWS3036	200	264	1	36	30	30	1.06
BRTWS3042	283	373	1	42	30	34	1.12
BRTWS3048	299	394	1	48	30	39	1.41
BRTWS3054	327	420	1	54	30	44	1.44
BRTWS3060	350	462	1	60	30	49	1.77
BRTWS3066	364	483	1	66	30	54	1.80
BRTWS3072	385	510	1	72	30	59	2.00
BRTWS3078	410	540	1	78	30	64	2.10
BRTWS3084	456	596	1	84	30	69	2.24
BRTWS3642	343	431	1	42	36	39	2.63
BRTWS3648	389	485	1	48	36	45	3.00
BRTWS3654	433	542	1	54	36	51	3.38
BRTWS3660	480	600	1	60	36	56	3.75
BRTWS3666	523	656	1	66	36	62	4.13
BRTWS3672	569	712	1	72	36	68	4.50
BRTWS3678	612	765	1	78	36	73	4.88
BRTWS3684	658	824	1	84	36	79	5.25

**BRTWSA • Rectangular Worksurface Top with Access Door**

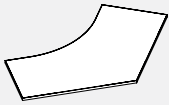
- **Tables Worksurfaces are available in high pressure laminate (HP: 1 1/16" thick), low pressure laminate (LP: 1" thick), 3 mm edging on all sides.**
- Worksurfaces provided with pilot holes for easier alignment purposes.
- Worksurfaces 42" through 72" have one access door.
- 3.5" deep anodized aluminum door provides access to power / data trough below worksurface.
- Access door is offset 13.5" from either side of worksurface.
- Worksurfaces with access doors cannot be combined with Above Worksurface Power Troughs.
- Worksurface available in HP and LP.

PRODUCT CODE	PRICE		SIZE/INCHES			WEIGHT VOL	
	LP	HP	H	W	D	LBS	FT <sup>3</sup>
BRTWSA2442	265	383	1	42	24	23	0.71
BRTWSA2448	299	433	1	48	24	28	0.90
BRTWSA2454	333	483	1	54	24	31	1.06
BRTWSA2460	373	535	1	60	24	35	1.20
BRTWSA2466	408	581	1	66	24	39	1.30
BRTWSA2472	441	639	1	72	24	43	1.41
BRTWSA3042	317	456	1	42	30	30	1.06
BRTWSA3048	355	516	1	48	30	34	1.12
BRTWSA3054	399	581	1	54	30	39	1.41
BRTWSA3060	441	639	1	60	30	44	1.44
BRTWSA3066	490	707	1	66	30	49	1.77
BRTWSA3072	523	763	1	72	30	54	1.80
BRTWSA3642	377	513	1	42	36	39	2.63
BRTWSA3648	449	608	1	48	36	45	3.00
BRTWSA3654	508	701	1	54	36	51	3.38
BRTWSA3660	570	777	1	60	36	56	3.75
BRTWSA3666	655	880	1	66	36	62	4.13
BRTWSA3672	709	964	1	72	36	68	4.50

**BRTWSAA • Rectangular Worksurface Top with 2 16" Access Doors**

- **Tables Worksurfaces are available in high pressure laminate (HP: 1 1/16" thick), low pressure laminate (LP: 1" thick), 3 mm edging on all sides.**
- Worksurfaces provided with pilot holes for easier alignment purposes.
- 3.5" deep anodized aluminum door provides access to power / data trough below worksurface.
- Access door is offset 10" (60" worksurfaces) and 13.5" (worksurfaces 66" and wider) from either side of worksurface.
- Worksurfaces with access doors cannot be combined with Above Worksurface Power Troughs.
- Dimension between doors is 8" for 60" and 66" long surfaces, 14" for 72", 20" for 78" and 26" for 84".
- Worksurface available in HP and LP. F
- Worksurfaces should not be used with Table Mounted Dividers BRPX3P21.

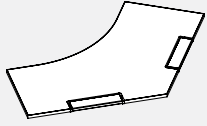
PRODUCT CODE	PRICE		SIZE/INCHES			WEIGHT VOL	
	LP	HP	H	W	D	LBS	FT <sup>3</sup>
BRTWSAA2460	405	575	1	60	24	35	1.20
BRTWSAA2466	441	630	1	66	24	39	1.30
BRTWSAA2472	476	692	1	72	24	43	1.41
BRTWSAA2478	480	697	1	78	24	47	1.54
BRTWSAA2484	508	752	1	84	24	51	1.70
BRTWSAA3060	476	692	1	60	30	44	1.44
BRTWSAA3066	534	762	1	66	30	49	1.77
BRTWSAA3072	563	826	1	72	30	54	1.80
BRTWSAA3078	568	846	1	78	30	59	2.00
BRTWSAA3084	603	897	1	84	30	64	2.10
BRTWSAA3660	537	748	1	60	36	56	3.75
BRTWSAA3666	622	854	1	66	36	62	4.13
BRTWSAA3672	670	948	1	72	36	68	4.50
BRTWSAA3678	695	983	1	78	36	73	4.88
BRTWSAA3684	763	1072	1	84	36	79	5.25

**BRTWAC120 • 120° Table Top**

- 5-sided worksurface can be used for a single, freestanding table, can form a pod of two or three tables, or can be combined with rectangular worksurfaces to create larger workstations.
- Worksurfaces provided with pilot holes for alignment purposes.

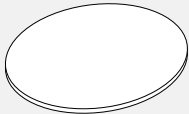
- Worksurface available in HP and LP.

PRODUCT CODE	PRICE		SIZE/INCHES			WEIGHT	VOL
	LP	HP	H	W	D	LBS	FT <sup>3</sup>
BRTWAC120424224	757	1003	1	42	24	31	1.06
BRTWAC120424230	824	1073	1	42	30	39	1.41

**BRTWAC120A • 120° Table Top with Access Door**

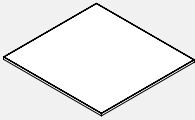
- 5-sided worksurface can be used for a single, freestanding table, can form a pod of two or three tables, or can be combined with rectangular worksurfaces to create larger workstations.
- 3.5" deep anodized aluminum door provides access to power / data trough below worksurface.
- 120° Worksurface as above with Worksurface access door - anodized aluminum worksurface access door provides access to power / data trough below worksurface.
- Worksurface with access doors cannot be combined with above worksurface power trough.
- Access door is offset 13.5" from either side of worksurface.
- Worksurface available in HP and LP.

PRODUCT CODE	PRICE		SIZE/INCHES			WEIGHT	VOL
	LP	HP	H	W	D	LBS	FT <sup>3</sup>
BRTWAC120A424224	804	1072	1	42	24	31	1.06
BRTWAC120A424230	868	1204	1	42	30	39	1.41

**BRTMTR • Round Meeting Table Top**

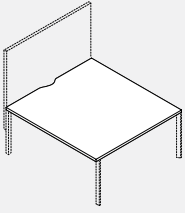
- Round top
- Worksurfaces provided with pilot holes for alignment purposes.
- Worksurface available in HP and LP.

PRODUCT CODE	PRICE		SIZE/INCHES			WEIGHT	VOL
	LP	HP	H	W	D	LBS	FT <sup>3</sup>
BRTMTR42	399	499	1	42	42	40	1.76

**BRTWS • Meeting Table Top**

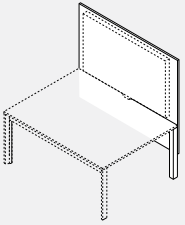
- Can create convenient, flexible extension of the Back 2 Back Bridges table assembly.
- Worksurfaces provided with pilot holes for alignment purposes.
- Meeting table top. 50.5" long side matches 24" deep, Back 2 Back Bridges table assembly
- Meeting table tops 62.5 long side matches 30" deep, Back 2 Back Bridges table assemblies.
- Worksurface available in HP and LP.

PRODUCT CODE	PRICE		SIZE/INCHES			WEIGHT	VOL
	LP	HP	H	W	D	LBS	FT <sup>3</sup>
BRTWS2451	299	394	1	50.5	24	31	1.06
BRTWS3051	312	410	1	50.5	30	37	1.41
BRTWS3651	465	542	1	50.5	36	43	1.71
BRTWS4251	514	653	1	50.5	42	48	1.93
BRTWS4851	586	736	1	50.5	48	52	2.07
BRTWS5151	626	770	1	50.5	50.5	55	2.12
BRTWS5451	678	864	1	50.5	54	59	2.19
BRTWS6051	770	962	1	50.5	60	63	2.26
BRTWS2463	342	454	1	62.5	24	39	1.41
BRTWS3063	354	473	1	62.5	30	49	1.77
BRTWS3663	522	656	1	62.5	36	53	1.94
BRTWS4263	626	786	1	62.5	42	57	2.07
BRTWS4863	752	941	1	62.5	48	61	2.13
BRTWS5463	849	1057	1	62.5	54	63	2.21
BRTWS6063	942	1174	1	62.5	60	67	2.34

**BRTWS-SCP • Display Wall Table Top with Scoop**

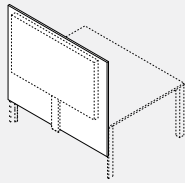
- Display wall mounts to the end of Bridges Back 2 Back table assembly supported by rectangular legs. As opposed to two separate Back 2 Back work surfaces, the Display Wall table top provides one continuous, uninterrupted surface with a scoop cutout next to the Display Wall (the scoop facilitates cable passage from below the table).
- Worksurfaces provided with pilot holes for alignment purposes.
- Table top: 50.5" long side matches 24" deep, Back 2 Back Bridges table assembly
- Meeting table tops 62.5 long side matches 30" deep, Back 2 Back Bridges table assemblies.
- Worksurface available in HP and LP.

PRODUCT CODE	PRICE		SIZE/INCHES			WEIGHT		VOL FT <sup>3</sup>
	LP	HP	H	W	D	LBS		
BRTWS4851SCP	586	736	1	50.5	48	60	1.40	
BRTWS5451SCP	678	864	1	50.5	54	68	1.58	
BRTWS6051SCP	770	962	1	50.5	60	75	1.75	
BRTWS4863SCP	752	941	1	62.5	48	75	1.74	
BRTWS5463SCP	849	1057	1	62.5	54	84	1.95	
BRTWS6063SCP	942	1174	1	62.5	60	93	2.17	

**BRTTVFT • Display Wall: Monitor Facing Double Work Station**

- Display wall mounts to the end of bridges Back 2 Back table assembly supported by bridges rectangular legs.
- Display faces the double work station - facilitates seated presentation area.
- Includes laminate board, TV/display brackets (black), mounting hardware, vertical cable manager (black). Slim (22mm) bracket capable of supporting displays/TVs up to 50" (resp. 62") wide, up to 80lbs. When installed, top of the 52" x 50.5" (resp. 62.5") wide board reaches 65.5" high.
- 1" LP or HP laminate board with 3mm edging. Different HP laminate finishes expand product functionality. For instance: white dryerase marker board laminate can be specified on "non-display" board surface. Specify laminate finish, HP laminate position (Display side, non-display side) and edging.
- Note: Included vertical cable manager passes through the gap between two Back 2 Back work surfaces. Should you need one continuous, uninterrupted surface specify Display Wall table top with a scoop (listed in the Work surface section of bridges Price List).
- Display wall mounts to the end of Bridges Back 2 Back table assembly supported by rectangular legs or Back 2 Back table structure with BRTWS-SCP Display Wall Table Top with scoop. As opposed to two separate Back 2 Back work surfaces, the BRTWS-SCP Display Wall Table Top provides one continuous, uninterrupted surface with a scoop cutout next to the display wall (the scoop facilitates cable passage from below the table top).
- Please add \$422 for white, dry erase on 51" wide Display Wall and \$576 for 63" wide.

PRODUCT CODE	PRICE		SIZE/INCHES			WEIGHT		VOL FT <sup>3</sup>
	LP	HP	H	W	D	LBS		
BRTTVFT51	1426	1900	52	50.5	4	62.00	6.08	
BRTTVFT63	1504	2059	52	62.5	4	74.00	7.52	

**BRTTVBK • Display Wall: Monitor Facing Back of Double Work Station**

- Display wall support board mounts to end of bridges Back 2 Back table assembly supported by bridges rectangular legs. Display faces back of the double work station - facilitates standing or seated presentation area (combine with collaborative seating).
- Includes laminate board, TV/display brackets (black), mounting hardware, vertical cable manager (black). Slim (22mm) bracket capable of supporting displays/TVs up to 50" (resp. 62") wide, up to 80lbs.
- When installed, top of the 52" x 50.5" (resp. 62.5") wide board reaches 65.5" high.
- 1" LP or HP laminate board with 3mm edging. Different HP laminate finished expand product functionality. For instance: white dry-erase marker board laminate can be specified on "non-display" board surface. Specify laminate finish, HP laminate position (Display side, non-display side) and edging.
- Display wall mounts to the end of Bridges Back 2 Back table assembly supported by rectangular legs or Back 2 Back table structure with BRTWS-SCP Display Wall Table Top with scoop. As opposed to two separate Back 2 Back work surfaces, the BRTWS-SCP Display Wall Table Top provides one continuous, uninterrupted surface with a scoop cutout next to the display wall (the scoop facilitates cable passage from below the table top).
- Please add \$422 for white, dry erase on 51" wide Display Wall and \$576 for 63" wide.

PRODUCT CODE	PRICE		SIZE/INCHES			WEIGHT		VOL FT <sup>3</sup>
	LP	HP	H	W	D	LBS		
BRTTVBK51	1426	1900	52	50.5	4	62.00	6.08	
BRTTVBK63	1504	2059	52	62.5	4	74.00	7.52	



## Power delivery / cable management

At the basic level, table and floor based office equipment is serviced by a wall or floor power supply. As the operation grows, there might be a need to organize excessive cable clutter.

Cable Basket (1) connects to the underside of worksurfaces with steel brackets and cables are simply dropped and coiled into them.

Cable Snake(2) installed in proximity of floor monument to manage vertical cable clutter.

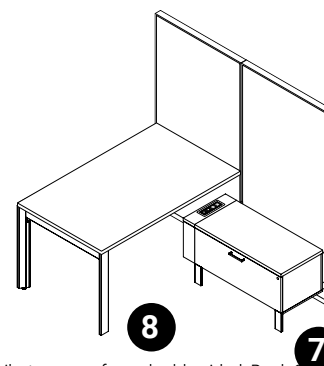
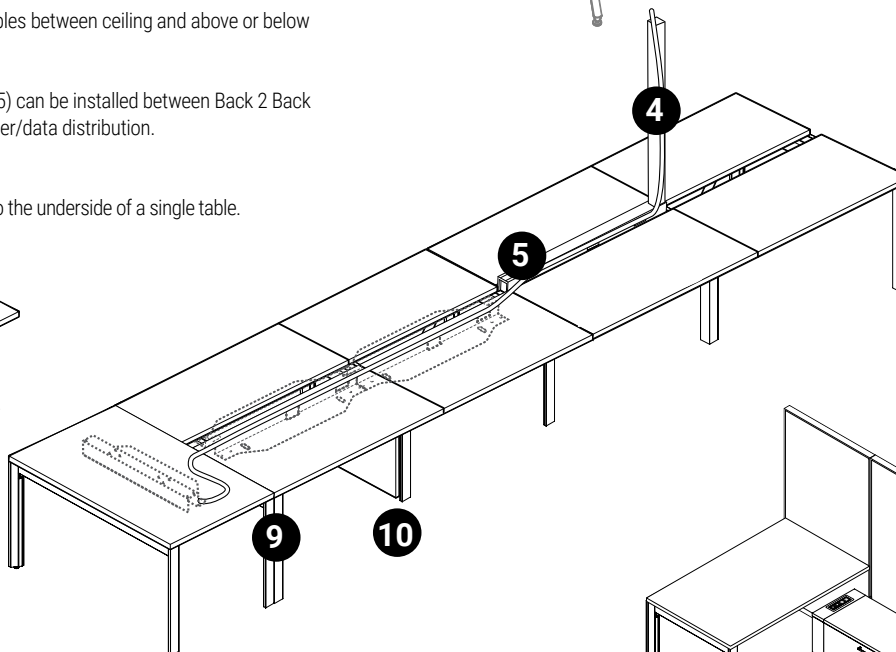
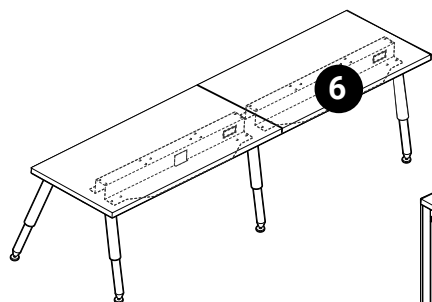
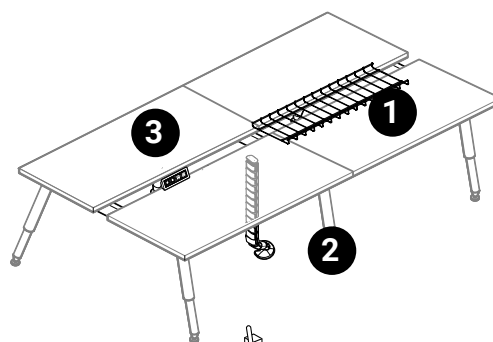
Table clamped, single circuit Desk Top Power Data Modules (3) deliver services to desk height, while tapping into wall or floor power supply. Again, the excessive cables can be managed with Cable Baskets.

Ceiling pole BRTCPP (4) manages power and data cables between ceiling and above or below worksurface power troughs.

Above and Below Worksurface Power/Data Troughs (5) can be installed between Back 2 Back tables for extended below and above desk height power/data distribution.

- 8 wire, 4-circuit system.

Single Sided Power/Data Troughs (6) can be installed to the underside of a single table.



Elevated storage units provide access to floor raceway power duplexes and data terminals (7). 1" gap between panels and storage allow for easy passage of cables.

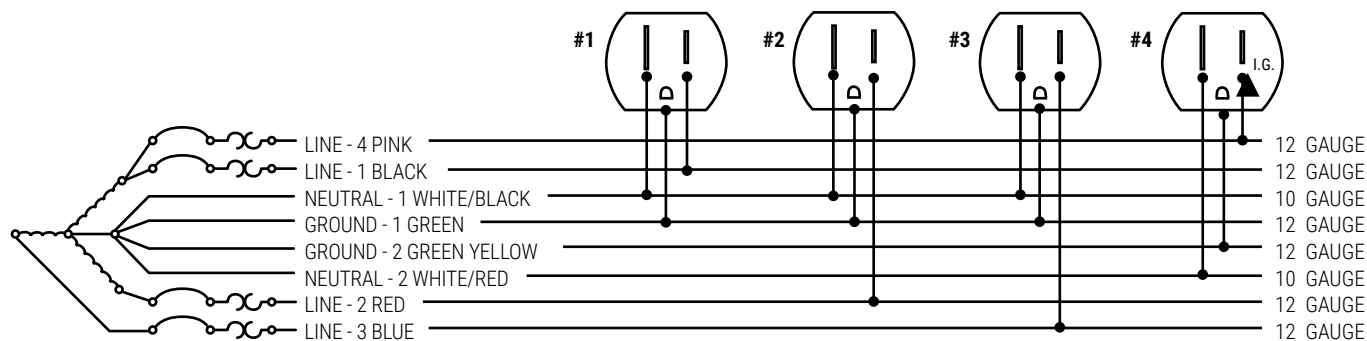
Some storage units can be connected to panel vertical slots and those allow to open and access panel floor raceway.

Storage power/data box BRTVCM (8) attaches to storage units and provides access to one duplex/data terminal on top storage surface. Integrated single circuit module can be plugged to floor monument under the storage, to a wall outlet or to a panel floor raceway duplex receptacle.

NOTE: Specify BRTHH58 (9) to distribute power from double sided, Back 2 Back below worksurface power trough to a single sided, below work surface power trough at the end of a table run.

Leg shroud (10) attaches to 34" wide legs and manages power floor feed as well as data cables from floor monument.

## Electrical system



An 8-wire, 4-circuits, 3+1 electrical systems complies with UL 1286

8 Wires  
4 Lines (12ga.)  
2 Neutrals  
2 Grounds (12ga.)

4 Circuits  
3 Utility Circuit  
1 Isolated Circuit

Receptacles  
Duplex - Up to 6 duplex receptacles per circuit

Specifications  
120 VAC system rated at 20A (15 CSA)



**BRED50AC • Duo Module with A+C**

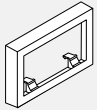
- The Duo power module is completely integrated with a mounting clamp to attach to the edge of a worksurface.
- 10' long three-prong cord.
- Provides two 15 Amp 120 Volt AC Receptacles; 2.4 amp USB-A port and 60 watt USB-C power delivery port.
- Available in W - White or B - Black as indicated by last letter of model number.

PRODUCT CODE	PRICE	SIZE/ INCHES			WEIGHT VOL	
		H	W	D	LBS	FT <sup>3</sup>
BRED50ACW	695	3	5.5	3.2	3	0.2
BRED50ACB	695	3	5.5	3.2	3	0.2

**BREDU51AC • Duo Under Module with A+C**

- The Duo under power module comes with a thin flush mounting bracket to attach to the underside of a work surface or above work surface shelves.
- 10' long three-prong cord.
- Provides two 15 Amp 120 Volt AC Receptacles; 2.4 amp USB-A port and 60 watt USB-C power delivery port.
- Available in W - White or B - Black as indicated by last letter of model number.

PRODUCT CODE	PRICE	SIZE/ INCHES			WEIGHT VOL	
		H	W	D	LBS	FT <sup>3</sup>
BREDU51ACW	695	1.8	5.5	2.8	3	0.2
BREDU51ACB	695	1.8	5.5	2.8	3	0.2

**B RTPDS • Data/Comm Spacer**

- Data/comm plate spacer extends the depth behind data/comm jacks by 0.6" in order to accommodate larger data/com cable bending radius.
- Black finish.
- "W" indicates White, "S" indicates Silver.

PRODUCT CODE	PRICE	SIZE/INCHES			WEIGHT VOL	
		H	W	D	LBS	FT <sup>3</sup>
B RTPDS	46	2.04	4.75	0.6	0.1	0.01
B RTPDSW	46	2.04	4.75	0.6	0.1	0.01
B RTPDSS	46	2.04	4.75	0.6	0.1	0.01

**BRACS • Cable Snake**

- Flexible cable management trough.
- Two pathways within the snake, one for data/communication and one for routing power cables.
- Clear (CLR) available only.

PRODUCT CODE	PRICE	SIZE/INCHES			WEIGHT VOL	
		H	W	D	LBS	FT <sup>3</sup>
BRACS	127	30	8	2	3	0.19
BRACSH	213	49	8	2	5	0.27

**B RTCM • Wire Manager**

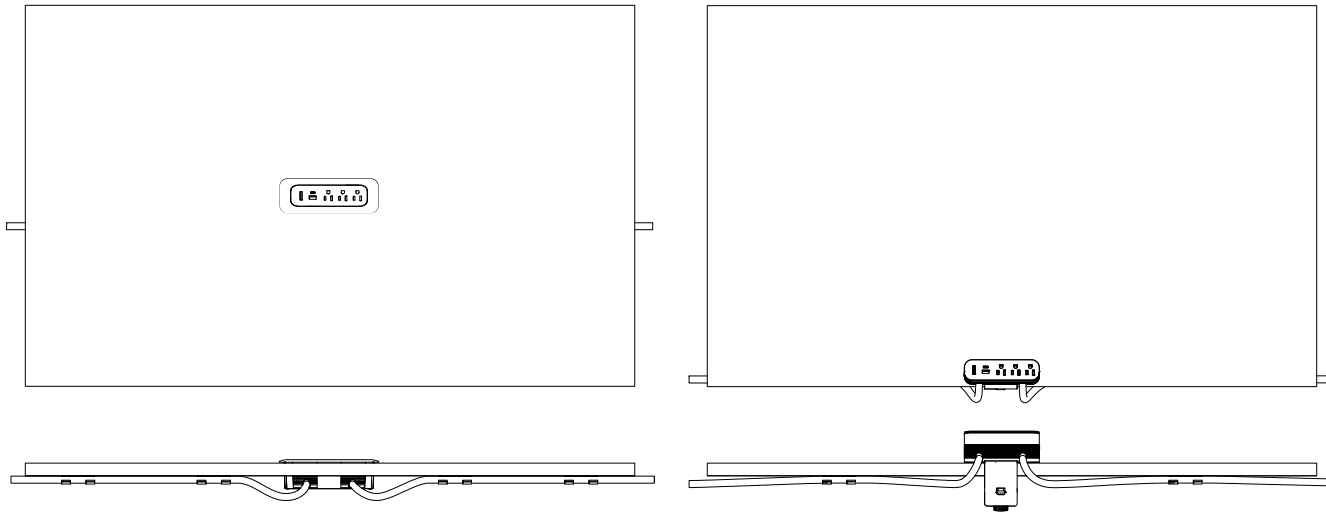
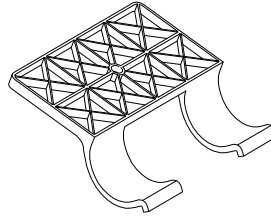
- Replacement wire manager can be added to Bridges. Wire manager neatly organizes and stores electrical and communication cables.
- Two lengths, 46" for tops 60" and under, 58" for tops 72".

PRODUCT CODE	PRICE	SIZE/INCHES			WEIGHT VOL	
		H	W	D	LBS	FT <sup>3</sup>
B RTCM43	48	3	5	46	8	0.67
B RTCM55	60	3	5	58	9	0.85

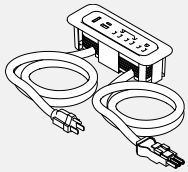
## ModPower Power Solution

- Power solutions for flexible spaces. Connect up to four units (in Canada)/six units in the USA from a single infeed with NEMA plug to deliver power and charging ports to the table top. In-surface modules and clamp on modules available.
- Easy to install; code compliant that allows users to optimize any space providing convenient power access. Perfect for training areas, meeting rooms, in-office workstations and more. Units feature tamper-resistant receptacles as well as both USB-A and USB-C charging ports.
- Easy to use connectors that are touch-safe with added latch to prevent unintended separation. Easy push together to connect, and simple press down on latch to disconnect.
- Maximum overall length not to exceed 48.5 feet per infeed. UL listed to UL962A SD, the standard for furniture power distribution units for portable/moveable work space tables.
- Certified to CSA standard C22.2 No. 203-16.
- Will work with Licence, Terina and Bridges Products.

- Surface mounted module ships with a clamp mount that will accommodate any material 1/2" to 1-1/2" thick; additional brackets are also included for screw in mounting options that can accommodate vertical or horizontal positions.



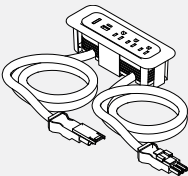
### GMDSF10 • ModPower In Surface Starter Unit



- ModPower starter unit includes one 10' cord with a NEMA plug and one 3' connector cord.
- Unit equipped with three 15A tamper resistant receptacles, one USB-A and one USB-C charging ports and a circuit breaker.
- 4 cable management cord clips included.
- MG at the end of the code indicates a magnesium finish, while WH is a white finish.

PRODUCT CODE	PRICE	DIMENSIONS			WEIGHT		VOL FT <sup>3</sup>
		H	W	D	LBS		
GMDSF10MG	597	2.63	7.63	2.63	3.44	1.0	
GMDSF10WH	597	2.63	7.63	2.63	3.44	1.0	

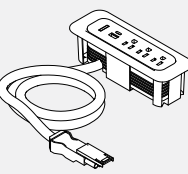
### GMDCF3 • ModPower In Surface Middle Unit



- ModPower middle unit includes two 3' connector cords.
- Unit equipped with three 15A rated 12A tamper resistant receptacles, one USB-A and one USB-C charging ports and a circuit breaker.
- 4 cable management cord clips included.
- MG at the end of the code indicates a magnesium finish, while WH is a white finish.

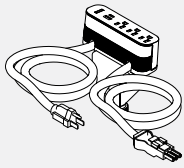
PRODUCT CODE	PRICE	DIMENSIONS			WEIGHT		VOL FT <sup>3</sup>
		H	W	D	LBS		
GMDCF3MG	562	2.63	7.63	2.63	2.44	1.0	
GMDCF3WH	562	2.63	7.63	2.63	2.44	1.0	

### GMDEF3 • ModPower In Surface End Unit



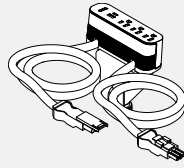
- ModPower end unit includes one 3' connector cord.
- Unit equipped with three 15A rated 12A tamper resistant receptacles, one USB-A and one USB-C charging ports and a circuit breaker.
- 2 cable management cord clips included.
- MG at the end of the code indicates a magnesium finish, while WH is a white finish.

PRODUCT CODE	PRICE	DIMENSIONS			WEIGHT		VOL FT <sup>3</sup>
		H	W	D	LBS		
GMDEF3MG	494	2.63	7.63	2.63	1.85	1.0	
GMDEF3WH	494	2.63	7.63	2.63	1.85	1.0	

**GMDSA10 • ModPower Starter Mounted Unit**

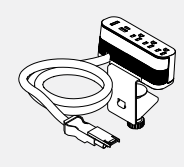
- ModPower starter unit includes one 10' cord with a NEMA plug and one 3' connector cord.
- Unit equipped with three 15A tamper resistant receptacles, one USB-A and one USB-C charging ports and a circuit breaker.
- Includes edge clamp and 3 other mounting methods; and 4 cable management cord clips.
- MG at the end of the code indicates a magnesium finish, while WH is a white finish.

PRODUCT CODE	PRICE	PRICE			WEIGHT		VOL FT <sup>3</sup>
		H	W	D	LBS	FT <sup>3</sup>	
GMDSA10MG	631	2.5	6.13	1.75	4.33	1.0	
GMDSA10WH	631	2.5	6.13	1.75	4.33	1.0	

**GMDCA3 • ModPower Middle Mounted Unit**

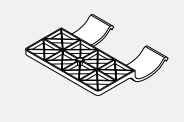
- ModPower middle unit includes two 3' connector cords.
- Unit equipped with three 15A rated 12A tamper resistant receptacles, one USB-A and one USB-C charging ports and a circuit breaker.
- Includes edge clamp and 3 other mounting methods; and 4 cable management cord clips.
- MG at the end of the code indicates a magnesium finish, while WH is a white finish.

PRODUCT CODE	PRICE	PRICE			WEIGHT		VOL FT <sup>3</sup>
		H	W	D	LBS	FT <sup>3</sup>	
GMDCA3MG	597	2.5	6.13	1.75	3.33	1.0	
GMDCA3WH	597	2.5	6.13	1.75	3.33	1.0	

**GMDEA3 • ModPower End Mounted Unit**

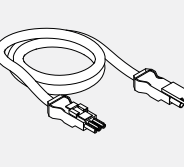
- ModPower end unit includes one 3' connector cord.
- Unit equipped with three 15A rated 12A tamper resistant receptacles, one USB-A and one USB-C charging ports and a circuit breaker.
- Includes edge clamp and 3 other mounting methods; and 2 cable management cord clips.
- MG at the end of the code indicates a magnesium finish, while WH is a white finish.

PRODUCT CODE	PRICE	PRICE			WEIGHT		VOL FT <sup>3</sup>
		H	W	D	LBS	FT <sup>3</sup>	
GMDEA3MG	528	2.5	6.13	1.75	2.75	1.0	
GMDEA3WH	528	2.5	6.13	1.75	2.75	1.0	

**GMDCLIPS • ModPower Management Clips**

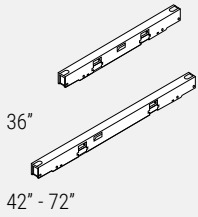
- Includes 10 clips.

PRODUCT CODE	PRICE	PRICE			WEIGHT		VOL FT <sup>3</sup>
		H	W	D	LBS	FT <sup>3</sup>	
GMDCLIPS	102	0.6	2.6	2.5	0.3	0.2	

**GMDJ36BK • ModPower Interconnecting Jumper**

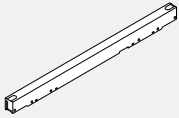
- ModPower interconnecting jumper cord to add an additional 3 feet of cord length between ModPower units.
- Package of 2, each 3 feet with male & female connector.

PRODUCT CODE	PRICE	PRICE			WEIGHT		VOL FT <sup>3</sup>
		H	W	D	LBS	FT <sup>3</sup>	
GMDJ36BK	329		36		1.38	0.9	

**BRTETA-KIT • Above Worksurface Power Trough**

- **Above Worksurface Power Trough Kit Facilitates power distribution and data/communication cable management.**
- Formed steel trough is secured between Back 2 Back stations. Not suitable for single table assemblies.
- Power Trough Kits 36-72 consist of one double sided steel trough, Power Distribution Housing, mounting brackets and one charcoal grey extruded Data/Communication cable manager.
- Power Trough Kits 78 and 84 consist of two double sided steel troughs (BRTETA78KIT = BRTETA36 above KIT + BRTETA42KIT + Jumper. BRTETA84KIT = BRTETA42KIT + BRTETA42KIT + Jumper), two Power Distribution Housings, mounting brackets and two charcoal grey extruded Data/Communication cable managers.
- Specify Duplex receptacles separately. 36" trough can house one duplex per side and 42-72" trough can house two duplexes per side, 78" trough can house three duplexes and 84" trough can house four duplexes per side. Specify Jumpers between tables separately.
- Ceiling feed entry through slots at either end; base feed entry at either end.
- Each trough provides two openings 1.37" x 2.68"(one per side) for data/communication terminal plates. A single terminal plate (not supplied) can accommodate up to 4 data/communication plates.
- Data/comm plate spacer BRTPDS available to accommodate larger cable-to-terminal bending radius
- Each trough provides two openings 1.37" x 2.68"(one per side) for data/communication terminal plates. A single terminal plate (not supplied) can accommodate up to 4 data/communication terminals (jacks).
- Painted finish.
- Specify above worksurface power trough end cap BRTETEC to finish open ends of the power trough.
- Each trough includes one black (BRTPDS) data/comm spacer extending the depth behind the data/comm jacks by 0.6". White (BRTPDSW) and Silver (BRTPDSS) are also available as an option. Additional spacers may be purchased individually for \$45 list, see BRTPDS.

PRODUCT CODE	PRICE	SIZE/INCHES			WEIGHT VOL	
		H	W	D	LBS	FT <sup>3</sup>
BRTETA36KIT	500	3.5	35.9	2.5	4.06	0.18
BRTETA42KIT	541	3.5	41.9	2.5	4.73	0.21
BRTETA48KIT	574	3.5	47.9	2.5	5.41	0.24
BRTETA54KIT	607	3.5	53.9	2.5	6.09	0.27
BRTETA60KIT	625	3.5	59.9	2.5	6.77	0.30
BRTETA66KIT	672	3.5	65.9	2.5	7.45	0.33
BRTETA72KIT	683	3.5	71.9	2.5	8.12	0.36
BRTETA78KIT	1038	3.5	78	2.5	8.81	0.39
BRTETA84KIT	1083	3.5	84	2.5	9.49	0.42

**BRTEST-KIT • Back 2 Back Storage Tower Gap Filler Kit**

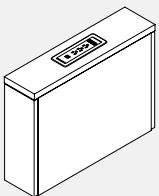
- **Consists of a formed sheet metal cover and four brackets which allow the cover to be mounted at either above worksurface power trough level or below work surface power trough level.**
- Versatile brackets secure the cover trough at corners, to the bottom of Back 2 Back work surface supported by either shared 51 or 63 legs or storage beam and storage towers.
- Note: the Back 2 Back storage tower gap filler is not compatible with single, freestanding tables.
- The BRTEST15kit covers the gap between two Back 2 Back BRRT5024x or BRRT5030x storage towers.
- The BRTEST30kit covers the gap between two pairs of Back 2 Back BRRT5024x or BRRT5030x storage towers.
- The BRTEST24kit covers the gap between two Back 2 Back BRRTW5024x or BRRTW5030x storage towers.
- The BRTEST48kit covers the gap between two pairs of Back 2 Back BRRTW5024x or BRRTW5030x storage towers.
- A corresponding harness is included.

PRODUCT CODE	PRICE	SIZE/INCHES			WEIGHT VOL	
		H	W	D	LBS	FT <sup>3</sup>
BRTEST15KIT	441	3.5	2.5	15.5	2	0.078
BRTEST30KIT	510	3.5	2.5	31	3.5	0.157
BRTEST24KIT	478	3.5	2.5	24	2.5	0.122
BRTEST48KIT	563	3.5	2.5	48	4	0.243

**BRTETEC • Above Worksurface Power Trough End Cap**

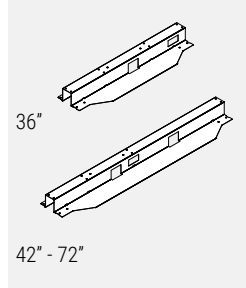
- **Covers the ends of the worksurface power trough.**
- Specify two per linear trough assembly.
- Finish white

PRODUCT CODE	PRICE	SIZE/INCHES			WEIGHT VOL	
		H	W	D	LBS	FT <sup>3</sup>
BRTETEC	9	3.1	2.25	0.5	0.1	0.002

**BRTVCM • Vertical Cable Manager**

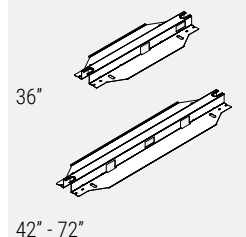
- 6" wide vertical channel which can be secured to an end or in-between 21" or 25" high storage units of corresponding depth.
- Facilitates power / data transfer from a floor monument under storage cabinets or from a panel base raceway to top of storage units.
- The units can join other 18" or 24" deep storage units to form a storage spine.
- Floor clearance allows for access to panel floor raceway duplex outlets.
- Removable top with a Below Worksurface Power/Data Module provides easy access.
- Optional Cable Basket suspends off storage unit's bottoms and manages cables along the horizontal plane.
- 3/4" LP chassis, fronts and back (specify LP finish), 1" top (specify LP or HP finish); unfinished cut-out edges. Universal connecting hardware included.
- Flush-mounted power module included.
- Provides three outlets and two 2.1 amp USB ports and an adapter kit containing blank cover, HDMI, RJ45 or VGA adapter brackets. Note: HDMI, RJ45 and VGA connectors are not included.

PRODUCT CODE	PRICE	SIZE/INCHES			WEIGHT VOL		
		LP	HP	H W D	LBS	FT <sup>3</sup>	
BRTVCM2118	930	948	21	6	18	14	1.31
BRTVCM2518	948	963	25	6	18	17	1.56
BRTVCM2124	982	998	21	6	24	17	1.75
BRTVCM2524	998	1015	25	6	24	22	2.08

**BRTETB-SKIT • Below Worksurface Single Power/Data Trough**

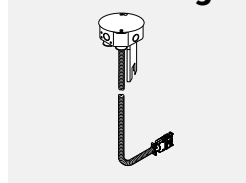
- **Below Worksurface Single Power Trough Kit Facilitates power distribution and data/communication cable management.**
- Formed steel trough is secured below a single table worksurface; outlets are facing the rear worksurface edge.
- Not suitable for Back 2 Back tables
- Power Trough Kits 36-72 consist of one single sided steel trough, Power Distribution Housing, mounting brackets and one charcoal grey extruded Data/Communication cable manager.
- Power Trough Kits 78 and 84 consist of two single sided steel troughs (BRTETB78KIT = BRTETB36KIT + BRTETB42KIT + Jumper. BRTETB84KIT = BRTETB42KIT + BRTETB42KIT + Jumper), two Power Distribution Housings, mounting brackets and two charcoal grey extruded Data/Communication cable managers.
- Specify Duplex receptacles separately. 36" trough can house one duplex, 42-72" trough can house two duplexes, 78" through can house three duplexes and 84" trough can house four duplexes per side.
- Specify Jumpers between tables separately.
- Base feed entry at either end; no ceiling feed.
- Each trough provides one opening 1.37" x 2.68" for terminal plate (not supplied). One terminal plate can accommodate up to 4 data/communication terminals (jacks).
- Each trough includes one black (BRTPDSS) data/comm spacer extending the depth behind the data/comm jacks by 0.6". White (BRTPDSSW) and Silver (BRTPDSSS) are also available as an option. Additional spacers may be purchased individually for \$45 list, see BRTPDSS.
- Painted finish.
- Note: Please specify BRTETB36SKIT Single Trough Kit for 120° Degree Tables BRTWAC120

PRODUCT CODE	PRICE	SIZE/INCHES			WEIGHT VOL	
		H	W	D	LBS	FT <sup>3</sup>
BRTETB36SKIT	441	2.5	30.34	8.5	4.5	0.59
BRTETB42SKIT	483	2.5	36.34	8.5	5.3	0.61
BRTETB48SKIT	523	2.5	42.34	8.5	6.2	0.71
BRTETB54SKIT	548	2.5	48.34	8.5	7.1	0.81
BRTETB60SKIT	557	2.5	54.34	8.5	8.0	0.91
BRTETB66SKIT	581	2.5	60.34	8.5	8.9	1.01
BRTETB72SKIT	600	2.5	66.34	8.5	9.8	1.11
BRTETB78SKIT	922	2.5	72.34	8.5	11.0	1.21
BRTETB84SKIT	963	2.5	78.34	8.5	12.0	1.31

**BRTETB-DKIT • Below Worksurface Double Power/Data Trough**

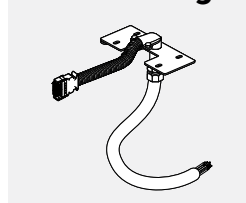
- **Below Worksurface Double Power Trough Kit Facilitates power distribution and data/communication cable management.**
- Formed steel trough is secured below worksurfaces, between Back 2 Back stations, supported by Back 2 Back Legs.
- Not suitable for single table assemblies.
- Power Trough Kits 36-72 consist of one double sided steel trough, Power Distribution Housing, mounting brackets and one charcoal grey extruded Data/Communication cable manager.
- Power Trough Kits 78 and 84 consist of two double sided steel troughs (BRTETB78KIT = BRTETB36KIT + BRTETB42KIT + Jumper. BRTETB84KIT = BRTETB42KIT + BRTETB42KIT + Jumper), two Power Distribution Housings, mounting brackets and two charcoal grey extruded Data/Communication cable managers.
- Specify Duplex receptacles separately. 36" trough can house one duplex per side, 42-72" trough can house two duplexes, 78" trough can house three duplexes and 84" trough can house four duplexes per side.
- Specify Jumpers between tables separately.
- Ceiling feed entry through slots at either end; base feed entry at either end.
- Each trough provides two openings 1.37" x 2.68" (one per side) for data/communication terminal plates (not supplied).
- Painted finish.
- Each trough includes one black (BRTPDSS) data/comm spacer extending the depth behind the data/comm jacks by 0.6". White (BRTPDSSW) and Silver (BRTPDSSS) are also available as an option. Additional spacers may be purchased individually for \$45 list, see BRTPDSS.

PRODUCT CODE	PRICE	SIZE/INCHES			WEIGHT VOL	
		H	W	D	LBS	FT <sup>3</sup>
BRTETB36DKIT	607	2.5	30.3	11.6	3.8	0.37
BRTETB42DKIT	625	2.5	36.3	11.6	4.5	0.44
BRTETB48DKIT	652	2.5	42.3	11.6	5.3	0.52
BRTETB54DKIT	665	2.5	48.3	11.6	6.0	0.59
BRTETB60DKIT	683	2.5	54.3	11.6	6.8	0.66
BRTETB66DKIT	707	2.5	60.3	11.6	7.5	0.74
BRTETB72DKIT	723	2.5	66.3	11.6	8.3	0.81
BRTETB78DKIT	1232	2.5	72.3	11.6	9.0	0.88
BRTETB84DKIT	1245	2.5	78.3	11.6	9.8	0.96

**BRTCF • Bridges Ceiling Feed**

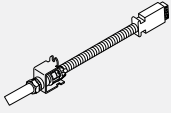
- **Ceiling feed provides a single power entry from ceiling, through Ceiling pole into Power Trough, into Power Distribution Housing.**
- An 8-wire (4-circuit) metal conduit harness with included metal junction box for hard wiring to the building power supply above ceiling tile.
- Must be hard wired to the building power supply by a licensed electrician.
- Ceiling Pole not included.

PRODUCT CODE	PRICE	SIZE/INCHES			WEIGHT VOL	
		H	W	D	LBS	FT <sup>3</sup>
BRTCF120	450	120	6	6	5	2
BRTCF144	501	144	6	6	6	3

**BRTBF • Bridges Base Feed**

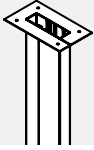
- **Provides single power entry from floor or wall located building power supply.**
- Connects to Power Distribution Housing.
- Must be hard wired to the building power supply by a licensed electrician.

PRODUCT CODE	PRICE	SIZE/INCHES			WEIGHT VOL	
		H	W	D	LBS	FT <sup>3</sup>
BRTBF	494	4	72	6	4	2
BRTBF120	705	4	120	6	6	2
BRTBF144	760	4	144	6	8	2

**BRTDIVPBF • Bridges Divider Panel Base Feed**

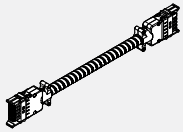
- Provides single power entry from floor or wall located building power supply.
- Connects to Power Distribution Housing.
- Must be hard wired to the building power supply by a licensed electrician.

PRODUCT CODE	PRICE	SIZE/INCHES			WEIGHT VOL	
		H	W	D	LBS	FT <sup>3</sup>
BRTDIVPBF	473	4	72	6	4	2

**BRTCPP • Bridges Ceiling Pole**

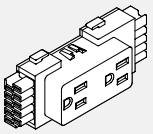
- Ceiling pole brings ceiling feed conduit and data cables from the ceiling down to Power troughs at desk height. Accommodates 10' ceiling heights.
- A two part construction allows power/data conduit lay-in.
- Includes mounting hardware and ceiling bezel.
- Painted finish.

PRODUCT CODE	PRICE	SIZE/INCHES			WEIGHT VOL	
		H	W	D	LBS	FT <sup>3</sup>
BRTCPP	249	99	4.75	1.5	13	0.48

**BRTHH • Housing to Housing Harness**

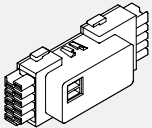
- Distributes power between Power Distribution Housings.
- Specify BRTHH58 to distribute power from double sided, Back 2 Back below the worksurface power trough to a single sided, below work surface power trough at the end of a table run.  
(Please see Power Delivery page at the beginning of electrical section (item #9)).

PRODUCT CODE	PRICE	SIZE/INCHES			WEIGHT VOL	
		H	W	D	LBS	FT <sup>3</sup>
BRTHH28	160	2	28	0.5	1.0	1.17
BRTHH44	190	2	44.5	0.5	1.5	1.17
BRTHH52	201	2	52.5	0.5	2.0	1.17
BRTHH58	208	2	58.5	0.5	2.2	1.17
BRTHH76	233	2	76.5	0.5	2.8	1.17

**BRT8D • Duplex Receptacles**

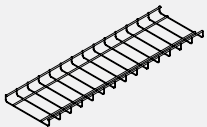
- Snaps into Power Distribution Housing.
- Up to 6 duplex receptacles per circuit.
- D1 = Circuit #1 (utility circuit)
- D2 = Circuit #2 (utility circuit)
- D3 = Circuit #3 (utility circuit)
- DA - Circuit #A (dedicated circuit)
- XW identifies white colour plastic, all others in standard black.

PRODUCT CODE	PRICE	SIZE/INCHES			WEIGHT VOL	
		H	W	D	LBS	FT <sup>3</sup>
BRT8D1	35	2	4.625	1.25	0.10	0.01
BRT8D2	35	2	4.625	1.25	0.10	0.01
BRT8D3	35	2	4.625	1.25	0.10	0.01
BRT8DA	35	2	4.625	1.25	0.10	0.01
BRT8DXW1	52	2	4.625	1.25	0.10	0.01
BRT8DXW2	52	2	4.625	1.25	0.10	0.01
BRT8DXW3	52	2	4.625	1.25	0.10	0.01
BRT8DXWA	52	2	4.625	1.25	0.10	0.01

**BE8D • USB Receptacles**

- Snaps into Power Distribution Housing.
- USB charging module provides convenient charging power access through dual ports on face of receptacles.
- Two USB ports.
- 2 amp output, considered as circuit #1.

PRODUCT CODE	PRICE	SIZE/INCHES			WEIGHT VOL	
		H	W	D	LBS	FT <sup>3</sup>
BRT8DU1-W	238	2	4.625	1.25	0.10	0.01
BRT8DU1-B	238	2	4.625	1.25	0.10	0.01

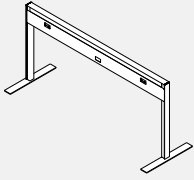
**BRTCB • Power/Data Cable Basket**

- Shallow, 8" wide basket manages cable excess. If suspended below Back 2 Back worksurfaces, it facilitates the simplest way of electrifying a workstation. The equipment can be plugged directly to a wall or floor monument outlets and the Cable Basket serves to manage cords and cables. It can be easily unclipped from steel brackets (included) to rearrange cable connections from below the worksurface.
- The same steel brackets can suspend the Cable Basket below storage cabinet's bottom where it keeps the cords and cables off the floor and manages them under storage cabinets along the horizontal plane - between panel base raceway outlets, floor monuments and Storage Vertical Cable Manager, for example.
- Tall storage cabinet's legs provide easy access to the Cable Basket where it can be easily unclipped from steel brackets (included) to rearrange cable connections.
- Note: wide Cable Baskets can span under several storage cabinets. As a general rule - specify Cable Basket min. 8" shorter than the storage cabinet spine assembly.
- Steel wire construction, black finish baskets; black steel hanging brackets, fasteners.
- BRTCB76KIT contains 2 pieces BRTCB34.

PRODUCT CODE	PRICE	SIZE/INCHES			WEIGHT VOL	
		H	W	D	LBS	FT <sup>3</sup>
BRTCB8	80	1	8	8	0.36	0.03
BRTCB16	89	1	16	8	0.73	0.07
BRTCB22	93	1	22	8	1.01	0.10
BRTCB28	100	1	28	8	1.20	0.13
BRTCB34	114	1	34	8	1.56	0.15
BRTCB40	117	1	40	8	1.80	0.18
BRTCB46	127	1	46	8	2.16	0.21
BRTCB52	133	1	52	8	2.39	0.24
BRTCB58	144	1	58	8	2.66	0.26
BRTCB64	146	1	64	8	2.94	0.29
BRTCB70	159	1	70	8	3.22	0.34
BRTCB76KIT	218	1	34	8	1.56	0.15



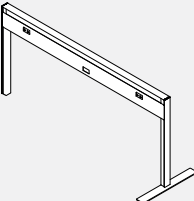
## BRPBS • Starter Beam



- Bridges Power Beam divides space, delineates territory, provides power and data to adjacent work spaces.
- Starter Beam can serve as a single, standalone unit or the beginning of a longer run of interconnected beams.
- 30" to 72" wide beams feature knockouts for two electrical duplex and one communication face plate on each side while 24" wide beams accommodate one electrical duplex and one communication face plate on each side.
- The leg expands by approximately 4" in height to compensate for uneven floors and allow for accurate levelling. Feet depth is 24".
- Starter Beam consist of the horizontal channel, raceway covers, two legs, two 24" deep feet, two vertical end trims and corresponding end trim capture strips.
- Specify standard Flat Top Trim (BRPBTC), Glass and Top Trim Kit (BRPBEG) or PET Felt and Top Trim Kit (BRPBEF) separately.
- Specify electrical components separately.
- Specify standard metal paint finish.
- Final built up height is not to exceed 50" high, including over panels.

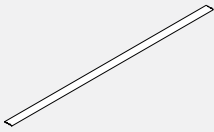
PRODUCT CODE	PRICE	SIZE/INCHES			WEIGHT LBS	VOL FT <sup>3</sup>
		H	W	D		
BRPBS1824	406	18	24	24	20.23	6.00
BRPBS1830	431	18	30	24	21.83	7.50
BRPBS1836	450	18	36	24	23.14	9.00
BRPBS1842	471	18	42	24	24.46	10.50
BRPBS1848	496	18	48	24	25.77	12.00
BRPBS1854	517	18	54	24	27.08	13.50
BRPBS1860	538	18	60	24	28.39	15.00
BRPBS1866	562	18	66	24	29.7	16.50
BRPBS1872	595	18	72	24	31.01	18.00
BRPBS2624	432	26	24	24	21.24	8.67
BRPBS2630	457	26	30	24	22.84	10.83
BRPBS2636	476	26	36	24	24.15	13.00
BRPBS2642	497	26	42	24	25.47	15.17
BRPBS2648	523	26	48	24	26.77	17.33
BRPBS2654	544	26	54	24	28.09	19.50
BRPBS2660	564	26	60	24	29.4	21.67
BRPBS2666	588	26	66	24	30.7	23.83
BRPBS2672	621	26	72	24	32.02	26.00
BRPBS3424	455	34	24	24	22.25	11.33
BRPBS3430	489	34	30	24	23.85	14.17
BRPBS3436	508	34	36	24	25.16	17.00
BRPBS3442	529	34	42	24	26.47	19.83
BRPBS3448	554	34	48	24	27.78	22.67
BRPBS3454	575	34	54	24	29.09	25.50
BRPBS3460	596	34	60	24	30.4	28.33
BRPBS3466	617	34	66	24	31.71	31.17
BRPBS3472	656	34	72	24	33.02	34.00

## BRPBA • Add-on Beam



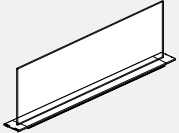
- Bridges Power Beam divides space, delineates territory, provides power and data to adjacent work spaces.
- Add-on Beam connects to the Starter Beam and serves to extend the run of Bridges Power Beams as desired.
- 30" to 72" wide beams feature knockouts for two electrical duplex and one communication face plate on each side while 24" wide beams accommodate one electrical duplex and one communication face plate on each side.
- Add-on Beam consist of the horizontal channel, raceway covers, two legs, one foot and a pair of beam-to-beam connecting capture strips.
- The leg expands by approximately 4" in height to compensate for uneven floors and allow for accurate levelling. Feet depth is 24".
- Specify standard Flat Top Trim (BRPBTC), Glass and Top Trim Kit (BRPBEG) or PET Felt and Top Trim Kit (BRPBEF) separately.
- Specify electrical components separately.
- Specify standard metal paint finish.
- Final built up height is not to exceed 50" high, including over panels.

PRODUCT CODE	PRICE	SIZE/INCHES			WEIGHT LBS	VOL FT <sup>3</sup>
		H	W	D		
BRPBA1824	298	18	24	24	14.46	6.00
BRPBA1830	323	18	30	24	16.06	7.50
BRPBA1836	342	18	36	24	17.37	9.00
BRPBA1842	363	18	42	24	18.68	10.50
BRPBA1848	389	18	48	24	19.99	12.00
BRPBA1854	410	18	54	24	21.31	13.50
BRPBA1860	430	18	60	24	22.62	15.00
BRPBA1866	451	18	66	24	23.92	16.50
BRPBA1872	487	18	72	24	25.24	18.00
BRPBA2624	325	26	24	24	15.5	8.67
BRPBA2630	350	26	30	24	17.11	10.83
BRPBA2636	369	26	36	24	18.42	13.00
BRPBA2642	389	26	42	24	19.73	15.17
BRPBA2648	415	26	48	24	21.04	17.33
BRPBA2654	436	26	54	24	22.35	19.50
BRPBA2660	456	26	60	24	23.66	21.67
BRPBA2666	477	26	66	24	24.97	23.83
BRPBA2672	513	26	72	24	26.28	26.00
BRPBA3424	356	34	24	24	16.55	11.33
BRPBA3430	381	34	30	24	18.15	14.17
BRPBA3436	400	34	36	24	19.46	17.00
BRPBA3442	421	34	42	24	20.77	19.83
BRPBA3448	447	34	48	24	22.08	22.67
BRPBA3454	468	34	54	24	23.4	25.50
BRPBA3460	488	34	60	24	24.71	28.33
BRPBA3466	509	34	66	24	26.01	31.17
BRPBA3472	545	34	72	24	27.33	34.00

**BRPBTC • Flat Top Trim**

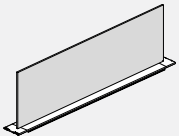
- Flat Top Trim attaches on top of Bridges Power Beams to add privacy or divide space.
- Flat top trim is made of an aluminum extrusion.
- Specify standard metal paint finish.

PRODUCT CODE	PRICE	SIZE/INCHES			WEIGHT LBS	VOL FT <sup>3</sup>
		H	W	D		
BRPBTC24	11	0.2	24	2.61	0.24	0.01
BRPBTC30	14	0.2	30	2.61	0.61	0.01
BRPBTC36	16	0.2	36	2.61	0.73	0.01
BRPBTC42	19	0.2	42	2.61	0.85	0.01
BRPBTC48	21	0.2	48	2.61	0.97	0.01
BRPBTC54	24	0.2	54	2.61	1.1	0.02
BRPBTC60	24	0.2	60	2.61	1.22	0.02
BRPBTC66	27	0.2	66	2.61	1.34	0.02
BRPBTC72	31	0.2	72	2.61	1.47	0.02

**BRPBEG • Embedded Glass and Top Trim Kit**

- Embedded Glass and Top Trim Kit attaches on top of beams to add privacy or divide space.
- Embedded Glass Top Trim Kit consist of the extruded aluminum channel, die-cast channel end covers, glass partition, gasket and hardware required to secure the trim to the beam's horizontal channel.
- Specify standard metal paint finish.
- Clear tempered glass is standard.
- NOTE: When specifying an application where two panels are side by side at different heights, a special is required to ensure proper fit.

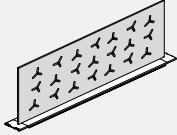
PRODUCT CODE	PRICE		SIZE/INCHES			WEIGHT LBS	VOL FT <sup>3</sup>
	CLR	FRST	H	W	D		
BRPBEG0824	129	213	8	24	2.61	9.42	0.29
BRPBEG0830	137	220	8	30	2.61	11.79	0.36
BRPBEG0836	144	229	8	36	2.61	14.15	0.44
BRPBEG0842	152	237	8	42	2.61	16.52	0.51
BRPBEG0848	168	262	8	48	2.61	18.88	0.58
BRPBEG0854	186	291	8	54	2.61	19.52	0.65
BRPBEG0860	204	320	8	60	2.61	20.58	0.73
BRPBEG0866	221	350	8	66	2.61	21.55	0.80
BRPBEG0872	245	385	8	72	2.61	23.62	0.87
BRPBEG1624	134	218	16	24	2.61	9.891	0.58
BRPBEG1630	165	264	16	30	2.61	12.37	0.73
BRPBEG1636	184	311	16	36	2.61	14.85	0.87
BRPBEG1642	210	357	16	42	2.61	17.346	1.02
BRPBEG1648	236	404	16	48	2.61	19.824	1.16
BRPBEG1654	261	425	16	54	2.61	21.25	1.31
BRPBEG1660	286	496	16	60	2.61	23.62	1.45
BRPBEG1666	312	543	16	66	2.61	25.98	1.60
BRPBEG1672	343	595	16	72	2.61	28.35	1.74

**BRPBEF • Embedded PET Felt and Top Trim Kit**

- Embedded PET Felt and Top Trim Kit attaches on top of beams to add privacy or divide space.
- Embedded PET Felt Top Trim Kit consist of the extruded aluminum channel, die-cast channel end covers, PET felt partition and hardware required to secure the trim to the beams horizontal channel.
- Specify standard metal paint finish.
- 9mm PET felt material is tackable. Please specify standard finish.
- NOTE: When specifying an application where two panels are side by side at different heights, a special is required to ensure proper fit.

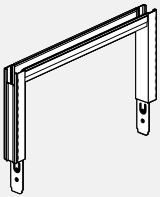
PRODUCT CODE	PRICE	SIZE/INCHES			WEIGHT LBS	VOL FT <sup>3</sup>
		H	W	D		
BRPBEF0824	63	8	24	2.61	1.32	0.29
BRPBEF0830	66	8	30	2.61	1.65	0.36
BRPBEF0836	88	8	36	2.61	1.99	0.44
BRPBEF0842	92	8	42	2.61	2.32	0.51
BRPBEF0848	165	8	48	2.61	2.65	0.58
BRPBEF0854	169	8	54	2.61	2.98	0.65
BRPBEF0860	172	8	60	2.61	3.32	0.73
BRPBEF0866	176	8	66	2.61	3.65	0.80
BRPBEF0872	185	8	72	2.61	3.98	0.87
BRPBEF1624	63	16	24	2.61	1.83	0.58
BRPBEF1630	66	16	30	2.61	2.3	0.73
BRPBEF1636	88	16	36	2.61	2.76	0.87
BRPBEF1642	92	16	42	2.61	3.22	1.02
BRPBEF1648	165	16	48	2.61	3.68	1.16
BRPBEF1654	169	16	54	2.61	4.14	1.31
BRPBEF1660	172	16	60	2.61	4.61	1.45
BRPBEF1666	176	16	66	2.61	5.07	1.60
BRPBEF1672	185	16	72	2.61	5.53	1.74



**BRPBEPF • Embedded Perforated PET Felt and Top Trim Kit**

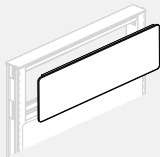
- Embedded Perforated PET Felt and Top Trim Kit attaches on top of beams to add privacy or divide space.
- Embedded Perforated PET Felt Top Trim Kit consist of the extruded aluminum channel, die-cast channel end covers, perforated PET felt partition and hardware required to secure the trim to the beams horizontal channel.
- Specify standard metal paint finish.
- 9mm PET felt material is tackable. Please specify standard finish.
- NOTE: When specifying an application where two panels are side by side at different heights, a special is required to ensure proper fit.

PRODUCT CODE	PRICE	SIZE/INCHES			WEIGHT LBS	VOL FT <sup>3</sup>
		H	W	D		
BRPBEPF0824	126	8	24	2.61	1.32	0.29
BRPBEPF0830	133	8	30	2.61	1.65	0.36
BRPBEPF0836	175	8	36	2.61	1.99	0.44
BRPBEPF0842	182	8	42	2.61	2.32	0.51
BRPBEPF0848	330	8	48	2.61	2.65	0.58
BRPBEPF0854	337	8	54	2.61	2.98	0.65
BRPBEPF0860	345	8	60	2.61	3.32	0.73
BRPBEPF0866	352	8	66	2.61	3.65	0.80
BRPBEPF0872	371	8	72	2.61	3.98	0.87
BRPBEPF1624	126	16	24	2.61	1.83	0.58
BRPBEPF1630	133	16	30	2.61	2.3	0.73
BRPBEPF1636	175	16	36	2.61	2.76	0.87
BRPBEPF1642	182	16	42	2.61	3.22	1.02
BRPBEPF1648	330	16	48	2.61	3.68	1.16
BRPBEPF1654	337	16	54	2.61	4.14	1.31
BRPBEPF1660	345	16	60	2.61	4.61	1.45
BRPBEPF1666	352	16	66	2.61	5.07	1.60
BRPBEPF1672	371	16	72	2.61	5.53	1.74

**BPX3OP • Over Panel Frame**

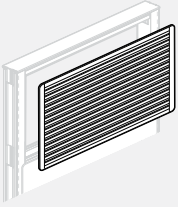
- **Over Panel Frame attaches on top of beams to add privacy or divide space.**
- Overpanel Extension consists of the extruded aluminum frame and bayonets connecting the frame to the top of the powerBEAM vertical leg.
- Any tile can be attached to either side to enclose the frame.
- Specify standard Flat Top Trim (BRPBTC), Vertical Trims (BA3VT), Glass and Top Trim Kit (BRPBEG) or PET Felt and Top Trim Kit (BRPBEF) separately.
- Specify standard metal paint finish.
- Final built up height is not to exceed 50" high, including over panels.

PRODUCT CODE	PRICE	SIZE/ INCHES			WEIGHT LBS	VOL FT <sup>3</sup>
		H	W	D		
BPX3OP0824	102	8	24	2.61	4	0.43
BPX3OP0830	109	8	30	2.61	4	0.65
BPX3OP0836	117	8	36	2.61	4	0.71
BPX3OP0842	131	8	42	2.61	5	0.87
BPX3OP0848	138	8	48	2.61	5	0.93
BPX3OP0854	146	8	54	2.61	6	1.04
BPX3OP0860	156	8	60	2.61	6	1.20
BPX3OP0866	173	8	66	2.61	7	1.31
BPX3OP0872	192	8	72	2.61	8	1.42
BPX3OP1624	102	16	24	2.61	5	0.73
BPX3OP1630	109	16	30	2.61	5	1.09
BPX3OP1636	117	16	36	2.61	5	1.18
BPX3OP1642	131	16	42	2.61	6	1.45
BPX3OP1648	138	16	48	2.61	6	1.55
BPX3OP1654	146	16	54	2.61	7	1.73
BPX3OP1660	156	16	60	2.61	7	2.00
BPX3OP1666	173	16	66	2.61	9	2.16
BPX3OP1672	192	16	72	2.61	10	2.37

**BP3FT • Removeable Face Tile - Fabric or Laminate**

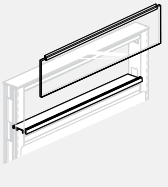
- **Attaches to any opening in a Pass-Thru Panel.**
- Tile clips included.
- Easily interchangeable on site.
- Specify two tiles per over panel opening of corresponding width. Tiles can be combined. For example, Fabric Tile on one side and Accessory Tile on the opposite side of the same panel.
- OPT\* = Laminate or Whiteboard.

PRODUCT CODE	PRICE			SIZE/ INCHES			WEIGHT LBS	VOL FT <sup>3</sup>
	GR1	GR2	OPT*	H	W	D		
BP3FT0824	97	106	113	8	24	0.25	1	0.16
BP3FT0830	106	117	134	8	30	0.25	2	0.20
BP3FT0836	131	144	159	8	36	0.25	2	0.25
BP3FT0842	139	151	169	8	42	0.25	2	0.29
BP3FT0848	145	159	173	8	48	0.25	3	0.33
BP3FT0854	153	169	181	8	54	0.25	3	0.37
BP3FT0860	159	172	187	8	60	0.25	4	0.41
BP3FT0866	180	239	305	8	66	0.25	4	0.46
BP3FT0872	233	307	384	8	72	0.25	4	0.50
BP3FT1624	109	115	124	16	24	0.25	2	0.33
BP3FT1630	116	132	146	16	30	0.25	3	0.41
BP3FT1636	144	157	172	16	36	0.25	3	0.50
BP3FT1642	153	169	181	16	42	0.25	3	0.58
BP3FT1648	161	174	192	16	48	0.25	4	0.66
BP3FT1654	170	181	199	16	54	0.25	4	0.75
BP3FT1660	187	247	205	16	60	0.25	5	0.83
BP3FT1666	205	264	329	16	66	0.25	5	0.92
BP3FT1672	253	336	420	16	72	0.25	6	1.00

**BP3AT • Removable Face Tile - Accessory**

- Attaches to any opening in an Over Panel Frame.
- Provides support for accessories.
- Easily interchangeable on site.
- Two tile clips included.
- Specify two tiles per over panel opening of corresponding width. Tiles can be combined. For example, Fabric Tile on one side and Accessory Tile on the opposite side of the same panel.
- Accessory Tile cannot be installed opposite an electrical tile.

PRODUCT CODE	PRICE	SIZE/ INCHES			WEIGHT VOL	
		H	W	D	LBS	FT <sup>3</sup>
BP3AT0824	115	08	24	0.25	2.3	0.16
BP3AT0830	127	08	30	0.25	2.9	0.20
BP3AT0836	149	08	36	0.25	3.5	0.25
BP3AT0842	180	08	42	0.25	4.1	0.29
BP3AT0848	211	08	48	0.25	4.7	0.33
BP3AT0854	227	08	54	0.25	5.3	0.37
BP3AT0860	259	08	60	0.25	5.9	0.41
BP3AT0866	279	08	66	0.25	6.5	0.45
BP3AT0872	303	08	72	0.25	7.0	0.50
BP3AT1624	138	16	24	0.25	4.7	0.33
BP3AT1630	147	16	30	0.25	5.7	0.41
BP3AT1636	178	16	36	0.25	7.0	0.50
BP3AT1642	211	16	42	0.25	8.2	0.58
BP3AT1648	245	16	48	0.25	9.4	0.66
BP3AT1654	265	16	54	0.25	10.6	0.75
BP3AT1660	304	16	60	0.25	11.9	0.83
BP3AT1666	336	16	66	0.25	13.0	0.91
BP3AT1672	366	16	72	0.25	14.0	1.00

**BP3GT • Removable Face Tile - Glazed**

- Attaches to any opening in a Pass-Thru Panel.
- 8" or 16" high glazing provides visual accessibility and light transfer.
- Easily interchangeable on site.
- Specify one Glazed Tile for over panel opening of corresponding width.
- Clear tempered glass standard.

PRODUCT CODE	PRICE	FRST/SMK	SIZE/ INCHES			WEIGHT VOL	
			H	W	D	LBS	FT <sup>3</sup>
BP3GT0824	115	138	8	24	2.61	3.1	0.16
BP3GT0830	127	151	8	30	2.61	3.9	0.20
BP3GT0836	148	178	8	36	2.61	4.7	0.25
BP3GT0842	173	208	8	42	2.61	5.5	0.29
BP3GT0848	200	238	8	48	2.61	6.3	0.33
BP3GT0854	225	270	8	54	2.61	7.1	0.37
BP3GT0860	249	301	8	60	2.61	7.8	0.41
BP3GT0866	276	331	8	66	2.61	8.6	0.46
BP3GT0872	301	363	8	72	2.61	9.4	0.50
BP3GT1624	125	149	16	24	2.61	5.8	0.33
BP3GT1630	144	172	16	30	2.61	7.2	0.41
BP3GT1636	174	210	16	36	2.61	8.7	0.50
BP3GT1642	204	245	16	42	2.61	10.2	0.58
BP3GT1648	235	280	16	48	2.61	11.6	0.66
BP3GT1654	264	317	16	54	2.61	13.1	0.75
BP3GT1660	295	352	16	60	2.61	14.6	0.83
BP3GT1666	324	372	16	66	2.61	16.0	0.91
BP3GT1672	352	406	16	72	2.61	17.5	1.00

**BRP3PS • 90 Degree Post**

- Post facilitates splitting of the beam run into up to 4 directions at 90 angle.
- Post kit consist of the extruded aluminum post and four pairs of capture strip connectors.
- Post Vertical Trim must be specified in accordance to your post 2-way, 3-way or 4-way configuration.
- Specify painted metal finish colour.

PRODUCT CODE	PRICE	SIZE/INCHES			WEIGHT LBS	VOL FT <sup>3</sup>
		H	W	D		
BRP3PS018	67	18	2.61	2.61	3.00	0.12
BRP3PS026	96	26	2.61	2.61	3.60	0.13
BRP3PS034	126	34	2.61	2.61	4.00	0.14

**BRP3PS • 60 Degree Post**

- Post facilitates splitting of the beam run into up to 3 directions at 120 angle.
- Post kit consist of the extruded aluminum post and three pairs of capture strip connectors.
- Post Vertical Trim must be specified in accordance to your post 2-way, 3-way or 4-way configuration.
- Specify painted metal finish colour.

PRODUCT CODE	PRICE	SIZE/INCHES			WEIGHT LBS	VOL FT <sup>3</sup>
		H	W	D		
BRP3PS60018	67	18	2.61	2.61	3.00	0.12
BRP3PS60026	96	26	2.61	2.61	3.60	0.13
BRP3PS60034	126	34	2.61	2.61	4.00	0.14

**BRP3PS • 45 Degree Post**

- Post facilitates two beams at 45 angle.
- Post kit consist of the extruded aluminum post and four pairs of capture strip connectors.
- Post Vertical Trim must be specified in accordance to your post 2-way, 3-way or 4-way configuration.
- Specify painted metal finish colour.

PRODUCT CODE	PRICE	SIZE/INCHES			WEIGHT LBS	VOL FT <sup>3</sup>
		H	W	D		
BRP3PS45018	67	18	2.61	2.61	3.00	0.12
BRP3PS45026	96	26	2.61	2.61	3.60	0.13
BRP3PS45034	126	34	2.61	2.61	4.00	0.14

**BRPVTRF • End Trim**

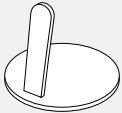
- Attaches to Post
- Consist of the extruded aluminum trim and one pair of capture strip connectors.
- Post Vertical Trim must be specified in accordance to your post 2-way, 3-way or 4-way configuration.
- Specify painted metal finish colour.

PRODUCT CODE	PRICE	SIZE/INCHES			WEIGHT LBS	VOL FT <sup>3</sup>
		H	W	D		
BRPVTRF18	23	18	2.61	2.61	0.50	0.01
BRPVTRF26	30	26	2.61	2.61	0.72	0.02
BRPVTRF34	38	34	2.61	2.61	0.94	0.03
BRPVTRF42	46	42	2.61	2.61	1.16	0.04
BRPVTRF50	56	50	2.61	2.61	1.38	0.05

**BA3VTEF • Overpanel End Trim**

- Attaches to sides of Overpanel Extension frame.
- Overpanel Extension Vertical Trim consist of the extruded aluminum trim, die-cast corner and a pair capture strip connectors.
- Overpanel Extension Vertical Trim must be specified because Overpanel Extensions may not necessarily continue in full length, and single, strategically positioned Overpane Extensions will therefore require their own vertical trims in corresponding locations.
- Specify metal finish colour

PRODUCT CODE	PRICE	SIZE/INCHES			WEIGHT LBS	VOL FT <sup>3</sup>
		H	W	D		
BA3VTEF8	11	8	2.61	0.125	0.20	0.01
BA3VTEF16	24	16	2.61	0.125	0.50	0.03
BA3VTEF32	38	32	2.61	0.125	1.00	0.06

**BRPRB • Round Disk Base for Leg**

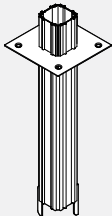
- Attached to the bottom of BRP3PS Post to provide stability at an intersection.
- Round metal plate is 1/4" thick.
- Specify painted metal finish colour.

PRODUCT CODE	PRICE	SIZE/INCHES			WEIGHT LBS	VOL FT <sup>3</sup>
		H	W	D		
BRPRB	242	6.5	7.5	7.5	3.67	0.01

**BH3PE • Post Extension for Over Panels**

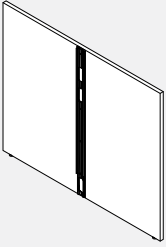
- Provides route for ceiling data or electrical cables through the post to the panel.
- Includes 2 "Capture Strip" panel connectors.

PRODUCT CODE	PRICE	SIZE/ INCHES			WEIGHT LBS	VOL FT <sup>3</sup>
		H	W	D		
BH3PE008	30	8	2.61	2.61	1	0.03
BH3PE016	54	16	2.61	2.61	2	0.07
BH3PE032	78	32	2.61	2.61	4	0.14
BH3PE45016	54	16	2.61	2.61	2	0.07
BH3PE45032	78	32	2.61	2.61	4	0.14
BH3PE60016	54	16	2.61	2.61	2	0.07
BH3PE60032	78	32	2.61	2.61	4	0.14

**BEPE • Post Extension**

- Lightweight aluminum pole to be used to bring power and/or data/communication cables from ceiling to a beam through a post.
- Attaches to ceiling and post.
- Includes connectors, ceiling trim plate and screws.
- Post extension will accept:
  - 75 cables 5.6mm (0.220") dia. data cables
  - 60 cables 5.6mm (0.220") dia. data cables with 1 power feed
  - 45 cables 5.6mm (0.220") dia. data cables with 2 power feeds.
- Ceiling bezel is white only.
- Specify metal finish colour

PRODUCT CODE	PRICE	SIZE/INCHES			WEIGHT LBS	VOL FT <sup>3</sup>
		H	W	D		
BEPE81	188	81	2.61	2.61	9	0.43

**B3LEP-NC • End of Run Gallery Panel in a T configuration, No Connectors for Additional Gallery Panels**

- Provides floor standing support while enclosing the end of a panel run on two sides.
- Attaches to the end of a Bridges Power Beam with capture strips to form a T configuration.
- Connection is on the interior face center.
- Includes all attachment hardware and glides.
- Total height is inclusive of panel glides extended to their full height.
- 51" wide gallery panel accommodates two 24" deep surfaces while the 63" wide accommodates two 30" deep surfaces and 75" wide two 36" deep surfaces.
- Please specify LP laminate finish and PVC edge finish.
- If a wood grain laminate is chosen, grain direction run horizontally.
- Edged in PVC on three exposed edges and self edged on bottom.

PRODUCT CODE	PRICE LP	SIZE / INCHES			WEIGHT LBS	VOL FT <sup>3</sup>
		H	W	D		
B3LEP4227NC	416	42	26.5	1	29.49	0.64
B3LEP4251NC	653	42	51	1	55.17	1.24
B3LEP4263NC	731	42	63	1	68.01	1.53
B3LEP4275NC	814	42	75	1	80.86	1.82
B3LEP5027NC	485	50	26.5	1	35.25	0.77
B3LEP5051NC	758	50	51	1	65.92	1.48
B3LEP5063NC	854	50	63	1	81.27	1.82
B3LEP5075NC	964	50	75	1	96.62	2.17

**B3LSEPL-NC • Left End of Run Single Gallery Panel in L Configuration, No Connectors for Additional Gallery Panels**

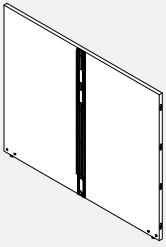
- Provides floor standing support while enclosing the end of a panel run on one side.
- Attaches to the end of a Bridges Power Beam with capture strips to form an L configuration.
- Connection is on interior face near it's right end.
- Includes all attachment hardware and glides.
- Total height is inclusive of panel glides extended to their full height.
- 27" wide gallery panel accommodates a 24" deep surface while the 33" wide accommodates a 30" deep surface and 39" wide a 36" deep surface.
- Please specify LP laminate finish and PVC edge finish.
- If a wood grain laminate is chosen, grain direction run horizontally.
- Edged in PVC on three exposed edges and self edged on bottom.

PRODUCT CODE	PRICE LP	SIZE / INCHES			WEIGHT LBS	VOL FT <sup>3</sup>
		H	W	D		
B3LSEPL4215NC	342	42	14.25	1	16.64	0.35
B3LSEPL4227NC	497	42	27	1	29.47	0.66
B3LSEPL4233NC	537	42	33	1	35.89	0.80
B3LSEPL4239NC	564	42	39	1	42.32	0.95
B3LSEPL5015NC	389	50	14.25	1	19.9	0.41
B3LSEPL5027NC	565	50	27	1	35.23	0.78
B3LSEPL5033NC	613	50	33	1	42.9	0.95
B3LSEPL5039NC	656	50	39	1	50.57	1.13

**B3LSEPR-NC • Right End of Run Single Gallery Panel in L Configuration, No Connectors for Additional Gallery Panels**

- Provides floor standing support while enclosing the end of a panel run on one side.
- Attaches to the end of a Bridges Power Beam with capture strips to form an L configuration.
- Connection is on interior face near it's right end.
- - Includes all attachment hardware and glides.
- Total height is inclusive of panel glides extended to their full height.
- 27" wide gallery panel accommodates a 24" deep surface while the 33" wide accommodates a 30" deep surface and 39" wide a 36" deep surface.
- Please specify LP laminate finish and PVC edge finish.
- If a wood grain laminate is chosen, grain direction run horizontally.
- Edged in PVC on three exposed edges and self edged on bottom.

PRODUCT CODE	PRICE LP	SIZE / INCHES			WEIGHT LBS	VOL FT <sup>3</sup>
		H	W	D		
B3LSEPR4215NC	342	42	14.25	1	16.64	0.35
B3LSEPR4227NC	497	42	27	1	29.47	0.66
B3LSEPR4233NC	537	42	33	1	35.89	0.80
B3LSEPR4239NC	564	42	39	1	42.32	0.95
B3LSEPR5015NC	389	50	14.25	1	19.9	0.41
B3LSEPR5027NC	565	50	27	1	35.23	0.78
B3LSEPR5033NC	613	50	33	1	42.9	0.95
B3LSEPR5039NC	656	50	39	1	50.57	1.13
B3LSEPR5415NC	389	54	14.25	1	21.52	0.45

**B3LEP • End of Run Gallery Panel in a T configuration, with Connectors for Additional Gallery Panels**

- Provides floor standing support while enclosing the end of a panel run.
- Attaches to the end of a Bridges Power Beam with capture strips to form a T configuration.
- Connections at both ends as well as on the middle of interior face.
- The end connections are to connect other Gallery Panels.
- The side right is compatible with right hand Gallery Panels (B3LXPRxxxx and B3LXPRxxxx-NC, B3L2PRxxxx and B3L3PRxxxx) only.
- The left side is compatible with left hand Gallery Panels (B3LXPLxxxx and B3LXPLxxxxNC, B3L2PLxxxx and B3L3PLxxxx) only.
- The middle interior face connections are for Boulevard panels.
- Includes all attachment hardware and glides.
- Total height is inclusive of panel glides extended to their full height.
- 51" wide gallery panel accommodates two 24" deep surface while the 63" wide accommodates two 30" deep surfaces and 75" wide two 36" deep surfaces.
- Please specify LP laminate finish and PVC edge finish.
- If a wood grain laminate is chosen, grain direction run horizontally.
- Gallery panel is edged in PVC on exposed top edge only and self edged on the three other edges.

PRODUCT CODE	PRICE LP	SIZE / INCHES			WEIGHT LBS	VOL FT <sup>3</sup>
		H	W	D		
B3LEP4251	667	42	51	1	55.25	1.24
B3LEP4263	745	42	63	1	68.1	1.53
B3LEP4275	828	42	75	1	80.95	1.82
B3LEP5051	773	50	51	1	66.01	1.48
B3LEP5063	868	50	63	1	81.36	1.82
B3LEP5075	979	50	75	1	96.71	2.17

**B3LSEPL • Left End of Run Single Gallery Panel in L Configuration, with Connectors for Additional Gallery Panels**

- Provides floor standing support while enclosing the end of a panel run.
- Attaches at the end of a Bridges Power Beam with capture strips to form an L configuration.
- Connection to the Boulevard panel is on interior face near it's right end.
- Connections for a Gallery Panel are on the left edge.
- Compatible with left hand Gallery Panels (B3LXPLxxxx and B3LXPLxxxxNC, B3L2PLxxxx and B3L3PLxxxx) only.
- Includes all attachment hardware and glides.
- Total height is inclusive of panel glides extended to their full height.
- 27" wide gallery panel accommodates a 24" deep surface while the 33" wide accommodates a 30" deep surface and 39" wide a 36" deep surface.
- Please specify LP laminate finish and PVC edge finish.
- If a wood grain laminate is chosen, grain direction run horizontally.
- Edged in PVC on two exposed edges, self edged on connecting to gallery panel edge and the bottom.

PRODUCT CODE	PRICE LP	SIZE / INCHES			WEIGHT LBS	VOL FT <sup>3</sup>
		H	W	D		
B3LSEPL4227	505	42	27	1	29.51	0.66
B3LSEPL4233	544	42	33	1	35.94	0.80
B3LSEPL4239	571	42	39	1	42.36	0.95
B3LSEPL5027	573	50	27	1	35.27	0.78
B3LSEPL5033	621	50	33	1	42.94	0.95
B3LSEPL5039	664	50	39	1	50.62	1.13

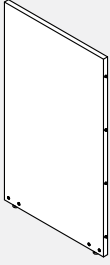
### B3LSEPR • Right End of Run Single Gallery Panel in L Configuration, with Connectors for additional Gallery Panels



- Provides floor standing support while enclosing the end of a panel run.
- Attaches at the end of a Bridges Power Beam with capture strips to form an L configuration.
- Connection to the Boulevard panel is on interior face near it's left end.
- Connections for a Gallery Panel are on the right edge.
- Compatible with right hand Gallery Panels (B3LXPRxxxx and B3LXPRxxxxNC, B3L2PRxxxx and B3L3PRxxxx) only.
- Includes all attachment hardware and glides.
- Total height is inclusive of panel glides extended to their full height.
- 27" wide gallery panel accomodates a 24" deep surface while the 33" wide accomodates a 30" deep surface and 39" wide a 36" deep surface.
- Please specify LP laminate finish and PVC edge finish.
- If a wood grain laminate is chosen, grain direction run horizontally.
- Edged in PVC on two exposed edges, self edged on connecting to gallery panel edge and the bottom.

PRODUCT CODE	PRICE LP	SIZE /INCHES			WEIGHT LBS	VOL FT <sup>3</sup>
		H	W	D		
B3LSEPR4227	505	42	27	1	29.51	0.66
B3LSEPR4233	544	42	33	1	35.94	0.80
B3LSEPR4239	571	42	39	1	42.36	0.95
B3LSEPR5027	573	50	27	1	35.27	0.78
B3LSEPR5033	621	50	33	1	42.94	0.95
B3LSEPR5039	664	50	39	1	50.62	1.13

### B3LXPL • Left Gallery Panel Extension, with Connectors for Additional Gallery Panels



- Provides floor standing support while extending the Gallery Panels run.
- Attaches to the left edge of a Gallery Panel by the pin connectors to allow for additional Gallery Panels to be added on the left side.
- Pin connectors on the right edge and modular connectors on the left edge of the interior face.
- The right side is compatible with Gallery Panels (B3LEPxxx, B3LSEPL, B3LMPxxx, B3LSMP and B3LXPLxxx) only.
- The left side is compatible with left hand Gallery Panels (B3LXPLxxxx and B3LXPLxxxxNC, B3L2PLxxxx and B3L3PLxxxx) only.
- Includes all attachment hardware and glides.
- Total height is inclusive of panel glides extended to their full height.
- Please specify LP laminate finish and PVC edge finish.
- If a wood grain laminate is chosen, grain direction run horizontally.
- Edged in PVC on two exposed edges, self edged on connecting to gallery panel edge and the bottom.
- Edged in PVC on exposed top edge only and self edges on the three other.

PRODUCT CODE	PRICE LP	SIZE /INCHES			WEIGHT LBS	VOL FT <sup>3</sup>
		H	W	D		
B3LXPL4224	260	42	24	1	25.83	0.58
B3LXPL4230	299	42	30	1	32.26	0.73
B3LXPL4236	338	42	36	1	38.68	0.88
B3LXPL4242	376	42	42	1	45.11	1.02
B3LXPL4248	415	42	48	1	51.53	1.17
B3LXPL5024	309	50	24	1	30.83	0.69
B3LXPL5030	357	50	30	1	38.51	0.87
B3LXPL5036	406	50	36	1	46.18	1.04
B3LXPL5042	453	50	42	1	53.86	1.22
B3LXPL5048	502	50	48	1	61.53	1.39

### B3LXPR • Right Gallery Panel Extension, with Connectors for Additional Gallery Panels



- Provides floor standing support while extending the Gallery Panels run.
- Attaches to the right edge of a Gallery Panel by the pin connectors to allow for additional Gallery Panels to be added on the right side.
- Pin connectors on the right edge and modular connectors on the left edge of the interior face.
- The right side is compatible with right hand Gallery Panels (B3LXPRxxxx and B3LXPRxxxxNC, B3L2PRxxxx and B3L3PRxxxx) only.
- The left side is compatible with Gallery Panels (B3LEPxxx, B3LSEPRxxx, B3LMPxxx and B3LXPRxxx) only.
- Includes all attachment hardware and glides.
- Total height is inclusive of panel glides extended to their full height.
- Please specify LP laminate finish and PVC edge finish.
- If a wood grain laminate is chosen, grain direction run horizontally.
- Edged in PVC on exposed top edge only and self edges on the three other.

PRODUCT CODE	PRICE LP	SIZE /INCHES			WEIGHT LBS	VOL FT <sup>3</sup>
		H	W	D		
B3LXPR4224	260	42	24	1	25.83	0.58
B3LXPR4230	299	42	30	1	32.26	0.73
B3LXPR4236	338	42	36	1	38.68	0.88
B3LXPR4242	376	42	42	1	45.11	1.02
B3LXPR4248	415	42	48	1	51.53	1.17
B3LXPR5024	309	50	24	1	30.83	0.69
B3LXPR5030	357	50	30	1	38.51	0.87
B3LXPR5036	406	50	36	1	46.18	1.04
B3LXPR5042	453	50	42	1	53.86	1.22
B3LXPR5048	502	50	48	1	61.53	1.39

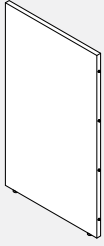
### B3LXPL-NC • Left Gallery Panel Extension, No Connectors for Additional Gallery Panels



- Provides floor standing support while enclosing the end of a Gallery Panel left run.
- Attached to the left edge of a Gallery Panel by the pin connectors to finish the run.
- Pin connectors are on the right edge of the interior face.
- Compatible with gallery panels (B3LEPxxxx, B3LSEPLxxxx, B3LMPxxxx, B3LSMPxxxx and B3LXPLxxxx) only.
- Includes all attachment hardware and glides.
- Total height is inclusive of panel glides extended to their full height.
- Please specify LP laminate finish and PVC edge finish.
- If a wood grain laminate is chosen, grain direction run horizontally.
- Edged in PVC on two exposed edges, self edged on connecting to gallery panel edge and the bottom.

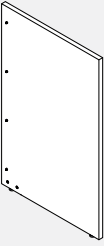
PRODUCT CODE	PRICE LP	SIZE /INCHES			WEIGHT LBS	VOL FT <sup>3</sup>
		H	W	D		
B3LXPL4212NC	142	42	12	1	12.95	0.29
B3LXPL4224NC	252	42	24	1	25.8	0.58
B3LXPL4230NC	291	42	30	1	32.22	0.73
B3LXPL4236NC	330	42	36	1	38.65	0.88
B3LXPL4242NC	370	42	42	1	45.07	1.02
B3LXPL4248NC	408	42	48	1	51.5	1.17
B3LXPL5012NC	177	50	12	1	15.45	0.35
B3LXPL5024NC	303	50	24	1	30.8	0.69
B3LXPL5030NC	350	50	30	1	38.47	0.87
B3LXPL5036NC	398	50	36	1	46.15	1.04
B3LXPL5042NC	448	50	42	1	53.82	1.22
B3LXPL5048NC	495	50	48	1	61.5	1.39



**B3LXPR-NC • Right Gallery Panel Extension, No Connectors for Additional Gallery Panels**

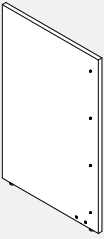
- Provides floor standing support while enclosing the end of a Gallery Panel right run.
- Attached to the right edge of a Gallery Panel by the pin connectors to finish the run.
- Pin connectors are on the left edge of the interior face.
- Compatible with gallery panels (B3LEPxxxx, B3LSEPRxxxx, B3LMPxxxx and B3LX-PRxxxx) only.
- Includes all attachment hardware and glides.
- Total height is inclusive of panel glides extended to their full height.
- Please specify LP laminate finish and PVC edge finish.
- If a wood grain laminate is chosen, grain direction run horizontally.
- Edged in PVC on two exposed edges, self edged on connecting to gallery panel edge and the bottom.

PRODUCT CODE	PRICE LP	SIZE / INCHES			WEIGHT LBS	VOL FT <sup>3</sup>
		H	W	D		
B3LXPR4212NC	142	42	12	1	12.95	0.29
B3LXPR4224NC	252	42	24	1	25.8	0.58
B3LXPR4230NC	291	42	30	1	32.22	0.73
B3LXPR4236NC	330	42	36	1	38.65	0.88
B3LXPR4242NC	370	42	42	1	45.07	1.02
B3LXPR4248NC	408	42	48	1	51.5	1.17
B3LXPR5012NC	177	50	12	1	15.45	0.35
B3LXPR5024NC	303	50	24	1	30.8	0.69
B3LXPR5030NC	350	50	30	1	38.47	0.87
B3LXPR5036NC	398	50	36	1	46.15	1.04
B3LXPR5042NC	448	50	42	1	53.82	1.22
B3LXPR5048NC	495	50	48	1	61.5	1.39

**B3L2PR • Right Gallery Panel End of Run Return**

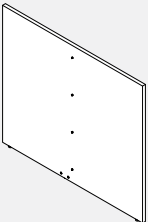
- Provides floor standing support while enclosing the end of a Gallery Panel run.
- Attaches at the Gallery Panel right edge with connectors to form an L configuration.
- Connections to Gallery Panel are on the interior face near it's left end.
- Compatible with Gallery Panels (B3LEPxxxx, B3LSEPRxxxx, B3LMPxxxx and B3LX-PRxxxx) only.
- Includes all attachment hardware and glides.
- Total height is inclusive of panel glides extended to their full height.
- 25" wide gallery panel accomodates a 24" deep surface while the 31" wide accomodates a 30" deep surface and 37" wide a 36" deep surface.
- Please specify LP laminate finish and PVC edge finish.
- If a wood grain laminate is chosen, grain direction run horizontally.
- Edged in PVC on three exposed edges and self edged on the bottom edge.

PRODUCT CODE	PRICE LP	SIZE / INCHES			WEIGHT LBS	VOL FT <sup>3</sup>
		H	W	D		
B3L2PR4213	153	42	13	1	14.02	0.32
B3L2PR4225	291	42	25	1	26.87	0.61
B3L2PR4231	330	42	31	1	33.29	0.75
B3L2PR4237	357	42	37	1	39.72	0.90
B3L2PR5013	192	50	13	1	16.73	0.38
B3L2PR5025	350	50	25	1	32.08	0.72
B3L2PR5031	398	50	31	1	39.75	0.90
B3L2PR5037	441	50	37	1	47.43	1.07

**B3L2PL • Left Gallery Panel End of Run Return**

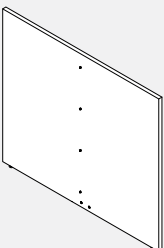
- Provides floor standing support while enclosing the end of a gallery panel run.
- Attaches at the Gallery Panel left edge with connectors to form an L configuration.
- Connections to Gallery Panel are on the interior face near it's right end.
- Compatible with Gallery Panels (B3LEPxxxx, B3LSEPLxxxx, B3LMPxxxx, B3LSMPxxxx and B3LXPLxxxx) only.
- Includes all attachment hardware and glides.
- Total height is inclusive of panel glides extended to their full height.
- 25" wide gallery panel accomodates a 24" deep surface while the 31" wide accomodates a 30" deep surface and 37" wide a 36" deep surface.
- Please specify LP laminate finish and PVC edge finish.
- If a wood grain laminate is chosen, grain direction run horizontally.
- Edged in PVC on three exposed edges and self edged on the bottom edge.

PRODUCT CODE	PRICE LP	SIZE / INCHES			WEIGHT LBS	VOL FT <sup>3</sup>
		H	W	D		
B3L2PL4213	153	42	13	1	14.02	0.32
B3L2PL4225	291	42	25	1	26.87	0.61
B3L2PL4231	330	42	31	1	33.29	0.75
B3L2PL4237	357	42	37	1	39.72	0.90
B3L2PL5013	192	50	13	1	16.73	0.38
B3L2PL5025	350	50	25	1	32.08	0.72
B3L2PL5031	398	50	31	1	39.75	0.90
B3L2PL5037	441	50	37	1	47.43	1.07

**B3L3PL • Left Gallery Panel End of Run 3-Way Return**

- Provides floor standing support while enclosing the end of a Gallery Panel run.
- Attaches to the Gallery Panel left edge with connectors to form an T configuration.
- Connections to Gallery Panel are on the interior face in the middle.
- Compatible with Gallery Panels (B3LEPxxxx, B3LSEPLxxxx, B3LMPxxxx, B3LSMPxxxx and B3LXPLxxxx) only.
- Includes all attachment hardware and glides.
- Total height is inclusive of panel glides extended to their full height.
- 49" wide gallery panel accomodates two 24" deep surfaces while the 61" wide accomodates two 30" deep surface and 73" wide two 36" deep surface.
- Please specify LP laminate finish and PVC edge finish.
- If a wood grain laminate is chosen, grain direction run horizontally.
- Edged in PVC on three exposed edges and self edged on the bottom edge.

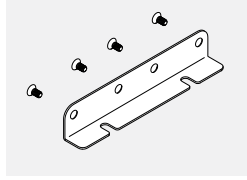
PRODUCT CODE	PRICE LP	SIZE / INCHES			WEIGHT LBS	VOL FT <sup>3</sup>
		H	W	D		
B3L3PL4225	229	42	25	1	26.87	0.61
B3L3PL4249	396	42	49	1	52.57	1.19
B3L3PL4261	524	42	61	1	65.41	1.48
B3L3PL4273	609	42	73	1	78.26	1.77
B3L3PL5025	286	50	25	1	32.08	0.72
B3L3PL5049	543	50	49	1	62.77	1.42
B3L3PL5061	639	50	61	1	78.12	1.77
B3L3PL5073	749	50	73	1	93.47	2.11

**B3L3PR • Right Gallery Panel End of Run 3-Way Return**

- Provides floor standing support while enclosing the end of a Gallery Panel run.
- Attaches to the Gallery Panel right edge with connectors to form an T configuration.
- Connections to Gallery Panel are on the interior face in the middle.
- Compatible with gallery panels (B3LEPxxxx, B3LSEPRxxxx, B3LMPxxxx and B3LXPRxxxx) only.
- Includes all attachment hardware and glides.
- Total height is inclusive of panel glides extended to their full height.
- 49" wide gallery panel accomodates two 24" deep surfaces while the 61" wide accomodates two 30" deep surface and 73" wide two 36" deep surface.
- Please specify LP laminate finish and PVC edge finish.
- If a wood grain laminate is chosen, grain direction run horizontally.
- Edged in PVC on three exposed edges and self edged on the bottom edge.

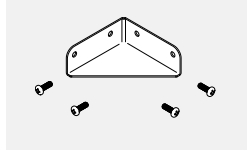
PRODUCT CODE	PRICE LP	SIZE / INCHES			WEIGHT LBS	VOL FT <sup>3</sup>
		H	W	D		
B3L3PR4225	229	42	25	1	26.87	0.61
B3L3PR4249	396	42	49	1	52.57	1.19
B3L3PR4261	524	42	61	1	65.41	1.48
B3L3PR4273	609	42	73	1	78.26	1.77
B3L3PR5025	286	50	25	1	32.08	0.72
B3L3PR5049	543	50	49	1	62.77	1.42
B3L3PR5061	639	50	61	1	78.12	1.77
B3L3PR5073	749	50	73	1	93.47	2.11



**B3HLPBB01 • Gallery Panel Bottom Inline Bracket**

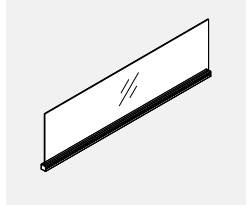
- Gallery Panel Bottom Inline Bracket connects two Gallery Panels at the bottom with screws.
- Available in standard paint colors.

PRODUCT CODE	PRICE	SIZE / INCHES			WEIGHT LBS	VOL FT <sup>3</sup>
		H	W	D		
B3HLPBB01	35	7	1.5	8	1	0.5

**B3HLPCB01 • Gallery Panel Corner Bracket**

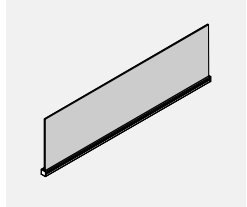
- Gallery Panel Corner Bottom bracket connects two Gallery Panels at 90 degrees.
- Available in standard paint colors.

PRODUCT CODE	PRICE	SIZE / INCHES			WEIGHT LBS	VOL FT <sup>3</sup>
		H	W	D		
B3HLPCB01	34	7	1.5	4	4	0.5

**B3PMP-GI-W • Privacy Glass for 1" Laminate Panels**

- Privacy glass integrated with aluminum top trim.
- Attaches on top of gallery panels to add privacy or divide space.
- Includes aluminum trim with channel, end caps and glass tile.
- Top rail may also be used to hang accessories.
- Glass and attachment hardware ship separately.
- Please specify standard paint finish for the channel.
- Standard in clear (CLR) or frosted (FRST).

PRODUCT CODE	PRICE		SIZE / INCHES			WEIGHT LBS	VOL FT <sup>3</sup>
	CLR	FRST	H	W	D		
B3PMP24GI8W	201	251	8	24	1	4.84	0.11
B3PMP30GI8W	219	276	8	30	1	6.06	0.14
B3PMP36GI8W	235	291	8	36	1	7.28	0.17
B3PMP42GI8W	251	313	8	42	1	8.5	0.19
B3PMP48GI8W	262	327	8	48	1	9.72	0.22
B3PMP24GI16W	201	251	16	24	1	8.92	0.22
B3PMP30GI16W	219	276	16	30	1	11.17	0.28
B3PMP36GI16W	235	291	16	36	1	13.43	0.33
B3PMP42GI16W	251	313	16	42	1	15.68	0.39
B3PMP48GI16W	262	327	16	48	1	17.92	0.44

**B3PFD-W • Felt divider for 1" Laminate Panels**

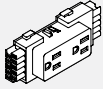
- Privacy felt integrated with aluminum top trim.
- Attaches on top of gallery panels to add privacy or divide space.
- Includes aluminum trim with channel, end caps and felt tile.
- Top rail may also be used to hang accessories.
- Felt and attachment hardware ship separately.
- Please specify standard paint finish for the channel.
- Please specify standard felt finish.

PRODUCT CODE	PRICE	SIZE / INCHES			WEIGHT LBS	VOL FT <sup>3</sup>
		H	W	D		
B3PFD0824W	72	8	24	1	1.32	0.11
B3PFD0830W	88	8	30	1	1.65	0.14
B3PFD0836W	102	8	36	1	1.99	0.17
B3PFD0842W	114	8	42	1	2.32	0.19
B3PFD0848W	170	8	48	1	2.65	0.22
B3PFD0854W	183	8	54	1	2.98	0.25
B3PFD0860W	199	8	60	1	3.32	0.28
B3PFD0866W	210	8	66	1	3.65	0.31
B3PFD0872W	238	8	72	1	3.98	0.33
B3PFD1624W	83	16	24	1	1.83	0.22
B3PFD1630W	98	16	30	1	2.3	0.28
B3PFD1636W	116	16	36	1	2.76	0.33
B3PFD1642W	130	16	42	1	3.22	0.39
B3PFD1648W	193	16	48	1	3.68	0.44
B3PFD1654W	210	16	54	1	4.14	0.50
B3PFD1660W	226	16	60	1	4.61	0.56
B3PFD1666W	238	16	66	1	5.07	0.61
B3PFD1672W	271	16	72	1	5.53	0.67

**BE8CI-1 • "I" Connector**

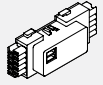
- Connects two Pass Thru Cables.
- Inline coupler used to connect two BE8CPxxHH Pass-Thru Cables.

PRODUCT CODE	PRICE	SIZE/ H	INCHES W	D	WEIGHT LBS	VOL FT <sup>3</sup>
BE8CI1	85	1.5	1.5	4.625	0.06	0.03

**BE8D • Duplex Receptacles**

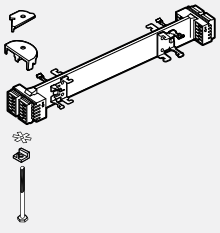
- Snaps into Power Distribution Housing.
- Up to 6 duplex receptacles per circuit.
- BE8D1 = Circuit #1 (utility circuit)
- BE8D2 = Circuit #2 (utility circuit)
- BE8D3 = Circuit #3 (utility circuit)
- BE8DA - Circuit #A (dedicated circuit)

PRODUCT CODE	PRICE	SIZE/ H	INCHES W	D	WEIGHT LBS	VOL FT <sup>3</sup>
BE8D1	35	2	4.625	1.25	0.10	0.01
BE8D2	35	2	4.625	1.25	0.10	0.01
BE8D3	35	2	4.625	1.25	0.10	0.01
BE8DA	35	2	4.625	1.25	0.10	0.01

**BE8D • USB Receptacles**

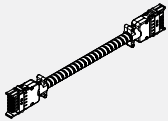
- Snaps into Power Distribution Housing.
- USB charging module provides convenient charging power access through dual ports on face of receptacles.
- Two USB ports.
- 2 amp output, considered as circuit #1.

PRODUCT CODE	PRICE	SIZE/ H	INCHES W	D	WEIGHT LBS	VOL FT <sup>3</sup>
BE8DU1-B	238	2	4.625	1.25	0.10	0.01
BE8DU1-W	238	2	4.625	1.25	0.10	0.01

**BE83D • Power Distribution Housing Kit - Beam Raceway**

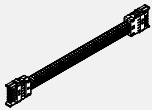
- Provides two duplex receptacles per panel side for all panel widths above 24" wide.
- Power Distribution Housing is specified per panel size. eg. BE83D36 is for use with a 36" panel.
- 24" wide panel allows for only one (1) duplex receptacle per panel side.

PRODUCT CODE	PRICE	SIZE/ H	INCHES L	D	WEIGHT LBS	VOL FT <sup>3</sup>
BE83D24	198	2	9.25	2.61	0.83	1.17
BE83D30	208	2	15.25	2.61	1.28	1.17
BE83D36	220	2	21.25	2.61	1.62	1.65
BE83D42	226	2	27.25	2.61	2.00	2.00
BE83D48	238	2	33.25	2.61	2.32	2.54
BE83D54	242	2	39.25	2.61	2.66	3.20
BE83D60	243	2	45.25	2.61	3.04	3.20
BE83D66	310	2	51.25	2.61	3.49	3.25
BE83D72	341	2	57.25	2.61	3.76	3.30

**BE8JC • Jumper Cable**

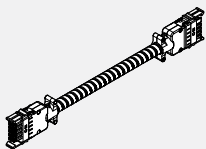
- Electrically connects two Power Distribution Housings.
- The BE8JC16 electrically connects two powered panels positioned side by side.
- The BE8JC20 electrically connects two powered panels separated by a post.
- Wires are concealed in a flexible metal conduit.
- Cannot go through a Boulevard 1 post in a corner application. (Please use the Jumper Cable Mesh)

PRODUCT CODE	PRICE	SIZE/ H	INCHES L	D	WEIGHT LBS	VOL FT <sup>3</sup>
BE8JC16	160	2	16.75	0.5	0.66	1.17
BE8JC20	162	2	20.75	0.5	0.78	1.17

**BE8JM19 • Jumper Cable Mesh**

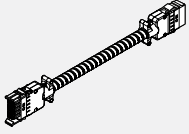
- Electrically connects two Power Distribution Housings in Boulevard 1 panels that are separated by a post in a corner application.
- BE8JM19 - Wires are covered with a durable nylon mesh.
- BE8JMS19 - Wires are concealed in a flexible metal shroud and covered with a durable nylon mesh.
- Used in System 3 Panels at tile position passing through post at corner application.

PRODUCT CODE	PRICE	SIZE/ H	INCHES L	D	WEIGHT LBS	VOL FT <sup>3</sup>
BE8JM19	162	2	19	0.5	0.75	1.17
BE8JMS19	184	2	19	0.5	0.75	1.17

**BE8CP-HH • Housing-to-Housing Pass-Thru Cable**

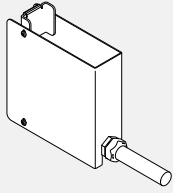
- Electrically connects two Power Distribution Housings in panels separated by one or more non-powered panels.
- Wires are concealed in a flexible metal conduit.
- NOTE : In Boulevard 1 and or System 3 tile position applications, the Housing-to-Housing Pass-Thru Cables can only be used in a straight run.

PRODUCT CODE	PRICE	SIZE/ H	INCHES L	D	WEIGHT LBS	VOL FT <sup>3</sup>
BE8CP40HH	161	2	40.5	0.5	1.44	1.17
BE8CP46HH	167	2	46.5	0.5	1.71	1.17
BE8CP52HH	177	2	52.5	0.5	1.95	1.17
BE8CP58HH	184	2	58.5	0.5	2.21	1.17
BE8CP64HH	190	2	64.5	0.5	2.37	1.17
BE8CP70HH	196	2	70.5	0.5	2.6	1.17
BE8CP76HH	204	2	76.5	0.5	2.81	1.17
BE8CP82HH	213	2	82.5	0.5	3.03	1.17
BE8CP88HH	221	2	88.5	0.5	3.05	1.17
BE8CP94HH	226	2	94.5	0.5	3.30	1.17
BE8CP100HH	233	2	100.5	0.5	3.47	1.17
BE8CP106HH	242	2	106.5	0.5	3.87	1.17
BE8CP118HH	256	2	118.5	0.5	4.08	1.17
BE8CP130HH	268	2	130.5	0.5	4.73	1.17
BE8CP142HH	282	2	142.5	0.5	4.99	1.17

**BE8CP-HJ • Housing-to-Jumper Pass-Thru Cable**

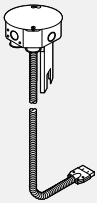
- Electrically connects a Power Distribution Housing to a Housing connection of a harness.
- Wires are concealed in a flexible metal conduit.
- **NOTE** : In both Boulevard 1 and System 3 Tile Position applications, the Housing-to-Jumper Pass-Thru Cables can only be used in a straight run.

PRODUCT CODE	PRICE	SIZE/ INCHES			WEIGHT VOL	
		H	L	D	LBS	FT <sup>3</sup>
BE8CP24HJ	144	2	24	0.5	0.9	1.17
BE8CP30HJ	151	2	30	0.5	1.3	1.17
BE8CP36HJ	156	2	36	0.5	1.44	1.17
BE8CP42HJ	169	2	42	0.5	1.71	1.17
BE8CP48HJ	177	2	48	0.5	1.95	1.17
BE8CP54HJ	188	2	54	0.5	2.21	1.17
BE8CP60HJ	196	2	60	0.5	2.37	1.17
BE8CP72HJ	204	2	72	0.5	2.81	1.17
BE8CP84HJ	220	2	84	0.5	3.05	1.17
BE8CP96HJ	233	2	96	0.5	3.3	1.17
BE8CP108HJ	243	2	108	0.5	3.87	1.17
BE8CP120HJ	257	2	120	0.5	4.08	1.17
BE8CP144HJ	293	2	144	0.5	4.59	1.17

**BRBPEFH • Base Feed and Housing for powerBeam**

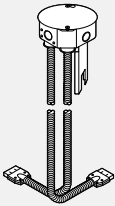
- Floorfeed housing and harness for Bridges Power Beam applications. Specify xx18 baseFEED for 18" high powerBEAMS. xx26 baseFEED for 26" Bridges Power Beam, etc.
- Attaches to inner side of the powerBEAM leg
- Base feed kit consist of two mounting brackets, steel shroud and base feed harness with 72" long liquid-tight conduit hardwired to building power supply.
- **NOTE**: on-site drilling required to secure mounting brackets to the inside of the beam vertical leg
- Post Vertical Trim must be specified in accordance to your post 2-way, 3-way or 4-way configuration.
- Specify metal finish colour

PRODUCT CODE	PRICE	SIZE/ INCHES			WEIGHT VOL	
		H	L	D	LBS	FT <sup>3</sup>
BRBPEFH18	576	6.9	6	2.5	2.70	0.06
BRBPEFH26	615	16.9	6	2.5	5.41	0.15
BRBPEFH34	644	22.9	6	2.5	7.03	0.20

**BE8CF-1 • Ceiling Feed - Single**

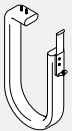
- Provides single power entry from ceiling, through post and into raceway channel.
- Power entry cable penetrates 8" into a panel and plugs into either a Power Distribution Housing or BE8CPxxHJ Pass-Thru Harness.
- Specify Post Extension separately.
- Must be hard wired to power source by a licensed electrician.

PRODUCT CODE	PRICE	SIZE/ INCHES			WEIGHT VOL	
		H	L	D	LBS	FT <sup>3</sup>
BE8CF1201	353	6	120	6	5.24	2
BE8CF1441	479	6	144	6	5.96	2

**BE8CF-2 • Ceiling Feed - Double**

- Provides dual power entry from ceiling, through post and into raceway channel.
- Power entry cable penetrates 8" into a panel and plugs into either a Power Distribution Housing or a BE8CPxxHJ Pass-Thru Harness.
- Use 1) In middle of run to distribute power in two directions.  
2) At beginning of run where second Ceiling Feed harness is connected to BE8CPxxHJ and distributes power underneath Power Distribution Housing to pick-up second circuit grouping in long panel run.
- Specify Post Extension separately.
- Must be hard wired to power source by a licensed electrician.

PRODUCT CODE	PRICE	SIZE/ INCHES			WEIGHT VOL	
		H	L	D	LBS	FT <sup>3</sup>
BE8CF1202	620	6	120	3	5.24	2
BE8CF1442	701	6	144	3	5.96	2

**BRTWMS • Wire Manager Kit**

- Provides wire management from under the Freefit worksurface to the Power Beam.
- The bracket can be aligned anywhere on the Power Beam.
- Kit includes a neoprene wire manager sock, bracket and screws.
- Please specify bracket paint finish.

PRODUCT CODE	PRICE	SIZE/ INCHES			WEIGHT VOL	
		H	L	D	LBS	FT <sup>3</sup>
BRTWMS	112	1.25	42	5.25	1.87	0.4

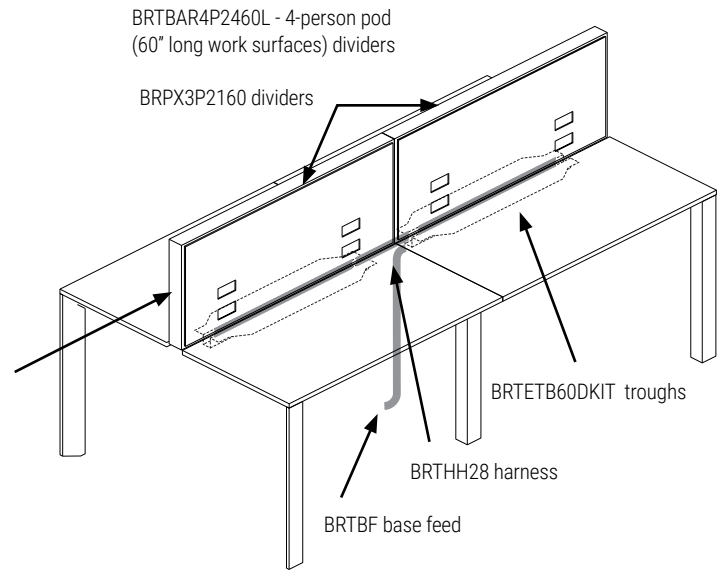
## Applications

Combining **Bridges tables with BRPX3P table mounted dividers** increases power, data capacity, offers optional, integrated desk-height power/data access and enhances sense of privacy with fabric covered panel tiles. Optional Accessory tiles support paper-organizing accessories.

**Non-powered BRPX3P dividers combined with BRTETB power troughs.** The troughs in this instance provide power/data distribution and access, while the BRPX3P dividers enhance sense of privacy and, with accessory tiles in place, provide support for bridges paper accessories.

Notice that the dividers combined with power troughs do not distribute any power.

Specify quantity and finish of BRA3VTRF22 vertical aluminum flat end trim at either end.



### BRPX3P dividers with built-in 8-wire, 4-circuit power distribution system and data.

The BRPX3P dividers provide power/data distribution, desk-height access, while enhancing sense of privacy. When specified, accessory tiles can provide support for Bridges paper accessories.

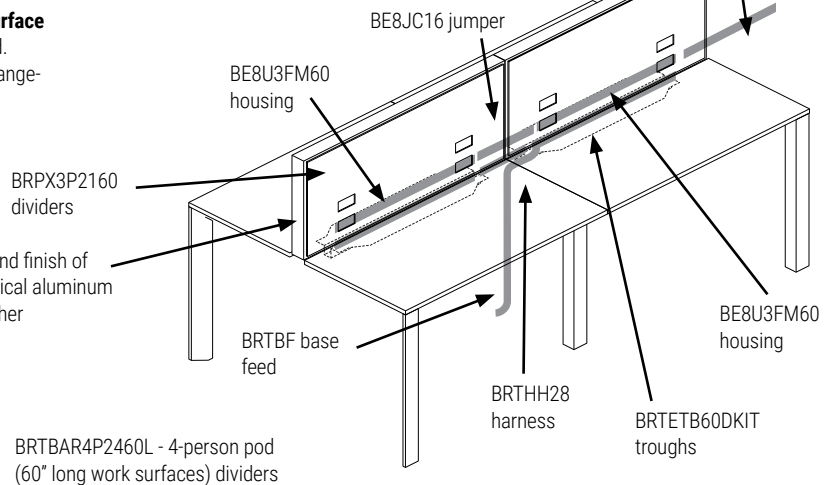
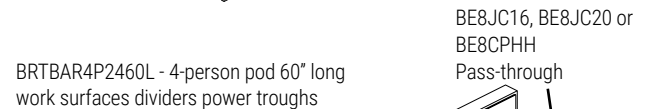
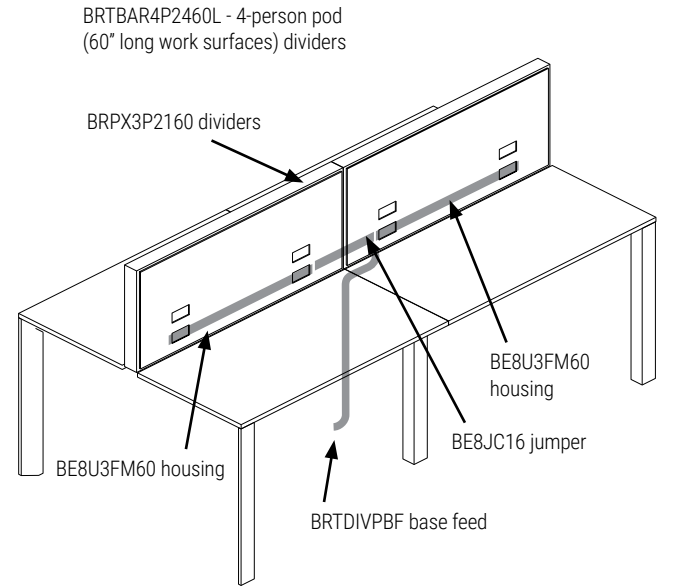
Note: **Powered BRPX3P dividers cannot be combined with BRTETB power troughs on freestanding Bridges tables.** They both require separate, dedicated base feed, and BRPX3P Divider's base feed would physically interfere with the BRTETB below work surface trough.

BRPX3P dividers and BRTETB below work surface troughs can only be combined if the **power to the BRPX3P dividers is fed horizontally from adjacent Boulevard System 3 panels** (thus preventing base feed's interfering with the troughs). BRTETB below work surface troughs remain powered by BRTDIVPBF base feed.

Under certain conditions **powered BRPX3P dividers can be combined with BRTETB power troughs.** Thus, in addition to enhanced privacy and support for accessories, the BRPX3P/BRTETB electrified combo provides double layered power distribution system (each with 8 wires and 4 circuits) for customers with high power demands. Note that each layer needs its own power supply source base feed power supply.

Note: BRPX3P dividers and BRTETB below work surface troughs can only be combined if the **power to the BRPX3P dividers is fed horizontally from adjacent Boulevard System 3 panels.**

**BRPX3P Divider's base feed will physically interfere with the BRTETB below work surface trough.** BRTETB below work surface troughs remain powered by BRTDIVPBF base feed. Bridges BRTBF base feed and BRTDIVPBF divider base feed are dedicated, non-interchangeable components.



## Applications

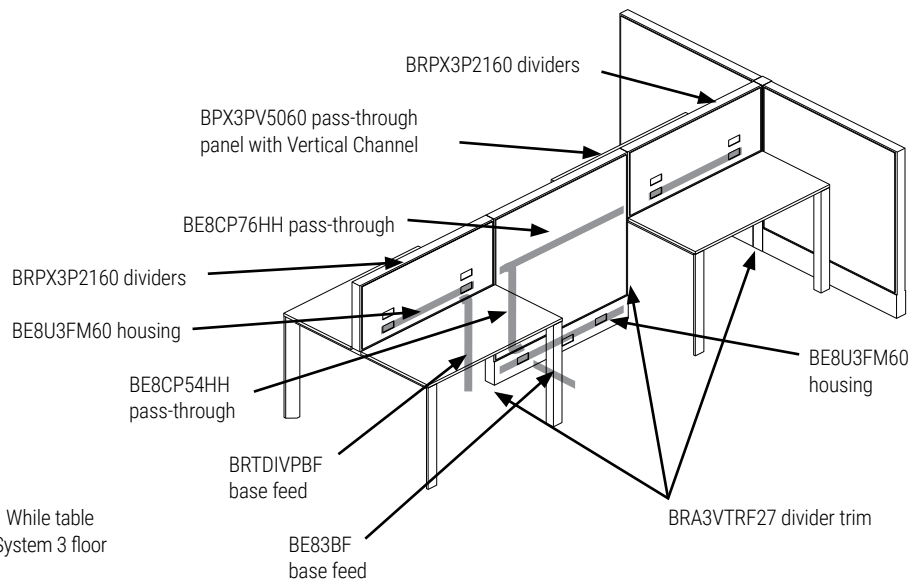
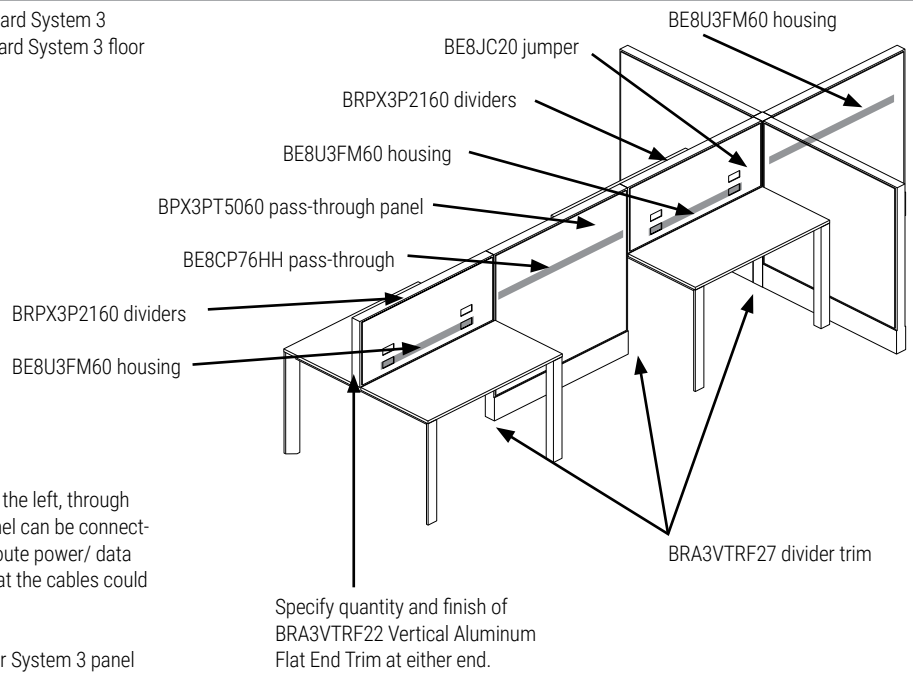
Bridges table mounted BRPX3P dividers offers can be combined with Boulevard System 3 panels. Table mounted BRPX3P dividers will match in height 50" high Boulevard System 3 floor standing panel.

### BRPX3P dividers combined with BOULEVARD System 3 panels.

Power routed through System 3 panels.

This example illustrates power routed from the System 3 panel assembly on the left, through the post and into table mounted BRPX3P dividers. Any 50" high System3 panel can be connected between two independent bridges table assemblies, but if you intend to route power/ data into the next bridges table cluster, specify BPX3PT Pass-through panel so that the cables could cross horizontally into the next table mounted BRPX3P divider on the right.

Specify quantity and finish of BRA3VTRF27 Bridges Divider trims which cover System 3 panel vertical face below Bridges table mounted BRPX3P dividers.



**BRPX3P dividers combined with BOULEVARD System 3 panels. Floor feed.** While table mounted BRPX3P dividers can be physically connected to 50" high Boulevard System 3 floor standing panels, power/data could be routed from the floor (as illustrated).

There are two ways of facilitating floor feed. 1: Power could enter through the bottom of table mounted BRPX3P divider, into BE8U3FM60 housing and then continues through BPX3PT5060 or BPX3PV5060 pass-through panel into adjacent BRPX3P divider. 2: BE83BF base feed supplies BE8U3FM60 housing within BPX3PV5060 pass-through panel (with integrated vertical channel). BE8CP54HH Pass-through harness then feeds BE8U3FM60 housing within the table mounted BRPX3P divider on the right. BE8CP76HH Pass-through harness then continues through BPX3PV5060 pass-through panel into adjacent BRPX3P divider.

**Note:** These two examples are for illustration purposes only as **two power feeds must not be connected to one power distribution system!**

## Applications

BRPX3MA25 and BRPXGMA25 Boulevard System 3 dividers facilitate seamless transition from panel-based office to open environment.

**BRPX3MA25 and BRPXGMA25 panels combined with BOULEVARD System 3.** Power routed through System 3 panels.

The first 50" high panel is furnished with face mount power through its integrated vertical channel.

Any equipment placed on top of the 25" storage cabinets can be plugged into the floor raceway (cables rising through the gap between the panels and the cabinet).

Specify quantity and finish of BRA3VTSF25 bridges-BLVD step down end trims.

BRPXGMA25 panel

BRPXGMA25 panel

The pair of work surface-mounted BRED50AC Duo Modules on the right (plugged into the floor raceway) provide easy access to power at desk height.

Specify quantity and finish of BRA3VTRF25 vertical aluminum flat end trim at the end.

This example illustrates power routed at the floor level from the System 3 panel assembly on the left into BRPX3MA25 and BRPXGMA25 panels.

Combination of **25" high Bridges storage cabinets with BRPX3S storage mounted dividers** forms storage-based linear spine capable of delivering 8-wire, 4-circuit power distribution along the spine.

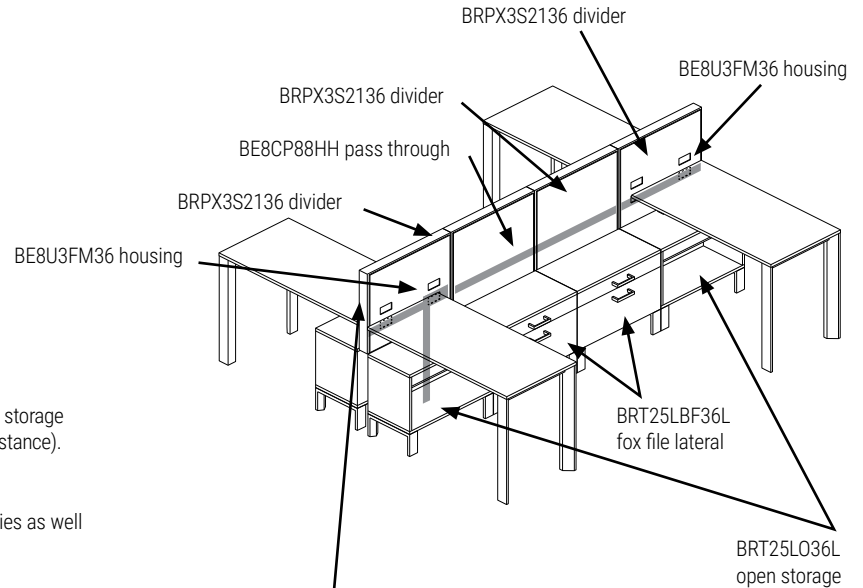
BRPX3S storage mounted dividers combined with Bridges 25" high storage.

BRPX3S dividers are secured to a storage-based spine formed by back-to-back Bridges storage cabinets of corresponding width (BRPX3S2136 divider secured to BRT25LBF36L, for instance). Optional Accessory tiles support paper-organizing accessories.

Storage mounted dividers reach 46" above the floor to suggest work station boundaries as well as to support paper organizers (with accessory tile installed).

Power enters the spine from the bottom, in-between the back-to-back storage cabinets and is then routed horizontally between the dividers.

Note: This assembly was conceived as a stand-alone application - **not compatible with floor standing Boulevard System 3 panels.**

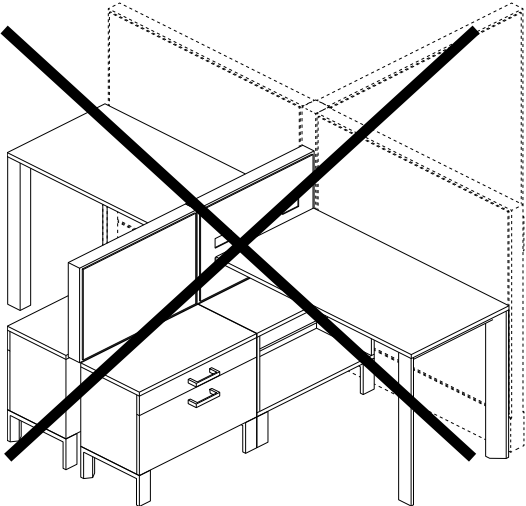


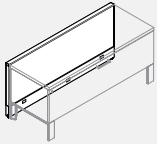
Specify quantity and finish of BRA3VTRF22 Vertical Aluminum Flat End Trim at either end.



**Applications**

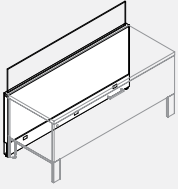
**Note:** BRPX3S storage mounted dividers combined with Bridges 25" high storage was conceived as a standalone application. It is not compatible with floor standing Boulevard System 3 panels.



**BRPX3MA25 • 25" High System 3 Panel**

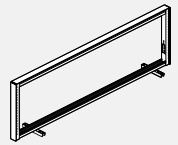
- 25" high System3 panel facilitates seamless transition from a panel-based, enclosed office to an open one. It can be connected to a cluster of panels on one side and continue with power / data spine distribution into collaborative areas.
- 25" high System3 panel also enables creation of a storage-based spine with full 8-wire, 4-circuit power and data capacity.

PRODUCT CODE	PRICE			SIZE/INCHES			WEIGHT VOL	
	GR1	GR2	OPT	H	W	D	LBS	FT <sup>3</sup>
BRPX3MA2530	452	475	495	25	30	2.5	5.00	1.09
BRPX3MA2536	491	537	563	25	36	2.5	6.00	1.30
BRPX3MA2542	537	578	607	25	42	2.5	7.00	1.52

**BRPX3GMA25 • 25" High System 3 Panel**

- 25" high System3 panel facilitates seamless transition from a panel-based, enclosed office to an open one. It can be connected to a cluster of panels on one side and continue with power / data spine distribution into collaborative areas.
- 25" high System3 panel also enables creation of a storage-based spine with full 8-wire, 4-circuit power and data capacity.
- B3 panel Top trim option provided with embedded, frame-less glass pane rising 8" above the top of the panel. For instance, when installed on 42" high B3 panel, overall height will be 50" high.
- There is 1.25" gap between two adjacent glass panes.
- Glass shipped separately, Allen key to set the glass pane plumb is provided with each panel.
- 5mm tempered glass, acid etched on one side or clear.
- Square corners on glass.
- Integrated adjustable brackets and extruded aluminum trim.
- Cannot be retrofit on-site.

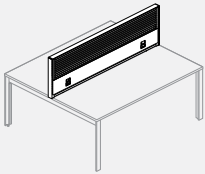
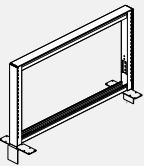
PRODUCT CODE	PRICE			SIZE/INCHES			WEIGHT VOL	
	GR1	GR2	OPT	H	W	D	LBS	FT <sup>3</sup>
BRPX3GMA2530	886	908	954	25	30	2.5	5.00	1.09
BRPX3GMA2536	931	973	1023	25	36	2.5	6.00	1.30
BRPX3GMA2542	987	1029	1083	25	42	2.5	7.00	1.52

**BRPX3P21 • Table Mounted Open Frame Divider**

- Aluminum panel frame designed to be secured between two back-2-back bridges work surfaces. When installed, the height of the panel matches the height of 50" high System3 panel. Note: individual panels can be interconnected with 'Capture strips'. The bridges panel is physically compatible with System 3 and can be interconnected using System 3 'Capture strips'.
- Intended to distribute 8-wire / 4-circuit power and data along table-based spine, enhance seated privacy, acoustics and support paper / task accessories. Not suitable for panel mounted Monitor arms. Divider is not slotted.
- Table mounting brackets and capture strips included (individual in-line panels can be interconnected with Capture strips). Specify power distribution harness, duplexes and tiles. End trims not included.
- Tile options: full fabric, full fabric with power/data openings, partial accessory/fabric tile and partial accessory / fabric with power/data openings.
- NOTE: The panel mounts only parallel, between back-2-back work surface. Perpendicular mounting brackets are not available.
- NOTE: Table Mounted Dividers with tiles should not be used with worksurfaces with access doors, BRTWSA & BRTWSAA.

PRODUCT CODE	PRICE	SIZE/INCHES			WEIGHT VOL	
		H	W	D	LBS	FT <sup>3</sup>
BRPX3P2130	171	22	30	2.5	5.40	0.95
BRPX3P2136	178	22	36	2.5	6.50	1.15
BRPX3P2142	183	22	42	2.5	7.50	1.34
BRPX3P2148	194	22	48	2.5	8.60	1.53
BRPX3P2154	201	22	54	2.5	9.70	1.72
BRPX3P2160	208	22	60	2.5	10.80	1.91
BRPX3P2166	213	22	66	2.5	11.90	2.10
BRPX3P2172	221	22	72	2.5	13.00	2.29

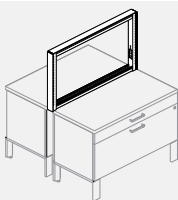
Application

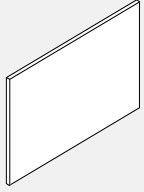
**BRPX3S • Storage Mounted B3 Divider**

- Aluminum panel frame designed to be secured between two back-2-back bridges 21" or 25" high lateral storage units. When installed, top of the panel reaches 42" or 46". Note: individual panels can be interconnected with 'Capture strips'. The bridges panel is physically compatible with System 3 and can be interconnected using System 3 'Capture strips'.
- Intended to distribute 8-wire / 4-circuit power and data along storage-based spine, enhance seated privacy, acoustics and support Paper / task accessories. Not suitable for panel mounted monitor arms. Divider is not slotted.
- Storage mounting brackets and capture strips included (individual in-line panels can be interconnected with capture strips)
- Specify power distribution harness, duplexes and tiles. End trims not included.
- Tile options: full fabric, full fabric with power/data openings, partial accessory/fabric tile and partial accessory fabric with power/data openings.
- NOTE: The panel mounts only parallel, between Back-2-back storage units. Perpendicular mounting brackets are not available.
- Horizontal cable management will not work between storage to table dividers or to panels.
- Cable management must be between dividers on storage only.

PRODUCT CODE	PRICE	SIZE/INCHES			WEIGHT VOL	
		H	W	D	LBS	FT <sup>3</sup>
BRPX3S2130	171	22	30	2.5	5.40	0.95
BRPX3S2136	178	22	36	2.5	6.50	1.15
BRPX3S2142	183	22	42	2.5	7.50	1.34

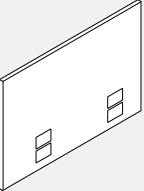
Application



**BRPX3FT21 • B3 Bridges Divider Tile**

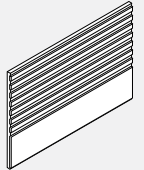
- Full fabric tile. Aluminum frame, fabric stretched around frame's perimeter.

PRODUCT CODE	PRICE			SIZE/INCHES			WEIGHT VOL	
	GR1	GR2	OPT	H	W	D	LBS	FT <sup>3</sup>
BRPX3FT2130	82	90	95	22	30	1	2.70	0.38
BRPX3FT2136	90	95	104	22	36	1	3.25	0.46
BRPX3FT2142	102	109	116	22	42	1	3.80	0.53
BRPX3FT2148	112	122	132	22	48	1	4.32	0.61
BRPX3FT2154	124	133	144	22	54	1	4.86	0.69
BRPX3FT2160	134	145	157	22	60	1	5.40	0.76
BRPX3FT2166	146	157	171	22	66	1	5.94	0.84
BRPX3FT2172	157	171	182	22	72	1	6.48	0.92

**BRPX3NET21 • B3 Bridges Fabric Electrical Tile**

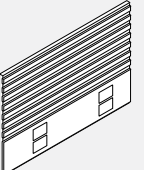
- Full fabric tile with openings for power and data. Aluminum frame, fabric stretched around frame's perimeter.
- Includes one data opening blank cover. Specify power distribution module, duplexes.
- Jumpers and power feed harnesses separately.

PRODUCT CODE	PRICE			SIZE/INCHES			WEIGHT VOL	
	GR1	GR2	OPT	H	W	D	LBS	FT <sup>3</sup>
BRPX3NET2130	156	169	180	22	30	1	2.70	0.38
BRPX3NET2136	159	172	183	22	36	1	3.25	0.46
BRPX3NET2142	162	176	192	22	42	1	3.80	0.53
BRPX3NET2148	169	179	195	22	48	1	4.32	0.61
BRPX3NET2154	171	182	200	22	54	1	4.86	0.69
BRPX3NET2160	174	190	204	22	60	1	5.40	0.76
BRPX3NET2166	178	194	208	22	66	1	5.94	0.84
BRPX3NET2172	181	199	212	22	72	1	6.48	0.92

**BRPX3ATF21 • B3 Bridges Accessory Fabric Tile**

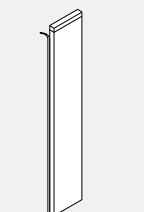
- Partial accessory/fabric tile. The kit consists of a 12" high accessory tile with horizontal slats and an 8" high fabric tile (fabric stretched over aluminum frame).

PRODUCT CODE	PRICE			SIZE/INCHES			WEIGHT VOL	
	GR1	GR2	OPT	H	W	D	LBS	FT <sup>3</sup>
BRPX3ATF2130	260	279	303	22	30	1	6.84	0.38
BRPX3ATF2136	268	291	313	22	36	1	8.20	0.46
BRPX3ATF2142	280	303	327	22	42	1	9.57	0.53
BRPX3ATF2148	291	313	340	22	48	1	10.94	0.61
BRPX3ATF2154	303	327	351	22	54	1	12.31	0.69
BRPX3ATF2160	312	339	366	22	60	1	13.68	0.76
BRPX3ATF2166	323	349	377	22	66	1	15.04	0.84
BRPX3ATF2172	333	363	389	22	72	1	16.40	0.92

**BRPX3ATE21 • B3 Bridges Accessory Electrical Tile**

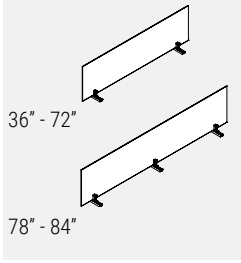
- Partial accessory/fabric power and data tile. The kit consists of a 12" high accessory tile with horizontal slats and an 8" high fabric tile (fabric stretched over aluminum frame).
- Power/data openings in the partial fabric tile section, cover includes one data opening blank cover.
- Specify power distribution module, Duplexes, Jumpers and Power feed harnesses separately.

PRODUCT CODE	PRICE			SIZE/INCHES			WEIGHT VOL	
	GR1	GR2	OPT	H	W	D	LBS	FT <sup>3</sup>
BRPX3ATE2130	284	307	333	22	30	1	7.00	0.38
BRPX3ATE2136	298	320	347	22	36	1	8.40	0.46
BRPX3ATE2142	309	333	363	22	42	1	9.80	0.53
BRPX3ATE2148	320	347	373	22	48	1	11.10	0.61
BRPX3ATE2154	333	361	388	22	54	1	12.50	0.69
BRPX3ATE2160	343	372	401	22	60	1	13.90	0.76
BRPX3ATE2166	354	384	417	22	66	1	15.20	0.84
BRPX3ATE2172	369	398	431	22	72	1	16.60	0.92

**BRA3VTRF22 • B3 Bridges Divider Trim**

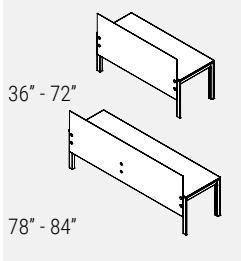
- For use with Bridges/System3 Panel/Storage Dividers.
- Table mounted BRPX3P End Trim.
- 25" Boulevard Panel Vertical trim.
- System3 step down panel trim - covers panel's vertical from the bottom of table mounted BRPX3P to the bottom of the adjacent System3 panel.
- System3 step down panel trim - covers panel's vertical from top of BRPX-GMA25 panel to top of adjacent BPX3-34" high System3 panel.
- System3 step down panel trim - covers panel's vertical from top of BRPX-GMA25 panel on top of adjacent BPX3- 42" high System3 panel.
- System3 step down panel trim - covers panel's vertical from top of BRPX-GMA25 panel to top of adjacent BPX3- 50" high System3 panel.

PRODUCT CODE	PRICE	SIZE/INCHES			WEIGHT VOL	
		H	W	D	LBS	FT <sup>3</sup>
BRA3VTRF22	29	22	2.61	0.125	0.045	
BRA3VTRF25	34	25	2.61	0.125	0.045	
BRA3VTRF27	41	27	2.61	0.125	0.05	
BRA3VTRF34	46	34	2.61	0.125	0.06	
BRA3VTRF38	54	38	2.61	0.125	0.07	
BRA3VTSF09	21	9	2.61	0.125	0.02	
BRA3VTSF17	24	17	2.61	0.125	0.03	
BRA3VTSF25	34	25	2.61	0.125	0.05	

**BRTAGDD • Glass Table Mounted Dividers**

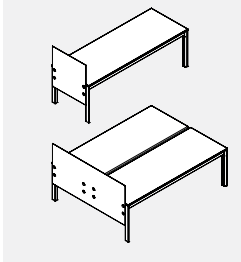
- **Parallel divider, Back 2 Back tables, glass**
- Secures between two Back 2 Back tables; provides privacy, divides space.
- Installed divider measures 15.7" from the top of the worksurface.
- 36" -72" dividers include 2 support brackets; 78" and 84" dividers include 3 support brackets.
- Tempered glass, acid etched finish on one side (similar to frosted), painted support brackets.

PRODUCT CODE	PRICE	SIZE/INCHES			WEIGHT VOL	
		H	W	D	LBS	FT <sup>3</sup>
BRTAGDD36	373	16	33	0.25	12	0.07
BRTAGDD42	417	16	39	0.25	14	0.09
BRTAGDD48	450	16	45	0.25	16	0.10
BRTAGDD54	490	16	51	0.25	18	0.11
BRTAGDD60	516	16	57	0.25	21	0.13
BRTAGDD66	557	16	63	0.25	23	0.14
BRTAGDD72	600	16	69	0.25	25	0.16
BRTAGDD78	697	16	75	0.25	27	0.17
BRTAGDD84	740	16	81	0.25	29	0.18

**BRTAGDS • Glass Table Mounted Parallel Divider**

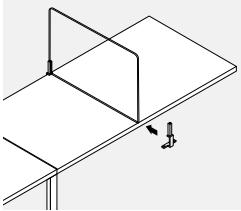
- **Secures to the rear edge of a single table; provides privacy, divides space while not obstructing available light.**
- 36"-72" dividers include 2 mounting brackets; 78" and 84" dividers include 3 mounting brackets.
- Tempered glass, acid etched on one side (similar to frosted), satin chrome disc fasteners and powder coated steel support brackets.
- Installed divider reaches 15.7" up and 15" down from the top of the worksurface.
- Not recommended for use on tables using 42" high legs.

PRODUCT CODE	PRICE	SIZE/INCHES			WEIGHT VOL	
		H	W	D	LBS	FT <sup>3</sup>
BRTAGDS36	707	30.7	33	0.250	23	0.150
BRTAGDS42	774	30.7	39	0.250	27	0.175
BRTAGDS48	840	30.7	45	0.250	31	0.200
BRTAGDS54	907	30.7	51	0.250	35	0.225
BRTAGDS60	972	30.7	57	0.250	39	0.250
BRTAGDS66	1038	30.7	63	0.250	43	0.275
BRTAGDS72	1106	30.7	69	0.250	47	0.300
BRTAGDS78	1324	30.7	75	0.250	51	0.325
BRTAGDS84	1389	30.7	81	0.250	55	0.350

**BRTAGED • Glass Perpendicular End of Run Divider**

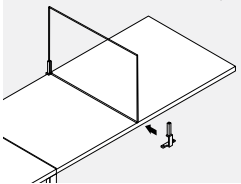
- **Secures to the perpendicular edge of a single or double Back 2 Back table; provides privacy, divides space while not obstructing available light.**
- Installed divider reaches 15.7" up and 15" down from the top of the worksurface.
- 1/2" radius front top corner of 24" and 30" deep glass dividers. 51" and 63" glass dividers for Back 2 Back tables have both top corners 1/2" radius.
- 24" and 30" dividers include 2 mounting brackets.
- 51" and 63" dividers include 4 mounting brackets.
- Tempered glass, acid etched on one side (similar to frosted), satin chrome disc fasteners and powder coated steel support brackets.
- Note: Outside of glass is etched and inside is smooth for left (BRTAGEDL) and right (BRTAGED-R).

PRODUCT CODE	PRICE	SIZE/INCHES			WEIGHT VOL	
		H	W	D	LBS	FT <sup>3</sup>
BRTAGED24L	672	30.7	25.4	0.250	23	0.150
BRTAGED24R	672	30.7	25.4	0.250	23	0.150
BRTAGED30L	740	30.7	31.4	0.250	27	0.175
BRTAGED30R	740	30.7	31.4	0.250	27	0.175
BRTAGED51	1324	30.7	50.5	0.250	31	0.200
BRTAGED63	1456	30.7	62.5	0.250	35	0.225

**BRTAGPPD-M • Shared Glass Perpendicular Side to Side Divider - Middle**

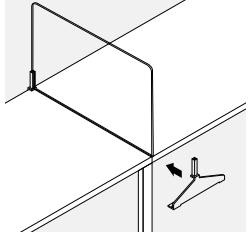
- **Provides privacy, divides space.**
- 24M and 30M kits are designed to be installed on tables with recessed legs (round legs, 34" rectangular legs).
- 24M and 30M kits consist of a rear and front bracket (powder coated steel), tempered glass with rounded top corners (acid etched on one side), bracket-fitting gaskets and mounting screws securing the brackets to the underside of the worksurface.
- Over the seam application would be installed with the wide bracket at the front (thus bypassing the shared leg) and "middle of the work surface" application would be installed with the wide bracket at the back and the narrow at the front".

PRODUCT CODE	PRICE	SIZE/INCHES			WEIGHT VOL	
		H	W	D	LBS	FT <sup>3</sup>
BRTAGPPD24M	499	16	24	0.250	9	0.055
BRTAGPPD30M	518	16	30	0.250	11.25	0.069

**BRTAGPPD-MQ • Shared Glass Perpendicular Side to Side Divider - Middle - Square Corners**

- **Provides privacy, divides space.**
- 24M and 30M kits are designed to be installed on tables with recessed legs (round legs, 34" rectangular legs).
- 24M and 30M kits consist of a rear and front bracket (powder coated steel), tempered glass with rounded top corners (acid etched on one side), bracket-fitting gaskets and mounting screws securing the brackets to the underside of the worksurface.
- Over the seam application would be installed with the wide bracket at the front (thus bypassing the shared leg) and "middle of the work surface" application would be installed with the wide bracket at the back and the narrow at the front".

PRODUCT CODE	PRICE	SIZE/INCHES			WEIGHT VOL	
		H	W	D	LBS	FT <sup>3</sup>
BRTAGPPD24MQ	421	16	24	0.250	9	0.055
BRTAGPPD30MQ	443	16	30	0.250	11.25	0.069

**BRTAGPPD-S • Shared Glass Perpendicular Side to Side Divider - Seam**

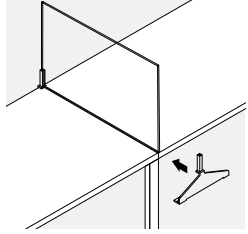
- Provides privacy, divides space.

• 24S and 30S kits are designed to be installed in the middle or over a seam of two adjacent work surfaces supported by a shared, full depth RECTANGULAR leg.

• 24S and 30S kits consist of a rear and front bracket (powder coated steel), tempered glass with rounded top corners (acid etched on one side), bracket-fitting gaskets and mounting screws securing the brackets to the underside of the worksurface.

• Note: Cannot be installed over two, side-by-side rectangular legs. Only one shared or recessed leg.

PRODUCT CODE	PRICE	SIZE/INCHES			WEIGHT VOL	
		H	W	D	LBS	FT <sup>3</sup>
BRTAGPPD24S	499	16	24	0.250	9	0.055
BRTAGPPD30S	518	16	30	0.250	11.25	0.069

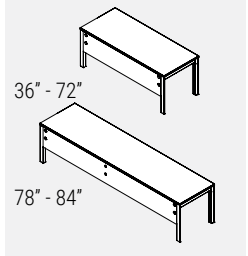
**BRTAGPPD-SQ • Shared Glass Perpendicular Side to Side Divider - Seam - Square Corners**

- Provides privacy, divides space.

• 24S and 30S kits are designed to be installed in the middle or over a seam of two adjacent work surfaces supported by a shared, full depth RECTANGULAR leg.

• 24S and 30S kits consist of a rear and front bracket (powder coated steel), tempered glass with rounded top corners (acid etched on one side), bracket-fitting gaskets and mounting screws securing the brackets to the underside of the worksurface. Note: Cannot be installed over two, side-by-side rectangular legs. Only one shared or recessed leg.

PRODUCT CODE	PRICE	SIZE/INCHES			WEIGHT VOL	
		H	W	D	LBS	FT <sup>3</sup>
BRTAGPPD24SQ	421	16	24	0.250	9	0.055
BRTAGPPD30SQ	443	16	30	0.250	11.25	0.069

**BRTAGMPS • Glass Modesty Panel**

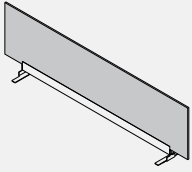
- Secures to the rear edge of a single table, between table legs; provides privacy. Installed divider reaches 15" below the worksurface.

• 36"-72" modesty panels include 2 mounting brackets.

• 78"-84" modesty panels include 3 mounting brackets.

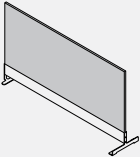
• Tempered glass, acid etched on one side (similar to frosted), satin chrome disc fasteners and powder coated steel support brackets.

PRODUCT CODE	PRICE	SIZE/INCHES			WEIGHT VOL	
		H	W	D	LBS	FT <sup>3</sup>
BRTAGMPS36	490	13.25	29.75	0.25	9	0.05
BRTAGMPS42	522	13.25	35.75	0.25	11	0.06
BRTAGMPS48	557	13.25	41.75	0.25	13	0.08
BRTAGMPS54	591	13.25	47.75	0.25	15	0.09
BRTAGMPS60	625	13.25	53.75	0.25	17	0.10
BRTAGMPS66	657	13.25	59.75	0.25	19	0.11
BRTAGMPS72	691	13.25	65.75	0.25	20	0.12
BRTAGMPS78	872	13.25	71.75	0.25	22	0.13
BRTAGMPS84	907	13.25	77.75	0.25	24	0.14

**BRTAFDD • Back 2 Back Parallel Felt Divider**

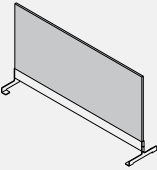
- **Secures to the underside of the worksurface.**
- 9mm felt material is tackable and comes in 18 different colours. Please specify colour.
- Installed divider measures 15.7" high from the top of the worksurface.
- Please choose standard metal finish for extrusion and brackets.
- Upcharge of \$96 for anodized extrusion option.

PRODUCT CODE	PRICE	SIZE/INCHES			WEIGHT		VOL FT <sup>3</sup>
		H	W	D	LBS	FT <sup>3</sup>	
BRTAFDD36	204	16.88	33	7.5	2.8	0.41	
BRTAFDD42	229	16.88	39	7.5	3.2	0.48	
BRTAFDD48	260	16.88	45	7.5	3.7	0.55	
BRTAFDD54	366	16.88	51	7.5	4.1	0.63	
BRTAFDD60	388	16.88	57	7.5	4.6	0.70	
BRTAFDD66	410	16.88	63	7.5	5.0	0.77	
BRTAFDD72	433	16.88	69	7.5	5.4	0.85	
BRTAFDD78	454	16.88	75	7.5	5.9	0.92	
BRTAFDD84	477	16.88	81	7.5	6.3	1.00	

**BRTAFPPD-M • Perpendicular Side to Side Off Module Felt Divider**

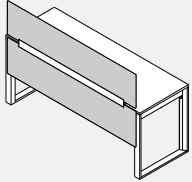
- **1 wide bracket at the back and 1 narrow bracket at the front secure the divider off module to worksurface edges.**
- 9mm felt material is tackable and comes in 18 different colours. Please specify colour.
- Installed divider measures 15.7" high from the top of the worksurface.
- Please choose standard metal finish for extrusion and brackets.
- Upcharge of \$96 for anodized extrusion option.

PRODUCT CODE	PRICE	SIZE/INCHES			WEIGHT		VOL FT <sup>3</sup>
		H	W	D	LBS	FT <sup>3</sup>	
BRTAFPPD24M	171	16.85	24.24	6.5	2.1	0.22	
BRTAFPPD30M	195	16.85	30.24	6.5	2.6	0.27	

**BRTAFPPD-S • Perpendicular Side to Side Felt Divider**

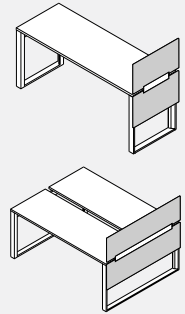
- **2 wide bracket secure the divider off module and over the seam of 2 adjacent worksurface.**
- 9mm felt material is tackable and comes in 18 different colours. Please specify colour.
- Installed divider measures 15.7" high from the top of the worksurface.
- Please choose standard metal finish for extrusion and brackets.
- Upcharge of \$96 for anodized extrusion option.

PRODUCT CODE	PRICE	SIZE/INCHES			WEIGHT		VOL FT <sup>3</sup>
		H	W	D	LBS	FT <sup>3</sup>	
BRTAFPPD24S	176	16.85	24.24	6.5	2.3	0.22	
BRTAFPPD30S	199	16.85	30.24	6.5	2.7	0.27	
BRTAFPPD51S	357	16.85	50.81	6.5	4.2	0.46	
BRTAFPPD63S	405	16.85	62.81	6.5	5.1	0.57	

**BRTAFDSN • Felt Divider and Modesty Panel Kit**

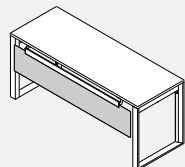
- **Felt divider and modesty panel kit secures to the rear bottom of a single Bridges table and provides privacy above and below the worksurface.**
- 9 mm felt material is tackable and comes in a wide range of colours.
- Installed, the divider measures 15.7 high from the top of the worksurface and 15" high below the top of the worksurface.
- Kit includes two felt dividers, support extrusion and left and right brackets.
- Please choose the finish of the felt and the metal finish for the extrusion and brackets.

PRODUCT CODE	PRICE	SIZE/INCHES			WEIGHT		VOL FT <sup>3</sup>
		H	W	D	LBS	FT <sup>3</sup>	
BRTAFDSN48	499	30.68	45	4.05	5.19	38.83	
BRTAFDSN54	603	30.68	51	4.05	5.87	44.01	
BRTAFDSN60	643	30.68	57	4.05	6.54	49.18	
BRTAFDSN66	672	30.68	63	4.05	7.21	54.36	
BRTAFDSN72	770	30.68	69	4.05	7.89	59.54	
BRTAFDSN78	812	30.68	72	4.05	8.57	62.13	
BRTAFDSN84	851	30.68	78	4.05	9.24	67.30	

**BRTAFEDN • Felt End Divider and Modesty Panel Kit**

- **Felt divider and modesty panel kit secures to the side bottom of a single or back to back Bridges table and provides privacy above and below the worksurface.**
- 9 mm felt material is tackable and comes in a wide range of colours.
- Installed, the divider measures 15.7 high from the top of the worksurface and 15" high below the top of the worksurface.
- Kit includes two felt dividers, support extrusion and left and right brackets.
- Please choose the finish of the felt and the metal finish for the extrusion and brackets.

PRODUCT CODE	PRICE	SIZE/INCHES			WEIGHT		VOL FT <sup>3</sup>
		H	W	D	LBS	FT <sup>3</sup>	
BRTAFEDN24	303	30.68	25.46	4.05	3.3	21.97	
BRTAFEDN30	341	30.68	31.46	4.05	3.98	27.15	
BRTAFEDN51	625	30.68	50.56	4.05	6.22	43.63	
BRTAFEDN63	713	30.68	62.56	4.05	7.57	53.98	

**BRTAFMPSN • Felt Modesty Panel**

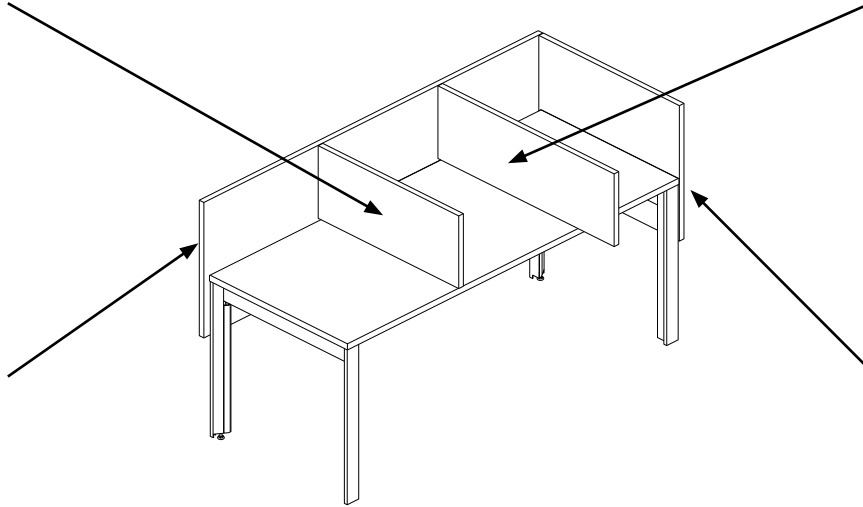
- **Felt modesty panel secures to the rear bottom of a single Bridges table and provides privacy below the worksurface.**
- 9 mm felt material is tackable and comes in a wide range of colours.
- Installed, the divider measures 15" high below the top of the worksurface.
- Kit includes felt modesty, support extrusion and left and right brackets.
- Please choose the finish of the felt and the metal finish for the extrusion and brackets.

PRODUCT CODE	PRICE	SIZE/INCHES			WEIGHT		VOL FT <sup>3</sup>
		H	W	D	LBS	FT <sup>3</sup>	
BRTAFMPSN48	202	13.82	41.76	4.17	3.31	16.71	
BRTAFMPSN54	276	13.82	47.76	4.17	3.72	19.11	
BRTAFMPSN60	289	13.82	53.76	4.17	4.13	21.51	
BRTAFMPSN66	307	13.82	59.76	4.17	4.54	23.92	
BRTAFMPSN72	327	13.82	65.76	4.17	4.95	26.32	
BRTAFMPSN78	343	13.82	71.76	4.17	5.36	28.72	
BRTAFMPSN84	364	13.82	77.76	4.17	5.77	31.12	



### Single Table Or Single Table Row Application:

Perpendicular laminate side to side divider  
BRTLPPD: flush with the front WS edge. Can be installed off-module to the front and back edge of work surface, regardless of type of leg support - supporting brackets can straddle over shared leg."

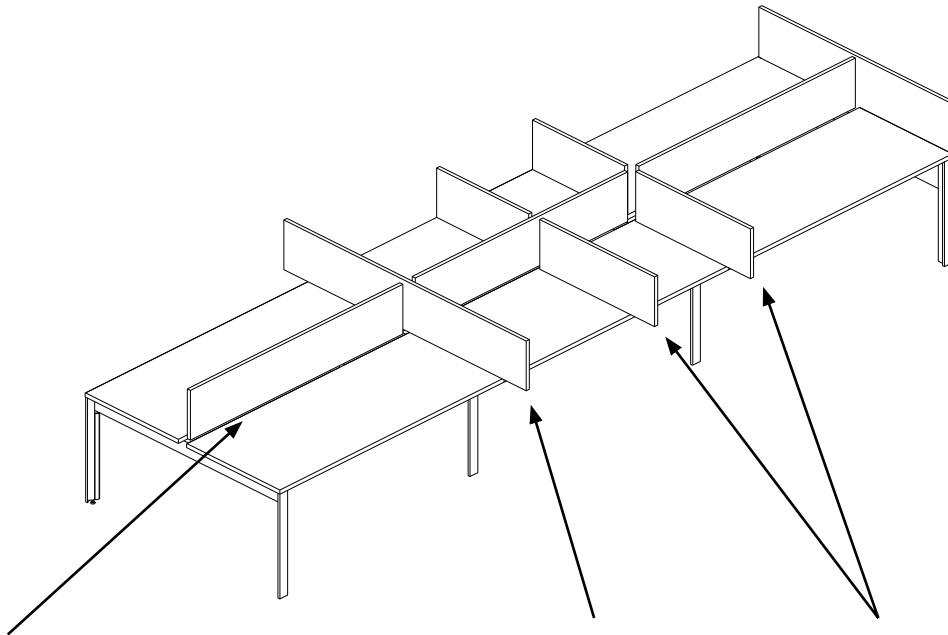


Extended Perpendicular Laminate side to side divider  
BRTLPE The extended version protrudes by 6" beyond the front WS edge for added privacy. Can be installed off-module to the front and back edge of work surface, regardless of type of leg support - supporting brackets can straddle over shared leg."

Parallel laminate table mounted divider  
BRTLPPDS for single table or single table row: recessed 1.3" at both ends; mounted to the table with 0.9" gap at the back.

Laminate perpendicular end of run divider  
BRTLPE 24, 30 for single table or single table run: flush at the front WS edge; extended back flush with BRTLPPDS divider."

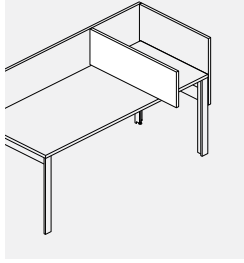
### Back-To-Back And Back 2 Back Table Row Application:



Parallel laminate table mounted divider  
BRTLPPD: recessed 1.3" at both ends; mounted between two back-to-back work surfaces."

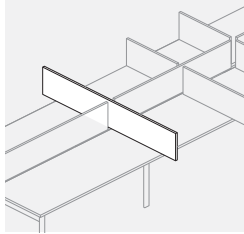
Extended perpendicular laminate side to side double divider BRTLPESE: this one piece divider spans beyond both back-2-back work surfaces: installs on-module, between two BRTLPPD dividers and is secured to the front edge of both work surfaces, regardless of type of leg support - supporting brackets can straddle over shared leg."  
Protrudes 6" beyond the front

Extended perpendicular laminate side to side divider  
BRTLPESE. The extended version protrudes by 6" beyond the front WS edge for added privacy. Can be installed off-module or on module to the front and back edge of work surface, regardless of type of leg support - supporting brackets can straddle over shared leg."  
Shown above in On-module and Off-module application.

**BRTLPESE • Perpendicular Laminate Side to Side Divider - Extended**

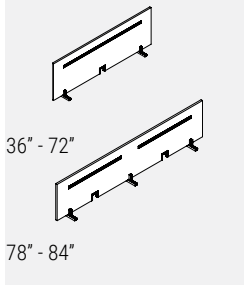
- Provides privacy, divides spaces.
- Protrudes by 6" beyond the front worksurface edge for added privacy.
- Specify BRTLPESE30 for 24" deep work surfaces and BRTLPESE36 for 30" deep work surfaces.
- Secures off-module or on-module to the front and back edge of work surface, regardless of type of leg support - supporting brackets can straddle over shared leg.
- Includes powder coated steel support brackets. 3/4 LP PVC edge boards, please specify laminate and 3mm PVC edge on order.

PRODUCT CODE	PRICE	SIZE/INCHES			WEIGHT VOL	
		H	W	D	LBS	FT <sup>3</sup>
BRTLPESE30	221	16	30	0.75	9.00	0.21
BRTLPESE36	252	16	36	0.75	11.00	0.25

**BRTLPESE • Perpendicular Laminate Side to Side Double Divider - Extended**

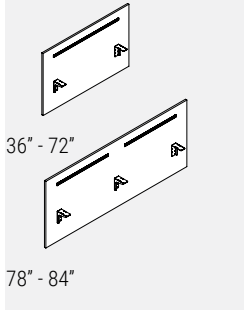
- Provides privacy, divides space. Protrudes 6" beyond the front worksurface edges on either side for added privacy.
- Specify BRTLPESE63 for 24" deep back 2 back work surfaces and BRTLPESE75 for 30" deep back 2 back work surfaces.
- Installs on-module, between two BRTLPESE dividers. It is secured to the front edge of both work surfaces, regardless of type of leg support - supporting brackets can straddle over shared leg.
- NOTE: Can only be installed on-module, between two BRTLPESE dividers.
- Includes powder coated steel support brackets. 3/4 LP PVC edge boards, please specify laminate and 3mm PVC edge on order.

PRODUCT CODE	PRICE	SIZE/INCHES			WEIGHT VOL	
		H	W	D	LBS	FT <sup>3</sup>
BRTLPESE63	411	16	63	0.75	18.00	0.44
BRTLPESE75	459	16	75	0.75	22.00	0.52

**BRTLPESE • Laminate Table Mounted Dividers**

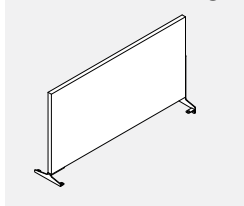
- Parallel divider, Back 2 Back tables, LP
- Secures between two Back 2 Back tables; provides privacy, divides space.
- Installed divider measures 15.7" from the top of the worksurface.
- 78" and 84" dividers include 3 support brackets and two pass-through grommets.
- Integrated anodized aluminum accessory rail, white cut out and rail trims; painted support brackets.
- 3/4" LP PVC edged boards, please specify laminate & 3mm PVC edge on order.

PRODUCT CODE	PRICE	SIZE/INCHES			WEIGHT VOL	
		H	W	D	LBS	FT <sup>3</sup>
BRTLPESE36	291	16	33	0.75	10	0.22
BRTLPESE42	318	16	39	0.75	12	0.27
BRTLPESE48	347	16	45	0.75	14	0.31
BRTLPESE54	366	16	51	0.75	15	0.35
BRTLPESE60	383	16	57	0.75	17	0.39
BRTLPESE66	401	16	63	0.75	19	0.43
BRTLPESE72	430	16	69	0.75	21	0.47
BRTLPESE78	539	16	75	0.75	23	0.52
BRTLPESE84	555	16	81	0.75	24	0.56

**BRTLPESE • High Laminate Table Mounted Divider**

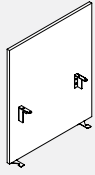
- Parallel divider, single tables, LP
- Accessory rail is installed on one side only.
- Secures to the back of a single table; provides privacy, divides space.
- Installed divider reaches 15.7" up and 15" down from the top of the worksurface.
- 36" - 72" dividers include 2 support brackets; 78" and 84" dividers include 3 support brackets.
- Integrated anodized aluminum accessory rail, white cut out and rail trims; powder coat brackets.
- Integrated modesty panel.
- 3/4" LP PVC edged boards, please specify laminate & 3mm PVC edge on order.
- Not recommended for use on tables using 42" high legs.

PRODUCT CODE	PRICE	SIZE/INCHES			WEIGHT VOL	
		H	W	D	LBS	FT <sup>3</sup>
BRTLPESE36	410	30.7	33	0.75	22	0.50
BRTLPESE42	501	30.7	39	0.75	25	0.56
BRTLPESE48	539	30.7	45	0.75	29	0.66
BRTLPESE54	567	30.7	51	0.75	32	0.75
BRTLPESE60	610	30.7	57	0.75	36	0.83
BRTLPESE66	645	30.7	63	0.75	40	0.91
BRTLPESE72	683	30.7	69	0.75	43	1.00
BRTLPESE78	837	30.7	75	0.75	47	1.08
BRTLPESE84	874	30.7	81	0.75	50	1.16

**BRTLPESE • High Perpendicular Laminate Side to Side Divider**

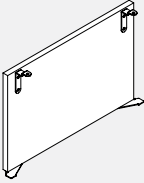
- **Perpendicular side-to-side divider, 3/4" LP PVC edged board, please specify laminate & 3mm PVC edge finish.**
- Includes powder coated steel support brackets.
- Provides privacy, divides space; secures off-module or on-module to the front and back edge of worksurface, regardless of type of leg support - supporting brackets can straddle over shared leg.
- Installed divider measures 15.7" from the top of the worksurface.

PRODUCT CODE	PRICE	SIZE/INCHES			WEIGHT VOL	
		H	W	D	LBS	FT <sup>3</sup>
BRTLPESE24	201	16	24	0.75	7	0.16
BRTLPESE30	218	16	30	0.75	9	0.20

**BRTLPEP • Laminate Perpendicular End of a Run Divider**

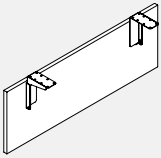
- Secures to the side edge of a table/tables; provides privacy, divides space, LP.
- Installed divider reaches 15.7 up and 15" down from the top of the worksurface.
- Includes powder coated steel support brackets for rectangular legs only.
- Integrated modesty panel.
- 3/4" LP self edged boards, please specify laminate & 3mm PVC edge on order.

PRODUCT CODE	PRICE	SIZE/INCHES			WEIGHT VOL	
		H	W	D	LBS	FT <sup>3</sup>
BRTLPEP24	319	30.7	24	0.75	7	0.16
BRTLPEP30	347	30.7	30	0.75	9	0.20
BRTLPEP51	546	30.7	50.5	0.75	15	0.35
BRTLPEP63	621	30.7	62.5	0.75	19	0.43

**BRTPEG • Laminate Gable for Rectangular Leg**

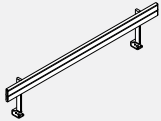
- Perpendicular end of a run gable, LP
- Secures to the side edge of a table/tables and rectangular legs; provides privacy, divides space.
- Includes powder coated steel support brackets.
- 3/4" LP self edged boards.
- 3 Gable heights available:
  - BRTPEG24, 30, 51 and 63 measure 15" below worksurface.
  - BRTPEGH21 lines up with the bottom of storage cabinets.
  - BRTPEGH27 reaches down 1" from the floor.
- Note: BRTPEGH27 will not fit on BRTSLLL Loop Leg.

PRODUCT CODE	PRICE	SIZE/INCHES			WEIGHT VOL	
		H	W	D	LBS	FT <sup>3</sup>
BRTPEG24	208	14	24	0.75	6	0.14
BRTPEG24H21	238	20.5	24	0.75	9	0.21
BRTPEG24H27	278	26.5	24	0.75	12	0.26
BRTPEG30	225	14	30	0.75	8	0.18
BRTPEG30H21	252	20.5	30	0.75	12	0.26
BRTPEG30H27	293	26.5	30	0.75	15	0.33
BRTPEG51	367	14	50.5	0.75	13	0.30
BRTPEG51H21	435	20.5	50.5	0.75	20	0.43
BRTPEG51H27	508	26.5	50.5	0.75	26	0.56
BRTPEG63	399	14	62.5	0.75	16	0.38
BRTPEG63H21	469	20.5	62.5	0.75	25	0.53
BRTPEG63H27	540	26.5	62.5	0.75	32	0.69

**BRTMPS • Laminate Modesty Panel**

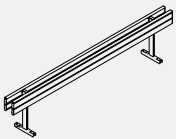
- Parallel modesty panel, single tables, LP
- Secures to the back edge of a table; provides privacy, divides space.
- Installed divider reaches 15" below worksurface.
- Includes powder coated steel support brackets.
- 3/4" LP self edged boards.
- Flip down for easy access to underside of worksurface.
- Note: actual size of modesty is different than the nominal code.

PRODUCT CODE	PRICE	SIZE/INCHES			WEIGHT VOL	
		H	W	D	LBS	FT <sup>3</sup>
BRTMPS36	355	14	30.5	0.75	9	0.21
BRTMPS42	373	14	36.5	0.75	11	0.25
BRTMPS48	391	14	42.5	0.75	13	0.29
BRTMPS54	408	14	48.5	0.75	14	0.32
BRTMPS60	422	14	54.5	0.75	16	0.36
BRTMPS66	441	14	60.5	0.75	17	0.40
BRTMPS72	456	14	66.5	0.75	19	0.43
BRTMPS78	475	14	72.5	0.75	20	0.47
BRTMPS84	490	14	78.5	0.75	22	0.51

**BRLBST • Single Rail Accessory Rail**

- Table mounted accessory rail
- Compatible with standard accessories.
- Includes end caps and mounting hardware.
- Please specify paint finish.

PRODUCT CODE	PRICE	SIZE/INCHES			WEIGHT VOL	
		H	W	D	LBS	FT <sup>3</sup>
BRLBST36	297	13.5	33	2.95	5.90	0.26
BRLBST42	310	13.5	39	2.95	6.44	0.30
BRLBST48	320	13.5	45	2.95	6.98	0.35
BRLBST54	333	13.5	51	2.95	7.52	0.39
BRLBST60	342	13.5	57	2.95	8.07	0.43
BRLBST66	352	13.5	63	2.95	8.61	0.48
BRLBST72	366	13.5	69	2.95	9.15	0.52
BRLBST78	376	13.5	75	2.95	9.69	0.56
BRLBST84	388	13.5	81	2.95	10.24	0.61

**BRLBB2B • Back 2 Back Accessory Rail**

- Double sided accessory rail mounts between worksurfaces on back 2 back assembly
- Compatible with standard accessories.
- Includes end caps and mounting hardware.
- Please specify paint finish.

PRODUCT CODE	PRICE	SIZE/INCHES			WEIGHT VOL	
		H	W	D	LBS	FT <sup>3</sup>
BRLBB2B36	457	13.5	33	7.50	9.02	0.32
BRLBB2B42	486	13.5	39	7.50	10.10	0.37
BRLBB2B48	510	13.5	45	7.50	11.19	0.42
BRLBB2B54	535	13.5	51	7.50	12.27	0.48
BRLBB2B60	550	13.5	57	7.50	13.36	0.53
BRLBB2B66	574	13.5	63	7.50	14.44	0.58
BRLBB2B72	595	13.5	69	7.50	15.52	0.63
BRLBB2B78	619	13.5	75	7.50	16.61	0.69
BRLBB2B84	643	13.5	81	7.50	17.69	0.74

### Single Table Or Single Table Row Application; 16" and 30" high dividers

Table Mounted Framed Divider for single table or single table row; recessed 1.5" at both ends, mounted to the table with 0.6" gap at the back.

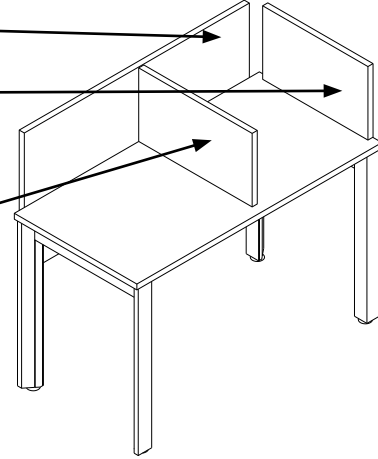
BRTMFD/BRTMLD 36" (33" actual) - 66" (63" actual) dividers have 2 mounting brackets.  
BRTMFD/BRTMLD 72" (69" actual) - 84" (81" actual) dividers have 3 mounting brackets.

Perpendicular Single Table End of Run Framed Divider;  
BREFD/BRELD 24" (21" actual for 24" deep work surfaces),  
BREFD/BRELD 30" (27" actual for 30" deep work surfaces),  
BREFD/BRELD 36" (33" actual for 36" deep work surfaces),

Two brackets secure the divider to the side edge of work surface. Flush with rear edge, 3" recessed from front work surface edge.

Perpendicular Shared Framed Divider;  
BRSFD/BRSLD 24" (21" actual for 24" deep work surfaces),  
BRSFD/BRSLD 30" (27" actual for 30" deep work surfaces),  
BRSFD/BRSLD 36" (33" actual for 36" deep work surfaces),

Single bracket secures the divider to the rear edge of work surface; Can be mounted off-module or over the seam of two adjacent work surfaces. Flush with the rear edge, 3" recessed from front work surface edge.



### Back 2 Back Table Application; 16" dividers

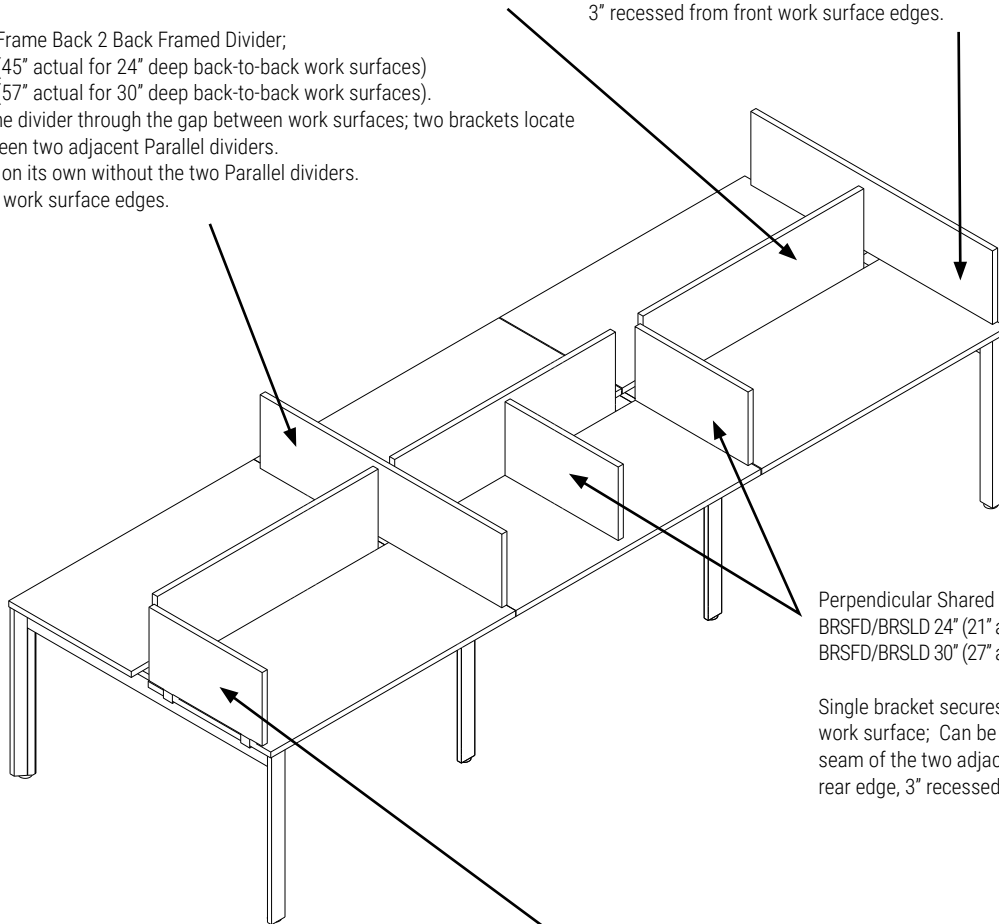
Perpendicular Back 2 Back Parallel Framed Divider secured between two back-to-back tables; recessed 1.5" at both ends; 0.6" gap between the divider and work surfaces.

BRPFD/BRPLD 36" (33" actual) - 66" (63" actual) dividers have 2 mounting brackets.  
BRPFD/BRPLD 72" (69" actual) - 84" (81" actual) dividers have 3 mounting brackets.

Perpendicular Shared Frame Back 2 Back Framed Divider;  
BRSDFD/BRSDL 51" (45" actual for 24" deep back-to-back work surfaces)  
BRSDFD/BRSDL 63" (57" actual for 30" deep back-to-back work surfaces).  
One bracket secures the divider through the gap between work surfaces; two brackets locate top of the divider between two adjacent Parallel dividers.

NOTE: cannot be used on its own without the two Parallel dividers.  
3" recessed from front work surface edges.

Perpendicular Back 2 Back End of Run Framed Divider;  
BREDFD/BREDLD 51" (45" actual for 24" deep back-to-back work surfaces)  
BREDFD/BREDLD 63" (57" actual for 30" deep back-to-back work surfaces).  
Three brackets secure the divider to both side edges of work surfaces.  
3" recessed from front work surface edges.



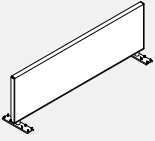
Perpendicular Shared Framed Divider;  
BRSFD/BRSLD 24" (21" actual for 24" deep work surfaces).  
BRSFD/BRSLD 30" (27" actual for 30" deep work surfaces).

Single bracket secures the divider to the rear edge of work surface; Can be mounted off-module or over the seam of the two adjacent work surfaces. Flush with the rear edge, 3" recessed from front work surfaces edge.

Perpendicular Single Table End of Run Framed Divider;  
BREFD/BRELD 24" (21" actual for 24" deep work surfaces).  
BREFD/BRELD 30" (27" actual for 30" deep work surfaces).

Two brackets secure the divider to the side edge of work surface. Flush with the rear edge, 3" recessed from front work surface edge.

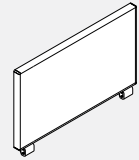
Note: Do not use framed dividers with glass dividers. Connection hardware will not fit.

**BRPFD/BRPLD • Back 2 Back Parallel Framed Dividers**

- **Secures to the underside of the worksurface**
- Divider frame and connecting hardware is painted, please choose from standard metal paint finishes.
- Fabric divider is tackable and always railroaded.
- Divider infill can be specified in fabric, low pressure laminate (LP), high pressure laminate (HP), dry erase whiteboard (DE) or dry erase magnetic whiteboard (DM).
- Installed divider measures 15.7" from top of worksurface.
- 36" to 54" dividers include 2 support brackets. 60" to 84" dividers include 3 support brackets.
- Note 60" - 84" dividers require 3 support brackets and cannot be used with work-surfaces that have a single access door

PRODUCT CODE	PRICE		SIZE/INCHES			WEIGHT VOL	
	GR1	GR2	H	W	D	LBS	FT <sup>3</sup>
BRPFD36	351	386	16	33	1.25	13	0.92
BRPFD42	363	396	16	39	1.25	15	1.08
BRPFD48	416	456	16	45	1.25	17	1.25
BRPFD54	434	483	16	51	1.25	19	1.42
BRPFD60	523	574	16	57	1.25	22	1.58
BRPFD66	551	608	16	63	1.25	23	1.75
BRPFD72	569	631	16	69	1.25	25	1.92
BRPFD78	578	643	16	75	1.25	27	2.08
BRPFD84	605	676	16	81	1.25	28	2.25

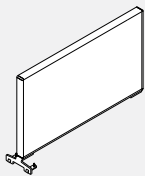
PRODUCT CODE	PRICE		SIZE/INCHES			LP/HP/DE LBS	MAG LBS	VOL FT <sup>3</sup>		
	LP	HP	DE	DM	H				W	D
BRPLD36	259	336	437	731	16	33	1.25	17	20	0.92
BRPLD42	273	357	473	809	16	39	1.25	19	23	1.08
BRPLD48	306	416	543	930	16	45	1.25	21	26	1.25
BRPLD54	357	501	886	1656	16	51	1.25	24	29	1.42
BRPLD60	431	591	935	1709	16	57	1.25	26	32	1.58
BRPLD66	444	645	943	1813	16	63	1.25	30	37	1.75
BRPLD72	459	649	1000	1827	16	69	1.25	33	40	1.92
BRPLD78	465	679	1007	1844	16	75	1.25	35	43	2.08
BRPLD84	475	712	1017	1857	16	81	1.25	37	46	2.25

**BREFD/BRELD • Perpendicular Single Table End of Run Framed Dividers**

- **Connects to the perpendicular end of a single or Back 2 Back table.**
- Divider frame and connecting hardware is painted, please choose from standard metal paint finishes.
- Fabric divider is tackable and always railroaded. Divider infill can be specified in fabric, low pressure laminate (LP), high pressure laminate (HP), dry erase whiteboard (DE) or dry erase magnetic whiteboard (DM) user side only.
- Installed divider measures 15.7" from top of worksurface.
- Divider comes with 2 support brackets.
- When dry erase magnetic whiteboard (DM) is specified it is applied user side ONLY and dry erase whiteboard (DE) is applied on the opposite side.
- Two brackets secure the divider to the side edge of work surface. Flush with the rear edge, 3" recessed from front work surface edge.

PRODUCT CODE	PRICE		SIZE/INCHES			WEIGHT VOL	
	GR1	GR2	H	W	D	LBS	FT <sup>3</sup>
BREFD24	271	301	16	21	1.25	9	0.58
BREFD30	280	309	16	27	1.25	11	0.75
BREFD36	306	342	16	33	1.25	12	0.92

PRODUCT CODE	PRICE		SIZE/INCHES			LP/HP/DE LBS	MAG LBS	VOL FT <sup>3</sup>		
	LP	HP	DE	DM	H				W	D
BRELD24	194	249	314	378	16	21	1.25	12	14	0.58
BRELD30	214	285	350	431	16	27	1.25	14	17	0.75
BRELD36	221	302	401	501	16	33	1.25	16	20	0.92

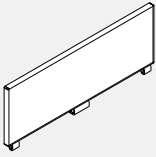
**BRSFD/BRSLD • Perpendicular Shared Framed Dividers**

- **Connects anywhere along and between worksurfaces to divide space and create privacy.**
- Divider is fastened under the worksurface flush to the back of the table and recessed 3" from the front edge on the user side.
- Divider frame and connecting hardware is painted, please choose from standard metal paint finishes.
- Fabric divider is tackable and always railroaded. Divider infill can be specified in fabric, low pressure laminate (LP), high pressure laminate (HP), dry erase whiteboard (DE) or dry erase magnetic whiteboard (DM).
- Installed divider measures 15.7" from top of worksurface.
- Divider comes with a support bracket at the back and a spacer plate with double sided adhesive at the front.

PRODUCT CODE	PRICE		SIZE/INCHES			WEIGHT VOL	
	GR1	GR2	H	W	D	LBS	FT <sup>3</sup>
BRSFD24	262	289	16	21	1.25	9	0.58
BRSFD30	271	301	16	27	1.25	11	0.75
BRSFD36	299	332	16	33	1.25	12	0.92

PRODUCT CODE	PRICE		SIZE/INCHES			LP/HP/DE LBS	MAG LBS	VOL FT <sup>3</sup>		
	LP	HP	DE	DM	H				W	D
BRSLD24	194	244	306	501	16	21	1.25	12	14	0.58
BRSLD30	208	279	343	621	16	27	1.25	14	17	0.75
BRSLD36	221	302	401	687	16	33	1.25	16	20	0.92

**BREDFD/BRELD • Perpendicular Back 2 Back End of Run Framed Dividers**

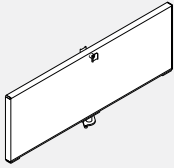


- Connects to the end of run on Back 2 Back tables to create privacy .
- Divider is fastened under the worksurface and recessed 3" from the user edge on the either side.
- Divider frame and connecting hardware is painted, please choose from standard metal paint finishes.
- Fabric divider is tackable and always railroaded.
- Divider infill can be specified in fabric, low pressure laminate (LP) , high pressure laminate (HP), dry erase whiteboard (DE) or dry erase magnetic whiteboard (DM) user side only.
- Installed divider measures 15.7" from top of worksurface.
- Divider comes with 1 large and 2 small support brackets.
- When dry erase magnetic whiteboard (DM) is specified it is applied user side ONLY and dry erase whiteboard (DE) is applied on the opposite side

PRODUCT CODE	PRICE		SIZE/ INCHES			WEIGHT VOL	
	GR1	GR2	H	W	D	LBS	FT³
BREDFD51	422	468	16	45	1.25	18	1.25
BREDFD63	478	527	16	57	1.25	21	1.58

PRODUCT CODE	PRICE				SIZE/INCHES			LP/HP/DE LBS	MAG LBS	VOL FT³
	LP	HP	DE	DM	H	W	D			
BRELD51	314	420	557	679	16	45	1.25	21	26	1.25
BRELD63	386	551	901	1153	16	57	1.25	26	32	1.58

**BRSDFD/BRSDLD • Perpendicular Back 2 Back Shared Framed Dividers**

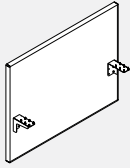


- Connects between parallel framed dividers for Back 2 Back tables to divide space and create privacy.
  - Divider is fastened under the worksurface and recessed 3" from the user edge on the either side.
  - Divider frame and connecting hardware is painted, please choose from standard metal paint finishes.
  - Fabric divider is tackable and always railroaded.
  - Divider infill can be specified in fabric, low pressure laminate (LP) , high pressure laminate (HP), dry erase whiteboard (DE) or dry erase magnetic whiteboard (DM).
  - Installed divider measures 15.7" from top of worksurface.
  - Divider comes with one center support bracket, two spacer plates with adhesive and two top spacer clamps.
- NOTE: cannot be used on its own without the two Parallel dividers.

PRODUCT CODE	PRICE		SIZE/ INCHES			WEIGHT VOL	
	GR1	GR2	H	W	D	LBS	FT³
BRSDFD51	397	439	16	45	1.25	17	1.25
BRSDFD63	451	501	16	57	1.25	20	1.58

PRODUCT CODE	PRICE				SIZE/INCHES			LP/HP/DE LBS	MAG LBS	VOL FT³
	LP	HP	DE	DM	H	W	D			
BRSDLD51	302	408	537	921	16	45	1.25	21	26	1.25
BRSDLD63	372	528	879	1651	16	57	1.25	26	32	1.58

**BRTMFD/BRTMLD • Table Mounted Framed Dividers**

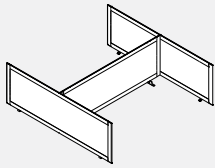


- Parallel divider for single tables.
- Divider frame and connecting hardware is painted, please choose from standard metal paint finishes.
- Fabric divider is tackable and always railroaded.
- Divider infill can be specified in fabric, low pressure laminate (LP) , high pressure laminate (HP), dry erase whiteboard (DE) or dry erase magnetic whiteboard (DM) user side only.
- Fastens to the underside of the worksurface
- 0.6 gap between worksurface and divider allows for cable pass thru.
- Installed divider reaches 15.7 up and 15" down from the top of the worksurface.
- 36" to 66" dividers include 2 support brackets. 72" to 84" dividers include 3 support brackets.
- When dry erase magnetic whiteboard (DM) is specified it is applied user side ONLY and dry erase whiteboard (DE) is applied on the opposite side.
- LAMINATE NOTE: 72" to 84" dividers require 3 support brackets and cannot be used with worksurfaces that have a single access door.
- FABRIC NOTE: 60" to 84" dividers require 3 support brackets and cannot be used with worksurfaces that have a single access door.

PRODUCT CODE	PRICE		SIZE/INCHES			WEIGHT VOL	
	GR1	GR2	H	W	D	LBS	FT³
BRTMFD36	316	350	30	33	1.25	20	1.90
BRTMFD42	378	415	30	39	1.25	22	2.03
BRTMFD48	422	468	30	45	1.25	25	2.34
BRTMFD54	471	520	30	51	1.25	27	2.66
BRTMFD60	534	582	30	57	1.25	30	2.97
BRTMFD66	605	660	30	63	1.25	33	3.28
BRTMFD72	622	687	30	69	1.25	37	3.59
BRTMFD78	649	713	30	75	1.25	40	3.91
BRTMFD84	694	765	30	81	1.25	43	4.22

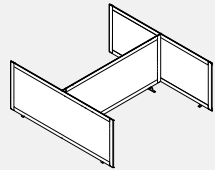
PRODUCT CODE	PRICE				SIZE/INCHES			LP/HP/DE LBS	MAG LBS	VOL FT³
	LP	HP	DE	DM	H	W	D			
BRTMLD36	376	525	763	1220	30	33	1.25	30	38	1.90
BRTMLD42	391	542	1101	1477	30	39	1.25	34	42	2.03
BRTMLD48	407	556	1107	1573	30	45	1.25	38	48	2.34
BRTMLD54	420	573	2122	2878	30	51	1.25	43	54	2.66
BRTMLD60	444	593	2251	3047	30	57	1.25	48	60	2.97
BRTMLD66	459	673	2257	3062	30	63	1.25	52	66	3.28
BRTMLD72	482	693	2272	3078	30	69	1.25	57	71	3.59
BRTMLD78	956	1273	2287	3091	30	75	1.25	61	77	3.91
BRTMLD84	971	1288	2301	3106	30	81	1.25	66	83	4.22



**BRTADP-H24 • Back 2 Back Polycarbonate Divider Screen Kit, 24" high**

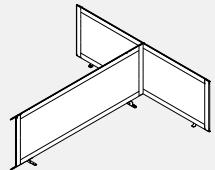
- Provides privacy in an open plan environment.
- Lightweight and easy to clean table mounted partitions.
- Consists of a powder coated aluminum frame, translucent fluted polycarbonate and all hardware to connect. Brackets are painted steel.
- Side dividers extend 6.25" from the front edge of each surface.
- Center divider sits over the gap between the worksurface allowing for the passage of cables to the trough. The gap for each side is approximately 1".
- BRTADP51-H24 are for 24" deep surfaces and BRTADP63-H24 are for 30" deep surfaces.
- Width and depth are nominal sizes representing the sizes of the Bridges configuration. Allow for 1/4" overhang at sides and 6 1/4" at front.
- Please choose any standard paint finish for frame and hardware. End trim cap is available only in CHR - charcoal.

PRODUCT CODE	PRICE	SIZE/INCHES			WEIGHT LBS	VOL FT <sup>3</sup>
		H	W	D		
BRTADP5136H24	1102	24.63	36	50.50	33.00	6.31
BRTADP5142H24	1125	24.63	42	50.50	34.50	7.36
BRTADP5148H24	1147	24.63	48	50.50	36.00	8.42
BRTADP5154H24	1170	24.63	54	50.50	37.50	9.47
BRTADP5160H24	1194	24.63	60	50.50	39.00	10.52
BRTADP5166H24	1218	24.63	66	50.50	40.50	11.57
BRTADP5172H24	1238	24.63	72	50.50	42.00	12.63
BRTADP5178H24	1262	24.63	78	50.50	43.50	13.68
BRTADP5184H24	1286	24.63	84	50.50	45.00	14.73
BRTADP6336H24	1193	24.63	36	62.50	46.50	7.81
BRTADP6342H24	1214	24.63	42	62.50	48.00	9.11
BRTADP6348H24	1237	24.63	48	62.50	49.50	10.42
BRTADP6354H24	1261	24.63	54	62.50	51.00	11.72
BRTADP6360H24	1283	24.63	60	62.50	52.50	13.02
BRTADP6366H24	1305	24.63	66	62.50	54.00	14.32
BRTADP6372H24	1329	24.63	72	62.50	55.50	15.63
BRTADP6378H24	1352	24.63	78	62.50	57.00	16.93
BRTADP6384H24	1375	24.63	84	62.50	58.50	18.23

**BRTADP-H30 • Back 2 Back Polycarbonate Divider Screen Kit, 30" high**

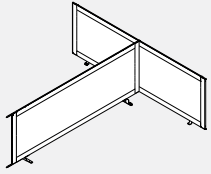
- Provides privacy in an open plan environment.
- Lightweight and easy to clean table mounted partitions.
- Consists of a powder coated aluminum frame, translucent fluted polycarbonate and all hardware to connect. Brackets are painted steel.
- Side dividers extend 6.25" from the front edge of each surface.
- Center divider sits over the gap between the worksurface allowing for the passage of cables to the trough. The gap for each side is approximately 1".
- BRTADP51-H24 are for 24" deep surfaces and BRTADP63-H24 are for 30" deep surfaces.
- Width and depth are nominal sizes representing the sizes of the Bridges configuration. Allow for 1/4" overhang at sides and 6 1/4" at front.
- Please choose any standard paint finish for frame and hardware. End trim cap is available only in CHR - charcoal.

PRODUCT CODE	PRICE	SIZE/INCHES			WEIGHT LBS	VOL FT <sup>3</sup>
		H	W	D		
BRTADP5136H30	1223	30.63	36	50.50	35.50	6.31
BRTADP5142H30	1248	30.63	42	50.50	37.00	7.36
BRTADP5148H30	1275	30.63	48	50.50	38.50	8.42
BRTADP5154H30	1302	30.63	54	50.50	40.00	9.47
BRTADP5160H30	1328	30.63	60	50.50	41.50	10.52
BRTADP5166H30	1355	30.63	66	50.50	43.00	11.57
BRTADP5172H30	1381	30.63	72	50.50	44.50	12.63
BRTADP5178H30	1407	30.63	78	50.50	46.00	13.68
BRTADP5184H30	1435	30.63	84	50.50	47.50	14.73
BRTADP6336H30	1372	30.63	36	62.50	49.00	7.81
BRTADP6342H30	1398	30.63	42	62.50	50.50	9.11
BRTADP6348H30	1428	30.63	48	62.50	52.00	10.42
BRTADP6354H30	1451	30.63	54	62.50	53.50	11.72
BRTADP6360H30	1480	30.63	60	62.50	55.00	13.02
BRTADP6366H30	1506	30.63	66	62.50	56.50	14.32
BRTADP6372H30	1533	30.63	72	62.50	58.00	15.63
BRTADP6378H30	1560	30.63	78	62.50	59.50	16.93
BRTADP6384H30	1585	30.63	84	62.50	61.00	18.23

**BRTADPE-H24 - Back 2 Back Polycarbonate Divider Screen Kit, 24" high**

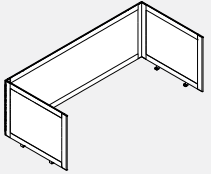
- Provides an extension for privacy in an open plan environment. Intended to always connect to Back 2 Back Divider Screen Kit
- Lightweight and easy to clean table mounted partitions.
- Consists of a powder coated aluminum frame, translucent fluted polycarbonate and all hardware to connect. Brackets are painted steel.
- Side dividers extend 6.25" from the front edge of each surface.
- Center divider sits over the gap between the worksurface allowing for the passage of cables to the trough. The gap for each side is approximately 1".
- BRTADPE51-H24 are for 24" deep surfaces and BRTADPE63-H24 are for 30" deep surfaces.
- Width and depth are nominal sizes representing the sizes of the Bridges configuration. Allow for 1/4" overhang at sides and 6 1/4" at front.
- Please choose any standard paint finish for frame and hardware. End trim cap is available only in CHR - charcoal.
- Can be used as left or right connection.

PRODUCT CODE	PRICE	SIZE/INCHES			WEIGHT LBS	VOL FT <sup>3</sup>
		H	W	D		
BRTADPE5136H24	747	24.63	36	50.50	26.35	6.31
BRTADPE5142H24	767	24.63	42	50.50	27.85	7.36
BRTADPE5148H24	791	24.63	48	50.50	29.35	8.42
BRTADPE5154H24	816	24.63	54	50.50	30.85	9.47
BRTADPE5160H24	839	24.63	60	50.50	32.35	10.52
BRTADPE5166H24	862	24.63	66	50.50	33.85	11.57
BRTADPE5172H24	885	24.63	72	50.50	35.35	12.63
BRTADPE5178H24	907	24.63	78	50.50	36.85	13.68
BRTADPE5184H24	930	24.63	84	50.50	38.35	14.73
BRTADPE6336H24	790	24.63	36	62.50	39.85	7.81
BRTADPE6342H24	814	24.63	42	62.50	41.35	9.11
BRTADPE6348H24	837	24.63	48	62.50	42.85	10.42
BRTADPE6354H24	860	24.63	54	62.50	44.35	11.72
BRTADPE6360H24	884	24.63	60	62.50	45.85	13.02
BRTADPE6366H24	907	24.63	66	62.50	47.35	14.32
BRTADPE6372H24	929	24.63	72	62.50	48.85	15.63
BRTADPE6378H24	952	24.63	78	62.50	50.35	16.93
BRTADPE6384H24	975	24.63	84	62.50	51.85	18.23

**BRTADPE-H30 • Back 2 Back Polycarbonate Divider Screen Kit, 30" high**

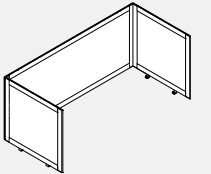
- Provides an extension for privacy in an open plan environment. Intended to always connect to Back 2 Back Divider Screen Kit
- Lightweight and easy to clean table mounted partitions.
- Consists of a powder coated aluminum frame, translucent fluted polycarbonate and all hardware to connect. Brackets are painted steel.
- Side dividers extend 6.25" from the front edge of each surface.
- Center divider sits over the gap between the worksurface allowing for the passage of cables to the trough. The gap for each side is approximately 1".
- BRTADPE51-H24 are for 24" deep surfaces and BRTADPE63-H24 are for 30" deep surfaces.
- Width and depth are nominal sizes representing the sizes of the Bridges configuration. Allow for 1/4" overhang at sides and 6 1/4" at front.
- Please choose any standard paint finish for frame and hardware. End trim cap is available only in CHR - charcoal.
- Can be used as left or right connection.

PRODUCT CODE	PRICE	SIZE/INCHES			WEIGHT LBS	VOL FT <sup>3</sup>
		H	W	D		
BRTADPE5136H30	820	30.63	36	50.50	28.85	6.31
BRTADPE5142H30	849	30.63	42	50.50	30.35	7.36
BRTADPE5148H30	874	30.63	48	50.50	31.85	8.42
BRTADPE5154H30	901	30.63	54	50.50	33.35	9.47
BRTADPE5160H30	928	30.63	60	50.50	34.85	10.52
BRTADPE5166H30	954	30.63	66	50.50	36.35	11.57
BRTADPE5172H30	982	30.63	72	50.50	37.85	12.63
BRTADPE5178H30	1006	30.63	78	50.50	39.35	13.68
BRTADPE5184H30	1033	30.63	84	50.50	40.85	14.73
BRTADPE6336H30	872	30.63	36	62.50	42.35	7.81
BRTADPE6342H30	898	30.63	42	62.50	43.85	9.11
BRTADPE6348H30	926	30.63	48	62.50	45.35	10.42
BRTADPE6354H30	952	30.63	54	62.50	46.85	11.72
BRTADPE6360H30	981	30.63	60	62.50	48.35	13.02
BRTADPE6366H30	1004	30.63	66	62.50	49.85	14.32
BRTADPE6372H30	1033	30.63	72	62.50	51.35	15.63
BRTADPE6378H30	1060	30.63	78	62.50	52.85	16.93
BRTADPE6384H30	1086	30.63	84	62.50	54.35	18.23

**BRTADP-H24 • Single Table Polycarbonate Divider Screen Kit, 24" high**

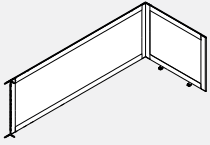
- Provides privacy in an open plan environment.
- Lightweight and easy to clean table mounted partitions.
- Consists of a powder coated aluminum frame, translucent fluted polycarbonate and all hardware to connect. Brackets are painted steel.
- Side dividers extend 6.25" from the front edge of each surface.
- Back divider extends over the back edge of the worksurface by 1 1/2" allowing for the passage of cables to the trough.
- BRTADP24-H24 are for 24" deep surfaces and BRTADP30-H24 are for 30" deep surfaces.
- Width and depth are nominal sizes representing the sizes of the Bridges configuration. Allow for 1/4" overhang at the sides, 1 1/2" at the back and 6 1/4" at the front.
- Please choose any standard paint finish for frame and hardware. End trim cap is available only in CHR - charcoal.

PRODUCT CODE	PRICE	SIZE/INCHES			WEIGHT LBS	VOL FT <sup>3</sup>
		H	W	D		
BRTADP2436H24	760	24.63	36	31.75	26.55	3.97
BRTADP2442H24	784	24.63	42	31.75	28.10	4.63
BRTADP2448H24	806	24.63	48	31.75	29.65	5.29
BRTADP2454H24	829	24.63	54	31.75	31.20	5.95
BRTADP2460H24	853	24.63	60	31.75	32.75	6.61
BRTADP2466H24	876	24.63	66	31.75	34.30	7.28
BRTADP2472H24	897	24.63	72	31.75	35.85	7.94
BRTADP2478H24	921	24.63	78	31.75	37.40	8.60
BRTADP2484H24	947	24.63	84	31.75	38.95	9.26
BRTADP3036H24	816	24.63	36	37.75	40.50	4.72
BRTADP3042H24	839	24.63	42	37.75	42.05	5.51
BRTADP3048H24	862	24.63	48	37.75	43.60	6.29
BRTADP3054H24	885	24.63	54	37.75	45.15	7.08
BRTADP3060H24	907	24.63	60	37.75	46.70	7.87
BRTADP3066H24	930	24.63	66	37.75	48.25	8.65
BRTADP3072H24	954	24.63	72	37.75	49.80	9.44
BRTADP3078H24	976	24.63	78	37.75	51.35	10.22
BRTADP3084H24	999	24.63	84	37.75	52.90	11.01

**BRTADP-H30 • Single Table Polycarbonate Divider Screen Kit, 30" high**

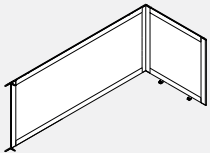
- Provides privacy in an open plan environment.
- Lightweight and easy to clean table mounted partitions.
- Consists of a powder coated aluminum frame, translucent fluted polycarbonate and all hardware to connect. Brackets are painted steel.
- Side dividers extend 6.25" from the front edge of each surface.
- Back divider extends over the back edge of the worksurface by 1 1/2" allowing for the passage of cables to the trough.
- BRTADP24-H24 are for 24" deep surfaces and BRTADP30-H24 are for 30" deep surfaces.
- Width and depth are nominal sizes representing the sizes of the Bridges configuration. Allow for 1/4" overhang at the sides, 1 1/2" at the back and 6 1/4" at the front.
- Please choose any standard paint finish for frame and hardware. End trim cap is available only in CHR - charcoal.

PRODUCT CODE	PRICE	SIZE/INCHES			WEIGHT LBS	VOL FT <sup>3</sup>
		H	W	D		
BRTADP2436H30	853	30.63	36	31.75	28.85	3.97
BRTADP2442H30	882	30.63	42	31.75	30.35	4.63
BRTADP2448H30	907	30.63	48	31.75	31.85	5.29
BRTADP2454H30	932	30.63	54	31.75	33.35	5.95
BRTADP2460H30	960	30.63	60	31.75	34.85	6.61
BRTADP2466H30	986	30.63	66	31.75	36.35	7.28
BRTADP2472H30	1015	30.63	72	31.75	37.85	7.94
BRTADP2478H30	1039	30.63	78	31.75	39.35	8.60
BRTADP2484H30	1065	30.63	84	31.75	40.85	9.26
BRTADP3036H30	905	30.63	36	37.75	42.35	4.72
BRTADP3042H30	932	30.63	42	37.75	43.85	5.51
BRTADP3048H30	959	30.63	48	37.75	45.35	6.29
BRTADP3054H30	985	30.63	54	37.75	46.85	7.08
BRTADP3060H30	1012	30.63	60	37.75	48.35	7.87
BRTADP3066H30	1038	30.63	66	37.75	49.85	8.65
BRTADP3072H30	1064	30.63	72	37.75	51.35	9.44
BRTADP3078H30	1091	30.63	78	37.75	52.85	10.22
BRTADP3084H30	1118	30.63	84	37.75	54.35	11.01

**BRTADPE-H24 • Single Table Polycarbonate Divider Screen Extension Kit, 24" high**

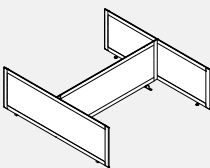
- Provides an extension for privacy in an open plan environment. Intended to always connect to Single Table Divider Screen Kit
- Lightweight and easy to clean table mounted partitions.
- Can be used as left or right connection.
- Consists of a powder coated aluminum frame, translucent fluted polycarbonate and all hardware to connect. Brackets are painted steel.
- Side dividers extend 6.25" from the front edge of each surface.
- Back divider extends over the back edge of the worksurface by 1 1/2" allowing for the passage of cables to the trough.
- BRTADPE24-H24 are for 24" deep surfaces and BRTADPE30-H24 are for 30" deep surfaces.
- Width and depth are nominal sizes representing the sizes of the Bridges configuration. Allow for 1/4" overhang at the sides, 1 1/2" at the back and 6 1/4" at the front.
- Please choose any standard paint finish for frame and hardware. End trim cap is available only in CHR - charcoal.
- Can be used as left or right connection.

PRODUCT CODE	PRICE	SIZE/INCHES			WEIGHT LBS	VOL FT <sup>3</sup>
		H	W	D		
BRTADPE2436H24	570	24.63	36	31.75	21.05	3.97
BRTADPE2442H24	626	24.63	42	31.75	22.60	4.63
BRTADPE2448H24	649	24.63	48	31.75	24.15	5.29
BRTADPE2454H24	672	24.63	54	31.75	25.70	5.95
BRTADPE2460H24	694	24.63	60	31.75	27.25	6.61
BRTADPE2466H24	718	24.63	66	31.75	28.80	7.28
BRTADPE2472H24	741	24.63	72	31.75	30.35	7.94
BRTADPE2478H24	763	24.63	78	31.75	31.90	8.60
BRTADPE2484H24	786	24.63	84	31.75	33.45	9.26
BRTADPE3036H24	592	24.63	36	37.75	35.00	4.72
BRTADPE3042H24	648	24.63	42	37.75	36.55	5.51
BRTADPE3048H24	672	24.63	48	37.75	38.10	6.29
BRTADPE3054H24	694	24.63	54	37.75	39.65	7.08
BRTADPE3060H24	718	24.63	60	37.75	41.20	7.87
BRTADPE3066H24	740	24.63	66	37.75	42.75	8.65
BRTADPE3072H24	762	24.63	72	37.75	44.30	9.44
BRTADPE3078H24	786	24.63	78	37.75	45.85	10.22
BRTADPE3084H24	811	24.63	84	37.75	47.40	11.01

**BRTADPE-H30 • Single Table Polycarbonate Divider Screen Extension Kit, 30" high**

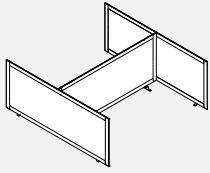
- Provides an extension for privacy in an open plan environment. Intended to always connect to Single Table Divider Screen Kit
- Lightweight and easy to clean table mounted partitions.
- Can be used as left or right connection.
- Consists of a powder coated aluminum frame, translucent fluted polycarbonate and all hardware to connect. Brackets are painted steel.
- Side dividers extend 6.25" from the front edge of each surface.
- Back divider extends over the back edge of the worksurface by 1 1/2" allowing for the passage of cables to the trough.
- BRTADPE24-H24 are for 24" deep surfaces and BRTADPE30-H24 are for 30" deep surfaces.
- Width and depth are nominal sizes representing the sizes of the Bridges configuration. Allow for 1/4" overhang at the sides, 1 1/2" at the back and 6 1/4" at the front.
- Please choose any standard paint finish for frame and hardware. End trim cap is available only in CHR - charcoal.
- Can be used as left or right connection.

PRODUCT CODE	PRICE	SIZE/INCHES			WEIGHT LBS	VOL FT <sup>3</sup>
		H	W	D		
BRTADPE2436H30	627	30.63	36	31.75	22.85	3.97
BRTADPE2442H30	687	30.63	42	31.75	24.40	4.63
BRTADPE2448H30	713	30.63	48	31.75	25.95	5.29
BRTADPE2454H30	739	30.63	54	31.75	27.50	5.95
BRTADPE2460H30	765	30.63	60	31.75	29.05	6.61
BRTADPE2466H30	791	30.63	66	31.75	30.60	7.28
BRTADPE2472H30	818	30.63	72	31.75	32.15	7.94
BRTADPE2478H30	846	30.63	78	31.75	33.70	8.60
BRTADPE2484H30	870	30.63	84	31.75	35.25	9.26
BRTADPE3036H30	654	30.63	36	37.75	36.80	4.72
BRTADPE3042H30	713	30.63	42	37.75	38.35	5.51
BRTADPE3048H30	739	30.63	48	37.75	39.90	6.29
BRTADPE3054H30	763	30.63	54	37.75	41.45	7.08
BRTADPE3060H30	791	30.63	60	37.75	43.00	7.87
BRTADPE3066H30	818	30.63	66	37.75	44.55	8.65
BRTADPE3072H30	845	30.63	72	37.75	46.10	9.44
BRTADPE3078H30	870	30.63	78	37.75	47.65	10.22
BRTADPE3084H30	896	30.63	84	37.75	49.20	11.01

**BRTADG-H24 • Back 2 Back Glass Divider Screen Kit, 24" high**

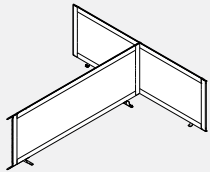
- Provides privacy in an open plan environment.
- Easy to clean table mounted partitions.
- Consists of a powder coated aluminum frame, 4mm clear (CLR) glass and all hardware to connect. Brackets are painted steel.
- Side dividers extend 6.25" from the front edge of each surface.
- Center divider sits over the gap between the worksurface allowing for the passage of cables to the trough. The gap for each side is approximately 1".
- BRTADG51-H24 are for 24" deep surfaces and BRTADG63-H24 are for 30" deep surfaces.
- Width and depth are nominal sizes representing the sizes of the Bridges configuration. Allow for 1/4" overhang at sides and 6 1/4" at front.
- Please choose any standard paint finish for frame and hardware. End trim cap is available only in CHR - charcoal.
- Upcharge for frosted (FRST) glass is 20%

PRODUCT CODE	PRICE	SIZE/INCHES			WEIGHT LBS	VOL FT <sup>3</sup>
		H	W	D		
BRTADG5136H24	1431	24.60	36	50.50	33.00	6.31
BRTADG5142H24	1464	24.60	42	50.50	34.50	7.36
BRTADG5148H24	1498	24.60	48	50.50	36.00	8.42
BRTADG5154H24	1533	24.60	54	50.50	37.50	9.47
BRTADG5160H24	1565	24.60	60	50.50	39.00	10.52
BRTADG5166H24	1600	24.60	66	50.50	40.50	11.57
BRTADG5172H24	1633	24.60	72	50.50	42.00	12.63
BRTADG5178H24	1667	24.60	78	50.50	43.50	13.68
BRTADG5184H24	1700	24.60	84	50.50	45.00	14.73
BRTADG6336H24	1565	24.60	36	62.50	46.50	7.81
BRTADG6342H24	1599	24.60	42	62.50	48.00	9.11
BRTADG6348H24	1632	24.60	48	62.50	49.50	10.42
BRTADG6354H24	1666	24.60	54	62.50	51.00	11.72
BRTADG6360H24	1698	24.60	60	62.50	52.50	13.02
BRTADG6366H24	1733	24.60	66	62.50	54.00	14.32
BRTADG6372H24	1765	24.60	72	62.50	55.50	15.63
BRTADG6378H24	1800	24.60	78	62.50	57.00	16.93
BRTADG6384H24	1834	24.60	84	62.50	58.50	18.23

**BRTADG-H30 • Back 2 Back Glass Divider Screen Kit, 30" high**

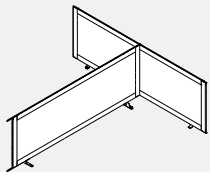
- Provides privacy in an open plan environment.
- Easy to clean table mounted partitions.
- Consists of a powder coated aluminum frame, 4mm clear (CLR) glass and all hardware to connect. Brackets are painted steel.
- Side dividers extend 6.25" from the front edge of each surface.
- Center divider sits over the gap between the worksurface allowing for the passage of cables to the trough. The gap for each side is approximately 1".
- BRTADG51-H30 are for 24" deep surfaces and BRTADG63-H30 are for 30" deep surfaces.
- Width and depth are nominal sizes representing the sizes of the Bridges configuration. Allow for 1/4" overhang at sides and 6 1/4" at front.
- Please choose any standard paint finish for frame and hardware. End trim cap is available only in CHR - charcoal.
- Upcharge for frosted (FRST) glass is 20%.

PRODUCT CODE	PRICE	SIZE/INCHES			WEIGHT LBS	VOL FT <sup>3</sup>
		H	W	D		
BRTADG5136H30	1511	30.60	36	50.50	35.50	6.31
BRTADG5142H30	1547	30.60	42	50.50	37.00	7.36
BRTADG5148H30	1581	30.60	48	50.50	38.50	8.42
BRTADG5154H30	1615	30.60	54	50.50	40.00	9.47
BRTADG5160H30	1651	30.60	60	50.50	41.50	10.52
BRTADG5166H30	1684	30.60	66	50.50	43.00	11.57
BRTADG5172H30	1706	30.60	72	50.50	44.50	12.63
BRTADG5178H30	1754	30.60	78	50.50	46.00	13.68
BRTADG5184H30	1788	30.60	84	50.50	47.50	14.73
BRTADG6336H30	1696	30.60	36	62.50	49.00	7.81
BRTADG6342H30	1732	30.60	42	62.50	50.50	9.11
BRTADG6348H30	1765	30.60	48	62.50	52.00	10.42
BRTADG6354H30	1801	30.60	54	62.50	53.50	11.72
BRTADG6360H30	1835	30.60	60	62.50	55.00	13.02
BRTADG6366H30	1869	30.60	66	62.50	56.50	14.32
BRTADG6372H30	1890	30.60	72	62.50	58.00	15.63
BRTADG6378H30	1939	30.60	78	62.50	59.50	16.93
BRTADG6384H30	1975	30.60	84	62.50	61.00	18.23

**BRTADG-H24 • Back 2 Back Glass Divider Screen Extension Kit, 24" high**

- Provides privacy in an open plan environment.
- Easy to clean table mounted partitions.
- Consists of a powder coated aluminum frame, 4mm clear (CLR) glass and all hardware to connect. Brackets are painted steel.
- Side dividers extend 6.25" from the front edge of each surface.
- Center divider sits over the gap between the worksurface allowing for the passage of cables to the trough. The gap for each side is approximately 1".
- BRTADG51-H30 are for 24" deep surfaces and BRTADG63-H30 are for 30" deep surfaces.
- Width and depth are nominal sizes representing the sizes of the Bridges configuration. Allow for 1/4" overhang at sides and 6 1/4" at front.
- Please choose any standard paint finish for frame and hardware. End trim cap is available only in CHR - charcoal.
- Upcharge for frosted (FRST) glass is 20%.
- Can be used as left or right connection.

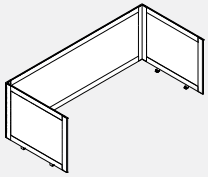
PRODUCT CODE	PRICE	SIZE/INCHES			WEIGHT LBS	VOL FT <sup>3</sup>
		H	W	D		
BRTADGE5136H24	943	24.60	36	50.50	26.35	6.31
BRTADGE5142H24	977	24.60	42	50.50	27.85	7.36
BRTADGE5148H24	1011	24.60	48	50.50	29.35	8.42
BRTADGE5154H24	1045	24.60	54	50.50	30.85	9.47
BRTADGE5160H24	1078	24.60	60	50.50	32.35	10.52
BRTADGE5166H24	1112	24.60	66	50.50	33.85	11.57
BRTADGE5172H24	1146	24.60	72	50.50	35.35	12.63
BRTADGE5178H24	1178	24.60	78	50.50	36.85	13.68
BRTADGE5184H24	1212	24.60	84	50.50	38.35	14.73
BRTADGE6336H24	1011	24.60	36	62.50	39.85	7.81
BRTADGE6342H24	1043	24.60	42	62.50	41.35	9.11
BRTADGE6348H24	1078	24.60	48	62.50	42.85	10.42
BRTADGE6354H24	1109	24.60	54	62.50	44.35	11.72
BRTADGE6360H24	1144	24.60	60	62.50	45.85	13.02
BRTADGE6366H24	1178	24.60	66	62.50	47.35	14.32
BRTADGE6372H24	1211	24.60	72	62.50	48.85	15.63
BRTADGE6378H24	1245	24.60	78	62.50	50.35	16.93
BRTADGE6384H24	1279	24.60	84	62.50	51.85	18.23

**BRTADG-H30 • Back 2 Back Glass Divider Screen Extension Kit, 30" high**

- Provides an extension for privacy in an open plan environment. Intended to always connect to Back 2 Back Divider Screen Kit
- Easy to clean table mounted partitions.
- Consists of a powder coated aluminum frame, 4mm clear (CLR) glass and all hardware to connect. Brackets are painted steel.
- Side dividers extend 6.25" from the front edge of each surface.
- Center divider sits over the gap between the worksurface allowing for the passage of cables to the trough. The gap for each side is approximately 1".
- BRTADGE51-H30 are for 24" deep surfaces and BRTADGE63-H30 are for 30" deep surfaces.
- Width and depth are nominal sizes representing the sizes of the Bridges configuration. Allow for 1/4" overhang at sides and 6 1/4" at front.
- Please choose any standard paint finish for frame and hardware. End trim cap is available only in CHR - charcoal.
- Upcharge for frosted (FRST) glass is 20%.
- Can be used as left or right connection.

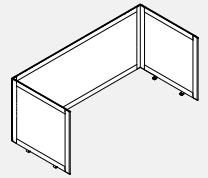
PRODUCT CODE	PRICE	SIZE/INCHES			WEIGHT LBS	VOL FT <sup>3</sup>
		H	W	D		
BRTADGE5136H30	995	30.60	36	50.50	28.85	6.31
BRTADGE5142H30	1029	30.60	42	50.50	30.35	7.36
BRTADGE5148H30	1064	30.60	48	50.50	31.85	8.42
BRTADGE5154H30	1099	30.60	54	50.50	33.35	9.47
BRTADGE5160H30	1133	30.60	60	50.50	34.85	10.52
BRTADGE5166H30	1168	30.60	66	50.50	36.35	11.57
BRTADGE5172H30	1189	30.60	72	50.50	37.85	12.63
BRTADGE5178H30	1237	30.60	78	50.50	39.35	13.68
BRTADGE5184H30	1272	30.60	84	50.50	40.85	14.73
BRTADGE6336H30	1063	30.60	36	62.50	42.35	7.81
BRTADGE6342H30	1099	30.60	42	62.50	43.85	9.11
BRTADGE6348H30	1132	30.60	48	62.50	45.35	10.42
BRTADGE6354H30	1167	30.60	54	62.50	46.85	11.72
BRTADGE6360H30	1201	30.60	60	62.50	48.35	13.02
BRTADGE6366H30	1236	30.60	66	62.50	49.85	14.32
BRTADGE6372H30	1258	30.60	72	62.50	51.35	15.63
BRTADGE6378H30	1305	30.60	78	62.50	52.85	16.93
BRTADGE6384H30	1340	30.60	84	62.50	54.35	18.23



**BRTADG-H24 • Single Table Glass Divider Screen Kit, 24" high**

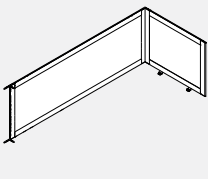
- Provides privacy in an open plan environment.
- Easy to clean table mounted partitions.
- Consists of a powder coated aluminum frame, 4mm clear (CLR) glass and all hardware to connect. Brackets are painted steel.
- Side dividers extend 6.25" from the front edge of each surface.
- Back divider extends over the back edge of the worksurface by 1 1/2" allowing for the passage of cables to the trough.
- BRTADG24-H24 are for 24" deep surfaces and BRTADG30-H24 are for 30" deep surfaces.
- Width and depth are nominal sizes representing the sizes of the Bridges configuration. Allow for 1/4" overhang at the sides, 1 1/2" at the back and 6 1/4" at the front.
- Please choose any standard paint finish for frame and hardware. End trim cap is available only in CHR - charcoal.
- Upcharge for frosted (FRST) glass is 20%.

PRODUCT CODE	PRICE	SIZE/INCHES			WEIGHT LBS	VOL FT <sup>3</sup>
		H	W	D		
BRTADG2436H24	1033	24.60	36	31.50	26.55	3.94
BRTADG2442H24	1066	24.60	42	31.50	28.10	4.59
BRTADG2448H24	1100	24.60	48	31.50	29.65	5.25
BRTADG2454H24	1133	24.60	54	31.50	31.20	5.91
BRTADG2460H24	1168	24.60	60	31.50	32.75	6.56
BRTADG2466H24	1200	24.60	66	31.50	34.30	7.22
BRTADG2472H24	1235	24.60	72	31.50	35.85	7.88
BRTADG2478H24	1267	24.60	78	31.50	37.40	8.53
BRTADG2484H24	1302	24.60	84	31.50	38.95	9.19
BRTADG3036H24	1096	24.60	36	37.75	40.50	4.72
BRTADG3042H24	1130	24.60	42	37.75	42.05	5.51
BRTADG3048H24	1165	24.60	48	37.75	43.60	6.29
BRTADG3054H24	1198	24.60	54	37.75	45.15	7.08
BRTADG3060H24	1232	24.60	60	37.75	46.70	7.87
BRTADG3066H24	1265	24.60	66	37.75	48.25	8.65
BRTADG3072H24	1299	24.60	72	37.75	49.80	9.44
BRTADG3078H24	1332	24.60	78	37.75	51.35	10.22
BRTADG3084H24	1367	24.60	84	37.75	52.90	11.01

**BRTADG-H30 • Single Table Glass Divider Screen Kit, 30" high**

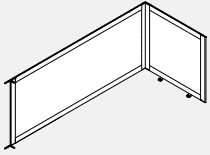
- Provides privacy in an open plan environment.
- Easy to clean table mounted partitions.
- Consists of a powder coated aluminum frame, 4mm clear (CLR) glass and all hardware to connect. Brackets are painted steel.
- Side dividers extend 6.25" from the front edge of each surface.
- Back divider extends over the back edge of the worksurface by 1 1/2" allowing for the passage of cables to the trough.
- BRTADG24-H30 are for 24" deep surfaces and BRTADG30-H30 are for 30" deep surfaces.
- Width and depth are nominal sizes representing the sizes of the Bridges configuration. Allow for 1/4" overhang at the sides, 1 1/2" at the back and 6 1/4" at the front.
- Please choose any standard paint finish for frame and hardware. End trim cap is available only in CHR - charcoal.
- Upcharge for frosted (FRST) glass is 20%.

PRODUCT CODE	PRICE	SIZE/INCHES			WEIGHT LBS	VOL FT <sup>3</sup>
		H	W	D		
BRTADG2436H30	1073	30.60	36	31.50	28.85	3.94
BRTADG2442H30	1108	30.60	42	31.50	30.40	4.59
BRTADG2448H30	1143	30.60	48	31.50	31.95	5.25
BRTADG2454H30	1178	30.60	54	31.50	33.50	5.91
BRTADG2460H30	1212	30.60	60	31.50	35.05	6.56
BRTADG2466H30	1248	30.60	66	31.50	36.60	7.22
BRTADG2472H30	1267	30.60	72	31.50	38.15	7.88
BRTADG2478H30	1317	30.60	78	31.50	39.70	8.53
BRTADG2484H30	1352	30.60	84	31.50	41.25	9.19
BRTADG3036H30	1143	30.60	36	37.75	42.80	4.72
BRTADG3042H30	1177	30.60	42	37.75	44.35	5.51
BRTADG3048H30	1211	30.60	48	37.75	45.90	6.29
BRTADG3054H30	1246	30.60	54	37.75	47.45	7.08
BRTADG3060H30	1280	30.60	60	37.75	49.00	7.87
BRTADG3066H30	1317	30.60	66	37.75	50.55	8.65
BRTADG3072H30	1336	30.60	72	37.75	52.10	9.44
BRTADG3078H30	1385	30.60	78	37.75	53.65	10.22
BRTADG3084H30	1420	30.60	84	37.75	55.20	11.01

**BRTADGE-H24 • Single Table Glass Divider Screen Extension Kit, 24" high**

- Provides an extension for privacy in an open plan environment. Intended to always connect to Single Table Divider Screen Kit
- Lightweight and easy to clean table mounted partitions.
- Consists of a powder coated aluminum frame, 4mm clear (CLR) glass and all hardware to connect. Brackets are painted steel.
- Side dividers extend 6.25" from the front edge of each surface.
- Back divider extends over the back edge of the worksurface by 1 1/2" allowing for the passage of cables to the trough.
- BRTADGE24-H24 are for 24" deep surfaces and BRTADGE30-H24 are for 30" deep surfaces.
- Width and depth are nominal sizes representing the sizes of the Bridges configuration. Allow for 1/4" overhang at the sides, 1 1/2" at the back and 6 1/4" at the front.
- Please choose any standard paint finish for frame and hardware. End trim cap is available only in CHR - charcoal.
- Upcharge for frosted (FRST) glass is 20%.
- Can be used as left or right connection.

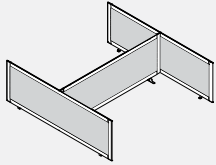
PRODUCT CODE	PRICE	SIZE/INCHES			WEIGHT LBS	VOL FT <sup>3</sup>
		H	W	D		
BRTADGE2436H24	737	24.60	36	31.50	21.05	3.94
BRTADGE2442H24	804	24.60	42	31.50	22.60	4.59
BRTADGE2448H24	839	24.60	48	31.50	24.15	5.25
BRTADGE2454H24	870	24.60	54	31.50	25.70	5.91
BRTADGE2460H24	905	24.60	60	31.50	27.25	6.56
BRTADGE2466H24	937	24.60	66	31.50	28.80	7.22
BRTADGE2472H24	972	24.60	72	31.50	30.35	7.88
BRTADGE2478H24	1004	24.60	78	31.50	31.90	8.53
BRTADGE2484H24	1039	24.60	84	31.50	33.45	9.19
BRTADGE3036H24	777	24.60	36	37.75	35.00	4.72
BRTADGE3042H24	842	24.60	42	37.75	36.55	5.51
BRTADGE3048H24	876	24.60	48	37.75	38.10	6.29
BRTADGE3054H24	909	24.60	54	37.75	39.65	7.08
BRTADGE3060H24	942	24.60	60	37.75	41.20	7.87
BRTADGE3066H24	976	24.60	66	37.75	42.75	8.65
BRTADGE3072H24	1011	24.60	72	37.75	44.30	9.44
BRTADGE3078H24	1043	24.60	78	37.75	45.85	10.22
BRTADGE3084H24	1078	24.60	84	37.75	47.40	11.01

**BRTADGE-H30 • Single Table Glass Divider Screen Extension Kit, 30" high**

- Provides an extension for privacy in an open plan environment. Intended to always connect to Single Table Divider Screen Kit
- Easy to clean table mounted partitions.
- Consists of a powder coated aluminum frame, 4mm clear (CLR) glass and all hardware to connect. Brackets are painted steel.
- Side dividers extend 6.25" from the front edge of each surface.
- Back divider extends over the back edge of the worksurface by 1 1/2" allowing for the passage of cables to the trough.
- BRTADGE24-H30 are for 24" deep surfaces and BRTADGE30-H30 are for 30" deep surfaces.
- Width and depth are nominal sizes representing the sizes of the Bridges configuration. Allow for 1/4" overhang at the sides, 1 1/2" at the back and 6 1/4" at the front.
- Please choose any standard paint finish for frame and hardware. End trim cap is available only in CHR - charcoal.
- Upcharge for frosted (FRST) glass is 20%.
- Can be used as left or right connection.

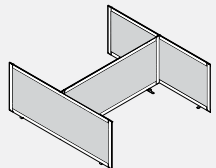
PRODUCT CODE	PRICE	SIZE/INCHES			WEIGHT LBS	VOL FT <sup>3</sup>
		H	W	D		
BRTADGE2436H30	775	30.60	36	31.50	22.85	3.94
BRTADGE2442H30	843	30.60	42	31.50	24.40	4.59
BRTADGE2448H30	877	30.60	48	31.50	25.95	5.25
BRTADGE2454H30	913	30.60	54	31.50	27.50	5.91
BRTADGE2460H30	948	30.60	60	31.50	29.05	6.56
BRTADGE2466H30	982	30.60	66	31.50	30.60	7.22
BRTADGE2472H30	1000	30.60	72	31.50	32.15	7.88
BRTADGE2478H30	1051	30.60	78	31.50	33.70	8.53
BRTADGE2484H30	1087	30.60	84	31.50	35.25	9.19
BRTADGE3036H30	809	30.60	36	37.75	36.80	4.72
BRTADGE3042H30	877	30.60	42	37.75	38.35	5.51
BRTADGE3048H30	911	30.60	48	37.75	39.90	6.29
BRTADGE3054H30	948	30.60	54	37.75	41.45	7.08
BRTADGE3060H30	982	30.60	60	37.75	43.00	7.87
BRTADGE3066H30	1016	30.60	66	37.75	44.55	8.65
BRTADGE3072H30	1035	30.60	72	37.75	46.10	9.44
BRTADGE3078H30	1086	30.60	78	37.75	47.65	10.22
BRTADGE3084H30	1121	30.60	84	37.75	49.20	11.01



**BRTADF-H24 • Back 2 Back Felt Divider Screen Kit, 24" high**

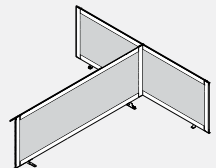
- Provides privacy in an open plan environment.
- Consists of a powder coated aluminum frame, 9mm felt and all hardware to connect. Brackets are painted steel.
- Side dividers extend 6.25" from the front edge of each surface.
- Center divider sits over the gap between the worksurface allowing for the passage of • cables to the trough. The gap for each side is approximately 1".
- BRTADF51-H24 are for 24" deep surfaces and BRTADF63-H24 are for 30" deep surfaces.
- Width and depth are nominal sizes representing the sizes of the Bridges configuration. Allow for 1/4" overhang at sides and 6 1/4" at front.
- Please choose any standard paint finish for frame and hardware. End trim cap is available only in CHR - charcoal.
- 9mm felt material is tackable and comes in a variety of colors.

PRODUCT CODE	PRICE	SIZE/INCHES			WEIGHT LBS	VOL FT <sup>3</sup>
		H	W	D		
BRTADF5136H24	917	24.60	36	50.50	28.00	6.31
BRTADF5142H24	932	24.60	42	50.50	29.50	7.36
BRTADF5148H24	951	24.60	48	50.50	31.00	8.42
BRTADF5154H24	964	24.60	54	50.50	32.50	9.47
BRTADF5160H24	986	24.60	60	50.50	34.00	10.52
BRTADF5166H24	1003	24.60	66	50.50	35.50	11.57
BRTADF5172H24	1022	24.60	72	50.50	37.00	12.63
BRTADF5178H24	1040	24.60	78	50.50	38.50	13.68
BRTADF5184H24	1074	24.60	84	50.50	40.00	14.73
BRTADF6336H24	986	24.60	36	62.50	41.50	7.81
BRTADF6342H24	1003	24.60	42	62.50	43.00	9.11
BRTADF6348H24	1022	24.60	48	62.50	44.50	10.42
BRTADF6354H24	1039	24.60	54	62.50	46.00	11.72
BRTADF6360H24	1057	24.60	60	62.50	47.50	13.02
BRTADF6366H24	1074	24.60	66	62.50	49.00	14.32
BRTADF6372H24	1092	24.60	72	62.50	50.50	15.63
BRTADF6378H24	1109	24.60	78	62.50	52.00	16.93
BRTADF6384H24	1144	24.60	84	62.50	53.50	18.23

**BRTADF-H30 • Back 2 Back Felt Divider Screen Kit, 30" high**

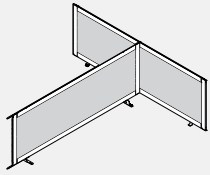
- Provides privacy in an open plan environment.
- Consists of a powder coated aluminum frame, 9mm felt and all hardware to connect. Brackets are painted steel.
- Side dividers extend 6.25" from the front edge of each surface.
- Center divider sits over the gap between the worksurface allowing for the passage of • cables to the trough. The gap for each side is approximately 1".
- BRTADF51-H30 are for 24" deep surfaces and BRTADF63-H30 are for 30" deep surfaces.
- Width and depth are nominal sizes representing the sizes of the Bridges configuration. Allow for 1/4" overhang at sides and 6 1/4" at front.
- Please choose any standard paint finish for frame and hardware. End trim cap is available only in CHR - charcoal.
- 9mm felt material is tackable and comes in a variety of colors.

PRODUCT CODE	PRICE	SIZE/INCHES			WEIGHT LBS	VOL FT <sup>3</sup>
		H	W	D		
BRTADF5136H30	917	30.60	36	50.50	30.50	6.31
BRTADF5142H30	932	30.60	42	50.50	32.00	7.36
BRTADF5148H30	951	30.60	48	50.50	33.50	8.42
BRTADF5154H30	964	30.60	54	50.50	35.00	9.47
BRTADF5160H30	986	30.60	60	50.50	36.50	10.52
BRTADF5166H30	1003	30.60	66	50.50	38.00	11.57
BRTADF5172H30	1022	30.60	72	50.50	39.50	12.63
BRTADF5178H30	1040	30.60	78	50.50	41.00	13.68
BRTADF5184H30	1074	30.60	84	50.50	42.50	14.73
BRTADF6336H30	986	30.60	36	62.50	44.00	7.81
BRTADF6342H30	1003	30.60	42	62.50	45.50	9.11
BRTADF6348H30	1022	30.60	48	62.50	47.00	10.42
BRTADF6354H30	1039	30.60	54	62.50	48.50	11.72
BRTADF6360H30	1057	30.60	60	62.50	50.00	13.02
BRTADF6366H30	1074	30.60	66	62.50	51.50	14.32
BRTADF6372H30	1092	30.60	72	62.50	53.00	15.63
BRTADF6378H30	1109	30.60	78	62.50	54.50	16.93
BRTADF6384H30	1144	30.60	84	62.50	56.00	18.23

**BRTADFE-H24 • Back 2 Back Felt Divider Screen Extension Kit, 24" high**

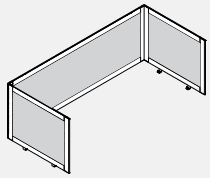
- Provides an extension for privacy in an open plan environment. Intended to always connect to Back 2 Back Divider Screen Kit.
- Consists of a powder coated aluminum frame, 9mm felt and all hardware to connect. Brackets are painted steel.
- Side dividers extend 6.25" from the front edge of each surface.
- Center divider sits over the gap between the worksurface allowing for the passage of • cables to the trough. The gap for each side is approximately 1".
- BRTADFE51-H24 are for 24" deep surfaces and BRTADFE63-H24 are for 30" deep surfaces.
- Width and depth are nominal sizes representing the sizes of the Bridges configuration. Allow for 1/4" overhang at sides and 6 1/4" at front.
- Please choose any standard paint finish for frame and hardware. End trim cap is available only in CHR - charcoal.
- 9mm felt material is tackable and comes in a variety of colors.
- Can be used as left or right connection.

PRODUCT CODE	PRICE	SIZE/INCHES			WEIGHT LBS	VOL FT <sup>3</sup>
		H	W	D		
BRTADFE5136H24	623	24.60	36	50.50	23.35	6.31
BRTADFE5142H24	643	24.60	42	50.50	24.85	7.36
BRTADFE5148H24	658	24.60	48	50.50	26.35	8.42
BRTADFE5154H24	678	24.60	54	50.50	27.85	9.47
BRTADFE5160H24	694	24.60	60	50.50	29.35	10.52
BRTADFE5166H24	713	24.60	66	50.50	30.85	11.57
BRTADFE5172H24	731	24.60	72	50.50	32.35	12.63
BRTADFE5178H24	748	24.60	78	50.50	33.85	13.68
BRTADFE5184H24	784	24.60	84	50.50	35.35	14.73
BRTADFE6336H24	657	24.60	36	62.50	36.85	7.81
BRTADFE6342H24	676	24.60	42	62.50	38.35	9.11
BRTADFE6348H24	693	24.60	48	62.50	39.85	10.42
BRTADFE6354H24	712	24.60	54	62.50	41.35	11.72
BRTADFE6360H24	727	24.60	60	62.50	42.85	13.02
BRTADFE6366H24	747	24.60	66	62.50	44.35	14.32
BRTADFE6372H24	763	24.60	72	62.50	45.85	15.63
BRTADFE6378H24	783	24.60	78	62.50	47.35	16.93
BRTADFE6384H24	818	24.60	84	62.50	48.85	18.23

**BRTADFE-H30 • Back 2 Back Felt Divider Screen Extension Kit, 30" high**

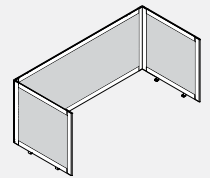
- Provides an extension for privacy in an open plan environment. Intended to always connect to Back 2 Back Divider Screen Kit.
- Consists of a powder coated aluminum frame, 9mm felt and all hardware to connect. Brackets are painted steel.
- Side dividers extend 6.25" from the front edge of each surface.
- Center divider sits over the gap between the worksurface allowing for the passage of • cables to the trough. The gap for each side is approximately 1".
- BRTADFE51-H30 are for 24" deep surfaces and BRTADFE63-H30 are for 30" deep surfaces.
- Width and depth are nominal sizes representing the sizes of the Bridges configuration. Allow for 1/4" overhang at sides and 6 1/4" at front.
- Please choose any standard paint finish for frame and hardware. End trim cap is available only in CHR - charcoal.
- 9mm felt material is tackable and comes in a variety of colors.
- Can be used as left or right connection.

PRODUCT CODE	PRICE	SIZE/INCHES			WEIGHT LBS	VOL FT <sup>3</sup>
		H	W	D		
BRTADFE5136H30	623	30.60	36	50.50	25.85	6.31
BRTADFE5142H30	643	30.60	42	50.50	27.35	7.36
BRTADFE5148H30	658	30.60	48	50.50	28.85	7.42
BRTADFE5154H30	678	30.60	54	50.50	30.35	9.47
BRTADFE5160H30	694	30.60	60	50.50	31.85	10.52
BRTADFE5166H30	713	30.60	66	50.50	33.35	11.57
BRTADFE5172H30	731	30.60	72	50.50	34.85	12.63
BRTADFE5178H30	748	30.60	78	50.50	36.35	13.68
BRTADFE5184H30	784	30.60	84	50.50	37.85	14.73
BRTADFE6336H30	657	30.60	36	62.50	39.35	7.81
BRTADFE6342H30	676	30.60	42	62.50	40.85	9.11
BRTADFE6348H30	693	30.60	48	62.50	42.35	10.42
BRTADFE6354H30	712	30.60	54	62.50	43.85	11.72
BRTADFE6360H30	727	30.60	60	62.50	45.35	13.02
BRTADFE6366H30	747	30.60	66	62.50	46.85	14.32
BRTADFE6372H30	763	30.60	72	62.50	48.35	15.63
BRTADFE6378H30	783	30.60	78	62.50	49.85	16.93
BRTADFE6384H30	818	30.60	84	62.50	51.35	18.23

**BRTADF-H24 • Single Table Divider Felt Screen Kit, 24" high**

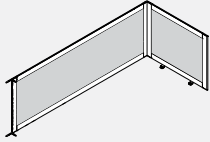
- Provides privacy in an open plan environment.
- Consists of a powder coated aluminum frame, 9mm felt and all hardware to connect. Brackets are painted steel.
- Side dividers extend 6.237" from the front edge of each surface.
- Back divider extends over the back edge of the worksurface by 1 1/2" allowing for the passage of cables to the trough.
- BRTADF24-H24 are for 24" deep surfaces and BRTADF30-H24 are for 30" deep surfaces.
- Width and depth are nominal sizes representing the sizes of the FreeFit Table. Allow for 1/4" overhang at the sides, 1 1/2" at the back and 6.237" at the front.
- Please choose any standard paint finish for frame and hardware. End trim cap is available only in CHR - charcoal.
- 9mm felt material is tackable and comes in a variety of colors.

PRODUCT CODE	PRICE	SIZE/INCHES			WEIGHT LBS	VOL FT <sup>3</sup>
		H	W	D		
BRTADF2436H24	666	24.60	36	31.50	22.55	3.94
BRTADF2442H24	683	24.60	42	31.50	24.10	4.59
BRTADF2448H24	701	24.60	48	31.50	25.65	5.25
BRTADF2454H24	720	24.60	54	31.50	27.20	5.91
BRTADF2460H24	737	24.60	60	31.50	28.75	6.56
BRTADF2466H24	755	24.60	66	31.50	30.30	7.22
BRTADF2472H24	774	24.60	72	31.50	31.85	7.88
BRTADF2478H24	790	24.60	78	31.50	33.40	8.53
BRTADF2484H24	826	24.60	84	31.50	34.95	9.19
BRTADF3036H24	689	24.60	36	37.75	36.50	4.72
BRTADF3042H24	709	24.60	42	37.75	38.05	5.51
BRTADF3048H24	724	24.60	48	37.75	39.60	6.29
BRTADF3054H24	744	24.60	54	37.75	41.15	7.08
BRTADF3060H24	760	24.60	60	37.75	41.70	7.87
BRTADF3066H24	779	24.60	66	37.75	44.25	8.65
BRTADF3072H24	796	24.60	72	37.75	45.80	9.44
BRTADF3078H24	814	24.60	78	37.75	47.35	10.22
BRTADF3084H24	850	24.60	84	37.75	48.90	11.01

**BRTADF-H30 • Single Table Divider Felt Screen Kit, 30" high**

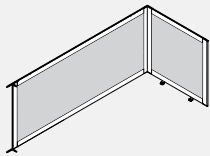
- Provides privacy in an open plan environment.
- Consists of a powder coated aluminum frame, 9mm felt and all hardware to connect. Brackets are painted steel.
- Side dividers extend 6.237" from the front edge of each surface.
- Back divider extends over the back edge of the worksurface by 1 1/2" allowing for the passage of cables to the trough.
- BRTADF24-H30 are for 24" deep surfaces and BRTADF30-H30 are for 30" deep surfaces.
- Width and depth are nominal sizes representing the sizes of the FreeFit Table. Allow for 1/4" overhang at the sides, 1 1/2" at the back and 6.237" at the front.
- Please choose any standard paint finish for frame and hardware. End trim cap is available only in CHR - charcoal.
- 9mm felt material is tackable and comes in a variety of colors.

PRODUCT CODE	PRICE	SIZE/INCHES			WEIGHT LBS	VOL FT <sup>3</sup>
		H	W	D		
BRTADF2436H30	666	30.60	36	31.50	24.85	3.94
BRTADF2442H30	683	30.60	42	31.50	26.40	4.59
BRTADF2448H30	701	30.60	48	31.50	27.95	5.25
BRTADF2454H30	720	30.60	54	31.50	29.50	5.91
BRTADF2460H30	737	30.60	60	31.50	31.05	6.56
BRTADF2466H30	755	30.60	66	31.50	32.60	7.22
BRTADF2472H30	774	30.60	72	31.50	34.14	7.88
BRTADF2478H30	790	30.60	78	31.50	34.70	8.53
BRTADF2484H30	826	30.60	84	31.50	37.25	9.19
BRTADF3036H30	689	30.60	36	37.75	38.80	4.72
BRTADF3042H30	709	30.60	42	37.75	40.35	5.51
BRTADF3048H30	724	30.60	48	37.75	41.90	6.29
BRTADF3054H30	744	30.60	54	37.75	43.45	7.08
BRTADF3060H30	760	30.60	60	37.75	45.00	7.87
BRTADF3066H30	779	30.60	66	37.75	46.55	8.65
BRTADF3072H30	796	30.60	72	37.75	48.10	9.44
BRTADF3078H30	814	30.60	78	37.75	49.65	10.22
BRTADF3084H30	850	30.60	84	37.75	51.20	11.01

**BRTADFE-H24 • Single Table Felt Divider Screen Extension Kit, 24" high**

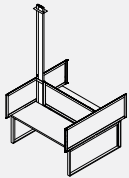
- Provides an extension for privacy in an open plan environment. Intended to always connect to Single Table Divider Screen Kit
- Consists of a powder coated aluminum frame, 9mm felt and all hardware to connect. Brackets are painted steel.
- Side dividers extend 6.237" from the front edge of each surface.
- Back divider extends over the back edge of the worksurface by 1 1/2" allowing for the passage of cables to the trough.
- BRTADFE24-H24 are for 24" deep surfaces and BRTADFE30-H24 are for 30" deep surfaces.
- Width and depth are nominal sizes representing the sizes of the FreeFit Table. Allow for 1/4" overhang at the sides, 1 1/2" at the back and 6.237" at the front.
- Please choose any standard paint finish for frame and hardware. End trim cap is available only in CHR - charcoal.
- 9mm felt material is tackable and comes in a variety of colors.
- Can be used as left or right connection.

PRODUCT CODE	PRICE	SIZE/INCHES			WEIGHT LBS	VOL FT <sup>3</sup>
		H	W	D		
BRTADFE2436H24	503	24.60	36	31.50	18.55	3.94
BRTADFE2442H24	552	24.60	42	31.50	20.10	4.59
BRTADFE2448H24	570	24.60	48	31.50	21.65	5.25
BRTADFE2454H24	588	24.60	54	31.50	23.20	5.91
BRTADFE2460H24	607	24.60	60	31.50	24.75	6.56
BRTADFE2466H24	623	24.60	66	31.50	26.30	7.22
BRTADFE2472H24	643	24.60	72	31.50	27.85	7.88
BRTADFE2478H24	658	24.60	78	31.50	29.40	8.53
BRTADFE2484H24	694	24.60	84	31.50	30.95	9.19
BRTADFE3036H24	522	24.60	36	37.75	32.50	4.72
BRTADFE3042H24	573	24.60	42	37.75	34.05	5.51
BRTADFE3048H24	589	24.60	48	37.75	35.60	6.29
BRTADFE3054H24	608	24.60	54	37.75	37.15	7.08
BRTADFE3060H24	625	24.60	60	37.75	38.70	7.87
BRTADFE3066H24	644	24.60	66	37.75	40.25	8.65
BRTADFE3072H24	659	24.60	72	37.75	41.80	9.44
BRTADFE3078H24	679	24.60	78	37.75	43.35	10.22
BRTADFE3084H24	714	24.60	84	37.75	44.90	11.01

**BRTADFE-H30 • Single Table Felt Divider Screen Extension Kit, 30" high**

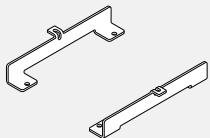
- Provides an extension for privacy in an open plan environment. Intended to always connect to Single Table Divider Screen Kit
- Consists of a powder coated aluminum frame, 9mm felt and all hardware to connect. Brackets are painted steel.
- Side dividers extend 6.237" from the front edge of each surface.
- Back divider extends over the back edge of the worksurface by 1 1/2" allowing for the passage of cables to the trough.
- BRTADFE24-H30 are for 24" deep surfaces and BRTADFE30-H30 are for 30" deep surfaces.
- Width and depth are nominal sizes representing the sizes of the FreeFit Table. Allow for 1/4" overhang at the sides, 1 1/2" at the back and 6.237" at the front.
- Please choose any standard paint finish for frame and hardware. End trim cap is available only in CHR - charcoal.
- 9mm felt material is tackable and comes in a variety of colors.
- Can be used as left or right connection.

PRODUCT CODE	PRICE	SIZE/INCHES			WEIGHT LBS	VOL FT <sup>3</sup>
		H	W	D		
BRTADFE2436H30	503	30.60	36	31.50	20.35	3.94
BRTADFE2442H30	552	30.60	42	31.50	21.90	4.59
BRTADFE2448H30	570	30.60	48	31.50	23.45	5.25
BRTADFE2454H30	588	30.60	54	31.50	25.00	5.91
BRTADFE2460H30	607	30.60	60	31.50	26.55	6.56
BRTADFE2466H30	623	30.60	66	31.50	28.10	7.22
BRTADFE2472H30	643	30.60	72	31.50	29.65	7.88
BRTADFE2478H30	658	30.60	78	31.50	31.20	8.53
BRTADFE2484H30	694	30.60	84	31.50	32.75	9.19
BRTADFE3036H30	522	30.60	36	37.75	34.30	4.72
BRTADFE3042H30	573	30.60	42	37.75	35.85	5.51
BRTADFE3048H30	589	30.60	48	37.75	37.40	6.29
BRTADFE3054H30	608	30.60	54	37.75	38.95	7.08
BRTADFE3060H30	625	30.60	60	37.75	40.50	7.87
BRTADFE3066H30	644	30.60	66	37.75	42.05	8.65
BRTADFE3072H30	659	30.60	72	37.75	43.60	9.44
BRTADFE3078H30	679	30.60	78	37.75	45.15	10.22
BRTADFE3084H30	714	30.60	84	37.75	46.70	11.01

**BRTADPCPP4 • Back 2 Back Ceiling Feed Pole Kit**

- Ceiling pole brings ceiling feed conduit and data cables from the ceiling to Power Troughs at desk height.
- To be used in conjunction with BRTCF - Bridges Ceiling Feed.
- A two part construction allows for power/data conduit lay-in.
- Includes mounting hardware and ceiling bezel, painted finish.
- Please specify the center divider 6" shorter when using the Ceiling Feed Pole Kit.

PRODUCT CODE	PRICE	SIZE/INCHES			WEIGHT LBS	VOL FT <sup>3</sup>
		H	W	D		
BRTADPCPP	283	99	4.75	1.50	13.00	0.48

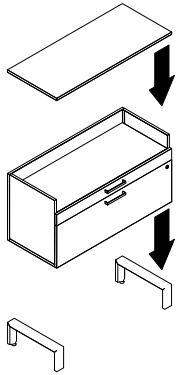
**BRTMKIT • Screen Middle Kit**

- Kit to be used with Bridges Screen Divider when the End Table Shelf is used.
- During installation, remove the end cap brackets and install th BRTMKIT instead.

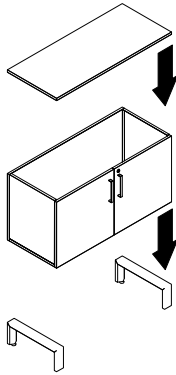
PRODUCT CODE	PRICE	SIZE/INCHES			WEIGHT LBS	VOL FT <sup>3</sup>
		H	W	D		
BRTMKIT	25	2	2	2	0.50	0.01

**Storage Assembly**

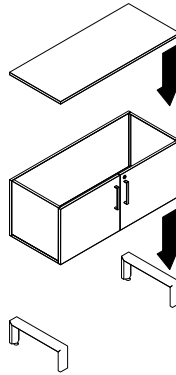
For a complete storage assembly, one must specify a top, a chassis and legs.



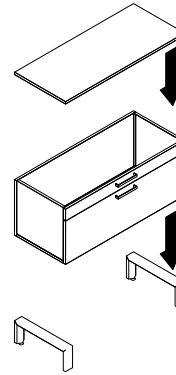
- 1 - BRT29LOBF-U
- 1 - BRTWU
- 2 - BRT-LEGL



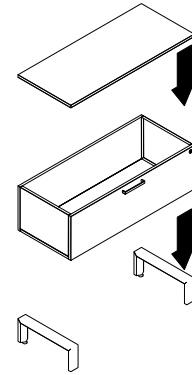
- 1 - BRT29L2D-U
- 1 - BRTWU
- 2 - BRT-LEGL



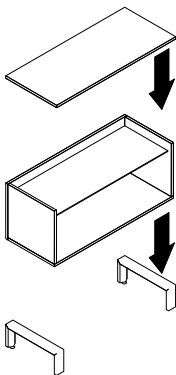
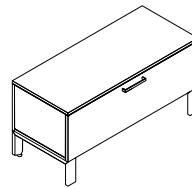
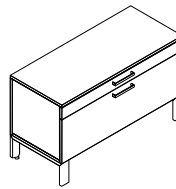
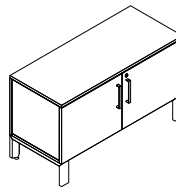
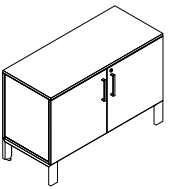
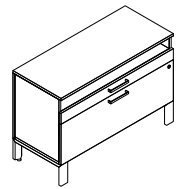
- 1 - BRT25L2D-U
- 1 - BRTWU
- 2 - BRT-LEGL



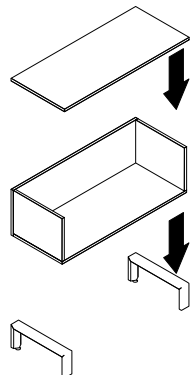
- 1 - BRT25LBF-U
- 1 - BRTWU
- 2 - BRT-LEGL



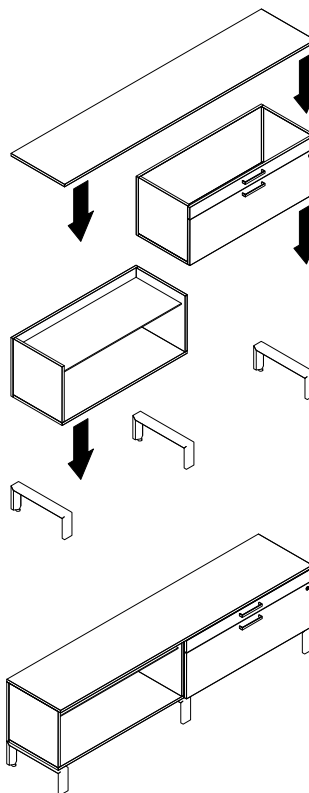
- 1 - BRT21F-U
- 1 - BRTWU
- 2 - BRT-LEGL



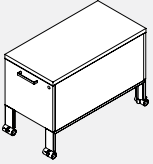
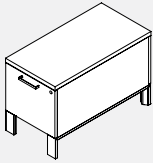
- 1 - BRT25LO-U
- 1 - BRTWU
- 2 - BRT-LEGL



- 1 - BRT21LO-U
- 1 - BRTWU
- 2 - BRT-LEGL

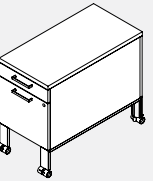
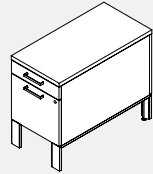


- For larger assemblies, legs may be shared.
- 1 - BRT25LO-U
  - 1 - BRT25LBF-U
  - 1 - BRTWU - ensuring the width of the surface equal the combined width of both storage chassis
  - 3 - BRT-LEGL

**BRT21BF • 21" File Pedestal****• Fits below Bridges tables**

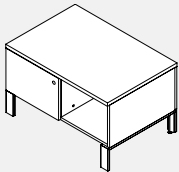
- Can join with other 21" high storage units of corresponding depth to form a spine or slides out on casters to serve as an additional worksurface.
- Floor clearance allows for access to panel floor raceway duplex outlets; units on levelers accommodate installation of an optional Cable Basket to manage cords and data cables under storage spine.
- One file drawer (holds letter, legal and A4 suspended file folders except 18" pedestals).
- Optional Cable Basket suspends off storage unit's bottom and manages cables along the horizontal plane. (NO CASTER models only)
- Fits under table beams even with optional seat cushion.
- LP chassis and drawer fronts (specify LP finish) 1" top (specify LP or HP finish); metal handles, powder coated aluminum or anodized aluminum legs specify 5/16x2" levelers or 40mm white/grey, locking casters.
- Anodized aluminum leg upcharge \$55.
- Optional e-lock available in the vertical position. Please specify V-Vertical and add \$224 list.

PRODUCT CODE	PRICE		SIZE/INCHES			WEIGHT VOL	
	LP	HP	H	W	D	LBS	FT <sup>3</sup>
<b>Levelers</b>							
BRT21BF18L	731	783	21	15.5	18	58	3.39
BRT21BF24L	850	896	21	15.5	24	64	4.52
BRT21BF30L	930	998	21	15.5	30	72	5.65
<b>Casters</b>							
BRT21BF18C	731	783	21	15.5	18	58	3.39
BRT21BF24C	850	896	21	15.5	24	64	4.52
BRT21BF30C	930	998	21	15.5	30	72	5.65

**BRT25BF-L • 25" Box/File Pedestal****• Fits below Bridges tables**

- Can join with other 25" high storage units of corresponding depth to form a spine or slides out on casters to serve as an additional worksurface.
- Floor clearance allows for access to panel floor raceway duplex outlets; units on levelers accommodate installation of an optional Cable Basket to manage cords and data cables under storage spine.
- One box drawer, one file drawer (holds letter, legal and A4 suspended file folders except 18" pedestals).
- Optional Cable Basket suspends off storage unit's bottom and manages cables along the horizontal plane. (NO CASTER models only)
- Fits under 30" worksurface table beams as is.
- LP chassis and drawer fronts (specify LP finish) 1" top (specify LP or HP finish); metal handles, powder coated aluminum or anodized aluminum legs specify 5/16x2" levelers or 40mm white/grey, locking casters
- Anodized aluminum leg upcharge \$55.
- Pedestal with cushion will not fit under beam.
- Black injection moulded pencil tray included.
- 25" high Bridges storage should not be used under Back 2 Back Bridges table applications using Below Worksurface Trough. Storage will not fit under the trough.
- Optional e-lock available in the vertical position. Please specify V-Vertical and add \$224 list.

PRODUCT CODE	PRICE		SIZE/INCHES			WEIGHT VOL	
	LP	HP	H	W	D	LBS	FT <sup>3</sup>
<b>Levelers</b>							
BRT25BF18L	830	883	25	15.5	18	69	3.89
BRT25BF24L	963	1016	25	15.5	24	74	5.02
BRT25BF30L	1050	1114	25	15.5	30	82	6.15
<b>Casters</b>							
BRT25BF18C	896	949	25	15.5	18	69	3.89
BRT25BF24C	1030	1083	25	15.5	24	74	5.02
BRT25BF30C	1114	1180	25	15.5	30	82	6.15

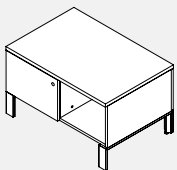
**BRT21LS-L/R • 21" Sliding Door Storage**

Right Open Shown

**• Fits below Bridges tables**

- Can join with other 21" high storage units to form a spine.
- Can serve as an additional worksurface or an ad-hoc guest seating with optional cushion.
- Floor clearance allows for access to panel floor raceway duplex outlets and for installation of an optional Cable Basket to manage cords and data cables under storage spine.
- Storage compartment internal height: 12.36"
- Sliding door locks on left side.
- Optional 15.5"x18" cushion.
- Optional Cable Basket suspends off storage unit's bottom and manages cables along the horizontal plane.
- LP chassis and sliding door (specify LP finish), 1" top (specify LP or HP finish); metal handles, powder coated aluminum or anodized aluminum legs.
- Anodized aluminum leg upcharge \$55.

PRODUCT CODE	PRICE		SIZE/INCHES			WEIGHT VOL	
	LP	HP	H	W	D	LBS	FT <sup>3</sup>
<b>Left</b>							
BRT21LS30L	797	864	21	30	18	53	6.56
BRT21LS36L	883	949	21	36	18	60	7.87
BRT21LS42L	963	1030	21	42	18	67	9.18
<b>Right</b>							
BRT21LS30R	797	864	21	30	18	53	6.56
BRT21LS36R	883	949	21	36	18	60	7.87
BRT21LS42R	963	1030	21	42	18	67	9.18

**BRT21LSS-L/R • 21" Shared Sliding Door Storage**

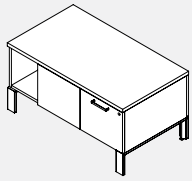
Right Open Shown

**• Shared units offer two 11" deep storage compartments on either side - positioned usually beside Bridges table assembly, between two adjacent workstations.**

- The units can join with other 21" high, 24" deep storage units to form a storage spine or to serve as an additional return worksurface or an ad-hoc guest seating with optional cushion.
- Floor clearance allows for installation of an optional Cable Basket to manage cords and data cables under storage spine. Storage compartment internal height: 12.36". Sliding door locks on left side.
- Optional 15.5"x18" cushion.
- Optional Cable Basket suspends off storage unit's bottom and manages cables along the horizontal plane.
- LP chassis and sliding door (specify LP finish) 1" top (specify LP or HP finish); metal handles, powder coated aluminum or anodized aluminum legs.
- Anodized aluminum leg upcharge \$55.

PRODUCT CODE	PRICE		SIZE/INCHES			WEIGHT VOL	
	LP	HP	H	W	D	LBS	FT <sup>3</sup>
<b>Left</b>							
BRT21LSS30L	1114	1180	21	30	24	69	8.75
BRT21LSS36L	1212	1298	21	36	24	78	10.50
BRT21LSS42L	1315	1414	21	42	24	87	12.25
<b>Right</b>							
BRT21LSS30R	1114	1180	21	30	24	69	8.75
BRT21LSS36R	1212	1298	21	36	24	78	10.50
BRT21LSS42R	1315	1414	21	42	24	87	12.25

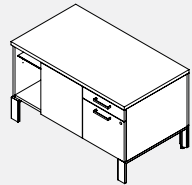


**BRT21LSO42L • 21" Shared File/Open Storage**

- Shared units offer storage compartments on either side - positioned usually between two adjacent Bridges workstations.

- The units can join with other 21" high, 24" deep storage units to form a storage spine or to serve as an additional return worksurface or an ad-hoc guest seating with optional cushion.
- Floor clearance allows for installation of an optional Cable Basket to manage cords and data cables under storage spine.
- One lockable file drawer, one open compartment per side. Storage compartment internal height without height adjustable glass shelf: 12.360"
- Optional 15.5" x 18" cushion. Optional Cable Basket suspends off storage unit's bottom manages cables along the horizontal plane.
- LP chassis drawer fronts (specify LP finish) 1" top (specify LP or HP finish); metal handles, powder coated aluminum or anodized aluminum legs.
- Anodized aluminum leg upcharge \$55.
- 25" high Bridges storage should not be used under Back 2 Back Bridges table applications using Below Worksurface Trough. Storage will not fit under the trough.
- Optional e-lock available in the vertical position. Please specify V-Vertical and add \$224 list.

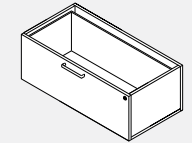
PRODUCT CODE	PRICE		SIZE/INCHES			WEIGHT VOL	
	LP	HP	H	W	D	LBS	FT <sup>3</sup>
BRT21LSO42L	1497	1613	21	42	24	124	14.0

**BRT25LBFO42L • 25" Shared Storage**

- Shared units offer storage compartments on either side.

- Positioned usually between two adjacent Bridges workstations. The units can join with other 25" high, 24" deep storage units to form a storage spine or to serve as an additional return worksurface.
- Floor clearance allows for installation of an optional Cable Basket to manage cords and data cables under storage spine.
- One lockable file drawer, one box drawer, one open compartment with adjustable glass shelf per side. Storage compartment internal height without height adjustable glass shelf: 16.08". Optional 15.5" x 18" cushion.
- Optional Cable Basket suspends off storage unit's bottom and manages cables along the horizontal plane.
- LP chassis and drawer fronts (specify LP finish) 1" top (specify LP or HP finish); metal handles, powder coated aluminum or anodized aluminum legs.
- Anodized aluminum leg upcharge \$55.
- Black injection moulded pencil tray included.
- 25" high Bridges storage should not be used under Back 2 Back Bridges table applications using Below Worksurface Trough. Storage will not fit under the trough.
- Optional e-lock available in the vertical position. Please specify V-Vertical and add \$224 list.

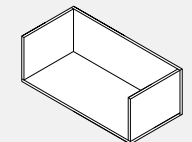
PRODUCT CODE	PRICE		SIZE/INCHES			WEIGHT VOL	
	LP	HP	H	W	D	LBS	FT <sup>3</sup>
BRT25LBFO42L	1878	1981	25	42	24	154	16.66

**BRT21F-U • 21" High Lateral File Drawer, No Top**

- Fits below Bridges tables.

- Can join with other 21" high storage units to form a spine.
- Floor clearance allows for access to panel floor raceway duplex outlets and for installation of an optional Cable Basket to manage cords and data cables under storage spine.
- One file drawer, top and legs to be ordered separately.
- LP chassis and drawer front (specify LP finish); metal handles.
- Optional Cable Basket suspends off storage unit's bottom and manages cables along the horizontal plane.
- Optional e-lock available in the vertical position. Please specify V-Vertical and add \$224 list.

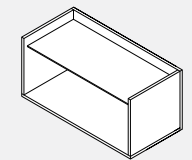
PRODUCT CODE	PRICE		SIZE/INCHES			WEIGHT VOL	
	LP	HP	H	W	D	LBS	FT <sup>3</sup>
BRT21F3018U	786		13	30	18	47	4.06
BRT21F3618U	868		13	36	18	51	4.88
BRT21F4218U	1007		13	42	18	56	5.69
BRT21F3024U	804		13	30	24	51	5.42
BRT21F3624U	895		13	36	24	55	6.50
BRT21F4224U	1055		13	42	24	60	7.58

**BRT21LO-U • 21" High Open Storage, No Top**

- An open storage unit with no top.

- Positioned usually beside Bridges table assembly or between two adjacent workstations.
- Can join with other 21" high storage units to form a spine.
- Floor clearance allows for access to panel floor raceway duplex outlets and for installation of an optional Cable Basket to manage cords and data cables under storage spine.
- One box opening, top and legs to be ordered separately.
- LP chassis (specify LP finish).
- Optional Cable Basket suspends off storage unit's bottom and manages cables along the horizontal plane.
- Unit ships knocked down.

PRODUCT CODE	PRICE		SIZE/INCHES			WEIGHT VOL	
	LP	HP	H	W	D	LBS	FT <sup>3</sup>
BRT21LO3018U	247		13	30	18	25	4.06
BRT21LO3618U	369		13	36	18	29	4.88
BRT21LO4218U	399		13	42	18	32	5.69
BRT21LO3024U	259		13	30	24	29	5.42
BRT21LO3624U	382		13	36	24	33	6.50
BRT21LO4224U	415		13	42	24	36	7.58

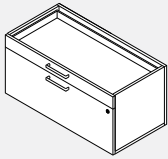
**BRT25LO-U • 25" High Open Storage with Glass Shelf, No Top**

- An open storage unit with glass shelf and no top.

- Positioned usually beside Bridges table assembly or between two adjacent workstations.
- Can join with other 25" high storage units to form a spine.
- Floor clearance allows for access to panel floor raceway duplex outlets and for installation of an optional Cable Basket to manage cords and data cables under storage spine.
- One box opening with glass shelf, top and legs to be ordered separately.
- LP chassis (specify LP finish).
- Optional Cable Basket suspends off storage unit's bottom and manages cables along the horizontal plane.
- 25" high Bridges storage should not be used under Back 2 Back Bridges table applications using Below Worksurface Trough. Storage will not fit under the trough.
- Unit ships knocked down.

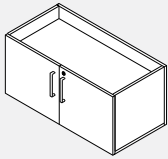
PRODUCT CODE	PRICE		SIZE/INCHES			WEIGHT VOL	
	LP	HP	H	W	D	LBS	FT <sup>3</sup>
BRT25LO3018U	366		17	30	18	40	5.31
BRT25LO3618U	501		17	36	18	46	6.38
BRT25LO4218U	518		17	42	18	52	7.44
BRT25LO3024U	391		17	30	24	44	7.08
BRT25LO3624U	521		17	36	24	50	8.50
BRT25LO4224U	544		17	42	24	56	9.92



**BRT25LBF-U • 25" High Box File Lateral, No Top**

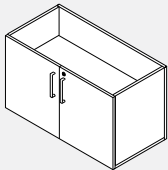
- **A box / file storage unit.**
- Positioned usually beside Bridges table assembly or between two adjacent workstations.
- Can join with other 25" high storage units to form a spine.
- Floor clearance allows for access to panel floor raceway duplex outlets and for installation of an optional Cable Basket to manage cords and data cables under storage spine.
- One lockable file drawer, one box drawer, top and legs to be ordered separately.
- LP chassis and drawer fronts (specify LP finish); metal handles.
- Black injection moulded pencil tray included (can be secured inside the drawer anywhere along the perimeter wall).
- 25" high Bridges storage should not be used under Back 2 Back Bridges table applications using Below Worksurface Trough. Storage will not fit under the trough.
- Optional Cable Basket suspends off storage unit's bottom and manages cables along the horizontal plane.
- Optional e-lock available in the vertical position. Please specify V-Vertical and add \$224 list.

PRODUCT CODE	PRICE LP	SIZE/INCHES			WEIGHT LBS	VOL FT <sup>3</sup>
		H	W	D		
BRT25LBF3018U	942	17	30	18	58	5.31
BRT25LBF3618U	1094	17	36	18	79	6.38
BRT25LBF4218U	1167	17	42	18	68	7.44
BRT25LBF3024U	981	17	30	24	62	7.08
BRT25LBF3624U	1137	17	36	24	83	8.50
BRT25LBF4224U	1212	17	42	24	72	9.92

**BRT25L2D-U • 25" High Storage Cabinet, No Top**

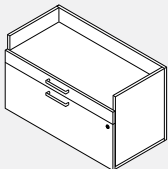
- **A 2 door storage unit.**
- Positioned usually beside Bridges table assembly, between two adjacent workstations.
- The units are level with Bridges tops, can join other 29" high storage units to form a credenza.
- Floor clearance allows for access to panel floor raceway duplex outlets and for installation of an optional Cable Basket to manage cords and data cables under storage spine.
- Two lockable doors, glass shelf included. Top and legs to be ordered separately.
- Storage compartment internal height is 20.5".
- LP chassis and drawer fronts (specify LP finish); metal handles.
- Optional Cable Basket suspends off storage unit's bottom and manages cables along the horizontal plane.
- Optional e-lock available in the horizontal position for the storage cabinet. Please specify HR - Horizontal Right or HL Horizontal Left and add \$224 list.
- Unit ships knocked down.

PRODUCT CODE	PRICE LP	SIZE/INCHES			WEIGHT LBS	VOL FT <sup>3</sup>
		H	W	D		
BRT25L2D3018U	695	17	30	18	39	5.31
BRT25L2D3618U	749	17	36	18	45	6.38
BRT25L2D4218U	780	17	42	18	54	7.44
BRT25L2D3024U	812	17	30	24	43	7.08
BRT25L2D3624U	885	17	36	24	49	8.50
BRT25L2D4224U	920	17	42	24	58	9.92

**BRT29L2D-U • 29" High Storage Cabinet, No Top**

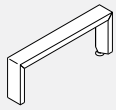
- **A 2 door storage unit.**
- Positioned usually beside Bridges table assembly, between two adjacent workstations.
- The units are level with Bridges tops, can join other 29" high storage units to form a credenza.
- Floor clearance allows for access to panel floor raceway duplex outlets and for installation of an optional Cable Basket to manage cords and data cables under storage spine.
- Two lockable doors, glass shelf included. Top and legs to be ordered separately.
- Storage compartment internal height is 20.5".
- LP chassis and drawer fronts (specify LP finish); metal handles.
- Optional Cable Basket suspends off storage unit's bottom and manages cables along the horizontal plane.
- Optional e-lock available in the horizontal position for the storage cabinet. Please specify HR - Horizontal Right or HL Horizontal Left and add \$224 list.
- Unit ships knocked down.

PRODUCT CODE	PRICE LP	SIZE/INCHES			WEIGHT LBS	VOL FT <sup>3</sup>
		H	W	D		
BRT29L2D3018U	796	21	30	18	49	6.56
BRT29L2D3618U	830	21	36	18	55	7.88
BRT29L2D4218U	867	21	42	18	64	9.19
BRT29L2D3024U	935	21	30	24	53	8.75
BRT29L2D3624U	976	21	36	24	59	10.50
BRT29L2D4224U	998	21	42	24	68	12.25

**BRT29LOBF-U • 29" High Box File Open Storage, No Top**

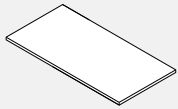
- **Box/file/shelf unit.**
- Positioned usually beside Bridges table assembly, between two adjacent workstations.
- The units are level with Bridges tops, can join other 29" high storage units to form a credenza.
- Floor clearance allows for access to panel floor raceway duplex outlets and for installation of an optional Cable Basket to manage cords and data cables under storage spine.
- One lockable file drawer, one box drawer, one open compartment. Top and legs to be ordered separately.
- Storage compartment internal height: 3.9"
- Black injection moulded pencil tray included (can be secured inside the drawer anywhere along the perimeter wall).
- LP chassis and drawer fronts (specify LP finish); metal handles.
- Optional Cable Basket suspends off storage unit's bottom and manages cables along the horizontal plane.
- Optional e-lock available in the vertical position. Please specify V-Vertical and add \$224 list.

PRODUCT CODE	PRICE LP	SIZE/INCHES			WEIGHT LBS	VOL FT <sup>3</sup>
		H	W	D		
BRT29LOBF3018U	1109	21	30	18	70	6.56
BRT29LOBF3618U	1254	21	36	18	78	7.88
BRT29LOBF4218U	1375	21	42	18	86	9.19
BRT29LOBF3024U	1155	21	30	24	74	8.75
BRT29LOBF3624U	1302	21	36	24	82	10.50
BRT29LOBF4224U	1431	21	42	24	90	12.25

**BRT-LEGL • Bridges Leg for Modular Storage**

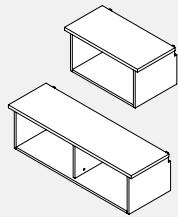
- Two single legs form the structure of the Bridges series modular storage.
- A single can be used at the each end of modular storage units or can be used to support where two modular units meet.
- Leveling glides, steel frame, aluminum legs.
- Please specify paint or anodized finish.
- Anodized aluminum leg upcharge \$55.

PRODUCT CODE	PRICE	SIZE/INCHES			WEIGHT VOL	
		H	W	D	LBS	FT <sup>3</sup>
BRT18LEGL	49	8	2.5	18	8	1.34
BRT24LEGL	58	8	2.5	24	8	1.34

**BRTWU • Bridges Worksurface for Modular Storage**

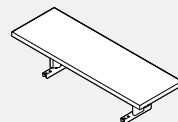
- Worksurfaces are available in high pressure laminate (HP 1 1/16" thick) and low pressure laminate (LP 1" thick) with a flat 3 mm edge profile on all sides.
- Worksurfaces provided with pilot holes for alignment purposes.
- Worksurfaces can be used for each modular unit or can span two to three units.

PRODUCT CODE	PRICE		SIZE/INCHES			WEIGHT VOL	
	LP	HP	H	W	D	LBS	FT <sup>3</sup>
BRTWU1830	138	183	1	30	18	15	0.50
BRTWU1836	159	210	1	36	18	18	0.59
BRTWU1842	208	278	1	42	18	21	0.68
BRTWU1860	329	422	1	60	18	29	0.97
BRTWU1866	344	452	1	66	18	32	1.10
BRTWU1872	363	478	1	72	18	35	1.20
BRTWU1878	380	503	1	78	18	38	1.30
BRTWU1884	417	546	1	84	18	41	1.40
BRTWU1890	434	568	1	90	18	44	1.50
BRTWU1896	450	590	1	96	18	47	1.60
BRTWU2430	145	190	1	30	24	20	0.65
BRTWU2436	161	213	1	36	24	24	0.78
BRTWU2442	211	280	1	42	24	28	0.90
BRTWU2460	336	443	1	60	24	39	1.30
BRTWU2466	350	462	1	66	24	43	1.41
BRTWU2472	366	484	1	72	24	47	1.54
BRTWU2478	392	516	1	78	24	51	1.70
BRTWU2484	422	553	1	84	24	55	1.80
BRTWU2490	441	578	1	90	24	59	1.90
BRTWU2496	457	600	1	96	24	63	2.00

**BRTTES • Table Mounted End Shelf**

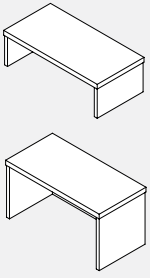
- Single or double open shelf / extended worksurface.
- Secured to the end of single or Back 2 Back Bridges table; supported by rectangular legs, all mounting hardware included.
- Storage compartment internal height: 13.25"
- LP chassis (specify LP finish) 1" top (specify LP or HP finish).
- NOTE: not compatible with round legs.
- 25" high Bridges storage should not be used under Back 2 Back Bridges table applications using Below Worksurface Trough. Storage will not fit under the trough.

PRODUCT CODE	PRICE		SIZE/INCHES			WEIGHT VOL	
	LP	HP	H	W	D	LBS	FT <sup>3</sup>
BRTTES24	614	665	15	24	15.5	29	3.22
BRTTES30	672	731	15	30	15.5	34	4.03
BRTTES51	1114	1224	15	50.5	15.5	57	6.79
BRTTES63	1224	1363	15	62.5	15.5	68	8.4

**BRTCMS • Centre Mount Shelf**

- Open, shared Centre mount shelf 'floats' 6.750" above the gap formed by two back-to-back work surfaces. 12" deep x 30" or 36" laminate shelf surface accepts BRTESBBIN Elevated Shelf Binder Bin - The 30" wide shelf accommodates two, while 36" shelf accommodates up to three BRTESBBIN bins. Shelves overhang the support structure by 6" on either side.
- Aluminum / die cast structure attaches to the underside of both work surfaces.
- Note: Not compatible with BRTETA Above Work Surface Power Trough and Work Surfaces with Access Doors.
- Specify high pressure laminate shelf (HP 1 1/16" thick) or low pressure laminate shelf (LP 1" thick).
- Specify support structure metal finish.
- Anodized support structure finish up charge \$55.

PRODUCT CODE	PRICE		SIZE/INCHES			WEIGHT VOL	
	LP	HP	H	W	D	LBS	FT <sup>3</sup>
BRTCMS30	221	252	6.75	30	12	12.60	1.41
BRTCMS36	317	349	6.75	36	12	15.20	1.69

**BRTSTS • Single Sided Elevated Table Shelf**

- **Single sided elevated shelf.**

- Secured perpendicularly to the single or Back 2 Back Bridges tables. Integrated anodized aluminum accessory rail. White cut out and accessory rail trims.

- Optional Elevated Shelf Binder Bin rests on top surface - better utilization of vertical space, enhanced sense of privacy.

- Three heights available:

- 8" high provides additional storage space without obstructing view; reaches 16" module height when combined with 8" high Binder Shelf. Internal height 6.6".

- 13" high lines up with 42" floor-standing panels.

- 16" high lines up with top of 16" table dividers

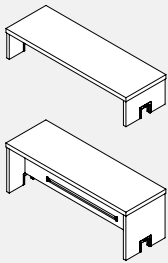
- (15.8"). Specify 12" narrower Shared Elevated Shelf immediately adjacent to the perpendicular elevated shelf. Internal height 14.6".

- NOTE: In order to prevent interference ensure that the Shared Elevated Shelves immediately adjacent to the perpendicular elevated shelf which are of equal or bigger height are specified 12" narrower than the supporting worksurface.

- Optional Elevated Shelf Binder Bin (BRTESBBIN) rests on top surface - better utilization of vertical space, enhanced sense of privacy.

- See Accessory compatibility chart.

PRODUCT CODE	PRICE		SIZE/INCHES			WEIGHT VOL	
	LP	HP	H	W	D	LBS	FT <sup>3</sup>
BRTSTS0824	217	283	8	24	12	14	1.33
BRTSTS0830	249	317	8	30	12	16	1.66
BRTSTS0851	399	500	8	50.5	12	25	2.80
BRTSTS0863	450	600	8	62.5	12	28	3.47
BRTSTS1324	234	299	13	24	12	18	2.16
BRTSTS1330	265	333	13	30	12	21	2.70
BRTSTS1351	399	500	13	50.5	12	32	4.55
BRTSTS1363	465	600	13	62.5	12	38	5.64
BRTSTS1624	265	333	16	24	12	19	2.66
BRTSTS1630	317	383	16	30	12	29	3.33
BRTSTS1651	465	581	16	50.5	12	33	5.61
BRTSTS1663	535	683	16	62.5	12	39	6.94

**BRTBTS • Shared Elevated Table Shelf**

- **Shared, Back 2 Back elevated shelf; rests on Back 2 Back Bridges tables.**

- Cut-outs in both supporting side gables allow placement over Above Worksurface Power/data troughs. Integrated anodized aluminum accessory rail. White cut out and accessory rail trims.

- Three heights available:

- 8" high provides additional storage space without obstructing view; reaches 16" module height when combined with 8" high Binder Shelf. Internal height 6.6".

- 13" high lines up with 42" floor-standing panels.

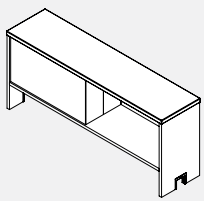
- 16" high lines up with top of 16" table dividers (15.8"). Specify 12" narrower Shared Elevated Shelf immediately adjacent to the perpendicular elevated shelf. Internal height 14.6".

- NOTE: In order to prevent interference ensure that the Shared Elevated Shelves immediately adjacent to the perpendicular elevated shelf which are of equal or bigger height are specified 12" narrower than the supporting worksurface.

- Optional Elevated Shelf Binder Bin (BRTESBBIN) rests on top surface - better utilization of vertical space, binder/book manager, enhanced sense of privacy, magnetic board on the opposite side.

- LP chassis (specify LP finish); 1" top (specify LP or HP finish).

PRODUCT CODE	PRICE		SIZE/INCHES			WEIGHT VOL	
	LP	HP	H	W	D	LBS	FT <sup>3</sup>
BRTBTS0836	333	399	8	36	12	16	2.00
BRTBTS0842	367	433	8	42	12	19	2.33
BRTBTS0848	399	500	8	48	12	21	2.66
BRTBTS0854	417	535	8	54	12	23	3.00
BRTBTS0860	465	600	8	60	12	26	3.33
BRTBTS0866	500	652	8	66	12	28	3.66
BRTBTS0872	535	683	8	72	12	30	4.00
BRTBTS0878	567	731	8	78	12	32	4.33
BRTBTS0884	600	783	8	84	12	35	4.66
BRTBTS1336	399	483	13	36	12	22	3.25
BRTBTS1342	450	535	13	42	12	25	3.79
BRTBTS1348	483	600	13	48	12	28	4.33
BRTBTS1354	535	652	13	54	12	30	4.87
BRTBTS1360	581	697	13	60	12	33	5.86
BRTBTS1366	567	763	13	66	12	36	6.45
BRTBTS1372	665	830	13	72	12	39	6.50
BRTBTS1378	717	883	13	78	12	42	7.04
BRTBTS1384	763	949	13	84	12	44	7.58
BRTBTS1636	417	483	16	36	12	25	4.00
BRTBTS1642	465	567	16	42	12	28	4.66
BRTBTS1648	516	614	16	48	12	31	5.33
BRTBTS1654	548	683	16	54	12	34	6.00
BRTBTS1660	600	731	16	60	12	38	6.66
BRTBTS1666	652	783	16	66	12	41	7.33
BRTBTS1672	697	850	16	72	12	44	8.00
BRTBTS1678	731	896	16	78	12	47	8.66
BRTBTS1684	783	963	16	84	12	50	9.33

**BRTBAS048 • Table Supported Shared Overhead**

- **One compartment per side; white magnetic back wall; lines up with 50" high floor standing storage.**

- Integrated anodized aluminum accessory rail below the shelves.

- Fits over the gap between two parallel Back 2 Back Bridges tables.

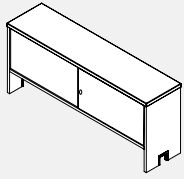
- Fits over above worksurface power/data trough.

- Storage compartment internal height: 12.25".

- Optional Elevated Shelf Binder Bin rests on top surface - better utilization of vertical space, enhanced sense of privacy.

- LP chassis (specify LP finish), white powder-coated steel central partition and backs; 1" top (specify LP or HP finish).

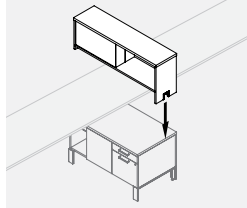
PRODUCT CODE	PRICE		SIZE/INCHES			WEIGHT VOL	
	LP	HP	H	W	D	LBS	FT <sup>3</sup>
BRTBAS048	665	763	21	48	12	54	7.00

**BRTBASL • Shared Elevated Overhead with Sliding Laminate Doors**

- **Two compartments facing in opposite direction can be locked with sliding laminate doors. Storage compartment internal height: 12.25**
- Shared elevated overhead fits over the gap between two parallel Bridges Back 2 Back tables.
- Integrated anodized aluminum accessory rail below the storage compartments. Fits over Above Worksurface Power/Data Troughs.
- NOTE: In order to prevent duplex outlet and work surface access door interference, please specify overhead of the same width as the width of the supporting worksurface.

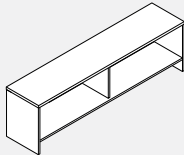
To prevent interference with ceiling feed pole please specify overhead 6" shorter in order width corresponding with the length of the supporting work surface. Elevated Shelf Binder Bins DO NOT work with this overhead. Bottom accessory rail accepts BALTO1 Letter Tray, BAMB01 Media Bin, BAUT01 Utility Tray and BVATH01 Telephone holder.  
LP chassis (specify LP finish); 1" top (specify LP or HP finish), satin lock.

PRODUCT CODE	PRICE		SIZE/INCHES			WEIGHT VOL	
	LP	HP	H	W	D	LBS	FT <sup>3</sup>
BRTBASL36	1891	2015	21	36	16	23.5	6.56
BRTBASL42	2023	2176	21	42	16	27.5	7.65
BRTBASL48	2128	2309	21	48	16	31.4	8.75
BRTBASL54	2289	2477	21	54	16	35.3	9.84
BRTBASL60	2414	2613	21	60	16	39.3	10.93
BRTBASL66	2725	2954	21	66	16	43.2	12.03
BRTBASL72	2869	3126	21	72	16	47.1	13.12
BRTBASL78	3020	3296	21	78	16	51.0	14.21
BRTBASL84	3059	3440	21	84	16	55.0	15.31

**BRTSDS48 • 45" High Shared Storage Divider**

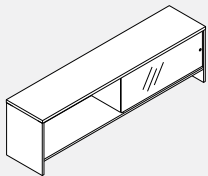
- **Divides side-2-side workstations; two shared open shelves**
- One compartment per side; white magnetic back wall. Rests on top of shared 25" box/file/open and Back 2 Back worksurface.
- Top of the unit is 15.7" from the top of the worksurface.
- Storage compartment internal height: 12.8".
- Optional Elevated Shelf Binder Bin (BRTSEBBIN) rests on top surface - better utilization of vertical space, enhanced sense of privacy.
- LP chassis (specify LP finish), white powder-coated steel central partition and backs; 1" top (specify LP or HP finish).

PRODUCT CODE	PRICE		SIZE/INCHES			WEIGHT VOL	
	LP	HP	H	W	D	LBS	FT <sup>3</sup>
BRTSDS48	535	631	16	48	12	54	5.33

**BRT21HO • Open Single Sided Storage**

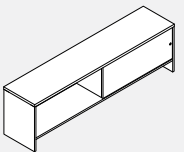
- **Table supported single sided open storage**
- Storage compartment internal height: 14"
- LP chassis (specify LP finish); 1" top (specify LP or HP finish).
- NOTE: Cannot be used in conjunction with above worksurface power trough.
- In order to prevent duplex outlet and work surface access door interference, please specify overhead of the same width as the width of the supporting worksurface.
- To prevent interference with ceiling feed pole please specify overhead 6" shorter width corresponding with the length of the supporting work surface.

PRODUCT CODE	PRICE		SIZE/INCHES			WEIGHT VOL	
	LP	HP	H	W	D	LBS	FT <sup>3</sup>
BRT21HO3616	835	947	21	36	16	81	9
BRT21HO4216	897	1027	21	42	16	96	10.5
BRT21HO4816	958	1102	21	48	16	100	12
BRT21HO5416	1017	1180	21	54	16	124	13.5
BRT21HO6016	1086	1266	21	60	16	134	15
BRT21HO6616	1154	1354	21	66	16	144	16.5
BRT21HO7216	1197	1424	21	72	16	152	18
BRT21HO7816	1288	1524	21	78	16	161	19.5
BRT21HO8416	1339	1592	21	84	16	168	21

**BRT21GS • Open Single Sided Storage with One Sliding Glass Door**

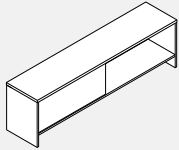
- **Table supported single sided open storage, single sliding glass door with recessed pull**
- Storage compartment internal height: 14"
- LP chassis (specify LP finish); 1" top (specify LP or HP finish).
- Not locking.
- Glass is clear.
- NOTE: Cannot be used in conjunction with above worksurface power trough.
- In order to prevent duplex outlet and work surface access door interference, please specify overhead of the same width as the width of the supporting worksurface.
- To prevent interference with ceiling feed pole please specify overhead 6" shorter width corresponding with the length of the supporting work surface.

PRODUCT CODE	PRICE		SIZE/INCHES			WEIGHT VOL	
	LP	HP	H	W	D	LBS	FT <sup>3</sup>
BRT21GS3616	1317	1428	21	36	16	87	9
BRT21GS4216	1383	1511	21	42	16	103	10.5
BRT21GS4816	1442	1587	21	48	16	108	12
BRT21GS5416	1721	1885	21	54	16	133	13.5
BRT21GS6016	1788	1972	21	60	16	144	15
BRT21GS6616	1876	2076	21	66	16	155	16.5
BRT21GS7216	1936	2155	21	72	16	164	18
BRT21GS7816	2040	2276	21	78	16	174	19.5
BRT21GS8416	2100	2356	21	84	16	181	21

**BRT21LS • Open Single Sided Storage with One Sliding Laminate Door**

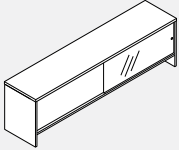
- **Table supported single sided open storage, single sliding laminate door with recessed pull**
- Storage compartment internal height: 14"
- LP chassis (specify LP finish); 1" top (specify LP or HP finish).
- Not locking.
- NOTE: Cannot be used in conjunction with above worksurface power trough.
- In order to prevent duplex outlet and work surface access door interference, please specify overhead of the same width as the width of the supporting worksurface.
- To prevent interference with ceiling feed pole please specify overhead 6" shorter width corresponding with the length of the supporting work surface.

PRODUCT CODE	PRICE		SIZE/INCHES			WEIGHT VOL	
	LP	HP	H	W	D	LBS	FT <sup>3</sup>
BRT21LS3616	1278	1434	21	36	16	94	9
BRT21LS4216	1341	1522	21	42	16	111	10.5
BRT21LS4816	1401	1606	21	48	16	117	12
BRT21LS5416	1460	1691	21	54	16	143	13.5
BRT21LS6016	1688	1947	21	60	16	155	15
BRT21LS6616	1758	2040	21	66	16	167	16.5
BRT21LS7216	1810	2118	21	72	16	177	18
BRT21LS7816	1891	2225	21	78	16	188	19.5
BRT21LS8416	1944	2301	21	84	16	198	21

**BRT21HDO • Open Double Sided Storage**

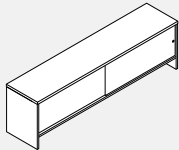
- **Table supported double sided open storage.**
- Fits over the gap between two parallel Bridges Back 2 Back tables.
- Storage compartment internal height: 14"
- LP chassis (specify LP finish); 1" top (specify LP or HP finish)
- NOTE: Cannot be used in conjunction with above worksurface power trough
- In order to prevent duplex outlet and work surface access door interference, please specify overhead of the same width as the width of the supporting worksurface.
- To prevent interference with ceiling feed pole please specify overhead 6" shorter width corresponding with the length of the supporting work surface.

PRODUCT CODE	PRICE		SIZE/INCHES			WEIGHT VOL	
	LP	HP	H	W	D	LBS	FT <sup>3</sup>
BRT21HDO3616	867	976	21	36	16	81	9
BRT21HDO4216	917	1043	21	42	16	96	10.5
BRT21HDO4816	959	1106	21	48	16	100	12
BRT21HDO5416	1034	1198	21	54	16	124	13.5
BRT21HDO6016	1088	1267	21	60	16	134	15
BRT21HDO6616	1170	1370	21	66	16	144	16.5
BRT21HDO7216	1208	1428	21	72	16	152	18
BRT21HDO7816	1303	1541	21	78	16	161	19.5
BRT21HDO8416	1340	1595	21	84	16	168	21

**BRT21GDS • Double Sided Storage with Sliding Glass Door**

- **Table supported double sided storage with sliding glass doors and recessed pull.**
- Fits over the gap between two parallel Bridges Back 2 Back tables.
- Storage compartment internal height: 14"
- LP chassis (specify LP finish); 1" top (specify LP or HP finish).
- Not Locking
- NOTE: Cannot be used in conjunction with above worksurface power trough
- In order to prevent duplex outlet and work surface access door interference, please specify overhead of the same width as the width of the supporting worksurface.
- To prevent interference with ceiling feed pole please specify overhead 6" shorter width corresponding with the length of the supporting work surface.

PRODUCT CODE	PRICE		SIZE/INCHES			WEIGHT VOL	
	LP	HP	H	W	D	LBS	FT <sup>3</sup>
BRT21GDS3616	1711	1819	21	36	16	94	9
BRT21GDS4216	1789	1918	21	42	16	111	10.5
BRT21GDS4816	1831	1976	21	48	16	117	12
BRT21GDS5416	2367	2531	21	54	16	143	13.5
BRT21GDS6016	2411	2593	21	60	16	155	15
BRT21GDS6616	2572	2773	21	66	16	167	16.5
BRT21GDS7216	2629	2845	21	72	16	177	18
BRT21GDS7816	2735	2971	21	78	16	188	19.5
BRT21GDS8416	2911	3167	21	84	16	196	21

**BRT21LDS • Double sided Storage with Sliding Laminate Door**

- **Table supported double sided storage with sliding laminate doors and recessed pull.**
- Fits over the gap between two parallel Bridges Back 2 Back tables.
- Storage compartment internal height: 14"
- LP chassis (specify LP finish); 1" top (specify LP or HP finish).
- Not Locking
- NOTE: Cannot be used in conjunction with above worksurface power trough
- In order to prevent duplex outlet and work surface access door interference, please specify overhead of the same width as the width of the supporting worksurface.
- To prevent interference with ceiling feed pole please specify overhead 6" shorter width corresponding with the length of the supporting work surface.

PRODUCT CODE	PRICE		SIZE/INCHES			WEIGHT VOL	
	LP	HP	H	W	D	LBS	FT <sup>3</sup>
BRT21LDS3616	1680	1788	21	36	16	106	9
BRT21LDS4216	1786	1915	21	42	16	126	10.5
BRT21LDS4816	1824	1970	21	48	16	134	12
BRT21LDS5416	2278	2442	21	54	16	162	13.5
BRT21LDS6016	2320	2501	21	60	16	176	15
BRT21LDS6616	2473	2674	21	66	16	190	16.5
BRT21LDS7216	2511	2731	21	72	16	203	18
BRT21LDS7816	2606	2842	21	78	16	216	19.5
BRT21LDS8416	2762	3016	21	84	16	227	21

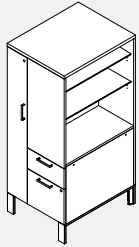


**BRTTW50-L/R • Storage Tower with Coat Storage**

Left Shown

- Provides storage and privacy at the end of a table
- Box+file drawers; open compartment with adjustable glass shelf (50" high); coat storage with hinged door.
- Specify Left or Right handed.
- Capable of supporting worksurface on one side (built-in threaded inserts to secure dedicated worksurface supporting beam).
- Open side storage compartment internal height: 19.6".
- Optional Cable Basket suspends off storage unit's bottom and manages cables along the horizontal plane.
- LP chassis (specify LP finish), 1" top (specify LP or HP finish); metal handles; powder coated aluminum or anodized aluminum legs (specify paint finish).
- Anodized aluminum leg upcharge \$55.
- Black injection moulded pencil tray included.
- Optional e-lock available in the vertical position for the box, file drawer. Please specify V-Vertical and add \$224 list.
- Optional e-lock available in the horizontal position for the wardrobe. Please specify HR-Horizontal Right or HL-Horizontal Left and add \$224 list.

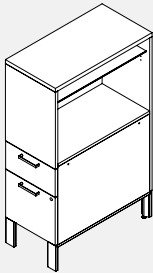
PRODUCT CODE	PRICE		SIZE/INCHES			WEIGHT VOL	
	LP	HP	H	W	D	LBS	FT <sup>3</sup>
BRTTW5024L	1812	1928	50	24	24	142	16.66
BRTTW5024R	1812	1928	50	24	24	142	16.66
BRTTW5030L	2014	2128	50	24	30	163	20.83
BRTTW5030R	2014	2128	50	24	30	163	20.83

**BRTTW66-L/R • Storage Tower with Coat Storage**

Left Shown

- Provides storage and privacy at the end of a table
- Box+file drawers; open compartment with adjustable glass shelf (66" high); coat storage with hinged door.
- Specify Left or Right handed.
- Capable of supporting worksurface on one side (built-in threaded inserts to secure dedicated worksurface supporting beam).
- Open side storage compartment internal height: 35.6".
- Optional Cable Basket suspends off storage unit's bottom and manages cables along the horizontal plane.
- LP chassis (specify LP finish), 1" top (specify LP or HP finish); metal handles; powder coated aluminum or anodized aluminum legs (specify paint finish).
- Anodized aluminum leg upcharge \$55.
- Black injection moulded pencil tray included.
- Optional e-lock available in the vertical position for the box, file drawer. Please specify V-Vertical and add \$224 list.
- Optional e-lock available in the horizontal position for the wardrobe. Please specify HR-Horizontal Right or HL-Horizontal Left and add \$224 list.

PRODUCT CODE	PRICE		SIZE/INCHES			WEIGHT VOL	
	LP	HP	H	W	D	LBS	FT <sup>3</sup>
BRTTW6624L	2356	2506	66	24	24	170	22
BRTTW6624R	2356	2506	66	24	24	170	22
BRTTW6630L	2616	2765	66	24	30	195	27.5
BRTTW6630R	2616	2765	66	24	30	195	27.5

**BRTT50-L/R • 50" High Storage Tower**

Left Shown

- Provides storage and privacy at the end of a table
- Box+file drawers; open compartment with adjustable glass shelf.
- Specify Left or Right handed.
- Capable of supporting worksurface on one side (built-in threaded inserts to secure dedicated worksurface supporting beam).
- Open side storage compartment internal height: 19.6"
- Optional Cable Basket suspends off storage unit's bottoms and manages cables along the horizontal plane.
- LP chassis (specify LP finish), 1" top (specify LP or HP finish); metal handles; powder coated aluminum or anodized aluminum legs (specify paint finish).
- Anodized aluminum leg upcharge \$55.
- Black injection moulded pencil tray included.
- Optional e-lock available in the vertical position. Please specify V-Vertical and add \$224 list.

PRODUCT CODE	PRICE		SIZE/INCHES			WEIGHT VOL	
	LP	HP	H	W	D	LBS	FT <sup>3</sup>
BRTT5024L	1348	1430	50	15.5	24	88	10.76
BRTT5024R	1348	1430	50	15.5	24	88	10.76
BRTT5030L	1481	1579	50	15.5	30	101	13.45
BRTT5030R	1481	1579	50	15.5	30	101	13.45

**BRTT66-L/R • 66" High Storage Tower**

Left Shown

- Provides storage and privacy at the end of a table
- Box+file drawers; open compartment with 2 adjustable glass shelf.
- Specify Left or Right handed.
- Capable of supporting worksurface on one side (built-in threaded inserts to secure dedicated worksurface supporting beam).
- Open side storage compartment internal height: 35.6"
- Optional Cable Basket suspends off storage unit's bottoms and manages cables along the horizontal plane.
- LP chassis (specify LP finish), 1" top (specify LP or HP finish); metal handles; powder coated aluminum or anodized aluminum legs (specify paint finish).
- Anodized aluminum leg upcharge \$55.
- Black injection moulded pencil tray included.
- Optional e-lock available in the vertical position. Please specify V-Vertical and add \$224 list.

PRODUCT CODE	PRICE		SIZE/INCHES			WEIGHT VOL	
	LP	HP	H	W	D	LBS	FT <sup>3</sup>
BRTT6624L	1751	1859	66	15.5	24	106	12.91
BRTT6624R	1751	1859	66	15.5	24	106	12.91
BRTT6630L	1925	2055	66	15.5	30	121	16.14
BRTT6630R	1925	2055	66	15.5	30	121	16.14



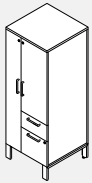
**BRTTW2D50-L/R - 50" High Two Door Storage Tower**

Left Shown

- **Provides storage and privacy at the end of a table**

- Box+file drawers; closed compartment with one adjustable laminate shelf and hinged door; coat storage with hinged door.
- Specify Left or Right handed.
- Closed side storage compartment internal height: 20.3"
- Optional Cable Basket suspends off storage unit's bottoms and manages cables along the horizontal plane.
- LP chassis (specify LP finish), 1" top (specify LP or HP finish); metal handles; powder coated aluminum or anodized aluminum legs (specify paint finish).
- Anodized aluminum leg upcharge \$55.
- Black injection moulded pencil tray included.
- Optional e-lock available in the vertical position for the box, file drawer. Please specify V-Vertical and add \$224 list.
- Optional e-lock available in the horizontal position for the wardrobe. Please specify HR-Horizontal Right or HL-Horizontal Left and add \$224 list.
- Optional e-lock available in the horizontal position for the closed compartment. Please specify HR-Horizontal Right or HL-Horizontal Left and add \$224 list.

PRODUCT CODE	PRICE		SIZE/INCHES			WEIGHT VOL	
	LP	HP	H	W	D	LBS	FT <sup>3</sup>
BRTTW2D5018L	1677	1766	50	24	18	121	12.50
BRTTW2D5018R	1677	1766	50	24	18	121	12.50
BRTTW2D5024L	1881	1996	50	24	24	142	16.67
BRTTW2D5024R	1881	1996	50	24	24	142	16.67
BRTTW2D5030L	2082	2196	50	24	30	163	20.83
BRTTW2D5030R	2082	2196	50	24	30	163	20.83

**BRTTW2D66-L/R - 66" High Two Door Storage Tower**

Left Shown

- **Provides storage and privacy at the end of a table**

- Box+file drawers; closed compartment with two adjustable laminate shelves and hinged door; coat storage with hinged door.
- Specify Left or Right handed.
- Closed side storage compartment internal height: 36.3"
- Anodized aluminum leg upcharge \$55.
- Optional Cable Basket suspends off storage unit's bottoms and manages cables along the horizontal plane.
- LP chassis (specify LP finish), 1" top (specify LP or HP finish); metal handles; powder coated aluminum or anodized aluminum legs (specify paint finish).
- Black injection moulded pencil tray included.
- Optional e-lock available in the vertical position for the box, file drawer. Please specify V-Vertical and add \$224 list.
- Optional e-lock available in the horizontal position for the wardrobe. Please specify HR-Horizontal Right or HL-Horizontal Left and add \$224 list.
- Optional e-lock available in the horizontal position for the closed compartment. Please specify HR-Horizontal Right or HL-Horizontal Left and add \$224 list.

PRODUCT CODE	PRICE		SIZE/INCHES			WEIGHT VOL	
	LP	HP	H	W	D	LBS	FT <sup>3</sup>
BRTTW2D6618L	2144	2254	66	24	18	145	16.50
BRTTW2D6618R	2144	2254	66	24	18	145	16.50
BRTTW2D6624L	2425	2574	66	24	24	170	22.00
BRTTW2D6624R	2425	2574	66	24	24	170	22.00
BRTTW2D6630L	2685	2834	66	24	30	195	27.50
BRTTW2D6630R	2685	2834	66	24	30	195	27.50

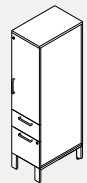
**BRTT1D50-L/R - 50" High Hinged Door Storage Tower**

Right Shown

- **Provides storage and privacy at the end of a table**

- Box+file drawers; closed compartment with one adjustable laminate shelf and hinged door.
- Specify Left or Right handed.
- Closed side storage compartment internal height: 20.3"
- Optional Cable Basket suspends off storage unit's bottoms and manages cables along the horizontal plane.
- LP chassis (specify LP finish), 1" top (specify LP or HP finish); metal handles; powder coated aluminum or anodized aluminum legs (specify paint finish).
- Anodized aluminum leg upcharge \$55.
- Black injection moulded pencil tray included.
- Optional e-lock available in the vertical position for the box, file drawer. Please specify V-Vertical and add \$224 list.
- Optional e-lock available in the horizontal position for the closed compartment. Please specify HR-Horizontal Right or HL-Horizontal Left and add \$224 list.

PRODUCT CODE	PRICE		SIZE/INCHES			WEIGHT VOL	
	LP	HP	H	W	D	LBS	FT <sup>3</sup>
BRTT1D5018L	1235	1298	50	15.5	18	110	8.07
BRTT1D5018R	1235	1298	50	15.5	18	110	8.07
BRTT1D5024L	1416	1498	50	15.5	24	131	10.76
BRTT1D5024R	1416	1498	50	15.5	24	131	10.76
BRTT1D5030L	1549	1647	50	15.5	30	152	13.45
BRTT1D5030R	1549	1647	50	15.5	30	152	13.45

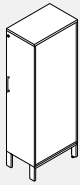
**BRTT1D66-L/R - 66" High Hinged Door Storage Tower**

Right Shown

- **Provides storage and privacy at the end of a table**

- Box+file drawers; closed compartment with two adjustable laminate shelves and hinged door.
- Specify Left or Right handed.
- Closed side storage compartment internal height: 36.3"
- Optional Cable Basket suspends off storage unit's bottoms and manages cables along the horizontal plane.
- LP chassis (specify LP finish), 1" top (specify LP or HP finish); metal handles; powder coated aluminum or anodized aluminum legs (specify paint finish).
- Anodized aluminum leg upcharge \$55.
- Black injection moulded pencil tray included.
- Optional e-lock available in the vertical position for the box, file drawer. Please specify V-Vertical and add \$224 list.
- Optional e-lock available in the horizontal position for the closed compartment. Please specify HR-Horizontal Right or HL-Horizontal Left and add \$224 list.

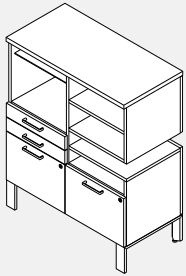
PRODUCT CODE	PRICE		SIZE/INCHES			WEIGHT VOL	
	LP	HP	H	W	D	LBS	FT <sup>3</sup>
BRTT1D6618L	1579	1669	66	15.5	18	134	10.66
BRTT1D6618R	1579	1669	66	15.5	18	134	10.66
BRTT1D6624L	1819	1928	66	15.5	24	159	14.21
BRTT1D6624R	1819	1928	66	15.5	24	159	14.21
BRTT1D6630L	1994	2125	66	15.5	30	184	17.76
BRTT1D6630R	1994	2125	66	15.5	30	184	17.76

**BRTW1D-L/R - Hinged Door Wardrobe Tower**

Right Shown

- Provides wardrobe and privacy at the end of a table.
- Specify Left or Right handed.
- Optional Cable Basket suspends off storage unit's bottoms and manages cables along the horizontal plane.
- LP chassis (specify LP finish), 1" top (specify LP or HP finish); metal handles; powder coated aluminum or anodized aluminum legs (specify paint finish).
- Anodized aluminum leg upcharge \$55.
- Optional e-lock available in the horizontal position for the wardrobe. Please specify HR-Horizontal Right or HL-Horizontal Left and add \$224 list.
- 18" unit has coat hooks, 24" and 30" units have a coat rod.

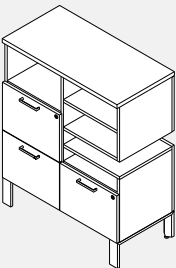
PRODUCT CODE	PRICE		SIZE/INCHES			WEIGHT VOL	
	LP	HP	H	W	D	LBS	FT <sup>3</sup>
BRTW1D5018L	952	1012	50	15.5	18	105	8.07
BRTW1D5018R	952	1012	50	15.5	18	105	8.07
BRTW1D5024L	1078	1157	50	15.5	24	126	10.76
BRTW1D5024R	1078	1157	50	15.5	24	126	10.76
BRTW1D5030L	1209	1309	50	15.5	30	147	13.45
BRTW1D5030R	1209	1309	50	15.5	30	147	13.45
BRTW1D6618L	1204	1265	66	15.5	18	129	10.66
BRTW1D6618R	1204	1265	66	15.5	18	129	10.66
BRTW1D6624L	1363	1441	66	15.5	24	154	14.21
BRTW1D6624R	1363	1441	66	15.5	24	154	14.21
BRTW1D6630L	1525	1622	66	15.5	30	179	17.76
BRTW1D6630R	1525	1622	66	15.5	30	179	17.76

**BRTCS45BBFF - Cantilever Storage Open Box, Box, File, Open, File**

Left Shown

- Provides storage and privacy anywhere along the length of the bench.
- The middle opening of the cabinet allows the upper portion to cantilever above the worksurface
- Two locking file drawers.
- Two pencil drawers not locking.
- Open compartment with adjustable glass shelf, internal dimension of 15.9"
- Three fixed open compartments two above worksurfaces (6.7" interior dimension), one below (3.7" interior dimension)
- Specify Left or Right handed.
- Optional Cable Basket suspends off storage unit's bottoms and manages cables along the horizontal plane.
- LP chassis (specify LP finish), 1" top (specify LP or HP finish); metal handles; powder coated aluminum or anodized aluminum legs (specify paint finish).
- Anodized aluminum leg upcharge \$55.
- Optional e-lock available in the vertical position. Please specify V-Vertical and add \$224 list each.
- Cantilever storage requires two e-locks.

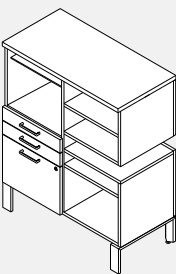
PRODUCT CODE	PRICE		SIZE/INCHES			WEIGHT VOL	
	LP	HP	H	W	D	LBS	FT <sup>3</sup>
BRTCS45BBFFL	2037	2141	45	36	18	256	24
BRTCS45BBFFR	2037	2141	45	36	18	256	24

**BRTCS45FFFO - Cantilever Storage Open, File, Open, File, Open**

Left Shown

- Provides storage and privacy anywhere along the length of the bench.
- The middle opening of the cabinet allows the upper portion to cantilever above the worksurface
- Three locking file drawers with two locks.
- Open compartment (10.3" interior dimension)
- Three fixed open compartments two above worksurface (6.7" interior dimension), one below (3.7" interior dimension).
- Specify Left or Right handed.
- Optional Cable Basket suspends off storage unit's bottoms and manages cables along the horizontal plane.
- LP chassis (specify LP finish), 1" top (specify LP or HP finish); metal handles; powder coated aluminum or anodized aluminum legs (specify paint finish).
- Anodized aluminum leg upcharge \$55.
- Optional e-lock available in the vertical position. Please specify V-Vertical and add \$224 list each.
- Cantilever storage requires two e-locks.

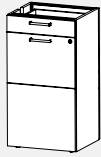
PRODUCT CODE	PRICE		SIZE/INCHES			WEIGHT VOL	
	LP	HP	H	W	D	LBS	FT <sup>3</sup>
BRTCS45FFFO L	2087	2188	45	36	18	256	24
BRTCS45FFFO R	2087	2188	45	36	18	256	24

**BRTCS45BBFOO - Cantilever Storage Open, Box, Box, File, Open**

Left Shown

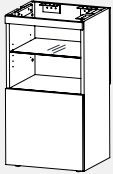
- Provides storage and privacy anywhere along the length of the bench.
- The middle opening of the cabinet allows the upper portion to cantilever above the worksurface
- Locking file drawer.
- Two pencil drawers not locking.
- Open compartment (10.3" interior dimension) with adjustable glass shelf.
- Four fixed open compartments two above worksurface (6.7" interior dimension), two below (lower 12.2" interior dimension and upper 3.3" interior dimension)
- Specify Left or Right handed.
- Optional Cable Basket suspends off storage unit's bottoms and manages cables along the horizontal plane.
- LP chassis (specify LP finish), 1" top (specify LP or HP finish); metal handles; powder coated aluminum or anodized aluminum legs (specify paint finish).
- Anodized aluminum leg upcharge \$55.
- Optional e-lock available in the vertical position. Please specify V-Vertical and add \$224 list each.
- Cantilever storage requires one e-lock.

PRODUCT CODE	PRICE		SIZE/INCHES			WEIGHT VOL	
	LP	HP	H	W	D	LBS	FT <sup>3</sup>
BRTCS45BBFOO L	1991	2093	45	36	18	256	24
BRTCS45BBFOO R	1991	2093	45	36	18	256	24

**BRTDS2B2F • Pier Storage unit Box/File, Box/File**

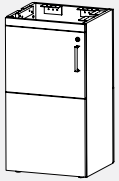
- Supports SideXSide divider with Box File on opposite sides for SideXSide application.
- Two lockable file drawers, two box drawers.
- Black injection moulded pencil tray included (can be secured inside the drawer anywhere along the perimeter wall).
- Optional e-lock available in the vertical position. Please specify V-Vertical and add \$446 list.

PRODUCT CODE	PRICE	SIZE/INCHES			WEIGHT VOL	
		H	W	D	LBS	FT <sup>3</sup>
BRTDS2B2F	1309	36	18	16	85	14

**BRTDSOP • Pier Storage unit Open with Two glass adjustable shelves**

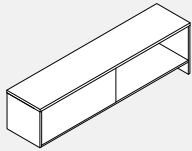
- Supports SideXSide divider with Box File on opposite sides for SideXSide application.
- Storage compartment internal height without height adjustable glass shelf: 15"

PRODUCT CODE	PRICE	SIZE/INCHES			WEIGHT VOL	
		H	W	D	LBS	FT <sup>3</sup>
BRTDSOP	868	36	18	16	75	14

**BRTDS2D • Pier Storage unit Hinged Door with Two glass adjustable shelves**

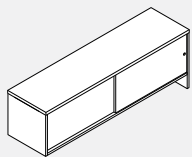
- Supports SideXSide divider with hinged lockable door on opposite sides for SideX-Side application.
- Storage compartment internal height without height adjustable shelf: 15"
- Optional e-lock available in the vertical position. Please specify HL HR- Horizontal Left and Right add \$446 list.

PRODUCT CODE	PRICE	SIZE/INCHES			WEIGHT VOL	
		H	W	D	LBS	FT <sup>3</sup>
BRTDS2D	1169	36	18	16	79	14

**BRT21PHDO • SideXSide Storage - Open Double Sided**

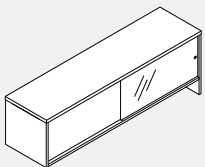
- Pier and Table supported SideXSide double sided open storage.
- Divides space and provides storage anywhere along bench or table.
- Storage compartment internal height: 14".
- LP chassis (specify LP finish); 1" top (specify LP or HP finish).

PRODUCT CODE	PRICE		SIZE/INCHES			WEIGHT VOL	
	LP	HP	H	W	D	LBS	FT <sup>3</sup>
BRT21PHDO4216	755	884	21	42	16	96	10.5
BRT21PHDO4816	804	951	21	48	16	100	12
BRT21PHDO5416	883	1045	21	54	16	124	13.5
BRT21PHDO6016	930	1113	21	60	16	134	15
BRT21PHDO6616	1009	1209	21	66	16	144	16.5
BRT21PHDO7216	1064	1283	21	72	16	152	18

**BRT21PLDS • SideXSide Storage - Sliding Laminate Double Sided**

- Pier and Table supported SideXSide double sided storage with sliding laminate doors and recessed pull.
- Divides space and provides storage anywhere along bench or table.
- Storage compartment internal height: 14".
- LP chassis (specify LP finish); 1" top (specify LP or HP finish).
- Not Locking

PRODUCT CODE	PRICE		SIZE/INCHES			WEIGHT VOL	
	LP	HP	H	W	D	LBS	FT <sup>3</sup>
BRT21PLDS4216	1754	1883	21	42	16	126	11
BRT21PLDS4816	1790	1936	21	48	16	134	12
BRT21PLDS5416	2246	2411	21	54	16	162	14
BRT21PLDS6016	2288	2470	21	60	16	176	15
BRT21PLDS6616	2442	2643	21	66	16	190	17
BRT21PLDS7216	2480	2698	21	72	16	203	18

**BRT21PGDS • SideXSide Storage - Sliding Glass Double Sided**

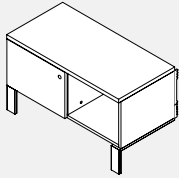
- Pier and Table supported SideXSide double sided storage with sliding glass doors and recessed pull.
- Divides space and provides storage anywhere along bench or table.
- Storage compartment internal height: 14".
- LP chassis (specify LP finish); 1" top (specify LP or HP finish).

PRODUCT CODE	PRICE		SIZE/INCHES			WEIGHT VOL	
	LP	HP	H	W	D	LBS	FT <sup>3</sup>
BRT21PGDS4216	1774	1898	21	42	16	110	10.5
BRT21PGDS4816	1811	1956	21	48	16	116	12
BRT21PGDS5416	2349	2514	21	54	16	141	13.5
BRT21PGDS6016	2392	2573	21	60	16	153	15
BRT21PGDS6616	2551	2751	21	66	16	165	16.5
BRT21PGDS7216	2608	2827	21	72	16	175	18

### Panel supporting laterals

- Provide storage and panel support. Full access to Boulevard System 3 bottom raceway cover and power/data outlets. Feet support the front of the unit while a set of brackets (included) secures the unit to Boulevard panels.
- Panel mounting brackets leave 1" deep space between the storage and the panel allowing for easy cable passage behind the storage. Note: that the brackets bring the total depth to 19" (18" deep storage units) from the panel and 24" (23" deep storage units).
- Optional Cable Basket suspends off storage unit's bottom and manages cables along the horizontal plane.
- LP chassis (specify LP finish); 1" top (specify LP or HP finish); metal handles; powder coated aluminum or anodized aluminum legs (specify finish).

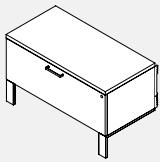
### BRTPSLS • Panel Supporting Lateral Sliding Door



- Fits below Bridges tables, can join with other 21" high, 18" and 23" deep storage units along the panel. Can serve as an additional work-surface or an ad-hoc guest seating with optional cushion.
- Storage compartment internal height: 12.36".
- Sliding door locks on left side.
- Anodized aluminum leg upcharge \$55.

PRODUCT CODE	PRICE		SIZE/INCHES			WEIGHT VOL	
	LP	HP	H	W	D	LBS	FT <sup>3</sup>
BRTPSLS30	1016	1083	21	30	19	53	6.56
BRTPSLS36	1096	1166	21	36	19	60	7.87
BRTPSLS42	1180	1245	21	42	19	67	9.18
BRTPSLS2330	1352	1441	21	30	24	61	8.39
BRTPSLS2336	1463	1550	21	36	24	70	10.06
BRTPSLS2342	1574	1664	21	42	24	79	11.74

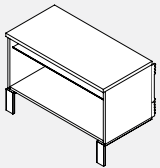
### BRTPSL • Panel Supporting Lateral File Drawer



- Fits below Bridges tables, can join with other 21" high, 18" and 23" deep storage units along the panel. Can serve as an additional work-surface or an ad-hoc guest seating with optional cushion.
- One file drawer (holds letter, legal and A4 suspended file folders).
- Anodized aluminum leg upcharge \$55.
- Optional e-lock available in the vertical position. Please specify V-Vertical and add \$224 list.

PRODUCT CODE	PRICE		SIZE/INCHES			WEIGHT VOL	
	LP	HP	H	W	D	LBS	FT <sup>3</sup>
BRTPSL30	1050	1064	21	30	19	77	6.56
BRTPSL36	1147	1212	21	36	19	84	7.87
BRTPSL42	1264	1329	21	42	19	92	9.18
BRTPSL2330	1396	1417	21	30	24	86	8.39
BRTPSL2336	1529	1617	21	36	24	95	10.06
BRTPSL2342	1691	1775	21	42	24	104	11.74

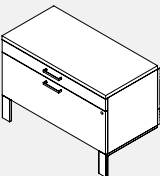
### BRTP25LO-L • Panel Supporting Open Storage



- Fits below Bridges tables, can join with other 25" high, 18" and 23" deep storage units along the panel. Can serve as an additional work-surface or an ad-hoc guest seating with optional cushion.
- Open compartment with glass adjustable glass shelf. Storage compartment internal height without height adjustable glass shelf: 15.8"
- Anodized aluminum leg upcharge \$55.

PRODUCT CODE	PRICE		SIZE/INCHES			WEIGHT VOL	
	LP	HP	H	W	D	LBS	FT <sup>3</sup>
BRTP25LO30L	581	697	25	30	19	49	7.81
BRTP25LO36L	731	797	25	36	19	55	9.37
BRTP25LO42L	797	883	25	42	19	62	10.93
BRTP25LO2330L	778	930	25	30	24	59	10.42
BRTP25LO2336L	975	1064	25	36	24	66	12.50
BRTP25LO2342L	1064	1174	25	42	24	72	14.58

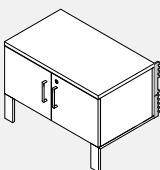
### BRTPLBF • Panel Supporting Lateral Box/File



- Fits below Bridges tables, can join with other 25" high, 18" and 23" deep storage units along the panel.
- One lockable file drawer (holds letter, legal and A4 suspended file folders), one box drawer.
- Anodized aluminum leg upcharge \$55.
- Black injection moulded pencil tray included (can be secured inside the drawer anywhere along the perimeter wall).
- Optional e-lock available in the vertical position. Please specify V-Vertical and add \$224 list.

PRODUCT CODE	PRICE		SIZE/INCHES			WEIGHT VOL	
	LP	HP	H	W	D	LBS	FT <sup>3</sup>
BRTPLBF30	1131	1198	25	30	19	88	7.81
BRTPLBF36	1298	1363	25	36	19	96	9.37
BRTPLBF42	1414	1497	25	42	19	104	10.93
BRTPLBF2330	1586	1664	25	30	24	98	10.42
BRTPLBF2336	1730	1816	25	36	24	107	12.50
BRTPLBF2342	1885	1994	25	42	24	116	14.58

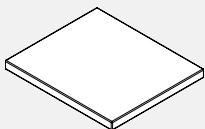
### BRTP25L2D • Panel Supporting Lateral w/hinged doors



- Fits below Bridges tables, can join with other 25" high, 18" or 23" deep storage units along the panel.
- Can serve as an additional worksurface or an ad-hoc guest seating with optional cushion.
- Two lockable doors
- LP chassis and door fronts (specify LP finish)
- 1" top (specify LP or HP finish); metal handles, powder coated aluminum or anodized aluminum legs. Anodized aluminum leg upcharge \$55.

PRODUCT CODE	PRICE		SIZE/INCHES			WEIGHT VOL	
	LP	HP	H	W	D	LBS	FT <sup>3</sup>
BRTP25L2D30	896	984	25	30	19	69	7.81
BRTP25L2D36	969	1069	25	36	19	78	9.38
BRTP25L2D42	1017	1135	25	42	19	90	10.94
BRTP25L2D3024	1027	1142	25	30	24	75	10.42
BRTP25L2D3624	1113	1250	25	36	24	84	12.50
BRTP25L2D4224	1197	1317	25	42	24	96	14.58

### BRTC • Cushion



- Optional seat cushion may be added to any storage component.

PRODUCT CODE	PRICE		SIZE/ INCHES			WEIGHT VOL				
	GR1	GR2	GR3	GR4	GR5	GR6	GR7	GR8	GR9	GR10
BRTC	193	227	252	286	339	384	433	478	524	577
BRTC	644	740	830	925	1132	1338	1547	1753	1959	2190

### Bridges Collaborative Seating

Bridges collaborative seating collection consists of seating, privacy screens, tables, tablets and power. It is a versatile modular furniture series which can be configured into many space planning scenarios including corner, in-line, open concept, traditional reception as well as secluded seating with high privacy partitions.

Furniture pieces can be used as stand alone items or can be mechanically linked together to form a variety of seating configurations.

Seat and backrest can be integrated with Bridges tables, as well as Boulevard panels.

Corner tables and in-line 6" table modules double as power delivery centers.

Dedicated seat backrests feature dual USB charging port.

Some Inline 6" table modules are furnished with grommets to support tablets.

Legs are available in standard Bridges metal painted finishes and anodized aluminum finish.

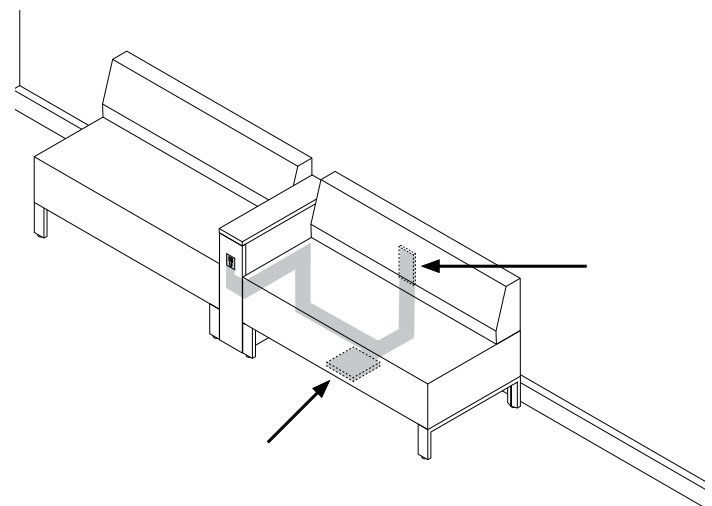
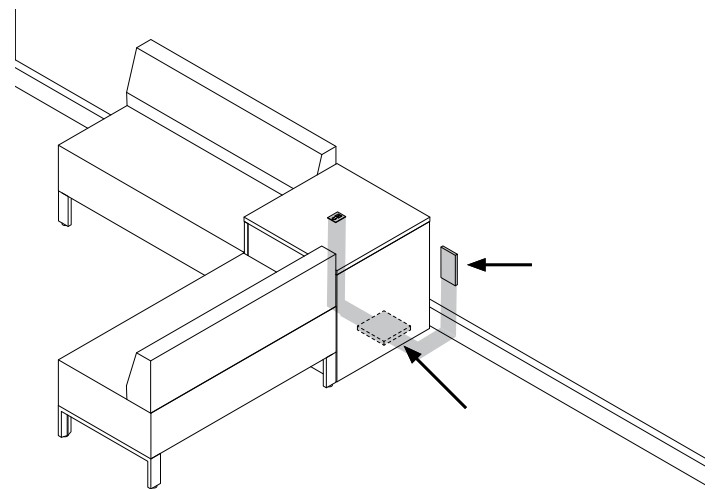
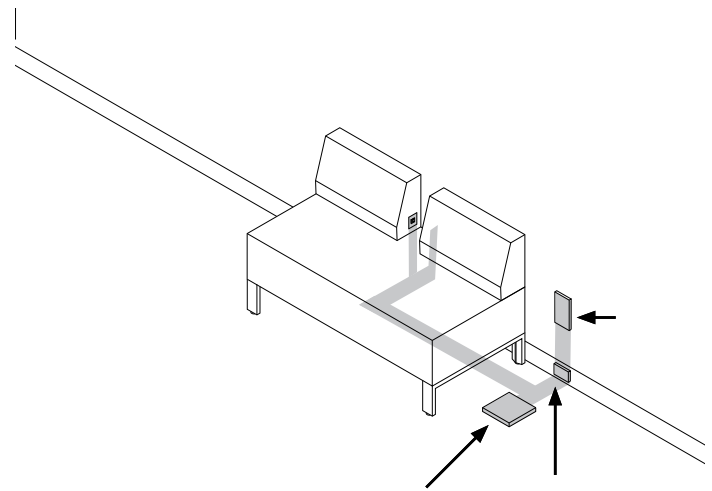
**Bridges Collaborative Seating upholstery** features a single stitch, thick white thread around the edges. The white, wide stitch along with crisp corners are part of its distinctive personality. In order to achieve crisp edges and to minimize "pillow" effect caused by taut fabric, the upholstery material has been applied deliberately loose, which may, over time, produce puckering of the upholstery surface material. This can be easily corrected by stretching the fabric by hand or during vacuuming.

In order to efficiently utilize fabric yield all 60" seats and backs feature a seam in the middle. The double stitch seam is sewn with a thin thread, closely matching the upholstery material in colour.

Some complicated fabric patterns prevent pattern matching and will be upholstered without the seam at the discretion of the factory.

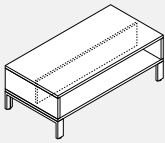
Should you require no middle seam by cutting into the roll, please specify "NO SEAM" at time of your order.

• COM yardage is an estimate only. More accurate yardage will be dependent on the width of the fabric and on the repeat pattern.





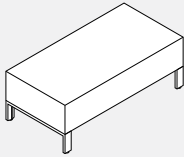
**BRTST24-F • Low Table**



- **Freestanding 17" high tables.**
- Central partition divides space under top surface into two 11" deep compartments. All LP chassis w/ HP or LP top (3mm edging). Bridges storage aluminum leg.
- Specify chassis and top finish, specify metal leg finish. Add \$57 for anodized aluminum leg finish.
- To convert to mobile, please add \$37 list and an "M" at the end of the product code.

PRODUCT CODE	PRICE		SIZE/INCHES			WEIGHT	VOL
	LP	HP	H	W	D	LBS	FT <sup>3</sup>
BRTST2424F	476	553	17	24	24	40.7	5.67
BRTST2448F	672	870	17	48	24	69.0	11.33
BRTST2460F	752	1029	17	60	24	83.6	14.17

**BRTSE-NB • Lounge Seat**



- **Fully upholstered armless lounge seat with metal base.**
- Seats can be freestanding or linked with optional interlocking bracket kit.
- Specify seating fabric and leg finish.
- Add \$57 for anodized aluminum leg finish.

PRODUCT CODE	PRICE	SIZE/INCHES			WEIGHT	VOL	YRDS
		H	W	D	LBS	FT <sup>3</sup>	(COM)
BRTSE24NB	672	17	24	24	22.7	5.57	1.25
BRTSE48NB	1227	17	48	24	36.9	11.33	2.00
BRTSE60NB	1419	17	60	24	47.0	14.17	2.50

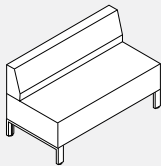
  

PRODUCT CODE	PRICE	GR1	GR2	GR3	GR4	GR5	GR6	GR7	GR8	GR9	GR10
BRTSE24NB	672	718	754	797	864	926	987	1045	1108	1174	
BRTSE48NB	1227	1300	1357	1428	1533	1632	1731	1820	1923	2028	
BRTSE60NB	1419	1511	1583	1670	1803	1927	2050	2164	2291	2423	

PRODUCT CODE	PRICE	GR11	GR12	GR13	GR14	GR15	GR16	GR17	GR18	GR19	GR20
BRTSE24NB	1261	1383	1504	1627	1895	2164	2435	2705	2973	3270	
BRTSE48NB	2168	2364	2559	2750	3185	3613	4046	4478	4907	5382	
BRTSE60NB	2598	2842	3082	3324	3867	4403	4946	5484	6020	6614	

**BRTSE-B • Lounge Seat with Backrest**



- **Fully upholstered armless lounge seat with full backrest and metal base.**
- Backrests are permanently secured to the seats and cannot be reconfigured on site.
- Seats can be freestanding or linked with optional interlocking bracket kit.
- Specify seating fabric and leg finish.
- Add \$57 for anodized aluminum leg finish.

PRODUCT CODE	PRICE	SIZE/INCHES			WEIGHT	VOL	YRDS
		H	W	D	LBS	FT <sup>3</sup>	(COM)
BRTSE2424B	1061	29	24	24	33.0	9.57	2.25
BRTSE4848B	1958	29	48	24	55.5	19.33	3.50
BRTSE6060B	2269	29	60	24	70.0	24.17	4.50

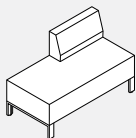
  

PRODUCT CODE	PRICE	GR1	GR2	GR3	GR4	GR5	GR6	GR7	GR8	GR9	GR10
BRTSE2424B	1061	1142	1205	1286	1405	1515	1628	1730	1844	1961	
BRTSE4848B	1958	2086	2187	2309	2494	2667	2841	2998	3179	3364	
BRTSE6060B	2269	2434	2563	2720	2956	3182	3406	3610	3839	4077	

PRODUCT CODE	PRICE	GR11	GR12	GR13	GR14	GR15	GR16	GR17	GR18	GR19	GR20
BRTSE2424B	2118	2341	2559	2775	3262	3742	4232	4716	5197	5735	
BRTSE4848B	3607	3950	4285	4624	5386	6132	6893	7649	8398	9231	
BRTSE6060B	4389	4828	5263	5697	6673	7636	8614	9585	10548	11621	

**BRTSE-BL/R • Lounge Seat, Single 24" Offset Backrest**



Right Hand Shown

- **Fully upholstered armless lounge seat with one backrest and metal base.**
- Specify backrest as either Left or Right side. Backrests are permanently secured to the bench and cannot be reconfigured on site.
- Seats can be freestanding or linked with optional interlocking bracket kit.
- Specify seating fabric and leg finish.
- Add \$57 for anodized aluminum leg finish.

PRODUCT CODE	PRICE	SIZE/INCHES			WEIGHT	VOL	YRDS
		H	W	D	LBS	FT <sup>3</sup>	(COM)
BRTSE2448BL	1615	29	48	24	46.10	19.33	3.00
BRTSE2448BR	1615	29	48	24	46.10	19.33	3.00

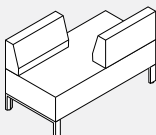
  

PRODUCT CODE	PRICE	GR1	GR2	GR3	GR4	GR5	GR6	GR7	GR8	GR9	GR10
BRTSE2448BL	1615	1722	1810	1914	2072	2221	2370	2505	2659	2817	
BRTSE2448BR	1615	1722	1810	1914	2072	2221	2370	2505	2659	2817	

PRODUCT CODE	PRICE	GR11	GR12	GR13	GR14	GR15	GR16	GR17	GR18	GR19	GR20
BRTSE2448BL	3024	3321	3611	3899	4550	5192	5845	6491	7134	7848	
BRTSE2448BR	3024	3321	3611	3899	4550	5192	5845	6491	7134	7848	

**BRTSE-BODL/R • Lounge Seat, Two 24" Offset Backrest**



Left Hand Shown

- **Fully upholstered armless lounge seat with two offset backrests and metal base.**
- Specify either Left or Right backrest configuration. Backrests are permanently secured to the bench and cannot be reconfigured on site.
- Seats can be freestanding or linked with optional interlocking bracket kit.
- Specify seating fabric and leg finish.
- Add \$57 for anodized aluminum leg finish.

PRODUCT CODE	PRICE	SIZE/INCHES			WEIGHT	VOL	YRDS
		H	W	D	LBS	FT <sup>3</sup>	(COM)
BRTSE2448BODL	2002	29	48	24	46.10	19.33	4.00
BRTSE2448BODR	2002	29	48	24	46.10	19.33	4.00

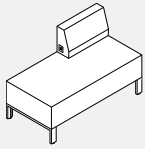
PRODUCT CODE	PRICE	GR1	GR2	GR3	GR4	GR5	GR6	GR7	GR8	GR9	GR10
BRTSE2448BODL	2002	2148	2262	2401	2612	2810	3010	3191	3395	3607	
BRTSE2448BODR	2002	2148	2262	2401	2612	2810	3010	3191	3395	3607	

PRODUCT CODE	PRICE	GR11	GR12	GR13	GR14	GR15	GR16	GR17	GR18	GR19	GR20
BRTSE2448BODL	3884	4276	4663	5048	5915	6773	7640	8504	9360	10311	
BRTSE2448BODR	3884	4276	4663	5048	5915	6773	7640	8504	9360	10311	



**BRTSE-EBL/R • Lounge Seat, Single 21" Wide Backrest with USB**



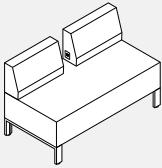
Right Hand Shown

- Fully upholstered armless lounge seat with one backrest and metal base.
- 21" wide backrest come with embedded dual USB port in its side.  
Note: the side mounted power/USB outlets always point to the centre of the seat. Each USB outlet offers 2 amps. AC/DC transformer plugs into the wall or floor monument (approximately 4' long cable available from the bottom of the seat). Transformer power consumption: 0.68 amps.
- Specify either Left or Right backrest configuration. Backrests are permanently secured to the bench and cannot be reconfigured on site.
- Seats can be freestanding or linked with optional interlocking bracket kit.
- White USB outlets.
- Specify seating fabric and leg finish.
- Add \$57 for anodized aluminum leg finish.

PRODUCT CODE	SIZE/INCHES			WEIGHT LBS	VOL FT <sup>3</sup>	YRDS (COM)
	H	W	D			
BRTSE2148EBL	29	48	24	46.10	19.33	3.00
BRTSE2148EBR	29	48	24	46.10	19.33	3.00

PRODUCT CODE	PRICE										
	GRADE	GR1	GR2	GR3	GR4	GR5	GR6	GR7	GR8	GR9	GR10
BRTSE2148EBL	1870	1981	2065	2170	2327	2476	2627	2762	2916	3074	
BRTSE2148EBR	1870	1981	2065	2170	2327	2476	2627	2762	2916	3074	
GRADE	GR11	GR12	GR13	GR14	GR15	GR16	GR17	GR18	GR19	GR20	
BRTSE2148EBL	3283	3578	3866	4156	4806	5449	6099	6745	7388	8103	
BRTSE2148EBR	3283	3578	3866	4156	4806	5449	6099	6745	7388	8103	

**BRTSE-E2B • Lounge Seat, two 21" Wide Backrests with USB**

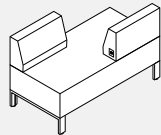


- Fully upholstered armless lounge seat with two backrests, each with dual USB outlet and metal base.
- Both 21" wide backrests come with embedded dual USB port in its side.  
Note: the side mounted power/USB outlets always point to the centre of the seat. Each USB outlet offers 2 amps. AC/DC transformer plugs into the wall or floor monument (about 52" long cable available from the bottom of the seat). Transformer power consumption: 0.68 amps.
- Backrests are permanently secured to the bench and cannot be reconfigured on site.
- Seats can be freestanding or linked with optional interlocking bracket kit.
- Specify seating fabric and leg finish.
- USB outlets are white.
- Add \$57 for anodized aluminum leg finish.

PRODUCT CODE	SIZE/INCHES			WEIGHT LBS	VOL FT <sup>3</sup>	YRDS (COM)
	H	W	D			
BRTSE2148E2B	29	48	24	57.00	19.33	4.00

PRODUCT CODE	PRICE										
	GRADE	GR1	GR2	GR3	GR4	GR5	GR6	GR7	GR8	GR9	GR10
BRTSE2148E2B	2515	2659	2775	2913	3125	3323	3523	3703	3908	4117	
GRADE	GR11	GR12	GR13	GR14	GR15	GR16	GR17	GR18	GR19	GR20	
BRTSE2148E2B	4396	4788	5175	5561	6428	7285	8152	9017	9872	10824	

**BRTSE-EBODL/R • Lounge Seat Two USB backrests Offset**



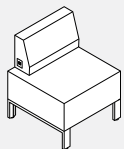
Left Hand Shown

- Fully upholstered armless lounge seat with two offset backrests, each with dual USB outlet and metal base.
- Both 21" wide backrests come with embedded dual USB port in its side.  
Note: the side mounted power/USB outlets always point to the centre of the seat. Each USB outlet offers 2 amps. AC/DC transformer plugs into the wall or floor monument (about 52" long cable available from the bottom of the seat). Transformer power consumption: 0.68 amps.
- Backrests are permanently secured to the bench and cannot be reconfigured on site.
- Seats can be freestanding or linked with optional interlocking bracket kit.
- Specify seating fabric and leg finish.
- USB outlets are white.
- Add \$57 for anodized aluminum leg finish.

PRODUCT CODE	SIZE/INCHES			WEIGHT LBS	VOL FT <sup>3</sup>	YRDS (COM)
	H	W	D			
BRTSE2148EBODL	29	48	24	57.00	19.33	4.00
BRTSE2148EBODR	29	48	24	57.00	19.33	4.00

PRODUCT CODE	PRICE										
	GRADE	GR1	GR2	GR3	GR4	GR5	GR6	GR7	GR8	GR9	GR10
BRTSE2148EBODL	2515	2659	2775	2913	3125	3323	3523	3703	3908	4117	
BRTSE2148EBODR	2515	2659	2775	2913	3125	3323	3523	3703	3908	4117	
GRADE	GR11	GR12	GR13	GR14	GR15	GR16	GR17	GR18	GR19	GR20	
BRTSE2148EBODL	4396	4788	5175	5561	6428	7285	8152	9017	9872	10824	
BRTSE2148EBODR	4396	4788	5175	5561	6428	7285	8152	9017	9872	10824	

**BRTSE-EBL/R • Single Seat, Single 21" Wide Backrest with USB**



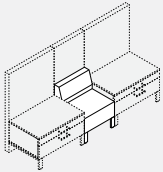
Right Hand Shown

- Fully upholstered armless lounge seat with one backrests, with dual USB outlet and metal base.
- 21" wide backrest come with embedded dual USB port in its side.  
Note: Each USB outlet offers 2 amps. AC/DC transformer plugs into the wall or floor monument (about 52" long cable available from the bottom of the seat). Transformer power consumption: 0.68 amps.
- Backrests are permanently secured to the bench and cannot be reconfigured on site.
- Seats can be freestanding or linked with optional interlocking bracket kit.
- Specify seating fabric and leg finish.
- USB outlets are white.
- Add \$57 for anodized aluminum leg finish.

PRODUCT CODE	SIZE/INCHES			WEIGHT LBS	VOL FT <sup>3</sup>	YRDS (COM)
	H	W	D			
BRTSE2124EBL	29	24	24	33.00	9.67	2.25
BRTSE2124EBR	29	24	24	33.00	9.67	2.25

PRODUCT CODE	PRICE										
	GRADE	GR1	GR2	GR3	GR4	GR5	GR6	GR7	GR8	GR9	GR10
BRTSE2124EBL	1317	1397	1463	1541	1660	1774	1883	1985	2100	2220	
BRTSE2124EBR	1317	1397	1463	1541	1660	1774	1883	1985	2100	2220	
GRADE	GR11	GR12	GR13	GR14	GR15	GR16	GR17	GR18	GR19	GR20	
BRTSE2124EBL	2375	2595	2812	3033	3521	3999	4487	4973	5456	5993	
BRTSE2124EBR	2375	2595	2812	3033	3521	3999	4487	4973	5456	5993	

**BRTSPI • Boulevard Integrated Lounge Seat**

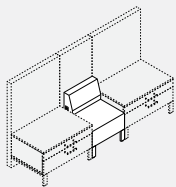


- **Fully upholstered armless lounge seat with full width backrest and special metal legs.**
- The single backrest is permanently secured to the bench and cannot be reconfigured on site.
- The seat brackets connect on-module to panel's vertical slots; **On-module applications only.** The seat width must be equal to panel width. The seat is **NOT** capable of supporting the panel.
- Seats and storage units can be interconnected with shared leg. Special leg support allows access to panel raceway cavity under the seat as well as access to panel-distributed duplex outlets.
- Backrests are permanently secured to the bench and cannot be reconfigured on site.
- Panels and storage units not included.
- Add \$57 for anodized aluminum leg finish.

PRODUCT CODE	SIZE/INCHES			WEIGHT LBS	VOL FT <sup>3</sup>	YRDS (COM)
	H	W	D			
BRTSPI2424	29	24	24	33.00	9.67	2.25
BRTSPI4848	29	48	24	55.50	19.33	3.50
BRTSPI6060	29	60	24	69.00	24.17	4.50

PRODUCT CODE	PRICE											
	GR1	GR2	GR3	GR4	GR5	GR6	GR7	GR8	GR9	GR10	GR11	GR12
BRTSPI2424	1061	1142	1205	1286	1405	1515	1628	1730	1844	1961		
BRTSPI4848	1958	2086	2187	2309	2494	2667	2841	2998	3179	3364		
BRTSPI6060	2269	2434	2563	2720	2956	3182	3406	3610	3839	4077		
GRADE	GR11	GR12	GR13	GR14	GR15	GR16	GR17	GR18	GR19	GR20		
BRTSPI2424	2118	2341	2559	2775	3262	3742	4232	4716	5197	5735		
BRTSPI4848	3607	3950	4285	4624	5386	6132	6893	7649	8398	9231		
BRTSPI6060	4389	4828	5263	5697	6673	7636	8614	9585	10548	11621		

**BRTSPI-L/R • Boulevard integrated Single Seat with USB**



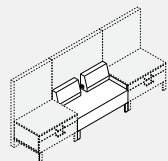
Right Hand Shown

- **Fully upholstered armless lounge seat with 21" wide backrest with dual USB outlets and special metal legs.**
- The single backrest is permanently secured to the bench and cannot be reconfigured on site.
- The seat brackets connect on-module to panel's vertical slots; **On-module applications only.** The seat width must be equal to panel width. The seat is **NOT** capable of supporting the panel.
- Seats and storage units can be interconnected with shared leg. Special leg support allows access to panel raceway cavity under the seat as well as access to panel-distributed duplex outlets.
- Note: Each USB outlet offers 2 amps. AC/DC transformer plugs into the wall or floor monument (about 52" long cable available from the bottom of the seat). Transformer power consumption:0.68 amps.
- Panels and storage units not included.
- USB outlets are white.
- Specify seating fabric and leg finish. Add \$57 for anodized aluminum leg finish.

PRODUCT CODE	SIZE/INCHES			WEIGHT LBS	VOL FT <sup>3</sup>	YRDS (COM)
	H	W	D			
BRTSPI2124L	29	24	24	33.00	9.67	2.25
BRTSPI2124R	29	24	24	55.50	19.33	2.25

PRODUCT CODE	PRICE											
	GR1	GR2	GR3	GR4	GR5	GR6	GR7	GR8	GR9	GR10	GR11	GR12
BRTSPI2124L	1317	1397	1463	1541	1660	1774	1883	1985	2100	2220		
BRTSPI2124R	1317	1397	1463	1541	1660	1774	1883	1985	2100	2220		
GRADE	GR11	GR12	GR13	GR14	GR15	GR16	GR17	GR18	GR19	GR20		
BRTSPI2124L	2375	2595	2812	3033	3521	3999	4487	4973	5456	5993		
BRTSPI2124R	2375	2595	2812	3033	3521	3999	4487	4973	5456	5993		

**BRTSPI-B2 • Boulevard integrated Lounge Seat Two 21" Backrests with USB**

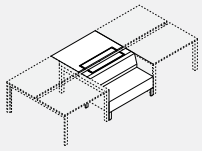


- **Fully upholstered armless lounge seat with 21" wide backrest with dual USB outlets and special metal legs.**
- The single backrest is permanently secured to the bench and cannot be reconfigured on site.
- The seat brackets connect on-module to panel's vertical slots; **On-module applications only.** The seat width must be equal to panel width. The seat is **NOT** capable of supporting the panel.
- Seats and storage units can be interconnected with shared leg. Special leg support allows access to panel raceway cavity under the seat as well as access to panel-distributed duplex outlets.
- Note: Each USB outlet offers 2 amps. AC/DC transformer plugs into the wall or floor monument (about 52" long cable available from the bottom of the seat). Transformer power consumption:0.68 amps.
- Panels and storage units not included.
- USB outlets are white.
- Specify seating fabric and leg finish. Add \$57 for anodized aluminum leg finish.

PRODUCT CODE	SIZE/INCHES			WEIGHT LBS	VOL FT <sup>3</sup>	YRDS (COM)
	H	W	D			
BRTSPI2148B2	29	48	24	33.00	9.67	4.00

PRODUCT CODE	PRICE											
	GR1	GR2	GR3	GR4	GR5	GR6	GR7	GR8	GR9	GR10	GR11	GR12
BRTSPI2148B2	2515	2659	2775	2913	3125	3323	3523	3703	3908	4117		
GRADE	GR11	GR12	GR13	GR14	GR15	GR16	GR17	GR18	GR19	GR20		
BRTSPI2148B2	4396	4788	5175	5561	6428	7285	8152	9017	9872	10824		

**BRTSINT-S • Bridges Integrated Lounge Seat Single Sided**



- Fully upholstered armless lounge seat with full width backrest and metal legs
- Integrated into Bridges 62.5" deep Back 2 Back linear table assembly.
- The Single-sided kit consists of 24"x48" or 24"x60" seat, full width back, three-sided below work surface enclosure, 6" deep work surface module with access door, 30"x48" or 30"x60" wide work surface with access door and supporting hardware.

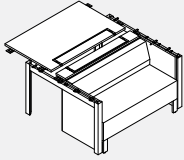
PRODUCT CODE	SIZE/INCHES			WEIGHT LBS	VOL FT <sup>3</sup>	YRDS (COM)
	H	W	D			
BRTSINT48S	29	48	24	126.00	19.33	3.50
BRTSINT60S	29	60	24	155.00	24.17	4.50

- **Note: Only compatible with Back 2 Back 30" deep work surfaces (62.5" total depth) supported by Bridges rectangular legs.**

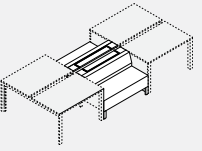
PRODUCT CODE	PRICE											
	GRADE	GR1	GR2	GR3	GR4	GR5	GR6	GR7	GR8	GR9	GR10	
BRTSINT48SLP	4289	4364	4420	4489	4593	4695	4795	4885	4986	5091		
BRTSINT60SLP	4484	4574	4646	4734	4864	4992	5114	5227	5356	5488		
BRTSINT48SHP	4518	4589	4646	4715	4822	4919	5021	5112	5215	5320		
BRTSINT60SHP	4710	4800	4874	4960	5090	5218	5340	5454	5581	5714		
GRADE	GR11	GR12	GR13	GR14	GR15	GR16	GR17	GR18	GR19	GR20		
BRTSINT48SLP	5232	5428	5620	5812	6247	6674	7111	7543	7969	8445		
BRTSINT60SLP	5663	5906	6148	6388	6931	7466	8009	8549	9084	9678		
BRTSINT48SHP	5458	5654	5847	6039	6473	6902	7337	7768	8195	8674		
BRTSINT60SHP	5887	6131	6372	6613	7155	7692	8235	8776	9309	9906		

- **Connecting Back 2 Back table beams, legs and worksurface need to be specified separately.**

- Not compatible with Bridges round legs, 24" deep work surfaces; not compatible with single line table assemblies 24" and 30" deep. The kit cannot be used at the end of a table run, nor can it be used as a standalone, freestanding configuration. It must always be supported by Back 2 Back Bridges table assemblies on either side.
- Note: the seat module accommodates continuation of power and data distribution services below work surfaces (specify Below Work surface Power Troughs and power components separately).
- The 6" deep work surface module with access door provides access to Below Work Surface Power Trough.
- Backrests are permanently secured to the bench and cannot be reconfigured on site.
- Tables not included.
- Specify seating fabric and leg finish. Add \$55 for anodized aluminum leg finish



**BRTSINT-D • Bridges Integrated Lounge Double Sided**



- Fully upholstered armless lounge bench with backrests and metal legs integrated into Bridges 62.5" deep Back 2 Back linear table assembly.
- The Double-sided kit consists of two 24"x48" or 24"x60" seats, full width backs, three-sided below work surface enclosures, 6" deep work surface modules with access doors and supporting hardware.

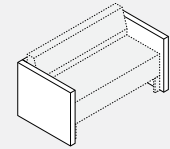
PRODUCT CODE	SIZE/INCHES			WEIGHT LBS	VOL FT <sup>3</sup>	YRDS (COM)
	H	W	D			
BRTSINT48D	29	48	24	182.00	19.33	3.50
BRTSINT60D	29	60	24	220.00	24.17	4.50

- Note: Only compatible with Back 2 Back 30" deep work surfaces (62.5" total depth) supported by Bridges rectangular legs. Not compatible with Bridges round legs, 24" deep work surfaces; not compatible with single line table assemblies 24" and 30" deep.

PRODUCT CODE	PRICE											
	GRADE	GR1	GR2	GR3	GR4	GR5	GR6	GR7	GR8	GR9	GR10	
BRTSINT48DLP	5275	5526	5731	5973	6341	6692	7037	7353	7715	8084		
BRTSINT60DLP	5899	6222	6483	6797	7271	7719	8166	8573	9034	9509		
BRTSINT48DHP	5499	5754	5955	6200	6568	6915	7263	7581	7938	8309		
BRTSINT60DHP	6124	6451	6709	7023	7496	7945	8390	8798	9259	9737		
GRADE	GR11	GR12	GR13	GR14	GR15	GR16	GR17	GR18	GR19	GR20		
BRTSINT48DLP	8569	9255	9928	10605	12124	13622	15143	16653	18152	19818		
BRTSINT60DLP	10133	11015	11884	12752	14705	16632	18585	20528	22455	24599		
BRTSINT48DHP	8795	9479	10155	10830	12350	13847	15370	16881	18379	20045		
BRTSINT60DHP	10362	11240	12110	12977	14932	16858	18812	20753	22681	24823		

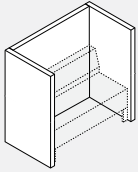
- The kit cannot be used at the end of a table run nor as a standalone, freestanding configuration. It must always be supported by Back 2 Back Bridges table assemblies on either side.
- Note: the seat module accommodates continuation of power and data distribution services below work surfaces (specify Below Work Surface Power Troughs and power components separately).
- The 6" deep work surface module with access door provides access to Below Work Surface Power Trough.
- Backrests are permanently secured to the bench and cannot be reconfigured on site.
- Tables not included.
- Specify seating fabric, LP laminate finish (enclosure), work surface and leg finish.
- Specify seating fabric and leg finish. Add \$57 for anodized aluminum leg finish.

**BRTPP-L1 • Seat Partitions**



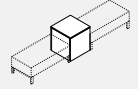
- Fully upholstered, 2.5" thick, 3-part, low level partition kit wraps around 24" or 48" bridges seat.
- The seat front is recessed by 2.5". The kit is secured to seats on-site (brackets connecting seat legs to the inner side of the partition are included).
- Upholsterd kits consist of 2" hollow core boards, 1/4 foam, fabric, levelers and connecting hardware. Specify panel fabric finish.
- Note: Seats and backrests are not included.

PRODUCT CODE	PRICE		SIZE/INCHES			WEIGHT LBS	VOL FT <sup>3</sup>	YRDS (COM)
	GR1	GR2	H	W	D			
BRTPP2424L1	1131	1243	25	29	28.7	32.00	12.04	2.50
BRTPP2448L1	1508	1664	25	53	28.7	41.00	22.01	3.25

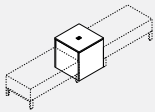
**BRTPP-L2 • Seat Privacy Partitions**

- Fully upholstered, 2.5" thick, 3-part, Two tier partition kit wraps around 24" or 48" bridges seat. The 50" high assembly provides seated visual privacy.
- 2.5" thick, upholstered partitions improve acoustic privacy for focused time away from the team or for a quiet phone call. Recessed seat extends the partition at the front by 2.5" for enhanced sense of privacy.
- The kit is secured to seats on-site (brackets connecting seat legs to the inner side of the partition are included).
- Upholstered kits consist of 2" hollow core boards, 1/4" foam, fabric, levelers and connecting hardware. Specify panel fabric finish.
- Note: Seats and backrests are not included.

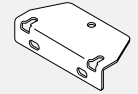
PRODUCT CODE	PRICE		SIZE/INCHES			WEIGHT		VOL		YRDS (COM)
	GR1	GR2	H	W	D	LBS	FT <sup>3</sup>			
BRTPP2424L2	1658	1885	50	29	28.7	38.00	24.08	5.00		
BRTPP2448L2	2187	2413	50	53	28.7	48.00	44.01	6.50		

**BRTS-B • Square Table Block**

- Freestanding 25" high, 24" square table block serves as a visual anchor whenever bridges seat needs to turn corner, or split into two, three or four directions.
- BRTS2424BP can be positioned directly over a floor monument, which will supply power to the top-mounted Power module. This option includes 24"x24" block chassis and flush-mounted Duo power module included (two outlets and two 2.1 amp USB ports, white face plate, outlets and bezel, 72" long three prong black cord).
- The square table block can function as a self-supporting, freestanding unit or it can be secured permanently to adjacent Bridges seats with optional interconnecting brackets listed below.
- Specify LP laminate chassis, 1" LP or HP laminate surface.
- 2 Square Table Ganging Brackets Kits included.
- Powered Square Table Block has optional side panel grommet as needed. Please specify GRMTRS for right side and GRMTLS for left side.



PRODUCT CODE	PRICE		SIZE/INCHES			WEIGHT		VOL	
	LP	HP	H	W	D	LBS	FT <sup>3</sup>		
BRTS2424B	527	604	25	24	24	57.00	8.33		
BRTS2424BP	1056	1131	25	24	24	59.30	8.33		

**BRTSTBG • Square Table Block Ganging Bracket Kit**

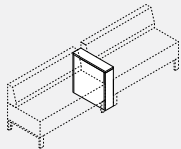
- Two Square Table Block Ganging Brackets connect seat legs permanently to the side of the 24" square table block on site. The kit employs machine screws connecting legs to seats and ships with wood screws which provide permanent connection to the Square Table Block.
- Includes 2 brackets and screws; Black powdercoat finish.

PRODUCT CODE	PRICE	SIZE/INCHES		WEIGHT		VOL	
		H	W	D	LBS	FT <sup>3</sup>	
BRTSTBG	37	1.1	5	2.4	0.50	0.01	

**BRTSTSB • Ganging Bracket Kit**

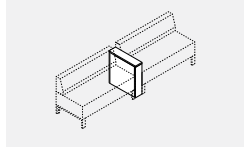
- Two ganging brackets connect seat temporarily to adjacent in-line seat or 24" deep bridges storage.
- Black powder coat finish.

PRODUCT CODE	PRICE	SIZE/INCHES		WEIGHT		VOL	
		H	W	D	LBS	FT <sup>3</sup>	
BRTSTSB	18	.1	6	1.3	0.3	0.00	

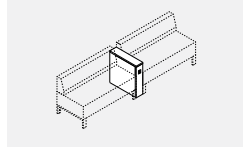
**BRTS-Bx • Inline 6" Block**

- Multifunctional In-line 6" table block divides seating areas, serves as a utility surface, can support tablet arms, lamps and double as a power delivery centre.
- It is permanently secured between two Bridges seats and cannot be placed at the end of a run. Two Square Table Block Ganging Brackets BRTSTBG connect seat legs permanently to the side of the in-line table block on site. The included kit employs machine screws connecting legs to seats and ships with wood screws which provide permanent connection to the Inline 6" Block. Black powder coat finish.
- The chassis is available without Power Module, with one Power Module or with two vertically embedded Power Modules.
- Vertical-panel flush-mounted Duo module provides two outlets and two 2.1 amp USB ports; 72" cord exits through the bottom and plugs into a floor monument under seats, white face plate and bezel.
- BRTS2406BT and BRTS2406BPT include 9.5" x 14.5" swivel tablet.
- Specify LP laminate chassis, 1" LP or HP laminate surface. If top is specified in LP the tablet will be manufactured in LP as well. If top is specified in HP the tablet will be manufactured in HP.
- 2 Square Table Ganging Bracket Kits included.

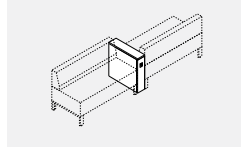
PRODUCT CODE	PRICE		SIZE/INCHES			WEIGHT		VOL	
	LP	HP	H	W	D	LBS	FT <sup>3</sup>		
BRTS2406B	452	488	25	6	24	21.00	2.08		
BRTS2406BP	982	1018	25	6	24	23.30	2.08		
BRTS2406B2P	1508	1545	25	6	24	24.30	2.08		
BRTS2406BT	867	905	25	6	24	25.60	2.08		
BRTS2406BPT	1395	1434	25	6	24	24.30	2.08		

**BRTS2406B**

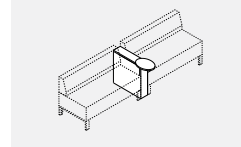
Inline table (without power module and swivel arm).

**BRTS2406BP**

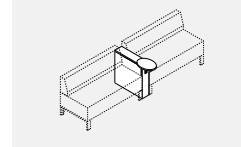
Inline table with front power module

**BRTS2406B2P**

Inline table with front and rear power module.

**BRTS2406BT**

Inline table with swivel tablet arm.

**BRTS2406BPT**

Inline table with front power module and swivel tablet arm.

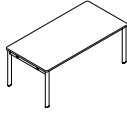
## Statement of Line

### Tables - Work Height Tables



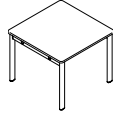
**SCTWDxxxx**

Core Collaboration Table  
Small Radius  
Corner Levelers



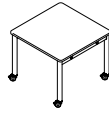
**SCTWSLxxxx**

Standard Collaboration Table  
Small Radius  
Corner Levelers



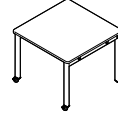
**SCTSWSLxxxx**

Workshop Table  
Small Radius  
Corners Levelers



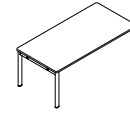
**SCTSWSCxxxx**

Workshop Table  
Small Radius  
Corners Casters



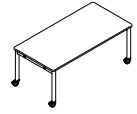
**SCTSWSXxxxx**

Workshop Table  
Small Radius  
Corners Levelers/Casters



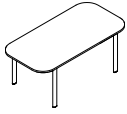
**SCTLWSLxxxx**

Large Collaboration Table  
Small Radius  
Corners Levelers



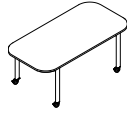
**SCTLWSCxxxx**

Large Collaboration Table  
Small Radius  
Corners Casters



**SCTLWLLxxxx**

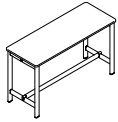
Large Collaboration Table  
Large Radius  
Corners Levelers



**SCTLWLCxxxx**

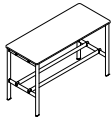
Large Collaboration Table  
Large Radius  
Corners Casters

### Tables - Cafe Height Tables



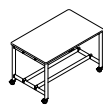
**SCTCSLxxxx**

Standard Collaboration Table  
Small Radius  
Corner Levelers



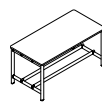
**SCTSCSLxxxx**

Workshop Table  
Small Radius  
Corners Levelers



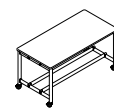
**SCTSCSCxxxx**

Workshop Table  
Small Radius  
Corners Casters



**SCTLCSLxxxx**

Large Collaboration Table  
Small Radius  
Corners Levelers



**SCTLCSCxxxx**

Large Collaboration Table  
Small Radius  
Corners Casters



**SCTLCLLxxxx**

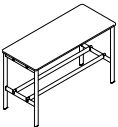
Large Collaboration Table  
Large Radius  
Corners Levelers



**SCTLCLCxxxx**

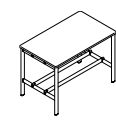
Large Collaboration Table  
Large Radius  
Corners Casters

### Tables - Bar Height Tables



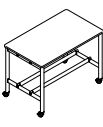
**SCTBSLxxxx**

Standard Collaboration Table  
Small Radius  
Corner Levelers



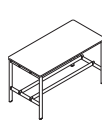
**SCTBSLxxxx**

Workshop Table  
Small Radius  
Corners Levelers



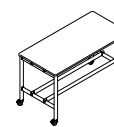
**SCTBSCLxxxx**

Workshop Table  
Small Radius  
Corners Casters



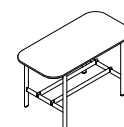
**SCTLBSLxxxx**

Large Collaboration Table  
Small Radius  
Corners Levelers



**SCTLBSCxxxx**

Large Collaboration Table  
Small Radius  
Corners Casters



**SCTLBLLxxxx**

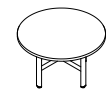
Large Collaboration Table  
Large Radius  
Corners Levelers



**SCTLBLCxxxx**

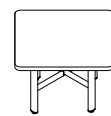
Large Collaboration Table  
Large Radius  
Corners Casters

### Tables - Occasional, Coffee Tables (17"H)



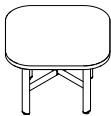
**SCOCRxxxx**

Coffee Table  
Round Top



**SCOCSxxxx**

Coffee Table  
Square Top  
Small Radius Corner



**SCOCSLxxxx**

Coffee Table  
Square Top  
Large Radius Corner



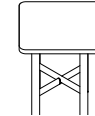
**SCOCCxxxx**

Coffee Table  
Racetrack Top



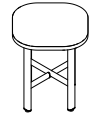
**SCORxxxx**

Side Table  
Round Top



**SCOCxxxx**

Side Table  
Square Top  
Small Radius Corner



**SCOCLxxxx**

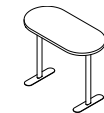
Side Table  
Square Top  
Large Radius Corner

### Tables - Laptop Tables



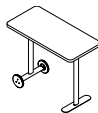
**SCLCCxxxx**

Laptop Table  
Racetrack Top  
Wheel + Foot Base



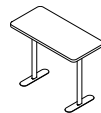
**SCLCBxxxx**

Laptop Table  
Racetrack Top  
Foot Base



**SCLTCxxxx**

Laptop Table  
Rectangular Top  
Wheel + Foot Base



**SCLTBxxxx**

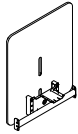
Laptop Table  
Rectangular Top  
Foot Base

### Tables - Laptop Tables

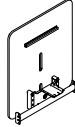


## Statement of Line

### Table - Accessories



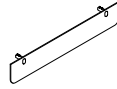
**SCTAMxx**  
Collaboration Table  
Media Unit



**SCTAMTxx**  
Collaboration Table  
Media Unit with TV Mount



**SCTALxx**  
Table Leg  
Cable Organizer



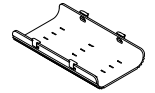
**SCTAPxx**  
PET Felt  
Modesty Panel



**SCTATxxxx**  
Wire Mesh  
Storage Tray



**SCTAH**  
Table Mounted  
Bag Hook



**SCTACT**  
PET Felt Wire  
Manager

### Table Power - Accessories



**SCTAPExx**  
Nik Edge/Clamp  
Power Module



**SCTAPsx**  
Nik In-Surface  
Power Module



**SCTAPBx**  
Nik Below Surface  
Power Module



**SCTAPPBx**  
Below Surface  
Power Bar



**SCAPTx**  
Collaborative  
Spaces Power Tray

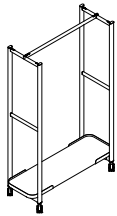


**SCTAOTx**  
Collaborative Spaces  
Organizer Tray

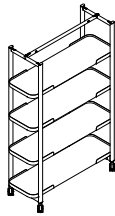


**SCTAPRx**  
Collaborative Spaces  
Recessed Power Tray

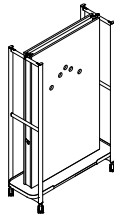
### Team - Carts



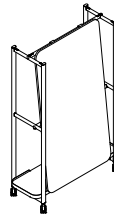
**SCRRxx**  
Coat Rack  
Cart



**SCSSxxxx**  
Shelf Cart



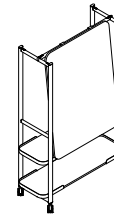
**SCCMxxxxxx**  
Media Cart



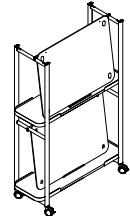
**SCCSWxxxx**  
Single Sided  
Writeboard Cart



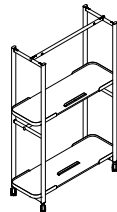
**SCCDWxxxx**  
Double Sided  
Writeboard Cart



**SCCCWxxxx**  
Combo Writeboard Cart



**SCCRWxxxx**  
Removable Writeboard Cart

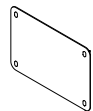


**SCCEWxxxx**  
Empty Removeable  
Writeboard Cart

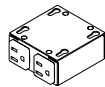


**SCHCxxxx**  
Hospitality Cart

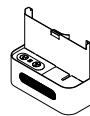
### Team Cart - Accessories



**SCCAPPxxxx**  
Cart Mounted PET Privacy  
Panel



**SCCAMP**  
Concealed Power  
Unit  
(for Media Cart)



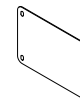
**SCCAMTxx**  
Media Tray  
(for Media Cart)



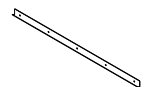
**SCCAC**  
Accessory Cup



**SCCAH**  
Accessory Hook



**SCCAWBxxxx**  
Writeboard



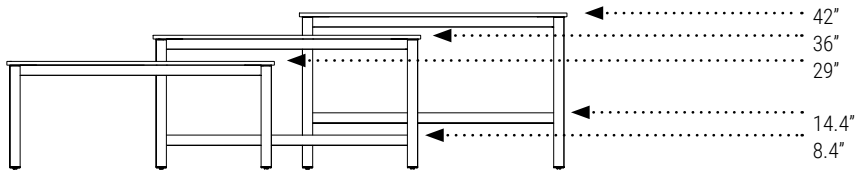
**SCCAWBRxx**  
Writeboard  
Wall Rail



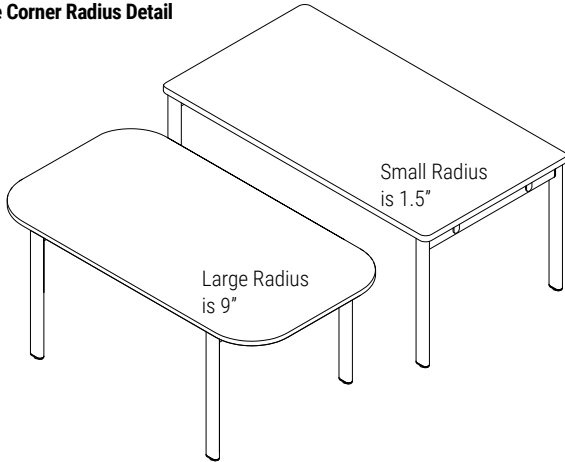
**SCCALSxxxx**  
Laptop Shelf

**Information**

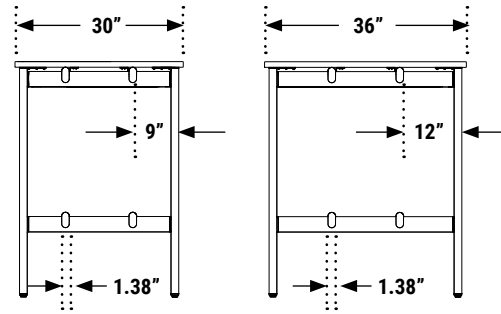
**Three table heights**



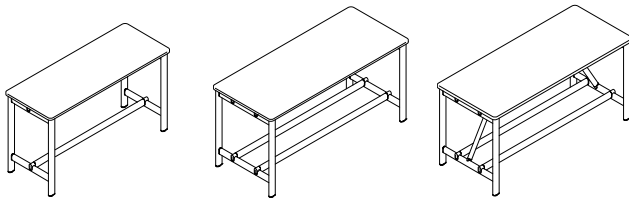
**Table Corner Radius Detail**



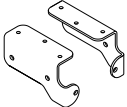

**Table End Leg Detail**



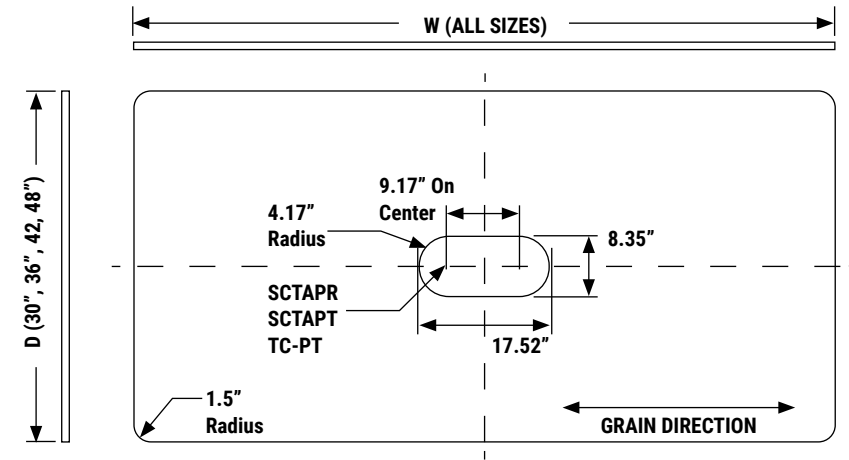
**Support Beam Detail**



**Beam Support**

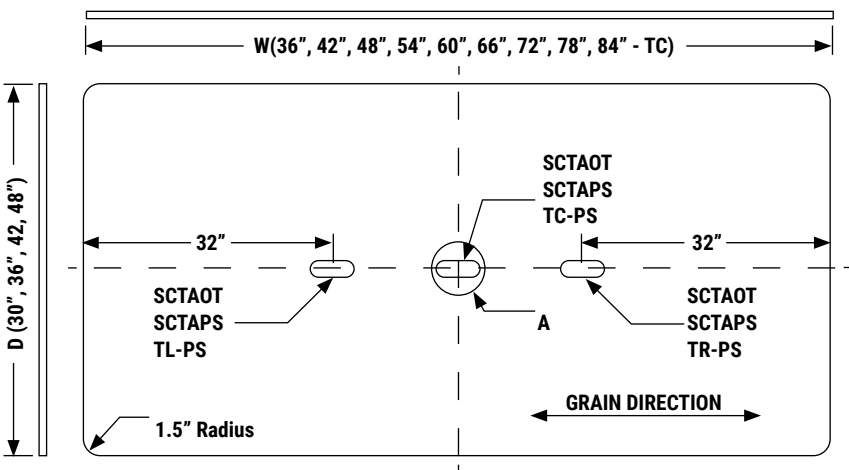
WIDTH RANGE	DEPTH RANGE	HEIGHT RANGE	BEAM SUPPORT - Y/N 	STANCHION - Y/N 
36", 42"	18" to 48" (ALL)	WORK, CAFÉ, BAR	NO	NO
48" to 72"	18" to 48"	WORK, CAFÉ, BAR	YES	NO
78" to 96"	30" to 48"	WORK	YES	NO
78" to 96"	30" to 48"	CAFÉ, BAR (Small Radius)	YES	YES

**Grommet Locations**



**NOTES:**

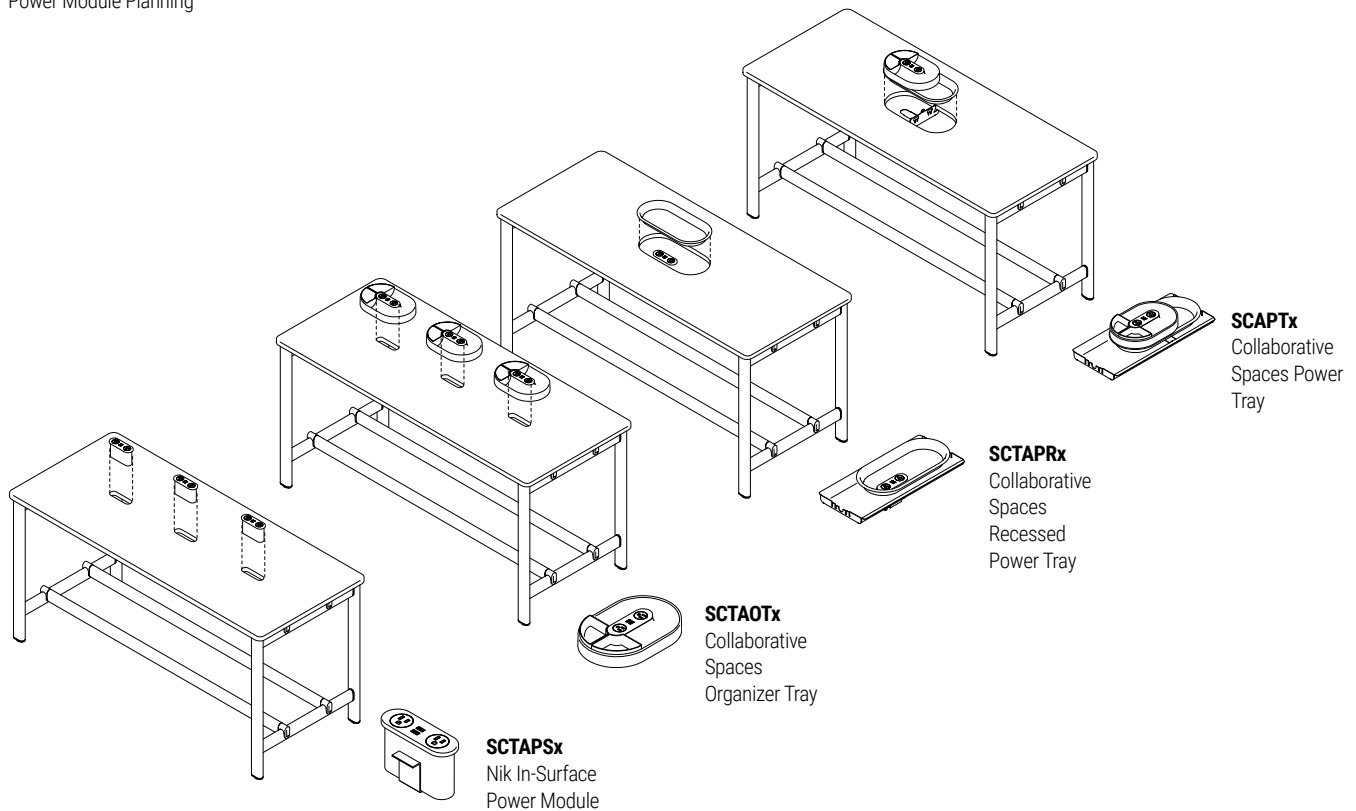
1. Cutout not available for 18" and 24" Deep Tables.
2. Cutout Position TC available only.
3. These rules apply to both Small and Large Radius Table Tops. Small Radius Top Shown.



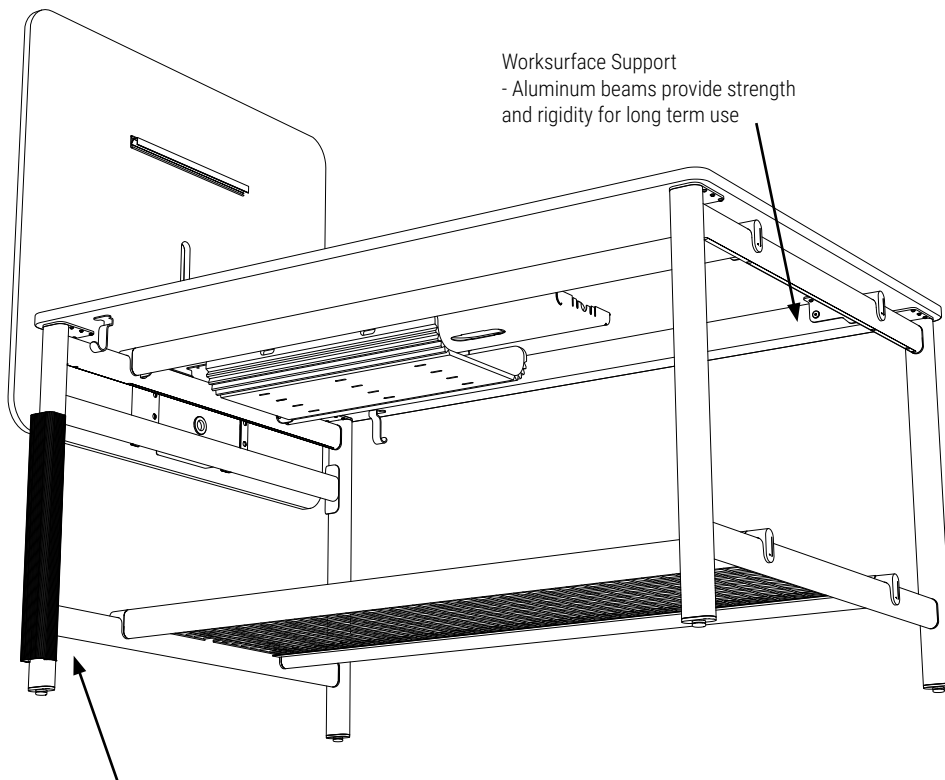
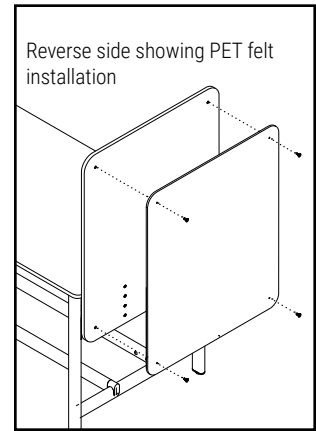
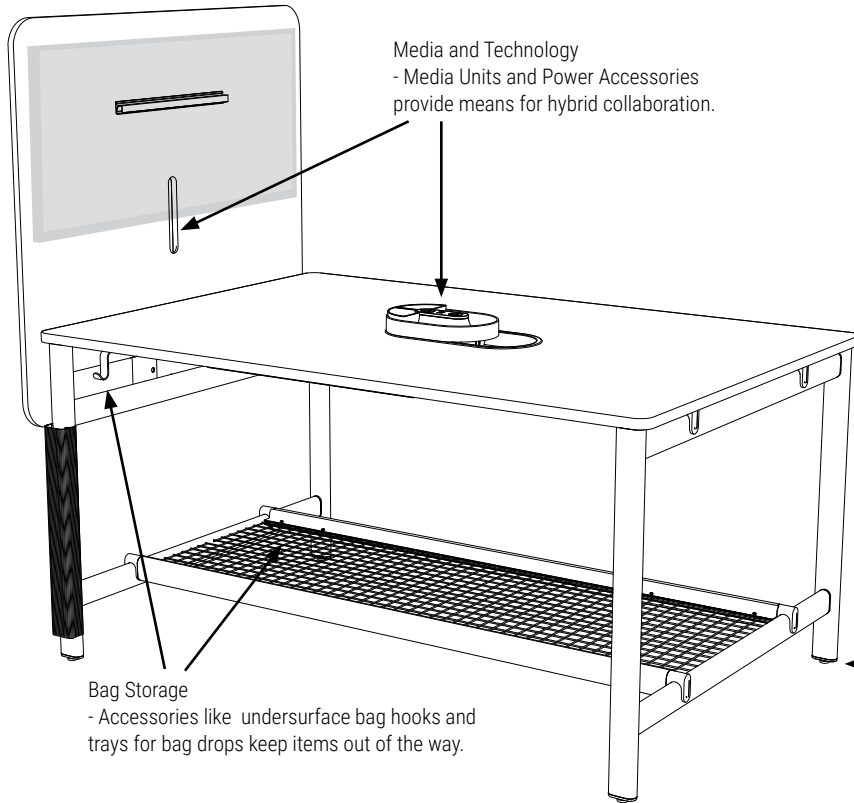
**NOTES:**

1. Cutout not available for 18" and 24" Deep Tables.
2. SCTAOT/SCTAPS/TL TR Available only for 90" & 96" WIDE TABLES.
3. These rules apply to both Small and Large Radius Table Tops. Small Radius Top Shown.

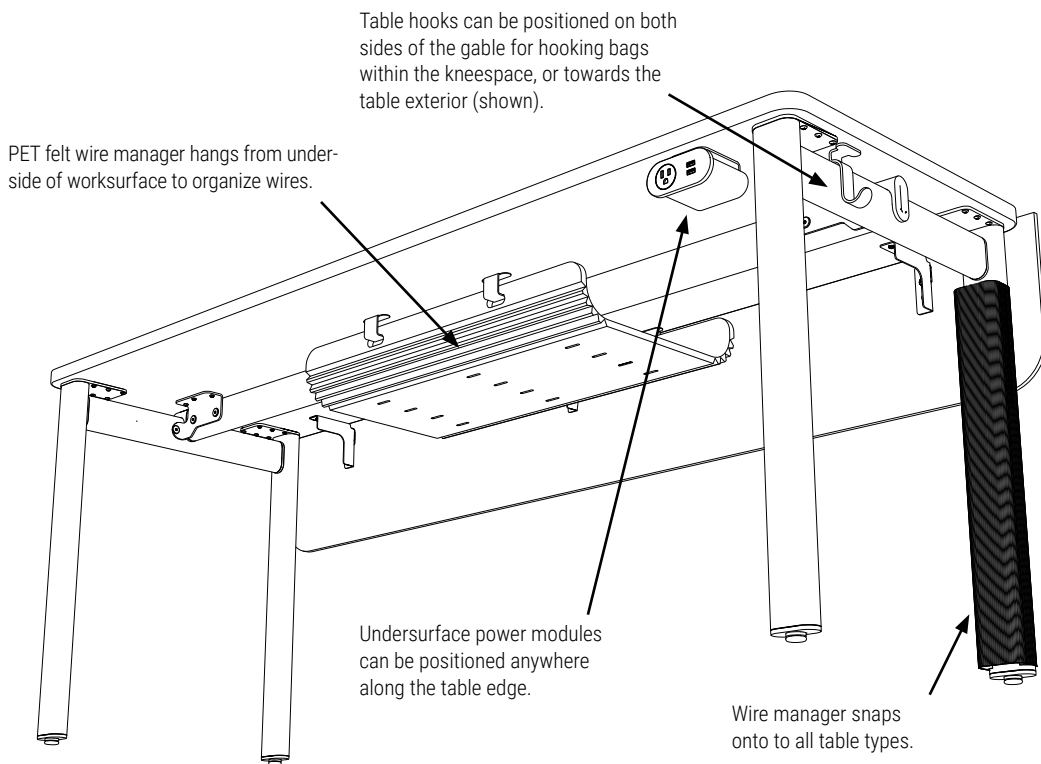
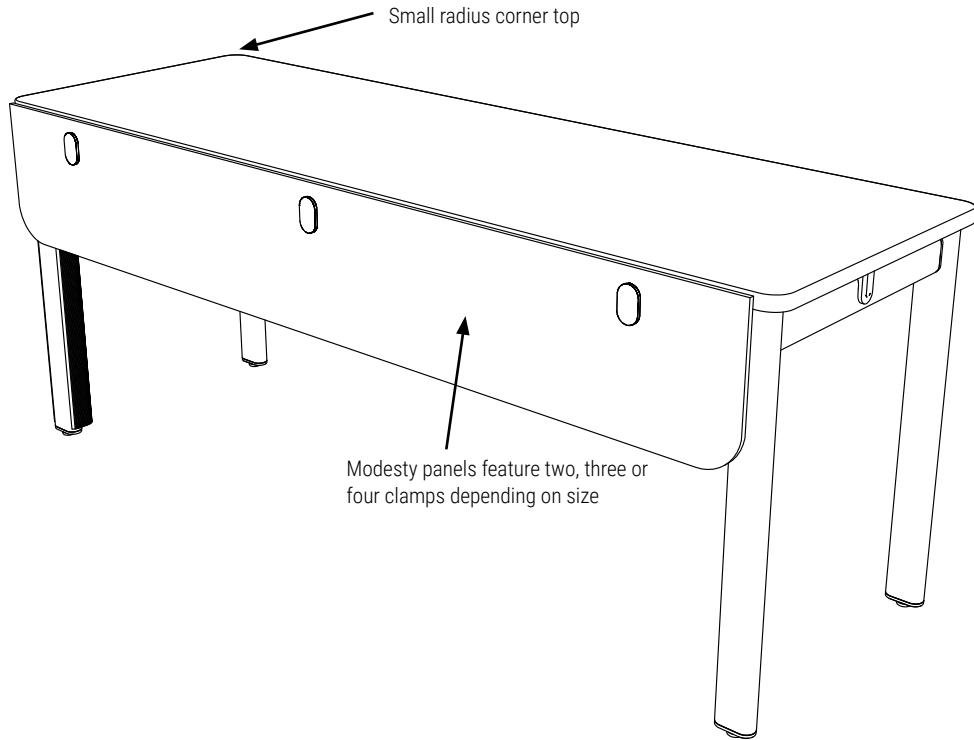
Power Module Planning



## Planning

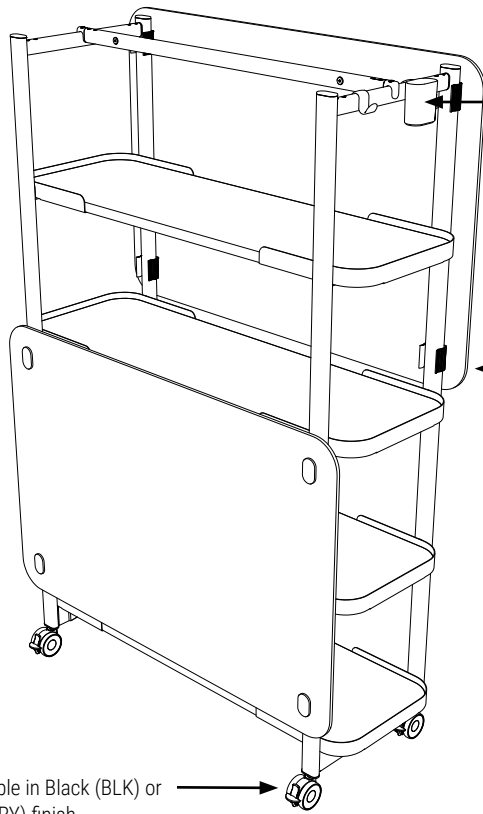


Planning





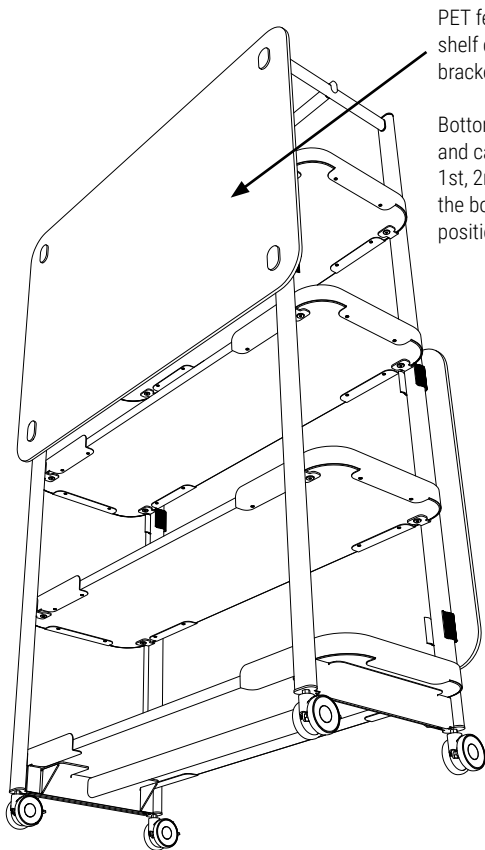
## Planning



Accessorize  
- Small side rails accept hooks and accessory cups

Privacy  
- PET Felt screens provide privacy and some acoustic properties while dividing space.

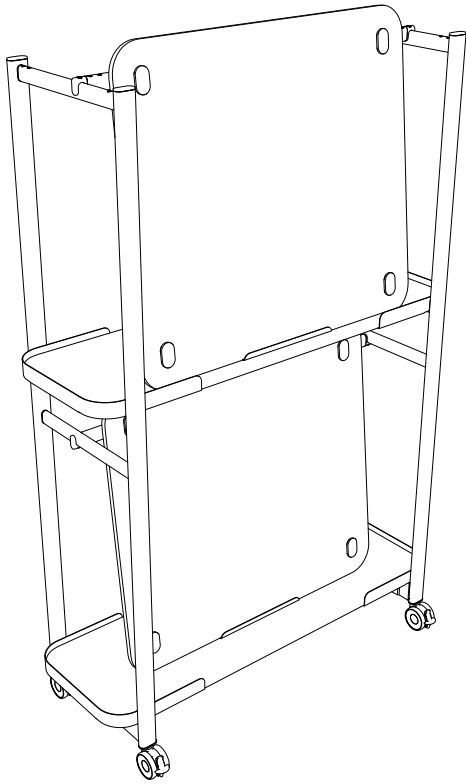
Casters  
- Available in Black (BLK) or Grey (GRY) finish



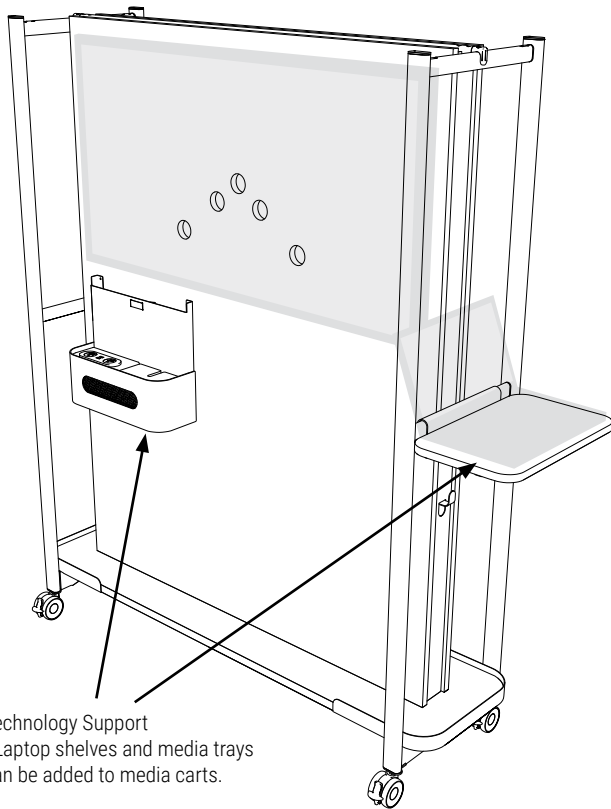
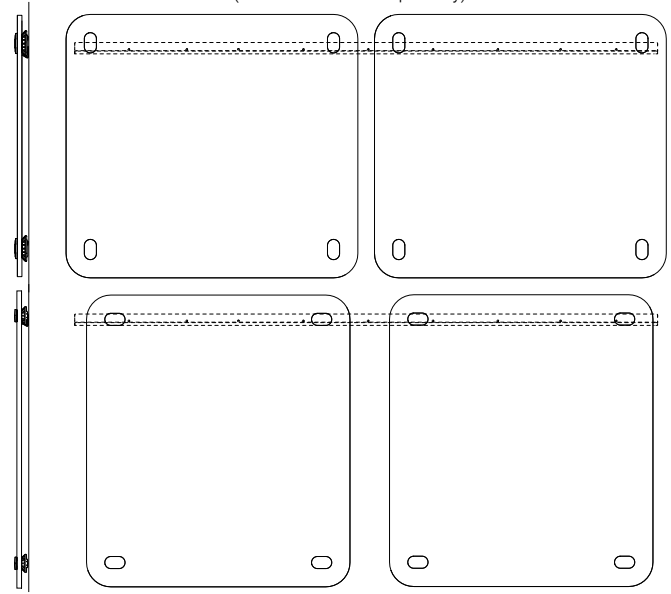
PET felt screens clip onto shelf carts with included brackets.

Bottom clip rests on shelves and can be placed at the 1st, 2nd or 3rd shelf from the bottom (1st and 3rd position shown).

Planning

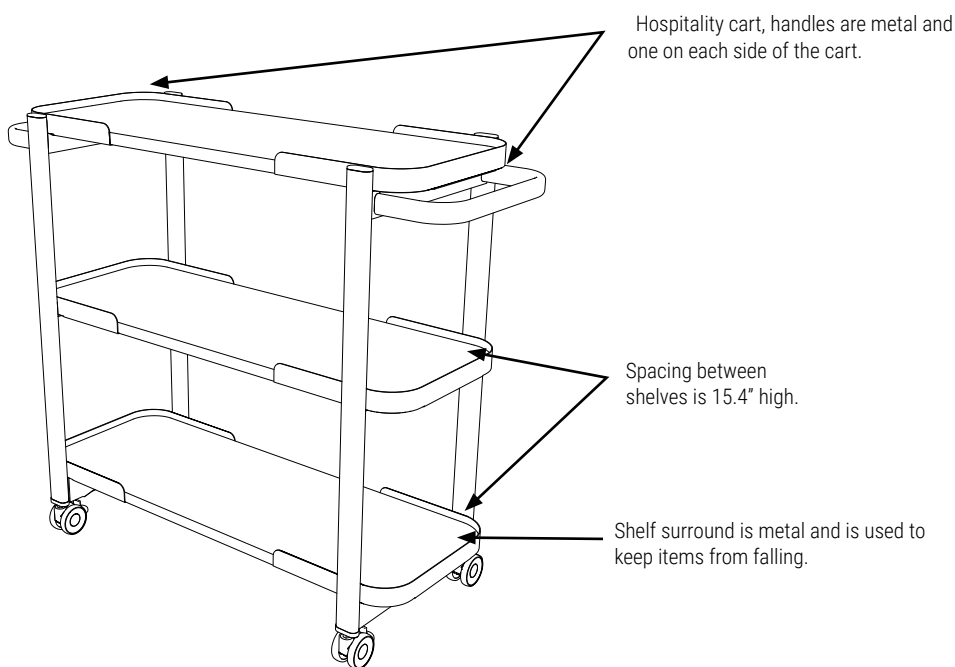
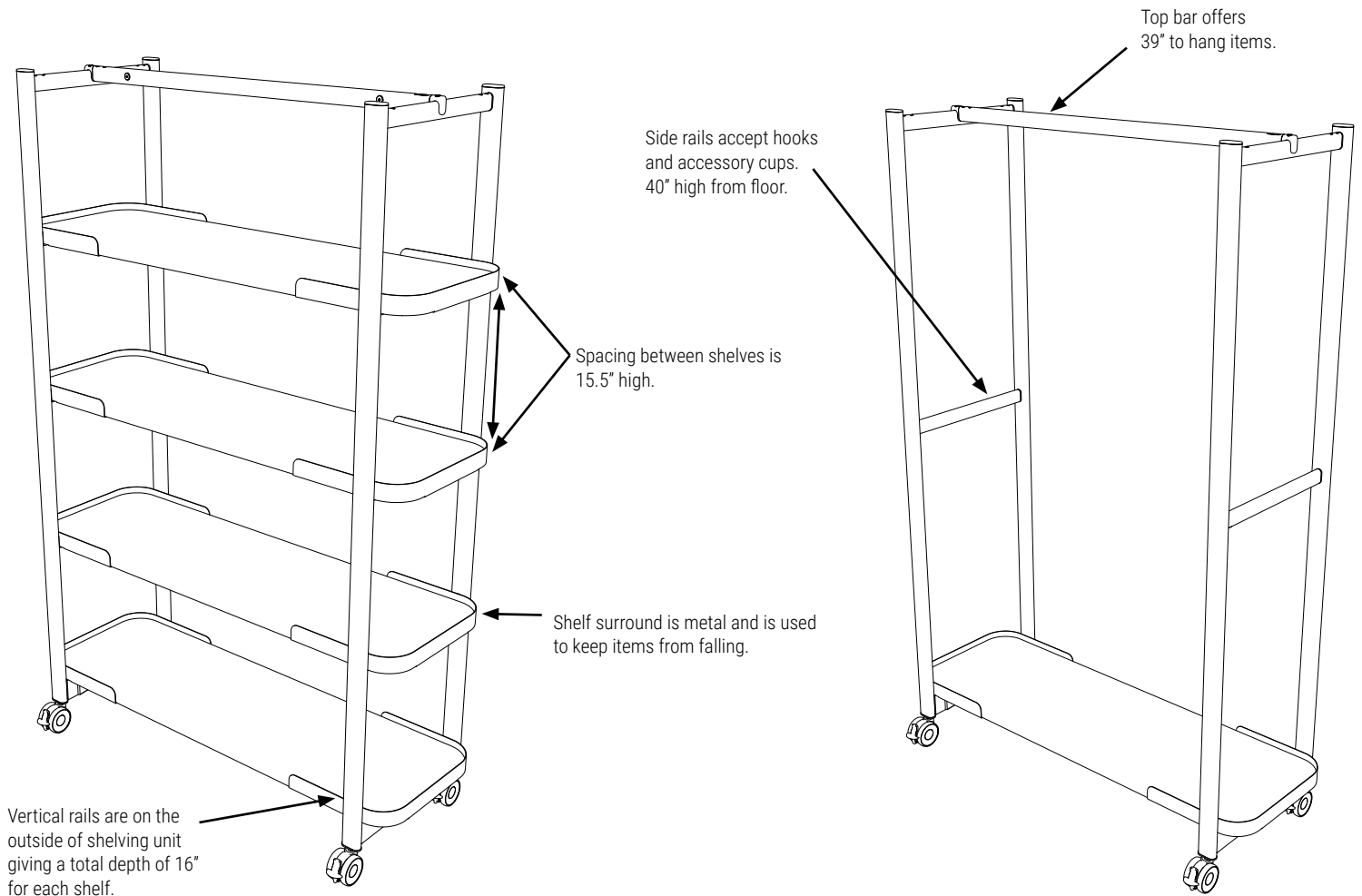


Writeboard on a wall (Wall rails are sold separately)

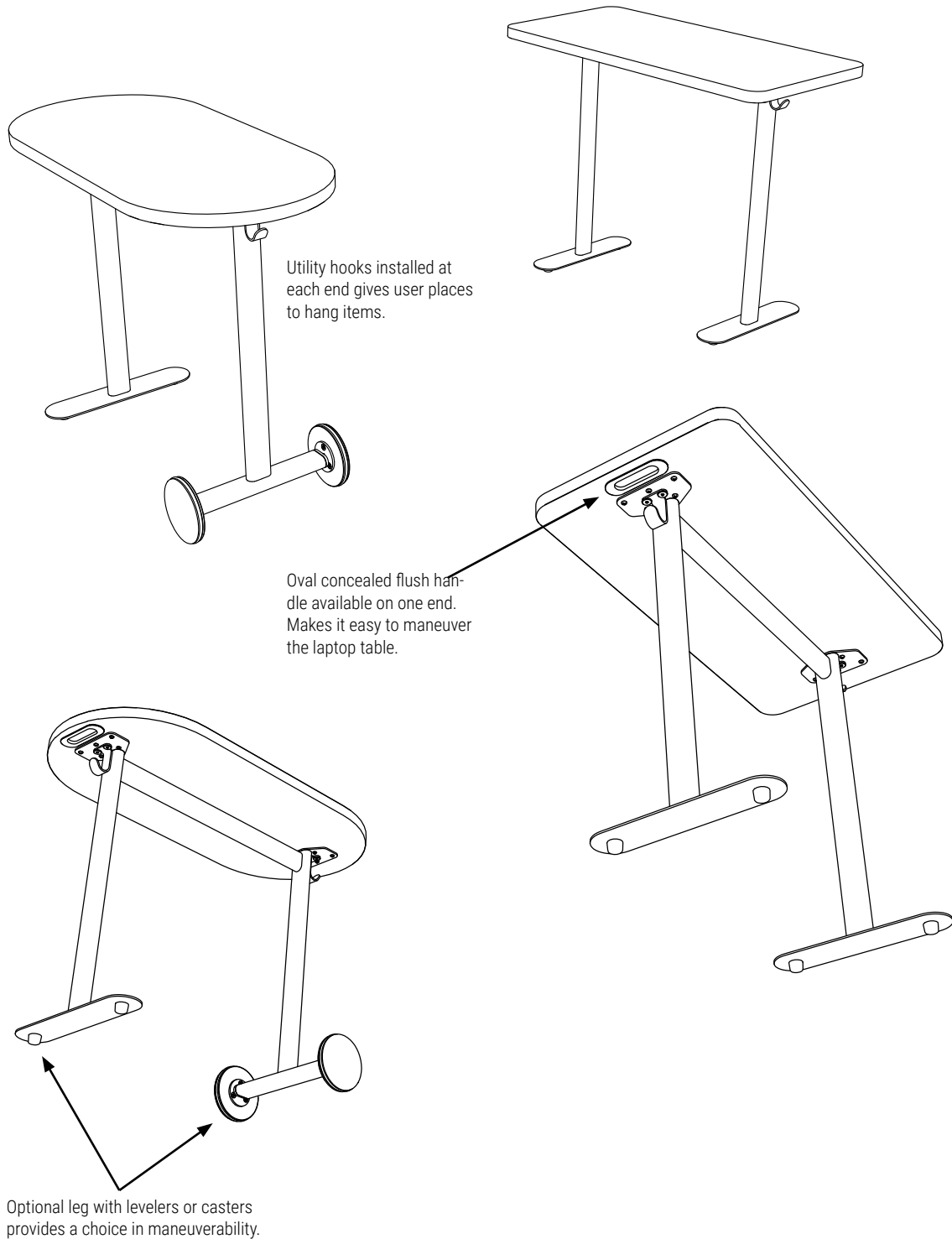


Technology Support  
- Laptop shelves and media trays  
can be added to media carts.

Planning



Planning



Please contact your Global Contract Service Representative at 416-739-5000 for any questions or concerns.

NOTE: Any alterations to listed components will void the manufacturer's warranty. The manufacturer will not be responsible for any damage or bodily harm caused by alterations in accordance with national or local electrical codes and manufacturer's speci-

fications. In accordance with the manufacturer's policy of continual product improvement, the product presented in this document is subject to change without notice or obligation.

# COLLABORATIVE SPACES

## Technical Notes

- All tables are available in HP - High Pressure Laminate (1-1/16" thick) or LP - Low Pressure Laminate (1" thick) with flat edge.
- Surfaces constructed of 45lb. density particleboard substructure with low pressure laminate or optional high pressure laminate.
- All tables are PVC 3mm edge banded.
- Grommet location must be specified at the time of order or it will default to a no grommet option.

- Power modules and grommets are not included, they must be specified separately.
- Table legs and bases are painted aluminum finish.
- Tables are shipped knocked down and must be assembled on site.
- Cart shelf load capacities : 120 lbs for 42" wide (Hospitality Cart), 140 lbs for 48" wide and 175 lbs for 60" wide.
- Casters cannot be used with TV Mount units and wire basket for tables larger than 78" long.

## DIMENSIONS

Corner radius for small radius table tops is 1.5".

Corner radius for large radius tables tops is 9".

Top end overhang for large tables is 10.5"

Worksurface support beams and footrests (where applicable) are centered for tables 18" and 24" deep.

Worksurface support beams and footrests (where applicable) are 9" from the outside table edges for tables 30" deep.

Worksurface support beams and footrests (where applicable) are 12" from the outside table edges for tables 36 to 48" deep.

## GENERAL NOTES

- GREENGUARD certified ([www.greenguard.org](http://www.greenguard.org))
- Carb compliant
- Level3™ certified ([www.levelcertified.org](http://www.levelcertified.org))
- Tested to meet or exceed ANSI/BIFMA X5.9.2019 , ANSI/ BIFMA X5.5.2021 and CAN/CGSB 44-227-2008
- Plant is ISO 9001:2015 (Quality) certified
- Plant is ISO 14001:2015 (Environmental) certified
- Plant is OHSAS 18001:2007 (Health and Safety) certified
- 100% made in Canada
- Lifetime Warranty

## STORAGE AND WORKSURFACE FINISHES

### Metal Storage Colors - Panel Frame

<b>Matches</b>	
Black	BLK
Blizzard	BZD
Charcoal	CHR
Designer White	DWT
Ink	TIN
Nevada	NEV
Silver	SIL
Stonedust	SDT
Taupe	TPE
Tungsten	TUN

### PVC Edge Finishes - Panel Frame

<b>Matches</b>	
Black	BLK
Blizzard	BZD
Brushed Cobalt	BRC
Charcoal	CHR
Designer White	DWE
Nevada	NEV
Silver	SIL
Stonedust	SDT
Taupe	TPE
Tungsten	TUN

### Worksurface PVC Edge Trim - Wood

<b>Grain Matches</b>			
Absolute Acajou	AAE	Noce Leggero	NEL
Asian Night	ASE	Noce Medio	NML
Avant Cherry	ACE	Quartered Mahogany	QTM
Avant Honey	AHE	Sheer Beauty	SBY
Clear Maple	CME	Walnut Heights	WHE
Dark Espresso	DEE	White Chocolate	CBE
Fashionista	FAS	Winter Cherry	WCE
First Class	FCL		
Noce Biondo	NBL		
Noce Grigio	NGL		

### Low Pressure Laminates (LP) Panel Frame Matches

Black	BLKLP
Blizzard	BZDLP
Brushed Cobalt (Tungsten)	BRCLP
Custom Grey (Silver)	CGYLP
Designer White	DWTLP
Hayden Grey (Taupe)	HGTLP
Stonedust	SDTLP
Storm Grey (Charcoal)	SOGLP
String (Nevada)	STGLP

### Low Pressure Laminates (LP) Solids and Patterns

Blizzard Matrix	BMXLP
Grey Matrix	GRXLP
Hayden Linen	HLNLP
Stone Linen	SLNLP
Studio White Matrix	SWXLP

### Low Pressure Laminates (LP) Wood Grain Laminates

Absolute Acajou	ACJLP	Noce Leggero	NELLP
Asian Night	ASNLP	Noce Medio	NMLLP
Avant Cherry	AWCLP	Quartered Mahogany	QTM LP
Avant Honey	AWHLP	Sheer Beauty	SBYLP
Clear Maple	CMBLP	Walnut Heights	WHELP
Dark Espresso	DESLP	White Chocolate	WHCLP
Fashionista	FASLP	Winter Cherry	WCRLP
First Class	FCLLP		
Noce Biondo	NBLLP		
Noce Grigio	NGLLP		

### High Pressure Laminates (HP) Panel Frame Matches

Black	BLKHP
Blizzard	BZDHP
Brushed Cobalt (Tungsten)	BRCHP
Custom Grey (Silver)	CGYHP
Designer White	DWTHP
Hayden Grey (Taupe)	HGTHP
Stonedust	SDTHP
Storm Grey (Charcoal)	SOGHP
String (Nevada)	STGHP

### High Pressure Laminates (HP) Solids and Patterns

Blizzard Matrix	BMXHP
Grey Matrix	GRXHP
Hayden Linen	HLNHP
Stone Linen	SLNHP
Studio White Matrix	SWXHP

### High Pressure Laminates (HP) Wood Grain Laminates

Absolute Acajou	ACJHP	Noce Leggero	NELHP
Asian Night	ASNHP	Noce Medio	NMLHP
Avant Cherry	AWCHP	Quartered Mahogany	QTMHP
Avant Honey	AWHHP	Sheer Beauty	SBYHP
Clear Maple	CMBHP	Walnut Heights	WHEHP
Dark Espresso	DESHP	White Chocolate	WHCHP
Fashionista	FASHP	Winter Cherry	WCRHP
First Class	FCLHP		
Noce Biondo	NBLHP		
Noce Grigio	NGLHP		

### Caster Finish

Black	BLK
Grey	GRC

# COLLABORATIVE SPACES

## Spaces Collaborative Specifications

### HOW TO SPECIFY :

**Example:** SCTWSL2472

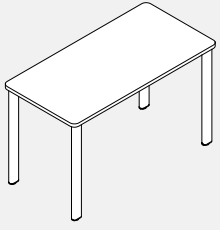
<b>SC</b>	Space Collaborative	
<b>T</b>	Table	
<b>W</b>	Work Height Table - 29"	Other Options: C - Café Height Table - 36" B - Bar Height Table - 42"
<b>S</b>	Small Radius - 1.5"	Other Options: L - Large Radius - 9"
<b>L</b>	Levelers	Other Options: C - Casters - Available in BLK - Black or GRC - Grey
<b>24</b>	Depth	
<b>72</b>	Width	
<b>LP</b>	Low Pressure Laminate	Other Options: HP - High Pressure

**Choose:** Laminate Finish  
Edging  
Paint  
Grommet location as per chart



# COLLABORATIVE SPACES

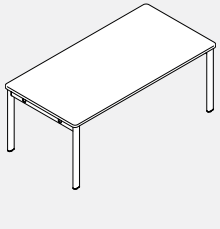
## SCTWD • Core Collaboration Table, 29" Work Height, Small Radius, Levelers



- Core Work Height Collaboration Tables on levelers consist of four individual legs and one surface with a small 1.5" radius at each corner.
- Surface available in LP - Low Pressure or HP - High Pressure laminates.
- Legs are painted extruded aluminum. Levelers have 1" adjustment for leveling.
- Tables from 48" to 72" include a center worksurface support beam
- Center worksurface support beam eliminates the possibility of a grommet cutout.

PRODUCT CODE	PRICE		SIZE/INCHES			WEIGHT LBS	VOL FT <sup>3</sup>
	LP	HP	H	W	D		
SCTWD1836	587	658	29	36	18	35.54	2.33
SCTWD1842	612	695	29	42	18	38.52	2.52
SCTWD1848	676	771	29	48	18	47.06	2.71
SCTWD1854	708	815	29	54	18	50.88	2.90
SCTWD1860	734	896	29	60	18	54.70	3.08
SCTWD1866	769	946	29	66	18	58.52	3.27
SCTWD1872	803	997	29	72	18	62.34	3.46
SCTWD2436	631	725	29	36	24	41.51	3.11
SCTWD2442	662	772	29	42	24	45.49	3.36
SCTWD2448	732	858	29	48	24	55.02	3.61
SCTWD2454	770	912	29	54	24	59.83	3.86
SCTWD2460	802	1015	29	60	24	64.65	4.11
SCTWD2466	843	1077	29	66	24	69.46	4.36
SCTWD2472	884	1138	29	72	24	74.27	4.61
SCTWD3036	674	792	29	36	30	47.47	3.89
SCTWD3042	712	850	29	42	30	52.45	4.20
SCTWD3048	788	945	29	48	30	62.98	4.51
SCTWD3054	832	1010	29	54	30	68.78	4.83
SCTWD3060	871	1134	29	60	30	74.59	5.14
SCTWD3066	918	1207	29	66	30	80.40	5.45
SCTWD3072	964	1280	29	72	30	86.20	5.76

## SCTWSL • Standard Collaboration Table, 29" Work Height, Small Radius, Levelers

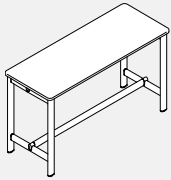


- Work Height Collaboration Tables on levelers consist of two leg assemblies, worksurface support beams and one worksurface with a small 1.5" radius at each corner.
- Surface available in LP - Low Pressure or HP - High Pressure laminates.
- Legs are painted extruded aluminum. Levelers have 1" adjustment for leveling.
- Cutouts for power modules are limited to specific sizes/configurations, please see Grommet Location Chart.
- 18" and 24" deep tables feature one worksurface support beam.
- 30" deep tables feature two worksurface support beams.

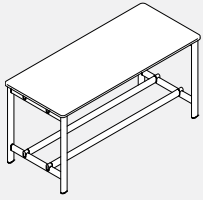
PRODUCT CODE	PRICE		SIZE/INCHES			WEIGHT LBS	VOL FT <sup>3</sup>
	LP	HP	H	W	D		
SCTWSL1836	899	970	29	36	18	40.05	2.33
SCTWSL1842	957	1040	29	42	18	43.65	2.52
SCTWSL1848	1140	1235	29	48	18	50.15	2.71
SCTWSL1854	1166	1272	29	54	18	53.75	2.90
SCTWSL1860	1213	1331	29	60	18	57.34	3.08
SCTWSL1866	1239	1368	29	66	18	60.93	3.27
SCTWSL1872	1301	1443	29	72	18	64.52	3.46
SCTWSL1878	1326	1480	29	78	18	68.12	3.65
SCTWSL1884	1352	1517	29	84	18	71.71	3.83
SCTWSL1890	1451	1628	29	90	18	75.31	4.02
SCTWSL1896	1476	1665	29	96	18	78.90	4.21
SCTWSL2436	967	1062	29	36	24	43.05	3.11
SCTWSL2442	1032	1142	29	42	24	46.65	3.36
SCTWSL2448	1221	1347	29	48	24	53.15	3.61
SCTWSL2454	1252	1394	29	54	24	56.75	3.86
SCTWSL2460	1306	1463	29	60	24	60.34	4.11
SCTWSL2466	1337	1511	29	66	24	63.93	4.36
SCTWSL2472	1406	1595	29	72	24	67.52	4.61
SCTWSL2478	1437	1642	29	78	24	71.12	4.86
SCTWSL2484	1469	1689	29	84	24	74.71	5.11
SCTWSL2490	1574	1810	29	90	24	78.31	5.36
SCTWSL2496	1606	1857	29	96	24	81.90	5.61
SCTWSL3036	1162	1280	29	36	30	46.05	3.89
SCTWSL3042	1266	1404	29	42	30	49.65	4.20
SCTWSL3048	1483	1641	29	48	30	56.15	4.51
SCTWSL3054	1521	1698	29	54	30	59.75	4.83
SCTWSL3060	1603	1800	29	60	30	63.34	5.14
SCTWSL3066	1641	1857	29	66	30	66.93	5.45
SCTWSL3072	1752	1988	29	72	30	70.52	5.76
SCTWSL3078	1808	2064	29	78	30	74.12	6.08
SCTWSL3084	1845	2121	29	84	30	77.71	6.70
SCTWSL3090	2030	2326	29	90	30	81.31	6.39
SCTWSL3096	2068	2383	29	96	30	84.90	7.01

# COLLABORATIVE SPACES

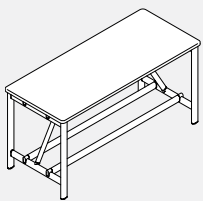
## SCTCSL • Standard Collaboration Table, 36" Café Height, Small Radius, Levelers



For 18" and 24" deep surfaces



For 30" deep tables, 36" to 72" wide



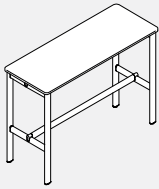
For 30" deep tables, 78" to 96" wide

- Café Height Collaboration Tables on levelers consist of two leg assemblies, worksurface support beam(s), footrest(s) and one worksurface with a small 1.5" radius at each corner.
- Surface available in LP - Low Pressure or HP - High Pressure laminates.
- Legs are painted extruded aluminum.
- Levelers have 1" adjustment for leveling.
- Cutouts for power modules are limited to specific sizes/configurations, please see Grommet Location Chart.
- Tables 18" and 24" deep feature one worksurface support beam and one footrest.
- Tables 30" deep feature two worksurface support beams and two footrests.
- Tables 30" deep and 78" wide and greater include a reinforcement cantilever for added stability.

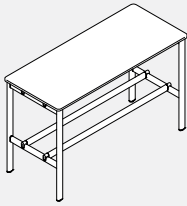
PRODUCT CODE	PRICE		SIZE/INCHES			WEIGHT LBS	VOL FT <sup>3</sup>
	LP	HP	H	W	D		
SCTCSL1836	1277	1348	36	36	18	50.14	2.33
SCTCSL1842	1369	1452	36	42	18	54.34	2.52
SCTCSL1848	1551	1645	36	48	18	61.46	2.71
SCTCSL1854	1576	1682	36	54	18	65.66	2.90
SCTCSL1860	1646	1764	36	60	18	69.87	3.08
SCTCSL1866	1671	1801	36	66	18	74.07	3.27
SCTCSL1872	1770	1912	36	72	18	78.28	3.46
SCTCSL1878	1796	1949	36	78	18	82.48	3.65
SCTCSL1884	1821	1987	36	84	18	86.69	3.83
SCTCSL1890	1994	2171	36	90	18	90.90	4.02
SCTCSL1896	2019	2208	36	96	18	95.10	4.21
SCTCSL2436	1370	1465	36	36	24	67.83	3.11
SCTCSL2442	1468	1578	36	42	24	74.58	3.36
SCTCSL2448	1656	1782	36	48	24	84.23	3.61
SCTCSL2454	1687	1829	36	54	24	90.98	3.86
SCTCSL2460	1763	1921	36	60	24	97.73	4.11
SCTCSL2466	1795	1968	36	66	24	104.48	4.36
SCTCSL2472	1900	2089	36	72	24	111.23	4.61
SCTCSL2478	1931	2136	36	78	24	117.98	4.86
SCTCSL2484	1963	2183	36	84	24	124.73	5.11
SCTCSL2490	2142	2378	36	90	24	131.48	5.36
SCTCSL2496	2173	2425	36	96	24	138.23	5.61
SCTCSL3036	1717	1835	36	36	30	86.09	3.89
SCTCSL3042	1887	2025	36	42	30	95.44	4.20
SCTCSL3048	2081	2239	36	48	30	107.70	4.51
SCTCSL3054	2119	2296	36	54	30	117.05	4.83
SCTCSL3060	2245	2442	36	60	30	126.41	5.14
SCTCSL3066	2282	2499	36	66	30	135.76	5.45
SCTCSL3072	2468	2704	36	72	30	145.11	5.76
SCTCSL3078	2651	2906	36	78	30	156.91	6.08
SCTCSL3084	2688	2964	36	84	30	166.26	6.70
SCTCSL3090	3021	3316	36	90	30	175.62	6.39
SCTCSL3096	3058	3373	36	96	30	184.97	7.01

# COLLABORATIVE SPACES

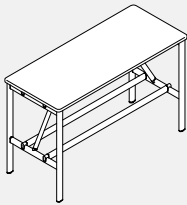
## SCTBSL • Standard Collaboration Table, 42" Bar Height, Small Radius, Levelers



For 18" and 24" deep surfaces



For 30" deep tables, 36" to 72" wide

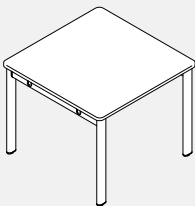


For 30" deep tables, 78" to 96" wide

- Bar Height Collaboration Tables on levelers consist of two leg assemblies, worksurface support beam(s), footrest(s) and one worksurface with a small 1.5" radius at each corner.
- Surface available in LP - Low Pressure or HP - High Pressure laminates.
- Legs are painted extruded aluminum. Levelers have 1" adjustment for leveling.
- Cutouts for power modules are limited to specific sizes/configurations, please see Grommet Location Chart.
- Tables 18" and 24" deep feature one worksurface support beam and one footrest.
- Tables 30" deep feature two worksurface support beams and two footrests.
- Tables 30" deep and 78" wide and greater include a reinforcement cantilever for added stability.

PRODUCT CODE	PRICE		SIZE/INCHES			WEIGHT		VOL FT <sup>3</sup>
	LP	HP	H	W	D	LBS		
SCTBSL1836	1378	1449	42	36	18	52.58	2.33	
SCTBSL1842	1470	1553	42	42	18	56.79	2.52	
SCTBSL1848	1652	1746	42	48	18	63.90	2.71	
SCTBSL1854	1677	1784	42	54	18	68.11	2.90	
SCTBSL1860	1747	1865	42	60	18	72.31	3.08	
SCTBSL1866	1772	1902	42	66	18	76.52	3.27	
SCTBSL1872	1871	2013	42	72	18	80.72	3.46	
SCTBSL1878	1897	2050	42	78	18	84.93	3.65	
SCTBSL1884	1922	2088	42	84	18	89.13	3.83	
SCTBSL1890	2095	2272	42	90	18	93.34	4.02	
SCTBSL1896	2121	2310	42	96	18	97.55	4.21	
SCTBSL2436	1471	1566	42	36	24	70.28	3.11	
SCTBSL2442	1569	1679	42	42	24	77.02	3.36	
SCTBSL2448	1757	1883	42	48	24	86.68	3.61	
SCTBSL2454	1789	1930	42	54	24	93.43	3.86	
SCTBSL2460	1864	2022	42	60	24	100.18	4.11	
SCTBSL2466	1896	2069	42	66	24	106.93	4.36	
SCTBSL2472	2001	2190	42	72	24	113.68	4.61	
SCTBSL2478	2033	2237	42	78	24	120.43	4.86	
SCTBSL2484	2064	2285	42	84	24	127.18	5.11	
SCTBSL2490	2243	2479	42	90	24	133.93	5.36	
SCTBSL2496	2275	2527	42	96	24	140.67	5.61	
SCTBSL3036	1818	1936	42	36	30	88.53	3.89	
SCTBSL3042	1988	2126	42	42	30	97.89	4.20	
SCTBSL3048	2182	2340	42	48	30	110.14	4.51	
SCTBSL3054	2220	2397	42	54	30	117.05	4.83	
SCTBSL3060	2346	2543	42	60	30	126.41	5.14	
SCTBSL3066	2384	2600	42	66	30	135.76	5.45	
SCTBSL3072	2569	2805	42	72	30	145.11	5.76	
SCTBSL3078	2752	3008	42	78	30	159.35	6.08	
SCTBSL3084	2789	3065	42	84	30	168.71	6.40	
SCTBSL3090	3122	3417	42	90	30	178.06	6.72	
SCTBSL3096	3160	3474	42	96	30	187.41	7.04	

## SCTSWSL • Workshop Table, 29" Work Height, Small Radius, Levelers

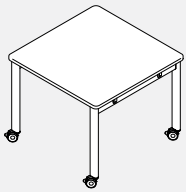


- Work Height Workshop Tables on levelers consist of two leg assemblies, two worksurface support beams and a one worksurface with a small 1.5" radius at each corner.
- Surface available in LP - Low Pressure or HP - High Pressure laminates.
- Legs are painted extruded aluminum. Levelers have 1" adjustment for leveling.
- Cutouts for power modules are limited to specific sizes/configurations, please see Grommet Location Chart.

PRODUCT CODE	PRICE		SIZE/INCHES			WEIGHT		VOL FT <sup>3</sup>
	LP	HP	H	W	D	LBS		
SCTSWSL3636	1235	1377	29	36	36	79.31	4.67	
SCTSWSL3642	1390	1555	29	42	36	88.83	5.04	
SCTSWSL3648	1567	1756	29	48	36	101.24	5.42	
SCTSWSL3654	1611	1824	29	54	36	110.76	5.79	
SCTSWSL3660	1699	1935	29	60	36	120.27	6.17	
SCTSWSL4242	1416	1609	29	42	42	99.72	5.88	
SCTSWSL4248	1644	1865	29	48	42	113.52	6.32	
SCTSWSL4254	1694	1942	29	54	42	124.41	6.76	
SCTSWSL4260	1788	2064	29	60	42	135.31	7.19	
SCTSWSL4848	1730	1982	29	48	48	125.80	7.22	
SCTSWSL4854	1786	2069	29	54	48	138.07	7.72	
SCTSWSL4860	1886	2201	29	60	48	150.35	8.22	

# COLLABORATIVE SPACES

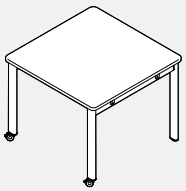
## SCTSWSC • Workshop Table, 29" Work Height, Small Radius, Casters



- Work Height Workshop Tables on casters consist of two leg assemblies, two worksurface support beams and a one worksurface with a small 1.5" radius at each corner.
- Surface available in LP - Low Pressure or HP - High Pressure laminates.
- Legs are painted extruded aluminum. Casters are lockable, in a choice of two finishes.
- Cutouts for power modules are limited to specific sizes/configurations, please see Grommet Location Chart.

PRODUCT CODE	PRICE		SIZE/INCHES			WEIGHT LBS	VOL FT <sup>3</sup>
	LP	HP	H	W	D		
SCTSWSC3636	1451	1593	29	36	36	79.40	4.67
SCTSWSC3642	1561	1727	29	42	36	88.92	5.04
SCTSWSC3648	1739	1928	29	48	36	101.33	5.42
SCTSWSC3654	1783	1996	29	54	36	110.85	5.79
SCTSWSC3660	1871	2107	29	60	36	120.36	6.17
SCTSWSC4242	1632	1825	29	42	42	99.81	5.88
SCTSWSC4248	1816	2037	29	48	42	113.61	6.32
SCTSWSC4254	1866	1942	29	54	42	124.50	6.76
SCTSWSC4260	1960	2236	29	60	42	135.40	7.19
SCTSWSC4848	1902	2154	29	48	48	125.89	7.22
SCTSWSC4854	1958	2241	29	54	48	138.16	7.72
SCTSWSC4860	2058	2373	29	60	48	150.44	8.22

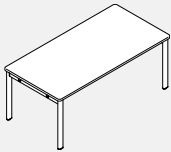
## SCTWSX • Workshop Table, 29" Work Height, Small Radius, Casters/Levelers



- Work Height Workshop Tables consist of one leg assembly with casters, one leg assembly with levelers, two worksurface support beams and a one worksurface with a small 1.5" radius at each corner.
- Surface available in LP - Low Pressure or HP - High Pressure laminates.
- Legs are painted extruded aluminum. Levelers have 1" adjustment for leveling. Casters are lockable, in a choice of 2 finishes.
- Cutouts for power modules are limited to specific sizes/configurations, please see Grommet Location Chart.

PRODUCT CODE	PRICE		SIZE/INCHES			WEIGHT LBS	VOL FT <sup>3</sup>
	LP	HP	H	W	D		
SCTWSX3636	1343	1485	29	36	36	79.36	4.67
SCTWSX3642	1453	1619	29	42	36	88.87	5.04
SCTWSX3648	1653	1842	29	48	36	101.29	5.42
SCTWSX3654	1697	1910	29	54	36	110.80	5.79
SCTWSX3660	1785	2021	29	60	36	120.31	6.17
SCTWSX4242	1524	1717	29	42	42	99.77	5.88
SCTWSX4248	1730	1951	29	48	42	113.56	6.32
SCTWSX4254	1780	2028	29	54	42	124.46	6.76
SCTWSX4260	1874	2150	29	60	42	135.36	7.19
SCTWSX4848	1816	2068	29	48	48	125.71	7.22
SCTWSX4854	1872	2155	29	54	48	137.99	7.72
SCTWSX4860	1972	2287	29	60	48	150.27	8.22

## SCTLWSL • Large Collaboration Table, 29" Work Height, Small Radius, Levelers

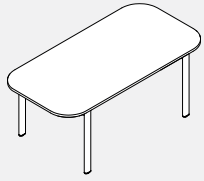


- Large Work Height Collaboration Tables on levelers consist of two leg assemblies, two worksurface support beams and a one worksurface with a small 1.5" radius at each corner.
- Surface available in LP - Low Pressure or HP - High Pressure laminates.
- Legs are painted extruded aluminum. Levelers have 1" adjustment for leveling.
- Cutouts for power modules are limited to specific sizes/configurations, please see Grommet Location Chart.

PRODUCT CODE	PRICE		SIZE/INCHES			WEIGHT LBS	VOL FT <sup>3</sup>
	LP	HP	H	W	D		
SCTLWSL3666	1743	2003	29	66	36	129.78	6.54
SCTLWSL3672	1860	2144	29	72	36	139.30	6.92
SCTLWSL3678	1922	2229	29	78	36	148.81	7.29
SCTLWSL3684	1966	2297	29	84	36	158.32	7.67
SCTLWSL3690	2157	2512	29	90	36	167.84	8.04
SCTLWSL3696	2201	2579	29	96	36	177.35	8.42
SCTLWSL4266	1838	2141	29	66	42	146.21	7.63
SCTLWSL4272	1962	2293	29	72	42	127.10	8.07
SCTLWSL4278	2030	2388	29	78	42	168.00	8.51
SCTLWSL4284	2080	2466	29	84	42	178.89	8.94
SCTLWSL4290	2277	2690	29	90	42	189.79	9.38
SCTLWSL4296	2327	2768	29	96	42	200.68	9.82
SCTLWSL4866	1942	2288	29	66	48	162.63	8.72
SCTLWSL4872	2072	2450	29	72	48	174.91	9.22
SCTLWSL4878	2146	2555	29	78	48	187.18	9.72
SCTLWSL4884	2202	2643	29	84	48	199.46	10.22
SCTLWSL4890	2405	2878	29	90	48	211.74	10.72
SCTLWSL4896	2461	2965	29	96	48	224.01	11.22

# COLLABORATIVE SPACES

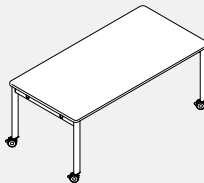
## SCTLWLL • Large Collaboration Table, 29" Work Height, Large Radius, Levelers



- Large Work Height Collaboration Tables on levelers consist of two leg assemblies, two worksurface support beams and a one worksurface with a large 9" radius at each corner with 10.5" overhang on each end.
- Surface available in LP - Low Pressure or HP - High Pressure laminates.
- Legs are painted extruded aluminum. Levelers have 1" adjustment for leveling.
- Cutouts for power modules are limited to specific sizes/configurations, please see Grommet Location Chart.
- Note: Large radius tables are not compatible with SCTAMxx and SCTAMTxx Media Units.

PRODUCT CODE	PRICE		SIZE/INCHES			WEIGHT LBS	VOL FT <sup>3</sup>
	LP	HP	H	W	D		
SCTLWLL3666	1699	1958	29	66	36	123.52	6.54
SCTLWLL3672	1742	2026	29	72	36	133.03	6.92
SCTLWLL3672	1830	2137	29	78	36	142.55	7.29
SCTLWLL3684	1874	2205	29	84	36	152.06	7.67
SCTLWLL3690	1992	2346	29	90	36	161.57	8.04
SCTLWLL3696	2054	2431	29	96	36	171.09	8.42
SCTLWLL4266	1794	2097	29	66	42	139.94	7.63
SCTLWLL4272	1844	2175	29	72	42	150.84	8.07
SCTLWLL4278	1938	2296	29	78	42	161.73	8.51
SCTLWLL4284	1988	2374	29	84	42	172.63	8.94
SCTLWLL4290	2111	2525	29	90	42	183.52	9.38
SCTLWLL4296	2158	2599	29	96	42	194.42	9.82
SCTLWLL4866	1898	2244	29	66	48	156.37	8.72
SCTLWLL4872	1954	2332	29	72	48	168.64	9.22
SCTLWLL4878	2054	2463	29	78	48	180.92	9.72
SCTLWLL4884	2110	2551	29	84	48	193.20	10.22
SCTLWLL4890	2240	2712	29	90	48	205.48	10.72
SCTLWLL4896	2314	2818	29	96	48	217.75	11.22

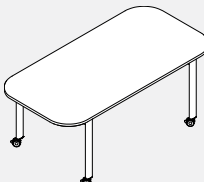
## SCTLWSC • Large Collaboration Table, 29" Work Height, Small Radius, Casters



- Large Work Height Collaboration Tables on casters consist of two leg assemblies, two worksurface support beams and a one worksurface with a small 1.5" radius at each corner.
- Surface available in LP - Low Pressure or HP - High Pressure laminates.
- Legs are painted extruded aluminum. Casters are lockable, in a choice of two finishes.
- Cutouts for power modules are limited to specific sizes/configurations, please see Grommet Location Chart.

PRODUCT CODE	PRICE		SIZE/INCHES			WEIGHT LBS	VOL FT <sup>3</sup>
	LP	HP	H	W	D		
SCTLWSC3666	1915	2175	29	66	36	129.87	6.54
SCTLWSC3672	2032	2316	29	72	36	139.39	6.92
SCTLWSC3678	2094	2401	29	78	36	148.90	7.29
SCTLWSC3684	2138	2469	29	84	36	158.41	7.67
SCTLWSC3690	2329	2683	29	90	36	167.93	8.04
SCTLWSC3696	2373	2751	29	96	36	177.44	8.42
SCTLWSC4266	2010	2313	29	66	42	146.30	7.63
SCTLWSC4272	2134	2464	29	72	42	157.19	8.07
SCTLWSC4278	2202	2560	29	78	42	168.09	8.51
SCTLWSC4284	2252	2637	29	84	42	178.98	8.94
SCTLWSC4290	2449	2862	29	90	42	189.88	9.38
SCTLWSC4296	2306	2747	29	96	42	200.77	9.82
SCTLWSC4866	2114	2460	29	66	48	162.72	8.72
SCTLWSC4872	2244	2621	29	72	48	175.00	9.22
SCTLWSC4878	2318	2727	29	78	48	187.27	9.72
SCTLWSC4884	2374	2815	29	84	48	199.55	10.22
SCTLWSC4890	2577	3050	29	90	48	211.83	10.72
SCTLWSC4896	2633	3137	29	96	48	224.10	11.22

## SCTLWLC • Large Collaboration Table, 29" Work Height, Large Radius, Casters



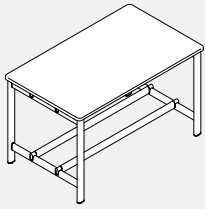
- Large Work Height Collaboration Tables on casters consist of two leg assemblies, two worksurface support beams and a one worksurface with a large 9" radius at each corner with 10.5" overhang on each end.
- Surface available in LP - Low Pressure or HP - High Pressure laminates.
- Legs are painted extruded aluminum. Casters are lockable, in a choice of two finishes.
- Cutouts for power modules are limited to specific sizes/configurations, please see Grommet Location Chart.
- Note: Large radius tables are not compatible with SCTAMxx and SCTAMTxx Media Units.

PRODUCT CODE	PRICE		SIZE/INCHES			WEIGHT LBS	VOL FT <sup>3</sup>
	LP	HP	H	W	D		
SCTLWLC3666	1871	2130	29	66	36	123.61	6.54
SCTLWLC3672	1914	2198	29	72	36	133.12	6.92
SCTLWLC3678	2002	2309	29	78	36	142.64	7.29
SCTLWLC3684	2046	2377	29	84	36	152.15	7.67
SCTLWLC3690	2163	2518	29	90	36	161.66	8.04
SCTLWLC3696	2225	2603	29	96	36	171.18	8.42
SCTLWLC4266	1966	2269	29	66	42	140.03	7.63
SCTLWLC4272	2016	2346	29	72	42	150.93	8.07
SCTLWLC4278	2110	2468	29	78	42	161.82	8.51
SCTLWLC4284	2160	2545	29	84	42	172.72	8.94
SCTLWLC4290	2283	2697	29	90	42	183.62	9.38
SCTLWLC4296	2351	2792	29	96	42	194.51	9.82
SCTLWLC4866	2070	2416	29	66	48	156.46	8.72
SCTLWLC4872	2126	2503	29	72	48	168.73	9.22
SCTLWLC4878	2226	2635	29	78	48	181.01	9.72
SCTLWLC4884	2282	2723	29	84	48	193.29	10.22
SCTLWLC4890	2411	2884	29	90	48	205.57	10.72
SCTLWLC4896	2486	2989	29	96	48	217.84	11.22



# COLLABORATIVE SPACES

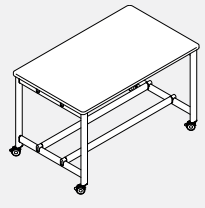
## SCTSCSL • Workshop Table, 36" Café Height, Small Radius, Levelers



- Café Height Workshop Tables on levelers consist of two leg assemblies, two worksurface support beams, dual footrests and a one worksurface with a small 1.5" radius at each corner.
- Surface available in LP - Low Pressure or HP - High Pressure laminates.
- Legs are painted extruded aluminum. Levelers have 1" adjustment for leveling.
- Cutouts for power modules are limited to specific sizes/configurations, please see Grommet Location Chart.

PRODUCT CODE	PRICE		SIZE/INCHES			WEIGHT LBS	VOL FT <sup>3</sup>
	LP	HP	H	W	D		
SCTSCSL3636	1817	1959	36	36	36	96.82	5.67
SCTSCSL3642	1993	2159	36	42	36	107.56	6.21
SCTSCSL3648	2193	2382	36	48	36	121.20	6.75
SCTSCSL3654	2237	2450	36	54	36	131.93	7.29
SCTSCSL3660	2369	2605	36	60	36	142.67	7.83
SCTSCSL4242	2043	2236	36	42	42	119.68	7.05
SCTSCSL4248	2291	2512	36	48	42	134.70	7.65
SCTSCSL4254	2341	2589	36	54	42	146.81	8.26
SCTSCSL4260	2480	2755	36	60	42	158.93	8.86
SCTSCSL4848	2406	2658	36	48	48	148.20	8.56
SCTSCSL4854	2462	2746	36	54	48	161.70	9.22
SCTSCSL4860	2607	2922	36	60	48	175.20	9.89

## SCTSCSC • Workshop Table, 36" Café Height, Small Radius, Casters



- Café Height Workshop Tables on casters consist of two leg assemblies, two worksurface support beams, dual footrests and a one worksurface with a small 1.5" radius at each corner.
- Surface available in LP - Low Pressure or HP - High Pressure laminates.
- Legs are painted extruded aluminum. Casters are lockable, in a choice of two finishes.
- Cutouts for power modules are limited to specific sizes/configurations, please see Grommet Location Chart.

PRODUCT CODE	PRICE		SIZE/INCHES			WEIGHT LBS	VOL FT <sup>3</sup>
	LP	HP	H	W	D		
SCTSCSC3636	2013	2155	36	36	36	96.66	5.67
SCTSCSC3642	2190	2355	36	42	36	107.39	6.21
SCTSCSC3648	2390	2579	36	48	36	121.03	6.75
SCTSCSC3654	2433	2646	36	54	36	131.77	7.29
SCTSCSC3660	2566	2802	36	60	36	142.50	7.83
SCTSCSC4242	2282	2475	36	42	42	119.51	7.05
SCTSCSC4248	2488	2708	36	48	42	134.53	7.65
SCTSCSC4254	2538	2786	36	54	42	146.65	8.26
SCTSCSC4296	2676	2952	36	60	42	158.77	8.86
SCTSCSC4848	2603	2855	36	48	48	148.03	8.56
SCTSCSC4854	2659	2942	36	54	48	161.53	9.22
SCTSCSC4860	2803	3118	36	60	48	175.03	9.89

## SCTLCSL • Large Collaboration Table, 36" Café Height, Small Radius, Levelers



For 66" and 72" wide tables



For 78" to 96" wide tables

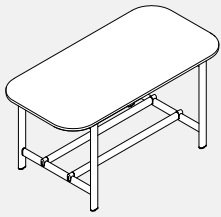
- Large Café Height Collaboration Tables on levelers consist of two leg assemblies, two worksurface support beams, dual footrests and a one worksurface with a small 1.5" radius at each corner.
- Surface available in LP - Low Pressure or HP - High Pressure laminates.
- Legs are painted extruded aluminum. Levelers have 1" adjustment for leveling.
- Cutouts for power modules are limited to specific sizes/configurations, please see Grommet Location Chart.
- Tables 78" wide and greater include a reinforcement cantilever for added stability.

PRODUCT CODE	PRICE		SIZE/INCHES			WEIGHT LBS	VOL FT <sup>3</sup>
	LP	HP	H	W	D		
SCTLCSL3666	2413	2673	36	66	36	153.40	8.38
SCTLCSL3672	2604	2888	36	72	36	164.14	8.92
SCTLCSL3678	2793	3100	36	78	36	177.32	9.46
SCTLCSL3684	2837	3168	36	84	36	188.05	10.00
SCTLCSL3690	3176	3530	36	90	36	198.79	10.54
SCTLCSL3696	3219	3597	36	96	36	209.52	11.08
SCTLCSL4266	2529	2832	36	66	42	171.05	9.47
SCTLCSL4272	2727	3057	36	72	42	183.17	10.07
SCTLCSL4278	2922	3280	36	78	42	197.73	10.67
SCTLCSL4284	2972	3358	36	84	42	209.84	11.28
SCTLCSL4290	3317	3730	36	90	42	221.96	11.88
SCTLCSL4296	3366	3807	36	96	42	234.08	12.49
SCTLCSL4866	2663	3009	36	66	48	188.69	10.56
SCTLCSL4872	2866	3244	36	72	48	202.19	11.22
SCTLCSL4878	3067	3477	36	78	48	218.14	11.89
SCTLCSL4884	3123	3564	36	84	48	231.63	12.56
SCTLCSL4890	3474	3947	36	90	48	245.13	13.22
SCTLCSL4896	3530	4034	36	96	48	258.63	13.89

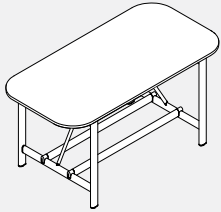


# COLLABORATIVE SPACES

## SCTLCLL • Large Collaboration Table, 36" Café Height, Large Radius, Levelers



For 66" to 90" wide tables

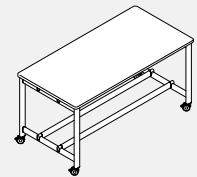


For 96" wide tables

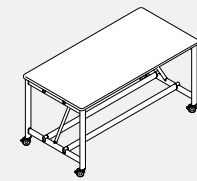
- Large Café Height Collaboration Tables on levelers consist of two leg assemblies, two worksurface support beams and a one worksurface with a large 9" radius at each corner with 10.5" overhang on each end.
- Surface available in LP - Low Pressure or HP - High Pressure laminates.
- Legs are painted extruded aluminum. Levelers have 1" adjustment for leveling.
- Cutouts for power modules are limited to specific sizes/configurations, please see Grommet Location Chart.
- Tables 78" wide and greater include a reinforcement cantilever for added stability.
- Note: Large radius tables are not compatible with SCTAMxx and SCTAMTx Media Units.

PRODUCT CODE	PRICE		SIZE/INCHES			WEIGHT LBS	VOL FT <sup>3</sup>
	LP	HP	H	W	D		
SCTLCLL3666	2324	2584	36	66	36	143.48	8.38
SCTLCLL3672	2368	2652	36	72	36	154.21	8.92
SCTLCLL3678	2500	2807	36	78	36	164.95	9.46
SCTLCLL3684	2544	2875	36	84	36	175.68	10.00
SCTLCLL3690	2735	3090	36	90	36	186.42	10.54
SCTLCLL3696	2924	3302	36	96	36	199.60	11.08
SCTLCLL4266	2441	2744	36	66	42	161.12	9.47
SCTLCLL4272	2491	2821	36	72	42	173.24	10.07
SCTLCLL4278	2629	2987	36	78	42	185.36	10.67
SCTLCLL4284	2679	3065	36	84	42	197.47	11.28
SCTLCLL4290	2876	3290	36	90	42	209.59	11.88
SCTLCLL4296	2724	3165	36	96	42	224.15	12.49
SCTLCLL4866	2574	2921	36	66	48	178.77	10.56
SCTLCLL4872	2630	3008	36	72	48	192.27	11.22
SCTLCLL4878	2775	3184	36	78	48	205.77	11.89
SCTLCLL4884	2830	3271	36	84	48	219.26	12.56
SCTLCLL4890	3034	3506	36	90	48	232.76	13.22
SCTLCLL4896	3235	3739	36	96	48	248.71	13.89

## SCTL CSC • Large Collaboration Table, 36" Café Height, Small Radius, Casters



For 66" to 90" wide tables

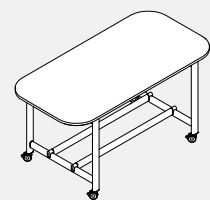


For 96" wide tables

- Large Café Height Collaboration Tables on casters consist of two leg assemblies, two worksurface support beams, dual footrests and a one worksurface with a small 1.5" radius at each corner.
- Surface available in LP - Low Pressure or HP - High Pressure laminates.
- Legs are painted extruded aluminum. Casters are lockable, in a choice of two finishes.
- Cutouts for power modules are limited to specific sizes/configurations, please see Grommet Location Chart.
- Tables 78" wide and greater include a reinforcement cantilever for added stability.

PRODUCT CODE	PRICE		SIZE/INCHES			WEIGHT LBS	VOL FT <sup>3</sup>
	LP	HP	H	W	D		
SCTL CSC3666	2609	2869	36	66	36	153.24	8.38
SCTL CSC3672	2801	3084	36	72	36	163.97	8.92
SCTL CSC3678	2990	3297	36	78	36	177.15	9.46
SCTL CSC3684	3033	3364	36	84	36	187.89	10.00
SCTL CSC3690	3372	3726	36	90	36	198.62	10.54
SCTL CSC3696	3416	3794	36	96	36	209.36	11.08
SCTL CSC4266	2726	3029	36	66	42	170.88	9.47
SCTL CSC4272	2923	3254	36	72	42	183.00	10.07
SCTL CSC4278	3118	3477	36	78	42	197.56	10.67
SCTL CSC4284	3168	3554	36	84	42	209.68	11.28
SCTL CSC4290	3513	3926	36	90	42	221.80	11.88
SCTL CSC4296	3563	4004	36	96	42	233.91	12.49
SCTL CSC4866	2859	3205	36	66	48	188.53	10.56
SCTL CSC4872	3062	3440	36	72	48	202.03	11.22
SCTL CSC4878	3264	3673	36	78	48	217.97	11.89
SCTL CSC4884	3320	3761	36	84	48	231.47	12.56
SCTL CSC4890	3671	4143	36	90	48	244.97	13.22
SCTL CSC4896	3727	4231	36	96	48	258.47	13.89

## SCTLCLC • Large Collaboration Table, 36" Café Height, Large Radius, Casters



For 66" to 90" wide tables



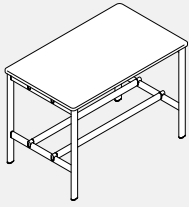
For 96" wide tables

- Large Café Height Collaboration Tables on casters consist of two leg assemblies, two worksurface support beams and a one worksurface with a large 9" radius at each corner with 10.5" overhang on each end.
- Surface available in LP - Low Pressure or HP - High Pressure laminates.
- Legs are painted extruded aluminum. Casters are lockable, in a choice of two finishes.
- Cutouts for power modules are limited to specific sizes/configurations, please see Grommet Location Chart.
- Tables 78" wide and greater include a reinforcement cantilever for added stability.
- Note: Large radius tables are not compatible with SCTAMxx and SCTAMTx Media Units.

PRODUCT CODE	PRICE		SIZE/INCHES			WEIGHT LBS	VOL FT <sup>3</sup>
	LP	HP	H	W	D		
SCTLCLC3666	2521	2781	36	66	36	143.31	8.38
SCTLCLC3672	2565	2848	36	72	36	154.05	8.92
SCTLCLC3678	2697	3004	36	78	36	164.78	9.46
SCTLCLC3684	2741	3071	36	84	36	175.52	10.00
SCTLCLC3690	2932	3286	36	90	36	186.25	10.54
SCTLCLC3696	3121	3499	36	96	36	199.43	11.08
SCTLCLC4266	2637	2940	36	66	42	160.96	9.47
SCTLCLC4272	2687	3018	36	72	42	173.07	10.07
SCTLCLC4278	2825	3184	36	78	42	185.19	10.67
SCTLCLC4284	2875	3261	36	84	42	197.31	11.28
SCTLCLC4290	3073	3486	36	90	42	209.43	11.88
SCTLCLC4296	3268	3709	36	96	42	223.98	12.49
SCTLCLC4866	2771	3117	42	66	48	178.60	10.56
SCTLCLC4872	2826	3204	42	72	48	192.10	11.22
SCTLCLC4878	2971	3380	42	78	48	205.60	11.89
SCTLCLC4884	3027	3468	42	84	48	219.10	12.56
SCTLCLC4890	3230	3703	42	90	48	232.60	13.22
SCTLCLC4896	3432	3936	42	96	48	248.54	13.89

# COLLABORATIVE SPACES

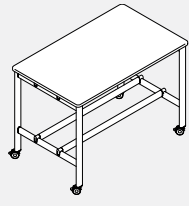
## SCTSBSL • Workshop Table, 42" Bar Height, Small Radius, Levelers



- Bar Height Workshop Tables on levelers consist of two leg assemblies, two worksurface support beams, dual footrests and a one worksurface with a small 1.5" radius at each corner.
- Surface available in LP - Low Pressure or HP - High Pressure laminates.
- Legs are painted extruded aluminum. Levelers have 1" adjustment for leveling.
- Cutouts for power modules are limited to specific sizes/configurations, please see Grommet Location Chart.

PRODUCT CODE	PRICE		SIZE/INCHES			WEIGHT LBS	VOL FT <sup>3</sup>
	LP	HP	H	W	D		
SCTSBSL3636	1918	2060	42	36	36	99.27	5.67
SCTSBSL3642	2094	2260	42	42	36	110.00	6.21
SCTSBSL3648	2294	2483	42	48	36	123.64	6.75
SCTSBSL3654	2338	2551	42	54	36	134.38	7.29
SCTSBSL3660	2470	2707	42	60	36	145.11	7.83
SCTSBSL4242	2186	2379	42	42	42	122.12	7.05
SCTSBSL4248	2392	2613	42	48	42	137.14	7.65
SCTSBSL4254	2442	2690	42	54	42	149.26	8.26
SCTSBSL4260	2581	2856	42	60	42	161.38	8.86
SCTSBSL4848	2507	2759	42	48	48	150.64	8.56
SCTSBSL4854	2563	2847	42	54	48	164.14	9.22
SCTSBSL4860	2708	3023	42	60	48	177.64	9.89

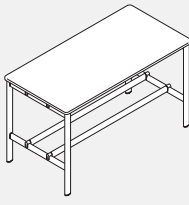
## SCTSBSC • Workshop Table, 42" Bar Height, Small Radius, Casters



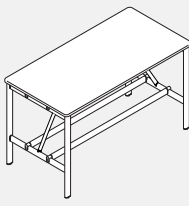
- Bar Height Workshop Tables on casters consist of two leg assemblies, two worksurface support beams, dual footrests and a one worksurface with a small 1.5" radius at each corner.
- Surface available in LP - Low Pressure or HP - High Pressure laminates.
- Legs are painted extruded aluminum. Levelers have 1" adjustment for leveling.
- Cutouts for power modules are limited to specific sizes/configurations, please see Grommet Location Chart.

PRODUCT CODE	PRICE		SIZE/INCHES			WEIGHT LBS	VOL FT <sup>3</sup>
	LP	HP	H	W	D		
SCTSBSC3636	2055	2197	42	36	36	99.10	5.67
SCTSBSC3642	2232	2397	42	42	36	109.84	6.21
SCTSBSC3648	2432	2621	42	48	36	123.48	6.75
SCTSBSC3654	2476	2688	42	54	36	134.21	7.29
SCTSBSC3660	2608	2844	42	60	36	144.95	7.83
SCTSBSC4242	2324	2517	42	42	42	121.95	7.05
SCTSBSC4248	2530	2750	42	48	42	136.98	7.65
SCTSBSC4254	2580	2828	42	54	42	149.09	8.26
SCTSBSC4260	2718	2994	42	60	42	161.21	8.86
SCTSBSC4848	2645	2897	42	48	48	150.47	8.56
SCTSBSC4854	2701	2984	42	54	48	163.97	9.22
SCTSBSC4860	2845	3160	42	60	48	177.47	9.89

## SCTLBSL • Large Collaboration Table, 42" Bar Height, Small Radius, Levelers



For 66" and 72" wide tables



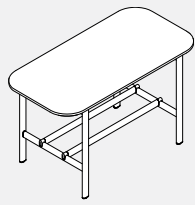
For 78" to 96" wide tables

- Large Bar Height Collaboration Tables on levelers consist of two leg assemblies, two worksurface support beams, dual footrests and a one worksurface with a small 1.5" radius at each corner.
- Surface available in LP - Low Pressure or HP - High Pressure laminates.
- Legs are painted extruded aluminum. Levelers have 1" adjustment for leveling.
- Cutouts for power modules are limited to specific sizes/configurations, please see Grommet Location Chart.
- Tables 78" wide and greater include a reinforcement cantilever for added stability.

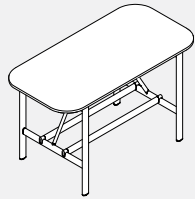
PRODUCT CODE	PRICE		SIZE/INCHES			WEIGHT LBS	VOL FT <sup>3</sup>
	LP	HP	H	W	D		
SCTLBSL3666	2514	2774	42	66	36	155.85	8.38
SCTLBSL3672	2705	2989	42	72	36	166.58	8.92
SCTLBSL3678	2917	3224	42	78	36	179.76	9.46
SCTLBSL3684	2960	3291	42	84	36	190.50	10.00
SCTLBSL3690	3299	3653	42	90	36	201.23	10.54
SCTLBSL3696	3343	3721	42	96	36	211.97	11.08
SCTLBSL4266	2630	2934	42	66	42	173.49	9.47
SCTLBSL4272	2828	3158	42	72	42	185.61	10.07
SCTLBSL4278	3045	3403	42	78	42	200.17	10.67
SCTLBSL4284	3095	3481	42	84	42	212.29	11.28
SCTLBSL4290	3440	3853	42	90	42	224.41	11.88
SCTLBSL4296	3490	3931	42	96	42	236.52	12.49
SCTLBSL4866	2764	3110	42	66	48	191.14	10.56
SCTLBSL4872	2967	3345	42	72	48	204.64	11.22
SCTLBSL4878	3191	3600	42	78	48	220.58	11.89
SCTLBSL4884	3247	3687	42	84	48	234.08	12.56
SCTLBSL4890	3597	4070	42	90	48	247.58	13.22
SCTLBSL4896	3653	4157	42	96	48	261.08	13.89

# COLLABORATIVE SPACES

## SCTLBLL • Large Collaboration Table, 42" Bar Height, Large Radius, Levelers



For 66" to 90" wide tables

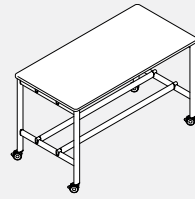


For 96" wide tables

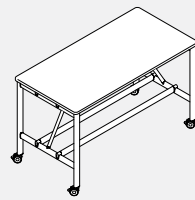
- Large Bar Height Collaboration Tables on levelers consist of two leg assemblies, two worksurface support beams and a one worksurface with a large 9" radius at each corner with 10.5" overhang on each end.
- Surface available in LP - Low Pressure or HP - High Pressure laminates.
- Legs are painted extruded aluminum. Levelers have 1" adjustment for leveling.
- Cutouts for power modules are limited to specific sizes/configurations, please see Grommet Location Chart.
- Tables 78" wide and greater include a reinforcement cantilever for added stability.
- Note: Large radius tables are not compatible with SCTAMxx and SCTAMTx Media Units.

PRODUCT CODE	PRICE		SIZE/INCHES			WEIGHT LBS	VOL FT <sup>3</sup>
	LP	HP	H	W	D		
SCTLBLL3666	2426	2685	42	66	36	145.92	8.38
SCTLBLL3672	2469	2753	42	72	36	156.66	8.92
SCTLBLL3678	2729	3036	42	78	36	167.39	9.46
SCTLBLL3684	2772	2976	42	84	36	178.13	10.00
SCTLBLL3690	2964	3191	42	90	36	188.86	10.54
SCTLBLL3696	3026	3403	42	96	36	202.04	11.08
SCTLBLL4266	2542	2845	42	66	42	163.57	9.47
SCTLBLL4272	2592	2922	42	72	42	175.68	10.07
SCTLBLL4278	2857	3088	42	78	42	187.80	10.67
SCTLBLL4284	2907	3166	42	84	42	199.92	11.28
SCTLBLL4290	3104	3391	42	90	42	212.04	11.88
SCTLBLL4296	3173	3613	42	96	42	226.60	12.49
SCTLBLL4866	2675	3022	42	66	48	181.21	10.56
SCTLBLL4872	2731	3109	42	72	48	194.71	11.22
SCTLBLL4878	3003	3285	42	78	48	208.21	11.89
SCTLBLL4884	3059	3372	42	84	48	221.71	12.56
SCTLBLL4890	3262	3607	42	90	48	235.21	13.22
SCTLBLL4896	3336	3840	42	96	48	251.15	13.89

## SCTLBSC • Large Collaboration Table, 42" Bar Height, Small Radius, Casters



For 66" and 72" wide tables

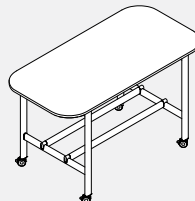


For 78" to 96" wide tables

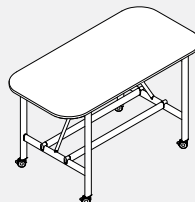
- Large Bar Height Collaboration Tables on casters consist of two leg assemblies, two worksurface support beams and a one worksurface with a small 1.5" radius at each corner.
- Surface available in LP - Low Pressure or HP - High Pressure laminates.
- Legs are painted extruded aluminum. Casters are lockable, in a choice of two finishes.
- Cutouts for power modules are limited to specific sizes/configurations, please see Grommet Location Chart.
- Tables 78" wide and greater include a reinforcement cantilever for added stability.

PRODUCT CODE	PRICE		SIZE/INCHES			WEIGHT LBS	VOL FT <sup>3</sup>
	LP	HP	H	W	D		
SCTLBSC3666	2652	2911	42	66	36	155.68	8.38
SCTLBSC3672	2843	3126	42	72	36	166.42	8.92
SCTLBSC3678	3054	3361	42	78	36	179.60	9.46
SCTLBSC3684	3098	3428	42	84	36	190.33	10.00
SCTLBSC3690	3436	3791	42	90	36	201.07	10.54
SCTLBSC3696	3480	3858	42	96	36	211.80	11.08
SCTLBSC4266	2768	3071	42	66	42	173.33	9.47
SCTLBSC4272	2965	3296	42	72	42	185.45	10.07
SCTLBSC4278	3183	3541	42	78	42	200.00	10.67
SCTLBSC4284	3232	3618	42	84	42	212.12	11.28
SCTLBSC4290	3577	3991	42	90	42	224.24	11.88
SCTLBSC4296	3627	4068	42	96	42	236.36	12.49
SCTLBSC4866	2901	3248	42	66	48	190.97	10.56
SCTLBSC4872	3105	3483	42	72	48	204.47	11.22
SCTLBSC4878	3328	3737	42	78	48	220.41	11.89
SCTLBSC4884	3384	3825	42	84	48	233.91	12.56
SCTLBSC4890	3735	4207	42	90	48	247.41	13.22
SCTLBSC4896	3791	4295	42	96	48	260.91	13.89

## SCTLBLC • Large Collaboration Table, 42" Bar Height, Large Radius, Casters



For 66" to 90" wide tables

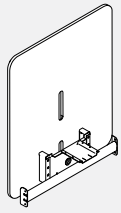


For 96" wide tables

- Large Bar Height Collaboration Tables on casters consist of two leg assemblies, two worksurface support beams and a one worksurface with a large 9" radius at each corner with 10.5" overhang on each end.
- Surface available in LP - Low Pressure or HP - High Pressure laminates.
- Legs are painted extruded aluminum. Casters are lockable, in a choice of two finishes.
- Cutouts for power modules are limited to specific sizes/configurations, please see Grommet Location Chart.
- Tables 96" wide include a reinforcement cantilever for added stability.
- Note: Large radius tables are not compatible with SCTAMxx and SCTAMTx Media Units.

PRODUCT CODE	PRICE		SIZE/INCHES			WEIGHT LBS	VOL FT <sup>3</sup>
	LP	HP	H	W	D		
SCTLBLC3666	2563	2823	42	66	36	145.75	8.38
SCTLBLC3672	2607	2890	42	72	36	156.49	8.92
SCTLBLC3678	2739	3046	42	78	36	167.23	9.46
SCTLBLC3684	2783	3113	42	84	36	177.96	10.00
SCTLBLC3690	2974	3328	42	90	36	188.70	10.54
SCTLBLC3696	3163	3541	42	96	36	201.87	11.08
SCTLBLC4266	2679	2983	42	66	42	163.40	9.47
SCTLBLC4272	2729	3060	42	72	42	175.52	10.07
SCTLBLC4278	2868	3226	42	78	42	187.63	10.67
SCTLBLC4284	2917	3303	42	84	42	199.75	11.28
SCTLBLC4290	3115	3528	42	90	42	211.87	11.88
SCTLBLC4296	3310	3751	42	96	42	226.43	12.49
SCTLBLC4866	2813	3159	42	66	48	181.04	10.56
SCTLBLC4872	2869	3247	42	72	48	197.54	11.22
SCTLBLC4878	3013	3422	42	78	48	208.04	11.89
SCTLBLC4884	3069	3510	42	84	48	221.54	12.56
SCTLBLC4890	3272	3745	42	90	48	235.04	13.22
SCTLBLC4896	3474	3978	42	96	48	250.98	13.89

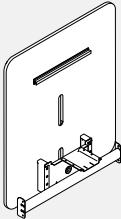
**SCTAM • Collaboration Table Media Unit**



- Collaboration Table Media Unit can be affixed to all small radius tables of the same nominal width. User side is thermally fused laminate to accept TV mounts. Side facing away from users features a tackable PET panel affixed to the thermally fused laminate with a 0.5" inset.
- Surface available in LP - Low Pressure Laminate.
- Felt backer available in all standard finishes.
- Brackets and reinforcement bar is painted metal.
- TV mount not included.
- Units 36" wide can accept TV's up to 40", not exceeding 50 lbs.
- Units 42" wide can accept TV's up to 43", not exceeding 50 lbs.
- Units 48" wide can accept TV's up to 55", not exceeding 50 lbs.

PRODUCT CODE	PRICE LP	SIZE/INCHES			WEIGHT VOL	
		H	W	D	LBS	FT <sup>3</sup>
SCTAM36	748	43	36	11.25	46.28	10.08
SCTAM42	767	43	42	11.25	52.50	11.76
SCTAM48	826	43	48	11.25	58.83	13.44

**SCTAMT • Collaboration Table Media Unit with TV Mount**



- Collaboration Table Media Unit with TV Mount can be affixed to all small radius tables of the same nominal width. User side is thermally fused laminate and includes a TV mount. Side facing away from users features a tackable PET panel affixed to the thermally fused laminate with a 0.5" inset.
- Surface available in LP - Low Pressure Laminate.
- Felt backer available in all standard finishes.
- Brackets and reinforcement bar is painted metal.
- Units 36" wide can accept TV's up to 40", not exceeding 50 lbs.
- Units 42" wide can accept TV's up to 43", not exceeding 50 lbs.
- Units 48" wide can accept TV's up to 55", not exceeding 50 lbs.

PRODUCT CODE	PRICE LP	SIZE/INCHES			WEIGHT VOL	
		H	W	D	LBS	FT <sup>3</sup>
SCTAMT36	942	43	36	11.25	47.58	10.08
SCTAMT42	961	43	42	11.25	53.80	11.76
SCTAMT48	1020	43	48	11.25	60.13	13.44

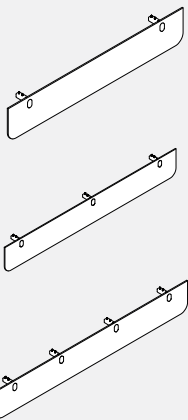
**SCTAL • Table Leg Cable Organizer**



- Table Leg Cable organizer snaps on to any leg to manage wires vertically. Black only.

PRODUCT CODE	PRICE	SIZE/INCHES			WEIGHT VOL	
		H	W	D	LBS	FT <sup>3</sup>
SCTAL21	29	21	2.965	2.21	0.60	0.09
SCTAL23	33	23	2.965	2.21	0.60	0.09

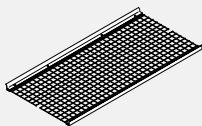
**SCTAP • PET Felt Modesty Panel**



- PET Felt modesty panel with metal brackets for use on Core, Standard and Workshop tables.
- Modesty panels 36" to 54" include two brackets.
- Modesty panels 60" to 90" include three brackets.
- Modesty panels 96" include four brackets.
- Specify matching nominal width to table.
- PET Felt available in standard finishes.

PRODUCT CODE	PRICE	SIZE/INCHES			WEIGHT VOL	
		H	W	D	LBS	FT <sup>3</sup>
SCTAP36	75	11	33	4.75	1.78	1.00
SCTAP42	81	11	39	4.75	1.99	1.18
SCTAP48	81	11	45	4.75	2.14	1.36
SCTAP54	85	11	51	4.75	2.38	1.54
SCTAP60	114	11	57	4.75	2.53	1.72
SCTAP66	118	11	63	4.75	2.68	1.90
SCTAP72	122	11	69	4.75	2.87	2.09
SCTAP78	126	11	75	4.75	3.05	2.27
SCTAP84	137	11	81	4.75	3.23	2.45
SCTAP90	149	11	87	4.75	3.41	2.63
SCTAP96	162	11	93	4.75	3.59	2.81

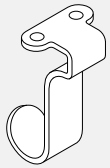
**SCTAT • Wire Mesh Storage Tray**



- Steel storage tray is attached between dual stretchers on tables 48"d x 48"w and larger.
- Specify matching nominal width to table.
- Can be combined with SCTAM/SCTAMT Media Units on any size table noted above with levelers and up to table sizes 48" d x 78" w on casters.
- Cannot be combined with SCTAM/SCTAMT Media Units on tables on casters over 78" w.

PRODUCT CODE	PRICE	SIZE/INCHES			WEIGHT VOL	
		H	W	D	LBS	FT <sup>3</sup>
SCTAT4848	204	1.6	42	22	7.85	0.98
SCTAT4854	229	1.6	48	22	8.97	1.10
SCTAT4860	260	1.6	54	22	10.09	1.22
SCTAT4866	294	1.6	60	22	11.19	1.34
SCTAT4872	392	1.6	66	22	12.29	1.47
SCTAT4878	403	1.6	72	22	13.40	1.59
SCTAT4884	417	1.6	78	22	14.52	1.71
SCTAT4890	481	1.6	84	22	15.62	1.83
SCTAT4896	495	1.6	90	22	16.72	1.96

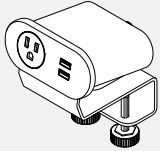
**SCTAH • Table Mounted Bag Hook**



- Steel hook for use on Collaborative tables.
- Specify standard metal paint finish.
- Maximum capacity of 10 lbs.

PRODUCT CODE	PRICE	SIZE/INCHES			WEIGHT VOL	
		H	W	D	LBS	FT <sup>3</sup>
SCTAH	16	3.5	1.5	0.65	0.30	

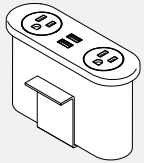
**SCTAPE • Nik Edge/Clamp Mount Power Module**



- Nik Edge/Clamp Mount Power Module in black with black receptacles, 10ft cord.
- Specify configuration, last letter of the code represents the following:
- A = 1 AC, 1 USB-A 1.5A charge port, 1 USB-A 2.4A quick charge port
- B = 2 AC
- C = 2 AC, 1 USB-A 1.5A charge port, 1 USB-A 2.4A quick charge port
- D = 1 AC, 1 USB-A 1.5A charge port, 1 USB-A 2.4A quick charge port, 1 60W USB-C charge port
- E = 3 AC

PRODUCT CODE	PRICE	SIZE/INCHES			WEIGHT VOL	
		H	W	D	LBS	FT <sup>3</sup>
SCTAPEA	516	3.7	6	2.10	4.00	
SCTAPEB	491	3.7	6	2.10	4.00	
SCTAPEC	569	3.7	6	2.10	4.00	
SCTAPED	672	3.7	6	2.10	4.00	
SCTAPEE	502	3.7	6	2.10	4.00	

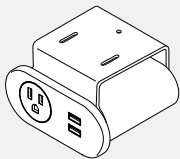
**SCTAPS • Nik In-Surface Power Module**



- Nik In-Surface Power Module in black with black receptacles, 10ft cord.
- Specify configuration, last letter of the code represents the following:
- C = 2 AC, 1 USB-A 1.5A charge port, 1 USB-A 2.4A quick charge port
- D = 1 AC, 1 USB-A 1.5A charge port, 1 USB-A 2.4A quick charge port, 1 60W USB-C charge port
- E = 3 AC

PRODUCT CODE	PRICE	SIZE/INCHES			WEIGHT VOL	
		H	W	D	LBS	FT <sup>3</sup>
SCTAPSC	578	3.7	6	2.10	4.00	0.03
SCTAPSD	718	3.7	6	2.10	4.00	0.03
SCTAPSE	509	3.7	6	2.10	4.00	0.03

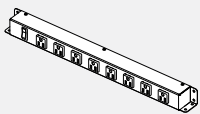
**SCTAPB • Nik Below Surface Power Module**



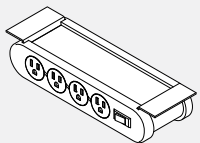
- Nik Below Surface Power Module in black with black receptacles, 10ft cord.
- Specify configuration, last letter of the code represents the following:
- A = 1 AC, 1 USB-A 1.5A charge port, 1 USB-A 2.4A quick charge port
- B = 2 AC
- C = 2 AC, 1 USB-A 1.5A charge port, 1 USB-A 2.4A quick charge port
- D = 1 AC, 1 USB-A 1.5A charge port, 1 USB-A 2.4A quick charge port, 1 60W USB-C charge port
- E = 3 AC

PRODUCT CODE	PRICE	SIZE/INCHES			WEIGHT VOL	
		H	W	D	LBS	FT <sup>3</sup>
SCTAPBA	562	3.7	6	2.10	4.00	0.03
SCTAPBB	512	3.7	6	2.10	4.00	0.03
SCTAPBC	596	3.7	6	2.10	4.00	0.03
SCTAPBD	741	3.7	6	2.10	4.00	0.03
SCTAPBE	524	3.7	6	2.10	4.00	0.03

**SCTAPPB • Below Surface Power Bar**



SCTAPPBS



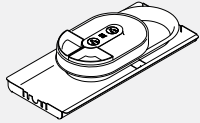
SCTAPPBD

- Below surface power bar is black only.
- Single (SCTAPPBS) includes 8 outlets on a single side.
- Double (SCTAPPBD) includes 4 outlets on each side of the bar. Built-in circuit breaker (shown).
- Cord length is 10'.

PRODUCT CODE	PRICE	SIZE/INCHES			WEIGHT VOL	
		H	W	D	LBS	FT <sup>3</sup>
SCTAPPBS	436	1.95	21	1.95	2.70	0.06
SCTAPPBD	1069	2.3	10.6	4.00	4.00	0.05



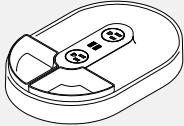
**SCTAPT • Collaborative Spaces Power Tray**



- Black plastic power tray with removable grey accessory trays. Top tray is offset for cable storage underneath. Recessed tray sits 3.7" below surface to keep cables out of sight.
- Specify configuration, last letter of the code represents the following.
- 10ft cord.
- C = 2 AC, 1 USB-A 1.5A charge port, 1 USB-A 2.4A quick charge port
- D = 1 AC, 1 USB-A 1.5A charge port, 1 USB-A 2.4A quick charge port, 1 60W USB-C charge port
- E = 3 AC

PRODUCT CODE	PRICE	SIZE/INCHES			WEIGHT VOL	
		H	W	D	LBS	FT <sup>3</sup>
SCTAPTC	858	4.53	23.26	10.51	7.73	0.64
SCTAPTD	999	4.53	23.26	10.51	7.73	0.64
SCTAPTE	789	4.53	23.26	10.51	7.73	0.64

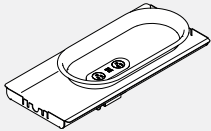
**SCTAOT • Collaborative Spaces Organizer Tray**



- Black plastic power tray with removable grey accessory trays. Top tray is offset for cable storage underneath. Recessed tray sits 3.7" below surface to keep cables out of sight.
- Specify configuration, last letter of the code represents the following:
- 10ft cord.
- C = 2 AC, 1 USB-A 1.5A charge port, 1 USB-A 2.4A quick charge port
- D = 1 AC, 1 USB-A 1.5A charge port, 1 USB-A 2.4A quick charge port, 1 60W USB-C charge port
- E = 3 AC

PRODUCT CODE	PRICE	SIZE/INCHES			WEIGHT VOL	
		H	W	D	LBS	FT <sup>3</sup>
SCTAOTC	639	4.28	12.40	8.32	1.50	0.26
SCTAOTD	779	4.28	12.40	8.32	1.50	0.26
SCTAOTE	570	4.28	12.40	8.32	1.50	0.26

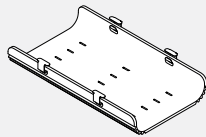
**SCTAPR • Collaborative Spaces Recessed Power Tray**



- Black plastic power tray. Recessed tray sits 3.7" below surface to keep cables out of sight.
- Specify configuration, last letter of the code represents the following:
- 10ft cord.
- C = 2 AC, 1 USB-A 1.5A charge port, 1 USB-A 2.4A quick charge port
- D = 1 AC, 1 USB-A 1.5A charge port, 1 USB-A 2.4A quick charge port, 1 60W USB-C charge port
- E = 3 AC

PRODUCT CODE	PRICE	SIZE/INCHES			WEIGHT VOL	
		H	W	D	LBS	FT <sup>3</sup>
SCTAPRC	760	6.4	23.26	10.51	6.06	0.91
SCTAPRD	900	6.4	23.26	10.51	6.06	0.91
SCTAPRE	691	6.4	23.26	10.51	6.06	0.91

**SCTACT • Collaborative Spaces PET Felt Wire Manager**

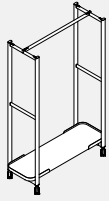


- PET Felt Wire Manager hangs from four brackets under the surface.
- Includes black painted metal brackets.
- PET Felt available in standard finishes.

PRODUCT CODE	PRICE	SIZE/INCHES			WEIGHT VOL	
		H	W	D	LBS	FT <sup>3</sup>
SCTACT	80	4	11	26	1.10	0.66



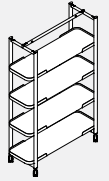
**SCCR • Coat Rack Cart**



- Cart includes side rails for compatible accessories and a single top rail for hanging coats, jackets, etc.
- Shelf available in LP - Low Pressure laminate.
- Painted aluminum frame available in standard paint finishes.
- Casters are lockable, in a choice of two finishes.

PRODUCT CODE	PRICE LP	SIZE/INCHES			WEIGHT LBS	VOL FT <sup>3</sup>
		H	W	D		
SCCR1848	1818	72	48	18	56.82	36.04
SCCR1860	1876	72	60	18	62.77	45.05

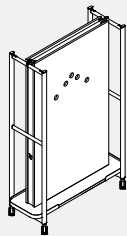
**SCCS • Shelf Cart**



- Cart includes four fixed shelves with metal trim detail. Vertical rails accept PET privacy panels (sold separately) to create space division within open areas.
- Horizontal top rail accepts compatible accessories.
- Shelves available in LP - Low Pressure laminate.
- Painted aluminum frame available in standard paint finishes.
- Casters are lockable, in a choice of two finishes.

PRODUCT CODE	PRICE LP	SIZE/INCHES			WEIGHT LBS	VOL FT <sup>3</sup>
		H	W	D		
SCCS1848	3400	72	48	18	123.88	36.04

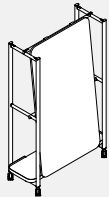
**SCCM • Media Cart**



- Media Cart includes a bottom shelf and thermally fused laminate TV board. Short side panels feature small cutout for wire pass thru and hook for wire management.
- Side rails accept compatible accessories.
- Shelf available in LP - Low Pressure laminate.
- Back panel is removeable for access to cavity for cable management. Back panel is whiteboard laminate.
- SCCMEP models include a power bar (SCCAMP) mounted internally.
- SCCMNE models do not include any power.
- Units 48" wide can accept TV's up to 55", not exceeding 50lbs.
- Units 60" wide can accept TV's up to 60", not exceeding 50lbs.
- Painted aluminum frame available in standard paint finishes.
- Casters are lockable, in a choice of two finishes.
- Note: TV mount included. TV and video conferencing units are not included.

PRODUCT CODE	PRICE LP	SIZE/INCHES			WEIGHT LBS	VOL FT <sup>3</sup>
		H	W	D		
SCCMEP1848	3515	72	48	18	171.42	36.04
SCCMEP1860	3945	72	60	18	214.23	45.05
SCCMNE1848	3343	72	48	18	170.92	36.04
SCCMNE1860	3772	72	60	18	213.73	45.05

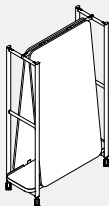
**SCCSW • Single Sided Whiteboard Cart**



- Cart includes one fixed shelf with metal trim detail, accessible from behind whiteboard.
- Front of vertical whiteboard panel is whiteboard only.
- Side rails accept compatible accessories.
- Back of vertical whiteboard panel is DWTL P - Designer White laminate with DWE - Designer White edging.
- Shelf available in LP - Low Pressure laminate.
- Painted aluminum frame available in standard paint finishes.
- Casters are lockable, in a choice of two finishes.

PRODUCT CODE	PRICE LP	SIZE/INCHES			WEIGHT LBS	VOL FT <sup>3</sup>
		H	W	D		
SCCSW1848	3011	72	48	18	106.37	36.04
SCCSW1860	3531	72	60	18	191.07	45.05

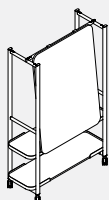
**SCCDW • Double Side Whiteboard Cart**



- Cart includes one fixed shelf with metal trim detail, accessible from behind whiteboard.
- Front of vertical whiteboard panels are whiteboard only.
- Side rails accept compatible accessories.
- Back of vertical whiteboard panels are DWTL P - Designer White laminate with DWE - Designer White edging.
- Shelf available in LP - Low Pressure laminate.
- Painted aluminum frame available in standard paint finishes.
- Casters are lockable, in a choice of two finishes.

PRODUCT CODE	PRICE LP	SIZE/INCHES			WEIGHT LBS	VOL FT <sup>3</sup>
		H	W	D		
SCCDW1848	4061	72	48	18	153.96	36.04
SCCDW1860	5027	72	60	18	191.07	45.05

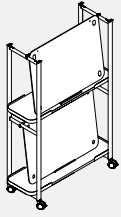
**SCCCW • Combo Whiteboard Cart**



- Cart includes two fixed shelves with metal trim detail. Bottom shelf is accessible from both sides of cart, top shelf accessible from behind whiteboard.
- Front of vertical whiteboard panel is whiteboard only.
- Side rails accept compatible accessories.
- Back of vertical whiteboard panel is DWTL P - Designer White laminate with DWE - Designer White edging.
- Shelves available in LP - Low Pressure laminate.
- Painted aluminum frame available in standard paint finishes.
- Casters are lockable, in a choice of two finishes.

PRODUCT CODE	PRICE LP	SIZE/INCHES			WEIGHT LBS	VOL FT <sup>3</sup>
		H	W	D		
SCCCW1848	3250	72	48	18	115.66	36.04
SCCCW1860	3736	72	60	18	150.33	45.05

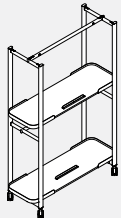
**SCCRW • Removable Whiteboard Cart**



- Cart includes two fixed shelves with spacers for removeable whiteboards.
- Includes five lightweight removeable whiteboard panels.
- One whiteboard can be stored at the top and four at the bottom.
- Cart accepts five lightweight removeable whiteboard panels maximum.
- Whiteboards feature whiteboard front and DWTHP - Designer White laminate back with DWE - Designer White edge.
- Hanging bracket finish matches the cart frame finish.
- Shelves available in LP - Low Pressure laminate.
- Side rails accept compatible accessories.
- Painted aluminum frame available in standard paint finishes.
- Casters are lockable, in a choice of two finishes.

PRODUCT CODE	PRICE LP	SIZE/INCHES			WEIGHT VOL	
		H	W	D	LBS	FT <sup>3</sup>
SCCRW1848	5013	72	48	18	188	42.05
SCCRW1860	5724	72	60	18	245.61	52.56

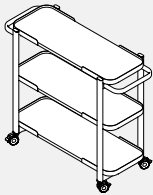
**SCCEW • Empty Removeable Whiteboard/Privacy Cart**



- Cart includes two fixed shelves with spacers for removeable whiteboards.
- Cart accepts five lightweight removeable whiteboard panels maximum.
- One whiteboard can be stored at the top and four at the bottom.
- To order Removeable Whiteboard, specify SCCAWB3336 for the 48" wide cart and SCCAWB3348 for the 60" wide cart.
- Hanging bracket finish matches the cart frame finish.
- Shelves available in LP - Low Pressure laminate.
- Side rails accept compatible accessories.
- Painted aluminum frame available in standard paint finishes.
- Casters are lockable, in a choice of two finishes.

PRODUCT CODE	PRICE LP	SIZE/INCHES			WEIGHT VOL	
		H	W	D	LBS	FT <sup>3</sup>
SCCEW1848	2455	72	48	18	82.31	42.05
SCCEW1860	2597	72	60	18	105.70	52.56

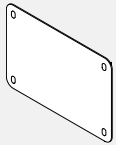
**SCHC • Hospitality Cart**



- Hospitality Cart includes three fixed shelves with metal trim.
- Surfaces available in LP - Low Pressure laminate.
- Legs and handles are painted aluminum available in standard paint finishes.
- Note: size is inclusive of handles, shelf sizing is approximately 10" shorter.

PRODUCT CODE	PRICE LP	SIZE/INCHES			WEIGHT VOL	
		H	W	D	LBS	FT <sup>3</sup>
SCHC2233	2653	41	43	18	81.31	15.39
SCHC2239	2763	41	49	18	95	17.96

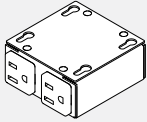
**SCCAPP • Cart Mounted PET Felt Privacy Panels**



- Lightweight removeable PET Felt panels, specify SCCAPP3248 for the 48" w cart and SCCAPP3260 for the 60" w cart.
- Snaps onto (SCCEWxxxx) vertical rails at various shelf heights to create space division and privacy.
- Cover caps painted metal finish should be specified to match the cart finish.
- PET Felt available in standard finishes.

PRODUCT CODE	PRICE	SIZE/INCHES			WEIGHT VOL	
		H	W	D	LBS	FT <sup>3</sup>
SCCAPP3248	223	32	48	0.5	4.16	0.32
SCCAPP3260	331	32	60	0.5	5.16	0.40

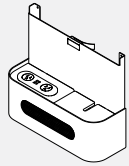
**SCCAMP • Concealed Power Unit**



- Provided inside SCCMEPxxxx media units, can be added to SCCNMExxxx in field.
- Includes two AC outlets.
- Compatible with Mobile Media Carts only.
- BLK - Black finish only.

PRODUCT CODE	PRICE	SIZE/INCHES			WEIGHT VOL	
		H	W	D	LBS	FT <sup>3</sup>
SCCAMP	251	1.5	3	3.00	0.50	0.01

**SCCAMT • Media Tray**



- Attaches to the front of the SCCMEPxxxx/SCCNMExxxx to provide a wire catch, wireless receiver area and easily accessible power at the front of the media carts.
- Compatible with Mobile Media Carts only.
- Tray is painted metal with a PET Felt insert.
- PET Felt available in 18 standard finishes.
- SCCAMT is empty and has no power capabilities.
- Specify configuration, last letter of the code represents the following:  
 • C = 2 AC, 1 USB-A 1.5A charge port, 1 USB-A 2.4A quick charge port  
 • D = 1 AC, 1 USB-A 1.5A charge port, 1 USB-A 2.4A quick charge port, 1 60W USB-C charge port  
 • E = 3 AC

PRODUCT CODE	PRICE	SIZE/INCHES			WEIGHT VOL	
		H	W	D	LBS	FT <sup>3</sup>
SCCAMT	611	13.80	14.57	5.60	12	0.65
SCCAMTPC	1189	13.80	14.57	5.60	12	0.65
SCCAMTPD	1329	13.80	14.57	5.60	12	0.65
SCCAMTPE	1120	13.80	14.57	5.60	12	0.65

**SCCAC • Accessory Cup**



- Hangs onto any team cart horizontal top or side rail. Black only.

PRODUCT CODE	PRICE	SIZE/INCHES			WEIGHT VOL	
		H	W	D	LBS	FT <sup>3</sup>
SCCAC	9	3.7	3.3	3.00	0.15	0.02

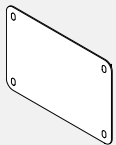
**SCCAH • Hook for Team Cart**



- Hangs onto any team cart horizontal top or side rail.
- Black only
- Maximum capacity of 10 lbs.

PRODUCT CODE	PRICE	SIZE/INCHES			WEIGHT VOL	
		H	W	D	LBS	FT <sup>3</sup>
SCCAH	6	1.8	1.3	0.65	0.10	

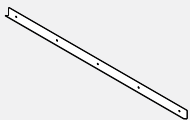
**SCCAWB • Whiteboard**



- Lightweight removeable whiteboard panels.
- Specify SCCAWB3336 for the 48" w cart and SCCAWB3348 for the 60" w cart.
- Back of whiteboard is DWT - Designer White with DWE - Designer White edging.
- Cover caps painted metal finish should be specified to match the cart finish.
- Horizontal and vertical mounting on wall rail(s).

PRODUCT CODE	PRICE	SIZE/INCHES			WEIGHT VOL	
		H	W	D	LBS	FT <sup>3</sup>
SCCAWB3336	501	33	36	0.50	17.62	0.34
SCCAWB3348	620	33	48	0.50	23.32	0.46

**SCCAWBR • Whiteboard Wall Rail**



- Wall rail for whiteboards.
- Accepts SCCAWBxxxx.
- Metal extrusion in BLK - Black only.

PRODUCT CODE	PRICE	SIZE/INCHES			WEIGHT VOL	
		H	W	D	LBS	FT <sup>3</sup>
SCCAWBR36	51	2	36	1	1.27	0.04
SCCAWBR48	63	2	48	1	1.71	0.05
SCCAWBR72	102	2	72	1.00	2.54	0.08
SCCAWBR96	126	2	96	1.00	3.42	0.11

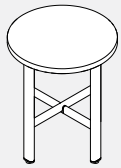
**SCCALSL • Laptop Shelf**



- Laminate laptop shelf with dual bracket.
- Can be flipped vertically to store when cart is not in use.
- Shelf available in LP - Low Pressure laminate.
- Bracket included is painted metal finish and should be specified to match the cart finish.

PRODUCT CODE	PRICE	SIZE/INCHES			WEIGHT VOL	
		H	W	D	LBS	FT <sup>3</sup>
SCCALSL1219	243	3	19	12	11.07	

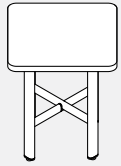
**SCOR • Occasional Side Table, Round Top**



- Occasional End Table includes leg assembly, cross beams and one worksurface.
- Surface available in LP - Low Pressure laminate.
- Legs and cross beam are painted aluminum available in standard paint finishes.

PRODUCT CODE	PRICE LP	SIZE/INCHES			WEIGHT LBS	VOL FT <sup>3</sup>
		H	W	D		
SCOR1818	514	21	18	18	18.52	3.94
SCOR2424	584	21	24	24	26.53	7.01

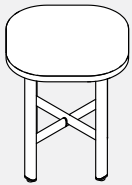
**SCOC • Occasional Side Table, Square Top**



- Occasional End Table includes leg assembly, cross beams and one worksurface with a small 1.5" radius at each corner.
- Surface available in LP - Low Pressure laminate.
- Legs and cross beam are painted aluminum available in standard paint finishes.

PRODUCT CODE	PRICE LP	SIZE/INCHES			WEIGHT LBS	VOL FT <sup>3</sup>
		H	W	D		
SCOC1818	514	21	18	18	21.12	3.94
SCOC2424	584	21	24	24	31.20	7.01

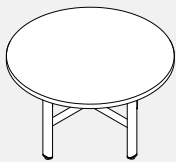
**SCOCL • Occasional Side Table, Square Top, Larger Radius**



- Occasional End Table includes leg assembly, cross beams and one worksurface with a larger 9" radius at each corner.
- Surface available in LP - Low Pressure laminate.
- Legs and cross beam are painted aluminum available in standard paint finishes.

PRODUCT CODE	PRICE LP	SIZE/INCHES			WEIGHT LBS	VOL FT <sup>3</sup>
		H	W	D		
SCOCL1818	550	21	18	18	21.12	3.94
SCOCL2424	648	21	24	24	31.20	7.01

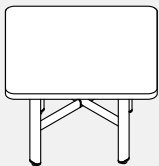
**SCOCR • Occasional Coffee Table, Round Top**



- Occasional End Table includes leg assembly, cross beams and one worksurface.
- Surface available in LP - Low Pressure laminate.
- Legs and cross beam are painted aluminum available in standard paint finishes.

PRODUCT CODE	PRICE LP	SIZE/INCHES			WEIGHT LBS	VOL FT <sup>3</sup>
		H	W	D		
SCOCR2424	563	17	24	24	25.55	5.67
SCOCR3030	643	17	30	30	35.76	8.86
SCOCR3636	739	17	36	36	48.13	12.76

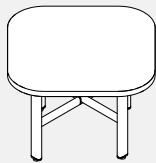
**SCOCS • Occasional Coffee Table, Square Top**



- Occasional Coffee Table includes leg assembly, cross beams and one worksurface with a small 1.5" radius at each corner.
- Surface available in LP - Low Pressure laminate.
- Legs and cross beam are painted aluminum available in standard paint finishes.

PRODUCT CODE	PRICE LP	SIZE/INCHES			WEIGHT LBS	VOL FT <sup>3</sup>
		H	W	D		
SCOCS2424	563	17	24	24	30.22	5.67
SCOCS3030	643	17	30	30	43.10	8.86

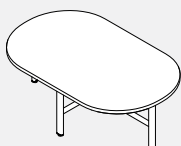
**SCOCSL • Occasional Coffee Table, Square Top, Larger Radius**



- Occasional Coffee Table includes leg assembly, cross beams and one worksurface with a larger 9" radius at each corner.
- Surface available in LP - Low Pressure laminate.
- Legs and cross beam are painted aluminum available in standard paint finishes.

PRODUCT CODE	PRICE LP	SIZE/INCHES			WEIGHT LBS	VOL FT <sup>3</sup>
		H	W	D		
SCOCSL2424	563	17	24	24	29.11	5.67
SCOCSL3030	643	17	30	30	41.99	8.86

**SCOCC • Occasional Coffee Table, Racetrack Top**



- Occasional Coffee Table includes leg assembly, cross beams and one racetrack worksurface.
- Surface available in LP - Low Pressure laminate.
- Legs and cross beam are painted aluminum available in standard paint finishes.

PRODUCT CODE	PRICE LP	SIZE/INCHES			WEIGHT LBS	VOL FT <sup>3</sup>
		H	W	D		
SCOCC2442	676	17	24	42	42.78	9.93
SCOCC3048	777	17	30	48	57.13	14.18

**SCLCC • Laptop Table, Racetrack Top, Wheel and Foot Base**



- Laptop Table includes leg assembly and two wheels with rubber trim, one leg assembly with a foot and one racetrack worksurface.
- Two bag hooks included, one on the exterior of each leg, mounted just under the surface for easy access.
- Each bag hook accepts up to 10 lbs, and painted to match the legs.
- Legs, beams and hook are painted aluminum available in standard paint finishes.
- Wheel insert is painted to match the legs and beams.
- Surface available in LP - Low Pressure laminate.

PRODUCT CODE	PRICE LP	SIZE/INCHES			WEIGHT		VOL FT <sup>3</sup>
		H	W	D	LBS		
SCLCC1633	901	26	33	16	25.60	6.51	

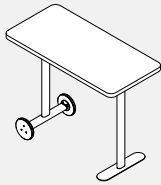
**SCLCB • Laptop Table, Racetrack Top, Foot Base**



- Laptop Table includes two leg assemblies a foot and one racetrack worksurface.
- Two bag hooks included, one on the exterior of each leg, mounted just under the surface for easy access.
- Each bag hook accepts up to 10 lbs, and painted to match the legs.
- Legs and beams are painted aluminum available in standard paint finishes.
- Surface available in LP - Low Pressure laminate.

PRODUCT CODE	PRICE LP	SIZE/INCHES			WEIGHT		VOL FT <sup>3</sup>
		H	W	D	LBS		
SCLCB1633	516	26	33	16	23.85	6.51	

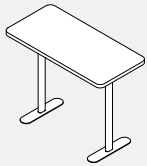
**SCLTC • Laptop Table, Rectangular Top, Small Radius, Wheel and Foot Base**



- Laptop Table includes leg assembly and two wheels with rubber trim, one leg assembly with a foot and one rectangular worksurface with a small 1.5" radius at each corner.
- Two bag hooks included, one on the exterior of each leg, mounted just under the surface for easy access.
- Each bag hook accepts up to 10 lbs, and painted to match the legs.
- Legs and beams are painted aluminum available in standard paint finishes.
- Wheel insert is painted to match the legs and beams.
- Surface available in LP - Low Pressure laminate.

PRODUCT CODE	PRICE LP	SIZE/INCHES			WEIGHT		VOL FT <sup>3</sup>
		H	W	D	LBS		
SCLTC1633	901	26	33	16	27.64	6.51	

**SCLTB • Laptop Table, Rectangular Top, Base**



- Laptop Table includes two leg assemblies a foot and one rectangular worksurface with a small 1.5" radius at each corner.
- Two bag hooks included, one on the exterior of each leg, mounted just under the surface for easy access.
- Each bag hook accepts up to 10 lbs, and painted to match the legs.
- Legs and beams are painted aluminum available in standard paint finishes.
- Surface available in LP - Low Pressure laminate.

PRODUCT CODE	PRICE LP	SIZE/INCHES			WEIGHT		VOL FT <sup>3</sup>
		H	W	D	LBS		
SCLTB1633	516	26	33	16	25.88	6.51	

**Guideline for Ordering Product**

**CODES:** The price list uses a numbering system with meaningful alphanumeric characters to create a simple-to-understand product number. This makes specifying the product much easier and more accurate.

**SPECIFICATION EXAMPLE OF A HEIGHT ADJUSTABLE TABLE**

Ordered as components, please order:

**1, BASE**

**PRODUCT CODE:**

FT - FreeFit  
 5 - Standard Range Legs  
 2 - Leg Quantity  
 SF - Small Frame  
 24 - Depth  
 CL - C-leg Style  
 S - Standard Controller



**OPTIONS:**

Frame Style: 5 - Standard Range Frame 27.5" to 47"  
 6 - Extended Range Frame 22.5" to 48.5"

Leg Quantity: 1 - 1 Leg for return Kit  
 2 - 2 Leg table Kit  
 3 - 3 Leg Table Kit  
 4 - 4 Leg Table Kit

Frame Size: SF - Small Frame, for 42" to 60" wide Tables  
 LF - Large Frame, for 66" to 84" wide Tables

Worksurface Depth: 24 - For 23" deep worksurfaces  
 30 - For 29" and 35" deep worksurfaces

Leg Style: CL - C Shaped Table Leg  
 TL - T Shaped Table Leg

Controller Style: S - Standard Controller  
 D - Display Controller

Base Finish: BLK - Black  
 DWT - Designer White  
 TUN - Tungsten

The following finishes are available for minimum orders of 72 legs for special projects. For customer who request the finishes below, and do not meet the 72 legs threshold, a 30% surcharge will apply to the base and an extended lead time of 6 weeks.

BZD - Blizzard                      SIL - Silver  
 CHR - Charcoal                    FOG - Steel  
 NEV - Nevada                    TPE - Taupe  
 SDT - Stonedust

**2, TOP**

**PRODUCT CODE:**

FTWR2436

Top: LP = LP (Low Pressure Laminate) Thickness 1"  
 HP = HP (High Pressure Laminate) Thickness 1 1/16"

Top Finish Laminate: Choose Colour

Top PVC Edging: Choose Colour

**3, ACCESSORIES**

**PRODUCT CODE:**

FTAEC12

Base Finish: BLK - Black  
 DWT - Designer White  
 TUN - Tungsten

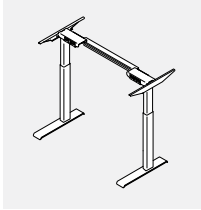
The following finishes are available for minimum orders of 72 legs for special projects. For customer who request the finishes below, and do not meet the 72 legs threshold, a 30% surcharge will apply to the base and an extended lead time of 6 weeks.

BZD - Blizzard                      SIL - Silver  
 CHR - Charcoal                    FOG - Steel  
 NEV - Nevada                    TPE - Taupe  
 SDT - Stonedust

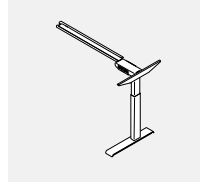


**Height Adjustable Tables • Product Map**

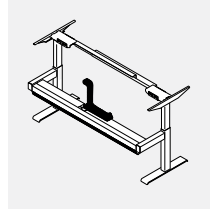
**C-Leg Base**  
Standard and Extended Range



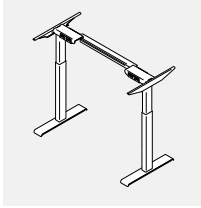
**90 Degree Retrofit Kit with C-Leg**  
Standard and Extended Range



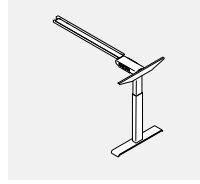
**Single Frame**  
Standard and Extended Range



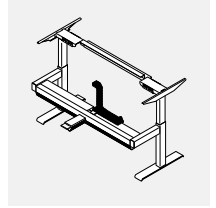
**T-Leg Base**  
Standard and Extended Range



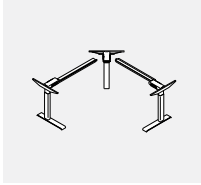
**90 Degree Retrofit Kit with T-Leg**  
Standard and Extended Range



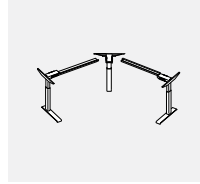
**Single End of Run Frame**  
Standard and Extended Range



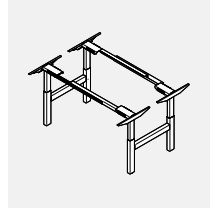
**90 Degree Table Base, Equal Sides**  
Standard and Extended Range



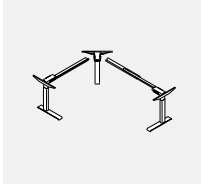
**120 Degree Table Base**  
Standard and Extended Range



**Media Table Frame**  
Standard and Extended Range



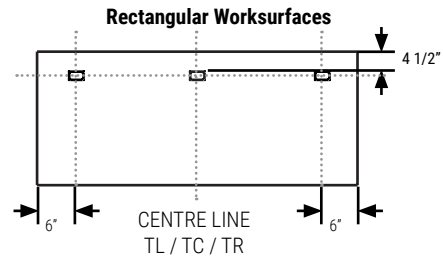
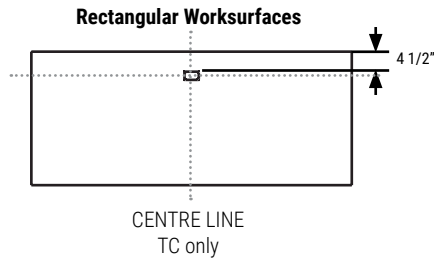
**90 Degree Table Base, Unequal Sides**  
Standard and Extended Range



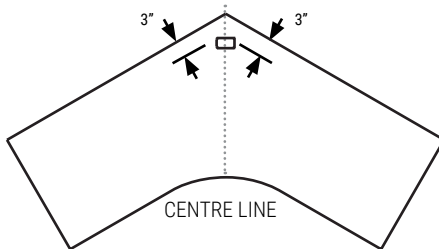
**Back to Back Frame**  
Standard and Extended Range



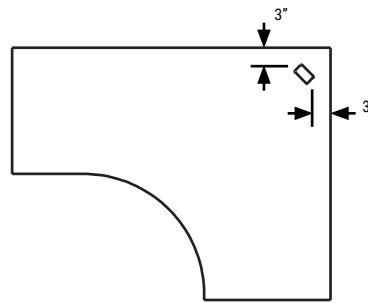
**FREEFIT GROMMET LOCATION**



**120° Corner Table Top**

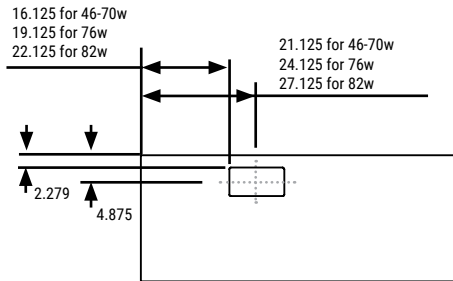


**90° Extended Corner Worksurface**

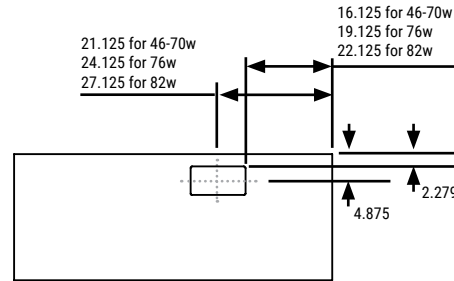


For FTWR worksurfaces 64" and larger, TL/TR, TL/TC and TC/TR are also available.

**GAADxx Grommets Rectangular Worksurface TL**

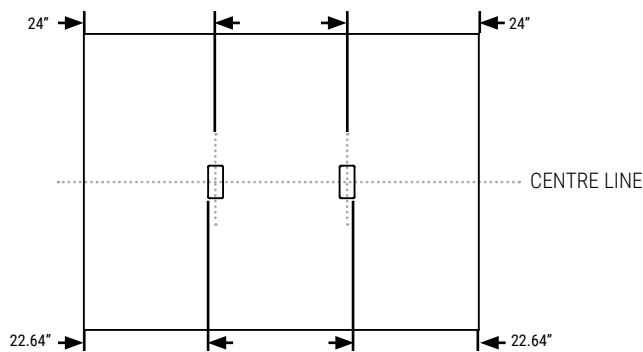


**GAADxx Grommets Rectangular Worksurface TR**



For Back to Back Tables and Freestanding Tables only. Not available for return table tops.

**Media Table Tops**



## General Specification

### FEATURES

- Table frames feature 80 X 50 mm rectangular outer leg with the large tube attached to the foot.
- Open base design with ample room for chair and user's legs.
- Flat foot design includes adjustable (10mm) glides.
- All table frames include expandable width upper crossbars to create a variety of size tables.
- Tables have no lower crossbars.
- All table frames are easy to assemble with few parts.
- Tables are designed so that the paint will never mar on the leg during operation.
- Steel construction of the leg assembly tubing, feet and upper structure assemblies.
- Powder coat finishes for bases standard in (DWT) Designer White, (BLK) Black and (TUN) Tungsten.
- All standard Global Contract laminate finishes are available.
- Sizes of tops are "nominal". Unless otherwise stated, actual depth is 1" less and actual width is 2" less than "nominal" size.
- Additional Finishes available minimum quantity of 72 legs (36 - 2 leg tables, 24 - 3 leg tables or 18 B2B Tables) Blizzard, Charcoal, Nevada, Silver, Steel, Stonedust, and Taupe
- All bases lift 350 lbs on two leg tables.
- All bases operate at 1.5" per second.
- Standard Range Frame adjusts from 27.5" to 47" including the worksurface.
- Extended Range Frame adjusts from 22.5" to 48.5" including the worksurface.
- Tops are warranted for lifetime and bases are warranted for 7 years.

### CERTIFICATIONS

Products are fully compliant with ANSI/BIFMA X5.5 – 2014, CAN/CGSB-44.227 - 2017; EN 60335-1 and UL962

All Global Contract Extended Range tables meet the BIFMA G1-2013 Ergonomic Guideline for "recommended adjustment range".

### EXTENDED RANGE COLUMNS

The 3-part construction ensures a short installation dimension combined with a long stroke length making the Extended Range Column the optimum choice no matter the height of the person using it. The middle profile of the column moves synchronously so the profiles are always in the same height optimising the desk design and the stability.

- Compact design where guide and actuator functions are an integrated unit
- Reinforced column and optimised motor housing design for extra strength and stability
- Maximum load 350 lbs. for 2 legged configurations, 525 lbs. for 3 legged configurations.
- Max. speed 38 mm/s unloaded
- Installation dimension: 560 mm 518 mm (BIFMA)
- Stroke length: 650 mm 665 mm (BIFMA)
- Dimensions column: 50 x 80 mm (outer profile), 43.5 x 73.5 mm (middle profile) and 37 x 67 mm (inner profile)
- Low noise level
- No visible gliding pads

### STANDARD RANGE COLUMNS

The 2-part lifting column is a perfect choice for a wide range of different desk applications in the office.

- Compact design where guide and actuator functions are an integrated unit
- Reinforced column and optimised motor housing design for extra strength and stability
- Maximum load 350 lbs. for 2 legged configurations, 525 lbs. for 3 legged configurations
- Max. speed: 38 mm/s unloaded
- Standard installation dimension 645 mm
- Standard stroke length 500 mm
- Dimensions column: 50 x 80 mm (outer profile) and 43.5 x 73.5 mm (inner profile)
- Dimension motor housing: 177 x 97 x 46 mm
- Low noise level
- No visible gliding pads

### FOOT

Freefit offers two foot styles either a "T" or "C".

The feet are available in two different lengths (560 mm and 710 mm). The foot offers a recessed connection for the column and connects from the bottom with 4 bolts. Adjustable glides are standard

### DESK MOUNT FRAME

- Can be specified in two lengths Short Frame (SF) for tables 42" – 60" in length. Long Frames (LF) for tables 66"– 84" in length
  - All metal parts Black
  - Cantilever length: 550 mm
  - Central or off-centre placement of columns (T-desk and C-desk)
- Includes all connecting hardware

### CONTROL BOX

Two leg tables come standard with a 200 W Control Box

- Mains voltage 230 VAC, 50 Hz, or 120 VAC, 60 Hz
- Ultra-compact; length 210 mm length
- Lightweight control box; weight only approx. 400 g

Three Leg Tables come standard with a 300 W Control Box

- can be connected up to 4 columns
- Mains voltage 100-240 VAC, 50-60 Hz (universal)
- Ultra-compact; length 265 mm length
- Lightweight control box; weight only approx. 500 g

Common features for the (200 W and 300 W):

- Ultra-low; height only 38 mm
- Environment: Operation Storage
- Ambient temperature: 5 to 40 °C -10 to +50 °C
- Relative humidity: 20 to 80 % at 30 °C 20 to 80 % at 30 °C
- Atmospheric pressure: 700 to 1060 hPa 700 to 1060 hPa
- Compact high-power SMPS (Switch Mode Power Supply)
- Colour: black
- Protection against overload (EOP), by individual current limitation
- The control box is designed with a soft start/stop function
- Autodetection of the number and type of columns connected
- Cable grooves at the bottom to optimise cable management
- White plugs for easy recognition when mounting/dismounting
- PVC-Free™
- Low standby power consumption – only 0.1 W.
- Exchangeable standard mains cable

### STANDARD UP/DOWN CONTROLLER

Features Bluetooth® connection, two favourite positions and a reminder via an LED to remind the users to use their desk. The Controller is activated by tilting the desk panel in the same direction as the desk is intended to drive. Via pulsating green and orange lights, the LED reminds the users to change positions. Using the integrated Bluetooth® and downloading the Desk Control™ App the user can also be reminded via notifications on computers and smart devices.

- Colour: Black
- Black cable with RJ45 modular plug, 1700 mm straight
- PVC-Free™
- Featuring ZERO™: Very low power consumption in standby mode
- Approved according to EN 60335-1
- Approved according to UL962

NOTE: All grommets must be specified separately.

**DISPLAY UP/DOWN CONTROLLER**

Features Bluetooth® connection, four favourite positions, a display to guide the users and a reminder via a light strip to remind the users to use their desks. The Controller is activated by tilting the desk panel in the same direction as the desk is intended to drive. The Display Controller features a modern discreet design with a glossy surface and an integrated display to ensure a clean and minimalist design. The display provides guidance to the users when operating the desk. Via pulsating green and orange lights, the light strip reminds the users to change positions. Using the integrated Bluetooth® and downloading the Desk Control™ App the users can also be reminded via notifications on smart devices.

- Colour: Black
- Black cable with RJ45 modular plug, 1700 mm straight
- PVC-Free™
- Featuring ZERO™: Very low power consumption in standby mode
- Approved according to EN 60335-1
- Approved according to UL962

**ANTI COLLISION SENSOR**

Features enhanced Anti-Collision protection which can limit material damage to a desk or an object if a collision occurs during driving of the desk. The sensor is a compact plug-in adapter based on gyroscope-technology, and it detects even little tilting of the desk when the desk is driving up or down. Upon detected tilting, the system stops and drives in the opposite direction to avoid collision and damage to the desk or the object. The sensor can detect both hard and soft obstacles. The Anti-Collision Sensor is standard on all desks.

- Reacts to angle changes bigger than 0.7° per second
- Just plug it in – no mounting required
- ZERO™ Power capable
- PVC-Free

**BATTERY BOX**

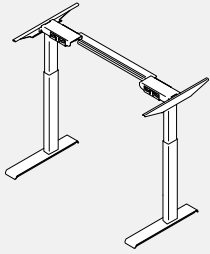
A high-performance lithium-Ion battery with a capacity of 2.15 Ah. On a full charge the table can cycle from 35 to 45 stroke lengths based upon the range of column selected and load on the table.

- Compact unit for easy handling and installation
- Battery alarm (audio) when charging is needed
- Battery charging indicator (LED light bars) indicating the capacity level
- Thermal switch protection, overcurrent protection
- Colour: black
- Battery capacity: 2.15 Ah / 52 Wh
- Nominal voltage: 24 V DC
- Discharge current: 9 A (max)
- Maximum charging voltage: 40 V DC
- Charging current: 0.5 A
- Weight: 600 g

**USAGE**

- Ambient temperature: 5 to 40 °C
- Storage temperature: 0 to 45 °C
- Approved according to:
  - EN 62133 (Battery safety testing)
  - UL 1642 (Lithium cells, standard test)
  - UN 38.3 (transportation of Lithium batteries)
  - UL 2054 (Household and commercial batteries)
  - EN 60335-1 with CBH Advanced

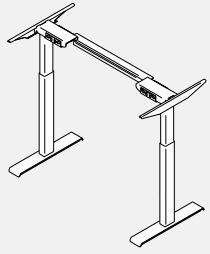
**FT52-CL • Standard Range Base with C-Legs**



- Kit includes one beam, two cantilevers, two standard range columns and two C styled feet.
- BF indicates a smaller frame for 30" to 42" tables.
- SF indicates small frame for 48" to 60" tables.
- LF indicates large frame: 66" to 84" tables.
- For 23" deep worksurfaces, use 24" CL leg.
- For 29" and 35" deep worksurface, use 30" CL leg.
- For enhanced collision detection an Anti Collision Desk Sensor included with every base.
- For Standard Up/Down Controller add (S) at the end of the code. For Display Controller, please add at "D" at the end of the product code and \$78 to the list price.
- Specify paint finish: BLK-Black, DWT-Designer White, TUN-Tungsten.

PRODUCT CODE	PRICE	HEIGHT MIN/MAX	WIDTH MIN/MAX	DEPTH MIN/MAX	WEIGHT LBS	VOL FT <sup>3</sup>
FT52BF24CL	1778	27.5" - 47"	30" - 42"	24" - 24"	56.12	2.3
FT52BF30CL	1791	27.5" - 47"	30" - 42"	30" - 30"	56.12	2.3
FT52SF24CL	1806	27.5" - 47"	48" - 60"	24" - 24"	56.12	2.3
FT52SF30CL	1821	27.5" - 47"	48" - 60"	30" - 36"	56.12	2.3
FT52LF24CL	1815	27.5" - 47"	66" - 84"	24" - 24"	59.3	2.3
FT52LF30CL	1827	27.5" - 47"	66" - 84"	30" - 36"	59.3	2.3

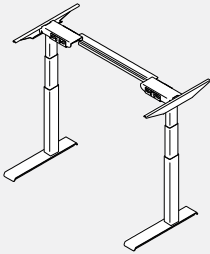
**FT52-TL • Standard Range Base with T-Legs**



- Kit includes one beam, two cantilevers, two standard range columns and two T styled feet.
- BF indicates a smaller frame for 30" to 42" tables.
- SF indicates small frame for 48" to 60" tables.
- LF indicates large frame: 66" to 84" tables.
- For 23" deep worksurfaces, use 24" TL leg.
- For 29" deep worksurface, use 30" TL leg.
- For enhanced collision detection an Anti Collision Desk Sensor included with every base.
- For Standard Up/Down Controller add (S) at the end of the code. For Display Controller, please add at "D" at the end of the product code and \$78 to the list price.
- Specify paint finish: BLK-Black, DWT-Designer White, TUN-Tungsten.

PRODUCT CODE	PRICE	HEIGHT MIN/MAX	WIDTH MIN/MAX	DEPTH MIN/MAX	WEIGHT LBS	VOL FT <sup>3</sup>
FT52BF24TL	1734	27.5" - 47"	30" - 42"	24" - 24"	56.12	2.3
FT52BF30TL	1748	27.5" - 47"	30" - 42"	30" - 30"	56.12	2.3
FT52SF24TL	1763	27.5" - 47"	48" - 60"	24" - 24"	56.12	2.3
FT52SF30TL	1778	27.5" - 47"	48" - 60"	30" - 36"	56.12	2.3
FT52LF24TL	1769	27.5" - 47"	66" - 84"	24" - 24"	59.3	2.3
FT52LF30TL	1784	27.5" - 47"	66" - 84"	30" - 36"	59.3	2.3

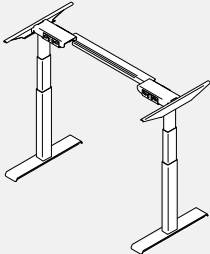
**FT62-CL • Extended Range Base with C-Legs**



- Kit includes one beam, two cantilevers, two extended range columns and two C styled feet.
- BF indicates a smaller frame for 30" to 42" tables.
- SF indicates small frame for 48" to 60" tables.
- LF indicates large frame: 66" to 84" tables.
- For 23" deep worksurfaces, use 24" CL leg.
- For 29" and 35" deep worksurface, use 30" CL leg.
- For enhanced collision detection an Anti Collision Desk Sensor included with every base.
- For Standard Up/Down Controller add (S) at the end of the code. For Display Controller, please add at "D" at the end of the product code and \$78 to the list price.
- Specify paint finish: BLK-Black, DWT-Designer White, TUN-Tungsten.

PRODUCT CODE	PRICE	HEIGHT MIN/MAX	WIDTH MIN/MAX	DEPTH MIN/MAX	WEIGHT LBS	VOL FT <sup>3</sup>
FT62BF24CL	1896	22.5" - 48.5"	30" - 42"	24" - 24"	56.12	2.3
FT62BF30CL	1911	22.5" - 48.5"	30" - 42"	30" - 30"	56.12	2.3
FT62SF24CL	1927	22.5" - 48.5"	48" - 60"	24" - 24"	59.3	2.3
FT62SF30CL	1941	22.5" - 48.5"	48" - 60"	30" - 36"	59.3	2.3
FT62LF24CL	1932	22.5" - 48.5"	66" - 84"	24" - 24"	64.7	2.3
FT62LF30CL	1947	22.5" - 48.5"	66" - 84"	30" - 36"	64.7	2.3

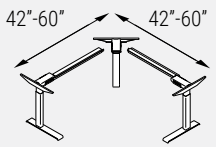
**FT62-TL • Extended Range Base with T-Legs**



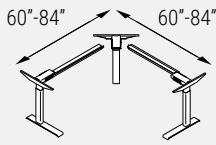
- Kit includes one beam, two cantilevers, two extended range columns and two T styled feet.
- BF indicates a smaller frame for 30" to 42" tables.
- SF indicates small frame for 48" to 60" tables.
- LF indicates large frame: 66" to 84" tables.
- For 23" deep worksurfaces, use 24" TL leg.
- For 29" deep worksurface, use 30" TL leg.
- For enhanced collision detection an Anti Collision Desk Sensor included with every base.
- For Standard Up/Down Controller add (S) at the end of the code. For Display Controller, please add at "D" at the end of the product code and \$78 to the list price.
- Specify paint finish: BLK-Black, DWT-Designer White, TUN-Tungsten.

PRODUCT CODE	PRICE	HEIGHT MIN/MAX	WIDTH MIN/MAX	DEPTH MIN/MAX	WEIGHT LBS	VOL FT <sup>3</sup>
FT62BF24TL	1854	22.5" - 48.5"	30" - 42"	24" - 24"	56.12	2.3
FT62BF30TL	1868	22.5" - 48.5"	30" - 42"	30" - 30"	56.12	2.3
FT62SF24TL	1884	22.5" - 48.5"	48" - 60"	24" - 24"	59.3	2.3
FT62SF30TL	1895	22.5" - 48.5"	48" - 60"	30" - 36"	59.3	2.3
FT62LF24TL	1890	22.5" - 48.5"	66" - 84"	24" - 24"	64.7	2.3
FT62LF30TL	1905	22.5" - 48.5"	66" - 84"	30" - 36"	64.7	2.3

**FT539F-CL • Standard Range 90 Degree Table Base, Equal Sides**



FS Base



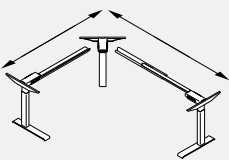
FL Base

- Kit includes two equal length beams, three cantilevers, one standard range corner column, two standard range columns and two C styled feet.
- FS indicates small base for 54" to 60" sided tables.
- FL indicates large base for 66" to 84" sided tables.
- For 23" deep worksurfaces, use 24" CL leg.
- For 29" and 35" deep worksurface, use 30" CL leg.

PRODUCT CODE	PRICE	HEIGHT MIN/MAX	WIDTH MIN/MAX	DEPTH MIN/MAX	WEIGHT LBS	VOL FT <sup>3</sup>
FT539FS24CL	2629	27.5" - 47"	42" - 60"	42" - 60"	79.1	4.7
FT539FS30CL	2644	27.5" - 47"	42" - 60"	42" - 60"	79.1	4.7
FT539FL24CL	2678	27.5" - 47"	66" - 84"	66" - 84"	59.3	4.7
FT539FL30CL	2690	27.5" - 47"	66" - 84"	66" - 84"	59.3	4.7

- For enhanced collision detection an Anti Collision Desk Sensor included with every base.
- For Standard Up/Down Controller add (S) at the end of the code. For Display Controller, please add at "D" at the end of the product code and \$78 to the list price.
- Specify paint finish: BLK-Black, DWT-Designer White, TUN-Tungsten.

**FT539FSL-CL • Standard Range 90 Degree Table Base, Unequal Sides**

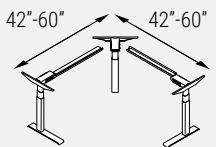


- Kit includes two beams (one small and one large), three cantilevers, one standard range corner column, two standard range columns and two C styled feet.
- For 23" deep worksurfaces, use 24" CL leg.
- For 29" and 35" deep worksurface, use 30" CL leg.

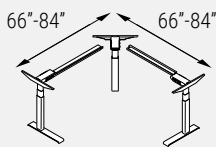
PRODUCT CODE	PRICE	HEIGHT MIN/MAX	WIDTH MIN/MAX	DEPTH MIN/MAX	WEIGHT LBS	VOL FT <sup>3</sup>
FT539FSL24CL	2652	27.5" - 47"	42" - 60"	66" - 84"	85.4	4.7
FT539FSL30CL	2666	27.5" - 47"	42" - 60"	66" - 84"	85.4	4.7

- For enhanced collision detection an Anti Collision Desk Sensor included with every base.
- For Standard Up/Down Controller add (S) at the end of the code. For Display Controller, please add at "D" at the end of the product code and \$78 to the list price.
- Specify paint finish: BLK-Black, DWT-Designer White, TUN-Tungsten.

**FT639F-CL • Extended Range 90 Degree Table Base, Equal Sides**



FS Base



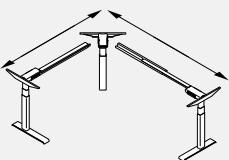
FL Base

- Kit includes two equal length beams, three cantilevers, one extended range corner column, two extended range columns and two C styled feet.
- FS indicates small base for 54" to 60" sided tables.
- FL indicates large base for 66" to 84" sided tables.
- For 23" deep worksurfaces, use 24" CL leg.
- For 29" and 35" deep worksurface, use 30" CL leg.

PRODUCT CODE	PRICE	HEIGHT MIN/MAX	WIDTH MIN/MAX	DEPTH MIN/MAX	WEIGHT LBS	VOL FT <sup>3</sup>
FT639FS24CL	2808	22.5" - 48.5"	42" - 60"	42" - 60"	76.5	4.7
FT639FS30CL	2822	22.5" - 48.5"	42" - 60"	42" - 60"	76.5	4.7
FT639FL24CL	2855	22.5" - 48.5"	66" - 84"	66" - 84"	82.7	4.7
FT639FL30CL	2869	22.5" - 48.5"	66" - 84"	66" - 84"	82.7	4.7

- For enhanced collision detection an Anti Collision Desk Sensor included with every base.
- For Standard Up/Down Controller add (S) at the end of the code. For Display Controller, please add at "D" at the end of the product code and \$78 to the list price.
- Specify paint finish: BLK-Black, DWT-Designer White, TUN-Tungsten.

**FT639FSL-CL • Extended Range 90 Degree Table Base, Unequal Sides**

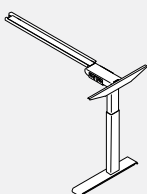


- Kit includes two beams (one small and one large), three cantilevers, one extended range corner column, two extended range columns and two C styled feet.
- For 23" deep worksurfaces, use 24" CL leg.
- For 29" and 35" deep worksurface, use 30" CL leg.

PRODUCT CODE	PRICE	HEIGHT MIN/MAX	WIDTH MIN/MAX	DEPTH MIN/MAX	WEIGHT LBS	VOL FT <sup>3</sup>
FT639FSL24CL	2832	22.5" - 48.5"	42" - 60"	48" - 84"	85.4	4.7
FT639FSL30CL	2845	22.5" - 48.5"	42" - 60"	48" - 84"	85.4	4.7

- For enhanced collision detection an Anti Collision Desk Sensor included with every base.
- For Standard Up/Down Controller add (S) at the end of the code. For Display Controller, please add at "D" at the end of the product code and \$78 to the list price.
- Specify paint finish: BLK-Black, DWT-Designer White, TUN-Tungsten.

**FT51-R-CL • Standard Range 90 Degree Table Retrofit Kit with with C-Leg**



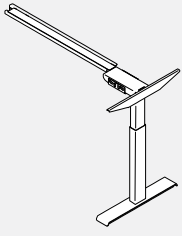
- Kit includes one beam, one cantilever, one standard range column and one C styled foot.
- SR indicates short returns.
- LR indicates long returns.
- For 23" deep worksurfaces, use 24" CL leg.
- For 29" and 35" deep worksurface, use 30" CL leg.

PRODUCT CODE	PRICE	HEIGHT MIN/MAX	WIDTH MIN/MAX	DEPTH MIN/MAX	WEIGHT LBS	VOL FT <sup>3</sup>
FT51SR24CL	1195	27.5" - 47"	24" - 48"	24" - 24"	24.9	4.7
FT51LR24CL	1219	27.5" - 47"	54" - 72"	24" - 24"	26.9	4.7
FT51SR30CL	1203	27.5" - 47"	24" - 48"	30" - 36"	24.9	4.7
FT51LR30CL	1225	27.5" - 47"	54" - 72"	30" - 36"	26.9	4.7

- Specify paint finish: BLK-Black, DWT-Designer White, TUN-Tungsten.



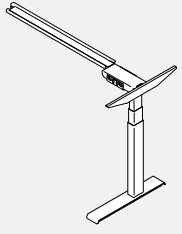
**FT51-R-TL • Standard Range 90 Degree Table Retrofit Kit with with T-Leg**



- Kit includes one beam, one cantilever, one standard range column and one T styled foot.
- SR indicates short returns.
- LR indicates long returns.
- For 23" deep worksurfaces, use 24" TL leg.
- For 29" and 35" deep work surface, use 30" TL leg.
- Specify paint finish: BLK-Black, DWT-Designer White, TUN-Tungsten.

PRODUCT CODE	PRICE	HEIGHT MIN/MAX	WIDTH MIN/MAX	DEPTH MIN/MAX	WEIGHT LBS	VOL FT <sup>3</sup>
FT51SR24TL	1176	27.5" - 47"	24" - 48"	24" - 24"	24.9	2.3
FT51LR24TL	1197	27.5" - 47"	54" - 72"	24" - 24"	26.9	2.3
FT51SR30TL	1181	27.5" - 47"	24" - 48"	30" - 36"	24.9	2.3
FT51LR30TL	1204	27.5" - 47"	54" - 72"	30" - 36"	26.9	2.3

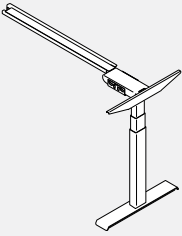
**FT61-R-CL • Extended Range 90 Degree Table Retrofit Kit with with C-Leg**



- Kit includes one beam, one cantilever, one extended range column and one C styled foot.
- SR indicates short returns.
- LR indicates long returns.
- For 23" deep worksurfaces, use 24" CL leg.
- For 29" and 35" deep work surface, use 30" CL leg.
- Specify paint finish: BLK-Black, DWT-Designer White, TUN-Tungsten.

PRODUCT CODE	PRICE	HEIGHT MIN/MAX	WIDTH MIN/MAX	DEPTH MIN/MAX	WEIGHT LBS	VOL FT <sup>3</sup>
FT61SR24CL	1255	22.5" - 48.5"	24" - 48"	24" - 24"	27.6	4.7
FT61LR24CL	1279	22.5" - 48.5"	54" - 72"	24" - 24"	30.7	4.7
FT61SR30CL	1262	22.5" - 48.5"	24" - 48"	30" - 36"	27.6	4.7
FT61LR30CL	1286	22.5" - 48.5"	54" - 72"	30" - 36"	30.7	4.7

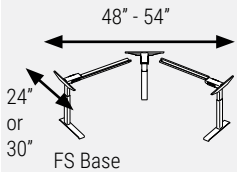
**FT61-R-TL • Extended Range 90 Degree Table Retrofit Kit with with T-Leg**



- Kit includes one beam, one cantilever, one extended range column and one T styled foot.
- SR indicates short returns.
- LR indicates long returns.
- For 23" deep worksurfaces, use 24" TL leg.
- For 29" and 35" deep work surface, use 30" TL leg.
- Specify paint finish: BLK-Black, DWT-Designer White, TUN-Tungsten.

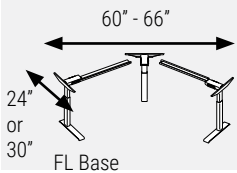
PRODUCT CODE	PRICE	HEIGHT MIN/MAX	WIDTH MIN/MAX	DEPTH MIN/MAX	WEIGHT LBS	VOL FT <sup>3</sup>
FT61SR24TL	1234	22.5" - 48.5"	24" - 48"	24" - 24"	27.6	2.3
FT61LR24TL	1257	22.5" - 48.5"	54" - 72"	24" - 24"	30.7	2.3
FT61SR30TL	1241	22.5" - 48.5"	24" - 48"	30" - 36"	27.6	2.3
FT61LR30TL	1265	22.5" - 48.5"	54" - 72"	30" - 36"	30.7	2.3

**FT531F-CL • Standard Range 120 Degree Table Base, Equal Sides**



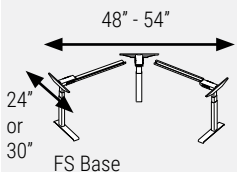
- Kit includes two beams, three cantilevers, one standard range corner column, two standard range columns and two C styled feet.
- FS indicates small base for 48" to 54" sided tables.
- FL indicates large base for 60" to 66" sided tables.
- For 23" deep worksurfaces, use 24" CL leg.
- For 29" and 35" deep work surface, use 30" CL leg.
- For enhanced collision detection an Anti Collision Desk Sensor included with every base.

PRODUCT CODE	PRICE	HEIGHT MIN/MAX	WIDTH MIN/MAX	DEPTH MIN/MAX	WEIGHT LBS	VOL FT <sup>3</sup>
FT531FS24CL	2629	27.5" - 47"	48" - 54"	48" - 54"	59.7	4.7
FT531FS30CL	2644	27.5" - 47"	48" - 54"	48" - 54"	59.7	4.7
FT531FL24CL	2678	27.5" - 47"	60" - 66"	60" - 66"	59.7	4.7
FT531FL30CL	2690	27.5" - 47"	60" - 66"	60" - 66"	59.7	4.7



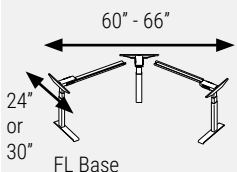
- For Standard Up/Down Controller add (S) at the end of the code. For Display Controller, please add at "D" at the end of the product code and \$78 to the list price.
- Specify paint finish: BLK-Black, DWT-Designer White, TUN-Tungsten.

**FT631F-CL • Extended Range 120 Degree Table Base, Equal Sides**



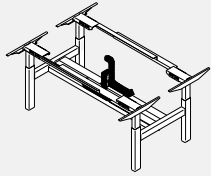
- Kit includes two beams, three cantilevers, one extended range corner column, two extended range columns and two C styled feet.
- FS indicates small base for 48" to 54" sided tables.
- FL indicates large base for 60" to 66" sided tables.
- For 23" deep worksurfaces, use 24" CL leg.
- For 29" and 35" deep work surface, use 30" CL leg.
- For enhanced collision detection an Anti Collision Desk Sensor included with every base.

PRODUCT CODE	PRICE	HEIGHT MIN/MAX	WIDTH MIN/MAX	DEPTH MIN/MAX	WEIGHT LBS	VOL FT <sup>3</sup>
FT631FS24CL	2808	22.5" - 48.5"	48" - 54"	48" - 54"	59.7	4.7
FT631FS30CL	2822	22.5" - 48.5"	48" - 54"	48" - 54"	59.7	4.7
FT631FL24CL	2855	22.5" - 48.5"	60" - 66"	60" - 66"	59.7	4.7
FT631FL30CL	2869	22.5" - 48.5"	60" - 66"	60" - 66"	59.7	4.7



- For Standard Up/Down Controller add (S) at the end of the code. For Display Controller, please add at "D" at the end of the product code and \$78 to the list price.
- Specify paint finish: BLK-Black, DWT-Designer White, TUN-Tungsten.

**FT5B2B • Back to Back Standard Range Base**



- Kit includes two beams, four cantilevers, four standard range columns and one power trough assembly with two energy chains.
- For 50.5" depth, use two x 23" deep worksurfaces.
- For 62.5" depth, use two x 29" deep worksurfaces.
- 30" or larger depth worksurfaces cannot be used with Back to Back bases.
- Duplex receptacles are not included, please specify separately.
- For enhanced collision detection an Anti Collision Desk Sensor included with every base.
- For Standard Up/Down Controller add (S) at the end of the code. For Display Controller, please add at "D" at the end of the product code and \$165 to the list price.
- Specify paint finish: BLK-Black, DWT-Designer White, TUN-Tungsten.

PRODUCT CODE	PRICE	HEIGHT MIN/MAX	WIDTH MIN/MAX	DEPTH MIN/MAX	WEIGHT LBS	VOL FT <sup>3</sup>
FT5B2B48	4977	27.5" - 47"	48" - 48"	50.5" - 62.5"	129	4.7
FT5B2B54	5014	27.5" - 47"	54" - 54"	50.5" - 62.5"	129	4.7
FT5B2B60	5066	27.5" - 47"	60" - 60"	50.5" - 62.5"	129	4.7
FT5B2B66	5104	27.5" - 47"	66" - 66"	50.5" - 62.5"	129	4.7
FT5B2B72	5117	27.5" - 47"	72" - 84"	50.5" - 62.5"	129	4.7

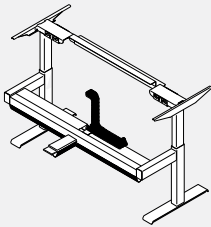
**FT6B2B • Back to Back Extended Range Base**



- Kit includes two beams, four cantilevers, four extended range columns and one power trough assembly with two energy chains.
- For 50.5" depth, use two x 23" deep worksurfaces.
- For 62.5" depth, use two x 29" deep worksurfaces.
- 30" or larger depth worksurfaces cannot be used with Back to Back bases.
- Duplex receptacles are not included, please specify separately.
- For enhanced collision detection an Anti Collision Desk Sensor included with every base.
- For Standard Up/Down Controller add (S) at the end of the code. For Display Controller, please add at "D" at the end of the product code and \$165 to the list price.
- Specify paint finish: BLK-Black, DWT-Designer White, TUN-Tungsten.

PRODUCT CODE	PRICE	HEIGHT MIN/MAX	WIDTH MIN/MAX	DEPTH MIN/MAX	WEIGHT LBS	VOL FT <sup>3</sup>
FT6B2B48	5204	22.5" - 48.5"	48" - 48"	50.5" - 62.5"	129	4.7
FT6B2B54	5241	22.5" - 48.5"	54" - 54"	50.5" - 62.5"	129	4.7
FT6B2B60	5294	22.5" - 48.5"	60" - 60"	50.5" - 62.5"	129	4.7
FT6B2B66	5331	22.5" - 48.5"	66" - 66"	50.5" - 62.5"	129	4.7
FT6B2B72	5343	22.5" - 48.5"	72" - 84"	50.5" - 62.5"	129	4.7

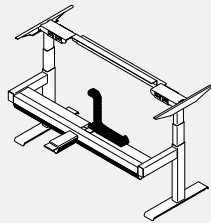
**FT5SGL-T • Standard Range Single Frame**



- Kit includes one beam, two cantilevers, two standard range columns, two T styled feet and one power trough assembly with one energy chains.
- For T24 leg, use 23" deep worksurfaces.
- For T30 leg, use 29" deep worksurfaces.
- 30" or larger depth worksurfaces cannot be used with Back to Back bases.
- Duplex receptacles are not included, please specify separately.
- For enhanced collision detection an Anti Collision Desk Sensor included with every base.
- For Standard Up/Down Controller add (S) at the end of the code. For Display Controller, please add at "D" at the end of the product code and \$78 to the list price.
- Specify paint finish: BLK-Black, DWT-Designer White, TUN-Tungsten.

PRODUCT CODE	PRICE	HEIGHT MIN/MAX	WIDTH MIN/MAX	DEPTH MIN/MAX	WEIGHT LBS	VOL FT <sup>3</sup>
FT5SGL48T24	2915	27.5" - 47"	48" - 48"	24" - 24"	75	2.3
FT5SGL54T24	2949	27.5" - 47"	54" - 54"	24" - 24"	75	2.3
FT5SGL60T24	2988	27.5" - 47"	60" - 60"	24" - 24"	75	2.3
FT5SGL66T24	3017	27.5" - 47"	66" - 66"	24" - 24"	75	2.3
FT5SGL72T24	3042	27.5" - 47"	72" - 84"	24" - 24"	75	2.3
FT5SGL48T30	2930	27.5" - 47"	48" - 48"	30" - 30"	75	2.3
FT5SGL54T30	2964	27.5" - 47"	54" - 54"	30" - 30"	75	2.3
FT5SGL60T30	3003	27.5" - 47"	60" - 60"	30" - 30"	75	2.3
FT5SGL66T30	3033	27.5" - 47"	66" - 66"	30" - 30"	75	2.3
FT5SGL72T30	3057	27.5" - 47"	72" - 84"	30" - 30"	75	2.3

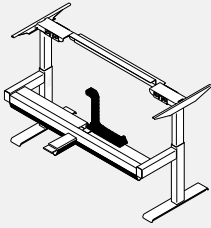
**FT6SGL-T • Extended Range Single Frame**



- Kit includes one beam, two cantilevers, two extended range columns, two (C or T) styled feet and one power trough assembly with one energy chain for single sided HA benching applications
- For T24 leg, use 23" deep worksurfaces.
- For T30 leg, use 29" deep worksurfaces.
- 30" or larger depth worksurfaces cannot be used with Back to Back bases.
- Duplex receptacles are not included, please specify separately.
- For enhanced collision detection an Anti Collision Desk Sensor included with every base.
- For Standard Up/Down Controller add (S) at the end of the code. For Display Controller, please add at "D" at the end of the product code and \$78 to the list price.
- Specify paint finish: BLK-Black, DWT-Designer White, TUN-Tungsten.

PRODUCT CODE	PRICE	HEIGHT MIN/MAX	WIDTH MIN/MAX	DEPTH MIN/MAX	WEIGHT LBS	VOL FT <sup>3</sup>
FT6SGL48T24	3029	22.5" - 48.5"	48" - 48"	24" - 24"	75	2.3
FT6SGL54T24	3063	22.5" - 48.5"	54" - 54"	24" - 24"	75	2.3
FT6SGL60T24	3103	22.5" - 48.5"	60" - 60"	24" - 24"	75	2.3
FT6SGL66T24	3132	22.5" - 48.5"	66" - 66"	24" - 24"	75	2.3
FT6SGL72T24	3157	22.5" - 48.5"	72" - 84"	24" - 24"	75	2.3
FT6SGL48T30	3043	22.5" - 48.5"	48" - 48"	30" - 30"	75	2.3
FT6SGL54T30	3076	22.5" - 48.5"	54" - 54"	30" - 30"	75	2.3
FT6SGL60T30	3115	22.5" - 48.5"	60" - 60"	30" - 30"	75	2.3
FT6SGL66T30	3146	22.5" - 48.5"	66" - 66"	30" - 30"	75	2.3
FT6SGL72T30	3170	22.5" - 48.5"	72" - 84"	30" - 30"	75	2.3

**FT5SGL-T • Standard Range End of Run Single Frame**

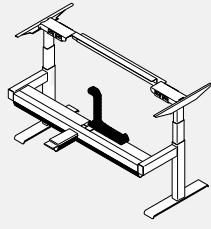


- Kit includes one beam, two cantilevers, two standard range columns, two T styled feet and one power trough assembly with one energy chains.

PRODUCT CODE	PRICE	HEIGHT MIN/MAX	WIDTH MIN/MAX	DEPTH MIN/MAX	WEIGHT LBS	VOL FT <sup>3</sup>
FT5SGL51T24	3178	27.5" - 47"	51" - 62"	24" - 24"	75	2.3
FT5SGL51T30	3194	27.5" - 47"	51" - 62"	30" - 30"	75	2.3

- For T24 leg, use 23" deep worksurfaces.
- For T30 leg, use 29" deep worksurfaces.
- 30" or larger depth worksurfaces cannot be used with Back to Back bases.
- Duplex receptacles are not included, please specify separately.
- For enhanced collision detection an Anti Collision Desk Sensor included with every base.
- For Standard Up/Down Controller add (S) at the end of the code. For Display Controller, please add at "D" at the end of the product code and \$78 to the list price.
- Specify paint finish: BLK-Black, DWT-Designer White, TUN-Tungsten.

**FT6SGL-T • Extended Range End of Run Single Frame**

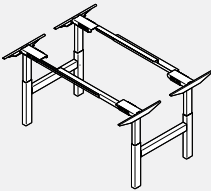


- Kit includes one beam, two cantilevers, two extended range columns, two T styled feet and one power trough assembly with one energy chains.

PRODUCT CODE	PRICE	HEIGHT MIN/MAX	WIDTH MIN/MAX	DEPTH MIN/MAX	WEIGHT LBS	VOL FT <sup>3</sup>
FT6SGL51T24	3293	22.5" - 48.5"	51" - 62"	24" - 24"	75	2.3
FT6SGL51T30	3306	22.5" - 48.5"	51" - 62"	30" - 30"	75	2.3

- For T24 leg, use 23" deep worksurfaces.
- For T30 leg, use 29" deep worksurfaces.
- 30" or larger depth worksurfaces cannot be used with Back to Back bases.
- Duplex receptacles are not included, please specify separately.
- For enhanced collision detection an Anti Collision Desk Sensor included with every base.
- For Standard Up/Down Controller add (S) at the end of the code. For Display Controller, please add at "D" at the end of the product code and \$78 to the list price.
- Specify paint finish: BLK-Black, DWT-Designer White, TUN-Tungsten.

**FTM5B2B-F • Standard Range Media Table Base**

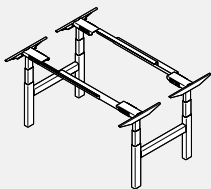


- Kit includes two beams, four cantilevers, four standard range columns and two controllers.

PRODUCT CODE	PRICE	HEIGHT MIN/MAX	WIDTH MIN/MAX	DEPTH MIN/MAX	WEIGHT LBS	VOL FT <sup>3</sup>
FTM5B2BSF	4067	27.5" - 47"	60" - 60"	54" - 60"	129	4.7
FTM5B2BLF	4081	27.5" - 47"	66" - 96"	54" - 60"	129	4.7

- SF indicates small base for 60" sided tables.
- LF indicates large base for 66" to 96" sided tables.
- For enhanced collision detection an Anti Collision Desk Sensor included with every base.
- For Standard Up/Down Controller add (S) at the end of the code. For Display Controller, please add at "D" at the end of the product code and \$165 to the list price.
- Specify paint finish: BLK-Black, DWT-Designer White, TUN-Tungsten.

**FTM6B2B-F • Extended Range Media Table Base**

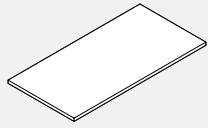


- Kit includes two beams, four cantilevers, four extended range columns and two controllers.

PRODUCT CODE	PRICE	HEIGHT MIN/MAX	WIDTH MIN/MAX	DEPTH MIN/MAX	WEIGHT LBS	VOL FT <sup>3</sup>
FTM6B2BSF	4294	22.5" - 48.5"	60" - 60"	54" - 60"	129	4.7
FTM6B2BLF	4308	22.5" - 48.5"	66" - 96"	54" - 60"	129	4.7

- SF indicates small base for 60" sided tables.
- LF indicates large base for 66" to 96" sided tables.
- For enhanced collision detection an Anti Collision Desk Sensor included with every base.
- For Standard Up/Down Controller add (S) at the end of the code. For Display Controller, please add at "D" at the end of the product code and \$165 to the list price.
- Specify paint finish: BLK-Black, DWT-Designer White, TUN-Tungsten.

**FTWR - Rectangular Worksurface**

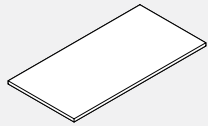


- Rectangular worksurfaces are non-handed and can be interchanged on site.
- Specify laminate finish and PVC edge finish.
- Grommet option for surfaces less than 64" is TC - Top Center only.
- Specification:
- For 23" deep worksurfaces, use FT52(S/L)F24CL/TL standard range or FT62(S/L)F24CL/TL extended range base.
- For 29" deep worksurfaces, use FT52(S/L)F30CL/TL standard range or FT62(S/L)F30CL/TL extended range base.
- For 35" deep worksurfaces, use FT5(S/L)F30CL/TL standard range or FT6(S/L)F30CL/TL extended range base.
- The 35" deep worksurfaces cannot be used with Back to Back Bases.
- For Back to Back bases, please use the following chart:

FTW(23/29)46, FT(5/6)B2B48  
 FTW(23/29)52, FT(5/6)B2B54  
 FTW(23/29)58, FT(5/6)B2B60  
 FTW(23/29)64, FT(5/6)B2B66  
 FTW(23/29)72, FT(5/6)B2B72  
 FTW(23/29)76, FT(5/6)B2B72  
 FTW(23/29)82, FT(5/6)B2B72

PRODUCT CODE	PRICE		SIZE/INCHES			WEIGHT LBS	VOL FT <sup>3</sup>
	LP	HP	H	W	D		
FTWR2328	149	191	1	28	23	20	1.16
FTWR2334	165	215	1	34	23	24	1.40
FTWR2340	212	279	1	40	23	28	1.64
FTWR2346	245	329	1	46	23	31	1.84
FTWR2352	290	383	1	52	23	36	2.08
FTWR2358	326	430	1	58	23	40	2.32
FTWR2364	340	449	1	64	23	44	2.56
FTWR2370	355	470	1	70	23	48	3.80
FTWR2376	381	501	1	76	23	52	3.03
FTWR2382	410	537	1	82	23	56	3.27
FTWR2928	173	227	1	28	29	25	1.46
FTWR2934	202	265	1	34	29	30	1.76
FTWR2940	283	371	1	40	29	35	2.06
FTWR2946	290	383	1	46	29	40	2.32
FTWR2952	317	408	1	52	29	45	2.62
FTWR2958	340	449	1	58	29	50	2.92
FTWR2964	353	469	1	64	29	55	3.22
FTWR2970	374	495	1	70	29	60	3.52
FTWR2976	398	524	1	76	29	65	3.83
FTWR2982	443	579	1	82	29	71	4.13
FTWR3528	178	234	1	28	35	30	2.00
FTWR3534	210	275	1	34	35	35	2.00
FTWR3540	295	385	1	40	35	40	2.50
FTWR3546	378	471	1	46	35	48	2.80
FTWR3552	420	526	1	52	35	54	3.16
FTWR3558	466	583	1	58	35	60	3.52
FTWR3564	508	637	1	64	35	67	3.89
FTWR3570	552	691	1	70	35	73	4.25
FTWR3576	594	743	1	76	35	79	4.62
FTWR3582	639	800	1	82	35	85	4.98

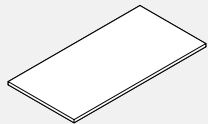
**FTWRR - Rectangular Return Worksurface**



- Rectangular return worksurfaces are non-handed and can be interchanged on site.
- Specify laminate finish and PVC edge finish.
- Includes two flat brackets for connection.
- Specification:
- For 23" deep worksurfaces, use FT51SR24CL/TL standard range or FT61SR24CL/TL extended range base.
- For 29" deep worksurfaces, use FT51SR30CL/TL standard range or FT61SR30CL/TL extended range base.

PRODUCT CODE	PRICE		SIZE/INCHES			WEIGHT LBS	VOL FT <sup>3</sup>
	LP	HP	H	W	D		
FTWRR2329	149	191	1	29	23	20	1.16
FTWRR2335	165	215	1	35	23	24	1.40
FTWRR2341	212	279	1	41	23	28	1.64
FTWRR2347	254	336	1	47	23	32	1.88
FTWRR2353	297	392	1	53	23	36	2.12
FTWRR2359	333	438	1	59	23	40	2.36
FTWRR2929	173	227	1	29	29	25	1.46
FTWRR2935	202	265	1	35	29	30	1.76
FTWRR2941	283	371	1	41	29	35	2.06
FTWRR2947	297	392	1	47	29	40	2.36
FTWRR2953	323	418	1	53	29	46	2.67
FTWRR2959	347	458	1	59	29	51	2.97

**FTWR - Rectangular End of Run Worksurface**

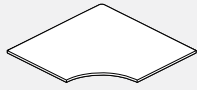


- Rectangular end of run worksurfaces are non-handed and can be interchanged on site.
- Specify laminate finish and PVC edge finish.
- Specification:
- For 23" deep worksurfaces, use FT52(S/F)L24CL/TL standard range or FT62(S/F)L24CL/TL extended range base.
- For 29" deep worksurfaces, use FT52(S/F)L30CL/TL standard range or FT62(S/F)L30CL/TL extended range base.
- For Back to Back bases, please use the following chart:
- FTWR(23/29)51, FT(5/6)B2B60
- FTWR(23/29)62, FT(5/6)B2B66

PRODUCT CODE	PRICE		SIZE/INCHES			WEIGHT LBS	VOL FT <sup>3</sup>
	LP	HP	H	W	D		
FTWR2351	326	430	1	51	23	40	2.02
FTWR2362	340	449	1	62	23	44	2.5
FTWR2951	340	449	1	51	29	50	2.54
FTWR2962	353	528	1	62	29	55	3.15

• LP = Thermally Fused Laminate, HP = High Pressure Laminate.

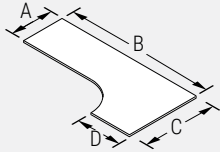
**FTWCC - 90 Degree Corner Worksurface**



- 90 Degree Corner Worksurface.
- Specify laminate finish and PVC edge finish.
- Specification:
- For tables that connect with 23" deep worksurfaces, use FT539FS-24CL standard range or FT539FS24CL extended range base.
- For table that connect with 29" deep worksurfaces, use FT539FS-30CL standard range or FT639FS30CL extended range base.

PRODUCT CODE	FINISH		SIZE / INCHES			WEIGHT LBS	VOL FT <sup>3</sup>
	LP	HP	H	W	D		
FTWCC234023	549	603	1	40	40	70	1.50
FTWCC234623	565	620	1	46	46	75	2.00
FTWCC235223	647	712	1	52	52	80	4.69
FTWCC235823	828	910	1	58	58	100	5.84
FTWCC294029	549	603	1	40	40	70	1.50
FTWCC294629	549	603	1	46	46	75	3.67
FTWCC295229	647	712	1	52	52	80	4.69
FTWCC295829	828	910	1	58	58	100	5.84

**FTWEC - Left Extended 90 Degree Corner Worksurface**



- Left Extended 90 Degree Corner Worksurface.
- Specify laminate finish and PVC edge finish.
- Specification:
- For tables that connect with 23" deep (A and D) worksurfaces, use FT539F(S/L)24CL standard range or FT639F(S/L)24CL extended range base.
- For table that connect with 29" deep (A and D) worksurfaces, use FT539F(S/L)30CL standard range or FT639F(S/L)30CL extended range base.

**NOTE: FTWEC**

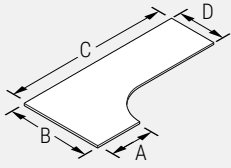
A	B	C	D
DEPTH	LENGTH	WIDTH	DEPTH

PRODUCT CODE	FINISH		SIZE / INCHES			WEIGHT LBS	VOL FT <sup>3</sup>
	LP	HP	H	W	D		
FTWEC23584023	741	927	1	58	40	115	2.55
FTWEC23644023	824	1030	1	64	40	127	2.81
FTWEC23704023	901	1128	1	70	40	138	3.07
FTWEC23764023	963	1200	1	76	40	150	3.34
FTWEC23824023	1020	1275	1	82	40	162	3.60
FTWEC23584623	763	955	1	58	46	115	2.55
FTWEC23644623	849	1060	1	64	46	127	2.81
FTWEC23704623	928	1162	1	70	46	138	3.07
FTWEC23764623	991	1236	1	76	46	150	3.34
FTWEC23824623	1051	1313	1	82	46	162	3.60
FTWEC23585223	787	985	1	58	52	130	2.88
FTWEC23645223	872	1093	1	64	52	143	3.18
FTWEC23705223	956	1197	1	70	52	156	3.48
FTWEC23765223	1020	1273	1	76	52	170	3.77
FTWEC23825223	1082	1353	1	82	52	183	4.07
FTWEC23645823	901	1125	1	64	58	160	3.54
FTWEC23705823	986	1232	1	70	58	174	3.88
FTWEC23765823	1051	1312	1	76	58	189	4.21
FTWEC23825823	1114	1394	1	82	58	204	4.54
FTWEC29584029	771	965	1	58	40	115	2.55
FTWEC29644029	858	1071	1	64	40	127	2.81
FTWEC29704029	936	1173	1	70	40	138	3.07
FTWEC29764029	1000	1247	1	76	40	150	3.34
FTWEC29824029	1060	1327	1	82	40	162	3.60
FTWEC29584629	794	993	1	58	46	115	2.55
FTWEC29644629	883	1102	1	64	46	127	2.81
FTWEC29704629	966	1208	1	70	46	138	3.07
FTWEC29764629	1031	1286	1	76	46	150	3.34
FTWEC29824629	1093	1366	1	82	46	162	3.60
FTWEC29585229	818	1024	1	58	52	130	2.88
FTWEC29645229	908	1136	1	64	52	143	3.18
FTWEC29705229	994	1243	1	70	52	156	3.48
FTWEC29765229	1060	1324	1	76	52	170	3.77
FTWEC29825229	1125	1407	1	82	52	183	4.07
FTWEC29645829	935	1170	1	64	58	160	3.54
FTWEC29705829	1025	1282	1	70	58	174	3.88
FTWEC29765829	1093	1365	1	76	58	189	4.21
FTWEC29825829	1159	1451	1	82	58	204	4.54

• LP = Thermally Fused Laminate, HP = High Pressure Laminate.



**FTWEC • Right Extended 90 Degree Corner Worksurface**



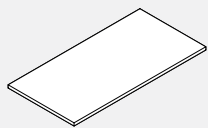
- Right Extended 90 Degree Corner Worksurface.
- Specify laminate finish and PVC edge finish.
- Specification:
- For tables that connect with 23" deep (A and D) worksurfaces, use FT539F(S/L)24CL standard range or FT639F(S/L)24CL extended range base.
- For table that connect with 29" deep (A and D) worksurfaces, use FT539F(S/L)30CL standard range or FT639F(S/L)30CL extended range base.

**NOTE: FTWEC**

A	B	C	D
DEPTH	WIDTH	LENGTH	DEPTH

PRODUCT CODE	FINISH		SIZE/INCHES			WEIGHT LBS	VOL FT <sup>3</sup>
	LP	HP	H	W	D		
FTWEC23405823	741	927	1	58	40	115	2.55
FTWEC23406423	824	1030	1	64	40	127	2.81
FTWEC23407023	901	1128	1	70	40	138	3.07
FTWEC23407623	963	1200	1	76	40	150	3.34
FTWEC23408223	1020	1275	1	82	40	162	3.60
FTWEC23465823	763	955	1	58	46	115	2.55
FTWEC23466423	849	1060	1	64	46	127	2.81
FTWEC23467023	928	1162	1	70	46	138	3.07
FTWEC23467623	991	1236	1	76	46	150	3.34
FTWEC23468223	1051	1313	1	82	46	162	3.6
FTWEC23525823	787	985	1	58	52	130	2.88
FTWEC23526423	872	1093	1	64	52	143	3.18
FTWEC23527023	956	1197	1	70	52	156	3.48
FTWEC23527623	1020	1273	1	76	52	170	3.77
FTWEC23528223	1082	1353	1	82	52	183	4.07
FTWEC23586423	901	1125	1	64	58	160	3.54
FTWEC23587023	986	1232	1	70	58	174	3.88
FTWEC23587623	1051	1312	1	76	58	189	4.21
FTWEC23588223	1114	1394	1	82	58	204	4.54
FTWEC29405829	771	965	1	58	40	115	2.55
FTWEC29406429	858	1071	1	64	40	127	2.81
FTWEC29407029	936	1173	1	70	40	138	3.07
FTWEC29407629	1000	1247	1	76	40	150	3.34
FTWEC29408229	1060	1327	1	82	40	162	3.60
FTWEC29465829	794	993	1	58	46	115	2.55
FTWEC29466429	883	1102	1	64	46	127	2.81
FTWEC29467029	966	1208	1	70	46	138	3.07
FTWEC29467629	1031	1286	1	76	46	150	3.34
FTWEC29468229	1093	1366	1	82	46	162	3.6
FTWEC29525829	818	1024	1	58	52	130	2.88
FTWEC29526429	908	1136	1	64	52	143	3.18
FTWEC29527029	994	1243	1	70	52	156	3.48
FTWEC29527629	1060	1324	1	76	52	170	3.77
FTWEC29528229	1125	1407	1	82	52	183	4.07
FTWEC29586429	935	1170	1	64	58	160	3.54
FTWEC29587029	1025	1282	1	70	58	174	3.88
FTWEC29587629	1093	1365	1	76	58	189	4.21
FTWEC29588229	1159	1451	1	82	58	204	4.54

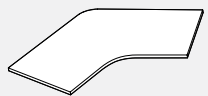
**FTWRE • Rectangular Extension Return Worksurface**



- **Worksurfaces to be used only with Extended 90 Degree Corner Worksurfaces.**
- Rectangular Extension Return Worksurface.
- Specify laminate finish and PVC edge finish.
- Includes 2 flat brackets for connection.
- Specification:
- FTWRE23 to be used with FTWEC23xxxx23.
- FTWRE29 to be used with FTWEC29xxxx29.

PRODUCT CODE	FINISH		SIZE/INCHES			WEIGHT LBS	VOL FT <sup>3</sup>
	LP	HP	H	W	D		
FTWRE2324	136	180	1	24	23	16	0.96
FTWRE2330	149	191	1	30	23	20	1.20
FTWRE2336	165	215	1	36	23	25	1.44
FTWRE2924	163	209	1	24	29	21	1.21
FTWRE2930	173	227	1	30	29	26	1.51
FTWRE2936	202	265	1	36	29	31	1.81

**FTWTC • 120 Degree Corner Worksurface**



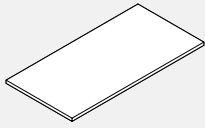
- 120 Degree Corner Worksurface.
- Specify laminate finish and PVC edge finish.
- Specification:
- For tables that connect with 23" deep (A and C) worksurfaces, use FT531F(S/L)24CL standard range or FT531F(S/L)24CL extended range base.
- For table that connect with 29" deep (A and C) worksurfaces, use FT531F(S/L)30CL standard range or FT631F(S/L)30CL extended range.
- Inside radius is 17.5".

PRODUCT CODE	FINISH		SIZE/INCHES			WEIGHT LBS	VOL FT <sup>3</sup>
	LP	HP	H	W	D		
FTWTC234623	773	1077	1	46	23	165	3.67
FTWTC235223	773	1077	1	52	23	211	4.69
FTWTC235823	1389	1961	1	58	23	263	5.84
FTWTC236423	1389	1961	1	64	23	320	7.11
FTWTC294629	773	1077	1	46	29	165	3.67
FTWTC295229	773	1077	1	52	29	211	4.69
FTWTC295829	1389	1961	1	58	29	263	5.84
FTWTC296429	1389	1961	1	64	29	320	7.10

• LP = Thermally Fused Laminate, HP = High Pressure Laminate.



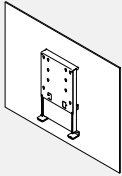
**FTWMR • Media Table Top**



- Media Table Top.
- Specify laminate finish and PVC edge finish.
- Specification:
- For tables FTWMR5a460 and 6060, use FTM5B2BSF standard range or FTM6B2BSF extended range base.
- For all other tables, use FTM5B2BLF standard range or FTM6B-2BLF extended range base.

PRODUCT CODE	FINISH LP	HP	SIZE / INCHES			WEIGHT LBS	VOL FT <sup>3</sup>
			H	W	D		
FTWMR5460	557	769	1	60	54	96	5.63
FTWMR5466	607	842	1	66	54	106	6.19
FTWMR5472	658	915	1	72	54	115	6.75
FTWMR5478	706	987	1	78	54	125	7.31
FTWMR5484	758	1058	1	84	54	135	7.88
FTWMR5490	807	1131	1	90	54	144	8.44
FTWMR5496	859	1201	1	96	54	154	9.00
FTWMR6060	611	850	1	60	60	107	6.25
FTWMR6066	667	930	1	66	60	118	6.88
FTWMR6072	723	1009	1	72	60	128	7.50
FTWMR6078	778	1088	1	78	60	139	8.13
FTWMR6084	833	1166	1	84	60	150	8.75
FTWMR6090	890	1247	1	90	60	160	9.38
FTWMR6096	944	1327	1	96	60	171	10.00

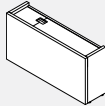
**FTMT5145 • TV Mount**



- TV Mount for FreeFit Media Tables.
- Includes the TV/Display bracket and mounting hardware.
- Maximum TV size is 50".
- Back panel is made of PET Felt.

PRODUCT CODE	FINISH LP	SIZE / INCHES			WEIGHT LBS	VOL FT <sup>3</sup>
		H	W	D		
FTMT5145	616	40.5	51	4	16.82	4.8

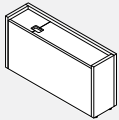
**FTB-L • Laminate Leg Shroud for C-Leg, Left**



- Laminate shroud for a FreeFit C-Leg on the left side.
- Includes a felt liner at the top.
- Short side panel is removable to access interior.
- Please specify low pressure laminate, PVC edge and felt finishes.
- NOTE: When integrating FreeFit height adjustable tables with casegoods, it is recommended to only use 2 stage bases (codes starting with FT5).

PRODUCT CODE	FINISH LP	SIZE / INCHES			WEIGHT LBS	VOL FT <sup>3</sup>
		H	W	D		
FTB23L	510	18	23	9	47	2
FTB29L	534	18	29	9	55	3
FTB35L	556	18	35	9	67	3

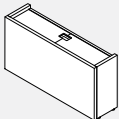
**FTB-R • Laminate Leg Shroud for C-Leg, Right**



- Laminate shroud for a FreeFit C-Leg on the right side.
- Includes a felt liner at the top.
- Short side panel is removable to access interior.
- Please specify low pressure laminate, PVC edge and felt finishes.
- NOTE: When integrating FreeFit height adjustable tables with casegoods, it is recommended to only use 2 stage bases (codes starting with FT5).

PRODUCT CODE	FINISH LP	SIZE / INCHES			WEIGHT LBS	VOL FT <sup>3</sup>
		H	W	D		
FTB23R	510	18	23	9	47	2
FTB29R	534	18	29	9	55	3
FTB35R	556	18	35	9	67	3

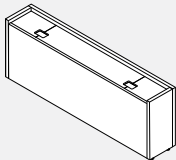
**FTB • Laminate Housing for T-Leg**



- Laminate Leg Shroud for T-Leg.
- Includes a felt liner at the top.
- Short side panel is removable to access interior.
- Please specify low pressure laminate, PVC edge and felt finishes.
- NOTE: When integrating FreeFit height adjustable tables with casegoods, it is recommended to only use 2 stage bases (codes starting with FT5).

PRODUCT CODE	FINISH LP	SIZE / INCHES			WEIGHT LBS	VOL FT <sup>3</sup>
		H	W	D		
FTB23	510	18	23	9	47	2
FTB29	534	18	29	9	55	3
FTB35	556	18	35	9	67	3

**FTB • Laminate Leg Shroud for Media Bases**

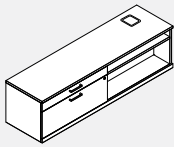


- Includes a felt liner at the top.
- Side panel is removable to access the interior.
- Please specify low pressure laminate, PVC edging and felt finish.
- NOTE: When integrating FreeFit height adjustable tables with casegoods, it is recommended to only use 2 stage bases (codes starting with FT5).

PRODUCT CODE	FINISH LP	SIZE / INCHES			WEIGHT LBS	VOL FT <sup>3</sup>
		H	W	D		
FTB54	802	18	54	9	110	5
FTB60	930	18	60	9	134	6

• LP = Thermally Fused Laminate, HP = High Pressure Laminate.

**FTCRBFO • Credenza, BF / Open**

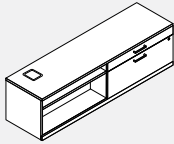


- Credenza storage with grommet to accommodate a FreeFit C leg base.
- Recommended for use with the standard range bases only.
- One lock included
- One adjustable Shelf
- Select any standard Licence2 handle
- Optional E-lock available in the vertical position. Please specify V - Vertical and add \$224.00 list.
- Grommet available only in BLK - Black
- Back of the unit where the leg is located is open the unit is intended to be within a panel surround or against a wall.

PRODUCT CODE	FINISH LP	B	W	SIZE/INCHES				WEIGHT LBS	VOL FT <sup>3</sup>
				H(LP/B)	H(W)	W	D		
FTCRBFO2060	1912	2093	2167	19.94	20.5	60	20	202	20
FTCRBFO2066	1969	2166	2247	19.94	20.5	66	20	220	22
FTCRBFO2072	2072	2286	2374	19.94	20.5	72	20	254	24
FTCRBFO2460	1987	2175	2254	19.94	20.5	60	24	202	20
FTCRBFO2466	2049	2254	2338	19.94	20.5	66	24	220	22
FTCRBFO2472	2155	2377	2469	19.94	20.5	72	24	254	24

• NOTE: When integrating FreeFit height adjustable tables with casegoods, it is recommended to only use 2 stage bases (codes starting with FT5).

**FTCROBF • Credenza, Open / BF**

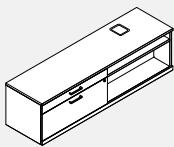


- Credenza storage with grommet to accommodate a FreeFit C leg base.
- Recommended for use with the standard range bases only.
- One lock included
- One adjustable Shelf
- Select any standard Licence2 handle
- Optional E-lock available in the vertical position. Please specify V - Vertical and add \$224.00 list.
- Grommet available only in BLK - Black
- Back of the unit where the leg is located is open the unit is intended to be within a panel surround or against a wall.

PRODUCT CODE	FINISH LP	B	W	SIZE/INCHES				WEIGHT LBS	VOL FT <sup>3</sup>
				H(LP/B)	H(W)	W	D		
FTCROBF2060	1912	2093	2167	19.94	20.5	60	20	202	20
FTCROBF2066	1969	2166	2247	19.94	20.5	66	20	220	22
FTCROBF2072	2072	2286	2374	19.94	20.5	72	20	254	24
FTCROBF2460	1987	2175	2254	19.94	20.5	60	24	202	20
FTCROBF2466	2049	2254	2338	19.94	20.5	66	24	220	22
FTCROBF2472	2155	2377	2469	19.94	20.5	72	24	254	24

• NOTE: When integrating FreeFit height adjustable tables with casegoods, it is recommended to only use 2 stage bases (codes starting with FT5).

**FTCRBFO-T • Credenza, BF / Open**

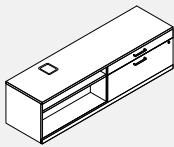


- Credenza storage with grommet to accommodate a FreeFit T-leg base.
- Recommended for use with the standard range bases only.
- One lock included
- One adjustable Shelf
- Select any standard Licence2 handle
- Optional E-lock available in the vertical position. Please specify V - Vertical and add \$224.00 list.
- Grommet available only in BLK - Black
- Back of the unit where the leg is located is open the unit is intended to be within a panel surround or against a wall.

PRODUCT CODE	FINISH LP	B	W	SIZE/INCHES				WEIGHT LBS	VOL FT <sup>3</sup>
				H(LP/B)	H(W)	W	D		
FTCRBFO2060T	1912	2093	2167	19.94	20.5	60	20	202	20
FTCRBFO2066T	1969	2166	2247	19.94	20.5	66	20	220	22
FTCRBFO2072T	2072	2286	2374	19.94	20.5	72	20	254	24
FTCRBFO2460T	1987	2175	2254	19.94	20.5	60	24	202	20
FTCRBFO2466T	2049	2254	2338	19.94	20.5	66	24	220	22
FTCRBFO2472T	2155	2377	2469	19.94	20.5	72	24	254	24

• NOTE: When integrating FreeFit height adjustable tables with casegoods, it is recommended to only use 2 stage bases (codes starting with FT5).

**FTCROBF-T • Credenza, Open / BF**

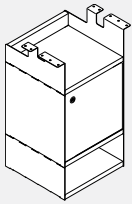


- Credenza storage with grommet to accommodate a FreeFit T-leg base.
- Recommended for use with the standard range bases only.
- One lock included
- One adjustable Shelf
- Select any standard Licence2 handle
- Optional E-lock available in the vertical position. Please specify V - Vertical and add \$224.00 list.
- Grommet available only in BLK - Black
- Back of the unit where the leg is located is open the unit is intended to be within a panel surround or against a wall.

PRODUCT CODE	FINISH LP	B	W	SIZE/INCHES				WEIGHT LBS	VOL FT <sup>3</sup>
				H(LP/B)	H(W)	W	D		
FTCROBF2060T	1912	2093	2167	19.94	20.5	60	20	202	20
FTCROBF2066T	1969	2166	2247	19.94	20.5	66	20	220	22
FTCROBF2072T	2072	2286	2374	19.94	20.5	72	20	254	24
FTCROBF2460T	1987	2175	2254	19.94	20.5	60	24	202	20
FTCROBF2466T	2049	2254	2338	19.94	20.5	66	24	220	22
FTCROBF2472T	2155	2377	2469	19.94	20.5	72	24	254	24

• NOTE: When integrating FreeFit height adjustable tables with casegoods, it is recommended to only use 2 stage bases (codes starting with FT5).

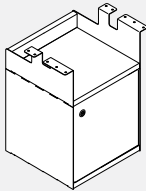
**FTSSPH12BFB • Cube Hanging Pedestal, One File Box and Two Open Boxes**



- Hanging pedestal with one file box in the middle and two open boxes, one at the top and one at the bottom.
- Attaches to the underside of a worksurface with supplied screws.
- File box interior dimensions: 11 7/8" h x 11 13/16" w x 10 7/16" d.
- Includes chrome wire divider and optional lock.
- Metal wire divider is chrome and sits 3 7/16" from either side and is interchangeable.
- File door lock, if specified is located on the top right corner for the right pedestal and top left corner for the left pedestal.
- Bottom, middle and top shelves, front door and back are made of 3/4" low pressure laminate.
- Sides are made of powder coated metal.
- Ships knocked-down.
- NOTE: To be used with Standard Range FreeFit Bases (FT5 and FTM5) only.

PRODUCT CODE	PRICE	SIZE/ INCHES			WEIGHT VOL	
		H	W	D	LBS	FT <sup>3</sup>
<b>Without Lock</b>						
FTSSPH12BFBR	444	24	12	12	26	2.33
FTSSPH12BFBL	444	24	12	12	26	2.33
<b>With Lock</b>						
FTSSPH12BFBKR	457	24	12	12	26	2.33
FTSSPH12BFBKL	457	24	12	12	26	2.33

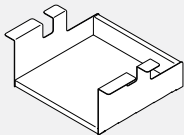
**FTSSPH12BF • Cube Hanging Pedestal, One File Box**



- Hanging pedestal with one file box at the bottom and one open box at the top.
- Attaches to the underside of a worksurface with supplied screws.
- File box interior dimensions: 11 7/8" h x 11 13/16" w x 10 7/16" d.
- Includes chrome wire divider and optional lock.
- Metal wire divider is chrome and sits 3 7/16" from either side and is interchangeable.
- File door lock, if specified is located on the top right corner for the right pedestal and top left corner for the left pedestal.
- Bottom, middle and top shelves, front door and back are made of 3/4" low pressure laminate.
- Sides are made of powder coated metal.
- Ships knocked-down.

PRODUCT CODE	PRICE	SIZE/ INCHES			WEIGHT VOL	
		H	W	D	LBS	FT <sup>3</sup>
<b>Without Lock</b>						
FTSSPH12BFR	334	18.5	12	12	20	1.83
FTSSPH12BFL	334	18.5	12	12	20	1.83
<b>With Lock</b>						
FTSSPH12BFKR	347	18.5	12	12	20	1.83
FTSSPH12BFKL	347	18.5	12	12	20	1.83

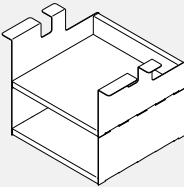
**FTSSPH12B • Cube Hanging Pedestal Box**



- Hanging pedestal open box.
- Attaches to the underside of a worksurface with supplied screws to create an open box.
- Bottom, middle and top shelves, front door and back are made of 3/4" low pressure laminate.
- Sides are made of powder coated metal.
- Ships knocked-down.

PRODUCT CODE	PRICE	SIZE/ INCHES			WEIGHT VOL	
		H	W	D	LBS	FT <sup>3</sup>
FTSSPH12B	136	6	12	12	6	0.96

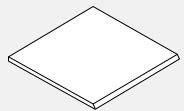
**FTSSPH12BB • Cube Hanging Pedestal, Two Open Boxes**



- Hanging pedestal with two open boxes.
- Attaches to the underside of a worksurface with supplied screws.
- Bottom, middle and top shelves, front door and back are made of 3/4" low pressure laminate.
- Sides are made of powder coated metal.
- Ships knocked-down.

PRODUCT CODE	PRICE	SIZE/ INCHES			WEIGHT VOL	
		H	W	D	LBS	FT <sup>3</sup>
FTSSPH12BB	251	11.5	12	12	12	1.42

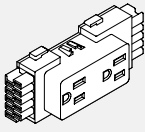
**FTFELT03BC • Felt Shelf Liner for Cube Pedestals**



- Felt shelf liner can be added to any closed back shelf.
- Front edge is cut at 45 degree.

PRODUCT CODE	PRICE	SIZE/ INCHES			WEIGHT VOL	
		H	W	D	LBS	FT <sup>3</sup>
FTFELT03BC	23	12	12	0.38	0.1	0.03

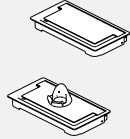
**BRT8D • Duplex Receptacles**



- Snaps into Power Distribution Housing.
- Up to 6 duplex receptacles per circuit.
- xxxD1 = Circuit #1 (utility circuit)
- xxxD2 = Circuit #2 (utility circuit)
- xxxD3 = Circuit #3 (utility circuit)
- xxxDA - Circuit #A (dedicated circuit)
- XW identifies white colour plastic, all others in standard black.

PRODUCT CODE	PRICE	SIZE/ INCHES			WEIGHT LBS	VOL FT <sup>3</sup>
		H	W	D		
BRT8D1	35	2	4.625	1.25	0.10	0.01
BRT8D2	35	2	4.625	1.25	0.10	0.01
BRT8D3	35	2	4.625	1.25	0.10	0.01
BRT8DA	35	2	4.625	1.25	0.10	0.01
BRT8DXW1	52	2	4.625	1.25	0.10	0.01
BRT8DXW2	52	2	4.625	1.25	0.10	0.01
BRT8DXW3	52	2	4.625	1.25	0.10	0.01
BRT8DXWA	52	2	4.625	1.25	0.10	0.01

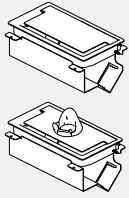
**GAADG • Access Door Module**



- Soft close door is set back from edge to allow for cable pass thru.
- Available in all standard panel frame finishes.
- GAADGDH includes device holder for most mobile phones or tablets. Holder is only available in white.
- FreeFit can only accomodate one grommet per worksurface.

PRODUCT CODE	PRICE	SIZE/INCHES			WEIGHT LBS	VOL FT <sup>3</sup>
		H	D	W		
GAADG	60	1.08	5.54	10.09	2	0.04
GAADGDH	65	1.08	5.54	10.09	2	0.04

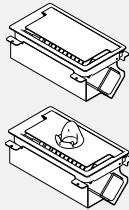
**GAADCT • Access Door Module with Cable Tray**



- Soft close door is set back from edge to allow for cable pass thru when closed.
- Cable tray comes one standard telcom knock out and a platform to mount a powerbar.
- Sides are open for easy access.
- Available in all standard panel frame finishes.
- GAADCTDH includes device holder for most mobile phones or tablets. Holder is only available in white.
- FreeFit can only accomodate one grommet per worksurface.

PRODUCT CODE	PRICE	SIZE/INCHES			WEIGHT LBS	VOL FT <sup>3</sup>
		H	D	W		
GAADCT	95	5.07	5.54	10.09	4	0.19
GAADCTDH	103	5.07	5.54	10.09	4	0.19

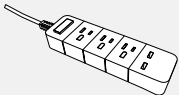
**GAADCTPD • Access Door Module with Cable Tray and Power Bar**



- Powerbar with 3 simplex and 2 USB, CSA Certified.
- Soft close door is set back from edge to allow for cable pass thru when closed.
- Cable tray comes one standard telcom knock out and a platform to mount a powerbar.
- Sides are open for easy access.
- Available in all standard panel frame finishes.
- GAADCTPDDH includes device holder for most mobile phones or tablets. Holder is only available in white.
- FreeFit can only accomodate one grommet per worksurface.

PRODUCT CODE	PRICE	SIZE/INCHES			WEIGHT LBS	VOL FT <sup>3</sup>
		H	D	W		
GAADCTPD	208	6.96	5.54	10.09	4	0.20
GAADCTPDDH	212	6.96	5.54	10.09	4	0.20

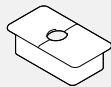
**BWAEGC00158GC • Power Bar with USB**



- Power Bar with 3 receptacles + 2 USB and power switch.
- Standard with 6' cord.
- Rating 15A, 125V, AC 60Hz, 1875W.
- USB output 5V, 2.6A (max.)
- White case, white cord.

PRODUCT CODE	PRICE	SIZE/ INCHES			WEIGHT LBS	VOL FT <sup>3</sup>
		H	W	D		
BWAEGC00158GC	99	1.3	2.3	1	1	0.02

**BG5 • Rectangular Grommet**



- Option  
(BLK) Black Plastic  
(GRY) Grey Plastic  
(WHT) White Plastic

PRODUCT CODE	PRICE	SIZE/ INCHES			WEIGHT LBS	VOL FT <sup>3</sup>
		H	W	D		
BG5	36		3.5	2		

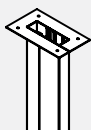
**MSPDM • 1 Duplex, 2 Data**



- Includes one duplex and 2 data jacks (both RJ45, Cat 6)
- Black plastic

PRODUCT CODE	PRICE	SIZE/ INCHES			WEIGHT LBS	VOL FT <sup>3</sup>
		H	W	D		
MSPDM	276	2.75	6.5	3.5	2	0.1

**BWAEFC • Ceiling Feed Post**



- Ceiling pole brings ceiling feed conduit and data cables from the ceiling down to Power troughs height. Accommodates 9'-3" ceiling heights.
- A two part construction allows power/data conduit lay-in.
- Includes mounting hardware and ceiling bezel.
- Painted finish.

PRODUCT CODE	PRICE	SIZE/INCHES			WEIGHT LBS	VOL FT <sup>3</sup>
		H	D	W		
BWAEFC	312	99.32	2.5	4.74	13	0.48

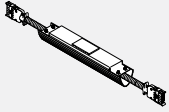
**BWAECFH • Ceiling Feed Harness**



- Ceiling feed provides a single power entry from ceiling, through Ceiling pole into Power Trough, into Power Distribution Housing.
- An 8-wire (4-circuit) metal conduit harness with included metal junction box for hard wiring to the building power supply above ceiling tile.
- Must be hard wired to the building power supply by a licensed electrician.
- Ceiling Pole not included.

PRODUCT CODE	PRICE	SIZE/INCHES			WEIGHT LBS	VOL FT <sup>3</sup>
		H	D	W		
BWAECFH120	410	120	6	6.00	5.00	2
BWAECFH144	459	144	6	6.00	6.00	3

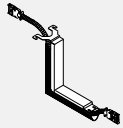
**FTAEC • Table to Table Connector**



- Connects Freefit back2back legs and trough provide power data/ communication pass thru
- Connector kit consist of formed steel housing, mounting brackets,
- Housing to housing harness and one charcoal grey extruded Data/ Communication cable manager
- For table to table up to 72" w (with no storage in between tables), use FTAEC12.
- For table to table 78" w (when no storage in between), use FTAEC18.
- For table to table 84" w (when no storage in between), use FTAEC24.
- For table to table up to 72" w with a Pantry Storage is in between, use FTAEC24.

PRODUCT CODE	PRICE	SIZE/INCHES			WEIGHT LBS	VOL FT <sup>3</sup>
		H	D	W		
FTAEC12	259	3	16	2.3	6.00	0.12
FTAEC18	278	3	22	2.3	8.00	0.15
FTAEC24	294	3	28	2.3	9.00	0.18
FTAEC30	310	3	34	2.3	10.60	0.22
FTAEC36	324	3	40	2.3	12.00	0.24
FTAEC42	348	3	46	2.3	11.60	0.28
FTAEC48	372	3	52	2.3	14.00	0.30

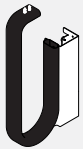
**FTABRC • Table to Bridges Connector**



- Connects FreeFit back2back benching to Bridges 29H table with below surface power trough.
- Please specify paint colour on bracket. Wire manager is always charcoal.

PRODUCT CODE	PRICE	SIZE/INCHES			WEIGHT LBS	VOL FT <sup>3</sup>
		H	D	W		
FTABRC	219	13	13	2.3	2.4	0.28

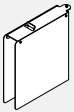
**FTACCL • Leg Wire Manager**



- Provides wire management from under FreeFit worksurface, down the leg and to the floor.
- Can only be used for FreeFit Regular and Media tables. Not for use on FreeFit Back to Back tables.
- Kit includes wire manager housing, magnets, screws and cable chain.
- Magnetically fastens to the Freefit leg and cable chain is screwed to work surface.
- Please specify housing paint finish.

PRODUCT CODE	PRICE	SIZE/INCHES			WEIGHT LBS	VOL FT <sup>3</sup>
		H	D	W		
FTACCL	388	13	3.2	2	0.06	0.06

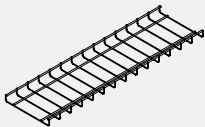
**FTAEFF • Floor Feed**



- Floor feed housing for FreeFit benching applications only
- Liquitite whip 72"
- Must be hard wired to power source by a licenced technician
- Please choose paint colour for housing.

PRODUCT CODE	PRICE	SIZE/INCHES			WEIGHT LBS	VOL FT <sup>3</sup>
		H	D	W		
FTAEFF	574	10.8	8.75	2	7	0.23

**FFTCB • Under Worksurface Cable Basket**



- Shallow 8" wide basket manages cable excess.
- It can be easily unclipped from steel brackets (included) to rear-range cable connections from below work surface.
- As a general rule- specify cable basket 30" shorter that the Freefit work surface.
- Steel wire construction, black painted finish, black steel hanging brackets and fasteners.

PRODUCT CODE	PRICE	SIZE/ H	INCHES		WEIGHT LBS	VOL FT <sup>3</sup>
			W	D		
FFTCB36	78	1	8	8	0.36	0.03
FFTCB48	86	1	16	8	0.73	0.07
FFTCB54	90	1	22	8	1.01	0.10
FFTCB60	97	1	28	8	1.20	0.13
FFTCB66	111	1	34	8	1.56	0.15
FFTCB72	114	1	40	8	1.80	0.18
FFTCB78	123	1	46	8	2.16	0.21
FFTCB84	129	1	52	8	2.39	0.24

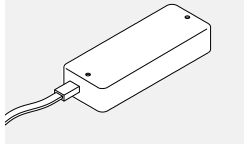
**BRACS • Cable Snake**



- **Flexible cable management trough.**
- Two pathways within the snake, one for data/communication and one for routing power cables.
- Clear (CLR) available only.

PRODUCT CODE	PRICE	SIZE/ H	INCHES		WEIGHT LBS	VOL FT <sup>3</sup>
			W	D		
BRACS	127	30	8	2	3	0.19
BRACSH	213	49	8	2	5	0.27

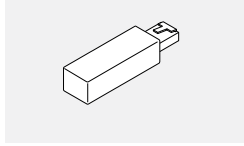
**FTBATT • Battery and Charger**



- Battery Pak with charging cable mounts to the underside of the worksurface
- Features LED bars indicating capacity level and audio alarm when it needs to be charged.
- On a full charge the table can cycle from 35 to 45 stroke lengths based upon the range of column selected and load on the table.

PRODUCT CODE	PRICE	SIZE/INCHES			WEIGHT		VOL FT <sup>3</sup>
		H	D	W	LBS		
FTBATT	859	1.5	8	3	1.54	0.02	

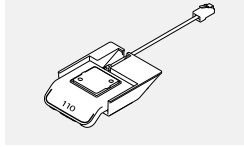
**FTACDS • Anti Collision Desk Sensor USB Plug**



- Provides enhanced anti-collision detection.
- Plugs directly into leg column.
- Only one USB plug required for table assembly.
- This is a replacement part. The sensor ships stand with every table.

PRODUCT CODE	PRICE	SIZE/INCHES			WEIGHT		VOL FT <sup>3</sup>
		H	D	W	LBS		
FTACDS	72	0.5	2.36	0.6	0.01	0.01	

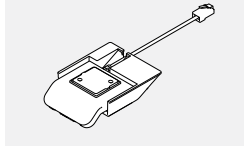
**FTDPG1C • Display + Bluetooth + Reminder Controller**



- Up/down drive with 4 memory positions.
- LED Light strip reminder, table height display.
- Bluetooth enabled connects to Desk Control App.

PRODUCT CODE	PRICE	SIZE/INCHES			WEIGHT		VOL FT <sup>3</sup>
		H	D	W	LBS		
FTDPG1C	166	1	3	4.3	0.4	0.01	

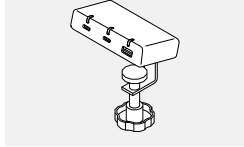
**FTDPG1M • Memory + Bluetooth + Diode Reminder Controller**



- Up/down drive with 2 memory positions.
- Bluetooth enabled connects to Desk Control App.
- This is a replacement part. Every base comes standard with a controller.

PRODUCT CODE	PRICE	SIZE/INCHES			WEIGHT		VOL FT <sup>3</sup>
		H	D	W	LBS		
FTDPG1M	66	1	3	4.3	0.4	0.01	

**FTCD2DUSB • Desk2Device USB Charger**



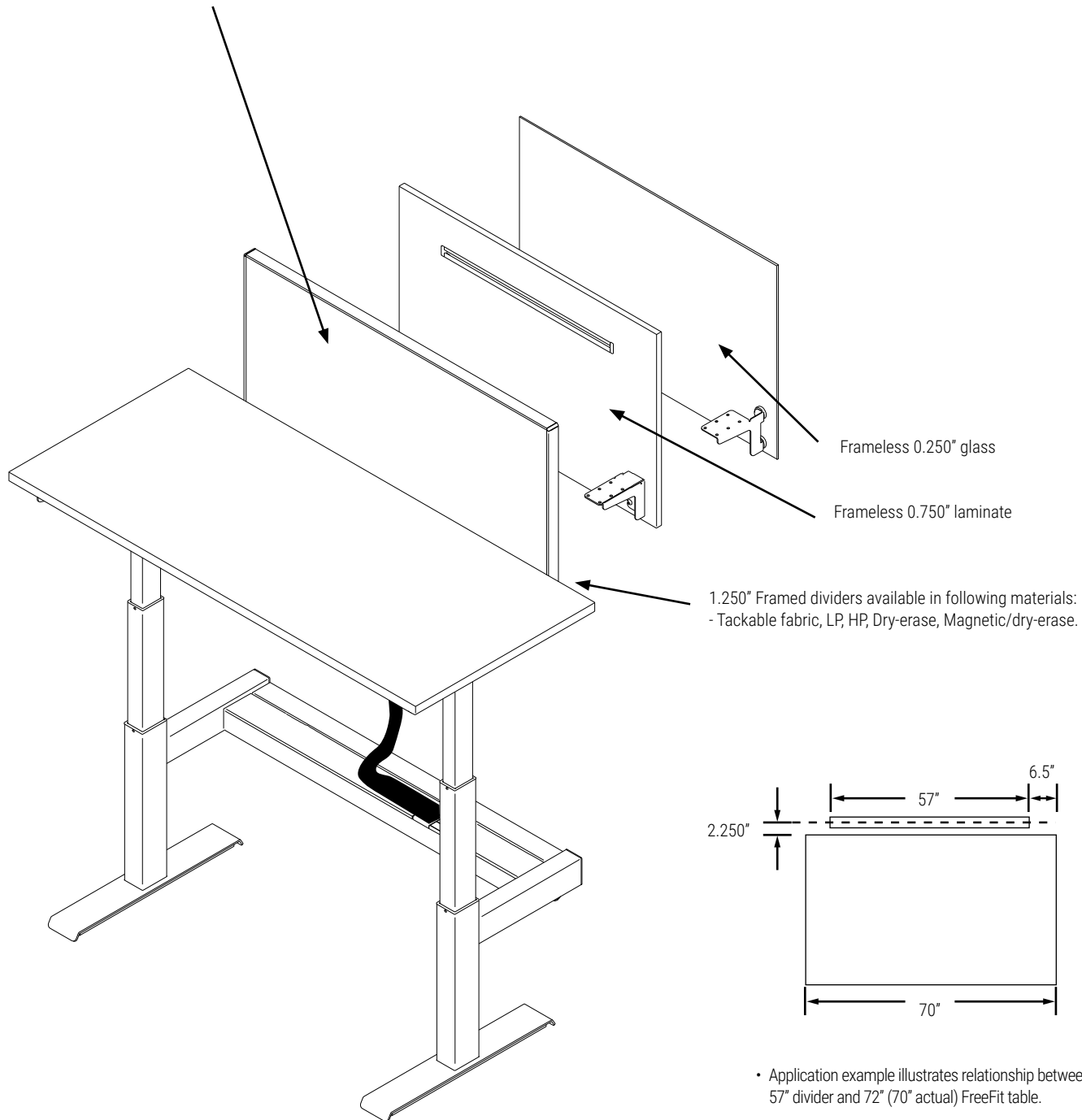
- Charge virtually any USB device directly from your FreeFit desk. Reduce cable clutter and get better power access.
- The charger is powered directly by the control box of a FreeFit table, no additional power outlet is required.
- Features one USB Type-A port (output 7.5w), two USB Type-C ports (output 50w if one port is used, 25w if both are used).
- Housing is white in color and the mounts are in black.
- Can be mounted on top of the table surface or underneath the surface (horizontal or slightly tilted).
- Includes two different mounts and a rubber (silicone) pad to secure placement on a smooth desk surface.
- Low standby power consumption of only 0.1w.
- LED diodes indicate either charging or that an active device is connected.
- PVC-Free (TM).

PRODUCT CODE	PRICE	SIZE/INCHES			WEIGHT		VOL FT <sup>3</sup>
		H	D	W	LBS		
FTCD2DUSB	422	0.85	3.77	1.96	0.187	0.004	



**FreeFit • Single Table; 21' high dividers**

- FreeFit table mounted dividers for single table or single table row, recessed 6.5" at both ends (for example - 72" (70" actual) FreeFit table mounted divider measures 57").
- The centre of all dividers is always mounted 2.250" from work surface's rear edge. Please note the gap between the divider and the work surface therefore varies, depending on the divider thickness (1.250" framed dividers. 0.750" frame-less LP and 0.250" frame-less glass).
- 48" (33" actual) - 66" (51" actual) dividers have 2 mounting brackets.
- 72" (57" actual) dividers have 3 mounting brackets.



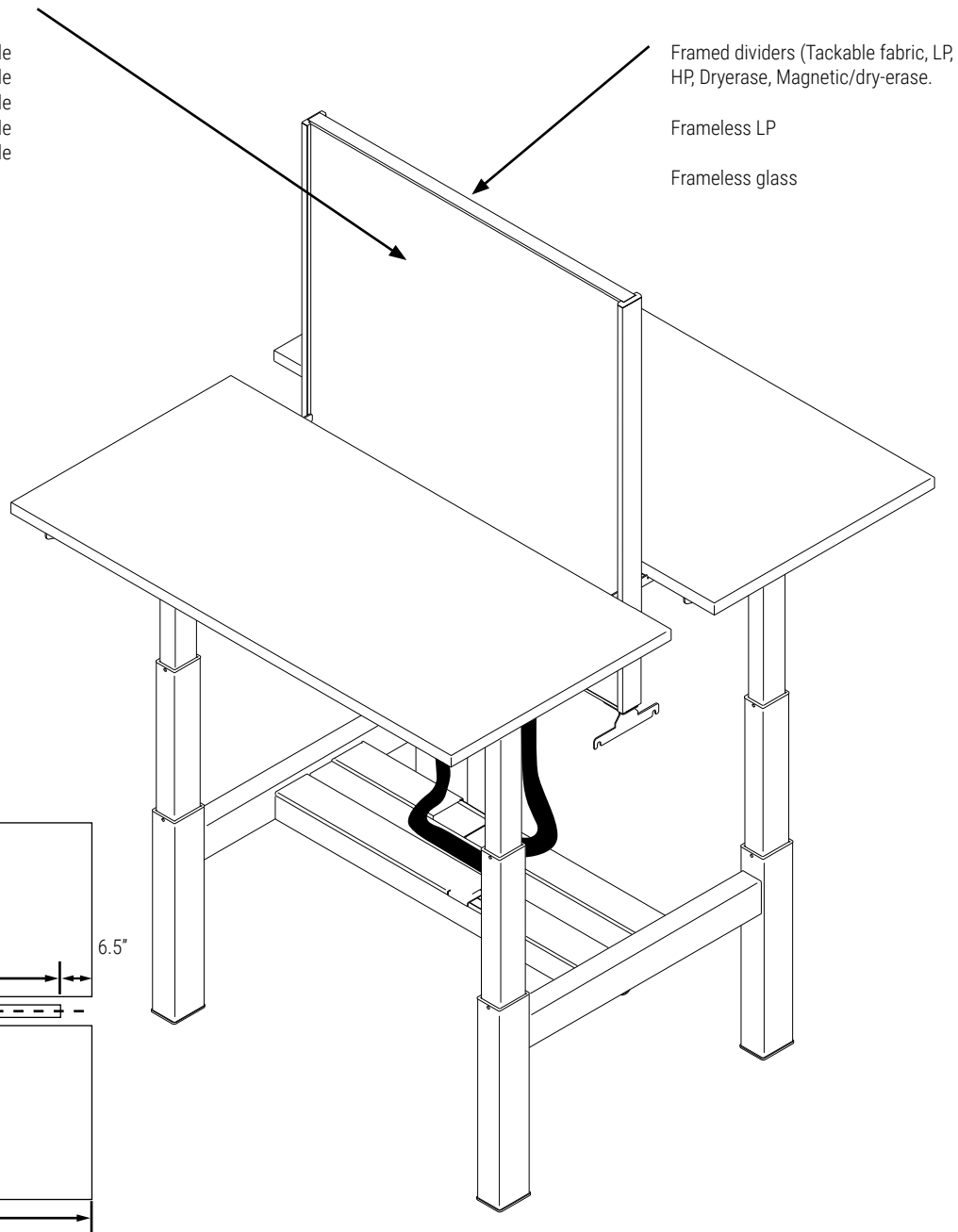
- Application example illustrates relationship between 57" divider and 72" (70" actual) FreeFit table.
- Example Order:  
 BWATMFD72  
 (actual dimension of 57") for  
 BWA2D3072A8  
 (actual dimension of 70").

**FreeFit • Back 2 Back Table; 37" high dividers**

FreeFit Back 2 Back stationary dividers; stationary, shared, secured to table structure; recessed 6.5" at both ends (for example - 72" (70" actual) FreeFit table mounted divider measures 57").

The centre of all dividers is always mounted 2.250" from work surface's rear edge. Please note the gap between the divider and the worksurface therefore varies, depending on the divider thickness (1.250" Framed dividers, 0.750" frame-less LP and 0.250" frame-less glass).

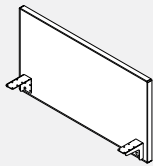
- 48" (33" actual) divider for 48" (46" actual) table
- 54" (39" actual) divider for 54" (52" actual) table
- 60" (45" actual) divider for 60" (58" actual) table
- 66" (51" actual) divider for 66" (64" actual) table
- 72" (57" actual) divider for 72" (70" actual) table



Application example illustrates relationship between 57" shared divider and 72" (70" actual) FreeFit Back 2 Back table.

- Example Order:  
 BWASFD72  
 (actual dimension of 57") for  
 BWA2D6072A8  
 (actual dimension of 70").

**BWATMFD/BWATMLD • Table Mounted Framed Dividers**



- **Connects parallel on Freefit single and back 2 back tables.**
- Divider frame and connecting hardware is painted, please choose from standard metal paint finishes.
- Fabric divider is tackable.
- Divider infill can be specified in fabric, low pressure laminate (LP), high pressure laminate (HP), dry erase whiteboard (DE) or dry erase magnetic whiteboard (DM) user side only.
- Fastens to the underside of the worksurface
- 1.625" gap between worksurface and divider allows for cable pass thru
- Installed divider measures 15.7" from top of worksurface and 5.75" below the worksurface.
- 48" to 66" dividers include 2 support brackets. 72" divider includes 3 support brackets.
- When dry erase magnetic whiteboard (DM) is specified it is applied user side ONLY and dry erase whiteboard (DE) is applied on the opposite side

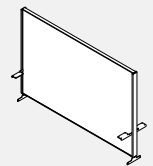
**TACKABLE FABRIC**

PRODUCT CODE	PRICE		SIZE/ INCHES			WEIGHT LBS	VOL FT <sup>3</sup>
	GR1	GR2	H	W	D		
BWATMFD48	333	370	21.5	33	1.25	16	1.23
BWATMFD54	357	392	21.5	39	1.25	18	1.46
BWATMFD60	388	432	21.5	45	1.25	20	1.68
BWATMFD66	434	483	21.5	51	1.25	22	1.90
BWATMFD72	478	527	21.5	57	1.25	26	2.13

**LAMINATE**

PRODUCT CODE	PRICE				SIZE/ INCHES			WEIGHT LBS	VOL FT <sup>3</sup>
	LP	HP	DE	DM	H	W	D		
BWATMLD48	208	330	494	645	21.5	33	1.25	35	1.23
BWATMLD54	237	392	591	786	21.5	39	1.25	39	1.46
BWATMLD60	279	444	655	865	21.5	45	1.25	44	1.68
BWATMLD66	320	551	1107	1485	21.5	51	1.25	48	1.90
BWATMLD72	350	580	1130	1507	21.5	57	1.25	52	2.13

**BWASFD/BWASLD • Stationary Framed Dividers**



- **Provides a stationary framed divider between back 2 back height adjustable tables**
- Divider frame and connecting hardware is painted, please choose from standard metal paint finishes.
- Fabric divider is tackable.
- Divider infill can be specified in fabric, low pressure laminate (LP), high pressure laminate (HP), dry erase whiteboard (DE) or dry erase magnetic whiteboard (DM).
- Divider is anchored to the base and captured between two aluminum upright tracks. The uprights have sliding brackets that connect the worksurfaces to the divider providing continuous support as it travels up and down.
- 1.625" gap between worksurface and divider allows for cable pass thru
- Installed divider measures 54" from floor.

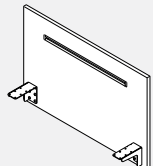
**TACKABLE FABRIC**

PRODUCT CODE	PRICE		SIZE/ INCHES			WEIGHT LBS	VOL FT <sup>3</sup>
	GR1	GR2	H	W	D		
BWASFD48	660	695	37.2	33	2	25	2.13
BWASFD54	678	712	37.2	39	2	28	2.52
BWASFD60	692	734	37.2	45	2	31	2.91
BWASFD66	732	781	37.2	51	2	34	3.29
BWASFD72	949	997	37.2	57	2	37	3.68

**LAMINATE**

PRODUCT CODE	PRICE				SIZE/ INCHES			WEIGHT LBS	VOL FT <sup>3</sup>
	LP	HP	DE	DM	H	W	D		
BWASLD48	573	886	1288	2446	37.2	33	2	58	2.13
BWASLD54	616	956	1369	2587	37.2	39	2	66	2.52
BWASLD60	631	971	1383	2603	37.2	45	2	73	2.91
BWASLD66	665	1043	2306	4623	37.2	51	2	81	3.29
BWASLD72	865	1430	2446	4882	37.2	57	2	88	3.68

**BWATMLLD • Table Mounted Laminate Dividers**

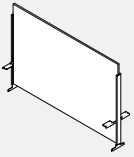


- **Connects parallel on Freefit single and back 2 back tables.**
- Laminate divider with integrated accessory rail, installed one side only.
- Integrated anodized aluminum accessory rail, white cut out and rail trims; white powder coat brackets.
- 3/4" LP PVC edged boards, please specify laminate & 3mm PVC edge.
- Fastens to the underside of the worksurface.
- 1.88 gap between worksurface and divider allows for cable pass thru.
- Installed divider measures 15.7" from top of worksurface and 5.75" below the worksurface.
- 48" to 66" dividers include 2 support brackets. 72" divider includes 3 support brackets.

**LAMINATE**

PRODUCT CODE	PRICE	SIZE/ INCHES			WEIGHT LBS	VOL FT <sup>3</sup>
		H	W	D		
BWATMLLD48	249	21.5	33	0.75	16	1.23
BWATMLLD54	265	21.5	39	0.75	19	1.46
BWATMLLD60	280	21.5	45	0.75	21	1.68
BWATMLLD66	416	21.5	51	0.75	24	1.90
BWATMLLD72	431	21.5	57	0.75	27	2.13

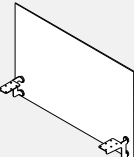
**BWASLLD • Stationary Laminate Dividers**



- Provides a stationary laminate divider between back 2 back height adjustable tables
- Divider uprights and connecting hardware is painted, please choose from standard metal paint finishes.
- Please specify laminate (LP) finish.
- Divider is anchored to the base and captured between two aluminum upright tracks. The uprights have sliding brackets that connect the worksurfaces to the divider providing continuous support as it travels up and down.
- 1.88" gap between worksurface and divider allows for cable pass thru.
- Installed divider measures 54" from floor.

LAMINATE PRODUCT CODE	PRICE	SIZE/ H	INCHES W	D	WEIGHT LBS	VOL FT <sup>3</sup>
BWASLLD48	508	37.2	33	2	28	2.13
BWASLLD54	522	37.2	39	2	33	2.52
BWASLLD60	539	37.2	45	2	37	2.91
BWASLLD66	816	37.2	51	2	41	3.29
BWASLLD72	829	37.2	57	2	46	3.68

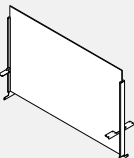
**BWATMGD • Table Mounted Glass Dividers**



- Frameless glass divider connects parallel on single and back 2 back tables.
- Tempered glass, acid etched on one side (similar to frosted), satin chrome disc fasteners and powder coated steel support brackets.
- Fastens to the underside of the worksurface.
- 2.13 gap between worksurface and divider allows for cable pass thru.
- Installed divider measures 15.7" from top of worksurface and 4.75" below the worksurface.
- 54" to 66" dividers include 2 support brackets. 72" divider includes 3 support brackets.
- 1/2" radius on all four corners.

GLASS PRODUCT CODE	PRICE	SIZE/ H	INCHES W	D	WEIGHT LBS	VOL FT <sup>3</sup>
BWATMGD48	537	21.5	33	0.25	16	1.23
BWATMGD54	578	21.5	39	0.25	19	1.46
BWATMGD60	619	21.5	45	0.25	22	1.68
BWATMGD66	656	21.5	51	0.25	24	1.90
BWATMGD72	697	21.5	57	0.25	28	2.13

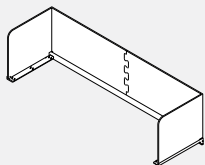
**BWASGD • Stationary Glass Dividers**



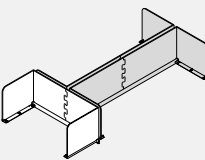
- Provides a stationary glass divider between back 2 back height adjustable tables.
- Tempered glass, acid etched on one side (similar to frosted), satin chrome disc fasteners and white powdercoated steel support brackets.
- Divider is anchored to the base and captured between two aluminum upright tracks. The uprights have sliding brackets that connect the worksurfaces to the divider providing continuous support as it travels up and down.
- 2.13 gap between worksurface and divider allows for cable pass thru.
- 1/2" radius on top two corners.

GLASS PRODUCT CODE	PRICE	SIZE/ H	INCHES W	D	WEIGHT LBS	VOL FT <sup>3</sup>
BWASGD48	476	37.2	33	2	30	2.13
BWASGD54	542	37.2	39	2	34	2.52
BWASGD60	614	37.2	45	2	39	2.91
BWASGD66	680	37.2	51	2	43	3.29
BWASGD72	747	37.2	57	2	48	3.68

**BWAFWR • Felt Wrap Around Divider for FreeFit Table**



Single

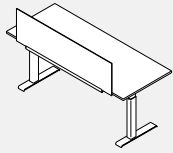


End of Run

- Wraps around FreeFit table to provide privacy.
- 9mm Felt material is tackable and comes in 18 different colours. Please specify colour.
- Installed divider measures 15.7" high from top of the worksurface.
- Please choose standard metal finish for extrusion and brackets.
- Upcharge of \$83 for anodized extrusion option.
- Divider extends by 1.5" at the back.
- For sizes 2346, 2351 and 2352, the felt will be manufactured in one pieces, while all others will be manufactured in two pieces as shown.
- Note: Cannot use ceiling feed option with this divider.

PRODUCT CODE	PRICE	SIZE/ H	INCHES W	D	WEIGHT LBS	VOL FT <sup>3</sup>
BWAFWR2346	392	18.24	46.84	18.46	26.58	1.07
BWAFWR2352	416	18.24	52.84	18.46	28.40	1.21
BWAFWR2358	438	18.24	58.84	18.46	30.22	1.34
BWAFWR2364	580	18.24	64.84	18.46	32.02	0.74
BWAFWR2370	618	18.24	70.84	18.46	33.84	0.81
BWAFWR2946	444	18.24	46.84	24.46	30.74	1.07
BWAFWR2952	587	18.24	52.84	24.46	32.55	0.60
BWAFWR2958	625	18.24	58.84	24.46	34.37	0.67
BWAFWR2964	661	18.24	64.84	24.46	36.19	0.74
BWAFWR2970	703	18.24	70.84	24.46	38.00	0.81
<b>End of Run</b>						
BWAFWR2351	398	18.24	51.34	27.94	27.94	1.05
BWAFWR2951	586	18.24	51.34	32.09	32.09	0.62
BWAFWR2363	579	18.24	63.34	31.57	31.57	1.50
BWAFWR2963	660	18.24	63.34	35.73	35.73	0.87

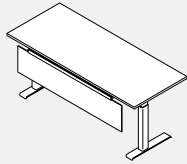
**BWAFPN • Parallel Felt Divider**



- **Felt divider connects parallel on a single or Back to Back FreeFit table.**
- 9 mm felt material is tackable and comes in a wide range of colours.
- Installed, the divider measures 15.7" high from the top of the worksurface.
- Kit includes felt divider, support extrusion and left and right brackets.
- Please choose the finish of the felt and the metal finish for the extrusion and brackets.

PRODUCT CODE	PRICE	SIZE/INCHES			WEIGHT LBS	VOL FT <sup>3</sup>
		H	W	D		
BWAFPN36	136	18.24	21	5.86	2.21	1.30
BWAFPN42	152	18.24	27	5.86	2.77	1.67
BWAFPN48	208	18.24	33	5.86	2.82	2.04
BWAFPN54	234	18.24	39	5.86	3.29	2.41
BWAFPN60	264	18.24	45	5.86	3.75	2.78
BWAFPN66	372	18.24	51	5.86	4.22	3.15
BWAFPN72	397	18.24	57	5.86	4.69	3.53

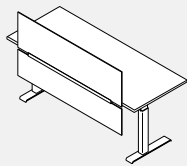
**BWAFMPSN • Modesty Felt Divider**



- **Felt modesty panel secures to the rear bottom of a regular FreeFit table and provides privacy below the worksurface.**
- 9 mm felt material is tackable and comes in a wide range of colours.
- Installed, the divider measures 15" high below the top of the worksurface.
- Kit includes felt modesty, support extrusion and left and right brackets.
- Please choose the finish of the felt and the metal finish for the extrusion and brackets.

PRODUCT CODE	PRICE	SIZE/INCHES			WEIGHT LBS	VOL FT <sup>3</sup>
		H	W	D		
BWAFMPSN36	128	13.94	21	4.17	1.84	0.71
BWAFMPSN42	139	13.94	27	4.17	2.32	0.91
BWAFMPSN48	195	13.94	33	4.17	2.44	1.11
BWAFMPSN54	217	13.94	39	4.17	2.86	1.31
BWAFMPSN60	246	13.94	45	4.17	3.27	1.51
BWAFMPSN66	347	13.94	51	4.17	3.68	1.72
BWAFMPSN72	370	13.94	57	4.17	4.09	1.92

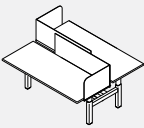
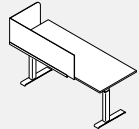
**BWAFPDN • Parallel Above & Below Felt Divider**



- **Felt divider and modesty panel kit secures to the rear bottom of a regular FreeFit table and provides privacy above and below the worksurface.**
- 9 mm felt material is tackable and comes in a wide range of colours.
- Installed, the divider measures 15.7 high from the top of the worksurface and 15" high below the top of the worksurface.
- Kit includes two felt dividers, support extrusion and left and right brackets.
- Please choose the finish of the felt and the metal finish for the extrusion and brackets.

PRODUCT CODE	PRICE	SIZE/INCHES			WEIGHT LBS	VOL FT <sup>3</sup>
		H	W	D		
BWAFPDN36	201	30.68	21	5.86	2.79	2.18
BWAFPDN42	219	30.68	27	5.86	3.56	2.81
BWAFPDN48	312	30.68	33	5.86	3.82	3.43
BWAFPDN54	346	30.68	39	5.86	4.5	4.06
BWAFPDN60	405	30.68	45	5.86	5.17	4.68
BWAFPDN66	618	30.68	51	5.86	5.85	5.31
BWAFPDN72	656	30.68	57	5.86	6.53	5.93

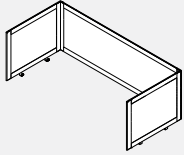
**BW AFC • Corner Wrap Felt Divider**



- **Felt Corner Wrap secures to the side and rear bottom of a FreeFit table, wraps around one side and provides limited privacy.**
- 9 mm felt material is tackable and comes in a wide range of colours.
- Installed, the divider measures 15.7 high from the top of the worksurface..
- Kit includes felt dividers, support extrusion and large and small handed brackets.
- Please choose the finish of the felt and the metal finish for the extrusion and brackets.

PRODUCT CODE	PRICE	SIZE/INCHES			WEIGHT LBS	VOL FT <sup>3</sup>
		H	W	D		
BW AFC2432L	283	18.24	32.46	18.52	4.99	6.35
BW AFC2432R	283	18.24	32.46	18.52	4.99	6.35
BW AFC2438L	323	18.24	38.46	18.52	5.46	7.52
BW AFC2438R	323	18.24	38.46	18.52	5.46	7.52
BW AFC2448L	347	18.24	47.46	18.52	6.16	9.28
BW AFC2448R	347	18.24	47.46	18.52	6.16	9.28
BW AFC3032L	319	18.24	32.46	24.52	5.72	8.40
BW AFC3032R	319	18.24	32.46	24.52	5.72	8.40
BW AFC3038L	343	18.24	38.46	24.52	6.19	9.95
BW AFC3038R	343	18.24	38.46	24.52	6.19	9.95
BW AFC3048L	369	18.24	47.46	24.52	6.89	12.28
BW AFC3048R	369	18.24	47.46	24.52	6.89	12.28

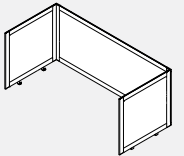
**FFTDP-H24 • Height Adjustable Table Polycarbonate Divider Screen Kit, 24" high**



- Provides privacy in an open plan environment.
- Lightweight and easy to clean table mounted partitions.
- Consists of a powder coated aluminum frame, translucent fluted polycarbonate and all hardware to connect. Brackets are painted steel.
- Side dividers extend 6.237" from the front edge of each surface.
- Back divider extends over the back edge of the worksurface by 1 1/2" allowing for the passage of cables to the trough.
- FFTDP24xxH24 are for 23" deep surfaces and FFTDP30xxH24 are for 29" deep surfaces.
- Width and depth are nominal sizes representing the sizes of the FreeFit Table. Allow for 1/4" overhang at the sides, 1 1/2" at the back and 6.237" at the front.
- Please choose any standard paint finish for frame and hardware. End trim cap is available only in CHR - charcoal.

PRODUCT CODE	PRICE	SIZE/ INCHES			WEIGHT LBS	VOL FT³
		H	W	D		
FFTDP2436H24	760	24.63	34	31.75	26.55	3.94
FFTDP2442H24	784	24.63	40	31.75	28.10	4.59
FFTDP2448H24	806	24.63	46	31.75	29.65	5.25
FFTDP2454H24	829	24.63	52	31.75	31.20	5.91
FFTDP2460H24	853	24.63	58	31.75	32.75	6.56
FFTDP2466H24	876	24.63	60	31.75	34.30	7.22
FFTDP2472H24	897	24.63	70	31.75	35.85	7.88
FFTDP2478H24	921	24.63	76	31.75	37.40	8.53
FFTDP2484H24	947	24.63	82	31.75	38.95	9.19
FFTDP3036H24	816	24.63	34	37.75	40.50	4.72
FFTDP3042H24	839	24.63	40	37.75	42.05	5.51
FFTDP3048H24	862	24.63	46	37.75	43.60	6.29
FFTDP3054H24	885	24.63	52	37.75	45.15	7.08
FFTDP3060H24	907	24.63	58	37.75	46.70	7.87
FFTDP3066H24	930	24.63	60	37.75	48.25	8.65
FFTDP3072H24	954	24.63	70	37.75	49.80	9.44
FFTDP3078H24	976	24.63	76	37.75	51.35	10.22
FFTDP3084H24	999	24.63	82	37.75	52.90	11.01

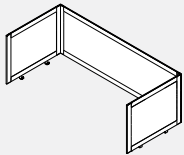
**FFTDP-H30 • Height Adjustable Table Polycarbonate Divider Screen Kit, 30" high**



- Provides privacy in an open plan environment.
- Lightweight and easy to clean table mounted partitions.
- Consists of a powder coated aluminum frame, translucent fluted polycarbonate and all hardware to connect. Brackets are painted steel.
- Side dividers extend 6.237" from the front edge of each surface.
- Back divider extends over the back edge of the worksurface by 1 1/2" allowing for the passage of cables to the trough.
- FFTDP24xxH24 are for 23" deep surfaces and FFTDP30xxH24 are for 29" deep surfaces.
- Width and depth are nominal sizes representing the sizes of the FreeFit Table. Allow for 1/4" overhang at the sides, 1 1/2" at the back and 6.237" at the front.
- Please choose any standard paint finish for frame and hardware. End trim cap is available only in CHR - charcoal.

PRODUCT CODE	PRICE	SIZE/ INCHES			WEIGHT LBS	VOL FT³
		H	W	D		
FFTDP2436H30	853	30.63	34	31.75	26.55	3.94
FFTDP2442H30	882	30.63	40	31.75	28.10	4.59
FFTDP2448H30	907	30.63	46	31.75	29.65	5.25
FFTDP2454H30	932	30.63	52	31.75	31.20	5.91
FFTDP2460H30	960	30.63	58	31.75	32.75	6.56
FFTDP2466H30	986	30.63	60	31.75	34.30	7.22
FFTDP2472H30	1015	30.63	70	31.75	35.85	7.88
FFTDP2478H30	1039	30.63	76	31.75	37.40	8.53
FFTDP2484H30	1065	30.63	82	31.75	38.95	9.19
FFTDP3036H30	905	30.63	34	37.75	40.50	4.72
FFTDP3042H30	932	30.63	40	37.75	42.05	5.51
FFTDP3048H30	959	30.63	46	37.75	43.60	6.29
FFTDP3054H30	985	30.63	52	37.75	45.15	7.08
FFTDP3060H30	1012	30.63	58	37.75	46.70	7.87
FFTDP3066H30	1038	30.63	60	37.75	48.25	8.65
FFTDP3072H30	1064	30.63	70	37.75	49.80	9.44
FFTDP3078H30	1091	30.63	76	37.75	51.35	10.22
FFTDP3084H30	1118	30.63	82	37.75	52.90	11.01

**FFTDG-H24 • Height Adjustable Table Glass Divider Screen Kit, 24" high**

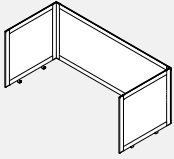


- Provides privacy in an open plan environment.
- Easy to clean table mounted partitions.
- Consists of a powder coated aluminum frame, 4mm clear (CLR) glass and all hardware to connect. Brackets are painted steel.
- Side dividers extend 6.237" from the front edge of each surface.
- Back divider extends over the back edge of the worksurface by 1 1/2" allowing for the passage of cables to the trough.
- FFTDG24xxH24 are for 23" deep surfaces and FFTDG30xxH24 are for 29" deep surfaces.
- Width and depth are nominal sizes representing the sizes of the FreeFit Table. Allow for 1/4" overhang at the sides, 1 1/2" at the back and 6.237" at the front.
- Please choose any standard paint finish for frame and hardware. End trim cap is available only in CHR - charcoal.
- Upcharge for frosted (FRST) glass is 20%.

PRODUCT CODE	PRICE	SIZE/ INCHES			WEIGHT LBS	VOL FT³
		H	W	D		
FFTDG2436H24	1024	24.60	34	31.50	26.55	3.94
FFTDG2442H24	1060	24.60	40	31.50	28.10	4.59
FFTDG2448H24	1091	24.60	46	31.50	29.65	5.25
FFTDG2454H24	1126	24.60	52	31.50	31.20	5.91
FFTDG2460H24	1159	24.60	58	31.50	32.75	6.56
FFTDG2466H24	1193	24.60	60	31.50	34.30	7.22
FFTDG2472H24	1226	24.60	70	31.50	35.85	7.88
FFTDG2478H24	1260	24.60	76	31.50	37.40	8.53
FFTDG2484H24	1294	24.60	82	31.50	38.95	9.19
FFTDG3036H24	1089	24.60	34	37.75	40.50	4.72
FFTDG3042H24	1122	24.60	40	37.75	42.05	5.51
FFTDG3048H24	1156	24.60	46	37.75	43.60	6.29
FFTDG3054H24	1191	24.60	52	37.75	45.15	7.08
FFTDG3060H24	1223	24.60	58	37.75	46.70	7.87
FFTDG3066H24	1258	24.60	60	37.75	48.25	8.65
FFTDG3072H24	1291	24.60	70	37.75	49.80	9.44
FFTDG3078H24	1325	24.60	76	37.75	51.35	10.22
FFTDG3084H24	1358	24.60	82	37.75	52.90	11.01



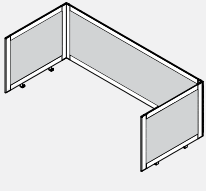
**FFTDG-H30 • Height Adjustable Table Glass Divider Screen Kit, 30" high**



- Provides privacy in an open plan environment.
- Easy to clean table mounted partitions.
- Consists of a powder coated aluminum frame, 4mm clear (CLR) glass and all hardware to connect. Brackets are painted steel.
- Side dividers extend 6.237" from the front edge of each surface.
- Back divider extends over the back edge of the worksurface by 1 1/2" allowing for the passage of cables to the trough.
- FTFDG24xxH30 are for 23" deep surfaces and FTFDG30xxH30 are for 29" deep surfaces.
- Width and depth are nominal sizes representing the sizes of the FreeFit Table. Allow for 1/4" overhang at the sides, 1 1/2" at the back and 6.237" at the front.
- Please choose any standard paint finish for frame and hardware. End trim cap is available only in CHR - charcoal.
- Upcharge for frosted (FRST) glass is 20%.

PRODUCT CODE	PRICE	SIZE/ INCHES			WEIGHT LBS	VOL FT³
		H	W	D		
FFTDG2436H30	1073	30.60	34	31.50	28.85	3.94
FFTDG2442H30	1107	30.60	40	31.50	30.40	4.59
FFTDG2448H30	1143	30.60	46	31.50	31.95	5.25
FFTDG2454H30	1177	30.60	52	31.50	33.50	5.91
FFTDG2460H30	1211	30.60	58	31.50	35.05	6.56
FFTDG2466H30	1246	30.60	60	31.50	36.60	7.22
FFTDG2472H30	1267	30.60	70	31.50	38.15	7.88
FFTDG2478H30	1317	30.60	76	31.50	39.70	8.53
FFTDG2484H30	1351	30.60	82	31.50	41.25	9.19
FFTDG3036H30	1142	30.60	34	37.75	42.80	4.72
FFTDG3042H30	1175	30.60	40	37.75	44.35	5.51
FFTDG3048H30	1211	30.60	46	37.75	45.90	6.29
FFTDG3054H30	1245	30.60	52	37.75	47.45	7.08
FFTDG3060H30	1279	30.60	58	37.75	49.00	7.87
FFTDG3066H30	1315	30.60	60	37.75	50.55	8.65
FFTDG3072H30	1336	30.60	70	37.75	52.10	9.44
FFTDG3078H30	1385	30.60	76	37.75	53.65	10.22
FFTDG3084H30	1419	30.60	82	37.75	55.20	11.01

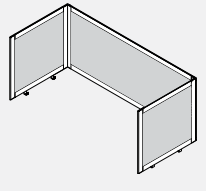
**FFTDF-H24 • Height Adjustable Table Felt Divider Screen Kit, 24" high**



- Provides privacy in an open plan environment.
- Consists of a powder coated aluminum frame, 9mm felt and all hardware to connect. Brackets are painted steel.
- Side dividers extend 6.237" from the front edge of each surface.
- Back divider extends over the back edge of the worksurface by 1 1/2" allowing for the passage of cables to the trough.
- FFTDF24xxH24 are for 23" deep surfaces and FFTDF30xxH24 are for 29" deep surfaces.
- Width and depth are nominal sizes representing the sizes of the FreeFit Table. Allow for 1/4" overhang at the sides, 1 1/2" at the back and 6.237" at the front.
- Please choose any standard paint finish for frame and hardware. Select also a felt finish. End trim cap is available only in CHR - charcoal.
- 9mm felt material is tackable and comes in a variety of colors.

PRODUCT CODE	PRICE	SIZE/INCHES			WEIGHT LBS	VOL FT³
		H	W	D		
FFTDF2436H24	666	24.60	34	31.50	22.55	3.94
FFTDF2442H24	683	24.60	40	31.50	24.10	4.59
FFTDF2448H24	701	24.60	46	31.50	25.65	5.25
FFTDF2454H24	720	24.60	52	31.50	27.20	5.91
FFTDF2460H24	737	24.60	58	31.50	28.75	6.56
FFTDF2466H24	757	24.60	60	31.50	30.30	7.22
FFTDF2472H24	774	24.60	70	31.50	31.85	7.80
FFTDF2478H24	790	24.60	76	31.50	33.40	8.53
FFTDF2484H24	826	24.60	82	31.50	34.95	9.19
FFTDF3036H24	689	24.60	34	37.75	36.50	4.72
FFTDF3042H24	709	24.60	40	37.75	38.05	5.51
FFTDF3048H24	724	24.60	46	37.75	39.60	6.29
FFTDF3054H24	744	24.60	52	37.75	41.15	7.08
FFTDF3060H24	760	24.60	58	37.75	41.70	7.87
FFTDF3066H24	779	24.60	60	37.75	44.25	8.65
FFTDF3072H24	796	24.60	70	37.75	45.80	9.44
FFTDF3078H24	814	24.60	76	37.75	47.35	10.22
FFTDF3084H24	850	24.60	82	37.75	48.90	11.01

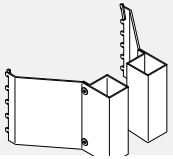
**FFTDF-H30 • Height Adjustable Table Felt Divider Screen Kit, 30" high**



- Provides privacy in an open plan environment.
- Consists of a powder coated aluminum frame, 9mm felt and all hardware to connect. Brackets are painted steel.
- Side dividers extend 6.237" from the front edge of each surface.
- Back divider extends over the back edge of the worksurface by 1 1/2" allowing for the passage of cables to the trough.
- FFTDF24xxH30 are for 23" deep surfaces and FFTDF30xxH30 are for 29" deep surfaces.
- Width and depth are nominal sizes representing the sizes of the FreeFit Table. Allow for 1/4" overhang at the sides, 1 1/2" at the back and 6.237" at the front.
- Please choose any standard paint finish for frame and hardware. Select also a felt finish. End trim cap is available only in CHR - charcoal.
- 9mm felt material is tackable and comes in a variety of colors.

PRODUCT CODE	PRICE	SIZE/INCHES			WEIGHT LBS	VOL FT³
		H	W	D		
FFTDF2436H30	660	30.60	34	31.50	24.85	3.94
FFTDF2442H30	679	30.60	40	31.50	26.40	4.59
FFTDF2448H30	694	30.60	46	31.50	27.95	5.25
FFTDF2454H30	712	30.60	52	31.50	29.50	5.91
FFTDF2460H30	726	30.60	58	31.50	31.05	6.56
FFTDF2466H30	745	30.60	60	31.50	32.60	7.22
FFTDF2472H30	760	30.60	70	31.50	34.15	7.88
FFTDF2478H30	778	30.60	76	31.50	35.70	8.53
FFTDF2484H30	817	30.60	82	31.50	37.25	9.19
FFTDF3036H30	693	30.60	34	37.75	38.80	4.72
FFTDF3042H30	711	30.60	40	37.75	40.35	5.51
FFTDF3048H30	725	30.60	46	37.75	41.90	6.29
FFTDF3054H30	744	30.60	52	37.75	43.45	7.08
FFTDF3060H30	760	30.60	58	37.75	45.00	7.87
FFTDF3066H30	778	30.60	60	37.75	46.55	8.65
FFTDF3072H30	792	30.60	70	37.75	48.10	9.44
FFTDF3078H30	811	30.60	76	37.75	49.65	10.22
FFTDF3084H30	849	30.60	82	37.75	51.20	11.01

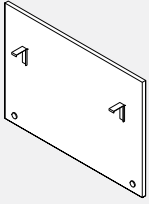
**FTATB • Boulevard Connector Kit**



- FreeFit to Boulevard kit secures FreeFit height adjustable freestanding tables to parallel Boulevard panels.
- It provides panel/table alignment, preventing moving parts from rubbing against panel vertical surfaces and maintains 1" clearance around table surface perimeter.
- Standard metal finishes.
- All hardware included.
- Sold as a pair.
- Note: - Kit connects to C style base only.

PRODUCT CODE	PRICE	SIZE/ INCHES			WEIGHT VOL	
		H	W	D	LBS	FT <sup>3</sup>
FTATB	140	10	6.5	10	7.00	0.50

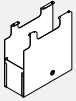
**FTAEG • Back to Back End Gable**



- Optional Back to Back Freefit End Gable is intended to be installed at the end of Freefit Back to Back table run.
- Made out of 3/4" PL Laminate, it enhances Freefit table assembly aesthetics by reducing number of visible elements below work surface.
- Two heights available.
- The End Gable connects to Freefit H-frame crossbar; compatible with Floor Feed.
- Please specify LP finish.
- Please specify paint finish for the brackets.

PRODUCT CODE	PRICE	SIZE/INCHES			WEIGHT		VOL FT <sup>3</sup>
		H	D	W	LBS		
FTAEG18H	311	18	30	0.75	10.00	0.24	
FTAEG22H	337	23	30	0.75	13.00	0.30	

**FTACPU • CPU Holder**



- Accepts tower CPU's with a width range from 7.6" to 2.25" and a maximum height of 18"
- Durable sheet metal construction
- Please specify paint finish.

PRODUCT CODE	PRICE	SIZE/INCHES			WEIGHT		VOL FT <sup>3</sup>
		H	D	W	LBS		
FTACPU	281	21	21	8	3.57	2.04	

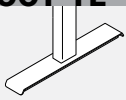
**BRTLCS • Locking Caster for Rectangular Leg Tables**



- Locking Caster for Rectangular Table.
- 40mm dia. locking caster with 8mm thread; whitebody, light grey tires.

PRODUCT CODE	PRICE	SIZE/INCHES			WEIGHT		VOL FT <sup>3</sup>
		H	D	W	LBS		
BRTLCS	27	2.5	2.7	2.6	0.06	0.01	

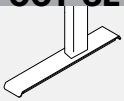
**FTFOOT-TL • T-foot**



- Replacement single "T" foot.
- Includes attachment hardware.

PRODUCT CODE	PRICE	SIZE/INCHES			WEIGHT		VOL FT <sup>3</sup>
		H	D	W	LBS		
FTFOOT24TL	83	1.16	23	3	4.4	0.25	
FTFOOT30TL	89	1.16	29	3	4.85	0.31	

**FTFOOT-CL • C-foot**



- Replacement single "C" foot.
- Includes attachment hardware.

PRODUCT CODE	PRICE	SIZE/INCHES			WEIGHT		VOL FT <sup>3</sup>
		H	D	W	LBS		
FTFOOT24CL	107	1.16	23	3	4.4	0.25	
FTFOOT30CL	116	1.16	29	3	4.85	0.31	

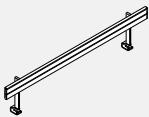
**FTSETGLIDE • Set of Glides**



- Replacement Glides a set of two with 1/2" adjustment

PRODUCT CODE	PRICE	SIZE/INCHES			WEIGHT		VOL FT <sup>3</sup>
		H	D	W	LBS		
FTSETGLIDE	12	1	1.5	1.5	0.06	0.01	

**BRLBST • Single Table Accessory Rail**



- **Table mounted accessory rail.**
- Compatible with standard Bins, Trays and Sorters.
- Includes end caps and mounting hardware.
- Please specify paint finish
- To ensure proper connection and clearance on tables 46" wide and up, choose accessory rail 13" smaller than the actual table width (70" wide table gets 57" wide rail).
- Tables 40" wide and smaller use 33" wide accessory rail.

PRODUCT CODE	PRICE	SIZE/ INCHES			WEIGHT VOL	
		H	W	D	LBS	FT <sup>3</sup>
BRLBST36	297	16	33	2.95	5.9	0.26
BRLBST42	310	16	39	2.95	6.44	0.30
BRLBST48	320	16	45	2.95	6.98	0.35
BRLBST54	333	16	51	2.95	7.52	0.39
BRLBST60	342	16	57	2.95	8.07	0.43
BRLBST66	352	16	63	2.95	8.61	0.48
BRLBST72	366	16	69	2.95	9.15	0.52
BRLBST78	376	16	75	2.95	9.69	0.56
BRLBST84	388	16	81	2.95	10.24	0.61

## Technical Information - Tables

### Common

- Tables up to and including 96" long are manufactured in one piece, 108" to 168" long are manufactured in two pieces and over 192" are manufactured in three pieces. If wood grain laminate or wood veneer is chosen, the wood grain may not line up for any tables longer than 10 feet.
- Tables in 2 or 3 pieces will have the joining edge finished, hardware will be shipped for assembly.
- Grommet locations must be specified at the time of order or it will default to "no grommet" option.
- Tables are pre-drilled with factory installed inserts for easy metal to metal base connection.

### Edge Options B & W

- "LKD" Rectangular shape tables with edge B and W have 1" radius at each corner. For tables with square corners, please add "NR" at the end of the product code, no upcharge required.
- The "NR" option is available only with the B and W edge profiles.
- All table surfaces are High Pressure Laminate in "B" (1 1/16") or "W" (1 7/16") thickness.

### Edge Options KL/FV/KV

- LKD" Rectangular shape tables have 90 degree corners. There is no radius corner option.
- All table surfaces are 1 3/16" thickness.
- KL is a high pressure laminate top with 3mm perimeter PVC edging with a 2" undercut knife profile.
- FV is a veneer top with a flat 3mm perimeter hardwood edge.
- KV is a veneer top with 3mm perimeter hardwood edge with a 2" undercut knife profile.

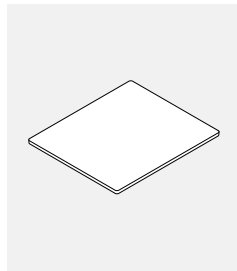
## Tables • Guidelines For Ordering Product

**CODES:** The price list uses a numbering system with meaningful alphanumeric characters to create a simple-to-understand product number. This makes specifying the product much easier and more accurate.

### SPECIFICATION EXAMPLE OF A TABLE UNIT

#### PRODUCT CODE:

LKD3636  
 L = Licence  
 KD = Kadin Tables  
 3636 = Size: Depth x Width

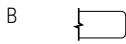


#### Edge Options:

##### "B" Edges

Laminate surface with PVC edge

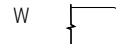
HP (B) 1.062" Thickness



##### "W" Edges

Laminate surface with PVC edge

HP (W) 1.437" Thickness



##### "KL" Edges

Laminate surface with PVC edge

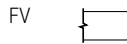
HP (KL) 1.187" Thickness



##### "FV" Edges

Veneer surface with Hardwood edge

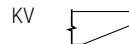
(FV) 1.187" Thickness



##### "KV" Edges

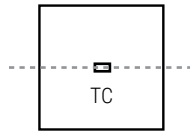
Veneer surface with Hardwood edge

(KV) 1.187" Thickness



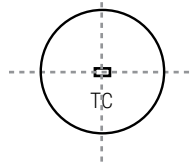
**LKD Grommet locations**

**Square Table (TC Grommet Only)**



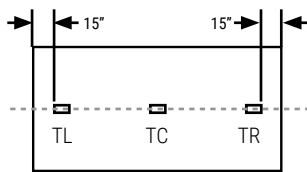
- LKD3636 accepts BG5.
- LKD4242, LKD4848, LKD5454 and LKD6060 accept all grommets and modules.
- LKD4248, LKD4254, LKD4854
- Note: Also accepts GCSRTMCD6xx

**Round Table (TC Grommet Only)**



- LKD36DIA accepts BG5.
- LKD42DIA, LKD48DIA, LKD54DIA and LKD60DIA accept BG5 and MSPDM.

**Rectangular Table**



**TC GROMMET ONLY**

- LKD3648
- LKD3654
- LKD4248
- LKD4254
- LKD4854
- LKD4248, LKD4254 and LKD4854 also accepts GCRTMCD602, GCRTMCD622 and GCRTMCD642.

**ONE GROMMET CHOICE ONLY - TL,TC OR TR**

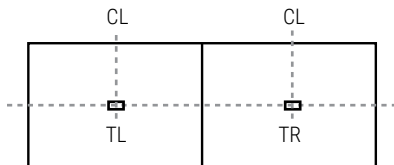
- LKD3660, LKD3666, LKD3672
- LKD4260, LKD4266, LKD4272

(Accept BG5, MSPDM, GCRTMCS401, GCRTMCS421)

**UP TO 3 GROMMETS IN TL,TC AND/OR TR**

- LKD3678, LKD3684, LKD3696
- LKD4278, LKD4284, LKD4296
- LKD4878, LKD4884, LKD4896

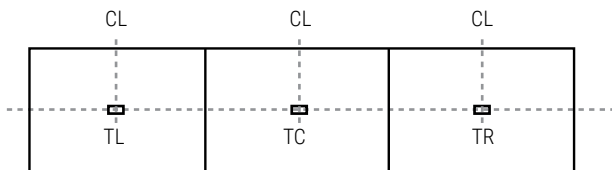
**Rectangular Table, 2 Piece Top**



**UP TO 2 GROMMETS IN TL, AND/OR TR**

LKD  
All sizes

**Rectangular Table, 3 Piece Top**



**UP TO 3 GROMMETS IN TL,TC AND/OR TR**

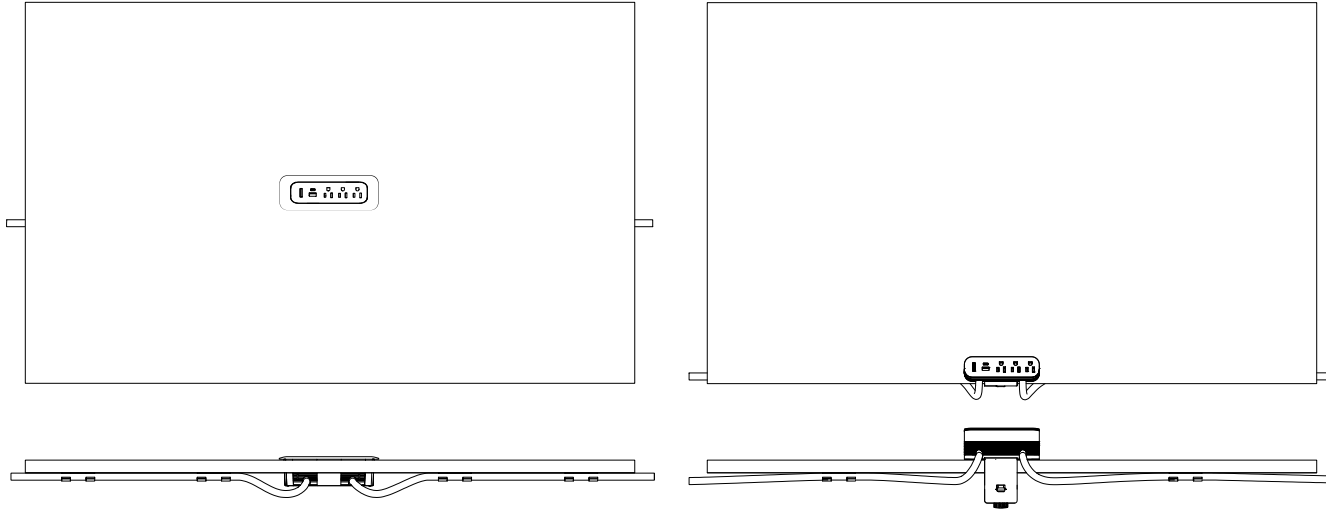
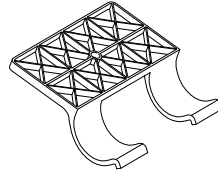
LKD  
All sizes

Note: Grommet orientation follows the length of table.

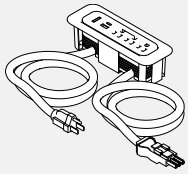
**ModPower Power Solution**

- Power solutions for flexible spaces. Connect up to four units (in Canada)/six units in the USA from a single infeed with NEMA plug to deliver power and charging ports to the table top. In-surface modules and clamp on modules available.
- Easy to install; code compliant that allows users to optimize any space providing convenient power access. Perfect for training areas, meeting rooms, in-office workstations and more. Units feature tamper-resistant receptacles as well as both USB-A and USB-C charging ports.
- Easy to use connectors that are touch-safe with added latch to prevent unintended separation. Easy push together to connect, and simple press down on latch to disconnect.
- Maximum overall length not to exceed 48.5 feet per infeed. UL listed to UL962A SD, the standard for furniture power distribution units for portable/moveable work space tables.
- Certified to CSA standard C22.2 No. 203-16.
- Will work with Licence, Terina and Bridges Products.

- Surface mounted module ships with a clamp mount that will accommodate any material 1/2" to 1-1/2" thick; additional brackets are also included for screw in mounting options that can accommodate vertical or horizontal positions.
- Modules can be integrated into surfaces but the surface must be specified as a special.



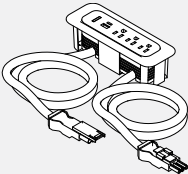
**GMDSF10 • ModPower In Surface Starter Unit**



- ModPower starter unit includes one 10' cord with a NEMA plug and one 3' connector cord.
- Unit equipped with three 15A tamper resistant receptacles, one USB-A and one USB-C charging ports and a circuit breaker.
- 4 cable management cord clips included.
- MG at the end of the code indicates a magnesium finish, while WH is a white finish.

PRODUCT CODE	PRICE	DIMENSIONS			WEIGHT		VOL FT <sup>3</sup>
		H	W	D	LBS		
GMDSF10MG	597	2.63	7.63	2.63	3.44	1.0	
GMDSF10WH	597	2.63	7.63	2.63	3.44	1.0	

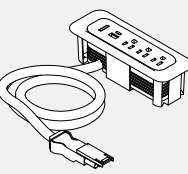
**GMDCF3 • ModPower In Surface Middle Unit**



- ModPower middle unit includes two 3' connector cords.
- Unit equipped with three 15A rated 12A tamper resistant receptacles, one USB-A and one USB-C charging ports and a circuit breaker.
- 4 cable management cord clips included.
- MG at the end of the code indicates a magnesium finish, while WH is a white finish.

PRODUCT CODE	PRICE	DIMENSIONS			WEIGHT		VOL FT <sup>3</sup>
		H	W	D	LBS		
GMDCF3MG	562	2.63	7.63	2.63	2.44	1.0	
GMDCF3WH	562	2.63	7.63	2.63	2.44	1.0	

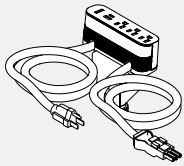
**GMDEF3 • ModPower In Surface End Unit**



- ModPower end unit includes one 3' connector cord.
- Unit equipped with three 15A rated 12A tamper resistant receptacles, one USB-A and one USB-C charging ports and a circuit breaker.
- 2 cable management cord clips included.
- MG at the end of the code indicates a magnesium finish, while WH is a white finish.

PRODUCT CODE	PRICE	DIMENSIONS			WEIGHT		VOL FT <sup>3</sup>
		H	W	D	LBS		
GMDEF3MG	494	2.63	7.63	2.63	1.85	1.0	
GMDEF3WH	494	2.63	7.63	2.63	1.85	1.0	

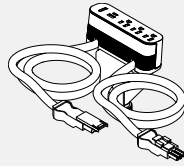
**GMDSA10 • ModPower Starter Mounted Unit**



- ModPower starter unit includes one 10' cord with a NEMA plug and one 3' connector cord.
- Unit equipped with three 15A tamper resistant receptacles, one USB-A and one USB-C charging ports and a circuit breaker.
- Includes edge clamp and 3 other mounting methods; and 4 cable management cord clips.
- MG at the end of the code indicates a magnesium finish, while WH is a white finish.

PRODUCT CODE	PRICE	PRICE			WEIGHT		VOL FT <sup>3</sup>
		H	W	D	LBS		
GMDSA10MG	631	2.5	6.13	1.75	4.33	1.0	
GMDSA10WH	631	2.5	6.13	1.75	4.33	1.0	

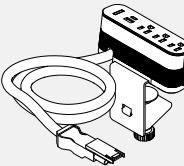
**GMDCA3 • ModPower Middle Mounted Unit**



- ModPower middle unit includes two 3' connector cords.
- Unit equipped with three 15A rated 12A tamper resistant receptacles, one USB-A and one USB-C charging ports and a circuit breaker.
- Includes edge clamp and 3 other mounting methods; and 4 cable management cord clips.
- MG at the end of the code indicates a magnesium finish, while WH is a white finish.

PRODUCT CODE	PRICE	PRICE			WEIGHT		VOL FT <sup>3</sup>
		H	W	D	LBS		
GMDCA3MG	597	2.5	6.13	1.75	3.33	1.0	
GMDCA3WH	597	2.5	6.13	1.75	3.33	1.0	

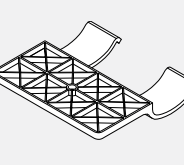
**GMDEA3 • ModPower End Mounted Unit**



- ModPower end unit includes one 3' connector cord.
- Unit equipped with three 15A rated 12A tamper resistant receptacles, one USB-A and one USB-C charging ports and a circuit breaker.
- Includes edge clamp and 3 other mounting methods; and 2 cable management cord clips.
- MG at the end of the code indicates a magnesium finish, while WH is a white finish.

PRODUCT CODE	PRICE	PRICE			WEIGHT		VOL FT <sup>3</sup>
		H	W	D	LBS		
GMDEA3MG	528	2.5	6.13	1.75	2.75	1.0	
GMDEA3WH	528	2.5	6.13	1.75	2.75	1.0	

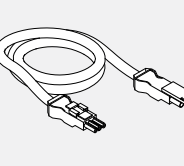
**GMDCLIPS • ModPower Management Clips**



- Includes 10 clips.

PRODUCT CODE	PRICE	PRICE			WEIGHT		VOL FT <sup>3</sup>
		H	W	D	LBS		
GMDCLIPS	102	0.6	2.6	2.5	0.3	0.2	

**GMDJ36BK • ModPower Interconnecting Jumper**



- ModPower interconnecting jumper cord to add an additional 3 feet of cord length between ModPower units.
- Package of 2, each 3 feet with male & female connector.

PRODUCT CODE	PRICE	PRICE			WEIGHT		VOL FT <sup>3</sup>
		H	W	D	LBS		
GMDJ36BK	329		36		1.38	0.9	



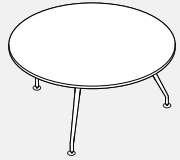
**LKD • Square Table**



- Leg finish option, chrome or paint.
- Beam finish, paint only.

PRODUCT CODE	PRICE		SIZE/INCHES						WEIGHT		VOL FT <sup>3</sup>
	B	W	KL	FV	KV	H(B)	H(W)	W	D	LBS	
LKD3636	1193	1339	1544	1760	1821	29	29.5	36	36	73	4
LKD4242	1363	1503	1803	2097	2182	29	29.5	42	42	86	4
LKD4848	1600	1769	2097	2482	2594	29	29.5	48	48	107	5
LKD5454	1763	1968	2522	3009	3150	29	29.5	54	54	120	5
LKD6060	1943	2187	2891	3490	3667	29	29.5	60	60	135	6

**LKD • Round Table**



- Leg finish option, chrome or paint.
- Beam finish, paint only.

PRODUCT CODE	PRICE		SIZE/INCHES						WEIGHT		VOL FT <sup>3</sup>
	B	W	KL	FV	KV	H(B)	H(W)	W	D	LBS	
LKD36DIA	962	1111	1310	1580	1656	29	29.5	36	36	66	3
LKD42DIA	1131	1272	1624	1989	2093	29	29.5	42	42	78	3
LKD48DIA	1344	1520	1976	2451	2592	29	29.5	48	48	99	4
LKD54DIA	1507	1717	2430	3030	3206	29	29.5	54	54	111	4
LKD60DIA	1684	1938	2873	3624	3835	29	29.5	60	60	126	5

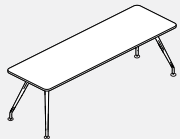
**LKD4 • Round Table with 4 Legs**



- Leg finish option, chrome or paint.
- Beam finish, paint only.

PRODUCT CODE	PRICE		SIZE/INCHES						WEIGHT		VOL FT <sup>3</sup>
	B	W	KL	FV	KV	H(B)	H(W)	W	D	LBS	
LKD436DIA	1193	1339	1458	1726	1804	29	29.5	36	36	66	3
LKD442DIA	1363	1503	1779	2146	2248	29	29.5	42	42	78	3
LKD448DIA	1600	1769	2162	2638	2780	29	29.5	48	48	99	4
LKD454DIA	1763	1968	2573	3176	3348	29	29.5	54	54	111	4
LKD460DIA	1943	2187	3035	3785	3996	29	29.5	60	60	126	5

**LKD • Rectangular Table**



- Leg finish option, chrome or paint.
- Beam finish, paint only.

PRODUCT CODE	PRICE		SIZE/INCHES						WEIGHT		VOL FT <sup>3</sup>
	B	W	KL	FV	KV	H(B)	H(W)	W	D	LBS	
LKD3648	1411	1559	1784	2074	2156	29	29.5	48	36	75	4
LKD3654	1472	1637	1951	2274	2369	29	29.5	54	36	81	4
LKD3660	1536	1717	2068	2432	2536	29	29.5	60	36	88	5
LKD3666	1600	1798	2190	2588	2702	29	29.5	66	36	95	5
LKD3672	1660	1876	2308	2741	2869	29	29.5	72	36	101	5
LKD3678	1723	1952	2427	2898	3038	29	29.5	78	36	105	5
LKD3684	1788	2032	2549	3054	3200	29	29.5	84	36	108	5
LKD3696	1914	2190	2786	3366	3532	29	29.5	96	36	115	6
LKD4248	1512	1658	1942	2277	2376	29	29.5	48	42	87	4
LKD4254	1586	1747	2124	2503	2614	29	29.5	54	42	90	5
LKD4260	1659	1836	2263	2682	2808	29	29.5	60	42	94	5
LKD4266	1736	1926	2402	2867	2999	29	29.5	66	42	101	5
LKD4272	1808	2014	2539	3045	3193	29	29.5	72	42	106	5
LKD4278	1884	2103	2677	3225	3384	29	29.5	78	42	110	6
LKD4284	1955	2192	2815	3408	3577	29	29.5	84	42	113	6
LKD4296	2104	2370	3092	3766	3962	29	29.5	96	42	129	6
LKD4854	1721	1900	2301	2735	2858	29	29.5	54	48	94	5
LKD4860	1804	2001	2457	2937	3077	29	29.5	60	48	99	5
LKD4866	1887	2098	2613	3142	3295	29	29.5	66	48	107	6
LKD4872	1970	2197	2768	3347	3515	29	29.5	72	48	114	6
LKD4878	2052	2297	2928	3553	3735	29	29.5	78	48	120	6
LKD4884	2136	2396	3083	3757	3954	29	29.5	84	48	125	6
LKD4896	2300	2595	3397	4169	4390	29	29.5	96	48	149	7

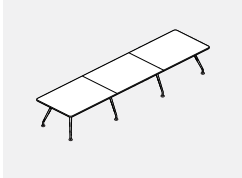
**LKD • Rectangular Table, 2 Piece Top**



- Leg finish option, chrome or paint.
- Beam finish, paint only.

PRODUCT CODE	PRICE					SIZE / INCHES				WEIGHT		VOL FT <sup>3</sup>
	B	W	KL	FV	KV	H(B)	H(W)	W	D	LBS		
LKD36108	2634	2839	3510	4159	4346	29	29.5	108	36	154	7	
LKD36120	2767	2995	3748	4473	4681	29	29.5	120	36	164	8	
LKD42108	2809	3042	3855	4612	4832	29	29.5	108	42	124	8	
LKD42120	2959	3214	4132	4973	5217	29	29.5	120	42	141	9	
LKD48108	3020	3272	4200	5066	5317	29	29.5	108	48	127	9	
LKD48120	3191	3474	4515	5475	5757	29	29.5	120	48	151	9	
LKD48132	3356	3663	4827	5886	6194	29	29.5	132	48	164	10	
LKD48144	3399	3713	5140	6295	6632	29	29.5	144	48	181	10	
LKD48156	3687	4045	5453	6705	7068	29	29.5	156	48	191	11	
LKD48168	3852	4234	5767	7116	7505	29	29.5	168	48	206	11	
LKD48180	4141	4566	6082	7525	7942	29	29.5	180	48	220	12	
LKD54144	3798	4160	5643	6943	7320	29	29.5	144	54	193	11	
LKD54168	4161	4581	6344	7858	8301	29	29.5	168	54	214	12	
LKD60144	4020	4417	6098	7542	7963	29	29.5	144	60	206	12	
LKD60168	4420	4874	6874	8558	9047	29	29.5	168	60	227	13	

**LKD • Rectangular Table, 3 Piece Top**



- Leg finish option, chrome or paint.
- Beam finish, paint only.

PRODUCT CODE	PRICE					SIZE / INCHES				WEIGHT		VOL FT <sup>3</sup>
	B	W	KL	FV	KV	H(B)	H(W)	W	D	LBS		
LKD48192	4657	5089	6881	8423	8870	29	29.5	192	48	279	14	
LKD54192	5005	5478	7537	9268	9773	29	29.5	192	54	288	15	
LKD54216	5368	5897	8239	10185	10751	29	29.5	216	54	270	16	
LKD54240	5732	6317	8938	11102	11733	29	29.5	240	54	298	17	
LKD60192	5300	5814	8145	10070	10630	29	29.5	192	60	257	16	
LKD60216	5699	6272	8921	11085	11714	29	29.5	216	60	283	17	
LKD60240	6097	6729	9693	12100	12797	29	29.5	240	60	311	18	

## LICENCE 2 SPECIFICATIONS

- Greenguard certified (www.greenguard.org)
- Carb compliant
- Level3™ certified (www.levelcertified.org)
- Tested to meet or exceed ANSI/BIFMA X5.9.2004 , ANSI/BIFMA X5.5.2008 and CAN/CGSB 44-227-2008
- Plant is ISO 9001:2015 (Quality) certified
- Plant is ISO 14001: 2015 (Environmental) certified
- Plant is OHSAS 18001:2007 (Health and Safety) certified
- 100% made in Canada
- Lifetime Warranty
- Over 6500 standard components
- Custom units available in 5 weeks lead time
- Over 24 standard laminate finishes available
- Edge colour can be specified - select from 20 colours and patterns
- Desk shells and rectangular returns non handed
- Panel end style with top over side panel design
- Tops available in 1" thick Low Pressure Laminate
- Tops available in 1-1/16" or 1-7/16" thick High Pressure Laminate
- Tops available in one edge style: Boulevard (S)
- Surfaces constructed of 45lb. density particleboard substructure with high performance thermally fused laminate or optional high pressure laminate
- Chassis constructed from 45lb. density particleboard substructure with thermally fused laminate
- 3mm edges surround all tops, end panels, drawers and door fronts
- Laminate full modesty and 10" partial modesty available as standard
- Anodized Aluminum framed frosted glazed doors available, no handles included.
- Box drawers mounted on full extension premium ball bearing slides
- File drawers mounted on premium full extension progressive ball bearing slides
- File drawers accommodate letter and/or legal hanging files (see file drawer capacity page G.2)
- Locks are standard on all units. Available in black or silver finish
- All lateral files feature a drawer interlocking mechanism
- Desk drawers open with pulls as standard
- Drawer bottoms are routed into the drawer sides
- Drawer fronts are edged on all four sides with matching 3mm edge
- All drawers locking as standard
- Key alike available
- Pedestals available in 15-1/2" width and 18, 20, 23, 24, 29, 30, 36 depth, include one pencil tray
- All mobile pedestals have option for a counterweight
- Storage modules feature levellers 5/16" x 1" easily accessible from outside the unit. All others feature 5/16" x 2" levellers.
- Monopost legs available in 3 different options, 2.5" or 3" square, 3" round and 6" round
- 6 handle options
- Storage modules available in 4 heights 29", 50", 65.8", 72.8"
- Lateral modules available in 3 widths 30", 36", 42"
- Rectangular grommets are standard and can be specified in a variety of locations as standard (see Grommet Location page A.10)
- Several Power Grommets style and configurations available.
- Drawers/Door fronts are available in a different finish than that of the chassis. Please specify option. Note that the kick plate will match the drawer front finish unless otherwise noted.

## FREESTANDING - TECHNICAL INFORMATION

### Worksurfaces

- Worksurfaces are offered in LP (1"), B (1 1/16") or W (1 7/16").
- All worksurfaces are drilled to accept connectors in a desk configuration.
- Worksurfaces are available in the following shapes: rectangular, bow, wedge and swerve.

### Worksurface Edge trim

- Available in 1 1/16" ("B" thickness), 1 7/16" ("W" thickness) or 1" ("LP" thickness).
- Wood grain PVC edge trim, available in Boulevard (S) edge "B" and "W" thickness only.

### Edge Options

Boulevard (S) Edge

"LP"

Thickness



HP "B"

Thickness



HP "W"

Thickness



Hardware

All attachment hardware is included.

### Modesty Panels

- Available in full panel 27 5/8" high or half panel ("H" option) 10" high.
- Modesty panels are flush mounted with 24", 30" and 36" deep end gables.
- Modesty panels are available recessed for 30" and 36" deep end gables.
- All recessed modesty panels are inset 6" from the edge.
- Only flush modesty panels are used for extended shell and bridge.
- Only full modesty panels are used for "L2D" desks: Rectangular, Bow, and Wedge worksurfaces.
- All exposed edges are edge banded.

### Panel and Gables

- The term "end gable" or "narrow gable" is used to configure a shell, single pedestal or return.
- The term "end panel" or "narrow panel" is used to configure a table desk with shaped worksurfaces such as "D", "P", or profiles.
- All end gables are interchangeable for left or right hand use.

- End gables 24", 30" and 36" deep are drilled to accept full or half modesty panels that are flush mounted.
- End gables 30" and 36" are used for full or half modesty panels that are recessed.
- All panels and end gables are 1" thick and 27 5/8" high.
- All panels and end gables are finished in low pressure laminate.
- End gables are used in shells and single pedestal desks.
- Narrow end gables are used in shells, single pedestal desks, "T", or "L" bases.
- Narrow panels are routed to accept modular connectors for "T" or "L" applications.
- All panels and gables are predrilled to accept levelers at the bottom and connectors at the top.
- All panels or gables are 3mm edge banded at the exposed edge .
- All narrow gables are routed at the top to allow cables to pass through and come with a connecting flat bracket.
- All bottom edges are edge banded.

### Handles

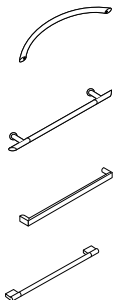
- Handles are offered in 4 styles.
- Options are as follows:

BB = Bow Matte Black  
BC = Bow Matte Chrome

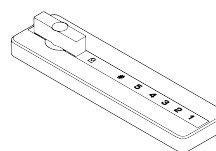
UB = "U"Dull Black  
UC = "U"Dull Chrome

FA = Flat Aluminum

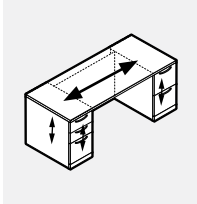
RN = Round Nickel



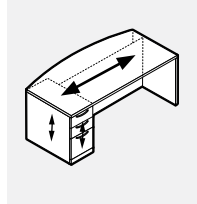
- Span dimension between drilling locations is 192mm.
- e-lock



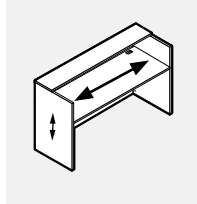
**WOOD GRAIN (WG) LAMINATE DIRECTION**



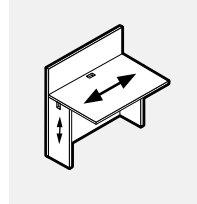
Double Pedestal Desks



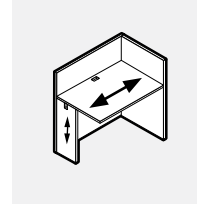
Single Pedestal Desks



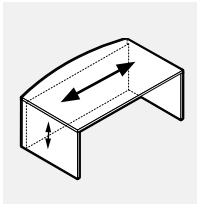
Reception Desks



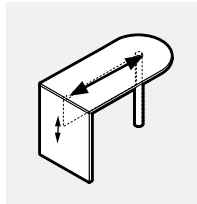
Surround Bridges



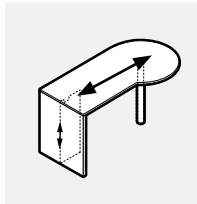
Right Hand Surround Bridges



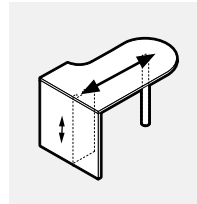
Shells



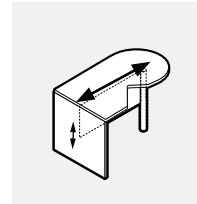
"D" Shaped Tables



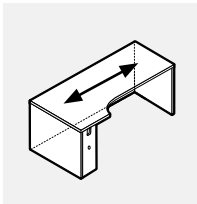
"P" Shaped Tables



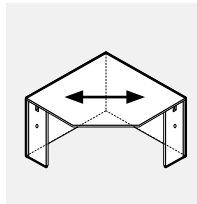
Profile Corner Round Tables



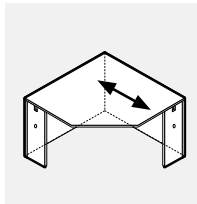
Profile Corner Cut Tables



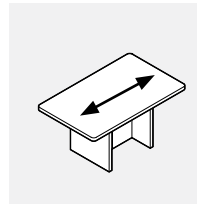
Profile Corner Desks



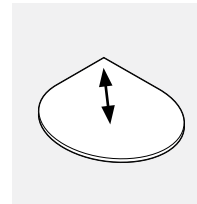
All Corner Desks 42" and Smaller



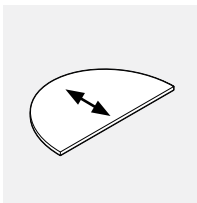
All Corner Desks Larger than 42"



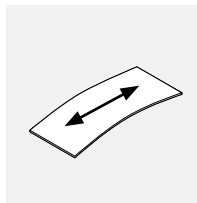
Occasional Tables



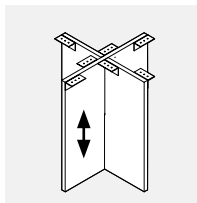
Teardrop Table Tops



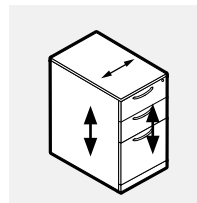
Half Moon Table Tops



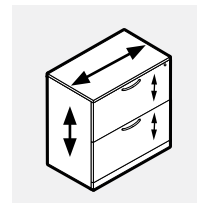
All Other Table Tops



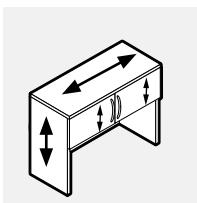
Bases



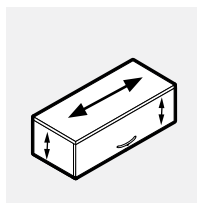
All Pedestals



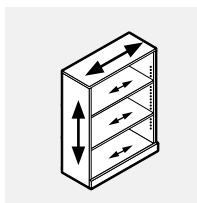
All Laterals



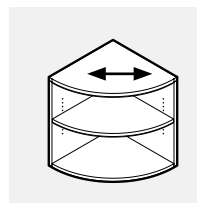
All Hinged Door Hutches



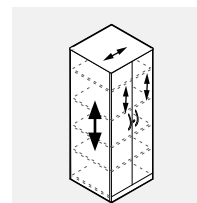
All Flip-Up Door Overheads



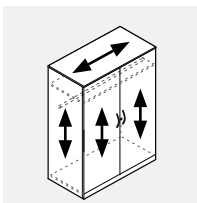
All Bookcases



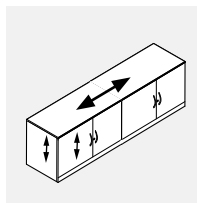
All Corner Bookcases



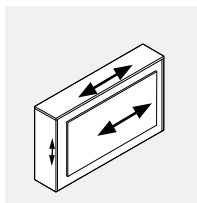
All Towers



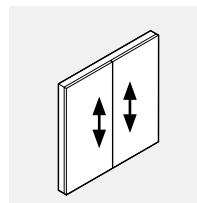
All Cabinets



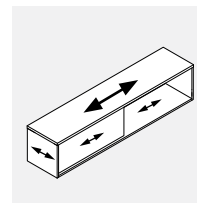
All Credenzas



Gallery Desk



Visual Board



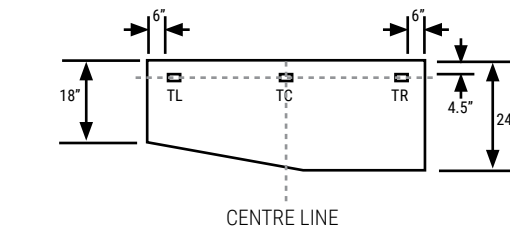
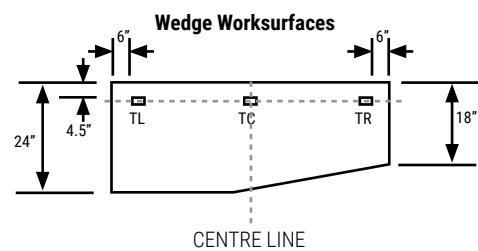
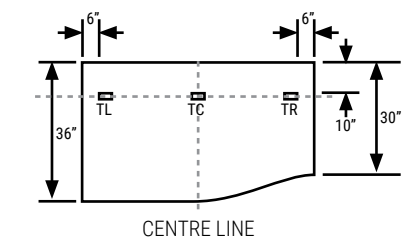
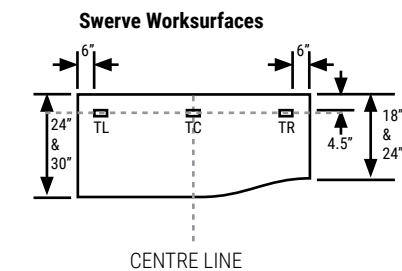
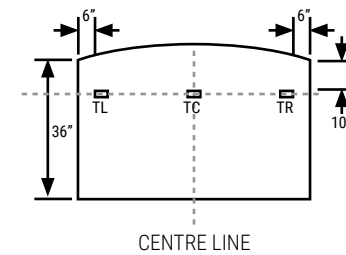
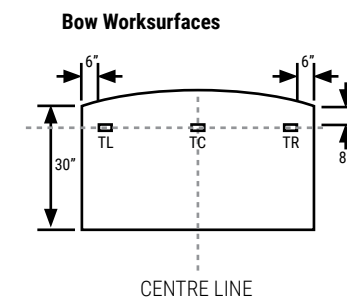
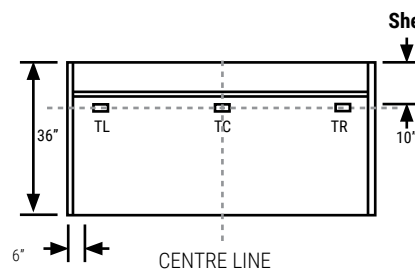
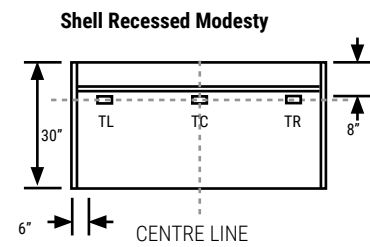
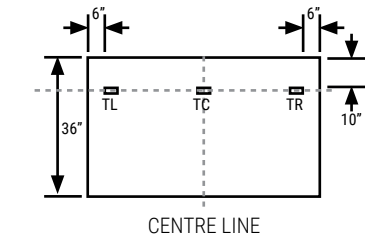
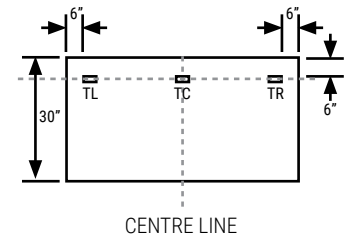
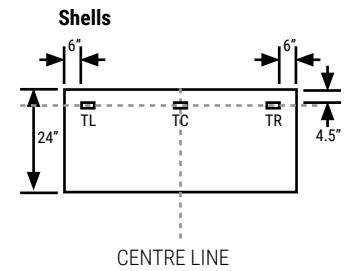
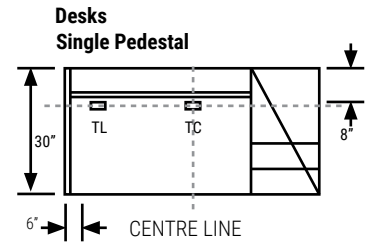
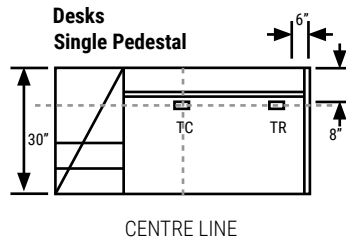
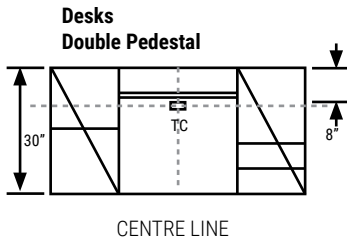
Overhead Divider Storage

**GROMMET LOCATION**

**Notes**

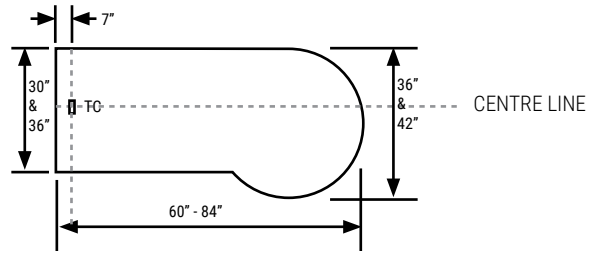
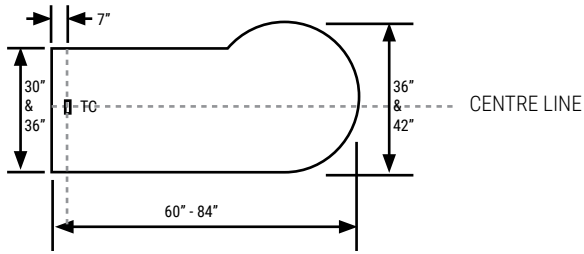
- All worksurfaces are standard with rectangular grommets # BG5.
- Worksurfaces 54" wide and under are standard with 1 grommet.

- Worksurfaces over 54" wide are standard with 2 grommets.
- Grommet location must be specified at time of order or it will default to "no grommet" option.

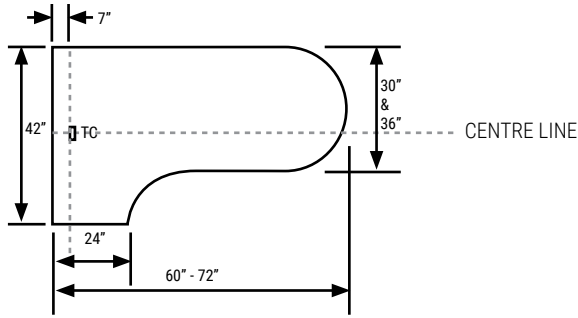


**GROMMET LOCATION**

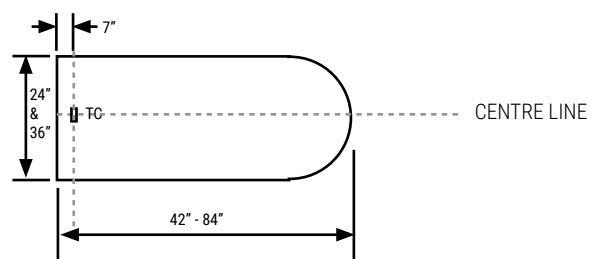
**"P" Shaped Tables "L2T"**



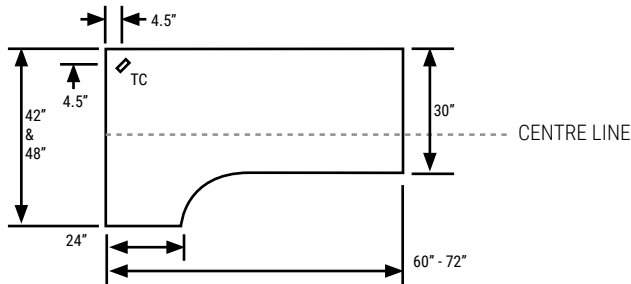
**Extended "D" - L2TED**



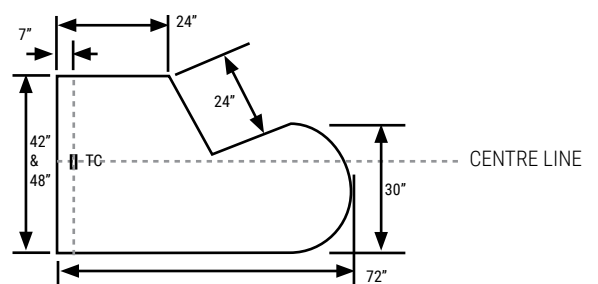
**"D" Shaped Tables**



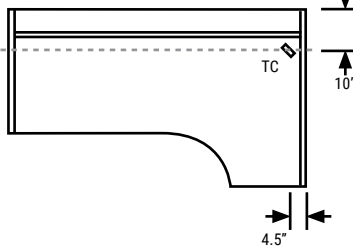
**Extended Corner "L2EC"**



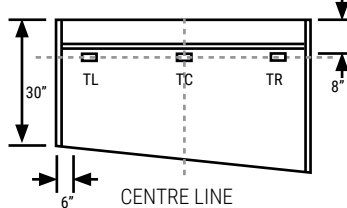
**Extended "D" Cut Out "L2TEDCO"**



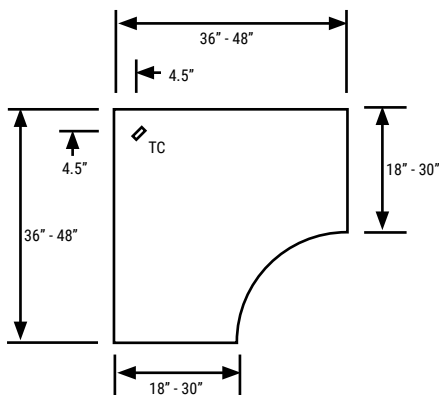
**Extended Corner Recessed Modesty**



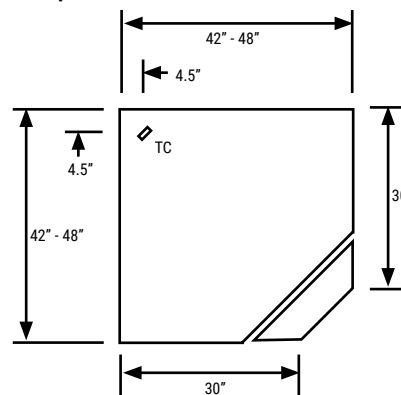
**Wedge Shell Recessed Modesty**



**Corner Worksurfaces - 1 Piece**



**Split Corner Worksurfaces - 2 Piece**



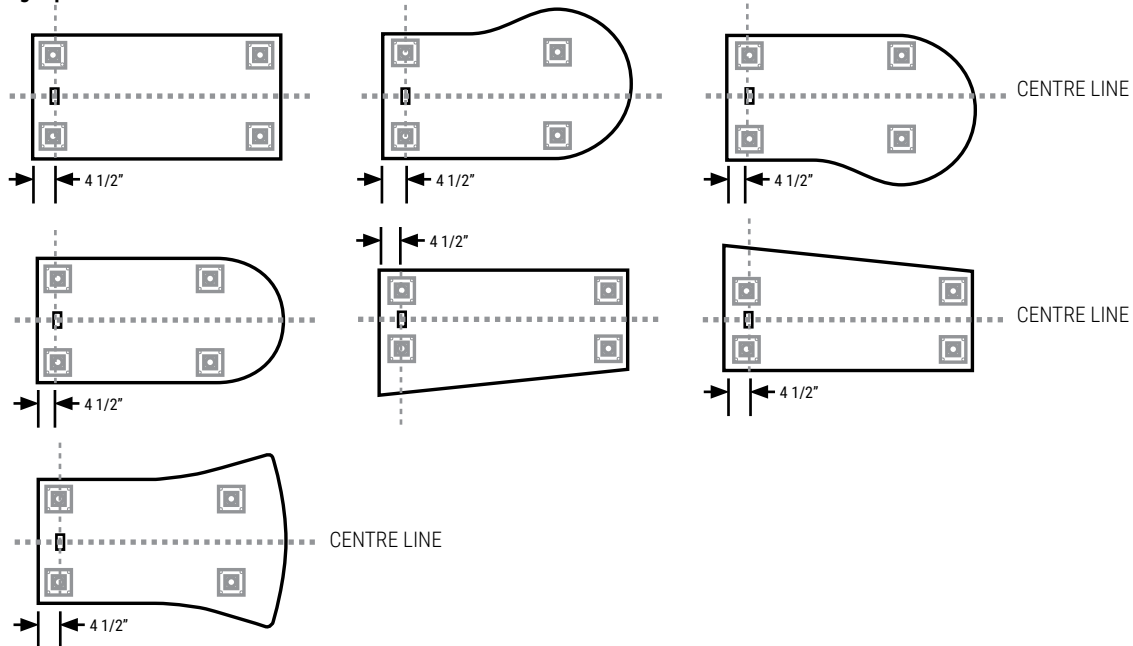


**GROMMET LOCATION**

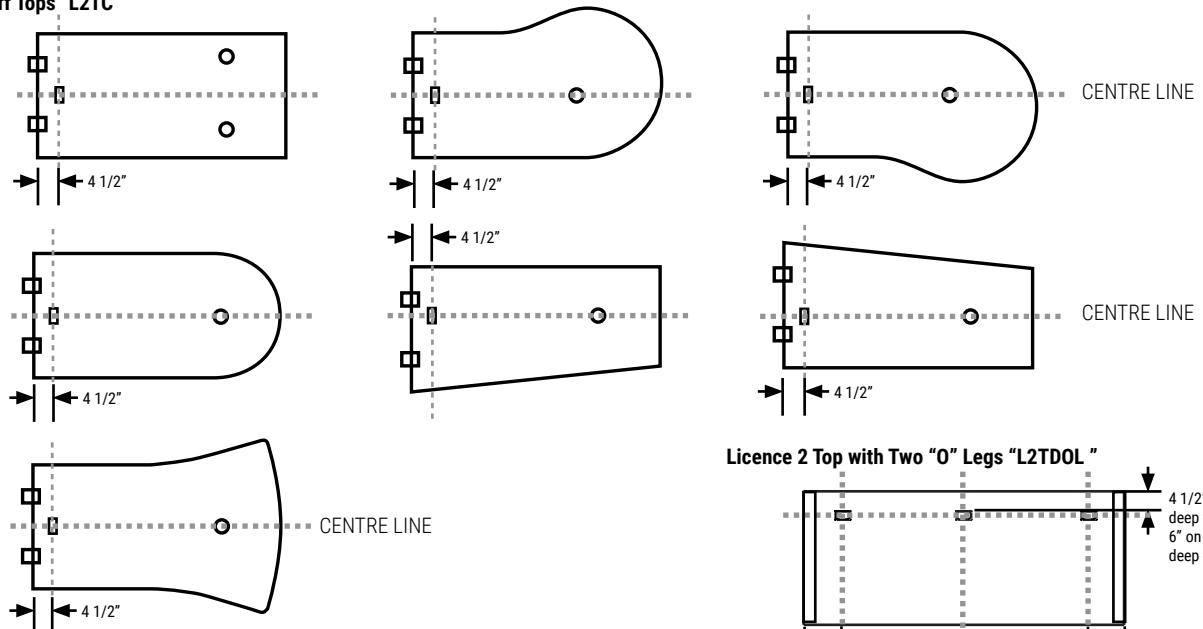
**Hockey Shaped Tables "L2TH"**



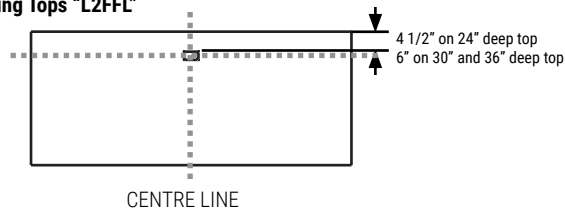
**Floating Tops "L2F"**



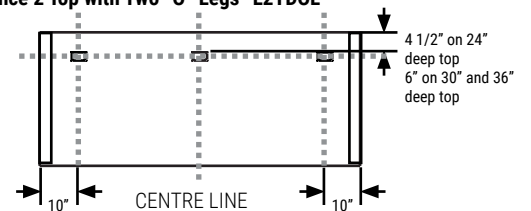
**Runoff Tops "L2TC"**



**Floating Tops "L2FFL"**



**Licence 2 Top with Two "O" Legs "L2TDOL"**



**Technical Information**

**Double Pedestal Desk/ Single Pedestal Desk**

- All desks are Shipped knocked down (KD).
- Pedestals are shipped assembled
- Pedestals are LP all over
- Non Interlocking mechanism Pedestals
- Half modesty available on all Double Pedestal Desks, specify 'H' Before size eg. L2DRH3060FB
- Half modesty available on Single Pedestal Desks, specify "H" before size eg. L2DRH3060BR
- All desks have modesty recessed 6"

**Executive Return Desk**

- All desks are Shipped knocked down (KD).
- This typed of desk must be connected at open end to adjoining worksurface with flat brackets.
- Half modesty available on all Single Pedestal Returns, specify "H" before size eg. L2RH2036FL

**Single Pedestal Returns**

- All desks are Shipped knocked down (KD).
- This type of desk must be connected at open end to adjoining worksurface with flat brackets.

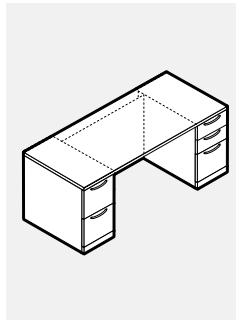
**DESKS • GUIDELINES FOR ORDERING PRODUCT**

**CODES:** The price list uses a numbering system with meaningful alphanumeric characters to create a simple-to-understand product number. This makes specifying the product much easier and more accurate.

**SPECIFICATION EXAMPLE OF A DESK UNIT**

**PRODUCT CODE:**

L2DR3060FB  
 L2 = New Licence  
 D = Desk  
 R = Rectangular  
 3060 = Size: Depth x Width  
 FB = PED FF LEFT / PED BBF RIGHT



**OPTIONS:**

Top: LP - LP (Low Pressure Laminate) Thickness 1"  
 HP B - B Thickness 1 1/16"  
 HP W - W Thickness 1 7/16"

Top Finish Laminate: Choose Colour

Top PVC Edging: Choose Colour

Chassis Laminate: Choose Colour

Chassis PVC Edging: Choose Colour

Handle Style: **BC - Bow Matte Chrome (DEFAULT)**

- BB - Bow Matt Black
- UB - "U" Dull Black
- UC - "U" Dull Chrome
- FA - Flat Aluminum
- RN - Round Nickel

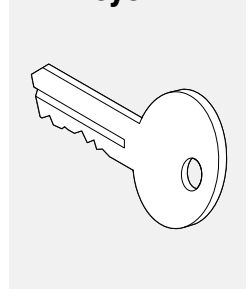
Grommet Location: **N - No grommet (DEFAULT)**

Double Pedestal desk: TC - Top Centre Only

Single Right Pedestal Desk: TC - Top Centre  
 TL - Top Left

Single Left Pedestal Desk: TC - Top Centre  
 TR - Top Right

**L2 • Keys**



- Additional key (specify at time of order).
- Please choose black or silver.

PRODUCT CODE	PRICE	SIZE/ H	INCHES W	D	WEIGHT LBS	VOL FT <sup>3</sup>
--------------	-------	---------	----------	---	------------	---------------------

**Master key:**

L2MK 30

**Extra key for existing cabinet:**

L2EK 13

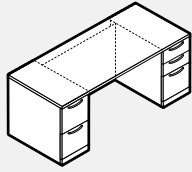
**Core key:**

L2CK 15

**Core & Key:**

L2LOCKKEY 32

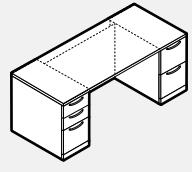
**L2DR-FB • Double Pedestal Desk, FF Left, BBF Right, Recessed Modesty**



• Optional e-lock available for each pedestal in the vertical position. Please specify V-Vertical and add \$231 list for each.

PRODUCT CODE	FINISH LP	B	W	SIZE/INCHES				D	WEIGHT LBS	VOL FT <sup>3</sup>
				H (LP/B)	H (W)	W	D			
L2DR3060FB	2359	2499	2627	29	29.5	60	30	224	24	
L2DR3066FB	2403	2556	2696	29	29.5	66	30	234	25	
L2DR3072FB	2447	2614	2765	29	29.5	72	30	244	25	
L2DR3078FB	2493	2671	2835	29	29.5	78	30	272	26	
L2DR3084FB	2537	2733	2907	29	29.5	84	30	299	26	
L2DR3672FB	2572	2774	2947	29	29.5	72	36	272	26	
L2DR3678FB	2620	2839	3023	29	29.5	78	36	299	28	
L2DR3684FB	2671	2905	3104	29	29.5	84	36	327	28	

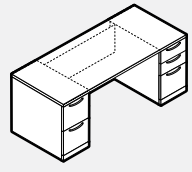
**L2DR-BF • Double Pedestal Desk, FF Right, BBF Left, Recessed Modesty**



• Optional e-lock available for each pedestal in the vertical position. Please specify V-Vertical and add \$231 list for each.

PRODUCT CODE	FINISH LP	B	W	SIZE/INCHES				D	WEIGHT LBS	VOL FT <sup>3</sup>
				H (LP/B)	H (W)	W	D			
L2DR3060BF	2359	2499	2627	29	29.5	60	30	224	24	
L2DR3066BF	2403	2556	2696	29	29.5	66	30	234	25	
L2DR3072BF	2447	2614	2765	29	29.5	72	30	244	25	
L2DR3078BF	2493	2671	2835	29	29.5	78	30	272	26	
L2DR3084BF	2537	2733	2907	29	29.5	84	30	299	26	
L2DR3672BF	2572	2774	2947	29	29.5	72	36	272	26	
L2DR3678BF	2620	2839	3023	29	29.5	78	36	299	28	
L2DR3684BF	2671	2905	3104	29	29.5	84	36	327	28	

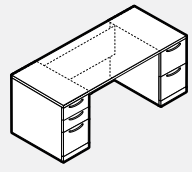
**L2DRH-FB • Double Pedestal Desk, FF Left, BBF Right Recessed Half Modesty**



• Optional e-lock available for each pedestal in the vertical position. Please specify V-Vertical and add \$231 list for each.

PRODUCT CODE	FINISH LP	B	W	SIZE/INCHES				D	WEIGHT LBS	VOL FT <sup>3</sup>
				H (LP/B)	H (W)	W	D			
L2DRH3060FB	2301	2440	2571	29	29.5	60	30	224	24	
L2DRH3066FB	2337	2493	2630	29	29.5	66	30	234	25	
L2DRH3072FB	2370	2536	2689	29	29.5	72	30	244	25	
L2DRH3078FB	2404	2585	2748	29	29.5	78	30	272	26	
L2DRH3084FB	2439	2633	2810	29	29.5	84	30	299	26	
L2DRH3672FB	2496	2696	2869	29	29.5	72	36	272	26	
L2DRH3678FB	2534	2750	2934	29	29.5	78	36	299	28	
L2DRH3684FB	2573	2808	3007	29	29.5	84	36	327	28	

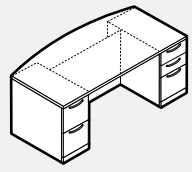
**L2DRH-BF • Double Pedestal Desk, BBF Left, FF Right Recessed Half Modesty**



• Optional e-lock available for each pedestal in the vertical position. Please specify V-Vertical and add \$231 list for each.

PRODUCT CODE	FINISH LP	B	W	SIZE/INCHES				D	WEIGHT LBS	VOL FT <sup>3</sup>
				H (LP/B)	H (W)	W	D			
L2DRH3060BF	2301	2440	2571	29	29.5	60	30	224	24	
L2DRH3066BF	2337	2493	2630	29	29.5	66	30	234	25	
L2DRH3072BF	2370	2536	2689	29	29.5	72	30	244	25	
L2DRH3078BF	2404	2585	2748	29	29.5	78	30	272	26	
L2DRH3084BF	2439	2633	2810	29	29.5	84	30	299	26	
L2DRH3672BF	2496	2696	2869	29	29.5	72	36	272	26	
L2DRH3678BF	2534	2750	2934	29	29.5	78	36	299	28	
L2DRH3684BF	2573	2808	3007	29	29.5	84	36	327	28	

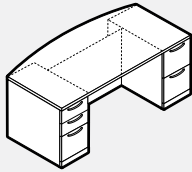
**L2DB-FB • Bowfront Double Pedestal Desk, FF Left, BBF Right, Recessed Modesty**



• Optional e-lock available for each pedestal in the vertical position. Please specify V-Vertical and add \$231 list for each.

PRODUCT CODE	FINISH LP	B	W	SIZE/INCHES				D	WEIGHT LBS	VOL FT <sup>3</sup>
				H (LP/B)	H (W)	W	D			
L2DB3060FB	2414	2582	2725	29	29.5	60	36	374	25	
L2DB3066FB	2462	2646	2803	29	29.5	66	36	383	26	
L2DB3072FB	2508	2710	2879	29	29.5	72	36	395	26	
L2DB3078FB	2560	2775	2955	29	29.5	78	36	422	28	
L2DB3084FB	2610	2843	3036	29	29.5	84	36	450	28	
L2DB3672FB	2635	2869	3059	29	29.5	72	42	422	28	
L2DB3678FB	2689	2941	3143	29	29.5	78	42	450	29	
L2DB3684FB	2744	3015	3232	29	29.5	84	42	477	29	

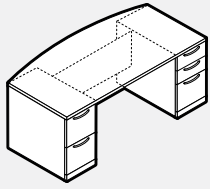
**L2DB-BF • Bowfront Double Pedestal Desk, FF Right, BBF Left, Recessed Modesty**



• Optional e-lock available for each pedestal in the vertical position. Please specify V-Vertical and add \$231 list for each.

PRODUCT CODE	FINISH LP	B	W	SIZE/INCHES				D	WEIGHT LBS	VOL FT <sup>3</sup>
				H (LP/B)	H (W)	W	D			
L2DB3060BF	2414	2582	2725	29	29.5	60	36	374	25	
L2DB3066BF	2462	2646	2803	29	29.5	66	36	383	26	
L2DB3072BF	2508	2710	2879	29	29.5	72	36	395	26	
L2DB3078BF	2560	2775	2955	29	29.5	78	36	422	28	
L2DB3084BF	2610	2843	3036	29	29.5	84	36	450	28	
L2DB3672BF	2635	2869	3059	29	29.5	72	42	422	28	
L2DB3678BF	2689	2941	3143	29	29.5	78	42	450	29	
L2DB3684BF	2744	3015	3232	29	29.5	84	42	477	29	

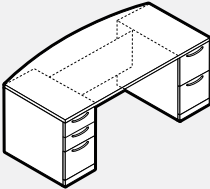
**L2DBH-FB • Bowfront Double Pedestal Desk, FF Left, BBF Right Recessed Half Modesty**



• Optional e-lock available for each pedestal in the vertical position. Please specify V-Vertical and add \$231 list for each.

PRODUCT CODE	FINISH LP	B	W	SIZE/INCHES			D	WEIGHT LBS	VOL FT <sup>3</sup>
				H (LP/B)	H (W)	W			
L2DBH3060FB	2359	2526	2670	29	29.5	60	36	374	25
L2DBH3066FB	2394	2582	2735	29	29.5	66	36	383	26
L2DBH3072FB	2434	2632	2803	29	29.5	72	36	395	26
L2DBH3078FB	2470	2689	2868	29	29.5	78	36	422	28
L2DBH3084FB	2511	2745	2936	29	29.5	84	36	450	28
L2DBH3672FB	2560	2791	2981	29	29.5	72	42	422	28
L2DBH3678FB	2601	2853	3055	29	29.5	78	42	450	29
L2DBH3684FB	2647	2918	3133	29	29.5	84	42	477	29

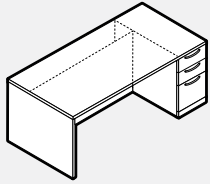
**L2DBH-BF • Bowfront Double Pedestal Desk, BBF Left, FF Right Recessed Half Modesty**



• Optional e-lock available for each pedestal in the vertical position. Please specify V-Vertical and add \$231 list for each.

PRODUCT CODE	FINISH LP	B	W	SIZE/INCHES			D	WEIGHT LBS	VOL FT <sup>3</sup>
				H (LP/B)	H (W)	W			
L2DBH3060BF	2359	2526	2670	29	29.5	60	36	374	25
L2DBH3066BF	2394	2582	2735	29	29.5	66	36	383	26
L2DBH3072BF	2434	2632	2803	29	29.5	72	36	395	26
L2DBH3078BF	2470	2689	2868	29	29.5	78	36	422	28
L2DBH3084BF	2511	2745	2936	29	29.5	84	36	450	28
L2DBH3672BF	2560	2791	2981	29	29.5	72	42	422	28
L2DBH3678BF	2601	2853	3055	29	29.5	78	42	450	29
L2DBH3684BF	2647	2918	3133	29	29.5	84	42	477	29

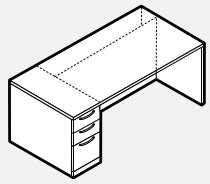
**L2DR-BR • Single Pedestal Desk, BBF Right, Recessed Modesty**



• Optional e-lock available for the pedestal in the vertical position. Please specify V-Vertical and add \$231 list.

PRODUCT CODE	FINISH LP	B	W	SIZE/INCHES			D	WEIGHT LBS	VOL FT <sup>3</sup>
				H (LP/B)	H (W)	W			
L2DR3060BR	1638	1776	1904	29	29.5	60	30	224	14
L2DR3066BR	1681	1834	1973	29	29.5	66	30	234	15
L2DR3072BR	1724	1892	2042	29	29.5	72	30	244	15
L2DR3078BR	1762	1942	2106	29	29.5	78	30	272	17
L2DR3084BR	1816	2014	2187	29	29.5	84	30	299	17
L2DR3672BR	1835	2034	2209	29	29.5	72	36	272	17
L2DR3678BR	1876	2092	2281	29	29.5	78	36	299	18
L2DR3684BR	1934	2166	2367	29	29.5	84	36	327	18

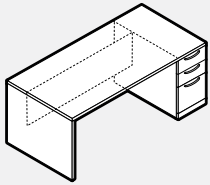
**L2DR-BL • Single Pedestal Desk, BBF Left, Recessed Modesty**



• Optional e-lock available for the pedestal in the vertical position. Please specify V-Vertical and add \$231 list.

PRODUCT CODE	FINISH LP	B	W	SIZE/INCHES			D	WEIGHT LBS	VOL FT <sup>3</sup>
				H (LP/B)	H (W)	W			
L2DR3060BL	1638	1776	1904	29	29.5	60	30	224	14
L2DR3066BL	1681	1834	1973	29	29.5	66	30	234	15
L2DR3072BL	1724	1892	2042	29	29.5	72	30	244	15
L2DR3078BL	1762	1942	2106	29	29.5	78	30	272	17
L2DR3084BL	1816	2014	2187	29	29.5	84	30	299	17
L2DR3672BL	1835	2034	2209	29	29.5	72	36	272	17
L2DR3678BL	1876	2092	2281	29	29.5	78	36	299	18
L2DR3684BL	1934	2166	2367	29	29.5	84	36	327	18

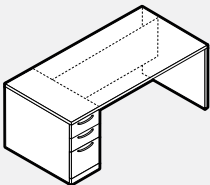
**L2DRH-BR • Single Pedestal Desk, BBF Right Recessed Half Modesty**



• Optional e-lock available for the pedestal in the vertical position. Please specify V-Vertical and add \$231 list.

PRODUCT CODE	FINISH LP	B	W	SIZE/INCHES			D	WEIGHT LBS	VOL FT <sup>3</sup>
				H (LP/B)	H (W)	W			
L2DRH3060BR	1530	1669	1800	29	29.5	60	30	224	14
L2DRH3066BR	1564	1718	1857	29	29.5	66	30	234	15
L2DRH3072BR	1599	1764	1918	29	29.5	72	30	244	15
L2DRH3078BR	1632	1812	1973	29	29.5	78	30	272	17
L2DRH3084BR	1668	1862	2037	29	29.5	84	30	299	17
L2DRH3672BR	1708	1907	2083	29	29.5	72	36	272	17
L2DRH3678BR	1746	1960	2149	29	29.5	78	36	299	18
L2DRH3684BR	1785	2020	2220	29	29.5	84	36	327	18

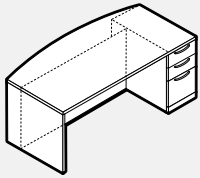
**L2DRH-BL • Single Pedestal Desk, BBF Left Recessed Half Modesty**



• Optional e-lock available for the pedestal in the vertical position. Please specify V-Vertical and add \$231 list.

PRODUCT CODE	FINISH LP	B	W	SIZE/INCHES			D	WEIGHT LBS	VOL FT <sup>3</sup>
				H (LP/B)	H (W)	W			
L2DRH3060BL	1530	1669	1800	29	29.5	60	30	224	14
L2DRH3066BL	1564	1718	1857	29	29.5	66	30	234	15
L2DRH3072BL	1599	1764	1918	29	29.5	72	30	244	15
L2DRH3078BL	1632	1812	1973	29	29.5	78	30	272	17
L2DRH3084BL	1668	1862	2037	29	29.5	84	30	299	17
L2DRH3672BL	1708	1907	2083	29	29.5	72	36	272	17
L2DRH3678BL	1746	1960	2149	29	29.5	78	36	299	18
L2DRH3684BL	1785	2020	2220	29	29.5	84	36	327	18

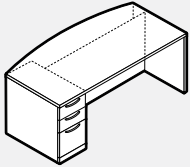
**L2DB-BR • Bowfront Single Pedestal Desk, BBF Right, Recessed Modesty**



• Optional e-lock available for the pedestal in the vertical position. Please specify V-Vertical and add \$231 list.

PRODUCT CODE	FINISH LP	B	W	SIZE/INCHES				WEIGHT		VOL FT <sup>3</sup>
				H (LP/B)	H (W)	W	D	LBS	FT <sup>3</sup>	
L2DB3060BR	1691	1859	2003	29	29.5	60	36	264	14	
L2DB3066BR	1741	1923	2083	29	29.5	66	36	274	15	
L2DB3072BR	1788	1987	2157	29	29.5	72	36	286	15	
L2DB3078BR	1831	2048	2227	29	29.5	78	36	314	17	
L2DB3084BR	1890	2121	2315	29	29.5	84	36	338	17	
L2DB3672BR	1898	2130	2322	29	29.5	72	42	310	17	
L2DB3678BR	1947	2197	2400	29	29.5	78	42	338	18	
L2DB3684BR	2006	2279	2495	29	29.5	84	42	362	18	

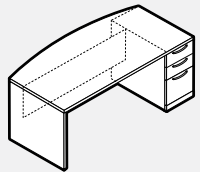
**L2DB-BL • Bowfront Single Pedestal Desk, BBF Left, Recessed Modesty**



• Optional e-lock available for the pedestal in the vertical position. Please specify V-Vertical and add \$231 list.

PRODUCT CODE	FINISH LP	B	W	SIZE/INCHES				WEIGHT		VOL FT <sup>3</sup>
				H (LP/B)	H (W)	W	D	LBS	FT <sup>3</sup>	
L2DB3060BL	1691	1859	2003	29	29.5	60	36	264	14	
L2DB3066BL	1741	1923	2083	29	29.5	66	36	274	15	
L2DB3072BL	1788	1987	2157	29	29.5	72	36	286	15	
L2DB3078BL	1831	2048	2227	29	29.5	78	36	314	17	
L2DB3084BL	1890	2121	2315	29	29.5	84	36	338	17	
L2DB3672BL	1898	2130	2322	29	29.5	72	42	310	17	
L2DB3678BL	1947	2197	2400	29	29.5	78	42	338	18	
L2DB3684BL	2006	2279	2495	29	29.5	84	42	362	18	

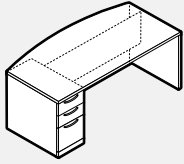
**L2DBH-BR • Bowfront Single Pedestal Desk, BBF Right Recessed Half Modesty**



• Optional e-lock available for the pedestal in the vertical position. Please specify V-Vertical and add \$231 list.

PRODUCT CODE	FINISH LP	B	W	SIZE/INCHES				WEIGHT		VOL FT <sup>3</sup>
				H (LP/B)	H (W)	W	D	LBS	FT <sup>3</sup>	
L2DBH3060BR	1586	1752	1895	29	29.5	60	36	264	14	
L2DBH3066BR	1622	1806	1961	29	29.5	66	36	274	15	
L2DBH3072BR	1660	1861	2028	29	29.5	72	36	286	15	
L2DBH3078BR	1697	1917	2093	29	29.5	78	36	314	17	
L2DBH3084BR	1740	1972	2164	29	29.5	84	36	338	17	
L2DBH3672BR	1772	2003	2193	29	29.5	72	42	310	17	
L2DBH3678BR	1812	2063	2266	29	29.5	78	42	338	18	
L2DBH3684BR	1857	2129	2347	29	29.5	84	42	362	18	

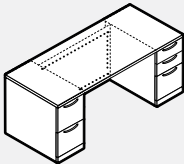
**L2DBH-BL • Bowfront Single Pedestal Desk, BBF Left Recessed Half Modesty**



- Optional e-lock available for the pedestal in the vertical position. Please specify V-Vertical and add \$231 list.

PRODUCT CODE	FINISH LP	B	W	SIZE/INCHES				WEIGHT LBS	VOL FT <sup>3</sup>
				H(LP/B)	H(W)	W	D		
L2DBH3060BL	1586	1752	1895	29	29.5	60	36	264	14
L2DBH3066BL	1622	1806	1961	29	29.5	66	36	274	15
L2DBH3072BL	1660	1861	2028	29	29.5	72	36	286	15
L2DBH3078BL	1697	1917	2093	29	29.5	78	36	314	17
L2DBH3084BL	1740	1972	2164	29	29.5	84	36	338	17
L2DBH3672BL	1772	2003	2193	29	29.5	72	42	310	17
L2DBH3678BL	1812	2063	2266	29	29.5	78	42	338	18
L2DBH3684BL	1857	2129	2347	29	29.5	84	42	362	18

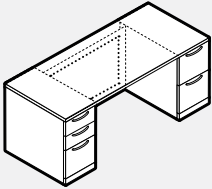
**L2DRA-FB • Double Desk, FF Left BBF Right Recessed, Glazed Full Modesty**



- Modesty is aluminum framed.
- Glazing is frosted acrylic.
- Optional e-lock available for each pedestal in the vertical position. Please specify V-Vertical and add \$231 list for each.

PRODUCT CODE	FINISH LP	B	W	SIZE/INCHES				WEIGHT LBS	VOL FT <sup>3</sup>
				H(LP/B)	H(W)	W	D		
L2DRA3060FB	2795	2931	3056	29.06	29.5	60	30	204	22
L2DRA3066FB	2881	3033	3168	29.06	29.5	66	30	213	23
L2DRA3072FB	2968	3130	3278	29.06	29.5	72	30	222	23
L2DRA3078FB	3051	3232	3389	29.06	29.5	78	30	247	24
L2DRA3084FB	3143	3334	3505	29.06	29.5	84	30	272	24
L2DRA3672FB	3091	3286	3456	29.06	29.5	72	36	247	24
L2DRA3678FB	3180	3392	3577	29.06	29.5	78	36	272	25
L2DRA3684FB	3275	3502	3698	29.06	29.5	84	36	297	25

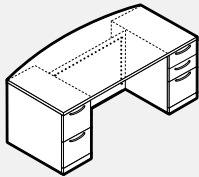
**L2DRA-BF • Double Desk, FF Right BBF Left Recessed, Glazed Full Modesty**



- Modesty is aluminum framed.
- Glazing is frosted acrylic.
- Optional e-lock available for each pedestal in the vertical position. Please specify V-Vertical and add \$231 list for each.

PRODUCT CODE	FINISH LP	B	W	SIZE/INCHES				WEIGHT LBS	VOL FT <sup>3</sup>
				H(LP/B)	H(W)	W	D		
L2DRA3060BF	2795	2931	3056	29.06	29.5	60	30	204	22
L2DRA3066BF	2881	3033	3168	29.06	29.5	66	30	213	23
L2DRA3072BF	2968	3130	3278	29.06	29.5	72	30	222	23
L2DRA3078BF	3051	3232	3389	29.06	29.5	78	30	247	24
L2DRA3084BF	3143	3334	3505	29.06	29.5	84	30	272	24
L2DRA3672BF	3091	3286	3456	29.06	29.5	72	36	247	24
L2DRA3678BF	3180	3392	3577	29.06	29.5	78	36	272	25
L2DRA3684BF	3275	3502	3698	29.06	29.5	84	36	297	25

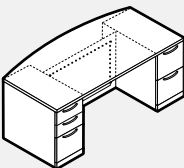
**L2DBA-FB • Bowfront Double Desk, FF Left BBF Right Recessed, Glazed Full Modesty**



- Modesty is aluminum framed.
- Glazing is frosted acrylic.
- Optional e-lock available for each pedestal in the vertical position. Please specify V-Vertical and add \$231 list for each.

PRODUCT CODE	FINISH LP	B	W	SIZE/INCHES				WEIGHT LBS	VOL FT <sup>3</sup>
				H(LP/B)	H(W)	W	D		
L2DBA3060FB	2847	3012	3153	29.06	29.5	60	36	340	23
L2DBA3066FB	2937	3118	3270	29.06	29.5	66	36	348	24
L2DBA3072FB	3033	3224	3389	29.06	29.5	72	36	359	24
L2DBA3078FB	3122	3329	3508	29.06	29.5	78	36	384	25
L2DBA3084FB	3216	3442	3629	29.06	29.5	84	36	409	25
L2DBA3672FB	3153	3380	3564	29.06	29.5	72	42	384	25
L2DBA3678FB	3248	3494	3692	29.06	29.5	78	42	409	26
L2DBA3684FB	3346	3612	3822	29.06	29.5	84	42	434	26

**L2DBA-BF • Bowfront Double Desk, FF Right BBF Left Recessed, Glazed Full Modesty**

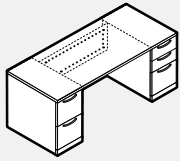


- Modesty is aluminum framed.
- Glazing is frosted acrylic.
- Optional e-lock available for each pedestal in the vertical position. Please specify V-Vertical and add \$231 list for each.

PRODUCT CODE	FINISH LP	B	W	SIZE/INCHES				WEIGHT LBS	VOL FT <sup>3</sup>
				H(LP/B)	H(W)	W	D		
L2DBA3060BF	2847	3012	3153	29.06	29.5	60	36	340	23
L2DBA3066BF	2937	3118	3270	29.06	29.5	66	36	348	24
L2DBA3072BF	3033	3224	3389	29.06	29.5	72	36	359	24
L2DBA3078BF	3122	3329	3508	29.06	29.5	78	36	384	25
L2DBA3084BF	3216	3442	3629	29.06	29.5	84	36	409	25
L2DBA3672BF	3153	3380	3564	29.06	29.5	72	42	384	25
L2DBA3678BF	3248	3494	3692	29.06	29.5	78	42	409	26
L2DBA3684BF	3346	3612	3822	29.06	29.5	84	42	434	26



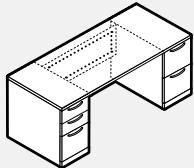
**L2DRAH-FB • Double Pedestal Desk, FF Left BBF Right Recessed, Half Glazed Modesty**



- Modesty is aluminum framed.
- Glazing is frosted acrylic.
- Optional e-lock available for each pedestal in the vertical position. Please specify V-Vertical and add \$231 list for each.

PRODUCT CODE	FINISH LP	B	W	SIZE/INCHES		W	D	WEIGHT LBS	VOL FT <sup>3</sup>
				H(LP/B)	H(W)				
L2DRAH3060FB	2646	2782	2908	29.06	29.5	60	30	204	22
L2DRAH3066FB	2717	2866	3005	29.06	29.5	66	30	213	23
L2DRAH3072FB	2778	2942	3091	29.06	29.5	72	30	222	23
L2DRAH3078FB	2842	3016	3177	29.06	29.5	78	30	247	24
L2DRAH3084FB	2908	3100	3269	29.06	29.5	84	30	272	24
L2DRAH3672FB	2903	3099	3265	29.06	29.5	72	36	247	24
L2DRAH3678FB	2968	3180	3363	29.06	29.5	78	36	272	25
L2DRAH3684FB	3039	3265	3460	29.06	29.5	84	36	297	25

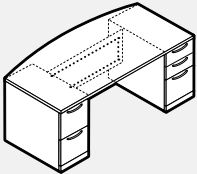
**L2DRAH-BF • Double Pedestal Desk, BBF Left FF Right Recessed, Half Glazed Modesty**



- Modesty is aluminum framed.
- Glazing is frosted acrylic.
- Optional e-lock available for each pedestal in the vertical position. Please specify V-Vertical and add \$231 list for each.

PRODUCT CODE	FINISH LP	B	W	SIZE/INCHES		W	D	WEIGHT LBS	VOL FT <sup>3</sup>
				H(LP/B)	H(W)				
L2DRAH3060BF	2646	2782	2908	29.06	29.5	60	30	204	22
L2DRAH3066BF	2717	2866	3005	29.06	29.5	66	30	213	23
L2DRAH3072BF	2778	2942	3091	29.06	29.5	72	30	222	23
L2DRAH3078BF	2842	3016	3177	29.06	29.5	78	30	247	24
L2DRAH3084BF	2908	3100	3269	29.06	29.5	84	30	272	24
L2DRAH3672BF	2903	3099	3265	29.06	29.5	72	36	247	24
L2DRAH3678BF	2968	3180	3363	29.06	29.5	78	36	272	25
L2DRAH3684BF	3039	3265	3460	29.06	29.5	84	36	297	25

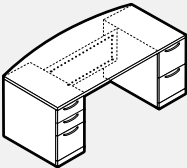
**L2DBAH-FB • Bowfront Double Desk, FF Left BBF Right Recessed, Half Glazed Modesty**



- Modesty is aluminum framed.
- Glazing is frosted acrylic.
- Optional e-lock available for each pedestal in the vertical position. Please specify V-Vertical and add \$231 list for each.

PRODUCT CODE	FINISH LP	B	W	SIZE/INCHES		W	D	WEIGHT LBS	VOL FT <sup>3</sup>
				H(LP/B)	H(W)				
L2DBAH3060FB	2699	2863	3005	29.06	29.5	60	36	340	23
L2DBAH3066FB	2775	2953	3105	29.06	29.5	66	36	348	24
L2DBAH3072FB	2841	3037	3199	29.06	29.5	72	36	359	24
L2DBAH3078FB	2907	3118	3296	29.06	29.5	78	36	384	25
L2DBAH3084FB	2979	3206	3394	29.06	29.5	84	36	409	25
L2DBAH3672FB	2963	3192	3376	29.06	29.5	72	42	384	25
L2DBAH3678FB	3036	3283	3478	29.06	29.5	78	42	409	26
L2DBAH3684FB	3106	3375	3584	29.06	29.5	84	42	434	26

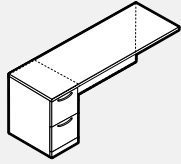
**L2DBAH-BF • Bowfront Double Desk, BBF Left FF Right Recessed, Half Glazed Modesty**



- Modesty is aluminum framed.
- Glazing is frosted acrylic.
- Optional e-lock available for each pedestal in the vertical position. Please specify V-Vertical and add \$231 list for each.

PRODUCT CODE	FINISH LP	B	W	SIZE/INCHES		W	D	WEIGHT LBS	VOL FT <sup>3</sup>
				H(LP/B)	H(W)				
L2DBAH3060BF	2699	2863	3005	29.06	29.5	60	36	340	23
L2DBAH3066BF	2775	2953	3105	29.06	29.5	66	36	348	24
L2DBAH3072BF	2841	3037	3199	29.06	29.5	72	36	359	24
L2DBAH3078BF	2907	3118	3296	29.06	29.5	78	36	384	25
L2DBAH3084BF	2979	3206	3394	29.06	29.5	84	36	409	25
L2DBAH3672BF	2963	3192	3376	29.06	29.5	72	42	384	25
L2DBAH3678BF	3036	3283	3478	29.06	29.5	78	42	409	26
L2DBAH3684BF	3106	3375	3584	29.06	29.5	84	42	434	26

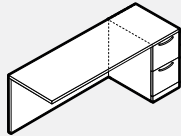
**L2ER-FL • Executive Return with FF Pedestal Left**



• Optional e-lock available for the pedestal in the vertical position. Please specify V-Vertical and add \$231 list.

PRODUCT CODE	FINISH LP	B	W	SIZE/INCHES				WEIGHT LBS	VOL FT <sup>3</sup>
				H (LP/B)	H (W)	W	D		
L2ER2036FL	1169	1235	1302	29	29.5	36	20	151	12
L2ER2042FL	1209	1290	1367	29	29.5	42	20	172	12
L2ER2048FL	1257	1340	1430	29	29.5	48	20	179	12
L2ER2054FL	1296	1395	1491	29	29.5	54	20	184	13
L2ER2436FL	1214	1286	1357	29	29.5	36	24	151	12
L2ER2442FL	1260	1339	1422	29	29.5	42	24	172	12
L2ER2448FL	1302	1395	1485	29	29.5	48	24	179	13
L2ER2454FL	1348	1451	1550	29	29.5	54	24	184	13

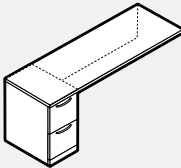
**L2ER-FR • Executive Return with FF Pedestal Right**



• Optional e-lock available for the pedestal in the vertical position. Please specify V-Vertical and add \$231 list.

PRODUCT CODE	FINISH LP	B	W	SIZE/INCHES				WEIGHT LBS	VOL FT <sup>3</sup>
				H (LP/B)	H (W)	W	D		
L2ER2036FR	1169	1235	1302	29	29.5	36	20	151	12
L2ER2042FR	1209	1290	1367	29	29.5	42	20	172	12
L2ER2048FR	1257	1340	1430	29	29.5	48	20	179	12
L2ER2054FR	1296	1395	1491	29	29.5	54	20	184	13
L2ER2436FR	1214	1286	1357	29	29.5	36	24	151	12
L2ER2442FR	1260	1339	1422	29	29.5	42	24	172	12
L2ER2448FR	1302	1395	1485	29	29.5	48	24	179	13
L2ER2454FR	1348	1451	1550	29	29.5	54	24	184	13

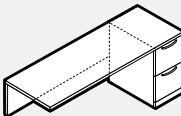
**L2ERH-FL • Executive Return with FF Pedestal Left and Half Modesty**



• Optional e-lock available for the pedestal in the vertical position. Please specify V-Vertical and add \$231 list.

PRODUCT CODE	FINISH LP	B	W	SIZE/INCHES				WEIGHT LBS	VOL FT <sup>3</sup>
				H (LP/B)	H (W)	W	D		
L2ERH2036FL	1117	1182	1255	29	29.5	36	20	151	12
L2ERH2042FL	1147	1226	1302	29	29.5	42	20	172	12
L2ERH2048FL	1175	1266	1354	29	29.5	48	20	179	12
L2ERH2054FL	1205	1304	1404	29	29.5	54	20	184	13
L2ERH2436FL	1160	1232	1301	29	29.5	36	24	151	12
L2ERH2442FL	1194	1272	1355	29	29.5	42	24	172	12
L2ERH2448FL	1225	1318	1407	29	29.5	48	24	179	13
L2ERH2454FL	1258	1360	1460	29	29.5	54	24	184	13

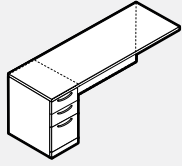
**L2ERH-FR • Executive Return with FF Pedestal Right and Half Modesty**



• Optional e-lock available for the pedestal in the vertical position. Please specify V-Vertical and add \$231 list.

PRODUCT CODE	FINISH LP	B	W	SIZE/INCHES				WEIGHT LBS	VOL FT <sup>3</sup>
				H (LP/B)	H (W)	W	D		
L2ERH2036FR	1117	1182	1255	29	29.5	36	20	151	12
L2ERH2042FR	1147	1226	1302	29	29.5	42	20	172	12
L2ERH2048FR	1175	1266	1354	29	29.5	48	20	179	12
L2ERH2054FR	1205	1304	1404	29	29.5	54	20	184	13
L2ERH2436FR	1160	1232	1301	29	29.5	36	24	151	12
L2ERH2442FR	1194	1272	1355	29	29.5	42	24	172	12
L2ERH2448FR	1225	1318	1407	29	29.5	48	24	179	13
L2ERH2454FR	1258	1360	1460	29	29.5	54	24	184	13

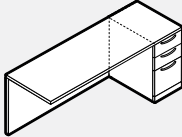
**L2ER-BL • Executive Return with BBF Pedestal Left**



• Optional e-lock available for the pedestal in the vertical position. Please specify V-Vertical and add \$231 list.

PRODUCT CODE	FINISH LP	B	W	SIZE/INCHES				WEIGHT LBS	VOL FT <sup>3</sup>
				H (LP/B)	H (W)	W	D		
L2ER2036BL	1232	1298	1367	29	29.5	36	20	151	12
L2ER2042BL	1272	1352	1430	29	29.5	42	20	172	12
L2ER2048BL	1317	1405	1491	29	29.5	48	20	179	12
L2ER2054BL	1358	1458	1554	29	29.5	54	20	184	13
L2ER2436BL	1279	1351	1422	29	29.5	36	24	151	12
L2ER2442BL	1325	1405	1485	29	29.5	42	24	172	12
L2ER2448BL	1368	1461	1550	29	29.5	48	24	179	13
L2ER2454BL	1414	1516	1616	29	29.5	54	24	184	13

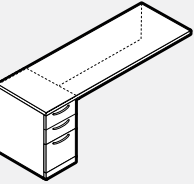
**L2ER-BR • Executive Return with BBF Pedestal Right**



• Optional e-lock available for the pedestal in the vertical position. Please specify V-Vertical and add \$231 list.

PRODUCT CODE	FINISH LP	B	W	SIZE/INCHES				WEIGHT LBS	VOL FT <sup>3</sup>
				H (LP/B)	H (W)	W	D		
L2ER2036BR	1232	1298	1367	29	29.5	36	20	151	12
L2ER2042BR	1272	1352	1430	29	29.5	42	20	172	12
L2ER2048BR	1317	1405	1491	29	29.5	48	20	179	12
L2ER2054BR	1358	1458	1554	29	29.5	54	20	184	13
L2ER2436BR	1279	1351	1422	29	29.5	36	24	151	12
L2ER2442BR	1325	1405	1485	29	29.5	42	24	172	12
L2ER2448BR	1368	1461	1550	29	29.5	48	24	179	13
L2ER2454BR	1414	1516	1616	29	29.5	54	24	184	13

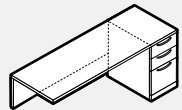
**L2ERH-BL • Executive Return with BBF Pedestal Left and Half Modesty**



• Optional e-lock available for the pedestal in the vertical position. Please specify V-Vertical and add \$231 list.

PRODUCT CODE	FINISH LP	B	W	SIZE/INCHES				WEIGHT LBS	VOL FT <sup>3</sup>
				H (LP/B)	H (W)	W	D		
L2ERH2036BL	1177	1243	1317	29	29.5	36	20	151	12
L2ERH2042BL	1208	1289	1366	29	29.5	42	20	172	12
L2ERH2048BL	1238	1328	1416	29	29.5	48	20	179	12
L2ERH2054BL	1269	1369	1466	29	29.5	54	20	184	13
L2ERH2436BL	1226	1296	1367	29	29.5	36	24	151	12
L2ERH2442BL	1259	1338	1419	29	29.5	42	24	172	12
L2ERH2448BL	1290	1382	1473	29	29.5	48	24	179	13
L2ERH2454BL	1323	1426	1525	29	29.5	54	24	184	13

**L2ERH-BR • Executive Return with BBF Pedestal Right and Half Modesty**



• Optional e-lock available for the pedestal in the vertical position. Please specify V-Vertical and add \$231 list.

PRODUCT CODE	FINISH LP	B	W	SIZE/INCHES				WEIGHT LBS	VOL FT <sup>3</sup>
				H (LP/B)	H (W)	W	D		
L2ERH2036BR	1177	1243	1317	29	29.5	36	20	151	12
L2ERH2042BR	1208	1289	1366	29	29.5	42	20	172	12
L2ERH2048BR	1238	1328	1416	29	29.5	48	20	179	12
L2ERH2054BR	1269	1369	1466	29	29.5	54	20	184	13
L2ERH2436BR	1226	1296	1367	29	29.5	36	24	151	12
L2ERH2442BR	1259	1338	1419	29	29.5	42	24	172	12
L2ERH2448BR	1290	1382	1473	29	29.5	48	24	179	13
L2ERH2454BR	1323	1426	1525	29	29.5	54	24	184	13

## Technical Information

### Technical Information

Reception Desk:

- All desks are shipped KD.
- Centre desk reception transaction top is available in "LP", "B" or "W" thickness to match the thickness and profile of worksurface edge.
- All other exposed edges are banded with 3mm PVC.
- Center unit is freestanding and can be connected on one or both sides with a return or bridge.
- **Bridge unit is connected to the centre unit to extend the return on either side. This unit must be connected on both ends and nonhanded.**
- Left or right hand unit is designed to extend the centre unit. This unit must be connected on one end.
- **Can be used as a freestanding unit or connected with surrounding bridge or corner surround.**
- **Comes with transaction top.**

## DESKS • GUIDELINES FOR ORDERING PRODUCT

**CODES:** The price list uses a numbering system with meaningful alphanumeric characters to create a simple-to-understand product number. This makes specifying the product much easier and more accurate.

### SPECIFICATION EXAMPLE OF A GALLERY RECEPTION DESK UNIT

#### PRODUCT CODE:

L2GR66  
 L2 = New Licence  
 G = Gallery  
 R = Reception  
 66 = Size: Width

#### OPTIONS:

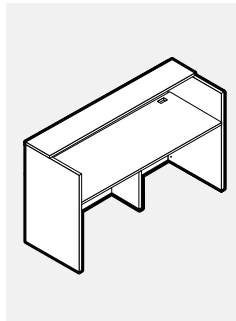
Top: LP - LP (Low Pressure Laminate) Thickness 1"  
 HP B - B Thickness 1 1/16"  
 HP W - W Thickness 1 7/16"

Top Finish Laminate: Choose Colour

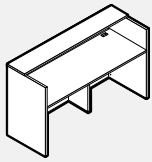
Top PVC Edging: Choose Colour

Chassis Laminate: Choose Colour

Chassis PVC Edging: Choose Colour



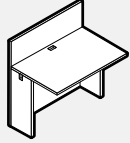
**L2GR • Gallery Reception Desk**



- Two grommets installed TL/TR.

PRODUCT CODE	FINISH			SIZE/INCHES				WEIGHT		VOL FT <sup>3</sup>
	LP	B	W	H (LP/B)	H(W)	W	D	LBS		
L2GR66	1352	1696	1889	42.315	42.750	66	25	149	15	
L2GR72	1422	1797	2001	42.315	42.750	72	25	163	17	
L2GR78	1490	1892	2117	42.315	42.750	78	25	166	18	
L2GR84	1560	1990	2231	42.315	42.750	84	25	171	20	
L2GR96	1697	2187	2461	42.315	42.750	96	25	178	23	

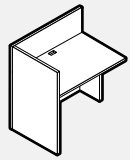
**L2GB • Gallery Bridge**



- One grommet installed TC.

PRODUCT CODE	FINISH			SIZE/INCHES				WEIGHT		VOL FT <sup>3</sup>
	LP	B	W	H (LP/B)	H(W)	W	D	LBS		
L2GB42	603	737	801	41.315	41.315	42	25	79	10	
L2GB48	658	812	885	41.315	41.315	48	25	86	12	
L2GB54	714	885	966	41.315	41.315	54	25	95	13	
L2GB60	766	956	1051	41.315	41.315	60	25	101	14	

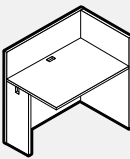
**L2GR-L • Gallery Left Return**



- One grommet installed TC.

PRODUCT CODE	FINISH			SIZE/INCHES				WEIGHT		VOL FT <sup>3</sup>
	LP	B	W	H (LP/B)	H(W)	W	D	LBS		
L2GR36L	672	796	854	41.315	41.315	36	25	90	9	
L2GR42L	726	868	937	41.315	41.315	42	25	97	11	
L2GR48L	785	942	1022	41.315	41.315	48	25	106	13	
L2GR54L	840	1017	1103	41.315	41.315	54	25	119	14	
L2GR60L	894	1089	1186	41.315	41.315	60	25	132	16	

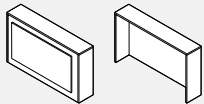
**L2GR-R • Gallery Right Return**



- One grommet installed TC.

PRODUCT CODE	FINISH			SIZE/INCHES				WEIGHT		VOL FT <sup>3</sup>
	LP	B	W	H (LP/B)	H(W)	W	D	LBS		
L2GR36R	672	796	854	41.315	41.315	36	25	90	9	
L2GR42R	726	868	937	41.315	41.315	42	25	97	11	
L2GR48R	785	942	1022	41.315	41.315	48	25	106	13	
L2GR54R	840	1017	1103	41.315	41.315	54	25	119	14	
L2GR60R	894	1089	1186	41.315	41.315	60	25	132	16	

**L2GD • Gallery Desk Decorative Panel**

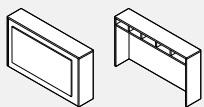


Front Back

- To be used in conjunction with a 66", 72" or 84" rectangular desk shell.
- Decorative Panel is high pressure laminate.

PRODUCT CODE	FINISH			SIZE/INCHES				WEIGHT		VOL FT <sup>3</sup>
	LP	B	W	H (LP/B)	H(W)	W	D	LBS		
L2GD66	1667	1810	1963	42.315	42.750	68.25	12	99	20	
L2GD72	1892	2059	2236	42.315	42.750	74.25	12	113	22	
L2GD84	2029	2213	2414	42.315	42.750	86.25	12	117	25	

**L2GDP • Gallery Desk with Pigeon Holes and Decorative Panel**

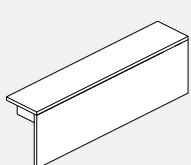


Front Back

- To be used in conjunction with a 66", 72" or 84" rectangular desk shell.
- Decorative Panel is high pressure laminate.

PRODUCT CODE	FINISH			SIZE/INCHES				WEIGHT		VOL FT <sup>3</sup>
	LP	B	W	H (LP/B)	H(W)	W	D	LBS		
L2GDP66	1732	1919	2076	42.315	42.750	68.25	12	99	20	
L2GDP72	1963	2183	2367	42.315	42.750	74.25	12	113	22	
L2GDP84	2117	2356	2563	42.315	42.750	86.25	12	117	25	

**L2GRKIT • Reception Kit Gallery**



- Unit to be placed on L2DR or L2CRS Desk Shell

PRODUCT CODE	FINISH			SIZE/INCHES				WEIGHT		VOL FT <sup>3</sup>
	LP	B	W	H (LP/B)	H(W)	W	D	LBS		
L2GRKIT36H36	418	442	459	18.37	18.75	36	12	68	1.50	
L2GRKIT42H36	456	485	507	18.37	18.75	42	12	79	1.75	
L2GRKIT48H36	495	534	551	18.37	18.75	48	12	90	2.00	
L2GRKIT54H36	537	574	600	18.37	18.75	54	12	101	2.25	
L2GRKIT60H36	575	619	645	18.37	18.75	60	12	113	2.50	
L2GRKIT36H42	462	509	524	24.37	24.75	36	12	68	1.50	
L2GRKIT42H42	510	563	581	24.37	24.75	42	12	79	1.75	
L2GRKIT48H42	555	614	639	24.37	24.75	48	12	90	2.00	
L2GRKIT54H42	604	670	694	24.37	24.75	54	12	101	2.25	
L2GRKIT60H42	652	723	752	24.37	24.75	60	12	113	2.50	

## Technical Information

- All Desks and connecting shells are Shipped knocked down (KD).
- All connecting units must be connected to an adjoining worksurface where there is either no end gable or a narrow gable with flat brackets.
- Gables & partial gables are interchangeable.
- All bottom edges are edge banded.
- Each shell allows for grommet (BG5) to be specified at no upcharge. Please see general information (Section A) for location.

## DESKS • GUIDELINES FOR ORDERING PRODUCT

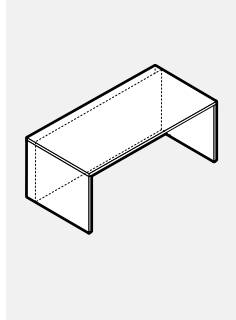
**CODES:** The price list uses a numbering system with meaningful alphanumeric characters to create a simple-to-understand product number. This makes specifying the product much easier and more accurate.

### SPECIFICATION EXAMPLE OF A DESK UNIT

**PRODUCT CODE:** L2DR3060  
 L2 = New Licence  
 D = Desk  
 R = Rectangular  
 3060 = Size: Depth x Width

**OPTIONS:**  
 Top: LP - LP (Low Pressure Laminate) Thickness 1"  
 HP B - B Thickness 1 1/16"  
 HP W - W Thickness 1 7/16"

Top Finish Laminate: Choose Colour  
 Top PVC Edging: Choose Colour  
 Chassis Laminate: Choose Colour  
 Chassis PVC Edging: Choose Colour

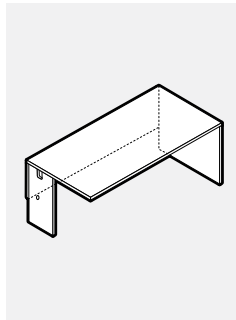


### SPECIFICATION EXAMPLE OF A CONNECTING RETURN UNIT

**PRODUCT CODE:** L2RCH2030R  
 L2 = New Licence  
 R = Return  
 C = Connecting  
 H = Half Back Panel  
 2030 = Size: Depth x Width  
 R = Connecting on Right

**OPTIONS:**  
 Top: LP - LP (Low Pressure Laminate) Thickness 1"  
 HP B - B Thickness 1 1/16"  
 HP W - W Thickness 1 7/16"

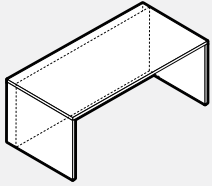
Top Finish Laminate: Choose Colour  
 Top PVC Edging: Choose Colour  
 Chassis Laminate: Choose Colour  
 Chassis PVC Edging: Choose Colour





**L2DR • Rectangular Desk, Recessed Modesty**

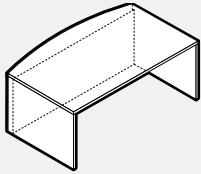
• All recessed modesties are inset 6" from the visitor edge.



PRODUCT CODE	FINISH LP	B	W	SIZE/INCHES				WEIGHT		VOL FT <sup>3</sup>
				H (LP/B)	H (W)	W	D	LBS		
L2DR3060	879	1072	1204	29	29.5	60	30	136	6	
L2DR3066	925	1135	1284	29	29.5	66	30	145	7	
L2DR3072	971	1200	1357	29	29.5	72	30	155	7	
L2DR3078	1018	1264	1431	29	29.5	78	30	175	9	
L2DR3084	1069	1332	1515	29	29.5	84	30	185	10	
L2DR3660	977	1205	1360	29	29.5	60	36	155	7	
L2DR3666	1029	1276	1443	29	29.5	66	36	165	9	
L2DR3672	1083	1351	1529	29	29.5	72	36	176	9	
L2DR3678	1131	1422	1615	29	29.5	78	36	197	11	
L2DR3684	1188	1499	1704	29	29.5	84	36	208	12	

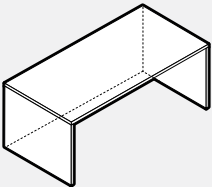
**L2DB • Bowfront Desk, Recessed Modesty**

• All recessed modesties are inset 6" from the visitor edge.



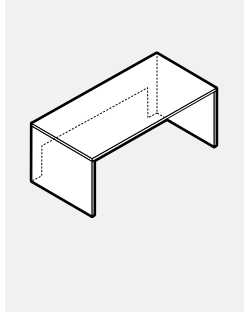
PRODUCT CODE	FINISH LP	B	W	SIZE/INCHES				WEIGHT		VOL FT <sup>3</sup>
				H (LP/B)	H (W)	W	D	LBS		
L2DB3060	936	1166	1325	29	29.5	60	36	155	7	
L2DB3066	987	1235	1407	29	29.5	66	36	165	9	
L2DB3072	1037	1304	1495	29	29.5	72	36	176	9	
L2DB3078	1089	1378	1577	29	29.5	78	36	197	11	
L2DB3084	1144	1457	1669	29	29.5	84	36	208	12	
L2DB3660	1037	1299	1476	29	29.5	60	42	155	7	
L2DB3666	1092	1378	1573	29	29.5	66	42	165	9	
L2DB3672	1147	1457	1667	29	29.5	72	42	176	9	
L2DB3678	1201	1538	1758	29	29.5	78	42	197	11	
L2DB3684	1264	1620	1861	29	29.5	84	42	208	12	

**L2CRS • Credenza Shell, Full End Gables on Both Sides and Flush Back**



PRODUCT CODE	FINISH LP	B	W	SIZE/INCHES				WEIGHT		VOL FT <sup>3</sup>
				H (LP/B)	H (W)	W	D	LBS		
L2CRS2024	518	592	644	29	29.5	24	20	68	3	
L2CRS2030	562	652	712	29	29.5	30	20	77	3	
L2CRS2036	604	701	779	29	29.5	36	20	87	3	
L2CRS2042	644	759	845	29	29.5	42	20	94	3	
L2CRS2048	688	817	911	29	29.5	48	20	102	4	
L2CRS2054	726	872	976	29	29.5	54	20	109	4	
L2CRS2060	779	936	1052	29	29.5	60	20	118	4	
L2CRS2066	823	994	1118	29	29.5	66	20	127	6	
L2CRS2072	863	1051	1182	29	29.5	72	20	135	6	
L2CRS2078	905	1106	1254	29	29.5	78	20	151	7	
L2CRS2084	954	1169	1325	29	29.5	84	20	160	8	
L2CRS2424	540	614	671	29	29.5	24	24	68	3	
L2CRS2430	582	672	740	29	29.5	30	24	77	3	
L2CRS2436	627	731	811	29	29.5	36	24	87	3	
L2CRS2442	670	791	879	29	29.5	42	24	94	3	
L2CRS2448	717	851	949	29	29.5	48	24	102	4	
L2CRS2454	758	908	1017	29	29.5	54	24	109	4	
L2CRS2460	811	973	1094	29	29.5	60	24	118	4	
L2CRS2466	853	1033	1165	29	29.5	66	24	127	6	
L2CRS2472	896	1090	1233	29	29.5	72	24	135	6	
L2CRS2478	941	1152	1300	29	29.5	78	24	151	7	
L2CRS2484	992	1214	1375	29	29.5	84	24	160	8	
L2CRS3030	639	746	820	29	29.5	30	30	90	3	
L2CRS3036	687	811	895	29	29.5	36	30	99	3	
L2CRS3042	731	872	971	29	29.5	42	30	109	4	
L2CRS3048	779	936	1050	29	29.5	48	30	119	4	
L2CRS3054	825	1000	1122	29	29.5	54	30	127	6	
L2CRS3060	879	1072	1204	29	29.5	60	30	136	6	
L2CRS3066	925	1135	1284	29	29.5	66	30	145	7	
L2CRS3072	971	1200	1357	29	29.5	72	30	155	7	
L2CRS3078	1018	1264	1431	29	29.5	78	30	175	9	
L2CRS3084	1069	1332	1515	29	29.5	84	30	185	10	

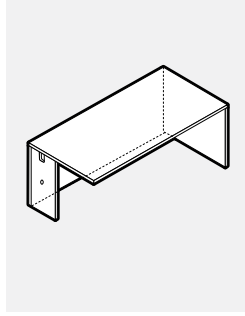
**L2CRSH • Credenza Shell, Flush Back, Cut Out Modesty, Full End Gables on Both Sides**



PRODUCT CODE	FINISH LP	B	W	SIZE / INCHES				WEIGHT LBS	VOL FT <sup>3</sup>
				H (LP/B)	H (W)	W	D		
L2CRSH2030	562	652	712	29	29.5	30	20	77	3
L2CRSH2036	604	701	779	29	29.5	36	20	87	3
L2CRSH2042	644	759	845	29	29.5	42	20	94	3
L2CRSH2048	688	817	911	29	29.5	48	20	102	4
L2CRSH2054	726	872	976	29	29.5	54	20	109	4
L2CRSH2060	779	936	1052	29	29.5	60	20	118	4
L2CRSH2066	823	994	1118	29	29.5	66	20	127	6
L2CRSH2072	863	1051	1182	29	29.5	72	20	135	6
L2CRSH2078	905	1106	1254	29	29.5	78	20	151	7
L2CRSH2084	954	1169	1325	29	29.5	84	20	160	8
L2CRSH2430	582	672	740	29	29.5	30	24	77	3
L2CRSH2436	627	731	811	29	29.5	36	24	87	3
L2CRSH2442	670	791	879	29	29.5	42	24	94	3
L2CRSH2448	717	851	949	29	29.5	48	24	102	4
L2CRSH2454	758	908	1017	29	29.5	54	24	109	4
L2CRSH2460	811	973	1094	29	29.5	60	24	118	4
L2CRSH2466	853	1033	1165	29	29.5	66	24	127	6
L2CRSH2472	896	1090	1233	29	29.5	72	24	135	6
L2CRSH2478	941	1152	1300	29	29.5	78	24	151	7
L2CRSH2484	992	1214	1375	29	29.5	84	24	160	8
L2CRSH3030	639	746	820	29	29.5	30	30	90	3
L2CRSH3036	687	811	895	29	29.5	36	30	99	3
L2CRSH3042	731	872	971	29	29.5	42	30	109	4
L2CRSH3048	779	936	1050	29	29.5	48	30	119	4
L2CRSH3054	825	1000	1122	29	29.5	54	30	127	6
L2CRSH3060	879	1072	1204	29	29.5	60	30	139	6
L2CRSH3066	925	1135	1284	29	29.5	66	30	145	7
L2CRSH3072	971	1200	1357	29	29.5	72	30	155	7
L2CRSH3078	992	1264	1431	29	29.5	78	30	175	9
L2CRSH3084	1069	1332	1515	29	29.5	84	30	185	10

**L2RC-R • Return, Connecting Right, Full Gable on Right and Narrow Gable on Left**

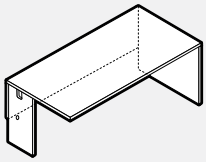
• Units are non-handed. They can be configured as either lefts or rights.



PRODUCT CODE	FINISH			SIZE/INCHES				WEIGHT		VOL FT <sup>3</sup>
	LP	B	W	H (LP/B)	H (W)	W	D	LBS		
L2RC2024R	486	561	610	29	29.5	24	20	64	3	
L2RC2030R	535	619	683	29	29.5	30	20	69	3	
L2RC2036R	577	676	752	29	29.5	36	20	79	3	
L2RC2042R	623	736	820	29	29.5	42	20	86	3	
L2RC2048R	666	794	891	29	29.5	48	20	95	4	
L2RC2054R	712	854	959	29	29.5	54	20	102	4	
L2RC2060R	766	926	1040	29	29.5	60	20	110	4	
L2RC2066R	816	986	1109	29	29.5	66	20	119	6	
L2RC2072R	863	1051	1182	29	29.5	72	20	128	6	
L2RC2078R	908	1108	1257	29	29.5	78	20	143	7	
L2RC2084R	954	1168	1325	29	29.5	84	20	152	8	
L2RC2424R	507	579	636	29	29.5	24	24	64	3	
L2RC2430R	553	641	709	29	29.5	30	24	69	3	
L2RC2436R	602	701	783	29	29.5	36	24	79	3	
L2RC2442R	645	763	853	29	29.5	42	24	86	3	
L2RC2448R	693	826	926	29	29.5	48	24	95	4	
L2RC2454R	740	891	998	29	29.5	54	24	102	4	
L2RC2460R	800	963	1084	29	29.5	60	24	110	4	
L2RC2466R	846	1026	1156	29	29.5	66	24	119	6	
L2RC2472R	896	1090	1233	29	29.5	72	24	128	6	
L2RC2478R	943	1153	1302	29	29.5	78	24	143	7	
L2RC2484R	992	1214	1375	29	29.5	84	24	152	8	
L2RC3030R	604	707	784	29	29.5	30	30	83	3	
L2RC3036R	654	775	862	29	29.5	36	30	91	3	
L2RC3042R	699	842	938	29	29.5	42	30	101	4	
L2RC3048R	751	908	1018	29	29.5	48	30	111	4	
L2RC3054R	800	973	1095	29	29.5	54	30	119	6	
L2RC3060R	862	1055	1189	29	29.5	60	30	129	6	
L2RC3066R	911	1121	1266	29	29.5	66	30	138	7	
L2RC3072R	963	1194	1349	29	29.5	72	30	147	7	
L2RC3078R	1012	1260	1508	29	29.5	78	30	167	9	
L2RC3084R	1063	1326	1590	29	29.5	84	30	177	10	
L2RC3660R	930	1158	1309	29	29.5	60	36	145	7	
L2RC3666R	986	1234	1397	29	29.5	66	36	157	9	
L2RC3672R	1041	1310	1490	29	29.5	72	36	169	9	
L2RC3678R	1095	1385	1577	29	29.5	78	36	190	11	
L2RC3684R	1148	1460	1667	29	29.5	84	36	201	12	

**L2RCH-R • Half Modesty Return, Connecting Right, Full Gable on Right and Narrow Gable on Left**

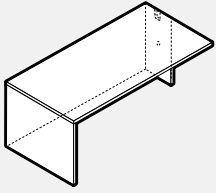
• Units are non-handed. They can be configured as either lefts or rights.



PRODUCT CODE	FINISH LP	B	W	SIZE/INCHES				WEIGHT LBS	VOL FT <sup>3</sup>
				H (LP/B)	H (W)	W	D		
L2RCH2024R	433	501	555	29	29.5	24	20	55	3
L2RCH2030R	464	546	609	29	29.5	30	20	57	3
L2RCH2036R	499	593	666	29	29.5	36	20	65	3
L2RCH2042R	528	638	723	29	29.5	42	20	69	3
L2RCH2048R	562	687	779	29	29.5	48	20	76	4
L2RCH2054R	593	727	833	29	29.5	54	20	81	4
L2RCH2060R	636	790	905	29	29.5	60	20	86	4
L2RCH2066R	670	833	959	29	29.5	66	20	92	6
L2RCH2072R	705	885	1021	29	29.5	72	20	99	6
L2RCH2078R	736	930	1074	29	29.5	78	20	112	7
L2RCH2084R	770	975	1132	29	29.5	84	20	119	8
L2RCH2424R	450	520	577	29	29.5	24	24	56	3
L2RCH2430R	483	569	634	29	29.5	30	24	57	3
L2RCH2436R	517	619	693	29	29.5	36	24	65	3
L2RCH2442R	550	661	752	29	29.5	42	24	69	3
L2RCH2448R	582	712	811	29	29.5	48	24	76	4
L2RCH2454R	619	759	867	29	29.5	54	24	81	4
L2RCH2460R	661	823	938	29	29.5	60	24	86	4
L2RCH2466R	695	867	998	29	29.5	66	24	92	6
L2RCH2472R	733	920	1062	29	29.5	72	24	99	6
L2RCH2478R	765	969	1119	29	29.5	78	24	112	7
L2RCH2484R	800	1017	1175	29	29.5	84	24	119	8
L2RCH3030R	537	636	712	29	29.5	30	30	77	3
L2RCH3036R	573	691	778	29	29.5	36	30	83	3
L2RCH3042R	608	744	842	29	29.5	42	30	87	4
L2RCH3048R	644	796	908	29	29.5	48	30	92	4
L2RCH3054R	683	851	972	29	29.5	54	30	98	6
L2RCH3060R	727	917	1052	29	29.5	60	30	105	6
L2RCH3066R	765	971	1117	29	29.5	66	30	111	7
L2RCH3072R	805	1027	1182	29	29.5	72	30	119	7
L2RCH3078R	843	1083	1320	29	29.5	78	30	136	9
L2RCH3084R	880	1134	1388	29	29.5	84	30	144	10
L2RCH3660R	800	1022	1173	29	29.5	60	36	123	7
L2RCH3666R	842	1084	1245	29	29.5	66	36	129	9
L2RCH3672R	885	1147	1326	29	29.5	72	36	141	9
L2RCH3678R	926	1205	1398	29	29.5	78	36	154	11
L2RCH3684R	966	1216	1473	29	29.5	84	36	162	12

**L2RC-L • Return, Connecting Left, Full Gable on Left and Narrow Gable on Right**

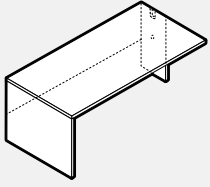
• Units are non-handed. They can be configured as either lefts or rights.



PRODUCT CODE	FINISH			SIZE/INCHES				WEIGHT LBS	VOL FT <sup>3</sup>
	LP	B	W	H (LP/B)	H (W)	W	D		
L2RC2024L	486	561	610	29	29.5	24	20	64	3
L2RC2030L	535	619	683	29	29.5	30	20	69	3
L2RC2036L	577	676	752	29	29.5	36	20	79	3
L2RC2042L	623	736	820	29	29.5	42	20	86	3
L2RC2048L	666	794	891	29	29.5	48	20	95	4
L2RC2054L	712	854	959	29	29.5	54	20	102	4
L2RC2060L	766	926	1040	29	29.5	60	20	110	4
L2RC2066L	816	986	1109	29	29.5	66	20	119	6
L2RC2072L	863	1051	1182	29	29.5	72	20	128	6
L2RC2078L	908	1108	1257	29	29.5	78	20	143	7
L2RC2084L	954	1168	1325	29	29.5	84	20	152	8
L2RC2424L	507	579	636	29	29.5	24	24	64	3
L2RC2430L	553	641	709	29	29.5	30	24	69	3
L2RC2436L	602	701	783	29	29.5	36	24	79	3
L2RC2442L	645	763	853	29	29.5	42	24	86	3
L2RC2448L	693	826	926	29	29.5	48	24	95	4
L2RC2454L	740	891	998	29	29.5	54	24	102	4
L2RC2460L	800	963	1084	29	29.5	60	24	110	4
L2RC2466L	846	1026	1156	29	29.5	66	24	119	6
L2RC2472L	896	1090	1233	29	29.5	72	24	128	6
L2RC2478L	943	1153	1302	29	29.5	78	24	143	7
L2RC2484L	992	1214	1375	29	29.5	84	24	152	8
L2RC3030L	604	707	784	29	29.5	30	30	83	3
L2RC3036L	654	775	862	29	29.5	36	30	91	3
L2RC3042L	699	842	938	29	29.5	42	30	101	4
L2RC3048L	751	908	1018	29	29.5	48	30	111	4
L2RC3054L	800	973	1095	29	29.5	54	30	119	6
L2RC3060L	862	1055	1189	29	29.5	60	30	129	6
L2RC3066L	911	1121	1266	29	29.5	66	30	138	7
L2RC3072L	963	1194	1349	29	29.5	72	30	147	7
L2RC3078L	1012	1260	1508	29	29.5	78	30	167	9
L2RC3084L	1063	1326	1590	29	29.5	84	30	177	10
L2RC3660L	930	1158	1309	29	29.5	60	36	145	7
L2RC3666L	986	1234	1397	29	29.5	66	36	157	9
L2RC3672L	1041	1310	1490	29	29.5	72	36	169	9
L2RC3678L	1095	1385	1577	29	29.5	78	36	190	11
L2RC3684L	1148	1460	1667	29	29.5	84	36	201	12

**L2RCH-L • Half Modesty Return, Connecting Left, Full Gable on Left and Narrow Gable on Right**

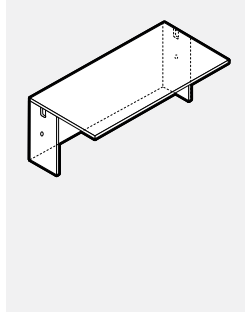
• Units are non-handed. They can be configured as either lefts or rights.



PRODUCT CODE	FINISH LP	B	W	SIZE/INCHES			D	WEIGHT LBS	VOL FT <sup>3</sup>
				H (LP/B)	H (W)	W			
L2RCH2024L	433	501	555	29	29.5	24	20	55	3
L2RCH2030L	464	546	609	29	29.5	30	20	57	3
L2RCH2036L	499	593	666	29	29.5	36	20	65	3
L2RCH2042L	528	638	723	29	29.5	42	20	69	3
L2RCH2048L	562	687	779	29	29.5	48	20	76	4
L2RCH2054L	593	727	833	29	29.5	54	20	81	4
L2RCH2060L	636	790	905	29	29.5	60	20	86	4
L2RCH2066L	670	833	959	29	29.5	66	20	92	5
L2RCH2072L	705	885	1021	29	29.5	72	20	99	5
L2RCH2078L	736	930	1074	29	29.5	78	20	112	6
L2RCH2084L	770	975	1132	29	29.5	84	20	119	7
L2RCH2424L	450	520	577	29	29.5	24	24	56	3
L2RCH2430L	483	569	634	29	29.5	30	24	57	3
L2RCH2436L	517	619	693	29	29.5	36	24	65	3
L2RCH2442L	550	661	752	29	29.5	42	24	69	3
L2RCH2448L	582	712	811	29	29.5	48	24	76	4
L2RCH2454L	619	759	867	29	29.5	54	24	81	4
L2RCH2460L	661	823	938	29	29.5	60	24	86	4
L2RCH2466L	695	867	998	29	29.5	66	24	92	5
L2RCH2472L	733	920	1062	29	29.5	72	24	99	5
L2RCH2478L	765	969	1119	29	29.5	78	24	112	6
L2RCH2484L	800	1017	1175	29	29.5	84	24	119	7
L2RCH3030L	537	636	712	29	29.5	30	30	77	3
L2RCH3036L	573	691	778	29	29.5	36	30	83	3
L2RCH3042L	608	744	842	29	29.5	42	30	87	4
L2RCH3048L	644	796	908	29	29.5	48	30	92	4
L2RCH3054L	683	851	972	29	29.5	54	30	98	5
L2RCH3060L	727	917	1052	29	29.5	60	30	105	5
L2RCH3066L	765	971	1117	29	29.5	66	30	111	6
L2RCH3072L	805	1027	1182	29	29.5	72	30	119	6
L2RCH3078L	843	1083	1320	29	29.5	78	30	136	8
L2RCH3084L	880	1134	1388	29	29.5	84	30	144	9
L2RCH3660L	800	1022	1173	29	29.5	60	36	123	6
L2RCH3666L	842	1084	1245	29	29.5	66	36	129	8
L2RCH3672L	885	1147	1326	29	29.5	72	36	141	8
L2RCH3678L	926	1205	1398	29	29.5	78	36	154	10
L2RCH3684L	966	1216	1473	29	29.5	84	36	162	11

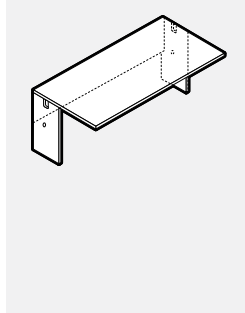


**L2RC-C • Return, Connecting Narrow Gables on Both Sides**



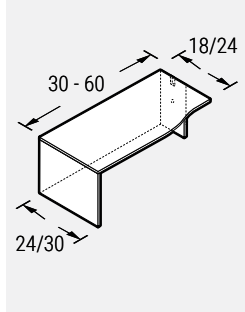
PRODUCT CODE	FINISH LP	B	W	SIZE/INCHES			D	WEIGHT LBS	VOL FT <sup>3</sup>
				H (LP/B)	H (W)	W			
L2RC2024C	433	503	555	29	29.5	24	20	56	3
L2RC2030C	477	540	602	29	29.5	30	20	62	3
L2RC2036C	522	593	666	29	29.5	36	20	72	3
L2RC2042C	568	653	731	29	29.5	42	20	78	3
L2RC2048C	610	707	797	29	29.5	48	20	87	4
L2RC2054C	657	761	863	29	29.5	54	20	95	4
L2RC2060C	717	830	941	29	29.5	60	20	102	4
L2RC2066C	759	886	1006	29	29.5	66	20	111	6
L2RC2072C	809	947	1078	29	29.5	72	20	120	6
L2RC2078C	853	1001	1142	29	29.5	78	20	135	7
L2RC2084C	896	1060	1208	29	29.5	84	20	144	8
L2RC2424C	451	522	577	29	29.5	24	24	56	3
L2RC2430C	499	562	626	29	29.5	30	24	62	3
L2RC2436C	543	621	693	29	29.5	36	24	72	3
L2RC2442C	591	676	761	29	29.5	42	24	78	3
L2RC2448C	636	734	829	29	29.5	48	24	87	4
L2RC2454C	686	792	896	29	29.5	54	24	95	4
L2RC2460C	744	864	977	29	29.5	60	24	102	4
L2RC2466C	790	922	1050	29	29.5	66	24	111	6
L2RC2472C	842	985	1121	29	29.5	72	24	120	6
L2RC2478C	888	1041	1189	29	29.5	78	24	135	7
L2RC2484C	935	1101	1259	29	29.5	84	24	144	8
L2RC3030C	557	658	733	29	29.5	30	30	75	3
L2RC3036C	605	724	812	29	29.5	36	30	84	3
L2RC3042C	655	791	892	29	29.5	42	30	94	4
L2RC3048C	701	820	926	29	29.5	48	30	103	4
L2RC3054C	754	884	999	29	29.5	54	30	116	6
L2RC3060C	816	959	1088	29	29.5	60	30	121	6
L2RC3066C	864	1022	1160	29	29.5	66	30	130	7
L2RC3072C	918	1089	1237	29	29.5	72	30	140	7
L2RC3078C	966	1153	1315	29	29.5	78	30	160	9
L2RC3084C	1017	1212	1389	29	29.5	84	30	169	10

**L2RCH-C • Half Modesty Return, Connecting Narrow Gables on Both Sides**



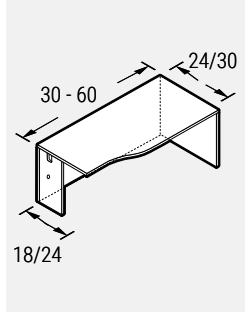
PRODUCT CODE	FINISH LP	B	W	SIZE/INCHES				WEIGHT LBS	VOL FT <sup>3</sup>
				H(LP/B)	H(W)	W	D		
L2RCH2024C	377	443	500	29	29.5	24	20	46	3
L2RCH2030C	410	490	553	29	29.5	30	20	50	3
L2RCH2036C	442	539	609	29	29.5	36	20	57	3
L2RCH2042C	475	581	666	29	29.5	42	20	62	3
L2RCH2048C	508	629	722	29	29.5	48	20	68	4
L2RCH2054C	522	672	779	29	29.5	54	20	74	4
L2RCH2060C	568	733	850	29	29.5	60	20	78	4
L2RCH2066C	602	779	903	29	29.5	66	20	85	6
L2RCH2072C	634	827	962	29	29.5	72	20	91	6
L2RCH2078C	666	874	1021	29	29.5	78	20	105	7
L2RCH2084C	698	920	1074	29	29.5	84	20	111	8
L2RCH2424C	394	462	518	29	29.5	24	24	46	3
L2RCH2430C	430	510	577	29	29.5	30	24	50	3
L2RCH2436C	460	557	634	29	29.5	36	24	57	3
L2RCH2442C	494	605	693	29	29.5	42	24	62	3
L2RCH2448C	527	655	752	29	29.5	48	24	68	4
L2RCH2454C	543	699	811	29	29.5	54	24	74	4
L2RCH2460C	591	761	883	29	29.5	60	24	78	4
L2RCH2466C	625	811	938	29	29.5	66	24	85	6
L2RCH2472C	659	862	1000	29	29.5	72	24	91	6
L2RCH2478C	693	909	1060	29	29.5	78	24	105	7
L2RCH2484C	725	956	1118	29	29.5	84	24	111	8
L2RCH3030C	487	590	661	29	29.5	30	30	72	3
L2RCH3036C	524	639	725	29	29.5	36	30	80	3
L2RCH3042C	562	693	791	29	29.5	42	30	85	4
L2RCH3048C	600	749	857	29	29.5	48	30	90	4
L2RCH3054C	634	801	922	29	29.5	54	30	95	6
L2RCH3060C	686	867	1000	29	29.5	60	30	97	6
L2RCH3066C	721	921	1066	29	29.5	66	30	103	7
L2RCH3072C	759	977	1135	29	29.5	72	30	111	7
L2RCH3078C	796	1033	1200	29	29.5	78	30	129	9
L2RCH3084C	831	1087	1265	29	29.5	84	30	136	10

**L2RCS • Return Connecting Swerve Left**



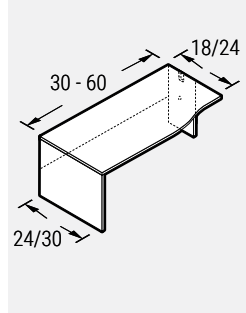
PRODUCT CODE	FINISH LP	B	W	SIZE/INCHES				WEIGHT LBS	VOL FT <sup>3</sup>
				H(LP/B)	H(W)	W	D		
L2RCS243018	586	672	784	29	29.5	30	24	70	2
L2RCS243618	630	733	853	29	29.5	36	24	79	3
L2RCS244218	673	792	922	29	29.5	42	24	88	3
L2RCS244818	721	852	992	29	29.5	48	24	97	4
L2RCS245418	763	911	1062	29	29.5	54	24	106	4
L2RCS246018	824	984	1143	29	29.5	60	24	114	4
L2RCS303024	638	746	864	29	29.5	30	30	81	3
L2RCS303624	688	812	942	29	29.5	36	30	91	3
L2RCS304224	736	879	1022	29	29.5	42	30	109	4
L2RCS304824	786	943	1101	29	29.5	48	30	119	4
L2RCS305424	833	1011	1177	29	29.5	54	30	127	6
L2RCS306024	885	1079	1259	29	29.5	60	30	136	6

**L2RCS • Return Connecting Swerve Right**



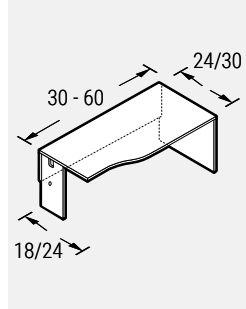
PRODUCT CODE	FINISH LP	B	W	SIZE/INCHES				WEIGHT LBS	VOL FT <sup>3</sup>
				H(LP/B)	H(W)	W	D		
L2RCS183024	586	672	784	29	29.5	30	24	70	2
L2RCS183624	630	733	853	29	29.5	36	24	79	3
L2RCS184224	673	792	922	29	29.5	42	24	88	3
L2RCS184824	721	852	992	29	29.5	48	24	97	4
L2RCS185424	763	911	1062	29	29.5	54	24	106	4
L2RCS186024	824	984	1143	29	29.5	60	24	114	4
L2RCS243030	638	746	864	29	29.5	30	30	81	3
L2RCS243630	688	812	942	29	29.5	36	30	91	3
L2RCS244230	736	879	1022	29	29.5	42	30	109	4
L2RCS244830	786	943	1101	29	29.5	48	30	119	4
L2RCS245430	833	1011	1177	29	29.5	54	30	127	6
L2RCS246030	885	1079	1259	29	29.5	60	30	136	6

**L2RCSH • Return Connecting Swerve Left with Half Modesty Panel**



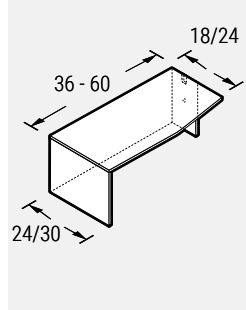
PRODUCT CODE	FINISH LP	B	W	SIZE / INCHES				WEIGHT LBS	VOL FT <sup>3</sup>
				H (LP/B)	H (W)	W	D		
L2RCSH243018	518	604	714	29	29.5	30	24	61	2
L2RCSH243618	550	652	766	29	29.5	36	24	65	3
L2RCSH244218	581	694	825	29	29.5	42	24	72	3
L2RCSH244818	614	741	883	29	29.5	48	24	77	4
L2RCSH245418	645	786	936	29	29.5	54	24	84	4
L2RCSH246018	692	846	1004	29	29.5	60	24	90	4
L2RCSH303024	570	672	794	29	29.5	30	30	78	3
L2RCSH303624	607	725	860	29	29.5	36	30	88	3
L2RCSH304224	643	780	925	29	29.5	42	30	105	4
L2RCSH304824	680	833	988	29	29.5	48	30	114	4
L2RCSH305424	718	888	1055	29	29.5	54	30	121	5
L2RCSH306024	754	941	1119	29	29.5	60	30	130	5

**L2RCSH • Return Connecting Swerve Right with Half Modesty Panel**



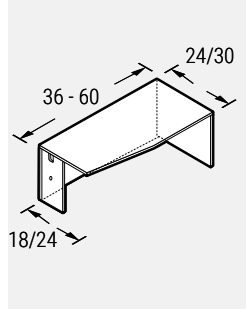
PRODUCT CODE	FINISH LP	B	W	SIZE / INCHES				WEIGHT LBS	VOL FT <sup>3</sup>
				H (LP/B)	H (W)	W	D		
L2RCSH183024	518	604	714	29	29.5	30	24	61	2
L2RCSH183624	550	652	766	29	29.5	36	24	65	3
L2RCSH184224	581	694	825	29	29.5	42	24	72	3
L2RCSH184824	614	741	883	29	29.5	48	24	77	4
L2RCSH185424	645	786	936	29	29.5	54	24	84	4
L2RCSH186024	692	846	1004	29	29.5	60	24	90	4
L2RCSH243030	570	672	794	29	29.5	30	30	78	3
L2RCSH243630	607	725	860	29	29.5	36	30	88	3
L2RCSH244230	643	780	925	29	29.5	42	30	105	4
L2RCSH244830	680	833	988	29	29.5	48	30	114	4
L2RCSH245430	718	888	1055	29	29.5	54	30	121	6
L2RCSH246030	754	941	1119	29	29.5	60	30	130	6

**L2RCW • Return Connecting Wedge Left**



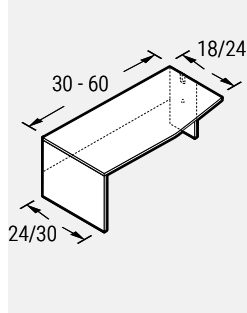
PRODUCT CODE	FINISH LP	B	W	SIZE / INCHES				WEIGHT LBS	VOL FT <sup>3</sup>
				H (LP/B)	H (W)	W	D		
L2RCW243018	586	672	784	29	29.5	30	24	70	2
L2RCW243618	630	733	853	29	29.5	36	24	79	3
L2RCW244218	673	792	922	29	29.5	42	24	88	3
L2RCW244818	721	852	992	29	29.5	48	24	97	4
L2RCW245418	763	911	1062	29	29.5	54	24	106	4
L2RCW246018	824	984	1143	29	29.5	60	24	114	4
L2RCW303024	638	746	864	29	29.5	30	30	81	3
L2RCW303624	688	812	942	29	29.5	36	30	91	3
L2RCW304224	736	879	1022	29	29.5	42	30	109	4
L2RCW304824	786	943	1101	29	29.5	48	30	119	4
L2RCW305424	833	1011	1177	29	29.5	54	30	127	6
L2RCW306024	885	1079	1259	29	29.5	60	30	136	6

**L2RCW • Return Connecting Wedge Right**



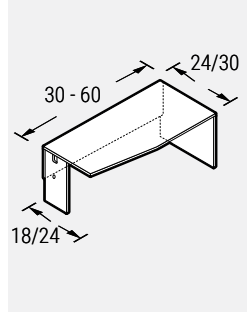
PRODUCT CODE	FINISH LP	B	W	SIZE / INCHES				WEIGHT LBS	VOL FT <sup>3</sup>
				H (LP/B)	H (W)	W	D		
L2RCW183024	586	672	784	29	29.5	30	24	70	2
L2RCW183624	630	733	853	29	29.5	36	24	79	3
L2RCW184224	673	792	922	29	29.5	42	24	88	3
L2RCW184824	721	852	992	29	29.5	48	24	97	4
L2RCW185424	763	911	1062	29	29.5	54	24	106	4
L2RCW186024	824	984	1143	29	29.5	60	24	114	4
L2RCW243030	638	746	864	29	29.5	30	30	81	3
L2RCW243630	688	812	942	29	29.5	36	30	91	3
L2RCW244230	736	879	1022	29	29.5	42	30	109	4
L2RCW244830	786	943	1101	29	29.5	48	30	119	4
L2RCW245430	833	1011	1177	29	29.5	54	30	127	6
L2RCW246030	885	1079	1259	29	29.5	60	30	136	6

**L2RCWH • Return Connecting Wedge Left with Half Modesty**



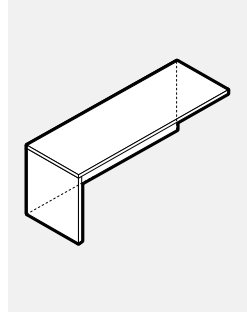
PRODUCT CODE	FINISH LP	B	W	SIZE / INCHES				WEIGHT		VOL FT <sup>3</sup>
				H (LP/B)	H (W)	W	D	LBS		
L2RCWH243018	518	604	714	29	29.5	30	24	61	2	
L2RCWH243618	550	652	766	29	29.5	36	24	65	3	
L2RCWH244218	581	694	825	29	29.5	42	24	72	3	
L2RCWH244818	614	741	883	29	29.5	48	24	77	4	
L2RCWH245418	645	786	936	29	29.5	54	24	84	4	
L2RCWH246018	692	846	1004	29	29.5	60	24	90	4	
L2RCWH303024	570	672	794	29	29.5	30	30	78	3	
L2RCWH303624	607	725	860	29	29.5	36	30	88	3	
L2RCWH304224	643	780	925	29	29.5	42	30	105	4	
L2RCWH304824	680	833	988	29	29.5	48	30	114	4	
L2RCWH305424	718	888	1055	29	29.5	54	30	121	6	
L2RCWH306024	754	941	1119	29	29.5	60	30	130	6	

**L2RCWH • Return Connecting Wedge Right with Half Modesty**



PRODUCT CODE	FINISH LP	B	W	SIZE / INCHES				WEIGHT		VOL FT <sup>3</sup>
				H (LP/B)	H (W)	W	D	LBS		
L2RCWH183024	518	604	714	29	29.5	30	24	61	2	
L2RCWH183624	550	652	766	29	29.5	36	24	65	3	
L2RCWH184224	581	694	825	29	29.5	42	24	72	3	
L2RCWH184824	614	741	883	29	29.5	48	24	77	4	
L2RCWH185424	645	786	936	29	29.5	54	24	84	4	
L2RCWH186024	692	846	1004	29	29.5	60	24	90	4	
L2RCWH243030	570	672	794	29	29.5	30	30	78	3	
L2RCWH243630	607	725	860	29	29.5	36	30	88	3	
L2RCWH244230	643	780	925	29	29.5	42	30	105	4	
L2RCWH244830	680	833	988	29	29.5	48	30	114	4	
L2RCWH245430	718	888	1055	29	29.5	54	30	121	6	
L2RCWH246030	754	941	1119	29	29.5	60	30	130	6	

**L2ER-L • Executive Return Left**

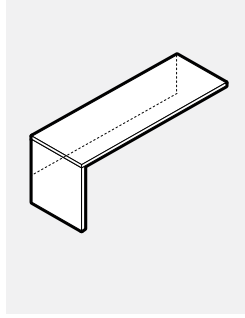


• Units are non-handed. They can be configured as either lefts or rights.

PRODUCT CODE	FINISH LP	B	W	SIZE / INCHES				WEIGHT		VOL FT <sup>3</sup>
				H (LP/B)	H (W)	W	D	LBS		
L2ER2024L	389	455	508	29	29.5	24	20	25	3	
L2ER2030L	434	516	577	29	29.5	30	20	29	3	
L2ER2036L	483	578	656	29	29.5	36	20	32	3	
L2ER2042L	536	644	727	29	29.5	42	20	35	3	
L2ER2048L	578	701	800	29	29.5	48	20	37	4	
L2ER2054L	625	762	868	29	29.5	54	20	40	4	
L2ER2060L	683	833	954	29	29.5	60	20	44	4	
L2ER2066L	725	894	1022	29	29.5	66	20	46	6	
L2ER2072L	773	955	1094	29	29.5	72	20	50	6	
L2ER2424L	405	475	527	29	29.5	24	24	25	3	
L2ER2430L	451	537	600	29	29.5	30	24	29	3	
L2ER2436L	503	603	683	29	29.5	36	24	32	3	
L2ER2442L	555	670	759	29	29.5	42	24	35	3	
L2ER2448L	603	731	830	29	29.5	48	24	37	4	
L2ER2454L	652	792	905	29	29.5	54	24	40	4	
L2ER2460L	709	867	988	29	29.5	60	24	44	4	
L2ER2466L	755	930	1063	29	29.5	66	24	46	6	
L2ER2472L	801	994	1139	29	29.5	72	24	50	6	

**L2ERH-L • Executive Return Left, Half Modesty**

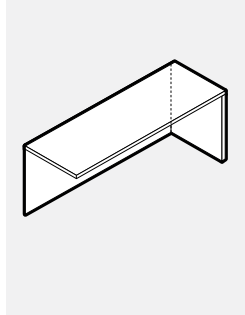
• Units are non-handed. They can be configured as either lefts or rights.



PRODUCT CODE	FINISH			SIZE / INCHES				WEIGHT LBS	VOL FT <sup>3</sup>
	LP	B	W	H (LP/B)	H (W)	W	D		
L2ERH2024L	336	399	451	29	29.5	24	20	25	3
L2ERH2030L	367	443	507	29	29.5	30	20	29	3
L2ERH2036L	409	501	577	29	29.5	36	20	32	3
L2ERH2042L	441	546	633	29	29.5	42	20	35	3
L2ERH2048L	473	593	691	29	29.5	48	20	37	4
L2ERH2054L	507	638	746	29	29.5	54	20	40	4
L2ERH2060L	550	697	816	29	29.5	60	20	44	4
L2ERH2066L	581	744	868	29	29.5	66	20	46	6
L2ERH2072L	612	790	929	29	29.5	72	20	50	6
L2ERH2424L	347	412	471	29	29.5	24	24	25	3
L2ERH2430L	380	462	524	29	29.5	30	24	29	3
L2ERH2436L	425	520	602	29	29.5	36	24	32	3
L2ERH2442L	459	569	658	29	29.5	42	24	35	3
L2ERH2448L	491	619	718	29	29.5	48	24	37	4
L2ERH2454L	524	665	775	29	29.5	54	24	40	4
L2ERH2460L	573	724	846	29	29.5	60	24	44	4
L2ERH2466L	605	774	905	29	29.5	66	24	46	6
L2ERH2472L	638	823	969	29	29.5	72	24	50	6

**L2ER-R • Executive Return Right**

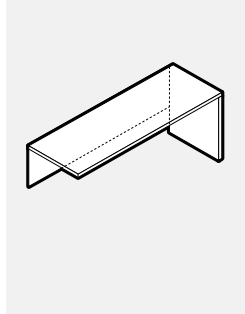
• Units are non-handed. They can be configured as either lefts or rights.



PRODUCT CODE	FINISH			SIZE / INCHES				WEIGHT LBS	VOL FT <sup>3</sup>
	LP	B	W	H (LP/B)	H (W)	W	D		
L2ER2024R	389	455	508	29	29.5	24	20	55	3
L2ER2030R	434	516	577	29	29.5	30	20	63	3
L2ER2036R	483	578	656	29	29.5	36	20	70	3
L2ER2042R	536	644	727	29	29.5	42	20	77	3
L2ER2048R	578	701	800	29	29.5	48	20	87	4
L2ER2054R	625	762	868	29	29.5	54	20	92	4
L2ER2060R	683	833	954	29	29.5	60	20	102	4
L2ER2066R	725	894	1022	29	29.5	66	20	110	6
L2ER2072R	773	955	1094	29	29.5	72	20	119	6
L2ER2424R	405	475	527	29	29.5	24	24	55	3
L2ER2430R	451	537	600	29	29.5	30	24	63	3
L2ER2436R	503	603	683	29	29.5	36	24	70	3
L2ER2442R	555	670	759	29	29.5	42	24	77	3
L2ER2448R	603	731	830	29	29.5	48	24	87	4
L2ER2454R	652	792	905	29	29.5	54	24	92	4
L2ER2460R	709	867	988	29	29.5	60	24	102	4
L2ER2466R	755	930	1063	29	29.5	66	24	110	6
L2ER2472R	801	994	1139	29	29.5	72	24	119	6

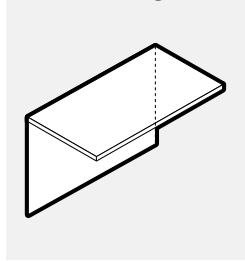
**L2ERH-R • Executive Return Right, Half Modesty**

• Units are non-handed. They can be configured as either lefts or rights.



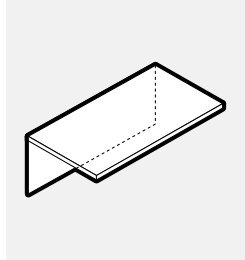
PRODUCT CODE	FINISH			SIZE / INCHES				WEIGHT LBS	VOL FT <sup>3</sup>
	LP	B	W	H (LP/B)	H (W)	W	D		
L2ERH2024R	336	399	451	29	29.5	24	20	45	3
L2ERH2030R	367	443	507	29	29.5	30	20	53	3
L2ERH2036R	409	501	577	29	29.5	36	20	62	3
L2ERH2042R	441	546	633	29	29.5	42	20	67	3
L2ERH2048R	473	593	691	29	29.5	48	20	77	4
L2ERH2054R	507	638	746	29	29.5	54	20	83	4
L2ERH2060R	550	697	816	29	29.5	60	20	94	4
L2ERH2066R	581	744	868	29	29.5	66	20	101	6
L2ERH2072R	612	790	929	29	29.5	72	20	110	6
L2ERH2424R	347	412	471	29	29.5	24	24	45	3
L2ERH2430R	380	462	524	29	29.5	30	24	53	3
L2ERH2436R	425	520	602	29	29.5	36	24	62	3
L2ERH2442R	459	569	658	29	29.5	42	24	67	3
L2ERH2448R	491	619	718	29	29.5	48	24	77	4
L2ERH2454R	524	665	775	29	29.5	54	24	83	4
L2ERH2460R	573	724	846	29	29.5	60	24	94	4
L2ERH2466R	605	774	905	29	29.5	66	24	101	6
L2ERH2472R	638	823	969	29	29.5	72	24	110	6

**L2B • Bridge with Flush Mounted Modesty**



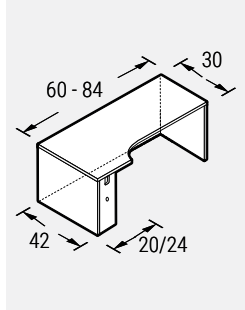
PRODUCT CODE	FINISH			SIZE / INCHES				WEIGHT LBS	VOL FT <sup>3</sup>
	LP	B	W	H (LP/B)	H (W)	W	D		
L2B2024	267	328	383	29	29.5	24	20	39	2
L2B2030	312	388	452	29	29.5	30	20	42	3
L2B2036	363	452	527	29	29.5	36	20	68	3
L2B2042	406	510	596	29	29.5	42	20	77	3
L2B2048	451	570	666	29	29.5	48	20	86	4
L2B2054	495	630	736	29	29.5	54	20	94	4
L2B2424	278	341	398	29	29.5	24	24	39	2
L2B2430	324	404	472	29	29.5	30	24	44	3
L2B2436	375	471	548	29	29.5	36	24	68	3
L2B2442	421	535	623	29	29.5	42	24	77	3
L2B2448	471	593	693	29	29.5	48	24	86	4
L2B2454	516	656	763	29	29.5	54	24	94	4

**L2BH • Bridge with Flush Mounted Half Modesty**



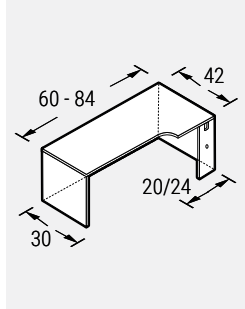
PRODUCT CODE	FINISH			SIZE / INCHES				WEIGHT LBS	VOL FT <sup>3</sup>
	LP	B	W	H (LP/B)	H (W)	W	D		
L2BH2024	212	271	327	29	29.5	24	20	36	2
L2BH2030	245	318	380	29	29.5	30	20	36	2
L2BH2036	280	369	443	29	29.5	36	20	54	3
L2BH2042	312	412	501	29	29.5	42	20	61	3
L2BH2048	344	459	555	29	29.5	48	20	66	4
L2BH2054	377	507	610	29	29.5	54	20	72	4
L2BH2424	221	283	339	29	29.5	24	24	36	2
L2BH2430	253	329	397	29	29.5	30	24	42	3
L2BH2436	293	383	462	29	29.5	36	24	54	3
L2BH2442	327	432	520	29	29.5	42	24	61	3
L2BH2448	361	477	578	29	29.5	48	24	66	4
L2BH2454	392	524	636	29	29.5	54	24	72	4

**L2EC-R • Extended Corner Desk with 10" End Panel on Left, Full Modesty & Full Gable on Right**



PRODUCT CODE	FINISH			SIZE / INCHES				WEIGHT LBS	VOL FT <sup>3</sup>
	LP	B	W	H (LP/B)	H (W)	W	D		
<b>For 20" Return Connection</b>									
L2EC20426030R	1109	1374	1561	29	29.5	60	42	187	8
L2EC20426630R	1167	1456	1655	29	29.5	66	42	209	9
L2EC20427230R	1223	1533	1748	29	29.5	72	42	231	10
L2EC20427830R	1273	1613	1842	29	29.5	78	42	253	11
L2EC20428430R	1329	1690	1935	29	29.5	84	42	275	12
<b>For 24" Return Connection</b>									
L2EC24426030R	1109	1374	1561	29	29.5	60	42	187	8
L2EC24426630R	1167	1456	1655	29	29.5	66	42	209	9
L2EC24427230R	1223	1533	1748	29	29.5	72	42	231	10
L2EC24427830R	1273	1613	1842	29	29.5	78	42	253	11
L2EC24428430R	1329	1690	1935	29	29.5	84	42	275	12

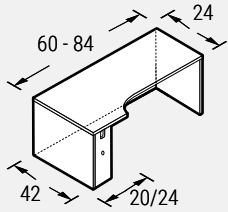
**L2EC-L • Extended Corner Desk with 10" End Panel on Right, Full Modesty & Full Gable on Left**



PRODUCT CODE	FINISH			SIZE / INCHES				WEIGHT LBS	VOL FT <sup>3</sup>
	LP	B	W	H (LP/B)	H (W)	W	D		
<b>For 20" Return Connection</b>									
L2EC30604220L	1109	1374	1561	29	29.5	60	42	187	8
L2EC30664220L	1167	1456	1655	29	29.5	66	42	209	9
L2EC30724220L	1223	1533	1748	29	29.5	72	42	231	10
L2EC30784220L	1273	1613	1842	29	29.5	78	42	253	11
L2EC30844220L	1329	1690	1935	29	29.5	84	42	275	12
<b>For 24" Return Connection</b>									
L2EC30604224L	1109	1374	1561	29	29.5	60	42	187	8
L2EC30664224L	1167	1456	1655	29	29.5	66	42	209	9
L2EC30724224L	1223	1533	1748	29	29.5	72	42	231	10
L2EC30784224L	1273	1613	1842	29	29.5	78	42	253	11
L2EC30844224L	1329	1690	1935	29	29.5	84	42	275	12

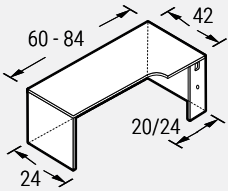


**L2EC-R • Extended Corner Desk with 10" End Panel on Left, Full Modesty & Full Gable on Right**



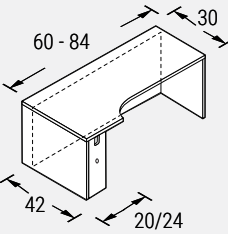
PRODUCT CODE	FINISH LP	B	W	SIZE / INCHES				WEIGHT LBS	VOL FT <sup>3</sup>
				H (LP/B)	H (W)	W	D		
<b>For 20" Return Connection</b>									
L2EC20426024R	1088	1352	1539	29	29.5	60	42	187	8
L2EC20426624R	1142	1431	1632	29	29.5	66	42	209	9
L2EC20427224R	1198	1509	1724	29	29.5	72	42	231	10
L2EC20427824R	1255	1588	1817	29	29.5	78	42	253	11
L2EC20428424R	1304	1668	1914	29	29.5	84	42	275	12
<b>For 24" Return Connection</b>									
L2EC24426024R	1088	1352	1539	29	29.5	60	42	187	8
L2EC24426624R	1142	1431	1632	29	29.5	66	42	209	9
L2EC24427224R	1198	1509	1724	29	29.5	72	42	231	10
L2EC24427824R	1255	1588	1817	29	29.5	78	42	253	11
L2EC24428424R	1304	1668	1914	29	29.5	84	42	275	12

**L2EC-L • Extended Corner Desk with 10" End Panel on Left, Full Modesty & Full Gable on Right**



PRODUCT CODE	FINISH LP	B	W	SIZE / INCHES				WEIGHT LBS	VOL FT <sup>3</sup>
				H (LP/B)	H (W)	W	D		
<b>For 20" Return Connection</b>									
L2EC24604220L	1088	1352	1539	29	29.5	60	42	187	8
L2EC24664220L	1142	1431	1632	29	29.5	66	42	209	9
L2EC24724220L	1198	1509	1724	29	29.5	72	42	231	10
L2EC24784220L	1255	1588	1817	29	29.5	78	42	253	11
L2EC24844220L	1304	1668	1914	29	29.5	84	42	275	12
<b>For 24" Return Connection</b>									
L2EC24604224L	1088	1352	1539	29	29.5	60	42	187	8
L2EC24664224L	1142	1431	1632	29	29.5	66	42	209	9
L2EC24724224L	1198	1509	1724	29	29.5	72	42	231	10
L2EC24784224L	1255	1588	1817	29	29.5	78	42	253	11
L2EC24844224L	1304	1668	1914	29	29.5	84	42	275	12

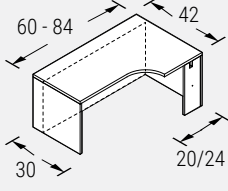
**L2DEC-R • Extended Corner Desk with 10" End Panel on Left, Full Modesty and Full Gable Right**



• All recessed modesties are inset 6" from the visitor edge.

PRODUCT CODE	FINISH LP	B	W	SIZE / INCHES				WEIGHT LBS	VOL FT <sup>3</sup>
				H (LP/B)	H (W)	W	D		
<b>For 20" Connection</b>									
L2DEC20426030R	1109	1374	1561	29	29.5	60	42	187	8
L2DEC20426630R	1167	1456	1655	29	29.5	66	42	209	9
L2DEC20427230R	1223	1533	1748	29	29.5	72	42	231	10
L2DEC20427830R	1273	1613	1842	29	29.5	78	42	253	11
L2DEC20428430R	1329	1690	1935	29	29.5	84	42	275	12
<b>For 24" Connection</b>									
L2DEC24426030R	1109	1374	1561	29	29.5	60	42	187	8
L2DEC24426630R	1167	1456	1655	29	29.5	66	42	209	9
L2DEC24427230R	1223	1533	1748	29	29.5	72	42	231	10
L2DEC24427830R	1273	1613	1842	29	29.5	78	42	253	11
L2DEC24428430R	1329	1690	1935	29	29.5	84	42	275	12

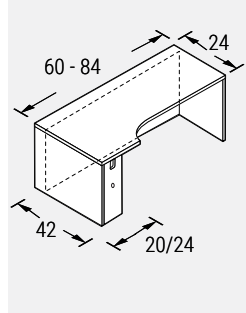
**L2DEC-L • Extended Corner Desk with 10" End Panel on Right, Full Modesty and Full Gable Left**



• All recessed modesties are inset 6" from the visitor edge.

PRODUCT CODE	FINISH LP	B	W	SIZE / INCHES				WEIGHT LBS	VOL FT <sup>3</sup>
				H (LP/B)	H (W)	W	D		
<b>For 20" Connection</b>									
L2DEC30604220L	1109	1374	1561	29	29.5	60	42	187	8
L2DEC30664220L	1167	1456	1655	29	29.5	66	42	209	9
L2DEC30724220L	1223	1533	1748	29	29.5	72	42	231	10
L2DEC30784220L	1273	1613	1842	29	29.5	78	42	253	11
L2DEC30844220L	1329	1690	1935	29	29.5	84	42	275	12
<b>For 24" Connection</b>									
L2DEC30604224L	1109	1374	1561	29	29.5	60	42	187	8
L2DEC30664224L	1167	1456	1655	29	29.5	66	42	209	9
L2DEC30724224L	1223	1533	1748	29	29.5	72	42	231	10
L2DEC30784224L	1273	1613	1842	29	29.5	78	42	253	11
L2DEC30844224L	1329	1690	1935	29	29.5	84	42	275	12

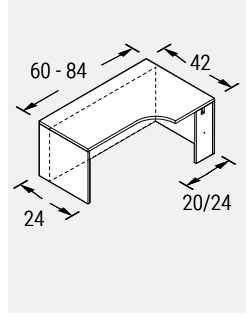
**L2DEC-R • Extended Corner Desk with 10" End Panel on Left, Full Modesty and Full Gable Right**



• All recessed modesties are inset 6" from the visitor edge.

PRODUCT CODE	FINISH LP	B	W	SIZE / INCHES				WEIGHT LBS	VOL FT <sup>3</sup>
				H (LP/B)	H (W)	W	D		
<b>For 20" Conection</b>									
L2DEC20426024R	1088	1352	1539	29	29.5	60	42	187	8
L2DEC20426624R	1142	1431	1632	29	29.5	66	42	209	9
L2DEC20427224R	1198	1509	1724	29	29.5	72	42	231	10
L2DEC20427824R	1255	1588	1817	29	29.5	78	42	253	11
L2DEC20428424R	1304	1668	1914	29	29.5	84	42	275	12
<b>For 24" Conection</b>									
L2DEC24426024R	1088	1352	1539	29	29.5	60	42	187	8
L2DEC24426624R	1142	1431	1632	29	29.5	66	42	209	9
L2DEC24427224R	1198	1509	1724	29	29.5	72	42	231	10
L2DEC24427824R	1255	1588	1817	29	29.5	78	42	253	11
L2DEC24428424R	1304	1668	1914	29	29.5	84	42	275	12

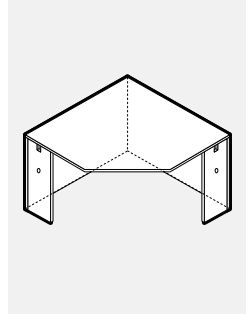
**L2DEC-L • Extended Corner Desk with 10" End Panel on Right, Full Modesty and Full Gable Left**



• All recessed modesties are inset 6" from the visitor edge.

PRODUCT CODE	FINISH LP	B	W	SIZE / INCHES				WEIGHT LBS	VOL FT <sup>3</sup>
				H (LP/B)	H (W)	W	D		
<b>For 20" Conection</b>									
L2DEC24604220L	1088	1352	1539	29	29.5	60	42	187	8
L2DEC24664220L	1142	1431	1632	29	29.5	66	42	209	9
L2DEC24724220L	1198	1509	1724	29	29.5	72	42	231	10
L2DEC24784220L	1255	1588	1817	29	29.5	78	42	253	11
L2DEC24844220L	1304	1668	1914	29	29.5	84	42	275	12
<b>For 24" Conection</b>									
L2DEC24604224L	1088	1352	1539	29	29.5	60	42	187	8
L2DEC24664224L	1142	1431	1632	29	29.5	66	42	209	9
L2DEC24724224L	1198	1509	1724	29	29.5	72	42	231	10
L2DEC24784224L	1255	1588	1817	29	29.5	78	42	253	11
L2DEC24844224L	1304	1668	1914	29	29.5	84	42	275	12

**L2CS • Corner with Straight Front, Full Back Panel & Narrow End Gables**

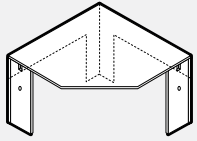


• For grain direction on surfaces larger than 42", please see grain direction chart at beginning of the Price List

PRODUCT CODE	FINISH LP	B	W	SIZE / INCHES				WEIGHT LBS	VOL FT <sup>3</sup>
				H (LP/B)	H (W)	W	D		
L2CS183618	888	1095	1369	29	29.5	36	36	79	3
L2CS183620	911	1122	1405	29	29.5	36	36	84	3
L2CS183624	911	1122	1405	29	29.5	36	36	84	3
L2CS203618	911	1122	1405	29	29.5	36	36	84	3
L2CS203620	949	1182	1524	29	29.5	36	36	88	3
L2CS203624	970	1209	1559	29	29.5	36	36	88	3
L2CS243618	911	1122	1405	29	29.5	36	36	84	3
L2CS243620	970	1209	1559	29	29.5	36	36	88	3
L2CS243624	970	1209	1559	29	29.5	36	36	88	3
L2CS184218	972	1203	1496	29	29.5	42	42	87	4
L2CS184220	999	1234	1533	29	29.5	42	42	92	4
L2CS184224	999	1234	1533	29	29.5	42	42	92	4
L2CS204218	999	1234	1533	29	29.5	42	42	92	4
L2CS204220	999	1234	1533	29	29.5	42	42	97	4
L2CS204224	1024	1264	1617	29	29.5	42	42	97	4
L2CS244218	999	1234	1533	29	29.5	42	42	92	4
L2CS244220	1024	1264	1617	29	29.5	42	42	97	4
L2CS244224	1024	1264	1617	29	29.5	42	42	97	4
L2CS184818	1030	1262	1552	29	29.5	48	48	97	6
L2CS184820	1057	1292	1590	29	29.5	48	48	101	6
L2CS184824	1057	1292	1590	29	29.5	48	48	101	6
L2CS204818	1057	1292	1590	29	29.5	48	48	101	6
L2CS204820	1057	1292	1590	29	29.5	48	48	107	6
L2CS204824	1084	1324	1675	29	29.5	48	48	107	6
L2CS244818	1057	1292	1590	29	29.5	48	48	101	6
L2CS244820	1084	1324	1675	29	29.5	48	48	107	6
L2CS244824	1084	1324	1675	29	29.5	48	48	107	6

**L2CSH • Corner with Straight Front, Cut Out Back Panel & Narrow End Gables**

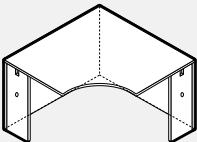
- For grain direction on surfaces larger than 42", please see grain direction chart at beginning of the Price List



PRODUCT CODE	FINISH LP	B	W	SIZE / INCHES				WEIGHT LBS	VOL FT <sup>3</sup>
				H (LP/B)	H (W)	W	D		
L2CSH183618	918	1126	1398	29	29.5	36	36	51	3
L2CSH183620	942	1154	1436	29	29.5	36	36	55	3
L2CSH183624	942	1154	1436	29	29.5	36	36	55	3
L2CSH203618	942	1154	1436	29	29.5	36	36	55	3
L2CSH203620	977	1212	1554	29	29.5	36	36	59	3
L2CSH203624	1000	1239	1588	29	29.5	36	36	59	3
L2CSH243618	942	1154	1436	29	29.5	36	36	55	3
L2CSH243620	1000	1239	1588	29	29.5	36	36	59	3
L2CSH243624	1000	1239	1588	29	29.5	36	36	59	3
L2CSH184218	1006	1237	1529	29	29.5	42	42	57	4
L2CSH184220	1034	1267	1570	29	29.5	42	42	63	4
L2CSH184224	1034	1267	1570	29	29.5	42	42	63	4
L2CSH204218	1034	1267	1570	29	29.5	42	42	63	4
L2CSH204220	1034	1267	1570	29	29.5	42	42	68	4
L2CSH204224	1060	1300	1654	29	29.5	42	42	68	4
L2CSH244218	1034	1267	1570	29	29.5	42	42	63	4
L2CSH244220	1060	1300	1654	29	29.5	42	42	68	4
L2CSH244224	1060	1300	1654	29	29.5	42	42	68	4
L2CSH184818	1065	1298	1587	29	29.5	48	48	65	6
L2CSH184820	1092	1327	1628	29	29.5	48	48	70	6
L2CSH184824	1092	1327	1628	29	29.5	48	48	70	6
L2CSH204818	1092	1327	1628	29	29.5	48	48	70	6
L2CSH204820	1092	1327	1628	29	29.5	48	48	76	6
L2CSH204824	1118	1358	1713	29	29.5	48	48	76	6
L2CSH244818	1092	1327	1628	29	29.5	48	48	70	6
L2CSH244820	1118	1358	1713	29	29.5	48	48	76	6
L2CSH244824	1118	1358	1713	29	29.5	48	48	76	6

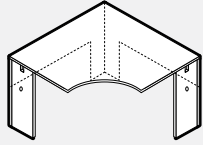
**L2CC • Corner with Curved Front, Full Back Panel & Narrow End Gables**

- For grain direction on surfaces larger than 42", please see grain direction chart at beginning of the Price List



PRODUCT CODE	FINISH LP	B	W	SIZE / INCHES				WEIGHT LBS	VOL FT <sup>3</sup>
				H (LP/B)	H (W)	W	D		
L2CC183618	898	1114	1396	29	29.5	36	36	79	3
L2CC183620	925	1142	1434	29	29.5	36	36	84	3
L2CC183624	925	1142	1434	29	29.5	36	36	84	3
L2CC203618	925	1142	1434	29	29.5	36	36	84	3
L2CC203620	962	1204	1554	29	29.5	36	36	88	3
L2CC203624	985	1233	1588	29	29.5	36	36	88	3
L2CC243618	925	1142	1434	29	29.5	36	36	84	3
L2CC243620	985	1233	1588	29	29.5	36	36	88	3
L2CC243624	985	1233	1588	29	29.5	36	36	88	3
L2CC184218	987	1225	1525	29	29.5	42	42	87	4
L2CC184220	1012	1258	1564	29	29.5	42	42	92	4
L2CC184224	1012	1258	1564	29	29.5	42	42	92	4
L2CC204218	1012	1258	1564	29	29.5	42	42	92	4
L2CC204220	1012	1258	1564	29	29.5	42	42	97	4
L2CC204224	1038	1289	1652	29	29.5	42	42	97	4
L2CC244218	1012	1258	1564	29	29.5	42	42	92	4
L2CC244220	1038	1289	1652	29	29.5	42	42	97	4
L2CC244224	1038	1289	1652	29	29.5	42	42	97	4
L2CC184818	1045	1284	1583	29	29.5	48	48	97	6
L2CC184820	1069	1315	1622	29	29.5	48	48	101	6
L2CC184824	1069	1315	1622	29	29.5	48	48	101	6
L2CC204818	1069	1315	1622	29	29.5	48	48	101	6
L2CC204820	1069	1315	1622	29	29.5	48	48	107	6
L2CC204824	1096	1344	1710	29	29.5	48	48	107	6
L2CC244818	1069	1315	1622	29	29.5	48	48	101	6
L2CC244820	1096	1344	1710	29	29.5	48	48	107	6
L2CC244824	1096	1344	1710	29	29.5	48	48	107	6

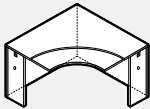
**L2CCH • Corner with Curved Front, Cut Out Back Panel & Narrow End Gables**



• For grain direction on surfaces larger than 42", please see grain direction chart at beginning of the Price List

PRODUCT CODE	FINISH LP	B	W	SIZE / INCHES				WEIGHT LBS	VOL FT <sup>3</sup>
				H (LP/B)	H (W)	W	D		
L2CCH183618	930	1143	1526	29	29.5	36	36	51	3
L2CCH183620	956	1173	1530	29	29.5	36	36	55	3
L2CCH183624	956	1173	1530	29	29.5	36	36	55	3
L2CCH203618	956	1173	1530	29	29.5	36	36	55	3
L2CCH203620	994	1235	1656	29	29.5	36	36	59	3
L2CCH203624	1017	1264	1656	29	29.5	36	36	59	3
L2CCH243618	956	1173	1530	29	29.5	36	36	55	3
L2CCH243620	1017	1264	1656	29	29.5	36	36	59	3
L2CCH243624	1017	1264	1656	29	29.5	36	36	59	3
L2CCH184218	1023	1260	1560	29	29.5	42	42	57	4
L2CCH184220	1051	1291	1601	29	29.5	42	42	63	4
L2CCH184224	1051	1291	1601	29	29.5	42	42	63	4
L2CCH204218	1051	1291	1601	29	29.5	42	42	63	4
L2CCH204220	1051	1291	1601	29	29.5	42	42	68	4
L2CCH204224	1073	1324	1686	29	29.5	42	42	68	4
L2CCH244218	1051	1291	1601	29	29.5	42	42	63	4
L2CCH244220	1073	1324	1686	29	29.5	42	42	68	4
L2CCH244224	1073	1324	1686	29	29.5	42	42	68	4
L2CCH184818	1083	1318	1617	29	29.5	48	48	65	6
L2CCH184820	1107	1349	1656	29	29.5	48	48	70	6
L2CCH184824	1107	1349	1656	29	29.5	48	48	70	6
L2CCH204818	1107	1349	1656	29	29.5	48	48	70	6
L2CCH204820	1107	1349	1656	29	29.5	48	48	76	6
L2CCH204824	1132	1381	1744	29	29.5	48	48	76	6
L2CCH244818	1107	1349	1656	29	29.5	48	48	70	6
L2CCH244820	1132	1381	1744	29	29.5	48	48	76	6
L2CCH244824	1132	1381	1744	29	29.5	48	48	76	6

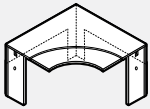
**L2CK • Split Corner Desk w/Curved Front Keyboard, Full Back Panel & Narrow End Gables**



• For grain direction on surfaces larger than 42", please see grain direction chart at beginning of the Price List

PRODUCT CODE	FINISH LP	B	W	SIZE / INCHES				WEIGHT LBS	VOL FT <sup>3</sup>
				H (LP/B)	H (W)	W	D		
L2CK244224	1769	2074	2461	29	29.5	42	42	97	4
L2CK244824	1826	2131	2521	29	29.5	48	48	107	6

**L2CHK • Split Corner Desk w/Curved Front Keyboard, Cut Out Back Panel & Narrow End Gables**



• For grain direction on surfaces larger than 42", please see grain direction chart at beginning of the Price List

PRODUCT CODE	FINISH LP	B	W	SIZE / INCHES				WEIGHT LBS	VOL FT <sup>3</sup>
				H (LP/B)	H (W)	W	D		
L2CHK244224	1803	2091	2477	29	29.5	42	42	68	4
L2CHK244824	1861	2151	2536	29	29.5	48	48	76	6

## Technical Information

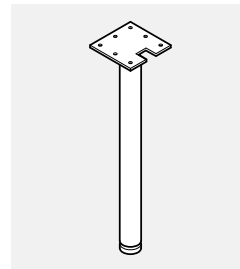
- All Shaped tables are Shipped knocked down (KD).
- Monoleg or square leg ships in a separate box.
- All Units must be connected to an adjoining unit with flat brackets.
- For 24" deep returns that connect to an adjoining unit with included flat brackets.
- For 24" deep returns that connect to the corner units, the narrow panel is 10" and for 30" deep returns, the narrow panel is 14".
- All bottom edges are edge banded.
- Monolegs are drilled to accept shoulder screws to attach to the modesty.
- Modesty are offered 10" high only.
- Top plate with cut-out for 3" monoleg will accept modesty panel 1" thick.
- 8 x 8" plate is attached to surface with #10 3/4 wood screws, included.
- 1" height adjustment range.

## TABLES • GUIDELINES FOR ORDERING PRODUCT

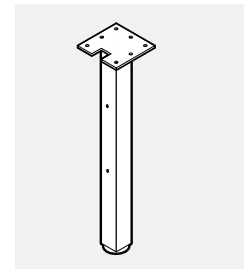
**CODES:** The price list uses a numbering system with meaningful alphanumeric characters to create a simple-to-understand product number. This makes specifying the product much easier and more accurate.

### SPECIFICATION EXAMPLE OF A SHAPED TABLE

- PRODUCT CODE:** L2TDH3060  
 L2 = New Licence  
 T = Table  
 D = D Shape Worksurface  
 H = Half Modesty (10"High)  
 3060 = Size: Depth x Width
- OPTIONS:**
- Top: LP - LPL (Low Pressure Laminate) Thickness 1"  
 HP B - B Thickness 1 1/16"  
 HP W - W Thickness 1 7/16"
- Leg Option: L2BHML03 (DEFAULT) Round Monoleg  
 L2LSQ3X3 - Square Leg
- Top Finish Laminate: Choose Colour
- Top PVC Edging: Choose Colour
- Chassis Laminate: Choose Colour
- Chassis PVC Edging: Choose Colour
- Metal Leg Finish: Choose Colour



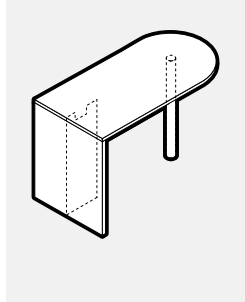
L2BHML03



L2LSQ3X3

## L2TD • D-Shaped Top with T-Base & Leg

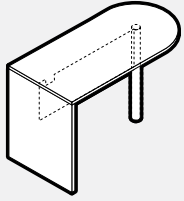
- Add \$118 to list price for chrome leg option.



PRODUCT CODE	FINISH LP	B	W	SIZE/INCHES				D	WEIGHT LBS	VOL FT <sup>3</sup>
				H (LP/B)	H (W)	W	D			
L2TD2442	783	903	994	29	29.5	42	24	64	3	
L2TD2448	802	937	1037	29	29.5	48	24	68	3	
L2TD2454	826	973	1086	29	29.5	54	24	72	3	
L2TD2460	850	1011	1131	29	29.5	60	24	76	4	
L2TD2466	870	1045	1174	29	29.5	66	24	79	4	
L2TD2472	893	1084	1224	29	29.5	72	24	84	4	
L2TD2478	917	1118	1266	29	29.5	78	24	87	6	
L2TD2484	937	1154	1315	29	29.5	84	24	91	6	
L2TD3054	896	1078	1204	29	29.5	54	30	97	4	
L2TD3060	925	1121	1261	29	29.5	60	30	107	7	
L2TD3066	954	1166	1317	29	29.5	66	30	117	8	
L2TD3072	977	1205	1369	29	29.5	72	30	127	9	
L2TD3078	1004	1254	1426	29	29.5	78	30	136	9	
L2TD3084	1033	1294	1481	29	29.5	84	30	146	10	
L2TD3654	963	1173	1320	29	29.5	54	36	107	4	
L2TD3660	996	1226	1383	29	29.5	60	36	111	10	
L2TD3666	1026	1275	1448	29	29.5	66	36	116	9	
L2TD3672	1057	1327	1511	29	29.5	72	36	153	10	
L2TD3678	1089	1378	1575	29	29.5	78	36	165	11	
L2TD3684	1119	1429	1639	29	29.5	84	36	176	12	

**L2TDH • D-Shaped Top with Half Modesty & Leg**

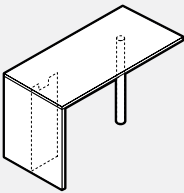
• Add \$118 to list price for chrome leg option.



PRODUCT CODE	FINISH			SIZE/INCHES				WEIGHT LBS	VOL FT <sup>3</sup>
	LP	B	W	H(LP/B)	H(W)	W	D		
L2TDH2442	763	886	975	29	29.5	42	24	63	3
L2TDH2448	797	931	1030	29	29.5	48	24	69	3
L2TDH2454	829	976	1088	29	29.5	54	24	75	3
L2TDH2460	862	1024	1143	29	29.5	60	24	81	4
L2TDH2466	894	1067	1199	29	29.5	66	24	87	4
L2TDH2472	926	1117	1258	29	29.5	72	24	94	4
L2TDH2478	958	1160	1310	29	29.5	78	24	99	6
L2TDH2484	988	1205	1367	29	29.5	84	24	106	6
L2TDH3054	897	1078	1204	29	29.5	54	30	95	4
L2TDH3060	935	1131	1269	29	29.5	60	30	102	7
L2TDH3066	971	1186	1333	29	29.5	66	30	112	8
L2TDH3072	1006	1237	1398	29	29.5	72	30	122	9
L2TDH3078	1043	1292	1464	29	29.5	78	30	132	9
L2TDH3084	1083	1344	1530	29	29.5	84	30	142	10
L2TDH3654	963	1174	1323	29	29.5	54	36	145	4
L2TDH3660	1004	1235	1394	29	29.5	60	36	151	10
L2TDH3666	1035	1289	1458	29	29.5	66	36	154	9
L2TDH3672	1078	1348	1530	29	29.5	72	36	156	10
L2TDH3678	1118	1407	1606	29	29.5	78	36	161	11
L2TDH3684	1158	1470	1681	29	29.5	84	36	172	12

**L2TR • Rectangular Top with T-Base & Mono Leg**

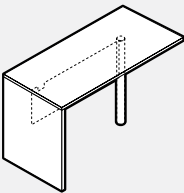
• Add \$118 to list price for chrome leg option.



PRODUCT CODE	FINISH			SIZE/INCHES				WEIGHT LBS	VOL FT <sup>3</sup>
	LP	B	W	H(LP/B)	H(W)	W	D		
L2TR2442	783	903	994	29	29.5	42	24	64	3
L2TR2448	802	937	1037	29	29.5	48	24	68	3
L2TR2454	826	973	1086	29	29.5	54	24	72	3
L2TR2460	850	1011	1131	29	29.5	60	24	76	4
L2TR2466	870	1045	1174	29	29.5	66	24	79	4
L2TR2472	893	1084	1224	29	29.5	72	24	84	4
L2TR2478	917	1118	1266	29	29.5	78	24	87	6
L2TR2484	937	1154	1315	29	29.5	84	24	91	6
L2TR3054	896	1078	1204	29	29.5	54	30	97	4
L2TR3060	925	1121	1261	29	29.5	60	30	107	7
L2TR3066	954	1166	1317	29	29.5	66	30	112	8
L2TR3072	977	1205	1369	29	29.5	72	30	127	9
L2TR3078	1004	1254	1426	29	29.5	78	30	136	9
L2TR3084	1033	1294	1481	29	29.5	84	30	146	10
L2TR3654	963	1173	1320	29	29.5	54	36	107	4
L2TR3660	996	1226	1383	29	29.5	60	36	111	7
L2TR3666	1026	1275	1448	29	29.5	66	36	116	8
L2TR3672	1057	1327	1511	29	29.5	72	36	153	9
L2TR3678	1089	1378	1575	29	29.5	78	36	165	9
L2TR3684	1119	1429	1639	29	29.5	84	36	176	10

**L2TRH • Rectangular Top with Half Modesty & Mono Leg**

• Add \$118 to list price for chrome leg option.

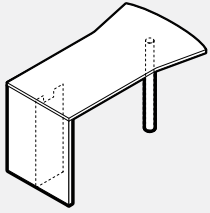


PRODUCT CODE	FINISH			SIZE/INCHES				WEIGHT LBS	VOL FT <sup>3</sup>
	LP	B	W	H(LP/B)	H(W)	W	D		
L2TRH2442	763	886	975	29	29.5	42	24	63	3
L2TRH2448	797	931	1040	29	29.5	48	24	69	3
L2TRH2454	829	976	1088	29	29.5	54	24	75	3
L2TRH2460	862	1024	1143	29	29.5	60	24	81	4
L2TRH2466	894	1067	1199	29	29.5	66	24	87	4
L2TRH2472	926	1117	1258	29	29.5	72	24	94	4
L2TRH2478	958	1160	1310	29	29.5	78	24	99	6
L2TRH2484	988	1205	1367	29	29.5	84	24	100	6
L2TRH3054	897	1078	1204	29	29.5	54	30	95	4
L2TRH3060	935	1131	1269	29	29.5	60	30	102	7
L2TRH3066	971	1186	1333	29	29.5	66	30	112	8
L2TRH3072	1006	1237	1398	29	29.5	72	30	132	9
L2TRH3078	1043	1292	1464	29	29.5	78	30	142	9
L2TRH3084	1083	1344	1530	29	29.5	84	30	145	10
L2TRH3654	963	1174	1323	29	29.5	54	36	145	4
L2TRH3660	1004	1235	1394	29	29.5	60	36	151	7
L2TRH3666	1035	1289	1458	29	29.5	66	36	154	8
L2TRH3672	1078	1348	1530	29	29.5	72	36	156	9
L2TRH3678	1118	1407	1606	29	29.5	78	36	161	9
L2TRH3684	1158	1470	1681	29	29.5	84	36	172	10



**L2TA • Axe Shaped Top with T-Base & Leg**

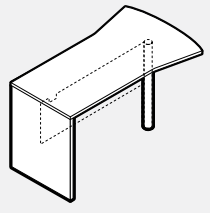
• Add \$118 to list price for chrome leg option.



PRODUCT CODE	FINISH LP	B	W	SIZE/INCHES				D	WEIGHT LBS	VOL FT <sup>3</sup>
				H (LP/B)	H (W)	W	D			
L2TA3060	1026	1290	1470	29	29.50	60	42	131	10	
L2TA3066	1063	1348	1542	29	29.50	66	42	140	11	
L2TA3072	1096	1405	1616	29	29.50	72	42	149	12	
L2TA3078	1132	1463	1688	29	29.50	78	42	157	12	
L2TA3084	1168	1520	1762	29	29.50	84	42	166	13	
L2TA3672	1174	1525	1757	29	29.50	72	48	153	13	
L2TA3678	1214	1590	1840	29	29.50	78	48	163	14	
L2TA3684	1258	1655	1922	29	29.50	84	48	173	15	

**L2TAH • Axe Shaped Top with Half Modesty & Leg**

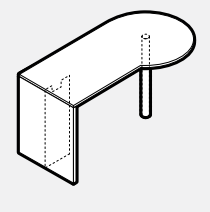
• Add \$118 to list price for chrome leg option.



PRODUCT CODE	FINISH LP	B	W	SIZE/INCHES				D	WEIGHT LBS	VOL FT <sup>3</sup>
				H (LP/B)	H (W)	W	D			
L2TAH3060	1035	1299	1481	29	29.50	60	42	127	10	
L2TAH3066	1083	1367	1563	29	29.50	66	42	135	11	
L2TAH3072	1126	1435	1646	29	29.50	72	42	144	12	
L2TAH3078	1170	1504	1730	29	29.50	78	42	153	12	
L2TAH3084	1214	1573	1812	29	29.50	84	42	162	13	
L2TAH3672	1197	1543	1777	29	29.50	72	48	149	13	
L2TAH3678	1243	1620	1869	29	29.50	78	48	158	14	
L2TAH3684	1294	1697	1960	29	29.50	84	48	168	15	

**L2TP-L • P-Shaped Top Left with T-Base & Leg**

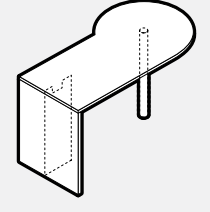
• Add \$118 to list price for chrome leg option.



PRODUCT CODE	FINISH LP	B	W	SIZE/INCHES				D	WEIGHT LBS	VOL FT <sup>3</sup>
				H (LP/B)	H (W)	W	D			
L2TP3060L	976	1205	1369	29	29.50	60	36	121	9	
L2TP3066L	1007	1260	1434	29	29.50	66	36	135	9	
L2TP3072L	1040	1306	1498	29	29.50	72	36	150	10	
L2TP3078L	1069	1360	1561	29	29.50	78	36	164	11	
L2TP3084L	1102	1411	1627	29	29.50	84	36	178	12	
L2TP3672L	1119	1429	1639	29	29.50	72	42	188	12	
L2TP3678L	1156	1485	1713	29	29.50	78	42	202	12	
L2TP3684L	1193	1547	1785	29	29.50	84	42	217	13	

**L2TP-R • P-Shaped Top Right with T-Base & Leg**

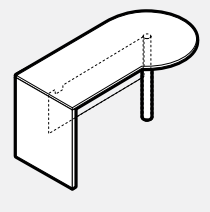
• Add \$118 to list price for chrome leg option.



PRODUCT CODE	FINISH LP	B	W	SIZE/INCHES				D	WEIGHT LBS	VOL FT <sup>3</sup>
				H (LP/B)	H (W)	W	D			
L2TP3060R	976	1205	1369	29	29.50	60	36	121	9	
L2TP3066R	1007	1260	1434	29	29.50	66	36	135	9	
L2TP3072R	1040	1306	1498	29	29.50	72	36	150	10	
L2TP3078R	1069	1360	1561	29	29.50	78	36	164	11	
L2TP3084R	1102	1411	1627	29	29.50	84	36	178	12	
L2TP3672R	1119	1429	1639	29	29.50	72	42	188	12	
L2TP3678R	1156	1485	1713	29	29.50	78	42	202	12	
L2TP3684R	1193	1547	1785	29	29.50	84	42	217	13	

**L2TPH-L • P-Shaped Top Left with Half Modesty & Leg**

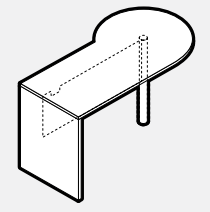
• Add \$118 to list price for chrome leg option.



PRODUCT CODE	FINISH LP	B	W	SIZE/INCHES				D	WEIGHT LBS	VOL FT <sup>3</sup>
				H (LP/B)	H (W)	W	D			
L2TPH3060L	987	1216	1378	29	29.50	60	36	117	9	
L2TPH3066L	1027	1275	1454	29	29.50	66	36	131	9	
L2TPH3072L	1067	1338	1526	29	29.50	72	36	145	10	
L2TPH3078L	1108	1398	1602	29	29.50	78	36	160	11	
L2TPH3084L	1152	1460	1675	29	29.50	84	36	174	12	
L2TPH3672L	1137	1448	1656	29	29.50	72	42	184	12	
L2TPH3678L	1181	1516	1743	29	29.50	78	42	198	12	
L2TPH3684L	1227	1585	1826	29	29.50	84	42	212	13	

**L2TPH-R • P-Shaped Top Right with Half Modesty & Leg**

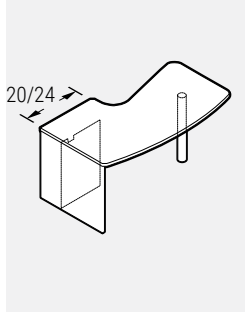
• Add \$118 to list price for chrome leg option.



PRODUCT CODE	FINISH LP	B	W	SIZE/INCHES				D	WEIGHT LBS	VOL FT <sup>3</sup>
				H (LP/B)	H (W)	W	D			
L2TPH3060R	987	1216	1378	29	29.50	60	36	117	9	
L2TPH3066R	1027	1275	1454	29	29.50	66	36	131	9	
L2TPH3072R	1067	1338	1526	29	29.50	72	36	145	10	
L2TPH3078R	1108	1398	1602	29	29.50	78	36	160	11	
L2TPH3084R	1152	1460	1675	29	29.50	84	36	174	12	
L2TPH3672R	1137	1448	1656	29	29.50	72	42	184	12	
L2TPH3678R	1181	1516	1743	29	29.50	78	42	198	12	
L2TPH3684R	1227	1585	1826	29	29.50	84	42	212	13	

**L2TH-L • Hockey Shaped Top Left with T-Base & Leg**

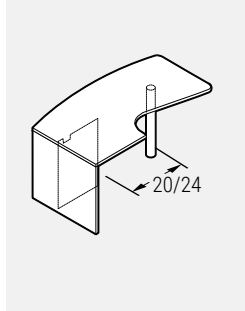
• Add \$118 to list price for chrome leg option.



PRODUCT CODE	FINISH LP	B	W	SIZE/INCHES			D	WEIGHT LBS	VOL FT <sup>3</sup>
				H(LP/B)	H(W)	W			
<b>For 20" Return Connection</b>									
L2TH203060L	1018	1255	1430	29	29.50	60	36	121	9
L2TH203066L	1051	1302	1496	29	29.50	66	36	135	9
L2TH203072L	1083	1355	1560	29	29.50	72	36	150	10
L2TH203078L	1112	1406	1627	29	29.50	78	36	164	11
L2TH203084L	1143	1460	1690	29	29.50	84	36	178	12
L2TH203660L	1089	1358	1556	29	29.50	60	42	188	10
L2TH203666L	1126	1417	1632	29	29.50	66	42	202	11
L2TH203672L	1165	1476	1706	29	29.50	72	42	217	12
L2TH203678L	1199	1539	1780	29	29.50	78	42	220	12
L2TH203684L	1234	1599	1856	29	29.50	84	42	237	13
<b>For 24" Return Connection</b>									
L2TH3060L	1018	1255	1430	29	29.50	60	36	121	9
L2TH3066L	1051	1302	1496	29	29.50	66	36	135	9
L2TH3072L	1083	1355	1560	29	29.50	72	36	150	10
L2TH3078L	1112	1406	1627	29	29.50	78	36	164	11
L2TH3084L	1143	1460	1690	29	29.50	84	36	178	12
L2TH3660L	1089	1358	1556	29	29.50	60	42	188	10
L2TH3666L	1126	1417	1632	29	29.50	66	42	202	11
L2TH3672L	1165	1476	1706	29	29.50	72	42	217	12
L2TH3678L	1199	1539	1780	29	29.50	78	42	220	12
L2TH3684L	1234	1599	1856	29	29.50	84	42	237	13

**L2TH-R • Hockey Shaped Top Right with T-Base & Leg**

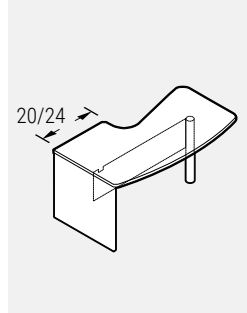
• Add \$118 to list price for chrome leg option.



PRODUCT CODE	FINISH LP	B	W	SIZE/INCHES			D	WEIGHT LBS	VOL FT <sup>3</sup>
				H(LP/B)	H(W)	W			
<b>For 20" Return Connection</b>									
L2TH203060R	1018	1255	1430	29	29.50	60	36	121	9
L2TH203066R	1051	1302	1496	29	29.50	66	36	135	9
L2TH203072R	1083	1355	1560	29	29.50	72	36	150	10
L2TH203078R	1112	1406	1627	29	29.50	78	36	164	11
L2TH203084R	1143	1460	1690	29	29.50	84	36	178	12
L2TH203660R	1089	1358	1556	29	29.50	60	42	188	10
L2TH203666R	1126	1417	1632	29	29.50	66	42	202	11
L2TH203672R	1165	1476	1706	29	29.50	72	42	217	12
L2TH203678R	1199	1539	1780	29	29.50	78	42	220	12
L2TH203684R	1234	1599	1856	29	29.50	84	42	237	13
<b>For 24" Return Connection</b>									
L2TH3060R	1018	1255	1430	29	29.50	60	36	121	9
L2TH3066R	1051	1302	1496	29	29.50	66	36	135	9
L2TH3072R	1083	1355	1560	29	29.50	72	36	150	10
L2TH3078R	1112	1406	1627	29	29.50	78	36	164	11
L2TH3084R	1143	1460	1690	29	29.50	84	36	178	12
L2TH3660R	1089	1358	1556	29	29.50	60	42	188	10
L2TH3666R	1126	1417	1632	29	29.50	66	42	202	11
L2TH3672R	1165	1476	1706	29	29.50	72	42	217	12
L2TH3678R	1199	1539	1780	29	29.50	78	42	220	12
L2TH3684R	1234	1599	1856	29	29.50	84	42	237	13

**L2THH-L • Hockey Shaped Top Left with Half Modesty & Leg**

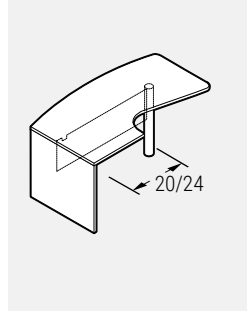
• Add \$118 to list price for chrome leg option.



PRODUCT CODE	FINISH LP	B	W	SIZE/INCHES			D	WEIGHT LBS	VOL FT <sup>3</sup>
				H(LP/B)	H(W)	W			
<b>For 20" Return Connection</b>									
L2THH203060L	1027	1262	1438	29	29.50	60	36	117	9
L2THH203066L	1067	1325	1516	29	29.50	66	36	131	9
L2THH203072L	1109	1388	1590	29	29.50	72	36	145	10
L2THH203078L	1153	1448	1668	29	29.50	78	36	160	11
L2THH203084L	1196	1511	1743	29	29.50	84	36	174	12
L2THH203660L	1090	1358	1556	29	29.50	60	42	184	10
L2THH203666L	1135	1429	1640	29	29.50	66	42	198	11
L2THH203672L	1181	1498	1724	29	29.50	72	42	212	12
L2THH203678L	1231	1568	1812	29	29.50	78	42	220	12
L2THH203684L	1272	1639	1895	29	29.50	84	42	237	13
<b>For 24" Return Connection</b>									
L2THH3060L	1027	1262	1438	29	29.50	60	36	117	9
L2THH3066L	1067	1325	1516	29	29.50	66	36	131	9
L2THH3072L	1109	1388	1590	29	29.50	72	36	145	10
L2THH3078L	1153	1448	1668	29	29.50	78	36	160	11
L2THH3084L	1196	1511	1743	29	29.50	84	36	174	12
L2THH3660L	1090	1358	1556	29	29.50	60	42	184	10
L2THH3666L	1135	1429	1640	29	29.50	66	42	198	11
L2THH3672L	1181	1498	1724	29	29.50	72	42	212	12
L2THH3678L	1231	1568	1812	29	29.50	78	42	220	12
L2THH3684L	1272	1639	1895	29	29.50	84	42	237	13

**L2THH-R • Hockey Shaped Top Right with Half Modesty & Leg**

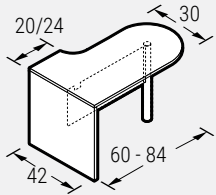
• Add \$118 to list price for chrome leg option.



PRODUCT CODE	FINISH LP	B	W	SIZE/INCHES			D	WEIGHT LBS	VOL FT <sup>3</sup>
				H(LP/B)	H(W)	W			
<b>For 20" Return Connection</b>									
L2THH203060R	1027	1262	1438	29	29.50	60	36	117	9
L2THH203066R	1067	1325	1516	29	29.50	66	36	131	9
L2THH203072R	1109	1388	1590	29	29.50	72	36	145	10
L2THH203078R	1153	1448	1668	29	29.50	78	36	160	11
L2THH203084R	1196	1511	1743	29	29.50	84	36	174	12
L2THH203660R	1090	1358	1556	29	29.50	60	42	184	10
L2THH203666R	1135	1429	1640	29	29.50	66	42	198	11
L2THH203672R	1181	1498	1724	29	29.50	72	42	212	12
L2THH203678R	1231	1568	1812	29	29.50	78	42	220	12
L2THH203684R	1272	1639	1895	29	29.50	84	42	237	13
<b>For 24" Return Connection</b>									
L2THH3060R	1027	1262	1438	29	29.50	60	36	117	9
L2THH3066R	1067	1325	1516	29	29.50	66	36	131	9
L2THH3072R	1109	1388	1590	29	29.50	72	36	145	10
L2THH3078R	1153	1448	1668	29	29.50	78	36	160	11
L2THH3084R	1196	1511	1743	29	29.50	84	36	174	12
L2THH3660R	1090	1358	1556	29	29.50	60	42	184	10
L2THH3666R	1135	1429	1640	29	29.50	66	42	198	11
L2THH3672R	1181	1498	1724	29	29.50	72	42	212	12
L2THH3678R	1231	1568	1812	29	29.50	78	42	220	12
L2THH3684R	1272	1639	1895	29	29.50	84	42	237	13

**L2TEDH-L • Extended “D” with Half Modesty & Leg**

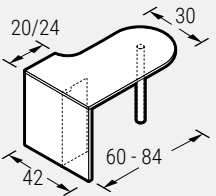
• Add \$118 to list price for chrome leg option.



PRODUCT CODE	FINISH LP	B	W	SIZE/INCHES			D	WEIGHT LBS	VOL FT <sup>3</sup>
				H(LP/B)	H(W)	W			
<b>For 20" Return Connection</b>									
L2TEDH603020L	1114	1327	1519	29	29.50	60	42	110	8
L2TEDH663020L	1160	1394	1602	29	29.50	66	42	121	9
L2TEDH723020L	1205	1461	1684	29	29.50	72	42	132	10
L2TEDH783020L	1257	1529	1766	29	29.50	78	42	143	11
L2TEDH843020L	1299	1599	1848	29	29.50	84	42	154	12
<b>For 24" Return Connection</b>									
L2TEDH603024L	1114	1327	1519	29	29.50	60	42	110	8
L2TEDH663024L	1160	1394	1602	29	29.50	66	42	121	9
L2TEDH723024L	1205	1461	1684	29	29.50	72	42	132	10
L2TEDH783024L	1257	1529	1766	29	29.50	78	42	143	11
L2TEDH843024L	1299	1599	1848	29	29.50	84	42	154	12

**L2TED-L • Extended “D” with T-Base & Leg**

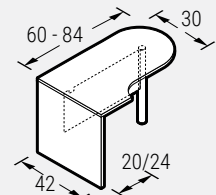
• Add \$118 to list price for chrome leg option.



PRODUCT CODE	FINISH LP	B	W	SIZE/INCHES			D	WEIGHT LBS	VOL FT <sup>3</sup>
				H(LP/B)	H(W)	W			
<b>For 20" Return Connection</b>									
L2TED603020L	1102	1301	1491	29	29.50	60	42	110	8
L2TED663020L	1139	1358	1563	29	29.50	66	42	121	9
L2TED723020L	1174	1416	1635	29	29.50	72	42	132	10
L2TED783020L	1210	1473	1708	29	29.50	78	42	143	11
L2TED843020L	1246	1529	1779	29	29.50	84	42	154	12
<b>For 24" Return Connection</b>									
L2TED603024L	1102	1301	1491	29	29.50	60	42	110	8
L2TED663024L	1139	1358	1563	29	29.50	66	42	121	9
L2TED723024L	1174	1416	1635	29	29.50	72	42	132	10
L2TED783024L	1210	1473	1708	29	29.50	78	42	143	11
L2TED843024L	1246	1529	1779	29	29.50	84	42	154	12

**L2TEDH-R • Extended “D” with Half Modesty & Leg**

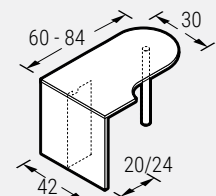
• Add \$118 to list price for chrome leg option.



PRODUCT CODE	FINISH LP	B	W	SIZE/INCHES			D	WEIGHT LBS	VOL FT <sup>3</sup>
				H(LP/B)	H(W)	W			
<b>For 20" Return Connection</b>									
L2TEDH603020R	1114	1327	1519	29	29.50	60	42	110	8
L2TEDH663020R	1160	1394	1602	29	29.50	66	42	121	9
L2TEDH723020R	1205	1461	1684	29	29.50	72	42	132	10
L2TEDH783020R	1257	1529	1766	29	29.50	78	42	143	11
L2TEDH843020R	1299	1599	1848	29	29.50	84	42	154	12
<b>For 24" Return Connection</b>									
L2TEDH603024R	1114	1327	1519	29	29.50	60	42	110	8
L2TEDH663024R	1160	1394	1602	29	29.50	66	42	121	9
L2TEDH723024R	1205	1461	1684	29	29.50	72	42	132	10
L2TEDH783024R	1257	1529	1766	29	29.50	78	42	143	11
L2TEDH843024R	1299	1599	1848	29	29.50	84	42	154	12

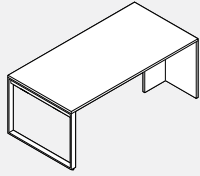
**L2TED-R • Extended “D” with T-Base & Leg**

• Add \$118 to list price for chrome leg option.



PRODUCT CODE	FINISH LP	B	W	SIZE/INCHES			D	WEIGHT LBS	VOL FT <sup>3</sup>
				H(LP/B)	H(W)	W			
<b>For 20" Return Connection</b>									
L2TED603020R	1102	1301	1491	29	29.50	60	42	110	8
L2TED663020R	1139	1358	1563	29	29.50	66	42	121	9
L2TED723020R	1174	1416	1635	29	29.50	72	42	132	10
L2TED783020R	1210	1473	1708	29	29.50	78	42	143	11
L2TED843020R	1246	1529	1779	29	29.50	84	42	154	12
<b>For 24" Return Connection</b>									
L2TED603024R	1102	1301	1491	29	29.50	60	42	110	8
L2TED663024R	1139	1358	1563	29	29.50	66	42	121	9
L2TED723024R	1174	1416	1635	29	29.50	72	42	132	10
L2TED783024R	1210	1473	1708	29	29.50	78	42	143	11
L2TED843024R	1246	1529	1779	29	29.50	84	42	154	12

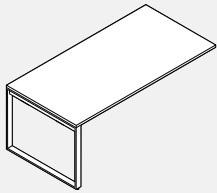
**L2TROL • Licence 2 Top with “O” Leg and T base**



- Includes worksurface, loop leg and laminate T base.
- BG5 grommet please specify TC only.
- Loop leg is painted please specify standard paint colour.

PRODUCT CODE	FINISH		SIZE / INCHES						WEIGHT		VOL FT³
	LP	B	W	H (LP/B)	H (W)	D	W	LBS			
L2TROL2442	916	982	1072	29	29.5	24	42	138	5		
L2TROL2448	955	1035	1119	29	29.5	24	48	153	5		
L2TROL2454	998	1089	1166	29	29.5	24	54	168	6		
L2TROL2460	1033	1135	1211	29	29.5	24	60	183	6		
L2TROL2466	1046	1155	1258	29	29.5	24	66	198	6		
L2TROL2472	1062	1174	1304	29	29.5	24	72	213	7		
L2TROL2478	1088	1204	1346	29	29.5	24	78	228	7		
L2TROL2484	1118	1241	1392	29	29.5	24	84	243	7		
L2TROL3042	1072	1158	1236	29	29.5	30	42	168	7		
L2TROL3048	1088	1177	1246	29	29.5	30	48	187	7		
L2TROL3054	1113	1203	1346	29	29.5	30	54	206	8		
L2TROL3060	1135	1243	1404	29	29.5	30	60	225	8		
L2TROL3066	1147	1262	1460	29	29.5	30	66	243	8		
L2TROL3072	1170	1289	1514	29	29.5	30	72	262	9		
L2TROL3078	1194	1315	1568	29	29.5	30	78	281	9		
L2TROL3084	1237	1371	1626	29	29.5	30	84	300	10		
L2TROL3642	1177	1260	1392	29	29.5	36	42	200	7		
L2TROL3648	1222	1312	1461	29	29.5	36	48	222	8		
L2TROL3654	1262	1367	1529	29	29.5	36	54	245	8		
L2TROL3660	1306	1419	1601	29	29.5	36	60	267	9		
L2TROL3666	1349	1474	1669	29	29.5	36	66	290	9		
L2TROL3672	1392	1526	1738	29	29.5	36	72	312	10		
L2TROL3678	1434	1579	1806	29	29.5	36	78	335	10		
L2TROL3684	1476	1634	1876	29	29.5	36	84	357	11		

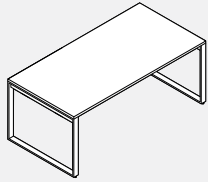
**L2TCROL • Licence 2 Return with “O” Leg**



- Includes worksurface, loop leg and connecting brackets and connecting flat brackets
- HAT channel is standard on all tops except 42 and 48 wide
- BG5 grommet please specify TL,TC,TR
- Loop leg is painted please specify standard paint colour
- Worksurface supporting pedestals and laterals will not fit due to the metal channel under the surface.

PRODUCT CODE	FINISH		SIZE / INCHES						WEIGHT		VOL FT³
	LP	B	W	H (LP/B)	H (W)	D	W	LBS			
L2TCROL2442	682	748	840	29	29.5	24	42	110	4		
L2TCROL2448	722	802	886	29	29.5	24	48	125	5		
L2TCROL2454	828	919	996	29	29.5	24	54	140	5		
L2TCROL2460	870	975	1052	29	29.5	24	60	155	5		
L2TCROL2466	894	1001	1103	29	29.5	24	66	170	6		
L2TCROL2472	918	1030	1160	29	29.5	24	72	185	6		
L2TCROL2478	952	1068	1211	29	29.5	24	78	200	6		
L2TCROL2484	988	1114	1264	29	29.5	24	84	215	7		
L2TCROL3042	814	898	977	29	29.5	30	42	137	6		
L2TCROL3048	828	919	988	29	29.5	30	48	156	6		
L2TCROL3054	918	1007	1153	29	29.5	30	54	175	7		
L2TCROL3060	950	1057	1216	29	29.5	30	60	194	7		
L2TCROL3066	970	1086	1280	29	29.5	30	66	212	8		
L2TCROL3072	1000	1119	1344	29	29.5	30	72	231	8		
L2TCROL3078	1033	1155	1407	29	29.5	30	78	250	8		
L2TCROL3084	1086	1218	1471	29	29.5	30	84	269	9		
L2TCROL3642	919	1000	1132	29	29.5	36	42	164	7		
L2TCROL3648	962	1055	1201	29	29.5	36	48	186	7		
L2TCROL3654	1066	1170	1333	29	29.5	36	54	209	8		
L2TCROL3660	1121	1234	1412	29	29.5	36	60	231	8		
L2TCROL3666	1171	1298	1491	29	29.5	36	66	254	9		
L2TCROL3672	1223	1357	1568	29	29.5	36	72	276	9		
L2TCROL3678	1272	1417	1645	29	29.5	36	78	299	10		
L2TCROL3684	1325	1481	1721	29	29.5	36	84	321	10		

**L2TDOL • Licence 2 Top with Two “O” Legs**



- Includes worksurface, 2 loop legs
- HAT channel is standard on all tops except 42 and 48 wide
- BG5 grommet please specify TL,TC,TR
- Loop leg is painted please specify standard paint colour
- Worksurface supporting pedestals and laterals will not fit due to the metal channel under the surface.

PRODUCT CODE	FINISH			SIZE / INCHES				WEIGHT		VOL FT <sup>3</sup>
	LP	B	W	H (LP/B)	H (W)	D	W	LBS		
L2TDOL2442	1087	1153	1243	29	29.5	24	42	115	6	
L2TDOL2448	1126	1205	1290	29	29.5	24	48	130	7	
L2TDOL2454	1233	1324	1398	29	29.5	24	54	145	7	
L2TDOL2460	1275	1378	1456	29	29.5	24	60	160	7	
L2TDOL2466	1299	1406	1508	29	29.5	24	66	175	8	
L2TDOL2472	1323	1435	1566	29	29.5	24	72	190	8	
L2TDOL2478	1355	1473	1615	29	29.5	24	78	205	8	
L2TDOL2484	1394	1517	1668	29	29.5	24	84	220	9	
L2TDOL3042	1280	1368	1443	29	29.5	30	42	143	9	
L2TDOL3048	1296	1385	1457	29	29.5	30	48	162	9	
L2TDOL3054	1383	1474	1617	29	29.5	30	54	181	10	
L2TDOL3060	1415	1524	1683	29	29.5	30	60	200	10	
L2TDOL3066	1436	1550	1747	29	29.5	30	66	218	11	
L2TDOL3072	1469	1585	1811	29	29.5	30	72	237	11	
L2TDOL3078	1499	1620	1874	29	29.5	30	78	256	11	
L2TDOL3084	1550	1684	1936	29	29.5	30	84	275	12	
L2TDOL3642	1434	1515	1646	29	29.5	36	42	170	10	
L2TDOL3648	1475	1568	1717	29	29.5	36	48	192	10	
L2TDOL3654	1581	1684	1848	29	29.5	36	54	215	11	
L2TDOL3660	1634	1747	1927	29	29.5	36	60	237	11	
L2TDOL3666	1686	1811	2005	29	29.5	36	66	260	12	
L2TDOL3672	1736	1870	2083	29	29.5	36	72	282	12	
L2TDOL3678	1786	1933	2159	29	29.5	36	78	305	13	
L2TDOL3684	1839	1994	2235	29	29.5	36	84	327	13	



**Technical Information**

- All units must be connected to an adjoining unit with flat brackets included.
- Grommet option for Runoff tables are "TC" only.
- NOTE: All Runoff tables includes HAT CHANNEL support.

**OPTIONS:**

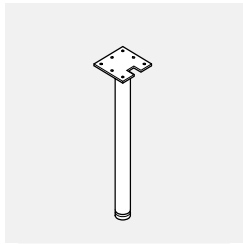
Top: LP - LPL (Low Pressure Laminate) Thickness 1"  
 HP B - B Thickness 1 1/16"  
 HP W - W Thickness 1 7/16"

Leg Option: BHML03 (DEFAULT) Round Monoleg  
 LLSQ3X3H28 - Square Leg

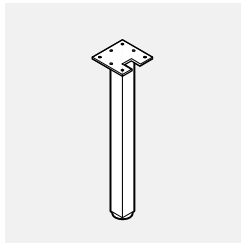
Top Finish Laminate: Choose Colour

Top PVC Edging: Choose Colour

Metal Leg Finish: Choose Colour

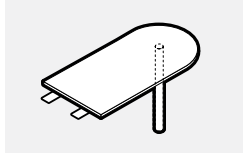


BHML03



LLSQ3X3H28

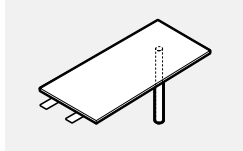
**L2TCD • "D" Shaped Runoff with Leg**



• Add \$118 to list price for chrome leg option.

PRODUCT CODE	FINISH			SIZE / INCHES				WEIGHT LBS	VOL FT <sup>3</sup>
	LP	B	W	H (LP/B)	H (W)	W	D		
L2TCD3060	734	922	975	29	29.5	60	30	97	4
L2TCD3066	780	985	1052	29	29.5	66	30	106	6
L2TCD3660	800	1022	1101	29	29.5	60	36	97	4
L2TCD3666	835	1078	1167	29	29.5	66	36	106	6

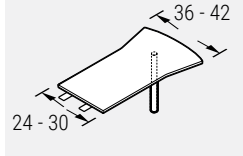
**L2TCR1L • Rectangular Shaped Runoff**



• Add \$118 to list price for chrome leg option.

PRODUCT CODE	FINISH			SIZE / INCHES				WEIGHT LBS	VOL FT <sup>3</sup>
	LP	B	W	H (LP/B)	H (W)	W	D		
L2TCR1L3060	711	888	947	29	29.5	60	30	97	4
L2TCR1L3066	740	935	998	29	29.5	66	30	106	6
L2TCR1L3660	758	970	1043	29	29.5	60	36	97	4
L2TCR1L3666	792	1023	1106	29	29.5	66	36	106	6

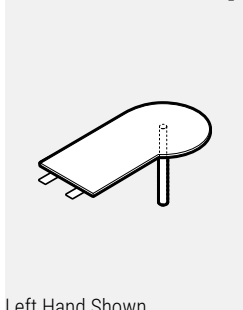
**L2TCA1L • Axe Shaped Runoff**



• Add \$118 to list price for chrome leg option.

PRODUCT CODE	FINISH			SIZE / INCHES				WEIGHT LBS	VOL FT <sup>3</sup>
	LP	B	W	H (LP/B)	H (W)	W	D		
L2TCA1L2460	761	972	1053	29	29.5	60	36	119	4
L2TCA1L2466	796	1026	1113	29	29.5	66	36	130	6
L2TCA1L3060	809	1051	1147	29	29.5	60	42	119	4
L2TCA1L3066	849	1109	1216	29	29.5	66	42	130	6

**L2TCP • "P" Shaped Runoff with Leg**

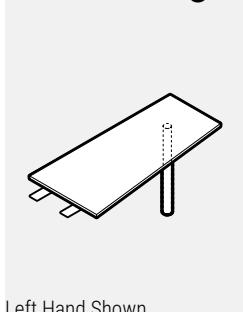


• Add \$118 to list price for chrome leg option.

PRODUCT CODE	FINISH			SIZE / INCHES				WEIGHT LBS	VOL FT <sup>3</sup>
	LP	B	W	H (LP/B)	H (W)	W	D		
<b>Right</b>									
L2TCP3060R	797	1018	1101	29	29.5	60	36	119	4
L2TCP3066R	833	1074	1167	29	29.5	66	36	130	6
L2TCP3660R	851	1103	1204	29	29.5	60	42	119	4
L2TCP3666R	892	1168	1276	29	29.5	66	42	130	6
<b>Left</b>									
L2TCP3060L	797	1018	1101	29	29.5	60	36	119	4
L2TCP3066L	833	1074	1167	29	29.5	66	36	130	6
L2TCP3660L	851	1103	1204	29	29.5	60	42	119	4
L2TCP3666L	892	1168	1276	29	29.5	66	42	130	6

Left Hand Shown

**L2TCW • Wedge Shaped Runoff with Leg**



• Add \$118 to list price for chrome leg option.

PRODUCT CODE	FINISH			SIZE / INCHES				WEIGHT LBS	VOL FT <sup>3</sup>
	LP	B	W	H (LP/B)	H (W)	W	D		
<b>Right</b>									
L2TCW3060R	755	942	1011	29	29.5	60	30	119	4
L2TCW3066R	788	994	1065	29	29.5	66	30	130	6
L2TCW3660R	809	1029	1117	29	29.5	60	36	119	4
L2TCW3666R	845	1087	1177	29	29.5	66	36	130	6
<b>Left</b>									
L2TCW3060L	755	942	1011	29	29.5	60	30	119	4
L2TCW3066L	788	994	1065	29	29.5	66	30	130	6
L2TCW3660L	809	1029	1117	29	29.5	60	36	119	4
L2TCW3666L	845	1087	1177	29	29.5	66	36	130	6

Left Hand Shown

**Floating Tops**

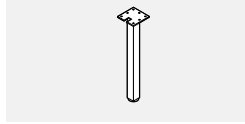
- Monolegs and Support channel ships in a separate box.
- Floating tops are not pre-drilled to accept monolegs or spacers.
- Grommet locations (TC only) must be specified at the time of order or it will default to "No Grommet" option.
- Floating top must be placed on top of 1H credenza or 1H lateral open.
- Grommet Option **TC** only
- All Floating tables include HAT CHANNEL support.

**LLSQ3X3 • "Spacer" Leg**



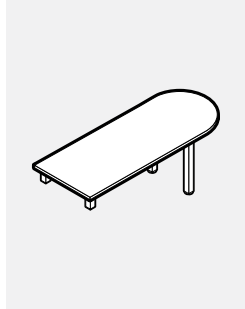
PRODUCT CODE	PRICE	CHROME OPT	SIZE/INCHES			WEIGHT LBS	VOL FT <sup>3</sup>
			H	W	D		
LLSQ3X3	149	253	8	3	3	4	0.09

**LLSQ3X3H28 • Square Leg**



PRODUCT CODE	PRICE	CHROME OPT	SIZE/INCHES			WEIGHT LBS	VOL FT <sup>3</sup>
			H	W	D		
LLSQ3X3H28	281	372	28	3	3	4	0.17

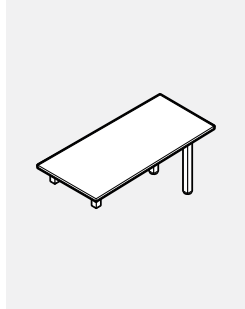
**L2FD • Floating "D" Shaped with Legs and Spacers**



- Add \$469 to list price for chrome leg option.

PRODUCT CODE	FINISH LP	B	W	SIZE/INCHES				WEIGHT LBS	VOL FT <sup>3</sup>
				H (LP/B)	H (W)	W	D		
L2FD3060	969	1167	1186	29	29.5	60	30	53	7
L2FD3066	1000	1214	1237	29	29.5	66	30	57	7
L2FD3072	1033	1264	1292	29	29.5	72	30	62	8
L2FD3078	1067	1320	1344	29	29.5	78	30	64	8
L2FD3084	1114	1381	1396	29	29.5	84	30	68	9
L2FD3660	1017	1272	1368	29	29.5	60	36	57	8
L2FD3666	1053	1330	1435	29	29.5	66	36	63	8
L2FD3672	1089	1391	1499	29	29.5	72	36	68	9
L2FD3678	1131	1454	1566	29	29.5	78	36	70	9
L2FD3684	1177	1524	1633	29	29.5	84	36	75	10

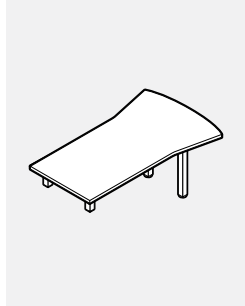
**L2FR • Floating Rectangular Shaped with Legs and Spacers**



- Add \$469 to list price for chrome leg option.

PRODUCT CODE	FINISH LP	B	W	SIZE/INCHES				WEIGHT LBS	VOL FT <sup>3</sup>
				H (LP/B)	H (W)	W	D		
L2FR2460	917	1083	1108	29	29.5	60	24	51	6
L2FR2466	943	1125	1154	29	29.5	66	24	55	6
L2FR2472	973	1167	1199	29	29.5	72	24	59	7
L2FR2478	1004	1210	1241	29	29.5	78	24	62	7
L2FR2484	1045	1265	1290	29	29.5	84	24	66	8
L2FR3060	963	1165	1208	29	29.5	60	30	53	7
L2FR3066	998	1210	1262	29	29.5	66	30	57	7
L2FR3072	1030	1262	1318	29	29.5	72	30	62	8
L2FR3078	1066	1317	1369	29	29.5	78	30	64	8
L2FR3084	1109	1375	1424	29	29.5	84	30	68	9
L2FR3660	1012	1241	1336	29	29.5	60	36	57	8
L2FR3666	1051	1300	1398	29	29.5	66	36	63	8
L2FR3672	1088	1358	1464	29	29.5	72	36	68	9
L2FR3678	1128	1417	1529	29	29.5	78	36	70	9
L2FR3684	1175	1487	1594	29	29.5	84	36	75	10

**L2FA • Floating Axe Shaped with Legs and Spacers**

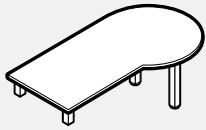


- Add \$469 to list price for chrome leg option.

PRODUCT CODE	FINISH LP	B	W	SIZE/INCHES				WEIGHT LBS	VOL FT <sup>3</sup>
				H (LP/B)	H (W)	W	D		
L2FA3060	1067	1332	1419	29	29.5	60	42	77	8
L2FA3066	1109	1397	1491	29	29.5	66	42	81	8
L2FA3072	1153	1463	1564	29	29.5	72	42	84	9
L2FA3078	1198	1530	1635	29	29.5	78	42	88	9
L2FA3084	1254	1607	1708	29	29.5	84	42	95	10
L2FA3660	1139	1436	1552	29	29.5	60	48	83	9
L2FA3666	1182	1508	1634	29	29.5	66	48	88	9
L2FA3672	1232	1581	1717	29	29.5	72	48	90	10
L2FA3678	1276	1656	1798	29	29.5	78	48	95	11
L2FA3684	1336	1741	1876	29	29.5	84	48	101	11

**L2FP • Floating “P” Shaped with Legs and Spacers**

• Add \$469 to list price for chrome leg option.

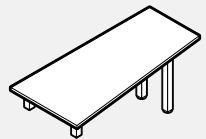


Left Hand Shown

PRODUCT CODE	FINISH		SIZE/INCHES						WEIGHT LBS	VOL FT <sup>3</sup>
	LP	B	W	H (LP/B)	H (W)	W	D			
<b>Right</b>										
L2FP3060R	1034	1265	1340	29	29.5	60	36	66	8	
L2FP3066R	1069	1325	1405	29	29.5	66	36	70	8	
L2FP3072R	1108	1381	1469	29	29.5	72	36	75	9	
L2FP3078R	1148	1441	1529	29	29.5	78	36	77	9	
L2FP3084R	1198	1511	1592	29	29.5	84	36	81	10	
L2FP3660R	1087	1351	1443	29	29.5	60	42	70	9	
L2FP3666R	1126	1415	1516	29	29.5	66	42	76	9	
L2FP3672R	1168	1481	1588	29	29.5	72	42	81	10	
L2FP3678R	1212	1548	1660	29	29.5	78	42	84	11	
L2FP3684R	1265	1626	1735	29	29.5	84	42	88	11	
<b>Left</b>										
L2FP3060L	1034	1265	1340	29	29.5	60	36	66	8	
L2FP3066L	1069	1325	1405	29	29.5	66	36	70	8	
L2FP3072L	1108	1381	1469	29	29.5	72	36	75	9	
L2FP3078L	1148	1441	1529	29	29.5	78	36	77	9	
L2FP3084L	1198	1511	1592	29	29.5	84	36	81	10	
L2FP3660L	1087	1351	1443	29	29.5	60	42	70	9	
L2FP3666L	1126	1415	1516	29	29.5	66	42	76	9	
L2FP3672L	1168	1481	1588	29	29.5	72	42	81	10	
L2FP3678L	1212	1548	1660	29	29.5	78	42	84	11	
L2FP3684L	1265	1626	1735	29	29.5	84	42	88	11	

**L2FW • Floating Wedge Shaped with Legs and Spacers**

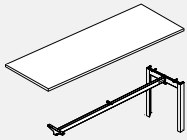
• Add \$469 to list price for chrome leg option.



Left Hand Shown

PRODUCT CODE	FINISH		SIZE/INCHES						WEIGHT LBS	VOL FT <sup>3</sup>
	LP	B	W	H (LP/B)	H (W)	W	D			
<b>Right</b>										
L2FW3060R	969	1167	1210	29	29.5	60	30	53	7	
L2FW3066R	1000	1214	1266	29	29.5	66	30	57	7	
L2FW3072R	1033	1264	1323	29	29.5	72	30	62	8	
L2FW3078R	1067	1320	1374	29	29.5	78	30	64	8	
L2FW3084R	1114	1381	1429	29	29.5	84	30	68	9	
L2FW3660R	1012	1241	1306	29	29.5	60	36	57	8	
L2FW3666R	1051	1300	1369	29	29.5	66	36	63	8	
L2FW3672R	1088	1358	1434	29	29.5	72	36	68	9	
L2FW3678R	1128	1417	1497	29	29.5	78	36	70	9	
L2FW3684R	1175	1487	1560	29	29.5	84	36	75	10	
<b>Left</b>										
L2FW3060L	969	1167	1210	29	29.5	60	30	53	7	
L2FW3066L	1000	1214	1266	29	29.5	66	30	57	7	
L2FW3072L	1033	1264	1323	29	29.5	72	30	62	8	
L2FW3078L	1067	1320	1374	29	29.5	78	30	64	8	
L2FW3084L	1114	1381	1429	29	29.5	84	30	68	9	
L2FW3660L	1012	1241	1306	29	29.5	60	36	57	8	
L2FW3666L	1051	1300	1369	29	29.5	66	36	63	8	
L2FW3672L	1088	1358	1434	29	29.5	72	36	68	9	
L2FW3678L	1128	1417	1497	29	29.5	78	36	70	9	
L2FW3684L	1175	1487	1560	29	29.5	84	36	75	10	

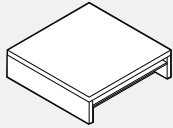
**L2FBR • Floating top Rectangular with Legs / SPACERS SOLD SEPARATELY**



- Anodized aluminum leg upcharge \$55.
- Due to beam location, grommet is only available as a special request, please contact your customer service representative.
- Worksurface supporting pedestals and laterals will not fit due to the metal channel under the surface.

PRODUCT CODE	FINISH LP	B	W	SIZE/INCHES			D	WEIGHT LBS	VOL FT <sup>3</sup>
				H (LP/B)	H (W)	W			
L2FBR2466	853	982	1084	1	1.44	66	24	51	6
L2FBR2472	880	1017	1128	1	1.44	72	24	55	6
L2FBR2478	915	1063	1181	1	1.44	78	24	59	7
L2FBR2484	954	1113	1239	1	1.44	84	24	62	7
L2FBR3066	922	1080	1201	1	1.44	66	30	53	8
L2FBR3072	952	1125	1257	1	1.44	72	30	57	8
L2FBR3078	992	1175	1318	1	1.44	78	30	62	9
L2FBR3084	1034	1235	1385	1	1.44	84	30	64	9

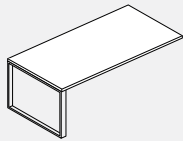
**L2SPBOX • Laminate Spacers with Glass Shelf**



- Glazing is clear.

PRODUCT CODE	PRICE LP	SIZE/INCHES			WEIGHT LBS	VOL FT <sup>3</sup>
		H	W	D		
L2SPBOX1620	563	8	16	20	15	1
L2SPBOX1626	630	8	16	26	18	2
L2SPBOX1634	717	8	16	34	22	5

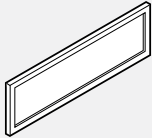
**L2FFL • Licence Floating Tops with "O" Leg**



- Kit includes a worksurface, "O" leg and channel.
- Option for grommet - BG5, TC only.
- Painted loop leg, please specify standard paint colour.
- Worksurface supporting pedestals and laterals will not fit due to the metal channel under the surface.

PRODUCT CODE	FINISH LP	B	W	SIZE/INCHES			D	WEIGHT LBS	VOL FT <sup>3</sup>
				H (LP/B)	H (W)	W			
L2FFL2466	829	937	1039	1	1.44	66	24	55	6
L2FFL2472	851	963	1094	1	1.44	72	24	59	7
L2FFL2478	883	999	1137	1	1.44	78	24	62	7
L2FFL2484	919	1043	1193	1	1.44	84	24	66	8
L2FFL3066	905	1021	1216	1	1.44	66	30	57	7
L2FFL3072	933	1052	1276	1	1.44	72	30	62	8
L2FFL3078	962	1086	1338	1	1.44	78	30	64	8
L2FFL3084	1015	1147	1401	1	1.44	84	30	68	9
L2FFL3666	1107	1233	1428	1	1.44	66	36	63	8
L2FFL3672	1155	1290	1499	1	1.44	72	36	68	9
L2FFL3678	1201	1348	1575	1	1.44	78	36	70	9
L2FFL3684	1255	1409	1652	1	1.44	84	36	75	10

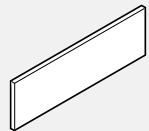
**L2HGAMP • Hanging Aluminum Framed Frosted Glazing Modesty**



- Framed is anodize aluminum.
- Glazing is frosted acrylic.
- Hanging brackets are included.

PRODUCT CODE	PRICE LP	SIZE/INCHES			WEIGHT LBS	VOL FT <sup>3</sup>
		H	W	D		
L2HGAMP36	505	14	35.50	0.75	12	1
L2HGAMP42	542	14	41.50	0.75	13	1
L2HGAMP48	579	14	47.50	0.75	14	1
L2HGAMP54	619	14	53.50	0.75	16	1

**L2HGMP • Hanging Laminate Modesty**



- Hanging brackets are included.

PRODUCT CODE	PRICE LP	SIZE/INCHES			WEIGHT LBS	VOL FT <sup>3</sup>
		H	W	D		
L2HGMP36	295	14	36	0.75	9	1
L2HGMP42	303	14	42	0.75	11	1
L2HGMP48	314	14	48	0.75	13	1
L2HGMP54	320	14	54	0.75	14	1

## General Notes

### Pedestals

**Pedestals are shipped assembled.**

- Pedestals are offered in three types of applications: Worksurface Supporting, Freestanding, and Mobile.
- Pedestal front width is 15-1/2" with a deep size variation 18" 23" 24" 29" 30" 36"
- If specifying a pedestal for a desk or credenza, please ensure you specify next depth lower ie. 23" deep pedestal for a 24" deep credenza or desk.
- Worksurface supporting Pedestals are 28"high
- Freestanding pedestals come with the choice of "LP", "B" for 29"high or "W" thickness top for 29.5"high
- Pedestals Freestanding are on adjustable levelers
- Mobile pedestals come with a top with the choice of "LP", "B" for 29"high or "W" thickness top for 29.5"high and have front locking casters to support the pedestal.
- Pencil tray included in the top box drawer of each pedestal.
- Box drawers mounted on full extension ball bearing slides
- File drawers mounted on full extension ball bearing slides
- All file drawers come with adjustable rails for legal or letter size hanging folders. See File Drawer Capacity chart page G2.
- Pull out shelf for CPU and printer units can support 75 lbs. per shelf and has telescopic extension.
- CPU and printer units have ventilation grommet on back panel.
- Interior clearance of printer shelf is 11".
- Printer pedestals have 2 pull out shelves and the back panel has four round grommets.
- CPU pedestals have 1 pull out shelf and the back panel has two round grommets.
- Both CPU and printer units must be installed under a worksurface to prevent tipping.
- All pedestals with a door, include 1 adjustable shelf.
- Cases and fronts are finished in low pressure laminate.
- Specify thickness of the top to match the thickness of the worksurface.
- Locks are standard on all units. Available in black or silver finish. The lock will match the handle finish.

### Hutches and Overheads

**Hutches and overheads are shipped assembled.**

- Hutches and overheads are offered in "LP" and "W" thickness with three option heights . See Storage Technical Info page G3.
- Specify thickness of hutch or overhead top to match the thickness of the worksurface.
- Cases and fronts are finished in low pressure laminate.
- Hutches and overheads with hinged doors (laminate or aluminum), flip up fronts have no handle option.
- Hutches with pigeon holes come with touch latch mechanism.
- Hutches and overheads with sliding laminate doors have standard handle options
- Hutches and overheads with sliding glass doors are offered with recessed handle only. The recessed handle is in chrome finish
- Hutches and wall mounted overheads are offered in 4 styles: Open storage, Hinged doors - laminate or anodized aluminum frame doors with the option for glazing : frosted or clear, sliding doors are laminate or glass doors and flip-up doors.
- Once installed, the bottom of the flip-up door overhead will not line up with the bottom of the open or hinged door overhead.
- Wall mounted storage cabinets must be securely attached to wall studs.
- Panel mounted overheads include attachment brackets for Boulevard panels.
- Back panels on hutches comes with a center round grommet for wire access.
- Top on hutch and overhead storage cabinets with flip-up doors is 3/4" thick Low Pressure Laminate. Doors slides on top of the unit.
- Inside dimension for hutches and wall mounted units with flip-up doors is 13 1/4" high x 14 1/2" deep
- Inside dimension for hutches and wall mounted with hinged doors is 12 3/4" high x 15 1/4" deep
- Inside dimension for open hutches and wall mounted is 12 3/4" high x 15 1/4" deep
- Inside dimension for hutches and wall mounted with sliding doors is 12-3/4"high x 13" deep
- Use double sided tape to attach hutches to worksurface.
- Locks are standard on all units. Available in black or silver finish. The lock will match the handle finish.
- Recommended to be installed against and fixed to a wall using appropriate hardware (not included).

### Credenzas

**Credenzas are shipped assembled.**

- Credenza model # L2CR2H2H or L2CR1H1H must be ordered with counterweights to avoid tipping.
- Credenza come with the choice of "LP", "B" or "W" thickness top
- Credenzas are offered with the choice of "LP", "B" for 20"h. or 29"high and "W" thickness top for 20.5"h or 29.5"high
- Credenza come with hinged doors, laminate or anodized aluminum frame doors with the option for glazing : frosted or clear
- Locks are standard on all units. Available in black or silver finish. The lock will match the handle finish.

### Bookcases

**Bookcases are Shipped knocked down (KD).**

- Available in 30" or 36" widths and 12.685" and 16.685"depths dimension at baseboard with range in height from 29" to 72" with 12" clearance between shelves.
- Bottom shelf is fixed and all other shelves are adjustable.
- Specify thickness of the top to match the thickness and profile of the worksurface.
- Tops are offered "LP" or "B" or "W".
- Up to 42"h, Bookcases are offered in "LP", "B", "W".
- 54"h. and up are offered in "LP" and "W".
- Recommended to be installed against and fixed to a wall using appropriate hardware (not included).

### Laterals

**Laterals are shipped assembled.**

- Laterals are available in three widths, 30" 36", 42" with a height variation of 28" to 54" and a depth of 20" and 24".
- Tops are offered LP, B or W
- Worksurface supporting units do not come with a top.
- Up to 42"h, laterals are offered in "LP", "B", "W".
- 54"h and up are offered in "LP" and "W".
- Cases and fronts are finished in low pressure laminate.
- Laterals with hinged doors, laminate or anodized aluminum frame doors with the option for glazing: frosted or clear
- Lateral files are offered in 2 types of applications: Worksurface Supporting and Freestanding.
- All lateral files feature a drawer interlocking mechanism
- Up to 42"h, Laterals are offered in "LP", "B", "W".
- 54"h, and up are offered in "LP" and "W".
- All file drawer come with adjustable rails for legal or letter size hanging folders.
- Counterweights must be specified in a lateral configurations except worksurface supporting.
- "C" combo lateral have a pencil drawer included in the box drawer. The penciltray is parallel with the depth of the drawer.
- In "C" combo lateral, only one side can be locked.
- All laterals with a door, include 1 adjustable shelf.
- File drawers mounted on full extension ball bearing slides
- Locks are standard on all units. Available in black or silver finish. The lock will match the handle finish.

### Towers and cabinets

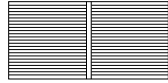
**Towers and cabinets are shipped assembled.**

- Towers offered 24"w and cabinets 30"w and 36"w are offered in "LP" and "W".
- Cases are finished in low pressure laminate.
- Towers or cabinets are offered with hinged doors, laminate or anodized aluminum frame with the option for glazing: frosted or clear
- Towers or cabinets with anodized aluminum doors are offered without handles. Touch latch mechanism is included.
- Storage tower with the cupboard above FF or BBF and wardrobe will lock only the wardrobe and drawers.
- Storage tower with the wardrobe include a coat rod.
- Locks are standard on all units. Available in black or silver finish. The lock will match the handle finish.
- Counterweights must be specified for units 20" deep by 60" to 72" high with 2H2D or 2H/ Open, please order 2 x LACWB for each unit.

**LATERAL FILE DRAWERS**

**Lateral File Drawer:**

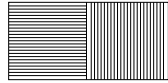
36W & 42W  
Legal Filing - front to back



- Drawer file with plastic rail
- 30"W Size 9.44"H x 25.75"W x 16"L
- 36"W Size 9.44"H x 31.75"W x 16"L
- 42"W Size 9.44"H x 37.75"W x 16"L

**Lateral File Drawer:**

36W & 42W  
Legal Filing - side to side  
Letter Filing - front to back



**Lateral File Drawer:**

30W, 36W & 42W  
Letter Filing - front to back



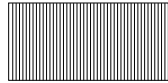
**Lateral File Drawer:**

36W & 42W  
Letter & Legal Filing - front to back



**Lateral File Drawer:**

30W, 36W & 42W  
Legal Filing - side to side



**PEDESTAL DRAWERS**

**Box Drawer:**

15.5W  
Legal Filing - side to side



- 18"D Drawer Box Size 3.93"H x 13"W x 16"L
- 20.23.24.29.30.36"D Drawer Box Size 3.93"H x 13"W x 20"L

**File Drawer:**

15.5W  
Letter Filing - front to back



- 18"D Drawer File with plastic rail Size 9.4"H x 13"W x 16"L
- 20"D and up Drawer File with plastic rail Size 9.4"H x 13"W x 20"L

**File Drawer:**

15.5W  
Legal Filing - side to side



- 18"D Drawer File with plastic rail Size 9.4"H x 13"W x 16"L
- 20"D and up Drawer File with plastic rail Size 9.4"H x 13"W x 20"L

**COMBO LATERAL FILE DRAWERS**

- For 30" wide units: Drawer width is 11 3/4" and can accommodate only side to side legal or letter filing.
- For 36" wide units: Drawer width is 14 3/4" and can accommodate only side to side legal or letter filing.



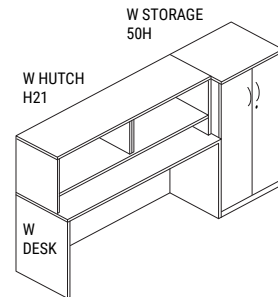
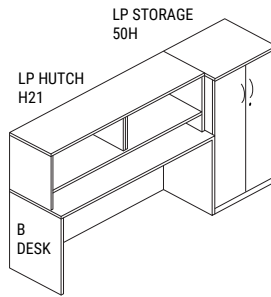
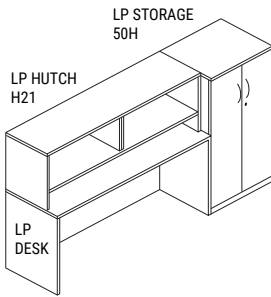
STORAGE TECHNICAL INFORMATION

1" LPL TOP  
LP HUTCH  
LP DESK 29H  
LP CABINET

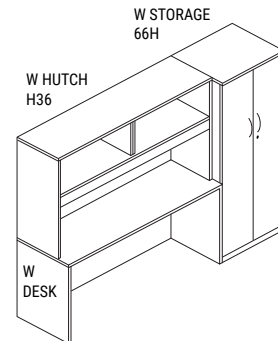
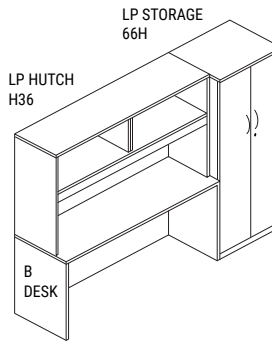
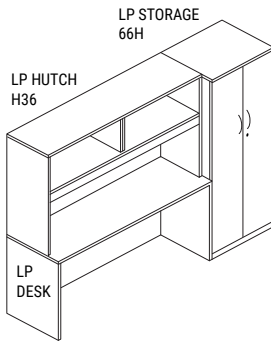
1-1/16" HPL TOP  
LP HUTCH  
B TOP DESK 29H  
LP CABINET

1-7/16" HPL TOP  
W TOP HUTCH  
W TOP DESK 29.5H  
W CABINET

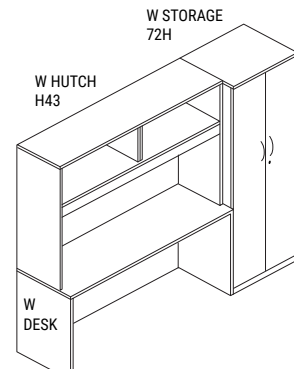
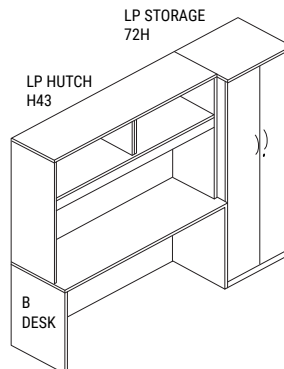
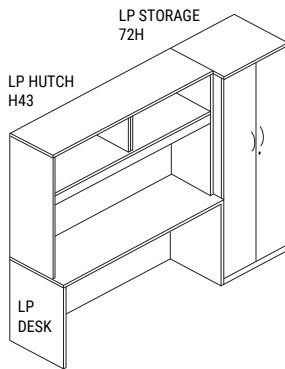
NO TACKBOARD  
LTB  
50" High



TACKBOARD  
LTB21  
66" High

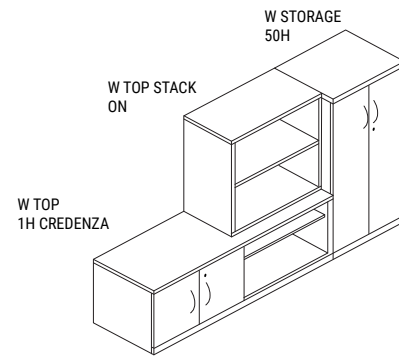
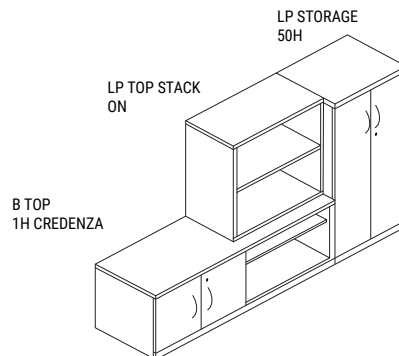
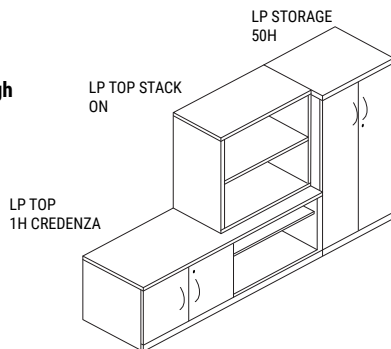


TACKBOARD  
LTB27  
72" High

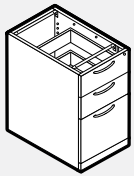


STACK ON TWO HEIGHT CABINET IS TO BE PLACED ON 1H CRENZENZA

50" High  
Only



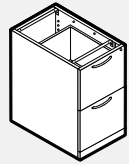
**L2PBBF • Worksurface Supporting Box, Box, File Pedestal**



- One lock included.
- Optional e-lock available in the vertical position. Please specify V - Vertical and add \$231 list.
- Counter weight must be ordered separately.

PRODUCT CODE	PRICE LP	SIZE/INCHES			WEIGHT LBS	VOL FT <sup>3</sup>
		H	W	D		
L2PBBF18	821	28	15.5	18	94	8
L2PBBF20	895	28	15.5	20	94	8
L2PBBF23	909	28	15.5	23	94	8
L2PBBF24	909	28	15.5	24	99	10
L2PBBF29	943	28	15.5	29	105	10
L2PBBF30	943	28	15.5	30	110	10
L2PBBF36	991	28	15.5	36	116	11

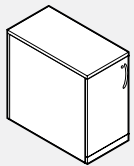
**L2PFF • Worksurface Supporting File, File Pedestal**



- One lock included.
- Optional e-lock available in the vertical position. Please specify V - Vertical and add \$231 list.

PRODUCT CODE	PRICE LP	SIZE/INCHES			WEIGHT LBS	VOL FT <sup>3</sup>
		H	W	D		
L2PFF18	748	28	15.5	18	94	8
L2PFF20	837	28	15.5	20	94	8
L2PFF23	847	28	15.5	23	94	8
L2PFF24	847	28	15.5	24	99	8
L2PFF29	891	28	15.5	29	105	10
L2PFF30	891	28	15.5	30	110	10
L2PFF36	927	28	15.5	36	116	11

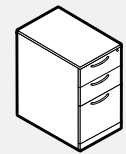
**L2P1D • Worksurface Supporting 1 Door Pedestal**



- Includes one adjustable shelf.
- One lock included.
- Optional e-lock available in the horizontal position. Please specify HL - Horizontal Left and add \$231 list.

PRODUCT CODE	PRICE LP	SIZE/INCHES			WEIGHT LBS	VOL FT <sup>3</sup>
		H	W	D		
L2P1D18	645	28	15.5	18	66	8
L2P1D20	695	28	15.5	20	74	8
L2P1D23	714	28	15.5	23	74	8
L2P1D24	714	28	15.5	24	75	10
L2P1D29	784	28	15.5	29	84	10
L2P1D30	784	28	15.5	30	85	10

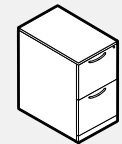
**L2PBBF-F • Freestanding Box, Box, File Pedestal**



- One lock included.
- Optional e-lock available in the vertical position. Please specify V - Vertical and add \$231 list.
- Counter weight must be ordered separately.

PRODUCT CODE	FINISH LP	B	W	SIZE/INCHES				WEIGHT LBS	VOL FT <sup>3</sup>
				H (LP/B)	H (W)	W	D		
L2PBBF20F	972	1000	1038	29	29.5	15.5	20	94	8
L2PBBF24F	987	1015	1055	29	29.5	15.5	24	99	8
L2PBBF30F	1029	1062	1106	29	29.5	15.5	30	105	10
L2PBBF36F	1077	1120	1168	29	29.5	15.5	36	116	11

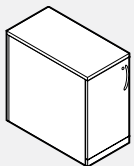
**L2PFF-F • Freestanding File, File Pedestal**



- One lock included.
- Optional e-lock available in the vertical position. Please specify V - Vertical and add \$231 list.
- Counter weight must be ordered separately.

PRODUCT CODE	FINISH LP	B	W	SIZE/INCHES				WEIGHT LBS	VOL FT <sup>3</sup>
				H (LP/B)	H (W)	W	D		
L2PFF20F	882	909	972	29	29.5	15.5	20	99	8
L2PFF24F	894	923	988	29	29.5	15.5	24	99	8
L2PFF30F	969	1003	1043	29	29.5	15.5	30	110	10
L2PFF36F	1054	1095	1109	29	29.5	15.5	36	116	11

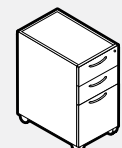
**L2P1D-F • Freestanding 1 Door Pedestal**



- Includes one adjustable shelf.
- One lock included.
- Optional e-lock available in the horizontal position. Please specify HL - Horizontal Left and add \$231 list.
- Counter weight must be ordered separately.

PRODUCT CODE	FINISH LP	B	W	SIZE/INCHES				WEIGHT LBS	VOL FT <sup>3</sup>
				H (LP/B)	H (W)	W	D		
L2P1D20F	775	827	864	29	29.5	15.5	20	78	8
L2P1D24F	786	840	877	29	29.5	15.5	24	98	8
L2P1D30F	864	930	973	29	29.5	15.5	30	103	10
L2P1D36F	949	1027	1078	29	29.5	15.5	36	110	11

**L2PBBF-MIT • Mobile Box, Box, File Pedestal to fit under Worksurface**



- One lock included.
- Optional e-lock available in the vertical position. Please specify V - Vertical and add \$231 list.
- Counter weight must be ordered separately.
- 18" deep mobile pedestal has a fifth caster at center bottom.

PRODUCT CODE	PRICE LP	SIZE/INCHES			WEIGHT LBS	VOL FT <sup>3</sup>
		H	W	D		
L2PBBF18MIT	1187	28	15.5	18	99	8
L2PBBF23MIT	1254	28	15.5	23	105	8
L2PBBF29MIT	1316	28	15.5	29	110	10

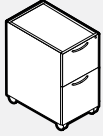
**L2PBBF-M • Mobile Box, Box, File Pedestal with Standard Top**



- One lock included.
- Optional e-lock available in the vertical position. Please specify V - Vertical and add \$231 list.
- Counter weight must be ordered separately.
- 20" deep mobile pedestal has a fifth caster at center bottom.

PRODUCT CODE	FINISH LP	B	W	SIZE / INCHES				WEIGHT LBS	VOL FT <sup>3</sup>
				H (LP/B)	H (W)	W	D		
L2PBBF20M	1280	1287	1348	29	29.5	15.5	20	99	8
L2PBBF24M	1299	1309	1366	29	29.5	15.5	24	99	8
L2PBBF30M	1327	1356	1400	29	29.5	15.5	30	105	10
L2PBBF36M	1381	1417	1458	29	29.5	15.5	36	110	11

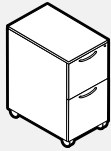
**L2PFF-MIT • Mobile File, File Pedestal to fit under Worksurface**



- One lock included.
- Optional e-lock available in the vertical position. Please specify V - Vertical and add \$231 list.
- Counter weight must be ordered separately.
- 18" deep mobile pedestal has a fifth caster at center bottom.

PRODUCT CODE	PRICE LP	SIZE / INCHES				WEIGHT LBS	VOL FT <sup>3</sup>
		H	W	D	D		
L2PFF18MIT	1011	28	15.5	18	99	8	
L2PFF23MIT	1076	28	15.5	23	105	8	
L2PFF29MIT	1133	28	15.5	29	110	10	

**L2PFF-M • Mobile File, File Pedestal with Standard Top**



- One lock included.
- Optional e-lock available in the vertical position. Please specify V - Vertical and add \$231 list.
- Counter weight must be ordered separately.
- 20" deep mobile pedestal has a fifth caster at center bottom.

PRODUCT CODE	FINISH LP	B	W	SIZE / INCHES				WEIGHT LBS	VOL FT <sup>3</sup>
				H (LP/B)	H (W)	W	D		
L2PFF20M	1084	1109	1141	29	29.5	15.5	20	99	8
L2PFF24M	1099	1126	1162	29	29.5	15.5	24	99	8
L2PFF30M	1139	1169	1230	29	29.5	15.5	30	105	10
L2PFF36M	1198	1233	1280	29	29.5	15.5	36	110	11

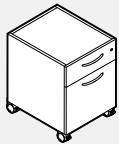
**L2PBF-M • Mobile Box, File Pedestal with Standard Top**



- One lock included.
- Optional e-lock available in the vertical position. Please specify V - Vertical and add \$231 list.
- Counter weight must be ordered separately.
- 20" deep mobile pedestal has a fifth caster at center bottom.

PRODUCT CODE	FINISH LP	B	W	SIZE / INCHES				WEIGHT LBS	VOL FT <sup>3</sup>
				H (LP/B)	H (W)	W	D		
L2PBF20M	944	972	1026	22.69	23.15	15.5	20	78	7
L2PBF24M	957	987	1038	22.69	23.15	15.5	24	80	7
L2PBF30M	991	1025	1064	22.69	23.15	15.5	30	90	9

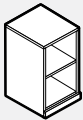
**L2PBF-MIT • Mobile Box, File Pedestal with Inset Top**



- One lock included.
- Optional e-lock available in the vertical position. Please specify V - Vertical and add \$231 list.
- Counter weight must be ordered separately.
- 18" deep mobile pedestal has a fifth caster at center bottom.

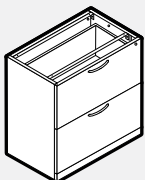
PRODUCT CODE	PRICE LP	SIZE / INCHES				WEIGHT LBS	VOL FT <sup>3</sup>
		H	W	D	D		
L2PBF18MIT	884	22	15.5	18	99	8	
L2PBF23MIT	941	22	15.5	23	99	8	
L2PBF24MIT	941	22	15.5	24	105	8	
L2PBF29MIT	994	22	15.5	29	105	8	
L2PBF30MIT	994	22	15.5	30	110	10	

**L2PU • Printer Unit with 2 Pull Out Shelves**



PRODUCT CODE	PRICE LP	SIZE / INCHES				WEIGHT LBS	VOL FT <sup>3</sup>
		H (LP/B)	W	D	D		
L2PU18	931	28	22	18	83	8	
L2PU22	1016	28	22	22	88	9	
L2PU24	1060	28	22	24	94	10	

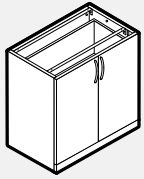
**L2L2H • Worksurface Supporting File, File Lateral for 18" deep and 22" deep units**



- One lock included.
- Optional e-lock available in the vertical position. Please specify V - Vertical and add \$231 list.

PRODUCT CODE	PRICE LP	SIZE / INCHES				WEIGHT LBS	VOL FT <sup>3</sup>
		H (LP/B)	W	D	D		
L2L2H1830	1241	28	30	18	189	12	
L2L2H1836	1324	28	36	18	209	14	
L2L2H1842	1374	28	42	18	216	20	
L2L2H2230	1275	28	30	22	189	12	
L2L2H2236	1360	28	36	22	209	14	
L2L2H2242	1456	28	42	22	216	20	

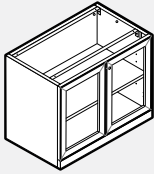
**L2L2D • Worksurface Supporting 2 Door Storage Lateral with 1 Adjustable Shelf**



- One lock included.
- Optional e-lock available in the horizontal position. Please specify HR - Horizontal Right and add \$231 list.

PRODUCT CODE	PRICE LP	SIZE/INCHES			WEIGHT LBS	VOL FT <sup>3</sup>
		H (LP/B)	W	D		
L2L2D1830	867	28	30	18	171	12
L2L2D1836	916	28	36	18	178	14
L2L2D1842	1003	28	42	18	180	20
L2L2D2230	937	28	30	22	171	12
L2L2D2236	963	28	36	22	178	14
L2L2D2242	1109	28	42	22	180	20

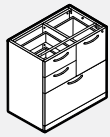
**L2L2AD • Worksurface Supporting 2 Aluminum Door Storage Lateral with 1 Adjustable Shelf**



- One lock included.
- E-lock not available for aluminum framed glass doors.

PRODUCT CODE	PRICE LP	SIZE/INCHES			WEIGHT LBS	VOL FT <sup>3</sup>
		H (LP/B)	W	D		
L2L2AD1830	1475	28	30	18	165	12
L2L2AD1836	1581	28	36	18	172	14
L2L2AD1842	1726	28	42	18	174	20
L2L2AD2230	1545	28	30	22	165	12
L2L2AD2236	1632	28	36	22	172	14
L2L2AD2242	1834	28	42	22	174	20

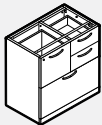
**L2LCR • Worksurface Supporting Lateral File Combo**



- One lock included.
- Optional e-lock available in the vertical position. Please specify V - Vertical and add \$231 list.

PRODUCT CODE	PRICE LP	SIZE/INCHES			WEIGHT LBS	VOL FT <sup>3</sup>
		H (LP/B)	W	D		
L2LCR1830	1524	28	30	18	204	12
L2LCR1836	1779	28	36	18	215	14
L2LCR2230	1774	28	30	22	204	12
L2LCR2236	1862	28	36	22	215	14

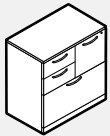
**L2LCL • Worksurface Supporting Lateral File Combo**



- One lock included.
- E-lock not available.

PRODUCT CODE	PRICE LP	SIZE/INCHES			WEIGHT LBS	VOL FT <sup>3</sup>
		H (LP/B)	W	D		
L2LCL1830	1524	28	30	18	204	12
L2LCL1836	1779	28	36	18	215	14
L2LCL2230	1774	28	30	22	204	12
L2LCL2236	1862	28	36	22	215	14

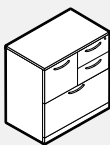
**L2LCR • Lateral File Combo with Top**



- One lock included.
- Optional e-lock available in the vertical position. Please specify V - Vertical and add \$231 list.

PRODUCT CODE	FINISH LP	B	W	SIZE/INCHES				WEIGHT LBS	VOL FT <sup>3</sup>
				H (LP/B)	H (W)	W	D		
L2LCR2030	1882	1925	1973	29	29.5	30	20	204	12
L2LCR2036	1972	1998	2100	29	29.5	36	20	215	14
L2LCR2430	1957	2001	2055	29	29.5	30	24	204	12
L2LCR2436	2051	2081	2187	29	29.5	36	24	215	14

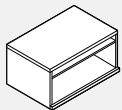
**L2LCL • Lateral File Combo with Top**



- One lock included.
- E-lock not available.

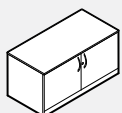
PRODUCT CODE	FINISH LP	B	W	SIZE/INCHES				WEIGHT LBS	VOL FT <sup>3</sup>
				H (LP/B)	H (W)	W	D		
L2LCL2030	1882	1925	1973	29	29.5	30	20	204	12
L2LCL2036	1972	1998	2100	29	29.5	36	20	215	14
L2LCL2430	1957	2001	2055	29	29.5	30	24	204	12
L2LCL2436	2051	2081	2187	29	29.5	36	24	215	14

**L2LO • Freestanding 1 High Open Unit**



PRODUCT CODE	FINISH LP	B	W	SIZE/INCHES				WEIGHT LBS	VOL FT <sup>3</sup>
				H (LP/B)	H (W)	W	D		
L2LO2030	671	762	827	19.94	20.4	30	20	75	11
L2LO2036	796	907	942	19.94	20.4	36	20	86	13
L2LO2430	697	792	862	19.94	20.4	30	24	75	11
L2LO2436	829	942	983	19.94	20.4	36	24	86	13

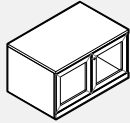
**L2L2D-H20 • Freestanding 2 Doors, 1 High Unit**



- One lock included.
- Includes one adjustable shelf.
- Optional e-lock available in the horizontal position. Please specify HR - Horizontal Right and add \$231 list.

PRODUCT CODE	FINISH LP	B	W	SIZE/INCHES				WEIGHT LBS	VOL FT <sup>3</sup>
				H (LP/B)	H (W)	W	D		
L2L2D2030H20	921	1001	1053	19.94	20.4	30	20	95	11
L2L2D2036H20	1001	1099	1156	19.94	20.4	36	20	106	13
L2L2D2430H20	959	1041	1095	19.94	20.4	30	24	95	11
L2L2D2436H20	1041	1142	1201	19.94	20.4	36	24	106	13

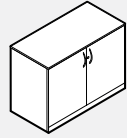
**L2L2AD • Freestanding 2 Aluminum Doors, 1 High**



- One lock included.
- Includes one adjustable shelf.
- E-lock not available for aluminum framed glass doors.

PRODUCT CODE	FINISH LP	B	W	SIZE / INCHES				WEIGHT LBS	VOL FT <sup>3</sup>
				H (LP/B)	H (W)	W	D		
L2L2AD2030H20	1411	1491	1542	19.5	20	30	20	86	10
L2L2AD2036H20	1533	1629	1686	19.5	20	36	20	96	12
L2L2AD2430H20	1448	1530	1585	19.5	20	30	24	86	10
L2L2AD2436H20	1573	1672	1732	19.5	20	36	24	96	12

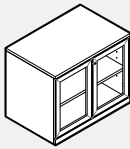
**L2L2D • Freestanding 2 Doors, 2 High Unit**



- One lock included.
- Includes one adjustable shelf.
- Optional e-lock available in the horizontal position. Please specify HR - Horizontal Right and add \$231 list.

PRODUCT CODE	FINISH LP	B	W	SIZE / INCHES				WEIGHT LBS	VOL FT <sup>3</sup>
				H (LP/B)	H (W)	W	D		
L2L2D2030	1017	1129	1158	29	29.5	30	20	171	12
L2L2D2036	1121	1216	1273	29	29.5	36	20	178	14
L2L2D2042	1257	1367	1430	29	29.5	42	20	208	20
L2L2D2430	1056	1174	1204	29	29.5	30	24	171	12
L2L2D2436	1167	1266	1326	29	29.5	36	24	178	14
L2L2D2442	1302	1419	1487	29	29.5	42	24	208	20

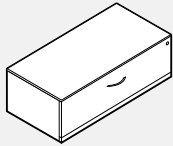
**L2L2AD • Freestanding 2 Aluminum Doors, 2 High Unit**



- One lock included.
- Includes one adjustable shelf.
- E-lock not available for aluminum framed glass doors.

PRODUCT CODE	FINISH LP	B	W	SIZE / INCHES				WEIGHT LBS	VOL FT <sup>3</sup>
				H (LP/B)	H (W)	W	D		
L2L2AD2030	1626	1738	1769	29	29.5	30	20	165	12
L2L2AD2036	1786	1885	1941	29	29.5	36	20	172	14
L2L2AD2042	1978	2089	2153	29	29.5	42	20	174	20
L2L2AD2430	1666	1782	1812	29	29.5	30	24	165	12
L2L2AD2436	1832	1933	1991	29	29.5	36	24	172	14
L2L2AD2442	2026	2144	2211	29	29.5	42	24	174	20

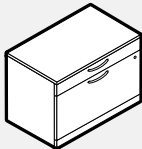
**L2L1H • Freestanding 1 High Lateral**



- One lock included.
- Optional e-lock available in the vertical position. Please specify V - Vertical and add \$231 list.

PRODUCT CODE	FINISH LP	B	W	SIZE / INCHES				WEIGHT LBS	VOL FT <sup>3</sup>
				H (LP/B)	H (W)	W	D		
L2L1H2030	917	966	1000	19.94	20.4	30	20	105	11
L2L1H2036	977	1038	1094	19.94	20.4	36	20	114	13
L2L1H2042	1060	1128	1193	19.94	20.4	42	20	133	15
L2L1H2430	954	1003	1040	19.94	20.4	30	24	105	11
L2L1H2436	1021	1083	1137	19.94	20.4	36	24	114	13
L2L1H2442	1101	1171	1236	19.94	20.4	42	24	133	15

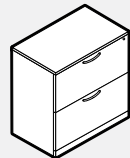
**L2LBFH20 • Freestanding Box File Lateral**



- One lock included.
- Optional e-lock available in the vertical position. Please specify V - Vertical and add \$231 list.

PRODUCT CODE	FINISH LP	B	W	SIZE / INCHES				WEIGHT LBS	VOL FT <sup>3</sup>
				H (LP/B)	H (W)	W	D		
L2LBF2030H20	1237	1270	1337	19.94	20	30	20	108	11
L2LBF2036H20	1332	1370	1447	19.94	20	36	20	117	13
L2LBF2042H20	1418	1462	1549	19.94	20	42	20	136	15
L2LBF2430H20	1282	1315	1382	19.94	20	30	24	108	11
L2LBF2436H20	1377	1415	1492	19.94	20	36	24	117	13
L2LBF2442H20	1464	1507	1594	19.94	20	42	24	136	15

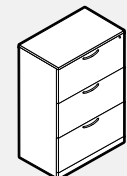
**L2L2H • Freestanding 2 High Lateral**



- One lock included.
- Optional e-lock available in the vertical position. Please specify V - Vertical and add \$231 list.

PRODUCT CODE	FINISH LP	B	W	SIZE / INCHES				WEIGHT LBS	VOL FT <sup>3</sup>
				H (LP/B)	H (W)	W	D		
L2L2H2030	1388	1435	1485	29	29.5	30	20	189	12
L2L2H2036	1484	1541	1599	29	29.5	36	20	209	14
L2L2H2042	1595	1664	1719	29	29.5	42	20	242	20
L2L2H2430	1442	1491	1547	29	29.5	30	24	189	12
L2L2H2436	1542	1604	1660	29	29.5	36	24	209	14
L2L2H2442	1658	1730	1788	29	29.5	42	24	242	20

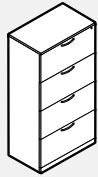
**L2L3H • Freestanding 3 High Lateral**



- One lock included.
- Optional e-lock available in the vertical position. Please specify V - Vertical and add \$231 list.

PRODUCT CODE	FINISH LP	B	W	SIZE / INCHES				WEIGHT LBS	VOL FT <sup>3</sup>
				H (LP/B)	H (W)	W	D		
L2L3H2030	1893	1941	1993	41.75	42.18	30	20	252	18
L2L3H2036	2039	2095	2108	41.75	42.18	36	20	264	21
L2L3H2430	1970	2019	2072	41.75	42.18	30	24	252	18
L2L3H2436	2121	2182	2194	41.75	42.18	36	24	264	21

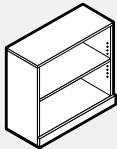
**L2L4H • Freestanding 4 High Lateral**



- One lock included.
- Optional e-lock available in the vertical position. Please specify V - Vertical and add \$231 list.

PRODUCT CODE	FINISH		SIZE / INCHES				WEIGHT LBS	VOL FT <sup>3</sup>
	LP	W	H (LP/B)	H (W)	W	D		
L2L4H2030	2448	2550	54.5	54.94	30	20	315	23
L2L4H2036	2571	2720	54.5	54.94	36	20	336	28
L2L4H2430	2545	2651	54.5	54.94	30	24	315	23
L2L4H2436	2673	2827	54.5	54.94	36	24	336	28

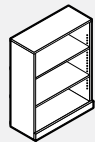
**L2B2H • Bookcase 1 Adjustable Shelf**



- Shipped knocked down (KD).

PRODUCT CODE	FINISH			SIZE / INCHES				WEIGHT LBS	VOL FT <sup>3</sup>
	LP	B	W	H (LP/B)	H (W)	W	D		
L2B2H3012	542	592	638	29	29.5	30	12	95	8
L2B2H3612	629	689	749	29	29.5	36	12	106	9
L2B2H30	645	720	792	29	29.5	30	17	95	11
L2B2H36	747	804	864	29	29.5	36	17	106	13

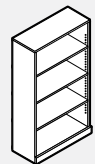
**L2B3H • Bookcase 2 Adjustable Shelves**



- Shipped knocked down (KD).

PRODUCT CODE	FINISH			SIZE / INCHES				WEIGHT LBS	VOL FT <sup>3</sup>
	LP	B	W	H (LP/B)	H (W)	W	D		
L2B3H3012	693	744	775	41.75	42.18	30	12	160	9
L2B3H3612	761	835	874	41.75	42.18	36	12	171	12
L2B3H30	863	935	996	41.75	42.18	30	17	160	15
L2B3H36	972	1057	1117	41.75	42.18	36	17	171	18

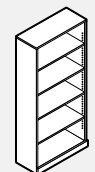
**L2B4H • Bookcase 3 Adjustable Shelves**



- Shipped knocked down (KD).

PRODUCT CODE	FINISH		SIZE / INCHES				WEIGHT LBS	VOL FT <sup>3</sup>
	LP	W	H (LP/B)	H (W)	W	D		
L2B4H3012	827	942	54.5	54.94	30	12	178	13
L2B4H3612	929	1062	54.5	54.94	36	12	189	15
L2B4H30	1055	1174	54.5	54.94	30	17	178	19
L2B4H36	1153	1264	54.5	54.94	36	17	189	22

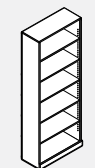
**L2B5H • Bookcase 4 Adjustable Shelves**



- Shipped knocked down (KD).

PRODUCT CODE	FINISH		SIZE / INCHES				WEIGHT LBS	VOL FT <sup>3</sup>
	LP	W	H (LP/B)	H (W)	W	D		
L2B5H3012	998	1063	65.81	66.25	30	12	193	15
L2B5H3612	1089	1225	65.81	66.25	36	12	204	19
L2B5H30	1181	1276	65.81	66.25	30	17	193	23
L2B5H36	1324	1464	65.81	66.25	36	17	204	28

**L2B6H • Bookcase 5 Adjustable Shelves**

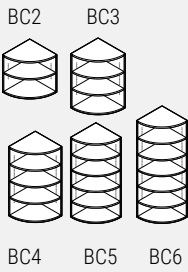


- Shipped knocked down (KD).

PRODUCT CODE	FINISH		SIZE / INCHES				WEIGHT LBS	VOL FT <sup>3</sup>
	LP	W	H (LP/B)	H (W)	W	D		
L2B6H3012	1074	1189	72.81	73.24	30	12	237	17
L2B6H3612	1204	1339	72.81	73.24	36	12	248	20
L2B6H30	1210	1336	72.81	73.24	30	17	242	25
L2B6H36	1448	1656	72.81	73.24	36	17	253	30



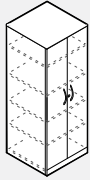
**L2BC • Corner Bookcase 20”D x 20”W /24”D x 24”W**



- Shipped knocked down (KD).

PRODUCT CODE	FINISH LP	B	W	SIZE/INCHES				WEIGHT LBS	VOL FT³
				H(LP/B)	H(W)	W	D		
L2BC2H20	872	1024	1062	29.00	29.50	20	20	90	11
L2BC2H24	908	1065	1102	29.00	29.50	24	24	90	11
L2BC3H20	1106	1259	1299	41.75	42.18	20	20	125	15
L2BC3H24	1152	1304	1351	41.75	42.18	24	24	125	15
L2BC4H20	1340	-	1539	54.50	54.94	20	20	158	20
L2BC4H24	1395	-	1601	54.50	54.94	24	24	158	20
L2BC5H20	1575	-	1777	65.81	66.25	20	20	188	24
L2BC5H24	1639	-	1848	65.81	66.25	24	24	188	24
L2BC6H20	1772	-	1985	72.81	73.24	20	20	218	26
L2BC6H24	1842	-	2062	72.81	73.24	24	24	218	26

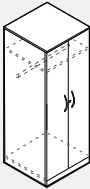
**L2TW2D-D • Storage Tower with 2 Doors and 4 Adjustable Shelves**



- 50” High Tower comes with 3 adjustable shelves.
- One lock on right door included.
- Optional e-lock available in the horizontal position. Please specify HR - Horizontal Right and add \$231 list.

PRODUCT CODE	FINISH LP	W	D	SIZE/INCHES				WEIGHT LBS	VOL FT³
				H(LP/B)	H(W)	W	D		
L2TW2D50H20D	1524	1634	20	49.56	50.00	24	20	211	22
L2TW2D66H20D	1684	1835	20	65.81	66.25	24	20	268	24
L2TW2D72H20D	1757	1902	20	72.81	73.24	24	20	283	26
L2TW2D50H24D	1581	1697	24	49.56	50.00	24	24	211	22
L2TW2D66H24D	1748	1906	24	65.81	66.25	24	24	268	24
L2TW2D72H24D	1826	1973	24	72.81	73.24	24	24	283	26

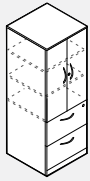
**L2TW2DCS-D • Storage Tower with 2 Doors, Coat Rod and Hat Shelf**



- 50” High Tower comes with one shelf.
- One lock on right door included.
- Optional e-lock available in the horizontal position. Please specify HR - Horizontal Right and add \$231 list.

PRODUCT CODE	FINISH LP	W	D	SIZE/INCHES				WEIGHT LBS	VOL FT³
				H(LP/B)	H(W)	W	D		
L2TW2DCS50H20D	1362	1519	20	49.56	50.00	24	20	178	22
L2TW2DCS66H20D	1541	1654	20	65.81	66.25	24	20	268	24
L2TW2DCS72H20D	1607	1720	20	72.81	73.24	24	20	284	26
L2TW2DCS50H24D	1415	1577	24	49.56	50.00	24	24	178	22
L2TW2DCS66H24D	1602	1718	24	65.81	66.25	24	24	268	24
L2TW2DCS72H24D	1670	1785	24	72.81	73.24	24	24	284	26

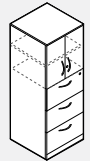
**L2TW2H2D-D • Storage Tower with a 3 High Cupboard over a 2 High Lateral**



- 50” High Tower comes with one adjustable shelf.
- Two locks included.
- Optional e-lock available in the vertical position for the file drawers. Please specify V - Vertical and add \$231 list.
- Optional e-lock available in the horizontal position for the upper storage cabinet. Please specify HR- Horizontal Right and add \$231 list.

PRODUCT CODE	FINISH LP	W	D	SIZE/INCHES				WEIGHT LBS	VOL FT³
				H(LP/B)	H(W)	W	D		
L2TW2H2D50H20D	2061	2104	20	49.56	50.00	24	20	222	22
L2TW2H2D66H20D	2290	2327	20	65.81	66.25	24	20	279	24
L2TW2H2D72H20D	2356	2521	20	72.81	73.24	24	20	295	26
L2TW2H2D50H24D	2145	2190	24	49.56	50.00	24	24	222	22
L2TW2H2D66H24D	2383	2419	24	65.81	66.25	24	24	279	24
L2TW2H2D72H24D	2450	2619	24	72.81	73.24	24	24	295	26

**L2TW3H2D-D • Storage Tower with a 2 High Cupboard over a 3 High Lateral**



- Two locks included.
- Optional e-lock available in the vertical position for the file drawers. Please specify V - Vertical and add \$231 list.
- Optional e-lock available in the horizontal position for the upper storage cabinet. Please specify HR- Horizontal Right and add \$231 list.

PRODUCT CODE	FINISH LP	W	D	SIZE/INCHES				WEIGHT LBS	VOL FT³
				H(LP/B)	H(W)	W	D		
L2TW3H2D66H20D	2526	2635	20	65.81	66.25	24	20	296	24
L2TW3H2D72H20D	2602	2681	20	72.81	73.24	24	20	311	26
L2TW3H2D66H24D	2627	2740	24	65.81	66.25	24	24	296	24
L2TW3H2D72H24D	2704	2789	24	72.81	73.24	24	24	311	26

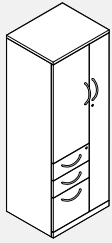
**L2TW4H2D-D • Tower with a 2 Door Storage Cabinet over a 4 High Lateral**



- Two locks included.
- Lock on cupboard is not available for UB, UC or RN handles.
- Optional e-lock available in the vertical position for the file drawers. Please specify V - Vertical and add \$231 list.
- Optional e-lock available in the horizontal position for the upper storage cabinet. Please specify HR- Horizontal Right and add \$231 list.

PRODUCT CODE	FINISH LP	W	D	SIZE/INCHES				WEIGHT LBS	VOL FT³
				H(LP/B)	H(W)	W	D		
L2TW4H2D66H20D	2868	2981	20	65.81	66.25	24	20	307	24
L2TW4H2D72H20D	2958	2995	20	72.81	73.24	24	20	322	26
L2TW4H2D66H24D	2982	3101	24	65.81	66.25	24	24	307	24
L2TW4H2D72H24D	3079	3114	24	72.81	73.24	24	24	322	26

**L2TWBBF2DL • Storage Tower with a 3 High Cupboard, BBF Drawers and Wardrobe**

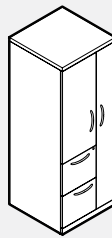


Right Hand Shown

- Storage compartment includes 1 adjustable shelves for 50”h. unit and 2 adjustable shelves for 66”h. and 72”h. units
- Two locks included.
- Optional e-lock available in the vertical position for the box, box, file drawers. Please specify V - Vertical and add \$231 list.
- Optional e-lock available in the horizontal position for the wardrobe. Please specify HR - Horizontal Right or HL - Horizontal Left and add \$231 list.

PRODUCT CODE	FINISH		SIZE/INCHES				WEIGHT LBS	VOL FT³
	LP	W	H (LP/B)	H (W)	W	D		
<b>Left</b>								
L2TWBBF2DL50H20D	2108	2265	49.56	50.00	24	20	288	20
L2TWBBF2DL66H20D	2348	2457	65.81	66.25	24	20	348	22
L2TWBBF2DL72H20D	2434	2541	72.81	73.25	24	20	378	24
L2TWBBF2DL50H24D	2193	2355	49.5	50.00	24	24	288	20
L2TWBBF2DL66H24D	2440	2555	65.81	66.25	24	24	348	22
L2TWBBF2DL72H24D	2529	2644	72.81	73.25	24	24	378	24
<b>Right</b>								
L2TWBBF2DR50H20D	2108	2265	49.56	50.00	24	20	288	20
L2TWBBF2DR66H20D	2348	2457	65.81	66.25	24	20	348	22
L2TWBBF2DR72H20D	2434	2541	72.81	73.25	24	20	378	24
L2TWBBF2DR50H24D	2193	2355	49.5	50.00	24	24	288	20
L2TWBBF2DR66H24D	2440	2555	65.81	66.25	24	24	348	22
L2TWBBF2DR72H24D	2529	2644	72.81	73.25	24	24	378	24

**L2TW2F2D-D • Storage Tower with a 3 High Cupboard, FF Drawers and Wardrobe**

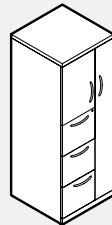


Right Hand Shown

- Wardrobe has a coat rod.
- Two locks included.
- Optional e-lock available in the vertical position for the file drawers. Please specify V - Vertical and add \$231 list.
- Optional e-lock available in the horizontal position for the wardrobe. Please specify HR - Horizontal Right or HL - Horizontal Left and add \$231 list.

PRODUCT CODE	FINISH		SIZE/INCHES				WEIGHT LBS	VOL FT³
	LP	W	H (LP/B)	H (W)	W	D		
<b>Left</b>								
L2TW2F2DL50H20D	1983	2141	49.56	50.00	24	20	222	22
L2TW2F2DL66H20D	2221	2329	65.81	66.25	24	20	279	24
L2TW2F2DL72H20D	2306	2415	72.81	73.24	24	20	295	26
L2TW2F2DL50H24D	2061	2223	49.56	50.00	24	24	222	22
L2TW2F2DL66H24D	2312	2422	65.81	66.25	24	24	279	24
L2TW2F2DL72H24D	2401	2511	72.81	73.24	24	24	295	26
<b>Right</b>								
L2TW2F2DR50H20D	1983	2141	49.56	50.00	24	20	222	22
L2TW2F2DR66H20D	2221	2329	65.81	66.25	24	20	279	24
L2TW2F2DR72H20D	2306	2415	72.81	73.24	24	20	295	26
L2TW2F2DR50H24D	2061	2223	49.56	50.00	24	24	222	22
L2TW2F2DR66H24D	2312	2422	65.81	66.25	24	24	279	24
L2TW2F2DR72H24D	2401	2511	72.81	73.24	24	24	295	26

**L2TW3F2D-D • Storage Tower with a 2 High Cupboard, FFF Drawers and Wardrobe**

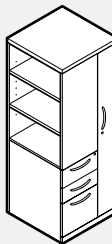


Right Hand Shown

- Two locks included.
- Optional e-lock available in the vertical position for the file drawers. Please specify V - Vertical and add \$231 list.
- Optional e-lock available in the horizontal position for the wardrobe. Please specify HR - Horizontal Right or HL - Horizontal Left and add \$231 list.

PRODUCT CODE	FINISH		SIZE/INCHES				WEIGHT LBS	VOL FT³
	LP	W	H (LP/B)	H (W)	W	D		
<b>Left</b>								
L2TW3F2DL66H20D	2349	2466	65.81	66.25	24	20	296	24
L2TW3F2DL72H20D	2435	2527	72.81	73.24	24	20	311	26
L2TW3F2DL66H24D	2443	2564	65.81	66.25	24	24	296	24
L2TW3F2DL72H24D	2534	2629	72.81	73.24	24	24	311	26
<b>Right</b>								
L2TW3F2DR66H20D	2349	2466	65.81	66.25	24	20	296	24
L2TW3F2DR72H20D	2435	2527	72.81	73.24	24	20	311	26
L2TW3F2DR66H24D	2443	2564	65.81	66.25	24	24	296	24
L2TW3F2DR72H24D	2534	2629	72.81	73.24	24	24	311	26

**L2TWBBFDO • Storage Tower with 3 High Side Open Cupboard, BBF Drawers and Wardrobe**

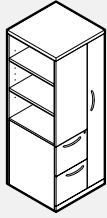


Right Hand Shown

- Open bookcase compartment includes 1 adjustable shelves for 50”h unit and 2 adjustable shelves for 66”h and 72”h units
- Two locks included.
- Optional e-lock available in the vertical position for the box, box, file drawers. Please specify V - Vertical and add \$231 list.
- Optional e-lock available in the horizontal position for the wardrobe. Please specify HR - Horizontal Right or HL - Horizontal Left and add \$231 list.

PRODUCT CODE	FINISH		SIZE/INCHES				WEIGHT LBS	VOL FT³
	LP	W	H (LP/B)	H (W)	W	D		
<b>Left</b>								
L2TWBBFDOL50H20D	1960	2085	49.50	50.00	24	20	285	20
L2TWBBFDOL66H20D	2170	2240	65.81	66.25	24	20	345	22
L2TWBBFDOL72H20D	2242	2309	72.81	73.25	24	20	375	24
L2TWBBFDOL50H24D	2040	2166	49.50	50.00	24	24	285	20
L2TWBBFDOL66H24D	2257	2330	65.81	66.25	24	24	345	22
L2TWBBFDOL72H24D	2331	2401	72.81	73.25	24	24	375	24
<b>Right</b>								
L2TWBBFDOR50H20D	1960	2085	49.50	50.00	24	20	285	20
L2TWBBFDOR66H20D	2170	2240	65.81	66.25	24	20	345	22
L2TWBBFDOR72H20D	2242	2309	72.81	73.25	24	20	375	24
L2TWBBFDOR50H24D	2040	2166	49.50	50.00	24	24	285	20
L2TWBBFDOR66H24D	2257	2330	65.81	66.25	24	24	345	22
L2TWBBFDOR72H24D	2331	2401	72.81	73.25	24	24	375	24

**L2TW2FDO-D • Storage Tower with a 3 High Side Open Cupboard, FF Drawers and Wardrobe**

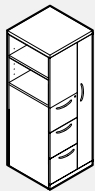


Right Hand Shown

- 50" High Tower comes with one adjustable shelf.
- Two locks included.
- Optional e-lock available in the vertical position for the file drawers. Please specify V - Vertical and add \$231 list.
- Optional e-lock available in the horizontal position for the wardrobe. Please specify HR - Horizontal Right or HL - Horizontal Left and add \$231 list.

PRODUCT CODE	FINISH		SIZE/INCHES				WEIGHT LBS	VOL FT <sup>3</sup>
	LP	W	H (LP/B)	H (W)	W	D		
<b>Left</b>								
L2TW2FDOL50H20D	1835	1957	49.56	50.00	24	20	211	22
L2TW2FDOL66H20D	2042	2115	65.81	66.25	24	20	268	24
L2TW2FDOL72H20D	2116	2182	72.81	73.24	24	20	284	26
L2TW2FDOL50H24D	1907	2034	49.56	50.00	24	24	211	22
L2TW2FDOL66H24D	2125	2197	65.81	66.25	24	24	268	24
L2TW2FDOL72H24D	2198	2268	72.81	73.24	24	24	284	26
<b>Right</b>								
L2TW2FDOR50H20D	1835	1957	49.56	50.00	24	20	211	22
L2TW2FDOR66H20D	2042	2115	65.81	66.25	24	20	268	24
L2TW2FDOR72H20D	2116	2182	72.81	73.24	24	20	284	26
L2TW2FDOR50H24D	1907	2034	49.56	50.00	24	24	211	22
L2TW2FDOR66H24D	2125	2197	65.81	66.25	24	24	268	24
L2TW2FDOR72H24D	2198	2268	72.81	73.24	24	24	284	26

**L2TW3FDO-D • Storage Tower with a 2 High Side Open Cupboard, FFF Drawers and Wardrobe**

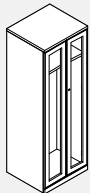


Right Hand Shown

- Two locks included.
- Optional e-lock available in the vertical position for the file drawers. Please specify V - Vertical and add \$231 list.
- Optional e-lock available in the horizontal position for the wardrobe. Please specify HR - Horizontal Right or HL - Horizontal Left and add \$231 list.

PRODUCT CODE	FINISH		SIZE/INCHES				WEIGHT LBS	VOL FT <sup>3</sup>
	LP	W	H (LP/B)	H (W)	W	D		
<b>Left</b>								
L2TW3FDOL66H20D	2207	2315	65.81	66.25	24	20	285	24
L2TW3FDOL72H20D	2345	2361	72.81	73.24	24	20	300	26
L2TW3FDOL66H24D	2292	2405	65.81	66.25	24	24	285	24
L2TW3FDOL72H24D	2436	2454	72.81	73.24	24	24	300	26
<b>Right</b>								
L2TW3FDOR66H20D	2207	2315	65.81	66.25	24	20	285	24
L2TW3FDOR72H20D	2345	2361	72.81	73.24	24	20	300	26
L2TW3FDOR66H24D	2292	2405	65.81	66.25	24	24	285	24
L2TW3FDOR72H24D	2436	2454	72.81	73.24	24	24	300	26

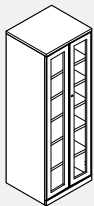
**L2TWA2DCS • Storage Tower with 2 Aluminum Doors, Coat Rod and Hat Shelf**



- 50" High Tower comes with 1 shelf above hang rod.
- One lock included.
- E-locks not available for aluminum framed glass doors.

PRODUCT CODE	FINISH		SIZE/INCHES				WEIGHT LBS	VOL FT <sup>3</sup>
	LP	W	H (LP/B)	H (W)	W	D		
L2TWA2DCS50H20D	2200	2359	49.56	50.00	24	20	162	20
L2TWA2DCS66H20D	2565	2680	65.81	66.25	24	20	244	22
L2TWA2DCS72H20D	2703	2816	72.81	73.25	24	20	258	24
L2TWA2DCS50H24D	2256	2415	49.56	50.00	24	24	162	20
L2TWA2DCS66H24D	2627	2744	65.81	66.25	24	24	244	22
L2TWA2DCS72H24D	2765	2881	72.81	73.25	24	24	258	24

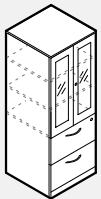
**L2TWA2D • Storage Tower with 2 Aluminum Doors and 4 Adjustable Shelves**



- 50" High Tower comes with 3 adjustable shelves.
- One lock included.
- E-locks not available for aluminum framed glass doors.

PRODUCT CODE	FINISH		SIZE/INCHES				WEIGHT LBS	VOL FT <sup>3</sup>
	LP	W	H (LP/B)	H (W)	W	D		
L2TWA2D50H20D	2363	2472	49.56	50.00	24	20	192	20
L2TWA2D66H20D	2710	2862	65.81	66.25	24	20	244	22
L2TWA2D72H20D	2852	2997	72.81	73.25	24	20	257	24
L2TWA2D50H24D	2419	2536	49.56	50.00	24	24	192	20
L2TWA2D66H24D	2776	2932	65.81	66.25	24	24	244	22
L2TWA2D72H24D	2920	3070	72.81	73.25	24	24	257	24

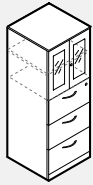
**L2TWA2H2D • Storage Tower with a 3 High Cupboard over a 2 High Lateral**



- 50" High Tower comes with 1 adjustable shelf.
- Lock is on the upper drawer.
- Two locks included.
- Optional e-lock available in the vertical position. Please specify V - Vertical and add \$231 list.
- E-locks not available for aluminum framed glass doors.

PRODUCT CODE	FINISH		SIZE/INCHES				WEIGHT LBS	VOL FT <sup>3</sup>
	LP	W	H (LP/B)	H (W)	W	D		
L2TWA2H2D50H20D	2574	2619	49.56	50.00	24	20	202	20
L2TWA2H2D66H20D	2989	3026	65.81	66.25	24	20	254	22
L2TWA2H2D72H20D	3127	3288	72.81	73.25	24	20	258	24
L2TWA2H2D50H24D	2659	2704	49.56	50.00	24	24	202	20
L2TWA2H2D66H24D	3082	3122	65.81	66.25	24	24	254	22
L2TWA2H2D72H24D	3221	3388	72.81	73.25	24	24	258	24

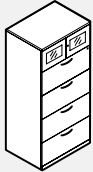
**L2TWA3H2D • Storage Tower with a 2 High Cupboard with Aluminum Doors over a 3 High Lateral**



- Lock is on the upper drawer.
- Two locks included.
- Optional e-lock available in the vertical position. Please specify V - Vertical and add \$231 list.
- E-locks not available for aluminum framed glass doors.

PRODUCT CODE	FINISH		SIZE/INCHES				WEIGHT LBS	VOL FT³
	LP	W	H (LP/B)	H (W)	W	D		
L2TWA3H2D66H20D	3078	3190	65.81	66.25	24	20	269	22
L2TWA3H2D72H20D	3222	3304	72.81	73.25	24	20	283	24
L2TWA3H2D66H24D	3179	3292	65.81	66.25	24	24	269	22
L2TWA3H2D72H24D	3326	3412	72.81	73.25	24	24	283	24

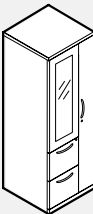
**L2TWA4H2D • Storage Tower with Cupboard with Aluminum Doors over a 4 High Lateral**



- Lock is on the upper drawer.
- Two locks included.
- Optional e-lock available in the vertical position. Please specify V - Vertical and add \$231 list.
- E-locks not available for aluminum framed glass doors.

PRODUCT CODE	FINISH		SIZE/INCHES				WEIGHT LBS	VOL FT³
	LP	W	H (LP/B)	H (W)	W	D		
L2TWA4H2D66H20D	3217	3328	65.81	66.25	24	20	279	22
L2TWA4H2D72H20D	3388	3424	72.81	73.25	24	20	293	24
L2TWA4H2D66H24D	3329	3447	65.81	66.25	24	24	293	22
L2TWA4H2D72H24D	3508	3545	72.81	73.25	24	24	293	24

**L2TWA2F2D • Storage Tower with a 3 High Cupboard, FF Drawers and Wardrobe**

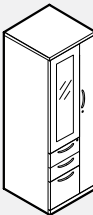


Right Hand Shown

- Storage compartment includes 1 adjustable shelves for 50" unit and 2 adjustable shelves for 66" and 72" units
- Two locks included.
- Optional e-lock available in the vertical position for the file drawers. Please specify V - Vertical and add \$231 list.
- Optional e-lock available in the horizontal position for the wardrobe. Please specify HR - Horizontal Right or HL - Horizontal Left and add \$231 list.
- E-locks not available for aluminum framed glass doors.

PRODUCT CODE	FINISH		SIZE/INCHES				WEIGHT LBS	VOL FT³
	LP	W	H (LP/B)	H (W)	W	D		
L2TWA2F2DR50H20D	2242	2400	49.56	50.00	24	20	219	20
L2TWA2F2DR66H20D	2591	2699	65.81	66.25	24	20	276	22
L2TWA2F2DR72H20D	2719	2827	72.81	73.25	24	20	292	24
L2TWA2F2DR50H24D	2322	2482	49.56	50.00	24	24	219	20
L2TWA2F2DR66H24D	2681	2791	65.81	66.25	24	24	276	22
L2TWA2F2DR72H24D	2811	2924	72.81	73.25	24	24	292	24
L2TWA2F2DL50H20D	2242	2400	49.56	50.00	24	20	219	20
L2TWA2F2DL66H20D	2591	2699	65.81	66.25	24	20	276	22
L2TWA2F2DL72H20D	2719	2827	72.81	73.25	24	20	292	24
L2TWA2F2DL50H24D	2322	2482	49.56	50.00	24	24	219	20
L2TWA2F2DL66H24D	2681	2791	65.81	66.25	24	24	276	22
L2TWA2F2DL72H24D	2811	2924	72.81	73.25	24	24	292	24

**L2TWABBF2D • Storage Tower with a 3 High Cupboard, BBF Drawers and Wardrobe**

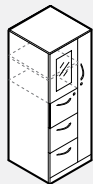


Right Hand Shown

- Storage compartment includes 1 adjustable shelves for 50" unit and 2 adjustable shelves for 66" and 72" units
- Two locks included.
- Optional e-lock available in the vertical position for the box, box, file drawers. Please specify V - Vertical and add \$231 list.
- Optional e-lock available in the horizontal position for the wardrobe. Please specify HR - Horizontal Right or HL - Horizontal Left and add \$231 list.
- E-locks not available for aluminum framed glass doors.

PRODUCT CODE	FINISH		SIZE/INCHES				WEIGHT LBS	VOL FT³
	LP	W	H (LP/B)	H (W)	W	D		
L2TWABBF2DL50H20D	2369	2526	49.56	50.00	24	20	288	20
L2TWABBF2DL66H20D	2719	2825	65.81	66.25	24	20	348	22
L2TWABBF2DL72H20D	2844	2954	72.81	73.25	24	20	378	24
L2TWABBF2DL50H24D	2447	2610	49.56	50.00	24	24	288	20
L2TWABBF2DL66H24D	2809	2919	65.81	66.25	24	24	348	22
L2TWABBF2DL72H24D	2937	3049	72.81	73.25	24	24	378	24
L2TWABBF2DR50H20D	2369	2526	49.56	50.00	24	20	288	20
L2TWABBF2DR66H20D	2719	2825	65.81	66.25	24	20	348	22
L2TWABBF2DR72H20D	2844	2954	72.81	73.25	24	20	378	24
L2TWABBF2DR50H24D	2447	2610	49.56	50.00	24	24	288	20
L2TWABBF2DR66H24D	2809	2919	65.81	66.25	24	24	348	22
L2TWABBF2DR72H24D	2937	3049	72.81	73.25	24	24	378	24

**L2TW3F2D-D • Storage Tower with a 2 High Cupboard, FFF Drawers and Wardrobe**

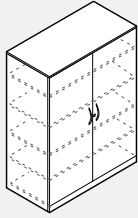


- Lock is on the upper drawer.
- Storage compartment includes 1 adjustable shelf.
- Two locks included.
- Optional e-lock available in the vertical position for the file drawers. Please specify V - Vertical and add \$231 list.
- Optional e-lock available in the horizontal position for the wardrobe. Please specify HR - Horizontal Right or HL - Horizontal Left and add \$231 list.
- E-locks not available for aluminum framed glass doors.

PRODUCT CODE	FINISH		SIZE/INCHES				WEIGHT LBS	VOL FT³
	LP	W	H (LP/B)	H (W)	W	D		
L2TWA3F2DR66H20D	2654	2773	65.81	66.25	24	20	340	22
L2TWA3F2DR72H20D	2778	2870	72.81	73.25	24	20	370	24
L2TWA3F2DR66H24D	2750	2870	65.81	66.25	24	24	340	22
L2TWA3F2DR72H24D	2876	2973	72.81	73.25	24	24	370	24
L2TWA3F2DL66H20D	2654	2773	65.81	66.25	24	20	340	22
L2TWA3F2DL72H20D	2778	2870	72.81	73.25	24	20	370	24
L2TWA3F2DL66H24D	2750	2870	65.81	66.25	24	24	340	22
L2TWA3F2DL72H24D	2876	2973	72.81	73.25	24	24	370	24



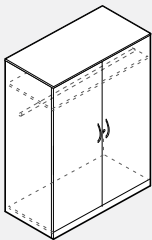
**L2CB • Storage Cabinet with 2 Doors and 4 Adjustable Shelves**



- 50"h. cabinet comes with 3 adjustable shelves.
- 66"h. and 72"h. Cabinet comes with 4 adjustable shelves.
- One lock included.
- Optional e-lock available in the horizontal position. Please specify HR - Horizontal Right and add \$231 list.

PRODUCT CODE	FINISH LP	W	SIZE/INCHES				D	WEIGHT LBS	VOL FT <sup>3</sup>
			H (LP/B)	H (W)	W	D			
L2CB20302D50H	1735	1876	49.56	50.00	30	20	245	21	
L2CB20362D50H	1857	2023	49.56	50.00	36	20	281	25	
L2CB20302D66H	1970	2108	65.81	66.25	30	20	310	28	
L2CB20362D66H	2118	2279	65.81	66.25	36	20	354	33	
L2CB20302D72H	2048	2184	72.81	73.24	30	20	327	30	
L2CB20362D72H	2197	2356	72.81	73.24	36	20	372	36	
L2CB24302D50H	1804	1953	49.56	50.00	30	24	245	25	
L2CB24362D50H	1930	2102	49.56	50.00	36	24	281	30	
L2CB24302D66H	2050	2194	65.81	66.25	30	24	310	33	
L2CB24362D66H	2202	2370	65.81	66.25	36	24	354	39	
L2CB24302D72H	2129	2272	72.81	73.24	30	24	327	36	
L2CB24362D72H	2287	2450	72.81	73.24	36	24	372	43	

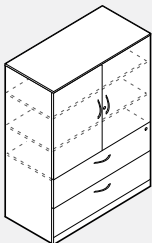
**L2CB • Storage Cabinet with 2 Doors Coat Rod and 1 Fixed Shelf**



- One lock included.
- Optional e-lock available in the horizontal position. Please specify HR - Horizontal Right and add \$231 list.

PRODUCT CODE	FINISH LP	W	SIZE/INCHES				D	WEIGHT LBS	VOL FT <sup>3</sup>
			H (LP/B)	H (W)	W	D			
L2CB20302DCS50H	1586	1718	49.56	50.00	30	20	204	21	
L2CB20362DCS50H	1674	1834	49.56	50.00	36	20	231	25	
L2CB20302DCS66H	1740	1904	65.81	66.25	30	20	249	28	
L2CB20362DCS66H	1831	1991	65.81	66.25	36	20	281	33	
L2CB20302DCS72H	1814	2086	72.81	73.24	30	20	265	30	
L2CB20362DCS72H	1914	2074	72.81	73.24	36	20	298	36	
L2CB24302DCS50H	1649	1786	49.56	50.00	30	24	204	25	
L2CB24362DCS50H	1741	1906	49.56	50.00	36	24	231	30	
L2CB24302DCS66H	1809	1983	65.81	66.25	30	24	249	33	
L2CB24362DCS66H	1903	2069	65.81	66.25	36	24	281	39	
L2CB24302DCS72H	1890	2166	72.81	73.24	30	24	265	36	
L2CB24362DCS72H	1990	2157	72.81	73.24	36	24	298	43	

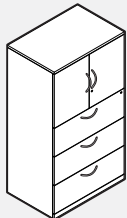
**L2CB • Storage Cabinet with 3 High Cupboard, 2 Adjustable Shelves over a 2 High Lateral**



- 50"h. cabinet comes with one adjustable shelf.
- 66" and 72" Cabinet comes with 2 adjustable shelves.
- Two locks included.
- Optional e-lock available for the file drawers vertical position. Please specify V - Vertical and add \$231 list.
- Optional e-lock available in the horizontal position for upper storage cabinet. Please specify HR - Horizontal Right and add \$231 list.

PRODUCT CODE	FINISH LP	W	SIZE/INCHES				D	WEIGHT LBS	VOL FT <sup>3</sup>
			H (LP/B)	H (W)	W	D			
L2CB20302H2D50H	2256	2381	49.56	50.00	30	20	256	21	
L2CB20362H2D50H	2394	2508	49.56	50.00	36	20	292	25	
L2CB20302H2D66H	2525	2652	65.81	66.25	30	20	321	28	
L2CB20362H2D66H	2689	2839	65.81	66.25	36	20	365	33	
L2CB20302H2D72H	2603	2732	72.81	73.24	30	20	338	30	
L2CB20362H2D72H	2745	2874	72.81	73.24	36	20	383	36	
L2CB24302H2D50H	2345	2473	49.56	50.00	30	24	256	25	
L2CB24362H2D50H	2494	2610	49.56	50.00	36	24	292	30	
L2CB24302H2D66H	2625	2757	65.81	66.25	30	24	321	33	
L2CB24362H2D66H	2796	2953	65.81	66.25	36	24	365	39	
L2CB24302H2D72H	2708	2840	72.81	73.24	30	24	338	36	
L2CB24362H2D72H	2853	2989	72.81	73.24	36	24	383	43	

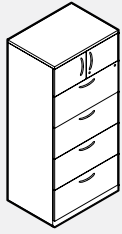
**L2CB • Storage Cabinet with a 2 High Cupboard, 1 Adjustable Shelf over a 3 High Lateral**



- One lock on right door.
- Two locks included.
- Optional e-lock available for the file drawers vertical position. Please specify V - Vertical and add \$231 list.
- Optional e-lock available in the horizontal position for upper storage cabinet. Please specify HR - Horizontal Right and add \$231 list.

PRODUCT CODE	FINISH LP	W	SIZE/INCHES				D	WEIGHT LBS	VOL FT <sup>3</sup>
			H (LP/B)	H (W)	W	D			
L2CB20303H2D66H	2646	2775	65.81	66.25	30	20	337	28	
L2CB20363H2D66H	2811	2963	65.81	66.25	36	20	381	33	
L2CB20303H2D72H	2750	2879	72.81	73.25	30	20	354	30	
L2CB20363H2D72H	2915	3071	72.81	73.25	36	20	399	36	
L2CB24303H2D66H	2751	2884	65.81	66.25	30	24	337	28	
L2CB24363H2D66H	2924	3081	65.81	66.25	36	24	381	33	
L2CB24303H2D72H	2862	2994	72.81	73.25	30	24	354	30	
L2CB24363H2D72H	3034	3194	72.81	73.25	36	24	399	36	

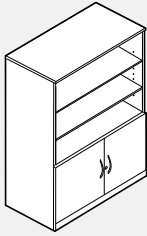
**L2CB • Storage Cabinet with a 2 Door Storage Cupboard above a 4 High Lateral**



- Two locks included.
- Lock on cupboard is not available for UB, UC or RN handles.
- Optional e-lock available for the file drawers vertical position. Please specify V - Vertical and add \$231 list.
- Optional e-lock available in the horizontal position for upper storage cabinet. Please specify HR - Horizontal Right and add \$231 list.

PRODUCT CODE	FINISH LP	W	SIZE/INCHES				WEIGHT LBS	VOL FT <sup>3</sup>
			H(LP/B)	H(W)	W	D		
L2CB20304H2D66H	3046	3199	65.81	66.25	30	20	343	28
L2CB20364H2D66H	3285	3445	65.81	66.25	36	20	387	33
L2CB20304H2D72H	3126	3260	72.81	73.24	30	20	360	30
L2CB20364H2D72H	3319	3476	72.81	73.24	36	20	405	36
L2CB24304H2D66H	3168	3328	65.81	66.25	30	24	278	33
L2CB24364H2D66H	3417	3583	65.81	66.25	36	24	314	39
L2CB24304H2D72H	3251	3390	72.81	73.24	30	24	343	36
L2CB24364H2D72H	3448	3615	72.81	73.24	36	24	387	43

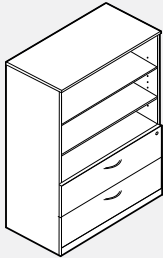
**L2CB • Storage Cabinet with Open Bookcase and 2 Adjustable Shelves & 2 Door Cupboard**



- 50"h. cabinet comes with one adjustable shelf.
- 66"h. and 72"h. Cabinet comes with 2 adjustable Shelves.
- One lock included.
- Optional e-lock available in the horizontal position. Please specify HR - Horizontal Right and add \$231 list.

PRODUCT CODE	FINISH LP	W	SIZE/INCHES				WEIGHT LBS	VOL FT <sup>3</sup>
			H(LP/B)	H(W)	W	D		
L2CB20302D050H	1456	1649	49.56	50.00	30	20	212	21
L2CB20362D050H	1554	1826	49.56	50.00	36	20	248	25
L2CB20302D066H	1633	1878	65.81	66.25	30	20	277	28
L2CB20362D066H	2002	2130	65.81	66.25	36	20	321	33
L2CB20302D072H	1687	1955	72.81	73.24	30	20	294	30
L2CB20362D072H	1840	2209	72.81	73.24	36	20	339	36
L2CB24302D050H	1527	1731	49.56	50.00	30	24	212	25
L2CB24362D050H	1633	1918	49.56	50.00	36	24	248	30
L2CB24302D066H	1714	1972	65.81	66.25	30	24	277	33
L2CB24362D066H	1849	2236	65.81	66.25	36	24	321	39
L2CB24302D072H	1772	2050	72.81	73.24	30	24	294	36
L2CB24362D072H	1930	2322	72.81	73.24	36	24	339	43

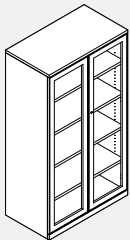
**L2CB • Storage Cabinet with Open Bookcase and 2 Adjustable Shelves over a 2 High Lateral**



- 50"h. cabinet comes with one adjustable shelf.
- 66"h. and 72"h. Cabinet comes with 2 adjustable Shelves.
- One lock included.
- Optional e-lock available in the vertical position. Please specify V - Vertical and add \$231 list.

PRODUCT CODE	FINISH LP	W	SIZE/INCHES				WEIGHT LBS	VOL FT <sup>3</sup>
			H(LP/B)	H(W)	W	D		
L2CB20302H050H	1757	1888	49.56	50.00	30	20	226	21
L2CB20362H050H	1845	1983	49.56	50.00	36	20	261	25
L2CB20302H066H	1935	2063	65.81	66.25	30	20	290	28
L2CB20362H066H	2092	2176	65.81	66.25	36	20	334	33
L2CB20302H072H	2014	2049	72.81	73.24	30	20	307	30
L2CB20362H072H	2148	2230	72.81	73.24	36	20	352	36
L2CB24302H050H	1843	1982	49.56	50.00	30	24	226	25
L2CB24362H050H	1935	2083	49.56	50.00	36	24	261	30
L2CB24302H066H	2032	2166	65.81	66.25	30	24	290	33
L2CB24362H066H	2197	2286	65.81	66.25	36	24	334	39
L2CB24302H072H	2114	2152	72.81	73.24	30	24	307	36
L2CB24362H072H	2256	2341	72.81	73.24	36	24	352	43

**L2CBA • Storage Cabinet with 2 Doors and 4 Adjustable Shelves**

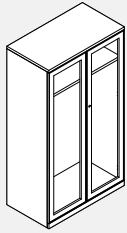


- One lock included.
- Door frame is anodized aluminum.
- Glazing is frosted acrylic.
- Doors standard with no handles.
- E-locks not available for aluminum framed glass doors.

PRODUCT CODE	FINISH LP	W	SIZE/INCHES				WEIGHT LBS	VOL FT <sup>3</sup>
			H(LP/B)	H(W)	W	D		
L2CBA20302D50H	2672	2813	49.56	50.00	30	20	235	21
L2CBA20362D50H	2893	3062	49.56	50.00	36	20	281	25
L2CBA20302D66H	3122	3260	65.81	66.25	30	20	300	28
L2CBA20362D66H	3395	3558	65.81	66.25	36	20	344	33
L2CBA20302D72H	3278	3417	72.81	73.25	30	20	317	30
L2CBA20362D72H	3565	3726	72.81	73.25	36	20	362	36
L2CBA24302D50H	2743	2891	49.56	50.00	30	24	235	21
L2CBA24362D50H	2968	3138	49.56	50.00	36	24	281	25
L2CBA24302D66H	3199	3346	65.81	66.25	30	24	300	28
L2CBA24362D66H	3479	3647	65.81	66.25	36	24	344	33
L2CBA24302D72H	3361	3502	72.81	73.25	30	24	317	30
L2CBA24362D72H	3652	3821	72.81	73.25	36	24	362	36



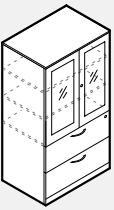
**L2CBA • Storage Cabinet with 2 Doors, Coat Rod and 1 Adjustable Shelf**



- One lock included.
- Door frame is anodized aluminum.
- Glazing is frosted acrylic.
- Doors standard with no handles.
- E-locks not available for aluminum framed glass doors.

PRODUCT CODE	FINISH LP	SIZE/INCHES				D	WEIGHT		VOL FT <sup>3</sup>
		W	H (LP/B)	H (W)	W		LBS		
L2CBA20302DCS50H	2526	2657	49.56	50.00	30	20	195	21	
L2CBA20362DCS50H	2710	2870	49.56	50.00	36	20	221	25	
L2CBA20302DCS66H	2890	3055	65.81	66.25	30	20	239	28	
L2CBA20362DCS66H	3106	3269	65.81	66.25	36	20	271	33	
L2CBA20362DCS72H	3047	3318	72.81	73.25	30	20	255	30	
L2CBA20362DCS72H	3283	3442	72.81	73.25	36	20	288	36	
L2CBA24302DCS50H	2589	2725	49.56	50.00	30	24	195	21	
L2CBA24362DCS50H	2777	2944	49.56	50.00	36	24	221	25	
L2CBA24302DCS66H	2958	3133	65.81	66.25	30	24	239	28	
L2CBA24362DCS66H	3180	3349	65.81	66.25	36	24	271	33	
L2CBA24302DCS72H	3122	3397	72.81	73.25	30	24	255	30	
L2CBA24362DCS72H	3356	3525	72.81	73.25	36	24	288	36	

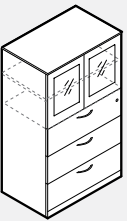
**L2CBA • Storage Cabinet with 3 High Cupboard, 2 Adjustable Shelves over a 2 High Lateral**



- Cabinet 2h2d.
- One lock on right door.
- One lock on upper drawer.
- Door frame is anodized aluminum with lock(s).
- Glazing is frosted acrylic.
- Doors standard with no handles.
- Two locks included.
- Optional e-lock available in the vertical position. Please specify V - Vertical and add \$231 list.
- E-locks not available for aluminum framed glass doors.

PRODUCT CODE	FINISH LP	SIZE/INCHES				D	WEIGHT		VOL FT <sup>3</sup>
		W	H (LP/B)	H (W)	W		LBS		
L2CBA20302H2D50H	2822	2948	49.56	50.00	30	20	233	19	
L2CBA20362H2D50H	3013	3129	49.56	50.00	36	20	265	22	
L2CBA20302H2D66H	3303	3430	65.81	66.25	30	20	292	25	
L2CBA20362H2D66H	3547	3696	65.81	66.25	36	20	332	29	
L2CBA20302H2D72H	3460	3589	72.81	73.25	30	20	307	27	
L2CBA20362H2D72H	3693	3821	72.81	73.25	36	20	348	32	
L2CBA24302H2D50H	2911	3041	49.56	50.00	30	24	233	22	
L2CBA24362H2D50H	3108	3226	49.56	50.00	36	24	265	27	
L2CBA24302H2D66H	3406	3536	65.81	66.25	30	24	292	29	
L2CBA24362H2D66H	3652	3809	65.81	66.25	36	24	332	35	
L2CBA24302H2D72H	3565	3697	72.81	73.25	30	24	307	32	
L2CBA24362H2D72H	3800	3936	72.81	73.25	36	24	348	38	

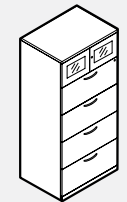
**L2CBA • Storage Cabinet with 2 High Cupboard, 1 Adjustable Shelves over a 3 High Lateral**



- Cabinet 3h2d.
- One lock on right door.
- One lock on upper drawer.
- Door frame is anodized aluminum with lock(s).
- Glazing is frosted acrylic.
- Doors standard with no handles.
- Two locks included.
- Optional e-lock available in the vertical position. Please specify V - Vertical and add \$231 list.
- E-locks not available for aluminum framed glass doors.

PRODUCT CODE	FINISH LP	SIZE/INCHES				D	WEIGHT		VOL FT <sup>3</sup>
		W	H (LP/B)	H (W)	W		LBS		
L2CBA20303H2D66H	3255	3384	65.81	66.25	30	20	337	28	
L2CBA20363H2D66H	3478	3629	65.81	66.25	36	20	381	33	
L2CBA20303H2D72H	3441	3567	72.81	73.25	30	20	354	30	
L2CBA20363H2D72H	3671	3827	72.81	73.25	36	20	399	36	
L2CBA24303H2D66H	3361	3494	65.81	66.25	30	24	337	28	
L2CBA24363H2D66H	3590	3748	65.81	66.25	36	24	381	33	
L2CBA24303H2D72H	3549	3682	72.81	73.25	30	24	354	30	
L2CBA24363H2D72H	3788	3953	72.81	73.25	36	24	399	36	

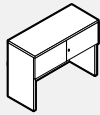
**L2CBA • Storage Cabinet with 2 Aluminum Door Storage Cupboard above a 4 high Lateral**



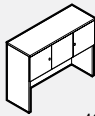
- Two locks included.
- Door frame is anodized aluminum.
- Glazing is frosted acrylic.
- Doors standard with no handles.
- One lock on right door.
- One lock on upper drawer.
- Optional e-lock available in the vertical position. Please specify V - Vertical and add \$231 list.
- E-locks not available for aluminum framed glass doors.

PRODUCT CODE	FINISH LP	SIZE/INCHES				D	WEIGHT		VOL FT <sup>3</sup>
		W	H (LP/B)	H (W)	W		LBS		
L2CBA20304H2D66H	3463	3617	65.81	66.25	30	20	343	28	
L2CBA20364H2D66H	3807	3968	65.81	66.25	36	20	387	33	
L2CBA20304H2D72H	3630	3765	72.81	73.25	30	20	360	30	
L2CBA20364H2D72H	3868	4026	72.81	73.25	36	20	345	36	
L2CBA24304H2D66H	3586	3746	65.81	66.25	30	24	343	28	
L2CBA24364H2D66H	3939	4105	65.81	66.25	36	24	387	33	
L2CBA24304H2D72H	3758	3896	72.81	73.25	30	24	360	30	
L2CBA24364H2D72H	3999	4167	72.81	73.25	36	24	345	36	

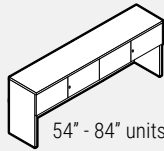
**L2HH • Hutch with Hinged Doors**



30" - 42" units



48" units

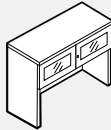


54" - 84" units

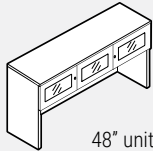
- 30" - 42" units come with one lock.
- 48" - 84" units come with two locks.
- Optional e-lock available in the horizontal position. Please specify HR - Horizontal Right and add \$231 list.
- Hutches 48" or longer require two e-locks.

PRODUCT CODE	FINISH		SIZE/INCHES				WEIGHT		VOL FT <sup>3</sup>
	LP	W	H(LP)	H(W)	W	D	LBS		
L2HH30H36	877	983	36.81	37.25	30	16	138	17	
L2HH36H36	926	1045	36.81	37.25	36	16	145	18	
L2HH42H36	1003	1153	36.81	37.25	42	16	163	19	
L2HH48H36	1267	1422	36.81	37.25	48	16	180	22	
L2HH54H36	1500	1656	36.81	37.25	54	16	208	26	
L2HH60H36	1533	1726	36.81	37.25	60	16	216	29	
L2HH66H36	1615	1832	36.81	37.25	66	16	233	30	
L2HH72H36	1658	1891	36.81	37.25	72	16	251	32	
L2HH78H36	1753	2048	36.81	37.25	78	16	264	46	
L2HH84H36	1804	2072	36.81	37.25	84	16	277	50	
L2HH30H43	942	1038	43.81	44.25	30	16	158	19	
L2HH36H43	973	1094	43.81	44.25	36	16	166	20	
L2HH42H43	1074	1233	43.81	44.25	42	16	175	22	
L2HH48H43	1325	1475	43.81	44.25	48	16	191	24	
L2HH54H43	1540	1719	43.81	44.25	54	16	209	31	
L2HH60H43	1594	1788	43.81	44.25	60	16	227	32	
L2HH66H43	1681	1898	43.81	44.25	66	16	249	33	
L2HH72H43	1759	1994	43.81	44.25	72	16	259	36	
L2HH78H43	1826	2118	43.81	44.25	78	16	272	48	
L2HH84H43	1874	2152	43.81	44.25	84	16	285	53	

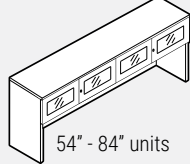
**L2HH-A • Hutch with Aluminum Hinged Doors**



30" - 42" units



48" units

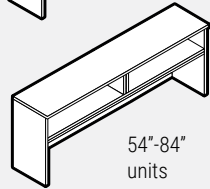
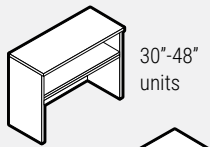
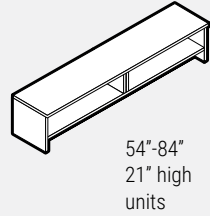
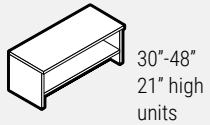


54" - 84" units

- 30" - 42" units come with one lock.
- 48" - 84" units come with two locks.
- Door frame is anodized aluminum.
- Glazing is frosted acrylic.
- Doors standard with no handles.
- E-locks not available for aluminum framed glass doors.

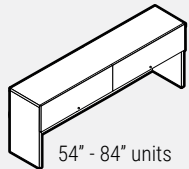
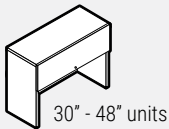
PRODUCT CODE	FINISH		SIZE/INCHES				WEIGHT		VOL FT <sup>3</sup>
	LP	W	H(LP)	H(W)	W	D	LBS		
L2HH30H36A	1392	1495	36.81	37.25	30	16	138	17	
L2HH36H36A	1473	1592	36.81	37.25	36	16	145	18	
L2HH42H36A	1568	1684	36.81	37.25	42	16	163	19	
L2HH48H36A	2057	2209	36.81	37.25	48	16	180	22	
L2HH54H36A	2505	2664	36.81	37.25	54	16	208	26	
L2HH60H36A	2571	2765	36.81	37.25	60	16	216	29	
L2HH66H36A	2665	2692	36.81	37.25	66	16	233	30	
L2HH72H36A	2735	2967	36.81	37.25	72	16	251	32	
L2HH78H36A	2831	3126	36.81	37.25	78	16	264	46	
L2HH84H36A	2911	3194	36.81	37.25	84	16	277	50	
L2HH30H43A	1457	1554	43.81	44.25	30	16	158	19	
L2HH36H43A	1524	1642	43.81	44.25	36	16	166	20	
L2HH42H43A	1639	1800	43.81	44.25	42	16	175	22	
L2HH48H43A	2114	2264	43.81	44.25	48	16	191	24	
L2HH54H43A	2565	2725	43.81	44.25	54	16	209	31	
L2HH60H43A	2633	2829	43.81	44.25	60	16	227	32	
L2HH66H43A	2731	2852	43.81	44.25	66	16	249	33	
L2HH72H43A	2843	3079	43.81	44.25	72	16	259	36	
L2HH78H43A	2904	3195	43.81	44.25	78	16	272	48	
L2HH84H43A	2987	3262	43.81	44.25	84	16	285	53	

**L2HO • Open Hutch**



PRODUCT CODE	FINISH LP	W	SIZE/INCHES				WEIGHT		VOL FT <sup>3</sup>
			H(LP)	H(W)	W	D	LBS		
L2HO30H21	486	596	20.56	21	30	16	73	11	
L2HO36H21	534	623	20.56	21	36	16	81	13	
L2HO42H21	592	749	20.56	21	42	16	96	15	
L2HO48H21	658	823	20.56	21	48	16	100	18	
L2HO54H21	792	959	20.56	21	54	16	124	20	
L2HO60H21	820	1027	20.56	21	60	16	134	22	
L2HO66H21	874	1107	20.56	21	66	16	144	24	
L2HO72H21	908	1156	20.56	21	72	16	152	26	
L2HO78H21	960	1205	20.56	21	78	16	161	29	
L2HO84H21	1006	1300	20.56	21	84	16	169	31	
L2HO30H36	593	701	36.81	37.25	30	16	91	18	
L2HO36H36	645	774	36.81	37.25	36	16	109	19	
L2HO42H36	712	867	36.81	37.25	42	16	127	22	
L2HO48H36	823	985	36.81	37.25	48	16	131	24	
L2HO54H36	930	1096	36.81	37.25	54	16	145	29	
L2HO60H36	963	1171	36.81	37.25	60	16	138	31	
L2HO66H36	1026	1262	36.81	37.25	66	16	142	33	
L2HO72H36	1072	1323	36.81	37.25	72	16	149	36	
L2HO78H36	1129	1441	36.81	37.25	78	16	154	46	
L2HO84H36	1188	1474	36.81	37.25	84	16	158	50	
L2HO30H43	661	701	43.81	44.25	30	16	99	22	
L2HO36H43	697	774	43.81	44.25	36	16	108	26	
L2HO42H43	825	867	43.81	44.25	42	16	122	31	
L2HO48H43	880	985	43.81	44.25	48	16	127	35	
L2HO54H43	1001	1096	43.81	44.25	54	16	151	40	
L2HO60H43	1095	1171	43.81	44.25	60	16	161	44	
L2HO66H43	1160	1262	43.81	44.25	66	16	171	48	
L2HO72H43	1245	1323	43.81	44.25	72	16	178	53	
L2HO78H43	1270	1441	43.81	44.25	78	16	187	57	
L2HO84H43	1332	1474	43.81	44.25	84	16	196	62	

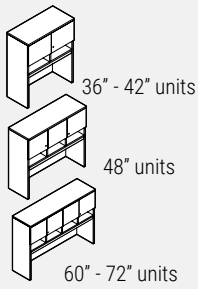
**L2HF • Hutch with Flip Up Doors**



- 30" - 48" units come with one lock.
- 54" - 84" units come with two locks.
- Optional e-lock available in the horizontal position. Please specify HR - Horizontal Right and add \$231 list.
- Hutches 48" or longer require two e-locks.

PRODUCT CODE	FINISH LP	W	SIZE/INCHES				WEIGHT		VOL FT <sup>3</sup>
			H(LP)	H(W)	W	D	LBS		
L2HF30H36	883	917	36.81	37.25	30	16	142	18	
L2HF36H36	941	977	36.81	37.25	36	16	146	19	
L2HF42H36	1012	1053	36.81	37.25	42	16	158	22	
L2HF48H36	1018	1060	36.81	37.25	48	16	180	24	
L2HF54H36	1527	1587	36.81	37.25	54	16	182	29	
L2HF60H36	1620	1686	36.81	37.25	60	16	220	31	
L2HF66H36	1696	1764	36.81	37.25	66	16	253	33	
L2HF72H36	1747	1817	36.81	37.25	72	16	259	36	
L2HF78H36	1827	1900	36.81	37.25	78	16	264	46	
L2HF84H36	1894	1970	36.81	37.25	84	16	275	50	
L2HF30H43	971	1007	43.81	44.25	30	16	150	22	
L2HF36H43	976	1018	43.81	44.25	36	16	154	26	
L2HF42H43	1052	1092	43.81	44.25	42	16	166	31	
L2HF48H43	1126	1170	43.81	44.25	48	16	188	35	
L2HF54H43	1543	1606	43.81	44.25	54	16	194	40	
L2HF60H43	1668	1735	43.81	44.25	60	16	232	44	
L2HF66H43	1753	1825	43.81	44.25	66	16	265	48	
L2HF72H43	1801	1870	43.81	44.25	72	16	271	53	
L2HF78H43	1934	2015	43.81	44.25	78	16	276	57	
L2HF84H43	2006	2087	43.81	44.25	84	16	287	62	

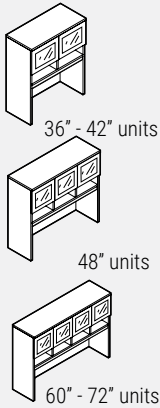
**L2HHP • Hutch with Laminate Doors and Pigeon Holes**



- For tackboards, please use LTB21xx.
- 36" - 42" units come with one lock.
- 48" - 72" units come with two locks.
- Optional e-lock available in the horizontal position. Please specify HR - Horizontal Right or HL - Horizontal Left for the 48" wide unit and add \$231 list.
- Hutches 48" or longer require two e-locks.

PRODUCT CODE	FINISH		SIZE/INCHES				WEIGHT		VOL FT <sup>3</sup>
	LP	W	H(LP)	H(W)	W	D	LBS		
L2HHP36	1125	1239	43.81	44.25	36	16	145	17	
L2HHP42	1194	1328	43.81	44.25	42	16	163	19	
L2HHP48	1608	1766	43.81	44.25	48	16	180	22	
L2HHP60	1947	2130	43.81	44.25	60	16	216	26	
L2HHP66	2007	2234	43.81	44.25	66	16	233	30	
L2HHP72	2091	2322	43.81	44.25	72	16	251	32	

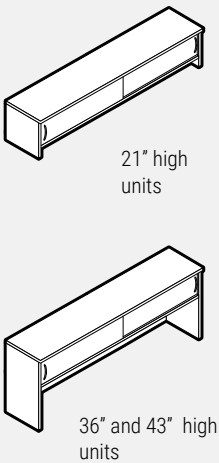
**L2HHP-A • Hutch with Aluminum Hinged Doors and Pigeon Holes**



- For tackboards, please use LTB21xx.
- 36" - 42" units come with one lock.
- 48" - 72" units come with two locks.
- Door frame is anodized aluminum.
- Glazing is frosted acrylic.
- Doors standard with no handles.
- E-locks not available for aluminum framed glass doors.

PRODUCT CODE	FINISH		SIZE/INCHES				WEIGHT		VOL FT <sup>3</sup>
	LP	W	H(LP)	H(W)	W	D	LBS		
L2HHP36A	1577	1695	43.81	37.25	36	16.8	132	15	
L2HHP42A	1720	1857	43.81	37.25	42	16.8	148	17	
L2HHP48A	2306	2463	43.81	37.25	48	16.8	164	20	
L2HHP60A	2851	3037	43.81	37.25	60	16.8	196	24	
L2HHP66A	2950	3177	43.81	37.25	66	16.8	212	27	
L2HHP72A	3072	3303	43.81	37.25	72	16.8	228	29	

**L2HSD • Hutch with Sliding Laminate Doors**

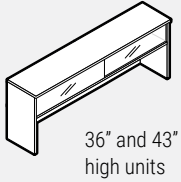
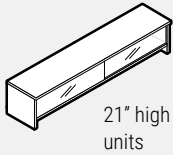


- One lock included.

PRODUCT CODE	FINISH		SIZE/INCHES				WEIGHT		VOL FT <sup>3</sup>
	LP	W	H(LP)	H(W)	W	D	LBS		
L2HSD48H21	1094	1262	20.56	21	48	16	122	18	
L2HSD54H21	1200	1389	20.56	21	54	16	146	20	
L2HSD60H21	1241	1451	20.56	21	60	16	156	22	
L2HSD66H21	1324	1554	20.56	21	66	16	166	24	
L2HSD72H21	1362	1586	20.56	21	72	16	174	26	
L2HSD78H21	1429	1721	20.56	21	78	16	183	29	
L2HSD84H21	1471	1759	20.56	21	84	16	191	31	
L2HSD48H36	1355	1529	36.81	37.25	48	16	141	24	
L2HSD54H36	1498	1670	36.81	37.25	54	16	165	29	
L2HSD60H36	1533	1748	36.81	37.25	60	16	175	31	
L2HSD66H36	1626	1867	36.81	37.25	66	16	185	33	
L2HSD72H36	1668	1906	36.81	37.25	72	16	193	36	
L2HSD78H36	1757	2087	36.81	37.25	78	16	201	46	
L2HSD84H36	1797	2117	36.81	37.25	84	16	210	50	
L2HSD48H43	1436	1609	43.81	44.25	48	16	149	35	
L2HSD54H43	1586	1751	43.81	44.25	54	16	173	40	
L2HSD60H43	1628	1843	43.81	44.25	60	16	183	44	
L2HSD66H43	1722	1962	43.81	44.25	66	16	193	48	
L2HSD72H43	1816	2057	43.81	44.25	72	16	200	53	
L2HSD78H43	1866	2191	43.81	44.25	78	16	209	57	
L2HSD84H43	1925	2223	43.81	44.25	84	16	218	62	

**L2HGSD • Hutch with Sliding Glass Doors**

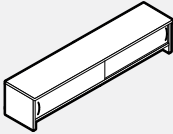
- One lock included.
- Glass is frosted tempered.



PRODUCT CODE	FINISH LP	W	SIZE/INCHES		W	D	WEIGHT VOL	
			H(LP)	H(W)			LBS	FT <sup>3</sup>
L2HGSD48H21	2349	2525	20.56	21	48	16	139	18
L2HGSD54H21	2476	2671	20.56	21	54	16	163	20
L2HGSD60H21	2526	2740	20.56	21	60	16	184	22
L2HGSD66H21	2619	2862	20.56	21	66	16	194	24
L2HGSD72H21	2680	2936	20.56	21	72	16	201	26
L2HGSD78H21	2779	3081	20.56	21	78	16	210	29
L2HGSD84H21	2847	3147	20.56	21	84	16	219	31
L2HGSD48H36	2497	2671	36.81	37.25	48	16	157	24
L2HGSD54H36	2653	2825	36.81	37.25	54	16	182	29
L2HGSD60H36	2692	2907	36.81	37.25	60	16	202	31
L2HGSD66H36	2795	3037	36.81	37.25	66	16	212	33
L2HGSD72H36	2862	3142	36.81	37.25	72	16	220	36
L2HGSD78H36	2977	3300	36.81	37.25	78	16	229	46
L2HGSD84H36	3055	3354	36.81	37.25	84	16	238	50
L2HGSD48H43	2555	2803	43.81	44.25	48	16	165	35
L2HGSD54H43	2692	2961	43.81	44.25	54	16	189	40
L2HGSD60H43	2755	3046	43.81	44.25	60	16	210	44
L2HGSD66H43	2862	3142	43.81	44.25	66	16	220	48
L2HGSD72H43	2936	3288	43.81	44.25	72	16	228	53
L2HGSD78H43	3049	3428	43.81	44.25	78	16	237	57
L2HGSD84H43	3133	3505	43.81	44.25	84	16	245	62

**L2DSH • Double Sided Hutch with Laminate Doors**

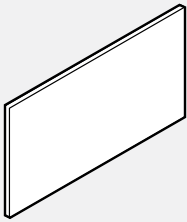
- Two locks included.



PRODUCT CODE	FINISH LP	W	SIZE/INCHES		W	D	WEIGHT VOL	
			H(LP)	H(W)			LBS	FT <sup>3</sup>
L2DSH60H21	1306	1516	20.56	21	60	16	156	22
L2DSH66H21	1391	1622	20.56	21	66	16	166	24
L2DSH72H21	1434	1633	20.56	21	72	16	201	26
L2DSH78H21	1508	1800	20.56	21	78	16	210	29
L2DSH84H21	1554	1840	20.56	21	84	16	219	31

**LTB27 • Tackboards for 43" High Hutches**

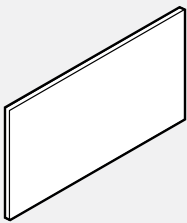
- Provides a tackable surface for notes and memos.
- Velcro for installation is included.
- Tackboards for hutches are 3" shorter than the overall size of the hutch.



PRODUCT CODE	FABRIC		SIZE/INCHES			WEIGHT LBS	VOL FT <sup>3</sup>
	GR1	GR2	H	W	D		
LTB2727	307	324	27	27	1	7	0.46
LTB2733	333	354	27	33	1	7	0.57
LTB2739	363	389	27	39	1	7	0.67
LTB2745	411	441	27	45	1	8	0.78
LTB2751	473	501	27	51	1	8	0.88
LTB2757	527	555	27	57	1	9	0.98
LTB2763	581	610	27	63	1	9	1.09
LTB2769	639	672	27	69	1	10	1.19
LTB2775	717	752	27	75	1	10	1.30
LTB2781	800	835	27	81	1	11	1.40

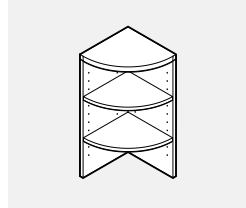
**LTB21 • Tackboards for 36" High Hutches**

- Provides a tackable surface for notes and memos.
- Velcro for installation is included.
- Tackboards for hutches are 3" shorter than the overall size of the hutch.



PRODUCT CODE	FABRIC		SIZE/INCHES			WEIGHT LBS	VOL FT <sup>3</sup>
	GR1	GR2	H	W	D		
LTB2127	240	260	21	27	1	4	0.38
LTB2133	261	281	21	33	1	4	0.42
LTB2139	283	312	21	39	1	4	0.49
LTB2145	323	351	21	45	1	5	0.56
LTB2151	370	383	21	51	1	5	0.63
LTB2157	411	441	21	57	1	6	0.69
LTB2163	455	488	21	63	1	6	0.76
LTB2169	501	528	21	69	1	7	0.83
LTB2175	561	589	21	75	1	7	0.89
LTB2181	626	655	21	81	1	8	0.96

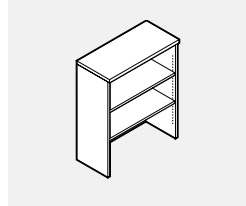
**L2HC • Corner Curved Bookcase**



- Shipped knocked down (KD).

PRODUCT CODE	FINISH LP	W	SIZE/INCHES				WEIGHT LBS	VOL FT <sup>3</sup>
			H(LP)	H(W)	W	D		
L2HC1637	636	733	36.81	37.25	16.87	16.87	57	7
L2HC1644	676	775	43.81	44.25	16.87	16.87	63	8

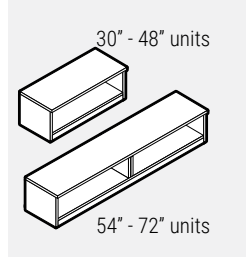
**L2HBK • Open Hutch Bookcase**



- Shipped knocked down (KD).

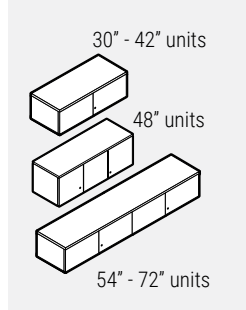
PRODUCT CODE	FINISH LP	W	SIZE/INCHES				WEIGHT LBS	VOL FT <sup>3</sup>
			H(LP)	H(W)	W	D		
L2HBK303	746	870	36.81	37.25	30	16.875	109	12
L2HBK363	805	956	43.81	44.25	36	16.875	123	14
L2HBK304	817	942	36.81	37.25	30	16.875	119	13
L2HBK364	862	1011	43.81	44.25	36	16.875	135	17

**L2WHO • Wall Mounted Open Storage**



PRODUCT CODE	FINISH LP	W	SIZE/INCHES				WEIGHT LBS	VOL FT <sup>3</sup>
			H(LP/B)	H(W)	W	D		
L2WHO30	536	636	16.75	17.18	30	16	69	7
L2WHO36	570	717	16.75	17.18	36	16	78	8
L2WHO42	658	800	16.75	17.18	42	16	87	9
L2WHO48	698	856	16.75	17.18	48	16	97	10
L2WHO54	755	952	16.75	17.18	54	16	106	11
L2WHO60	942	1063	16.75	17.18	60	16	117	12
L2WHO66	988	1096	16.75	17.18	66	16	125	13
L2WHO72	1033	1205	16.75	17.18	72	16	139	14

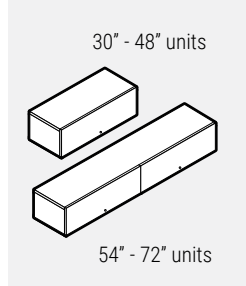
**L2WHH • Wall Mounted Hinged Door**



- 30" - 42" units come with one lock.
- 48" - 72" units come with two locks.
- Optional e-lock available in the horizontal position. Please specify HR - Horizontal Right or HL - Horizontal Left for the 48" wide unit and add \$231 list.
- Hutches 48" or longer require two e-locks.

PRODUCT CODE	FINISH LP	W	SIZE/INCHES				WEIGHT LBS	VOL FT <sup>3</sup>
			H(LP/B)	H(W)	W	D		
L2WHH30	722	800	16.75	17.18	30	16	120	7
L2WHH36	775	867	16.75	17.18	36	16	139	8
L2WHH42	846	960	16.75	17.18	42	16	143	9
L2WHH48	1060	1182	16.75	17.18	48	16	145	10
L2WHH54	1257	1395	16.75	17.18	54	16	155	11
L2WHH60	1300	1409	16.75	17.18	60	16	165	12
L2WHH66	1360	1487	16.75	17.18	66	16	175	13
L2WHH72	1417	1606	16.75	17.18	72	16	187	14

**L2WHF • Wall Mounted Flip-up Door**

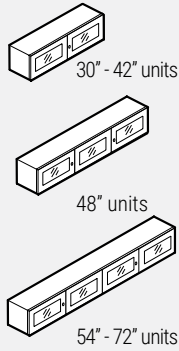


- 30" - 48" units come with one lock.
- 54" - 72" units come with two locks.
- Optional e-lock available in the horizontal position. Please specify HR - Horizontal Right or HL - Horizontal Left add \$231 list.
- Hutches 54" or longer require two e-locks.

PRODUCT CODE	FINISH LP	W	SIZE/INCHES				WEIGHT LBS	VOL FT <sup>3</sup>
			H(LP/B)	H(W)	W	D		
L2WHF30	805		17.63	17.63	30	16	94	7
L2WHF36	854		17.63	17.63	36	16	103	8
L2WHF42	930		17.63	17.63	42	16	113	9
L2WHF48	976		17.63	17.63	48	16	123	10
L2WHF54	1441		17.63	17.63	54	16	130	11
L2WHF60	1484		17.63	17.63	60	16	141	12
L2WHF66	1573		17.63	17.63	66	16	151	13
L2WHF72	1613		17.63	17.63	72	16	163	14



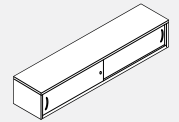
**L2WHH • Wall Mounted Unit with Aluminum Doors**



- Horizontal wall rails included.
- 30" - 42" units come with one lock.
- 48" - 72" units come with two locks.
- Door frame is anodized aluminum.
- Glazing is frosted acrylic.
- Doors standard with no handles.
- E-locks not available for aluminum framed glass doors.

PRODUCT CODE	FINISH LP	W	SIZE/INCHES				WEIGHT		VOL FT <sup>3</sup>
			H(LP/B)	H(W)	W	D	LBS		
L2WHH30A	1201	1278	16.75	17.19	30	16	109	6	
L2WHH36A	1296	1389	16.75	17.19	36	16	126	7	
L2WHH42A	1407	1524	16.75	17.19	42	16	130	8	
L2WHH48A	1800	1923	16.75	17.19	48	16	132	9	
L2WHH54A	2173	2313	16.75	17.19	54	16	141	10	
L2WHH60A	2259	2369	16.75	17.19	60	16	150	11	
L2WHH66A	2347	2473	16.75	17.19	66	16	159	12	
L2WHH72A	2461	2647	16.75	17.19	72	16	170	13	

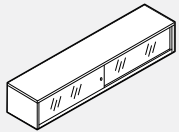
**L2WSD • Wall Mounted Unit with Sliding Laminate Doors**



- Wall mounting horizontal rails included.
- One lock included.

PRODUCT CODE	FINISH LP	W	SIZE/INCHES				WEIGHT		VOL FT <sup>3</sup>
			H(LP/B)	H(W)	W	D	LBS		
L2WSD36	1055	1186	16.75	17.19	36	16	128	7	
L2WSD42	1152	1304	16.75	17.19	42	16	130	8	
L2WSD48	1194	1348	16.75	17.19	48	16	132	9	
L2WSD54	1323	1508	16.75	17.19	54	16	141	10	
L2WSD60	1379	1585	16.75	17.19	60	16	150	11	
L2WSD66	1473	1711	16.75	17.19	66	16	159	12	
L2WSD72	1515	1769	16.75	17.19	72	16	170	13	

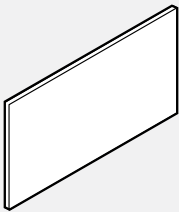
**L2WGSD • Wall Mounted Unit with Sliding Glass Doors**



- Wall mounting horizontal rails included.
- Standard recessed chrome pull.
- Lock is included and must be installed at time of manufacturing, please specify key number.
- Frosted tempered glass.

PRODUCT CODE	FINISH LP	W	SIZE/INCHES				WEIGHT		VOL FT <sup>3</sup>
			H(LP/B)	H(W)	W	D	LBS		
L2WGSD36	1959	2272	16.75	17.19	36	16	128	7	
L2WGSD42	2290	2449	16.75	17.19	42	16	130	8	
L2WGSD48	2347	2521	16.75	17.19	48	16	132	9	
L2WGSD54	2454	2647	16.75	17.19	54	16	141	10	
L2WGSD60	2519	2732	16.75	17.19	60	16	150	11	
L2WGSD66	2625	2869	16.75	17.19	66	16	159	12	
L2WGSD72	2725	2983	16.75	17.19	72	16	170	13	

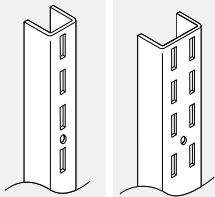
**LTB20 • Tackboards for Wall Mounted Units**



- Please specify wall rails BHV01 and BHV02 separately, see Boulevard Price List.
- Provides a tackable surface for notes and memos.
- Mounting brackets for installation included.
- Tackboards for Wall Mounted Unit. Wall Rails (BHV01 and BHV02) must be ordered separately.
- For tackboards longer than 60", please include an additional BHV01 at the centre.

PRODUCT CODE	FABRIC		SIZE/INCHES			WEIGHT		VOL FT <sup>3</sup>
	GR1	GR2	H	W	D	LBS		
LTB2030	240	264	19.5	30	1	4	0.38	
LTB2036	261	284	19.5	36	1	4	0.42	
LTB2042	283	298	19.5	42	1	4	0.49	
LTB2048	323	339	19.5	48	1	5	0.56	
LTB2054	370	380	19.5	54	1	5	0.63	
LTB2060	411	433	19.5	60	1	6	0.69	
LTB2066	455	483	19.5	66	1	6	0.76	
LTB2072	501	528	19.5	72	1	7	0.83	
LTB2078	561	595	19.5	78	1	7	0.89	
LTB2084	626	670	19.5	84	1	8	0.96	

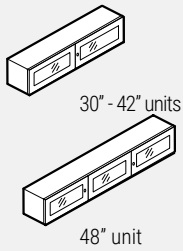
**BHV • Component Wall Adapter - Single and Double**



- Used to attach system components to fixed wall.
- Panel frame finish.
- The vertical wall adapter is a "U" shaped channel with a vertical row of slots with 1" centers.
- The double Component Wall Adapter has a double row of slots with 1" centers.
- Comes in 60" length only.
- Care should be taken to mount adapters only to wall studs using correct fasteners.
- Does not include mounting hardware. Mounting hardware selection to be based on wall material.
- Failure to do this may result in collapse of the unit and subsequent possible personal injury.
- Sold in pairs.

PRODUCT CODE	PRICE	SIZE/INCHES			WEIGHT		VOL FT <sup>3</sup>
		H	W	D	LBS		
BHV01	102	60	0.75	0.5	4	0.009	
BHV02	117	60	1.50	0.5	5	0.026	

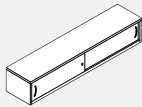
**L2PHH • Boulevard Panel Mounted Unit with Aluminum Doors**



- 30" - 42" units comes with one lock
- 48" Unit comes with two locks.
- Door frame is anodized aluminum.
- Glazing is frosted acrylic.
- Doors standard with no handles.
- E-locks not available for aluminum framed glass doors.

PRODUCT CODE	FINISH LP	W	SIZE/INCHES		W	D	WEIGHT		VOL FT <sup>3</sup>
			H(LP/B)	H(W)			LBS	FT <sup>3</sup>	
L2PHH30A	1339	1473	16.75	17.19	30	14.75	111	6	
L2PHH36A	1426	1585	16.75	17.19	36	14.75	128	7	
L2PHH42A	1529	1712	16.75	17.19	42	14.75	132	8	
L2PHH48A	1906	2154	16.75	17.19	48	14.75	134	9	

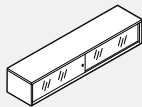
**L2PSD • Boulevard Panel Mounted Unit with Sliding Laminate Doors**



- Hardware included to mount the unit on the panel.
- One lock included.

PRODUCT CODE	FINISH LP	W	SIZE/INCHES		W	D	WEIGHT		VOL FT <sup>3</sup>
			H(LP/B)	H(W)			LBS	FT <sup>3</sup>	
L2PSD36	1112	1237	16.75	17.19	36	14.75	123	7	
L2PSD42	1188	1343	16.75	17.19	42	14.75	132	8	
L2PSD48	1214	1370	16.75	17.19	48	14.75	141	9	

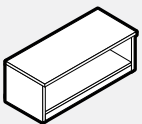
**L2PGSD • Boulevard Panel Mounted Unit with Sliding Glass Doors**



- Hardware included to mount the unit on the panel.
- One lock included.
- Standard recessed chrome pull.

PRODUCT CODE	FINISH LP	W	SIZE/INCHES		W	D	WEIGHT		VOL FT <sup>3</sup>
			H(LP/B)	H(W)			LBS	FT <sup>3</sup>	
L2PGSD36	2236	2363	16.75	17.19	36	14.75	123	7	
L2PGSD42	2329	2491	16.75	17.19	42	14.75	132	8	
L2PGSD48	2371	2542	16.75	17.19	48	14.75	141	9	

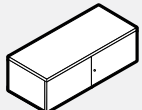
**L2PHO • Boulevard Panel Mounted Unit Open Overhead**



- Hardware included to mount the unit on the panel.

PRODUCT CODE	FINISH LP	W	SIZE/INCHES		W	D	WEIGHT		VOL FT <sup>3</sup>
			H(LP/B)	H(W)			LBS	FT <sup>3</sup>	
L2PHO30	557	641	16.75	17.18	30	14.75	72	7	
L2PHO36	592	723	16.75	17.18	36	14.75	80	8	
L2PHO42	608	784	16.75	17.18	42	14.75	89	9	
L2PHO48	643	852	16.75	17.18	48	14.75	99	10	

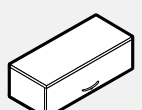
**L2PHH • Boulevard Panel Mounted Hinged Door Overhead**



- Hardware included to mount the unit on the panel.
- One lock included.
- Optional e-lock available in the horizontal position. Please specify HR - Horizontal Right or HL - Horizontal Left for the 48" wide unit and add \$231 list.
- Hutches 48" or longer require two e-locks.

PRODUCT CODE	FINISH LP	W	SIZE/INCHES		W	D	WEIGHT		VOL FT <sup>3</sup>
			H(LP/B)	H(W)			LBS	FT <sup>3</sup>	
L2PHH30	860	994	16.75	17.18	30	14.75	122	7	
L2PHH36	905	1064	16.75	17.18	36	14.75	141	8	
L2PHH42	969	1148	16.75	17.18	42	14.75	145	9	
L2PHH48	1168	1415	16.75	17.18	48	14.75	147	10	

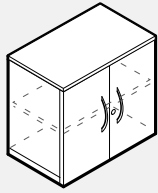
**L2PHF • Boulevard Panel Mounted Flip-up Door Overhead**



- Hardware included to mount the unit on the panel.
- One lock included.
- Optional e-lock available in the horizontal position. Please specify HR - Horizontal Right and add \$231 list.

PRODUCT CODE	FINISH LP	SIZE/INCHES		W	D	WEIGHT		VOL FT <sup>3</sup>
		H(LP)	H(W)			LBS	FT <sup>3</sup>	
L2PHF30	877	17.63	17.19	30	16	94	7	
L2PHF36	920	17.63	17.19	36	16	103	8	
L2PHF42	971	17.63	17.19	42	16	113	9	
L2PHF48	1023	17.63	17.19	48	16	123	10	

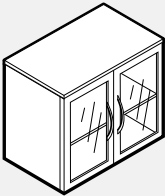
**L2SOHD • Stack On 2H Cabinet with Hinged Doors & Adjustable Shelf for 1H Storage**



- One lock included.
- Optional e-lock available in the horizontal position. Please specify HR - Horizontal Right and add \$231 list.

PRODUCT CODE	FINISH LP	W	SIZE/INCHES				WEIGHT LBS	VOL FT <sup>3</sup>
			H(LP)	H(W)	W	D		
<b>one door</b>								
L2SOHDL15	645	718	29.63	29.63	15	16	95	7
L2SOHDR15	645	718	29.63	29.63	15	16	95	7
L2SOHDL18	661	734	29.63	29.63	18	16	99	9
L2SOHDR18	661	734	29.63	29.63	18	16	99	9
<b>double door</b>								
L2SOHD30	928	1037	29.63	29.63	30	16	171	11
L2SOHD36	1034	1168	29.63	29.63	36	16	178	13

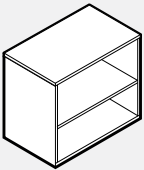
**L2SOALD • Stack On 2H Cabinet with Aluminum Hinged Doors & Adjustable Shelf for 1H Storage**



- No lock available for the one door units, one lock included for the double door units.
- Door frame is anodized aluminum.
- Glazing is frosted acrylic.
- Doors standard with no handles.
- E-locks not available for aluminum framed glass doors.

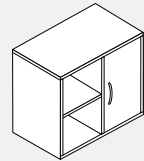
PRODUCT CODE	FINISH LP	W	SIZE/INCHES				WEIGHT LBS	VOL FT <sup>3</sup>
			H(LP)	H(W)	W	D		
<b>one door</b>								
L2SOALDL15	1074	1144	29.63	29.63	15	16	88	7
L2SOALDR15	1074	1144	29.63	29.63	15	16	88	7
L2SOALDL18	1122	1194	29.63	29.63	18	16	94	9
L2SOALDR18	1122	1194	29.63	29.63	18	16	94	9
<b>double door</b>								
L2SOALD30	1817	1928	29.63	29.63	30	16	164	11
L2SOALD36	1970	2099	29.63	29.63	36	16	172	13

**L2SOO • Stack On 2H Cabinet with Adjustable Shelf for 1H Storage**



PRODUCT CODE	FINISH LP	W	SIZE/INCHES				WEIGHT LBS	VOL FT <sup>3</sup>
			H(LP)	H(W)	W	D		
L2SOO15	473	548	29.63	29.63	15	16	61	7
L2SOO18	484	562	29.63	29.63	18	16	72	8
L2SOO30	622	741	29.63	29.63	30	16	88	14
L2SOO36	725	870	29.63	29.63	36	16	94	19

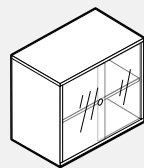
**L2SOSD • Stack On 2H Cabinet with Sliding Door, Divider & Adjustable Shelves for 1H Storage**



- Includes one sliding door.
- Lock not included.

PRODUCT CODE	FINISH LP	W	SIZE/INCHES				WEIGHT LBS	VOL FT <sup>3</sup>
			H(LP)	H(W)	W	D		
L2SOSD30	952	1062	29.63	29.63	30	16	116	14
L2SOSD36	1119	1255	29.63	29.63	36	16	121	19

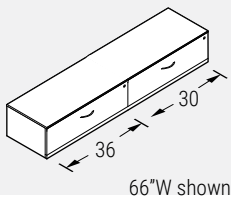
**L2SOGSD • Stack On 2H Cabinet with Sliding Glass Doors & Adjustable Shelf for 1H Storage**



- One lock included.
- Standard recessed chrome pull.
- Glass is frosted tempered.

PRODUCT CODE	FINISH LP	W	SIZE/INCHES				WEIGHT LBS	VOL FT <sup>3</sup>
			H(LP)	H(W)	W	D		
L2SOGSD30	2240	2337	29.63	29.63	30	16	116	14
L2SOGSD36	2450	2568	29.63	29.63	36	16	121	19

**L2CR1H1H • Credenza, 1 High File / File**

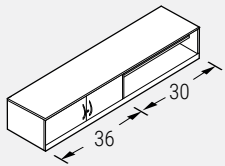


66"W shown

- Two locks included.
- Optional e-lock available in the vertical position. Please specify V - Vertical and add \$231 list.
- Hutches 48" or longer require two e-locks.

PRODUCT CODE	FINISH LP	B	W	SIZE/INCHES				WEIGHT LBS	VOL FT <sup>3</sup>
				H(LP/B)	H(W)	W	D		
L2CR1H1H2060	1714	1803	1842	19.94	20.5	60	20	189	22
L2CR1H1H2066	1797	1892	1933	19.94	20.5	66	20	209	24
L2CR1H1H2072	1822	1928	1973	19.94	20.5	72	20	246	26
L2CR1H1H2460	1782	1874	1918	19.94	20.5	60	24	189	22
L2CR1H1H2466	1867	1963	2014	19.94	20.5	66	24	209	24
L2CR1H1H2472	1894	2006	2053	19.94	20.5	72	24	246	26

**L2CR2DO • Credenza, 1 High 2 Doors / Open Shelf**

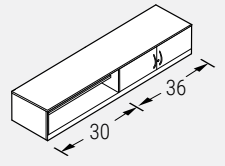


66"W shown

- One lock included.
- One height adjustable shelf included.
- Optional e-lock available in the horizontal position. Please specify HR - Horizontal Right and add \$231 list.

PRODUCT CODE	FINISH			SIZE/INCHES				WEIGHT		VOL FT <sup>3</sup>
	LP	B	W	H(LP/B)	H(W)	W	D	LBS		
L2CR2DO2060	1469	1629	1718	19.94	20.5	60	20	169	22	
L2CR2DO2066	1533	1711	1805	19.94	20.5	66	20	180	24	
L2CR2DO2072	1601	1797	1900	19.94	20.5	72	20	191	26	
L2CR2DO2460	1526	1695	1785	19.94	20.5	60	24	169	22	
L2CR2DO2466	1594	1779	1878	19.94	20.5	66	24	180	24	
L2CR2DO2472	1666	1866	1976	19.94	20.5	72	24	191	26	

**L2CRO2D • Credenza, 1 High Open Shelf / 2 Doors**

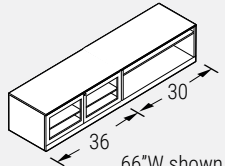


66"W shown

- One lock included.
- One height adjustable shelf included.
- Optional e-lock available in the horizontal position. Please specify HR - Horizontal Right and add \$231 list.

PRODUCT CODE	FINISH			SIZE/INCHES				WEIGHT		VOL FT <sup>3</sup>
	LP	B	W	H(LP/B)	H(W)	W	D	LBS		
L2CRO2D2060	1469	1629	1718	19.94	20.5	60	20	169	22	
L2CRO2D2066	1533	1711	1805	19.94	20.5	66	20	180	24	
L2CRO2D2072	1601	1797	1900	19.94	20.5	72	20	191	26	
L2CRO2D2460	1526	1695	1785	19.94	20.5	60	24	169	22	
L2CRO2D2466	1594	1779	1878	19.94	20.5	66	24	180	24	
L2CRO2D2472	1666	1866	1976	19.94	20.5	72	24	191	26	

**L2CR2ADO • Credenza, 2 Aluminum Doors / 1 High Open Shelf**

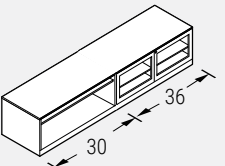


66"W shown

- One lock included.
- One height adjustable shelf included.
- Door frame is anodized aluminum.
- Glazing is frosted acrylic.
- Doors standard with no handles.

PRODUCT CODE	FINISH			SIZE/INCHES				WEIGHT		VOL FT <sup>3</sup>
	LP	B	W	H(LP/B)	H(W)	W	D	LBS		
L2CR2ADO2060	1957	2118	2208	19.94	20.5	60	20	154	20	
L2CR2ADO2066	2062	2240	2334	19.94	20.5	66	20	164	22	
L2CR2ADO2072	2129	2324	2432	19.94	20.5	72	20	174	24	
L2CR2ADO2460	2016	2183	2275	19.94	20.5	60	24	154	20	
L2CR2ADO2466	2125	2310	2409	19.94	20.5	66	24	164	22	
L2CR2ADO2472	2194	2394	2503	19.94	20.5	72	24	174	24	

**L2CRO2AD • Credenza, 1 High Open Shelf / 2 Aluminum Doors**

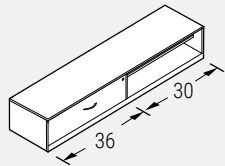


66"W shown

- One lock included.
- One height adjustable shelf included.
- Door frame is anodized aluminum.
- Glazing is frosted acrylic.
- Doors standard with no handles.

PRODUCT CODE	FINISH			SIZE/INCHES				WEIGHT		VOL FT <sup>3</sup>
	LP	B	W	H(LP/B)	H(W)	W	D	LBS		
L2CRO2AD2060	1957	2118	2208	19.94	20.5	60	20	154	20	
L2CRO2AD2066	2062	2240	2334	19.94	20.5	66	20	164	22	
L2CRO2AD2072	2129	2324	2432	19.94	20.5	72	20	174	24	
L2CRO2AD2460	2016	2183	2275	19.94	20.5	60	24	154	20	
L2CRO2AD2466	2125	2310	2409	19.94	20.5	66	24	164	22	
L2CRO2AD2472	2194	2394	2503	19.94	20.5	72	24	174	24	

**L2CR1HO • Credenza, 1 High File / Open Shelf**

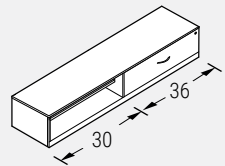


66"W shown

- One lock included.
- One height adjustable shelf included.
- Optional e-lock available in the vertical position. Please specify V - Vertical and add \$231 list.

PRODUCT CODE	FINISH			SIZE/INCHES				WEIGHT		VOL FT <sup>3</sup>
	LP	B	W	H(LP/B)	H(W)	W	D	LBS		
L2CR1HO2060	1491	1622	1717	19.94	20.5	60	20	179	22	
L2CR1HO2066	1554	1696	1809	19.94	20.5	66	20	189	24	
L2CR1HO2072	1668	1825	1914	19.94	20.5	72	20	200	26	
L2CR1HO2460	1550	1687	1783	19.94	20.5	60	24	179	22	
L2CR1HO2466	1616	1762	1879	19.94	20.5	66	24	189	24	
L2CR1HO2472	1735	1895	1990	19.94	20.5	72	24	200	26	

**L2CRO1H • Credenza, Open Shelf / 1 High File**

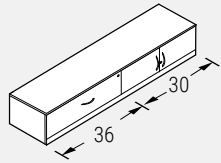


66"W shown

- One lock included.
- One height adjustable shelf included.
- Optional e-lock available in the vertical position. Please specify V - Vertical and add \$231 list.

PRODUCT CODE	FINISH			SIZE/INCHES				WEIGHT		VOL FT <sup>3</sup>
	LP	B	W	H(LP/B)	H(W)	W	D	LBS		
L2CRO1H2060	1491	1622	1717	19.94	20.5	60	20	179	22	
L2CRO1H2066	1554	1696	1809	19.94	20.5	66	20	189	24	
L2CRO1H2072	1668	1825	1914	19.94	20.5	72	20	200	26	
L2CRO1H2460	1550	1687	1783	19.94	20.5	60	24	179	22	
L2CRO1H2466	1616	1762	1879	19.94	20.5	66	24	189	24	
L2CRO1H2472	1735	1895	1990	19.94	20.5	72	24	200	26	

**L2CRO1H • Credenza, 1 High File / 2 Door**

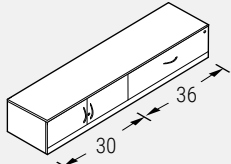


66"W shown

- Two locks included.
- Optional e-lock available in the vertical position for the file drawer. Please specify V - Vertical and add \$231 list.
- Optional e-lock available in the horizontal position. Please specify HR - Horizontal Right and add \$231 list.

PRODUCT CODE	FINISH			SIZE/INCHES				WEIGHT		VOL FT <sup>3</sup>
	LP	B	W	H(LP/B)	H(W)	W	D	LBS		
L2CR1H2D2060	1814	1906	2029	19.94	20.5	60	20	199	22	
L2CR1H2D2066	1832	1936	2193	19.94	20.5	66	20	209	24	
L2CR1H2D2072	1947	2142	2246	19.94	20.5	72	20	220	26	
L2CR1H2D2460	1889	1984	2115	19.94	20.5	60	24	199	22	
L2CR1H2D2466	1904	2017	2281	19.94	20.5	66	24	209	24	
L2CR1H2D2472	2021	2227	2334	19.94	20.5	72	24	220	26	

**L2CR2D1H • Credenza, 2 Door / 1 High File**

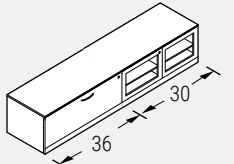


66"W shown

- Two locks included.
- Optional e-lock available in the vertical position for the file drawer. Please specify V - Vertical and add \$231 list.
- Optional e-lock available in the horizontal position. Please specify HR - Horizontal Right and add \$231 list.

PRODUCT CODE	FINISH			SIZE/INCHES				WEIGHT		VOL FT <sup>3</sup>
	LP	B	W	H(LP/B)	H(W)	W	D	LBS		
L2CR2D1H2060	1814	1906	2029	19.94	20.5	60	20	199	22	
L2CR2D1H2066	1832	1936	2193	19.94	20.5	66	20	209	24	
L2CR2D1H2072	1947	2142	2246	19.94	20.5	72	20	220	26	
L2CR2D1H2460	1889	1984	2115	19.94	20.5	60	24	199	22	
L2CR2D1H2466	1904	2017	2281	19.94	20.5	66	24	209	24	
L2CR2D1H2472	2021	2227	2334	19.94	20.5	72	24	220	26	

**L2CR1H2AD • Credenza, 1 High File / 2 Aluminum Door**

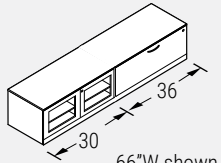


66"W shown

- Two locks included.
- One height adjustable shelf included.
- Door frame is anodized aluminum.
- Glazing is frosted acrylic.
- Doors standard with no handles.
- Optional e-lock available in the vertical position. Please specify V - Vertical and add \$231 list.
- E-locks not available for aluminum framed glass doors.

PRODUCT CODE	FINISH			SIZE/INCHES				WEIGHT		VOL FT <sup>3</sup>
	LP	B	W	H(LP/B)	H(W)	W	D	LBS		
L2CR1H2AD2060	2303	2394	2522	19.94	20.5	60	20	181	20	
L2CR1H2AD2066	2363	2469	2722	19.94	20.5	66	20	190	22	
L2CR1H2AD2072	2474	2671	2777	19.94	20.5	72	20	200	24	
L2CR1H2AD2460	2377	2472	2603	19.94	20.5	60	24	181	20	
L2CR1H2AD2466	2435	2546	2811	19.94	20.5	66	24	190	22	
L2CR1H2AD2472	2552	2757	2866	19.94	20.5	72	24	200	24	

**L2CR2AD1H • Credenza, 2 Aluminum Door / 1 High File**

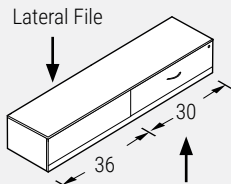


66"W shown

- Two locks included.
- One height adjustable shelf included.
- Door frame is anodized aluminum.
- Glazing is frosted acrylic.
- Doors standard with no handles.
- Optional e-lock available in the vertical position. Please specify V - Vertical and add \$231 list.
- E-locks not available for aluminum framed glass doors.

PRODUCT CODE	FINISH			SIZE/INCHES				WEIGHT		VOL FT <sup>3</sup>
	LP	B	W	H(LP/B)	H(W)	W	D	LBS		
L2CR2AD1H2060	2303	2394	2522	19.94	20.5	60	20	181	20	
L2CR2AD1H2066	2363	2469	2722	19.94	20.5	66	20	190	22	
L2CR2AD1H2072	2474	2671	2777	19.94	20.5	72	20	200	24	
L2CR2AD1H2460	2377	2472	2603	19.94	20.5	60	24	181	20	
L2CR2AD1H2466	2435	2546	2811	19.94	20.5	66	24	190	22	
L2CR2AD1H2472	2552	2757	2866	19.94	20.5	72	24	200	24	

**L2DSCR1H • Double Sided 1H Credenza Lateral**

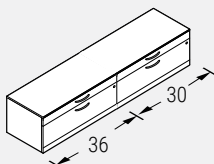


Lateral File  
66"W shown

- Two locks included.
- Optional e-lock available in the vertical position. Please specify V - Vertical and add \$231 list.
- Credenzas require two e-locks.

PRODUCT CODE	FINISH			SIZE/INCHES				WEIGHT		VOL FT <sup>3</sup>
	LP	B	W	H(LP/B)	H(W)	W	D	LBS		
L2DSCR1H2060	2020	2118	2188	19.94	20.5	60	20	196	22	
L2DSCR1H2066	2085	2191	2281	19.94	20.5	66	20	206	24	
L2DSCR1H2072	2148	2264	2374	19.94	20.5	72	20	217	26	
L2DSCR1H2460	2100	2202	2275	19.94	20.5	60	24	196	22	
L2DSCR1H2466	2165	2279	2371	19.94	20.5	66	24	206	24	
L2DSCR1H2472	2233	2354	2469	19.94	20.5	72	24	217	26	

**L2CRBFBF • Credenza, BF / BF**



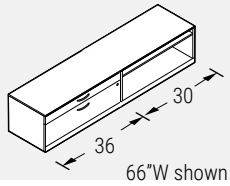
66"W shown

- Two locks included.
- Optional e-lock available in the vertical position. Please specify V - Vertical and add \$231 list.
- Credenzas require two e-locks.

PRODUCT CODE	FINISH			SIZE/INCHES				WEIGHT		VOL FT <sup>3</sup>
	LP	B	W	H(LP/B)	H(W)	W	D	LBS		
L2CRBFBF2060	2292	2381	2419	19.94	20.5	60	20	218	20	
L2CRBFBF2066	2383	2481	2525	19.94	20.5	66	20	228	22	
L2CRBFBF2072	2423	2529	2574	19.94	20.5	72	20	239	24	
L2CRBFBF2460	2363	2454	2497	19.94	20.5	60	24	218	20	
L2CRBFBF2466	2459	2559	2603	19.94	20.5	66	24	228	22	
L2CRBFBF2472	2497	2606	2654	19.94	20.5	72	24	239	24	



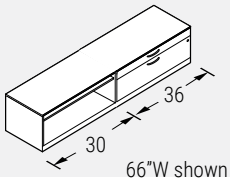
**L2CRBFO • Credenza, BF / Open**



- One lock included.
- One height adjustable shelf included.
- Optional e-lock available in the vertical position. Please specify V - Vertical and add \$231 list.

PRODUCT CODE	FINISH			SIZE/INCHES				WEIGHT LBS	VOL FT <sup>3</sup>
	LP	B	W	H(LP/B)	H(W)	W	D		
L2CRBFO2060	1780	1912	2006	19.94	20.5	60	20	202	20
L2CRBFO2066	1856	1996	2108	19.94	20.5	66	20	220	22
L2CRBFO2072	1969	2125	2213	19.94	20.5	72	20	254	24
L2CRBFO2460	1853	1987	2087	19.94	20.5	60	24	202	20
L2CRBFO2466	1929	2076	2193	19.94	20.5	66	24	220	22
L2CRBFO2472	2048	2210	2302	19.94	20.5	72	24	254	24

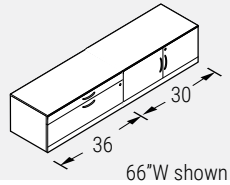
**L2CROBF • Credenza, Open / BF**



- One lock included.
- One height adjustable shelf included.
- Optional e-lock available in the vertical position. Please specify V - Vertical and add \$231 list.

PRODUCT CODE	FINISH			SIZE/INCHES				WEIGHT LBS	VOL FT <sup>3</sup>
	LP	B	W	H(LP/B)	H(W)	W	D		
L2CROBF2060	1780	1912	2006	19.94	20.5	60	20	202	20
L2CROBF2066	1856	1996	2108	19.94	20.5	66	20	220	22
L2CROBF2072	1969	2125	2213	19.94	20.5	72	20	254	24
L2CROBF2460	1853	1987	2087	19.94	20.5	60	24	202	20
L2CROBF2466	1929	2076	2193	19.94	20.5	66	24	220	22
L2CROBF2472	2048	2210	2302	19.94	20.5	72	24	254	24

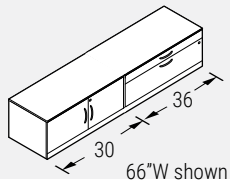
**L2CRBF • Credenza, Box File / 2 Doors**



- Two locks included.
- One height adjustable shelf included.
- Optional e-lock available in the vertical position for the file drawer. Please specify V - Vertical and add \$231 list.
- Optional e-lock available in the horizontal position. Please specify HR - Horizontal Right and add \$231 list.

PRODUCT CODE	FINISH			SIZE/INCHES				WEIGHT LBS	VOL FT <sup>3</sup>
	LP	B	W	H(LP/B)	H(W)	W	D		
L2CRBF2D2060	2106	2195	2322	19.94	20.5	60	20	214	20
L2CRBF2D2066	2131	2238	2495	19.94	20.5	66	20	224	22
L2CRBF2D2072	2246	2440	2546	19.94	20.5	72	20	235	24
L2CRBF2D2460	2190	2285	2414	19.94	20.5	60	24	214	20
L2CRBF2D2466	2219	2329	2593	19.94	20.5	66	24	224	22
L2CRBF2D2472	2337	2538	2648	19.94	20.5	72	24	235	24

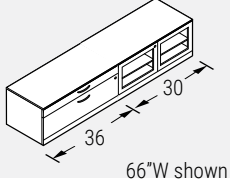
**L2CR2DBF • Credenza, 2 Doors / Box File**



- Two locks included.
- One height adjustable shelf included.
- Optional e-lock available in the vertical position for the file drawer. Please specify V - Vertical and add \$231 list.
- Optional e-lock available in the horizontal position. Please specify HR - Horizontal Right and add \$231 list.

PRODUCT CODE	FINISH			SIZE/INCHES				WEIGHT LBS	VOL FT <sup>3</sup>
	LP	B	W	H(LP/B)	H(W)	W	D		
L2CR2DBF2060	2106	2195	2322	19.94	20.5	60	20	214	20
L2CR2DBF2066	2131	2238	2495	19.94	20.5	66	20	224	22
L2CR2DBF2072	2246	2440	2546	19.94	20.5	72	20	235	24
L2CR2DBF2460	2190	2285	2414	19.94	20.5	60	24	214	20
L2CR2DBF2466	2219	2329	2593	19.94	20.5	66	24	224	22
L2CR2DBF2472	2337	2538	2648	19.94	20.5	72	24	235	24

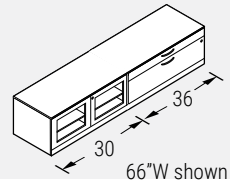
**L2CRBF2AD • Credenza, Box File / 2 Aluminum Door**



- Two locks included.
- One height adjustable shelf included.
- Door frame is anodized aluminum.
- Glazing is frosted acrylic.
- Doors standard with no handles.
- Optional e-lock available in the vertical position. Please specify V - Vertical and add \$231 list.
- E-locks not available for aluminum framed glass doors.

PRODUCT CODE	FINISH			SIZE/INCHES				WEIGHT LBS	VOL FT <sup>3</sup>
	LP	B	W	H(LP/B)	H(W)	W	D		
L2CRBF2AD2060	2594	2686	2810	19.94	20.5	60	20	214	20
L2CRBF2AD2066	2664	2768	3023	19.94	20.5	66	20	224	22
L2CRBF2AD2072	2777	2973	3078	19.94	20.5	72	20	235	24
L2CRBF2AD2460	2697	2790	2921	19.94	20.5	60	24	214	20
L2CRBF2AD2466	2773	2879	3146	19.94	20.5	66	24	224	22
L2CRBF2AD2472	2888	3091	3199	19.94	20.5	72	24	235	24

**L2CR2ADBF • Credenza, 2 Aluminum Doors, Box File**

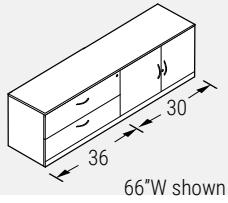


- Two locks included.
- One height adjustable shelf included.
- Door frame is anodized aluminum.
- Glazing is frosted acrylic.
- Doors standard with no handles.
- Optional e-lock available in the vertical position. Please specify V - Vertical and add \$231 list.
- E-locks not available for aluminum framed glass doors.

PRODUCT CODE	FINISH			SIZE/INCHES				WEIGHT LBS	VOL FT <sup>3</sup>
	LP	B	W	H(LP/B)	H(W)	W	D		
L2CR2ADBF2060	2594	2686	2810	19.94	20.5	60	20	214	20
L2CR2ADBF2066	2664	2768	3023	19.94	20.5	66	20	224	22
L2CR2ADBF2072	2777	2973	3078	19.94	20.5	72	20	235	24
L2CR2ADBF2460	2697	2790	2921	19.94	20.5	60	24	214	20
L2CR2ADBF2466	2773	2879	3146	19.94	20.5	66	24	224	22
L2CR2ADBF2472	2888	3091	3199	19.94	20.5	72	24	235	24



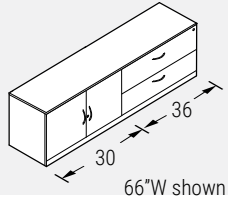
**L2CR2H2D • Credenza, 2 High File / 2 Door**



- Two locks included.
- Optional e-lock available in the vertical position for the file drawer. Please specify V - Vertical and add \$231 list.
- Optional e-lock available in the horizontal position. Please specify HR - Horizontal Right and add \$231 list.

PRODUCT CODE	FINISH			SIZE / INCHES				WEIGHT		VOL FT <sup>3</sup>
	LP	B	W	H (LP/B)	H (W)	W	D	LBS		
L2CR2H2D2060	2365	2527	2605	29	29.5	60	20	363	24	
L2CR2H2D2066	2462	2632	2719	29	29.5	66	20	374	26	
L2CR2H2D2072	2565	2721	2835	29	29.5	72	20	396	30	
L2CR2H2D2460	2460	2629	2711	29	29.5	60	24	363	24	
L2CR2H2D2466	2561	2737	2827	29	29.5	66	24	374	26	
L2CR2H2D2472	2670	2829	2948	29	29.5	72	24	396	30	

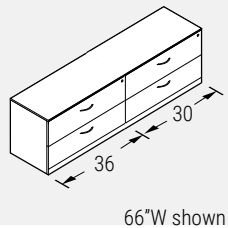
**L2CR2D2H • Credenza, 2 Door / 2 High File**



- Two locks included.
- Optional e-lock available in the vertical position for the file drawer. Please specify V - Vertical and add \$231 list.
- Optional e-lock available in the horizontal position. Please specify HR - Horizontal Right and add \$231 list.

PRODUCT CODE	FINISH			SIZE / INCHES				WEIGHT		VOL FT <sup>3</sup>
	LP	B	W	H (LP/B)	H (W)	W	D	LBS		
L2CR2D2H2060	2365	2527	2605	29	29.5	60	20	363	24	
L2CR2D2H2066	2462	2632	2719	29	29.5	66	20	374	26	
L2CR2D2H2072	2565	2721	2835	29	29.5	72	20	396	30	
L2CR2D2H2460	2460	2629	2711	29	29.5	60	24	363	24	
L2CR2D2H2466	2561	2737	2827	29	29.5	66	24	374	26	
L2CR2D2H2472	2670	2829	2948	29	29.5	72	24	396	30	

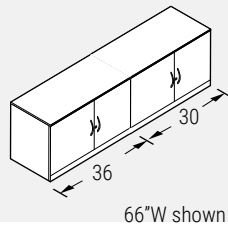
**L2CR2H2H • Credenza, 2 High File / File**



- Two locks included.
- Optional e-lock available in the vertical position. Please specify V - Vertical and add \$231 list.
- Credenzas require two e-locks.

PRODUCT CODE	FINISH			SIZE / INCHES				WEIGHT		VOL FT <sup>3</sup>
	LP	B	W	H (LP/B)	H (W)	W	D	LBS		
L2CR2H2H2060	2744	2839	2941	29	29.5	60	20	385	24	
L2CR2H2H2066	2840	2946	3050	29	29.5	66	20	407	26	
L2CR2H2H2072	2934	3049	3164	29	29.5	72	20	418	30	
L2CR2H2H2460	2852	2950	3059	29	29.5	60	24	385	24	
L2CR2H2H2466	2953	3063	3171	29	29.5	66	24	407	26	
L2CR2H2H2472	3051	3171	3289	29	29.5	72	24	418	30	

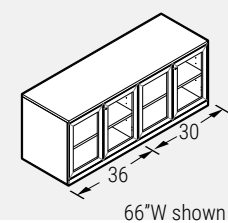
**L2CR2D2D • Credenza, 2 High 4 Doors**



- Two locks included.
- Optional e-lock available in the horizontal position. Please specify HR - Horizontal Right and add \$231 list.
- Credenzas require two e-locks.

PRODUCT CODE	FINISH			SIZE / INCHES				WEIGHT		VOL FT <sup>3</sup>
	LP	B	W	H (LP/B)	H (W)	W	D	LBS		
L2CR2D2D2060	1993	2221	2281	29	29.5	60	20	341	24	
L2CR2D2D2066	2098	2309	2394	29	29.5	66	20	352	26	
L2CR2D2D2072	2204	2398	2511	29	29.5	72	20	363	30	
L2CR2D2D2460	2072	2312	2370	29	29.5	60	24	341	24	
L2CR2D2D2466	2183	2403	2494	29	29.5	66	24	352	26	
L2CR2D2D2472	2291	2495	2613	29	29.5	72	24	363	30	

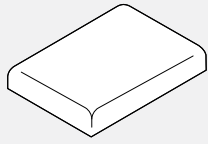
**L2CR4AD • Credenza, 2 High 4 Aluminum Doors**



- Two locks included.
- Door frame is anodized aluminum.
- Glazing is frosted acrylic.
- Doors standard with no handles.
- E-lock not available for aluminum framed glass doors.

PRODUCT CODE	FINISH			SIZE / INCHES				WEIGHT		VOL FT <sup>3</sup>
	LP	B	W	H (LP/B)	H (W)	W	D	LBS		
L2CR4AD2060	3209	3440	3499	29	29.5	60	20	336	24	
L2CR4AD2066	3429	3639	3729	29	29.5	66	20	347	26	
L2CR4AD2072	3650	3842	3958	29	29.5	72	20	358	30	
L2CR4AD2460	3289	3527	3587	29	29.5	60	24	336	24	
L2CR4AD2466	3514	3734	3824	29	29.5	66	24	347	26	
L2CR4AD2472	3738	3940	4059	29	29.5	72	24	358	30	

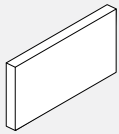
**LPSTC/LLSTC • Pedestal/Lateral Seat Cushion**



PRODUCT CODE	YRDS	SIZE/ INCHES			WEIGHT VOL	
		H	W	D	LBS	FT <sup>3</sup>
LPSTC1518	0.75	2	15.5	18	2	0.34
LPSTC1520	0.75	2	15.5	20	2	0.40
LPSTC1523	0.75	2	15.5	23	3	0.44
LPSTC1524	0.75	2	15.5	24	3	0.46
LPSTC1529	1.00	2	15.5	29	3	0.55
LPSTC1530	1.00	2	15.5	30	3	0.24
LLSTC2030	1.00	2	20	30	5	0.76
LLSTC2036	1.25	2	20	36	6	0.91
LLSTC2230	1.00	2	22	30	6	0.84
LLSTC2236	1.25	2	22	36	7	1.01
LLSTC2430	1.00	2	24	30	6	0.91
LLSTC2436	1.25	2	24	36	7	1.10

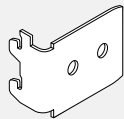
PRODUCT CODE	PRICE																			
	GR1	GR2	GR3	GR4	GR5	GR6	GR7	GR8	GR9	GR10	GR11	GR12	GR13	GR14	GR15	GR16	GR17	GR18	GR19	GR20
LPSTC1518	202	233	252	280	323	364	401	435	477	518	574	652	724	802	972	1142	1312	1482	1652	1839
LPSTC1520	208	237	261	286	329	369	408	442	483	523	579	656	731	809	977	1147	1318	1487	1656	1844
LPSTC1523	212	240	264	291	333	372	411	448	486	528	582	659	736	813	984	1153	1324	1495	1661	1848
LPSTC1524	218	247	270	298	340	378	418	452	491	537	590	666	744	819	988	1157	1328	1499	1668	1855
LPSTC1529	267	305	336	371	426	480	534	579	631	688	759	864	964	1065	1294	1517	1747	1973	2198	2448
LPSTC1530	274	310	341	377	433	485	539	584	638	693	765	869	971	1072	1300	1525	1753	1981	2204	2454
LLSTC2030	289	328	355	394	450	503	552	603	655	712	783	886	987	1089	1317	1541	1772	1996	2221	2471
LLSTC2036	343	391	430	475	543	608	673	733	801	869	960	1089	1214	1343	1628	1908	2194	2474	2757	3070
LLSTC2230	295	332	364	398	454	508	557	607	658	715	786	892	994	1092	1323	1545	1776	2001	2225	2474
LLSTC2236	350	397	434	480	548	613	681	740	806	877	966	1094	1223	1348	1633	1916	2199	2481	2763	3077
LLSTC2430	298	336	366	401	456	510	562	609	660	718	790	894	996	1095	1325	1548	1778	2003	2230	2477
LLSTC2436	354	404	441	485	553	621	687	746	813	883	972	1101	1227	1354	1639	1921	2207	2490	2769	3081

**LACWB • Counterweight Balance for use in Licence Storage Units**



PRODUCT CODE	PRICE	SIZE/INCHES			WEIGHT VOL	
		H	W	D	LBS	FT <sup>3</sup>
LACWB	95	0.5	11.62	11.62	10	0.07

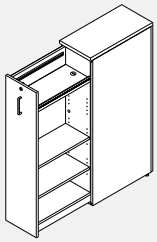
**BHTP01 • Bracket to connect Licence Towers to Boulevard Panels**



• Panel Frame Finish

PRODUCT CODE	PRICE	SIZE/ INCHES			WEIGHT VOL	
		H	W	D	LBS	FT <sup>3</sup>
BHTP01	27	2	2.5	1	2	0.05

**L2PO • Pantry Storage**



Left Hand Shown

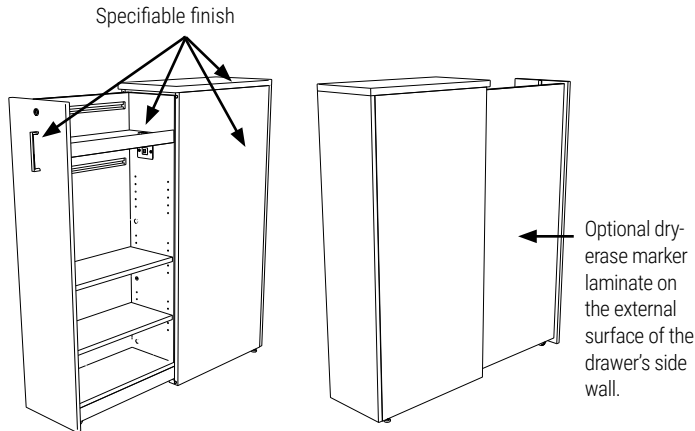
- The pull out cabinet serves as a multifunction, customizable storage unit that both defines space and enhances privacy in an open plan environment.
- Can be used in conjunction with Licence, Bridges, FreeFit and Boulevard.
- Internal organization consists of two fixed shelves top and bottom. The two middle shelves are adjustable. Two accessory rails are standard and will accept GC metal accessories
- Interior cabinet shelves and back are standard in Designer White. Cabinet shell, drawer and top can be specified in any standard laminate.
- L2PO12-NL/R does not fit binders.
- Only available with FA handle.

**Finish**

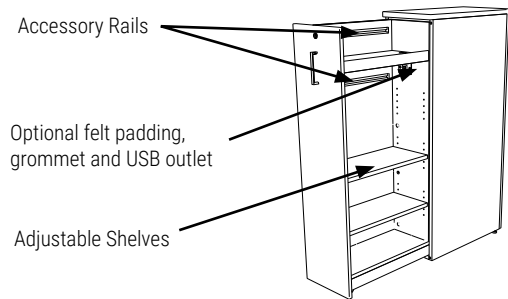
While the Pantry Storage cabinet walls, top and pull-out drawer front door and back panel finish can be specified, the internal cabinet back and adjustable shelves are standard white. Please specify the cabinet top and pull-out drawer front finish.

**Options**

- Dual USB A+C outlet kit - please add "USB" at the end of the code. Add \$388 to the list price
- When you specify dual USB outlet the top shelf will come with grey felt surface and grommet which allows for cable passage from the USB outlet (located below the top shelf). A two-prong power cord exits the cabinet through the floor at the back.
- Dry-erase marker board - Choose "DE" option. Please add \$372 to the list price. If specified the Dry-erase marker laminate will be applied to the external surface of the pull-out drawer side wall.



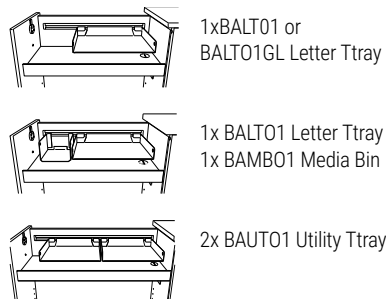
PRODUCT CODE	PRICE			SIZE/INCHES				WEIGHT LBS	VOL FT³
	LP	B	W	H(LP/B)	H(W)	W	D		
L2PO1224H42NL	1538	1556	1592	41.56	42	12	24	128	7
L2PO1230H42NL	1615	1638	1680	41.56	42	12	30	143	9
L2PO1236H42NL	1690	1718	1769	41.56	42	12	36	157	11
L2PO1824H42NL	1767	1796	1844	41.56	42	18	24	156	11
L2PO1830H42NL	1853	1888	1946	41.56	42	18	30	172	13
L2PO1836H42NL	1937	1980	2047	41.56	42	18	36	187	16
L2PO1224NL	1673	1689	1721	49.56	50	12	24	133	8
L2PO1230NL	1753	1786	1813	49.56	50	12	30	148	10
L2PO1236NL	1834	1882	1906	49.56	50	12	36	162	15
L2PO1824NL	1942	1975	2009	49.56	50	18	24	161	12
L2PO1830NL	2028	2083	2112	49.56	50	18	30	177	15
L2PO1836NL	2117	2189	2213	49.56	50	18	36	192	18
L2PO1224H54NL	1691	1709	1741	53.56	54	12	24	138	9
L2PO1230H54NL	1772	1792	1813	53.56	54	12	30	153	11
L2PO1236H54NL	1853	1878	1904	53.56	54	12	36	167	14
L2PO1824H54NL	1961	1986	2029	53.56	54	18	24	166	14
L2PO1830H54NL	2049	2081	2131	53.56	54	18	30	182	17
L2PO1836H54NL	2137	2173	2233	53.56	54	18	36	197	20
L2PO1224H42NR	1538	1556	1592	41.56	42	12	24	128	7
L2PO1230H42NR	1615	1638	1680	41.56	42	12	30	143	9
L2PO1236H42NR	1690	1718	1769	41.56	42	12	36	157	11
L2PO1824H42NR	1767	1796	1844	41.56	42	18	24	156	11
L2PO1830H42NR	1853	1888	1946	41.56	42	18	30	172	13
L2PO1836H42NR	1937	1980	2047	41.56	42	18	36	187	16
L2PO1224NR	1673	1689	1721	49.56	50	12	24	133	8
L2PO1230NR	1753	1786	1813	49.56	50	12	30	148	10
L2PO1236NR	1834	1882	1906	49.56	50	12	36	162	15
L2PO1824NR	1942	1975	2009	49.56	50	18	24	161	12
L2PO1830NR	2028	2083	2112	49.56	50	18	30	177	15
L2PO1836NR	2117	2189	2213	49.56	50	18	36	192	18
L2PO1224H54NR	1691	1709	1741	53.56	54	12	24	138	9
L2PO1230H54NR	1772	1792	1813	53.56	54	12	30	153	11
L2PO1236H54NR	1853	1878	1904	53.56	54	12	36	167	14
L2PO1824H54NR	1961	1986	2029	53.56	54	18	24	166	14
L2PO1830H54NR	2049	2081	2131	53.56	54	18	30	182	17
L2PO1836H54NR	2137	2173	2233	53.56	54	18	36	197	20



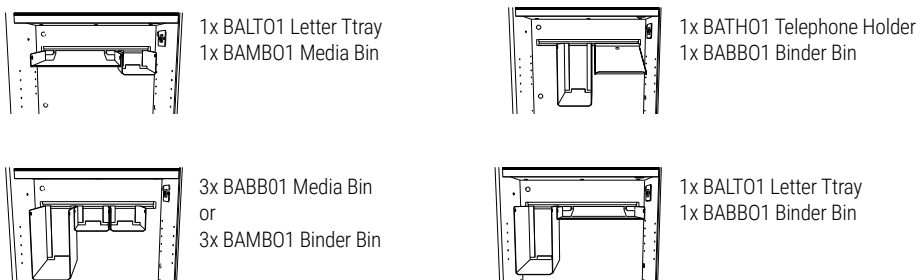
**Integrated Accessory rails**

Two accessory rails (each 18.25" long) are provided to further enhance customization with Global Contract metal accessories.

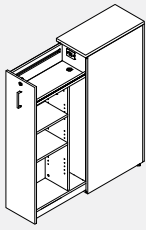
**Upper Accessory Rail:**



**Lower Accessory Rail:**



**L2PW • Wardrobe Pantry Storage**



Left Hand Shown

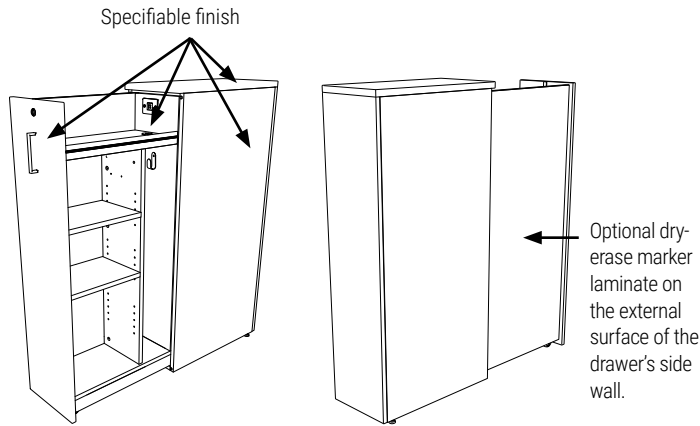
- The pull out cabinet serves as a multifunction, customizable storage unit that both defines space and enhances privacy in an open plan environment.
- Can be used in conjunction with Licence,, FreeFit and Boulevard.
- Internal organization consists of one fixed shelf at the top. The two middle shelves are adjustable. Wardrobe includes coat hook.
- Interior cabinet shelves and back are standard in Designer White. Cabinet shell, drawer and top can be specified in any standard laminate.
- L2PW12-NL/R does not fit binders.
- Only available with FA handle.

**Finish**

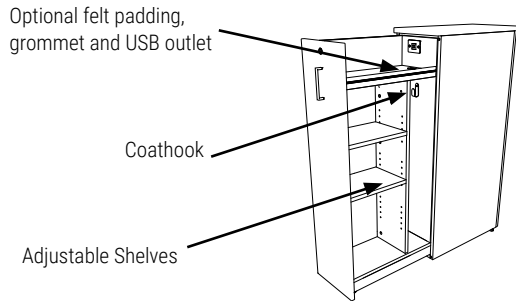
While the Pantry Storage cabinet walls, top and pull-out drawer front door and back panel finish can be specified, the internal cabinet back and adjustable shelves are standard white. Please specify the cabinet top and pull-out drawer front finish.

**Options**

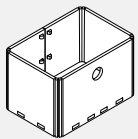
- Dual USB A+C outlet kit - please add "USB" at the end of the code. Add \$388 to the list price
- When you specify dual USB outlet the top shelf will come with grey felt surface and grommet which allows for cable passage from the USB outlet (located below the top shelf). A two-prong power cord exits the cabinet through the floor at the back.
- Dry-erase marker board - Choose "DE" option. Please add \$372 to the list price. If specified the Dry-erase marker laminate will be applied to the external surface of the pull-out drawer side wall.



PRODUCT CODE	PRICE LP	SIZE/INCHES				WEIGHT LBS	VOL FT³		
		B	W	H(LP/B)	H(W)				
L2PW1224H42NL	1680	1698	1735	41.56	42	12	24	128	7
L2PW1230H42NL	1757	1780	1822	41.56	42	12	30	143	9
L2PW1236H42NL	1832	1860	1911	41.56	42	12	36	157	11
L2PW1824H42NL	1946	1975	2022	41.56	42	18	24	156	11
L2PW1830H42NL	2031	2066	2124	41.56	42	18	30	172	13
L2PW1836H42NL	2116	2158	2225	41.56	42	18	36	187	16
L2PW1224NL	1831	1848	1880	49.56	50	12	24	133	8
L2PW1230NL	1912	1945	1971	49.56	50	12	30	148	10
L2PW1236NL	1993	2040	2064	49.56	50	12	36	162	15
L2PW1824NL	2140	2173	2207	49.56	50	18	24	161	12
L2PW1830NL	2227	2281	2310	49.56	50	18	30	177	15
L2PW1836NL	2315	2388	2412	49.56	50	18	36	192	18
L2PW1224H54NL	1866	1884	1916	53.56	54	12	24	138	9
L2PW1230H54NL	1947	1967	1988	53.56	54	12	30	153	11
L2PW1236H54NL	2028	2053	2080	53.56	54	12	36	167	14
L2PW1824H54NL	2182	2206	2250	53.56	54	18	24	166	14
L2PW1830H54NL	2269	2301	2351	53.56	54	18	30	182	17
L2PW1836H54NL	2358	2394	2453	53.56	54	18	36	197	20
L2PW1224H42NR	1680	1698	1735	41.56	42	12	24	128	7
L2PW1230H42NR	1757	1780	1822	41.56	42	12	30	143	9
L2PW1236H42NR	1832	1860	1911	41.56	42	12	36	157	11
L2PW1824H42NR	1946	1975	2022	41.56	42	18	24	156	11
L2PW1830H42NR	2031	2066	2124	41.56	42	18	30	172	13
L2PW1836H42NR	2116	2158	2225	41.56	42	18	36	187	16
L2PW1224NR	1831	1848	1880	49.56	50	12	24	133	8
L2PW1230NR	1912	1945	1971	49.56	50	12	30	148	10
L2PW1236NR	1993	2040	2064	49.56	50	12	36	162	15
L2PW1824NR	2140	2173	2207	49.56	50	18	24	161	12
L2PW1830NR	2227	2281	2310	49.56	50	18	30	177	15
L2PW1836NR	2315	2388	2412	49.56	50	18	36	192	18
L2PW1224H54NR	1866	1884	1916	53.56	54	12	24	138	9
L2PW1230H54NR	1947	1967	1988	53.56	54	12	30	153	11
L2PW1236H54NR	2028	2053	2080	53.56	54	12	36	167	14
L2PW1824H54NR	2182	2206	2250	53.56	54	18	24	166	14
L2PW1830H54NR	2269	2301	2351	53.56	54	18	30	182	17
L2PW1836H54NR	2358	2394	2453	53.56	54	18	36	197	20



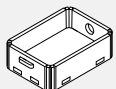
**L2PSB • Pantry Felt Storage Bin**



- Crafted from recycled PET felt, felt bins are an intuitive and versatile organization solution within your Pantry unit.
- Felt is 9mm, please choose from our 18 difference finishes.

PRODUCT CODE	PRICE	SIZE/INCHES			WEIGHT LBS	VOL FT³
		H	W	D		
L2PSB0912	47	7.5	11.8	8.6	0.30	0.44

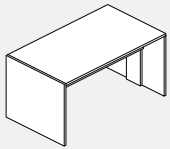
**L2PST • Pantry Felt Storage Tray**



- Crafted from recycled PET felt, felt bins are an intuitive and versatile organization solution within your Pantry unit.
- Felt is 9mm, please choose from our 18 difference finishes.

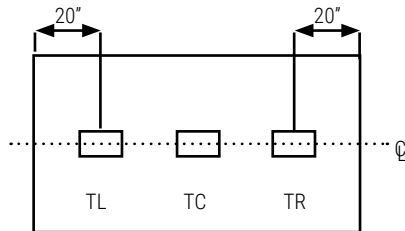
PRODUCT CODE	PRICE	SIZE/INCHES			WEIGHT LBS	VOL FT³
		H	W	D		
L2PST0609	18	2.6	8.6	5.9	0.28	0.08

**L2CT • Collaboration Tables with Integrated Wire Management**



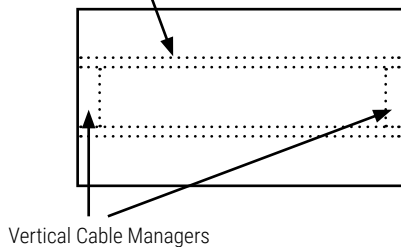
- Units Shipped knocked down (KD)
- Footrest to be ordered separately.
- Add "FR" to the end of the code for a footrail and add \$1,890 to the list price.
- Foot rail kit will include a quantity of two 2" diameter rails and 4 flanges.
- "W" thick (1 7/16") top and gables.
- Low pressure modesty panel.

**Standard Grommet Location:**



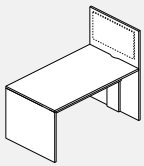
Please see Accessories Section for power grommets.

Half Modesty at 15" high.



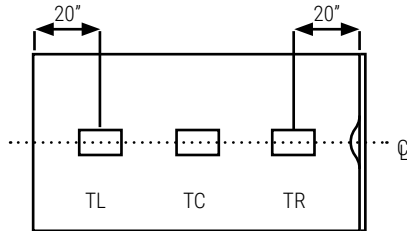
PRODUCT CODE	FINISH "W"	H(W)	W	D	WEIGHT LBS	VOL FT³
L2CT3060H29	1741	29.5	60	30	171	13
L2CT3066H29	1814	29.5	66	30	180	14
L2CT3072H29	1891	29.5	72	30	189	15
L2CT3078H29	1962	29.5	78	30	198	16
L2CT3084H29	2040	29.5	84	30	207	18
L2CT3096H29	2190	29.5	96	30	216	20
L2CT3060H36	1845	36	60	30	176	19
L2CT3066H36	1922	36	66	30	185	21
L2CT3072H36	1996	36	72	30	194	23
L2CT3078H36	2071	36	78	30	203	24
L2CT3084H36	2148	36	84	30	212	26
L2CT3096H36	2298	36	96	30	221	30
L2CT3060H42	1994	42	60	30	181	25
L2CT3066H42	2071	42	66	30	190	28
L2CT3072H42	2145	42	72	30	199	30
L2CT3078H42	2221	42	78	30	208	33
L2CT3084H42	2297	42	84	30	217	35
L2CT3096H42	2446	42	96	30	226	40
L2CT3660H29	1953	29.5	60	36	180	15
L2CT3666H29	2037	29.5	66	36	189	17
L2CT3672H29	2120	29.5	72	36	198	18
L2CT3678H29	2204	29.5	78	36	207	20
L2CT3684H29	2287	29.5	84	36	216	21
L2CT3696H29	2454	29.5	96	36	225	24
L2CT3660H36	2081	36	60	36	185	23
L2CT3666H36	2161	36	66	36	194	25
L2CT3672H36	2246	36	72	36	203	27
L2CT3678H36	2330	36	78	36	212	29
L2CT3684H36	2414	36	84	36	221	32
L2CT3696H36	2582	36	96	36	230	36
L2CT3660H42	2251	42	60	36	190	30
L2CT3666H42	2332	42	66	36	199	33
L2CT3672H42	2416	42	72	36	208	36
L2CT3678H42	2500	42	78	36	217	39
L2CT3684H42	2585	42	84	36	226	42
L2CT3696H42	2751	42	96	36	235	48
L2CT4260H29	2165	29.5	60	42	189	18
L2CT4266H29	2258	29.5	66	42	198	19
L2CT4272H29	2349	29.5	72	42	207	21
L2CT4278H29	2440	29.5	78	42	216	23
L2CT4284H29	2534	29.5	84	42	225	25
L2CT4296H29	2717	29.5	96	42	234	28
L2CT4260H36	2313	36	60	42	194	26
L2CT4266H36	2405	36	66	42	203	29
L2CT4272H36	2497	36	72	42	212	32
L2CT4278H36	2589	36	78	42	221	34
L2CT4284H36	2681	36	84	42	230	37
L2CT4296H36	2866	36	96	42	239	42
L2CT4260H42	2503	42	60	42	199	35
L2CT4266H42	2595	42	66	42	208	39
L2CT4272H42	2689	42	72	42	217	42
L2CT4278H42	2779	42	78	42	226	46
L2CT4284H42	2871	42	84	42	235	49
L2CT4296H42	3055	42	96	42	244	56

**L2CTV • Collaboration Tables with Media Wall Integrated Wire Management**



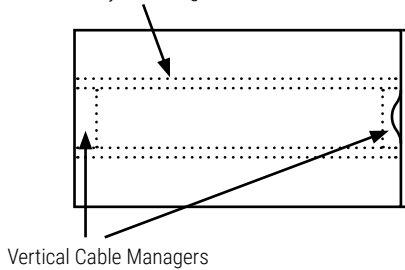
- Units Shipped knocked down (KD)
- Footrest to be ordered separately.
- Add "FR" to the end of the code for a foot rail and add \$1,890 to the list price.
- Foot rail kit will include a quantity of two 2" diameter rails and 4 flanges.
- Unit includes TV/Display bracket & mounting hardware.
- "W" thick (1 7/16") top and gables.
- Low pressure modesty panel.

**Standard Grommet Location:**



Please see Accessories Section for power grommets.

Half Modesty at 15" high.



PRODUCT CODE	FINISH "W"	H (W)	W	D	WEIGHT	
					LBS	FT <sup>3</sup>
L2CTV4260H29H66	3203	29.5	60	42	192	18
L2CTV4266H29H66	3295	29.5	66	42	201	19
L2CTV4272H29H66	3387	29.5	72	42	210	21
L2CTV4278H29H66	3478	29.5	78	42	219	23
L2CTV4284H29H66	3568	29.5	84	42	228	25
L2CTV4296H29H66	3757	29.5	96	42	237	28
L2CTV4860H29H66	3478	29.5	60	48	198	20
L2CTV4866H29H66	3579	29.5	66	48	207	22
L2CTV4872H29H66	3679	29.5	72	48	216	24
L2CTV4878H29H66	3779	29.5	78	48	225	26
L2CTV4884H29H66	3882	29.5	84	48	234	28
L2CTV4896H29H66	4079	29.5	96	48	243	32
L2CTV4260H36H72	3351	36	60	42	197	26
L2CTV4266H36H72	3443	36	66	42	206	29
L2CTV4272H36H72	3535	36	72	42	215	32
L2CTV4278H36H72	3627	36	78	42	224	34
L2CTV4284H36H72	3717	36	84	42	233	37
L2CTV4296H36H72	3902	36	96	42	242	42
L2CTV4860H36H72	3646	36	60	48	203	30
L2CTV4866H36H72	3746	36	66	48	212	33
L2CTV4872H36H72	3849	36	72	48	221	36
L2CTV4878H36H72	3950	36	78	48	230	39
L2CTV4884H36H72	4047	36	84	48	239	42
L2CTV4896H36H72	3741	36	96	48	248	48
L2CTV4260H42H72	3468	42	60	42	202	35
L2CTV4266H42H72	3559	42	66	42	211	39
L2CTV4272H42H72	3650	42	72	42	220	42
L2CTV4278H42H72	3776	42	78	42	229	46
L2CTV4284H42H72	3836	42	84	42	238	49
L2CTV4296H42H72	4052	42	96	42	247	56
L2CTV4860H42H72	3773	42	60	48	208	40
L2CTV4866H42H72	3873	42	66	48	217	44
L2CTV4872H42H72	3975	42	72	48	226	48
L2CTV4878H42H72	4075	42	78	48	235	52
L2CTV4884H42H72	4177	42	84	48	244	56
L2CTV4896H42H72	4375	42	96	48	253	64



**Technical Information - Tables**

**Tables**

- All table surfaces are High Pressure Laminate in "B" or "W" thickness.
- All tables have "T" mold edge band, unless otherwise indicated.
- Tables up to and including 96" long are manufactured in one piece, 120" to 192" long are manufactured in two pieces and over 216" are manufactured in three pieces. If wood grain laminate is chosen, the wood grain pattern will not line up.
- Tables in 2 or 3 pieces will have the joining edge finished with PVC edge (0.5mm), hardware will be shipped for assembly.
- Grommet locations must be specified at the time of order or it will default to "no grommet" option.
- Power modules and grommets are not included, they must be specified separately.
- Positions for drop in power and data grommets are intended for use on tops with the following bases: LR, LSQ, LDRUM, TELRS, TELRR, TELBS, TELBR. For any other base, please consult Customer Service Representative.
- Tables are not pre-drilled to accept legs or bases.
- "LTR" Rectangular shape tables with edge B and W have a 1" radius at each corner.
- For table tops with square corners, please add "NR" at the end of the product code, no upcharge required. The "NR" option is available only with the B and W edge profiles.
- "LBT" Boat shape tables are 6" narrower at the ends. The nominal size is identified at the centre.
- "LBTB" Boat shape tables with bow ends are 12" narrower at the ends. The nominal size is identified at the centre.
- Trapezoid tables can be used in several combinations.
- Power modules and grommets are not included, they must be specified separately.

**Bases**

- Available in variety of materials metal, high pressure laminate or low pressure laminate, please refer to specific base in price list
- "LR" Rectangular and "LSQ" square bases come standard with removable access door and cut out on the bottom of the base for pass-thru cables.
- "TELRS / TELBS" square and "TELRR / TELBR" rectangular bases come standard with cut out on the bottom of the base for pass-thru cables. Hinged access doors are optional and must be specified with an "HD" at the end of the code. There will be an upcharge of \$122 to the list price.
- Drum bases are finished in high pressure only and comes with a full bottom and notch at the top. Sand bag included. Access door is not an option.
- Drum, rectangular and square bases are shipped assembled.

**Folding Legs**

- Legs are folded by pressing the lever. Once folded, the legs are held securely by the interlocking springs.
- Includes adjustable levelers offering 12mm (1/2") of adjustment.
- Minimum special sizing for tables is 54" in length and 25" in depth.
- Sold per pair.

**Flip Top Training Tables**

- "GFT" Rectangular Flip tables with edge B and W edge have straight corners.

**Visual Board**

- Unit offered in high pressure laminate (B) comes with 2 high pressure laminate doors
- Cork board included on one inside door.
- Unit closes with a touch latch mechanism, but no lock option.
- "MG" indicates a magnetic white board.

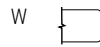
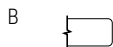
**Tables • Guidelines For Ordering Product**

**CODES:** The price list uses a numbering system with meaningful alphanumeric characters to create a simple-to-understand product number. This makes specifying the product much easier and more accurate.

**SPECIFICATION EXAMPLE OF A TABLE UNIT**

**PRODUCT CODE:** LTS2424  
 L = Licence  
 T = Table  
 S = Square  
 2424 = Size: Depth x Width

**Edge Options:**      **"B" Edges**                      **"W" Edges**  
 HP (B) 1.062" Thickness      HP (W) 1.437" Thickness



**Base Specification Guide (See Installation Manual For Examples).**

- Tables up to 96" in length require 2 T bases
- Tables 108" to 144" in length require 3 T bases
- Tables 156" to 192" in length require 4 T bases
- Tables 216" to 240" in length require 6 T bases

**FLAT BAR 3 PRONG "TTFL"**

BASE SPREAD	TOP WIDTH
18"	24W
22"	30W
24"	36W
30"	42W
36"	48W
36"	54W

**LLT/LLTT W/BULLNOSE ENDS**

BASE SPREAD	TOP WIDTH
18"	24W
26"	30W
26"	36W
30"	42W
36"	48W
36"	54W
42"	60W

**TTFLT FLAT BAR "T"**

BASE SPREAD	TOP WIDTH
18"	24W
22"	30W
24"	36W
30"	42W
36"	48W
36"	54W

**LD DRUM**

BASE SPREAD	ROUND TOP SIZE
18" dia	30" dia
18" dia	36" dia
24" dia	42" dia
24" dia	48" dia
30" dia	54" dia
30" dia	60" dia

**LSQ, TELRS & TELBS SQUARE**

BASE SPREAD	TOP SIZE
18"	30x30
18"	36x36
24"	42x42
24"	48x48
30"	54x54
30"	60x60

**LCT CROSS BASE**

BASE SPREAD	TOP SIZE
18"	24x24
24"	30x30
24"	36x36
30"	42x42
30"	48x48
36"	54x54
42"	60x60

- 1 Piece Tables up to 96" in length require 2 bases
- Tables 108" to 192" in length require 3 bases
- Tables 216" to 240" in length require 4 bases

**LR, LSQ, TELRS, TELRR, TELBS, TELBR**

BASE SPREAD	TOP WIDTH
18"	30
18"	36
24"	42
24"	48
30"	54
30"	60

**LELBA**

BASE SPREAD	TOP WIDTH
18"	30
18"	36
24"	42
30"	48
36"	54
36"	60

**TRUMPET 28H**

BASE SPREAD	TOP SIZE
18"	24x24
24"	30x30
24"	36x36
30"	42x42
30"	48x48

**FLAT SQUARE**

BASE SPREAD	TOP SIZE
18"	24x24
18"	30x30
23"	36x36
23"	42x42
30"	48x48

**FLAT DISC 28H**

BASE SPREAD	TOP SIZE
18"	24x24
18"	30x30
24"	36x36
30"	42x42
30"	48x48
36"	54x54

**FLATBAR X**

BASE SPREAD	TOP SIZE
18"	24x24
18"	30x30
24"	36x36
24"	42x42
30"	48x48
36"	54x54

**TRUMPET 40.5H**

BASE SPREAD	TOP SIZE
18"	24x24
24"	30x30
24"	36x36

**FLAT SQUARE 40.5H**

BASE SPREAD	TOP SIZE
18"	24x24
23"	30x30

**FLAT DISC 40.5H**

BASE SPREAD	TOP SIZE
18"	24x24
22"	30x30
24"	36x36

**FLATBAR X 40.5H**

BASE SPREAD	TOP SIZE
18"	24x24
22"	30x30

**LL4S W/BULLNOSE ENDS**

BASE SPREAD	TOP SIZE
18"	24x24
26"	30x30
26"	36x36
26"	42x42
30"	48x48
36"	54x54

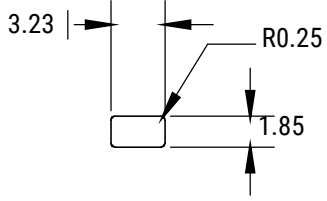
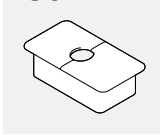
**LHC HAT CHANNEL**

- LHC40 For Table 54" Wide
- LHC46 For Table 60" Wide
- LHC52 For Table 66" Wide
- LHC58 For Table 72" Wide
- LHC64 For Table 78" Wide
- LHC70 For Table 84" Wide

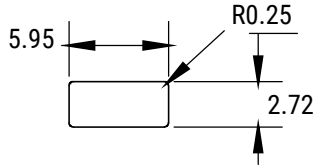
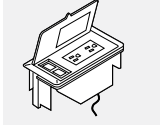
Tops with post legs must be specified with HAT Channels for structural reinforcement.

**Grommet Cut Dimensions (inches)**

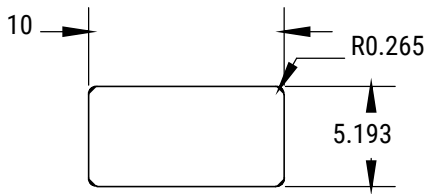
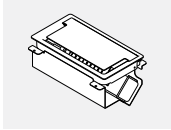
**BG5**



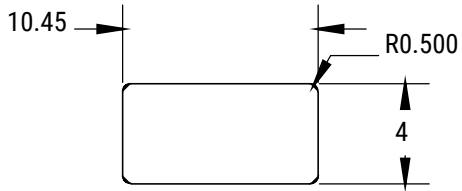
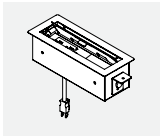
**MSPDM**



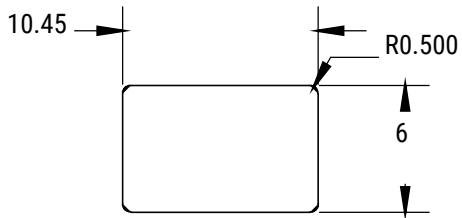
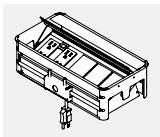
**GAAD**



**GCRTMCS4xx**



**GCSRTMCD6xx**

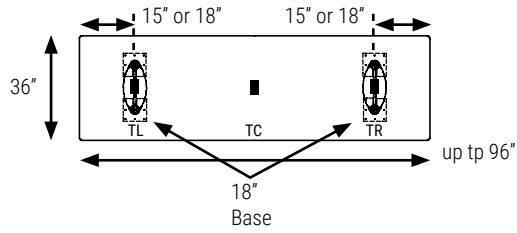


**Table Dimension Chart & Grommet Location**

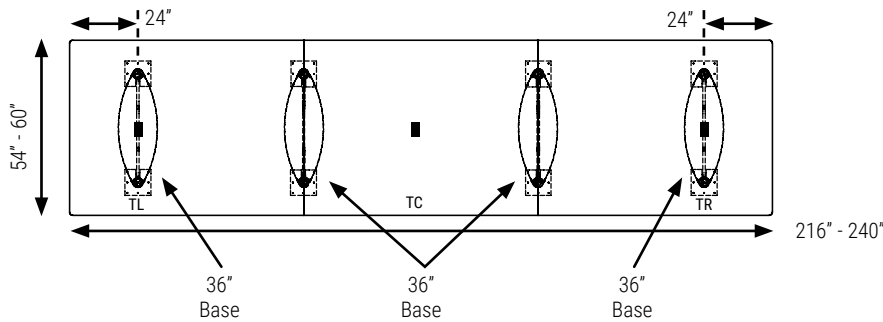
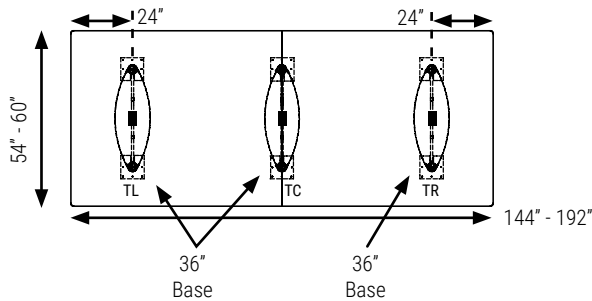
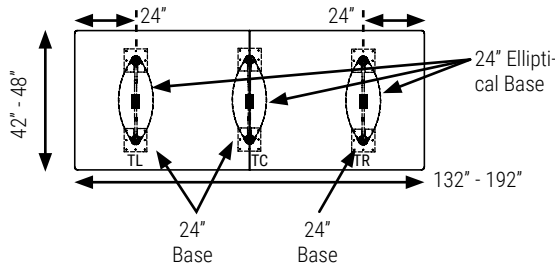
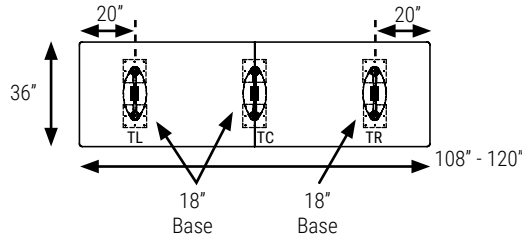
LELBA - Elliptical Base

For One Piece Top

LELBA BASE SPREAD	TOP WIDTH
18"	30
18"	36
24"	42
30"	48
36"	54
36"	60



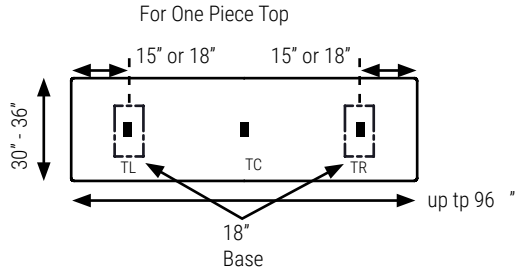
\*15" for table widths between 60" and 72" and 18" for table widths between 78" and 96"



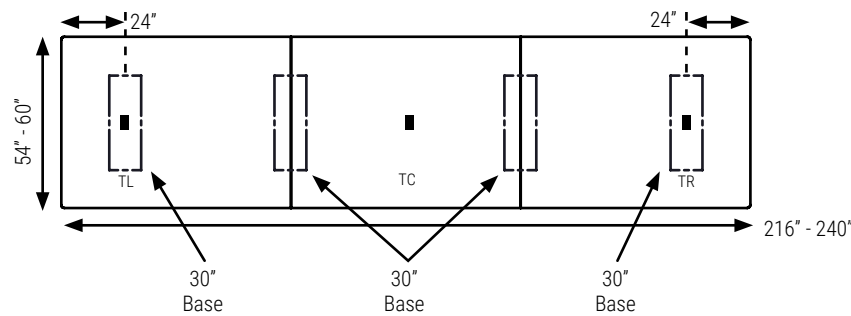
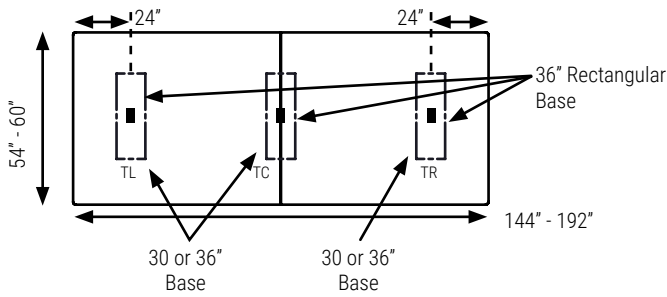
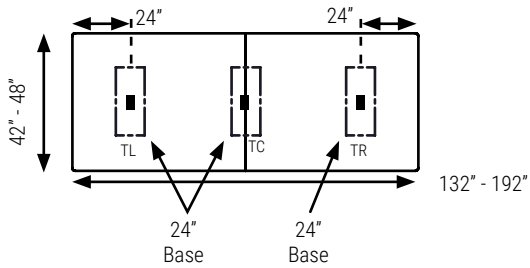
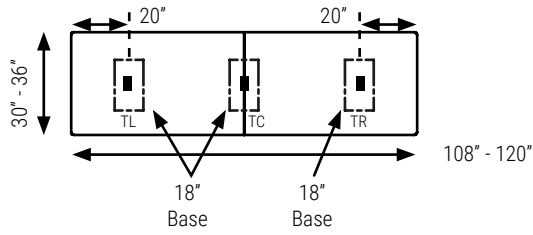
Note: Grommet orientation is perpendicular to the length of table.

**Table Dimension Chart & Grommet Location**

LR - Rectangular Base



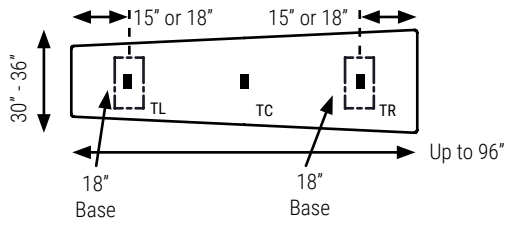
\*15" for table widths between 60" and 72" and 18" for table widths between 78" and 96"



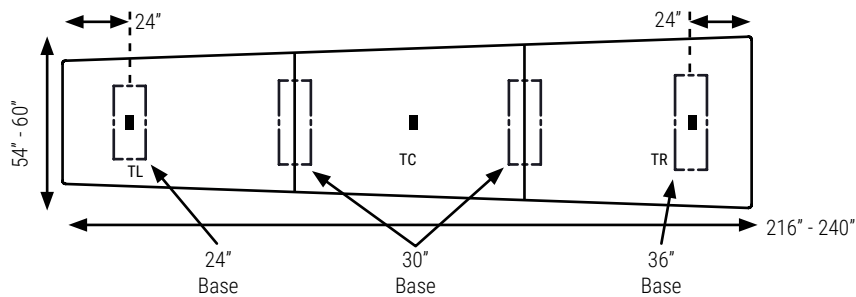
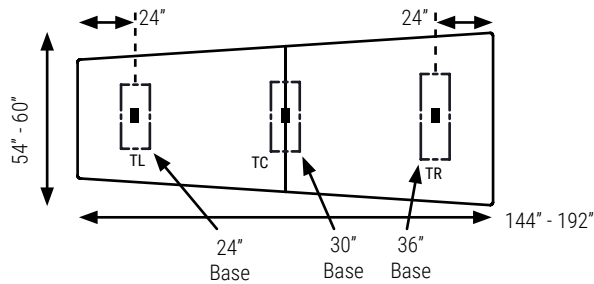
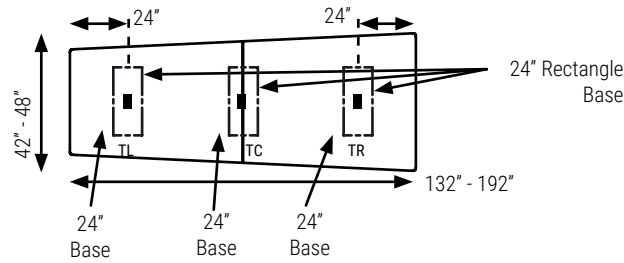
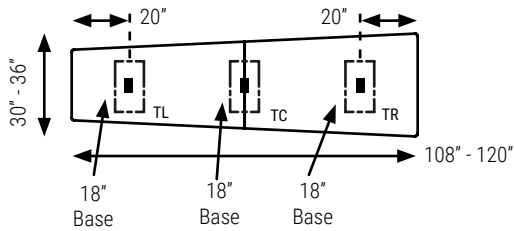
Note: Grommet orientation is perpendicular to the length of table.

**Table Dimension Chart & Grommet Location**

For One Piece Top



\*15" for table widths between 60" and 72" and 18" for table widths between 78" and 96"



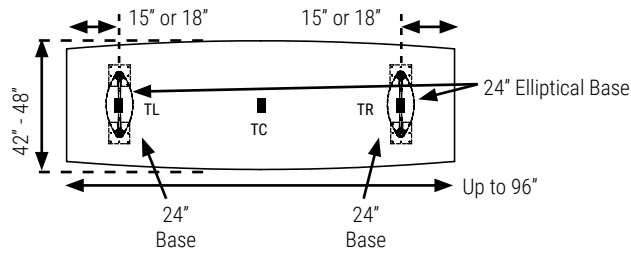
Note: Grommet orientation is perpendicular to the length of table.



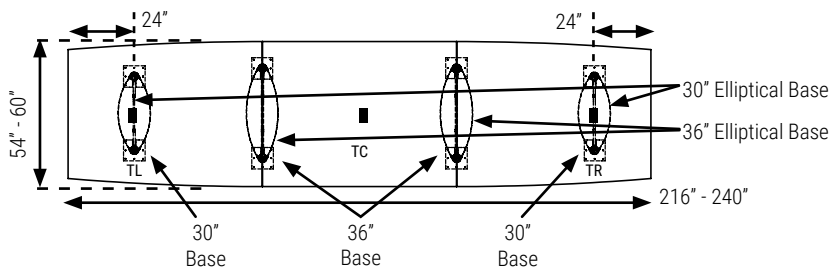
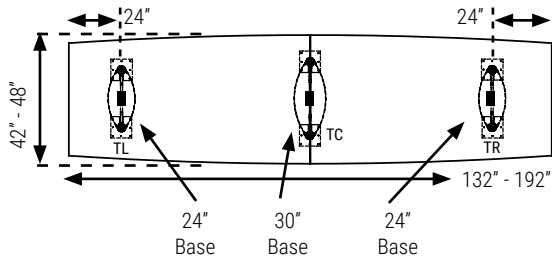
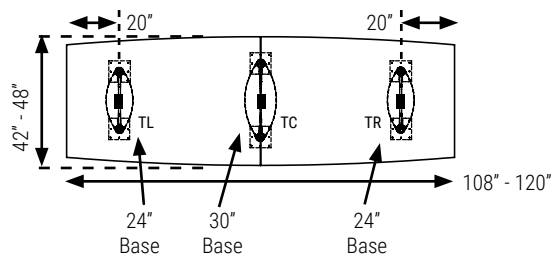
**Table Dimension Chart & Grommet Location**

LELBA - Elliptical Base

For One Piece Top



\*15" for table widths between 60" and 72" and 18" for table widths between 78" and 96"

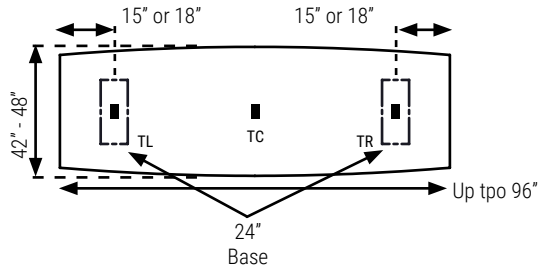


Note: Grommet orientation is perpendicular to the length of table.

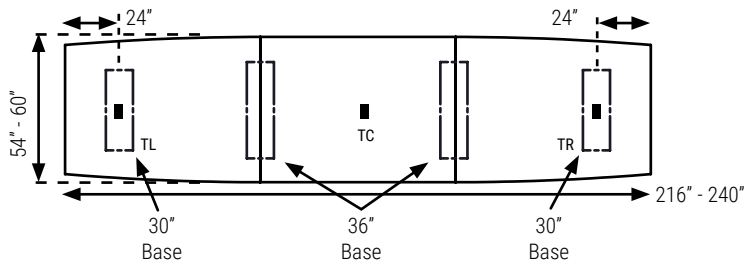
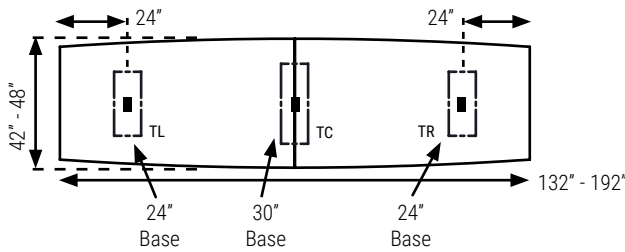
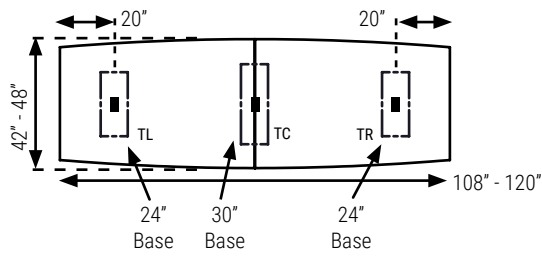
**Table Dimension Chart & Grommet Location**

LELBA - Rectangular Base

For One Piece Top



\*15" for table widths between 60" and 72" and 18" for table widths between 78" and 96"

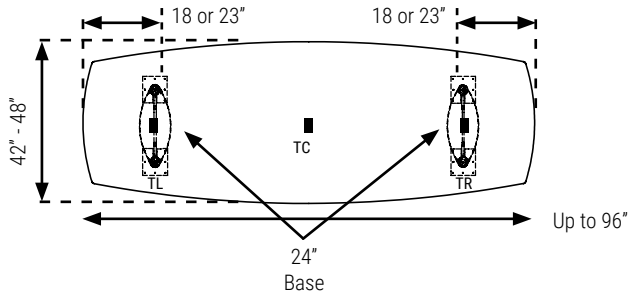


Note: Grommet orientation is perpendicular to the length of table.

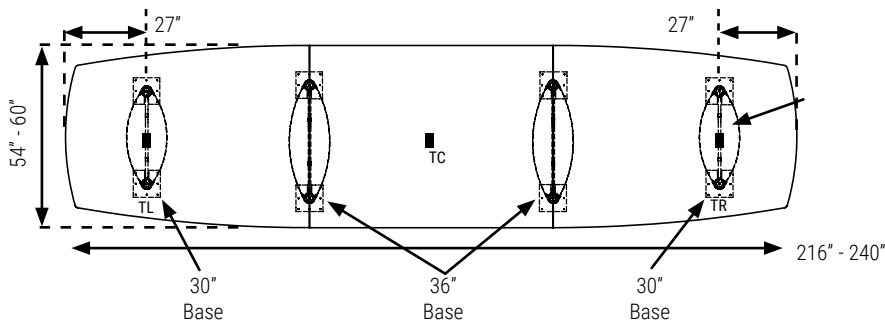
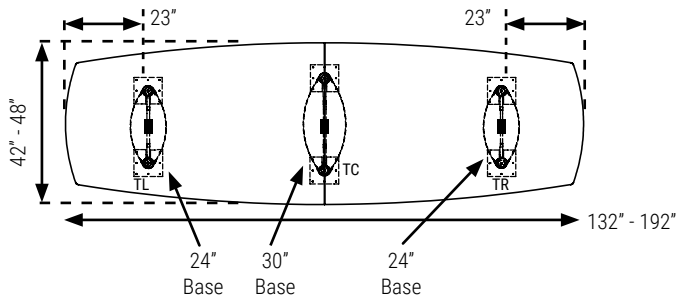
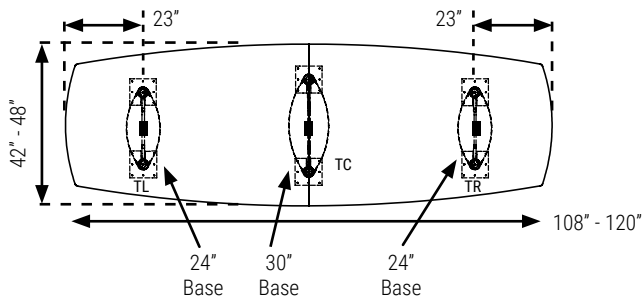
**Table Dimension Chart & Grommet Location**

LR - Elliptical Base

For One Piece Top



\*18" for table widths between 60" and 72" and 23" for table widths between 78" and 96"

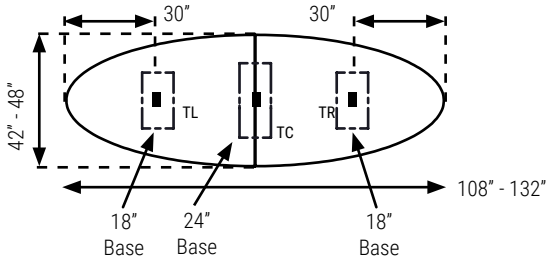
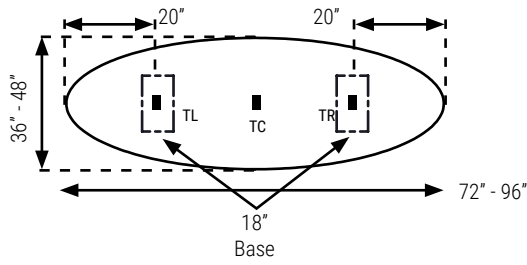


Note: Grommet orientation is perpendicular to the length of table.

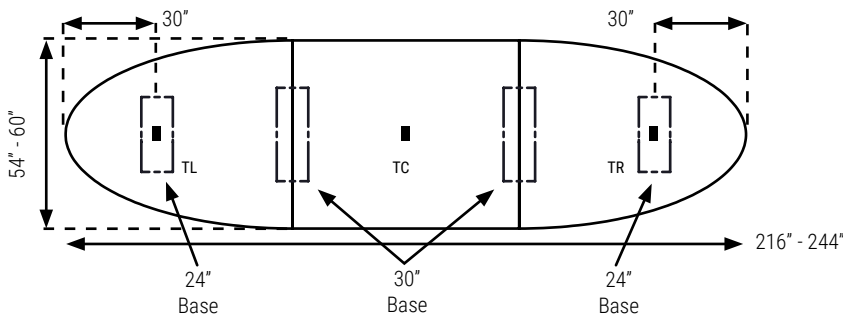
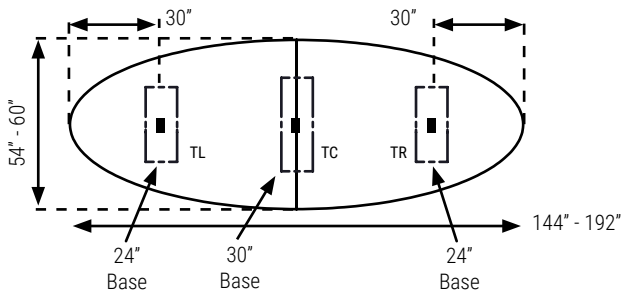
**Table Dimension Chart**

LR - Rectangular Base

For One Piece Top



\*15" for table widths between 60" and 72" and 18" for table widths between 78" and 96"

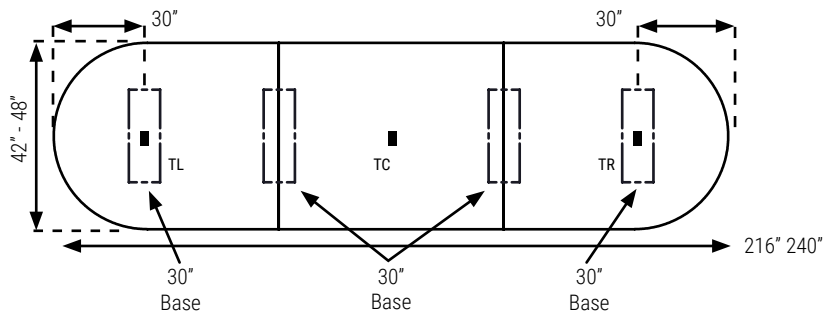
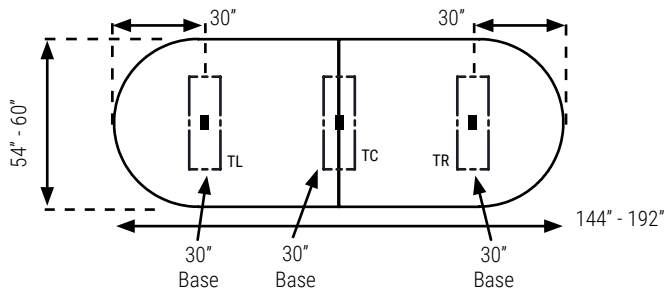
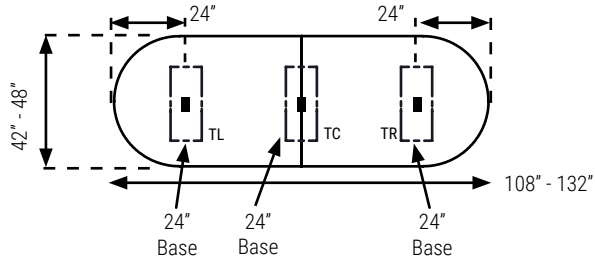
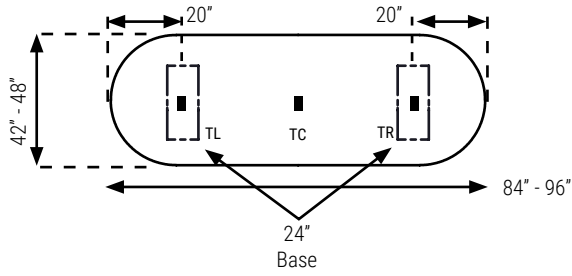


Note: Grommet orientation is perpendicular to the length of table.

**Table Dimension Chart**

LR - Rectangular Base

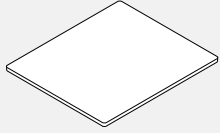
For One Piece Top



Note: Grommet orientation is perpendicular to the length of table.

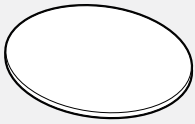
**LTS • Square Table Top**

• Tops with Band W thickness have 1" radius corners.



PRODUCT CODE	EDGE		SIZE/INCHES				WEIGHT LBS	VOL FT <sup>3</sup>
	B	W	H(B)	H(W)	W	D		
LTS2424	178	260	1	1.5	24	24	29	3
LTS3030	225	372	1	1.5	30	30	32	3
LTS3636	324	476	1	1.5	36	36	46	4
LTS4242	483	626	1	1.5	42	42	57	6
LTS4848	621	792	1	1.5	48	48	75	7
LTS5454	770	984	1	1.5	54	54	86	10
LTS6060	937	1194	1	1.5	60	60	99	12

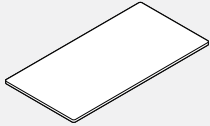
**L-DIA • Circle Table Top**



PRODUCT CODE	EDGE		SIZE/INCHES				WEIGHT LBS	VOL FT <sup>3</sup>
	B	W	H(B)	H(W)	W	D		
L24DIA	182	265	1	1.5	24 dia	24 dia	29	3
L30DIA	233	384	1	1.5	30	30	32	3
L36DIA	333	487	1	1.5	36	36	46	4
L42DIA	499	643	1	1.5	42	42	57	6
L48DIA	636	819	1	1.5	48	48	75	7
L54DIA	792	1012	1	1.5	54	54	86	10
L60DIA	966	1231	1	1.5	60	60	99	12

**LTR • Rectangle Table Top**

• Tops with B and W thickness have 1" radius corners.

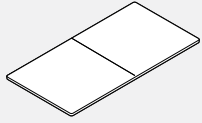


PRODUCT CODE	EDGE		SIZE/INCHES				WEIGHT LBS	VOL FT <sup>3</sup>
	B	W	H(B)	H(W)	W	D		
LTR2430	190	286	1	1.5	30	24	26	2
LTR2436	213	331	1	1.5	36	24	31	2
LTR2442	280	377	1	1.5	42	24	33	3
LTR2448	339	425	1	1.5	48	24	35	3
LTR2454	394	475	1	1.5	54	24	40	3
LTR2460	443	522	1	1.5	60	24	42	4
LTR2466	462	570	1	1.5	66	24	47	4
LTR2472	484	622	1	1.5	72	24	53	4
LTR3036	264	398	1	1.5	36	30	31	2
LTR3042	373	455	1	1.5	42	30	35	2
LTR3048	394	513	1	1.5	48	30	40	3
LTR3054	420	573	1	1.5	54	30	44	3
LTR3060	462	630	1	1.5	60	30	48	3
LTR3066	483	689	1	1.5	66	30	53	3
LTR3072	510	747	1	1.5	72	30	57	3
LTR3078	540	804	1	1.5	78	30	59	4
LTR3084	596	863	1	1.5	84	30	62	4
LTR3096	692	977	1	1.5	96	30	66	4
LTR3642	431	569	1	1.5	42	36	42	2
LTR3648	485	641	1	1.5	48	36	46	2
LTR3654	542	714	1	1.5	54	36	51	2
LTR3660	600	786	1	1.5	60	36	57	3
LTR3666	656	860	1	1.5	66	36	63	3
LTR3672	712	930	1	1.5	72	36	68	3
LTR3678	765	1003	1	1.5	78	36	72	3
LTR3684	824	1078	1	1.5	84	36	74	4
LTR3696	936	1224	1	1.5	96	36	79	4
LTR4248	581	734	1	1.5	48	42	57	3
LTR4254	653	819	1	1.5	54	42	59	3
LTR4260	720	898	1	1.5	60	42	62	3
LTR4266	786	985	1	1.5	66	42	68	3
LTR4272	853	1066	1	1.5	72	42	73	3
LTR4278	921	1152	1	1.5	78	42	76	3
LTR4284	988	1234	1	1.5	84	42	78	3
LTR4296	1125	1398	1	1.5	96	42	92	4
LTR4854	736	921	1	1.5	54	48	62	3
LTR4860	813	1017	1	1.5	60	48	66	3
LTR4866	891	1108	1	1.5	66	48	73	3
LTR4872	966	1201	1	1.5	72	48	79	3
LTR4878	1041	1298	1	1.5	78	48	84	3
LTR4884	1119	1391	1	1.5	84	48	88	4
LTR4896	1270	1577	1	1.5	96	48	110	4



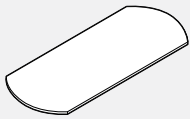
**LTR • Rectangle Table Top 2 Piece**

- Tables larger than 192" long are manufactured in 3 pieces.
- Tops with B and W thickness have 1" radius corners.



PRODUCT CODE	EDGE		SIZE/INCHES				WEIGHT LBS	VOL FT <sup>3</sup>
	B	W	H(B)	H(W)	W	D		
LTR36108	1201	1415	1	1.5	108	36	105	4
LTR36120	1325	1561	1	1.5	120	36	114	4
LTR42108	1370	1613	1	1.5	108	42	108	6
LTR42120	1508	1774	1	1.5	120	42	123	6
LTR48108	1530	1797	1	1.5	108	48	110	6
LTR48120	1690	1984	1	1.5	120	48	132	7
LTR48132	1843	2161	1	1.5	132	48	143	7
LTR48144	1869	2195	1	1.5	144	48	158	8
LTR48156	2151	2524	1	1.5	156	48	167	8
LTR48168	2301	2699	1	1.5	168	48	176	9
LTR48180	2584	3024	1	1.5	180	48	189	10
LTR48192	2610	3059	1	1.5	192	48	201	10
LTR54144	2268	2646	1	1.5	144	54	169	10
LTR54168	2610	3045	1	1.5	168	54	187	10
LTR54192	2953	3443	1	1.5	192	54	212	13
LTR54216	3292	3841	1	1.5	216	54	234	18
LTR54240	3636	4242	1	1.5	240	54	259	20
LTR60144	2490	2895	1	1.5	144	60	180	11
LTR60168	2864	3334	1	1.5	168	60	198	13
LTR60192	3242	3773	1	1.5	192	60	223	18
LTR60216	3617	4213	1	1.5	216	60	245	22
LTR60240	3996	4651	1	1.5	240	60	270	24

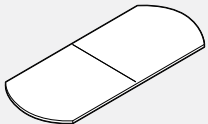
**LTRB • Rectangle Table Top with Bow Ends**



PRODUCT CODE	EDGE		SIZE/INCHES				WEIGHT LBS	VOL FT <sup>3</sup>
	B	W	H(B)	H(W)	W	D		
LTRB4284	1021	1269	1	1.5	84	42	78	3
LTRB4296	1158	1441	1	1.5	96	42	92	4
LTRB4884	1153	1431	1	1.5	84	48	88	4
LTRB4896	1309	1626	1	1.5	96	48	110	4

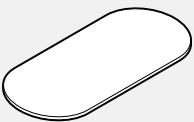
**LTRB • Rectangle Table Top with Bow Ends 2 Piece**

- Tables larger than 192" long are manufactured in 3 pieces.



PRODUCT CODE	EDGE		SIZE/INCHES				WEIGHT LBS	VOL FT <sup>3</sup>
	B	W	H(B)	H(W)	W	D		
LTRB42108	1414	1660	1	1.5	108	42	108	6
LTRB42120	1552	1826	1	1.5	120	42	123	6
LTRB48108	1577	1846	1	1.5	108	48	110	6
LTRB48120	1741	2042	1	1.5	120	48	132	7
LTRB48132	1898	2227	1	1.5	132	48	143	7
LTRB48144	1927	2262	1	1.5	144	48	158	8
LTRB48156	2213	2595	1	1.5	156	48	167	8
LTRB48168	2371	2782	1	1.5	168	48	176	9
LTRB48180	2659	3116	1	1.5	180	48	189	10
LTRB48192	2689	3153	1	1.5	192	48	201	10
LTRB54144	2337	2722	1	1.5	144	54	169	10
LTRB54168	2691	3134	1	1.5	168	54	187	10
LTRB54192	3040	3547	1	1.5	192	54	212	13
LTRB54216	3392	3956	1	1.5	216	54	234	18
LTRB54240	3745	4366	1	1.5	240	54	259	20
LTRB60144	2562	2982	1	1.5	144	60	180	11
LTRB60168	2950	3433	1	1.5	168	60	198	13
LTRB60192	3339	3887	1	1.5	192	60	223	18
LTRB60216	3729	4339	1	1.5	216	60	245	22
LTRB60240	4115	4790	1	1.5	240	60	270	24

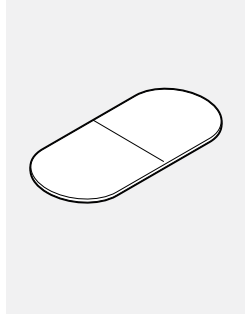
**LRT • Racetrack Table Top**



PRODUCT CODE	EDGE		SIZE/INCHES				WEIGHT LBS	VOL FT <sup>3</sup>
	B	W	H(B)	H(W)	W	D		
LRT4284	1021	1269	1	1.5	84	42	78	3
LRT4296	1158	1441	1	1.5	96	42	92	4
LRT4884	1153	1431	1	1.5	84	48	88	4
LRT4896	1309	1626	1	1.5	96	48	110	4

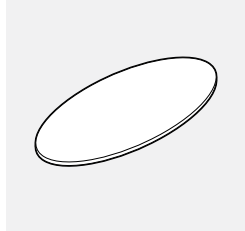
**LRT • Racetrack Table Top 2 Piece**

• Tables larger than 192" long are manufactured in 3 pieces.



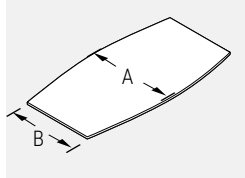
PRODUCT CODE	EDGE		SIZE / INCHES				WEIGHT		VOL FT <sup>3</sup>
	B	W	H (B)	H (W)	W	D	LBS		
LRT42108	1414	1660	1	1.5	108	42	108	6	
LRT42120	1552	1826	1	1.5	120	42	123	6	
LRT48108	1577	1846	1	1.5	108	48	110	6	
LRT48120	1741	2042	1	1.5	120	48	132	7	
LRT48132	1898	2227	1	1.5	132	48	143	7	
LRT48144	1927	2262	1	1.5	144	48	158	8	
LRT48156	2213	2595	1	1.5	156	48	167	8	
LRT48168	2371	2782	1	1.5	168	48	176	9	
LRT48180	2659	3116	1	1.5	180	48	189	10	
LRT48192	2689	3153	1	1.5	192	48	201	10	
LRT54144	2337	2722	1	1.5	144	54	169	10	
LRT54168	2691	3134	1	1.5	168	54	187	10	
LRT54192	3040	3547	1	1.5	192	54	204	10	
LRT54216	3392	3956	1	1.5	216	54	226	11	
LRT54240	3745	4366	1	1.5	240	54	253	11	
LRT60144	2562	2982	1	1.5	144	60	180	11	
LRT60168	2950	3433	1	1.5	168	60	198	13	
LRT60192	3339	3887	1	1.5	192	60	223	18	
LRT60216	3729	4339	1	1.5	216	60	245	22	
LRT60240	4115	4790	1	1.5	240	60	270	24	

**LO • Oval Table Top**



PRODUCT CODE	EDGE		SIZE / INCHES				WEIGHT		VOL FT <sup>3</sup>
	B	W	H (B)	H (W)	W	D	LBS		
LO3672	731	959	1	1.5	72	36	68	3	
LO3684	850	1108	1	1.5	84	36	74	3	
LO3696	963	1260	1	1.5	96	36	79	3	
LO4284	1021	1269	1	1.5	84	42	78	3	
LO4296	1158	1441	1	1.5	96	42	92	4	
LO4884	1153	1431	1	1.5	84	48	88	4	
LO4896	1309	1626	1	1.5	96	48	110	4	

**LBT • Boat Table Top**

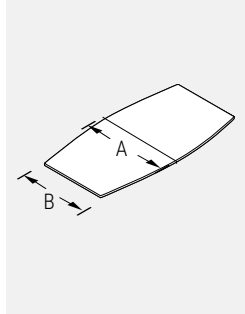


A	B
42	36
48	42

PRODUCT CODE	EDGE		SIZE / INCHES				WEIGHT		VOL FT <sup>3</sup>
	B	W	H (B)	H (W)	W	D	LBS		
LBT4284	1021	1269	1	1.5	84	42	78	3	
LBT4296	1158	1441	1	1.5	96	42	92	4	
LBT4884	1153	1431	1	1.5	84	48	99	4	
LBT4896	1309	1626	1	1.5	96	48	110	4	

**LBT • Boat Table Top 2 Piece**

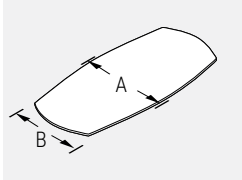
• Tables larger than 192" long are manufactured in 3 pieces.  
 • 6" narrower at the ends.



A	B
42	36
48	42
54	48
60	54

PRODUCT CODE	EDGE		SIZE / INCHES				WEIGHT		VOL FT <sup>3</sup>
	B	W	H (B)	H (W)	W	D	LBS		
LBT42108	1414	1660	1	1.5	108	42	108	6	
LBT42120	1552	1826	1	1.5	120	42	123	6	
LBT48108	1577	1846	1	1.5	108	48	110	6	
LBT48120	1741	2042	1	1.5	120	48	132	7	
LBT48132	1898	2227	1	1.5	132	48	143	7	
LBT48144	1927	2262	1	1.5	144	48	158	8	
LBT48156	2213	2595	1	1.5	156	48	167	8	
LBT48168	2371	2782	1	1.5	168	48	176	9	
LBT48180	2659	3116	1	1.5	180	48	189	10	
LBT48192	2689	3153	1	1.5	192	48	201	10	
LBT54144	2337	2722	1	1.5	144	54	169	10	
LBT54168	2691	3134	1	1.5	168	54	187	10	
LBT54192	3040	3547	1	1.5	192	54	212	13	
LBT54216	3392	3956	1	1.5	216	54	234	18	
LBT54240	3745	4366	1	1.5	240	54	259	20	
LBT60144	2562	2982	1	1.5	144	60	180	11	
LBT60168	2950	3433	1	1.5	168	60	198	13	
LBT60192	3339	3887	1	1.5	192	60	223	18	
LBT60216	3729	4339	1	1.5	216	60	245	22	
LBT60240	4115	4790	1	1.5	240	60	270	24	

**LBTB • Boat Table Top with Bow Ends**

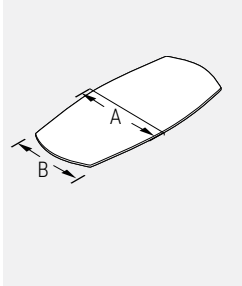


A	B
42	30
48	36

PRODUCT CODE	EDGE		SIZE / INCHES				WEIGHT LBS	VOL FT <sup>3</sup>
	B	W	H(B)	H(W)	W	D		
LBTB4284	1021	1269	1	1.5	84	42	78	3
LBTB4296	1158	1441	1	1.5	96	42	92	4
LBTB4884	1153	1431	1	1.5	84	48	88	4
LBTB4896	1309	1626	1	1.5	96	48	110	4

**LBTB • Boat Table Top with Bow Ends 2 Piece**

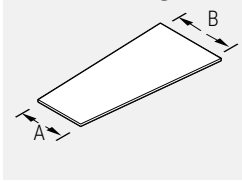
• Tables larger than 192" long are manufactured in 3 pieces.



A	B
60	48
54	42
48	36
42	30

PRODUCT CODE	EDGE		SIZE / INCHES				WEIGHT LBS	VOL FT <sup>3</sup>
	B	W	H(B)	H(W)	W	D		
LBTB42108	1414	1660	1	1.5	108	42	108	6
LBTB42120	1552	1826	1	1.5	120	42	123	6
LBTB48108	1577	1846	1	1.5	108	48	110	6
LBTB48120	1741	2042	1	1.5	120	48	132	7
LBTB48132	1898	2227	1	1.5	132	48	143	7
LBTB48144	1927	2262	1	1.5	144	48	158	8
LBTB48156	2213	2595	1	1.5	156	48	167	8
LBTB48168	2371	2782	1	1.5	168	48	176	9
LBTB48180	2659	3116	1	1.5	180	48	189	10
LBTB48192	2689	3153	1	1.5	192	48	204	11
LBTB54144	2337	2722	1	1.5	144	54	176	9
LBTB54168	2691	3134	1	1.5	168	54	187	10
LBTB54192	3040	3547	1	1.5	192	54	212	13
LBTB54216	3392	3956	1	1.5	216	54	234	18
LBTB54240	3745	4366	1	1.5	240	54	259	20
LBTB60144	2562	2982	1	1.5	144	60	180	11
LBTB60168	2950	3433	1	1.5	168	60	198	13
LBTB60192	3339	3887	1	1.5	192	60	223	18
LBTB60216	3729	4339	1	1.5	216	60	245	22
LBTB60240	4115	4790	1	1.5	240	60	270	24

**LTW • Wedge Table Top**

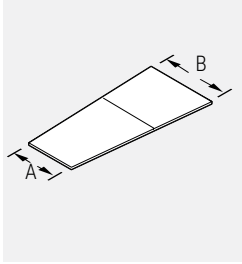


A	B
36	48

PRODUCT CODE	EDGE		SIZE / INCHES				WEIGHT LBS	VOL FT <sup>3</sup>
	B	W	H(B)	H(W)	W	D		
LTW4896	1309	1626	1	1.5	96	48	110	4

**LTW • Wedge Table Top 2 Piece**

• Tables larger than 192" long are manufactured in 3 pieces.

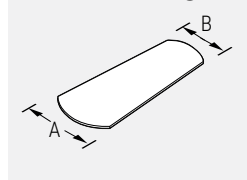


A	B
36	48
42	54
48	60

PRODUCT CODE	EDGE		SIZE / INCHES				WEIGHT LBS	VOL FT <sup>3</sup>
	B	W	H(B)	H(W)	W	D		
LTW48108	1577	1846	1	1.5	108	48	110	6
LTW48120	1741	2042	1	1.5	120	48	132	7
LTW48132	1898	2227	1	1.5	132	48	143	7
LTW48144	1927	2262	1	1.5	144	48	158	8
LTW48156	2213	2595	1	1.5	156	48	167	8
LTW48168	2371	2782	1	1.5	168	48	176	9
LTW48180	2659	3116	1	1.5	180	48	189	10
LTW48192	2689	3153	1	1.5	192	48	201	10
LTW54144	2337	2722	1	1.5	144	54	169	10
LTW54168	2691	3134	1	1.5	168	54	187	10
LTW54192	3040	3547	1	1.5	192	54	212	13
LTW54216	3392	3956	1	1.5	216	54	234	18
LTW54240	3745	4366	1	1.5	240	54	259	20
LTW60144	2562	2982	1	1.5	144	60	180	11
LTW60168	2950	3433	1	1.5	168	60	198	13
LTW60192	3339	3887	1	1.5	192	60	223	18
LTW60216	3729	4339	1	1.5	216	60	245	22
LTW60240	4115	4790	1	1.5	240	60	270	24

LTW... first dash is B, and the second dash is the length. A is not included in the code and is the smaller end.

**LTWB • Wedge Table Top with Bow Ends**

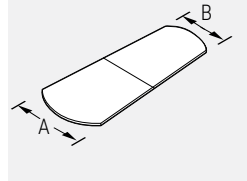


A	B
48	36

PRODUCT CODE	EDGE				W	D	WEIGHT		VOL FT <sup>3</sup>
	B	H(B)	H(W)	LBS					
LTWB4896	1309	1626	1	1.5	96	48	110	4	

**LTWB • Wedge Table Top with Bow Ends 2 Piece**

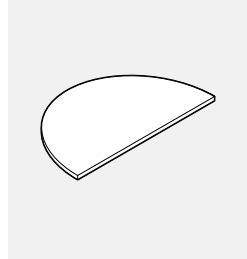
• Tables larger than 192" long are manufactured in 3 pieces.



A	B
48	36
54	42
60	48

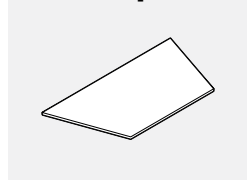
PRODUCT CODE	EDGE				W	D	WEIGHT		VOL FT <sup>3</sup>
	B	H(B)	H(W)	LBS					
LTWB48108	1577	1846	1	1.5	108	48	110	6	
LTWB48120	1741	2042	1	1.5	120	48	132	7	
LTWB48132	1898	2227	1	1.5	132	48	143	7	
LTWB48144	1927	2262	1	1.5	144	48	158	8	
LTWB48156	2213	2595	1	1.5	156	48	167	8	
LTWB48168	2371	2782	1	1.5	168	48	176	9	
LTWB48180	2659	3116	1	1.5	180	48	189	10	
LTWB48192	2689	3153	1	1.5	192	48	198	11	
LTWB54144	2337	2722	1	1.5	144	54	178	9	
LTWB54168	2691	3134	1	1.5	168	54	187	10	
LTWB54192	3040	3547	1	1.5	192	54	212	13	
LTWB54216	3392	3956	1	1.5	216	54	234	18	
LTWB54240	3745	4366	1	1.5	240	54	259	20	
LTWB60144	2562	2982	1	1.5	144	60	180	11	
LTWB60168	2950	3433	1	1.5	168	60	198	13	
LTWB60192	3339	3887	1	1.5	192	60	223	18	
LTWB60216	3729	4339	1	1.5	216	60	245	22	
LTWB60240	4115	4790	1	1.5	240	60	270	24	

**LHM • Halfmoon Table Top**



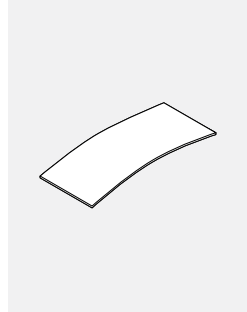
PRODUCT CODE	EDGE				W	D	WEIGHT		VOL FT <sup>3</sup>
	B	H(B)	H(W)	LBS					
LHM2424	182	265	1	1.5	24	24	29	3	
LHM2448	347	439	1	1.5	48	24	35	3	
LHM2460	456	540	1	1.5	60	24	42	4	
LHM2472	500	638	1	1.5	72	24	53	6	
LHM3030	233	384	1	1.5	30	30	32	3	
LHM3048	406	528	1	1.5	48	30	40	4	
LHM3060	476	652	1	1.5	60	30	48	6	
LHM3072	524	770	1	1.5	72	30	57	7	

**LTZ • Trapezoid Table Top**



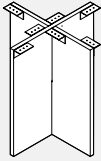
PRODUCT CODE	EDGE				W	D	WEIGHT		VOL FT <sup>3</sup>
	B	H(B)	H(W)	LBS					
LTZ2460	456	540	1	1.5	60	24	42	4	
LTZ2472	500	638	1	1.5	72	24	53	6	
LTZ3060	476	652	1	1.5	60	30	48	6	
LTZ3072	524	770	1	1.5	72	30	57	7	

**LW • Wave Table Top**



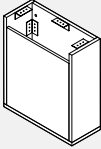
PRODUCT CODE	EDGE				W	D	WEIGHT		VOL FT <sup>3</sup>
	B	H(B)	H(W)	LBS					
LW2448	347	439	1	1.5	48	24	35	3	
LW2460	456	540	1	1.5	60	24	42	4	
LW2466	476	590	1	1.5	66	24	47	6	
LW2472	500	638	1	1.5	72	24	53	6	
LW3060	476	652	1	1.5	60	30	48	6	
LW3066	499	709	1	1.5	66	30	53	7	
LW3072	524	770	1	1.5	72	30	64	8	
LW3660	614	811	1	1.5	60	36	53	7	
LW3666	672	885	1	1.5	66	36	63	8	
LW3672	731	959	1	1.5	72	36	68	9	

**LCT • Cross Base for Table Tops**



PRODUCT CODE	PRICE	SIZE/INCHES			WEIGHT LBS	VOL FT <sup>3</sup>
		H	W	D		
LCT18	516	28	18	18	29	6
LCT24	516	28	24	24	39	4
LCT30	579	28	30	30	48	6
LCT36	664	28	36	36	57	8
LCT42	745	28	42	42	62	9

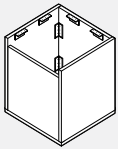
**LR • Rectangular Base for Table Tops**



- Short side panel is removable for full wire access.

PRODUCT CODE	PRICE	SIZE/INCHES			WEIGHT LBS	VOL FT <sup>3</sup>
		H	W	D		
LR18	447	28	18	10	39	3
LR24	505	28	24	10	46	4
LR30	558	28	30	10	54	6
LR36	622	28	36	10	66	8
LR42	715	28	42	10	83	9

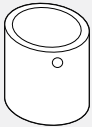
**LSQ • Square Base for Table Tops**



- Short side panel is removable for full wire access.

PRODUCT CODE	PRICE	SIZE/INCHES			WEIGHT LBS	VOL FT <sup>3</sup>
		H	W	D		
LSQ18	560	28	18	18	50	7
LSQ24	686	28	24	24	66	11
LSQ30	818	28	30	30	83	17

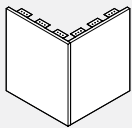
**LDRUM • Drum Base for Table Tops**



- Drum bases are finished in high pressure only and come with a full bottom.
- A 2" hole at the top to run the cables from the floor to the table top.
- Sand bag included.
- Access door is not an option.

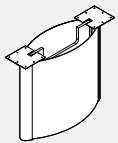
PRODUCT CODE	PRICE	SIZE/INCHES			WEIGHT LBS	VOL FT <sup>3</sup>
		H	W	D		
LDRUM18	909	28	18	18	32	8
LDRUM24	969	28	24	24	43	11
LDRUM30	993	28	30	30	54	14

**LV • "V" Base for Table Tops**



PRODUCT CODE	PRICE	SIZE/INCHES			WEIGHT LBS	VOL FT <sup>3</sup>
		H	W	D		
LV1818	298	28	18	18	29	3
LV2424	341	28	24	24	39	4
LV3030	400	28	30	30	48	6

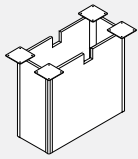
**LELBA • Elliptical Base with Aluminum Extrusion**



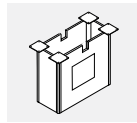
- Laminate side panels are removable for full wire access.
- Standard in metal paint finishes.
- Optional anodized aluminum finish available, please add \$50 list.

PRODUCT CODE	PRICE	SIZE/INCHES			WEIGHT LBS	VOL FT <sup>3</sup>
		H	W	D		
LELBA18	1266	28	18	9	33	2
LELBA24	1348	28	24	10	44	2
LELBA30	1511	28	30	12	55	4
LELBA36	1679	28	36	13	66	7
LELBA42	1841	28	42	14	77	9

**TELRR • Rectangular Panel Base with Anodized Aluminum Radius Corner Detail**

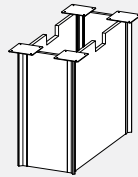


Single hinged access door is optional. Add "HD" to the end of the code. Add \$122 to list price.

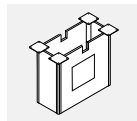


PRODUCT CODE	PRICE	SIZE/INCHES			WEIGHT LBS	VOL FT <sup>3</sup>
		H	W	D		
TELRR18	757	28	18	12	66	7
TELRR24	800	28	24	12	72	9
TELRR30	844	28	30	12	105	11
TELRR36	887	28	36	12	129	13
TELRR42	930	28	42	12	129	15

**TELBR • Rectangular Base with Rectangular Anodized Aluminum Corner Detail**

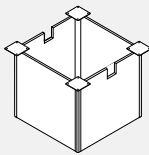


Single hinged access door is optional. Add "HD" to the end of the code. Add \$122 to list price.

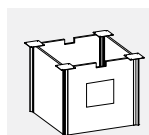


PRODUCT CODE	PRICE	SIZE/INCHES			WEIGHT LBS	VOL FT <sup>3</sup>
		H	W	D		
TELBR18	781	28	18	12	66	7
TELBR24	826	28	24	12	72	9
TELBR30	868	28	30	12	105	11
TELBR36	912	28	36	12	129	13
TELBR42	956	28	42	12	129	15

**TELSR • Square Panel Base with Anodized Aluminum Radius Corner Detail**

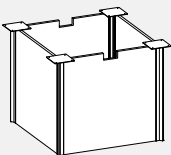


Single hinged access door is optional. Add "HD" to the end of the code. Add \$122 to list price.

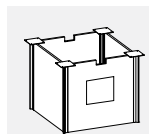


PRODUCT CODE	PRICE	SIZE/INCHES			WEIGHT LBS	VOL FT <sup>3</sup>
		H	W	D		
TELSR18	811	28	18	18	77	7
TELSR24	894	28	24	24	83	9
TELSR30	979	28	30	30	117	20
TELSR36	1064	28	36	36	140	24
TELSR42	1146	28	42	42	140	24

**TELBS • Square Base with Rectangular Anodized Aluminum End Detail**

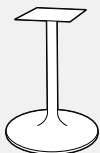


Single hinged access door is optional. Add "HD" to the end of the code. Add \$122 to list price.



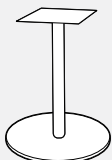
PRODUCT CODE	PRICE	SIZE/INCHES			WEIGHT LBS	VOL FT <sup>3</sup>
		H	W	D		
TELBS18	837	28	18	18	77	7
TELBS24	936	28	24	24	83	9
TELBS30	1040	28	30	30	117	20
TELBS36	1156	28	36	36	140	24
TELBS42	1275	28	42	42	140	24

**TRUM • Trumpet Column Base**



PRODUCT CODE	PRICE		SIZE/INCHES			WEIGHT LBS	VOL FT <sup>3</sup>
	PAINTED	CHROME	H	W	D		
TRUM18	473	618	28	18	18	15	9
TRUM24	542	686	28	24	24	18	13
TRUM30	880	1024	28	30	30	20	15
TRUM18BH	699	842	40.5	18	18	26	18
TRUM24BH	799	944	40.5	24	24	29	15

**TTFD • Flat Disk Column Base**



PRODUCT CODE	PRICE		SIZE/INCHES			WEIGHT LBS	VOL FT <sup>3</sup>
	PAINTED	CHROME	H	W	D		
TTFD18	845	1007	28	18	18	50	9
TTFD22	912	1073	28	22	22	55	13
TTFD24	980	1140	28	24	24	66	14
TTFD30	1423	1492	28	30	30	88	15
TTFD36	1895	2054	28	36	36	110	15
TTFD18BH	1036	1197	40.5	18	18	72	11
TTFD22BH	1103	1263	40.5	22	22	77	15
TTFD24BH	1169	1330	40.5	24	24	110	17



**TTSQ • Flat Square Column Base**

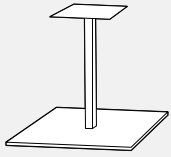


Plate size: (18"-30" 11"x11"), (36" 14"x14").  
Column size: (18"-24" 2.1/2"), (30"-36" 3")

PRODUCT CODE	PRICE		SIZE/INCHES			WEIGHT LBS	VOL FT <sup>3</sup>
	PAINTED	CHROME	H	W	D		
TTSQ18	1184	1328	28	18	18	50	9
TTSQ23	1319	1463	28	23	23	61	13
TTSQ30	1691	1836	28	30	30	88	15
TTSQ18BH	1375	1519	40.5	18	18	72	11
TTSQ23BH	1508	1653	40.5	23	23	83	15

**TTFLTX • Flat Bar "X" Column Base**

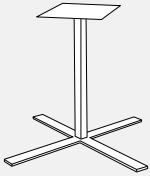


Plate size: (18"-30" 11"x11"), (36" 14"x14").  
Column size: (18"-24" 2.1/2"), (30"-36" 3")

PRODUCT CODE	PRICE		SIZE/INCHES			WEIGHT LBS	VOL FT <sup>3</sup>
	PAINTED	CHROME	H	W	D		
TTFLTX18	1251	1476	28	18	18	15	9
TTFLTX22	1268	1493	28	22	22	17	11
TTFLTX24	1285	1510	28	24	24	18	13
TTFLTX30	1319	1511	28	30	30	20	15
TTFLTX36	1352	1576	28	36	36	22	24
TTFLTX18BH	1441	1668	40.5	18	18	26	11
TTFLTX22BH	1459	1682	40.5	22	22	28	13
TTFLTX24BH	1508	1737	40.5	24	24	29	15

**TTFLT • Flat Bar "T" Column Base**

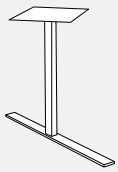


Plate size: (18"-30" 11"x11"), (36" 14"x14").  
Column size: (18"-24" 2.1/2"), (30"-36" 3")

PRODUCT CODE	PRICE		SIZE/INCHES			WEIGHT LBS	VOL FT <sup>3</sup>
	PAINTED	CHROME	H	W	D		
TTFLT18	946	1108	28		18	9	2
TTFLT22	965	1126	28		22	10	2
TTFLT24	980	1140	28		24	11	3
TTFLT30	1015	1176	28		30	13	3
TTFLT36	1049	1209	28		36	15	3

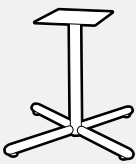
**TTFL3P • Flat Bar 3 Prong Column Base**



Plate size: (18"-30" 11"x11"), (36" 14"x14").  
Column size: (18"-24" 2.1/2"), (30"-36" 3")

PRODUCT CODE	PRICE		SIZE/INCHES			WEIGHT LBS	VOL FT <sup>3</sup>
	PAINTED	CHROME	H	W	D		
TTFL3P18	1184	1410	28		18	11	7
TTFL3P22	1201	1427	28		22	12	13
TTFL3P24	1218	1443	28		24	13	15
TTFL3P30	1251	1476	28		30	15	15
TTFL3P36	1268	1493	28		36	18	24

**LL4S • 4 Star Table Leg with Bullnose End**



- Leg Plate is 11"x11" for 26" and 30" spread and 14"x14" for 36" spread.
- For the caster option specify "CS" at the end of the code with a \$77 upcharge

PRODUCT CODE	PRICE		SIZE/INCHES			WEIGHT LBS	VOL FT <sup>3</sup>
	PAINTED	CHROME	H	W	D		
LL4S18	481	608	28	18	18	15	7
LL4S26	571	699	28	26	26	18	15
LL4S30	607	736	28	30	30	20	15
LL4S36	668	796	28	36	36	22	24

**LL4S-42 • Bistro Leg with Bullnose End**



- Leg Plate is 11"x11" for 26" and 30" spread.

PRODUCT CODE	PRICE		SIZE/INCHES			WEIGHT LBS	VOL FT <sup>3</sup>
	PAINTED	CHROME	H	W	D		
LL4S2642	651	781	40.5	26	26	22	18
LL4S3042	696	825	40.5	30	30	24	23
LL4S3642	760	887	40.5	36	36	26	28

**LLT • "T" Table Leg with Bullnose End**



- Leg Plate is 11"x11"
- For the caster option specify "CS" at the end of the code with a \$37 upcharge

PRODUCT CODE	PRICE		SIZE/INCHES			WEIGHT LBS	VOL FT <sup>3</sup>
	PAINTED	CHROME	H	W	D		
LLT18	295	424	28	18	6	9	2
LLT26	312	440	28	26	6	11	3
LLT30	325	451	28	30	6	13	3
LLT36	601	728	28	36	6	15	3

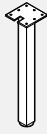
**LLTT • “TT” Table Leg with Bullnose End**



- Leg Plate is 11”x 24”
- For the caster option specify “CS” at the end of the code with a \$37 upcharge

PRODUCT CODE	PRICE		SIZE/INCHES			WEIGHT		VOL FT <sup>3</sup>
	PAINTED	CHROME	H	W	D	LBS		
LLTT18	492	653	28	18	6	13	2	
LLTT26	518	679	28	26	6	20	3	
LLTT30	534	696	28	30	6	24	3	
LLTT36	769	928	28	36	6	26	3	
LLTT42	899	1062	28	42	6	31	4	

**LLSQ • Square Post Leg**



- 2.5” x 2.5” square tubular leg provides support for worksurfaces.
- Top plate welded to leg.
- 8” x 8” plate attached with #10 3/4” wood screws included.
- 1” height adjustment range.

PRODUCT CODE	PRICE		SIZE/INCHES			WEIGHT		VOL FT <sup>3</sup>
	PAINTED	CHROME	H	W	D	LBS		
LLSQ25X25H28	240	367	28	2.5	2.5	9	0.17	

**LATBL • Tapered Leg**



- Tapered leg provides support for worksurfaces.
- Top plate welded to leg.
- 8” x 8” plate attached with #10 3/4” wood screws included.
- 1” height adjustment range.
- Bottom of leg tube is a 1” diameter and top is 2 3/8” diameter.

PRODUCT CODE	PRICE		SIZE/INCHES			WEIGHT		VOL FT <sup>3</sup>
	PAINTED	CHROME	H	W	D	LBS		
LATBL28	195	331	28	3	3	9	0.17	

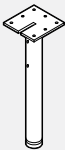
**BHML • Monoleg**



- 3” diameter Monoleg provides support for worksurfaces.
- Top plate welded to leg.
- 8” x 8” plate attached with #10 3/4” wood screws included.
- 1” height adjustment range.

PRODUCT CODE	PRICE		SIZE/INCHES			WEIGHT		VOL FT <sup>3</sup>
	PAINTED	CHROME	H	W	D	LBS		
BHML03	207	334	28	3	3	9	0.17	

**L2BHML • Monoleg**



- 3” diameter Monoleg provides support for worksurfaces.
- Cut-out top plate welded to leg. Cut-out accepts 3/4” modesty panel.
- 8” x 8” plate attached with #10 3/4” wood screws included.
- 1” height adjustment range.

PRODUCT CODE	PRICE		SIZE/INCHES			WEIGHT		VOL FT <sup>3</sup>
	PAINTED	CHROME	H	W	D	LBS		
L2BHML03	207	334	28	3	3	9	0.17	

**LBHML06 • 6” Monoleg**



- 6” diameter Monoleg provides support for worksurfaces.
- Top plate welded to leg flush.
- 8” x 8” plate attached with #10 3/4” wood screws, included.
- 1” height adjustment range.
- Leg is offset flush to edge.

PRODUCT CODE	PRICE		SIZE/INCHES			WEIGHT		VOL FT <sup>3</sup>
	PAINTED	CHROME	H	W	D	LBS		
LBHML06	398	559	28	6	6	9	0.17	

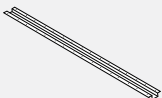
**FOLDLEG • Folding Leg**



- Sold as a set of two.
- Available in only in (SIL) Silver or (BLK) Black.

PRODUCT CODE	PRICE	SIZE/INCHES			WEIGHT		VOL FT <sup>3</sup>
		H	W	D	LBS		
FOLDLEG	460	28	24.625	3	11	7	

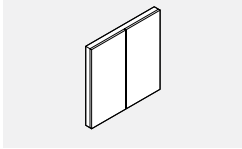
**LHC • HAT Channel for Conference Tables**



- See chart on page H.2

PRODUCT CODE	PRICE	SIZE/INCHES			WEIGHT		VOL FT <sup>3</sup>
		H	W	D	LBS		
LHC40	58	1.4	40	5	4	0.20	
LHC46	64	1.4	46	5	6	0.22	
LHC52	68	1.4	52	5	7	0.25	
LHC58	78	1.4	58	5	8	0.28	
LHC64	88	1.4	64	5	9	0.31	
LHC70	94	1.4	70	5	10	0.33	

**LVB • Visual Board**



• See page H.1 for technical information.

PRODUCT CODE	FINISH		SIZE/INCHES			WEIGHT		VOL FT <sup>3</sup>
	LP/B	HP/B	H (LP/B)	W	D	LBS		
LVB48	1579	1748	48	48	8	154	10	
LVB48MG	2457	2708	48	48	8	154	10	

**MSPDM • 1 Duplex, 2 Data**



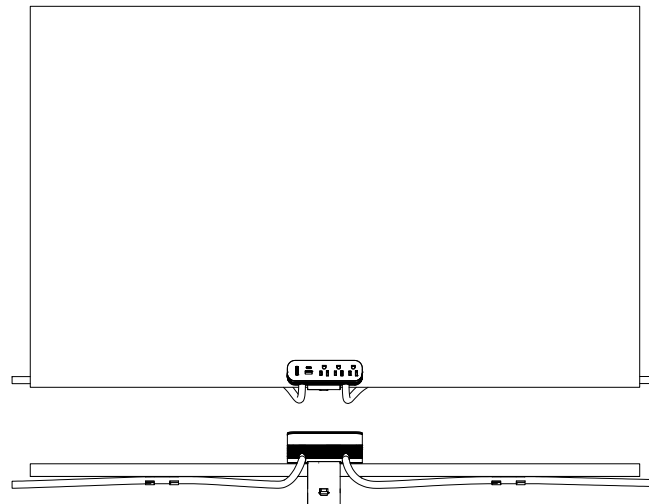
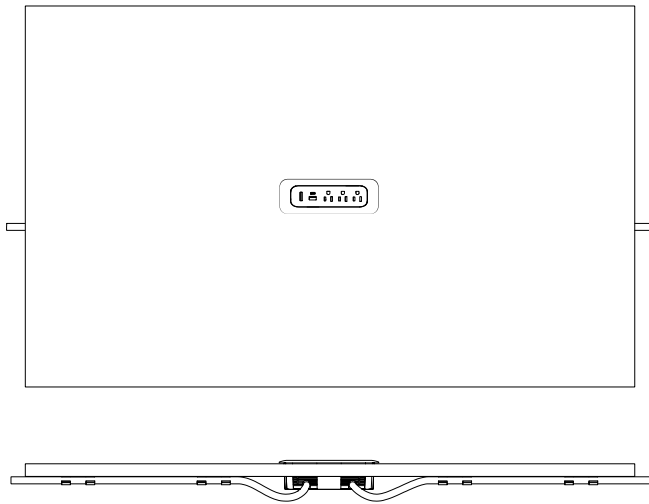
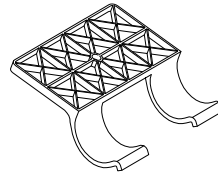
- Includes one duplex and 2 data jacks (both RJ45, Cat 6)
- Black plastic

PRODUCT CODE	PRICE	PRICE			WEIGHT		VOL FT <sup>3</sup>
		H	W	D	LBS		
MSPDM	276	2.75	6.5	3.5	2	0.1	

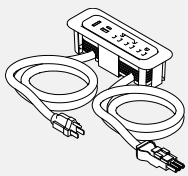
**ModPower Power Solution**

- Power solutions for flexible spaces. Connect up to four units (in Canada)/six units in the USA from a single infeed with NEMA plug to deliver power and charging ports to the table top. In-surface modules and clamp on modules available.
- Easy to install; code compliant that allows users to optimize any space providing convenient power access. Perfect for training areas, meeting rooms, in-office workstations and more. Units feature tamper-resistant receptacles as well as both USB-A and USB-C charging ports.
- Easy to use connectors that are touch-safe with added latch to prevent unintended separation. Easy push together to connect, and simple press down on latch to disconnect.
- Maximum overall length not to exceed 48.5 feet per infeed. UL listed to UL962A SD, the standard for furniture power distribution units for portable/moveable work space tables.
- Certified to CSA standard C22.2 No. 203-16.
- Will work with Licence, Terina and Bridges Products.
- Surface mounted module ships with a clamp mount that will accommodate any material 1/2" to 1-1/2" thick; additional brackets are also included for screw in mounting options that

- can accommodate vertical or horizontal positions.
- Modules can be integrated into surfaces but the surface must be specified as a special.



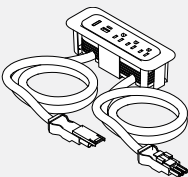
**GMDSF10 • ModPower In Surface Starter Unit**



- ModPower starter unit includes one 10' cord with a NEMA plug and one 3' connector cord.
- Unit equipped with three 15A tamper resistant receptacles, one USB-A and one USB-C charging ports and a circuit breaker.
- 4 cable management cord clips included.
- MG at the end of the code indicates a magnesium finish, while WH is a white finish.

PRODUCT CODE	PRICE	PRICE			WEIGHT		VOL FT <sup>3</sup>
		H	W	D	LBS		
GMDSF10MG	597	7.63	2.75	2.63	3.44	1.0	
GMDSF10WH	597	7.63	2.75	2.63	3.44	1.0	

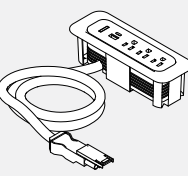
**GMDCF3 • ModPower In Surface Middle Unit**



- ModPower middle unit includes two 3' connector cords.
- Unit equipped with three 15A rated 12A tamper resistant receptacles, one USB-A and one USB-C charging ports and a circuit breaker.
- 4 cable management cord clips included.
- MG at the end of the code indicates a magnesium finish, while WH is a white finish.

PRODUCT CODE	PRICE	PRICE			WEIGHT		VOL FT <sup>3</sup>
		H	W	D	LBS		
GMDCF3MG	562	7.63	2.75	2.63	2.44	1.0	
GMDCF3WH	562	7.63	2.75	2.63	2.44	1.0	

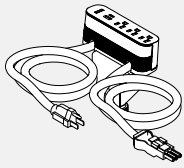
**GMDEF3 • ModPower In Surface End Unit**



- ModPower end unit includes one 3' connector cord.
- Unit equipped with three 15A rated 12A tamper resistant receptacles, one USB-A and one USB-C charging ports and a circuit breaker.
- 2 cable management cord clips included.
- MG at the end of the code indicates a magnesium finish, while WH is a white finish.

PRODUCT CODE	PRICE	PRICE			WEIGHT		VOL FT <sup>3</sup>
		H	W	D	LBS		
GMDEF3MG	494	7.63	2.75	2.63	1.85	1.0	
GMDEF3WH	494	7.63	2.75	2.63	1.85	1.0	

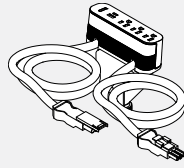
**GMDSA10 • ModPower Starter Mounted Unit**



- ModPower starter unit includes one 10' cord with a NEMA plug and one 3' connector cord.
- Unit equipped with three 15A tamper resistant receptacles, one USB-A and one USB-C charging ports and a circuit breaker.
- Includes edge clamp and 3 other mounting methods; and 4 cable management cord clips.
- MG at the end of the code indicates a magnesium finish, while WH is a white finish.

PRODUCT CODE	PRICE	PRICE			WEIGHT		VOL	
		H	W	D	LBS	FT <sup>3</sup>		
GMDSA10MG	631	6.13	1.75	2.5	4.33	1.0		
GMDSA10WH	631	6.13	1.75	2.5	4.33	1.0		

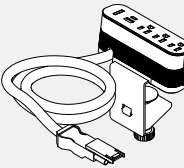
**GMDCA3 • ModPower Middle Mounted Unit**



- ModPower middle unit includes two 3' connector cords.
- Unit equipped with three 15A rated 12A tamper resistant receptacles, one USB-A and one USB-C charging ports and a circuit breaker.
- Includes edge clamp and 3 other mounting methods; and 4 cable management cord clips.
- MG at the end of the code indicates a magnesium finish, while WH is a white finish.

PRODUCT CODE	PRICE	PRICE			WEIGHT		VOL	
		H	W	D	LBS	FT <sup>3</sup>		
GMDCA3MG	597	6.13	1.75	2.5	3.33	1.0		
GMDCA3WH	597	6.13	1.75	2.5	3.33	1.0		

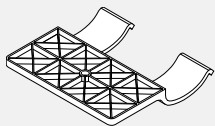
**GMDEA3 • ModPower End Mounted Unit**



- ModPower end unit includes one 3' connector cord.
- Unit equipped with three 15A rated 12A tamper resistant receptacles, one USB-A and one USB-C charging ports and a circuit breaker.
- Includes edge clamp and 3 other mounting methods; and 2 cable management cord clips.
- MG at the end of the code indicates a magnesium finish, while WH is a white finish.

PRODUCT CODE	PRICE	PRICE			WEIGHT		VOL	
		H	W	D	LBS	FT <sup>3</sup>		
GMDEA3MG	528	6.13	1.75	2.5	2.75	1.0		
GMDEA3WH	528	6.13	1.75	2.5	2.75	1.0		

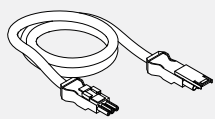
**GMDCLIPS • ModPower Management Clips**



- Includes 10 clips.

PRODUCT CODE	PRICE	PRICE			WEIGHT		VOL	
		H	W	D	LBS	FT <sup>3</sup>		
GMDCLIPS	102	2.6	2.5	0.6	0.3	0.2		

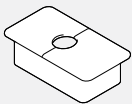
**GMDJ36BK • ModPower Interconnecting Jumper**



- ModPower interconnecting jumper cord to add an additional 3 feet of cord length between ModPower units.
- Package of 2, each 3 feet with male & female connector.

PRODUCT CODE	PRICE	PRICE			WEIGHT		VOL	
		H	W	D	LBS	FT <sup>3</sup>		
GMDJ36BK	329	36			1.38	0.9		

**BG5 • Rectangular Grommet**



- Option  
(BLK) Black Plastic  
(GRY) Grey Plastic  
(WHT) White Plastic

PRODUCT CODE	PRICE	PRICE			WEIGHT		VOL	
		H	W	D	LBS	FT <sup>3</sup>		
BG5	36		3.5	2				

**Telecom Plates**



**PRODUCT CODE**  
**Black telecom plate with 2 RJ45 cat 6 data**  
 ABLBB 252

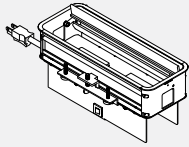


**Black telecom plate with 3 RJ45 cat 6 data**  
 ABLBBB 372



**Black telecom plate with 4 RJ45 cat 6 data**  
 ABLBBBB 490

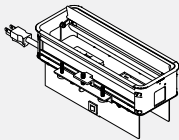
**GCRTMCS401 • Recessed Power Block, 1 Duplex, 1 Data Knock-outs, 1 Power Duplex**



- Single sided recessed power block with 1 regular duplex and 1 data knock-out on top, 1 power duplex on bottom.
- 10 ft power cord with straight plug.
- Telecom plates ordered separately.
- Available in Black - B, Tungsten - T or Designer White - W as indicated by last letter of model number; duplexes always grey.
- Not approved for daisy-chain applications.

PRODUCT CODE	PRICE	H	W	D	WEIGHT LBS	VOL FT <sup>3</sup>
GCRTMCS401B	578	4.86	10.78	4.22	4.3	0.51
GCRTMCS401T	578	4.86	10.78	4.22	4.3	0.51
GCRTMCS401W	578	4.86	10.78	4.22	4.3	0.51

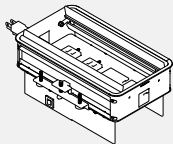
**GCRTMCS421 • Recessed Power Block, 1 Power including USB A+C, 1 Data Knock-outs, 1 Power Duplex**



- Single sided recessed power block with 1 power and USB A+C duplex and 1 data knock-out on top, 1 power duplex on bottom.
- USB Type A port charges maximum 2.4 amps at 5V and Type C port charges maximum 3 amps at 5V.
- 10 ft power cord with straight plug.
- Telecom plates ordered separately.
- Available in Black - B, Tungsten - T or Designer White - W as indicated by last letter of model number; duplexes always grey.
- Not approved for daisy-chain applications.

PRODUCT CODE	PRICE	H	W	D	WEIGHT LBS	VOL FT <sup>3</sup>
GCRTMCS421B	759	4.86	10.78	4.22	4.3	0.51
GCRTMCS421T	759	4.86	10.78	4.22	4.3	0.51
GCRTMCS421W	759	4.86	10.78	4.22	4.3	0.51

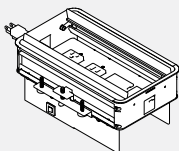
**GCRTMCD602 • Recessed Power Block, 2 Duplex, 2 Data Knock-outs, 1 Power Duplex**



- Double sided recessed power block with 2 regular duplex and 2 data knock-outs on top, 1 power duplex on bottom.
- 10 ft power cord with straight plug.
- Telecom plates ordered separately.
- Available in Black - B, Tungsten - T or Designer White - W as indicated by last letter of model number; duplexes always grey.
- Not approved for daisy-chain applications.

PRODUCT CODE	PRICE	H	W	D	WEIGHT LBS	VOL FT <sup>3</sup>
GCRTMCD602B	660	4.86	10.78	6.22	5.9	0.51
GCRTMCD602T	660	4.86	10.78	6.22	5.9	0.51
GCRTMCD602W	660	4.86	10.78	6.22	5.9	0.51

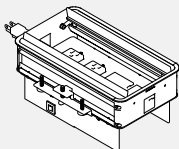
**GCRTMCD622 • Recessed Power Block, 1 Duplex, 1 Power including USB A+C, 2 Data Knockouts, Power Duplex**



- Double sided recessed power block with 1 regular duplex, 1 power and USB A+C and 2 data knock-outs on top, 1 power duplex on bottom.
- USB Type A port charges maximum 2.4 amps at 5V and Type C port charges maximum 3 amps at 5V.
- 10 ft power cord with straight plug.
- Telecom plates ordered separately.
- Available in Black - B, Tungsten - T or Designer White - W as indicated by last letter of model number; duplexes always grey.
- Not approved for daisy-chain applications.

PRODUCT CODE	PRICE	H	W	D	WEIGHT LBS	VOL FT <sup>3</sup>
GCRTMCD622B	831	4.86	10.78	6.22	6.1	0.51
GCRTMCD622T	831	4.86	10.78	6.22	6.1	0.51
GCRTMCD622W	831	4.86	10.78	6.22	6.1	0.51

**GCRTMCD642 • Recessed Power Block, 2 Power including USB A+C, 2 Data Knock-outs, 1 Power Duplex**



- Double sided recessed power block with 2 power and USB A+C and 2 data knock-outs on top, 1 power duplex on bottom.
- USB Type A port charges maximum 2.4 amps at 5V and Type C port charges maximum 3 amps at 5V.
- 10 ft power cord with straight plug.
- Telecom plates ordered separately.
- Available in Black - B, Tungsten - T or Designer White - W as indicated by last letter of model number; duplexes always grey.
- Not approved for daisy-chain applications.

PRODUCT CODE	PRICE	H	W	D	WEIGHT LBS	VOL FT <sup>3</sup>
GCRTMCD642B	1001	4.86	10.78	6.22	6.3	0.51
GCRTMCD642T	1001	4.86	10.78	6.22	6.3	0.51
GCRTMCD642W	1001	4.86	10.78	6.22	6.3	0.51



**Terina Tables**

Terina™ is a multi-purpose table that allows you to quickly adapt your space to suit your needs. The simple flip-top mechanism is designed for single-handed operation. Tables nest in an upright position to minimize storage space.

**Worksurfaces**

Laminate surfaces (B) are 1-1/16" thick tops constructed of 45lb. density particle board with high pressure laminate and finished on the underside of the surface with a kraft paper backing. Veneer (V) surfaces are 1-3/16" thick tops constructed of 45 lb. density particle board and are balanced on the underside with veneer (unfinished). Worksurfaces are pre-drilled for alignment of the Terina base.

**Base**

Tables feature an aluminum leg, cross beam and die-cast foot. Legs and cross beam are available in all standard panel frame painted finishes. Die-cast foot is always in polished aluminum finish. Foot span is 23". Stacking depth of 9".

**Casters**

Casters are standard on all tables. 2-3/8" dual wheel casters with manual lock. Full 360° swivel. Suggested for carpeted surfaces. Available in grey only.

**Ganging Plates**

Ganging plates are available for ganging adjoining tables together. Ganging plates are black epoxy coated steel plates with two thumbscrews.

**Wire Management**

Wire management option is a snap-in channel that fits on the interior of the leg or on the understand of the flip-top cross beam.

**Modesty Panels**

10" Modesty panel affixes to the top and base, articulating when it folds down. available in all standard LP laminate and veneer finishes.

**GFT-R • Rectangular Flip Top Training Table**

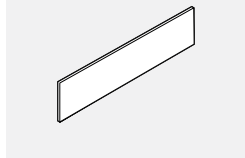
- B and V edge tops have square corners



PRODUCT CODE	PRICE					WEIGHT LBS	VOL FT³
	B	V	H	W	D		
GFT2448R	1212	2055	29	48	24	48	6
GFT2454R	1262	2206	29	54	24	53	6
GFT2460R	1312	2237	29	60	24	55	7
GFT2466R	1331	2279	29	66	24	61	7
GFT2472R	1349	2317	29	72	24	66	7
GFT3048R	1262	2103	29	48	30	53	6
GFT3054R	1290	2265	29	54	30	55	6
GFT3060R	1331	2305	29	60	30	61	7
GFT3066R	1347	2395	29	66	30	66	7
GFT3072R	1377	2478	29	72	30	68	7

**GFT-M • Folding Modesty Panel**

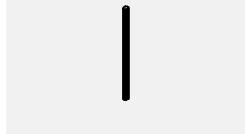
- Includes hardware to connect to Terina Tables.
- Woodgrain modesty panels over 60" will have the woodgrain run horizontally, whereas others will run vertically.
- Due to location of the modesty panel, only MSPDM and GMDSF10 grommets can be used on Terina tables with modesty panels.



PRODUCT CODE	PRICE					WEIGHT LBS	VOL FT³
	LP	V	H	W	D		
GFT48M	299	518	10	46	0.75	11	1
GFT54M	311	581	10	52	0.75	13	1
GFT60M	323	643	10	58	0.75	15	1
GFT66M	334	702	10	64	0.75	18	2
GFT72M	349	764	10	70	0.75	20	2

**GFTCM • Wire Manager**

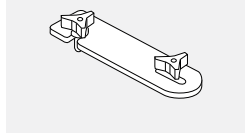
- Set of four
- Each piece is 10" long



PRODUCT CODE	PRICE				WEIGHT LBS	VOL FT³
	H	W	D			
GFTCM04BLK	37	2	10	2	1	1

**GFCNGFP • Ganging Flush Plate**

- Please specify application so that inserts may be added to surface.



PRODUCT CODE	PRICE			WEIGHT LBS	VOL FT³
	H	W	D		
GFCNGFP	37	2.5	5	0.1	0.01

**Technical Information - Vice Versa Tables**

**Tables**

- All worksurfaces have threaded inserts for metal-to-metal connection of support hardware.
- 60" and 72" tables come standard with wire manager.
- HP tops are 1 1/16" thick laminate particle board.

**HP Top with T-Mould Edge**

- Rectangular mobile table made of 1 1/16" thick particle board with High Pressure laminate finish. HP tops have 3.5mm PVC edge.

**Viceversa Leg**

- Universal mounting plate can be used to gang 2 tables simply by rotating 45° to span 2 table tops without metal skirts.

- Table legs have a wire management channel that neatly organizes electrical and communication cables running from the worksurfaces to the floor.

- The channel is covered by a clear PVC snap-on cover.

- The Viceversa leg features a push button height adjustment mechanism. This mechanism allows the user to easily set the height of a table.

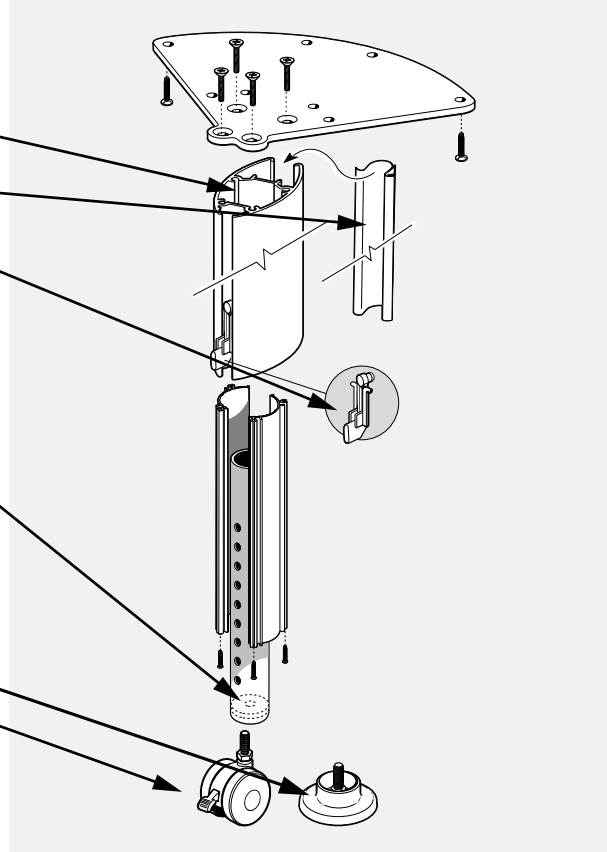
Legs have a height range of 23.5" – 30.5" in 1" increments for levelers and 25"-33" with casters.

**Viceversa legs are available with:**

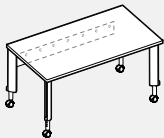
- Levelers
- Locking casters.

**NOTES:**

- Levelers have a 0.5" height range.
- Levelers available in Charcoal Grey only.
- Casters available in grey with black only.
- Legs are available in our (6) standard finishes.
- Finish is durable environmentally friendly paint.



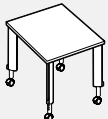
**VVRT • Rectangular Tables with 4 Legs**



- **Tables are designed to work individually or as a group. They can be moved to meet the changing needs of an individual or group.**
- Tables come standard with 4 locking casters. Optional levelers available, please specify.
- 6" metal skirt provides strength and stability.
- Modesty Panel, Pong Panel or 6" metal skirt cannot be used on tables with 2 legs or shared tables.

PRODUCT CODE	PRICE HP	SIZE/ INCHES			WEIGHT VOL	
		H	D	W	LBS	FT³
VVRT2448HP4	927	26-32	24	48	63	7.11
VVRT2460HP4	1019	26-32	24	60	71	7.36
VVRT2472HP4	1067	26-32	24	72	78	7.62
VVRT3060HP4	1113	26-32	30	60	80	7.69
VVRT3072HP4	1158	26-32	30	72	90	8.01

**VVS • Square Tables with 4 Legs**



- **Square tables are designed to work individually or as a grouping. They can be moved to meet the changing needs of an individual or group.**
- Tables come standard with 4 locking casters. Optional levelers available, please specify.

PRODUCT CODE	PRICE HP	SIZE/ INCHES			WEIGHT VOL	
		H	D	W	LBS	FT³
VVS30HP4	1019	26-32	30	30	71	7.2
VVS36HP4	1067	26-32	36	36	76	7.6
VVS42HP4	1113	26-32	42	42	82	8.0
VVS48HP4	1208	26-32	48	48	88	8.4

**VVR • Round Tables with 4 Legs**



- **Round tables are designed to work individually or as a group. They can be moved to meet the changing needs of an individual or group.**
- Tables come standard with 4 locking casters. Optional levelers available, please specify.

PRODUCT CODE	PRICE HP	SIZE/ INCHES			WEIGHT VOL	
		H	D	W	LBS	FT³
VVR30HP4	975	26-32	30	30	57	6.8
VVR36HP4	1019	26-32	36	36	64	7
VVR42HP4	1067	26-32	42	42	71	7.2
VVR48HP4	1158	26-32	48	48	79	7.6