

**BOULEVARD 1 PANELS**

**Features:**

- Desk height power and data management
- Patented "Knuckle-Loc", rigid connection, prevents light and sound transmission
- Built-in acoustical/tackable properties
- Sectional multi-accent design options
- Fabric surfaces are able to be replaced on-site
- Frame incorporates 1" centred slots for component adjustability
- Requires no additional top caps, end caps, trim caps, hinges, kick plates or clips
- Simple to specify
- Reduced installation time
- Easy to reconfigure
- High-tech look/stackable grid appearance
- Rigid, no sway, straight panel sight line
- Self levelers reduce assembly time, ensure even height
- Over panels extend to 10 feet to enclose an office in fabric and glazed options
- Patented Raceway cover easily removed
- Raceway panels top and bottom portion semi tackable

**Construction:**

- Rigid extruded aluminum, finished frame, self-leveling 2 5/8" thick panel
- 1 1/8" sound absorbent Mineral Wool each side of hardboard septum Sizes:
- 8 Heights: 29", 37", 42", 50", 54", 58", 66" 74" and 82"
- 9 Widths: 6", 18" to 60" in 6" increments, 72" wide in selected panel configurations.

**Adjustability:**

- 3" glide stem permits 2 1/2" height adjustment
- Slotted at 1" increments
- Over panels, 8", 16", 24", 37" and 42" for enclosed offices (Non-slotted) Acoustic Rating
- .80NRC/26STC

**Door:**

- 2 door panel widths, glazed/unglazed, lockable, reversible
- 2 sliding door widths, non-lockable

**Flexibility:**

- Universal connector

**Panel Finishes:**

- 2 grades of fabric, air flow grill, glaze, tempered glass, laminate & COM

**Electrical:**

- Desk height 8 wire/4 circuit - 1 dedicated

**Communication:**

- Desk height data channel
- Raceway cover easily removed
- Fabric covered raceways available

**SYSTEM 3 PANELS**

**Features:**

- Base power and data lay-in
- Desk height power and data feed thru
- Top data lay-in
- Patented "Knuckle-Loc", rigid connection, prevents light and sound transmission
- Removable multi-functional tile design options
- Fabric surfaces are able to be replaced on-site
- Reduced installation time
- Easy to reconfigure
- High-tech look/stackable grid appearance
- Rigid, no sway, straight panel sight line
- Self levelers reduce assembly time, ensure even height
- Over panels extend height to enclose an office in fabric, glazed or laminate options
- Raceway cover easily removed

**Construction:**

- Rigid extruded aluminum

**Sizes:**

- 5 Heights: 34", 42", 50", 54", 66"
- 8 Widths: 18" to 60"

**Adjustability:**

- 3" glide stem permits 2 1/2" height adjustment
- Slotted at 1" centres
- Over panels, 8" and 16" (Non-slotted)

**Door:**

- 2 widths, glazed/solid, lockable, reversible
- 2 sliding door widths, non-lockable

**Flexibility:**

- Universal connector

**Panel Finishes:**

- Fabric, air flow accessory, tempered glass, laminate, whiteboard, corkboard (at base only)

**ELECTRICAL FOR BOULEVARD 1 PANELS**

**Features:**

- Customized power capabilities in each panel
- State-of-the-art snap-in electrical
- 8 wire with 3 regular 15 AMP circuits and 1 isolated 15 AMP circuit.
- 3N and 8K electrical available upon request.
- Snap-in installation - harnesses, junction boxes, duplexes
- Accessibility makes changing circuits easy
- Flexibility in choice of duplexes within panel: choice of circuits for each duplex; choice of quantity of duplexes (1 or 2 duplexes per panel)

- Electrical cords are concealed
- Separate large channel for data
- Change electrical without moving pedestals
- Lower installation/reconfiguration costs
- Data terminals snap into cable holder
- Floor or ceiling feed
- Duplexes accessible from both sides

**ELECTRICAL FOR SYSTEM 3 PANELS**

**Features:**

- Customized power capabilities in each panel
- State-of-the-art snap-in duplex receptacles
- 8 wire with 3 regular 15 AMP circuits and 1 isolated 15 AMP circuit
- Snap-in installation - harnesses, junction boxes, duplexes

- Accessibility makes changing circuits easy
- Flexibility in choice of duplexes within panel
- Data terminals snap into base raceway cover and mid panel electrical tile
- Floor or ceiling feed
- Duplexes accessible from both sides

## WORKSURFACES / HARDWARE

### Features:

- One universal cantilever support
- Pedestal eliminates need for end panel/cantilever
- Grommets are not needed
- Continuous cable accessibility across back
- Adjustable to any height, in 1" increments.
- Flush abutment side edge minimize seam crevice
- Metal-to-metal connections (Metal Inserts)
- Additional cable manager under worksurface

### Construction:

- Medium-density particle board 1 1/16" thick

### Sizes:

- 3 Depths: 18", 24" and 30"
- 12 Widths: 18" to 84" in 6" increments

### Finishes:

- Tops: High Pressure Laminate, Low Pressure Laminate or Wood
- Edges: Edge banded PVC or Wood

### Types:

- Transaction, keyboard, rectangular worksurface, corner, curved, D-top, P-top, Arc-top and freestanding

## OVERHEAD STORAGE

### Features:

- Completely enclosed unit for 16" overheads
- Shipped fully assembled or KD
- 13.5" inside height for oversized binders
- Metal-to-metal connection
- Lock secures into bottom shelf
- Doors operate smoothly
- Flipper door retrofittable on site
- Safety bracket used for extra support
- Reinforcement built in for larger unit
- Can be removed and reconfigured without disassembly

### Fronts:

- Open or closed fronts

### Sizes:

- Overheads - 6 widths in 6" increments
- Shelves - 7 widths in 6" increments
- 16" deep welded overhead for EDP, ring binder, letter/legal
- 12" deep KD overhead
- 15" deep KD overhead with "Soft-to-the-touch" handles

### Paint:

- Dry epoxy powder coating

## PEDESTALS

### Features:

- Double wall construction on all drawer fronts
- Fully progressive suspension system
- Full-width pull, "Hytrel®" or "Soft-to-the-touch" handles on drawer fronts
- Worksurface supporting option
- Full extension roller bearing glides on all file drawers
- Rubber bumpers for quietness
- Movable drawer divider/pencil tray
- 25" filing capacity for file drawers (only in 30" pedestal)
- Durable epoxy finish
- Keyed alike options
- Box/Box/File standard with pencil tray

### Construction:

- Double wall drawer fronts
- 18-20 gauge steel

### Sizes:

- 18", 24", 30" depth

### Types:

- Worksurface Supporting, Mobile, Freestanding

### Paint:

- Dry epoxy powder coating

**HOW BOULEVARD 1 CAN REDUCE YOUR COSTS**

**Finished Panel:**

- No inventory costs for connectors, trim caps, top caps, kick plates and clips.
- Less time required to install, or to disassemble, move and re-install.

**Fewer Parts:**

- Only 1 universal cantilever and 3 brackets are needed to build most workstations.
- Easy to attach and remove components from panels.
- Universal post for 2-way, 3-way and 4-way applications.

**Desk Height Electric:**

- Ease of initial electrical installation lowers energy management costs.
- Snap-in electrical components reduce reconfiguration costs.
- Can customize power in each panel, pay only for what is required.

**Simplified Specifications:**

- Fewer parts and components make specifying, ordering, and verifying less work.
- Product fits a 6" planning module.

**Replaceable Panels:**

- Panels can be re-upholstered on site.

**Communications/Data Channel:**

- Desk height data channel reduces time to install and change cables.

**Floor to Ceiling Enclosed Office:**

- Re-usable enclosed offices with doors eliminate future costs for drywall demolition, new construction, mess and extensive cash flow.
- Depreciation expense indirectly increases cash flow.

**Warranty:**

- Limited Lifetime Warranty on materials and workmanship.

**Product:**

- Priced less than most other "A" Grade panel systems.

**HOW BOULEVARD SYSTEM 3 REDUCES YOUR COSTS**

**Finished Panel:**

- No inventory costs for connectors, top caps, kick plates and clips.
- Less time required to install, or to disassemble, move and re-install.

**Fewer Parts:**

- Only 1 universal cantilever and 3 brackets are needed to build most workstations.
- Easy to attach and remove components from panels.
- Universal post for 2-way, 3-way and 4-way applications.

**Base Panel Electric System:**

- Ease of initial electrical installation lowers energy management costs.
- Snap-in electrical components reduce reconfigurations costs.
- Can customize power in each panel, pay only for what is required.

**Simplified Specifications:**

- Fewer parts and components make specifying, ordering, and verifying less work.
- Product fits a 6" planning module.

**Replaceable Panel Tiles:**

- Over Panels and face tiles can be added and interchanged as needs change.

**Communications/Data Channel:**

- Base and top lay-in communications channel reduces time to install and change cables.

**Warranty:**

- Limited Lifetime Warranty on materials and workmanship.

**Product:**

- Priced less than most other "A" Grade panel systems.

**Value-Added Benefits**

On the following pages, we selected a grouping of Boulevard 1, System 3 configurations, some with electrical components and task lights, to give you a better understanding of our product's specifications as they relate to workstations. Our objective is to not only illustrate applications using panels and components, but also to have this serve as a pricing exercise.

**All of the value-added benefits of the Boulevard 1 are standard as follows:**

- Desk height power and data capabilities.
- Finished panel including top, corner and end caps.
- Sectional panel with multiple fabric options.
- Ease of installation and reconfigurations.
- Removable fabric for on-site refurbishing.
- Exceptional storage capacity in pedestals, overheads, lateral files, storage cabinets and towers.
- Simplified specifications.

**All of the value-added benefits of the Boulevard System 3 are standard as follows:**

- Base power and data capabilities.
- Finished panel including top and corner.
- Monolithic or Pass-Thru panels with multiple fabric options.

- Ease of installation and reconfiguration.
- Removable fabric tiles in Pass-Thru Panels for on-site refurbishing.
- Exceptional storage capacity in pedestals, overheads, lateral files, storage cabinets and towers.
- Simplified specifications.

**All of the value-added benefits of the Diet System are standard as follows:**

- Finished panel including top, corner and end caps.
- Sectional panels with multiple fabric options.
- Ease of installation and reconfigurations.
- Removable fabric for on-site refurbishing.
- Exceptional storage capacity in pedestals, overheads, lateral files, storage cabinets and towers.
- Simplified specifications.

**When specifying Boulevard 1, Boulevard System 3 or Diet, you benefit from the ability to:**

- Customize the energy management.
- Minimize the number of necessary parts.
- Offer a competitive list price.

NOTE: If Key Alike Instructions are not submitted to GLOBAL CONTRACT with the Customer's Purchase Order, all components will be keyed randomly.

**WOOD GRAIN (WG) LAMINATE DIRECTION**

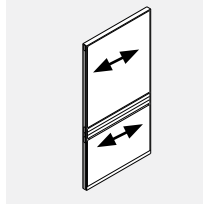

\* Panel general direction will default to vertical if monolithic panel is 54" high and if raceway panels are on same order.

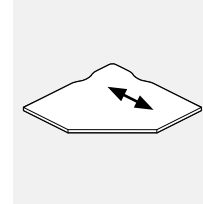
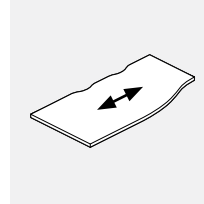
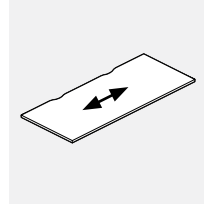
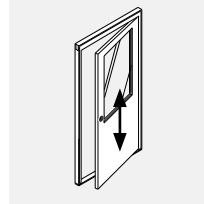

**All Panels**

With Exception of 66" or higher panels, the grain is vertical.

**BPD**  
Doors.

**BWS**  
Worksurfaces.

**BWSC**  
Worksurfaces.

**BWCF**  
Corner Worksurfaces.

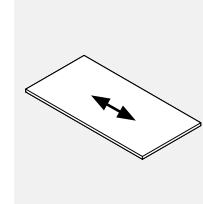
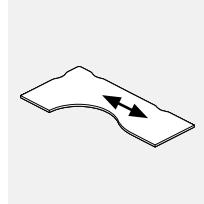
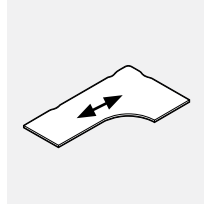
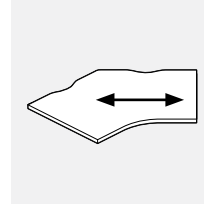
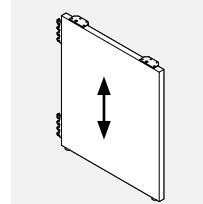
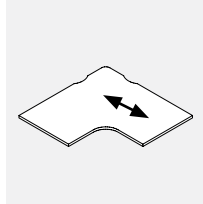

**BWCL**  
Corner Worksurfaces.

**BHFG**  
Full Gable.

**BWAC** Angled Corner  
Worksurfaces

**BWCE**  
Extended Worksurfaces.

**BWCEC**  
Extended Worksurfaces.

**BK**  
Desking Worksurfaces.

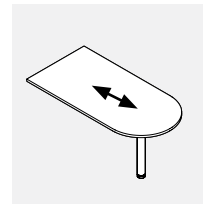
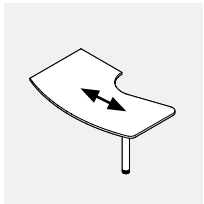
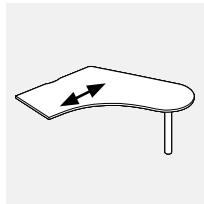
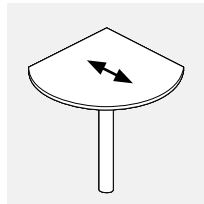
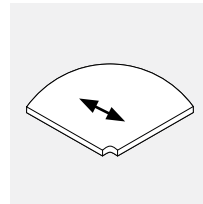
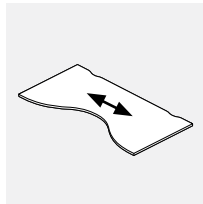

**BWBT**  
Bow Tie Worksurfaces.

**BWR**  
Radius Worksurfaces.

**BWRTD**  
Teardrop Worksurfaces.

**BWC**  
Extended "D"  
Worksurfaces.

**BWSL**  
Curvilinear  
Worksurfaces.

**BWD**  
Worksurfaces.

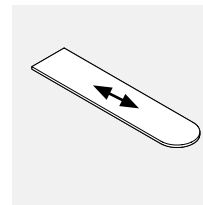
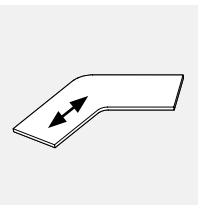
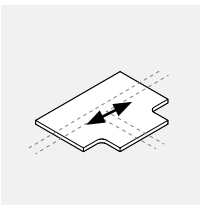
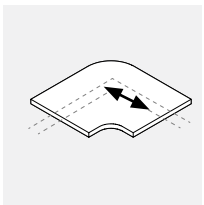
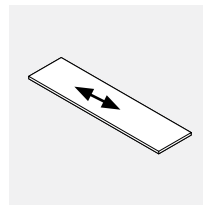
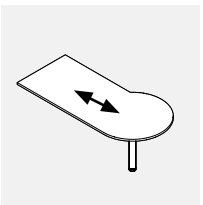

**BWP**  
Worksurfaces.

**BWT**  
Transaction Work-  
surfaces.

**BWTC**  
Corner Transaction  
Worksurfaces.

**BWTT**  
Transaction Work-  
surfaces.

**BWTAC**  
Transaction  
Worksurfaces.

**BWTD "D"**  
Transaction  
Worksurfaces.

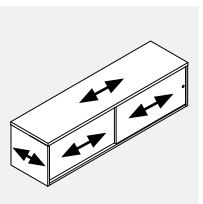
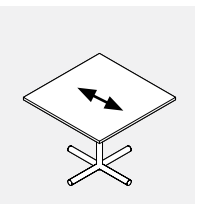
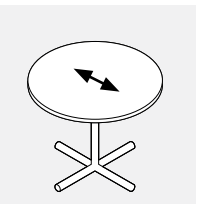
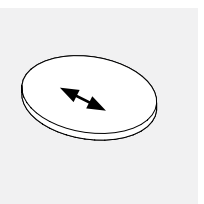
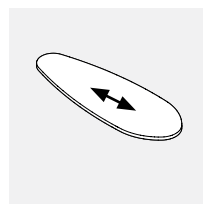
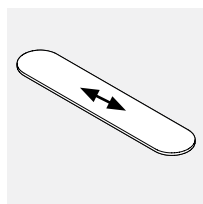

**BWTDD "D"**  
Transaction  
Worksurfaces.

**BWTE**  
Ellipse Transaction  
Worksurfaces

**BWTP**  
Round Transaction  
Worksurfaces.

**BWCD**  
Round Tables.

**BWSQ**  
Square Tables.

**BSP**  
Laminate Divider  
Storage

## Boulevard 1 Panel System

The Boulevard philosophy is based on simplicity. A product that is simple to install... simple to reconfigure... and simple to specify, without sacrificing delivery time or quality.

Technically superb and exceptionally precise aluminum extrusion and die-cast fittings achieve exact levels of consistency, panel after panel; everything fits, aligns, and assembles, first time, every time. Most of all it requires very few of the "small parts" associated with most systems. This cross-market integration is celebrated in Boulevard.

Truly a system of broad application, whether installed in a high-tech environment, factory application or executive office, Boulevard will perform! We invite you to share with us a product designed, built and marketed for a global economy.

### Our Mission

Our mission is to continue to develop and offer innovative, quality office furniture to value-oriented customers, through a dealer network that provides consistent, high quality service. Our approach in the contract furniture industry is to focus on customer concerns and needs to develop products that minimize your costs of ownership. It represents the culmination of creativity, industry expertise, specialists,

and integrity to help you achieve cost-effective solutions to problems. Our vision is to create a company-wide environment that supports constant improvement and promotes customer satisfaction. We believe that as good as we are today, we must be better tomorrow. Thus, our desire to improve is both continuous and tireless.

### Environmental Commitment

At Global Contract, protecting the next generations' environment is of paramount concern. Global Contract believes that it is our responsibility to help protect the environment for future generations. We continue to operate with the environment in mind, making wise business decisions that help protect the earth and its precious natural resources. Our manufacturing procedure incorporates the latest technology for painting products, using a dry epoxy powder or gel paint. This process produces no toxic residue, and therefore is environmentally safe, while other manufacturers still use the wet paint process. Our packaging, veneer selections, and reduction in waste programs all contribute to a better environment. In addition, our concern for the reduction of finishing emissions and wood dust has resulted in a healthier work environment in many ways, including this price book, printed on recycled paper.

## Technical Information

### Panels

- All panels are 2 5/8" thick.
- Lightweight aluminum box frame construction creates superior panel rigidity.
- Panel frame finish is durable epoxy powder coated.
- Hang-on capabilities at 1" increments.
- Patented "Knuckle-Loc" design provides solid panel-to-panel connection for fast installation and reconfiguration.
- Knuckle lock feature ensures even panel heights throughout installation.
- 3" glide stem permits 2 1/2" height adjustment.
- Panel sizes are actual, eliminating creepage.
- Panels come complete, eliminating need for separate top, corner end trim and clips.
- Fabric is replaceable on site.
- All panels include 2 "Capture Strip" panel connectors.
- Fabric retainer is clear.
- Panels are UL listed and CSA approved and have a Class "A" fire rating except when Customer's Own Material (COM) is used.
- Centre septum above raceway overlaid on either side with tackable, 1 1/8" "Sound Absorbent Mineral Board".
- For glazing - Smoke developed index 500.
- For tempered glass, add "TG" to the end of the product code and add 20% to the price regardless of fabric grade.
- Solid metal sheet is an OPT option and price accordingly, however, the sheets are 48" wide and cannot be specified on 48" and wider unless they are railroaded. Contact your Customer Service Representative for more information.

### Panel Options

- Laminate, whiteboard, or corkboard may be substituted for fabric on panels only, not raceways, see "OPT" column.
- Laminate and whiteboard are held in place with a PVC retainer matching the frame colour and can be retrofitted on site.
- Laminate and whiteboard options reduce the acoustical value of the panel.

### Raceway Options

- Raceways are standard in PVC matching the panel frame finish.
- Fabric Covered Raceway (FRC) available. Aluminum raceway available.
- Wood veneer raceway available.
- Face mount electrical raceway available.
- Face mount openings are 1.5x2.85 for electrical and 1.37x2.755 for data.
- Cable capacity in raceways is 83 - 0.220" dia. cables (cat.6).

### Desk Height Management

- Desk height electrical and communication raceway system.
- State-of-the-art engineering.

- Snap-in modularity of all electrical components including harnesses, junction boxes, duplexes and circuit designations.
- All power and data outlets are easily accessible from both sides of panel.
- 8 wire system with 4, 15 amp circuits (including 1 dedicated circuit).
- Optional facemount electrical with 2 duplexes per panel side.
- Outlet and circuit changes accomplished without disruption to workstation.
- Large raceway cavity permits storage of excess cables and equipment cords.
- Total flexibility for 8 wire system: choice of 1, 2 or 4 duplexes per panel; choice of circuitry in each duplex .
- Unique design of fire retardant PVC raceway cover permits access to raceway without disruption to equipment on worksurfaces.
- Clip-on communication management channel (BECC01 and BPH001) included with each raceway panel.
- Communication management channel accepts modular Data/Comm terminals (not supplied by Global Contract Inc.).

### Posts

- Enables connection for multiple panel runs such as 90°, 45° or 60° angles and 2 way, 3 way or 4 way.
- Provides route for base, ceiling, and worksurface cable entry to a panel.
- Self levelling feature maintains even height of all connected panels.
- Solid lightweight aluminum extrusion fits together through a unique "Knuckle-Loc" design providing rigid post-to-panel connection.
- Includes all required panel connectors and caps.
- Posts add 2 5/8" to a panel run.
- Posts are 1/8" oversized to allow for "panel wrap around" of freestanding desks.
- For all panel runs with multiple posts, this 1/8" must be allotted for.

**PANELS - GUIDELINES FOR ORDERING PRODUCT**

**Codes**

The product guide uses a numbering system with meaningful alphanumeric characters to create a simple-to-understand product number. This makes specifying the product much easier and more accurate.

Example of Panel: **BPRA6636 CHR CHR**

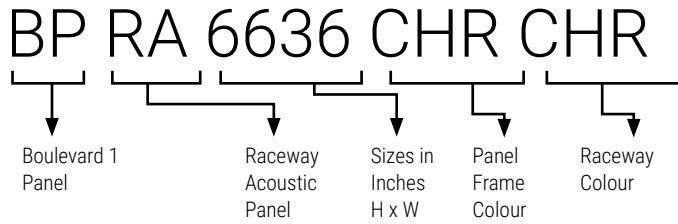

- AN50 Inside Lower Fabric
- AN50 Inside Upper Fabric
- BE21 Outside Lower Fabric
- BE21 Outside Upper Fabric

**How to Specify**

- Specify Boulevard 1 panel type and size by code.
- Specify panel frame finish - ie. CHR (Charcoal).
- Specify PVC raceway finish - ie. CHR (Charcoal). If PVC raceway colour not specified at time of order, default will be the panel frame colour.
- Specify all four panel fabric options if necessary.
- Some fabrics have directional pattern and cannot be applied horizontally or vertically. Panels wider than 60" will have fabrics applied horizontally (railroad). Please specify if you want adjacent panels and the rest of the installation upholstered the same way.

Example of Post: **BHP066 CHR**

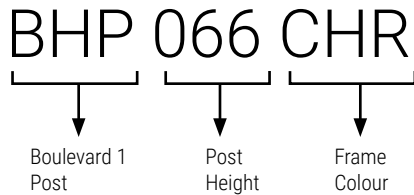

**How to Specify**

- Specify Boulevard 1 post by code.
- Specify frame colour - ie. CHR (Charcoal).

**Raceways**

**PVC:**

- Standard, at time of order, includes 2 covers.
- Standard, when ordering individuals: RCSxxCOL.
- Facemount raceways: RCWxxD.
- **Fabric:**
- Standard, at time of order: RCWxxFAB, \$34 per side, sold as pair, panel mounted.
- Standard, when ordering individuals: 1006FRCxx, shipped separately.
- Facemount raceways: FCRxxD.

**Aluminum:**

- Standard, when ordering individuals: BARCxx,
- Facemount raceways: RCAxxD.

**ORDERS**

**Each Order Must Include**

- Purchase Order
- Layout showing where the image(s) appear in the run of panels.
- A completed Price Chart, showing the location of the image(s) on each appropriate panel.

Artwork must be submitted in accordance with the following artwork specifications.

**NOTE:** Final artwork specification approval must be given before order can be processed.

**Transfer Devices**

- E-mail up to 10MB to your Global Contract Customer Service Representative.
- Courier CD/DVD/USB stick to your Global Contract Customer Service Representative.

**Artwork Specifications**

- Non-Photographic artwork should be vector art, saved in Adobe Illustrator (.ai) or as an EPS (.eps)
- All bitmap or photographic artwork has to be at a minimum of 100 dpi at the full size of the panel to be printed.
- We accept Adobe CS5 files.
- Any linked files must be included or imbedded.
- Leave any PSD files unflattened
- All fonts must be converted to outlines.
- Do not convert to CMYK, leave all images as RGB if possible
- No Word, Powerpoint, Publisher or other Microsoft files can be used.
- Include a PDF or .jpg for reference when sending native Photoshop or Illustrator format files.

**Colour Matching**

- A Pantone colour reference must be supplied or we cannot accept responsibility for correct colour.
- When it is not possible to refer to Pantone colours, we will do our best to meet your requirements.

**Image Clarity**

- We will advise should the selected image not lend itself to the element size requested.

**NOTE:**

We reserve the right to put an order on hold when the files are found to be incomplete or when documents have been either incorrectly saved. Fonts not converted to curves or the job appears not to be commercially acceptable.

**Image Bleed:**

- To facilitate placement on the panel. Extension of the image past the finished visible area of the panel (bleed) is required
- Boulevard Panels need a 5" Bleed on all sides.

**Example Of Image resolution:**

The resolution required for a 36 wide x 24 high Boulevard panel at 100 dpi (minimum resolution)

The resolution required for a 36 wide x 24 high Boulevard panel at 300 dpi (higher quality)

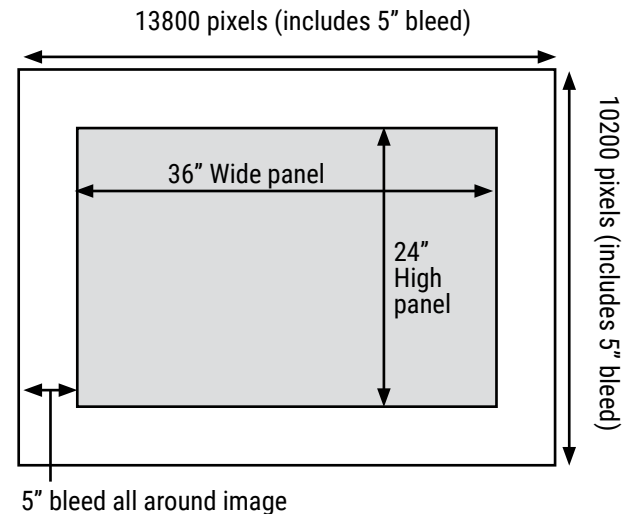
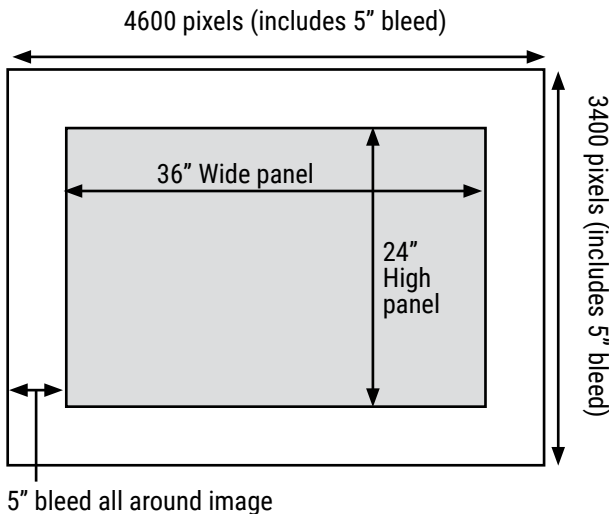

**Pricing, Initial Set-Up Charge per Order:\$256 net**

**Boulevard 1 Panels • Below Raceway Only**

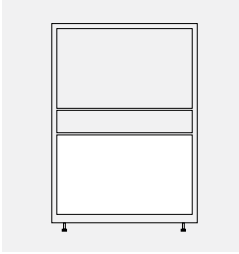

- This List applies to the following panels:
- BPRA
- BPRG
- BPRP
- BPAR

PANEL HEIGHT	PANEL WIDTH	LIST PRICE
29"	24"	300
29"	30"	353
29"	36"	409
29"	42"	462
29"	48"	521
29"	54"	572
29"	60"	622
29"	66"	673
29"	72"	725

**Boulevard 1 • Above Raceway Only**

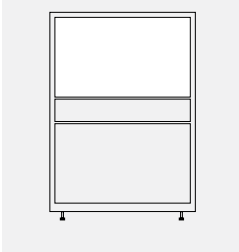

- This List applies to the following panels:
- BPRA
- BPRF

PANEL WIDTH	HEIGHT	LIST PRICE	42"	50"	54"	58"	66"	74"	82"
24"	N/A	178	211	241	308	373	433		
30"	N/A	212	251	286	366	439	512		
36"	N/A	251	290	330	418	505	592		
42"	N/A	278	330	381	474	572	673		
48"	N/A	315	371	425	534	642	768		
54"	N/A	343	403	462	586	710	827		
60"	N/A	373	439	505	642	777	908		
66"	N/A	403							
72"	N/A	439							

**Boulevard Fabric Acoustic Panels**

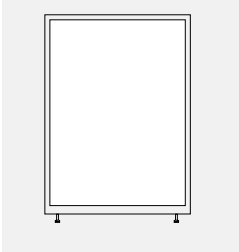

- This List applies to the following panels:
- BPFA

PANEL WIDTH	HEIGHT	LIST PRICE	42"	50"	54"	58"	66"	74"	82"
24"	396	462	495	527	586	651	718		
30"	469	541	584	622	696	768	842		
36"	541	630	673	718	805	886	972		
42"	615	710	761	813	908	1010	1106		
48"	690	799	854	908	1019	1126	1236		
54"	761	879	942	1003	1120	1246	1368		
60"	827	967	1032	1098	1229	1363	1494		
66"	893	1032							
72"	967	1120							

**Boulevard 1 Over Panels**

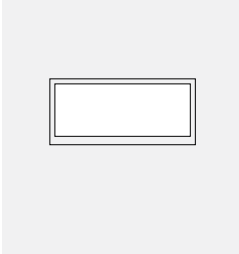

- This List applies to the following Panels:
- BPOF

PANEL WIDTH	HEIGHT	LIST PRICE	8"	16"	24"	37"	42"
24"	140	205	263	366	409		
30"	166	241	315	433	484		
36"	191	278	359	498	557		
42"	220	315	409	572	630		
48"	241	353	455	630	702		
54"	271	396	505	702	777		
60"	294	433	550	915	849		
66"	315	462	592	827	915		
72"	343	498	637	893	988		

Note: Prices shown are an upcharge to the panel price, please add to the list price of panel which you are specifying the graphic for.



**BPRA • Acoustical Raceway Panel**

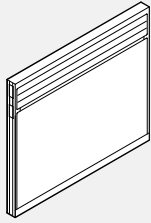

37" High

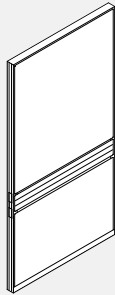

72" Wide

- Fabric above the raceway provides visual and acoustic privacy.
- Centre septum above and below raceway overlaid on either side with tackable, 1 1/8" "Sound absorbent mineral board".
- Centre septum below raceway overlaid on either side with 1 1/8" Mineral board.
- Acoustic rating of .80 NRC and 26 STC.
- OPT\* = Laminate or Whiteboard.

PRODUCT CODE	PRICE			SIZE/ H	INCHES			WEIGHT VOL	
	GR1	GR2	OPT*		W	D	LBS	FT <sup>3</sup>	
BPRA3718	513	527	541	37	18	2.61	18	1.58	
BPRA3724	573	586	601	37	24	2.61	21	2.054	
BPRA3730	633	642	660	37	30	2.61	25	2.528	
BPRA3736	684	732	783	37	36	2.61	28	3.002	
BPRA3742	741	790	842	37	42	2.61	32	3.476	
BPRA3748	799	845	898	37	48	2.61	35	3.950	
BPRA3754	857	904	956	37	54	2.61	39	4.424	
BPRA3760	911	959	1011	37	60	2.61	44	4.898	
BPRA3766	970	1029	1090	37	66	2.61	50	5.499	
BPRA3772	1029	1085	1147	37	72	2.61	56	6.000	
BPRA4218	549	575	605	42	18	2.61	22	1.782	
BPRA4224	607	635	663	42	24	2.61	28	2.317	
BPRA4230	666	693	723	42	30	2.61	32	2.852	
BPRA4236	716	771	829	42	36	2.61	36	3.387	
BPRA4242	777	831	890	42	42	2.61	40	3.921	
BPRA4248	831	888	945	42	48	2.61	44	4.456	
BPRA4254	890	945	1004	42	54	2.61	48	4.991	
BPRA4260	945	1000	1059	42	60	2.61	52	5.525	
BPRA4266	1055	1169	1291	42	66	2.61	62	6.148	
BPRA4272	1162	1277	1399	42	72	2.61	72	6.770	
BPRA5018	585	612	640	50	18	2.61	25	2.106	
BPRA5024	642	686	729	50	24	2.61	30	2.738	
BPRA5030	705	750	792	50	30	2.61	35	3.370	
BPRA5036	769	839	911	50	36	2.61	40	4.002	
BPRA5042	827	895	969	50	42	2.61	45	4.634	
BPRA5048	890	958	1032	50	48	2.61	50	5.266	
BPRA5054	948	1019	1090	50	54	2.61	55	5.898	
BPRA5060	1010	1080	1152	50	60	2.61	60	6.530	
BPRA5066	1104	1221	1342	50	66	2.61	70	7.300	
BPRA5072	1197	1312	1433	50	72	2.61	80	8.000	
BPRA5418	611	638	668	54	18	2.61	27	2.250	
BPRA5424	672	713	757	54	24	2.61	32	2.960	
BPRA5430	732	773	817	54	30	2.61	37	3.689	
BPRA5436	796	879	968	54	36	2.61	42	4.318	
BPRA5442	857	938	1029	54	42	2.61	47	4.934	
BPRA5448	920	1000	1090	54	48	2.61	52	5.666	
BPRA5454	978	1060	1151	54	54	2.61	59	6.398	
BPRA5460	1042	1123	1214	54	60	2.61	62	7.035	

**BPRA • Acoustical Raceway Panel ...Cont**

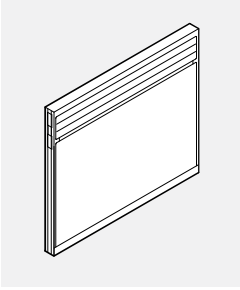

37" High

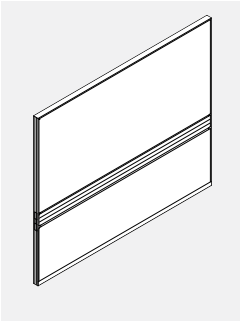
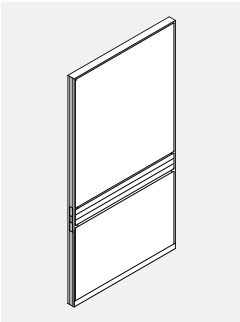

72" Wide

- Fabric above the raceway provides visual and acoustic privacy.
- Centre septum above and below raceway overlaid on either side with tackable, 1 1/8" "Sound absorbent mineral board".
- Centre septum below raceway overlaid on either side with 1 1/8" Mineral board.
- Acoustic rating of .80 NRC and 26 STC.
- OPT\* = Laminate or Whiteboard.

PRODUCT CODE	PRICE			SIZE / INCHES			WEIGHT VOL	
	GR 1	GR 2	OPT*	H	W	D	LBS	FT <sup>3</sup>
BPRA5818	636	663	693	58	18	2.61	28	2.431
BPRA5824	700	740	785	58	24	2.61	33	3.160
BPRA5830	757	799	842	58	30	2.61	38	3.889
BPRA5836	821	903	993	58	36	2.61	43	4.618
BPRA5842	886	968	1057	58	42	2.61	48	5.347
BPRA5848	947	1030	1119	58	48	2.61	53	6.076
BPRA5854	1010	1092	1181	58	54	2.61	58	6.806
BPRA5860	1074	1154	1246	58	60	2.61	63	7.535
BPRA6618	679	723	765	66	18	2.61	32	2.755
BPRA6624	748	802	860	66	24	2.61	37	3.581
BPRA6630	813	868	927	66	30	2.61	42	4.407
BPRA6636	877	972	1076	66	36	2.61	48	5.234
BPRA6642	942	1036	1140	66	42	2.61	53	6.060
BPRA6648	1007	1104	1205	66	48	2.61	58	6.887
BPRA6654	1071	1168	1271	66	54	2.61	63	7.713
BPRA6660	1136	1232	1335	66	60	2.61	68	8.539
BPRA7418	737	779	824	74	18	2.61	34	3.079
BPRA7424	802	858	916	74	24	2.61	39	4.002
BPRA7430	868	924	983	74	30	2.61	45	4.926
BPRA7436	935	1047	1163	74	36	2.61	50	5.850
BPRA7442	1004	1114	1230	74	42	2.61	55	6.773
BPRA7448	1070	1179	1297	74	48	2.61	60	7.697
BPRA7454	1136	1247	1364	74	54	2.61	65	8.620
BPRA7460	1202	1313	1430	74	60	2.61	70	9.544
BPRA8218	799	839	883	82	18	2.61	36	3.403
BPRA8224	867	935	1008	82	24	2.61	42	4.424
BPRA8230	935	1004	1077	82	30	2.61	48	5.444
BPRA8236	1005	1131	1262	82	36	2.61	54	6.465
BPRA8242	1074	1197	1329	82	42	2.61	60	7.486
BPRA8248	1141	1264	1398	82	48	2.61	66	8.507
BPRA8254	1209	1334	1467	82	54	2.61	72	9.528
BPRA8260	1282	1403	1537	82	60	2.61	78	10.549

**BPRG • Partly Glazed Raceway Panel**

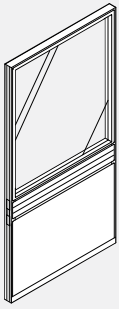

- Glazing above the raceway provides visual accessibility.
- Centre septum below raceway overlaid on either side with 1 1/8" "Sound absorbent mineral board".
- Glazing replaceable on site.
- Standard glaze is acrylic.
- For tempered glass, add "TG" to the end of the product code and add 20% to the price regardless of fabric grade or finish.
- OPT\* = Laminate or Whiteboard.

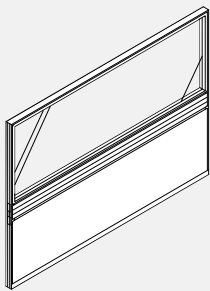

72" Wide

PRODUCT CODE	PRICE			SIZE/INCHES			WEIGHT VOL	
	GR1	GR2	OPT*	H	W	D	LBS	FT³
BPRG4218	691	702	718	42	18	2.61	22	1.782
BPRG4224	755	782	811	42	24	2.61	28	2.317
BPRG4230	820	847	877	42	30	2.61	32	2.852
BPRG4236	886	942	999	42	36	2.61	36	3.387
BPRG4242	948	1004	1062	42	42	2.61	40	3.921
BPRG4248	1015	1070	1131	42	48	2.61	44	4.456
BPRG4254	1080	1135	1195	42	54	2.61	48	4.991
BPRG4260	1143	1199	1258	42	60	2.61	52	5.525
BPRG4266	1208	1265	1329	42	66	2.61	62	6.148
BPRG4272	1274	1330	1394	42	72	2.61	72	6.770
BPRG5018	768	782	796	50	18	2.61	24	2.106
BPRG5024	831	859	889	50	24	2.61	29	2.738
BPRG5030	899	927	956	50	30	2.61	34	3.370
BPRG5036	967	1022	1081	50	36	2.61	39	4.002
BPRG5042	1032	1088	1146	50	42	2.61	44	4.634
BPRG5048	1098	1153	1210	50	48	2.61	48	5.266
BPRG5054	1165	1222	1280	50	54	2.61	54	5.898
BPRG5060	1230	1287	1345	50	60	2.61	59	6.530
BPRG5066	1271	1328	1392	50	66	2.61	70	7.300
BPRG5072	1309	1366	1399	50	72	2.61	78	8.000
BPRG5418	807	821	837	54	18	2.61	27	2.250
BPRG5424	871	901	930	54	24	2.61	30	2.960
BPRG5430	942	969	998	54	30	2.61	35	3.689
BPRG5436	1010	1064	1123	54	36	2.61	40	4.318
BPRG5442	1077	1134	1191	54	42	2.61	45	4.934
BPRG5448	1143	1199	1258	54	48	2.61	49	5.666
BPRG5454	1210	1266	1327	54	54	2.61	55	6.398
BPRG5460	1280	1335	1394	54	60	2.61	60	7.035
BPRG5818	847	860	875	58	18	2.61	26	2.431
BPRG5824	914	942	970	58	24	2.61	31	3.160
BPRG5830	983	1010	1038	58	30	2.61	36	3.889
BPRG5836	1054	1109	1166	58	36	2.61	41	4.618
BPRG5842	1122	1177	1236	58	42	2.61	46	5.347
BPRG5848	1189	1246	1304	58	48	2.61	51	6.076
BPRG5854	1258	1313	1371	58	54	2.61	56	6.806
BPRG5860	1327	1383	1440	58	60	2.61	61	7.535
BPRG6618	921	934	948	66	18	2.61	29	2.755
BPRG6624	993	1021	1051	66	24	2.61	34	3.581
BPRG6630	1064	1093	1122	66	30	2.61	39	4.407
BPRG6636	1137	1195	1252	66	36	2.61	45	5.234
BPRG6642	1209	1265	1326	66	42	2.61	50	6.060
BPRG6648	1285	1339	1398	66	48	2.61	55	6.887
BPRG6654	1355	1412	1470	66	54	2.61	60	7.713
BPRG6660	1432	1489	1548	66	60	2.61	65	8.539
BPRG7418	994	1007	1022	74	18	2.61	30	3.079
BPRG7424	1071	1099	1131	74	24	2.61	35	4.002
BPRG7430	1147	1202	1262	74	30	2.61	41	4.926
BPRG7436	1224	1280	1338	74	36	2.61	46	5.850
BPRG7442	1300	1355	1415	74	42	2.61	51	6.773
BPRG7448	1378	1433	1494	74	48	2.61	56	7.697
BPRG7454	1454	1509	1568	74	54	2.61	61	8.620
BPRG7460	1544	1599	1660	74	60	2.61	66	9.544
BPRG8218	1048	1059	1075	82	18	2.61	31	3.403
BPRG8224	1134	1162	1190	82	24	2.61	36	4.424
BPRG8230	1222	1250	1279	82	30	2.61	43	5.444
BPRG8236	1309	1365	1423	82	36	2.61	49	6.465
BPRG8242	1393	1448	1505	82	42	2.61	55	7.486
BPRG8248	1482	1537	1596	82	48	2.61	61	8.507
BPRG8254	1566	1621	1681	82	54	2.61	67	9.528
BPRG8260	1664	1722	1779	82	60	2.61	73	10.549

**BPRF • Air Flow Panel**

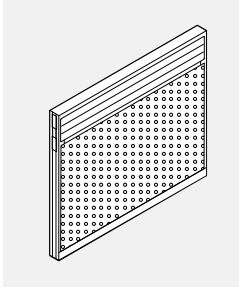

37" High

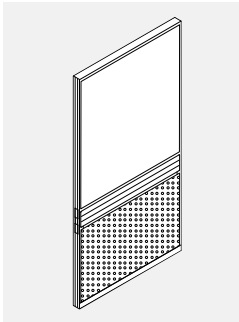

72" Wide

- Double wall of perforated metal below the raceway allows air to flow freely through the bottom of the panel.
- Centre septum above raceway overlaid on either side with tackable, 1 1/8" "Sound absorbent mineral board".
- For air flow option above the raceway, add 20% to the Grade 1 price and tag each item with "air flow above raceway". For example: BPRF4218 TAG:\*air flow above raceway.
- OPT\* = Laminate or Whiteboard.

PRODUCT CODE	PRICE			SIZE/INCHES			WEIGHT VOL	
	GR 1	GR 2	OPT*	H	W	D	LBS	FT <sup>3</sup>
BPRF3718	575	-	-	37	18	2.61	18	1.58
BPRF3724	650	-	-	37	24	2.61	21	2.054
BPRF3730	733	-	-	37	30	2.61	25	2.528
BPRF3736	809	-	-	37	36	2.61	28	3.002
BPRF3742	889	-	-	37	42	2.61	32	3.476
BPRF3748	967	-	-	37	48	2.61	35	3.950
BPRF3754	1043	-	-	37	54	2.61	39	4.424
BPRF3760	1122	-	-	37	60	2.61	44	4.898
BPRF3766	1207	-	-	37	66	2.61	50	5.449
BPRF3772	1291	-	-	37	72	2.61	56	6.000
BPRF4218	594	603	609	42	18	2.61	22	1.782
BPRF4224	674	681	691	42	24	2.61	28	2.317
BPRF4230	755	761	768	42	30	2.61	32	2.852
BPRF4236	835	847	862	42	36	2.61	36	3.387
BPRF4242	916	930	944	42	42	2.61	40	3.921
BPRF4248	996	1008	1024	42	48	2.61	44	4.456
BPRF4254	1076	1089	1104	42	54	2.61	48	4.991
BPRF4260	1161	1173	1188	42	60	2.61	52	5.525
BPRF4266	1294	1353	1416	42	66	2.61	62	6.270
BPRF4272	1430	1488	1552	42	72	2.61	72	6.770
BPRF5018	668	679	696	50	18	2.61	25	2.106
BPRF5024	750	761	777	50	24	2.61	30	2.738
BPRF5030	832	845	860	50	30	2.61	35	3.370
BPRF5036	919	945	974	50	36	2.61	40	4.002
BPRF5042	1004	1032	1060	50	42	2.61	45	4.634
BPRF5048	1088	1115	1144	50	48	2.61	50	5.266
BPRF5054	1170	1199	1228	50	54	2.61	55	5.898
BPRF5060	1256	1285	1313	50	60	2.61	60	6.530
BPRF5066	1383	1439	1502	50	66	2.61	70	7.300
BPRF5072	1505	1562	1626	50	72	2.61	80	8.000
BPRF5418	692	712	733	54	18	2.61	27	2.250
BPRF5424	774	795	817	54	24	2.61	32	2.960
BPRF5430	860	882	903	54	30	2.61	37	3.689
BPRF5436	945	987	1031	54	36	2.61	42	4.318
BPRF5442	1032	1074	1118	54	42	2.61	47	4.934
BPRF5448	1118	1159	1201	54	48	2.61	52	5.666
BPRF5454	1201	1242	1287	54	54	2.61	57	6.398
BPRF5460	1288	1329	1373	54	60	2.61	62	7.035

**BPRF • Air Flow Panel ...Cont**

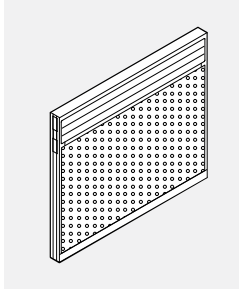

37" High

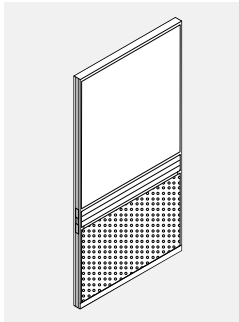

72" Wide

- Double wall of perforated metal below the raceway allows air to flow freely through the bottom of the panel.
- Centre septum above raceway overlaid on either side with tackable, 1 1/8" "Sound absorbent mineral board".
- For air flow option above the raceway, add 20% to the Grade 1 price and tag each item with "air flow above raceway". For example: BPRF4218 TAG:\*air flow above raceway.
- OPT\* = Laminate or Whiteboard.

PRODUCT CODE	PRICE			SIZE/INCHES			WEIGHT VOL	
	GR 1	GR 2	OPT*	H	W	D	LBS	FT <sup>3</sup>
BPRF5818	713	733	756	58	18	2.61	28	2.431
BPRF5824	800	820	842	58	24	2.61	33	3.160
BPRF5830	889	909	931	58	30	2.61	38	3.889
BPRF5836	972	1015	1058	58	36	2.61	43	4.618
BPRF5842	1058	1099	1143	58	42	2.61	48	5.347
BPRF5848	1146	1188	1230	58	48	2.61	53	6.076
BPRF5854	1230	1272	1316	58	54	2.61	58	6.806
BPRF5860	1318	1360	1403	58	60	2.61	63	7.535
BPRF6618	761	789	818	66	18	2.61	32	2.755
BPRF6624	853	881	909	66	24	2.61	37	3.581
BPRF6630	941	968	997	66	30	2.61	42	4.407
BPRF6636	1029	1076	1126	66	36	2.61	48	5.234
BPRF6642	1177	1227	1279	66	42	2.61	53	6.060
BPRF6648	1250	1297	1349	66	48	2.61	58	6.887
BPRF6654	1354	1401	1454	66	54	2.61	63	7.713
BPRF6660	1393	1440	1493	66	60	2.61	68	8.539
BPRF7418	817	844	872	74	18	2.61	34	3.079
BPRF7424	904	932	963	74	24	2.61	39	4.002
BPRF7430	996	1024	1054	74	30	2.61	45	4.926
BPRF7436	1088	1158	1229	74	36	2.61	50	5.850
BPRF7442	1256	1326	1398	74	42	2.61	55	6.773
BPRF7448	1293	1364	1437	74	48	2.61	60	7.697
BPRF7454	1356	1427	1498	74	54	2.61	65	8.620
BPRF7460	1448	1517	1590	74	60	2.61	70	9.544
BPRF8218	881	921	966	82	18	2.61	36	3.403
BPRF8224	971	1013	1057	82	24	2.61	42	4.424
BPRF8230	1062	1104	1147	82	30	2.61	48	5.444
BPRF8236	1166	1242	1323	82	36	2.61	54	6.465
BPRF8242	1293	1370	1452	82	42	2.61	60	7.486
BPRF8248	1354	1430	1511	82	48	2.61	66	8.507
BPRF8254	1498	1575	1656	82	54	2.61	72	9.528
BPRF8260	1529	1606	1687	82	60	2.61	78	10.549

**BPRAE • Raceway Panel Electrical**

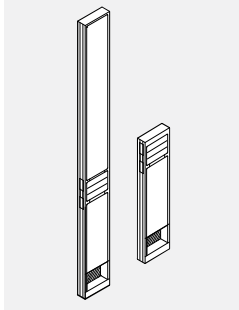

- A 6" raceway panel allows power and communication/data entry along a straight run of panels where a standard post entry cannot be utilized.
- Sections above and below the raceway are upholstered in fabric.
- Inner lower raceway area allows for single or double power feed entry and provides 1.3" x 2.9" opening for communication/data cables.
- All 6" panels must be used in conjunction with a second panel to form a standard panel width. For example: BPRAE6606 + BPRAE6618 is equivalent to BPRAE6624.
- 6" panels are not to be used as a stability panel in a panel run.

PRODUCT CODE	PRICE			SIZE/ INCHES			WEIGHT VOL	
	GR 1	GR 2	OPT*	H	W	D	LBS	FT <sup>3</sup>
BPRAE3706	573	587	603	37	6	2.61	24	0.6
BPRAE4206	573	601	633	42	6	2.61	26	0.7
BPRAE5006	642	688	730	50	6	2.61	29	0.8
BPRAE5406	672	715	758	54	6	2.61	31	0.9
BPRAE5806	700	741	787	58	6	2.61	32	0.9
BPRAE6606	748	802	862	66	6	2.61	35	1.0
BPRAE7406	802	858	919	74	6	2.61	37	1.1
BPRAE8206	867	935	1010	82	6	2.61	41	1.2

**BPRA • Raceway Panel Filler**

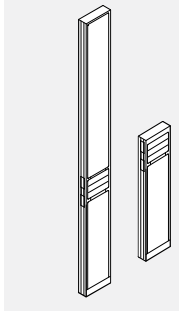

- A 6" (BPRA) raceway panel for use as a filler panel.
- Sections above and below the raceway are upholstered in fabric.
- All 6" panels must be used in conjunction with a second panel to form a standard panel width. For example: BPRA6606 + BPRA6618 is equivalent to BPRA6624.
- 6" panels are not to be used as a stability panel in a panel run.

PRODUCT CODE	PRICE			SIZE/INCHES			WEIGHT VOL	
	GR 1	GR 2	OPT*	H	W	D	LBS	FT <sup>3</sup>
BPRA3706	573	586	601	37	6	2.61	24	0.6
BPRA4206	573	601	630	42	6	2.61	26	0.7
BPRA5006	642	686	729	50	6	2.61	29	0.8
BPRA5406	672	713	757	54	6	2.61	31	0.9
BPRA5806	700	740	785	58	6	2.61	32	0.9
BPRA6606	748	802	860	66	6	2.61	35	1.0
BPRA7406	802	858	916	74	6	2.61	37	1.1
BPRA8206	867	935	1008	82	6	2.61	41	1.2

**BPRP • Pass-Thru Raceway Panel**

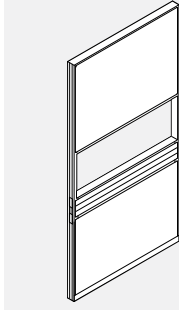

- 10.5" Open cavity allows accessibility between workstations.
- Center septum above 10.5" opening overlaid on either side with tackable, 1 1/8" mineral board.
- Center septum below raceway overlaid on either side with tackable, 1 1/8" mineral board.
- Pass-thru opening is 10.5" high starting above the raceway.
- Panel height to top of opening is fixed.

PRODUCT CODE	PRICE			SIZE/INCHES			WEIGHT VOL	
	GR 1	GR 2	OPT*	H	W	D	LBS	FT <sup>3</sup>
BPRP6618	921	934	948	66	18	2.61	32	2.755
BPRP6624	993	1021	1051	66	24	2.61	33	3.581
BPRP6630	1064	1093	1122	66	30	2.61	38	4.407
BPRP6636	1137	1195	1252	66	36	2.61	44	5.234
BPRP6642	1209	1265	1326	66	42	2.61	49	6.060
BPRP6648	1285	1339	1398	66	48	2.61	54	6.887
BPRP6654	1355	1412	1470	66	54	2.61	59	7.713
BPRP6660	1432	1489	1548	66	60	2.61	64	8.539
BPRP7418	994	1029	1062	74	18	2.61	31	3.079
BPRP7424	1071	1126	1187	74	24	2.61	36	4.002
BPRP7430	1147	1202	1262	74	30	2.61	42	4.926
BPRP7436	1224	1290	1364	74	36	2.61	47	5.850
BPRP7442	1300	1355	1415	74	42	2.61	52	6.773
BPRP7448	1378	1470	1566	74	48	2.61	57	7.697
BPRP7454	1454	1544	1641	74	54	2.61	62	8.620
BPRP7460	1544	1599	1660	74	60	2.61	67	9.544
BPRP8218	1048	1086	1131	82	18	2.61	34	3.403
BPRP8224	1134	1187	1242	82	24	2.61	40	4.424
BPRP8230	1222	1274	1330	82	30	2.61	46	5.444
BPRP8236	1309	1405	1507	82	36	2.61	52	6.465
BPRP8242	1393	1502	1619	82	42	2.61	58	7.486
BPRP8248	1482	1591	1707	82	48	2.61	64	8.507
BPRP8254	1566	1674	1792	82	54	2.61	70	9.528
BPRP8260	1664	1774	1892	82	60	2.61	76	10.549

**BPRPSD • Pass-Thru Sliding Door Kit**

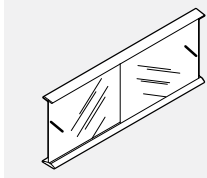

- To close the opening in a Boulevard 1 Pass-Thru Panel.
- Sliding frosted tempered glass doors.

PRODUCT CODE	PRICE	SIZE/ INCHES			WEIGHT VOL	
		H	W	D	LBS	FT <sup>3</sup>
BPRPSD36	374	10	36	2.61	13	1.2
BPRPSD42	420	10	42	2.61	16	1.4
BPRPSD48	469	10	48	2.61	18	1.5
BPRPSD54	513	10	54	2.61	20	1.7
BPRPSD60	561	10	60	2.61	22	2.0

**BPAR • Accessory Rail Panel**

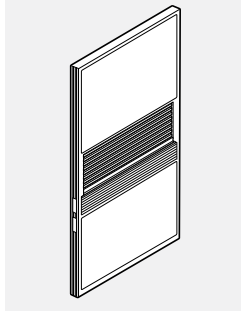

- 12" Accessory rail covers the standard pass-thru opening and allows users to hang accessories.
- Centre septum above 12" opening overlaid on either side with tackable, 1 1/8" "Sound absorbent mineral board".
- Centre septum below raceway overlaid on either side with 1 1/8" mineral board.
- Accessory rail is 12" high starting above the raceway. Panel height to top of opening is fixed.
- OPT\* = Laminate or Whiteboard.

PRODUCT CODE	PRICE			SIZE/INCHES			WEIGHT VOL	
	GR 1	GR 2	OPT*	H	W	D	LBS	FT <sup>3</sup>
BPAR6618	1075	1088	1102	66	18	2.61	35	2.755
BPAR6624	1166	1196	1224	66	24	2.61	42	3.581
BPAR6630	1282	1309	1338	66	30	2.61	49	4.407
BPAR6636	1400	1456	1516	66	36	2.61	57	5.234
BPAR6642	1549	1605	1663	66	42	2.61	65	6.060
BPAR6648	1664	1722	1779	66	48	2.61	72	6.887
BPAR6654	1784	1838	1898	66	54	2.61	79	7.713
BPAR6660	1896	1953	2011	66	60	2.61	86	8.539
BPAR7418	1151	1184	1221	74	18	2.61	38	3.079
BPAR7424	1242	1299	1356	74	24	2.61	45	4.002
BPAR7430	1356	1414	1471	74	30	2.61	53	4.926
BPAR7436	1484	1553	1623	74	36	2.61	60	5.850
BPAR7442	1634	1690	1749	74	42	2.61	68	6.773
BPAR7448	1752	1848	1949	74	48	2.61	75	7.697
BPAR7454	1874	1929	1989	74	54	2.61	82	8.620
BPAR7460	2000	2055	2114	74	60	2.61	89	9.544
BPAR8218	1198	1236	1280	82	18	2.61	41	3.403
BPAR8224	1301	1354	1412	82	24	2.61	49	4.424
BPAR8230	1427	1481	1535	82	30	2.61	57	5.444
BPAR8236	1561	1660	1760	82	36	2.61	65	6.465
BPAR8242	1723	1833	1949	82	42	2.61	74	7.486
BPAR8248	1850	1960	2079	82	48	2.61	82	8.507
BPAR8254	1983	2093	2211	82	54	2.61	90	9.528
BPAR8260	2111	2221	2338	82	60	2.61	98	10.549

**BPFA • Acoustical Fabric Panel**

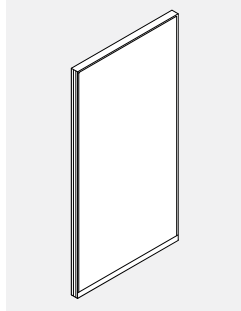

- Complete fabric panel without raceway.
- Acoustical rating of .80 NRC and 26 STC.
- Centre septum overlaid on either side with 1 1/8" Mineral board, non tackable.
- OPT\* = Laminate or Whiteboard.

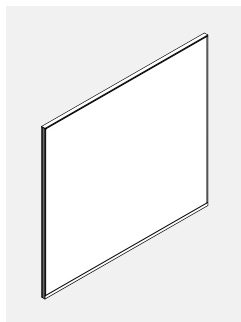

72" Wide

PRODUCT CODE	PRICE			SIZE/INCHES			WEIGHT VOL	
	GR 1	GR 2	OPT*	H	W	D	LBS	FT <sup>3</sup>
BPFA2918	353	380	408	29	18	2.61	15	1.256
BPFA2924	381	410	443	29	24	2.61	17	1.633
BPFA2930	407	436	464	29	30	2.61	19	2.009
BPFA2936	437	493	551	29	36	2.61	21	2.386
BPFA2942	463	520	576	29	42	2.61	23	2.763
BPFA2948	493	549	607	29	48	2.61	25	3.139
BPFA2954	520	574	634	29	54	2.61	27	3.513
BPFA2960	547	603	661	29	60	2.61	29	3.893
BPFA2966	565	624	688	29	66	2.61	36	4.332
BPFA2972	586	641	-	29	72	2.61	42	4.770
BPFA4218	463	492	521	42	18	2.61	18	1.782
BPFA4224	494	550	608	42	24	2.61	21	2.317
BPFA4230	523	576	636	42	30	2.61	24	2.852
BPFA4236	552	620	694	42	36	2.61	27	3.387
BPFA4242	583	650	724	42	42	2.61	30	3.921
BPFA4248	611	678	754	42	48	2.61	33	4.456
BPFA4254	639	706	782	42	54	2.61	36	4.991
BPFA4260	671	739	813	42	60	2.61	39	5.525
BPFA4266	756	870	994	42	66	2.61	47	6.148
BPFA4272	840	956	-	42	72	2.61	54	6.770
BPFA5018	524	551	579	50	18	2.61	22	2.106
BPFA5024	556	595	639	50	24	2.61	25	2.738
BPFA5030	587	628	672	50	30	2.61	28	3.370
BPFA5036	617	701	789	50	36	2.61	31	4.002
BPFA5042	649	730	820	50	42	2.61	34	4.634
BPFA5048	678	761	851	50	48	2.61	38	5.266
BPFA5054	712	793	883	50	54	2.61	41	5.898
BPFA5060	743	826	915	50	60	2.61	43	6.530
BPFA5066	818	934	1057	50	66	2.61	53	7.300
BPFA5072	893	1008	-	50	72	2.61	62	8.000
BPFA5418	553	583	611	54	18	2.61	23	2.250
BPFA5424	586	626	671	54	24	2.61	26	2.960
BPFA5430	617	660	702	54	30	2.61	30	3.689
BPFA5436	650	732	821	54	36	2.61	34	4.318
BPFA5442	681	763	854	54	42	2.61	38	4.934
BPFA5448	715	796	886	54	48	2.61	41	5.666
BPFA5454	748	828	919	54	54	2.61	43	6.398
BPFA5460	782	865	954	54	60	2.61	46	7.035

**BPFA • Acoustical Fabric Panel ...Cont**

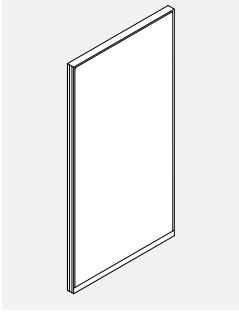

- Complete fabric panel without raceway.
- Acoustical rating of .80 NRC and 26 STC.
- Centre septum overlaid on either side with 1 1/8" Mineral board, non tackable.
- OPT\* = Laminate or Whiteboard.

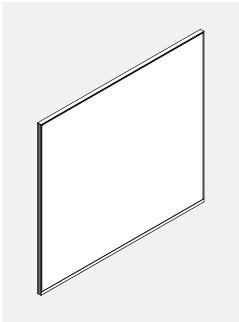

72" Wide

PRODUCT CODE	PRICE			SIZE/INCHES			WEIGHT VOL	
	GR1	GR2	OPT*	H	W	D	LBS	FT <sup>3</sup>
BPFA5818	584	624	668	58	18	2.61	24	2.431
BPFA5824	616	672	730	58	24	2.61	27	3.160
BPFA5830	649	703	762	58	30	2.61	31	3.889
BPFA5836	679	778	881	58	36	2.61	35	4.618
BPFA5842	715	811	914	58	42	2.61	39	5.347
BPFA5848	750	844	947	58	48	2.61	42	6.076
BPFA5854	782	879	982	58	54	2.61	46	6.806
BPFA5860	818	915	1019	58	60	2.61	50	7.535
BPFA6618	637	677	723	66	18	2.61	26	2.755
BPFA6624	673	729	788	66	24	2.61	29	3.581
BPFA6630	710	765	825	66	30	2.61	34	4.407
BPFA6636	748	857	972	66	36	2.61	39	5.234
BPFA6642	785	894	1011	66	42	2.61	43	6.060
BPFA6648	821	931	1049	66	48	2.61	47	6.887
BPFA6654	859	969	1086	66	54	2.61	51	7.713
BPFA6660	894	1004	1121	66	60	2.61	55	8.539
BPFA7418	699	739	783	74	18	2.61	28	3.079
BPFA7424	736	805	879	74	24	2.61	32	4.002
BPFA7430	774	843	916	74	30	2.61	37	4.926
BPFA7436	813	935	1069	74	36	2.61	42	5.850
BPFA7442	853	974	1109	74	42	2.61	47	6.773
BPFA7448	891	1015	1147	74	48	2.61	51	7.697
BPFA7454	930	1054	1187	74	54	2.61	55	8.620
BPFA7460	970	1093	1227	74	60	2.61	60	9.544
BPFA8218	755	809	868	82	18	2.61	30	3.403
BPFA8224	795	865	936	82	24	2.61	35	4.424
BPFA8230	838	906	978	82	30	2.61	40	5.444
BPFA8236	881	1019	1164	82	36	2.61	45	6.465
BPFA8242	921	1058	1203	82	42	2.61	50	7.486
BPFA8248	965	1101	1249	82	48	2.61	55	8.507
BPFA8254	1007	1144	1290	82	54	2.61	60	9.528
BPFA8260	1052	1189	1335	82	60	2.61	65	10.549

**BPFG • Glazed Panel**

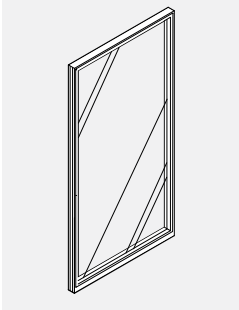

- Full-height glazing provides visual accessibility.
- Glazing is replaceable on site.
- For tempered glass, add "TG" to the end of the product code and 20% to the list price regardless of finish.

PRODUCT CODE	PRICE	SIZE/ INCHES			WEIGHT VOL	
		H	W	D	LBS	FT <sup>3</sup>
BPFG5824	809	58	24	2.61	21	3.160
BPFG5830	891	58	30	2.61	24	3.889
BPFG5836	971	58	36	2.61	27	4.618
BPFG5842	1054	58	42	2.61	30	5.347
BPFG5848	1133	58	48	2.61	33	6.076
BPFG6624	975	66	24	2.61	25	3.581
BPFG6630	1058	66	30	2.61	28	4.407
BPFG6636	1143	66	36	2.61	31	5.234
BPFG6642	1227	66	42	2.61	34	6.060
BPFG6648	1313	66	48	2.61	37	6.887
BPFG7424	1022	74	24	2.61	28	4.002
BPFG7430	1110	74	30	2.61	31	4.926
BPFG7436	1199	74	36	2.61	34	5.850
BPFG7442	1288	74	42	2.61	37	6.773
BPFG7448	1375	74	48	2.61	40	7.697
BPFG8224	1115	82	24	2.61	31	4.424
BPFG8230	1218	82	30	2.61	34	5.444
BPFG8236	1313	82	36	2.61	37	6.465
BPFG8242	1412	82	42	2.61	40	7.486
BPFG8248	1509	82	48	2.61	43	8.507



**BPOF • Fabric Over Panel**

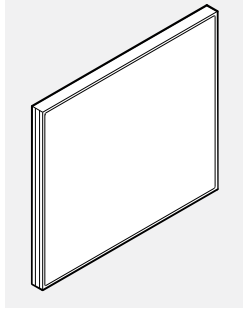

- Attaches to top of a panel to create floor-to-ceiling wall.
- Centre septum overlaid on either side with 1 1/8" Mineral board.
- Non-slotted.
- Factory installed PVC strip attaches and aligns over panel to top of base panel.
- PVC strip runs entire width eliminating light seepage.
- For custom heights and widths, please order size required and price as next size up. Example: 26" high, 35" wide, order BPOF2635 at \$459 Grade 1.
- Custom heights over 42" must be quoted separately.
- Overpanels can be stacked on any panel. Example: BPOF2418 stacked on BPRA4218 to give an overall height of 66".
- When stacking on 29" or 37" high B1 panels, custom height required, please contact customer service.
- Exact height should be specified when ordering, with allowance of at least 1" of free space between over panel and ceiling to accommodate height variations in ceiling and floor. Runs of over panels should be captured at either end with full height posts, wall adapters, taller panels, and/or vertical trims.
- Minimum height of 6".
- OPT\* = Laminate or Whiteboard.

PRODUCT CODE	PRICE			SIZE/INCHES			WEIGHT VOL	
	GR1	GR2	OPT*	H	W	D	LBS	FT <sup>3</sup>
BPOF0818	177	193	206	8	18	2.61	6	0.351
BPOF0824	206	233	263	8	24	2.61	6	0.468
BPOF0830	245	273	303	8	30	2.61	8	0.730
BPOF0836	284	311	341	8	36	2.61	10	0.912
BPOF0842	314	341	371	8	42	2.61	10	0.912
BPOF0848	353	380	408	8	48	2.61	12	1.094
BPOF0854	394	421	450	8	54	2.61	12	1.094
BPOF0860	421	449	477	8	60	2.61	14	1.277
BPOF0866	459	518	578	8	66	2.61	17	1.549
BPOF0872	494	551	613	08	72	2.61	20	1.820
BPOF1618	234	251	263	16	18	2.61	8	0.730
BPOF1624	266	294	322	16	24	2.61	8	0.730
BPOF1630	304	332	361	16	30	2.61	10	0.912
BPOF1636	343	372	400	16	36	2.61	12	1.094
BPOF1642	374	403	433	16	42	2.61	12	1.094
BPOF1648	413	441	470	16	48	2.61	14	1.277
BPOF1654	451	480	508	16	54	2.61	14	1.277
BPOF1660	481	508	537	16	60	2.61	15	1.368
BPOF1666	506	563	626	16	66	2.61	20	1.774
BPOF1672	557	613	675	16	72	2.61	24	2.180
BPOF2418	323	337	353	24	18	2.61	12	1.094
BPOF2424	350	377	406	24	24	2.61	14	1.422
BPOF2430	378	406	436	24	30	2.61	17	1.750
BPOF2436	405	444	490	24	36	2.61	18	2.078
BPOF2442	433	472	519	24	42	2.61	21	2.406
BPOF2448	461	501	546	24	48	2.61	22	2.734
BPOF2454	486	513	545	24	54	2.61	24	3.063
BPOF2460	513	556	597	24	60	2.61	27	3.391
BPOF2466	552	609	672	24	66	2.61	32	3.766
BPOF2472	589	646	706	24	72	2.61	36	4.140
BPOF3718	367	396	425	37	18	2.61	17	1.580
BPOF3724	398	426	457	37	24	2.61	19	2.054
BPOF3730	428	469	512	37	30	2.61	22	2.528
BPOF3736	459	527	601	37	36	2.61	24	3.006
BPOF3742	486	556	628	37	42	2.61	28	3.476
BPOF3748	519	586	660	37	48	2.61	30	3.950
BPOF3754	547	615	690	37	54	2.61	32	4.424
BPOF3760	575	642	718	37	60	2.61	34	4.898
BPOF3766	642	760	883	37	66	2.61	41	5.449
BPOF3772	712	827	-	37	72	2.61	48	6.000
BPOF4218	463	492	521	42	18	2.61	18	1.780
BPOF4224	494	550	608	42	24	2.61	21	2.310
BPOF4230	523	576	636	42	30	2.61	24	2.850
BPOF4236	552	620	694	42	36	2.61	27	3.390
BPOF4242	583	650	724	42	42	2.61	30	3.920
BPOF4248	612	679	755	42	48	2.61	33	4.460
BPOF4254	639	706	782	42	54	2.61	36	4.990
BPOF4260	671	739	813	42	60	2.61	39	5.250
BPOF4266	751	866	988	42	66	2.61	47	6.015
BPOF4272	828	944	-	42	72	2.61	54	6.780

**BPOG • Glazed Over Panel**

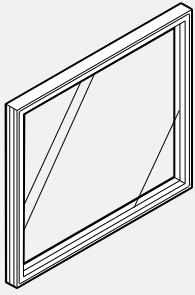

- **Attaches to top of a panel to create floor-to-ceiling wall.**
- Non-slotted.
- Factory installed PVC strip attaches and aligns over panel to top of base panel.
- PVC strip runs entire width eliminating light seepage.
- For custom heights and widths, order size required and price as next size up. Example: 26" high, 35" wide, order BPOG2635 at \$620 in acrylic.
- Custom heights over 42" must be quoted separately.
- Over panels can be stacked on any panel. Example: BPOG2418 stacked on BPRA4218 to give an overall height of 66".
- When stacking on 29" or 37" high B1 panels, custom height required, please contact customer service.
- Exact height should be specified when ordering, with allowance of at least 1" of free space between over panel and ceiling to accommodate height variations in ceiling and floor. Runs of over panels should be captured at either end with full height posts, wall adapters, taller panels, and/or vertical trims.
- Minimum height of 6".
- For tempered glass option, add "TG" to the end of the product code and 20% to the list price.

PRODUCT CODE	PRICE	SIZE/ INCHES			WEIGHT VOL	
		H	W	D	LBS	FT <sup>3</sup>
BPOG0818	118	8	18	2.61	6	0.351
BPOG0824	147	8	24	2.61	6	0.468
BPOG0830	177	8	30	2.61	8	0.730
BPOG0836	205	8	36	2.61	10	0.912
BPOG0842	234	8	42	2.61	10	0.912
BPOG0848	267	8	48	2.61	12	1.094
BPOG0854	296	8	54	2.61	12	1.094
BPOG0860	326	8	60	2.61	14	1.277
BPOG0866	344	8	66	2.61	17	1.549
BPOG0872	364	8	72	2.61	20	1.820
BPOG1618	188	16	18	2.61	8	0.730
BPOG1624	227	16	24	2.61	8	0.730
BPOG1630	267	16	30	2.61	10	0.912
BPOG1636	314	16	36	2.61	12	1.094
BPOG1642	343	16	42	2.61	12	1.094
BPOG1648	383	16	48	2.61	14	1.277
BPOG1654	421	16	54	2.61	14	1.277
BPOG1660	462	16	60	2.61	15	1.368
BPOG1666	481	16	66	2.61	20	1.774
BPOG1672	501	16	72	2.61	24	2.180
BPOG2418	334	24	18	2.61	12	1.094
BPOG2424	378	24	24	2.61	14	1.422
BPOG2430	419	24	30	2.61	17	1.750
BPOG2436	461	24	36	2.61	18	2.078
BPOG2442	501	24	42	2.61	21	2.406
BPOG2448	545	24	48	2.61	22	2.734
BPOG2454	584	24	54	2.61	24	3.063
BPOG2460	622	24	60	2.61	27	3.391
BPOG2466	679	24	66	2.61	32	3.766
BPOG2472	739	24	72	2.61	36	4.140
BPOG3718	480	37	18	2.61	17	1.580
BPOG3724	527	37	24	2.61	19	2.054
BPOG3730	576	37	30	2.61	22	2.528
BPOG3736	620	37	36	2.61	24	3.006
BPOG3742	671	37	42	2.61	28	3.476
BPOG3748	715	37	48	2.61	30	3.950
BPOG3754	763	37	54	2.61	32	4.424
BPOG3760	809	37	60	2.61	34	4.898
BPOG3766	847	37	66	2.61	41	5.449
BPOG3772	886	37	72	2.61	48	6.000
BPOG4218	508	42	18	2.61	18	1.780
BPOG4224	560	42	24	2.61	21	2.310
BPOG4230	612	42	30	2.61	24	2.850
BPOG4236	658	42	36	2.61	27	3.390
BPOG4242	715	42	42	2.61	30	3.920
BPOG4248	763	42	48	2.61	33	4.460
BPOG4254	809	42	54	2.61	36	4.990
BPOG4260	860	42	60	2.61	39	5.250
BPOG4266	904	42	66	2.61	47	6.015
BPOG4272	948	42	72	2.61	54	6.780

**BAPAS • Glass Over Panel with Round Tucks for Boulevard 1**

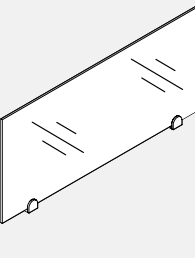

- **Glass Over Panel creates division.**
- Glass Over Panel with no frame sits on top of a Boulevard 1 Panel with clamps that are secured to the top of the panel.
- Tempered glass is 16" high.
- Custom sizes available, contact your Customer Service Representative.
- For application where the over panel is sandwiched between two taller panels, please request a special as the glass will not fit due to trims.

PRODUCT CODE	PRICE CLR	FRST	SIZE/ INCHES			WEIGHT VOL	
			H	W	D	LBS	FT <sup>3</sup>
BAPAS0824	198	228	8	24	1.3	4	0.22
BAPAS0830	222	254	8	30	1.3	5	0.30
BAPAS0836	234	275	8	36	1.3	6	0.37
BAPAS0842	254	297	8	42	1.3	7	0.43
BAPAS0848	273	314	8	48	1.3	8	0.48
BAPAS1624	212	241	16	24	1.3	8	0.44
BAPAS1630	234	268	16	30	1.3	10	0.59
BAPAS1636	252	290	16	36	1.3	12	0.73
BAPAS1642	268	311	16	42	1.3	14	0.85
BAPAS1648	273	329	16	48	1.3	16	0.96

**BAPASS • Glass Over Panel with Square Pucks for Boulevard 1**

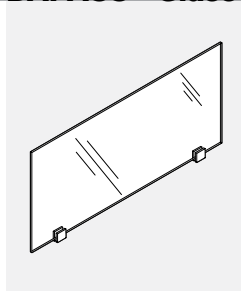

- **Glass Over Panel creates division.**
- Glass Over Panel with no frame sits on top of a Boulevard 1 Panel with clamps that are secured to the top of the panel.
- Tempered glass is 16" high.
- Custom sizes available, contact your Customer Service Representative.
- For application where the over panel is sandwiched between two taller panels, please request a special as the glass will not fit due to trims.

PRODUCT CODE	PRICE CLR	FRST	SIZE/INCHES			WEIGHT VOL	
			H	W	D	LBS	FT <sup>3</sup>
BAPASS0824	212	241	8	24	1.3	4	0.22
BAPASS0830	234	268	8	30	1.3	5	0.30
BAPASS0836	254	290	8	36	1.3	6	0.37
BAPASS0842	268	311	8	42	1.3	7	0.43
BAPASS0848	289	329	8	48	1.3	8	0.48
BAPASS1624	228	256	16	24	1.3	8	0.44
BAPASS1630	252	283	16	30	1.3	10	0.59
BAPASS1636	266	304	16	36	1.3	12	0.73
BAPASS1642	283	328	16	42	1.3	14	0.85
BAPASS1648	290	342	16	48	1.3	16	0.96

**BAPAST • Felt Over Panel with Round Pucks for Boulevard 1**

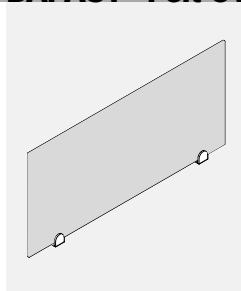

- **Felt Over Panel creates division.**
- Felt Over Panel with no frame sits on top of a Boulevard 1 panel with round clamps that are secured to the top of the panel.
- Felt panel is 8" and 16" high.
- 9mm different colours. Please specify colour.
- For application where the over panel is sandwiched between two taller panels, please request a special as the glass will not fit due to trims.

PRODUCT CODE	PRICE	SIZE/INCHES			WEIGHT VOL	
		H	W	D	LBS	FT <sup>3</sup>
BAPAST0824	100	8	22.7	1.13	1.0	0.11
BAPAST0830	107	8	28.7	1.13	1.1	0.14
BAPAST0836	114	8	34.7	1.13	1.2	0.17
BAPAST0842	125	8	40.7	1.13	1.3	0.20
BAPAST0848	135	8	46.7	1.13	1.4	0.23
BAPAST1624	128	16	22.7	1.13	1.4	0.23
BAPAST1630	144	16	28.7	1.13	1.5	0.29
BAPAST1636	165	16	34.7	1.13	1.7	0.35
BAPAST1642	178	16	40.7	1.13	1.9	0.42
BAPAST1648	191	16	46.7	1.13	2.0	0.48

**BAPASST • Felt Over Panel with Square Pucks for Boulevard 1**

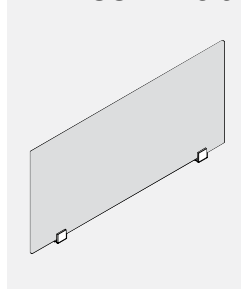

- **Felt Over Panel creates division.**
- Felt Over Panel with no frame sits on top of a Boulevard 1 panel with round clamps that are secured to the top of the panel.
- Felt panel is 8" and 16" high.
- 9mm different colours. Please specify colour.
- For application where the over panel is sandwiched between two taller panels, please request a special as the glass will not fit due to trims.

PRODUCT CODE	PRICE	SIZE/INCHES			WEIGHT VOL	
		H	W	D	LBS	FT <sup>3</sup>
BAPASST0824	100	8	22.7	1.13	1.0	0.11
BAPASST0830	107	8	28.7	1.13	1.1	0.14
BAPASST0836	114	8	34.7	1.13	1.2	0.17
BAPASST0842	125	8	40.7	1.13	1.3	0.20
BAPASST0848	135	8	46.7	1.13	1.4	0.23
BAPASST1624	128	16	22.7	1.13	1.4	0.23
BAPASST1630	144	16	28.7	1.13	1.5	0.29
BAPASST1636	165	16	34.7	1.13	1.7	0.35
BAPASST1642	178	16	40.7	1.13	1.9	0.42
BAPASST1648	191	16	46.7	1.13	2.0	0.48

**BPDS • Solid Door Panel**

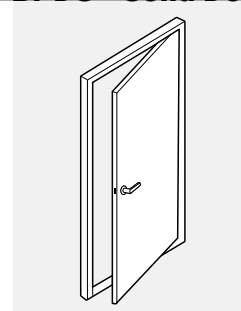

- **Aluminum frame with high pressure laminate.**
- 1 3/8" thick hollow core door.
- Actual door size:  
80" x 32 1/2" in 82" x 36" frame  
80" x 38 1/2" in 82" x 42" frame
- 42" wide Door Panel permits wheelchair accessibility.
- No hang-on capabilities.
- Non slotted frame.
- 180 degree swing.
- Specify Door Knob (DL01) or Door Lever (DL02).
- Lock standard.
- Handedness can be changed on site.
- Please specify Right hand (R) or Left hand (L) hung.

PRODUCT CODE	PRICE HP	SIZE/INCHES			WEIGHT VOL	
		H	W	D	LBS	FT <sup>3</sup>
BPDS8236R	2263	82	36	2.61	61	6.465
BPDS8242R	2465	82	42	2.61	68	7.486
BPDS8236L	2263	82	36	2.61	61	6.465
BPDS8242L	2465	82	42	2.61	68	7.486

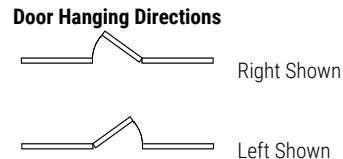

- Door Handle Option**
- Door Knob - DL01
  - Lock Standard
  - Door Lever - DL02(Default)
  - Lock Standard
  - Lever complies with all accessibility standards



**BPDH • Half Glazed Door Panel**

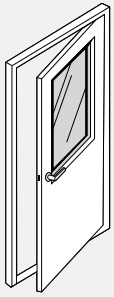

- **Aluminum frame with high pressure laminate door and window.**
- 1 3/8" thick hollow core door.
- Actual door size:  
80" x 32 1/2" in 82" x 36" frame  
80"x381/2" in 82"x42" frame
- 42" wide Door Panel permits wheelchair accessibility.
- No hang-on capabilities.
- 180 degree swing.
- Specify Door Knob (DL01) or Door Lever (DL02).
- Lock standard.
- Handedness can be changed on site.
- Please specify Right hand (R) or Left hand (L) hung.
- For tempered glass option, add "TG" at the end of the product code and add an upcharge of \$145 for 36" wide doors and \$174 for 42" wide doors.

PRODUCT CODE	PRICE HP	SIZE/INCHES			WEIGHT VOL	
		H	W	D	LBS	FT <sup>3</sup>
BPDH8236R	2807	82	36	2.61	53	6.465
BPDH8242R	3068	82	42	2.61	59	7.486
BPDH8236L	2807	82	36	2.61	53	6.465
BPDH8242L	3068	82	42	2.61	59	7.486

**Door Hanging Directions**

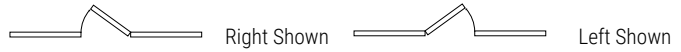

**Door Handle Option**

- Door Knob - DL01
- Lock Standard
- Door Lever - DL02(Default)
- Lock Standard
- Lever complies with all accessibility standards



**BPDG • Solid Glazed Door Panel**

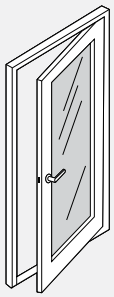

- **Aluminum frame with either high pressure laminate door and window.**
- 1 3/8" thick hollow core door.
- Actual door size:  
80" x 32 1/2" in 82" x 36" frame  
80"x381/2" in 82"x42" frame
- 42" wide Door Panel permits wheelchair accessibility.
- No hang-on capabilities.
- 180 degree swing.
- Specify Door Knob (DL01) or Door Lever (DL02).
- Lock standard.
- Handedness can be changed on site.
- Please specify Right hand (R) or Left hand (L) hung.
- For tempered glass option, add "TG" at the end of the product code and add an upcharge of \$293 for 36" wide doors and \$365 for 42" wide doors.
- Laminate frame is 5" thick on sides and 4" at top and bottom.

PRODUCT CODE	PRICE HP	SIZE/INCHES			WEIGHT VOL	
		H	W	D	LBS	FT <sup>3</sup>
BPDG8236R	3227	82	36	2.61	53	6.465
BPDG8242R	3531	82	42	2.61	59	7.486
BPDG8236L	3227	82	36	2.61	53	6.465
BPDG8242L	3531	82	42	2.61	59	7.486

**Door Hanging Directions**

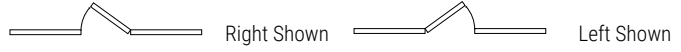

**Door Handle Option**

- Door Knob - DL01
- Lock Standard
- Door Lever - DL02(Default)
- Lock Standard
- Lever complies with all accessibility standards



**BPDSL • Privacy Screen**

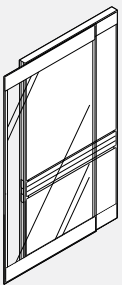

- **Provides territorial privacy in an open plan environment.**
- Lightweight, panel mounted sliding partition.
- Consists of translucent textured polycarbonate.
- Must be mounted to a straight panel of the same size.
- The face of the Privacy Screen sits 3" away from the face of the panel to which it is attached.
- Cable lay-in modules, wood trim and non-load bearing panels may be applied to the top of a panel to which the screen is attached, but not the screen itself.
- When open, the screen may interfere with access doors that open on the outside of an adjacent panel.
- Must specify left or right for the direction in which the door will slide once installed.
- Caps located on the end of the frame default to the panel frame colour.
- All hardware included.
- Can be mounted on Boulevard 1 or Boulevard System 3 panels of the same width as the Privacy Screen.
- Note: Specify left or right for the direction in which the door will slide as per examples above.

PRODUCT CODE	PRICE	SIZE/ INCHES			WEIGHT VOL	
		H	W	D	LBS	FT <sup>3</sup>
BPDSL6636R	1923	66	36	2.61	35	5.98
BPDSL6642R	2070	66	42	2.61	42	6.93
BPDSL8136R	2308	81	36	2.61	43	7.30
BPDSL8142R	2477	81	42	2.61	50	8.45
BPDSL6636L	1923	66	36	2.61	35	5.98
BPDSL6642L	2070	66	42	2.61	42	6.93
BPDSL8136L	2308	81	36	2.61	43	7.30
BPDSL8142L	2477	81	42	2.61	50	8.45

**Left Hang Option**

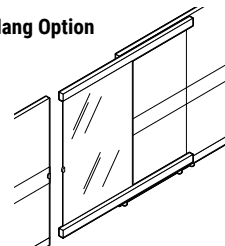

**Right Hang Hung**

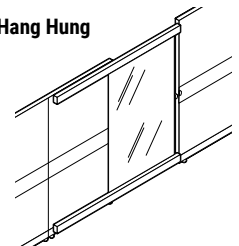

**BPDSLLOCK • Privacy Screen Lock**

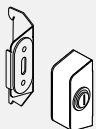

Left Hand Shown

- Lock bracket attaches to Privacy Screen with screws
- Includes strike plate bracket which attaches to slots in connector.
- Lock included.
- Available in tungsten only.
- Requires on site installation, drilling into the Privacy Screen aluminum frame.

PRODUCT CODE	PRICE	SIZE/ INCHES			WEIGHT VOL	
		H	W	D	LBS	FT <sup>3</sup>
BPDSLLOCKR	233	2.65	1.2	0.9	1	0.2
BPDSLLOCKL	233	2.65	1.2	0.9	1	0.2

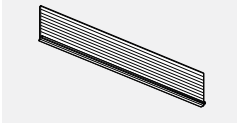
**BPXCF • Ceiling Filler**

- Durable PVC designed to seal a gap between ceiling and over panel.
- Available in lengths of 124" to be pressed into over panel's horizontal wing profile.
- Can be applied during installation or retrofitted later.
- For use only with Boulevard 1 panels.

PRODUCT CODE	PRICE	SIZE/INCHES			WEIGHT VOL	
		H	W	D	LBS	FT <sup>3</sup>
BPXCF124	63	3.25	124	0.125	1	1.2

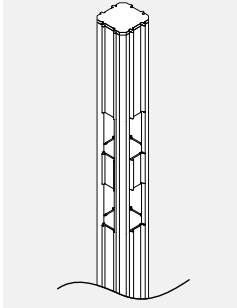
**BHP • 90 Degree Post**

- Enables connection for multiple panel runs such as 90 degree, 3 way and 4 way.
- Includes 2 "Capture Strip" panel connectors, 4 end strips, 4 pairs of raceway end caps, and 1 post cap.
- Posts are designed to accept the following:
  - 75 cables 5.6mm (0.220") diameter
  - 60 cables 5.6mm (0.220") diameter with 1 powerfeed
  - 45 cables 5.6mm (0.220") diameter with 2 powerfeeds

PRODUCT CODE	PRICE	SIZE/INCHES			WEIGHT VOL	
		H	W	D	LBS	FT <sup>3</sup>
BHP029	79	29	2.61	2.61	4	0.154
BHP037	128	37	2.61	2.61	5	0.195
BHP042	141	42	2.61	2.61	5	0.221
BHP050	157	50	2.61	2.61	6	0.263
BHP054	165	54	2.61	2.61	6	0.284
BHP058	173	58	2.61	2.61	7	0.305
BHP066	189	66	2.61	2.61	8	0.346
BHP074	205	74	2.61	2.61	9	0.388
BHP082	221	82	2.61	2.61	9	0.430
BHP106	264	106	2.61	2.61	12	0.560
BHP119	283	119	2.61	2.61	13	0.622

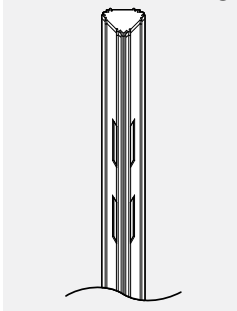
**BHP45 • 45 Degree Post**

- Enables connection for two panels at 45 degrees.
- Includes 2 "Capture Strip" panel connectors, 4 end strips, 2 pairs of raceway end caps, and 1 post cap.
- 45 degree post does not accept PVC or Wood End Trim.
- No power infeed/post extension capabilities.
- Posts are designed to accept 30 cables 5.6mm (0.220") diameter

PRODUCT CODE	PRICE	SIZE/INCHES			WEIGHT VOL	
		H	W	D	LBS	FT <sup>3</sup>
BHP4529	79	29	2.61	2.61	4	0.154
BHP4537	128	37	2.61	2.61	5	0.195
BHP4542	141	42	2.61	2.61	5	0.221
BHP4550	157	50	2.61	2.61	6	0.263
BHP4554	165	54	2.61	2.61	6	0.284
BHP4558	173	58	2.61	2.61	7	0.305
BHP4566	189	66	2.61	2.61	8	0.346
BHP4574	205	74	2.61	2.61	9	0.388
BHP4582	221	82	2.61	2.61	9	0.430
BHP45106	264	106	2.61	2.61	12	0.560
BHP45119	283	119	2.61	2.61	13	0.622

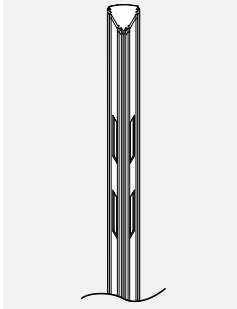
**BHP60 • 60 Degree Post**

- Enables connection for multiple panel runs such as 120 degrees and 3 way.
- Includes 2 "Capture Strip" panel connectors, 4 end strips, 3 pair of raceway end caps, and 1 post cap.
- No power infeed/post extension capabilities.

PRODUCT CODE	PRICE	SIZE/INCHES			WEIGHT VOL	
		H	W	D	LBS	FT <sup>3</sup>
BHP6029	79	29	2.61	2.61	4	0.154
BHP6037	128	37	2.61	2.61	5	0.195
BHP6042	141	42	2.61	2.61	5	0.221
BHP6050	157	50	2.61	2.61	6	0.263
BHP6054	165	54	2.61	2.61	6	0.284
BHP6058	173	58	2.61	2.61	7	0.305
BHP6066	189	66	2.61	2.61	8	0.346
BHP6074	205	74	2.61	2.61	9	0.388
BHP6082	221	82	2.61	2.61	9	0.430
BHP60106	264	106	2.61	2.61	12	0.560
BHP60119	283	119	2.61	2.61	13	0.622

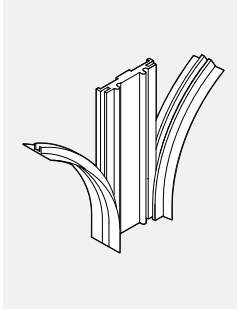
**BHWA • Wall Adapter**

- Starts a run of panels off an existing wall.
- Includes 2 "Capture Strip" panel connectors and 1 pair of raceway end caps.
- Mounting hardware not included. The mounting hardware selected must be based on the wall or wall stud material.
- Wall adapter adds 5/16" to a panel run.

PRODUCT CODE	PRICE	SIZE/INCHES			WEIGHT VOL	
		H	W	D	LBS	FT <sup>3</sup>
BHWA029	55	29	2.61	0.375	4	0.01
BHWA037	58	37	2.61	0.375	5	0.013
BHWA042	62	42	2.61	0.375	5	0.015
BHWA050	66	50	2.61	0.375	6	0.018
BHWA054	70	54	2.61	0.375	6	0.020
BHWA058	72	58	2.61	0.375	7	0.021
BHWA066	78	66	2.61	0.375	8	0.024
BHWA074	87	74	2.61	0.375	9	0.027
BHWA082	90	82	2.61	0.375	9	0.030
BHWA106	116	106	2.61	0.375	12	0.039
BHWA119	133	119	2.61	0.375	13	0.043

**BHWASL • Adapter Sleeve**



- **Wall Adapter Sleeve is attached to the building to provide flexible support to a panel run.**
- As opposed to the BHW wall adapter, which connects to the panels securely to a wall, B1 and B3 Boulevard panels rest inside the vertical "U" channel, providing up to 3.5" of flexible adjustment.
- For panel runs taller than 66" order two Wall Adapter Sleeve and either have them cut short on site below the ceiling, or cut a rectangular hole in the ceiling tile. Rectangular slots in the Channels correspond to 66", 58", 50" and 42" high B1 and B3 panels.
- Powder coated steel; specify metal finish.
- Note: the Wall Adapter Sleeve provides flexible, connection, blocks vertical 1" increment clots and cannot, therefore, be used to support overheads and worksurfaces, they must be supported by perpendicular panels, c-legs or gables.
- Note: No fasteners are provided with the Wall Adapter Sleeve. Select the appropriate fasteners according to a structurally wall type.
- Cannot be used to support a door or panel and cannot be used with laminate, airflow or metal skin panels.

PRODUCT CODE	PRICE	SIZE/ INCHES			WEIGHT VOL	
		H	W	D	LBS	FT <sup>3</sup>
BHWASL42	145	34.7	4	2	2.5	0.161
BHWASL50	157	42.7	4	2	3.6	0.198
BHWASL54	165	46.7	4	2	4.2	0.220
BHWASL58	169	50.7	4	2	5.1	0.244
BHWASL66	182	58.7	4	2	6.0	0.272

**BHHF • High Profile Foot**

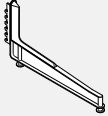

- **Provides added support to panel under load.**
- Adjustable glides included.
- Made of cast aluminum and cold rolled steel.
- Cannot be used with System 3 Panels

PRODUCT CODE	PRICE	SIZE/INCHES			WEIGHT VOL	
		H	W	D	LBS	FT <sup>3</sup>
BHHF01	222	9	1	18.375	4	0.130

**BHLF • Low Profile Foot**

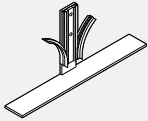

- **Stabilizes a run of panels.**
- Attaches with supplied connectors to an end of a panel.
- Made of cold rolled steel.
- Cannot be used with System 3 Panels

PRODUCT CODE	PRICE	SIZE/ INCHES			WEIGHT VOL	
		H	W	D	LBS	FT <sup>3</sup>
BHLF01	52	6	9	2.5	7	0.230

**BHPA • Panel to Panel Adapter**

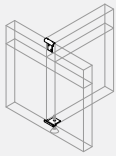

- **Enables mid panel, off-module connection.**
- Slim profile.
- Formed steel construction.
- Permanent clamps fit around base channel and fits to top rail.
- Priced as a complete kit.
- Designed for use with Boulevard 1 panels of the same height only.
- Not to be used on the panel seam, with over panels or laminate and metal faced panels.

PRODUCT CODE	PRICE	SIZE/ INCHES			WEIGHT VOL	
		H	W	D	LBS	FT <sup>3</sup>
BHPA02	52	2	2.5	00.0	0.25	0.120

**BHCS • Capture Strip Slot Cover**

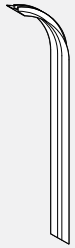

- **An extruded PVC channel to adjoin two panels or a panel to a post. Runs the full length of the panel on both sides providing a positive connection of the "Knuckle-Loc" design.**
- Priced per pair.
- Pliable side membranes cover panel slots.
- Included with panel components.
- Only to be ordered separately if required.

PRODUCT CODE	PRICE	SIZE/ INCHES			WEIGHT VOL	
		H	W	D	LBS	FT <sup>3</sup>
BHCS29	11	29			0.21	0.09
BHCS37	12	37			0.24	0.11
BHCS42	12	42			0.28	0.13
BHCS50	13	50			0.33	0.15
BHCS54	13	54			0.31	0.17
BHCS58	15	58			0.63	0.19
BHCS66	20	66			0.40	0.19
BHCS74	21	74			0.43	0.20
BHCS82	23	82			0.47	0.20

**BHCE • End Strip Slot Cover**



- **End strips with pliable side membrane covers panel slots at end of run.**
- Priced per pair.
- Included with panel components.
- Only to be ordered separately if required.

PRODUCT CODE	PRICE	SIZE/ INCHES			WEIGHT VOL	
		H	W	D	LBS	FT <sup>3</sup>
BHCE29	10	29			0.10	0.04
BHCE37	11	37			0.12	0.05
BHCE42	11	42			0.14	0.06
BHCE50	12	50			0.16	0.07
BHCE54	12	54			0.31	0.08
BHCE58	12	58			0.18	0.08
BHCE66	13	66			0.20	0.09
BHCE74	15	74			0.22	0.10
BHCE82	20	82			0.23	0.11

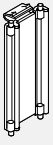
**BHRC • Raceway End Cap**

- Provides clean detail at the end of a panel run or post. End caps fit flush into communication and power channel entry.
- Priced per pair.
- Made of injection molded ABS.
- Included with panel components. Only to be ordered separately if required.

PRODUCT CODE	PRICE	SIZE/ INCHES			WEIGHT VOL	
		H	W	D	LBS	FT <sup>3</sup>
BHRC02	9	3	2.61	0.5	0.04	0.02

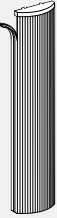
**BVTE • Vertical End PVC Trim**

- Provides a rounded finished detail to the end of the panel run, or a post.
- Includes 2 "Capture Strip" panel connectors and 1 injection molded top cap.
- The PVC end trim is designed to snap at the end of the panel or post.
- Site installed.

PRODUCT CODE	PRICE	SIZE/ INCHES			WEIGHT VOL	
		H	W	D	LBS	FT <sup>3</sup>
BVTE37	41	37	2.61	0.25	0.41	0.065
BVTE42	48	42	2.61	0.25	0.48	0.074
BVTE50	54	50	2.61	0.25	0.57	0.088
BVTE54	68	54	2.61	0.25	0.62	0.095
BVTE58	75	58	2.61	0.25	0.66	0.102
BVTE66	78	66	2.61	0.25	0.75	0.115
BVTE74	83	74	2.61	0.25	0.84	0.013
BVTE82	89	82	2.61	0.25	0.93	0.143

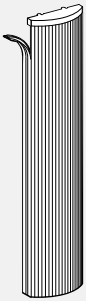
**BVTS • Vertical Step Down PVC Trim**

- Provides a rounded finished detail to the end of the panel run where two different height panels are specified.
- Includes 2 "Capture Strip" panel connectors and 1 injection molded top cap.
- The PVC end trim is designed to snap at the end of the panel or post.
- Site installed.
- Please specify panels to be used when ordering a 29" step (BVTS29).

PRODUCT CODE	PRICE	SIZE/ INCHES			WEIGHT VOL	
		H	W	D	LBS	FT <sup>3</sup>
BVTS04	11	4	2.61	0.25	0.05	0.010
BVTS08	13	8	2.61	0.25	0.09	0.015
BVTS12	20	12	2.61	0.25	0.12	0.021
BVTS16	28	16	2.61	0.25	0.18	0.029
BVTS20	30	20	2.61	0.25	0.20	0.035
BVTS24	33	24	2.61	0.25	0.27	0.043
BVTS32	37	32	2.61	0.25	0.36	0.056
BVTS38	44	38	2.61	0.25	0.45	0.067
BVTS40	46	40	2.61	0.25	0.45	0.070
BVTS48	53	48	2.61	0.25	0.54	0.084
BVTS56	63	56	2.61	0.25	0.63	0.098

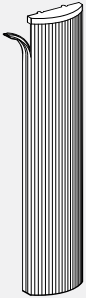
**BVTS • Vertical Step Down PVC Trim for 37" High Panels**

- Provides a finished detail to the end of the panel run that sits next to a 37" high panel. This PVC trim will bridge the distance between the 37" and higher panel.
- Includes 2 "Capture Strip" panel connectors and 1 injection molded top cap.
- The PVC end trim is designed to snap at the end of the panel or post.
- Site installed.
- Please specify panels to be used when ordering a 29" step (BVTS29).

PRODUCT CODE	PRICE	SIZE/ INCHES			WEIGHT VOL	
		H	W	D	LBS	FT <sup>3</sup>
BVTS05	11	5	2.61	0.25	0.06	0.015
BVTS13	20	13	2.61	0.25	0.15	0.029
BVTS17	29	17	2.61	0.25	0.15	0.035
BVTS21	31	21	2.61	0.25	0.24	0.043
BVTS29	34	29	2.61	0.25	0.33	0.051
BVTS37	43	37	2.61	0.25	0.41	0.067
BVTS45	47	45	2.61	0.25	0.51	0.084

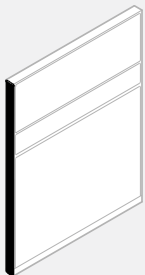
**BAVTE • Aluminum Vertical End Round Trim**

- Provides a finished detail to the end of a panel run.
- Aluminum radiused front section and injection molded top cap.
- Includes 2 "Capture Strip" panel connectors and 1 injection molded top cap.
- The Aluminum End Trim is designed to snap at the end of the panel or post.
- Site installed.
- BAVTE119 cannot ship via courier and must be combined with other product.

PRODUCT CODE	PRICE	SIZE/ INCHES			WEIGHT VOL	
		H	W	D	LBS	FT <sup>3</sup>
BAVTE37	43	37	2.61	0.125	1.2	0.03
BAVTE42	48	42	2.61	0.125	1.4	0.03
BAVTE50	54	50	2.61	0.125	1.7	0.04
BAVTE54	68	54	2.61	0.125	1.8	0.04
BAVTE58	75	58	2.61	0.125	1.9	0.04
BAVTE66	78	66	2.61	0.125	2.2	0.05
BAVTE74	83	74	2.61	0.125	2.4	0.05
BAVTE82	89	82	2.61	0.125	2.7	0.06
BAVTE119	133	119	2.61	0.125	3.9	0.08

**BAVTS • Aluminum Vertical End Round Trim - Standard Step Down**

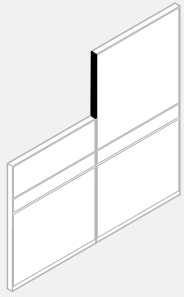

- Provides a finished detail to the end of a panel run where two different height panels are specified.
- Aluminum radiused front section and injection molded top cap.
- Includes 2 "Capture Strip" panel connectors and 1 injection molded top cap.
- The Aluminum End Trim is designed to snap at the end of the panel or post.
- Site installed.
- Specify panels to be used when ordering a 29" step.

PRODUCT CODE	PRICE	SIZE/ INCHES			WEIGHT VOL	
		H	W	D	LBS	FT <sup>3</sup>
BAVTS04	11	4	2.61	0.125	0.2	0.01
BAVTS08	13	8	2.61	0.125	0.3	0.02
BAVTS12	20	12	2.61	0.125	0.4	0.02
BAVTS16	28	16	2.61	0.125	0.5	0.03
BAVTS20	30	20	2.61	0.125	0.7	0.04
BAVTS24	33	24	2.61	0.125	0.8	0.04
BAVTS32	37	32	2.61	0.125	1.1	0.06
BAVTS38	44	38	2.61	0.125	1.3	0.07
BAVTS40	45	40	2.61	0.125	1.3	0.07
BAVTS48	53	48	2.61	0.125	1.6	0.08
BAVTS56	63	56	2.61	0.125	1.8	0.10

**BAVTSF • Aluminum Vertical End Round Trim - Step Down for 37" High Panels**

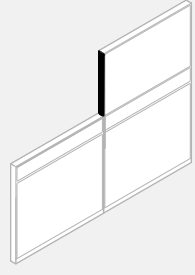

- Provides a finished detail to the end of a panel run adjacent to a 37" high panel.
- Aluminum radiused front section and injection molded top cap.
- Includes 2 "Capture Strip" panel connectors and 1 injection molded top cap.
- The Aluminum End Trim is designed to snap at the end of the panel or post.
- Site installed.

PRODUCT CODE	PRICE	SIZE/ INCHES			WEIGHT VOL	
		H	W	D	LBS	FT <sup>3</sup>
BAVTSF05	12	5	2.61	0.125	0.2	0.02
BAVTSF13	21	13	2.61	0.125	0.4	0.03
BAVTSF17	29	17	2.61	0.125	0.6	0.04
BAVTSF21	31	21	2.61	0.125	0.7	0.04
BAVTSF29	34	29	2.61	0.125	1.0	0.05
BAVTSF37	43	37	2.61	0.125	1.2	0.07
BAVTSF45	51	45	2.61	0.125	1.5	0.08

**BARC • Aluminum Raceway Cover**

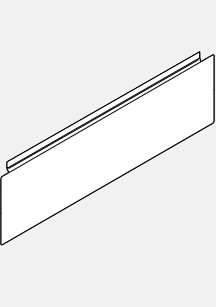

- Offers an alternative to the existing raceway options.
- Cover hinges upward for easy access to power and data/communication terminals.
- Cover may be removed for installation and reconfiguration.
- May not be used with Boulevard System 3 panels.
- Sold as singles.

PRODUCT CODE	PRICE	SIZE/ INCHES			WEIGHT VOL	
		H	W	D	LBS	FT <sup>3</sup>
BARC06	24	00.0	5	0.125	0.3	0.001
BARC18	26	00.0	17	0.125	1.1	0.001
BARC24	31	00.0	23	0.125	1.4	0.001
BARC30	34	00.0	29	0.125	1.8	0.002
BARC36	36	00.0	35	0.125	2.2	0.002
BARC42	39	00.0	41	0.125	2.5	0.002
BARC48	41	00.0	47	0.125	2.9	0.003
BARC54	47	00.0	53	0.125	3.2	0.003
BARC60	56	00.0	59	0.125	3.7	0.003
BARC66	61	00.0	65	0.125	4.1	0.004
BARC72	65	00.0	72	0.125	4.4	0.004

**Boulevard 1 • Flat Aluminum Trims**

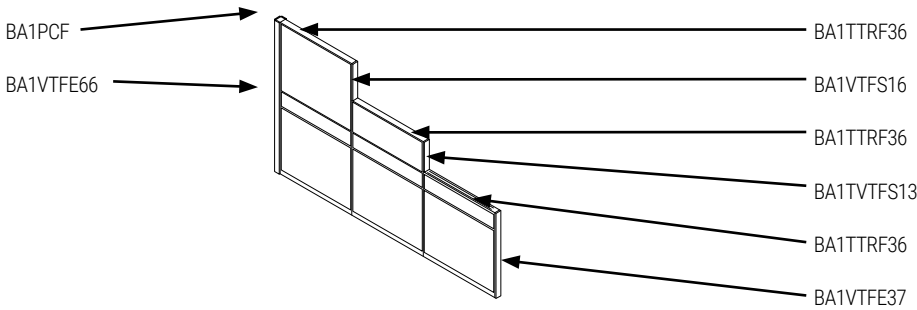

- Flat Aluminum Trims For Boulevard 1: Designed to use top and vertical trims together on the panel. Specifying vertical trims only will make them too long and will not fit correctly.
- You must specify vertical trims as a special if you are NOT using top trims.
- Post caps BA1PCF must be specified separately when using trims, .

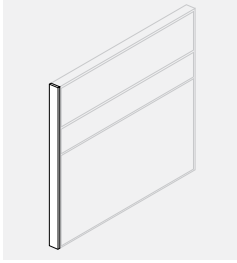

**BA1VTFE • Aluminum Vertical Flat End Trim**

- Provides a finish detail to the end of a panel run.
- Aluminum flat profile with injection molded top cap.
- Included: 2 "capture strip" panel connectors and 1 injection molded top cap.
- The Aluminum End Trim is designed to snap at the end of the panel or post.
- Site installed.
- For use with Aluminum Top Caps.

PRODUCT CODE	PRICE	SIZE/ INCHES			WEIGHT VOL	
		H	W	D	LBS	FT <sup>3</sup>
BA1VTFE29	35	29	2.61	0.125	0.7	0.01
BA1VTFE37	43	37	2.61	0.125	1.0	0.02
BA1VTFE42	48	42	2.61	0.125	1.2	0.03
BA1VTFE50	54	50	2.61	0.125	1.5	0.04
BA1VTFE54	68	54	2.61	0.125	1.6	0.04
BA1VTFE58	75	58	2.61	0.125	1.7	0.04
BA1VTFE66	78	66	2.61	0.125	2.0	0.05
BA1VTFE74	83	74	2.61	0.125	2.2	0.05
BA1VTFE82	89	82	2.61	0.125	2.4	0.06

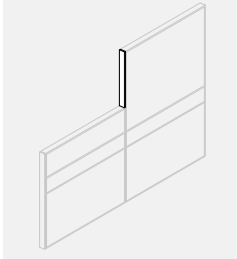
**BA1VTFS • Aluminum Vertical Flat End Trim - Standard Step Down**

- Provides a finish detail to the end of a panel run where 2 different height panels are specified.
- Aluminum flat profile with injection molded top cap.
- Included: 2 "capture strip" panel connectors and 1 injection molded top cap.
- The aluminum end trim is designed to snap at the end of the panel or post.
- Site installed.
- For use with Aluminum Top Caps.

PRODUCT CODE	PRICE	SIZE/ INCHES			WEIGHT VOL	
		H	W	D	LBS	FT <sup>3</sup>
BA1VTFS04	11	4	2.61	0.125	0.1	0.01
BA1VTFS08	13	8	2.61	0.125	0.2	0.01
BA1VTFS12	20	12	2.61	0.125	0.4	0.02
BA1VTFS16	28	16	2.61	0.125	0.6	0.02
BA1VTFS20	30	20	2.61	0.125	0.6	0.03
BA1VTFS24	33	24	2.61	0.125	0.7	0.03
BA1VTFS32	37	32	2.61	0.125	0.9	0.03
BA1VTFS38	44	38	2.61	0.125	1.1	0.03
BA1VTFS40	46	40	2.61	0.125	1.1	0.03
BA1VTFS48	54	48	2.61	0.125	1.3	0.04
BA1VTFS56	63	56	2.61	0.125	1.6	0.05

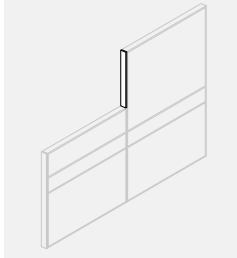
**BA1VTFS • Aluminum Vertical Flat End Trim - Standard Step Down 37" High Panels**

- Provides a finish detail to the end of a panel run adjacent to a 37" high panel.
- Aluminum flat profile with injection molded top cap
- Included 2 "capture strip" panel connectors and 1 injection molded top cap
- The aluminum end trim is designed to snap at the end of the panel or post
- Site installed
- Specify panels to be used when ordering a 29" step down trim.
- For use with Aluminum Top Caps.

PRODUCT CODE	PRICE	SIZE/ INCHES			WEIGHT VOL	
		H	W	D	LBS	FT <sup>3</sup>
BA1VTFS05	12	5	2.61	0.125	0.2	0.01
BA1VTFS13	21	13	2.61	0.125	0.4	0.01
BA1VTFS17	29	17	2.61	0.125	0.4	0.01
BA1VTFS21	31	21	2.61	0.125	0.6	0.02
BA1VTFS29	34	19	2.61	0.125	0.7	0.03
BA1VTFS37	43	37	2.61	0.125	1.1	0.03
BA1VTFS45	51	45	2.61	0.125	1.3	0.04

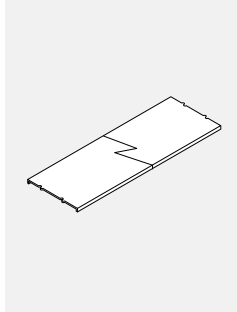
**BA1TTRF • Aluminum Top Cap**

- Provides a finish detail to the top of a Boulevard 1 panel.
- Designed to snap to the top of a panel rail.
- Must be used on panels of corresponding width.
- Site installed.
- For applications using transaction tops and top mounted storage, please use BHBT02FT bracket
- To be used with Flat Vertical Trim.

PRODUCT CODE	PRICE	SIZE/ INCHES			WEIGHT VOL	
		H	W	D	LBS	FT <sup>3</sup>
BA1TTRF06	12	0.125	6	2.61	0.2	0.01
BA1TTRF18	29	0.125	18	2.61	0.6	0.02
BA1TTRF24	33	0.125	24	2.61	0.7	0.03
BA1TTRF30	35	0.125	30	2.61	0.9	0.04
BA1TTRF36	42	0.125	36	2.61	1.1	0.05
BA1TTRF42	48	0.125	42	2.61	1.3	0.06
BA1TTRF48	55	0.125	48	2.61	1.5	0.06
BA1TTRF54	68	0.125	54	2.61	1.6	0.07
BA1TTRF60	75	0.125	60	2.61	1.8	0.08
BA1TTRF66	78	0.125	66	2.61	2.0	0.09
BA1TTRF72	83	0.125	72	2.61	2.2	0.10

**BA1PCF • Post Cap**

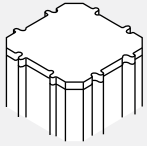

- Bridges the height difference when using Boulevard 1 panels only with Aluminum Horizontal Top Trims.
- Injection molded post cap to fit on top of 90 degree corner post.
- Extends post's overall height to the level corresponding with the height of aluminum horizontal top trim installed on standard Boulevard panel.
- Site installed.
- Used for Boulevard 1 panels when top aluminum horizontal trim is used.

PRODUCT CODE	PRICE	SIZE/ INCHES			WEIGHT VOL	
		H	W	D	LBS	FT <sup>3</sup>
BA1PCF	9	0.25	2.61	2.61	0.02	0.01

**BHBT37FT • Transaction Bracket for 37" Panels with Flat Trim**



- Provides a secure attachment of a transaction worksurface for a 37" high panel with top trim.
- Includes a left and right bracket and bracket retainer clips.

PRODUCT CODE	PRICE	SIZE/ INCHES			WEIGHT VOL	
		H	W	D	LBS	FT <sup>3</sup>
BHBT37FT	25	3.3	1.5	2.3	2.0	0.010

**BHBT02FT • Transaction Bracket for 42" Panels with Flat Trim**

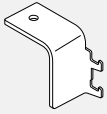

- Provides a secure attachment of a transaction worksurface for 42" high Boulevard panels with flat trim.
- Includes a left and right bracket and bracket retainer clips.

PRODUCT CODE	PRICE	SIZE/ INCHES			WEIGHT VOL	
		H	W	D	LBS	FT <sup>3</sup>
BHBT02FT	30	4	1	3	0.5	0.007

30

**FRC • Fabric Raceway Cover**

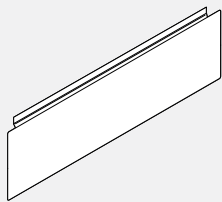

- Offers an alternative to the existing raceway options.
- Cover hinges upward for easy access to power and data/communication terminals.
- Cover may be removed for installation and reconfiguration.
- May not be used with Boulevard System 3 panels.
- Sold as singles.

PRODUCT CODE	PRICE	SIZE/ INCHES			WEIGHT VOL	
		H	W	D	LBS	FT <sup>3</sup>
FRC24	28	7	23	0.125	1.4	0.001
FRC30	34	7	29	0.125	1.8	0.002
FRC36	36	7	35	0.125	2.2	0.002
FRC42	39	7	41	0.125	2.5	0.002
FRC48	41	7	47	0.125	2.9	0.003
FRC54	50	7	53	0.125	3.2	0.003
FRC60	53	7	59	0.125	3.7	0.003
FRC66	56	7	65	0.125	4.1	0.004
FRC72	58	7	72	0.125	4.4	0.004

**RCW-D • PVC Facemount Raceway Cover**

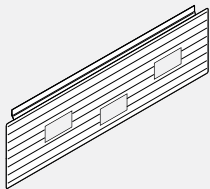

- PVC raceway cover is punched out to align with the Face Mount Power Distribution Housing and Duplexes.
- Data punch-out accepts industry standard terminal faceplates (not supplied by Global Contract Inc.) Size of opening is 1.37" x 2.755".
- Electrical cut-outs have black PVC trim. Size of opening is 1.5" x 2.85".
- May not be used with Boulevard System 3 Panels.
- Cover hinges upward for easy access to power and data/communication terminals.

PRODUCT CODE	PRICE	SIZE/ INCHES			WEIGHT VOL	
		H	W	D	LBS	FT <sup>3</sup>
RCW24D	35	7	24	0.125	3	0.05
RCW30D	37	7	30	0.125	3	0.06
RCW36D	42	7	36	0.125	4	0.07
RCW42D	51	7	42	0.125	5	0.08
RCW48D	55	7	48	0.125	5	0.09
RCW54D	58	7	54	0.125	6	0.10
RCW60D	62	7	60	0.125	7	0.11
RCW66D	65	7	66	0.125	7	0.12
RCW72D	70	7	72	0.125	8	0.12

**FCR-D • Fabric Covered Facemount Raceway**

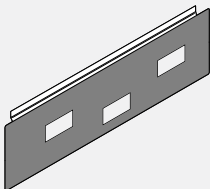

- Fabric raceway cover is punched out to align with the Face Mount Power Distribution Housing and Duplexes.
- Data punch-out accepts industry standard terminal faceplates (not supplied by Global Contract Inc.) Size of opening is 1.37" x 2.755".
- Electrical cut-outs have black PVC trim. Size of opening is 1.5" x 2.85".
- May not be used with Boulevard System 3 Panels.
- Cover hinges upward for easy access to power and data/communication terminals.

PRODUCT CODE	PRICE	SIZE/ INCHES			WEIGHT VOL	
		H	W	D	LBS	FT <sup>3</sup>
FCR24D	80	7	24	0.125	3	0.05
FCR30D	86	7	30	0.125	3	0.06
FCR36D	89	7	36	0.125	4	0.07
FCR42D	94	7	42	0.125	5	0.08
FCR48D	100	7	48	0.125	5	0.09
FCR54D	103	7	54	0.125	6	0.10
FCR60D	109	7	60	0.125	7	0.11
FCR66D	113	7	66	0.125	7	0.12
FCR72D	120	7	72	0.125	8	0.12

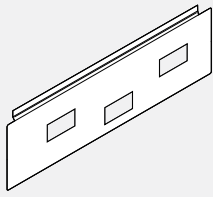
**RCA-D • Aluminum Raceway Cover for Face Mounted**

- Aluminum raceway cover is punched out to align with the Face Mount Power Distribution Housing and Duplexes.
- Data punch-out accepts industry standard terminal face-plates (not supplied by Global Contract Inc.) Size of opening is 1.37" x 2.755".
- Electrical cut-outs have black PVC trim. Size of opening is 1.5" x 2.85".
- May not be used with Boulevard System 3 Panels.
- Cover hinges upward for easy access to power and data/communication terminals.

PRODUCT CODE	PRICE	SIZE/ INCHES			WEIGHT VOL	
		H	W	D	LBS	FT <sup>3</sup>
RCA24D	61	7	24	0.125	2.0	0.06
RCA30D	64	7	30	0.125	2.1	0.06
RCA36D	70	7	36	0.125	2.2	0.07
RCA42D	76	7	42	0.125	2.5	0.08
RCA48D	78	7	48	0.125	2.9	0.09
RCA54D	85	7	54	0.125	3.2	0.10
RCA60D	88	7	60	0.125	3.7	0.11
RCA66D	92	7	66	0.125	3.9	0.12
RCA72D	99	7	72	0.125	4.1	0.12

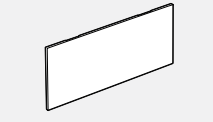
**BPMB • Raceway Cover Caps**

- To provide clean detail for the punch-outs of a raceway cover when the punch-outs are not in use. Order only when required.
- Made of injection molded ABS.
- B = Black
- W = White
- G = Grey

PRODUCT CODE	PRICE	SIZE/ INCHES			WEIGHT VOL	
		H	W	D	LBS	FT <sup>3</sup>
BPMB020104B	9	1.5	3	0.125	0.04	0.02
BPMB020104G	9	1.5	3	0.125	0.04	0.02
BPMB020104W	9	1.5	3	0.125	0.04	0.02

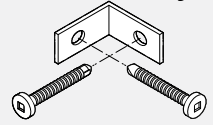
**BHSL • Safety Lock**

- Provides customers a higher degree of privacy.
- Safety Lock is a set of two ready made brackets and
- It is installed from the inside of a panel adjacent to an opening the door through the raceway.
- To be used for PVC raceways only.

PRODUCT CODE	PRICE
BHSL02	30

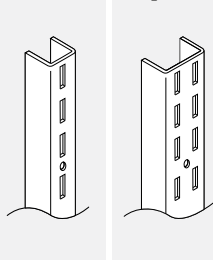
**BHV • Component Wall Adapter - Single and Double**

- Used to attach system components to fixed wall.
- Panel frame finish.
- The vertical wall adapter is a "U" shaped channel with a vertical row of slots with 1" centers.
- The double Component Wall Adapter has a double row of slots with 1" centers.
- Comes in 60" length only.
- Care should be taken to mount adapters only to wall studs using correct fasteners.
- Does not include mounting hardware. Mounting hardware selection to be based on wall material.
- Sold in pairs.
- Failure to do this may result in collapse of the unit and subsequent possible personal injury.

PRODUCT CODE	PRICE	SIZE/ INCHES			WEIGHT VOL	
		H	W	D	LBS	FT <sup>3</sup>
BHV01	99	60	0.75	0.5	4	0.009
BHV02	114	60	1.50	0.5	5	0.026

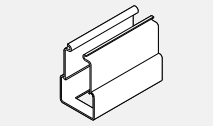
**BECC01 • Cable Terminal Channel**

- Houses various combinations of voice and data cables.
- 1 included with every Raceway Panel.
- Accommodates assorted snap-in modular voice and data terminals (not supplied by Global Contract Inc).
- Black only.

PRODUCT CODE	PRICE	SIZE/ INCHES			WEIGHT VOL	
		H	W	D	LBS	FT <sup>3</sup>
BECC01	30	6	4.5	2.5	.20	0.21

**BPHC01 • Cable Terminal Channel**

- Houses various combinations of voice and data cables.
- 2 included with every Raceway Panel.
- Black only.
- For use with Boulevard 1 Panels only.

PRODUCT CODE	PRICE	SIZE/ INCHES			WEIGHT VOL	
		H	W	D	LBS	FT <sup>3</sup>
BPHC01	8	2.5	1	2	0.1	0.003

## Boulevard System 3 Panel System

Boulevard System 3... The next generation of BOULEVARD offers the freedom to plan the office environment 'your way', while keeping an eye on the bottom line. Boulevard System 3 boasts a rich toolbox featuring stack-on panels, complete data/communication lay-in at the top, comprehensive power and data/communication at both the base and at desk height, a selection of interchangeable tiles, monolithic panels, up-mounted storage, new ergonomic worksurface shapes & a revised colour pallet featuring recycled fabrics... all wrapped up in a sophisticated design statement. Enjoy planning it your way and having the tools to really do it. Boulevard System 3 offers the building blocks to create the framework that perfectly suits your office environment. Combinations of fabric, glazed, open and slat wall panel surface tiles effectively support the creation of various work settings, whether open (to encourage interaction and teamwork) or traditional, with enclosed functional task organizers. Boulevard System 3 lets you plan more effectively and with more versatility than ever before. It is simple to comprehend, specify, install,

maintain and reconfigure. Offering multifunctional furnishing solutions, Boulevard System 3 can be specified on its own or used as a power/data and privacy provider, bridging freestanding/mobile furniture and panels and task related options such as worksurface shapes that help you work better. By utilizing up-mount storage, lower panel heights can be maintained without sacrificing overhead storage where and when needed. Another value-oriented tool... Consider 'Spine' planning to create a power wall that feeds data/communication to a string of perpendicular offices. Incorporate monolithic panels which offer the best cost/performance advantages for value sensitive environments with base panel raceway power/data cable distribution, while adding visual interest...and of course, reconfiguration is a breeze. Now you can have an endless visual pallet and array of practical solutions for today's ever changing and demanding workplace. When you add it all up, Boulevard System 3 gives you more value than ever before.

## Technical Information

### Panels

- All panels are 2 5/8" thick.
- Lightweight aluminum box frame construction creates superior panel rigidity.
- Panel frame finish is durable epoxy powder coated.
- Hang-on capabilities at 1" increments.
- Patented "Knuckle-Loc" design provides solid panel-to-panel connection for fast installation and reconfiguration.
- Knuckle lock feature ensures even panel heights throughout installation.
- 3" glide stem permits 2 1/2" height adjustment.
- Panel sizes are actual, eliminating creepage.
- Vertical end trims must be specified to give the panel a finished appearance.
- Horizontal top trims are included with all panels.
- All panels include 2 "Capture Strip" panel connectors.
- Panels are UL listed and CSA approved and have a Class "A" fire rating except when Customer's Own Material (COM) is used.
- All panels accept Over Panels (see page D.7).

### Panel Options

- Laminate, whiteboard, or corkboard may be substituted for fabric on panels only, see "OPT" column.
- Laminate and whiteboard are held in place with a PVC retainer matching the frame colour and can be retrofitted on site.
- Laminate and whiteboard options reduce the acoustical value of the panel.

### Monolithic Panels

- Fabric on Monolithic Panels can be re-upholstered on site.

### Pass Thru Panels

- Fabric at base of Pass-Thru Panels can be re-upholstered on site.
- Tiles cannot be re-upholstered on site.

### Bottom Lay-in Raceway

- Bottom raceway snaps to the bottom of the panel and can be completely removed for unobstructed cable lay-in installation.
- Bottom lay-in raceway is 60 mm (2.380") wide x 141 mm (5.560") high.
- Maximum capacity: 70 cables 5 mm (0.200) diameter, 2 parallel 8 wire, 4 circuit power distribution.
- State-of-the-art engineering.
- Snap-in modularity of all electrical components including harnesses, distribution housings, duplexes and circuit designations.
- All power and data outlets are easily accessible from both sides of panel.
- 8 wire system with 4, 15 amp circuits (including 1 dedicated circuit).
- Facemount electrical with 2 duplex per panel side.
- Included is 1 data/communication terminal bracket per side.

- Raceway cover openings of 2.71" x 1.38" can accommodate a single modular Data/Comm terminal plate per side (not supplied by Global Contract Inc).
- Opening complies with the ANSI/TIA/EIA standard furniture openings.
- Outlet and circuit changes accomplished without disruption to work station.
- Large raceway cavity permits storage of excess cables and equipment cords.
- Total flexibility for 8 wire system: choice of up to 4 duplexes per panel; choice of circuitry in each duplex .
- Unique design of fire retardant metal raceway cover permits access to raceway without disruption to equipment.

### Horizontal Lay-in Channel (Excluding all panels with Embedded Glass)

- Integrated horizontal lay-in channel 33.5 mm (1.320") wide and 38 mm (1.500") high at the top of panels and on top of the door frame.
- Maximum capacity: 36 cables 5 mm (0.200") in diameter.
- Maximum cable bending radius between two perpendicular panels: 141.2 mm (5.560") [5 mm (0.200") in diameter cables].

### Vertical Wire Channel

- Where applicable, the vertical wire channel connects horizontal channel above desk height with floor level raceway.
- Opening in horizontal channel allows for vertical cable passage from top lay-in channel to base raceway.
- Integrated vertical channel 76 mm (2.990") x 27 mm (1.060").
- Maximum capacity: 60 cables 5 mm (0.200") in diameter.
- Maximum cable bending radius: 141.2 mm (5.560").

### Posts

- Enables connection for multiple panel runs such as 90°, 45° or 60° angle and 2 way, 3 way or 4 way.
- Starts at the top of the bottom lay-in raceway.
- 90 degree post provides route for ceiling power and data entry to a panel raceway.
- Knuckle lock feature maintains even height of all connected panels.
- Solid lightweight aluminum extrusion fits together through a unique "Knuckle-Loc" design providing rigid post-to-panel connection.
- Post has punch-outs at the top to allow for unobstructed horizontal cable passage between adjacent panels.
- Includes all required panel connectors and caps.
- Posts add 2 5/8" to a panel run.
- Posts are 1/8" oversized to allow for "panel wrap around" of freestanding desks.
- For all panel runs with multiple posts, this 1/8" must be allotted for.
- Maximum capacity:
  - 80 cables 5mm(0.200") diameter
  - 65 cables 5mm(0.200") diameter with 1 power feed
  - 50 cables 5mm (0.200") diameter with 2 power feeds

**PANELS - GUIDELINES FOR ORDERING PRODUCT**

**Codes**

The product guide uses a numbering system with meaningful alphanumeric characters to create a simple-to-understand product number. This makes specifying the product much easier and more accurate.

Example of Panel: **BPX3MA6636 CHR CHR P1 AN50 BE21**

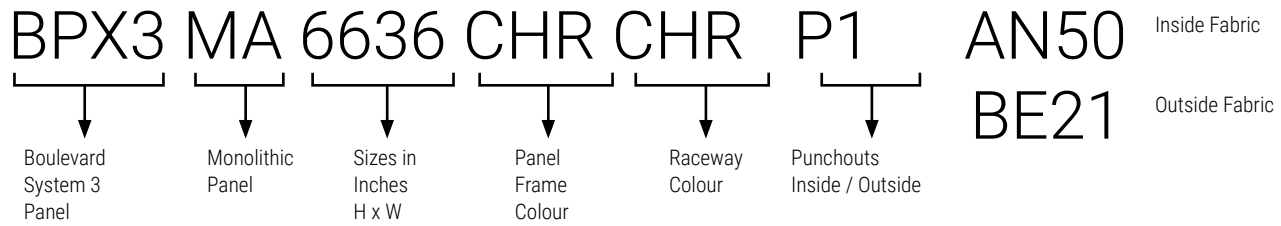

**How to Specify**

- Specify Boulevard System 3 panel type and size by code.
- Specify panel frame finish - ie. CHR (Charcoal).
- Specify PVC raceway finish - ie. CHR (Charcoal). If raceway colour not specified at time of order, default will be the panel frame colour.
- Specify all two panel fabric options if necessary.
- Some fabrics have directional pattern and cannot be applied horizontally or vertically. Panels wider than 60" will have fabrics applied horizontally (railroad). Please specify if you want adjacent panels and the rest of the installation upholstered the same way.
- Specify whether punchouts are required inside and outside of raceway or if no knockouts are required.
  - P2 - Punchouts on both sides.
  - P1 - Punchouts on one side.
  - NP - No punchouts.
- For special width panels, a special must be processed and additional costs apply. Please contact your customer service representative.

Example of Post: **BH3PS066 CHR**

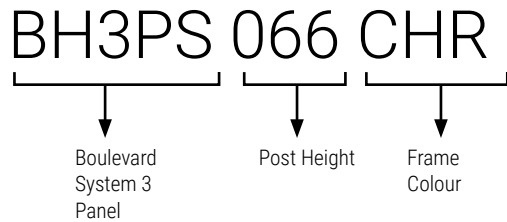

**How to Specify**

- Specify Boulevard System 3 post by code.
- Specify frame colour - ie. CHR (Charcoal).

**ORDERS**

**Each Order Must Include**

- Purchase Order
- Layout showing where the image(s) appear in the run of panels.
- A completed Price Chart, showing the location of the image(s) on each appropriate panel.

Artwork must be submitted in accordance with the following artwork specifications.

**NOTE:** Final artwork specification approval must be given before order can be processed.

**Transfer Devices**

- E-mail up to 10MB to your Global Contract Customer Service Representative.
- Courier CD/DVD/USB stick to your Global Contract Customer Service Representative.

**Artwork Specifications**

- Non-Photographic artwork should be vector art, saved in Adobe Illustrator (.ai) or as an EPS (.eps)
- All bitmap or photographic artwork has to be at a minimum of 100 dpi at the full size of the panel to be printed.
- We accept Adobe CS5 files.
- Any linked files must be included or imbedded.
- Leave any PSD files unflattened
- All fonts must be converted to outlines.
- Do not convert to CMYK, leave all images as RGB if possible
- No Word, Powerpoint, Publisher or other Microsoft files can be used.
- Include a PDF or .jpg for reference when sending native Photoshop or Illustrator format files.

**Colour Matching**

- A Pantone colour reference must be supplied or we cannot accept responsibility for correct colour.
- When it is not possible to refer to Pantone colours, we will do our best to meet your requirements.

**Image Clarity**

- We will advise should the selected image not lend itself to the element size requested.

**NOTE:**

We reserve the right to put an order on hold when the files are found to be incomplete or when documents have been either incorrectly saved. Fonts not converted to curves or the job appears not to be commercially acceptable.

**Image Bleed:**

- To facilitate placement on the panel. Extension of the image past the finished visible area of the panel (bleed) is required
- Boulevard Panels need a 5" Bleed on all sides.

**Example Of Image resolution:**

The resolution required for a 36 wide x 24 high Boulevard panel at 100dpi (minimum resolution)

The resolution required for a 36 wide x 24 high Boulevard panel at 300dpi (higher quality)

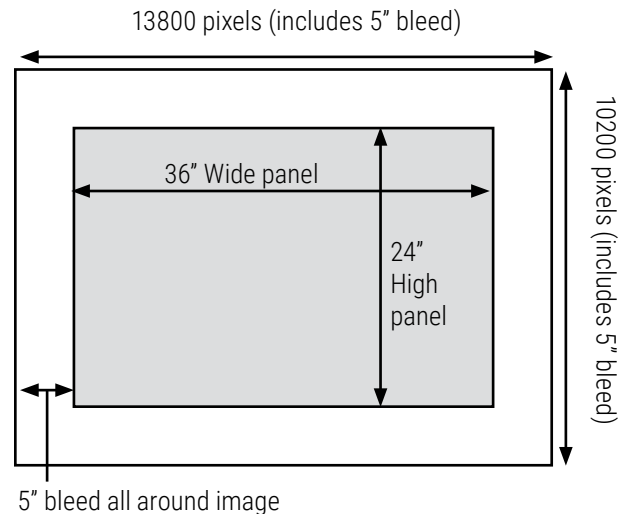
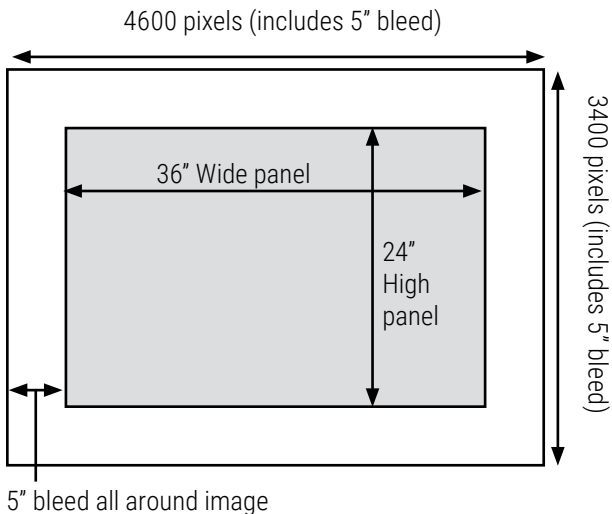

**Pricing, Initial Set-Up Charge per Image:\$256 net**

**Boulevard System 3 Tiles**

- This List applies to the following panels:
- BP3FT
- BP3ET



PANEL WIDTH	HEIGHT 8"	LIST PRICE 16"
24"	140	205
30"	168	241
36"	191	278
42"	220	315
48"	241	353
54"	271	396
60"	294	433
66"	315	462
72"	343	498

**Boulevard System 3 Bottom Section of Pass-Through Panel**

- This List applies to the following panels:
- BPX3PT
- BPX3PV

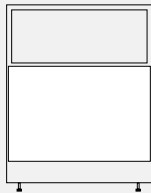

PANEL WIDTH	LIST PRICE 28"
24"	294
30"	343
36"	396
42"	455
48"	505
54"	557
60"	608
66"	660
72"	710

**Boulevard System 3 Monolithic Panels**

- This List applies to the following panels:
- BPX3MA
- BPX3MV

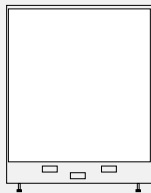

PANEL WIDTH	HEIGHT 34"	42"	50"	66"
24"	294	359	418	550
30"	343	418	498	642
36"	396	484	572	748
42"	455	550	637	849
48"	505	615	732	944
54"	557	679	799	1048
60"	608	748	879	1141
66"	660			
72"	710			

Note: Prices shown are an upcharge to the panel price, please add to the list price of panel which you are specifying the graphic for.

**BPX3MA • Monolithic Acoustical Panel**

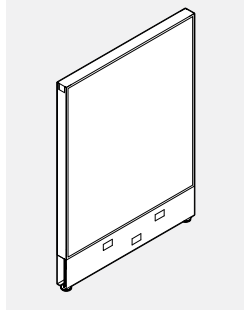

- Provides visual and acoustic privacy.
- Centre septum above raceway overlaid on either side with 1 1/8" "Sound absorbent mineral board".
- Acoustic rating of .70 NRC and 25 STC.
- OPT\* = Laminate or Whiteboard
- "No Knockouts" option for raceways available at no additional charge. Please choose option for interior and/or exterior raceways.

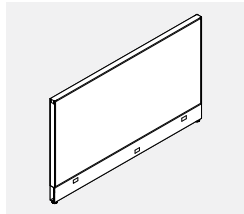

72" Wide

PRODUCT CODE	PRICE			SIZE/ INCHES			WEIGHT VOL	
	GR1	GR2	OPT*	H	W	D	LBS	FT <sup>3</sup>
BPX3MA3418	360	381	403	34	18	2.61	11	1.337
BPX3MA3424	399	420	442	34	24	2.61	12	1.738
BPX3MA3430	439	461	481	34	30	2.61	13	2.139
BPX3MA3436	477	521	563	34	36	2.61	15	2.540
BPX3MA3442	521	561	605	34	42	2.61	16	2.941
BPX3MA3448	560	601	642	34	48	2.61	18	3.342
BPX3MA3454	603	641	688	34	54	2.61	20	3.743
BPX3MA3460	639	679	725	34	60	2.61	22	4.144
BPX3MA3466	677	735	799	34	66	2.61	26	4.612
BPX3MA3472	716	773	-	34	72	2.61	30	5.080
BPX3MA4218	386	414	443	42	18	2.61	12	1.782
BPX3MA4224	429	458	486	42	24	2.61	13	2.317
BPX3MA4230	471	499	528	42	30	2.61	15	2.852
BPX3MA4236	512	567	626	42	36	2.61	17	3.387
BPX3MA4242	557	612	671	42	42	2.61	19	3.921
BPX3MA4248	601	656	715	42	48	2.61	21	4.456
BPX3MA4254	641	699	757	42	54	2.61	23	4.991
BPX3MA4260	681	737	796	42	60	2.61	25	5.525
BPX3MA4266	751	862	983	42	66	2.61	29	6.148
BPX3MA4272	816	928	-	42	72	2.61	34	6.770
BPX3MA5018	497	536	583	50	18	2.61	13	2.106
BPX3MA5024	549	589	634	50	24	2.61	15	2.738
BPX3MA5030	603	641	688	50	30	2.61	17	3.370
BPX3MA5036	651	733	824	50	36	2.61	20	4.002
BPX3MA5042	703	787	875	50	42	2.61	23	4.634
BPX3MA5048	756	838	927	50	48	2.61	24	5.266
BPX3MA5054	806	889	977	50	54	2.61	25	5.898
BPX3MA5060	859	942	1031	50	60	2.61	27	6.530
BPX3MA5066	930	1042	1163	50	66	2.61	33	7.265
BPX3MA5072	999	1113	-	50	72	2.61	40	8.000
BPX3MA5418	519	558	603	54	18	2.61	14	2.406
BPX3MA5424	569	611	653	54	24	2.61	16	3.181
BPX3MA5430	624	666	706	54	30	2.61	19	3.907
BPX3MA5436	674	757	845	54	36	2.61	22	4.602
BPX3MA5442	729	811	901	54	42	2.61	25	5.306
BPX3MA5448	781	862	953	54	48	2.61	26	5.966
BPX3MA5454	832	915	1004	54	54	2.61	27	7.287
BPX3MA5460	886	968	1057	54	60	2.61	30	7.539
BPX3MA6618	579	649	723	66	18	2.61	14	2.755
BPX3MA6624	637	704	779	66	24	2.61	17	3.581
BPX3MA6630	690	757	829	66	30	2.61	20	4.407
BPX3MA6636	744	856	971	66	36	2.61	24	5.234
BPX3MA6642	802	911	1030	66	42	2.61	26	6.060
BPX3MA6648	857	967	1084	66	48	2.61	28	6.887
BPX3MA6654	910	1021	1137	66	54	2.61	30	7.713
BPX3MA6660	967	1076	1195	66	60	2.61	32	8.539



**BPX3MV • Monolithic Acoustical Panel with Vertical Wire Channel**

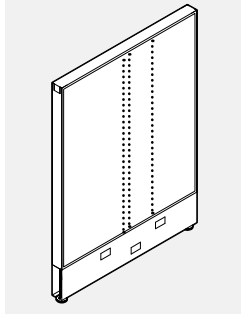

- Provides visual and acoustic privacy and allows for vertical cable passage from top lay-in channel to bottom raceway within panel.
- Centre septum above raceway overlaid on either side with 1 1/8" "Sound absorbent mineral board".
- Acoustic rating of .70 NRC and 25 STC. Includes integrated vertical wire channel.
- OPT\* = Laminate or Whiteboard
- "No Knockouts" option for raceways available at no additional charge. Please choose option for interior and/or exterior raceways.

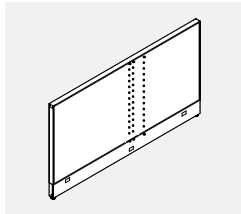

72" Wide

PRODUCT CODE	PRICE			SIZE/ INCHES			WEIGHT VOL	
	GR1	GR2	OPT*	H	W	D	LBS	FT <sup>3</sup>
BPX3MV3430	472	494	518	34	30	2.61	15	2.139
BPX3MV3436	512	553	596	34	36	2.61	17	2.540
BPX3MV3442	552	592	637	34	42	2.61	18	2.941
BPX3MV3448	592	635	677	34	48	2.61	20	3.342
BPX3MV3454	635	674	719	34	54	2.61	22	3.743
BPX3MV3460	672	713	757	34	60	2.61	24	4.144
BPX3MV3466	760	817	881	34	66	2.61	29	4.612
BPX3MV3472	762	820	-	34	72	2.61	34	5.080
BPX3MV4230	519	546	574	42	30	2.61	17	2.852
BPX3MV4236	557	612	671	42	36	2.61	19	3.387
BPX3MV4242	604	660	718	42	42	2.61	21	3.921
BPX3MV4248	641	699	757	42	48	2.61	23	4.456
BPX3MV4254	686	740	800	42	54	2.61	25	4.991
BPX3MV4260	727	783	842	42	60	2.61	27	5.525
BPX3MV4266	803	916	1035	42	66	2.61	32	6.148
BPX3MV4272	872	987	-	42	72	2.61	38	6.770
BPX3MV5030	652	694	737	50	30	2.61	19	3.370
BPX3MV5036	706	790	881	50	36	2.61	22	4.002
BPX3MV5042	757	839	928	50	42	2.61	25	4.634
BPX3MV5048	811	893	983	50	48	2.61	26	5.266
BPX3MV5054	860	943	1032	50	54	2.61	27	5.898
BPX3MV5060	915	997	1086	50	60	2.61	29	6.530
BPX3MV5066	996	1109	1228	50	66	2.61	35	7.265
BPX3MV5072	1076	1189	-	50	72	2.61	40	8.000
BPX3MV5430	681	724	767	54	30	2.61	19	3.907
BPX3MV5436	736	818	908	54	36	2.61	22	4.602
BPX3MV5442	788	869	958	54	42	2.61	25	5.306
BPX3MV5448	842	924	1013	54	48	2.61	26	5.966
BPX3MV5454	893	974	1063	54	54	2.61	27	7.287
BPX3MV5460	947	1030	1119	54	60	2.61	30	7.539
BPX3MV6630	768	838	910	66	30	2.61	22	4.407
BPX3MV6636	820	930	1048	66	36	2.61	26	5.234
BPX3MV6642	879	988	1106	66	42	2.61	28	6.060
BPX3MV6648	932	1042	1161	66	48	2.61	30	6.887
BPX3MV6654	987	1096	1214	66	54	2.61	32	7.713
BPX3MV6660	1042	1152	1268	66	60	2.61	34	8.539

**BPX3MG • Monolithic Glazed Panel**

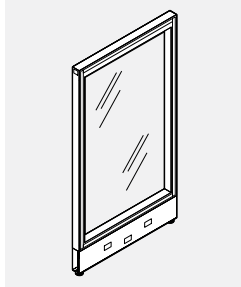

- Full-height glazing provides visual accessibility.
- Glazing is replaceable on site. Tempered clear glass standard.
- Glazing is standard on one side.
- "No Knockouts" option for raceways available at no additional charge. Please choose option for interior and/or exterior raceways.

PRODUCT CODE	PRICE	FRST	SIZE/ INCHES			WEIGHT VOL	
			H	W	D	LBS	FT <sup>3</sup>
BPX3MG5024	872	1049	50	24	2.61	25	2.738
BPX3MG5030	1109	1329	50	30	2.61	29	3.370
BPX3MG5036	1174	1408	50	36	2.61	33	4.002
BPX3MG5042	1239	1488	50	42	2.61	36	4.634
BPX3MG5048	1305	1564	50	48	2.61	41	5.266
BPX3MG5424	930	1115	54	24	2.61	29	3.138
BPX3MG5430	1126	1353	54	30	2.61	34	3.807
BPX3MG5436	1200	1440	54	36	2.61	38	4.602
BPX3MG5442	1272	1527	54	42	2.61	43	5.334
BPX3MG5448	1343	1613	54	48	2.61	48	6.066
BPX3MG6624	1088	1306	66	24	2.61	33	3.581
BPX3MG6630	1181	1417	66	30	2.61	39	4.407
BPX3MG6636	1280	1535	66	36	2.61	44	5.234
BPX3MG6642	1370	1645	66	42	2.61	49	6.060
BPX3MG6648	1462	1756	66	48	2.61	54	6.887

**BPX3PT • Pass-Thru Panel - Fabric Base**

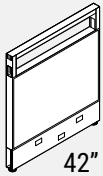

42" High

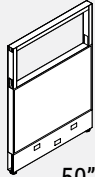

50" High

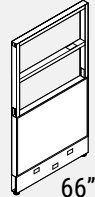

66" High

- Opening allows choice of tile above desk height.
- Solid fabric base up to 34".
- Single 8" opening above 34" for 42" high panels.
- Single 16" opening above 34" for 50" high panels.
- Two individual 16" openings above 34" for 66" high panels.
- Horizontal cable management at 34" height.
- OPT\* = Laminate or Whiteboard.
- "No Knockouts" option for raceways available at no additional charge. Please choose option for interior and/or exterior raceways.

PRODUCT CODE	PRICE			SIZE/ INCHES			WEIGHT VOL	
	GR 1	GR 2	OPT*	H	W	D	LBS	FT <sup>3</sup>
BPX3PT4218	369	397	428	42	18	2.61	14	1.689
BPX3PT4224	418	444	474	42	24	2.61	16	2.233
BPX3PT4230	462	490	521	42	30	2.61	17	2.792
BPX3PT4236	505	532	563	42	36	2.61	19	3.351
BPX3PT4242	550	576	608	42	42	2.61	21	3.908
BPX3PT4248	596	625	656	42	48	2.61	23	4.466
BPX3PT4254	640	669	700	42	54	2.61	26	5.025
BPX3PT4260	684	712	741	42	60	2.61	27	5.592
BPX3PT4266	730	788	851	42	66	2.61	32	6.148
BPX3PT4272	778	835	-	42	72	2.61	38	6.700
BPX3PT5018	369	397	428	50	18	2.61	15	2.106
BPX3PT5024	418	444	474	50	24	2.61	17	2.738
BPX3PT5030	462	490	521	50	30	2.61	18	3.370
BPX3PT5036	505	532	563	50	36	2.61	20	4.002
BPX3PT5042	550	576	608	50	42	2.61	22	4.634
BPX3PT5048	596	625	656	50	48	2.61	24	5.266
BPX3PT5054	640	669	700	50	54	2.61	27	5.898
BPX3PT5060	684	712	741	50	60	2.61	29	6.530
BPX3PT5066	730	788	851	50	66	2.61	34	7.265
BPX3PT5072	778	835	-	50	72	2.61	40	8.000
BPX3PT6618	461	490	520	66	18	2.61	19	2.755
BPX3PT6624	512	541	572	66	24	2.61	21	3.581
BPX3PT6630	569	597	628	66	30	2.61	23	4.407
BPX3PT6636	619	649	677	66	36	2.61	25	5.234
BPX3PT6642	674	703	733	66	42	2.61	27	6.060
BPX3PT6648	732	761	790	66	48	2.61	30	6.887
BPX3PT6654	782	811	840	66	54	2.61	33	7.713
BPX3PT6660	838	867	895	66	60	2.61	36	8.539

**BPX3PV • Pass-Thru Panel with Vertical Wire Channel**

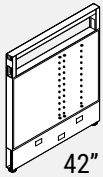

42" High

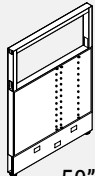

50" High

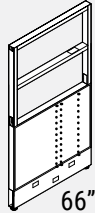

66" High

- Opening allows choice of tile above desk height. Vertical wire channel allows passage of cables from top lay-in channel to bottom raceway within panel.
- Solid fabric base up to 34".
- Single 8" opening above 34" for 42" high panels.
- Single 16" opening above 34" for 50" high panels.
- Two individual 16" openings above 34" for 66" high panels.
- Includes integrated vertical wire channel.
- Horizontal cable management at 34" height.
- OPT\* = Laminate or Whiteboard.
- "No Knockouts" option for raceways available at no additional charge. Please choose option for interior and/or exterior raceways.

PRODUCT CODE	PRICE			SIZE/ INCHES			WEIGHT VOL	
	GR 1	GR 2	OPT*	H	W	D	LBS	FT <sup>3</sup>
BPX3PV4230	505	532	563	42	30	2.61	19	2.792
BPX3PV4236	550	576	608	42	36	2.61	21	3.351
BPX3PV4242	596	625	656	42	42	2.61	23	3.908
BPX3PV4248	640	669	700	42	48	2.61	23	4.466
BPX3PV4254	684	712	741	42	54	2.61	28	5.025
BPX3PV4260	733	761	792	42	60	2.61	30	5.592
BPX3PV4266	769	827	890	42	66	2.61	36	6.148
BPX3PV4272	806	865	-	42	72	2.61	42	6.700
BPX3PV5030	505	532	563	50	30	2.61	20	3.370
BPX3PV5036	550	576	608	50	36	2.61	22	4.002
BPX3PV5042	596	625	656	50	42	2.61	24	4.634
BPX3PV5048	640	669	700	50	48	2.61	26	5.266
BPX3PV5054	684	712	741	50	54	2.61	29	5.898
BPX3PV5060	733	761	792	50	60	2.61	31	6.530
BPX3PV5066	769	827	890	50	66	2.61	37	7.265
BPX3PV5072	806	865	-	50	72	2.61	44	8.000
BPX3PV6630	612	640	671	66	30	2.61	25	4.407
BPX3PV6636	668	697	726	66	36	2.61	27	5.234
BPX3PV6642	719	750	778	66	42	2.61	29	6.060
BPX3PV6648	774	803	832	66	48	2.61	32	6.887
BPX3PV6654	827	857	886	66	54	2.61	35	7.713
BPX3PV6660	882	910	941	66	60	2.61	38	8.539

**BPX3PF • Pass-Tru Panel - Air Flow Base**

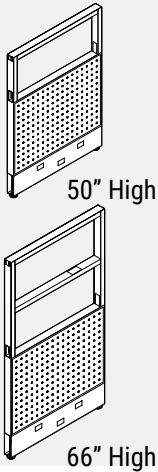

- **Allows air to flow freely through the bottom of the panel.**
- Double wall perforated metal base up to 34".
- Single 16" opening above 34" for 50" high panels.
- Two individual 16" openings above 34" for 66" high panels.
- Horizontal cable management at 34" height.
- "No Knockouts" option for raceways available at no additional charge. Please choose option for interior and/or exterior raceways.

PRODUCT CODE	PRICE	SIZE/ INCHES			WEIGHT VOL	
		H	W	D	LBS	FT <sup>3</sup>
BPX3PF5018	520	50	18	2.61	17	2.106
BPX3PF5024	587	50	24	2.61	18	2.738
BPX3PF5030	653	50	30	2.61	20	3.370
BPX3PF5036	727	50	36	2.61	22	4.002
BPX3PF5042	800	50	42	2.61	23	4.634
BPX3PF5048	869	50	48	2.61	26	5.266
BPX3PF5054	941	50	54	2.61	28	5.898
BPX3PF5060	1008	50	60	2.61	31	6.530
BPX3PF6618	607	66	18	2.61	21	2.755
BPX3PF6624	684	66	24	2.61	23	3.581
BPX3PF6630	768	66	30	2.61	25	4.407
BPX3PF6636	849	66	36	2.61	27	5.234
BPX3PF6642	932	66	42	2.61	29	6.060
BPX3PF6648	1015	66	48	2.61	32	6.887
BPX3PF6654	1096	66	54	2.61	35	7.713
BPX3PF6660	1177	66	60	2.61	37	8.539

**BPX3OP • Over Panel Frame**

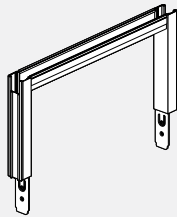

- **Attaches to the top of any Boulevard System 3 panel to create a floor-to-ceiling wall.**
- Any tile can be attached to either side to enclose the frame.
- Two non-slotted uprights at either end slide into vertical extrusions on the base panel.
- Shipped without horizontal and vertical trim; the horizontal trim from the base panel will be used.
- Openings in horizontal channels allow for vertical cable passage from top lay-in channel and behind the cover tiles
- Over Panel Frames 18" and 24" wide are not punched for vertical wire channel.
- Boulevard System 3 Over Panel is not compatible with Boulevard 1 panels.

PRODUCT CODE	PRICE	SIZE/ INCHES			WEIGHT VOL	
		H	W	D	LBS	FT <sup>3</sup>
BPX3OP0818	90	8	18	2.61	3	0.383
BPX3OP0824	99	8	24	2.61	4	0.438
BPX3OP0830	106	8	30	2.61	4	0.656
BPX3OP0836	114	8	36	2.61	4	0.712
BPX3OP0842	127	8	42	2.61	5	0.875
BPX3OP0848	134	8	48	2.61	5	0.930
BPX3OP0854	142	8	54	2.61	6	1.040
BPX3OP0860	151	8	60	2.61	6	1.204
BPX3OP0866	168	8	66	2.61	7	1.310
BPX3OP0872	186	8	72	2.61	8	1.420
BPX3OP1618	90	16	18	2.61	4	0.638
BPX3OP1624	99	16	24	2.61	5	0.730
BPX3OP1630	106	16	30	2.61	5	1.094
BPX3OP1636	114	16	36	2.61	5	1.186
BPX3OP1642	127	16	42	2.61	6	1.459
BPX3OP1648	134	16	48	2.61	6	1.550
BPX3OP1654	142	16	54	2.61	7	1.733
BPX3OP1660	151	16	60	2.61	7	2.006
BPX3OP1666	168	16	66	2.61	9	2.165
BPX3OP1672	186	16	72	2.61	10	2.370

**BPX3GMA • Monolithic Acoustical Panel with Embedded Glass**

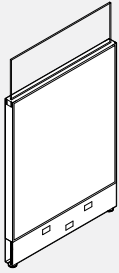

- Provides visual and acoustic privacy.
- Centre septum above raceway overlaid on either side with 1 1/8" "Sound absorbent mineral board".
- Acoustic rating of .70 NRC and 25 STC.
- OPT\* = Laminate or Whiteboard
- B3 panel top trim option provided with embedded, frame-less glass pane rising 8" above the top of the panel. For instance, when installed on 42" high B3 panel, overall height will be 50" high.
- There is 1.25" gap between two adjacent glass panes.
- Glass shipped separately, Allen key to set the glass pane plumb is provided with each panel.
- 6mm tempered glass, frosted or clear.
- Square corners on glass.
- Integrated adjustable brackets and extruded aluminum trim.
- Not retrofitable on-site.
- 16" Glass available as an option, please tag 16" and add the following upcharge per panel size.

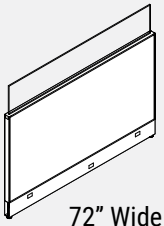

72" Wide

**UPCHARGES FOR 16" GLASS**

PANEL WIDTH	LIST
18	77
24	85
30	90
36	99
42	105
48	111
54	119
60	127
66	132
72	140

PRODUCT CODE	PRICE			SIZE/ INCHES			WEIGHT VOL	
	GR1	GR2	OPT*	H	W	D	LBS	FT <sup>3</sup>
BPX3GMA3418	773	793	816	34	18	2.61	14	1.627
BPX3GMA3424	817	838	859	34	24	2.61	17	2.178
BPX3GMA3430	860	882	903	34	30	2.61	20	2.729
BPX3GMA3436	904	945	991	34	36	2.61	23	3.270
BPX3GMA3442	958	999	1043	34	42	2.61	25	3.791
BPX3GMA3448	1019	1058	1102	34	48	2.61	29	4.302
BPX3GMA3454	1093	1135	1177	34	54	2.61	32	4.853
BPX3GMA3460	1158	1198	1241	34	60	2.61	35	5.404
BPX3GMA3466	1227	1285	1348	34	66	2.61	40	6.022
BPX3GMA3472	1297	1354	-	34	72	2.61	46	6.640
BPX3GMA4218	800	827	857	42	18	2.61	15	2.072
BPX3GMA4224	845	872	903	42	24	2.61	18	2.757
BPX3GMA4230	893	921	949	42	30	2.61	22	3.442
BPX3GMA4236	938	994	1054	42	36	2.61	25	4.117
BPX3GMA4242	996	1052	1110	42	42	2.61	28	4.771
BPX3GMA4248	1058	1114	1173	42	48	2.61	32	5.416
BPX3GMA4254	1135	1190	1250	42	54	2.61	35	6.101
BPX3GMA4260	1199	1254	1313	42	60	2.61	38	6.785
BPX3GMA4266	1299	1412	1531	42	66	2.61	44	7.558
BPX3GMA4272	1396	1509	-	42	72	2.61	50	8.330
BPX3GMA5018	909	949	994	50	18	2.61	16	2.396
BPX3GMA5024	966	1005	1051	50	24	2.61	20	3.178
BPX3GMA5030	1024	1063	1109	50	30	2.61	24	3.960
BPX3GMA5036	1077	1161	1250	50	36	2.61	28	4.732
BPX3GMA5042	1143	1225	1315	50	42	2.61	32	5.484
BPX3GMA5048	1214	1294	1386	50	48	2.61	35	6.226
BPX3GMA5054	1299	1381	1470	50	54	2.61	37	7.008
BPX3GMA5060	1375	1458	1548	50	60	2.61	40	7.790
BPX3GMA5066	1480	1591	1711	50	66	2.61	48	8.675
BPX3GMA5072	1582	1694	-	50	72	2.61	56	9.560
BPX3GMA5418	930	970	1015	54	18	2.61	16	2.704
BPX3GMA5424	987	1029	1071	54	24	2.61	21	3.678
BPX3GMA5430	1047	1086	1132	54	30	2.61	26	4.560
BPX3GMA5436	1101	1183	1272	54	36	2.61	30	5.332
BPX3GMA5442	1168	1251	1339	54	42	2.61	34	7.126
BPX3GMA5448	1238	1320	1409	54	48	2.61	38	7.923
BPX3GMA5454	1326	1406	1496	54	54	2.61	41	8.423
BPX3GMA5460	1401	1484	1573	54	60	2.61	47	9.219
BPX3GMA6618	993	1060	1135	66	18	2.61	17	3.045
BPX3GMA6624	1055	1122	1197	66	24	2.61	22	4.021
BPX3GMA6630	1110	1177	1252	66	30	2.61	27	4.997
BPX3GMA6636	1170	1282	1398	66	36	2.61	32	5.964
BPX3GMA6642	1241	1351	1469	66	42	2.61	35	6.910
BPX3GMA6648	1315	1426	1541	66	48	2.61	39	7.847
BPX3GMA6654	1401	1514	1629	66	54	2.61	42	8.823
BPX3GMA6660	1483	1592	1708	66	60	2.61	45	9.799

**BPX3GMG • Monolithic Glazed Panel with Embedded Glass**

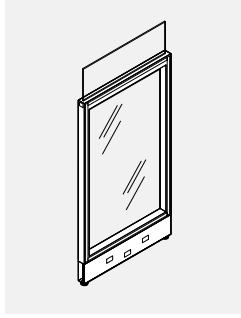

- **Full-height glazing provides visual accessibility.**
- Glazing is replaceable on site. Tempered clear glass standard.
- B3 panel top trim option provided with embedded, frame-less glass pane rising 8" above the top of the panel. For instance, when installed on 42" high B3 panel, overall height will be 50" high.
- There is 1.25" gap between two adjacent glass panes.
- Glass shipped separately, Allen key to set the glass pane plumb is provided with each panel.
- 6mm tempered glass, frosted or clear.
- Square corners on glass.
- Integrated adjustable brackets and extruded aluminum trim.
- Not retrofitable on-site.
- 16" Glass available as an option, please tag 16" and add the following upcharge per panel size.

PRODUCT CODE	PRICE	FRST	SIZE/ INCHES			WEIGHT VOL	
			H	W	D	LBS	FT <sup>3</sup>
BPX3GMG5024	1290	1465	50	24	2.61	30	3.178
BPX3GMG5030	1529	1751	50	30	2.61	36	3.960
BPX3GMG5036	1599	1835	50	36	2.61	41	4.732
BPX3GMG5042	1680	1926	50	42	2.61	45	5.484
BPX3GMG5048	1761	2024	50	48	2.61	52	6.226
BPX3GMG5424	1345	1616	54	24	2.61	32	3.678
BPX3GMG5430	1549	1860	54	30	2.61	40	4.360
BPX3GMG5436	1626	1953	54	36	2.61	46	5.317
BPX3GMG5442	1711	2054	54	42	2.61	52	6.010
BPX3GMG5448	1802	2162	54	48	2.61	56	6.890
BPX3GMG6624	1504	1724	66	24	2.61	38	4.021
BPX3GMG6630	1604	1838	66	30	2.61	46	4.997
BPX3GMG6636	1705	1961	66	36	2.61	52	5.964
BPX3GMG6642	1811	2083	66	42	2.61	58	6.910
BPX3GMG6648	1922	2213	66	48	2.61	65	7.847

**UPCHARGES FOR 16" GLASS**

PANEL WIDTH	LIST
18	77
24	85
30	90
36	99
42	105
48	111
54	119
60	127
66	132
72	140

**BPX3GPT • Pass-Thru Panel with Embedded Glass - Fabric Base**

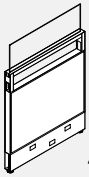

42" High

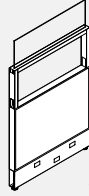

50" High

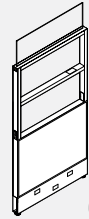

66" High

- Opening allows choice of tile above desk height.
- Solid fabric base up to 34".
- Single 8" opening above 34" for 42" high panels.
- Single 16" opening above 34" for 50" high panels.
- Two individual 16" openings above 34" for 66" high panels.
- Horizontal cable management at 34" height.
- OPT\* = Laminate or Whiteboard.
- B3 panel Top trim option provided with embedded, frame-less glass pane rising 8" above the top of the panel. For instance, when installed on 42" high B3 panel, overall height will be 50" high.
- There is 1.25" gap between two adjacent glass panes.
- Glass shipped separately.
- 6mm tempered glass, frosted or clear.
- Square corners on glass.
- Integrated adjustable brackets and extruded aluminum trim.
- Not retrofittable on-site.
- 16" Glass available as an option, please tag 16" and add the following upcharge per panel size.

PRODUCT CODE	PRICE			SIZE/ H	INCHES			WEIGHT VOL	
	GR 1	GR 2	OPT*		W	D	LBS	FT <sup>3</sup>	
BPX3GPT4218	782	809	840	42	18	2.61	17	1.979	
BPX3GPT4224	835	862	893	42	24	2.61	21	2.673	
BPX3GPT4230	883	910	942	42	30	2.61	24	3.382	
BPX3GPT4236	931	958	991	42	36	2.61	27	4.081	
BPX3GPT4242	988	1016	1048	42	42	2.61	30	4.758	
BPX3GPT4248	1056	1084	1114	42	48	2.61	34	5.426	
BPX3GPT4254	1134	1162	1191	42	54	2.61	38	6.135	
BPX3GPT4260	1200	1228	1260	42	60	2.61	40	6.852	
BPX3GPT4266	1280	1337	1399	42	66	2.61	47	7.556	
BPX3GPT4272	1357	1416	-	42	72	2.61	54	8.260	
BPX3GPT5018	782	809	840	50	18	2.61	18	2.396	
BPX3GPT5024	835	862	893	50	24	2.61	22	3.178	
BPX3GPT5030	883	910	942	50	30	2.61	25	3.960	
BPX3GPT5036	931	958	991	50	36	2.61	28	4.732	
BPX3GPT5042	988	1016	1048	50	42	2.61	31	5.484	
BPX3GPT5048	1056	1084	1114	50	48	2.61	35	6.226	
BPX3GPT5054	1134	1162	1191	50	54	2.61	39	7.008	
BPX3GPT5060	1200	1228	1260	50	60	2.61	42	7.790	
BPX3GPT5066	1280	1337	1399	50	66	2.61	49	8.675	
BPX3GPT5072	1357	1416	-	50	72	2.61	56	9.560	
BPX3GPT6618	871	902	931	66	18	2.61	22	3.045	
BPX3GPT6624	930	958	988	66	24	2.61	26	4.021	
BPX3GPT6630	992	1021	1051	66	30	2.61	30	4.997	
BPX3GPT6636	1047	1075	1104	66	36	2.61	33	5.964	
BPX3GPT6642	1114	1143	1173	66	42	2.61	36	6.910	
BPX3GPT6648	1190	1221	1250	66	48	2.61	41	7.847	
BPX3GPT6654	1274	1304	1332	66	54	2.61	45	8.823	
BPX3GPT6660	1354	1384	1414	66	60	2.61	49	9.799	

**UPCHARGES FOR 16" GLASS**

PANEL WIDTH	LIST
18	77
24	85
30	90
36	99
42	105
48	111
54	119
60	127
66	132
72	140

**BPX3GPV • Pass-Thru Panel with Vertical Wire Channel and Embedded Glass- Fabric Base**

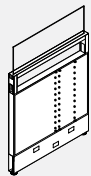

42" High

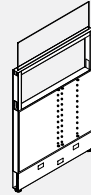

50" High

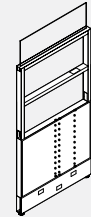

66" High

- Opening allows choice of tile above desk height. Vertical wire channel allows passage of cables from lay-in channel to bottom raceway within panel.
- Solid fabric base up to 34".
- Single 8" opening above 34" for 42" high panels.
- Single 16" opening above 34" for 50" high panels.
- Two individual 16" openings above 34" for 66" high panels.
- Includes integrated vertical wire channel.
- Horizontal cable management at 34" height.
- OPT\* = Laminate or Whiteboard.
- B3 panel Top trim option provided with embedded, frame-less glass pane rising 8" above the top of the panel. For instance, when installed on 42" high B3 panel, overall height will be 50" high.
- There is 1.25" gap between two adjacent glass panes.
- Glass shipped separately, Allen key to set the glass pane plumb is provided with each panel.
- 6mm tempered glass, frosted or clear.
- Square corners on glass.
- Integrated adjustable brackets and extruded aluminum trim.
- Not retrofittable on-site.
- 16" Glass available as an option, please tag 16" and add the following upcharge per panel size.

PRODUCT CODE	PRICE			SIZE/ INCHES			WEIGHT VOL	
	GR 1	GR 2	OPT*	H	W	D	LBS	FT <sup>3</sup>
BPX3GPV4230	927	955	986	42	30	2.61	26	3.382
BPX3GPV4236	974	1003	1033	42	36	2.61	29	4.081
BPX3GPV4242	1035	1063	1095	42	42	2.61	32	4.758
BPX3GPV4248	1099	1126	1159	42	48	2.61	37	5.426
BPX3GPV4254	1175	1202	1233	42	54	2.61	40	6.135
BPX3GPV4260	1251	1279	1309	42	60	2.61	43	6.852
BPX3GPV4266	1318	1375	1439	42	66	2.61	51	7.556
BPX3GPV4272	1388	1444	-	42	72	2.61	58	8.260
BPX3GPV5030	927	955	986	50	30	2.61	27	3.960
BPX3GPV5036	974	1003	1033	50	36	2.61	30	4.732
BPX3GPV5042	1035	1063	1095	50	42	2.61	33	5.484
BPX3GPV5048	1099	1126	1159	50	48	2.61	37	6.226
BPX3GPV5054	1175	1202	1233	50	54	2.61	41	7.008
BPX3GPV5060	1251	1279	1309	50	60	2.61	44	7.790
BPX3GPV5066	1318	1375	1439	50	66	2.61	52	8.675
BPX3GPV5072	1388	1444	-	50	72	2.61	60	9.560
BPX3GPV6630	1033	1062	1092	66	30	2.61	32	4.997
BPX3GPV6636	1093	1122	1152	66	36	2.61	35	5.964
BPX3GPV6642	1159	1188	1218	66	42	2.61	38	6.910
BPX3GPV6648	1232	1262	1290	66	48	2.61	43	7.847
BPX3GPV6654	1318	1349	1376	66	54	2.61	47	8.823
BPX3GPV6660	1398	1428	1456	66	60	2.61	51	9.799

**UPCHARGES FOR 16" GLASS**

PANEL WIDTH	LIST
18	77
24	85
30	90
36	99
42	105
48	111
54	119
60	127
66	132
72	140

**BPX3GPF • Pass-Tru Panel with Embedded Glass - Air Flow Base**

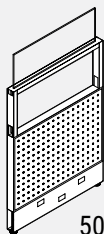

50" High

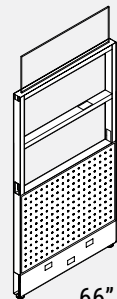

66" High

- Allows air to flow freely through the bottom of the panel.
- Double wall perforated metal base up to 34".
- Single 16" opening above 34" for 50" high panels.
- Two individual 16" openings above 34" for 66" high panels.
- Horizontal cable management at 34" height.
- B3 panel Top trim option provided with embedded, frame-less glass pane rising 8" above the top of the panel. For instance, when installed on 42" high B3 panel, overall height will be 50" high.
- There is 1.25" gap between two adjacent glass panes.
- Glass shipped separately, Allen key to set the glass pane plumb is provided with each panel.
- 6mm tempered glass, frosted or clear.
- Square corners on glass.
- Integrated adjustable brackets and extruded aluminum trim.
- Not retrofittable on-site.
- 16" Glass available as an option, please tag 16" and add the following upcharge per panel size.

PRODUCT CODE	PRICE	SIZE/ INCHES			WEIGHT VOL	
		H	W	D	LBS	FT <sup>3</sup>
BPX3GPF5018	931	50	18	2.61	20	2.396
BPX3GPF5024	1004	50	24	2.61	23	3.178
BPX3GPF5030	1076	50	30	2.61	27	3.960
BPX3GPF5036	1153	50	36	2.61	30	4.732
BPX3GPF5042	1238	50	42	2.61	32	5.484
BPX3GPF5048	1328	50	48	2.61	37	6.226
BPX3GPF5054	1431	50	54	2.61	40	7.008
BPX3GPF5060	1526	50	60	2.61	44	7.790
BPX3GPF6618	1020	66	18	2.61	24	3.045
BPX3GPF6624	1101	66	24	2.61	28	4.021
BPX3GPF6630	1190	66	30	2.61	32	4.997
BPX3GPF6636	1275	66	36	2.61	35	5.964
BPX3GPF6642	1371	66	42	2.61	38	6.910
BPX3GPF6648	1472	66	48	2.61	43	7.847
BPX3GPF6654	1587	66	54	2.61	47	8.823
BPX3GPF6660	1695	66	60	2.61	50	9.799

**UPCHARGES FOR 16" GLASS**

PANEL WIDTH	LIST
18	77
24	85
30	90
36	99
42	105
48	111
54	119
60	127
66	132
72	140

**BPX3GOP • Over Panel Frame with Embedded Glass**

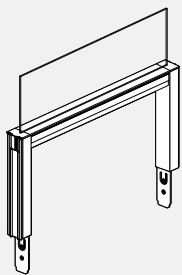

- Attaches to the top of any Boulevard System 3 panel to create a floor-to-ceiling wall.
- Any tile can be attached to either side to enclose the frame.
- Two non-slotted uprights at either end slide into vertical extrusions on the base panel.
- Shipped without horizontal and vertical trim; the horizontal trim from the base panel will be used.
- Boulevard System 3 Over Panel is not compatible with Boulevard 1 panels.
- B3 panel Top trim option provided with embedded, frame-less glass pane rising 8" above the top of the panel. For instance, when installed on 42" high B3 panel, overall height will be 50" high.
- There is 1.25" gap between two adjacent glass panes.
- Glass shipped separately, Allen key to set the glass pane plumb is provided with each panel.
- 5mm tempered glass, frosted or clear.
- Square corners on glass.
- Integrated adjustable brackets and extruded aluminum trim.
- Not retrofittable on-site.
- 16" Glass available as an option, please tag 16" and add the following upcharge per panel size.

PRODUCT CODE	PRICE	SIZE/ INCHES			WEIGHT VOL	
		H	W	D	LBS	FT <sup>3</sup>
BPX3GOP0818	503	8	18	2.61	6	0.673
BPX3GOP0824	518	8	24	2.61	9	0.878
BPX3GOP0830	527	8	30	2.61	11	1.246
BPX3GOP0836	541	8	36	2.61	12	1.442
BPX3GOP0842	564	8	42	2.61	14	1.725
BPX3GOP0848	591	8	48	2.61	16	1.890
BPX3GOP0854	635	8	54	2.61	18	2.150
BPX3GOP0860	668	8	60	2.61	19	2.464
BPX3GOP0866	712	8	66	2.61	22	2.722
BPX3GOP0872	765	8	72	2.61	24	2.980
BPX3GOP1618	503	16	18	2.61	7	0.928
BPX3GOP1624	518	16	24	2.61	10	1.170
BPX3GOP1630	527	16	30	2.61	12	1.684
BPX3GOP1636	541	16	36	2.61	13	1.916
BPX3GOP1642	564	16	42	2.61	15	2.309
BPX3GOP1648	591	16	48	2.61	17	2.510
BPX3GOP1654	635	16	54	2.61	19	2.843
BPX3GOP1660	668	16	60	2.61	20	3.266
BPX3GOP1666	712	16	66	2.61	23	3.598
BPX3GOP1672	765	16	72	2.61	26	3.930

**UPCHARGES FOR 16" GLASS**

PANEL WIDTH	LIST
18	77
24	85
30	90
36	99
42	105
48	111
54	119
60	127
66	132
72	140



**BPX3TMA • Monolithic Acoustical Panel with Embedded Felt Divider**

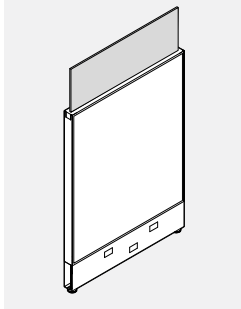

- Provides visual and acoustic privacy
- B3 panel top trim option provided with embedded, frame-less felt panel rising 8" or 16" above the top of the panel. For instance, when installed on 42" high B3 panel, overall height will be 50" high for 8" and 58" high for 16".
- There is 1.25" gap between two adjacent felt panels.
- Felt panel shipped separately.
- 9mm Felt material is tackable and comes in 18 different colours. Please specify colour.
- NOTE: List price shown is for 8" high felt only.

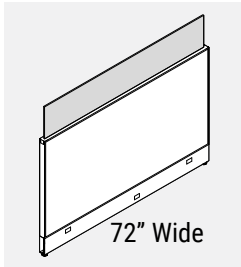

**UPCHARGES FOR 16" FELT**

PANEL WIDTH	LIST
18	24
24	29
30	37
36	45
42	54
48	56
54	61
60	73
66	78
72	86

PRODUCT CODE	PRICE			SIZE/ INCHES			WEIGHT VOL	
	GR1	GR2	OPT*	H	W	D	LBS	FT³
BPX3TMA3418	406	426	447	34	18	2.61	11.9	1.627
BPX3TMA3424	455	473	495	34	24	2.61	14.1	2.178
BPX3TMA3430	502	523	543	34	30	2.61	16.3	2.729
BPX3TMA3436	549	589	629	34	36	2.61	18.5	3.270
BPX3TMA3442	600	639	681	34	42	2.61	19.7	3.791
BPX3TMA3448	647	688	727	34	48	2.61	22.8	4.302
BPX3TMA3454	704	744	787	34	54	2.61	25.0	4.853
BPX3TMA3460	752	792	832	34	60	2.61	27.2	5.404
BPX3TMA3466	799	853	911	34	66	2.61	31.4	6.022
BPX3TMA3472	843	898	-	34	72	2.61	36.6	6.640
BPX3TMA4218	433	460	487	42	18	2.61	12.9	2.072
BPX3TMA4224	510	537	565	42	24	2.61	15.1	2.757
BPX3TMA4230	534	561	589	42	30	2.61	18.3	3.442
BPX3TMA4236	584	635	692	42	36	2.61	20.5	4.117
BPX3TMA4242	636	689	744	42	42	2.61	22.7	4.771
BPX3TMA4248	690	740	799	42	48	2.61	25.8	5.416
BPX3TMA4254	745	799	856	42	54	2.61	28.0	6.101
BPX3TMA4260	794	845	903	42	60	2.61	30.2	6.785
BPX3TMA4266	870	978	1093	42	66	2.61	35.4	7.558
BPX3TMA4272	944	1052	-	42	72	2.61	40.6	8.330
BPX3TMA5018	543	584	625	50	18	2.61	13.9	2.396
BPX3TMA5024	603	641	684	50	24	2.61	17.1	3.178
BPX3TMA5030	666	704	745	50	30	2.61	20.3	3.960
BPX3TMA5036	722	800	883	50	36	2.61	23.5	4.732
BPX3TMA5042	785	864	947	50	42	2.61	26.7	5.484
BPX3TMA5048	843	922	1005	50	48	2.61	28.8	6.226
BPX3TMA5054	909	988	1071	50	54	2.61	30.0	7.008
BPX3TMA5060	970	1049	1133	50	60	2.61	32.2	7.790
BPX3TMA5066	1051	1158	1272	50	66	2.61	39.4	8.675
BPX3TMA5072	1126	1235	-	50	72	2.61	46.6	9.560
BPX3TMA5418	563	628	699	54	18	2.61	13.9	2.704
BPX3TMA5424	624	689	758	54	24	2.61	18.1	3.678
BPX3TMA5430	686	751	821	54	30	2.61	22.3	4.560
BPX3TMA5436	744	850	961	54	36	2.61	25.5	5.332
BPX3TMA5442	807	914	1025	54	42	2.61	28.7	7.126
BPX3TMA5448	868	972	1085	54	48	2.61	31.8	7.923
BPX3TMA5454	934	1038	1152	54	54	2.61	34.0	8.423
BPX3TMA5460	997	1101	1214	54	60	2.61	39.2	9.219
BPX3TMA6618	627	692	762	66	18	2.61	14.9	3.045
BPX3TMA6624	692	757	827	66	24	2.61	19.1	4.021
BPX3TMA6630	752	817	888	66	30	2.61	23.3	4.997
BPX3TMA6636	816	921	1032	66	36	2.61	27.5	5.964
BPX3TMA6642	882	987	1098	66	42	2.61	29.7	6.910
BPX3TMA6648	944	1049	1161	66	48	2.61	32.8	7.847
BPX3TMA6654	1013	1119	1229	66	54	2.61	35.0	8.823
BPX3TMA6660	1077	1184	1294	66	60	2.61	37.2	9.799

**BPX3TMG • Monolithic Glazed Panel with Embedded Felt Divider**

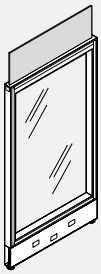

- Full-height glazing provides visual accessibility.
- B3 panel top trim option provided with embedded, frame-less felt panel rising 8" or 16" above the top of the panel. For instance, when installed on 42" high B3 panel, overall height will be 50" high for 8" and 58" high for 16".
- There is 1.25" gap between two adjacent felt panels.
- Felt panel shipped separately.
- 9mm Felt material is tackable and comes in 18 different colours. Please specify colour.
- NOTE: List price shown is for 8" high felt only.

PRODUCT CODE	PRICE	FRST	SIZE/ INCHES			WEIGHT VOL	
			H	W	D	LBS	FT <sup>3</sup>
BPX3TMG5024	928	1101	50	24	2.61	27.1	3.178
BPX3TMG5030	1170	1392	50	30	2.61	32.3	3.960
BPX3TMG5036	1243	1480	50	36	2.61	36.5	4.732
BPX3TMG5042	1320	1568	50	42	2.61	39.7	5.484
BPX3TMG5048	1393	1651	50	48	2.61	45.8	6.226
BPX3TMG5424	985	1169	54	24	2.61	29.1	3.678
BPX3TMG5430	1189	1415	54	30	2.61	36.3	4.360
BPX3TMG5436	1271	1511	54	36	2.61	41.5	5.317
BPX3TMG5442	1352	1606	54	42	2.61	46.7	6.010
BPX3TMG5448	1431	1701	54	48	2.61	49.8	6.890
BPX3TMG6624	1141	1362	66	24	2.61	35.1	4.021
BPX3TMG6630	1242	1480	66	30	2.61	42.3	4.997
BPX3TMG6636	1351	1605	66	36	2.61	47.5	5.964
BPX3TMG6642	1451	1724	66	42	2.61	52.7	6.910
BPX3TMG6648	1552	1843	66	48	2.61	58.8	7.847

**UPCHARGES FOR 16" FELT**

PANEL WIDTH	LIST
18	24
24	29
30	37
36	45
42	54
48	56
54	61
60	73
66	78
72	86

**BPX3TPT • Pass-Thru Panel with Embedded Felt Divider**

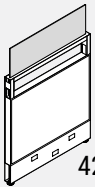

42" High

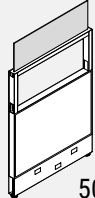

50" High

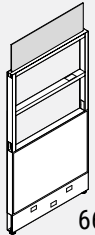

66" High

- Opening allows choice of tile above desk height.
- B3 panel top trim option provided with embedded, frame-less felt panel rising 8" or 16" above the top of the panel. For instance, when installed on 42" high B3 panel, overall height will be 50" high for 8" and 58" high for 16".
- There is 1.25" gap between two adjacent felt panels.
- Felt panel shipped separately.
- 9mm Felt material is tackable and comes in 18 different colours. Please specify colour.
- NOTE: List price shown is for 8" high felt only.

PRODUCT CODE	PRICE			SIZE/ INCHES			WEIGHT VOL	
	GR 1	GR 2	OPT*	H	W	D	LBS	FT <sup>3</sup>
BPX3TPT4218	417	442	471	42	18	2.61	17	1.979
BPX3TPT4224	471	498	527	42	24	2.61	21	2.673
BPX3TPT4230	524	550	578	42	30	2.61	24	3.382
BPX3TPT4236	574	601	630	42	36	2.61	27	4.081
BPX3TPT4242	629	656	686	42	42	2.61	30	4.758
BPX3TPT4248	686	712	740	42	48	2.61	34	5.426
BPX3TPT4254	743	769	800	42	54	2.61	38	6.135
BPX3TPT4260	795	822	851	42	60	2.61	40	6.852
BPX3TPT4266	851	905	966	42	66	2.61	47	7.556
BPX3TPT4272	906	961	-	42	72	2.61	54	8.260
BPX3TPT5018	417	442	471	50	18	2.61	18	2.396
BPX3TPT5024	471	498	527	50	24	2.61	22	3.178
BPX3TPT5030	524	550	578	50	30	2.61	25	3.960
BPX3TPT5036	574	601	630	50	36	2.61	28	4.732
BPX3TPT5042	629	656	686	50	42	2.61	31	5.484
BPX3TPT5048	686	712	740	50	48	2.61	35	6.226
BPX3TPT5054	743	769	800	50	54	2.61	39	7.008
BPX3TPT5060	795	822	851	50	60	2.61	42	7.790
BPX3TPT5066	851	905	966	50	66	2.61	49	8.675
BPX3TPT5072	906	961	-	50	72	2.61	56	9.560
BPX3TPT6618	484	509	539	66	18	2.61	22	3.045
BPX3TPT6624	546	572	601	66	24	2.61	26	4.021
BPX3TPT6630	612	638	668	66	30	2.61	30	4.997
BPX3TPT6636	672	699	727	66	36	2.61	33	5.964
BPX3TPT6642	738	765	794	66	42	2.61	36	6.910
BPX3TPT6648	805	832	862	66	48	2.61	41	7.847
BPX3TPT6654	878	904	933	66	54	2.61	45	8.823
BPX3TPT6660	943	969	998	66	60	2.61	49	9.799

**UPCHARGES FOR 16" FELT**

PANEL WIDTH	LIST
18	24
24	29
30	37
36	45
42	54
48	56
54	61
60	73
66	78
72	86

**BPX3TPV • Pass-Thru Panel with Vertical Wire Channel and Embedded Felt Divider- Fabric Base**

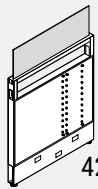

42" High

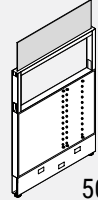

50" High

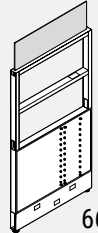

66" High

- Opening allows choice of tile above desk height. Vertical wire channel allows passage of cables from lay-in channel to bottom raceway within panel.
- B3 panel top trim option provided with embedded, frame-less felt panel rising 8" or 16" above the top of the panel. For instance, when installed on 42" high B3 panel, overall height will be 50" high for 8" and 58" high for 16".
- There is 1.25" gap between two adjacent felt panels.
- Felt panel shipped separately.
- 9mm Felt material is tackable and comes in 18 different colours. Please specify colour.
- NOTE: List price shown is for 8" high felt only.

PRODUCT CODE	PRICE			SIZE/ INCHES			WEIGHT VOL	
	GR1	GR2	OPT*	H	W	D	LBS	FT <sup>3</sup>
BPX3TPV4230	567	594	624	42	30	2.61	22.3	3.382
BPX3TPV4236	620	647	675	42	36	2.61	24.5	4.081
BPX3TPV4242	677	703	733	42	42	2.61	26.7	4.758
BPX3TPV4248	729	756	785	42	48	2.61	30.8	5.426
BPX3TPV4254	787	813	842	42	54	2.61	33.0	6.135
BPX3TPV4260	845	871	902	42	60	2.61	35.2	6.852
BPX3TPV4266	890	944	1004	42	66	2.61	42.4	7.556
BPX3TPV4272	935	991	-	42	72	2.61	48.6	8.260
BPX3TPV5030	567	594	624	50	30	2.61	23.3	3.960
BPX3TPV5036	620	647	675	50	36	2.61	25.5	4.732
BPX3TPV5042	677	703	733	50	42	2.61	27.7	5.484
BPX3TPV5048	729	756	785	50	48	2.61	30.8	6.226
BPX3TPV5054	787	813	842	50	54	2.61	34.0	7.008
BPX3TPV5060	845	871	902	50	60	2.61	36.2	7.790
BPX3TPV5066	890	944	1004	50	66	2.61	43.4	8.675
BPX3TPV5072	935	991	-	50	72	2.61	50.6	9.560
BPX3TPV6630	674	701	730	66	30	2.61	28.3	4.997
BPX3TPV6636	738	765	794	66	36	2.61	30.5	5.964
BPX3TPV6642	800	826	856	66	42	2.61	32.7	6.910
BPX3TPV6648	862	889	919	66	48	2.61	36.8	7.847
BPX3TPV6654	930	956	986	66	54	2.61	40.0	8.823
BPX3TPV6660	993	1020	1049	66	60	2.61	43.2	9.799

**UPCHARGES FOR 16" FELT**

PANEL WIDTH	LIST
18	24
24	29
30	37
36	45
42	54
48	56
54	61
60	73
66	78
72	86

**BPX3TPF • Pass-Thru Panel with Embedded Felt Divider - Air Flow Base**

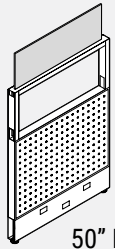

50" High

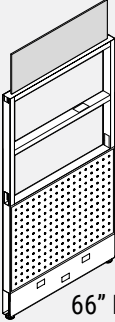

66" High

- Allows air to flow freely through the bottom of the panel.
- B3 panel top trim option provided with embedded, frameless felt panel rising 8" or 16" above the top of the panel. For instance, when installed on 42" high B3 panel, overall height will be 50" high for 8" and 58" high for 16".
- There is 1.25" gap between two adjacent felt panels.
- Felt panel shipped separately.
- 9mm Felt material is tackable and comes in 18 different colours. Please specify colour.
- NOTE: List price shown is for 8" high felt only.

PRODUCT CODE	PRICE	SIZE/ INCHES			WEIGHT VOL	
		H	W	D	LBS	FT <sup>3</sup>
BPX3TPF5018	564	50	18	2.61	17.9	2.396
BPX3TPF5024	640	50	24	2.61	20.1	3.178
BPX3TPF5030	716	50	30	2.61	23.3	3.960
BPX3TPF5036	799	50	36	2.61	25.5	4.732
BPX3TPF5042	879	50	42	2.61	26.7	5.484
BPX3TPF5048	957	50	48	2.61	30.8	6.226
BPX3TPF5054	1042	50	54	2.61	33.0	7.008
BPX3TPF5060	1121	50	60	2.61	36.2	7.790
BPX3TPF6618	653	66	18	2.61	21.9	3.045
BPX3TPF6624	737	66	24	2.61	25.1	4.021
BPX3TPF6630	829	66	30	2.61	28.3	4.997
BPX3TPF6636	921	66	36	2.61	30.5	5.964
BPX3TPF6642	1013	66	42	2.61	32.7	6.910
BPX3TPF6648	1102	66	48	2.61	36.8	7.847
BPX3TPF6654	1199	66	54	2.61	40.0	8.823
BPX3TPF6660	1290	66	60	2.61	42.2	9.799

**UPCHARGES FOR 16" FELT**

PANEL WIDTH	LIST
18	24
24	29
30	37
36	45
42	54
48	56
54	61
60	73
66	78
72	86

**BPX3TOP • Over Panel Frame with Embedded Felt Divider**

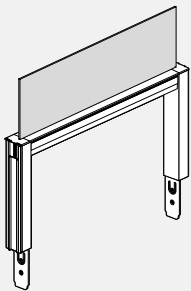

- Attaches to the top of any Boulevard System 3 panel to create a floor-to-ceiling wall
- B3 panel top trim option provided with embedded, frameless felt panel rising 8" or 16" above the top of the panel. For instance, when installed on 42" high B3 panel, overall height will be 50" high for 8" and 58" high for 16".
- There is 1.25" gap between two adjacent felt panels.
- Felt panel shipped separately.
- 9mm Felt material is tackable and comes in 18 different colours. Please specify colour.

PRODUCT CODE	PRICE	SIZE/ INCHES			WEIGHT VOL	
		H	W	D	LBS	FT <sup>3</sup>
BPX3TOP0818	136	8	18	2.61	3.9	0.673
BPX3TOP0824	152	8	24	2.61	6.1	0.878
BPX3TOP0830	168	8	30	2.61	7.3	1.246
BPX3TOP0836	187	8	36	2.61	7.5	1.442
BPX3TOP0842	206	8	42	2.61	8.7	1.725
BPX3TOP0848	222	8	48	2.61	9.8	1.890
BPX3TOP0854	245	8	54	2.61	11.0	2.150
BPX3TOP0860	263	8	60	2.61	11.2	2.464
BPX3TOP0866	290	8	66	2.61	13.4	2.722
BPX3TOP0872	311	8	72	2.61	14.6	2.980
BPX3TOP1618	136	16	18	2.61	4.9	0.928
BPX3TOP1624	152	16	24	2.61	7.1	1.170
BPX3TOP1630	168	16	30	2.61	8.3	1.684
BPX3TOP1636	187	16	36	2.61	8.5	1.916
BPX3TOP1642	206	16	42	2.61	9.7	2.309
BPX3TOP1648	222	16	48	2.61	10.8	2.510
BPX3TOP1654	245	16	54	2.61	12.0	2.843
BPX3TOP1660	263	16	60	2.61	12.2	3.266
BPX3TOP1666	290	16	66	2.61	14.4	3.598
BPX3TOP1672	311	16	72	2.61	16.6	3.930

**UPCHARGES FOR 16" FELT**

PANEL WIDTH	LIST
18	24
24	29
30	37
36	45
42	54
48	56
54	61
60	73
66	78
72	86

**BP3DS • Solid Door Panel**

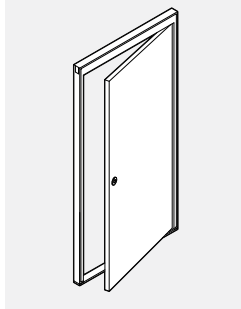

- **Aluminum frame with either high pressure laminate door.**
- 1 3/8" thick hollow core door.
- Actual door size:  
79.9" x 32 1/2" in 82" x 36" frame  
79.9" x 38 1/2" in 82" x 42" frame
- 42" wide Door Panel permits wheelchair accessibility.
- No hang-on capabilities.
- 180 degree swing.
- Specify Door Knob (DL01) or Door Lever (DL02).
- Lock standard.
- Handedness can be changed on site.
- Please specify Right hand (R) or Left hand (L) hung.
- Includes a Horizontal Lay-in Channel.

PRODUCT CODE	PRICE HP	SIZE/ INCHES			WEIGHT VOL	
		H	W	D	LBS	FT <sup>3</sup>
BP3DS8236R	2263	82	36	2.61	61	6.465
BP3DS8242R	2465	82	42	2.61	68	7.486
BP3DS8236L	2263	82	36	2.61	61	6.465
BP3DS8242L	2465	82	42	2.61	68	7.486

**Door Hanging Directions**

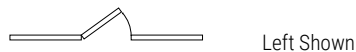
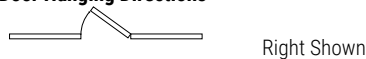

**Door Handle Option**

- Door Knob - DL01
- Lock Standard



- Door Lever - DL02 (Default)

- Lock Standard
- Lever complies with all accessibility standards



**BP3DH • Half Glazed Door Panel**

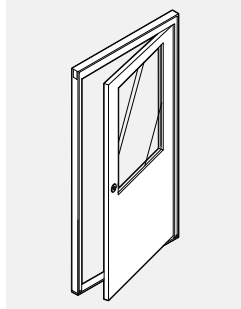

- **Aluminum frame with either high pressure laminate door and window.**
- 1 3/8" thick hollow core door.
- Actual door size:  
79.9" x 32 1/2" in 82" x 36" frame  
79.9" x 38 1/2" in 82" x 42" frame
- 42" wide Door Panel permits wheelchair accessibility.
- No hang-on capabilities.
- 180 degree swing.
- Specify Door Knob (DL01) or Door Lever (DL02).
- Lock standard.
- Handedness can be changed on site.
- Please specify Right hand (R) or Left hand (L) hung.
- For tempered glass option, add "TG" at the end of the product code and add an upcharge of \$145 for 36" wide doors and \$184 for 42" wide doors.
- Includes a Horizontal Lay-in Channel.

PRODUCT CODE	PRICE HP	SIZE/ INCHES			WEIGHT VOL	
		H	W	D	LBS	FT <sup>3</sup>
BP3DH8236R	2807	82	36	2.61	53	6.465
BP3DH8242R	3068	82	42	2.61	59	7.486
BP3DH8236L	2807	82	36	2.61	53	6.465
BP3DH8242L	3068	82	42	2.61	59	7.486

**Door Hanging Directions**



**Door Handle Option**

- Door Knob - DL01
- Lock Standard



- Door Lever - DL02 (Default)

- Lock Standard
- Lever complies with all accessibility standards



**BP3DG • Full Glazed Door Panel**

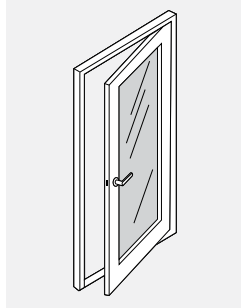

- **Aluminum frame with either high pressure laminate door and window.**
- 1 3/8" thick hollow core door.
- Actual door size:  
79.9" x 32 1/2" in 82" x 36" frame  
79.9" x 38 1/2" in 82" x 42" frame
- 42" wide Door Panel permits wheelchair accessibility.
- No hang-on capabilities.
- 180 degree swing.
- Specify Door Knob (DL01) or Door Lever (DL02).
- Lock standard.
- Handedness can be changed on site.
- Please specify Right hand (R) or Left hand (L) hung.
- For tempered glass option, add "TG" at the end of the product code and add an upcharge of \$293 for 36" wide doors and \$365 for 42" wide doors.
- Includes a Horizontal Lay-in Channel.
- Laminate frame is 5" thick at the sides and 4" at the top and bottom.

PRODUCT CODE	PRICE HP	SIZE/ INCHES			WEIGHT VOL	
		H	W	D	LBS	FT <sup>3</sup>
BP3DG8236R	3227	82	36	2.61	53	6.465
BP3DG8242R	3531	82	42	2.61	59	7.486
BP3DG8236L	3227	82	36	2.61	53	6.465
BP3DG8242L	3531	82	42	2.61	59	7.486

**Door Hanging Directions**

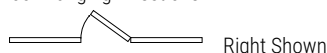

**Door Handle Option**

- Door Knob - DL01
- Lock Standard



- Door Lever - DL02 (Default)

- Lock Standard
- Lever complies with all accessibility standards



**BPX3NET • Removable Face Tile - Electrical Tile Kit**

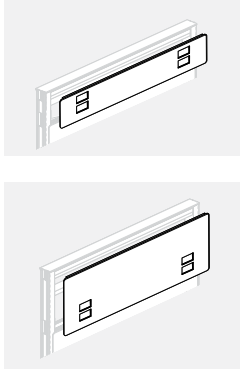

- Attaches to an 8" or 16" opening in a Pass-Thru Panel.
- Fabric covered tile with knock-out for power and data. (Data/Comm blank covers included).
- 24" wide tiles have one duplex and one data/comm opening. 30" and wider tiles have two duplex and two data/comm openings.
- Easily interchangeable on site.
- Provides access to electrical and data at a required location.
- Specify Tile Electrical Kit separately.
- Duplexes and covers must be specified separately.
- For power outlets on both sides of the panel, specify two Electrical Tiles per panel. For power outlets on one side only, specify one Electrical Tile and a Fabric Tile for the opposite side.
- OPT\* = Laminate or Whiteboard.
- For use on panels manufactured after November 1, 2014

PRODUCT CODE	PRICE			SIZE/ H	INCHES			WEIGHT VOL	
	GR 1	GR 2	OPT*		W	D	LBS	FT <sup>3</sup>	
BPX3NET0824	191	204	218	8	24	0.125	2.0	0.170	
BPX3NET0830	215	229	242	8	30	0.125	2.5	0.200	
BPX3NET0836	240	254	268	8	36	0.125	2.5	0.250	
BPX3NET0842	251	262	276	8	42	0.125	2.5	0.292	
BPX3NET0848	255	268	283	8	48	0.125	3.0	0.333	
BPX3NET0854	266	278	294	8	54	0.125	3.0	0.375	
BPX3NET0860	272	286	300	8	60	0.125	4.5	0.417	
BPX3NET0866	303	360	422	8	66	0.125	4.7	0.475	
BPX3NET0872	333	393	-	8	72	0.125	5.0	0.500	
BPX3NET1624	191	204	218	16	24	0.125	2.5	3.400	
BPX3NET1630	215	229	242	16	30	0.125	3.0	0.416	
BPX3NET1636	240	254	268	16	36	0.125	3.0	0.500	
BPX3NET1642	251	262	276	16	42	0.125	3.0	0.583	
BPX3NET1648	255	268	283	16	48	0.125	4.0	0.666	
BPX3NET1654	266	278	294	16	54	0.125	4.0	0.750	
BPX3NET1660	272	286	300	16	60	0.125	5.0	0.833	
BPX3NET1666	303	360	422	16	66	0.125	5.5	0.911	
BPX3NET1672	333	393	-	16	72	0.125	6.0	1.000	

**BP3GT • Removable Face Tile - Glazed**

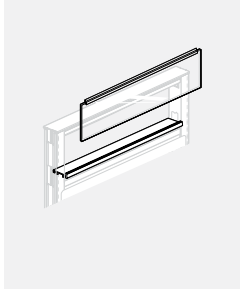

- Attaches to any opening in a Pass-Thru Panel.
- 8" or 16" high glazing provides visual accessibility and light transfer.
- Easily interchangeable on site.
- Specify one Glazed Tile for panel opening of corresponding width.
- Clear tempered glass standard.

PRODUCT CODE	PRICE	FRST	SIZE/ H	INCHES			WEIGHT VOL	
				W	D	LBS	FT <sup>3</sup>	
BP3GT0818	100	120	8	18	2.61	2.3	0.146	
BP3GT0824	112	134	8	24	2.61	3.1	0.165	
BP3GT0830	123	147	8	30	2.61	3.9	0.200	
BP3GT0836	144	173	8	36	2.61	4.7	0.250	
BP3GT0842	168	202	8	42	2.61	5.5	0.292	
BP3GT0848	194	231	8	48	2.61	6.3	0.333	
BP3GT0854	218	262	8	54	2.61	7.1	0.375	
BP3GT0860	242	292	8	60	2.61	7.8	0.417	
BP3GT0866	268	321	8	66	2.61	8.6	0.460	
BP3GT0872	292	352	8	72	2.61	9.4	0.500	
BP3GT1618	106	127	16	18	2.61	4.3	0.292	
BP3GT1624	121	145	16	24	2.61	5.8	0.333	
BP3GT1630	140	167	16	30	2.61	7.2	0.416	
BP3GT1636	169	204	16	36	2.61	8.7	0.500	
BP3GT1642	198	238	16	42	2.61	10.2	0.583	
BP3GT1648	228	272	16	48	2.61	11.6	0.666	
BP3GT1654	256	308	16	54	2.61	13.1	0.750	
BP3GT1660	286	342	16	60	2.61	14.6	0.833	
BP3GT1666	315	361	16	66	2.61	16.0	0.911	
BP3GT1672	342	394	16	72	2.61	17.5	1.000	

**BP3DGT • Removable Face Tile - Double Glazed**

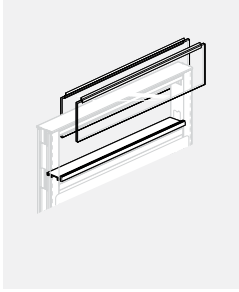

- Attaches to any opening in a Pass-Thru Panel.
- 8" or 16" high glazing provides visual accessibility and light transfer.
- Easily interchangeable on site.
- Specify one Double Glazed Tile for panel opening of corresponding width.
- Clear tempered glass standard.

PRODUCT CODE	PRICE	FRST	SIZE/ INCHES			WEIGHT VOL	
			H	W	D	LBS	FT <sup>3</sup>
BP3DGT0818	185	220	8	18	2.61	6.0	0.292
BP3DGT0824	204	242	8	24	2.61	8.2	0.330
BP3DGT0830	227	268	8	30	2.61	10.4	0.400
BP3DGT0836	276	330	8	36	2.61	12.6	0.500
BP3DGT0842	321	385	8	42	2.61	14.7	0.584
BP3DGT0848	367	443	8	48	2.61	16.9	0.666
BP3DGT0854	417	499	8	54	2.61	19.0	0.750
BP3DGT0860	463	556	8	60	2.61	21.3	0.834
BP3DGT0866	509	611	8	66	2.61	23.4	0.920
BP3DGT0872	556	667	8	72	2.61	25.6	1.000
BP3DGT1618	196	233	16	18	2.61	10.0	0.584
BP3DGT1624	209	252	16	24	2.61	13.6	0.666
BP3DGT1630	266	318	16	30	2.61	17.1	0.832
BP3DGT1636	323	387	16	36	2.61	20.6	1.000
BP3DGT1642	377	451	16	42	2.61	24.1	1.166
BP3DGT1648	433	520	16	48	2.61	27.7	1.322
BP3DGT1654	488	586	16	54	2.61	31.2	1.500
BP3DGT1660	545	652	16	60	2.61	34.7	1.666
BP3DGT1666	600	690	16	66	2.61	38.2	1.822
BP3DGT1672	652	751	16	72	2.61	41.7	2.000

**BP30T • Removable Face Tile - Open Pass-Thru Kit**

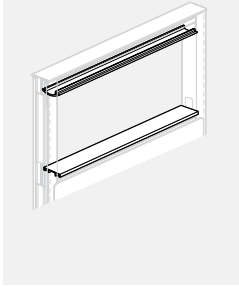

- Attaches to any opening in a Pass-Thru Panel.
- Trims and internal corners included to create an opening.
- Easily interchangeable on site.
- Specify one Pass-Thru Kit for panel opening of corresponding width.
- Kit works for 8" & 16" openings.
- Please specify panel frame colour.

PRODUCT CODE	PRICE	SIZE/ H	INCHES		WEIGHT VOL	
			W	D	LBS	FT <sup>3</sup>
BP30T1618	18	16	18	2.61	0.4	0.292
BP30T1624	21	16	24	2.61	0.6	0.333
BP30T1630	26	16	30	2.61	0.8	0.416
BP30T1636	30	16	36	2.61	1.0	0.500
BP30T1642	34	16	42	2.61	1.1	0.583
BP30T1648	40	16	48	2.61	1.3	0.666
BP30T1654	44	16	54	2.61	1.5	0.750
BP30T1660	47	16	60	2.61	1.7	0.833
BP30T1666	52	16	66	2.61	1.9	0.911
BP30T1672	54	16	72	2.61	2.0	1.000

**BP3AT • Removable Face Tile - Accessory**

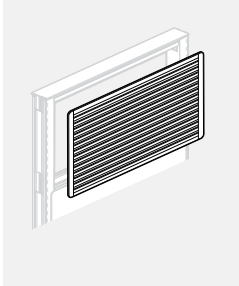

- Attaches to any opening in a Pass-Thru Panel.
- Provides support for accessories.
- Easily interchangeable on site.
- Two tile clips included.
- Specify two tiles per panel opening of corresponding width. Tiles can be combined. For example, Fabric Tile on one side and Accessory Tile on the opposite side of the same panel.
- Accessory Tile cannot be installed opposite an electrical tile.

PRODUCT CODE	PRICE	SIZE/ H	INCHES		WEIGHT VOL	
			W	D	LBS	FT <sup>3</sup>
BP3AT0818	94	08	18	0.25	1.7	0.146
BP3AT0824	112	08	24	0.25	2.3	0.167
BP3AT0830	123	08	30	0.25	2.9	0.208
BP3AT0836	145	08	36	0.25	3.5	0.250
BP3AT0842	175	08	42	0.25	4.1	0.292
BP3AT0848	205	08	48	0.25	4.7	0.333
BP3AT0854	220	08	54	0.25	5.3	0.375
BP3AT0860	251	08	60	0.25	5.9	0.417
BP3AT0866	271	08	66	0.25	6.5	0.459
BP3AT0872	294	08	72	0.25	7.0	0.500
BP3AT1618	111	16	18	0.25	3.5	0.292
BP3AT1624	134	16	24	0.25	4.7	0.333
BP3AT1630	143	16	30	0.25	5.7	0.416
BP3AT1636	173	16	36	0.25	7.0	0.500
BP3AT1642	205	16	42	0.25	8.2	0.583
BP3AT1648	238	16	48	0.25	9.4	0.666
BP3AT1654	257	16	54	0.25	10.6	0.750
BP3AT1660	295	16	60	0.25	11.9	0.833
BP3AT1666	326	16	66	0.25	13.0	0.916
BP3AT1672	355	16	72	0.25	14.0	1.000

**BP3FT • Removable Face Tile - Fabric**

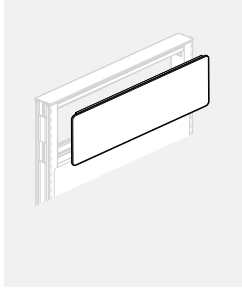

- Attaches to any opening in a Pass-Thru Panel.
- Tile clips included.
- Easily interchangeable on site.
- Specify two tiles per panel opening of corresponding width. Tiles can be combined. For example, Fabric Tile on one side and Accessory Tile on the opposite side of the same panel.
- OPT\* = Laminate or Whiteboard.

PRODUCT CODE	PRICE			SIZE/ H	INCHES			WEIGHT VOL	
	GR 1	GR 2	OPT*		W	D	LBS	FT <sup>3</sup>	
BP3FT0818	89	97	105	8	18	0.25	1	0.146	
BP3FT0824	94	103	110	8	24	0.25	1	0.165	
BP3FT0830	103	114	130	8	30	0.25	2	0.200	
BP3FT0836	127	140	154	8	36	0.25	2	0.250	
BP3FT0842	135	147	164	8	42	0.25	2	0.292	
BP3FT0848	141	154	168	8	48	0.25	3	0.333	
BP3FT0854	149	164	176	8	54	0.25	3	0.375	
BP3FT0860	154	167	182	8	60	0.25	4	0.417	
BP3FT0866	175	232	296	8	66	0.25	4	0.460	
BP3FT0872	226	298	-	8	72	0.25	4	0.500	
BP3FT1618	100	107	113	16	18	0.25	2	0.292	
BP3FT1624	106	112	120	16	24	0.25	2	0.333	
BP3FT1630	113	128	142	16	30	0.25	3	0.416	
BP3FT1636	140	152	167	16	36	0.25	3	0.500	
BP3FT1642	149	164	176	16	42	0.25	3	0.583	
BP3FT1648	156	169	186	16	48	0.25	4	0.666	
BP3FT1654	165	176	193	16	54	0.25	4	0.750	
BP3FT1660	182	240	199	16	60	0.25	5	0.833	
BP3FT1666	199	256	319	16	66	0.25	5	0.920	
BP3FT1672	246	326	-	16	72	0.25	6	1.000	

**BP3OPFA • Fabric Over Panel**

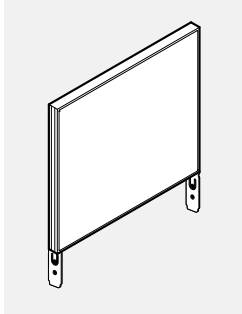

- Attaches to top of a panel to create floor-to-ceiling wall.
- Centre septum overlaid on either side with 1 1/8" "Sound absorbent mineral board".
- Non-slotted.
- Exact height should be specified when ordering, with allowance of at least 1" of free space between over panel and ceiling to accommodate height variations in ceiling and floor. Can be any height from 4.4" minimum to 15.9" maximum. Please tag exact height required.
- Runs of over panels should be captured at either end with full height posts, wall adapters, taller panels, and/or vertical trims.
- OPT\* = Laminate or Whiteboard.

PRODUCT CODE	PRICE			SIZE/ H	INCHES			WEIGHT VOL	
	GR 1	GR 2	OPT*		W	D	LBS	FT <sup>3</sup>	
BP3OPFA18	234	251	263	16	18	2.61	8	0.730	
BP3OPFA24	266	278	294	16	24	2.61	8	0.730	
BP3OPFA30	304	318	332	16	30	2.61	10	0.912	
BP3OPFA36	343	358	372	16	36	2.61	12	1.094	
BP3OPFA42	374	387	403	16	42	2.61	12	1.094	
BP3OPFA48	413	426	441	16	48	2.61	14	1.277	
BP3OPFA54	451	466	480	16	54	2.61	14	1.277	
BP3OPFA60	481	495	508	16	60	2.61	15	1.368	

**BP3OPFV • Fabric Over Panel with Vertical Wire Channel**

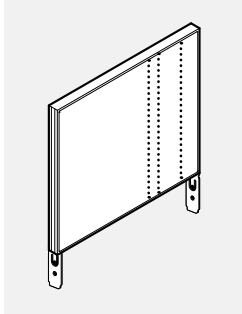

- Attaches to top of a panel to create floor-to-ceiling wall.
- Centre septum overlaid on either side with 1" sound absorbent mineral board.
- Non-slotted.
- Exact height should be specified when ordering, with allowance of at least 1" of free space between over panel and ceiling to accommodate height variations in ceiling and floor. Can be any height from 4.4" minimum to 15.9" maximum. Please tag exact height required.
- Runs of over panels should be captured at either end with full height posts, wall adapters, taller panels, and/or vertical trims.
- OPT\* = Laminate or Whiteboard.

PRODUCT CODE	PRICE			SIZE/ H	INCHES			WEIGHT VOL	
	GR 1	GR 2	OPT*		W	D	LBS	FT <sup>3</sup>	
BP3OPFV18	278	292	305	16	18	2.61	8	0.73	
BP3OPFV24	308	321	334	16	24	2.61	8	0.73	
BP3OPFV30	345	360	374	16	30	2.61	10	0.912	
BP3OPFV36	386	399	414	16	36	2.61	12	1.094	
BP3OPFV42	418	430	444	16	42	2.61	12	1.094	
BP3OPFV48	457	469	484	16	48	2.61	14	1.277	
BP3OPFV54	495	507	524	16	54	2.61	14	1.277	
BP3OPFV60	524	535	551	16	60	2.61	15	1.368	



**BA3PAS • Glass Over Panel with Round Pucks for System 3**

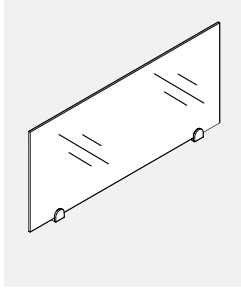

- **Glass Over Panel creates division.**
- Glass Over Panel with no frame sits on top of a System 3 Panel with clamps that are secured to the top of the panel.
- Tempered glass is 16" high.
- Custom sizes available, contact your Customer Service Representative.
- For application where the over panel is sandwiched between two taller panels, please request a special as the glass will not fit due to trims.

PRODUCT CODE	PRICE CLR	FRST	SIZE/ H	INCHES W	D	WEIGHT LBS	VOL FT <sup>3</sup>
BA3PAS0824	198	228	8	24	1.3	4	0.22
BA3PAS0830	222	254	8	30	1.3	5	0.30
BA3PAS0836	234	275	8	36	1.3	6	0.37
BA3PAS0842	254	297	8	42	1.3	7	0.43
BA3PAS0848	273	314	8	48	1.3	8	0.48
BA3PAS1624	212	241	16	24	1.3	8	0.44
BA3PAS1630	234	268	16	30	1.3	10	0.59
BA3PAS1636	252	290	16	36	1.3	12	0.73
BA3PAS1642	268	311	16	42	1.3	14	0.85
BA3PAS1648	273	329	16	48	1.3	16	0.96

**BA3PASS • Glass Over Panel with Square Pucks for System 3**

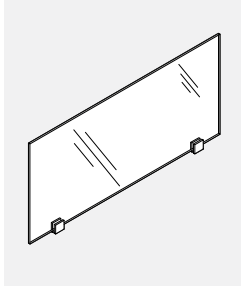

- **Glass Over Panel creates division.**
- Glass Over Panel with no frame sits on top of a System 3 Panel with clamps that are secured to the top of the panel.
- Tempered glass is 16" high.
- Custom sizes available, contact your Customer Service Representative.
- For application where the over panel is sandwiched between two taller panels, please request a special as the glass will not fit due to trims.

PRODUCT CODE	PRICE CLR	FRST	SIZE/ H	INCHES W	D	WEIGHT LBS	VOL FT <sup>3</sup>
BA3PASS0824	212	241	8	24	1.3	4	0.22
BA3PASS0830	234	268	8	30	1.3	5	0.30
BA3PASS0836	254	290	8	36	1.3	6	0.37
BA3PASS0842	268	311	8	42	1.3	7	0.43
BA3PASS0848	289	329	8	48	1.3	8	0.48
BA3PASS1624	228	256	16	24	1.3	8	0.44
BA3PASS1630	252	283	16	30	1.3	10	0.59
BA3PASS1636	266	304	16	36	1.3	12	0.73
BA3PASS1642	283	328	16	42	1.3	14	0.85
BA3PASS1648	290	342	16	48	1.3	16	0.96

**BPMB • Raceway Cover Caps**

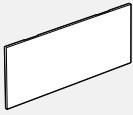

- To provide clean detail for the punch-outs of a raceway cover when the punch-outs are not in use. Order only when required.
- Made of injection molded ABS.
- B = Black
- G = Grey
- W = White

PRODUCT CODE	PRICE	SIZE/ INCHES			WEIGHT VOL	
		H	W	D	LBS	FT <sup>3</sup>
BPMB020104B	9	1.5	3	0.125	0.04	0.02
BPMB020104G	9	1.5	3	0.125	0.04	0.02
BPMB020104W	9	1.5	3	0.125	0.04	0.02

**BH3PS • 90 Degree Post**



- Enables connection for multiple panel runs such as 90°, 3 way and 4 way.
- Includes 2 "Capture Strip" panel connectors, 4 end strips, 2 pairs of raceway end caps, and 1 post cap.
- Posts are designed to accept the following:
  - 75 cables 5.6mm (0.220") diameter
  - 60 ccables 5.6mm (0.220") diameter with 1 power feed
  - 45 cables 5.6mm (0.220") diameter with 2 power feeds

PRODUCT CODE	PRICE	SIZE/ INCHES			WEIGHT VOL	
		H	W	D	LBS	FT <sup>3</sup>
BH3PS034	122	27	2.61	2.61	4	0.14
BH3PS042	134	35	2.61	2.61	5	0.18
BH3PS050	151	43	2.61	2.61	7	0.22
BH3PS054	169	47	2.61	2.61	7	0.27
BH3PS058	174	51	2.61	2.61	8	0.29
BH3PS066	182	59	2.61	2.61	8	0.31

**BH3PS45 • 45 Degree Post**



- Enables connection for two panels at 45°.
- Includes 2 "Capture Strip" panel connectors and 1 post cap.
- 45 degree post does not accept End Trim.
- No power infeed capabilities.
- Posts are designed to accept the following:
  - 30 cables 5.6mm (0.220") diameter

PRODUCT CODE	PRICE	SIZE/ INCHES			WEIGHT VOL	
		H	W	D	LBS	FT <sup>3</sup>
BH3PS45034	122	27	2.61	2.61	4	0.14
BH3PS45042	134	35	2.61	2.61	5	0.18
BH3PS45050	151	43	2.61	2.61	7	0.22
BH3PS45054	169	47	2.61	2.61	7	0.27
BH3PS45058	174	51	2.61	2.61	8	0.29
BH3PS45066	182	59	2.61	2.61	8	0.31

**BH3PS60 • 60 Degree Post**



- Enables connection for multiple panel runs such as 120° and 3 way.
- Includes 2 "Capture Strip" panel connectors and 1 post cap.
- No power infeed capabilities.
- Posts are designed to accept the following:
  - 35 cables 5.6mm (0.220") diameter

PRODUCT CODE	PRICE	SIZE/ INCHES			WEIGHT VOL	
		H	W	D	LBS	FT <sup>3</sup>
BH3PS60034	122	27	2.61	2.61	4	0.14
BH3PS60042	134	35	2.61	2.61	5	0.18
BH3PS60050	151	43	2.61	2.61	7	0.22
BH3PS60054	169	47	2.61	2.61	7	0.27
BH3PS60058	174	51	2.61	2.61	8	0.29
BH3PS60066	182	59	2.61	2.61	8	0.31

**BH3PE • Post Extension for Over Panels**



- Provides route for ceiling data or electrical cables through the post to the panel.
- Includes 2 "Capture Strip" panel connectors.

PRODUCT CODE	PRICE	SIZE/ INCHES			WEIGHT VOL	
		H	W	D	LBS	FT <sup>3</sup>
BH3PE008	29	8	2.61	2.61	1	0.03
BH3PE016	52	16	2.61	2.61	2	0.07
BH3PE032	76	32	2.61	2.61	4	0.14
BH3PE45016	52	16	2.61	2.61	2	0.07
BH3PE45032	76	32	2.61	2.61	4	0.14
BH3PE60016	52	16	2.61	2.61	2	0.07
BH3PE60032	76	32	2.61	2.61	4	0.14

**BH3PA • Off-Module Connector (Panel to Panel Adapter)**

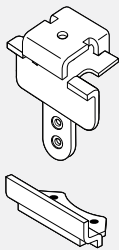

- Connects Boulevard System 3 panel to another perpendicular Boulevard System 3 Monolithic Panel off-module.
- Top and bottom brackets bolt to panel vertical of one panel and engage to top and bottom "fabric" edges of adjacent, perpendicular Monolithic Panel of even height.
- While connecting tile panel to Monolithic Panel is possible, never attempt to secure Off-Module Connectors to a tile panel.
- Once an off-module panel is secure to Monolithic Panel spine with Off-Module Connecting Kit, the raceway on the spine panel cannot be accessed and can only be opened from the opposite side.
- Special top trim required, provide application to your Customer Service Representative.
- This connector is not a load-bearing connection.
- Not to be used on the panel seam, with over panels or laminate and metal faced panels.

PRODUCT CODE	PRICE	SIZE/ INCHES			WEIGHT VOL	
		H	W	D	LBS	FT <sup>3</sup>
BH3PA02	90	3.5			0.5	0.035

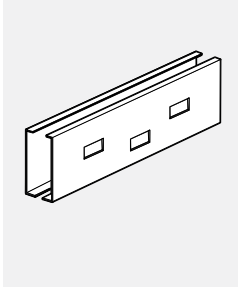
**RCX3WMP2 • Raceway Cover with Punchouts Both Sides**

- **Metal raceway organizes cables at the base.**
- Snaps directly into the base of the panel.
- When opened, cover's side rests on the floor, providing unobstructed access to data/power installation.
- 18" Raceway Covers do not have power and data/communication punch-outs.
- 24" Raceway covers have electrical and one data opening.
- Data opening sizing is as follows: 1.38" x 2.71".
- Comes standard with all System 3 panels.
- "No Knockouts" option for raceways available at no additional charge. Please choose option for interior and/or exterior raceways.

PRODUCT CODE	PRICE	SIZE/ INCHES			WEIGHT VOL	
		H	W	D	LBS	FT <sup>3</sup>
RCX3WM24P2	61	5.62	24	2.61	3.3	0.21
RCX3WM30P2	66	5.62	30	2.61	4.1	0.26
RCX3WM36P2	76	5.62	36	2.61	4.9	0.31
RCX3WM42P2	87	5.62	42	2.61	5.7	0.36
RCX3WM48P2	92	5.62	48	2.61	6.6	0.42
RCX3WM54P2	101	5.62	54	2.61	7.4	0.47
RCX3WM60P2	110	5.62	60	2.61	8.3	0.52
RCX3WM66P2	114	5.62	66	2.61	9.1	0.57
RCX3WM72P2	123	5.62	72	2.61	9.8	0.62

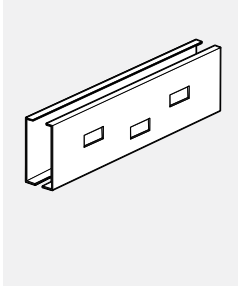
**RCX3WMP1 • Raceway Cover with Punchouts One Side, None Other Side**

- **Metal raceway organizes cables at the base.**
- Snaps directly into the base of the panel.
- When opened, cover's side rests on the floor, providing unobstructed access to data/power installation.
- 18" Raceway Covers do not have power and data/communication punch-outs.
- 24" Raceway covers have electrical and one data opening.
- Data opening sizing is as follows: 1.38" x 2.71".
- Comes standard with all System 3 panels.
- "No Knockouts" option for raceways available at no additional charge. Please choose option for interior and/or exterior raceways.

PRODUCT CODE	PRICE	SIZE/ INCHES			WEIGHT VOL	
		H	W	D	LBS	FT <sup>3</sup>
RCX3WM24P1	61	5.62	24	2.61	3.3	0.21
RCX3WM30P1	66	5.62	30	2.61	4.1	0.26
RCX3WM36P1	76	5.62	36	2.61	4.9	0.31
RCX3WM42P1	87	5.62	42	2.61	5.7	0.36
RCX3WM48P1	92	5.62	48	2.61	6.6	0.42
RCX3WM54P1	101	5.62	54	2.61	7.4	0.47
RCX3WM60P1	110	5.62	60	2.61	8.3	0.52
RCX3WM66P1	114	5.62	66	2.61	9.1	0.57
RCX3WM72P1	123	5.62	72	2.61	9.8	0.62

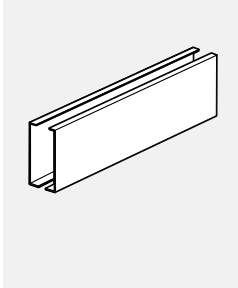
**RCX3WMNP • Raceway Cover with No Punchouts Both Sides**

- **Metal raceway organizes cables at the base.**
- Snaps directly into the base of the panel.
- When opened, cover's side rests on the floor, providing unobstructed access to data/power installation.

PRODUCT CODE	PRICE	SIZE/ INCHES			WEIGHT VOL	
		H	W	D	LBS	FT <sup>3</sup>
RCX3WM18NP	54	5.62	18	2.61	2.4	0.16
RCX3WM24NP	61	5.62	24	2.61	3.3	0.21
RCX3WM30NP	66	5.62	30	2.61	4.1	0.26
RCX3WM36NP	76	5.62	36	2.61	4.9	0.31
RCX3WM42NP	87	5.62	42	2.61	5.7	0.36
RCX3WM48NP	92	5.62	48	2.61	6.6	0.42
RCX3WM54NP	101	5.62	54	2.61	7.4	0.47
RCX3WM60NP	110	5.62	60	2.61	8.3	0.52
RCX3WM66NP	114	5.62	66	2.61	9.1	0.57
RCX3WM72NP	123	5.62	72	2.61	9.8	0.62

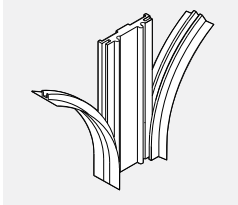
**B3HWA • Wall Adapter**

- **Starts a run of panels off an existing wall.**
- Includes 2 "Capture Strip" panel connectors and 1 pair of raceway end caps.
- Mounting hardware not included.
- Mounting hardware selection should be based on wall or wall stud material.
- Wall Adapter adds 5/16" to a panels run.

PRODUCT CODE	PRICE	SIZE/ INCHES			WEIGHT VOL	
		H	W	D	LBS	FT <sup>3</sup>
B3HWA034	59	34	2.61	0.375	2	0.011
B3HWA042	62	42	2.61	0.375	3	0.015
B3HWA050	66	50	2.61	0.375	3	0.018
B3HWA054	72	54	2.61	0.375	3	0.020
B3HWA058	76	58	2.61	0.375	4	0.021
B3HWA066	78	66	2.61	0.375	4	0.021

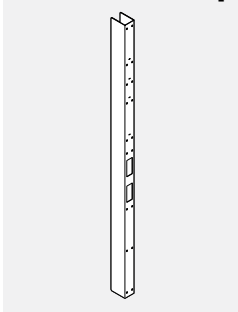
**BHWASL • Adapter Sleeve**

- **Wall Adapter Sleeve is attached to the building to provide flexible support to a panel run.**
- As opposed to the BHWA wall adapter, which connects to the panels rigidly to a wall, B1 and B3 Boulevard panels rest inside of the vertical "U" channel, providing up to 3.5" of flexible adjustment.
- For panel runs taller than 66" order two Wall Adapter Sleeves and either have it cut short on the site below ceiling, or cut a rectangular hole in the ceiling tile. Rectangular slots in the Channels correspond to 66", 58", 54", 50" and 42" high B1 and B3 panels.
- Powder coated steel; specify metal finish.
- Note: the Wall Adapter Sleeve provides flexible, non-structural connection, blocks vertical 1" increment clots and cannot, therefore, be used to support overheads and worksurfaces, they must be supported by perpendicular panels, c-legs or gables.
- Note: no fasteners are provided with the Wall Adapter Sleeve. Select the appropriate fasteners according to a structurally sound connection.
- Cannot be used to support a door or panel and cannot be used with laminate, airflow or metal skin panels.

PRODUCT CODE	PRICE	SIZE/ INCHES			WEIGHT VOL	
		H	W	D	LBS	FT <sup>3</sup>
BHWASL42	145	34.7	4	2	2.5	0.161
BHWASL50	157	42.7	4	2	3.6	0.148
BHWASL54	165	46.7	4	2	4.2	0.216
BHWASL58	169	52.7	4	2	5.1	0.244
BHWASL66	182	58.7	4	2	6.0	0.272

**BH3CS • Capture Strip Slot Cover**

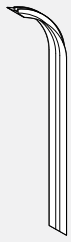

- An extruded PVC channel to adjoin two panels or a panel to a post. Runs the full length of the panel on both sides providing a positive connection of the "Knuckle-Loc" design.
- Priced per pair.
- Pliable side membranes cover panel slots.
- Included with panel components.
- Only to be ordered separately if required.

PRODUCT CODE	PRICE	SIZE/ INCHES		WEIGHT VOL	
		H		LBS	FT <sup>3</sup>
BH3CS34	12	37		0.24	0.11
BH3CS42	12	42		0.28	0.13
BH3CS50	13	50		0.33	0.15
BH3CS54	13	54		0.31	0.17
BH3CS66	20	66		0.4	0.19

**BH3CE • End Strip Slot Cover**

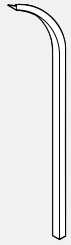

- End strips with pliable side membrane covers panel slots at end of run.
- Priced per pair.
- Included with panel components.
- Only to be ordered separately if required.

PRODUCT CODE	PRICE	SIZE/ INCHES		WEIGHT VOL	
		H		LBS	FT <sup>3</sup>
BH3CE34	11	37		0.12	0.05
BH3CE42	11	42		0.14	0.06
BH3CE50	12	50		0.16	0.07
BH3CE54	12	54		0.31	0.08
BH3CE66	13	66		0.20	0.09

**BA3VTR • Vertical Aluminum End Trim**

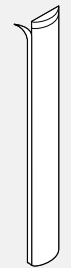

- Finishes the vertical edges of panels and posts (90 and 60 degree).
- In the case of the panel, the trim runs from the top of the panel to the bottom of the raceway, enclosing the horizontal channel openings and the raceway opening.
- In the case of the Over Panel, the trim runs from the top of the Over Panel to the bottom of the Over Panel, enclosing the horizontal channel openings.

PRODUCT CODE	PRICE	TYPE	SIZE/ INCHES			WEIGHT VOL	
			H	W	D	LBS	FT <sup>3</sup>
BA3VTR34	37	REGULAR PANEL	34	2.61	0.25	1.1	0.03
BA3VTR42	45		42	2.61	0.25	1.4	0.03
BA3VTR50	54		50	2.61	0.25	1.7	0.04
BA3VTR54	62		54	2.61	0.25	1.9	0.04
BA3VTR58	65		58	2.61	0.25	2.1	0.05
BA3VTR66	73		66	2.61	0.25	2.2	0.05
BA3VTE16	23	OVER PANEL	16	2.61	0.25	0.5	0.03
BA3VTE32	37		32	2.61	0.25	1.1	0.06

**BA3VTS • Vertical Aluminum End Trim Standard Step Down**

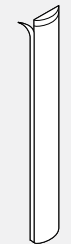

- Finishes the vertical edges of panels and posts (90 and 60 degree).
- Trims run from the top of one panel to the top of lower panel enclosing the horizontal channel opening.

PRODUCT CODE	PRICE	SIZE/ INCHES			WEIGHT VOL	
		H	W	D	LBS	FT <sup>3</sup>
BA3VTS04	11	4	2.61	0.25	0.2	0.010
BA3VTS08	13	8	2.61	0.25	0.3	0.015
BA3VTS12	20	12	2.61	0.25	0.4	0.022
BA3VTS16	23	16	2.61	0.25	0.5	0.030
BA3VTS20	28	20	2.61	0.25	0.7	0.039
BA3VTS24	30	24	2.61	0.25	0.9	0.045
BA3VTS32	37	32	2.61	0.25	1.1	0.060

**BV3VTR • Vertical PVC End Trim**

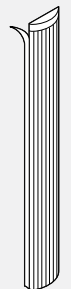

- Finishes the vertical edges of panels and posts (90 and 60 degree).
- In the case of the panel, the trim runs from the top of the panel to the bottom of the raceway, enclosing the horizontal channel openings and the raceway opening.
- In the case of the over panel, the trim runs from the top of the over panel to the bottom of the over panel, enclosing the horizontal channel openings.

PRODUCT CODE	PRICE	TYPE	SIZE/ INCHES			WEIGHT VOL	
			H	W	D	LBS	FT <sup>3</sup>
BV3VTR34	28	REGULAR PANEL	34	2.61	0.25	0.6	0.030
BV3VTR42	29		42	2.61	0.25	0.7	0.030
BV3VTR50	34		50	2.61	0.25	0.9	0.040
BV3VTR54	36		54	2.61	0.25	1.0	0.045
BV3VTR58	39		58	2.61	0.25	1.0	0.047
BV3VTR66	42		66	2.61	0.25	1.1	0.050
BV3VTE16	21	OVER PANEL	16	2.61	0.25	0.3	0.030
BV3VTE32	28		32	2.61	0.25	0.6	0.060

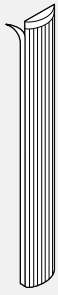
**BV3VTS • Vertical PVC End Trim Standard Step Down**

- Finishes the vertical edges of panels and posts (90 and 60 degree).
- Trims run from the top of one panel to the top of lower panel enclosing the horizontal channel opening.

PRODUCT CODE	PRICE	SIZE/ INCHES			WEIGHT VOL	
		H	W	D	LBS	FT <sup>3</sup>
BV3VTS04	11	3.75	2.61	0.25	0.1	0.010
BV3VTS08	13	7.75	2.61	0.25	0.1	0.015
BV3VTS12	20	11.75	2.61	0.25	0.2	0.020
BV3VTS16	22	15.75	2.61	0.25	0.3	0.030
BV3VTS20	29	19.75	2.61	0.25	0.3	0.035
BV3VTS24	24	23.75	2.61	0.25	0.4	0.045
BV3VTS32	28	31.75	2.61	0.25	0.6	0.060

**BA3VTRF • Vertical Aluminum Flat End Trim**

- Finishes the vertical edges of panels and posts (90 and 60 degree).
- In the case of the panel, the trim runs from the top of the panel to the bottom of the raceway, enclosing the horizontal channel openings and the raceway opening.
- In the case of the over panel, the trim runs from the top of the over panel to the bottom of the over panel, enclosing the horizontal channel openings.
- BABVTRF119 cannot ship via courier and must be combined with other product.

PRODUCT CODE	PRICE	TYPE	SIZE/ INCHES			WEIGHT VOL	
			H	W	D	LBS	FT <sup>3</sup>
BA3VTRF34	37	REGULAR PANEL	34	2.61	0.125	1.1	0.03
BA3VTRF42	45		42	2.61	0.125	1.4	0.03
BA3VTRF50	54		50	2.61	0.125	1.7	0.04
BA3VTRF54	62		54	2.61	0.125	1.9	0.04
BA3VTRF58	65		58	2.61	0.125	1.9	0.04
BA3VTRF66	67		66	2.61	0.125	2.2	0.05
BA3VTRF119	130		119	2.61	0.125	3.6	0.08
BA3VTEF8	11	OVER PANEL	8	2.61	0.125	0.2	0.01
BA3VTEF16	23		16	2.61	0.125	0.5	0.03
BA3VTEF32	37		32	2.61	0.125	1.1	0.06

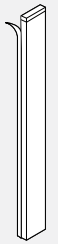
**BA3VTSF • Vertical Aluminum Flat End Trim Standard Step Down**

- Finishes the vertical edges of panels and posts (90 and 60 degree).
- Trims run from the top of one panel to the top of lower panel enclosing the horizontal channel opening.

PRODUCT CODE	PRICE	SIZE/ INCHES			WEIGHT VOL	
		H	W	D	LBS	FT <sup>3</sup>
BA3VTSF04	11	3.75	2.61	0.125	0.1	0.010
BA3VTSF08	13	7.75	2.61	0.125	0.3	0.015
BA3VTSF12	20	11.75	2.61	0.125	0.4	0.020
BA3VTSF16	23	15.75	2.61	0.125	0.5	0.030
BA3VTSF20	28	19.75	2.61	0.125	0.8	0.035
BA3VTSF24	30	23.75	2.61	0.125	0.9	0.045
BA3VTSF32	37	31.75	2.61	0.125	1.1	0.060

**B3LEP-NC • End of Run Gallery Panel in a T configuration, No Connectors for Additional Gallery Panels**

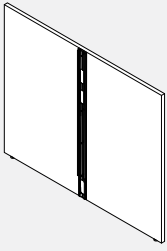

- Provides floor standing support while enclosing the end of a panel run on two sides.
- Attaches to the end of a Boulevard 1 or System 3 Panel with capture strips to form a T configuration.
- Connection is on the interior face center.
- Includes all attachment hardware and glides.
- Total height is inclusive of panel glides extended to their full height.
- 51" wide gallery panel accommodates two 24" deep surfaces while the 63" wide accommodates two 30" deep surfaces and 75" wide two 36" deep surfaces.
- Please specify LP laminate finish and PVC edge finish.
- If a wood grain laminate is chosen, grain direction run horizontally.
- Edged in PVC on three exposed edges and self edged on bottom.

PRODUCT CODE	PRICE LP	SIZE/INCHES			WEIGHT LBS	VOL FT <sup>3</sup>
		H	W	D		
B3LEP4227NC	404	42	26.5	1	29.49	0.64
B3LEP4251NC	634	42	51	1	55.17	1.24
B3LEP4263NC	710	42	63	1	68.01	1.53
B3LEP4275NC	790	42	75	1	80.86	1.82
B3LEP5027NC	471	50	26.5	1	35.25	0.77
B3LEP5051NC	736	50	51	1	65.92	1.48
B3LEP5063NC	829	50	63	1	81.27	1.82
B3LEP5075NC	936	50	75	1	96.62	2.17
B3LEP5427NC	471	54	26.5	1	38.12	0.83
B3LEP5451NC	758	54	51	1	71.3	1.59
B3LEP5463NC	854	54	63	1	87.9	1.97
B3LEP5475NC	965	54	75	1	104.49	2.34

**B3LSEPL-NC • Left End of Run Single Gallery Panel in L Configuration, No Connectors for Additional Gallery Panels**



- Provides floor standing support while enclosing the end of a panel run on one side.
- Attaches to the end of a Boulevard 1 or System 3 Panel with capture strips to form an L configuration.
- Connection is on interior face near it's right end.
- Includes all attachment hardware and glides.
- Total height is inclusive of panel glides extended to their full height.
- 27" wide gallery panel accommodates a 24" deep surface while the 33" wide accommodates a 30" deep surface and 39" wide a 36" deep surface.
- Please specify LP laminate finish and PVC edge finish.
- If a wood grain laminate is chosen, grain direction run horizontally.
- Edged in PVC on three exposed edges and self edged on bottom.

PRODUCT CODE	PRICE LP	SIZE/INCHES			WEIGHT LBS	VOL FT <sup>3</sup>
		H	W	D		
B3LSEPL4215NC	332	42	14.25	1	16.64	0.35
B3LSEPL4227NC	483	42	27	1	29.47	0.66
B3LSEPL4233NC	521	42	33	1	35.89	0.80
B3LSEPL4239NC	548	42	39	1	42.32	0.95
B3LSEPL5015NC	378	50	14.25	1	19.9	0.41
B3LSEPL5027NC	549	50	27	1	35.23	0.78
B3LSEPL5033NC	595	50	33	1	42.9	0.95
B3LSEPL5039NC	637	50	39	1	50.57	1.13
B3LSEPL5415NC	378	54	14.25	1	21.52	0.45
B3LSEPL5427NC	565	54	27	1	38.1	0.84
B3LSEPL5433NC	614	54	33	1	46.4	1.03
B3LSEPL5439NC	657	54	39	1	54.7	1.22

**B3LSEPR-NC • Right End of Run Single Gallery Panel in L Configuration, No Connectors for Additional Gallery Panels**



- Provides floor standing support while enclosing the end of a panel run on one side.
- Attaches to the end of a Boulevard 1 or System 3 Panel with capture strips to form an L configuration.
- Connection is on interior face near it's right end.
- - Includes all attachment hardware and glides.
- Total height is inclusive of panel glides extended to their full height.
- 27" wide gallery panel accommodates a 24" deep surface while the 33" wide accommodates a 30" deep surface and 39" wide a 36" deep surface.
- Please specify LP laminate finish and PVC edge finish.
- If a wood grain laminate is chosen, grain direction run horizontally.
- Edged in PVC on three exposed edges and self edged on bottom.

PRODUCT CODE	PRICE LP	SIZE/INCHES			WEIGHT LBS	VOL FT <sup>3</sup>
		H	W	D		
B3LSEPR4215NC	332	42	14.25	1	16.64	0.35
B3LSEPR4227NC	483	42	27	1	29.47	0.66
B3LSEPR4233NC	521	42	33	1	35.89	0.80
B3LSEPR4239NC	548	42	39	1	42.32	0.95
B3LSEPR5015NC	378	50	14.25	1	19.9	0.41
B3LSEPR5027NC	549	50	27	1	35.23	0.78
B3LSEPR5033NC	595	50	33	1	42.9	0.95
B3LSEPR5039NC	637	50	39	1	50.57	1.13
B3LSEPR5415NC	378	54	14.25	1	21.52	0.45
B3LSEPR5427NC	565	54	27	1	38.1	0.84
B3LSEPR5433NC	614	54	33	1	46.4	1.03
B3LSEPR5439NC	657	54	39	1	54.7	1.22

**B3LMP-NC • Middle of Run Single Gallery Panel in X Configuration, No Connectors for Additional Gallery Panels**

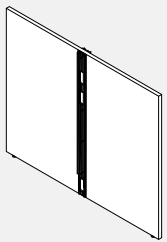

- Provides floor standing support in the middle of a panel run.
- Attaches between panels in a straight Boulevard 1 or System 3 Panel run with capture strips to form an X configuration.
- Connections are at the center of the interior and exterior faces.
- Includes all attachment hardware and glides.
- Total height is inclusive of panel glides extended to their full height.
- 51" wide gallery panel accommodates two 24" deep surfaces while the 63" wide accommodates two 30" deep surfaces and 75" wide two 36" deep surfaces.
- Please specify LP laminate finish and PVC edge finish.
- If a wood grain laminate is chosen, grain direction run horizontally.
- Edged in PVC on three exposed edges and self edged on bottom.

PRODUCT CODE	PRICE LP	SIZE/INCHES			WEIGHT LBS	VOL FT <sup>3</sup>
		H	W	D		
B3LMP4251NC	840	42	51	1	55.98	1.24
B3LMP4263NC	915	42	63	1	68.83	1.53
B3LMP4275NC	998	42	75	1	81.68	1.85
B3LMP5051NC	952	50	51	1	66.97	1.48
B3LMP5063NC	1046	50	63	1	82.32	1.82
B3LMP5075NC	1153	50	75	1	97.67	2.17
B3LMP5451NC	980	54	51	1	72.46	1.59
B3LMP5463NC	1077	54	63	1	89.06	1.97
B3LMP5475NC	1187	54	75	1	105.66	2.34

**B3LSMP-NC • Middle of Run Single Gallery Panel in T Configuration, No Connectors for Additional Gallery Panels**

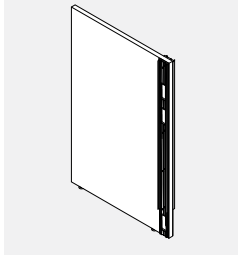

- Provides floor standing support at the middle of a panel run.
- Attaches in the middle of a straight Boulevard 1 or System 3 panel run with capture strips to form a T configuration.
- Connections are on the interior and exterior faces of one end.
- Includes all attachment hardware and glides.
- Total height is inclusive of panel glides extended to their full height.
- 27" wide gallery panel accommodates a 24" deep surface while the 33" wide accommodates a 30" deep surface and 39" wide a 36" deep surface.
- Please specify LP laminate finish and PVC edge finish.
- If a wood grain laminate is chosen, grain direction run horizontally.
- Edged in PVC on three exposed edges and self edged on bottom.

PRODUCT CODE	PRICE LP	SIZE /INCHES			WEIGHT LBS	VOL FT³
		H	W	D		
B3LSMP4227NC	691	42	27	1	30.28	0.66
B3LSMP4233NC	727	42	33	1	36.71	0.80
B3LSMP4239NC	755	42	39	1	43.13	0.95
B3LSMP5027NC	765	50	27	1	36.28	0.78
B3LSMP5033NC	811	50	33	1	43.95	0.95
B3LSMP5039NC	853	50	39	1	51.63	1.13
B3LSMP5427NC	788	54	27	1	39.26	0.84
B3LSMP5433NC	836	54	33	1	47.56	1.03
B3LSMP5439NC	879	54	39	1	55.86	1.22

**B3LEP • End of Run Gallery Panel in a T configuration, with Connectors for Additional Gallery Panels**

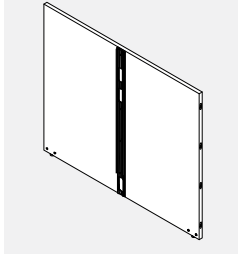

- Provides floor standing support while enclosing the end of a panel run.
- Attaches to the end of a Boulevard 1 or System 3 panel with capture strips to form a T configuration.
- Connections at both ends as well as on the middle of interior face.
- The end connections are to connect other Gallery Panels.
- The side right is compatible with right hand Gallery Panels (B3LX-PRxxxx and B3LXPRxxxxNC, B3L2PRxxxx and B3L3PRxxxx) only.
- The left side is compatible with left hand Gallery Panels (B3LX-PLxxxx and B3LXPLxxxxNC, B3L2PLxxxx and B3L3PLxxxx) only.
- The middle interior face connections are for Boulevard panels.
- Includes all attachment hardware and glides.
- Total height is inclusive of panel glides extended to their full height.
- 51" wide gallery panel accomodates two 24" deep surface while the 63" wide accomodates two 30" deep surfaces and 75" wide two 36" deep surfaces.
- Please specify LP laminate finish and PVC edge finish.
- If a wood grain laminate is chosen, grain direction run horizontally.
- Gallery panel is edged in PVC on exposed top edge only and self edged on the three other edges.

PRODUCT CODE	PRICE LP	SIZE /INCHES			WEIGHT LBS	VOL FT³
		H	W	D		
B3LEP4251	648	42	51	1	55.25	1.24
B3LEP4263	723	42	63	1	68.1	1.53
B3LEP4275	804	42	75	1	80.95	1.82
B3LEP5051	750	50	51	1	66.01	1.48
B3LEP5063	843	50	63	1	81.36	1.82
B3LEP5075	950	50	75	1	96.71	2.17
B3LEP5451	772	54	51	1	71.38	1.59
B3LEP5463	868	54	63	1	87.98	1.97
B3LEP5475	979	54	75	1	104.58	2.34

**B3LSEPL • Left End of Run Single Gallery Panel in L Configuration, with Connectors for Additional Gallery Panels**

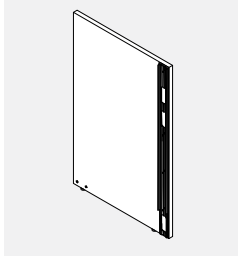

- Provides floor standing support while enclosing the end of a panel run.
- Attaches at the end of a Boulevard 1 or System 3 panel with capture strips to form an L configuration.
- Connection to the Boulevard panel is on interior face near it's right end.
- Connections for a Gallery Panel are on the left edge.
- Compatible with left hand Gallery Panels (B3LXPLxxxx and B3LXPLxxxxNC, B3L2PLxxxx and B3L3PLxxxx) only.
- Includes all attachment hardware and glides.
- Total height is inclusive of panel glides extended to their full height.
- 27" wide gallery panel accomodates a 24" deep surface while the 33" wide accomodates a 30" deep surface and 39" wide a 36" deep surface.
- Please specify LP laminate finish and PVC edge finish.
- If a wood grain laminate is chosen, grain direction run horizontally.
- Edged in PVC on two exposed edges, self edged on connecting to gallery panel edge and the bottom.

PRODUCT CODE	PRICE LP	SIZE /INCHES			WEIGHT LBS	VOL FT³
		H	W	D		
B3LSEPL4227	490	42	27	1	29.51	0.66
B3LSEPL4233	528	42	33	1	35.94	0.80
B3LSEPL4239	554	42	39	1	42.36	0.95
B3LSEPL5027	556	50	27	1	35.27	0.78
B3LSEPL5033	603	50	33	1	42.94	0.95
B3LSEPL5039	645	50	39	1	50.62	1.13
B3LSEPL5427	572	54	27	1	38.14	0.84
B3LSEPL5433	620	54	33	1	46.44	1.03
B3LSEPL5439	663	54	39	1	54.74	1.22

**B3LSEPR • Right End of Run Single Gallery Panel in L Configuration, with Connectors for additional Gallery Panels**

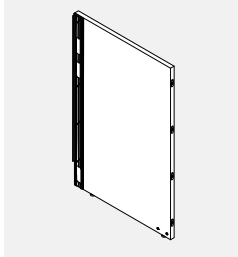

- Provides floor standing support while enclosing the end of a panel run.
- Attaches at the end of a Boulevard 1 or System 3 panel with capture strips to form an L configuration.
- Connection to the Boulevard panel is on interior face near it's left end.
- Connections for a Gallery Panel are on the right edge.
- Compatible with right hand Gallery Panels (B3LXPRxxxx and B3LXPRxxxxNC, B3L2PRxxxx and B3L3PRxxxx) only.
- Includes all attachment hardware and glides.
- Total height is inclusive of panel glides extended to their full height.
- 27" wide gallery panel accomodates a 24" deep surface while the 33" wide accomodates a 30" deep surface and 39" wide a 36" deep surface.
- Please specify LP laminate finish and PVC edge finish.
- If a wood grain laminate is chosen, grain direction run horizontally.
- Edged in PVC on two exposed edges, self edged on connecting to gallery panel edge and the bottom.

PRODUCT CODE	PRICE LP	SIZE /INCHES			WEIGHT LBS	VOL FT³
		H	W	D		
B3LSEPR4227	490	42	27	1	29.51	0.66
B3LSEPR4233	528	42	33	1	35.94	0.80
B3LSEPR4239	554	42	39	1	42.36	0.95
B3LSEPR5027	556	50	27	1	35.27	0.78
B3LSEPR5033	603	50	33	1	42.94	0.95
B3LSEPR5039	645	50	39	1	50.62	1.13
B3LSEPR5427	572	54	27	1	38.14	0.84
B3LSEPR5433	620	54	33	1	46.44	1.03
B3LSEPR5439	663	54	39	1	54.74	1.22

**B3LMP • Middle of Run Single Gallery Panel in X Configuration, with Connectors for Additional Gallery Panels**

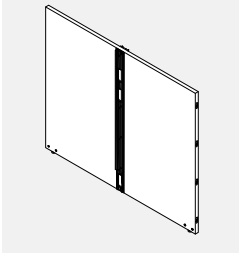

- Provides floor standing support in the middle of a panel run.
- Attached in the middle of a straight Boulevard 1 or System 3 panel run with capture strips to form an X configuration.
- Connections at both ends (for Gallery Panels) as well as on the middle of the interior and exterior faces (for Boulevard Panels).
- The right side is compatible with right hand Gallery Panels (B3LX-PRxxxx and B3LXPRxxxxNC, B3L2PRxxxx and B3L3PRxxxx) only.
- The left side is compatible with left hand Gallery Panels (B3LX-PLxxxx and B3LXPLxxxxNC, B3L2PLxxxx and B3L3PLxxxx) only.
- Includes all attachment hardware and glides.
- Total height is inclusive of panel glides extended to their full height.
- 51" wide gallery panel accommodates two 24" deep surface while the 63" wide accommodates two 30" deep surfaces and 75" wide two 36" deep surfaces.
- Please specify LP laminate finish and PVC edge finish.
- If a wood grain laminate is chosen, grain direction run horizontally.
- Edged in PVC on exposed top edge only and self edged on the three other.

PRODUCT CODE	PRICE LP	SIZE / INCHES			WEIGHT LBS	VOL FT <sup>3</sup>
		H	W	D		
B3LMP4251	854	42	51	1	56.07	1.24
B3LMP4263	930	42	63	1	68.91	1.53
B3LMP4275	1011	42	75	1	81.76	1.82
B3LMP5051	966	50	51	1	67.06	1.48
B3LMP5063	1058	50	63	1	82.41	1.82
B3LMP5075	1166	50	75	1	97.76	2.17
B3LMP5451	994	54	51	1	72.55	1.59
B3LMP5463	1090	54	63	1	89.15	1.97
B3LMP5475	1201	54	75	1	105.74	2.34

**B3LSMP - Middle of Run Single Gallery Panel in T Configuration, with Connectors for Additional Gallery Panels**

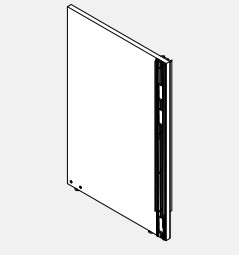

- Provides floor standing support at the middle of a panel run.
- Attached in the middle of a straight Boulevard 1 or System 3 panel run with capture strips to form a T configuration.
- Connections are on the exposed edge (for Gallery Panel) and near the opposite end on both interior and exterior faces (for Boulevard Panels).
- Compatible with left hand gallery panels (B3LXPLxxxx and B3LXPLxxxxNC, B3L2PLxxxx and B3L3PLxxxx) only.
- Includes all attachment hardware and glides.
- Total height is inclusive of panel glides extended to their full height.
- 27" wide gallery panel accommodates a 24" deep surface while the 33" wide accommodates a 30" deep surface and 39" wide a 36" deep surface.
- Please specify LP laminate finish and PVC edge finish.
- If a wood grain laminate is chosen, grain direction run horizontally.
- Edged in PVC on two exposed edges, self edged on connecting to gallery panel edge and the bottom.

PRODUCT CODE	PRICE LP	SIZE / INCHES			WEIGHT LBS	VOL FT <sup>3</sup>
		H	W	D		
B3LSMP4227	696	42	27	1	30.33	0.66
B3LSMP4233	735	42	33	1	36.75	0.80
B3LSMP4239	761	42	39	1	43.17	0.95
B3LSMP5027	772	50	27	1	36.32	0.78
B3LSMP5033	818	50	33	1	43.99	0.95
B3LSMP5039	860	50	39	1	51.67	1.13
B3LSMP5427	795	54	27	1	39.31	0.84
B3LSMP5433	843	54	33	1	47.61	1.03
B3LSMP5439	886	54	39	1	55.91	1.22

**B3LXPL • Left Gallery Panel Extension, with Connectors for Additional Gallery Panels**

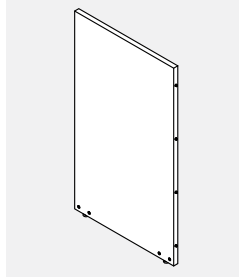

- Provides floor standing support while extending the Gallery Panels run.
- Attaches to the left edge of a Gallery Panel by the pin connectors to allow for additional Gallery Panels to be added on the left side.
- Pin connectors on the right edge and modular connectors on the left edge of the interior face.
- The right side is compatible with Gallery Panels (B3LEPxxx, B3LSEPL, B3LMPxxx, B3LSMP and B3LXPLxxx) only.
- The left side is compatible with left hand Gallery Panels (B3LX-PLxxxx and B3LXPLxxxxNC, B3L2PLxxxx and B3L3PLxxxx) only.
- Includes all attachment hardware and glides.
- Total height is inclusive of panel glides extended to their full height.
- Please specify LP laminate finish and PVC edge finish.
- If a wood grain laminate is chosen, grain direction run horizontally.
- Edged in PVC on exposed top edge only and self edges on the three other.
- Edged in PVC on two exposed edges, self edged on connecting to gallery panel edge and the bottom.

PRODUCT CODE	PRICE LP	SIZE / INCHES			WEIGHT LBS	VOL FT <sup>3</sup>
		H	W	D		
B3LXPL4224	252	42	24	1	25.83	0.58
B3LXPL4230	290	42	30	1	32.26	0.73
B3LXPL4236	328	42	36	1	38.68	0.88
B3LXPL4242	365	42	42	1	45.11	1.02
B3LXPL4248	403	42	48	1	51.53	1.17
B3LXPL5024	300	50	24	1	30.83	0.69
B3LXPL5030	347	50	30	1	38.51	0.87
B3LXPL5036	394	50	36	1	46.18	1.04
B3LXPL5042	440	50	42	1	53.86	1.22
B3LXPL5048	487	50	48	1	61.53	1.39
B3LXPL5424	310	54	24	1	33.34	0.75
B3LXPL5430	358	54	30	1	41.64	0.94
B3LXPL5436	405	54	36	1	49.94	1.13
B3LXPL5442	452	54	42	1	58.24	1.31
B3LXPL5448	503	54	48	1	66.54	1.50



**B3LXPR • Right Gallery Panel Extension, with Connectors for Additional Gallery Panels**

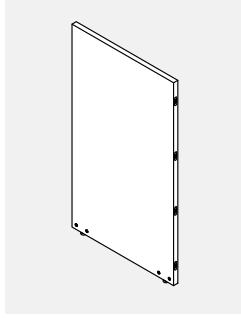

- Provides floor standing support while extending the Gallery Panels run.
- Attaches to the right edge of a Gallery Panel by the pin connectors to allow for additional Gallery Panels to be added on the right side.
- Pin connectors on the right edge and modular connectors on the left edge of the interior face.
- The right side is compatible with right hand Gallery Panels (B3LX-PRxxxx and B3LXPRxxxxNC, B3L2PRxxxx and B3L3PRxxxx) only.
- The left side is compatible with Gallery Panels (B3LEPxxx, B3LSEPRxxx, B3LMPxxx and B3LXPRxxx) only.
- Includes all attachment hardware and glides.
- Total height is inclusive of panel glides extended to their full height.
- Please specify LP laminate finish and PVC edge finish.
- If a wood grain laminate is chosen, grain direction run horizontally.
- Edged in PVC on exposed top edge only and self edges on the three other.

PRODUCT CODE	PRICE LP	SIZE /INCHES			WEIGHT LBS	VOL FT <sup>3</sup>
		H	W	D		
B3LXPR4224	252	42	24	1	25.83	0.58
B3LXPR4230	290	42	30	1	32.26	0.73
B3LXPR4236	328	42	36	1	38.68	0.88
B3LXPR4242	365	42	42	1	45.11	1.02
B3LXPR4248	403	42	48	1	51.53	1.17
B3LXPR5024	300	50	24	1	30.83	0.69
B3LXPR5030	347	50	30	1	38.51	0.87
B3LXPR5036	394	50	36	1	46.18	1.04
B3LXPR5042	440	50	42	1	53.86	1.22
B3LXPR5048	487	50	48	1	61.53	1.39
B3LXPR5424	310	54	24	1	33.34	0.75
B3LXPR5430	358	54	30	1	41.64	0.94
B3LXPR5436	405	54	36	1	49.94	1.13
B3LXPR5442	452	54	42	1	58.24	1.31
B3LXPR5448	503	54	48	1	66.54	1.50

**B3LXPL-NC • Left Gallery Panel Extension, No Connectors for Additional Gallery Panels**

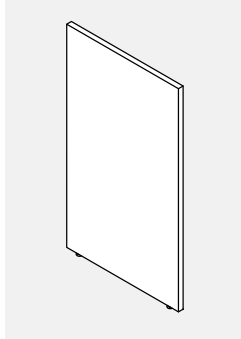

- Provides floor standing support while enclosing the end of a Gallery Panel left run.
- Attached to the left edge of a Gallery Panel by the pin connectors to finish the run.
- Pin connectors are on the right edge of the interior face.
- Compatible with gallery panels (B3LEPxxxx, B3LSEPLxxxx, B3LMPxxxx, B3LSMPxxxx and B3LXPLxxxx) only.
- Includes all attachment hardware and glides.
- Total height is inclusive of panel glides extended to their full height.
- Please specify LP laminate finish and PVC edge finish.
- If a wood grain laminate is chosen, grain direction run horizontally.
- Edged in PVC on two exposed edges, self edged on connecting to gallery panel edge and the bottom.

PRODUCT CODE	PRICE LP	SIZE /INCHES			WEIGHT LBS	VOL FT <sup>3</sup>
		H	W	D		
B3LXPL4212NC	138	42	12	1	12.95	0.29
B3LXPL4224NC	245	42	24	1	25.8	0.58
B3LXPL4230NC	283	42	30	1	32.22	0.73
B3LXPL4236NC	320	42	36	1	38.65	0.88
B3LXPL4242NC	359	42	42	1	45.07	1.02
B3LXPL4248NC	396	42	48	1	51.5	1.17
B3LXPL5012NC	172	50	12	1	15.45	0.35
B3LXPL5024NC	294	50	24	1	30.8	0.69
B3LXPL5030NC	340	50	30	1	38.47	0.87
B3LXPL5036NC	386	50	36	1	46.15	1.04
B3LXPL5042NC	435	50	42	1	53.82	1.22
B3LXPL5048NC	481	50	48	1	61.5	1.39
B3LXPL5412NC	172	54	12	1	16.7	0.38
B3LXPL5424NC	303	54	24	1	33.3	0.75
B3LXPL5430NC	351	54	30	1	41.6	0.94
B3LXPL5436NC	398	54	36	1	49.9	1.13
B3LXPL5442NC	447	54	42	1	58.2	1.31
B3LXPL5448NC	494	54	48	1	66.5	1.50

**B3LXPR-NC • Right Gallery Panel Extension, No Connectors for Additional Gallery Panels**

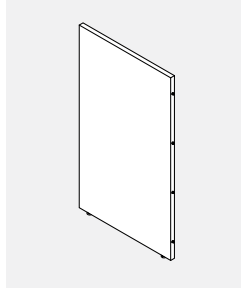

- Provides floor standing support while enclosing the end of a Gallery Panel right run.
- Attached to the right edge of a Gallery Panel by the pin connectors to finish the run.
- Pin connectors are on the left edge of the interior face.
- Compatible with gallery panels (B3LEPxxxx, B3LSEPRxxxx, B3LMPxxxx and B3LXPRxxxx) only.
- Includes all attachment hardware and glides.
- Total height is inclusive of panel glides extended to their full height.
- Please specify LP laminate finish and PVC edge finish.
- If a wood grain laminate is chosen, grain direction run horizontally.
- Edged in PVC on two exposed edges, self edged on connecting to gallery panel edge and the bottom.

PRODUCT CODE	PRICE LP	SIZE /INCHES			WEIGHT LBS	VOL FT <sup>3</sup>
		H	W	D		
B3LXPR4212NC	138	42	12	1	12.95	0.29
B3LXPR4224NC	245	42	24	1	25.8	0.58
B3LXPR4230NC	283	42	30	1	32.22	0.73
B3LXPR4236NC	320	42	36	1	38.65	0.88
B3LXPR4242NC	359	42	42	1	45.07	1.02
B3LXPR4248NC	396	42	48	1	51.5	1.17
B3LXPR5012NC	172	50	12	1	15.45	0.35
B3LXPR5024NC	294	50	24	1	30.8	0.69
B3LXPR5030NC	340	50	30	1	38.47	0.87
B3LXPR5036NC	386	50	36	1	46.15	1.04
B3LXPR5042NC	435	50	42	1	53.82	1.22
B3LXPR5048NC	481	50	48	1	61.5	1.39
B3LXPR5412NC	172	54	12	1	16.7	0.38
B3LXPR5424NC	303	54	24	1	33.3	0.75
B3LXPR5430NC	351	54	30	1	41.6	0.94
B3LXPR5436NC	398	54	36	1	49.9	1.13
B3LXPR5442NC	447	54	42	1	58.2	1.31
B3LXPR5448NC	494	54	48	1	66.5	1.50

**B3L2PR • Right Gallery Panel End of Run Return**

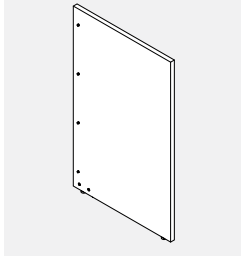

- Provides floor standing support while enclosing the end of a Gallery Panel run.
- Attaches at the Gallery Panel right edge with connectors to form an L configuration.
- Connections to Gallery Panel are on the interior face near it's left end.
- Compatible with Gallery Panels (B3LEPxxxx, B3LSEPRxxxx, B3LMPxxxx and B3LXPRxxxx) only.
- Includes all attachment hardware and glides.
- Total height is inclusive of panel glides extended to their full height.
- 25" wide gallery panel accomodates a 24" deep surface while the 31" wide accomodates a 30" deep surface and 37" wide a 36" deep surface.
- Please specify LP laminate finish and PVC edge finish.
- If a wood grain laminate is chosen, grain direction run horizontally.
- Edged in PVC on three exposed edges and self edged on the bottom edge.

PRODUCT CODE	PRICE LP	SIZE /INCHES			WEIGHT LBS	VOL FT³
		H	W	D		
B3L2PR4213	149	42	13	1	14.02	0.32
B3L2PR4225	283	42	25	1	26.87	0.61
B3L2PR4231	320	42	31	1	33.29	0.75
B3L2PR4237	347	42	37	1	39.72	0.90
B3L2PR5013	186	50	13	1	16.73	0.38
B3L2PR5025	340	50	25	1	32.08	0.72
B3L2PR5031	386	50	31	1	39.75	0.90
B3L2PR5037	428	50	37	1	47.43	1.07
B3L2PR5413	186	54	13	1	18.08	0.41
B3L2PR5425	351	54	25	1	34.68	0.78
B3L2PR5431	398	54	31	1	42.98	0.97
B3L2PR5437	441	54	37	1	51.28	1.16

**B3L2PL • Left Gallery Panel End of Run Return**

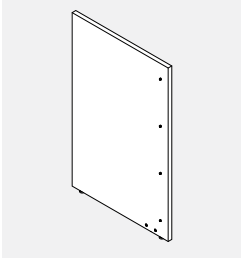

- Provides floor standing support while enclosing the end of a gallery panel run.
- Attaches at the Gallery Panel left edge with connectors to form an L configuration.
- Connections to Gallery Panel are on the interior face near it's right end.
- Compatible with Gallery Panels (B3LEPxxxx, B3LSEPLxxxx, B3LMPxxxx, B3LSMPxxxx and B3LXPLxxxx) only.
- Includes all attachment hardware and glides.
- Total height is inclusive of panel glides extended to their full height.
- 25" wide gallery panel accomodates a 24" deep surface while the 31" wide accomodates a 30" deep surface and 37" wide a 36" deep surface.
- Please specify LP laminate finish and PVC edge finish.
- If a wood grain laminate is chosen, grain direction run horizontally.
- Edged in PVC on three exposed edges and self edged on the bottom edge.

PRODUCT CODE	PRICE LP	SIZE /INCHES			WEIGHT LBS	VOL FT³
		H	W	D		
B3L2PL4213	149	42	13	1	14.02	0.32
B3L2PL4225	283	42	25	1	26.87	0.61
B3L2PL4231	320	42	31	1	33.29	0.75
B3L2PL4237	347	42	37	1	39.72	0.90
B3L2PL5013	186	50	13	1	16.73	0.38
B3L2PL5025	340	50	25	1	32.08	0.72
B3L2PL5031	386	50	31	1	39.75	0.90
B3L2PL5037	428	50	37	1	47.43	1.07
B3L2PL5413	186	54	13	1	18.08	0.41
B3L2PL5425	351	54	25	1	34.68	0.78
B3L2PL5431	398	54	31	1	42.98	0.97
B3L2PL5437	441	54	37	1	51.28	1.16

**B3L3PL • Left Gallery Panel End of Run 3-Way Return**

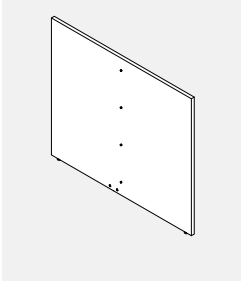

- Provides floor standing support while enclosing the end of a Gallery Panel run.
- Attaches to the Gallery Panel left edge with connectors to form an T configuration.
- Connections to Gallery Panel are on the interior face in the middle.
- Compatible with Gallery Panels (B3LEPxxxx, B3LSEPLxxxx, B3LMPxxxx, B3LSMPxxxx and B3LXPLxxxx) only.
- Includes all attachment hardware and glides.
- Total height is inclusive of panel glides extended to their full height.
- 49" wide gallery panel accomodates two 24" deep surfaces while the 61" wide accomodates two 30" deep surface and 73" wide two 36" deep surface.
- Please specify LP laminate finish and PVC edge finish.
- If a wood grain laminate is chosen, grain direction run horizontally.
- Edged in PVC on three exposed edges and self edged on the bottom edge.

PRODUCT CODE	PRICE LP	SIZE /INCHES			WEIGHT LBS	VOL FT³
		H	W	D		
B3L3PL4225	222	42	25	1	26.87	0.61
B3L3PL4249	384	42	49	1	52.57	1.19
B3L3PL4261	509	42	61	1	65.41	1.48
B3L3PL4273	591	42	73	1	78.26	1.77
B3L3PL5025	278	50	25	1	32.08	0.72
B3L3PL5049	527	50	49	1	62.77	1.42
B3L3PL5061	620	50	61	1	78.12	1.77
B3L3PL5073	727	50	73	1	93.47	2.11
B3L3PL5425	278	54	25	1	34.68	0.78
B3L3PL5449	543	54	49	1	67.88	1.53
B3L3PL5461	639	54	61	1	84.48	1.91
B3L3PL5473	750	54	73	1	101.08	2.28

**B3L3PR • Right Gallery Panel End of Run 3-Way Return**

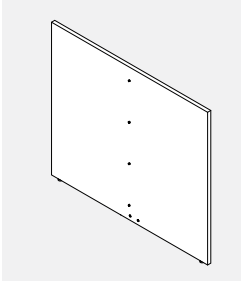

- Provides floor standing support while enclosing the end of a Gallery Panel run.
- Attaches to the Gallery Panel right edge with connectors to form an T configuration.
- Connections to Gallery Panel are on the interior face in the middle.
- Compatible with gallery panels (B3LEPxxxx, B3LSEPRxxxx, B3LMPxxxx and B3LXPRxxxx) only.
- Includes all attachment hardware and glides.
- Total height is inclusive of panel glides extended to their full height.
- 49" wide gallery panel accomodates two 24" deep surfaces while the 61" wide accomodates two 30" deep surface and 73" wide two 36" deep surface.
- Please specify LP laminate finish and PVC edge finish.
- If a wood grain laminate is chosen, grain direction run horizontally.
- Edged in PVC on three exposed edges and self edged on the bottom edge.

PRODUCT CODE	PRICE LP	SIZE /INCHES			WEIGHT LBS	VOL FT³
		H	W	D		
B3L3PR4225	222	42	25	1	26.87	0.61
B3L3PR4249	384	42	49	1	52.57	1.19
B3L3PR4261	509	42	61	1	65.41	1.48
B3L3PR4273	591	42	73	1	78.26	1.77
B3L3PR5025	278	50	25	1	32.08	0.72
B3L3PR5049	527	50	49	1	62.77	1.42
B3L3PR5061	620	50	61	1	78.12	1.77
B3L3PR5073	727	50	73	1	93.47	2.11
B3L3PR5425	278	54	25	1	34.68	0.78
B3L3PR5449	543	54	49	1	67.88	1.53
B3L3PR5461	639	54	61	1	84.48	1.91
B3L3PR5473	750	54	73	1	101.08	2.28

**B3HLPBB01 • Gallery Panel Bottom Inline Bracket**

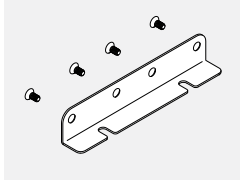

- Gallery Panel Bottom Inline Bracket connects two Gallery Panels at the bottom with screws.
- Available in standard paint colors.

PRODUCT CODE	PRICE	SIZE /INCHES			WEIGHT LBS	VOL FT <sup>3</sup>
		H	W	D		
B3HLPBB01	34	7	1.5	8	1	0.5

**B3HLPCB01 • Gallery Panel Corner Bracket**

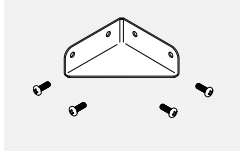

- Gallery Panel Corner Bottom bracket connects two Gallery Panels at 90 degrees.
- Available in standard paint colors.

PRODUCT CODE	PRICE	SIZE /INCHES			WEIGHT LBS	VOL FT <sup>3</sup>
		H	W	D		
B3HLPCB01	33	7	1.5	4	4	0.5

**B3PMP-GI-W • Privacy Glass for 1" Laminate Panels**

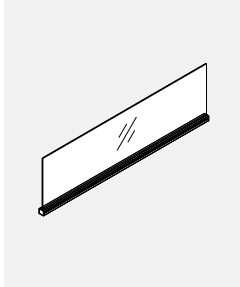

- Privacy glass integrated with aluminum top trim.
- Attaches on top of gallery panels to add privacy or divide space.
- Includes aluminum trim with channel, end caps and glass tile.
- Top rail may also be used to hang accessories.
- Glass and attachment hardware ship separately.
- Please specify standard paint finish for the channel.
- Standard in clear (CLR) or frosted (FRST).

PRODUCT CODE	PRICE		SIZE /INCHES			WEIGHT LBS	VOL FT <sup>3</sup>
	CLR	FRST	H	W	D		
B3PMP24GI8W	195	244	8	24	1	4.84	0.11
B3PMP30GI8W	213	268	8	30	1	6.06	0.14
B3PMP36GI8W	228	283	8	36	1	7.28	0.17
B3PMP42GI8W	244	304	8	42	1	8.5	0.19
B3PMP48GI8W	254	317	8	48	1	9.72	0.22
B3PMP24GI16W	195	244	16	24	1	8.92	0.22
B3PMP30GI16W	213	268	16	30	1	11.17	0.28
B3PMP36GI16W	228	283	16	36	1	13.43	0.33
B3PMP42GI16W	244	304	16	42	1	15.68	0.39
B3PMP48GI16W	254	317	16	48	1	17.92	0.44

**B3PFD-W • Felt divider for 1" Laminate Panels**

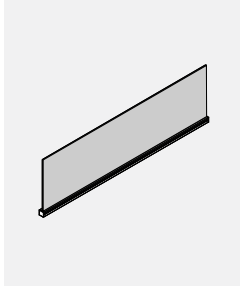

- Privacy felt integrated with aluminum top trim.
- Attaches on top of gallery panels to add privacy or divide space.
- Includes aluminum trim with channel, end caps and felt tile.
- Top rail may also be used to hang accessories.
- Felt and attachment hardware ship separately.
- Please specify standard paint finish for the channel.
- Please specify standard felt finish.

PRODUCT CODE	PRICE	SIZE /INCHES			WEIGHT LBS	VOL FT <sup>3</sup>
		H	W	D		
B3PFD0824W	70	8	24	1	1.32	0.11
B3PFD0830W	85	8	30	1	1.65	0.14
B3PFD0836W	99	8	36	1	1.99	0.17
B3PFD0842W	111	8	42	1	2.32	0.19
B3PFD0848W	165	8	48	1	2.65	0.22
B3PFD0854W	178	8	54	1	2.98	0.25
B3PFD0860W	193	8	60	1	3.32	0.28
B3PFD0866W	204	8	66	1	3.65	0.31
B3PFD0872W	231	8	72	1	3.98	0.33
B3PFD1624W	81	16	24	1	1.83	0.22
B3PFD1630W	95	16	30	1	2.3	0.28
B3PFD1636W	113	16	36	1	2.76	0.33
B3PFD1642W	126	16	42	1	3.22	0.39
B3PFD1648W	187	16	48	1	3.68	0.44
B3PFD1654W	204	16	54	1	4.14	0.50
B3PFD1660W	219	16	60	1	4.61	0.56
B3PFD1666W	231	16	66	1	5.07	0.61
B3PFD1672W	263	16	72	1	5.53	0.67

## Electrical

Affordability and widespread availability of wireless networking is gradually diminishing the need for extensive cable capacity housing. However, as our desk top equipment still requires electricity, providing access to power from within a work station is an integral part of any work place design.

The Global Contract family of power components has been assembled to address a variety of common requirements as well as to satisfy specific customer needs and budgets.

Global Contract can now offer the option of 3 duplex per panel, please contact your Customer Service Representative.

### Direct Access:

When office equipment plugs directly into a wall or raised floor power source, cable troughs, as well the Boulevard panel internal cavity serve the purpose of organizing cables.

### Extensions:

Keeping minimal installation costs in mind, the next natural step is the employment of fused and surge protected power bars, worksurface-clamped receptacles or floor standing power towers.

### Four circuit power systems:

In the absence of a raised floor, or when office equipment is to be installed further away from wall outlets, the Boulevard panel or Bridges unit the building power supply - office equipment gap by distributing power at either floor or desk height level, or both.

While Boulevard panels are capable of surrounding a given work station with power and data outlets at multiple levels, it is important to remember that the most economical way of providing four-circuit power distribution is if the harness, junction box and receptacle system remained within the central spine structure. The cost savings here come from a number and lengths of individual connecting power harnesses.

Should there be a need to branch power from Boulevard or central spine onto adjacent, perpendicular work surfaces, the employment of fused and surge protected power bars will assist in keeping the cost under control.

However, the very same, 4-circuit system is capable of delivering a considerable amount of power as there can be up to six, 8 wire-4 circuit systems accommodated within System3 pass-thru panel. For instance: three systems at the floor level and two systems at the desk height.

Various ceiling or floor level power entry feeds are available. See the following pages for individual component description and technical specifications.

## Technical Information

### Wire Schematic

4-2-2 Wiring Schematic

8-Wire Shared Neutral

"3+1" -3 Utility circuits, 1 dedicated circuit.

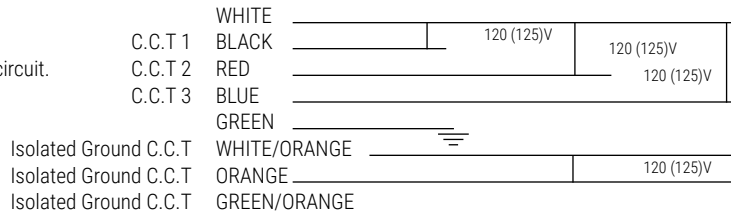

### 8 Wires

4 Lines (12 ga.)  
2 Neutrals (10 ga.)  
2 Grounds (12 ga.)

### 4 Circuits

3 Utility Circuits  
1 Dedicated Circuits

### Receptacles

Duplex – Up to 6 duplex receptacles per circuit (Up to 48 infeed)

### Specifications

System rated for connection to a grounded 120/240 V, single phase\*, 20A, 60Hz or 120/208 V, 3 phase, 20A, 60Hz branch circuit for U.S. and 15A if product is marked with a C-UL Mark. Outlets rated 15A max.

### UL Recognised CSA Certified

**Warning:** It is recommended that installation of the electrical harness be made under the supervision of a licensed electrician in accordance with applicable codes and regulations.

**Special Note:** Always determine that harness is electrically connected to only one power supply.

\* When connected to Single Phase. Only Circuit 1,3 & A are available.

**STEP-BY-STEP SPECIFICATION - 8 WIRE ELECTRICAL FOR BOULEVARD 1 AND RACEWAY PANELS**

**STEP 1:** Determine the location of the source power entry entering the panel through a post.

a) From the floor:

- i) Choose from a selection of single or double Base Feeds (BE81BF721, BE81BF722, BE81BF1441, BE81BF1442) to bring the power from the floor to the raceway channel.
- ii) Select a post adjacent to the panel (or panels if using a Double Base Feed) to which the end of the Base Feed will be attached. This panel requires a Power Distribution Housing and must be located next to the post through which the Base Feed is entering.

**Note: If it is not practical to have a Power Distribution Housing in a panel adjacent to the selected Base Feed Post, use a BE8CPxxHJ Housing-to-Jumper Pass-Thru Cable to transition through the adjacent non-powered panel(s) that are between the Base Feed Post and the first powered panel. The length of the cable will equal the combined width of the non-powered panel(s).**

b) From the Ceiling:

- i) Choose from a selection of single or double Ceiling Feeds (BE81CF1201, BE81CF120-2, BE81CF1441, BE81CF1442) to bring the power from the ceiling to the raceway.
- ii) Select a post adjacent to the panel (or panels if using a Double Ceiling Feed) to which the Ceiling Feed will be attached. This panel requires a Power Distribution Housing and must be located next to the post through which the Ceiling Feed is entering.

**STEP 2:** Determine which panels are to be powered.

- a) Use a BE81D Concealed Desk Height Power Distribution Housing or a BE8U2D Face Mount Desk Height Power Distribution Housing that corresponds with the width of each panel selected to be powered.

**Note: Specify Face Mount Raceway Covers for panels that contain BE8U2D Face Mount Desk Height Power Distribution Housings.**

**STEP 3:** Connect power to the panels.

- a) Use a BE8JC16 Jumper between two adjacent powered panels.
- b) Use a BE8JC20 Jumper between two powered panels separated by a post.
- c) **Use a BE8JM19 Shielded Mesh Jumper between two powered panels separated by a post.**
- d) Use a BE8CPxxHJ Housing-to-Jumper Pass-Thru Cable to electrically connect a BE8JM19 Shielded Mesh Jumper and a powered panel when the two are separated by one or more non-powered panels in a straight line application only.
  - i) The length of the BE8CPxxHJ Housing-to-Jumper Pass-Thru Cable will equal the combined width of the non-powered panel(s).
- e) Use a BE8CPxxHH Housing-to-Housing Pass-Thru Cable to electrically connect two powered panel separated by one or more non-powered panels in a straight line application only.
  - i) The length of the Pass-Thru Cable corresponds with the width(s) of the non-powered panels that separate two powered panels plus 16" (the termination blocks of the Power Distribution Housing are 8" in from the edge of the powered panel), plus 4" for each post.
- f) Connect two jumpers or cables together by using the I-Connector BE8C11. This functions as a female-female adapter and it allows the male ends of jumpers and pass-thru cables to connect together.

**STEP 4:** Designate which circuit each duplex is to tap into.

- a) Each powered panel has four (4) potential locations for duplex receptacles - 2 per side. (Exception: 24" wide panel has only two (2) potential locations - 1 per side, 18" wide panel has no locations for receptacles).
- b) At each location there is a choice of four (4) circuit options. Select the circuit option for each location.

**Circuit Selections : Circuits 1, 2, and 3 are utility circuits, all sharing a ground and a neutral. Circuit A is a dedicated circuit with its own ground and neutral.**

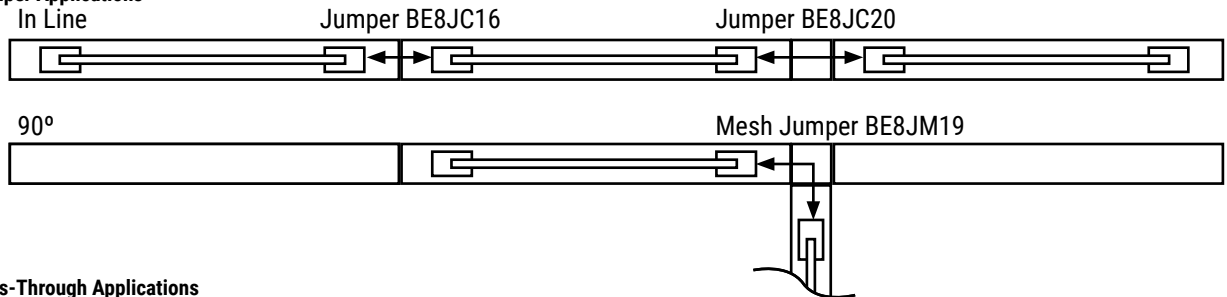
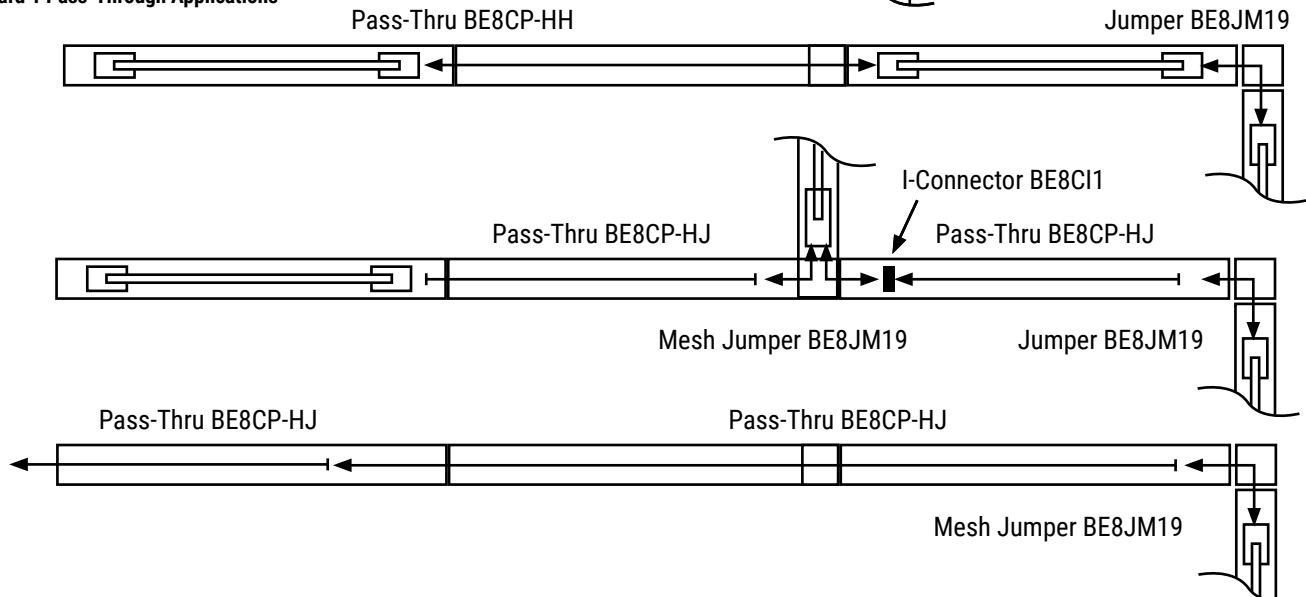
**SPECIFICATION APPLICATIONS****Boulevard 1 Jumper Applications****Boulevard 1 Pass-Through Applications**

**STEP-BY-STEP SPECIFICATION - 8 WIRE ELECTRICAL FOR BOULEVARD SYSTEM 3 BASE RACEWAY**

**STEP 1:** Determine the location of the source power entry entering the panel.

- a. At the base of a panel:
  - i. Use a BE8BFxx Base Feed.
  - ii. Select the panel to which the Base Feed will be attached. This panel requires a BE83D Power Distribution Housing.
  - iii. Select the side of the panel and the receptacle outlet to which the Base Feed is to be attached.
- b. From the ceiling:
  - i. Use a BE8CFxx-1 or -2 (single or double).
  - ii. Select the post through which to feed the Ceiling Feed.
  - iii. One panel adjacent to the selected post requires a BE83D Power Distribution Housing. Attach the Ceiling Feed to the nearest end of the Power Distribution Housing.

**Note: If it is not practical to have a Power Distribution Housing in a panel adjacent to the selected Ceiling Feed Post, use a BE8CPxxHJ Housing-to-Jumper Pass-Thru Cable to transition through the adjacent non-powered panel(s) that are between the Ceiling Feed Post and the first powered panel. The length of the cable will equal the combined width of the non-powered panel(s).**

- c. At the base of an adjoining panel:
  - i. Use a BE83BFR72 Raceway Entry Base Feed
  - ii. Select a non-powered panel adjacent to the panel with a Power Distribution Housing.
  - iii. Choose a duplex opening on either side of the panel to insert and attach the Raceway Entry Base Feed at that point.
  - iv. The Raceway Entry Base Feed will attach to the nearest end of the Power Distribution Housing (similar to the Ceiling Feed attachment).

**STEP 2:** Determine which panels are to be powered.

- a. Use a BE83D Power Distribution Housing that corresponds with the width of the selected panel.

**STEP 3:** Connect power to the panels.

- a. Use a BE8JC16 Jumper between two adjacent powered panels.
- b. Use a BE8JC20 Jumper between two powered panels separated by a post.
- c. Use a BE8CPxxHH Housing-to-Housing Pass-Thru Cable to connect two powered panels separated by one or more non-powered panels. i. The length of the Pass-Thru Cable corresponds with the width(s) of the non-powered panels that separate two powered panels plus 16" (the termination blocks of the Power Distribution Housing are 8" in from the edge of the powered panel plus 4" for each post).

**STEP 4:** Designate which circuit each duplex is to tap into.

- a. Each powered panel has four (4) potential locations for duplex receptacles - 2 per side. (Exception: 24" wide panel has only two (2) potential locations - 1 per side, 18" wide panel has no locations for receptacles).
- b. At each location there is a choice of four (4) circuit options. Select the circuit option for each location.

**Circuit Selections : Circuits 1, 2, and 3 are utility circuits, all sharing a ground and a neutral. Circuit A is a dedicated circuit with its own ground and neutral.**

**SPECIFICATION APPLICATIONS**

**Boulevard System 3 Jumper Applications**

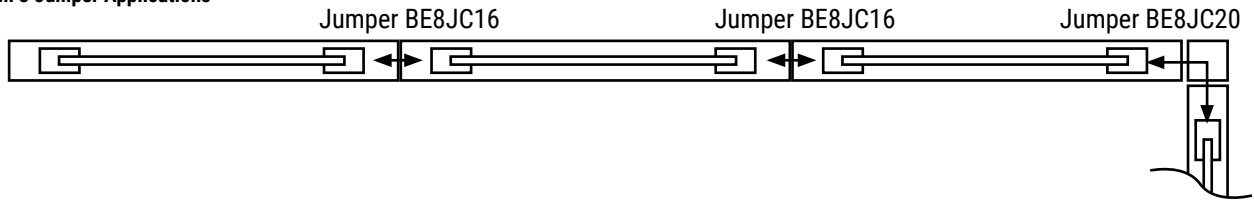

**Boulevard System 3 Jumper Applications**

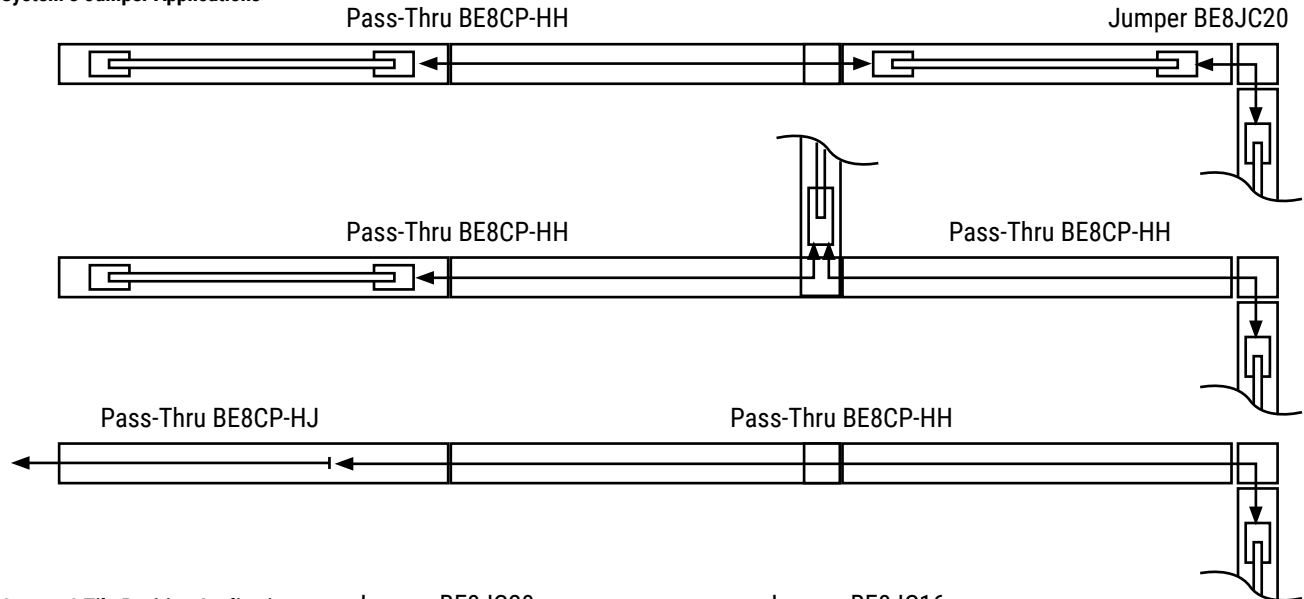

**Boulevard System 3 Tile Position Application**

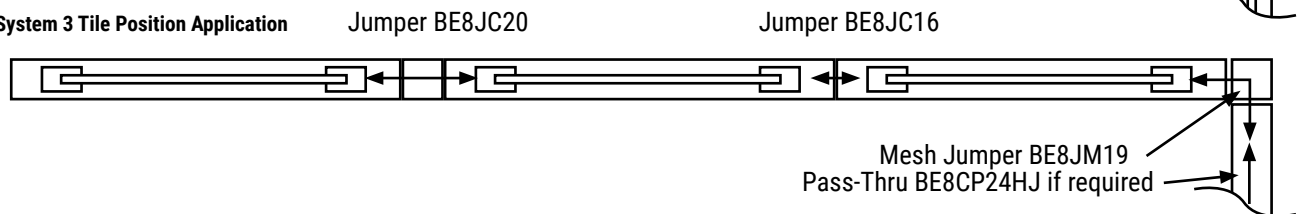

**BE8CI-1 • "I" Connector**

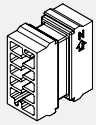

- Connects two Pass Thru Cables.
- Inline coupler used to connect two BE8CPxxHH Pass-Thru Cables.

PRODUCT CODE	PRICE	SIZE/ INCHES			WEIGHT VOL	
		H	W	D	LBS	FT <sup>3</sup>
BE8CI1	77	1.5	1.5	4.625	0.06	0.03

**BE8D • Duplex Receptacles**

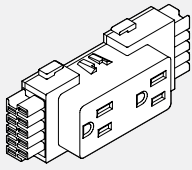

- Snaps into Power Distribution Housing.
- Up to 6 duplex receptacles per circuit.
- BE8D1 = Circuit #1 (utility circuit)
- BE8D2 = Circuit #2 (utility circuit)
- BE8D3 = Circuit #3 (utility circuit)
- BE8DA - Circuit #A (dedicated circuit)

PRODUCT CODE	PRICE	SIZE/ INCHES			WEIGHT VOL	
		H	W	D	LBS	FT <sup>3</sup>
BE8D1	32	2	4.625	1.25	0.10	0.01
BE8D2	32	2	4.625	1.25	0.10	0.01
BE8D3	32	2	4.625	1.25	0.10	0.01
BE8DA	32	2	4.625	1.25	0.10	0.01

**BE8D • USB Receptacles**

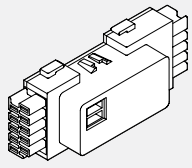

- Snaps into Power Distribution Housing.
- USB charging module provides convenient charging power access through dual ports on face of receptacles.
- Two USB ports.
- 2 amp output, considered as circuit #1.

PRODUCT CODE	PRICE	SIZE/ INCHES			WEIGHT VOL	
		H	W	D	LBS	FT <sup>3</sup>
BE8DU1-B	216	2	4.625	1.25	0.10	0.01
BE8DU1-W	216	2	4.625	1.25	0.10	0.01

**BE83BF • Reversible Base Feed (Boulevard System 3 only)**

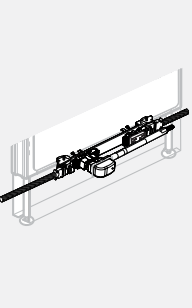

- Provides single power entry from floor circuit to raceway.
- Takes the place of a duplex receptacle by connecting to the base raceway channel of a Boulevard System 3 panel.
- BE83BF72 includes 72" long liquid-tite conduit, BE83BF144 includes 144" long liquid-tite conduit.
- Must be hard wired to power source by a licensed electrician.

PRODUCT CODE	PRICE	SIZE/ INCHES			WEIGHT VOL	
		H	L	D	LBS	FT <sup>3</sup>
BE83BF72	321	3	72	3	3.82	2
BE83BF144	409	3	144	3	6.98	2

**BE83BFR72 • Raceway Entry Base Feed (Boulevard System 3 only)**

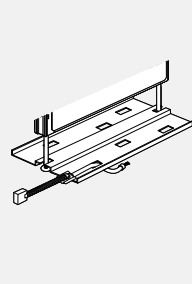

- Brings power to an adjacent panel by entering a non-powered raceway of a Boulevard System 3 panel through a duplex opening.
- Includes 72" long liquid-tite conduit.
- Must be hard wired to power source by a licensed electrician.

PRODUCT CODE	PRICE	SIZE/ INCHES			WEIGHT VOL	
		H	L	D	LBS	FT <sup>3</sup>
BE83BFR72	397	3	88	3	4.82	2

**BE8CF-1 • Ceiling Feed - Single**

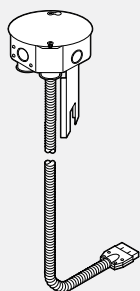

- Provides single power entry from ceiling, through post and into raceway channel.
- Power entry cable penetrates 8" into a panel and plugs into either a Power Distribution Housing or BE8CPxxHJ Pass-Thru Harness.
- Specify Post Extension separately.
- Must be hard wired to power source by a licensed electrician.

PRODUCT CODE	PRICE	SIZE/ INCHES			WEIGHT VOL	
		H	L	D	LBS	FT <sup>3</sup>
BE8CF1201	321	6	120	6	5.24	2
BE8CF1441	435	6	144	6	5.96	2

**BE8CF-2 • Ceiling Feed - Double**

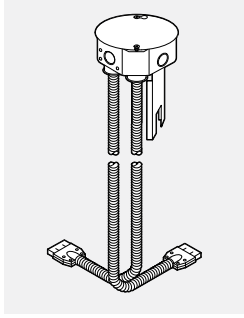

- Provides dual power entry from ceiling, through post and into raceway channel.
- Power entry cable penetrates 8" into a panel and plugs into either a Power Distribution Housing or a BE8CPxxHJ Pass-Thru Harness.
- Use 1) In middle of run to distribute power in two directions.  
2) At beginning of run where second Ceiling Feed harness is connected to BE8CPxxHJ and distributes power underneath Power Distribution Housing to pick-up second circuit grouping in long panel run.
- Specify Post Extension separately.
- Must be hard wired to power source by a licensed electrician.

PRODUCT CODE	PRICE	SIZE/ INCHES			WEIGHT VOL	
		H	L	D	LBS	FT <sup>3</sup>
BE8CF1202	564	6	120	3	5.24	2
BE8CF1442	637	6	144	3	5.96	2

**BE81BF-1 • Base Feed - Single (Boulevard 1 only)**

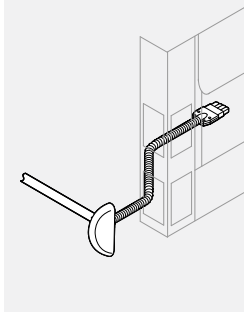

- Provides single power entry from floor, through post and into Boulevard 1 raceway channel.
- Power entry cable penetrates 8" into a panel and plugs into either a Power Distribution Housing or a BE8CPxxHJ Pass-Thru Harness.
- Power entry dome available in black only, but "Capture Strip" connector will match the post colour as standard.
- 2 1/2" clearance in depth and 5 1/2" away from any obstructions required from power entry point.
- Comes with 32" harness attached. Liquid-tite whip 72" and 144".
- Must be hard wired to power source by a licensed electrician.

PRODUCT CODE	PRICE	SIZE/ INCHES			WEIGHT VOL	
		H	L	D	LBS	FT <sup>3</sup>
BE81BF721	317	6	107	3	3.82	2
BE81BF1441	424	6	179	3	5.96	2

**BE81BF-1FL • Base Feed - Single (Boulevard 1 only)**

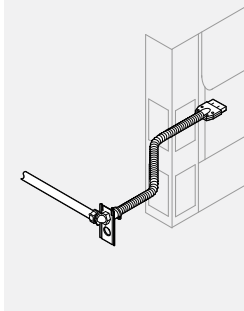

- Provides single power entry from floor, through post and into Boulevard 1 raceway channel.
- Power entry cable penetrates 8" into a panel and plugs into either a Power Distribution Housing or a BE8CPxxHJ Pass-Thru Harness.
- Power entry plate available in black only, but "Capture Strip" connector will match the post colour as standard.
- 2 1/2" clearance in depth and 5 1/2" away from any obstructions required from power entry point.
- Comes with 32" harness attached. Liquid-tite whip 72" and 144".
- Must be hard wired to power source by a licensed electrician.

PRODUCT CODE	PRICE	SIZE/ INCHES			WEIGHT VOL	
		H	L	D	LBS	FT <sup>3</sup>
BE81BF721FL	317	6	107	3	3.82	2
BE81BF1441FL	424	6	179	3	3.82	2

**BE81BF-2 • Base Feed - Double (Boulevard 1 only)**

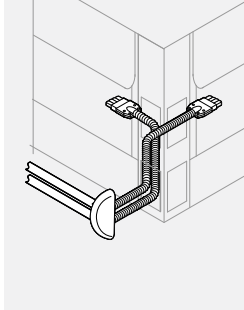

- Provides dual power entry from floor, through post and into Boulevard 1 raceway channel.
- Power entry cable penetrates 8" into a panel and plugs into either a Power Distribution Housing or a BE8CPxxHJ Pass-Thru Harness.
- Use 1) In middle of run to distribute power in two directions.  
2) At beginning of run where second Base Feed Harness is connected to BE8CPxxHJ and distributes power underneath Power Distribution Housing to pick-up second circuit grouping in long panel run.
- Liquitite whip 72" and 144".
- Power entry box available in black only, but "Capture Strip" connector will match the post colour as standard.
- 2 1/2" clearance in depth and 5 1/2" away from any obstructions required from power entry point.
- Comes with 32" harness attached.
- Must be hard wired to power source by a licensed electrician.

PRODUCT CODE	PRICE	SIZE/ INCHES			WEIGHT VOL	
		H	L	D	LBS	FT <sup>3</sup>
BE81BF722	670	6	107	3	6.98	2
BE81BF1442	894	6	179	3	6.98	2

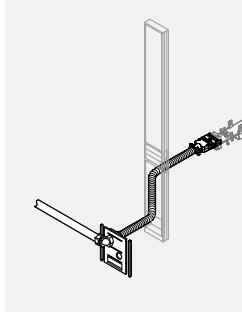

**BE81BF601 • Base Feed - Single (Boulevard 1 only)**

- Provides single power entry from floor, through 6" panel and into Boulevard 1 raceway panel.
- Power entry cable penetrates 8" into a panel and plugs into either a Power Distribution Housing or a BE8CPxxHJ Pass-Thru Harness.
- For 6" Power/Cable Access Panel only.
- Comes with 32" harness attached.
- Liquitite whip 72".
- Must be hard wired to power source by a licensed electrician.

PRODUCT CODE	PRICE	SIZE/ INCHES			WEIGHT VOL	
		H	L	D	LBS	FT <sup>3</sup>
BE81BF601	345	6	107	3	4.90	0.062

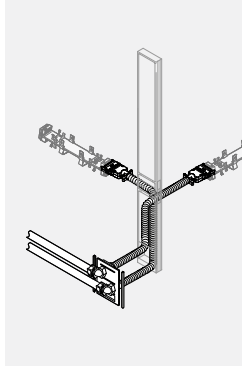
**BE81BF602 • Base Feed - Double (Boulevard 1 only)**

- Provides dual power entry from floor, through 6" panel and into Boulevard 1 raceway panel.
- Power entry cable penetrates 8" into a panel and plugs into either a Power Distribution Housing or a BE8CPxxHJ Pass-Thru Harness.
- Use
  1. In middle of run to distribute power in two directions.
  2. At beginning of run where second Base Feed Harness is connected to BE8CPxxHJ and distributes power underneath Power Distribution Housing to pick-up second circuit grouping in long panel run.
- For 6" Power/Cable Access Panel only.
- Comes with 2x32" harness attached.
- Liquid-tite whip 72".
- Must be hard wired to power source by a licensed electrician.

PRODUCT CODE	PRICE	SIZE/ INCHES			WEIGHT VOL	
		H	L	D	LBS	FT <sup>3</sup>
BE81BF602	692	6	107	3	5.30	0.071

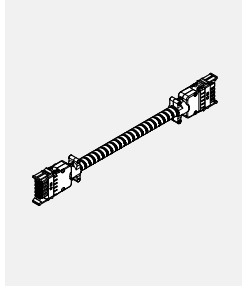
**BE8JC • Jumper Cable**

- Electrically connects two Power Distribution Housings.
- The BE8JC16 electrically connects two powered panels positioned side by side.
- The BE8JC20 electrically connects two powered panels separated by a post.
- Wires are concealed in a flexible metal conduit.
- Cannot go through a Boulevard 1 post in a corner application. (Please use the Jumper Cable Mesh)

PRODUCT CODE	PRICE	SIZE/ INCHES			WEIGHT VOL	
		H	L	D	LBS	FT <sup>3</sup>
BE8JC16	145	2	16.75	0.5	0.66	1.17
BE8JC20	147	2	20.75	0.5	0.78	1.17

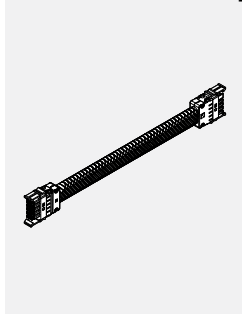
**BE8JM19 • Jumper Cable Mesh**

- Electrically connects two Power Distribution Housings in Boulevard 1 panels that are separated by a post in a corner application.
- BE8JM19 - Wires are covered with a durable nylon mesh.
- BE8JMS19 - Wires are concealed in a flexible metal shroud and covered with a durable nylon mesh.
- Used in System 3 Panels at tile position passing through post at corner application.

PRODUCT CODE	PRICE	SIZE/ INCHES			WEIGHT VOL	
		H	L	D	LBS	FT <sup>3</sup>
BE8JM19	147	2	19	0.5	0.75	1.17
BE8JMS19	167	2	19	0.5	0.75	1.17

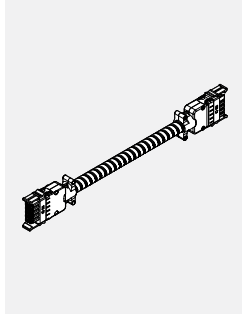
**BE83BT • Base-to-Tile Cable**

- Electrically connects a Base Raceway Power Distribution Housing to a Face Mount Tile Power Distribution Housing within a System 3 PV panel.
- Wires are concealed in a flexible metal conduit.
- BE83BT82 to be used on panels manufactured before November 1st, 2014 and BE83BT40 after.

PRODUCT CODE	PRICE	SIZE/ INCHES			WEIGHT VOL	
		H	L	D	LBS	FT <sup>3</sup>
BE83BT82	174	2	82.5	0.5	3.05	1.38
BE83BT40	146	2	40.5	0.5	1.44	1.17

**BE8CP-HH • Housing-to-Housing Pass-Thru Cable**

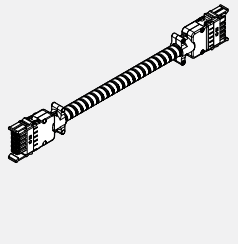

- Electrically connects two Power Distribution Housings in panels separated by one or more non-powered panels.
- Wires are concealed in a flexible metal conduit.
- **NOTE** : In Boulevard 1 and or System 3 tile position applications, the Housing-to-Housing Pass-Thru Cables can only be used in a straight run.

PRODUCT CODE	PRICE	SIZE/ INCHES			WEIGHT VOL	
		H	L	D	LBS	FT <sup>3</sup>
BE8CP40HH	146	2	40.5	0.5	1.44	1.17
BE8CP46HH	152	2	46.5	0.5	1.71	1.17
BE8CP52HH	161	2	52.5	0.5	1.95	1.17
BE8CP58HH	167	2	58.5	0.5	2.21	1.17
BE8CP64HH	173	2	64.5	0.5	2.37	1.17
BE8CP70HH	178	2	70.5	0.5	2.6	1.17
BE8CP76HH	185	2	76.5	0.5	2.81	1.17
BE8CP82HH	194	2	82.5	0.5	3.03	1.17
BE8CP88HH	201	2	88.5	0.5	3.05	1.17
BE8CP94HH	205	2	94.5	0.5	3.30	1.17
BE8CP100HH	212	2	100.5	0.5	3.47	1.17
BE8CP106HH	220	2	106.5	0.5	3.87	1.17
BE8CP118HH	233	2	118.5	0.5	4.08	1.17
BE8CP130HH	244	2	130.5	0.5	4.73	1.17
BE8CP142HH	256	2	142.5	0.5	4.99	1.17

**BE8CP-HJ • Housing-to-Jumper Pass-Thru Cable**

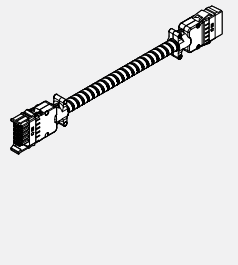

- Electrically connects a Power Distribution Housing to a Housing connection of a harness.
- Wires are concealed in a flexible metal conduit.
- **NOTE** : In both Boulevard 1 and System 3 Tile Position applications, the Housing-to-Jumper Pass-Thru Cables can only be used in a straight run.

PRODUCT CODE	PRICE	SIZE/ INCHES			WEIGHT VOL	
		H	L	D	LBS	FT <sup>3</sup>
BE8CP24HJ	113	2	24	0.5	0.9	1.17
BE8CP30HJ	119	2	30	0.5	1.3	1.17
BE8CP36HJ	124	2	36	0.5	1.44	1.17
BE8CP42HJ	154	2	42	0.5	1.71	1.17
BE8CP48HJ	161	2	48	0.5	1.95	1.17
BE8CP54HJ	171	2	54	0.5	2.21	1.17
BE8CP60HJ	178	2	60	0.5	2.37	1.17
BE8CP72HJ	185	2	72	0.5	2.81	1.17
BE8CP84HJ	200	2	84	0.5	3.05	1.17
BE8CP96HJ	212	2	96	0.5	3.3	1.17
BE8CP108HJ	221	2	108	0.5	3.87	1.17
BE8CP120HJ	234	2	120	0.5	4.08	1.17
BE8CP144HJ	266	2	144	0.5	4.59	1.17

**BE81D • Power Distribution Housing Kit - Concealed Desk Height (Boulevard 1 only)**

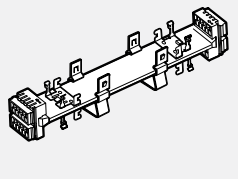

- Provides two duplex receptacles per panel for all panel widths above 24" wide.
- Power Distribution Housing is specified per panel size. eg. BE81D36 is for use with a 36" panel.

PRODUCT CODE	PRICE	SIZE/ INCHES			WEIGHT VOL	
		H	L	D	LBS	FT <sup>3</sup>
BE81D24	180	2	9.25	2.61	0.83	1.17
BE81D30	189	2	15.25	2.61	1.28	1.17
BE81D36	200	2	21.25	2.61	1.62	1.65
BE81D42	205	2	27.25	2.61	2.00	2.00
BE81D48	216	2	33.25	2.61	2.32	2.54
BE81D54	220	2	39.25	2.61	2.66	3.20
BE81D60	221	2	45.25	2.61	3.04	3.20
BE81D66	282	2	51.25	2.61	3.49	3.25
BE81D72	310	2	57.2	2.61	3.76	3.30

**BE8U2D • Power Distribution Housing Kit - Face Mount Desk Height (Boulevard 1 only)**

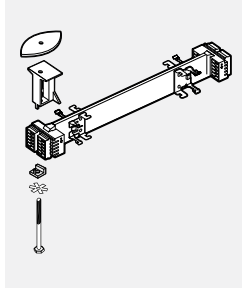

- Provides two duplex receptacles per panel side for all panel widths above 24" wide.
- Power Distribution Housing is specified per panel size. eg. BE8U2D36 is for use with a 36" panel.
- 24" wide panel allows for only one (1) duplex receptacle per panel side.

PRODUCT CODE	PRICE	SIZE/ H	INCHES			WEIGHT VOL	
			L	D	LBS	FT <sup>3</sup>	
BE8U2D24	180	2	9.25	2.61	0.83	1.17	
BE8U2D30	189	2	15.25	2.61	1.28	1.17	
BE8U2D36	200	2	21.25	2.61	1.62	1.65	
BE8U2D42	205	2	27.25	2.61	2.00	2.00	
BE8U2D48	216	2	33.25	2.61	2.32	2.54	
BE8U2D54	220	2	39.25	2.61	2.66	3.20	
BE8U2D60	221	2	45.25	2.61	3.04	3.20	
BE8U2D66	282	2	51.25	2.61	3.49	3.25	
BE8U2D72	310	2	57.25	2.61	3.76	3.30	

**BE83D • Power Distribution Housing Kit - Base Raceway (Boulevard System 3 only)**

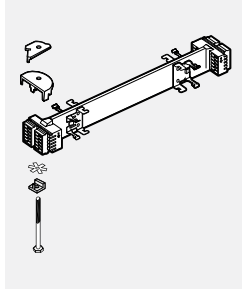

- Provides two duplex receptacles per panel side for all panel widths above 24" wide.
- Power Distribution Housing is specified per panel size. eg. BE83D36 is for use with a 36" panel.
- 24" wide panel allows for only one (1) duplex receptacle per panel side.

PRODUCT CODE	PRICE	SIZE/ H	INCHES			WEIGHT VOL	
			L	D	LBS	FT <sup>3</sup>	
BE83D24	180	2	9.25	2.61	0.83	1.17	
BE83D30	189	2	15.25	2.61	1.28	1.17	
BE83D36	200	2	21.25	2.61	1.62	1.65	
BE83D42	205	2	27.25	2.61	2.00	2.00	
BE83D48	216	2	33.25	2.61	2.32	2.54	
BE83D54	220	2	39.25	2.61	2.66	3.20	
BE83D60	221	2	45.25	2.61	3.04	3.20	
BE83D66	282	2	51.25	2.61	3.49	3.25	
BE83D72	310	2	57.25	2.61	3.76	3.30	

**BE8U3FM • Power Distribution Housing Kit - Face Mount Tile (Boulevard System 3 only)**

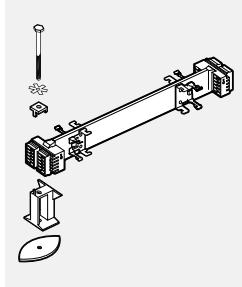

- Provides two duplex receptacles for all tile widths above 24". 24" wide tile allows for one (1) duplex receptacle.
- Housing and mounting hardware included.
- Specify duplexes, cables and tiles separately.
- BE83BT40 Base-to-Tile Cable is used to connect the tile mounted housing to the Power Distribution Housing tile in the base of the same "PV" panel.
- 24" wide tiles have one duplex and one data/comm opening. 30" and wider tiles have two data/comm openings.
- Note: Not compatible with panels built prior November 1st, 2014.

PRODUCT CODE	PRICE	SIZE/ H	INCHES			WEIGHT VOL	
			L	D	LBS	FT <sup>3</sup>	
BE8U3FM24	180	2	9.25	2.61	0.83	1.17	
BE8U3FM30	189	2	15.25	2.61	1.28	1.17	
BE8U3FM36	200	2	21.25	2.61	1.62	1.65	
BE8U3FM42	205	2	27.25	2.61	2.00	2.00	
BE8U3FM48	216	2	33.25	2.61	2.32	2.54	
BE8U3FM54	220	2	39.25	2.61	2.66	3.20	
BE8U3FM60	221	2	45.25	2.61	3.04	3.20	
BE8U3FM66	282	2	51.25	2.61	3.49	3.25	
BE8U3FM72	310	2	57.25	2.61	3.76	3.30	

**BE81D-CM • Centermount Power Distribution Housing Quad Kit - Concealed Desk Height (B1 only)**

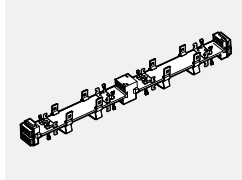

- Provides four duplex receptacles per panel for widths 36" and above.
- Centermount Distribution Housing is specified per panel size. ie. BE81D36CM is for 36" panel.
- Not available for panels less than 36" wide.

PRODUCT CODE	PRICE	SIZE/ H	INCHES			WEIGHT VOL	
			L	D	LBS	FT <sup>3</sup>	
BE81D36CM	330	2	21.99	2.61	3.24	1.65	
BE81D42CM	340	2	27.99	2.61	4.00	2.00	
BE81D48CM	347	2	33.99	2.61	4.64	2.54	
BE81D54CM	354	2	39.99	2.61	5.32	3.20	
BE81D60CM	360	2	45.99	2.61	6.04	3.20	
BE81D66CM	420	2	51.99	2.61	6.98	3.25	
BE81D72CM	481	2	57.99	2.61	7.52	3.30	

**BEPE • Post Extension**

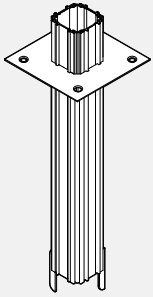

- **Lightweight aluminum pole to be used to bring power and/or data/communication cables from ceiling to a panel through a post.**
- Attaches to ceiling and post.
- Includes connectors, ceiling trim plate and screws.
- Post extension will accept:
  - 75 cables 5.6mm (0.220") dia. data cables
  - 60 cables 5.6mm (0.220") dia. data cables with 1 power feed
  - 45 cables 5.6mm (0.220") dia. data cables with 2 power feeds.
- Ceiling bezel is white only.

PRODUCT CODE	PRICE	SIZE/	INCHES		WEIGHT VOL	
			L	D	LBS	FT <sup>3</sup>
BEPE49	113	49	2.61	5.00	0.258	
BEPE81	171	81	2.61	9.00	0.424	

**BHPOST • Lay in Post Extension**

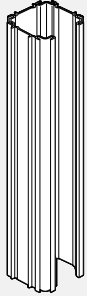

- **Three sided lightweight aluminum pole to be used to bring power and/or data/communication cables from ceiling to a panel. True lay-in application use**
- Attaches to ceiling and post.
- Includes connectors and ceiling bezel plate and screws.
- Requires vertical end trim to enclose when used in 2 way and 3 way panel run application.
- Trim encloses lay-in cable post extension, sold separately.

PRODUCT CODE	PRICE	TYPE	SIZE/ H	INCHES			WEIGHT VOL	
				L	D	LBS	FT <sup>3</sup>	
BHPOST66	177	BASE	66	2.61	2.61	8	0.346	
BHPOSTE30	83	EXTENSION	30	2.61	2.61	5	0.195	
BHPOSTE78	215	EXTENSION	78	2.61	2.61	9	0.430	

**BE2PE • Off-Module Post Extension**

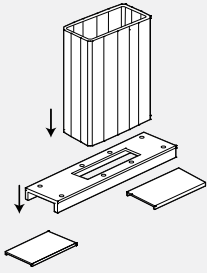

- **An alternative to the existing Ceiling Post, allows for an off-module Ceiling Feed location.**
- Attaches to the top of horizontal trim.
- Panel ceiling post consists of two aluminum extrusions for a true lay-in application.
- Includes brackets, hardware and ceiling trim plate and screws.
- Harness length will vary in length depending on post location along the panel.
- Can only be used with Boulevard System 3 "PV" and "MV" Panels.
- Requires on site cutting of top trim for placement along panel.

PRODUCT CODE	PRICE	SIZE/ H	INCHES			WEIGHT VOL	
			L	D	LBS	FT <sup>3</sup>	
BE2PE49	255	49	7.61	3.00	5	0.258	
BE2PE81	377	81	7.61	3.00	9	0.424	

**Worksurfaces**

Global Contract offers a wide variety of worksurfaces and user friendly worksurface shapes to support a variety of tasks, applications and personal preferences.

- 1 1/16" particle board.
- 45 lb. density
- 100% recycled from post consumer industrial material
- "Scoops" for cable management.
- All worksurfaces have threaded inserts for metal-to-metal connection of support hardware.

- High and Low pressure worksurfaces are 3mm edge banded.
- Wood veneer surfaces or solid wood edges available.

**Technical Information**

**Worksurfaces**

- All worksurfaces have threaded inserts for metal-to-metal connection of support hardware.
- Back edge features scoop detail.
- Worksurfaces 48" or less have one scoop while those that are 54" or more have a double scoop feature with a 1/2" wire passage trough between the scoops.
- LP and HP worksurfaces are 3mm edge banded.
- LP worksurfaces are 1" thick particle board with laminate finish.
- HP worksurfaces are 1 1/16" thick particle board with laminate finish.
- T worksurfaces are 1 1/16" thick particle board with laminate finish and wood trim.
- W worksurfaces are 1 3/16" thick particle board with wood veneer finish. Edge is solid wood edge banded.
- One universal cantilever supports two abutting worksurfaces.

- 20" deep worksurfaces available at same price as 24" deep worksurfaces.
- Support hardware must be ordered separately.
- Edge banded worksurfaces without scoops available, substitute "NFL" for "SCP" at the end of the code.

**Transaction Worksurfaces**

- To install transaction worksurfaces to a 42" high panel, use BHBT02 bracket.
- To install transaction worksurfaces to a 37" high panel, use BHBT37 bracket.

**WORKSURFACE COMPONENTS - GUIDELINES FOR ORDERING PRODUCT**

**Codes**

The price list uses a numbering system with meaningful alphanumeric characters to create a simple-to-understand product number. This makes specifying the product much easier and more accurate.

Example of Worksurface: **BWS2460PHPMR71TCHR**

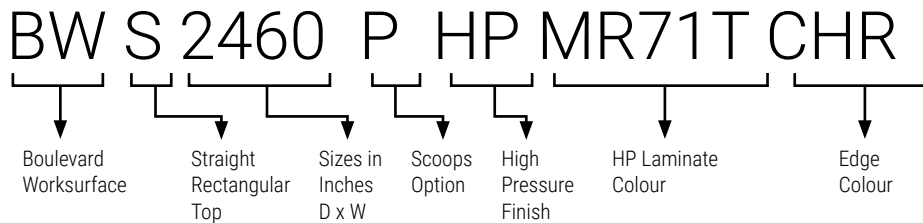

**How to Specify**

- Specify Boulevard worksurface type and size by code.
- Specify scoops option by adding "P" at end of code.
- Specify type of finish.
- Specify High Pressure Laminate Colour.
- Specify PVC edge colour.

Example of Hardware: **BHC24 CHR**

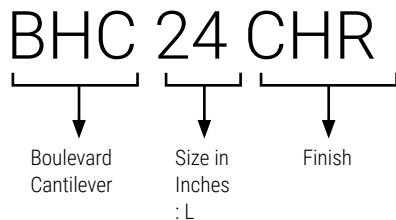

**How to Specify**

- Specify Boulevard hardware type and size by code.
- Specify type of finish.

**BWS • Straight Rectangular Worksurface**

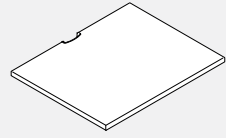

**Worksurfaces 54" or Less**

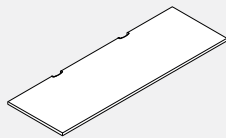

**Worksurfaces 60" or Longer**

• **Straight rectangular work-surfaces are non-handed and can be interchanged on site.**

• Please choose from DWT - Designer White, SIL - Silver or BLK - Black for scoop covers.

• Surfaces with wood trim (T) and complete wood (W) will not have the plastic scoop, they will remain with the curve cut scoop.

• To specify wood trim (T) or complete wood (W) surfaces, please remove the last "P" from the code, replace with "SCP" and add either a "T" or "W" and the old scoop style is going to be created.

PRODUCT CODE	PRICE LP*	GROUP			SIZE/ H	INCHES			WEIGHT VOL	
		HP*	T*	W*		W	D	LBS	FT <sup>3</sup>	
BWS1818P	123	156	352	462	1	18	18	9	0.29	
BWS1824P	127	169	359	546	1	24	18	12	0.39	
BWS1830P	134	178	386	638	1	30	18	15	0.49	
BWS1836P	154	204	421	729	1	36	18	18	0.59	
BWS1842P	202	270	497	853	1	42	18	21	0.68	
BWS1848P	242	318	505	890	1	48	18	24	0.78	
BWS1854P	284	374	722	1024	1	54	18	27	0.88	
BWS1860P	319	410	729	1042	1	60	18	30	1.00	
BWS1866P	334	439	750	1070	1	66	18	32	1.10	
BWS1872P	352	464	774	1096	1	72	18	35	1.20	
BWS1878P	369	488	934	1168	1	78	18	38	1.30	
BWS1884P	405	530	959	1238	1	84	18	41	1.40	
BWS2418P	127	163	383	513	1	18	24	12	0.40	
BWS2424P	129	173	392	609	1	24	24	16	0.52	
BWS2430P	141	184	419	718	1	30	24	20	0.65	
BWS2436P	156	207	451	818	1	36	24	23	0.78	
BWS2442P	205	272	528	963	1	42	24	28	0.90	
BWS2448P	245	329	537	1055	1	48	24	31	1.03	
BWS2454P	290	383	750	1198	1	54	24	35	1.20	
BWS2460P	326	430	756	1227	1	60	24	39	1.30	
BWS2466P	340	449	765	1264	1	66	24	43	1.41	
BWS2472P	355	470	796	1300	1	72	24	47	1.54	
BWS2478P	381	501	862	1389	1	78	24	51	1.70	
BWS2484P	410	537	956	1480	1	84	24	55	1.80	
BWS3018P	145	186	413	612	1	18	30	15	0.50	
BWS3024P	154	202	421	736	1	24	30	20	0.70	
BWS3030P	165	218	484	851	1	30	30	25	0.97	
BWS3036P	194	256	526	986	1	36	30	30	1.06	
BWS3042P	275	362	624	1029	1	42	30	34	1.12	
BWS3048P	290	383	635	1099	1	48	30	39	1.30	
BWS3054P	317	408	816	1254	1	54	30	44	1.44	
BWS3060P	340	449	821	1291	1	60	30	49	1.60	
BWS3066P	353	469	849	1376	1	66	30	54	1.80	
BWS3072P	374	495	894	1458	1	72	30	59	2.00	
BWS3078P	398	524	971	1560	1	78	30	64	2.10	
BWS3084P	443	579	1029	1664	1	84	30	69	2.24	
BWS3672P	528	693	1082	1734	1	72	36	71	2.30	

• LP = Thermally Fused Laminate, HP = High Pressure Laminate, T= High Pressure Laminate with Wood Trim, W= Wood Veneer

**BWSP • Straight Rectangular Worksurface to span a Post**

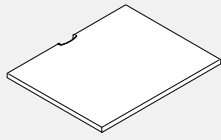

Worksurfaces 57" or Less

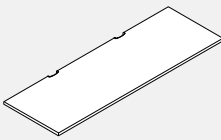

Worksurfaces 63" or Longer

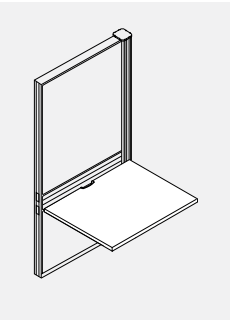

Application of Worksurface

• Straight rectangular work-surfaces are non-handed and can be interchanged on site.

• Worksurface will span the width of a post eliminating a gap between standard sizes.

• Please choose from DWT - Designer White, SIL - Silver or BLK - Black for scoop covers.

• Surfaces with wood trim (T) and complete wood (W) will not have the plastic scoop, they will remain with the curve cut scoop.

• To specify wood trim (T) or complete wood (W) surfaces, please remove the last "P" from the code, replace with "SCP" and add either a "T" or "W" and the old scoop style is going to be created.

PRODUCT CODE	PRICE LP*	GROUP HP*	T*	W*	SIZE/ INCHES			WEIGHT VOL	
					H	W	D	LBS	FT <sup>3</sup>
BWSP1821P	127	169	359	546	1	21	18	10	0.34
BWSP1827P	134	178	386	638	1	27	18	13	0.44
BWSP1833P	154	204	421	729	1	33	18	16	0.53
BWSP1839P	202	270	497	853	1	39	18	19	0.63
BWSP1845P	242	318	505	890	1	45	18	22	0.72
BWSP1851P	284	374	605	908	1	51	18	25	0.82
BWSP1857P	319	410	729	1042	1	57	18	28	0.92
BWSP1863P	334	439	750	1070	1	63	18	31	1.01
BWSP1869P	352	464	774	1096	1	69	18	34	1.11
BWSP1875P	369	488	838	1168	1	75	18	37	1.21
BWSP1881P	405	530	884	1238	1	81	18	40	1.30
BWSP1887P	435	573	931	1313	1	87	18	43	1.40
BWSP2421P	129	173	392	609	1	21	24	14	0.45
BWSP2427P	141	184	419	718	1	27	24	17	0.60
BWSP2433P	156	207	451	818	1	33	24	21	0.70
BWSP2439P	205	272	528	963	1	39	24	25	0.83
BWSP2445P	245	329	537	1055	1	45	24	29	1.00
BWSP2451P	290	383	634	1082	1	51	24	33	1.10
BWSP2457P	326	430	756	1227	1	57	24	37	1.22
BWSP2463P	340	449	796	1264	1	63	24	41	1.34
BWSP2469P	355	470	837	1300	1	69	24	45	1.47
BWSP2475P	381	501	862	1389	1	75	24	49	1.60
BWSP2481P	410	537	910	1480	1	81	24	53	1.73
BWSP2487P	443	589	958	1568	1	87	24	57	1.90
BWSP3021P	163	202	421	736	1	21	30	17	0.56
BWSP3027P	165	218	484	851	1	27	30	22	0.72
BWSP3033P	194	256	526	986	1	33	30	27	0.88
BWSP3039P	275	362	624	1029	1	39	30	32	1.04
BWSP3045P	290	383	635	1099	1	45	30	37	1.20
BWSP3051P	317	408	699	1137	1	51	30	41	1.40
BWSP3057P	340	449	821	1291	1	57	30	46	1.51
BWSP3063P	353	469	849	1376	1	63	30	51	1.67
BWSP3069P	374	495	894	1458	1	69	30	56	1.83
BWSP3075P	398	524	971	1560	1	75	30	61	2.00
BWSP3081P	443	579	1029	1664	1	81	30	66	2.20
BWSP3087P	488	646	1085	1764	1	87	30	70	2.30
BWSP3675P	541	712	1082	1734	1	75	36	73	2.40

• LP = Thermally Fused Laminate, HP = High Pressure Laminate, T= High Pressure Laminate with Wood Trim, W= Wood Veneer

**BWS • Straight Rectangular Worksurface without Flex Lip or Scoops**

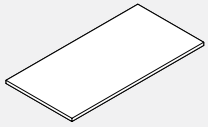

- Straight rectangular work-surfaces are non-handed and can be interchanged on site.
- Worksurface features no scoop or flex lip.

PRODUCT CODE	PRICE LP*	GROUP HP*	T*	W*	SIZE/ INCHES			WEIGHT VOL	
					H	W	D	LBS	FT <sup>3</sup>
BWS1818NFL	123	156	233	343	1	18	18	9	0.28
BWS1824NFL	127	169	242	428	1	24	18	12	0.40
BWS1830NFL	134	178	270	523	1	30	18	15	0.50
BWS1836NFL	154	204	303	612	1	36	18	18	0.59
BWS1842NFL	202	270	380	736	1	42	18	21	0.68
BWS1848NFL	242	318	389	771	1	48	18	24	0.78
BWS1854NFL	284	374	488	792	1	54	18	27	0.88
BWS1860NFL	319	410	495	807	1	60	18	29	0.97
BWS1866NFL	334	439	518	847	1	66	18	32	1.10
BWS1872NFL	352	464	545	862	1	72	18	35	1.20
BWS1878NFL	369	488	605	934	1	78	18	38	1.30
BWS1884NFL	405	530	650	1007	1	84	18	41	1.40
BWS2418NFL	127	163	266	397	1	18	24	12	0.40
BWS2424NFL	129	173	272	493	1	24	24	16	0.52
BWS2430NFL	141	184	300	603	1	30	24	20	0.65
BWS2436NFL	156	207	334	702	1	36	24	24	0.78
BWS2442NFL	205	272	410	843	1	42	24	28	0.90
BWS2448NFL	245	329	420	938	1	48	24	31	1.03
BWS2454NFL	290	383	518	965	1	54	24	35	1.20
BWS2460NFL	326	430	524	993	1	60	24	39	1.30
BWS2466NFL	340	449	561	1032	1	66	24	43	1.41
BWS2472NFL	355	470	603	1067	1	72	24	47	1.54
BWS2478NFL	381	501	626	1158	1	78	24	51	1.70
BWS2484NFL	410	537	675	1247	1	84	24	55	1.80
BWS3018NFL	145	186	297	495	1	18	30	15	0.50
BWS3024NFL	154	202	304	619	1	24	30	20	0.65
BWS3030NFL	165	218	366	733	1	30	30	25	0.81
BWS3036NFL	194	256	408	868	1	36	30	29	1.00
BWS3042NFL	275	362	508	911	1	42	30	34	1.13
BWS3048NFL	290	383	519	982	1	48	30	39	1.30
BWS3054NFL	317	408	583	1021	1	54	30	44	1.44
BWS3060NFL	340	449	587	1058	1	60	30	49	1.60
BWS3066NFL	353	469	615	1141	1	66	30	54	1.76
BWS3072NFL	374	495	660	1164	1	72	30	59	1.91
BWS3078NFL	398	524	737	1327	1	78	30	64	2.10
BWS3084NFL	443	579	795	1430	1	84	30	69	2.24
BWS3672NFL	528	693	1082	1734	1	72	36	71	2.30

**BWSC • Curvelinear Front Edge Worksurface**

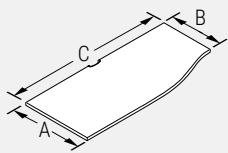

- Curvelinear front edge worksurface.
- Allows efficient use of a small footprint.
- The curve on the 30" and 36" wide worksurfaces have been modified to allow a pedestal to fit.
- Please choose from DWT - Designer White, SIL - Silver or BLK - Black for scoop covers.
- Surfaces with wood trim (T) and complete wood (W) will not have the plastic scoop, they will remain with the curve cut scoop.
- To specify wood trim (T) or complete wood (W) surfaces, please remove the last "P" from the code, replace with "SCP" and add either a "T" or "W" and the old scoop style is going to be created.
- Surfaces 60" wide will have two scoops, all others have one scoop.

PRODUCT CODE	PRICE LP*	GROUP HP*	T*	W*	SIZE/ INCHES			WEIGHT VOL	
					H	W	D	LBS	FT <sup>3</sup>
BWSC182430P	177	233	574	944	1	30	24	18	0.65
BWSC182436P	211	281	616	1080	1	36	24	22	0.78
BWSC182442P	245	329	715	1123	1	42	24	26	0.90
BWSC182448P	281	374	724	1195	1	48	24	30	1.03
BWSC182454P	317	420	904	1350	1	54	24	34	1.20
BWSC182460P	344	469	911	1388	1	60	24	38	1.30
BWSC241830P	177	233	574	944	1	30	24	18	0.65
BWSC241836P	211	281	616	1080	1	36	24	22	0.78
BWSC241842P	245	329	715	1123	1	42	24	26	0.90
BWSC241848P	281	374	724	1195	1	48	24	30	1.03
BWSC241854P	317	420	904	1350	1	54	24	34	1.2
BWSC241860P	344	469	911	1388	1	60	24	38	1.3
BWSC243030P	186	244	710	1189	1	30	30	23	0.81
BWSC243036P	222	281	765	1288	1	36	30	28	1
BWSC243042P	303	400	895	1522	1	42	30	33	1.13
BWSC243048P	317	420	904	1540	1	48	30	38	1.3
BWSC243054P	353	469	1107	1811	1	54	30	42	1.44
BWSC243060P	380	513	1115	1827	1	60	30	47	1.6
BWSC302430P	186	244	710	1189	1	30	30	23	0.81
BWSC302436P	222	281	765	1288	1	36	30	28	1
BWSC302442P	303	400	895	1522	1	42	30	33	1.13
BWSC302448P	317	420	904	1540	1	48	30	38	1.3
BWSC302454P	353	469	1107	1811	1	54	30	42	1.44
BWSC302460P	380	513	1115	1827	1	60	30	47	1.6

**NOTE: BWSC**

<b>24</b>	<b>18</b>	<b>30</b>
A	B	C
WIDTH	WIDTH	LENGTH

• LP = Thermally Fused Laminate, HP = High Pressure Laminate, T= High Pressure Laminate with Wood Trim, W= Wood Veneer



**BWCC • Curved Corner Worksurface**

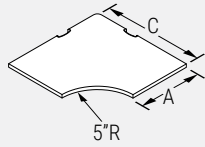

**NOTE: BWCC**

<b>36</b>	<b>18</b>
<b>C</b>	<b>A</b>
<b>WIDTH</b>	<b>DEPTH</b>

- Allows efficient use of corner space for computer or printer applications.

• BWCC3624 has a front radius of 12". It is not usable for keyboard support.

• Please choose from DWT - Designer White, SIL - Silver or BLK - Black for scoop covers.

• Surfaces with wood trim (T) and complete wood (W) will not have the plastic scoop, they will remain with the curve cut scoop.

• To specify wood trim (T) or complete wood (W) surfaces, please remove the last "P" from the code, replace with "SCP" and add either a "T" or "W" and the old scoop style is going to be created.

PRODUCT CODE	PRICE LP*	GROUP HP*	T*	W*	SIZE/ H	INCHES W	D	WEIGHT LBS	VOL FT <sup>3</sup>
BWCC3618P	385	481	818	1428	1	36	36	29	1.20
BWCC3624P	426	532	818	1428	1	36	36	32	1.20
BWCC4224P	574	715	1038	1647	1	42	42	41	1.60
BWCC4230P	589	737	1038	1647	1	42	42	45	1.60
BWCC4824P	668	832	1287	2096	1	48	48	50	2.00
BWCC4830P	668	832	1287	2096	1	48	48	56	2.00

CODE	RADIUS "R"
BWCC3618P	18"
BWCC3624P	12"
BWCC4224P	18"
BWCC4230P	12"
BWCC4824P	24"
BWCC4830P	18"

NOTE: 12" radius not recommended for keyboards

**BWCF • Five Sided Corner Worksurface**

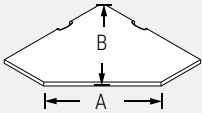

- Creates efficient use of corner space for computer or printer applications.

• Please choose from DWT - Designer White, SIL - Silver or BLK - Black for scoop covers.

• Surfaces with wood trim (T) and complete wood (W) will not have the plastic scoop, they will remain with the curve cut scoop.

• To specify wood trim (T) or complete wood (W) surfaces, please remove the last "P" from the code, replace with "SCP" and add either a "T" or "W" and the old scoop style is going to be created.

PRODUCT CODE	PRICE LP*	GROUP HP*	T*	W*	SIZE/ H	INCHES W	D	WEIGHT LBS	VOL FT <sup>3</sup>
BWCF3012P	251	311	774	1277	1	30	30	28	1.00
BWCF3612P	331	413	882	1290	1	36	36	30	1.03
BWCF3618P	331	413	789	1290	1	36	36	31	1.20
BWCF3624P	344	433	789	1290	1	36	36	33	1.20
BWCF3630P	361	451	789	1290	1	36	36	35	1.20
BWCF4218P	471	589	994	1507	1	42	42	40	1.60
BWCF4224P	488	609	994	1507	1	42	42	45	1.60
BWCF4230P	502	633	994	1507	1	42	42	47	1.60
BWCF4818P	534	669	1082	1651	1	48	48	40	1.60
BWCF4824P	550	686	1082	1651	1	48	48	45	1.60
BWCF4830P	579	725	1082	1651	1	48	48	47	1.60

CODE	PANEL SIZES	ADJOINED WORKSURFACE DEPTH	A	B
BWCF3012P	30	12	25.5	29.8
BWCF3612P	36	12	34.0	34.0
BWCF3618P	36	18	25.5	37.9
BWCF3624P	36	24	17.0	42.1
BWCF3630P	36	30	8.5	46.4
BWCF4218P	42	18	33.9	42.1
BWCF4224P	42	24	25.5	46.4
BWCF4230P	42	30	17.0	50.6
BWCF4818P	48	18	42.4	46.4
BWCF4824P	48	24	33.9	50.6
BWCF4830P	48	30	25.5	54.8

**BWCL • "L" Corner Worksurface**

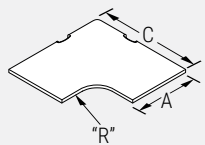

**NOTE: BWCL**

- 5" radius not recommended for keyboards.

<b>36</b>	<b>18</b>
<b>C</b>	<b>A</b>
<b>WIDTH</b>	<b>DEPTH</b>

- Creates efficient use of corner space for computer or printer applications.

• Please choose from DWT - Designer White, SIL - Silver or BLK - Black for scoop covers.

• Surfaces with wood trim (T) and complete wood (W) will not have the plastic scoop, they will remain with the curve cut scoop.

• To specify wood trim (T) or complete wood (W) surfaces, please remove the last "P" from the code, replace with "SCP" and add either a "T" or "W" and the old scoop style is going to be created.

PRODUCT CODE	PRICE LP*	GROUP HP*	T*	W*	SIZE/ H	INCHES W	D	WEIGHT LBS	VOL FT <sup>3</sup>
BWCL3018P	229	284	433	1249	1	30	30	20	0.80
BWCL3024P	234	296	433	1249	1	30	30	23	0.80
BWCL3618P	344	433	585	1254	1	36	36	27	1.20
BWCL3624P	362	451	585	1254	1	36	36	31	1.20
BWCL3630P	378	471	585	1254	1	36	36	34	1.20
BWCL4218P	503	626	805	1472	1	42	42	32	1.60
BWCL4224P	520	649	805	1472	1	42	42	39	1.60
BWCL4230P	534	669	805	1472	1	42	42	44	1.60
BWCL4818P	550	688	932	1625	1	48	48	38	2.00
BWCL4824P	564	705	932	1625	1	48	48	47	2.00
BWCL4830P	583	727	932	1625	1	48	48	54	2.00

• LP = Thermally Fused Laminate, HP = High Pressure Laminate, T= High Pressure Laminate with Wood Trim, W= Wood Veneer

**BWAC45 • Curved Corner Worksurface for 45 Degree Angle**

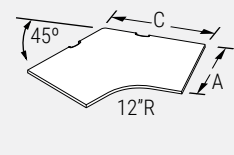

**NOTE: BWAC**

<b>45°</b>	<b>24</b>	<b>18</b>
	C	A
45° POST	WIDTH	DEPTH

- **Five sided corner unit for 45 degree Corner Posts.**
- Creates efficient use of space for computer or printer application.
- Please choose from DWT - Designer White, SIL - Silver or BLK - Black for scoop covers.
- Surfaces with wood trim (T) and complete wood (W)

PRODUCT CODE	PRICE LP*	GROUP HP*	T*	W*	SIZE/ INCHES			WEIGHT VOL	
					H	W	D	LBS	FT <sup>3</sup>
BWAC452418P	385	481	1007	1343	1	24	18	38	1.14
BWAC452424P	399	501	1518	2026	1	24	24	42	1.29
BWAC452430P	418	521	2006	2677	1	24	30	48	1.45
BWAC453018P	497	619	1223	1628	1	30	18	53	1.61
BWAC453024P	561	702	1454	1939	1	30	24	60	1.80
BWAC453030P	622	779	1861	2481	1	30	30	66	2.01
BWAC453618P	699	869	1416	1890	1	36	18	66	2.01
BWAC453624P	774	969	1746	2323	1	36	24	71	2.16
BWAC453630P	851	1062	2198	2930	1	36	30	76	2.30

- Surfaces with wood trim (T) and complete wood (W) will not have the plastic scoop, they will remain with the curve cut scoop.
- To specify wood trim (T) or complete wood (W) surfaces, please remove the last "P" from the code, replace with "SCP" and add either a "T" or "W" and the old scoop style is going to be created.

**BWAC60 • Curved Corner Worksurface for 60 Degree Angle**

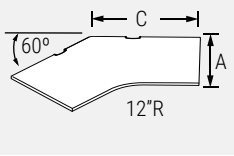

**NOTE: BWAC**

<b>60°</b>	<b>24</b>	<b>18</b>
	C	A
60° POST	WIDTH	DEPTH

- **Five sided corner unit for 60 degree Corner Posts.**
- Creates efficient use of space for computer or printer application.
- Please choose from DWT - Designer White, SIL - Silver or BLK - Black for scoop covers.
- Surfaces with wood trim (T) and complete wood (W)

PRODUCT CODE	PRICE LP*	GROUP HP*	T*	W*	SIZE/ INCHES			WEIGHT VOL	
					H	W	D	LBS	FT <sup>3</sup>
BWAC602418P	331	413	837	1114	1	24	18	33	0.99
BWAC602424P	344	433	1003	1334	1	24	24	36	1.09
BWAC602430P	361	451	1063	1418	1	24	30	39	1.19
BWAC603018P	451	564	1025	1365	1	30	18	48	1.46
BWAC603024P	493	613	1207	1612	1	30	24	52	1.58
BWAC603030P	528	663	1315	1752	1	30	30	56	1.71
BWAC603618P	642	805	1197	1594	1	36	18	66	2.01
BWAC603624P	691	866	1416	1890	1	36	24	71	2.16
BWAC603630P	740	926	1541	2056	1	36	30	76	2.31

- Surfaces with wood trim (T) and complete wood (W) will not have the plastic scoop, they will remain with the curve cut scoop.
- To specify wood trim (T) or complete wood (W) surfaces, please remove the last "P" from the code, replace with "SCP" and add either a "T" or "W" and the old scoop style is going to be created.

**BWCE • Extended Curved Corner Worksurface**

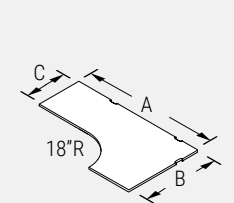

**NOTE: BWCE**

<b>60</b>	<b>42</b>	<b>24</b>
A	B	C
WIDTH	WIDTH	LENGTH

- **Extended curved corner unit with a radius user edge.**
- Creates efficient use of a corner unit.
- Please choose from DWT - Designer White, SIL - Silver or BLK - Black for scoop covers.
- Surfaces with wood trim (T) and complete wood (W) will not have the plastic scoop, they will remain with the curve cut scoop.
- To specify wood trim (T) or complete wood (W) surfaces, please remove the last "P" from the code, replace with "SCP" and add either a "T" or "W" and the old scoop style is going to be created.

PRODUCT CODE	PRICE LP*	GROUP HP*	T*	W*	SIZE/ INCHES			WEIGHT VOL	
					H	W	D	LBS	FT <sup>3</sup>
BWCE426024P	668	832	1230	2020	1	60	42	57	2.2
BWCE426624P	736	919	1286	2107	1	66	42	62	2.5
BWCE427224P	811	1015	1440	2362	1	72	42	66	2.7
BWCE427824P	867	1084	1539	2519	1	78	42	71	2.9
BWCE428424P	934	1166	1656	2715	1	84	42	75	3.1
BWCE486024P	763	955	1528	2507	1	60	48	66	2.5
BWCE486624P	849	1060	1575	2641	1	66	48	71	2.8
BWCE487224P	928	1162	1575	2641	1	72	48	76	3.1
BWCE487824P	991	1236	1733	2842	1	78	48	83	3.3
BWCE488424P	1051	1313	1733	2842	1	84	48	93	3.6
BWCE486030P	849	1060	1528	2507	1	60	48	68	2.5
BWCE486630P	928	1162	1608	2640	1	66	48	74	2.8
BWCE487230P	991	1236	1647	2698	1	72	48	80	3.1
BWCE487830P	1051	1313	1785	2926	1	78	48	85	3.3
BWCE488430P	1124	1408	1923	3149	1	84	48	96	3.6
BWCE604224P	668	832	1230	2020	1	42	60	57	2.2
BWCE604824P	763	955	1528	2507	1	48	60	66	2.6
BWCE604830P	849	1060	1528	2507	1	48	60	68	2.6
BWCE664224P	736	919	1286	2107	1	42	66	62	2.5
BWCE664824P	849	1060	1575	2641	1	48	66	71	2.8
BWCE664830P	928	1162	1608	2640	1	48	66	74	2.8
BWCE724224P	811	1015	1440	2362	1	42	72	66	2.7
BWCE724824P	928	1162	1575	2641	1	48	72	76	3.1
BWCE724830P	991	1236	1647	2698	1	48	72	80	3.1
BWCE784224P	867	1084	1539	2519	1	42	78	71	2.9
BWCE784824P	991	1236	1733	2842	1	48	78	83	3.3
BWCE784830P	1051	1313	1785	2926	1	48	78	85	3.3
BWCE844224P	934	1166	1656	2715	1	42	84	75	3.1
BWCE844824P	1051	1313	1733	2844	1	48	84	93	3.6
BWCE844830P	1124	1408	1923	3149	1	48	84	96	3.6

• LP = Thermally Fused Laminate, HP = High Pressure Laminate, T= High Pressure Laminate with Wood Trim, W= Wood Veneer

**BWCEC • Extended Curvilinear Corner Worksurface**

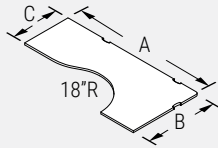

• **Extended curved corner unit with a radius user edge.**

- Creates efficient use of a corner unit.
- Please choose from DWT - Designer White, SIL - Silver or BLK - Black for scoop covers.
- Surfaces with wood trim (T) and complete wood (W) will not have the plastic scoop, they will remain with the curve cut scoop.
- To specify wood trim (T) or complete wood (W) surfaces, please remove the last "P" from the code, replace with "SCP" and add either a "T" or "W" and the old scoop style is going to be created.

**NOTE: BWSC**

<b>66</b>	<b>42</b>	<b>24</b>
A	B	C
WIDTH	WIDTH	LENGTH

PRODUCT CODE	PRICE LP*	GROUP		W*	SIZE/ INCHES			WEIGHT VOL	
		HP*	T*		A	B	C	LBS	FT <sup>3</sup>
BWCEC366024P	626	782	1524	2030	36	60	24	59	0.05
BWCEC366624P	658	821	1581	2107	36	66	24	65	0.60
BWCEC367224P	716	895	1746	2323	36	72	24	71	0.07
BWCEC367824P	778	971	1847	2461	36	78	24	77	0.07
BWCEC368424P	868	1084	2032	2626	36	84	24	83	0.08
BWCEC426624P	757	945	1843	2457	42	66	24	76	0.07
BWCEC427224P	838	1047	2032	2710	42	72	24	83	0.08
BWCEC427824P	893	1118	2155	2872	42	78	24	90	0.08
BWCEC428424P	963	1202	2300	3066	42	84	24	96	0.09
BWCEC487230P	1022	1279	2245	2991	48	72	30	94	0.09
BWCEC487830P	1099	1375	2396	3192	48	78	30	102	0.09
BWCEC488430P	1161	1451	2548	3392	48	84	30	110	0.10
BWCEC488424P	1098	1375	2300	3066	48	84	24	110	0.10
BWCEC603624P	626	782	1524	2030	60	36	24	59	0.05
BWCEC663624P	658	821	1581	2107	66	36	24	65	0.60
BWCEC664224P	757	945	1843	2457	66	42	24	76	0.07
BWCEC723624P	716	895	1746	2323	72	36	24	71	0.07
BWCEC724224P	838	1047	2032	2710	72	42	24	83	0.08
BWCEC724830P	1022	1279	2245	2991	72	48	30	94	0.09
BWCEC783624P	778	971	1847	2461	78	36	24	77	0.07
BWCEC784224P	893	1118	2155	2872	78	42	24	89	0.08
BWCEC784830P	1099	1375	2396	3192	78	48	30	102	0.09
BWCEC843624P	868	1084	2032	2626	84	36	24	83	0.08
BWCEC844224P	963	1202	2032	2626	84	42	24	96	0.09
BWCEC844824P	1098	1375	2300	3066	84	48	24	110	0.10
BWCEC844830P	1161	1451	2548	3392	84	48	30	110	0.10

**BWSL • Curvilinear Arc Worksurface**

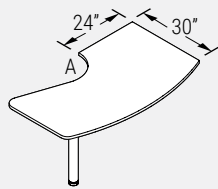

RIGHT HAND SHOWN MONOLEG MOUNTED ON THE RIGHT USER SIDE.

• **Arc shaped worksurface provides an extended conferencing area.**

- 1 BHML03 Monoleg included.
- Not recommended for use with modesty panel due to knee swing interference.
- For chrome finish on leg, please add \$106 list upcharge.

PRODUCT CODE	PRICE LP*	GROUP		W*	SIZE/ INCHES			WEIGHT VOL	
		HP*	T*		H	W	D	LBS	FT <sup>3</sup>
BWSL3060L	867	1031	1135	1928	29	60	30	48	1.69
BWSL3066L	908	1080	1261	2160	29	66	30	53	1.85
BWSL3072L	944	1131	1388	2396	29	72	30	58	2.01
BWSL3060R	867	1031	1135	1928	29	60	30	48	1.69
BWSL3066R	908	1080	1261	2160	29	66	30	53	1.85
BWSL3072R	944	1131	1388	2396	29	72	30	58	2.01

- A = 27" for 60", 66" worksurfaces
- A = 26.5" for 72" worksurfaces

**BWSL • Curvilinear Arc Worksurface**

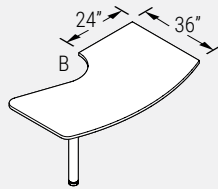

RIGHT HAND SHOWN MONOLEG MOUNTED ON THE RIGHT USER SIDE.

• **Arc shaped worksurface provides an extended conferencing area.**

- 1 BHML03 Monoleg included.
- For chrome finish on leg, please add \$106 list upcharge.

PRODUCT CODE	PRICE LP*	GROUP		W*	SIZE/ INCHES			WEIGHT VOL	
		HP*	T*		H	W	D	LBS	FT <sup>3</sup>
BWSL3660L	983	1177	1290	2220	29	60	36	57	2.07
BWSL3666L	1063	1279	1440	2489	29	66	36	64	2.26
BWSL3672L	1140	1375	1587	2762	29	72	36	71	2.45
BWSL3660R	983	1177	1290	2220	29	60	36	57	2.07
BWSL3666R	1063	1279	1440	2489	29	66	36	64	2.26
BWSL3672R	1140	1375	1587	2762	29	72	36	71	2.45

- B = 33" for 60", 66" worksurfaces
- B = 32.5" for 72" worksurfaces

• LP = Thermally Fused Laminate, HP = High Pressure Laminate, T= High Pressure Laminate with Wood Trim, W= Wood Veneer

**BWD • “D” Worksurface**

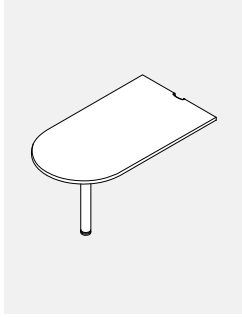

• **Rounded work surface for conferencing.**

- Supported by Monoleg at one end and panel at the opposite end.
- 1 BHML03 Monoleg included.
- Modesty panel available, see BWMP (not included).
- For chrome finish on leg, please add \$106 list upcharge.
- Please choose from DWT - Designer White, SIL - Silver or BLK - Black for scoop covers.

PRODUCT CODE	PRICE LP*	GROUP			SIZE/ INCHES			WEIGHT VOL	
		HP*	T*	W*	H	W	D	LBS	FT <sup>3</sup>
BWD2442P	552	640	675	1162	1	42	24	27	0.97
BWD2448P	576	673	705	1201	1	48	24	31	1.11
BWD2454P	592	691	778	1430	1	54	24	35	1.24
BWD2460P	605	704	813	1658	1	60	24	39	1.36
BWD2466P	622	732	849	1720	1	66	24	43	1.52
BWD2472P	642	756	884	1807	1	72	24	47	1.66
BWD3048P	579	675	807	1650	1	48	30	38	1.38
BWD3054P	609	712	838	1707	1	54	30	43	1.56
BWD3060P	646	757	879	1814	1	60	30	48	1.69
BWD3066P	674	793	944	1903	1	66	30	53	1.82
BWD3072P	710	839	966	1995	1	72	30	58	2.01
BWD3078P	751	890	1031	2145	1	78	30	63	2.25
BWD3084P	816	970	1096	2296	1	84	30	68	2.42

- Surfaces with wood trim (T) and complete wood (W) will not have the plastic scoop, they will remain with the curve cut scoop.
- To specify wood trim (T) or complete wood (W) surfaces, please remove the last “P” from the code, replace with “SCP” and add either a “T” or “W” and the old scoop style is going to be created.

**BWP • “P” Worksurface**

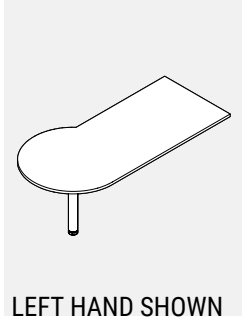

• **Rounded work surface provides an extended conferencing area.**

- **36” diameter end.**
- Supported by monoleg at one end and panel at the opposite end.
- 1 BHML03 Monoleg included.
- Modesty panel available, see BWMP (not included).
- For chrome finish on leg, please add \$106 list upcharge.

PRODUCT CODE	PRICE LP*	GROUP			SIZE/ INCHES			WEIGHT VOL	
		HP*	T*	W*	H	W	D	LBS	FT <sup>3</sup>
BWPL3054	851	1008	1124	2399	1	54	36	51	1.87
BWPL3060	889	1056	1135	2423	1	60	36	58	2.03
BWPL3066	963	1148	1164	2724	1	66	36	65	2.24
BWPL3072	1004	1200	1280	3027	1	72	36	70	2.41
BWPL3084	1110	1334	1618	3571	1	84	36	81	2.79
BWPR3054	851	1008	1124	2399	1	54	36	51	1.87
BWPR3060	889	1056	1135	2423	1	60	36	58	2.03
BWPR3066	963	1148	1164	2724	1	66	36	65	2.24
BWPR3072	1004	1200	1280	3027	1	72	36	70	2.41
BWPR3084	1110	1334	1618	3571	1	84	36	81	2.79

LEFT HAND SHOWN

**BWMP • “D” and “P” Worksurface Modesty Panel**

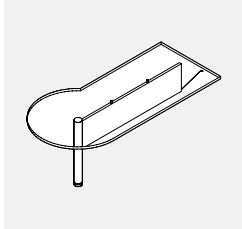

• **Made of cold rolled steel, fastens to the work surface and Monoleg for additional privacy.**

PRODUCT CODE	PRICE	SIZE/ INCHES			WEIGHT VOL	
		H	W	D	LBS	FT <sup>3</sup>
BWMP1248	122	1	32	12	12	0.4
BWMP1254	145	1	38	12	15	0.47
BWMP1260	169	1	44	12	17	0.53
BWMP1266	194	1	50	12	20	0.61
BWMP1272	218	1	56	12	22	0.66
BWMP1278	233	1	62	12	25	0.71
BWMP1284	252	1	68	12	27	0.79

**BWR • Radius Worksurface**

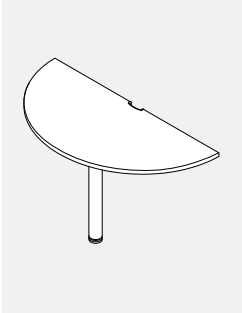

• **Rounded work surface for conferencing provides a radius corner.**

- 18” and 24” come with 1 BHML03 Monoleg and 30” comes with 2.
- Radius cut out on the straight edge allows space for aluminum trims.
- For chrome finish on leg, please add \$106 list upcharge for each leg.
- Please choose from DWT - Designer White, SIL - Silver or BLK - Black for scoop covers.
- Surfaces with wood trim (T) and complete wood (W) will not have the plastic scoop, they will remain with the curve cut scoop.
- To specify wood trim (T) or complete wood (W) surfaces, please remove the last “P” from the code and add either a “T” or “W” and the old scoop style is going to be created.

PRODUCT CODE	PRICE LP*	GROUP			SIZE/ INCHES			WEIGHT VOL	
		HP*	T*	W*	H	W	D	LBS	FT <sup>3</sup>
BWR18P	488	561	765	1289	1	38.5	18	27	1.70
BWR24P	560	649	837	1524	1	50.5	24	41	2.20
BWR30P	941	1076	1251	2305	1	62.5	30	59	2.70

• LP = Thermally Fused Laminate, HP = High Pressure Laminate, T = High Pressure Laminate with Wood Trim, W = Wood Veneer

**BWRTD • Teardrop Worksurface**

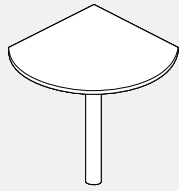

- Rounded worksurface for conferencing provides a radius corner from a work-surface to worksurface.
- 1 BHML03 Monoleg included.
- For chrome finish on leg, please add \$106 list upcharge.

PRODUCT CODE	PRICE LP*	GROUP HP*	T*	W*	SIZE/ H	INCHES			WEIGHT VOL	
						W	D	LBS	FT <sup>3</sup>	
BWRTD18	315	358	633	777	1	18	18	24	1.60	
BWRTD24	380	430	751	938	1	24	24	33	1.90	
BWRTD30	455	552	909	1154	1	30	30	43	2.20	

**BWRP • Corner Radius Worksurface with Cutout**

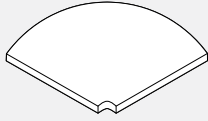

- Corner Radius Worksurface with Cut-Out allows worksurface to be used around a post.
- Cut out fits snug to the post, if trim is attached to the post, the worksurface or PVC trim may need to be cut on site to fit.

PRODUCT CODE	PRICE LP*	GROUP HP*	T*	W*	SIZE/ H	INCHES			WEIGHT VOL	
						W	D	LBS	FT <sup>3</sup>	
BWRP1818	157	196	374	518	1	21	21	12	0.40	
BWRP2424	228	284	498	762	1	27	27	19	0.64	
BWRP3030	281	353	622	859	1	33	33	29	1.00	

**BWT • Transaction Worksurface**

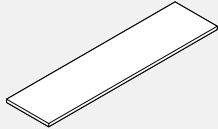

- Attaches to the top of a 37" or 42" high panel to form a transaction worksurface.
- To attach a Boulevard 1 37" high panel please specify BHBT37, all other heights specify BHBT02.
- To attach a Boulevard 1 panel with flat trim, please specify BHBT37FT or BHBT02FT.

PRODUCT CODE	PRICE LP*	GROUP HP*	T*	W*	SIZE/ H	INCHES			WEIGHT VOL	
						W	D	LBS	FT <sup>3</sup>	
BWT1512	58	75	151	220	1	12	15	5	0.22	
BWT1518	72	99	189	251	1	18	15	7	0.30	
BWT1524	90	120	229	332	1	24	15	10	0.38	
BWT1530	109	142	268	394	1	30	15	12	0.46	
BWT1536	124	165	308	429	1	36	15	14	0.54	
BWT1542	142	188	355	497	1	42	15	17	0.62	
BWT1548	161	211	377	537	1	48	15	19	0.70	
BWT1554	173	232	425	562	1	54	15	22	0.78	
BWT1560	193	255	441	589	1	60	15	24	0.86	
BWT1566	207	276	481	647	1	66	15	28	0.94	
BWT1572	227	298	520	679	1	72	15	29	1.02	
BWT1578	242	323	561	877	1	78	15	31	1.10	
BWT1584	259	343	667	954	1	84	15	34	1.18	

**BWTC • Transaction Corner Worksurface**

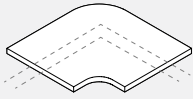

- Attaches to the top of a 37" or 42" high panel to form a corner transaction worksurface.
- Covers 12" of a panel.
- To attach a 37" high panel please specify BHBT37, all other heights specify BHBT02.
- To attach a Boulevard 1 panel with flat trim, please specify BHBT37FT or BHBT02FT.

PRODUCT CODE	PRICE LP*	GROUP HP*	T*	W*	SIZE/ H	INCHES			WEIGHT VOL	
						W	D	LBS	FT <sup>3</sup>	
BWTC90	154	193	310	667	1	20.7	20.7	11	0.49	
BWTC45	189	234	362	693	1	21.5	21.5	12	0.53	
BWTC60	198	234	362	693	1	22.5	22.5	14	0.60	

• LP = Thermally Fused Laminate, HP = High Pressure Laminate, T= High Pressure Laminate with Wood Trim, W= Wood Veneer

**BWTT • Transaction “T” Worksurface**

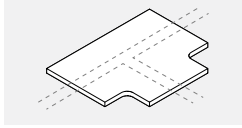

- Attaches to the top of a 37” or 42” high panel to form a “T” corner transaction worksurface
- Covers 12” of a panel.
- To attach a 37” high panel please specify BHBT37, all other heights specify BHBT02.

PRODUCT CODE	PRICE LP*	GROUP			SIZE/ INCHES			WEIGHT VOL	
		HP*	T*	W*	H	W	D	LBS	FT <sup>3</sup>
BWTT2721	166	206	326	835	1	21.5	26.5	15	0.6

**BWTAC • Transaction Worksurface for 45 Degree Corner Worksurface**

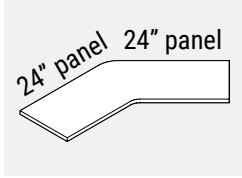

- Attaches to the top of 37” or 42” high panel to form a 45 degree corner transaction worksurface.
- To attach a 37” high panel please specify BHBT37, all other heights specify BHBT02.

PRODUCT CODE	PRICE LP*	GROUP			SIZE/ INCHES			WEIGHT VOL	
		HP*	T*	W*	H	W	D	LBS	FT <sup>3</sup>
BWTAC452415	686	859	886	1209	1	47	15	39	1.38

**BWTAC • Transaction Worksurface for 60 Degree Corner Worksurface**

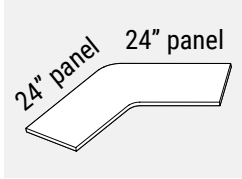

- Attaches to the top of 42” high panel to form a 60 degree corner transaction worksurface.
- To attach a 37” high panel please specify BHBT37, all other heights specify BHBT02.

PRODUCT CODE	PRICE LP*	GROUP			SIZE/ INCHES			WEIGHT VOL	
		HP*	T*	W*	H	W	D	LBS	FT <sup>3</sup>
BWTAC602415	743	930	944	1260	1	44	15	38	1.32

**BWTD • Transaction “D” Worksurface**

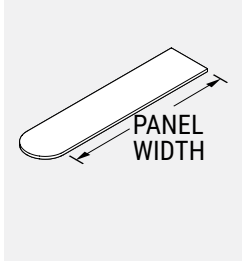

- Attaches to the top of a 37” or 42” high panel to form a transaction worksurface with a radiused end.
- Surface overhangs the panel by 7 1/2” on one side.
- To attach a 37” high panel please specify BHBT37, all other heights specify BHBT02.

PRODUCT CODE	PRICE LP*	GROUP			SIZE/ INCHES			WEIGHT VOL	
		HP*	T*	W*	H	W	D	LBS	FT <sup>3</sup>
BWTD1530	141	184	341	551	1	37.5	15	17	0.65
BWTD1536	149	198	361	585	1	43.5	15	19	0.69
BWTD1542	166	222	399	646	1	49.5	15	22	0.74
BWTD1548	186	244	419	699	1	55.5	15	25	0.77
BWTD1554	201	266	435	724	1	61.5	15	27	0.85
BWTD1560	222	294	447	744	1	67.5	15	30	0.94
BWTD1566	238	314	512	853	1	73.5	15	33	1.02
BWTD1572	257	341	575	958	1	79.5	15	35	1.10

• LP = Thermally Fused Laminate, HP = High Pressure Laminate, T= High Pressure Laminate with Wood Trim, W= Wood Veneer

**BWTDD • Transaction Double “D” Worksurface**

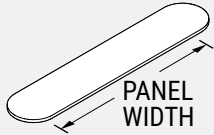

- Attaches to the top of a 37” or 42” high panel to form a transaction worksurface with 2 radius ends.
- Surface overhangs the panel by 7 1/2” on each end.
- To attach a 37” high panel please specify BHBT37, all other heights specify BHBT02.

PRODUCT CODE	PRICE LP*	GROUP			W*	SIZE/ H	INCHES			WEIGHT VOL	
		HP*	T*	W*			H	W	D	LBS	FT <sup>3</sup>
BWTDD1548	207	276	512	853	1	63	15	28	1.00		
BWTDD1554	227	298	527	879	1	69	15	31	1.01		
BWTDD1560	242	323	541	902	1	75	15	33	1.04		
BWTDD1566	263	345	607	1007	1	81	15	35	1.13		
BWTDD1572	281	374	669	1114	1	87	15	38	1.21		

**BWTE • Elliptical Transaction Worksurface**

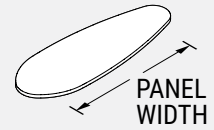

- Attaches to the top of a 37” or 42” high panel to form a transaction worksurface.
- To attach a 37” high panel please specify BHBT37, all other heights specify BHBT02.
- Depth different than standard tops.

PRODUCT CODE	PRICE LP*	GROUP			W*	SIZE/ H	INCHES			WEIGHT VOL	
		HP*	T*	W*			H	W	D	LBS	FT <sup>3</sup>
BWTE36	331	413	991	1454	1	52	18	22	0.78		
BWTE42	378	471	991	1454	1	58	19	24	0.81		

**BWTP • Oval Transaction Worksurface**

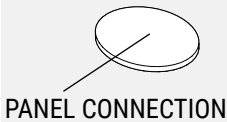

- Attaches to the top of a 37” or 42” high panel to form a transaction worksurface.
- To attach a 37” high panel please specify BHBT37, all other heights specify BHBT02.
- Must be specified at post condition or panel joint.

PRODUCT CODE	PRICE LP*	GROUP			W*	SIZE/ H	INCHES			WEIGHT VOL	
		HP*	T*	W*			H	W	D	LBS	FT <sup>3</sup>
BWTP1518	238	296	413	596	1	15	18	10	0.35		

**BWCD • Round Table**



- Freestanding round meeting table with 4 prong tubular base.
- For chrome base please upcharge \$106 list.

PRODUCT CODE	PRICE LP*	GROUP			W*	SIZE/ H	INCHES			WEIGHT VOL	
		HP*	T*	W*			H	W	D	LBS	FT <sup>3</sup>
BWCD30	490	541	827	1075	29	30 dia	30 dia	35	10.0		
BWCD36	556	622	938	1235	29	36 dia	36 dia	42	10.0		
BWCD42	681	782	1239	1671	29	42 dia	42 dia	52	11.0		

**BWSQ • Square Table**

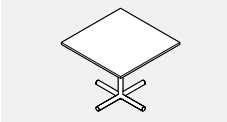

- Freestanding square meeting table with 4 prong tubular base.
- For chrome base please upcharge \$106 list.

PRODUCT CODE	PRICE LP*	GROUP			W*	SIZE/ H	INCHES			WEIGHT VOL	
		HP*	T*	W*			H	W	D	LBS	FT <sup>3</sup>
BWSQ24	469	513	585	765	29	24	24	34	10.0		
BWSQ30	490	541	716	1008	29	30	30	38	10.0		
BWSQ36	556	622	835	1224	29	36	36	46	11.0		
BWSQ42	681	782	959	1596	29	42	42	57	11.0		

• LP = Thermally Fused Laminate, HP = High Pressure Laminate, T = High Pressure Laminate with Wood Trim, W = Wood Veneer

**BHCL • “C” Leg**

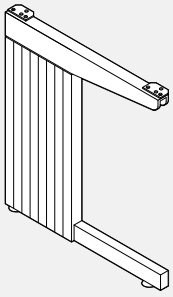

- **Attaches to panel support worksurface or to provide free-standing table support.**
- Steel structure, PVC cover.
- Universal non-handed.
- For a single rectangular freestanding worksurface application, specify two “C” Legs and one Modesty Panel of corresponding width.
- May be used as a shared leg between two adjoining worksurfaces. Specify one “C” Leg, one Modesty Panel of corresponding width, plus one Modesty Panel Extension Bracket.
- For corner worksurfaces, specify two “C” Legs, one Corner Leg and two Modesty Panels 6” shorter than rear sides of the corner worksurface.
- Can be used as a floor support in a panel attached application (similar to a cantilever).
- Includes worksurface mounting brackets with screws, Bracket Retainer Clip and panel bracket.
- Accommodates 15” knee space.
- Intended for use with flexlip worksurfaces. When used on other worksurfaces, modesty panel must be installed upside down.

PRODUCT CODE	PRICE	SIZE/ INCHES			WEIGHT VOL	
		H	W	D	LBS	FT <sup>3</sup>
BHCL2618	220	25	1	18	7	0.27
BHCL2624	228	25	1	24	8	0.36
BHCL2918	238	28	1	18	8	0.30
BHCL2924	246	28	1	24	9	0.40

**BKC • Corner Leg**



- **Five sided worksurface support.**
- Steel construction.
- Non handed.
- Includes bolts for modesty panel attachment.
- For corner worksurfaces, specify two “C” Legs, one Corner Leg and two Modesty Panels 6” shorter than rear sides of the corner worksurface.

PRODUCT CODE	PRICE	SIZE/ INCHES			WEIGHT VOL	
		H	W	D	LBS	FT <sup>3</sup>
BKC26	140	25	7	7	3.0	0.02
BKC29	157	28	7	7	3.2	0.02

**BKMP • Modesty Panel**

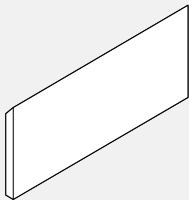

- **For rectangular worksurfaces, specify Modesty Panel of corresponding width. For corner worksurfaces, specify two Modesty Panels 6” shorter than rear side of corner worksurface.**
- Attaches between two “C” Legs, or between one “C” Leg and a Corner Leg, or a shared “C” Leg and “C” Leg at the end of a run.
- Includes brackets and screws to attach Modesty Panel to worksurface.
- For use with flex lip worksurfaces only.
- To install on “SCP” or “NFL” worksurface, modesty panel must be inverted.

PRODUCT CODE	PRICE	SIZE/ INCHES			WEIGHT VOL	
		H	W	D	LBS	FT <sup>3</sup>
BKMP1224	165	11	24	0.25	2.75	0.17
BKMP1230	174	11	30	0.25	2.75	0.21
BKMP1236	188	11	36	0.25	3.00	0.25
BKMP1242	195	11	42	0.25	4.00	0.29
BKMP1248	206	11	48	0.25	4.50	0.33
BKMP1254	215	11	54	0.25	5.00	0.38
BKMP1260	228	11	60	0.25	5.50	0.42

**BHMEB • Modesty Panel Extension Bracket**



- **Modesty Panel Extension Bracket made of cold rolled steel.**
- Attaches the Modesty Panel of an adjoining worksurface to a shared “C” Leg.
- Includes all attachment hardware.

PRODUCT CODE	PRICE	SIZE/ INCHES			WEIGHT VOL	
		H	W	D	LBS	FT <sup>3</sup>
BHMEB01	22	10	1.5	0.125	0.5	0.01

**BHFG • Full Gable - Self Edged**

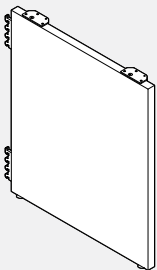

- **Provides floor standing support while enclosing an end of a run of worksurfaces.**
- Includes attachment hardware, Bracket Retainer Clip and levelling glides.
- Non-handed.
- May be used as a shared gable between two adjoining worksurfaces.

PRODUCT CODE	PRICE LP*	GROUP HP*	SIZE/ INCHES			WEIGHT VOL	
			H	W	D	LBS	FT <sup>3</sup>
BHFG2608	142	177	25	1	8	7	0.14
BHFG2612	182	227	25	1	12	13	0.21
BHFG2618	222	276	25	1	18	13	0.27
BHFG2624	244	304	25	1	24	19	0.36
BHFG2630	329	408	25	1	30	23	0.45
BHFG2636	410	513	25	1	36	24	0.57
BHFG2908	142	177	28	1	8	7	0.16
BHFG2912	182	227	28	1	12	14	0.30
BHFG2918	222	276	28	1	18	14	0.30
BHFG2924	244	304	28	1	24	17	0.40
BHFG2930	329	408	28	1	30	21	0.50
BHFG2936	410	513	28	1	36	26	0.65

• LP = Thermally Fused Laminate, HP = High Pressure Laminate, T= High Pressure Laminate with Wood Trim, W= Wood Veneer



**BHFGP • Full Gable - 3mm PVC Edged**

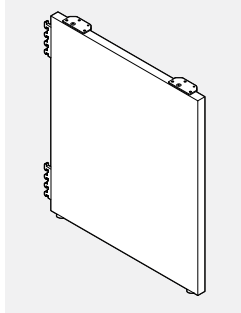

- Provides floor standing support while enclosing an end of a run of worksurfaces.
- Includes attachment hardware, Bracket Retainer Clip and levelling glides.
- Provides consistent edging matching the worksurface trim.
- Handed once installed.
- May be used as a shared gable between two adjoining worksurfaces.

PRODUCT CODE	PRICE LP*	GROUP HP*	SIZE/ INCHES			WEIGHT VOL	
			H	W	D	LBS	FT <sup>3</sup>
BHFGP2608	142	177	25	1	8	7	0.14
BHFGP2612	182	227	25	1	12	13	0.21
BHFGP2618	222	276	25	1	18	13	0.27
BHFGP2624	244	304	25	1	24	19	0.36
BHFGP2630	329	408	25	1	30	23	0.45
BHFGP2636	410	513	25	1	36	24	0.57
BHFGP2908	142	177	28	1	8	7	0.16
BHFGP2912	182	227	28	1	12	14	0.30
BHFGP2918	222	276	28	1	18	14	0.30
BHFGP2924	244	304	28	1	24	17	0.40
BHFGP2930	329	408	28	1	30	21	0.50
BHFGP2936	410	513	28	1	36	26	0.65

**BHPG • "P" Shaped Full Gable - 3mm PVC Edged**

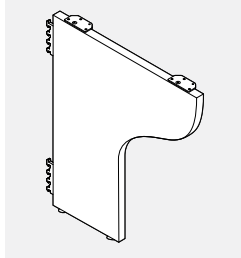

- Provides floor standing support while enclosing an end of a run of worksurfaces.
- Includes attachment hardware, Bracket Retainer Clip and levelling glides.
- Handed due to hardware attachment and PVC edge.

PRODUCT CODE	PRICE LP*	GROUP HP*	SIZE/ INCHES			WEIGHT VOL	
			H	W	D	LBS	FT <sup>3</sup>
BHPG2624L	244	304	25	1	24	19	0.36
BHPG2924L	244	304	28	1	24	17	0.40
BHPG2624R	244	304	25	1	24	19	0.36
BHPG2924R	244	304	28	1	24	17	0.40

**BHLEG • Gable Leg**

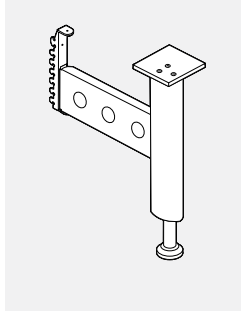

- Support the worksurface and enhances the stability of connected panels.
- Universal leg plate bolts to the underside of the worksurface.
- Can be configured on-site for left, right or shared worksurface support application on front edge
- Back edge does not have shared support.
- Tubular leg section adjusts in 1" increments, the leveller can be used for fine adjustment.
- 1" increment leg adjustment and 1" increment panel slots allow the leg of installed worksurface to be supported from 26" to 32". (Leg must be removed from panel to manually adjust.)
- Side plate is secured to the slots in the vertical of the Boulevard 1 or System 3 panels and the leg plate bolts to underside of the worksurface.
- Made of extruded aluminum and steel.
- Includes all mounting hardware to connect to panel and worksurface.

PRODUCT CODE	PRICE	GROUP	SIZE/ H	INCHES W	D	WEIGHT LBS	VOL FT <sup>3</sup>
BHLEG	205		28	6	23	8	0.15

**BRTHLEG • Boulevard Leg Assembly**

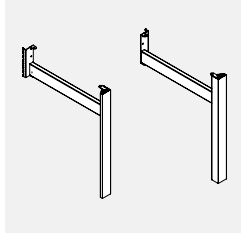

- Boulevard Leg Assembly attaches to a Boulevard panel for applications which require functionality of Boulevard panels with an open environment of Bridges tables.
- One leg with horizontal member connecting to 1" increment slots in panel's vertical frame member. Provides support to panel and panel-connected worksurface at the end of a run; design coordinated with Bridges freestanding tables.
- Supports 24" and 30" deep worksurfaces. By adding 2 BHBF01 flat brackets and 1 BHBC02 corner bracket, a single leg can then support the adjoining worksurface. Leveling glide is standard. No worksurface supporting beams, use panel cantilevers and storage for worksurface support. One aluminum leg with steel structure - specify Left or Right and 24" or 30" deep for corresponding worksurface depths. Panel bracket, dislodgment clip and worksurface hardware included.
- Anodized aluminum leg upcharge \$28.
- Please specify paint finish for support.

PRODUCT CODE	PRICE	SIZE/ H	INCHES W	D	WEIGHT LBS	VOL FT <sup>3</sup>
BRTHLEG24LL	308	28	2.5	24	9	1.25
BRTHLEG24RL	308	28	2.5	24	9	1.25
BRTHLEG30LL	323	28	2.5	30	11	1.45
BRTHLEG30RL	323	28	2.5	30	11	1.45

**BRTBL • Boulevard Leg Assembly**

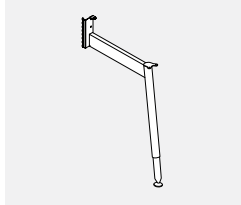

- Boulevard Leg Assembly attaches to a Boulevard panel for applications which require functionality of Boulevard panels with an open environment of Bridge 2 tables.
- Panel bracket secures the leg to the panel in 1" increments, within a 24" to 32" height range.
- Panel mounting bracket is reversible for non-handed applications.
- Supports 24" and 30" deep worksurfaces. By adding 2 BHBF01 flat brackets and 1 BHBC02 corner bracket, a single leg can then support the adjoining worksurface. Leveling glide is standard. No worksurface supporting beams, use panel cantilevers and storage for worksurface support. Panel bracket, dislodgment clip and worksurface hardware included.
- Leveling glide is standard.

PRODUCT CODE	PRICE	SIZE/ H	INCHES W	D	WEIGHT LBS	VOL FT <sup>3</sup>
BRTBL	328	28	3	24	12	1.25

• LP = Thermally Fused Laminate, HP = High Pressure Laminate, T= High Pressure Laminate with Wood Trim, W= Wood Veneer

**BHML • Monoleg**

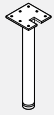

- **3" diameter Monoleg provides support for worksurfaces.**
- Top plate welded to leg.
- 8" x 8" plated attached to worksurface with #10 3/4" wood screws, included.
- 1" height adjustment range.
- For chrome finish on leg, please add \$106 list upcharge.

PRODUCT CODE	PRICE	SIZE/ INCHES			WEIGHT VOL	
		H	W	D	LBS	FT <sup>3</sup>
BHML03	188	28	3	3	8	0.15

**LATBL • Tapered Leg**



- **Tapered leg provides support for worksurfaces.**
- Top plate welded to leg.
- 8" x 8" plated attached to worksurface with #10 3/4" wood screws, included.
- 1" height adjustment range.
- For chrome finish on leg, please add \$106 list upcharge.

PRODUCT CODE	PRICE	SIZE/ INCHES			WEIGHT VOL	
		H	W	D	LBS	FT <sup>3</sup>
LATBL28	177	28	3	3	8	0.15

**VVLEGLV • Leg with Leveler**

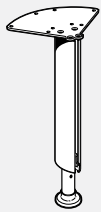

- **The Viceversa leg features a push button height adjustment mechanism. This mechanism allows the user to easily set the height of a table. The universal mounting plate can be used to gang 2 tables without metal skirt simply by rotating 45 degrees to span both tops.**
- The Viceversa Leg has a wire management channel that neatly organizes electrical and communication cables running from the worksurface to the floor.
- Legs have a height range of 25" to 32" in 1" increments (includes 1" top).
- The wire channel is covered by a clear PVC snap-on cover.
- Levelers have a 1/2" height range.
- Levelers come in charcoal only.
- Includes mounting hardware.

PRODUCT CODE	PRICE	SIZE/ INCHES			WEIGHT VOL	
		H	D	W	LBS	FT <sup>3</sup>
VVLEGLV	177	25-32	8	10	8	1.5

**VVLEGLC • Leg with Caster**

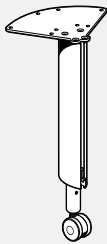

- **The Viceversa leg features a push button height adjustment mechanism. This mechanism allows the user to easily set the height of a table. The universal mounting plate can be used to gang 2 tables without metal skirt simply by rotating 45 degrees to span both tops.**
- The Viceversa Leg has a wire management channel that neatly organizes electrical and communication cables running from the worksurface to the floor.
- Legs have a height range of 26" to 33" in 1" increments.
- The wire channel is covered by a clear PVC snap-on cover.
- Casters come in grey with black only.
- Includes mounting hardware.

PRODUCT CODE	PRICE	SIZE/ INCHES			WEIGHT VOL	
		H	D	W	LBS	FT <sup>3</sup>
VVLEGLC	177	26-33	8	10	8	1.5

**VVLEGF • Fixed Height Leg**

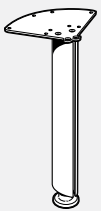

- **The Viceversa fixed height leg with leveler supports the worksurface at a fixed height of 29".**
- The Viceversa leg has a wire management channel that neatly organizes electrical and communication cables running from the worksurface to the floor.
- Leg can be installed for each corner of the worksurface or can be shared at adjoining surfaces.
- The wire channel is covered by a clear PVC snap-on cover.
- Levelers have a 1/2" height range.
- Levelers come in charcoal only.
- Includes mounting hardware.

PRODUCT CODE	PRICE	SIZE/ INCHES			WEIGHT VOL	
		H	D	W	LBS	FT <sup>3</sup>
VVLEGF	141	28	8	10	8	1.5

**BHC • Cantilever**

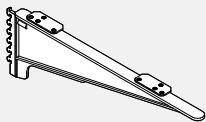

- **Universal cantilever with steel attachment bracket constructed of cast aluminum to provide support for worksurfaces.**
- Attaches a worksurface to a panel.
- May be used for shared worksurface support.
- Interchangeable in the field for left or right positioning.
- Includes Bracket Retainer Clip.

PRODUCT CODE	PRICE	SIZE/ INCHES			WEIGHT VOL	
		H	W	D	LBS	FT <sup>3</sup>
BHC18	101	7	17	2.5	17	0.04
BHC24	118	7	23	2.5	23	0.05

• LP = Thermally Fused Laminate, HP = High Pressure Laminate, T= High Pressure Laminate with Wood Trim, W= Wood Veneer

**BHBC • Corner End Bracket**

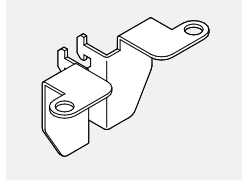

- Formed steel bracket for a corner worksurface or a straight worksurface.
- Attaches a corner of any worksurface to a panel through the panel vertical slots.
- Priced one left and one right per package.
- Includes Bracket Retainer Clip.

PRODUCT CODE	PRICE	SIZE/ INCHES			WEIGHT VOL	
		H	W	D	LBS	FT <sup>3</sup>
BHBC02	25	3.3	1.5	2.3	2	0.007

**BHBF • Flat Bracket**

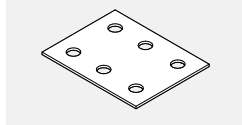

- Flat Bracket made of cold rolled steel.
- May be used to ensure alignment of neighboring worksurfaces.

PRODUCT CODE	PRICE	SIZE/ INCHES			WEIGHT VOL	
		H	W	D	LBS	FT <sup>3</sup>
BHBF01	13	0.1	3	4	0.5	0.007

**BHBT • Transaction Bracket**

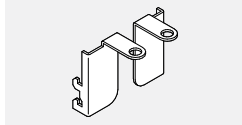

- For use on 34", 42", 50", 58", 66", 74" and 82" high Boulevard panels.
- Transaction Bracket made of cold rolled steel.
- To provide a secure attachment of a transaction worksurface.
- Priced one left and one right per package.
- Includes Bracket Retainer Clip.

PRODUCT CODE	PRICE	SIZE/ INCHES			WEIGHT VOL	
		H	W	D	LBS	FT <sup>3</sup>
BHBT02	25	3.3	1.5	2.3	2	0.001

**BHBT • Transaction Bracket for 37" High Boulevard 1 Panels**

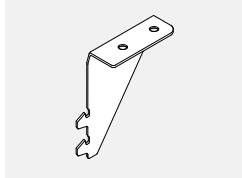

- Transaction Bracket made of cold rolled steel.
- To provide a secure attachment of a transaction worksurface for a 37" high Boulevard 1 panel only. Transaction Bracket engages with the top slots in the 37" high panel to be supported for the transaction worksurface.
- Priced one left and one right per package.
- Includes Bracket Retainer Clip.

PRODUCT CODE	PRICE	SIZE/ INCHES			WEIGHT VOL	
		H	W	D	LBS	FT <sup>3</sup>
BHBT37	30	4	1	3	0.5	0.007

**BHBZ • "Z" Bracket**

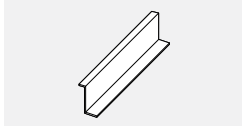

- Attaches two different heights of worksurfaces.
- To be used in conjunction with a cantilever.

PRODUCT CODE	PRICE	SIZE/ INCHES			WEIGHT VOL	
		H	W	D	LBS	FT <sup>3</sup>
BHBZ03	79	4	21	4	2	0.190

**FTATB • Boulevard Connector Kit**

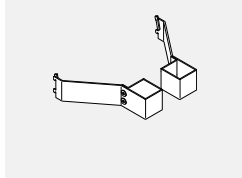

- FreeFit to Boulevard kit secures FreeFit height adjustable freestanding tables to parallel Boulevard panels.
- It provides panel/table alignment, preventing moving parts from rubbing against panel vertical surfaces and maintains 1" clearance around table surface perimeter.
- Standard metal finishes.
- All hardware included.
- Sold as a pair.

PRODUCT CODE	PRICE	SIZE/ INCHES			WEIGHT VOL	
		H	W	D	LBS	FT <sup>3</sup>
FTATB	140	10	6.5	10	7.00	0.50

**LHC • HAT Channel**

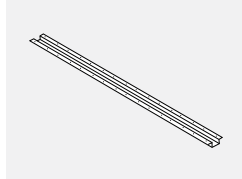

PRODUCT CODE	PRICE	SIZE/ INCHES			WEIGHT VOL	
		H	W	D	LBS	FT <sup>3</sup>
LHC40	56	1.4	40	5	4	0.20
LHC46	62	1.4	46	5	6	0.22
LHC52	66	1.4	52	5	7	0.25
LHC58	76	1.4	58	5	8	0.28
LHC64	85	1.4	64	5	9	0.31
LHC70	91	1.4	70	5	10	0.33

• LP = Thermally Fused Laminate, HP = High Pressure Laminate, T= High Pressure Laminate with Wood Trim, W= Wood Veneer

**LATERAL FILE FEATURES • TECHNICAL INFORMATION**

Counterweights are recommended for use in all lateral, verticals, pedestals and free standing files of all widths and heights.

- Counterweight not included. In order to meet ANSI/BIFMA X5.9-2004, Counterweight must be specified separately.

**Pedestals**

- Quality steel construction.
- For Linear and C series, the pedestal drawer suspension is as follows:
  - Box drawers have 3/4 extension ball bearing slides.
  - File drawers have full extension ball bearing slides.
- FF contains 2 file drawers, BF contains 1 box drawer and 1 file drawer, BBF contains 2 box drawers and 1 file drawer.
- 1 pencil tray and 1 drawer divider is included with each unit containing a box drawer.
- Includes lock with 2 keys.
- Can be keyed alike to other metal storage components.
- Cannot be field converted into mobile units.
- Drawer configuration can be converted in the field.
- Interior drawer depth for radius pedestals is as follows: 19.75" for 24" deep and 24.75" for 30" deep.
- Interiors of drawer bodies are finished Recycled Grey.
- Levelers provide 1" height adjustment.

**Overhead Storage**

- Overhead storage comes in a variety of styles and materials.
- Styles include shelves, open overhead, closed overhead with flipper or hinged door.
- Materials include metal and wood.

**Filing**

- A variety of heights in 30", 36" and 42" widths available.
- Slots for letter, legal and "A4" metric size material.
- "B" receding opening accommodates ring binders and fixed front opening will accommodate 14 7/8" x 11" EDP binders.
- Receding doors slide into the cabinet.
- Pull-out shelves have a rolled front edge.
- Fixed drawers are flat for easy material retrieval.
- Locks are standard with removable cores.
- All cabinets are of welded construction using 18 to 22 gauge cold rolled steel.
- Front corners are mig-welded and ground smooth where the case meets the top and bottom.
- Interiors are finished with recycled paint.
- Positive interlocking system is integrated into each drawer for safety.
- File bars are Recycled Grey and pre-installed in drawers.
- Three stage, full progressive, ball bearing suspension.
- Epoxy powder coated .2 mm thick for durability.
- Drawer fronts come with double wall construction and full pulls.
- Drawer mechanism includes an anti-bounce-back device.

- All four leveling glides can be accessed from the interior of the cabinet.
- Changes to fixed or receding fronts are special order.
- Master key available.
- All filing can be purchased in customer colours at a 10% upcharge for 10 or less units, with the exception of metallic colours. If a color sample has to be made, this could add to your delivery time, please check with your Customer Service Representative.

**Storage Cabinet**

- Comes complete with adjustable non-slotted shelves.
- Quality steel construction.
- Include hinged doors, lock with two keys and leveling glides.
- Can be keyed alike to other metal storage components.

**Multi Storage Cabinets**

- Provides hinged door storage over a 12" Series opening combination lateral file for multi-functional storage of material.
- Includes side to side file bars, leveling glides and lock with two keys.
- Counterweight not included. In order to meet ANSI/BIFMA X5.9-2004, Counterweight must be specified separately.
- Can be keyed alike to other metal storage components.
- Drawer interiors are finished in Recycled Grey.

**Towers**

- Quality steel construction.
- The tower drawer suspension is as follows:
  - Box drawers have 3/4 extension ball bearing slides.
  - File drawers have full extension ball bearing slides.
- FF contains 2 file drawers, BF contains 1 box drawer and 1 file drawer, BBF contains 2 box drawers and 1 file drawer.
- 1 pencil tray and 1 drawer divider is included with each unit containing a box drawer.
- Includes 2 locks with 2 keys each for side open towers and 3 locks with 2 keys each for standard towers.
- Can be keyed alike to other metal storage components.
- Materials include metal and wood.
- Master key available.
- Individual lock for drawers and doors.

**Vertical Filing**

- Recessed full pulls.
- Includes lock and leveling glides.
- Full side walls for suspended folders.
- Follower back.
- Full progressive suspension.
- Double wall fronts.
- Interior paint matches exterior paint.

**STORAGE COMPONENTS - GUIDELINES FOR ORDERING PRODUCT**

**Codes**

The price list uses a numbering system with meaningful alphanumeric characters to create a simple-to-understand product number. This makes specifying the product much easier and more accurate.

Example of Pedestal: **BS1218BBFC CHR**

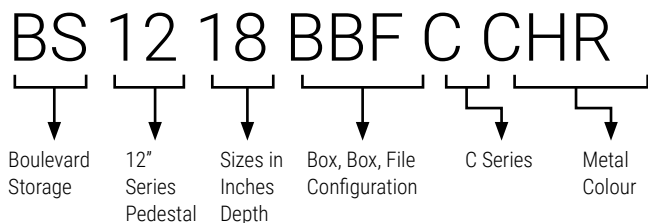

**How to Specify**

- Specify storage pedestal type and size by code, including depth.
- Specify metal colour - ie. CHR (Charcoal).
- Specify handle colour if pedestal is "Radius" or "Linear" series.

"C" Series Drawer



"L" Linear Drawer

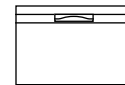

Example of Overhead: **BSOF1636 CHR**

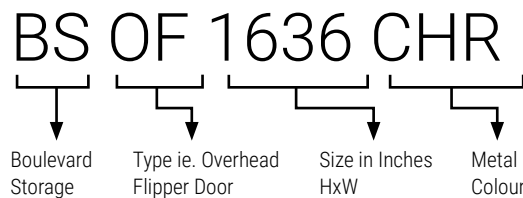

**How to Specify**

- Specify overhead storage type and size by code.
- Specify metal colour - ie. CHR (Charcoal).
- Specify handle colour if pedestal is "Radius" series.

## 30" WIDE UNITS

### MEDIA TYPE:

#### Letter

All Openings  
Fixed Front Drawers and Roll-Out Shelves

### SIDE TO SIDE

Capacity - 26 9/16"  
Accessories required HFB30

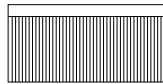

### FRONT TO BACK

Capacity - 31 1/2"  
Accessories required HFB30 and one pair of FBB



#### Legal

All Openings  
Fixed Front Drawers and Roll-Out Shelves

Capacity - 26 9/16"  
Accessories required HFB30

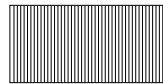

Capacity - 26 5/16"  
Accessories required HFB30 and one pair of FBB

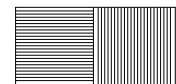

## 36" WIDE UNITS

### MEDIA TYPE:

#### Letter

All Openings  
Fixed Front Drawers and Roll-Out Shelves

### SIDE TO SIDE

Capacity - 32 9/16"  
Accessories required HFB36

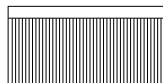

### FRONT TO BACK

Capacity - 31 1/2"  
Accessories required HFB36 and one pair of FBB

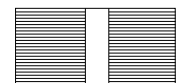

#### Legal

All Openings  
Fixed Front Drawers and Roll-Out Shelves

Capacity - 32 9/16"  
Accessories required HFB36

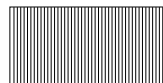

Capacity - 31 1/2"  
Accessories required HFB36 and one pair of FBB



## 42" WIDE UNITS

### MEDIA TYPE:

#### Letter

All Openings  
Fixed Front Drawers and Roll-Out Shelves

### SIDE TO SIDE

Capacity - 38 9/16"  
Accessories required HFB42

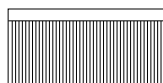

### FRONT TO BACK

Capacity - 47 1/4"  
Accessories required HFB42 and two pair of FBB

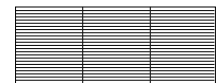

#### Legal

All Openings  
Fixed Front Drawers and Roll-Out Shelves

Capacity - 38 9/16"  
Accessories required HFB42

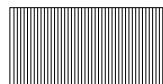

Capacity - 40 1/16"  
Accessories required HFB42 and one pair of FBB

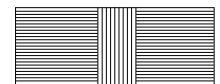

## OPENING DIMENSIONS

Interior Clear Opening  
Height Dimensions

### SIDE TO SIDE

<b>All Opening</b>	
Fixed Front Drawer	10 1/2"
Receding Door and Roll-Out Shelf	10"
Receding Door and Fixed Shelf	10 3/8"
Fixed Shelf and no Receding Door	11 1/2"

### All Opening

Drawer - Depth	15 3/4"
Roll-Out Shelf - Depth	15 3/4"
Fixed Shelf - Depth	15 3/4"

Interior Clear Opening  
Width Dimensions and  
Filing Capacities

### 30" Wide Cabinets

Fixed Front Drawer	26 1/2"
Receding Door and Roll-Out Shelf	26 1/2"
Receding Door and Fixed Shelf	28 1/4"

### 42" Wide Cabinets

Fixed Front Drawer	38 1/2"
Receding Door and Roll-Out Shelf	38 1/2"
Receding Door and Fixed Shelf	40 1/4"

### 36" Wide Cabinets

Fixed Front Drawer	32 1/2"
Receding Door and Roll-Out Shelf	32 1/2"
Receding Door and Fixed Shelf	34 1/4"

## STANDARD "B" OPENINGS

### EDP 30" Wide

"B" Opening  
Fixed Front Drawers Only

Capacity - 26 1/2"  
Accessories required HFB30  
and one pair of EDPS

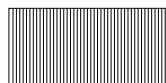

Interior Clear Opening  
Height Dimensions

### SIDE TO SIDE

<b>All Opening</b>	
Fixed Front Drawer	13"
Receding Door and Roll-Out Shelf	12 1/8"
Receding Door and Fixed Shelf	12"
Fixed Shelf and no Receding Door	12 3/4"

### EDP 36" Wide

"B" Opening  
Fixed Front Drawers Only

Capacity - 32 1/2"  
Accessories required HFB36  
and one pair EDPS

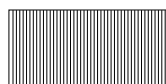

### EDP 42" Wide

"B" Opening  
Fixed Front Drawers Only

Capacity - 38 1/2"  
Accessories required HFB42  
and one pair EDPS

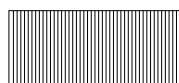

### All Opening

Drawer - Depth	15 3/4"
Roll-Out Shelf - Depth	15 3/4"
Fixed Shelf - Depth	15 3/4"

**BSOL • KD Low Profile Shelf**

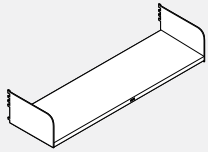

- 12" deep panel-mounted storage shelf with back lip that protects fabric.
- Includes black lock hole plug with Boulevard logo and attachment hardware.
- Sides are 5" high.
- Shipped KD.

PRODUCT CODE	PRICE	SIZE/ INCHES			WEIGHT VOL	
		H	W	D	LBS	FT <sup>3</sup>
BSOL1224	133	5	24	12.5	8	0.16
BSOL1230	141	5	30	12.5	10	0.20
BSOL1236	155	5	36	12.5	12	0.25
BSOL1242	161	5	42	12.5	13	0.29
BSOL1248	172	5	48	12.5	15	0.33
BSOL1254	179	5	54	12.5	17	0.37
BSOL1260	184	5	60	12.5	18	0.41

**BSOC • KD Corner Shelf Kit**

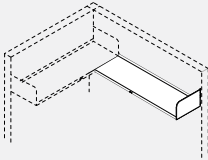

RIGHT SHOWN

- The corner shelf kit must be used in conjunction with a Low Profile Shelf (BSOL12xx). The Corner Shelf Kit reflects the panel width, the actual size is actual 12" smaller.
- Includes handed corner side end gable, flat bracket, black lock hole plug with Boulevard logo and attachment hardware.
- Shipped KD.

PRODUCT CODE	PRICE	SIZE/ INCHES			WEIGHT VOL	
		H	W	D	LBS	FT <sup>3</sup>
BSOC1236L	133	5	24	12.5	8	0.16
BSOC1242L	141	5	30	12.5	10	0.20
BSOC1248L	155	5	36	12.5	12	0.25
BSOC1254L	161	5	42	12.5	13	0.29
BSOC1260L	172	5	48	12.5	15	0.33
BSOC1266L	179	5	54	12.5	17	0.37
BSOC1272L	184	5	60	12.5	18	0.41
BSOC1236R	133	5	24	12.5	8	0.16
BSOC1242R	141	5	30	12.5	10	0.20
BSOC1248R	155	5	36	12.5	12	0.25
BSOC1254R	161	5	42	12.5	13	0.29
BSOC1260R	172	5	48	12.5	15	0.33
BSOC1266R	179	5	54	12.5	17	0.37
BSOC1272R	184	5	60	12.5	18	0.41

**BSOH • High Profile Shelf**

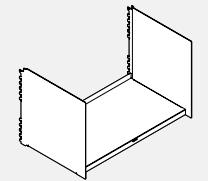

- 12" deep panel mounted shelf with back lip to protect fabric.
- Includes black lock hole plug with Boulevard logo and attachment hardware.
- Shipped KD.

PRODUCT CODE	PRICE	SIZE/ INCHES			WEIGHT VOL	
		H	W	D	LBS	FT <sup>3</sup>
BSOH1224	232	14.6	24	13.5	14	0.18
BSOH1230	242	14.6	30	13.5	16	0.22
BSOH1236	256	14.6	36	13.5	17	0.26
BSOH1242	264	14.6	42	13.5	19	0.31
BSOH1248	270	14.6	48	13.5	21	0.35
BSOH1254	281	14.6	54	13.5	23	0.40
BSOH1260	288	14.6	60	13.5	24	0.44

**BSOF • KD Overhead Flipper Door Storage Unit**

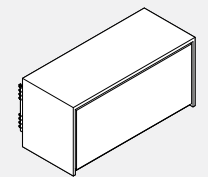

- 12" Deep units accept BSOFD01, BSOF12DIV or BASD12 binder plate dividers.
- Door retracts up and over the cabinet.
- Inside dimensions: 12" high x 11 3/4" deep.
- All cabinets 54" and longer are reinforced for proper weight distribution.
- Includes mounting brackets, black lock hole plug with Boulevard logo and attachment hardware.
- Lock not included, specify BALK12 if required.
- Shipped KD.
- Not Recommended for use with wall rails.
- Back panel ordered separately.

PRODUCT CODE	PRICE	SIZE/ INCHES			WEIGHT VOL	
		H	W	D	LBS	FT <sup>3</sup>
BSOF1224	499	14.6	24	13.5	27	0.79
BSOF1230	517	14.6	30	13.5	31	0.83
BSOF1236	573	14.6	36	13.5	36	0.99
BSOF1242	630	14.6	42	13.5	41	1.16
BSOF1248	690	14.6	48	13.5	46	1.32
BSOF1254	747	14.6	54	13.5	51	1.49
BSOF1260	803	14.6	60	13.5	56	1.66

**BSFC • KD Overhead Flipper Door Conversion Kit**

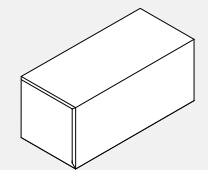

- Converts a BSOH12xx unit into a flipper door storage unit on site.
- Includes gables, top, door and conversion hardware.
- Lock not included, order BALK12 if lock is required.
- Shipped KD.

PRODUCT CODE	PRICE	SIZE/ INCHES			WEIGHT VOL	
		H	W	D	LBS	FT <sup>3</sup>
BSFC1224	386	14.5	24	12	4	0.42
BSFC1230	400	14.5	30	12	5	0.48
BSFC1236	462	14.5	36	12	7	0.57
BSFC1242	517	14.5	42	12	9	0.67
BSFC1248	573	14.5	48	12	10	0.77
BSFC1254	630	14.5	54	12	12	0.86
BSFC1260	690	14.5	60	12	13	0.96

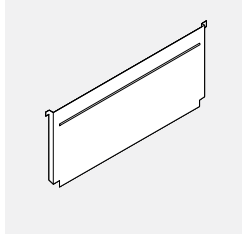
**BSBC • KD Back Wall Conversion Kit**

- Encloses the back of the overhead BSOF12xx for security.

PRODUCT CODE	PRICE	SIZE/ INCHES			WEIGHT VOL	
		H	W	D	LBS	FT <sup>3</sup>
BSBC1224	138	14.5	24	12	4	0.42
BSBC1230	144	14.5	30	12	5	0.48
BSBC1236	153	14.5	36	12	7	0.57
BSBC1242	158	14.5	42	12	9	0.67
BSBC1248	162	14.5	48	12	10	0.77
BSBC1254	168	14.5	54	12	12	0.86
BSBC1260	182	14.5	60	12	13	0.96

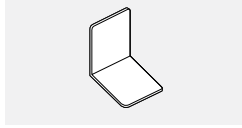
**BASD • Shelf Dividers for KD Storage**

- Supports books on all types of storage shelves.
- Two dividers per package.

PRODUCT CODE	PRICE	SIZE/ INCHES			WEIGHT VOL	
		H	W	D	LBS	FT <sup>3</sup>
BASD12	61	4.5	4.5	4.5	0.6	0.03

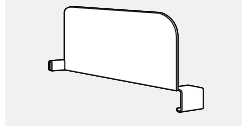
**BSOF-DIV • Shelf Dividers for KD Storage**

- Supports book on BSOL12xx and BSOF12xx.
- Installs over front edge of shelf and back lip.

PRODUCT CODE	PRICE	SIZE/ INCHES			WEIGHT VOL	
		H	W	D	LBS	FT <sup>3</sup>
BSOF12DIV	162			12		

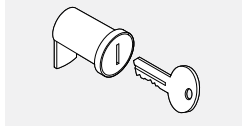
**BALK12 • Lock for Overhead Flipper Door Storage Unit BSOF12**

- Includes lock and two keys for BSOF12.
- Site installed.

PRODUCT CODE	PRICE	SIZE/ INCHES			WEIGHT VOL	
		H	W	D	LBS	FT <sup>3</sup>
BALK12	41				0.13	0.001

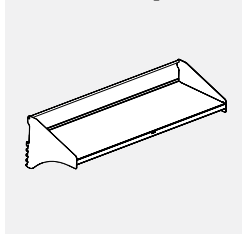
**BSOLC • Upmount KD Open Shelf**

- 12" deep panel up-mounted shelf.
- includes back shelf lip and rod that act as bookstops.
- Does not work in conjunction with any overpanel.
- Shipped KD.

PRODUCT CODE	PRICE	SIZE/ INCHES			WEIGHT VOL	
		H	W	D	LBS	FT <sup>3</sup>
BSOLC1224	244	10	24	12	10	0.20
BSOLC1230	255	10	30	12	12	0.24
BSOLC1236	263	10	36	12	14	0.29
BSOLC1242	276	10	42	12	15	0.34
BSOLC1248	286	10	48	12	17	0.37
BSOLC1254	295	10	54	12	19	0.41
BSOLC1260	307	10	60	12	20	0.45

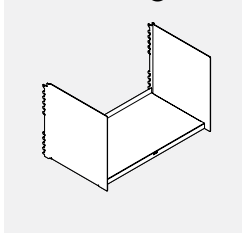
**BSOH • High Profile Shelf**

- 16" deep panel mounted storage shelf with back lip to protect fabric.
- Shipped KD.
- Includes attachment hardware.

PRODUCT CODE	PRICE	SIZE/ INCHES			WEIGHT VOL	
		H	W	D	LBS	FT <sup>3</sup>
BSOH1624	362	17.55	24	15.765	18	0.21
BSOH1630	386	17.55	30	15.765	21	0.26
BSOH1636	411	17.55	36	15.765	22	0.32
BSOH1642	433	17.55	42	15.765	25	0.37
BSOH1648	462	17.55	48	15.765	27	0.43
BSOH1654	485	17.55	54	15.765	30	0.48
BSOH1660	530	17.55	60	15.765	31	0.53

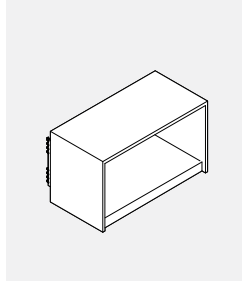
**BSOO • Open Overhead Storage**

- 16" deep panel mounted storage open overhead built with metal sides and back.
- 16" deep unit accommodates letter, legal and tab binder, EDP, and A4 metric filing.
- All cabinets 36" and longer are reinforced for proper weight distribution. Includes mounting brackets.
- Includes mounting brackets.
- Accepts BAPD03 and BAHPD03 plate dividers.
- Flipper door and track assembly (BAFD) can be field retrofitted.
- Shipped assembled.

PRODUCT CODE	PRICE	SIZE/ INCHES			WEIGHT VOL	
		H	W	D	LBS	FT <sup>3</sup>
BSOO1624	558	17.55	24	15.765	29	3.85
BSOO1630	580	17.55	30	15.765	35	4.86
BSOO1636	622	17.55	36	15.765	47	5.83
BSOO1642	666	17.55	42	15.765	54	6.81
BSOO1648	703	17.55	48	15.765	59	7.78
BSOO1654	747	17.55	54	15.765	64	8.75
BSOO1660	769	17.55	60	15.765	65	9.72

**BAFD • Flipper Door and Track Assembly Retrofit Kit**

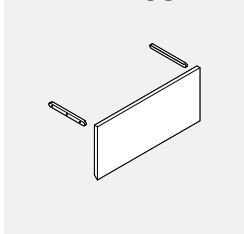

- Converts an open overhead BS0016xx storage unit into a flipper door storage unit on site.
- Includes conversion hardware and lock

PRODUCT CODE	PRICE	SIZE/ INCHES			WEIGHT VOL	
		H	W	D	LBS	FT <sup>3</sup>
BAFD24	328	15	24	1	9	0.21
BAFD30	350	15	30	1	10	0.26
BAFD36	363	15	36	1	12	0.31
BAFD42	380	15	42	1	13	0.36
BAFD48	398	15	48	1	14	0.42
BAFD54	416	15	54	1	15	0.47
BAFD60	446	15	60	1	17	0.52

**BSOF • Overhead Flipper Door Storage Unit**

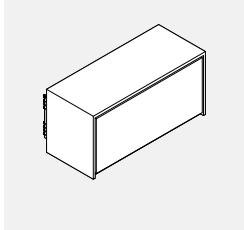

- 16" deep unit accommodates letter, legal and tab binder, EDP, and A4 metric filing.
- All cabinets 36" and longer are reinforced for proper weight distribution.
- Includes mounting brackets and lock with two keys.
- Accepts BAPD03 and BAHPD03 plate dividers.
- Shipped assembled.
- Inside dimensions are 12.75" high by 14.9" deep.

PRODUCT CODE	PRICE	SIZE/ INCHES			WEIGHT VOL	
		H	W	D	LBS	FT <sup>3</sup>
BSOF1624	893	17.5	24	16	29	3.95
BSOF1630	916	17.5	30	16	49	4.86
BSOF1636	960	17.5	36	16	56	5.83
BSOF1642	1024	17.5	42	16	64	6.81
BSOF1648	1089	17.5	48	16	75	7.78
BSOF1654	1148	17.5	54	16	86	8.75
BSOF1660	1200	17.5	60	16	98	9.72

**BHOC • Upmount Cantilever**

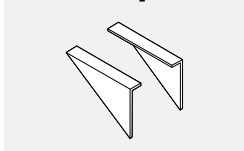

- Cantilevers up-mount a BSOF16xx

PRODUCT CODE	PRICE	SIZE/ INCHES			WEIGHT VOL	
		H	W	D	LBS	FT <sup>3</sup>
BHOC	141	8	1	13.25	3	0.09

**BHOBP • Up Mount Back Panel**

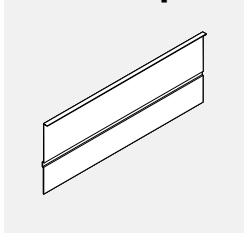

- Optional back panel aesthetically covers the back of the overhead when you up-mount a BSOF16xx and BS0016xx overhead on top of lower panel.

PRODUCT CODE	PRICE	SIZE/ INCHES			WEIGHT VOL	
		H	W	D	LBS	FT <sup>3</sup>
BHOBP24	189	17.55	24	1	3	0.320
BHOBP30	241	17.55	30	1	3	0.320
BHOBP36	254	17.55	36	1	4	0.375
BHOBP42	276	17.55	42	1	5	0.438
BHOBP48	376	17.55	48	1	6	0.500
BHOBP54	400	17.55	54	1	7	0.563
BHOBP60	436	17.55	60	1	8	0.018

**BSOL • Radius Low Profile Shelf**

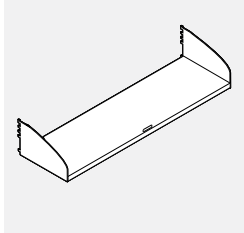

- 14" deep panel mounted storage shelf with back lip to protect panel fabric.
- Includes attachment hardware.
- Shipped KD.
- Shelf ends are 6" high and shelf depth is 13.5 deep.

PRODUCT CODE	PRICE	SIZE/ INCHES			WEIGHT VOL	
		H	W	D	LBS	FT <sup>3</sup>
BSOL1524	222	6	24	14	13	1.6
BSOL1530	230	6	30	14	15	1.8
BSOL1536	241	6	36	14	17	1.8
BSOL1542	254	6	42	14	19	1.8
BSOL1548	264	6	48	14	21	1.8
BSOL1554	276	6	54	14	23	3.1
BSOL1560	288	6	60	14	25	3.1

**BSOH • Radius High Profile Shelf**

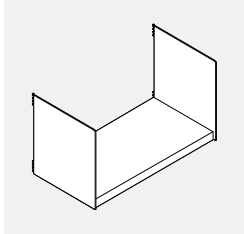

- 15" deep panel mounted storage shelf with back lip to protect panel fabric.
- Includes attachment hardware.
- Shipped KD.
- Shelf ends are 16.5" high and shelf depth is 13.5" deep.

PRODUCT CODE	PRICE	SIZE/ INCHES			WEIGHT VOL	
		H	W	D	LBS	FT <sup>3</sup>
BSOH1524	255	16.5	24	14.75	23	2.2
BSOH1530	264	16.5	30	14.75	25	2.2
BSOH1536	276	16.5	36	14.75	27	2.2
BSOH1542	288	16.5	42	14.75	29	2.2
BSOH1548	295	16.5	48	14.75	31	2.2
BSOH1554	310	16.5	54	14.75	43	2.2
BSOH1560	319	16.5	60	14.75	45	2.2

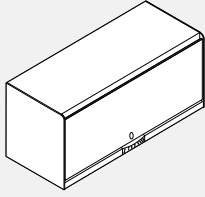

**BSKD • Radius Overhead Storage Unit**

- 15" deep panel mounted overhead storage unit with metal sides, retracting flipper door and "soft-to-the-touch" handle.
- 15" deep units accept BASD12 binder plate dividers.
- All cabinets 54" and longer are reinforced for proper weight distribution.
- Inside dimensions are 12.5" high by 13.5" deep.
- Includes attachment hardware, lock and mounting brackets.
- Not recommended for use with wall rails.
- Shipped KD.
- Cannot be converted to up-mount.
- Back not included.

PRODUCT CODE	PRICE	SIZE/ INCHES			WEIGHT VOL	
		H	W	D	LBS	FT <sup>3</sup>
BSKD1530	743	16.5	30	14.75	39	2.2
BSKD1536	803	16.5	36	14.75	44	2.2
BSKD1542	859	16.5	42	14.75	49	2.2
BSKD1548	917	16.5	48	14.75	55	2.2
BSKD1554	978	16.5	54	14.75	60	2.2
BSKD1560	1033	16.5	60	14.75	66	2.2

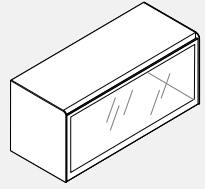
**BSKDGD • Radius Overhead Storage Unit with Glazed Door**

- Frosted acrylic glazing available.
- 15" deep panel mounted overhead storage unit with metal sides and retracting flipper door.
- 15" deep units accept BASD12 binder plate dividers.
- All cabinets 54" and longer are reinforced for proper weight distribution.
- Inside dimensions are 12.5" high by 13.5" deep.
- Includes attachment hardware, lock and mounting brackets.
- Not recommended for use with wall rails.
- Shipped KD.
- Cannot be converted to up-mount.
- Back not included.

PRODUCT CODE	PRICE	SIZE/ INCHES			WEIGHT VOL	
		H	W	D	LBS	FT <sup>3</sup>
BSKD1530GD	1029	16.5	30	14.75	39	2.2
BSKD1536GD	1153	16.5	36	14.75	44	2.2
BSKD1542GD	1263	16.5	42	14.75	49	2.2
BSKD1548GD	1323	16.5	48	14.75	55	2.2
BSKD1554GD	1493	16.5	54	14.75	60	2.2
BSKD1560GD	1588	16.5	60	14.75	66	2.2

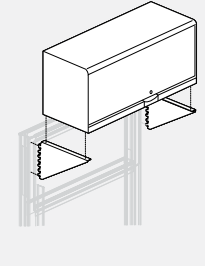
**BSKDC • Radius Up Mount Overhead Storage Unit**

- Up mounted radius overhead retracting flipper door unit on top of lower panel adds privacy without the expense of an over panel.
- 15" deep units accepts BASD12 binder plate dividers.
- All cabinets 54" and longer are reinforced for proper weight distribution.
- Inside dimensions: 12" high x 14 3/4" deep.
- Includes attachment hardware, lock and mounting brackets.
- Not recommended for use with wall rails, must be used attached to panels by the cantilevers provided.
- Features a completely finished back.
- Shipped KD

PRODUCT CODE	PRICE	SIZE/ INCHES			WEIGHT VOL	
		H	W	D	LBS	FT <sup>3</sup>
BSKDC1530	1118	16.5	30	14.75	43	19
BSKDC1536	1205	16.5	36	14.75	49	22
BSKDC1542	1293	16.5	42	14.75	54	24
BSKDC1548	1375	16.5	48	14.75	60	27
BSKDC1554	1464	16.5	54	14.75	66	30
BSKDC1560	1549	16.5	60	14.75	72	32

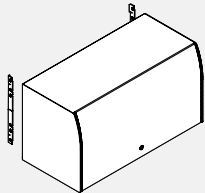
**BSADA-PM • Panel Mounted Overhead Storage Unit - AODA Compliant**

- Panel mounted metal overhead storage with opaque acrylic door. The mechanism lifts the door up and stores it out of the way, above the storage unit.
- Meets CSA B651 Barrier Free Design & AODA (Accessibility for Ontarians with Disabilities Act).
- 16" high units accept standard and A4 binders.
- All shelves are reinforced for proper weight distribution.
- Inside dimensions: 14.25" high x 13.4" deep.
- Unit includes attachment hardware, lock and mounting brackets. Back not included.
- Not recommended for use with wall rails.
- Unit can be converted to Up-Mount Overhead Storage Unit in the field by adding BSADAxKIT.
- Shipped partially assembled.

PRODUCT CODE	PRICE	SIZE/ INCHES			WEIGHT VOL	
		H	W	D	LBS	FT <sup>3</sup>
BSADA24PM	757	16	24	14.2	22	4.3
BSADA30PM	815	16	30	14.2	27	5.3
BSADA36PM	880	16	36	14.2	32	6.3
BSADA42PM	942	16	42	14.2	37	7.3
BSADA48PM	1007	16	48	14.2	42	8.3
BSADA54PM	1069	16	54	14.2	47	9.3
BSADA60PM	1133	16	60	14.2	53	10.3

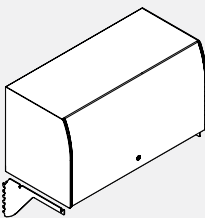
**BSADA-UM • Up-Mount Overhead Storage Unit - AODA Compliant**

- Up mounted storage can reduce furniture costs by reducing the height of all panels to 50". Complete 50" panel installations simplify cable routing at one level, within the top lay-in channel. Up-mounted cantilevers maintain accessibility and functionality of the panels' top lay-in channel.
- Meets CSA B651 Barrier Free Design & AODA (Accessibility for Ontarians with Disabilities Act).
- 16" high units accept standard and A4 binders.
- All shelves are reinforced for proper weight distribution.
- Inside dimensions: 14.25" high x 13.4" deep.
- Unit includes attachment hardware, lock, mounting cantilevers and has a finished back.
- Unit can be converted to a Panel Mounted Overhead Storage Unit in the field by adding BSADAPMxxKIT.
- Shipped partially assembled.

PRODUCT CODE	PRICE	SIZE/ INCHES			WEIGHT VOL	
		H	W	D	LBS	FT <sup>3</sup>
BSADA24UM	928	16	24	14.2	25	4.3
BSADA30UM	970	16	30	14.2	33	5.3
BSADA36UM	1016	16	36	14.2	40	6.3
BSADA42UM	1073	16	42	14.2	46	7.3
BSADA48UM	1132	16	48	14.2	53	8.3
BSADA54UM	1186	16	54	14.2	59	9.3
BSADA60UM	1255	16	60	14.2	66	10.3

**BSADA-KIT • Up-Mount Conversion Kit**

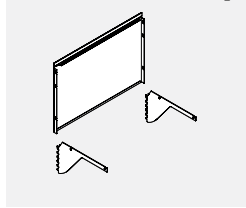

- Converts an existing Panel Mounted Overhead Storage Unit BSADA-PM to an Up-Mounted Overhead Storage unit BSADA-UM.
- When used on a 50" high panel, the top of the overhead will match the height of 66" high panels.
- Kit includes a back panel for the Overhead and Up-Mount Cantilevers.

PRODUCT CODE	PRICE	SIZE/ INCHES			WEIGHT VOL	
		H	W	D	LBS	FT <sup>3</sup>
BSADA24KIT	188	16	24	2	6	0.6
BSADA30KIT	195	16	30	2	8	0.6
BSADA36KIT	204	16	36	2	10	0.7
BSADA42KIT	218	16	42	2	11	0.8
BSADA48KIT	228	16	48	2	13	0.9
BSADA54KIT	240	16	54	2	14	1.0
BSADA60KIT	253	16	60	2	15	1.1

**BSADA-OMKIT • Off-Module Conversion Kit**

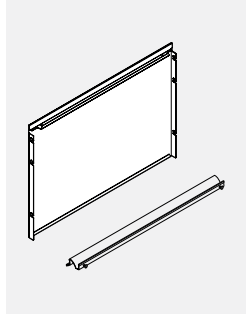

- Converts an existing Panel Mounted Storage Unit BSADA-PM to Off-Module Overhead Storage unit BSADA-OMKIT.
- Kit includes a back panel with integrated hanging bracket and an extruded bottom bracket.
- IMPORTANT: BSADA Overhead with Off-Module Conversion kit can only be installed on B3 fabric tile. Tiles below the overhead can be fabric, laminate and accessory tile. However, the tile the overhead is hanging on must be fabric.
- BSADA Overhead with Off-Module Conversion Kit can be suspended off of a single fabric tile, or can span two fabric tiles on two adjacent, directly interconnected panels.
- BSADA Overhead with Off-Module Conversion Kit CANNOT be suspended off of two panels separated by a post.

PRODUCT CODE	PRICE	SIZE/ INCHES			WEIGHT VOL	
		H	W	D	LBS	FT <sup>3</sup>
BSADA24OMKIT	188	16	24	2	6	0.5
BSADA30OMKIT	195	16	30	2	8	0.6
BSADA36OMKIT	204	16	36	2	10	0.7
BSADA42OMKIT	218	16	42	2	11	0.8
BSADA48OMKIT	228	16	48	2	13	0.9
BSADA54OMKIT	240	16	54	2	14	1.0
BSADA60OMKIT	253	16	60	2	15	1.1

**BSADA-KIT • Panel Mount Conversion Kit**



- Converts an existing Up-Mount Overhead Storage Unit BSADA-UM to a Panel Mounted Overhead Storage Unit BSADA-PM.
- Kit includes panel mounting brackets.

PRODUCT CODE	PRICE	SIZE/ INCHES			WEIGHT VOL	
		H	W	D	LBS	FT <sup>3</sup>
BSADAPMKIT	39	16	0.5	2	2	0.009

**BSOFD • Overhead Divider**

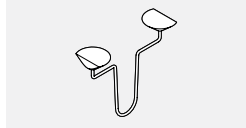

- Attaches to the inside top of the overhead top shelf.
- Provides a rigid division for books and binders.
- 1 per package.
- Can be used on BSOF12.

PRODUCT CODE	PRICE	SIZE/ INCHES			WEIGHT VOL	
		H	W	D	LBS	FT <sup>3</sup>
BSOFD01	67	10	0.875		0.5	0.10

**BSP1DO • Overhead Divider Storage for Boulevard 1 - Open Double Sided**

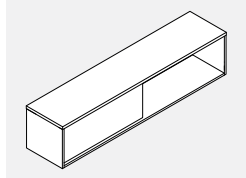

- Panel top mount allows access on both sides.
- Storage compartment internal height: 14".
- Overhead available in standard GC laminate finishes.
- Top mount on panels.
- Connecting hardware included.

PRODUCT CODE	PRICE		SIZE/ INCHES			WEIGHT VOL	
	LP	HP	H	W	D	LBS	FT <sup>3</sup>
BSP1DO36	636	716	16	36	16	81	7
BSP1DO42	655	744	16	42	16	96	8
BSP1DO48	680	784	16	48	16	100	9

**BSP1LDS • Overhead Divider Storage for Boulevard 1 - Open Double Sided with Sliding Laminate Door**

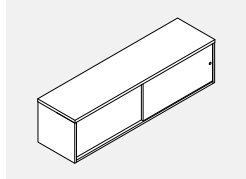

- Panel top mount allows access on both sides.
- Storage compartment internal height: 14".
- Overhead available in standard GC laminate finishes.
- Top mount on panels.
- Connecting hardware included.
- Sliding laminate doors are not locking.

PRODUCT CODE	PRICE		SIZE/ INCHES			WEIGHT VOL	
	LP	HP	H	W	D	LBS	FT <sup>3</sup>
BSP1LDS36	1997	2074	16	36	16	87	7
BSP1LDS42	2042	2135	16	42	16	103	8
BSP1LDS48	2069	2175	16	48	16	108	9

**BSP1GDS • Overhead Divider Storage for Boulevard 1 - Open Double Sided with Sliding Glass Door**

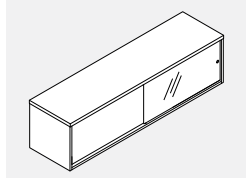

- Panel top mount allows access on both sides.
- Storage compartment internal height: 14".
- Overhead available in standard GC laminate finishes.
- Top mount on panels.
- Connecting hardware included.
- Sliding glass doors are not locking.

PRODUCT CODE	PRICE		SIZE/ INCHES			WEIGHT VOL	
	LP	HP	H	W	D	LBS	FT <sup>3</sup>
BSP1GDS36	2067	2146	16	36	16	92	7
BSP1GDS42	2102	2195	16	42	16	108	8
BSP1GDS48	2132	2237	16	48	16	113	9

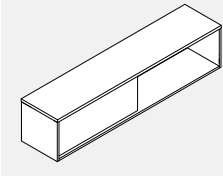
**BSP3DO • Overhead Divider Storage for Boulevard System 3 - Open Double Sided**

- Panel top mount allows access on both sides.
- Storage compartment internal height: 14".
- Overhead available in standard GC laminate finishes.
- Top mount on panels.
- Connecting hardware included.

PRODUCT CODE	PRICE		SIZE / INCHES			WEIGHT VOL	
	LP	HP	H	W	D	LBS	FT <sup>3</sup>
BSP3DO36	615	695	16	36	16	81	9
BSP3DO42	641	734	16	42	16	96	10.5
BSP3DO48	669	773	16	48	16	100	12

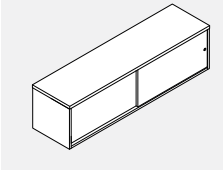
**BSP3LDS • Overhead Divider Storage for Boulevard System 3 - Open Double Sided with Sliding Laminate Door**

- Panel top mount allows access on both sides.
- Storage compartment internal height: 14".
- Overhead available in standard GC laminate finishes.
- Top mount on panels.
- Connecting hardware included.
- Sliding laminate doors are not locking.

PRODUCT CODE	PRICE		SIZE / INCHES			WEIGHT VOL	
	LP	HP	H	W	D	LBS	FT <sup>3</sup>
BSP3LDS36	1977	2055	16	36	16	106	7
BSP3LDS42	2025	2115	16	42	16	126	8
BSP3LDS48	2049	2156	16	48	16	134	9

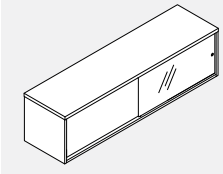
**BSP3GDS • Overhead Divider Storage for Boulevard System 3 - Open Double Sided with Sliding Glass Door**

- Panel top mount allows access on both sides.
- Storage compartment internal height: 14".
- Overhead available in standard GC laminate finishes.
- Top mount on panels.
- Connecting hardware included.
- Sliding glass doors are not locking.

PRODUCT CODE	PRICE		SIZE / INCHES			WEIGHT VOL	
	LP	HP	H	W	D	LBS	FT <sup>3</sup>
BSP3GDS36	2047	2126	16	36	16	87	6
BSP3GDS42	2081	2175	16	42	16	103	7
BSP3GDS48	2111	2217	16	48	16	107	9

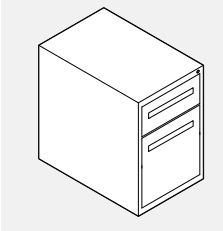
**BS12BF • One and 1/2 Height BP Pedestal**

- Freestanding Pedestal with long pull offers finished top and back.
- Non worksurface supporting.
- Steel top features folded corner construction.
- Lock positioned on the front face, right side.
- Drawer configuration cannot be changed on site.

PRODUCT CODE	PRICE		SIZE / INCHES			WEIGHT VOL	
	"C"	"L"	H	W	D	LBS	FT <sup>3</sup>
BS1218BF	571	616	21.6	15	19	50	4.65
BS1223BF	579	625	21.6	15	23	54	5.52
BS1229BF	656	700	21.6	15	29	60	6.80

Note: "C" Indicates "C" Series featuring a full width pull. "L" indicates "Linear" Series featuring a "Soft-to-the-touch" handles.

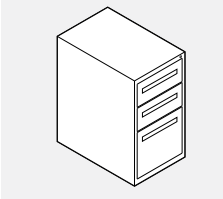
**BS12BBF • 12" Series BBF Pedestal Worksurface Supporting**

- Worksurface Supporting Pedestal with long pull and double wall drawer front construction.
- Lock is positioned on the front face, right side.

Note: "C" Indicates "C" Series featuring a full width pull. "L" indicates "Linear" Series featuring a "Soft-to-the-touch" handles.

PRODUCT CODE	PRICE		SIZE / INCHES			WEIGHT VOL	
	"C"	"L"	H	W	D	LBS	FT <sup>3</sup>
BS1218BBF	637	703	27.6	15	18	70	4.29
BS1223BBF	644	710	27.6	15	23	84	5.62
BS1224BBF	644	710	27.6	15	24	84	5.62
BS1229BBF	710	776	27.6	15	29	94	7.03
BS1230BBF	710	776	27.6	15	30	94	7.03

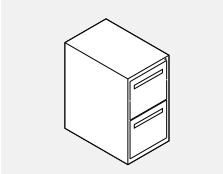
**BS12FF • 12" Series FF Pedestal Worksurface Supporting**

- Worksurface Supporting Pedestal with long pull and double wall drawer front construction.
- Lock is positioned on the front face, right side.

Note: "C" Indicates "C" Series featuring a full width pull. "L" indicates "Linear" Series featuring a "Soft-to-the-touch" handles.

PRODUCT CODE	PRICE		SIZE / INCHES			WEIGHT VOL	
	"C"	"L"	H	W	D	LBS	FT <sup>3</sup>
BS1218FF	637	684	27.6	15	18	70	4.29
BS1223FF	644	690	27.6	15	23	84	5.62
BS1224FF	644	690	27.6	15	24	84	5.62
BS1229FF	710	757	27.6	15	29	94	7.03
BS1230FF	710	757	27.6	15	30	94	7.03

**BS1230DP • 12" Combination Pedestal**

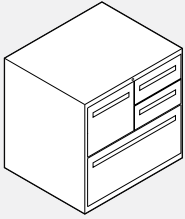

Left Hand Shown

- Fits under standard 29" worksurface and can be supporting.
- Includes leveling glides.
- Lock is positioned on the front face, center.
- Interiors are finished in black.
- No handle or casters.

Note: "C" Indicates "C" Series featuring a full width pull. "L" indicates "Linear" Series featuring a "Soft-to-the-touch" handles.

PRODUCT CODE	PRICE		SIZE/ INCHES			WEIGHT VOL	
	"C"	"L"	H	W	D	LBS	FT <sup>3</sup>
BS1230DPL	1609	1697	27.875	30	18	108	11
BS1230DPR	1609	1697	27.875	30	18	108	11

- Business Lateral File Taxi with two box drawers on right with one pencil tray and one divider plate. Efficient, stationary storage and additional work space.
- 12" legal file drawer on left with full suspension and hanging bars.
- Fixed front drawer with three divider plates.

**BS12BFM • 12" BF Mobile Pedestal**

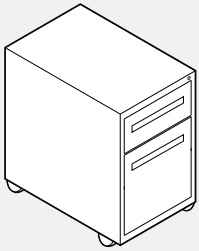

- Mobile Pedestal with flat front, double wall drawer construction with "soft-to-the touch" handles.
- Includes 4 casters and 1 counterweight balance.
- Lock is positioned on the front face, right side.
- Includes panel mounting bracket, bracket retainer clip and leveling glides.
- Pedestal will fit under 29" high worksurface.

Note: "C" Indicates "C" Series featuring a full width pull. "L" indicates "Linear" Series featuring a "Soft-to-the-touch" handles.

PRODUCT CODE	PRICE		SIZE/ INCHES			WEIGHT VOL	
	"C"	"L"	H	W	D	LBS	FT <sup>3</sup>
BS1218BFM	758	800	22.5	15	18	80	5.71
BS1223BFM	763	806	22.5	15	23	83	6.25
BS1229BFM	878	921	22.5	15	29	86	7.05

**BMP2315C • Mobile Pedestal with File, Box, Pencil Drawer**

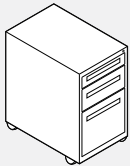

- Mobile Pedestal with flat front, double wall drawer construction.
- Has a file drawer, box drawer and pencil drawer.
- Includes 4 casters and 1 counterweight balance.
- Lock is positioned on the front face, right side.
- Includes panel mounting bracket, bracket retainer clip and leveling glides.
- Pedestal will fit under 29" high worksurface.
- Not available with "Soft-to-the-touch" handles.

PRODUCT CODE	PRICE		SIZE/ INCHES			WEIGHT VOL	
	"C"	"L"	H	W	D	LBS	FT <sup>3</sup>
BMP2315C	1084		25	15	23	84	5.62

**BS12PSB-BBFM • Box Box File Long Pull Mobile Pedestal**

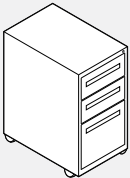

- Mobile Pedestal with long pull offers finished top and back. Will fit under 29" high worksurface.
- Includes 4 casters and 1 factory installed counterweight balance.
- Steel top features folded corner construction.
- Lock positioned on the front face, right side.
- Drawer configuration cannot be changed on site.

Note: "C" Indicates "C" Series featuring a full width pull. "L" indicates "Linear" Series featuring a "Soft-to-the-touch" handles.

PRODUCT CODE	PRICE		SIZE/ INCHES			WEIGHT VOL	
	"C"	"L"	H	W	D	LBS	FT <sup>3</sup>
BS12PSB19BBFM	800	864	28	15	19	95	6.08
BS12PSB23BBFM	807	871	28	15	23	101	7.21
BS12PSB29BBFM	928	990	28	15	29	106	8.91

**BS12PSB-FFM • File File Long Pull Mobile Pedestal**

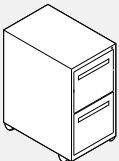

- Mobile Pedestal with long pull offers finished top and back. Will fit under 29" high worksurface.
- Includes 4 casters and 1 factory installed counterweight balance.
- Steel top features folded corner construction.
- Lock positioned on the front face, right side.
- Drawer configuration cannot be changed on site.

Note: "C" Indicates "C" Series featuring a full width pull. "L" indicates "Linear" Series featuring a "Soft-to-the-touch" handles.

PRODUCT CODE	PRICE		SIZE/ INCHES			WEIGHT VOL	
	"C"	"L"	H	W	D	LBS	FT <sup>3</sup>
BS12PSB19FFM	800	843	28	15	19	95	6.08
BS12PSB23FFM	807	850	28	15	23	101	7.21
BS12PSB29FFM	928	970	28	15	29	106	8.91

**BS12X1HF • One and 1/2 Height Fixed Front & One 12" Fixed Front Lateral File**

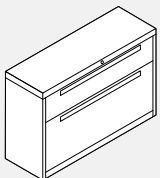

- One and half height storage module with long pull handles.
- Top opening is a 1/2 height box drawer.
- Bottom opening is a full height lateral drawer.

Note: "C" Indicates "C" Series featuring a full width pull. "L" indicates "Linear" Series featuring a "Soft-to-the-touch" handles.

PRODUCT CODE	PRICE		SIZE/ INCHES			WEIGHT VOL	
	"C"	"L"	H	W	D	LBS	FT <sup>3</sup>
BS1230X1HF	1268	1311	21.75	30	18	137	11
BS1236X1HF	1320	1363	21.75	36	18	164	13
BS1242X1HF	1364	1406	21.75	42	18	189	15

**BS12X1S1F • One 1/2 Height Open Shelf & One 12" Fixed Front Lateral File**

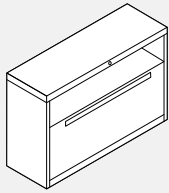

- One and half height storage module with long pull handles.
- Top opening is a half height open shelf.
- Bottom opening is a full height lateral drawer.

Note: "C" Indicates "C" Series featuring a full width pull. "L" indicates "Linear" Series featuring a "Soft-to-the-touch" handles.

PRODUCT CODE	PRICE		SIZE/ INCHES			WEIGHT VOL	
	"C"	"L"	H	W	D	LBS	FT <sup>3</sup>
BS1230X1S1F	1225	1249	21.75	30	18	127	11
BS1236X1S1F	1250	1272	21.75	36	18	150	13
BS1242X1S1F	1279	1299	21.75	42	18	174	15

**BS12X1SND • One 1/2 Height Open Shelf & One 12" Open Shelf Lateral Cabinet**

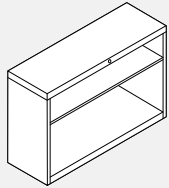

- One and half height storage module.
- Shelf is height adjustable.

PRODUCT CODE	PRICE	SIZE/ INCHES			WEIGHT VOL	
		H	W	D	LBS	FT <sup>3</sup>
BS1230X1SND	989	21.75	30	18	107	11
BS1236X1SND	1077	21.75	36	18	130	13
BS1242X1SND	1153	21.75	42	18	154	15

**BS12X1S • One 1/2 Height Shelf & One 12" Shelf Lateral Cabinet with Doors**

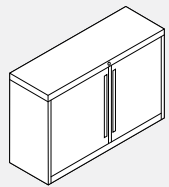

- One and half height storage module with long pulls.
- Storage cabinet with doors.
- One height adjustable shelf included.

Note: "C" indicates "C" Series featuring a full width pull. "L" indicates "Linear" Series featuring a "Soft-to-the-touch" handles.

PRODUCT CODE	PRICE		SIZE/ INCHES			WEIGHT VOL	
	"C"	"L"	H	W	D	LBS	FT <sup>3</sup>
BS1230X1S	1040	1085	21.75	30	18	117	6.80
BS1236X1S	1161	1202	21.75	36	18	140	8.15
BS1242X1S	1262	1307	21.75	42	18	164	9.50

**BSTC • Pedestal/Lateral Seat Cushion**

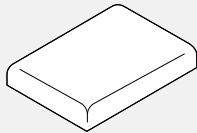

PRODUCT CODE	YRDS	SIZE/ INCHES			WEIGHT VOL	
		H	W	D	LBS	FT <sup>3</sup>
BSTCP1518	.75	2	15	18	2	0.41
BSTCP1519	.75	2	15	19	2	0.42
BSTCP1523	.75	2	15	23	2.5	0.5
BSTCP1524	.75	2	15	24	2.5	0.52
BSTCP1529	1	2	15	29	3	0.63
BSTCP1530	1	2	15	30	3	0.75
BSTCL1830	1	2	18	30	4	0.33
BSTCL1836	1.25	2	18	36	5	0.4

PRODUCT CODE	PRICE																			
	GR1	GR2	GR3	GR4	GR5	GR6	GR7	GR8	GR9	GR10	GR11	GR12	GR13	GR14	GR15	GR16	GR17	GR18	GR19	GR20
BSTCP1518	196	226	245	272	314	353	389	422	463	503	557	633	703	779	944	1109	1274	1439	1604	1785
BSTCP1519	199	230	253	278	319	358	396	429	469	508	562	637	710	785	949	1114	1280	1444	1608	1790
BSTCP1523	206	233	256	283	323	361	399	435	472	513	565	640	715	789	955	1119	1285	1451	1613	1794
BSTCP1524	212	240	262	289	330	367	406	439	477	521	573	647	722	795	959	1123	1289	1455	1619	1801
BSTCP1529	259	296	326	360	414	466	518	562	613	668	737	839	936	1034	1256	1473	1696	1916	2134	2377
BSTCP1530	266	301	331	366	420	471	523	567	619	673	743	844	943	1041	1262	1481	1702	1923	2140	2383
BSTCL1830	281	318	345	383	437	488	536	585	636	691	760	860	958	1057	1279	1496	1720	1938	2156	2399
BSTCL1836	333	380	417	461	527	590	653	712	778	844	932	1057	1179	1304	1581	1852	2130	2402	2677	2981

**BS12T502B1F • 12" BBF Storage Tower 50" High**

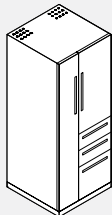

Left Shown

- This versatile tower can be used freestanding or integrated into a workstation to provide efficient vertical storage and filing, and provides storage for hats and coats.
- Coat storage may be specified right or left.
- Full height coat storage is 50" high x 8" wide with ventilation.
- Storage tower has 1 adjustable shelves and 1 fixed shelf with a 21" high door for 50" high unit.

Note: "C" Indicates "C" Series featuring a full width pull. "L" indicates "Linear" Series featuring a "Soft-to-the-touch" handles.

PRODUCT CODE	PRICE	SIZE/INCHES			WEIGHT VOL		
		"C"	"L"	H	W	D	LBS
BS12T502B1FL	2822	2930	50	24	24	158	20
BS12T502B1FR	2822	2930	50	24	24	158	20

**BS12T502F • 12" FF Storage Tower 50" High**

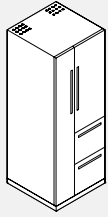

Left Shown

PRODUCT CODE	PRICE "C"	"L"	SIZE/INCHES			WEIGHT VOL	
			H	W	D	LBS	FT <sup>3</sup>
BS12T502FL	2822	2906	50	24	24	158	20
BS12T502FR	2822	2906	50	24	24	158	20

- This versatile tower can be used freestanding or integrated into a workstation to provide efficient vertical storage and filing, and provides storage for hats and coats.
- Coat storage may be specified right or left.
- Full height coat storage is 50" high x 8" wide with ventilation.
- Storage tower has 1 adjustable shelves and 1 fixed shelf with a 21" high door for 50" high unit.

Note: "C" Indicates "C" Series featuring a full width pull. "L" indicates "Linear" Series featuring a "Soft-to-the-touch" handles.

**BS12T542B1F • 12" BBF Storage Tower 54" High**

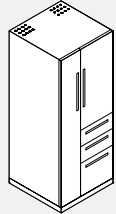

Left Shown

PRODUCT CODE	PRICE "C"	"L"	SIZE/INCHES			WEIGHT VOL	
			H	W	D	LBS	FT <sup>3</sup>
BS12T542B1FL	2836	2948	54	24	24	163	22
BS12T542B1FR	2836	2948	54	24	24	163	22

- This versatile tower can be used freestanding or integrated into a workstation to provide efficient vertical storage and filing, and provides storage for hats and coats.
- Coat storage may be specified right or left.
- Full height coat storage is 54" high x 8" wide with ventilation.
- Storage tower has 1 adjustable shelves and 1 fixed shelf with a 24 13/16" high door for 54" high unit.

Note: "C" Indicates "C" Series featuring a full width pull. "L" indicates "Linear" Series featuring a "Soft-to-the-touch" handles.

**BS12T542F • 12" FF Storage Tower 54" High**

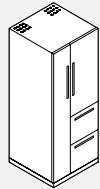

Left Shown

PRODUCT CODE	PRICE "C"	"L"	SIZE/INCHES			WEIGHT VOL	
			H	W	D	LBS	FT <sup>3</sup>
BS12T542FL	2836	2927	54	24	24	163	22
BS12T542FR	2836	2927	54	24	24	163	22

- This versatile tower can be used freestanding or integrated into a workstation to provide efficient vertical storage and filing, and provides storage for hats and coats.
- Coat storage may be specified right or left.
- Full height coat storage is 54" high x 8" wide with ventilation.
- Storage tower has 1 adjustable shelves and 1 fixed shelf with a 24 13/16" high door for 54" high unit.

Note: "C" Indicates "C" Series featuring a full width pull. "L" indicates "Linear" Series featuring a "Soft-to-the-touch" handles.

**BS12T662B1F • 12" BBF Storage Tower 65 7/8" High**

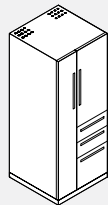

Left Shown

PRODUCT CODE	PRICE "C"	"L"	SIZE/INCHES			WEIGHT VOL	
			H	W	D	LBS	FT <sup>3</sup>
BS12T662B1FL	2968	3076	65.875	24	24	177	26
BS12T662B1FR	2968	3076	65.875	24	24	177	26

- This versatile tower can be used freestanding or integrated into a workstation to provide efficient vertical storage and filing, and provides storage for hats and coats.
- Coat storage may be specified right or left.
- Full height coat storage is 65" x 8" with ventilation.
- Storage towers with box, box, file drawers has 2 adjustable shelves and 1 fixed shelf and a 36 3/4" high door.

Note: "C" Indicates "C" Series featuring a full width pull. "L" indicates "Linear" Series featuring a "Soft-to-the-touch" handles.

**BS12T662F • 12" FF Storage Tower 65 7/8" High**

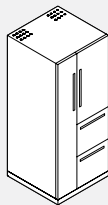

Left Shown

PRODUCT CODE	PRICE "C"	"L"	SIZE/INCHES			WEIGHT VOL	
			H	W	D	LBS	FT <sup>3</sup>
BS12T662FL	2968	3076	65.875	24	24	177	26
BS12T662FR	2968	3076	65.875	24	24	177	26

- This versatile tower can be used freestanding or integrated into a workstation to provide efficient vertical storage and filing, and provides storage for hats and coats.
- Coat storage may be specified right or left.
- Full height coat storage is 65" x 8" with ventilation.
- Storage towers with 2 file drawer or box, box, file drawers has 2 adjustable shelves and 1 fixed shelf and a 36 3/4" high door.

Note: "C" Indicates "C" Series featuring a full width pull. "L" indicates "Linear" Series featuring a "Soft-to-the-touch" handles.

**BS12TSO502F • 12" Side Opening FF Storage Tower 50" High**

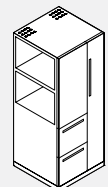

Right Shown

PRODUCT CODE	PRICE "C"	"L"	SIZE/INCHES			WEIGHT VOL	
			H	W	D	LBS	FT <sup>3</sup>
BS12TSO502FL	3117	3182	50	24	24	158	20
BS12TSO502FR	3117	3182	50	24	24	158	20

- This versatile tower can be used freestanding or integrated into a workstation to provide efficient vertical storage and filing, and provides storage for hats and coats.
- Coat storage may be specified right or left.
- Full height coat storage is 50" high x 8" wide with ventilation.
- Storage tower has 1 adjustable shelf and 1 fixed shelf with a 21" side opening for 50" high unit.
- Towers come with 2 locks, 1 for the file drawers and 1 for the coat locker.

Note: "C" Indicates "C" Series featuring a full width pull. "L" indicates "Linear" Series featuring a "Soft-to-the-touch" handles.

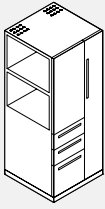
**BS12TS0502B1F • 12" Series Side Opening BBF Storage Tower 50" High**

Right Shown

• This versatile tower can be used freestanding or integrated into a workstation to provide efficient vertical storage and filing, and provides storage for hats and coats.

- Coat storage may be specified right or left.
- Full height coat storage is 50" high x 7" wide with ventilation.
- Storage tower has 1 adjustable shelf and 1 fixed shelf with a 21" side opening for 50" high unit.
- Towers come with 2 locks, 1 for the file drawers and 1 for the coat locker.

Note: "C" Indicates "C" Series featuring a full width pull. "L" indicates "Linear" Series featuring a "Soft-to-the-touch" handles.

PRODUCT CODE	PRICE		SIZE/INCHES			WEIGHT VOL	
	"C"	"L"	H	W	D	LBS	FT <sup>3</sup>
BS12TS0502B1FL	3117	3204	50	24	24	158	20
BS12TS0502B1FR	3117	3204	50	24	24	158	20

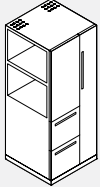
**BS12TS0542F • 12" Side Opening FF Storage Tower 54" High**

Right Shown

• This versatile tower can be used freestanding or integrated into a workstation to provide efficient vertical storage and filing, and provides storage for hats and coats.

- Coat storage may be specified right or left.
- Full height coat storage is 54" high x 8" wide with ventilation.
- Storage tower has 1 adjustable shelf and 1 fixed shelf with a 24 13/16" side opening for 54" high unit.
- Towers come with 2 locks, 1 for the file drawers and 1 for the coat locker.

Note: "C" Indicates "C" Series featuring a full width pull. "L" indicates "Linear" Series featuring a "Soft-to-the-touch" handles.

PRODUCT CODE	PRICE		SIZE/INCHES			WEIGHT VOL	
	"C"	"L"	H	W	D	LBS	FT <sup>3</sup>
BS12TS0542FL	3135	3202	54	24	24	163	22
BS12TS0542FR	3135	3202	54	24	24	163	22

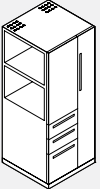
**BS12TS0542B1F • 12" Side Opening BBF Storage Tower 54" High**

Right Shown

• This versatile tower can be used freestanding or integrated into a workstation to provide efficient vertical storage and filing, and provides storage for hats and coats.

- Coat storage may be specified right or left.
- Full height coat storage is 54" high x 8" wide with ventilation.
- Storage tower has 1 adjustable shelf and 1 fixed shelf with a 24 13/16" side opening for 54" high unit.
- Towers come with 2 locks, 1 for the file drawers and 1 for the coat locker.

Note: "C" Indicates "C" Series featuring a full width pull. "L" indicates "Linear" Series featuring a "Soft-to-the-touch" handles.

PRODUCT CODE	PRICE		SIZE/INCHES			WEIGHT VOL	
	"C"	"L"	H	W	D	LBS	FT <sup>3</sup>
BS12TS0542B1FL	3135	3223	54	24	24	163	22
BS12TS0542B1FR	3135	3223	54	24	24	163	22

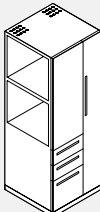
**BS12T662B1F • 12" Side Opening BBF Storage Tower 65 7/8" High**

Right Shown

• This versatile tower can be used freestanding or integrated into a workstation to provide efficient vertical storage and filing, and provides storage for hats and coats.

- Coat storage may be specified right or left.
- Full height coat storage is 65" x 8" with ventilation.
- Storage towers with 2 file drawers or box, box, file drawers have 2 adjustable shelves and 1 fixed shelf and a 36 3/4" high opening.
- Towers come with 2 locks, 1 for the file drawers and 1 for the coat locker.

Note: "C" Indicates "C" Series featuring a full width pull. "L" indicates "Linear" Series featuring a "Soft-to-the-touch" handles.

PRODUCT CODE	PRICE		SIZE/INCHES			WEIGHT VOL	
	"C"	"L"	H	W	D	LBS	FT <sup>3</sup>
BS12TS0662B1FL	3131	3219	65.875	24	24	177	26
BS12TS0662B1FR	3131	3219	65.875	24	24	177	26

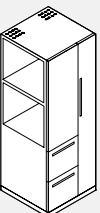
**BS12T662F • 12" Side Opening FF Storage Tower 65 7/8" High**

Right Shown

• This versatile tower can be used freestanding or integrated into a workstation to provide efficient vertical storage and filing, and provides storage for hats and coats.

- Coat storage may be specified right or left.
- Full height coat storage is 65" x 8" with ventilation.
- Storage towers with 2 file drawers or box, box, file drawers have 2 adjustable shelves and 1 fixed shelf and a 36 3/4" high opening.
- Towers come with 2 locks, 1 for the file drawers and 1 for the coat locker.

Note: "C" Indicates "C" Series featuring a full width pull. "L" indicates "Linear" Series featuring a "Soft-to-the-touch" handles.

PRODUCT CODE	PRICE		SIZE/INCHES			WEIGHT VOL	
	"C"	"L"	H	W	D	LBS	FT <sup>3</sup>
BS12TS0662FL	3131	3219	65.875	24	24	177	26
BS12TS0662FR	3131	3219	65.875	24	24	177	26

**BS12F • 12" Opening Lateral File Fixed Front Drawers**

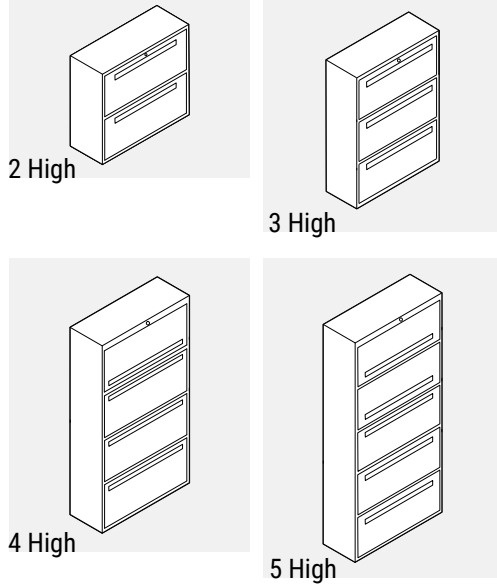

PRODUCT CODE	PRICE "C"	"L"	SIZE/INCHES			WEIGHT VOL	
			H	W	D	LBS	FT <sup>3</sup>
<b>2 High</b>							
BS123022FWS	1268	1311	27.75	30	18	103	8.60
BS123622FWS	1327	1367	27.75	36	18	110	10.41
BS124222FWS	1399	1440	27.75	42	18	117	12.14
<b>3 High</b>							
BS123033F	1662	1729	40.5	30	18	136	12.66
BS123633F	1749	1813	40.5	36	18	150	15.19
BS124233F	1849	1915	40.5	42	18	164	17.72
<b>4 High</b>							
BS123041S3F	2112	2199	54	30	18	169	16.88
BS123641S3F	2226	2311	54	36	18	190	20.25
BS124241S3F	2352	2442	54	42	18	211	23.63
<b>5 High</b>							
BS123052S3F	2609	2721	65.88	30	18	202	20.59
BS123652S3F	2720	2829	65.88	36	18	230	27.02
BS124252S3F	2866	2976	65.88	42	18	258	28.82

- 12" Opening Lateral File.
  - Two High: - All openings are Fixed Front Drawer.
  - Three High: - All openings are Fixed Front Drawer.
  - Four High: - Top opening is Receding door with fixed shelves, all others are Fixed Front Drawers
  - Five High: - Top two openings are Receding doors with fixed shelves, Remaining 3 drawers are Fixed Front Drawer.
  - Side-to-Side Bars and Lock included.
- Note: "C" Indicates "C" Series featuring a full width pull. "L" indicates "Linear" Series featuring a "Soft-to-the-touch" handles.

**BS12R1F • 12" Receding Door and Roll-Out Shelves**

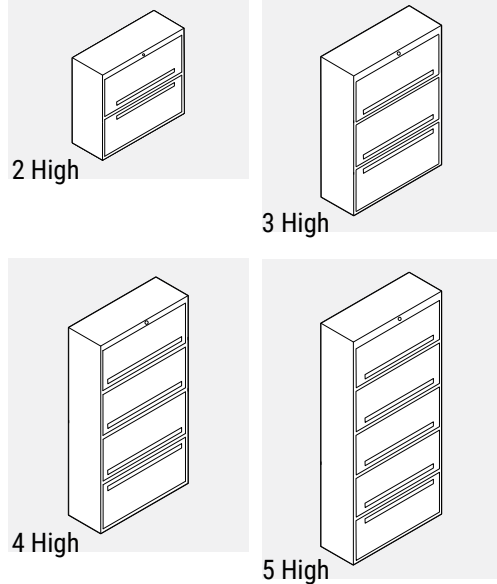

PRODUCT CODE	PRICE "C"	"L"	SIZE/INCHES			WEIGHT VOL	
			H	W	D	LBS	FT <sup>3</sup>
<b>2 High</b>							
BS123021R1FWS	1254	1295	27.75	30	18	103	8.60
BS123621R1FWS	1307	1353	27.75	36	18	110	10.41
BS124221R1FWS	1384	1426	27.75	42	18	117	12.14
<b>3 High</b>							
BS123032R1F	1735	1802	40.5	30	18	136	12.66
BS123632R1F	1822	1888	40.5	36	18	150	15.19
BS124232R1F	1920	1987	40.5	42	18	164	17.72
<b>4 High</b>							
BS123043R1F	2219	2308	54	30	18	169	16.88
BS123643R1F	2335	2420	54	36	18	190	20.25
BS124243R1F	2460	2548	54	42	18	211	23.63
<b>5 High</b>							
BS123054R1F	2702	2811	65.88	30	18	202	20.59
BS123654R1F	2841	2952	65.88	36	18	230	27.02
BS124254R1F	3000	3109	65.88	42	18	258	28.82

- 12" Opening Lateral File.
  - Two High: - Top opening is Receding Door and Roll-out Shelf. - Bottom drawer is Fixed Front Drawer.
  - Three High: - Top 2 openings are Receding Door and Roll-out Shelf. - Bottom drawer is Fixed Front Drawer.
  - Four High: - Top 3 openings are Receding Door and Roll-out Shelf. - Bottom drawer is Fixed Front Drawer.
  - Five High: - Top 4 openings are Receding Door and Roll-out Shelf. - Bottom drawer is Fixed Front Drawer.
  - Side-to-Side Bars and Lock included.
- Note: "C" Indicates "C" Series featuring a full width pull. "L" indicates "Linear" Series featuring a "Soft-to-the-touch" handles.



**BS12SWS • 12" Receding Door and Fixed Shelves**

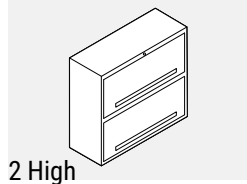

2 High

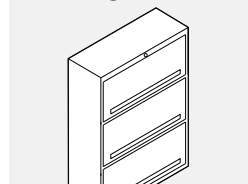

3 High

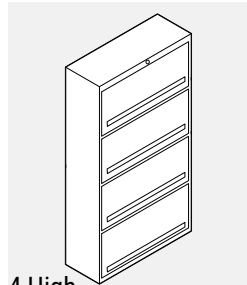

4 High

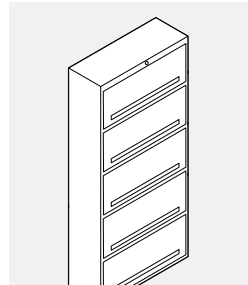

5 High

PRODUCT CODE	PRICE "C"	"L"	SIZE/INCHES			WEIGHT VOL	
			H	W	D	LBS	FT <sup>3</sup>
<b>2 High</b>							
BS123022SWS	1268	1311	27.75	30	18	103	8.60
BS123622SWS	1327	1367	27.75	36	18	110	10.41
BS124222SWS	1399	1440	27.75	42	18	117	12.14
<b>3 High</b>							
BS123033S	1662	1729	40.5	30	18	136	12.66
BS123633S	1749	1813	40.5	36	18	150	15.19
BS124233S	1849	1915	40.5	42	18	164	17.72
<b>4 High</b>							
BS123044S	2112	2199	54	30	18	169	16.88
BS123644S	2226	2311	54	36	18	190	20.25
BS124244S	2352	2442	54	42	18	211	23.63
<b>5 High</b>							
BS123055S	2609	2721	65.88	30	18	202	20.59
BS123655S	2720	2859	65.88	36	18	230	27.02
BS124255S	2867	2977	65.88	42	18	258	28.82

12" Opening Lateral File.

- Two High: - All openings are Receding Doors and Fixed Shelves.
- Three High: - All openings are Receding Doors and Fixed Shelves.
- Four High: - All openings are Receding Doors and Fixed Shelves.
- Five High: - All openings are Receding Doors and Fixed Shelves.
- 3 Plate Dividers and Lock are included.

Note: "C" Indicates "C" Series featuring a full width pull. "L" indicates "Linear" Series featuring a "Soft-to-the-touch" handles.

**BS12B3F • 12" Opening Lateral File "B" Opening Receding Door and Fixed Shelves**

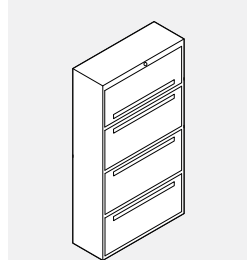

4 High

- 12" Opening Lateral File.
- Four High: - Top opening is "B": size with Receding Door, Fixed Shelf and 3 Plate Dividers. Remaining 3 drawers are Fixed Front Drawer with Hanging File Bars.
- Five High: - Top opening is "B": size with Receding Door, Fixed Shelf and 3 Plate Dividers. Remaining 4 drawers are Fixed Front Drawer with Hanging File Bars.
- Lock is included.

PRODUCT CODE	PRICE "C"	"L"	SIZE/INCHES			WEIGHT VOL	
			H	W	D	LBS	FT <sup>3</sup>
<b>4 High</b>							
BS123041B3F	2283	2373	55.375	30	18	103	16.88
BS123641B3F	2373	2460	55.375	36	18	110	20.25
BS124241B3F	2461	2550	55.375	42	18	117	23.63
<b>5 High</b>							
BS123051B1S3F	2751	2860	67.25	30	18	136	20.59
BS123651B1S3F	2896	3007	67.25	36	18	150	27.02
BS124251B1S3F	3061	3170	67.25	42	18	164	28.82

**CF-RB • C Series "B" Opening Receding Door and Fixed Shelves**

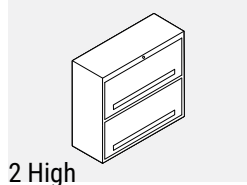

2 High

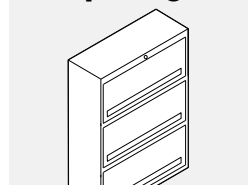

3 High

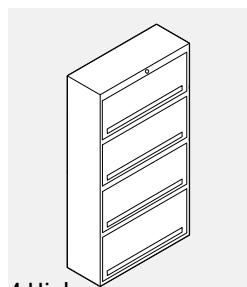

4 High

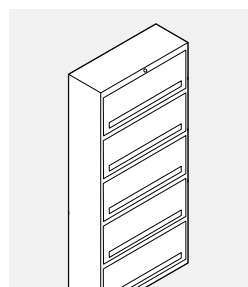

5 High

- "B" opening, receding door with fixed shelves file cabinet with Full Pull handles.
- Two high: 2 receding doors and fixed shelves, unit will not fit under standard height worksurfaces.
- Three high: 3 receding doors and fixed shelves.
- Four high: 4 receding doors and fixed shelves.
- Five high: 5 receding doors and fixed shelves.

PRODUCT CODE	PRICE	SIZE/INCHES		D	WEIGHT VOL	
		H	W		LBS	FT <sup>3</sup>
<b>2 High</b>						
CF2030RB	1697	29.25	30	18	111	8.48
CF2036RB	1777	29.25	36	18	110	10.17
CF2042RB	1879	29.25	42	18	127	11.87
<b>3High</b>						
CF3030RB	2105	42.625	30	18	150	12.66
CF3036RB	2206	42.625	36	18	167	15.19
CF3042RB	2323	42.625	42	18	187	17.72
<b>4 High</b>						
CF4030RB	2512	56.125	30	18	191	16.88
CF4036RB	2633	56.125	36	18	214	20.25
CF4042RB	2772	56.125	42	18	238	23.63
<b>5 High</b>						
CF5030RB	3090	69.5	30	18	235	20.39
CF5036RB	3241	69.5	36	18	266	24.47
CF5042RB	3420	69.5	42	18	297	28.55

**BF-RB • Linear “B” Opening Receding Door and Fixed Shelves**

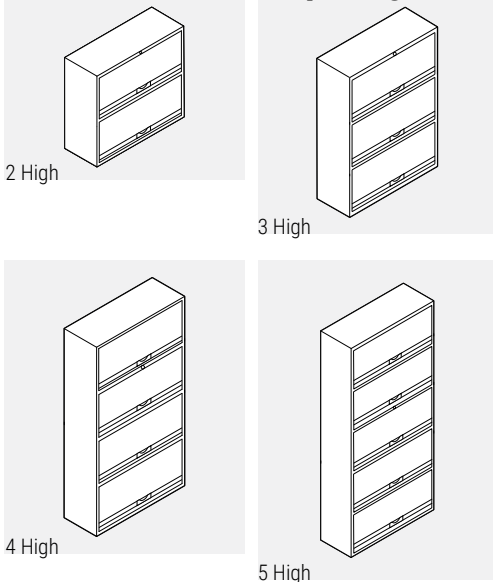

- “B” opening, receding door with fixed shelves file cabinet with handles.
- Two high: 2 receding doors and fixed shelves, unit will not fit under standard height worksurfaces.
- Three high: 3 receding doors and fixed shelves.
- Four high: 4 receding doors and fixed shelves.
- Five high: 5 receding doors and fixed shelves.

PRODUCT CODE	PRICE	SIZE/ INCHES			WEIGHT VOL	
		H	W	D	LBS	FT <sup>3</sup>
<b>2 High</b>						
BF2030SB	1697	29.25	30	18	111	8.48
BF2036SB	1777	29.25	36	18	110	10.17
BF2042SB	1879	29.25	42	18	127	11.87
<b>3 High</b>						
BF3030SB	2105	42.625	30	18	150	12.66
BF3036SB	2206	42.625	36	18	167	15.19
BF3042SB	2323	42.625	42	18	187	17.72
<b>4 High</b>						
BF4030SB	2512	56.125	30	18	191	16.88
BF4036SB	2633	56.125	36	18	214	20.25
BF4042SB	2772	56.125	42	18	238	23.63
<b>5 High</b>						
BF5030SB	3090	69.5	30	18	235	20.39
BF5036SB	3241	69.5	36	18	266	24.47
BF5042SB	3420	69.5	42	18	297	28.55

**BS12S2F • 12” Opening Multi Storage Unit**

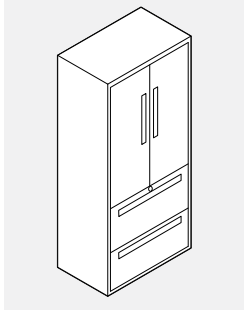

- 2 lateral file drawers and closed cupboard with door height of 24.531”.
  - Includes 1 fully adjustable shelf.
  - Lateral file drawers are same depth for 18” and 24” deep cabinets.
- Note: “C” Indicates “C” Series featuring a full width pull. “L” indicates “Linear” Series featuring a “Soft-to-the-touch” handles.

PRODUCT CODE	PRICE		SIZE/ INCHES			WEIGHT VOL	
	“C”	“L”	H	W	D	LBS	FT <sup>3</sup>
<b>4 High (50” High)</b>							
BS1230M502S2F	2665	2754	50	30	18	185	18.66
BS1236M502S2F	2853	2939	50	36	18	209	18.75
BS1242M502S2F	3072	3160	50	42	18	233	21.88
<b>4 High (54” High)</b>							
BS1230M542S2F	2796	2888	54	30	18	191	16.88
BS1236M542S2F	2992	3081	54	36	18	215	20.25
BS1242M542S2F	3225	3315	54	42	18	238	23.63
<b>5 High (2 Lateral)</b>							
BS1230M662S2F	3069	3157	65.88	30	18	235	19.45
BS1236M662S2F	3344	3433	65.88	36	18	266	23.34
BS1242M662S2F	3491	3574	65.88	42	18	297	27.23
<b>5 High (3 Lateral)</b>							
BS1230M662S3F	3083	3193	65.88	30	18	235	19.45
BS1236M662S3F	3344	3414	65.88	36	18	266	23.34
BS1242M662S3F	3581	3607	65.88	42	18	297	27.23

**BS12S • 12” Storage Cabinet with Hinged Door**

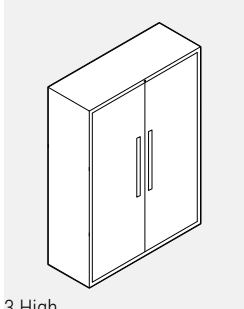

- 2S - 27 3/4” high with 1 shelf.
  - 3S - 40 1/2” high with 2 shelves.
  - 4S - 54” high with 3 shelves.
  - 5S - 65 7/8” high with 4 shelves.
  - 5W - 65 7/8” high wardrobe cabinet with a coat rod and 4 half shelves in the 36” and 42” wide units. 30” wide units have a coat rod and 4 coat hooks.
- Note: “C” Indicates “C” Series featuring a full width pull. “L” indicates “Linear” Series featuring a “Soft-to-the-touch” handles.

PRODUCT CODE	PRICE		SIZE/ INCHES			WEIGHT VOL	
	“C”	“L”	H	W	D	LBS	FT <sup>3</sup>
<b>2 High (WS Supporting)</b>							
BS12302SWS	1040	1085	27.75	30	18	74	8.47
BS12362SWS	1161	1202	27.75	36	18	82	10.17
BS12422SWS	1262	1307	27.75	42	18	91	11.87
<b>3 High</b>							
BS12303S	1297	1342	40.5	30	18	100	12.66
BS12363S	1459	1500	40.5	36	18	113	15.19
BS12423S	1612	1656	40.5	42	18	126	17.72
<b>4 High</b>							
BS12304S	1551	1595	54	30	18	130	16.88
BS12364S	1734	1777	54	36	18	147	20.25
BS12424S	1920	1961	54	42	18	163	23.63
<b>5 High</b>							
BS12305S	1751	1795	65.88	30	18	155	20.59
BS12365S	1961	2005	65.88	36	18	177	27.02
BS12425S	2176	2219	65.88	42	18	195	28.82
<b>5 High Wardrobe</b>							
BS12305W	1789	1835	65.88	30	18	136	20.59
BS12365W	1998	2042	65.88	36	18	168	27.02
BS12425W	2198	2241	65.88	42	18	183	28.82

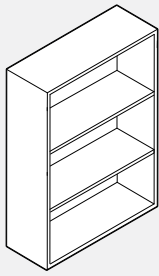
**BS12ND • Open Storage Cabinet 2 High (WS Supporting)**

Storage Cabinet with no doors.

- 2SND - 27 3/4" high with 1 shelf.
- 3SND - 40 1/2" high with 2 shelves.
- 4SND - 54" high with 3 shelves.
- 5SND - 65 7/8" high with 4 shelves.

PRODUCT CODE	PRICE	SIZE/ INCHES			WEIGHT VOL	
		H	W	D	LBS	FT <sup>3</sup>
2 High (WS Supporting)						
BS1230SF2SNDWS	989	27.75	30	18	61	8.47
BS1236SF2SNDWS	1077	27.75	36	18	74	10.17
BS1242SF2SNDWS	1148	27.75	42	18	76	11.87
3 High						
BS1230SF3SND	1109	40.5	30	18	39	12.66
BS1236SF3SND	1232	40.5	36	18	44	15.19
BS1242SF3SND	1345	40.5	42	18	48	17.72
4 High						
BS1230SF4SND	1328	54	30	18	50	16.88
BS1236SF4SND	1418	54	36	18	58	20.25
BS1242SF4SND	1502	54	42	18	61	23.63
5 High						
BS1230SF5SND	1531	65.88	30	18	62	20.59
BS1236SF5SND	1620	65.88	36	18	69	27.02
BS1242SF5SND	1690	65.88	42	18	76	28.82

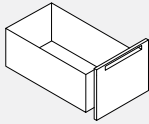
**BS12FKIT • 1212 Drawer Conversion Kit**

- Converts an existing box, box, file (6612) Pedestal into a file, file (1212).
- Kit includes 1-12" high drawer front, 1-12" high drawer body, set of slides and 1212 lock bar.
- Specify the type of conversion kit, colour of front, colour of handle, existing pedestal depth to be retrofitted and "soft-to-the-touch" handle colour.

PRODUCT CODE	PRICE		SIZE/ INCHES			WEIGHT VOL	
	"C"	"L"	H	W	D	LBS	FT <sup>3</sup>
BS1218FKIT	188	210	15	15	18	20	2
BS1223FKIT	188	210	15	15	23	22	3
BS1224FKIT	188	210	15	15	24	24	3
BS1229FKIT	188	210	15	15	29	24	3
BS1230FKIT	188	210	15	15	30	24	3

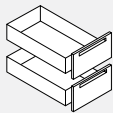
**BS12BKIT • 6612 Drawer Conversion Kit**

- Converts an existing file, file (1212) Pedestal into a box, box, file (6612).
- Kit includes 2-6" high drawer front, 2-6" high drawer body, 2 sets of slides and 6612 lock bar.
- Specify the type of conversion kit, colour of front, colour of handle, existing pedestal depth to be retrofitted and "soft-to-the-touch" handle colour.

PRODUCT CODE	PRICE		SIZE/ INCHES			WEIGHT VOL	
	"C"	"L"	H	W	D	LBS	FT <sup>3</sup>
BS1218BKIT	188	231	15	15	18	20	2
BS1223BKIT	188	231	15	15	23	22	3
BS1224BKIT	188	231	15	15	24	24	3
BS1229BKIT	188	231	15	15	29	24	3
BS1230BKIT	188	231	15	15	30	24	3

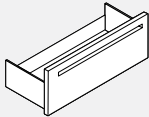
**BS12FFKIT • Fixed Front Drawer Kit**

- Fixed front drawer, roll-out drawer.
- Indicate position (1,2,3,4 or 5) of conversion from top to bottom.
- Drawer interiors are finished in black.

PRODUCT CODE	PRICE		SIZE/ INCHES			WEIGHT VOL	
	"C"	"L"	H	W	D	LBS	FT <sup>3</sup>
BS1230FFKIT	244	266	13.5	30	17	14	3.73
BS1236FFKIT	244	266	13.5	36	17	16	4.52
BS1242FFKIT	244	266	13.5	42	17	18	5.30

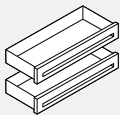
**Half Height Drawer Kit**

- **For half height drawer kit, contact your customer service representative.**
- Receding Door with Fixed Slotted Shelf cannot be substituted.

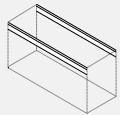
**BAHFB • Hanging File Bars**

- Used in lateral files only.

PRODUCT CODE	PRICE	SIZE/ INCHES			WEIGHT VOL	
		H	W	D	LBS	FT <sup>3</sup>
BAHFB30	48		30		4	0.017
BAHFB36	48		36		4	0.020
BAHFB42	48		42		4	0.024

**BAFBB • Front to Back Bars**

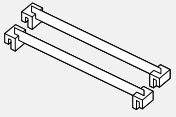

- Used in lateral files only.
- Shipped in pairs.

PRODUCT CODE	PRICE	SIZE/ H	INCHES			WEIGHT VOL	
			W	D	LBS	FT <sup>3</sup>	
BAFBB	28		15.25		1	0.03	

**BALAB • Legal to Letter Adapter**

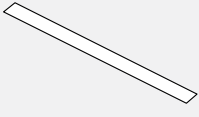

- Used in lateral files only.

PRODUCT CODE	PRICE	SIZE/ H	INCHES			WEIGHT VOL	
			W	D	LBS	FT <sup>3</sup>	
BALAB30	28		30		2	0.001	
BALAB36	28		36		2	0.002	
BALAB42	28		42		2	0.003	

**BAPD • Divider Plates**

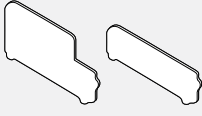

- Used in full-height shelves and lateral file drawers only.
- Three plates per package.

PRODUCT CODE	PRICE		SIZE/ H	INCHES			WEIGHT VOL	
				W	D	LBS	FT <sup>3</sup>	
BAPD03	61	Full Height	7	0.8	13.25	4	0.017	
BAHPD03	45	Half Height	4	0.8	13.25	3	0.017	

**BAPD • Pedestal Divider Plates**

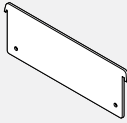

- Priced and shipped individually.

PRODUCT CODE	PRICE	SIZE/ H	INCHES			WEIGHT VOL	
			W	D	LBS	FT <sup>3</sup>	
BAPDIV	31		3.5		12.62		

**BAPED-BAR • Pedestal Hanging File Bar**

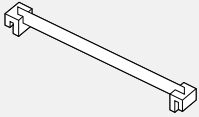

- Priced and shipped individually.

PRODUCT CODE	PRICE	SIZE/ H	INCHES			WEIGHT VOL	
			W	D	LBS	FT <sup>3</sup>	
BAPED-BAR	28		15.6		0.5	0.01	

**BAFFS • Full Flat Shelf**

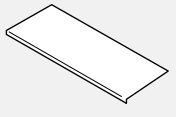

- For use in 12" series storage cabinets (non-slotted).

PRODUCT CODE	PRICE	SIZE/ H	INCHES			WEIGHT VOL	
			W	D	LBS	FT <sup>3</sup>	
BAFFS30	141		30	16	6	0.29	
BAFFS36	147		36	16	7	0.34	
BAFFS42	155		42	16	8	0.40	

**BAFS • Full Fixed Slotted Shelf**

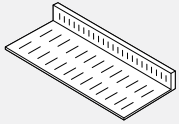

- For use in 12" series storage cabinets.

PRODUCT CODE	PRICE	SIZE/ H	INCHES			WEIGHT VOL	
			W	D	LBS	FT <sup>3</sup>	
BAFS30	154		30	16	9	1.72	
BAFS36	160		36	16	11	2.06	
BAFS42	176		42	16	13	2.41	

**BAHFFS • Half Fixed Flat Shelf**

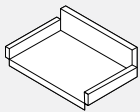

- For use in 12" series wardrobe cabinets (non-slotted).

PRODUCT CODE	PRICE	SIZE/ H	INCHES			WEIGHT VOL	
			W	D	LBS	FT <sup>3</sup>	
BAHFFS12	74		12	5	16	3	0.55

**BAEDPS • EDP Adapter**

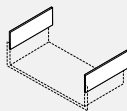

- EDP adapters (EDPS). Not for use in receding front drawers.

PRODUCT CODE	PRICE	SIZE/ H	INCHES			WEIGHT VOL	
			W	D	LBS	FT <sup>3</sup>	
BAEDPS	51		3	16.5	4	0.01	

**BAMS • Max-Stor Module**

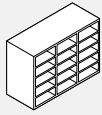

- The module can be freestanding or installed in any of the empty 36" width storage cabinets at either the top, middle or bottom location. Specify location at time of order.
- Includes 3 vertical sections and 12 adjustable trays

PRODUCT CODE	PRICE	SIZE/	INCHES			WEIGHT VOL	
		H	W	D	LBS	FT <sup>3</sup>	
BAMS3624	884	24	34.25	14.5	50	6.84	

**BAMST • Max-Stor Trays**

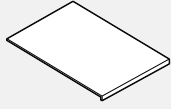

- Package of 12 trays for the BAMS3624 Max-Stor Module.

PRODUCT CODE	PRICE	SIZE/	INCHES			WEIGHT VOL	
		H	W	D	LBS	FT <sup>3</sup>	
BAMST18	267	1	1.187	14.5			

**BTLP • Pencil Tray**

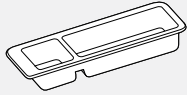

- Plastic molded pen/pencil tray fits into the drawer of 12" series pedestals or towers.
- Compartments organize your writing instruments and paper clips.

PRODUCT CODE	PRICE	SIZE/	INCHES			WEIGHT VOL	
		H	W	D	LBS	FT <sup>3</sup>	
BTLPTRAY	45	1	13	5.5	1	0.08	

**C28 • Letter Width Vertical Storage**

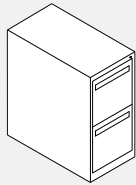

2 High

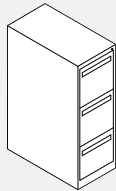

3 High

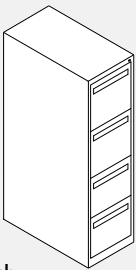

4 High

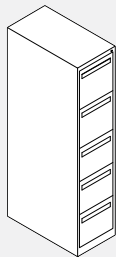

5 High

- C28 series letter vertical filing.
- Leveler height adjustment range is 3/4".

PRODUCT CODE	PRICE	SIZE/	INCHES			WEIGHT VOL	
		H	W	D	LBS	FT <sup>3</sup>	
2 High C28202	966	28	15	28	82	8	
3 High C28302	1271	40.37	15	28	13	13	
4 High C28402	1584	52.25	15	28	151	16	
5 High C28502	1910	62.75	15	28	186	21	

**C28 • Legal Width Vertical Storage**

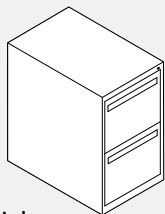

2 High

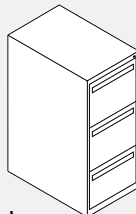

3 High

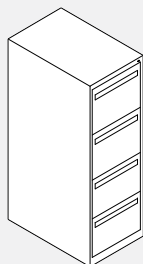

4 High

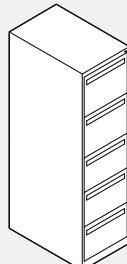

5 High

- C28 series legal vertical filing.
- Leveler height adjustment range is 3/4".

PRODUCT CODE	PRICE	SIZE/	INCHES			WEIGHT VOL	
		H	W	D	LBS	FT <sup>3</sup>	
2 High C28252	971	28	18	28	90		
3 High C28352	1321	40.37	18	28	127		
4 High C28452	1624	52.25	18	28	167		
5 High C28552	1940	62.75	18	28	200		

**BACWB • Counterweight Balance**

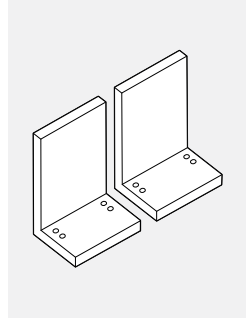

- Recommended for use in all laterals, verticals, pedestals and free standing files of all widths and heights.
- Sold per pair
- "X" represents half height.
- **NOTE: File cabinets with counterweight balance included must be specified as special, please contact your customer service representative.**

PRODUCT CODE	PRICE	SIZE/ INCHES			WEIGHT VOL	
		H	W	D	LBS	FT <sup>3</sup>
For 30" wide						
BACWB12301X	420				56	
BACWB12302	278				42	
BACWB12303	234				32	
BACWB12304	234				33	
BACWB12305	158				20	
For 36" wide						
BACWB12361X	350				56	
BACWB12362	314				48	
BACWB12363	278				42	
BACWB12364	228				31	
BACWB12365	140				19	
For 42" wide						
BACWB12421X	473				61	
BACWB12422	404				61	
BACWB12423	278				42	
BACWB12424	278				42	
BACWB12425	278				24	
BACWBLATMLT	303				80	
BACWBVER	145				25	
BACWBPED	121				25	
BACWBPDF	230				25	

**BA • Keys**

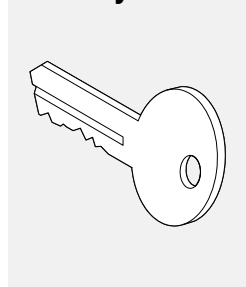

- Additional key (specify at time of order)

PRODUCT CODE	PRICE	SIZE/ INCHES			WEIGHT VOL	
		H	W	D	LBS	FT <sup>3</sup>
BAAK91	14					
<b>Master key:</b>						
BAMK91	36					
<b>Extra key for existing cabinet:</b>						
BAEK91	14					
<b>Core key:</b>						
BACK91	17					
<b>Core &amp; Key:</b>						
BALOCKKEY	41					

**LO • Lock and Key**

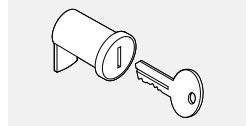

- Lock and key for wood overhead storage unit.
- Includes two keys.
- If ordering for units larger than 48", order 2 LO.
- Locks for wood storage units are not compatible with locks for metal units.

PRODUCT CODE	PRICE	SIZE/ INCHES			WEIGHT VOL	
		H	W	D	LBS	FT <sup>3</sup>
LO	41				0.13	

## Diet Panel System

Diet represents an innovative tool for creating an economical, efficient work space, accommodating various tasks. From 42" high panels which provide an open office feel to 50" and 54" high panels, for seated privacy and 66" high panels for standing privacy, Diet effectively supports the creation of various work environments. Diet is simple, easy to comprehend, easy to specify and install, with a minimum of add-on and dedicated/handed components to maximize reconfiguration flexibility. All Diet panels ship with a set of self-leveling connectors that accommodate any angle, but also straight, 90°, three-way T and 120° configurations, as well as four-way "X". Truly universal connectors support the above panel configurations regardless of panel heights. Such a configuration and height independent connecting method eliminates the need to order additional components during future office reconfigurations. Diet is an economical, "soft wire" system with simple means of optional power and data/communication cable management trough that snaps to the

bottom of the panel. With the exception of panels with open area below the mid rail, all Diet panels are built with 6" clearance opening between the floor and the bottom rail. This feature not only serves as a simple passage for cables between back-to-back stations and an interface for a snap on cable trough, but it mainly provides ultimate flexibility of panel station placement even if one panel needs to be located right above a floor monument. Diet's slim appearance, sophisticated industrial design, detailing and advanced engineering communicate high perceived value, exceeding expectations usually related to budget products. Diet can be specified on its own, with integrated worksurface, storage and accessory support, privacy and space organization in free standing office environments. Whether combined with Boulevard system, or raised floors, Diet, as a tool, bridges mobile or stationary freestanding furniture with power/data delivery solutions, that are hard wired to a building power supply.

## Technical Information

### Panels

- Panels are 1.3" thick.
- Width ranges from 24" to 60" at 6" increments.
- Heights include 42", 50", 54" and 66" (nominal).
- Extruded aluminum frame surrounds a fabric wrapped interior with a 7/8" particle board frame, sandwiched between 2 pieces of 1/8" masonite.
- Panel frame finish is durable epoxy powder coated.
- Finished panel includes top, corner and end caps.
- For glazing - Smoke development index 500.
- For tempered glass, add "TG" to the end of the product code and add 20% to the price regardless of fabric grade.
- Top rail accepts Global Contract accessories, monitor arm supports, off-module shelves, and task light brackets.
- Top rail on Glazed Top Panels is not intended for use with panel mounted shelves and panel mounted overhead.
- Middle rail accepts bracket for off-module worksurface support, Global Contract accessories, off-module shelves and power bar.
- Bottom rail accepts brackets for off-module worksurface support, Global Contract accessories, off-module shelves and optional cable manager and power bar.
- Optional PVC cable manager friction fits into bottom rail.

- Two leveler are included with a 1.75" leveling range.
- Vertical frame members have integrated grooves for additional components.
- Charcoal covers are provided at front of vertical members where connectors attach.
- Panels include 3 sets of hinge connectors, 1 set of spacers and 6 pins.
- Connecting method is simple, accommodating typical configuration, as well as connection of panels at any angle, regardless of height.

### Panel Options

- Laminate or whiteboard may be substituted for fabric on panels only, see "OPT" column.
  - Tackboard panels available, please add 25% upcharge.
  - Steel facing available, contact your customer service representative.
- Note:
- 42" High Diet panels do not match Boulevard 42"
  - 50" High Diet panels match Boulevard 50"
  - 54" High Diet panels do not match standard Boulevard 54"
  - 66" High Diet panels matches Boulevard 66"
  - To order 42" and 54" high Diet panels to match Boulevard, please order "BDPFF" and "BDPOF".

## HOW DIET REDUCES YOUR COSTS

### Finished Panel:

- No inventory costs for connectors, top caps, kick plates and clips.
- Less time required to install, or to disassemble, move and re-install.
- Open bottom panels can reduce cost and improve circulation within the office.

### Fewer Parts:

- Only 1 universal cantilever and 3 brackets are needed to build most workstations.
- Easy to attach and remove components from panels.

### Simplified Specifications:

- Fewer parts and components make specifying, ordering, and verifying less work.
- Product fits a 6" planning module.

### Communications Channel:

- Base communication channel reduces time to install and change cables.

### Warranty:

- Limited Lifetime Warranty on materials and workmanship.

## DIET PANELS - GUIDELINES FOR ORDERING PRODUCT

### Codes

The product guide uses a numbering system with meaningful alphanumeric characters to create a simple-to-understand product number. This makes specifying the product much easier and more accurate.

Example of Panel: **DPFRF6636 CHR**

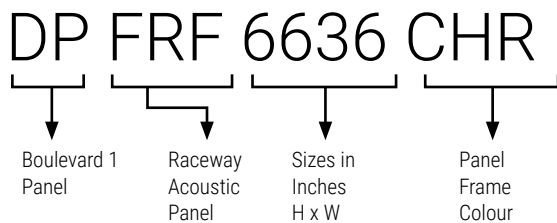

### How to Specify

- Specify Diet Panel type and size by code.
- Specify panel frame finish - ie. CHR (Charcoal).
- Specify all six panel fabric options if necessary.

AN50	Inside Lower Fabric
AN50	Inside Middle Fabric
AN50	Inside Upper Fabric
BE21	Outside Lower Fabric
BE21	Outside Middle Fabric
BE21	Outside Upper Fabric

**DPFF • Fabric Bottom and Fabric Top Panel**

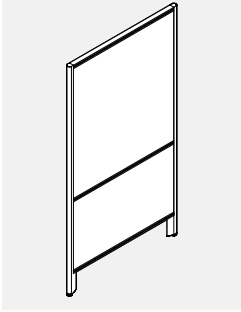

- Fabric above and below the middle rail provides visual privacy.
- Full panel with top, middle and bottom rail.
- OPT\* = Laminate or Whiteboard.
- DPFF Panels do not match standard Boulevard heights of 42" and 54".
- DPFF Panels of 50" and 66" height will match standard Boulevard panel heights.

PRODUCT CODE	PRICE			SIZE/ H	INCHES			WEIGHT VOL	
	GR1	GR2	OPT*		W	D	LBS	FT <sup>3</sup>	
DPFF4224	377	421	471	42	24	1.3	16	1.32	
DPFF4230	397	442	493	42	30	1.3	19	1.62	
DPFF4236	420	502	591	42	36	1.3	23	1.94	
DPFF4242	442	525	613	42	42	1.3	27	2.24	
DPFF4248	466	549	637	42	48	1.3	31	2.55	
DPFF4254	488	569	660	42	54	1.3	35	2.85	
DPFF4260	508	591	679	42	60	1.3	39	3.16	
DPFF5024	470	518	564	50	24	1.3	16	1.62	
DPFF5030	495	539	590	50	30	1.3	21	2.08	
DPFF5036	521	630	748	50	36	1.3	25	2.47	
DPFF5042	546	653	771	50	42	1.3	30	2.85	
DPFF5048	573	681	800	50	48	1.3	35	3.25	
DPFF5054	596	705	825	50	54	1.3	40	3.63	
DPFF5060	622	732	849	50	60	1.3	45	4.02	
DPFF5424	470	518	564	54	24	1.3	18	1.62	
DPFF5430	495	539	590	54	30	1.3	23	2.08	
DPFF5436	521	630	748	54	36	1.3	27	2.47	
DPFF5442	546	653	771	54	42	1.3	32	2.85	
DPFF5448	573	681	800	54	48	1.3	37	3.25	
DPFF5454	596	705	825	54	54	1.3	42	3.63	
DPFF5460	622	732	849	54	60	1.3	47	4.02	
DPFF6624	512	586	663	66	24	1.3	23	2.04	
DPFF6630	541	615	693	66	30	1.3	29	2.52	
DPFF6636	572	679	799	66	36	1.3	35	3.00	
DPFF6642	601	710	827	66	42	1.3	41	3.46	
DPFF6648	626	736	854	66	48	1.3	47	3.93	
DPFF6654	652	762	881	66	54	1.3	53	4.40	
DPFF6660	679	790	908	66	60	1.3	59	4.90	

**BDPFF • Fabric Bottom and Fabric Top Panel to Match Boulevard Panels**

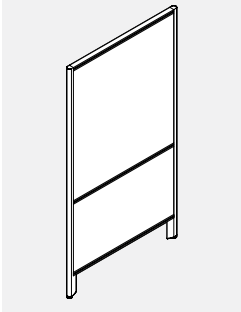

- Fabric above and below the middle rail provides visual privacy.
- Full panel with top, middle and bottom rail.
- OPT\* = Laminate or Whiteboard
- Panels will match corresponding Boulevard Panel heights.

PRODUCT CODE	PRICE			SIZE/ H	INCHES			WEIGHT VOL	
	GR1	GR2	OPT*		W	D	LBS	FT <sup>3</sup>	
BDPFF4224	377	421	471	42	24	1.3	16	1.32	
BDPFF4230	397	442	493	42	30	1.3	19	1.62	
BDPFF4236	420	502	591	42	36	1.3	23	1.94	
BDPFF4242	442	525	613	42	42	1.3	27	2.24	
BDPFF4248	466	549	637	42	48	1.3	31	2.55	
BDPFF4254	488	569	660	42	54	1.3	35	2.85	
BDPFF4260	508	591	679	42	60	1.3	39	3.16	
BDPFF5424	470	518	564	54	24	1.3	18	1.62	
BDPFF5430	495	539	590	54	30	1.3	23	2.08	
BDPFF5436	521	630	748	54	36	1.3	27	2.47	
BDPFF5442	546	653	771	54	42	1.3	32	2.85	
BDPFF5448	573	681	800	54	48	1.3	37	3.25	
BDPFF5454	596	705	825	54	54	1.3	42	3.63	
BDPFF5460	622	732	849	54	60	1.3	47	4.02	



**DPOF • Open Bottom and Fabric Top Panel**

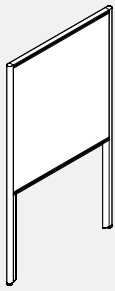

- Fabric above the middle rail provides visual privacy.
- Panel with top and middle rail only.
- Open bottom reduces cost and improves air circulation within the office.
- OPT\* = Laminate or Whiteboard.
- DPOF Panels do not match standard Boulevard heights of 42" and 54".
- DPOF Panels of 50" and 66" height will match standard Boulevard panel heights.

PRODUCT CODE	PRICE			SIZE/ H	INCHES			WEIGHT VOL	
	GR1	GR2	OPT*		W	D	LBS	FT <sup>3</sup>	
DPOF4224	246	260	275	42	24	1.3	9	1.32	
DPOF4230	263	276	292	42	30	1.3	12	1.62	
DPOF4236	304	332	361	42	36	1.3	15	1.94	
DPOF4242	318	344	374	42	42	1.3	17	2.24	
DPOF4248	333	361	392	42	48	1.3	19	2.55	
DPOF4254	350	377	406	42	54	1.3	22	2.85	
DPOF4260	362	392	420	42	60	1.3	24	3.16	
DPOF5024	310	339	367	50	24	1.3	10	1.62	
DPOF5030	330	358	386	50	30	1.3	13	2.08	
DPOF5036	394	449	507	50	36	1.3	16	2.47	
DPOF5042	413	469	527	50	42	1.3	19	2.85	
DPOF5048	433	488	547	50	48	1.3	21	3.25	
DPOF5054	450	506	564	50	54	1.3	25	3.63	
DPOF5060	470	526	585	50	60	1.3	28	4.02	
DPOF5424	310	339	367	54	24	1.3	12	1.62	
DPOF5430	330	358	386	54	30	1.3	15	2.08	
DPOF5436	394	449	507	54	36	1.3	18	2.47	
DPOF5442	413	469	527	54	42	1.3	21	2.85	
DPOF5448	433	488	547	54	48	1.3	24	3.25	
DPOF5454	450	506	564	54	54	1.3	27	3.63	
DPOF5460	470	526	585	54	60	1.3	30	4.02	
DPOF6624	378	435	493	66	24	1.3	17	2.04	
DPOF6630	400	458	518	66	30	1.3	21	2.52	
DPOF6636	471	527	586	66	36	1.3	25	3.00	
DPOF6642	520	574	634	66	42	1.3	29	3.46	
DPOF6648	545	597	658	66	48	1.3	33	3.93	
DPOF6654	565	622	679	66	54	1.3	37	4.40	
DPOF6660	589	642	702	66	60	1.3	41	4.90	

**BDPOF • Open Bottom and Fabric Top Panel to Match Boulevard Panels**

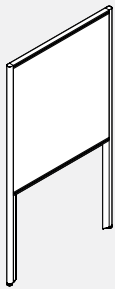

- Fabric above the middle rail provides visual privacy.
- Panel with top and middle rail only.
- Open bottom reduces cost and improves air circulation within the office.
- OPT\* = Laminate or Whiteboard
- Panels will match corresponding Boulevard Panel heights.

PRODUCT CODE	PRICE			SIZE/ H	INCHES			WEIGHT VOL	
	GR1	GR2	OPT*		W	D	LBS	FT <sup>3</sup>	
BDPOF4224	246	260	275	42	24	1.3	9	1.32	
BDPOF4230	263	276	292	42	30	1.3	12	1.62	
BDPOF4236	304	332	361	42	36	1.3	15	1.94	
BDPOF4242	318	344	374	42	42	1.3	17	2.24	
BDPOF4248	333	361	392	42	48	1.3	19	2.55	
BDPOF4254	350	377	406	42	54	1.3	22	2.85	
BDPOF4260	362	392	420	42	60	1.3	24	3.16	
BDPOF5424	310	339	367	54	24	1.3	12	1.62	
BDPOF5430	330	358	386	54	30	1.3	15	2.08	
BDPOF5436	394	449	507	54	36	1.3	18	2.47	
BDPOF5442	413	469	527	54	42	1.3	21	2.85	
BDPOF5448	433	488	547	54	48	1.3	24	3.25	
BDPOF5454	450	506	564	54	54	1.3	27	3.63	
BDPOF5460	470	526	585	54	60	1.3	30	4.02	

**DPFRF • Fabric Bottom, Middle and Top Panel**

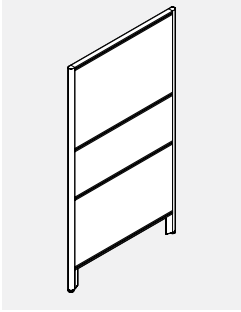

- Fabric above, below and between the middle rails provides visual privacy.
- Full panel with additional rail at 42" high.
- Upper middle rail accepts Global Contract Accessories, Monitor Arm Support and Off-Module Shelves.
- OPT\* = Laminate or Whiteboard

PRODUCT CODE	PRICE			SIZE/ H	INCHES			WEIGHT VOL	
	GR1	GR2	OPT*		W	D	LBS	FT <sup>3</sup>	
DPFRF5024	494	537	589	50	24	1.3	16	1.62	
DPFRF5030	521	552	586	50	30	1.3	21	2.08	
DPFRF5036	547	603	661	50	36	1.3	25	2.47	
DPFRF5042	574	639	710	50	42	1.3	30	2.85	
DPFRF5048	603	684	773	50	48	1.3	35	3.25	
DPFRF5054	626	706	799	50	54	1.3	40	3.63	
DPFRF5060	652	751	853	50	60	1.3	45	4.02	
DPFRF5424	494	537	589	54	24	1.3	18	1.62	
DPFRF5430	521	552	586	54	30	1.3	23	2.08	
DPFRF5436	547	603	661	54	36	1.3	27	2.47	
DPFRF5442	574	639	710	54	42	1.3	32	2.85	
DPFRF5448	603	684	773	54	48	1.3	37	3.25	
DPFRF5454	626	706	799	54	54	1.3	42	3.63	
DPFRF5460	652	735	825	54	60	1.3	47	4.02	
DPFRF6624	537	589	640	66	24	1.3	23	2.04	
DPFRF6630	569	619	672	66	30	1.3	29	2.52	
DPFRF6636	601	681	771	66	36	1.3	35	3.00	
DPFRF6642	633	725	825	66	42	1.3	41	3.46	
DPFRF6648	658	752	851	66	48	1.3	47	3.93	
DPFRF6654	686	785	890	66	54	1.3	53	4.40	
DPFRF6660	715	853	998	66	60	1.3	59	4.90	

**DPORF • Open Bottom Fabric Middle and Top Panel**

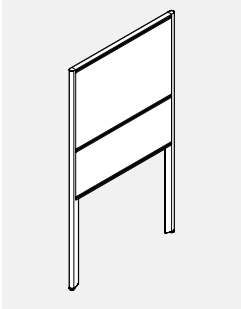

- Fabric above the middle rail provides visual privacy.
- Open bottom panel with additional rail at 42" high.
- Upper middle rail accepts Global Contract Accessories, Monitor Arm Support and Off-Module Shelves.
- Open bottom reduces cost and improves air circulation within the office.
- OPT\* = Laminate or Whiteboard

PRODUCT CODE	PRICE			SIZE/ H	INCHES			WEIGHT VOL	
	GR1	GR2	OPT*		W	D	LBS	FT <sup>3</sup>	
DPORF5024	326	358	392	50	24	1.3	10	1.62	
DPORF5030	344	378	410	50	30	1.3	13	2.08	
DPORF5036	413	446	481	50	36	1.3	16	2.47	
DPORF5042	433	474	524	50	42	1.3	19	2.85	
DPORF5048	455	498	546	50	48	1.3	21	3.25	
DPORF5054	472	519	563	50	54	1.3	25	3.63	
DPORF5060	494	545	595	50	60	1.3	28	4.02	
DPORF5424	326	358	392	54	24	1.3	12	1.62	
DPORF5430	344	378	410	54	30	1.3	15	2.08	
DPORF5436	413	446	481	54	36	1.3	18	2.47	
DPORF5442	433	474	524	54	42	1.3	21	2.85	
DPORF5448	455	498	546	54	48	1.3	24	3.25	
DPORF5454	472	524	575	54	54	1.3	27	3.63	
DPORF5460	494	545	595	54	60	1.3	30	4.02	
DPORF6624	397	441	488	66	24	1.3	17	2.04	
DPORF6630	421	466	512	66	30	1.3	21	2.52	
DPORF6636	497	567	642	66	36	1.3	25	3.00	
DPORF6642	546	622	703	66	42	1.3	29	3.46	
DPORF6648	572	641	719	66	48	1.3	33	3.93	
DPORF6654	594	672	755	66	54	1.3	37	4.40	
DPORF6660	617	691	765	66	60	1.3	41	4.90	

**DPFFG • Fabric Bottom, Middle and Glazed Top Panel**

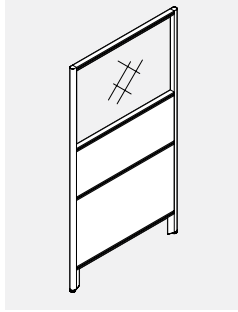

- Fabric below and between the middle rails provides visual privacy.
- Fabric bottom panel with additional rail at 28" high.
- Upper middle rail accepts Global Contract Accessories, Monitor Arm Support and Off-Module Shelves.
- Extruded aluminum frame surrounds acrylic glazing at top.
- PVC Extrusion is only Charcoal.
- For tempered glass, add "TG" to the end of the product code and add 20% to the price regardless of fabric grade.
- OPT\* = Laminate or Whiteboard

PRODUCT CODE	PRICE			SIZE/ H	INCHES			WEIGHT VOL	
	GR1	GR2	OPT*		W	D	LBS	FT <sup>3</sup>	
DPFFG5024	498	530	563	50	24	1.3	12	1.62	
DPFFG5030	546	576	611	50	30	1.3	15	2.08	
DPFFG5036	592	662	735	50	36	1.3	18	2.47	
DPFFG5042	640	710	783	50	42	1.3	21	2.85	
DPFFG5048	688	756	828	50	48	1.3	24	3.25	
DPFFG5054	737	806	881	50	54	1.3	27	3.63	
DPFFG5060	800	866	935	50	60	1.3	30	4.02	
DPFFG5424	498	530	563	54	24	1.3	17	1.62	
DPFFG5430	546	576	611	54	30	1.3	21	2.08	
DPFFG5436	592	662	735	54	36	1.3	25	2.47	
DPFFG5442	640	710	783	54	42	1.3	29	2.85	
DPFFG5448	688	756	828	54	48	1.3	33	3.25	
DPFFG5454	737	806	881	54	54	1.3	37	3.63	
DPFFG5460	800	868	942	54	60	1.3	41	4.02	
DPFFG6624	590	646	703	66	24	1.3	20	2.04	
DPFFG6630	653	710	768	66	30	1.3	25	2.52	
DPFFG6636	719	790	867	66	36	1.3	30	3.00	
DPFFG6642	785	857	932	66	42	1.3	35	3.46	
DPFFG6648	851	923	998	66	48	1.3	40	3.93	
DPFFG6654	915	987	1062	66	54	1.3	45	4.40	
DPFFG6660	994	1076	1165	66	60	1.3	50	4.90	

**DPOFG • Open Bottom, Middle Fabric and Glazed Top Panel**

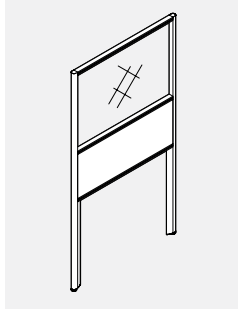

- Fabric between the middle rails.
- Open bottom panel with additional rail at 42" high.
- Upper middle rail accepts Global Contract Accessories, Monitor Arm Support and Off-Module Shelves.
- Extruded aluminum frame surrounds acrylic glazing at top.
- PVC Extrusion is only Charcoal.
- For tempered glass, add "TG" to the end of the product code and add 20% to the price regardless of fabric grade.
- OPT\* = Laminate or Whiteboard

PRODUCT CODE	PRICE			SIZE/ H	INCHES			WEIGHT VOL	
	GR1	GR2	OPT*		W	D	LBS	FT <sup>3</sup>	
DPOFG5024	393	406	420	50	24	1.3	14	1.62	
DPOFG5030	429	442	458	50	30	1.3	17	2.08	
DPOFG5036	464	476	493	50	36	1.3	20	2.47	
DPOFG5042	502	518	530	50	42	1.3	24	2.85	
DPOFG5048	537	552	565	50	48	1.3	27	3.25	
DPOFG5054	575	604	634	50	54	1.3	30	3.63	
DPOFG5060	617	646	674	50	60	1.3	34	4.02	
DPOFG5424	393	406	420	54	24	1.3	14	1.62	
DPOFG5430	429	442	458	54	30	1.3	17	2.08	
DPOFG5436	464	476	493	54	36	1.3	20	2.47	
DPOFG5442	502	518	530	54	42	1.3	24	2.85	
DPOFG5448	537	552	565	54	48	1.3	27	3.25	
DPOFG5454	575	604	634	54	54	1.3	30	3.63	
DPOFG5460	617	646	674	54	60	1.3	34	4.02	
DPOFG6624	490	502	519	66	24	1.3	17	2.04	
DPOFG6630	545	557	572	66	30	1.3	21	2.52	
DPOFG6636	601	628	658	66	36	1.3	25	3.00	
DPOFG6642	640	669	699	66	42	1.3	29	3.46	
DPOFG6648	697	725	755	66	48	1.3	33	3.93	
DPOFG6654	750	777	805	66	54	1.3	37	4.40	
DPOFG6660	809	838	867	66	60	1.3	41	4.90	

**DPFG • Fabric Bottom and Glazed Top Panel**

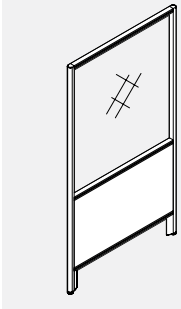

- **Fabric between the middle rails.**
- Open bottom panel with additional rail at 42" high.
- Upper middle rail accepts Global Contract Accessories, Monitor Arm Support and Off-Module Shelves.
- Open bottom reduces cost and improves air circulation within the office.
- Extruded aluminum frame surrounds acrylic glazing at top.
- PVC Extrusion is only Charcoal.
- For tempered glass, add "TG" to the end of the product code and add 20% to the price regardless of fabric grade.
- OPT\* = Laminate or Whiteboard

PRODUCT CODE	PRICE			SIZE/ H	INCHES			WEIGHT VOL	
	GR1	GR2	OPT*		W	D	LBS	FT <sup>3</sup>	
DPFG4224	539	558	578	42	24	1.3	11	1.32	
DPFG4230	585	603	622	42	30	1.3	14	1.62	
DPFG4236	636	652	673	42	36	1.3	16	1.94	
DPFG4242	677	733	792	42	42	1.3	18	2.24	
DPFG4248	724	779	838	42	48	1.3	21	2.55	
DPFG4254	773	828	888	42	54	1.3	23	2.85	
DPFG4260	817	871	931	42	60	1.3	26	3.16	
DPFG5024	651	669	691	50	24	1.3	12	1.62	
DPFG5030	703	723	741	50	30	1.3	15	2.08	
DPFG5036	751	767	788	50	36	1.3	18	2.47	
DPFG5042	802	858	916	50	42	1.3	21	2.85	
DPFG5048	849	904	965	50	48	1.3	24	3.25	
DPFG5054	899	955	1013	50	54	1.3	27	3.63	
DPFG5060	948	1004	1062	50	60	1.3	29	4.02	
DPFG5424	651	669	691	54	24	1.3	13	1.62	
DPFG5430	703	723	741	54	30	1.3	16	2.08	
DPFG5436	751	767	788	54	36	1.3	20	2.47	
DPFG5442	802	858	916	54	42	1.3	23	2.85	
DPFG5448	849	904	965	54	48	1.3	26	3.25	
DPFG5454	899	955	1013	54	54	1.3	29	3.63	
DPFG5460	948	1004	1062	54	60	1.3	32	4.02	
DPFG6624	706	726	748	66	24	1.3	17	2.04	
DPFG6630	761	779	800	66	30	1.3	21	2.52	
DPFG6636	813	868	927	66	36	1.3	24	3.00	
DPFG6642	866	921	978	66	42	1.3	28	3.46	
DPFG6648	916	971	1031	66	48	1.3	32	3.93	
DPFG6654	970	1026	1085	66	54	1.3	36	4.40	
DPFG6660	1025	1081	1139	66	60	1.3	40	4.90	

**DPFS • Fabric Bottom Slat Top Panel**

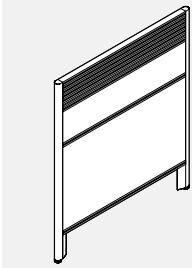

- **Integrated 6" slat rail provides flexibility of use.**
- Panel integrated slat rail accepts Global Contract Accessories, Monitor Arm Support, Off-Module Shelves, Task Light Bracket and Power Bar.
- OPT\* = Laminate or Whiteboard

PRODUCT CODE	PRICE			SIZE/ H	INCHES			WEIGHT VOL	
	GR1	GR2	OPT*		W	D	LBS	FT <sup>3</sup>	
DPFS4224	385	409	437	42	24	1.3	19	1.32	
DPFS4230	470	495	523	42	30	1.3	23	1.62	
DPFS4236	524	591	666	42	36	1.3	28	1.94	
DPFS4242	572	639	713	42	42	1.3	33	2.24	
DPFS4248	616	686	758	42	48	1.3	37	2.55	
DPFS4254	667	735	807	42	54	1.3	42	2.85	
DPFS4260	712	781	854	42	60	1.3	47	3.16	

**DPFSF • Fabric Bottom, Slat Middle and Fabric Top Panel**

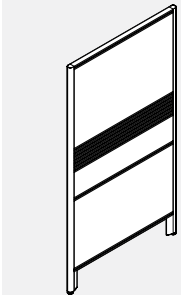

- **Integrated 6" slat rail between the middle rails provides flexibility of use. Fabric at the top provides visual privacy.**
- Panel integrated slat rail accepts Global Contract Accessories, Monitor Arm Support, Off-Module Shelves, Task Light Bracket and Power Bar.
- OPT\* = Laminate or Whiteboard

PRODUCT CODE	PRICE			SIZE/ H	INCHES			WEIGHT VOL	
	GR1	GR2	OPT*		W	D	LBS	FT <sup>3</sup>	
DPFSF5024	535	561	587	50	24	1.3	21	1.62	
DPFSF5030	592	617	642	50	30	1.3	28	2.08	
DPFSF5036	651	722	793	50	36	1.3	34	2.47	
DPFSF5042	706	778	851	50	42	1.3	40	2.85	
DPFSF5048	767	837	909	50	48	1.3	46	3.25	
DPFSF5054	820	889	963	50	54	1.3	52	3.63	
DPFSF5060	877	945	1020	50	60	1.3	58	4.02	
DPFSF5424	535	561	587	54	24	1.3	23	1.62	
DPFSF5430	592	617	642	54	30	1.3	30	2.08	
DPFSF5436	651	722	793	54	36	1.3	36	2.47	
DPFSF5442	706	778	851	54	42	1.3	42	2.85	
DPFSF5448	767	837	909	54	48	1.3	48	3.25	
DPFSF5454	820	889	963	54	54	1.3	54	3.63	
DPFSF5460	877	945	1020	54	60	1.3	60	4.02	
DPFSF6624	615	661	710	66	24	1.3	28	2.04	
DPFSF6630	675	723	771	66	30	1.3	35	2.52	
DPFSF6636	741	853	969	66	36	1.3	42	3.00	
DPFSF6642	802	911	1030	66	42	1.3	49	3.46	
DPFSF6648	862	971	1089	66	48	1.3	56	3.93	
DPFSF6654	923	1032	1148	66	54	1.3	63	4.40	
DPFSF6660	982	1090	1207	66	60	1.3	70	4.90	

**DPOSF • Open Bottom, Slat Middle Panel**

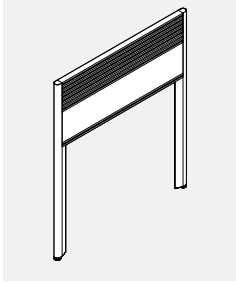

- Integrated 6" slat rail between the middle rails provides flexibility of use.
- Panel integrated slat rail accepts Global Contract Accessories, Monitor Arm Support, Off-Module Shelves, Task Light Bracket and Power Bar.
- OPT\* = Laminate or Whiteboard

PRODUCT CODE	PRICE			SIZE/ H	INCHES			WEIGHT VOL	
	GR1	GR2	OPT*		W	D	LBS	FT <sup>3</sup>	
DPOSF4224	345	355	360	42	24	1.3	12	1.32	
DPOSF4230	386	394	399	42	30	1.3	17	1.62	
DPOSF4236	428	441	457	42	36	1.3	24	1.94	
DPOSF4242	466	477	494	42	42	1.3	28	2.24	
DPOSF4248	507	523	535	42	48	1.3	36	2.55	
DPOSF4254	547	560	574	42	54	1.3	40	2.85	
DPOSF4260	585	596	612	42	60	1.3	44	3.16	

**DPOSF • Open Bottom, Slat Middle and Fabric Top Panel**

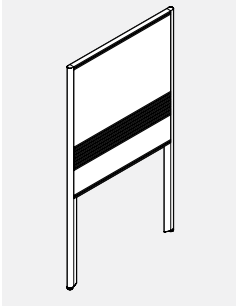

- Integrated 6" slat rail between the middle rails provides flexibility of use. Fabric above middle rail provides privacy.
- Panel integrated slat rail accepts Global Contract Accessories, Monitor Arm Support, Off-Module Shelves, Task Light Bracket and Power Bar.
- Open bottom reduces cost and improves air circulation within the office.
- OPT\* = Laminate or Whiteboard

PRODUCT CODE	PRICE			SIZE/ H	INCHES			WEIGHT VOL	
	GR1	GR2	OPT*		W	D	LBS	FT <sup>3</sup>	
DPOSF5024	461	480	502	50	24	1.3	13	1.62	
DPOSF5030	508	530	552	50	30	1.3	14	2.08	
DPOSF5036	557	596	640	50	36	1.3	21	2.47	
DPOSF5042	607	647	692	50	42	1.3	25	2.85	
DPOSF5048	652	694	737	50	48	1.3	29	3.25	
DPOSF5054	703	744	789	50	54	1.3	31	3.63	
DPOSF5060	751	790	835	50	60	1.3	35	4.02	
DPOSF5424	461	480	502	54	24	1.3	15	1.62	
DPOSF5430	508	530	552	54	30	1.3	19	2.08	
DPOSF5436	557	596	640	54	36	1.3	23	2.47	
DPOSF5442	607	647	692	54	42	1.3	27	2.85	
DPOSF5448	652	694	737	54	48	1.3	31	3.25	
DPOSF5454	703	744	789	54	54	1.3	34	3.63	
DPOSF5460	751	790	835	54	60	1.3	38	4.02	
DPOSF6624	541	575	612	66	24	1.3	18	2.04	
DPOSF6630	594	628	666	66	30	1.3	23	2.52	
DPOSF6636	646	715	788	66	36	1.3	28	3.00	
DPOSF6642	700	768	842	66	42	1.3	33	3.46	
DPOSF6648	752	832	923	66	48	1.3	38	3.93	
DPOSF6654	805	888	975	66	54	1.3	43	4.40	
DPOSF6660	857	938	1029	66	60	1.3	47	4.90	

**DPOSG • Open Bottom, Slat Middle and Glazed Top Panel**

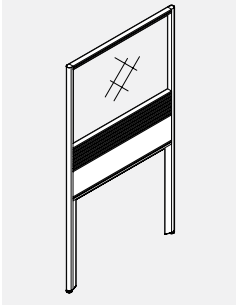

- Integrated 6" slat rail between the middle rails provides flexibility of use.
- Panel integrated slat rail accepts Global Contract Accessories, Monitor Arm Support, Off-Module Shelves, Task Light Bracket and Power Bar.
- Open bottom reduces cost and improves air circulation within the office.
- Extruded aluminum frame surrounds acrylic glazing at top.
- PVC Extrusion is only Charcoal.
- For tempered glass, add "TG" to the end of the product code and add 20% to the price regardless of fabric grade.
- OPT\* = Laminate or Whiteboard

PRODUCT CODE	PRICE			SIZE/ H	INCHES			WEIGHT VOL	
	GR1	GR2	OPT*		W	D	LBS	FT <sup>3</sup>	
DPOSG5024	684	692	697	50	24	1.3	12	1.62	
DPOSG5030	737	744	752	50	30	1.3	15	2.08	
DPOSG5036	788	801	816	50	36	1.3	18	2.47	
DPOSG5042	842	856	869	50	42	1.3	22	2.85	
DPOSG5048	891	904	920	50	48	1.3	25	3.25	
DPOSG5054	944	957	971	50	54	1.3	28	3.63	
DPOSG5060	994	1007	1022	50	60	1.3	32	4.02	
DPOSG5424	684	692	697	54	24	1.3	14	1.62	
DPOSG5430	737	744	752	54	30	1.3	17	2.08	
DPOSG5436	788	801	816	54	36	1.3	20	2.47	
DPOSG5442	842	856	869	54	42	1.3	24	2.85	
DPOSG5448	891	904	920	54	48	1.3	27	3.25	
DPOSG5454	944	957	971	54	54	1.3	30	3.63	
DPOSG5460	994	1007	1022	54	60	1.3	34	4.02	
DPOSG6624	743	752	757	66	24	1.3	17	2.04	
DPOSG6630	800	806	813	66	30	1.3	21	2.52	
DPOSG6636	854	867	882	66	36	1.3	25	3.00	
DPOSG6642	909	923	936	66	42	1.3	29	3.46	
DPOSG6648	963	974	991	66	48	1.3	33	3.93	
DPOSG6654	1020	1032	1048	66	54	1.3	37	4.40	
DPOSG6660	1076	1089	1104	66	60	1.3	41	4.90	

**DPFSG • Fabric Bottom, Slat Middle and Glazed Top Panel**

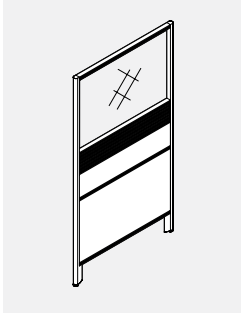

- **Integrated 6" slat rail provides flexibility of use.**
- Panel integrated slat rail accepts Global Contract Accessories, Monitor Arm Support, Off-Module Shelves, Task Light Bracket and Power Bar.
- Extruded aluminum frame surrounds acrylic glazing at top.
- PVC Extrusion is only Charcoal.
- For tempered glass, add "TG" to the end of the product code and add 20% to the price regardless of fabric grade.
- OPT\* = Laminate or Whiteboard

PRODUCT CODE	PRICE			SIZE/ H	INCHES			WEIGHT VOL	
	GR1	GR2	OPT*		W	D	LBS	FT <sup>3</sup>	
DPFSG5024	751	774	801	50	24	1.3	15	1.62	
DPFSG5030	807	832	859	50	30	1.3	19	2.08	
DPFSG5036	866	934	1007	50	36	1.3	23	2.47	
DPFSG5042	923	992	1063	50	42	1.3	27	2.85	
DPFSG5048	975	1047	1119	50	48	1.3	31	3.25	
DPFSG5054	1032	1101	1174	50	54	1.3	35	3.63	
DPFSG5060	1089	1159	1230	50	60	1.3	39	4.02	
DPFSG5424	751	774	801	54	24	1.3	17	1.62	
DPFSG5430	807	832	859	54	30	1.3	21	2.08	
DPFSG5436	866	934	1007	54	36	1.3	25	2.47	
DPFSG5442	923	992	1063	54	42	1.3	29	2.85	
DPFSG5448	975	1047	1119	54	48	1.3	33	3.25	
DPFSG5454	1032	1101	1174	54	54	1.3	37	3.63	
DPFSG5460	1089	1159	1230	54	60	1.3	41	4.02	
DPFSG6624	816	840	867	66	24	1.3	20	2.04	
DPFSG6630	877	902	928	66	30	1.3	25	2.52	
DPFSG6636	934	1003	1076	66	36	1.3	30	3.00	
DPFSG6642	994	1062	1136	66	42	1.3	35	3.46	
DPFSG6648	1056	1123	1198	66	48	1.3	40	3.93	
DPFSG6654	1114	1183	1256	66	54	1.3	45	4.40	
DPFSG6660	1177	1249	1320	66	60	1.3	50	4.90	

**DPOPF • Diet Over Panel**

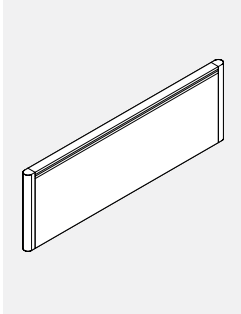

- **Over Panels attach to regular Diet Panels to provide additional visual privacy.**
- Over Panel is secured to regular Diet Panels with 4 brackets and set screws.
- Accessory loading capabilities only.
- Not for use with overhead storage.
- OPT\* = Laminate or Whiteboard

PRODUCT CODE	PRICE			SIZE/ H	INCHES			WEIGHT VOL	
	GR1	GR2	OPT*		W	D	LBS	FT <sup>3</sup>	
DPOPF1224	204	217	231	12	24	1.3	5	0.30	
DPOPF1230	232	245	260	12	30	1.3	7	0.60	
DPOPF1236	262	290	319	12	36	1.3	8	0.75	
DPOPF1242	284	311	341	12	42	1.3	9	0.88	
DPOPF1248	315	342	372	12	48	1.3	11	1.00	
DPOPF1254	344	373	403	12	54	1.3	12	1.13	
DPOPF1260	366	394	422	12	60	1.3	13	1.25	
DPOPF2424	283	310	340	24	24	1.3	10	1.00	
DPOPF2430	308	334	364	24	30	1.3	14	1.25	
DPOPF2436	329	369	413	24	36	1.3	16	1.45	
DPOPF2442	350	389	435	24	42	1.3	18	1.75	
DPOPF2448	372	413	458	24	48	1.3	22	2.00	
DPOPF2454	394	436	477	24	54	1.3	24	2.25	
DPOPF2460	418	459	502	24	60	1.3	26	2.50	

**DTMPP • Table Mounted Diet Panels**

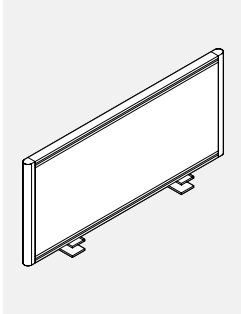

- **Creates privacy and flexibility at the end of workspaces.**
- Side Panels for sides of Viceversa® Tables or sides of workspaces available 24", and 36" widths (nominal width).
- Back Panels for sides of Viceversa® Tables available 48", 54" and 60" widths.
- Attaches with similar clamp to other clamp on accessories.
- Non tackable, non load-bearing, no hang on capabilities and not for use with transaction tops.
- Not for use with Licence product due to interference of gables and flush modesties.
- OPT\* = Laminate or Whiteboard

PRODUCT CODE	PRICE			SIZE/ H	INCHES			WEIGHT VOL	
	GR1	GR2	OPT*		W	D	LBS	FT <sup>3</sup>	
<b>SIDE PANELS</b>									
DTMPP24	224	234	252	16.5	21	1.3	7	0.75	
DTMPP30	240	254	268	16.5	27	1.3	8	0.94	
DTMPP36	257	286	315	16.5	33	1.3	10	1.13	
<b>BACK PANELS</b>									
DTMPP48	284	311	341	16.5	48	1.3	15	1.53	
DTMPP54	311	340	369	16.5	54	1.3	17	1.72	
DTMPP60	340	367	397	16.5	60	1.3	18	1.91	

**DPCBM • Panel Cable Manager**

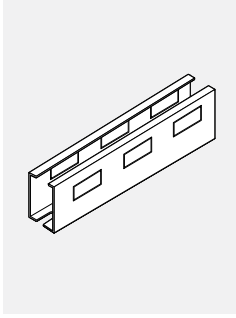

- Provides wire management for the Diet Panels.
- Extruded, dual durometer "U" channel organizes cables below panels.
- Snaps into bottom rail and into mid rail on open bottom panels.
- One data partial knock-out (2.67" wide x 1.36" high) provided on either side of the Raceway Cover accommodates terminal plates from various vendors.
- Panel Cable Manager comes in charcoal only.

PRODUCT CODE	PRICE	SIZE/ INCHES			WEIGHT VOL	
		H	W	D	LBS	FT <sup>3</sup>
DPCBM24	15	4	18	1.3	1.3	0.07
DPCBM30	23	4	24	1.3	1.4	0.08
DPCBM36	25	4	30	1.3	1.5	0.10
DPCBM42	28	4	36	1.3	1.6	0.13
DPCBM48	30	4	42	1.3	1.7	0.15
DPCBM54	34	4	48	1.3	1.8	0.16
DPCBM60	36	4	54	1.3	1.9	0.19

**DPOFM • Off Module Panel Connector**

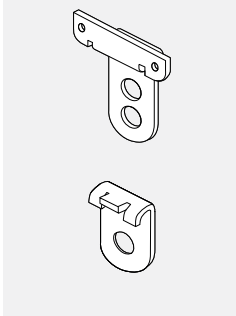

- Connects two perpendicular Diet Panels Off-Module.
- Top and bottom brackets bolt to Diet Panel verticals and engage to top and bottom rails of adjacent, perpendicular panel of even or lower height.
- Connectors can also be used to connect a panel in the middle of perpendicular DPFRF, DPORF, DPFFG, DPFSG and DPFSF at their 42" height secondary middle rail.
- Top and bottom brackets fit in place of standard hinge connectors.
- All fasteners included.

PRODUCT CODE	PRICE	SIZE/ INCHES			WEIGHT VOL	
		H	W	D	LBS	FT <sup>3</sup>
DPOFM	58	4	3	2	1	0.08

**DPPWA • Wall Adapter**

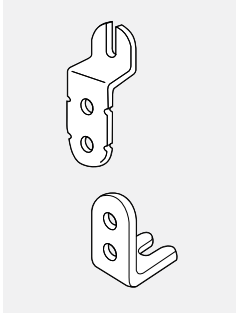

- Connects Diet Panels to walls.
- Bolts to Diet Panel vertical in place of the standard hinge connectors.
- Keyhole openings in Diet adapter slide over fasteners pre-installed to the wall.
- All fasteners included, however, the mounting hardware to affix adapter to wall not included, they will be based on type of wall material.

PRODUCT CODE	PRICE	SIZE/ INCHES			WEIGHT VOL	
		H	W	D	LBS	FT <sup>3</sup>
DPPWA	42	40	2.5		1	0.08

**DPCSTR • Casters**

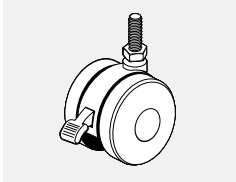

- Changes a freestanding Diet Panel to mobile.
- Must be used on two panels or more.
- Order 1 caster more than the number of panels. (Using only 1 caster where panels connect.) For example, 3 panels, 4 casters or 2 panels, 3 casters.
- Casters raise Diet Panels by a height of 1.1".

PRODUCT CODE	PRICE	SIZE/ INCHES			WEIGHT VOL	
		H	W	D	LBS	FT <sup>3</sup>
DPCSTR	12	1.5	1.5	1.5	.25	1.02

**DPLTSBKIT • Telescopic Sliding Kit**

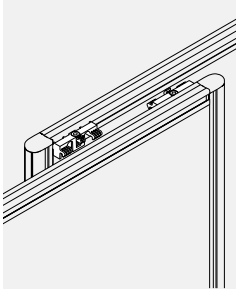

- Diet Telescopic Sliding Kit flexibly connects two standard parallel Diet panels and forms a length-adjustable partition.
- Kit consists of two top and two bottom sliding box assemblies and all the necessary connecting hardware.
- Made of black injection molded resin.
- The panels must be of the same height and equipped with top and bottom standard Diet extrusions.
- The kit can be installed as right or left on site, determining the direction of nesting/sliding.
- The kit offsets the parallel panel and the resulting gap is 12.5mm (½")
- Up to three standard Diet panels can be connected to form the length-adjustable partition.
- The kit is not intended to be used in place of a sliding door.
- The kit cannot be used with Diet overpanels or Diet Linking Panels.

PRODUCT CODE	PRICE	SIZE/ INCHES			WEIGHT VOL	
		H	W	D	LBS	FT <sup>3</sup>
DPLTSBKIT	76	0.75	3	0.5	0.04	0.15

**DBSCB • Diet to Boulevard Slot Connector**

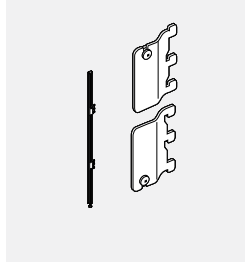

- Connects a Diet Panel to a Boulevard Panel via slots eliminating the need for the Boulevard Post and reducing the overall length and cost of a panel run.
- Connector can be installed in left or right configuration.
- Comes as a pair (Upper and lower brackets).
- Worksurfaces should be ordered based on application keeping in mind that this connector will align to the left or right of the end of the Boulevard Panel.
- Application drawings and layout must be provided for specials.

PRODUCT CODE	PRICE	SIZE/ H	INCHES			WEIGHT VOL	
			W	D	LBS	FT <sup>3</sup>	
DBSCB02	56	3	0.5	00.0	1	0.05	

**DAPPF • Diet Gap Filler**

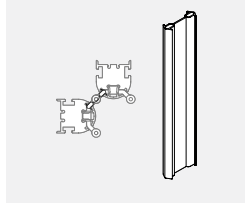

- Closes the gap between panels.
- Must be used on two or more panels.
- Order 1 DAPPF36 for a 42" high panel, 1 DAPPF36 and 1 DAPPF12 for a 54" high panel, or 1 DAPPF36 and 2 DAPPF12 for 66" high panel.

PRODUCT CODE	PRICE	SIZE/ H	INCHES			WEIGHT VOL	
			W	D	LBS	FT <sup>3</sup>	
DAPPF12	9	9	11.5				
DAPPF36	22	36.33					

**DHFFA • Single Flat Foot**

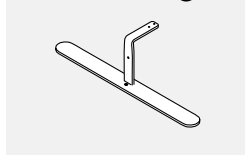

- Used to create a freestanding panel
- Foot is flat to the floor with no adjustable glides
- No load capabilities on freestanding panel
- Only for use with Fabric Bottom panels
- Can be used to retro fit existing Diet panels on site
- Not for use with Diet Linking Panels
- Specify standard panel frame paint finishes

PRODUCT CODE	PRICE	SIZE/ H	INCHES			WEIGHT VOL	
			W	D	LBS	FT <sup>3</sup>	
DHFFA	97	6	20	2	3.48	0.15	

**DHFFA02 • Flat Foot Kit**

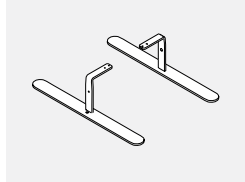

- Used to create a freestanding panel
- Feet are flat to the floor with no adjustable glides
- No load capabilities on freestanding panel
- Cannot be used with open bottom panels or Linking Panels.
- Can be used to retro fit existing Diet panels on site
- Not for use with Diet Linking Panels
- Specify standard panel frame paint finishes

PRODUCT CODE	PRICE	SIZE/ H	INCHES			WEIGHT VOL	
			W	D	LBS	FT <sup>3</sup>	
DHFFA02	191	6	20	2	7	0.3	

**DHCFAN • Single Caster Foot**

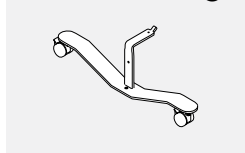

- Used to create a mobile panel
- Casters are locking
- No load capabilities on mobile panel
- Only for use with Fabric Bottom panels
- Can be used to retro fit existing Diet panels on site
- Not for use with Diet Linking Panels
- Specify standard panel frame paint finishes

PRODUCT CODE	PRICE	SIZE/ H	INCHES			WEIGHT VOL	
			W	D	LBS	FT <sup>3</sup>	
DHCFAN	127	6	20	2	3.87	0.15	

**DHCFAN02 • Caster Foot Kit**

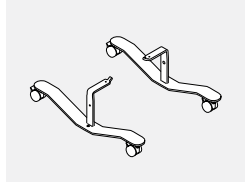

- Used to create a mobile panel
- Casters are locking
- No load capabilities on mobile panel
- Only for use with Fabric Bottom panels
- Can be used to retro fit existing Diet panels on site
- Not for use with Diet Linking Panels
- Specify standard panel frame paint finishes

PRODUCT CODE	PRICE	SIZE/ H	INCHES			WEIGHT VOL	
			W	D	LBS	FT <sup>3</sup>	
DHCFAN02	253	6	20	2	7.7	0.3	

**DHCFAL01 • Diet Caster Assembly Kit**

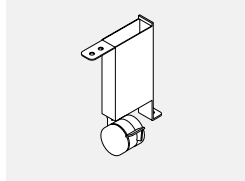

- To be used on one side to create a mobile panel with DHCFAN on the other side.
- Caster is locking.
- No load capabilities on mobile panel
- Only for use with Fabric Bottom panels.
- Can be used to retrofit existing Diet panels on site.
- Not for use with Diet Linking Panels.
- Specigy standard panel frame paint finishes.

PRODUCT CODE	PRICE	SIZE/ H	INCHES			WEIGHT VOL	
			W	D	LBS	FT <sup>3</sup>	
DHCFAL01	61	6	1	4.8	1	0.02	



**DB-P-X • Diet to Boulevard Slim Connector in “X” Configuration**

• Creates a perpendicular connection between Diet Panel and Boulevard Panel that eliminates the need for special sized work-surfaces.

• Note: For use with new BDPFF & BDPOF panels.

**Diet to Boulevard 1 “X” Configuration**

PRODUCT CODE	PRICE	B1 HEIGHT	DIET PANEL HEIGHT	SIZE/ H	INCHES W	D	WEIGHT LBS	VOL FT <sup>3</sup>
BDB1P4242X	128	42"	42"	42	1.3	2.6	4	0.207
BDB1P4250X	143	50"	42"	50	1.3	2.6	5	0.245
BDB1P4254X	151	54"	42"	54	1.3	2.6	5	0.264
BDB1P4258X	157	58"	42"	58	1.3	2.6	6	0.283
BDB1P4266X	173	66"	42"	66	1.3	2.6	7	0.322
BDB1P4274X	188	74"	42"	74	1.3	2.6	8	0.360
BDB1P4282X	202	82"	42"	82	1.3	2.6	9	0.399
BDB1P5050X	173	50"	50"	50	1.3	2.6	5	0.245
BDB1P5054X	173	54"	50"	54	1.3	2.6	5	0.264
BDB1P5058X	173	58"	50"	58	1.3	2.6	6	0.283
BDB1P5066X	173	66"	50"	66	1.3	2.6	7	0.322
BDB1P5074X	188	74"	50"	74	1.3	2.6	8	0.360
BDB1P5082X	202	82"	50"	82	1.3	2.6	9	0.399
BDB1P5454X	145	54"	54"	54	1.3	2.6	5	0.264
BDB1P5458X	157	58"	54"	58	1.3	2.6	6	0.283
BDB1P5466X	173	66"	54"	66	1.3	2.6	7	0.322
BDB1P5474X	188	74"	54"	74	1.3	2.6	8	0.360
BDB1P5482X	202	82"	54"	82	1.3	2.6	9	0.399
BDB1P6666X	173	66"	66"	66	1.3	2.6	7	0.322
BDB1P6674X	188	74"	66"	74	1.3	2.6	8	0.360
BDB1P6682X	202	82"	66"	82	1.3	2.6	9	0.399

**Diet to System 3 “X” Configuration**

PRODUCT CODE	PRICE	SYSTEM3 HEIGHT	DIET PANEL HEIGHT	SIZE/ H	INCHES W	D	WEIGHT LBS	VOL FT <sup>3</sup>
BDB3P4242X	128	42"	42"	42	1.3	2.6	4	0.207
BDB3P4250X	143	50"	42"	50	1.3	2.6	5	0.245
BDB3P4254X	145	54"	42"	54	1.3	2.6	6	0.260
BDB3P4266X	173	66"	42"	66	1.3	2.6	7	0.322
BDB3P5050X	173	50"	50"	50	1.3	2.6	5	0.245
BDB3P5054X	145	54"	50"	54	1.3	2.6	6	0.260
BDB3P5066X	173	66"	50"	66	1.3	2.6	7	0.322
BDB3P5454X	145	54"	54"	54	1.3	2.6	6	0.260
BDB3P5466X	173	66"	54"	66	1.3	2.6	7	0.322
BDB3P6666X	173	66"	66"	66	1.3	2.6	7	0.322

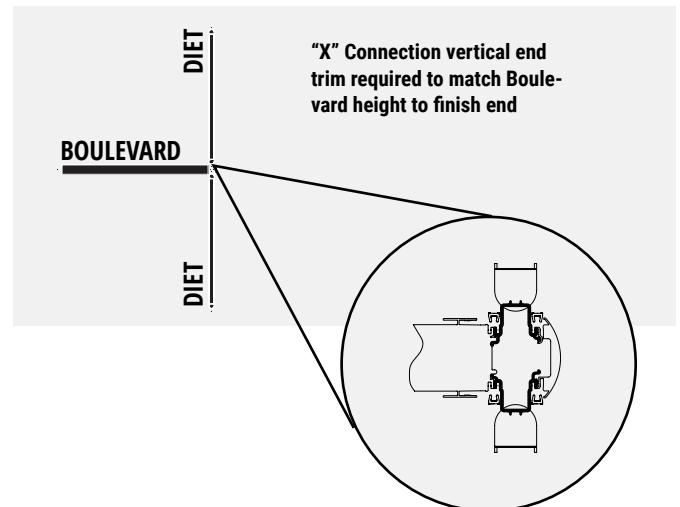
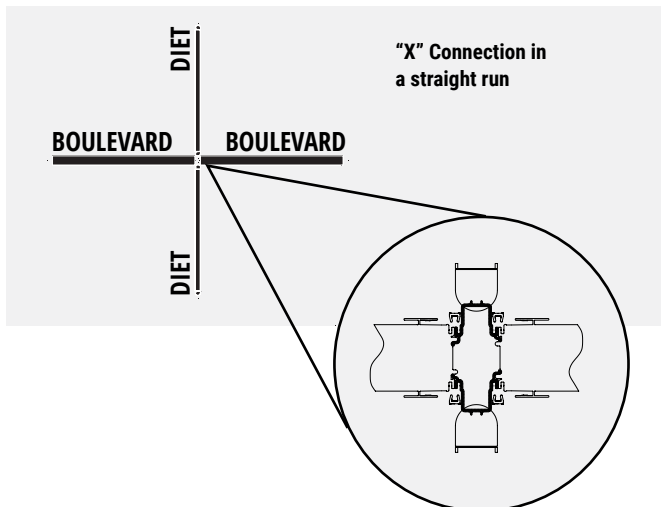

\* Please specify separate end trim (round or flat) to close end.

**DBXP-T • Diet to Boulevard Slim Connector in “T” Configuration**

- Creates a perpendicular connection between Diet Panel and Boulevard Panel that eliminates the need for special sized worksurfaces.
- Note: For use with new BDPFF & BDPOF panels.

**Diet to Boulevard 1 “T” Configuration**

PRODUCT CODE	PRICE	B1 HEIGHT	DIET PANEL HEIGHT	SIZE/ H	INCHES W	D	WEIGHT LBS	VOL FT <sup>3</sup>
BDB1P4242T	128	42"	42"	42	1.3	2.6	4	0.207
BDB1P4250T	143	50"	42"	50	1.3	2.6	5	0.245
BDB1P4254T	151	54"	42"	54	1.3	2.6	5	0.264
BDB1P4258T	157	58"	42"	58	1.3	2.6	6	0.283
BDB1P4266T	173	66"	42"	66	1.6	2.6	7	0.322
BDB1P4274T	188	74"	42"	74	1.3	2.6	8	0.360
BDB1P4282T	202	82"	42"	82	1.3	2.6	9	0.399
BDB1P5050T	173	50"	50"	50	1.3	2.6	5	0.245
BDB1P5054T	173	54"	50"	54	1.3	2.6	5	0.264
BDB1P5058T	173	58"	50"	58	1.3	2.6	6	0.283
BDB1P5066T	173	66"	50"	66	1.3	2.6	7	0.322
BDB1P5074T	188	74"	50"	74	1.3	2.6	8	0.360
BDB1P5082T	202	82"	50"	82	1.3	2.6	9	0.399
BDB1P5454T	145	54"	54"	54	1.3	2.6	6	0.245
BDB1P5458T	157	58"	54"	58	1.3	2.6	6	0.283
BDB1P5466T	173	66"	54"	66	1.3	2.6	7	0.322
BDB1P5474T	188	74"	54"	74	1.3	2.6	8	0.360
BDB1P5482T	202	82"	54"	82	1.3	2.6	9	0.399
BDB1P6666T	173	66"	66"	66	1.3	2.6	7	0.322
BDB1P6674T	188	74"	66"	74	1.3	2.6	8	0.360
BDB1P6682T	202	82"	66"	82	1.3	2.6	9	0.399

**Diet to System 3 “T” Configuration**

PRODUCT CODE	PRICE	SYSTEM 3 HEIGHT	DIET PANEL HEIGHT	SIZE/ H	INCHES W	D	WEIGHT LBS	VOL FT <sup>3</sup>
BDB3P4242T	128	42"	42"	42	1.3	2.6	4	0.207
BDB3P4250T	143	50"	42"	50	1.3	2.6	5	0.245
BDB3P4254T	145	54"	42"	54	1.3	2.6	6	0.245
BDB3P4266T	173	66"	42"	66	1.3	2.6	7	0.322
BDB3P5050T	173	50"	50"	50	1.3	2.6	5	0.245
BDB3P5054T	145	54"	50"	54	1.3	2.6	6	0.245
BDB3P5066T	173	66"	50"	66	1.3	2.6	7	0.322
BDB3P5454T	145	54"	54"	54	1.3	2.6	6	0.245
BDB3P5466T	173	66"	54"	66	1.3	2.6	7	0.322
BDB3P6666T	173	66"	66"	66	1.3	2.6	7	0.322

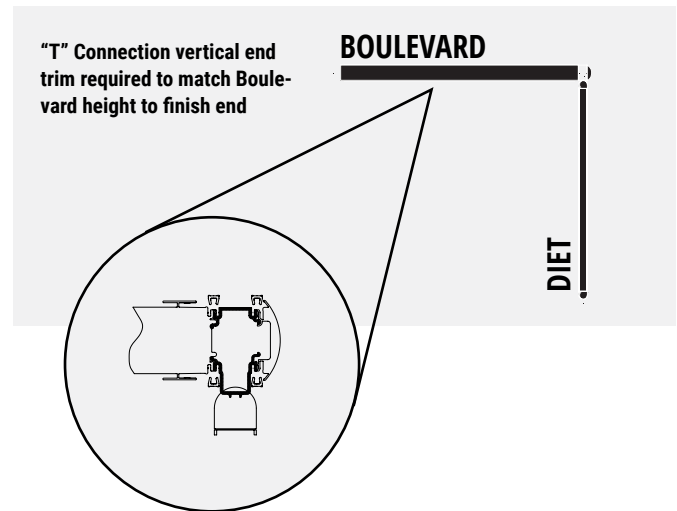
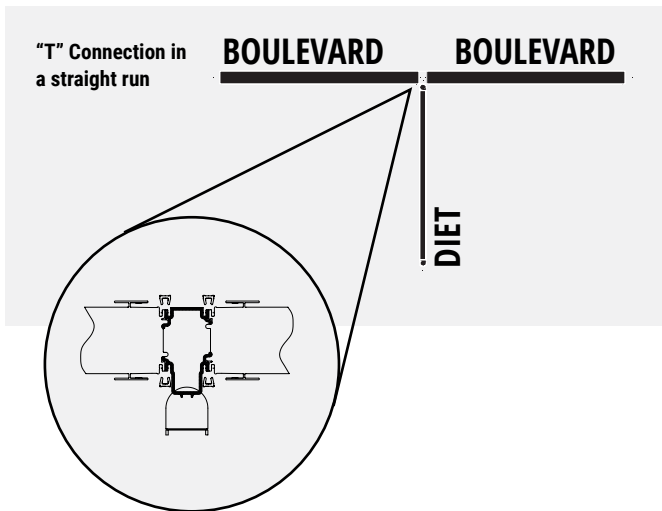

\* Please specify separate end trim (round or flat) to close end.

**DB-P-X • Diet to Boulevard Slim Connector in "X" Configuration**

- Creates a perpendicular connection between Diet Panel and Boulevard Panel that eliminates the need for special sized worksurfaces.
- Note: For use with regular DP panels.

**Diet to Boulevard 1 "X" Configuration**

PRODUCT CODE	PRICE	B1 HEIGHT	DIET PANEL HEIGHT	SIZE/ H	INCHES W	D	WEIGHT LBS	VOL FT <sup>3</sup>
DB1P4242X	128	42"	42"	42	1.3	2.6	4	0.207
DB1P4250X	143	50"	42"	50	1.3	2.6	5	0.245
DB1P4254X	154	54"	42"	54	1.3	2.6	6	0.266
DB1P4266X	173	66"	42"	66	1.3	2.6	7	0.322
DB1P4274X	188	74"	42"	74	1.3	2.6	8	0.360
DB1P4282X	202	82"	42"	82	1.3	2.6	9	0.399
DB1P5050X	173	50"	50"	50	1.3	2.6	5	0.245
DB1P5054X	173	54"	50"	54	1.3	2.6	6	0.266
DB1P5058X	173	58"	50"	58	1.3	2.6	6	0.283
DB1P5066X	173	66"	50"	66	1.3	2.6	7	0.322
DB1P5074X	188	74"	50"	74	1.3	2.6	8	0.360
DB1P5082X	202	82"	50"	82	1.3	2.6	9	0.399
DB1P5458X	157	58"	54"	58	1.3	2.6	6	0.283
DB1P5466X	173	66"	54"	66	1.3	2.6	7	0.322
DB1P5474X	188	74"	54"	74	1.3	2.6	8	0.360
DB1P5482X	202	82"	54"	82	1.3	2.6	9	0.399
DB1P6666X	173	66"	66"	66	1.3	2.6	7	0.322
DB1P6674X	188	74"	66"	74	1.3	2.6	8	0.360
DB1P6682X	202	82"	66"	82	1.3	2.6	9	0.399

**Diet to System 3 "X" Configuration**

PRODUCT CODE	PRICE	SYSTEM 3 HEIGHT	DIET PANEL HEIGHT	SIZE/ H	INCHES W	D	WEIGHT LBS	VOL FT <sup>3</sup>
DB3P4242X	128	42"	42"	42	1.3	2.6	4	0.207
DB3P4250X	143	50"	42"	50	1.3	2.6	5	0.245
DB3P4266X	173	66"	42"	66	1.3	2.6	7	0.322
DB3P5050X	173	50"	50"	50	1.3	2.6	5	0.245
DB3P5066X	173	66"	50"	66	1.3	2.6	7	0.322
DB3P5466X	173	66"	54"	66	1.3	2.6	7	0.322
DB3P5454X	173	54"	54"	54	1.3	2.6	6	0.266
DB3P6666X	173	66"	66"	66	1.3	2.6	7	0.322

**Diet to Boulevard 1 Overpanels**

PRODUCT CODE	PRICE	OVER PANEL HEIGHT	SIZE/ H	INCHES W	D	WEIGHT LBS	VOL FT <sup>3</sup>
DB1OPPC08X	58	8"	8	1.3	2.6	0.8	0.043
DB1OPPC16X	62	16"	16	1.3	2.6	1.6	0.082
DB1OPPC24X	64	24"	24	1.3	2.6	2.5	0.120
DB1OPPC37X	72	37"	37	1.3	2.6	3.5	0.183
DB1OPPC42X	81	42"	42	1.3	2.6	4.0	0.207

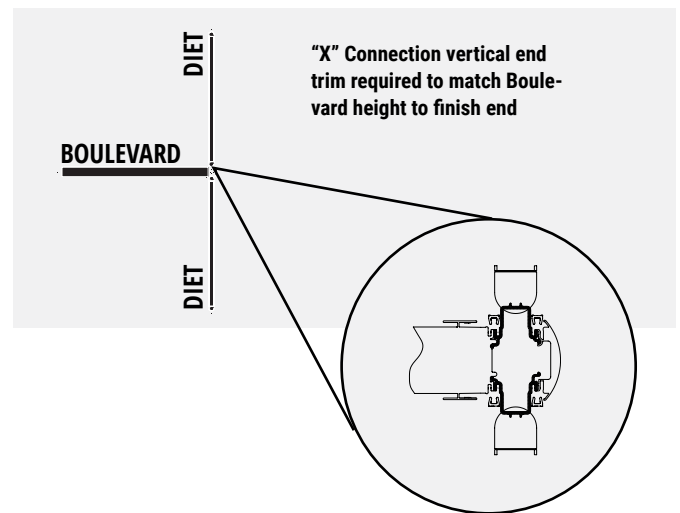
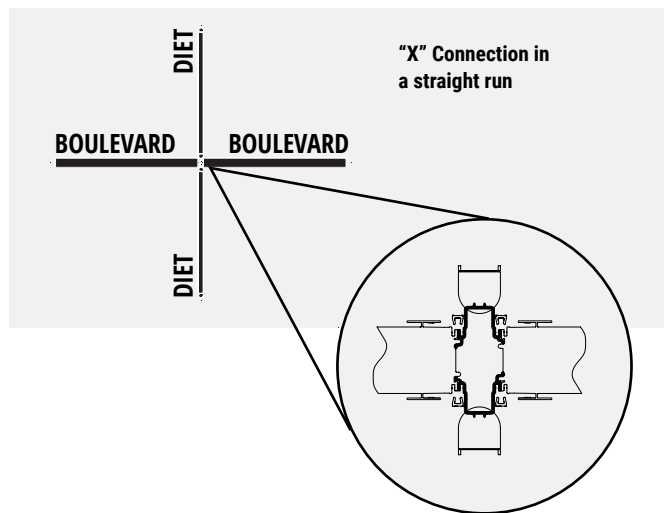

**DBXP-T • Diet to Boulevard Slim Connector in “T” Configuration**

• Creates a perpendicular connection between Diet Panel and Boulevard Panel that eliminates the need for special sized work-surfaces.

• Note: For use with regular DP panels.

**Diet to Boulevard 1 “T” Configuration**

PRODUCT CODE	PRICE	B1 HEIGHT	DIET PANEL HEIGHT	SIZE/ H	INCHES W	D	WEIGHT LBS	VOL FT <sup>3</sup>
DB1P4242T	128	42"	42"	42	1.3	2.6	4	0.207
DB1P4250T	143	50"	42"	50	1.3	2.6	5	0.245
DB1P4258T	157	58"	42"	58	1.3	2.6	6	0.283
DB1P4266T	173	66"	42"	66	1.6	2.6	7	0.322
DB1P4274T	188	74"	42"	74	1.3	2.6	8	0.360
DB1P4282T	202	82"	42"	82	1.3	2.6	9	0.399
DB1P5050T	173	50"	50"	50	1.3	2.6	5	0.245
DB1P5058T	173	58"	50"	58	1.3	2.6	6	0.283
DB1P5066T	173	66"	50"	66	1.3	2.6	7	0.322
DB1P5074T	188	74"	50"	74	1.3	2.6	8	0.360
DB1P5082T	202	82"	50"	82	1.3	2.6	9	0.399
DB1P5458T	157	58"	54"	58	1.3	2.6	6	0.283
DB1P5466T	173	66"	54"	66	1.3	2.6	7	0.322
DB1P5474T	188	74"	54"	74	1.3	2.6	8	0.360
DB1P5482T	202	82"	54"	82	1.3	2.6	9	0.399
DB1P6666T	173	66"	66"	66	1.3	2.6	7	0.322
DB1P6674T	188	74"	66"	74	1.3	2.6	8	0.360
DB1P6682T	202	82"	66"	82	1.3	2.6	9	0.399

**Diet to System 3 “T” Configuration**

PRODUCT CODE	PRICE	SYSTEM 3 HEIGHT	DIET PANEL HEIGHT	SIZE/ H	INCHES W	D	WEIGHT LBS	VOL FT <sup>3</sup>
DB3P4242T	128	42"	42"	42	1.3	2.6	4	0.207
DB3P4250T	143	50"	42"	50	1.3	2.6	5	0.245
DB3P4266T	173	66"	42"	66	1.3	2.6	7	0.322
DB3P5050T	173	50"	50"	50	1.3	2.6	5	0.245
DP3P5066T	173	66"	50"	66	1.3	2.6	7	0.322
DB3P5466T	173	66"	54"	66	1.3	2.6	7	0.322
DB3P6666T	173	66"	66"	66	1.3	2.6	7	0.322

**Diet to System 3 Overpanels**

PRODUCT CODE	PRICE	OVER PANEL HEIGHT	SIZE/ H	INCHES W	D	WEIGHT LBS	VOL FT <sup>3</sup>
DB3OPPC16	62	16"	16	1.3	2.6	1.6	0.082
DB3OPPC32	72	32"	32	1.3	2.6	3.2	0.159

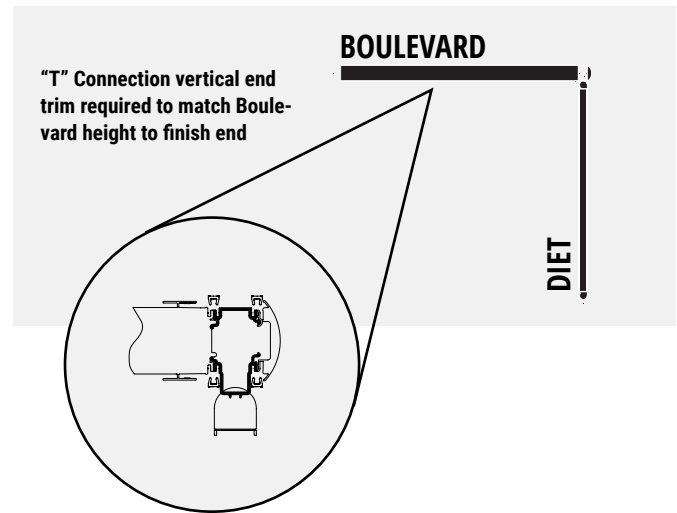
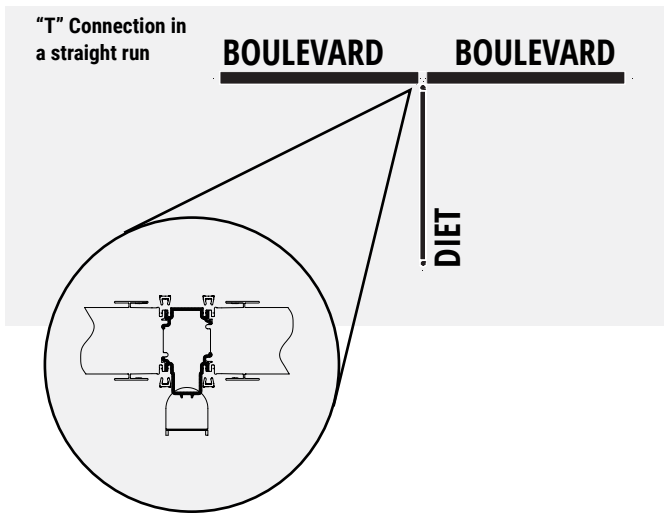

\* Please specify separate end trim (round or flat) to close end.

**DEK • Jumper Harness**

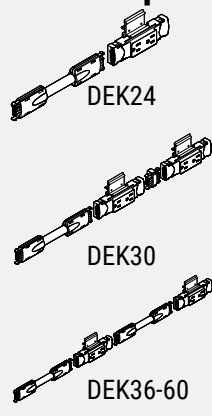

- **Kit includes all components to add power to Diet Panels.**
- Typical kit includes: 2 Duplex Receptacle Blocks (either circuit #1 or circuit #2), the Jumper Harness between the Duplex Receptacle Blocks, the Jumper Harness to the next panel, the pre-punched Raceway Cover, the aluminum Raceway Junction Cover, 2 PVC Duplex Receptacle Block Spacers and the hardware to attach the components.
- The length of the Jumper Harness between two Duplex Receptacle Blocks is based on the panel width.
- Jumper Harness going into the next panel and the aluminum Raceway Junction Covers are standard size.
- Raceway Cover and Raceway Junction Cover are Charcoal (CHR) only.
- Each kit is identified as circuit #1 (ie. DEK240"1") or circuit #2 (ie. DEK240"2").
- 24" wide panels have a single Duplex Receptacle Block only.
- 30" wide panels have 2 Duplex Receptacle Blocks, however they must be facing the same direction.
- 24" and 30" wide panels are not pre-punched for data.
- 36" to 60" wide panels are pre-punched for Duplex Receptacle Blocks on either side and for data just off-center on both sides.

PRODUCT CODE	PRICE	SIZE/ INCHES			WEIGHT VOL	
		H	W	D	LBS	FT <sup>3</sup>
DEK2401	184	4	18	1.3	4.90	0.07
DEK3001	267	4	24	1.3	5.25	0.08
DEK3601	278	4	30	1.3	5.70	0.10
DEK4201	290	4	36	1.3	6.00	0.13
DEK4801	301	4	42	1.3	6.40	0.15
DEK5401	315	4	48	1.3	7.10	0.16
DEK6001	330	4	54	1.3	7.60	0.19
DEK2402	184	4	18	1.3	4.90	0.07
DEK3002	267	4	24	1.3	5.25	0.08
DEK3602	278	4	30	1.3	5.70	0.10
DEK4202	290	4	36	1.3	6.00	0.13
DEK4802	301	4	42	1.3	6.40	0.15
DEK5402	315	4	48	1.3	7.10	0.16
DEK6002	330	4	54	1.3	7.60	0.19

**DEJH • Diet Pass-Thru Kit**

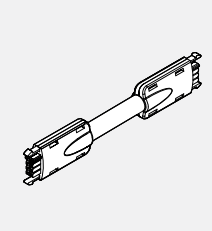

- **Kit allows electrical to pass through a Diet Panel.**
- Kit includes: female-female jumper harness, Raceway Cover and Raceway Junction Cover.
- Pass-Thru harness connects to a Duplex Receptacle Block within one powered panel; passes through a non-powered panel, and the opposite end connects to another Receptacle Block within the second powered panel.
- Raceway Cover and Raceway Junction Cover are Charcoal (CHR) only.

PRODUCT CODE	PRICE	SIZE/ INCHES			WEIGHT VOL	
		H	L	D	LBS	FT <sup>3</sup>
DEJH24	127	2	42	1	1.81	0.025
DEJH30	141	2	48	1	2.07	0.028
DEJH36	155	2	54	1	2.12	0.032
DEJH42	167	2	60	1	2.60	0.035
DEJH48	178	2	66	1	2.86	0.038
DEJH54	194	2	72	1	3.13	0.041
DEJH60	205	2	78	1	3.39	0.044

**DEBF • Diet Base Feed**

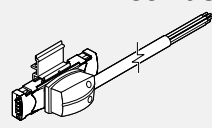

- **Provides single power entry from floor into raceway.**
- Single Ceiling Feed has a 6' whip, liquid tight.
- Raceway connection replaces one Duplex Receptacle Block in a standard kit.

PRODUCT CODE	PRICE	SIZE/ INCHES			WEIGHT VOL	
		H	L	D	LBS	FT <sup>3</sup>
DEBF01	134	2	72	2	5.6	0.06

**DECF • Diet Ceiling Feed**

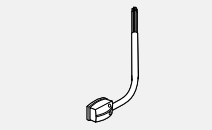

- **Provides single power entry from ceiling through a post into raceway.**
- Raceway connection replaces one Duplex Receptacle Block in a standard kit.

PRODUCT CODE	PRICE	SIZE/ INCHES			WEIGHT VOL	
		H	L	D	LBS	FT <sup>3</sup>
DECF01	272	2	144	2	5.6	0.06

**DEPE • Diet Post Extension**

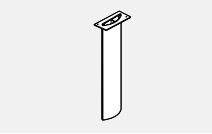

- **Lightweight aluminum pole manages power and data cables between ceiling and floor level raceway.**
- Aluminum extrusion with PVC extruded cover secures to the outside of the panel and passes through the worksurface scoop.
- Includes all hardware and bezel.
- Intended for use on Diet panels with fabric bottoms.

PRODUCT CODE	PRICE	SIZE/ INCHES			WEIGHT VOL	
		H	W	D	LBS	FT <sup>3</sup>
DEPE116	174	116	4.5	1	7	0.82

**DERJC • Raceway Junction Cover**

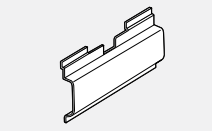

- **Provides an external cover for cables passing between adjacent, in-line panels and off-module "X" panel configurations. Also, capable of bridging two in-line panels in a "T" configuration (outside).**
- Aluminum, powder coated finish.

PRODUCT CODE	PRICE	SIZE/ INCHES			WEIGHT VOL	
		H	W	D	LBS	FT <sup>3</sup>
DERJC	22	4.3	10	1	0.5	0.1

**DPL • Linking Panel - Levelers on both legs**

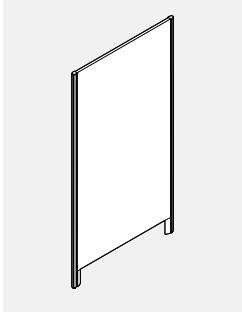

- **Diet Linking Panel provides privacy.**
- Aluminum extrusion comes in powder coated paint finish, DWT - Designer White or TUN - Tungsten.
- Laminate core available in DWTLPL - Designer White or ACJLP - Absolute Acajou.
- Edge banded to match laminate finish.
- Standard height of 54", 66", width in 6" increments from 24" to 60".
- Comes complete with hinge kits and levelers on both legs.

PRODUCT CODE	PRICE	SIZE/ INCHES			WEIGHT VOL	
		H	W	D	LBS	FT <sup>3</sup>
DPL5424	385	54	24	1.3	18	1.62
DPL5430	428	54	30	1.3	23	2.08
DPL5436	470	54	36	1.3	27	2.47
DPL5442	512	54	42	1.3	32	2.85
DPL5448	556	54	48	1.3	37	3.25
DPL5454	597	54	54	1.3	42	3.63
DPL5460	639	54	60	1.3	47	4.02
DPL6624	437	66	24	1.3	23	2.04
DPL6630	484	66	30	1.3	29	2.52
DPL6636	531	66	36	1.3	35	3.00
DPL6642	576	66	42	1.3	41	3.46
DPL6648	625	66	48	1.3	47	3.93
DPL6654	671	66	54	1.3	53	4.40
DPL6660	717	66	60	1.3	59	4.90

**DPLSCH • Diet Laminate Panel - Single caster on one leg, leveler on the other**

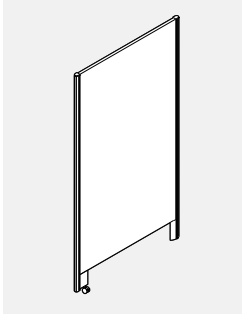

- **Diet Linking Panel provides privacy.**
- Aluminum extrusion comes in powder coated paint finish, DWT - Designer White or TUN - Tungsten.
- Laminate core available in DWTLPL - Designer White or ACJLP - Absolute Acajou.
- Edge banded to match laminate finish.
- Standard height of 54", 66", width in 6" increments from 24" to 60".
- Comes complete with hinge kits, caster on one leg and leveler on the other.

PRODUCT CODE	PRICE	SIZE/ INCHES			WEIGHT VOL	
		H	W	D	LBS	FT <sup>3</sup>
DPLSCH5424	462	54	24	1.3	18	1.62
DPLSCH5430	507	54	30	1.3	23	2.08
DPLSCH5436	551	54	36	1.3	27	2.47
DPLSCH5442	595	54	42	1.3	32	2.85
DPLSCH5448	639	54	48	1.3	37	3.25
DPLSCH5454	684	54	54	1.3	42	3.63
DPLSCH5460	729	54	60	1.3	47	4.02
DPLSCH6624	515	66	24	1.3	23	2.04
DPLSCH6630	563	66	30	1.3	29	2.52
DPLSCH6636	612	66	36	1.3	35	3
DPLSCH6642	661	66	42	1.3	41	3.46
DPLSCH6648	710	66	48	1.3	47	3.93
DPLSCH6654	777	66	54	1.3	53	4.4
DPLSCH6660	806	66	60	1.3	59	4.9

**DPLDF • Diet Linking Panel - Flat foot on both legs**

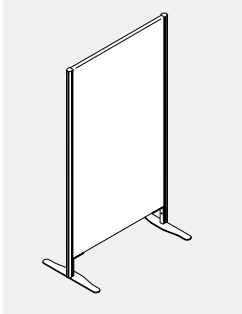

- **Diet Linking Panel provides privacy.**
- Aluminum extrusion comes in powder coated paint finish, DWT - Designer White or TUN - Tungsten.
- Laminate core available in DWTLPL - Designer White or ACJLP - Absolute Acajou.
- Edge banded to match laminate finish.
- Standard height of 54", 66", width in 6" increments from 24" to 60".
- Comes complete with hinge kits and flat foot on both legs.

PRODUCT CODE	PRICE	SIZE/ INCHES			WEIGHT VOL	
		H	W	D	LBS	FT <sup>3</sup>
DPLDF5424	528	54	24	1.3	40.2	1.6
DPLDF5430	565	54	30	1.3	47.6	2.1
DPLDF5436	601	54	36	1.3	54.9	2.5
DPLDF5442	638	54	42	1.3	62.3	2.9
DPLDF5448	675	54	48	1.3	69.6	3.3
DPLDF5454	713	54	54	1.3	77.0	3.6
DPLDF5460	751	54	60	1.3	84.3	4.0
DPLDF6624	572	66	24	1.3	48.6	2.0
DPLDF6630	612	66	30	1.3	57.9	2.5
DPLDF6636	653	66	36	1.3	67.3	3.0
DPLDF6642	693	66	42	1.3	76.6	3.5
DPLDF6648	735	66	48	1.3	85.9	3.9
DPLDF6654	774	66	54	1.3	95.2	4.4
DPLDF6660	816	66	60	1.3	104.5	4.9

**DPLMN • Diet Linking Panel - Double caster base on both legs**

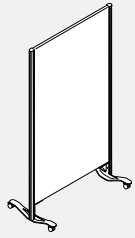

- **Diet Linking Panel provides privacy.**
- Aluminum extrusion comes in powder coated paint finish, DWT - Designer White or TUN - Tungsten.
- Laminate core available in DWTL P - Designer White or ACJLP - Absolute Acajou.
- Edge banded to match laminate finish.
- Standard height of 54", 66", width in 6" increments from 24" to 60".
- Comes complete with hinge kits, and double caster foot on both legs.

PRODUCT CODE	PRICE	SIZE/ INCHES			WEIGHT VOL	
		H	W	D	LBS	FT <sup>3</sup>
DPLMN5424	561	54	24	1.3	41.8	1.6
DPLMN5430	609	54	30	1.3	49.1	2.1
DPLMN5436	659	54	36	1.3	56.5	2.5
DPLMN5442	705	54	42	1.3	63.8	2.9
DPLMN5448	756	54	48	1.3	71.2	3.3
DPLMN5454	804	54	54	1.3	78.5	3.6
DPLMN5460	853	54	60	1.3	85.8	4.0
DPLMN6624	622	66	24	1.3	50.2	2.0
DPLMN6630	673	66	30	1.3	59.5	2.5
DPLMN6636	727	66	36	1.3	68.8	3.0
DPLMN6642	782	66	42	1.3	78.1	3.5
DPLMN6648	835	66	48	1.3	87.4	3.9
DPLMN6654	889	66	54	1.3	96.8	4.4
DPLMN6660	943	66	60	1.3	106.1	4.9

**DPLDCMN • Diet Linking Panel - Single caster on one leg and double caster base on the other**

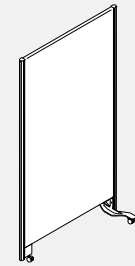

- **Diet Linking Panel provides privacy.**
- Aluminum extrusion comes in powder coated paint finish, DWT - Designer White or TUN - Tungsten.
- Laminate core available in DWTL P - Designer White or ACJLP - Absolute Acajou.
- Edge banded to match laminate finish.
- Standard height of 54", 66", width in 6" increments from 24" to 60".
- Comes complete with hinge kits, single caster on the one leg and double caster foot on the other.

PRODUCT CODE	PRICE	SIZE/ INCHES			WEIGHT VOL	
		H	W	D	LBS	FT <sup>3</sup>
DPLDCMN5424	527	54	24	1.3	37.6	1.6
DPLDCMN5430	574	54	30	1.3	45.0	2.1
DPLDCMN5436	620	54	36	1.3	52.3	2.5
DPLDCMN5442	668	54	42	1.3	59.7	2.9
DPLDCMN5448	715	54	48	1.3	67.0	3.3
DPLDCMN5454	760	54	54	1.3	74.4	3.6
DPLDCMN5460	806	54	60	1.3	81.7	4.0
DPLDCMN6624	584	66	24	1.3	46.0	2.0
DPLDCMN6630	635	66	30	1.3	55.3	2.5
DPLDCMN6636	686	66	36	1.3	64.7	3.0
DPLDCMN6642	736	66	42	1.3	74.0	3.5
DPLDCMN6648	788	66	48	1.3	83.3	3.9
DPLDCMN6654	838	66	54	1.3	92.6	4.4
DPLDCMN6660	890	66	60	1.3	101.9	4.9

**DPLDCHN • Diet Linking Panel - Leveler on one leg and double caster base on the other**

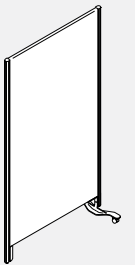

- **Diet Linking Panel provides privacy.**
- Aluminum extrusion comes in powder coated paint finish, DWT - Designer White or TUN - Tungsten.
- Laminate core available in DWTL P - Designer White or ACJLP - Absolute Acajou.
- Edge banded to match laminate finish.
- Standard height of 54", 66", width in 6" increments from 24" to 60".
- Comes complete with hinge kits, leveler on one leg and double caster foot on the other.

PRODUCT CODE	PRICE	SIZE/ INCHES			WEIGHT VOL	
		H	W	D	LBS	FT <sup>3</sup>
DPLDCHN5424	497	54	24	1.3	37.1	1.6
DPLDCHN5430	540	54	30	1.3	44.5	2.1
DPLDCHN5436	590	54	36	1.3	51.8	2.5
DPLDCHN5442	636	54	42	1.3	59.2	2.9
DPLDCHN5448	681	54	48	1.3	66.5	3.3
DPLDCHN5454	729	54	54	1.3	73.9	3.6
DPLDCHN5460	776	54	60	1.3	81.2	4.0
DPLDCHN6624	551	66	24	1.3	45.5	2.0
DPLDCHN6630	603	66	30	1.3	54.9	2.5
DPLDCHN6636	653	66	36	1.3	64.2	3.0
DPLDCHN6642	703	66	42	1.3	73.5	3.5
DPLDCHN6648	756	66	48	1.3	82.8	3.9
DPLDCHN6654	806	66	54	1.3	92.1	4.4
DPLDCHN6660	859	66	60	1.3	101.4	4.9

**DPLWA • Wall Connection for Linking Panels**

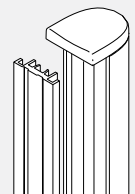

- **Wall Connection connects Linking**
- Panels to walls.
- Aluminum extrusion comes in powder coated paint finish, DWT - Designer White or TUN - Tungsten.
- Kit consists of Diet vertical extrusion, charcoal PVC cover and hinge kits.

PRODUCT CODE	PRICE	SIZE/ INCHES			WEIGHT VOL	
		H	W	D	LBS	FT <sup>3</sup>
DPLWA54	100	54	2	2	2.3	0.13
DPLWA66	112	66	2	2	3.5	0.15

**DPLEKIT • Expanding Kit**

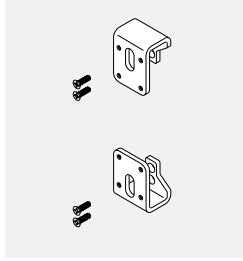

- **Expanding Kit connects two linking panels in a straight line.**
- This kit will accommodate any special width by overlapping the panels.
- Aluminum extrusion comes in powder coated paint finish, DWT - Designer White or TUN - Tungsten.
- Kit consists of a top and bottom bracket and all the hardware needed.

PRODUCT CODE	PRICE	SIZE/ INCHES			WEIGHT VOL	
		H	W	D	LBS	FT <sup>3</sup>
DPLEKIT	174	3	2	2.0	1	0.05

**DP • Door and Door Catch Kit for Linking Panels**

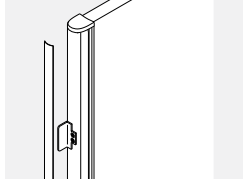

- **Door Catch Kit converts any Linking Panel into a door.**
- Aluminum extrusion comes in powder coated paint finish, DWT - Designer White or TUN - Tungsten.
- Kit consists of striker plate, two hinge kits, single caster foot assembly and 1" Diet caster

PRODUCT CODE	PRICE	SIZE/ INCHES			WEIGHT VOL	
		H	W	D	LBS	FT <sup>3</sup>
DPDC01	109	6	3	1.3	2	0.50

**DP • Over Panel for Linking Panels**

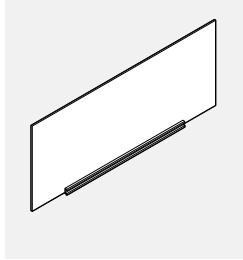

- **Over Panel sits atop of Linking Panel and bridges the gap between the top of 66" high Linking Panel and the top of the Screening Booth.**
- Kit contains aluminum extrusion and felt insert.
- Aluminum extrusion comes in powder coated paint finish, DWT - Designer White or TUN - Tungsten.

PRODUCT CODE	PRICE	SIZE/ INCHES			WEIGHT VOL	
		H	W	D	LBS	FT <sup>3</sup>
DPLOP24	89	16.8	24	1.05	1.74	0.39
DPLOP30	105	16.8	30	1.05	2.20	0.49
DPLOP36	124	16.8	36	1.05	2.67	0.59
DPLOP42	139	16.8	42	1.05	3.14	0.70
DPLOP48	206	16.8	48	1.05	3.60	0.80
DPLOP54	224	16.8	54	1.05	4.07	0.90
DPLOP60	241	16.8	60	1.05	4.35	1.01

**DP • Booth to Linking Panel Connector**

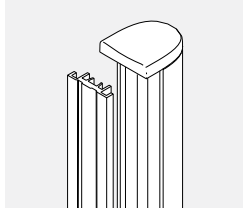

- **Booth to Linking Panel Connector facilitates the connection of a Linking Panel to the back gable edge of the Screening Booth.**
- Aluminum extrusion comes in powder coated paint finish, DWT - Designer White or TUN - Tungsten.
- Kit includes a Diet vertical extrusion, charcoal PVC cover and all hardware.

PRODUCT CODE	PRICE	SIZE/ INCHES			WEIGHT VOL	
		H	W	D	LBS	FT <sup>3</sup>
DEBPA	77	66	3	1.3	3.5	0.15

**DPVAC • Diet VAC Laminate Panels**

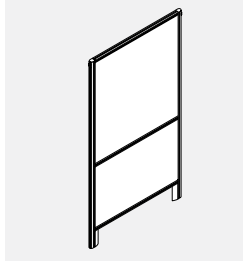

- **Special panel construction designed specifically for clinical applications.**
- Segmentated panels offer a thermally fused laminate lower and high pressure upper pressed on a lightweight core.
- Minimal footprint for storage.
- Easy to connect.
- Easy to reconfigure.
- Easy to clean.
- Laminate core available in DWTLHP/HP Designer White or ACJLP/ACJHP Absolute Acajou.
- Aluminum extrusion comes in powder coated paint finish. DWT Designer White or TUN Tungsten.
- Comes completed with hinge kits and levelers on both legs.

PRODUCT CODE	PRICE	SIZE/ INCHES			WEIGHT VOL	
		H	W	D	LBS	FT <sup>3</sup>
DPVAC6636	669	66	36	1.3	35	3.00
DPVAC6642	690	66	42	1.3	41	3.46
DPVAC6648	703	66	48	1.3	47	3.93
DPVAC6660	1059	66	60	1.3	59	4.90



**DWS • Worksurface for Diet Panels**

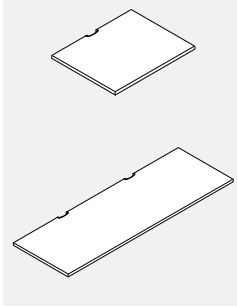

- **Worksurfaces have scoops at back to allow wires and cables to pass to and from floor level.**
- Includes support brackets (DHBRKT), 4 for worksurfaces up to 48", and 5 for any work-surface longer than 48".
- Please choose from DWT - Designer White, SIL - Silver or BLK - Black for scoop covers.

PRODUCT CODE	PRICE		SIZE/ INCHES			WEIGHT VOL	
	LP*	HP*	H	W	D	LBS	FT <sup>3</sup>
DWS2424P	145	182	1	24	24	15	0.60
DWS2430P	154	193	1	30	24	19	0.72
DWS2436P	175	218	1	36	24	23	0.85
DWS2442P	228	286	1	42	24	27	0.98
DWS2448P	275	343	1	48	24	31	1.11
DWS2454P	323	400	1	54	24	35	1.23
DWS2460P	362	451	1	60	24	39	1.36
DWS2466P	378	471	1	66	24	43	1.49
DWS2472P	396	494	1	72	24	48	1.62
DWS3024P	169	212	1	24	30	19	0.74
DWS3030P	184	229	1	30	30	24	0.90
DWS3036P	215	270	1	36	30	29	1.06
DWS3042P	304	381	1	42	30	34	1.22
DWS3048P	323	400	1	48	30	39	1.38
DWS3054P	353	441	1	54	30	43	1.54
DWS3060P	378	471	1	60	30	48	1.69
DWS3066P	394	493	1	66	30	53	1.85
DWS3072P	417	521	1	72	30	58	2.01

**BHC • Diet/Boulevard Worksurface 12" Cantilever Support**

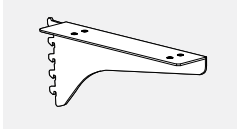

- An economical way to connect rear part of the side edge of a worksurface to the Boulevard Panel.
- Front part of the side edge of the worksurface must be supported by an off-module Diet Worksurface Bracket and locked into the adjacent Diet Panel.
- This cantilever is not a shared support

PRODUCT CODE	PRICE	SIZE/ INCHES			WEIGHT VOL	
		H	W	D	LBS	FT <sup>3</sup>
BHC12L	40	6	2	12	2	0.03
BHC12R	40	6	2	12	2	0.03

**DHLEG • Diet Gable Leg**

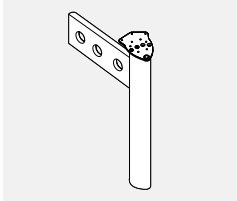

- **Universal leg, plate and side panel are non handed.**
- Supports the worksurface at 29° and enhances the stability of connected panels.
- Side plate is secured to the side of the Diet panel and leg plate bolts to worksurface.
- Made of extruded aluminum and steel.
- Levelers have 1.75" height adjustment.
- Includes all mounting hardware to connect to panel and worksurface.
- Must attach to Diet Panel vertical.

PRODUCT CODE	PRICE	SIZE/ INCHES			WEIGHT VOL	
		H	W	D	LBS	FT <sup>3</sup>
DHLEG	205	28	23	6	12	2.02

**DHBRKT • Diet Worksurface Bracket**

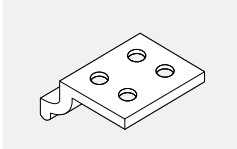

- **Extruded aluminum bracket that is bolted to the underside of the worksurface.**
- Bracket supports worksurface at any location along the mid rail of panel.
- Includes mounting hardware.
- Brackets are included for all worksurfaces DWS, 4 for worksurfaces up to 48", and 5 for any worksurface longer than 48".

PRODUCT CODE	PRICE	SIZE/ INCHES			WEIGHT VOL	
		H	W	D	LBS	FT <sup>3</sup>
DHBRKT	10	0.75	2.25	3.25	0.1	0.05

**DHTBRKT • Diet Transaction Bracket**

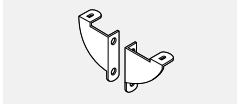

- Connects transaction tops to Diet Panels.
- Includes 1 set of two brackets and all hardware.

PRODUCT CODE	PRICE	SIZE/ INCHES			WEIGHT VOL	
		H	W	D	LBS	FT <sup>3</sup>
DHTBRKT	40	2.5	1.2	2.5	3	0.01

**DWSCSB • Diet Support Bar**

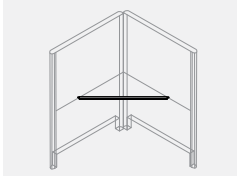

- **Supports worksurface in 90 degree corner application and eliminates the need for a leg.**
- Diagonally installed.
- If using a keyboard, spacers will be required.

PRODUCT CODE	PRICE	SIZE/ INCHES			WEIGHT VOL	
		H	W	D	LBS	FT <sup>3</sup>
DWSCSB46	106	1	46	1	7	0.116
DWSCSB80	152	1	80	1	12	0.189

For corner application where 24" deep or smaller adjoining worksurface:  
 For corner application where adjoining worksurface is larger than 24":

**DHOMC • Diet Off-Module Cantilever**



- **To be used with Diet Panels that have a fabric bottom.**
- Installs on horizontal rails of panels to provide worksurface support.
- Frees up space under the worksurface.

PRODUCT CODE	PRICE	SIZE/ INCHES			WEIGHT VOL	
		H	W	D	LBS	FT <sup>3</sup>
DHOMC	106	21	3	12	4	0.42

**DSOMSHLF • Diet Off Module 24" Shelf**

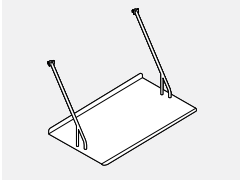

- Shelf hangs anywhere along Diet panel rails or Boulevard System 3 panel accessory tile.
- Can create a supplementary surface at worksurface level when suspended from a 42" high Diet panel.
- Shelves may be stacked, one hanging above the other from a higher rail.
- Shelf made of formed steel and includes suspended arms made of steel.

PRODUCT CODE	PRICE	SIZE/	INCHES			WEIGHT VOL	
		H	W	D	LBS	FT <sup>3</sup>	
DSOMSHLF	239	11.5	24	12	4	1.00	

**DSOS • Diet Panel Mounted Shelf**

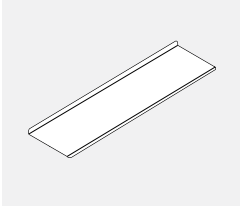

- Provides overhead storage capacity on top of 42" and 54" high Diet panels.
- Made of formed steel and includes steel mounting brackets.
- Support brackets lock to the top of Diet rail at the back and both sides of overhead.
- Must be installed on a "U" or "H" panel configuration.
- Due to structural issues, this product may not be used on top of glazed or partially glazed panels.

PRODUCT CODE	PRICE	SIZE/	INCHES			WEIGHT VOL	
		H	W	D	LBS	FT <sup>3</sup>	
DSOS48	288	15	48	13.5	40	5.60	
DSOS60	307	15	60	13.5	52	7.00	

**DOHLS • Diet Overhead Support**



- To be used with Diet back panel and Diet wing panel either left or right. The support leg will support only one side and eliminate the need for a third panel.
- To be used and supported on worksurface installed at standard height. Ensure the worksurface that the leg sits on is properly supported.

PRODUCT CODE	PRICE	SIZE/	INCHES			WEIGHT VOL	
		H	W	D	LBS	FT <sup>3</sup>	
DOHLS42	364	12	2	3.5	4	0.139	
DOHLS54	394	24	2	3.5	6	0.278	

**DSADA • Easy-Up Diet Overhead**

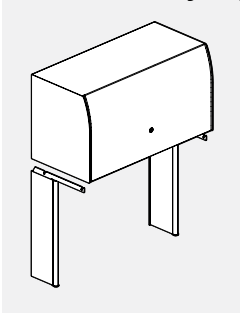

- Diet Panel mounted metal overhead storage with opaque acrylic door. The Metal finish (page A.29). mechanism lifts the door up and stores it out of the way, above the storage unit.
- Meets CSA B651 Barrier Free Design & AODA (Accessibility for Ontarians with Disabilities Act).
- Meets CSA B651 Barrier Free Design & ADA (Americans with Disabilities Act).
- 16" high units accept standard and A4 binders.
- All shelves are reinforced for proper weight distribution.
- Inside dimensions: 14.375" high x 12" deep.
- Unit includes back, support cantilevers, attachment hardware, and lock.
- Shipped partially assembled.

PRODUCT CODE	PRICE	SIZE/	INCHES			WEIGHT VOL	
		H	W	D	LBS	FT <sup>3</sup>	
DSADA30PM	1019	16	30	14.4	33	5.3	
DSADA36PM	1063	16	36	14.4	38	6.3	
DSADA42PM	1112	16	42	14.4	43	7.3	
DSADA48PM	1166	16	48	14.4	48	8.3	
DSADA54PM	1219	16	54	14.4	53	9.3	
DSADA60PM	1279	16	60	14.4	59	10.3	

**DHPEDB • Pedestal Bracket Kit for Diet Panels**

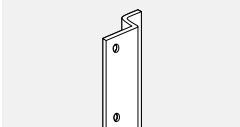

- Attaches to a metal Worksurface Supporting Pedestal at the back and connects the pedestal to the Diet Panel vertical.

PRODUCT CODE	PRICE	SIZE/	INCHES			WEIGHT VOL	
		H	W	D	LBS	FT <sup>3</sup>	
DHPEDB	35	8	1	1	0.5	0.001	

**Introduction**

**Compile Systems - Protecting the Environment for Future Generations**

- Our environmental success story began with the challenge to create an office system that would meet today's business requirements while maintaining a firm commitment to save and protect the environment.
- Sustainability became a part of the creative focus and development of Compile that incorporates the latest technology and design features to provide excellent performance at a competitive price.
- As government and industry environment ratings such as LEED & Greenguard become more prevalent, Compile offers designers and architects functional, attractive, and economical office designs that meet these standards.
- Global Contract is a leader in reducing waste in the manufacturing of its products as well as utilizing recycled materials wherever possible. We make extensive use of recycled plastic and wood waste from other Global factories.
- Global Contract is committed to the continuous improvement of our environmental systems, the prevention of pollution, and to comply with both the spirit and the letter of all relevant environmental legislation.

- Compile Panels are 82.3% recyclable at the end of their lifespan. Nothing from a Compile Panel needs to end up in a landfill.

**Compile Systems - Product Information**

- Compile offers fabrics that are made from 100% recycled polyester, which means less waste going to landfills. These fabrics also reduced the demand for petroleum products, and decrease the environmental impacts of processing those petroleum products into polyester.
- Compile's epoxy powder coating process involves no liquids and is solvent free. It contains no harmful VOC's or lead. Up to 99% of over sprayed powder is reclaimed, mixed with virgin powder and resused.
- Compile's entire panel is up to 82.3% recycled.
- Compile masonite is up to 85% recycled.
- Compile recycled wood for worksurfaces is up to 85% recycled.
- Compile's entire product line is up to 99.9% recyclable.

**Components • Panel Configuration**

Many components make up a panel configuration. This page provides an exploded view of a sample configuration highlighting each panel component required when specifying this configuration.

- A) CMET66 66"h. End of Run Trim Insert for Panel
- B) CMFF6636 66"h. x 36"w Single Segmented Fabric Panel
- C) CHP66 66"h. Universal Corner Post
- D) CMETP66 Trim Insert for 66"h. Universal Corner Post
- E) CMPC2 Post Base Cover for 2-Way Application
- F) CMET24 24"h Trim Insert for Step Down
- G) CMFF4236N1 42"h. x 36"w Single Segmented Fabric Panel, Punchouts on one side.
- H) CMET42 42"h. End of Run Trim Insert for Panel
- I) CMRC36NP 36"w Raceway Cover without Knockouts (if ordered separately)
- J) Panel Connectors, comes standard with panels and universal corner post

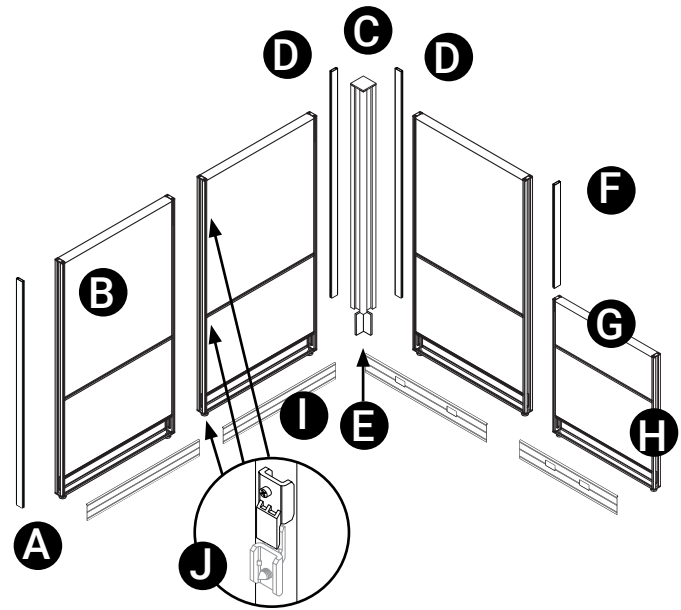

**Components • Worksurfaces**

- Compile thermally fused Worksurfaces are 1" thick and are finished with 3 mm PVC edging on all sides.
- Worksurfaces have pilot holes to enable proper alignment with worksurface supports.
- Most standard laminate offerings are available in thermally-fused. See laminate listings for details.
- Wood grain laminates on corner worksurfaces up to 42" available with laminate running diagonally at an upcharge. Otherwise, standard horizontal application of laminate will be used, as per drawings at right.
- Most wood grain laminate worksurfaces will have matching woodgrain trim unless specified otherwise.
- Depth of the worksurface scoops are 1 1/8" when measured from the panel the worksurface is attached to.
- All worksurfaces require support items. These are priced separately within this section.
- Grain direction for worksurfaces are as follows:
- Communication and electrical wires are routed through a cable scoop located at the back of the worksurface. When specifying a Straight Worksurface (CWS) or a Curvilinear Worksurface (CWVL), note that the number of cable scoops depends upon the width of the worksurface. All other Worksurface shapes have one scoop on panel edges.

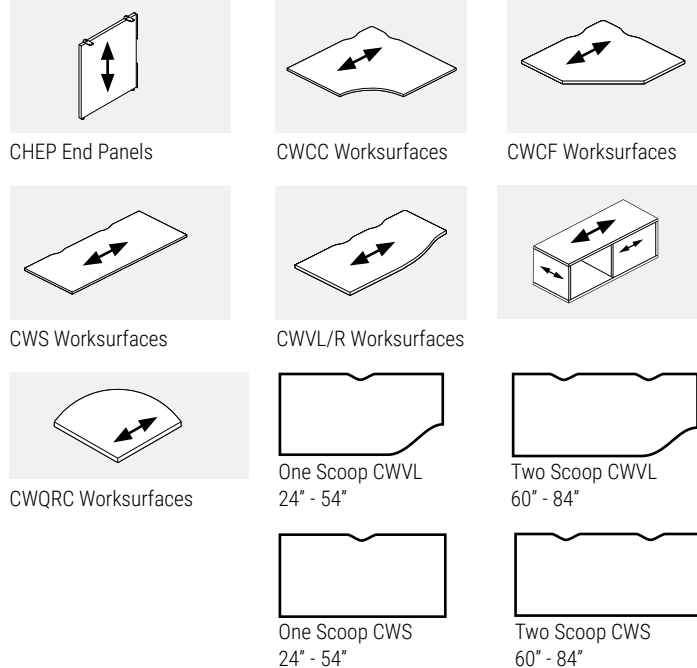

**Components • Electrical**

**2+2 Configuration (8 wire, 4 circuit)**

Two Utility Circuits [Compile's #1 & #2 circuits] share one neutral wire and one (system) ground wire. (2 hot [circuit] wires + 1 neutral wire\*\*\* + 1 green ground wire\* = 4 wires)

Two Dedicated Circuits [Compile's "A" & "B" circuits] share one neutral wire and one (isolated) ground wire. (2 hot [circuit] wires + neutral wire\*\*\* + 1 green/yellow ground wire\*\* = 4 wires)

Note: It is the ground wire that makes the difference between "Utility" and "Dedicated" circuits. Refer to Wiring Schematics found above.

\*A Green ground wire is a "system" ground. This means it could be grounded to any piece of metal, including the panel.

\*\*A Green/Yellow ground wire is isolated, within the wiring conduit, all the way back to the box at the source (building ground).

\*\*\*All neutral wires are 10 gauge rather than 12 gauge meaning they are larger than normal allowing greater protection against "noise" or interference on the circuit.

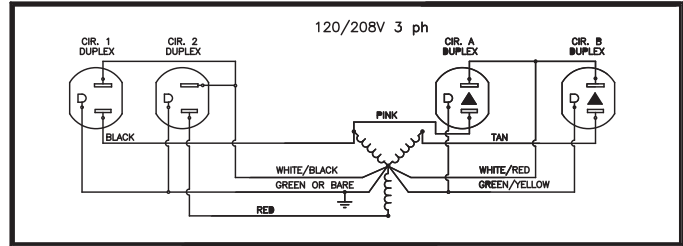
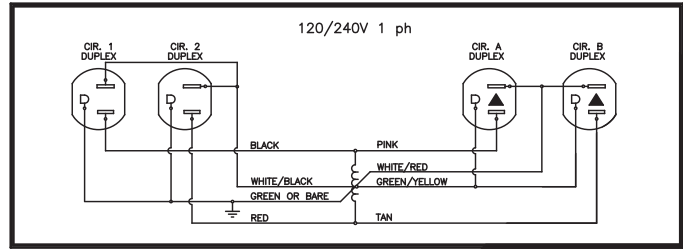

**UL RECOGNIZED AND CSA CERTIFIED**

**Warning:** It is recommended that installation of the electrical harness be made under the supervision of a licensed electrician in accordance with applicable codes and regulations.

**Special Note:** Always ensure that harness is electrically connected to only one power supply.

**Components • Panel Configuration - Electrical**

Many components make up a configuration. This page provides an exploded view of a sample configuration highlighting each Electrical component required when specifying this configuration.

A) CE8PD36 Power Distribution Housing  
Note: 8 wire, 4 circuits, 2+2 configuration

B) CE8CP17 Flexible Mesh Jumper Cable (connects two panels side by side or separated by a post in a corner application)

C) CE8RD Duplex Receptacle

D) CE8CI1 "I" Connector

E) CE8CP Pass-Through Cable  
Note: Must run in a straight line application only

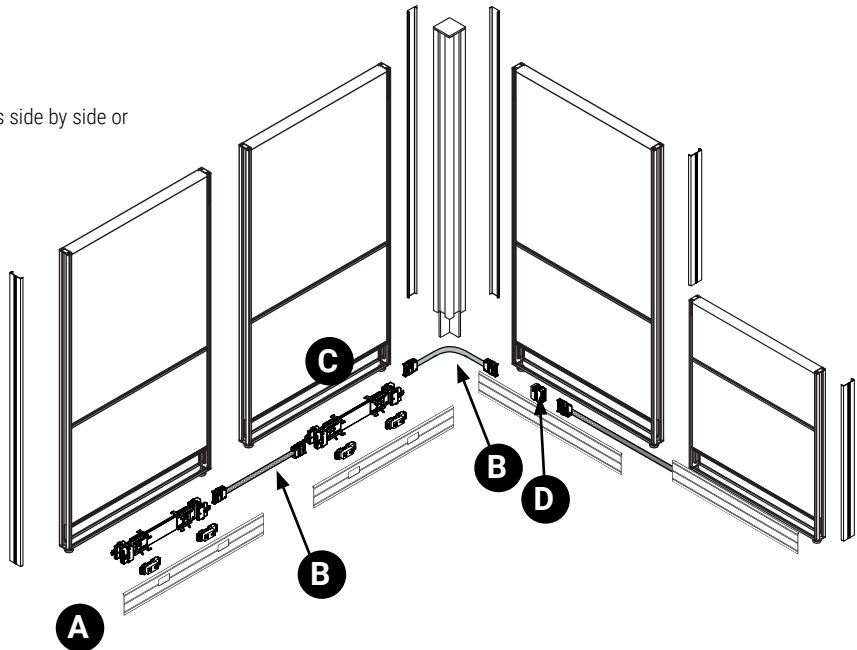

**PANEL FINISHES**

Panel Frame	Glazing Options	
Black	BLK	Clear CLR
Designer White	DWT	Frosted FRS
Nevada	NEV	
Fog	FOG	

**COMPILE - GUIDELINES FOR ORDERING PRODUCT**

**Codes**

The product guide uses a numbering system with meaningful alphanumeric characters to create a simple-to-understand product number. This makes specifying the product much easier and more accurate.

Example of Panel **CMFM4236** Product Code

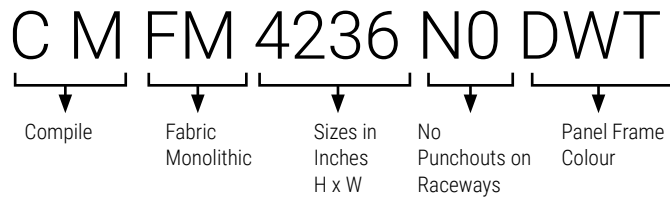

**How to Specify**

- Specify Compile panel type and size by code.
- Specify panel frame finish - ie. DWT (Designer White)
- Specify raceway power option.
- Specify all necessary panel fabric options.

**The information listed below provides you with basic features of Compile Panels.**

- Compile Panels can only be stacked one high.
- Available in four (4) basic heights: 30", 42", 54" and 66"; and seven (7) widths: 24", 30" 36", 42", 48", 54" and 60".
- 2 3/8" thick.
- Available in Monolithic and Single Segmented at just below the worksurface.
- Compile panels are not tackable.
- Raceway openings are 1.345" x 2.80".
- Opposite sides of each Module may have a different fabric within the same grade at no upcharge.
- Standard with aluminum frame.
- Individual fabric covered modules incorporated into an aluminum frame.
- Aluminum raceway covers can be ordered separately and shipped separately for reconfigurations. Raceway covers can be replaced in the field to change a panel from non powered to powered (or vice versa).

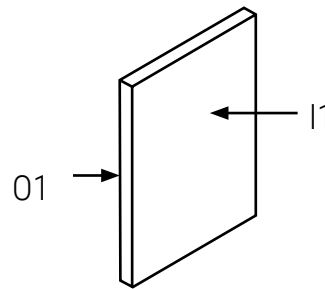

I1

AN50

Inside Fabric  
Position #1

O1

BE21

Outside Fabric  
Position #1

**NOTE: If different grades of fabric are used on one panel, the entire panel must be priced out at the higher grade.**

- On Compile Laminate and Gallery panels, if a wood grain laminate is chosen, grain direction runs horizontally.
- Base raceway lifts up and locks in an upright 90-degree position, or can be removed for open access to base raceway.
- Electric knockouts in the raceway have plastic covers that snap into place from the outside of the cover, when a duplex is not required. Electric knockout covers must be specified separately.
- 3 panel connector brackets per side for 30"h., 42"h. and 54"h. come installed on panels and 60° and 90° posts.
- 4 panel connector brackets per side for 66"h. panels come installed on panels and 60° and 90° posts.
- Panel connector brackets are opposite direction of each other per panel side, and can be removed with one screw per bracket.
- CMFF and CMFM 66" and 72" panels must have fabric railroaded. Please confirm at time of order if all panels or only those need fabric to be railroaded.

**CMFM-N0 • Monolithic Non Powered Fabric Panel, No Punchouts**

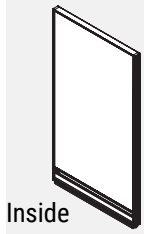

Inside



Outside

- Individual fabric-covered modules incorporated into an aluminum frame.
- Opposite sides of each module may have a different fabric within the same grade at no upcharge.
- If different grades of fabric are used on one panel, the entire panel must be priced at highest grade.
- Panels are not tackable.
- 3 Panel connector brackets per side come standard with 30"h., 42"h. and 54"h. panels.
- 4 Panel connector brackets per side come standard with 66"h. panels.
- Panels include 2 raceway covers with no punchouts, an integrated aluminum top cap and levelling glides.
- Note: Trim is not required at a straight connection between two panels of the same height.

PRODUCT CODE	PRICE		SIZE/ INCHES			WEIGHT VOL	
	GR 1	GR 2	H	W	D	LBS	FT <sup>3</sup>
CMFM3024N0	263	289	30	24	2.3	20	2.31
CMFM3030N0	326	352	30	30	2.3	25	2.85
CMFM3036N0	354	400	30	36	2.3	31	3.38
CMFM3042N0	387	437	30	42	2.3	36	3.92
CMFM3048N0	420	469	30	48	2.3	41	4.45
CMFM3054N0	463	509	30	54	2.3	46	4.99
CMFM3060N0	492	537	30	60	2.3	51	5.52
CMFM4224N0	263	289	42	24	2.3	20	2.31
CMFM4230N0	326	352	42	30	2.3	25	2.85
CMFM4236N0	354	400	42	36	2.3	31	3.38
CMFM4242N0	387	437	42	42	2.3	36	3.92
CMFM4248N0	420	469	42	48	2.3	41	4.45
CMFM4254N0	463	509	42	54	2.3	46	4.99
CMFM4260N0	492	537	42	60	2.3	51	5.52
CMFM4824N0	300	330	48	24	2.3	26	2.73
CMFM4830N0	340	369	48	30	2.3	33	3.37
CMFM4836N0	386	430	48	36	2.3	39	4.00
CMFM4842N0	441	499	48	42	2.3	46	4.63
CMFM4848N0	476	535	48	48	2.3	52	5.26
CMFM4854N0	523	579	48	54	2.3	59	5.89
CMFM4860N0	553	612	48	60	2.3	65	6.53
CMFM5424N0	300	330	54	24	2.3	26	2.73
CMFM5430N0	340	369	54	30	2.3	33	3.37
CMFM5436N0	386	430	54	36	2.3	39	4.00
CMFM5442N0	441	499	54	42	2.3	46	4.63
CMFM5448N0	476	535	54	48	2.3	52	5.26
CMFM5454N0	523	579	54	54	2.3	59	5.89
CMFM5460N0	553	612	54	60	2.3	65	6.53
CMFM6624N0	344	384	66	24	2.3	32	3.58
CMFM6630N0	400	439	66	30	2.3	40	4.40
CMFM6636N0	488	561	66	36	2.3	48	5.23
CMFM6642N0	539	613	66	42	2.3	56	6.06
CMFM6648N0	558	633	66	48	2.3	64	6.88
CMFM6654N0	574	647	66	54	2.3	72	7.71
CMFM6660N0	591	666	66	60	2.3	80	8.53

**CMFM-N1 • Monolithic Non Powered Fabric Panel, Punchouts on One Side**



Inside



Outside

- Individual fabric-covered modules incorporated into an aluminum frame.
- Opposite sides of each module may have a different fabric within the same grade at no upcharge.
- If different grades of fabric are used on one panel, the entire panel must be priced at highest grade.
- Panels are not tackable.
- 3 Panel connector brackets per side come standard with 30"h., 42"h. and 54"h. panels.
- 4 Panel connector brackets per side come standard with 66"h. panels.
- Panels include 1 raceway cover with punchouts on one side, 1 raceway cover with no punchouts on the other, an integrated aluminum top cap and levelling glides.
- 24" wide panels have one punchout, 30" wide panels and wider have 3 punchouts.
- Note: Trim is not required at a straight connection between two panels of the same height.

PRODUCT CODE	PRICE		SIZE/ INCHES			WEIGHT VOL	
	GR 1	GR 2	H	W	D	LBS	FT <sup>3</sup>
CMFM3024N1	263	289	30	24	2.3	20	2.31
CMFM3030N1	326	352	30	30	2.3	25	2.85
CMFM3036N1	354	400	30	36	2.3	31	3.38
CMFM3042N1	387	437	30	42	2.3	36	3.92
CMFM3048N1	420	469	30	48	2.3	41	4.45
CMFM3054N1	463	509	30	54	2.3	46	4.99
CMFM3060N1	492	537	30	60	2.3	51	5.52
CMFM4224N1	263	289	42	24	2.3	20	2.31
CMFM4230N1	326	352	42	30	2.3	25	2.85
CMFM4236N1	354	400	42	36	2.3	31	3.38
CMFM4242N1	387	437	42	42	2.3	36	3.92
CMFM4248N1	420	469	42	48	2.3	41	4.45
CMFM4254N1	463	509	42	54	2.3	46	4.99
CMFM4260N1	492	537	42	60	2.3	51	5.52
CMFM4824N1	300	330	48	24	2.3	26	2.73
CMFM4830N1	340	369	48	30	2.3	33	3.37
CMFM4836N1	386	430	48	36	2.3	39	4.00
CMFM4842N1	441	499	48	42	2.3	46	4.63
CMFM4848N1	476	535	48	48	2.3	52	5.26
CMFM4854N1	523	579	48	54	2.3	59	5.89
CMFM4860N1	553	612	48	60	2.3	65	6.53
CMFM5424N1	300	330	54	24	2.3	26	2.73
CMFM5430N1	340	369	54	30	2.3	33	3.37
CMFM5436N1	386	430	54	36	2.3	39	4.00
CMFM5442N1	441	499	54	42	2.3	46	4.63
CMFM5448N1	476	535	54	48	2.3	52	5.26
CMFM5454N1	523	579	54	54	2.3	59	5.89
CMFM5460N1	553	612	54	60	2.3	65	6.53
CMFM6624N1	344	384	66	24	2.3	32	3.58
CMFM6630N1	400	439	66	30	2.3	40	4.40
CMFM6636N1	488	561	66	36	2.3	48	5.23
CMFM6642N1	539	613	66	42	2.3	56	6.06
CMFM6648N1	558	633	66	48	2.3	64	6.88
CMFM6654N1	574	647	66	54	2.3	72	7.71
CMFM6660N1	591	666	66	60	2.3	80	8.53

**CMFM-N2 • Monolithic Non Powered Fabric Panel, Punchouts on Both Sides**

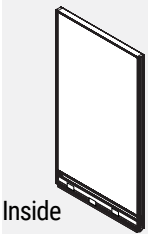

Inside

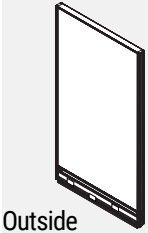

Outside

- Individual fabric-covered modules incorporated into an aluminum frame.
- Opposite sides of each module may have a different fabric within the same grade at no upcharge.
- If different grades of fabric are used on one panel, the entire panel must be priced at highest grade.
- Panels are not tackable.
- 3 Panel connector brackets per side come standard with 30”h., 42”h. and 54”h. panels.
- 4 Panel connector brackets per side come standard with 66”h. panels.
- Panels include 2 raceway covers with punchouts on both sides, an integrated aluminum top cap and levelling glides.
- 24” wide panels have two punchouts, one for electrical and one for data.
- 30” wide panels and wider have three punchouts, two for electrical and one for data.
- Note: Trim is not required at a straight connection between two panels of the same height.

PRODUCT CODE	PRICE		SIZE/ INCHES			WEIGHT VOL	
	GR 1	GR 2	H	W	D	LBS	FT³
CMFM3024N2	263	289	30	24	2.3	20	2.31
CMFM3030N2	326	352	30	30	2.3	25	2.85
CMFM3036N2	354	400	30	36	2.3	31	3.38
CMFM3042N2	387	437	30	42	2.3	36	3.92
CMFM3048N2	420	469	30	48	2.3	41	4.45
CMFM3054N2	463	509	30	54	2.3	46	4.99
CMFM3060N2	492	537	30	60	2.3	51	5.52
CMFM4224N2	263	289	42	24	2.3	20	2.31
CMFM4230N2	326	352	42	30	2.3	25	2.85
CMFM4236N2	354	400	42	36	2.3	31	3.38
CMFM4242N2	387	437	42	42	2.3	36	3.92
CMFM4248N2	420	469	42	48	2.3	41	4.45
CMFM4254N2	463	509	42	54	2.3	46	4.99
CMFM4260N2	492	537	42	60	2.3	51	5.52
CMFM4824N2	300	330	48	24	2.3	26	2.73
CMFM4830N2	340	369	48	30	2.3	33	3.37
CMFM4836N2	386	430	48	36	2.3	39	4.00
CMFM4842N2	441	499	48	42	2.3	46	4.63
CMFM4848N2	476	535	48	48	2.3	52	5.26
CMFM4854N2	523	579	48	54	2.3	59	5.89
CMFM4860N2	553	612	48	60	2.3	65	6.53
CMFM5424N2	300	330	54	24	2.3	26	2.73
CMFM5430N2	340	369	54	30	2.3	33	3.37
CMFM5436N2	386	430	54	36	2.3	39	4.00
CMFM5442N2	441	499	54	42	2.3	46	4.63
CMFM5448N2	476	535	54	48	2.3	52	5.26
CMFM5454N2	523	579	54	54	2.3	59	5.89
CMFM5460N2	553	612	54	60	2.3	65	6.53
CMFM6624N2	344	384	66	24	2.3	32	3.58
CMFM6630N2	400	439	66	30	2.3	40	4.40
CMFM6636N2	488	561	66	36	2.3	48	5.23
CMFM6642N2	539	613	66	42	2.3	56	6.06
CMFM6648N2	558	633	66	48	2.3	64	6.88
CMFM6654N2	574	647	66	54	2.3	72	7.71
CMFM6660N2	591	666	66	60	2.3	80	8.53



**CMFM-P1 • Monolithic Fabric Panel with Power Distribution Housing, Punchouts on One Side**

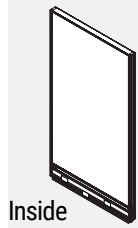

Inside

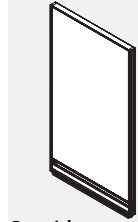

Outside

- Individual fabric-covered modules incorporated into an aluminum frame.
- Opposite sides of each module may have a different fabric within the same grade at no upcharge.
- If different grades of fabric are used on one panel, the entire panel must be priced at highest grade.
- Panels are not tackable.
- 3 Panel connector brackets per side come standard with 30"h., 42"h. and 54"h. panels.
- 4 Panel connector brackets per side come standard with 66"h. panels.
- Panels include 1 raceway cover with punchouts on one side, 1 raceway cover with no punchouts on the other, a power distribution housing, an integrated aluminum top cap and levelling glides.
- 24" wide panels have two punchouts, one for electrical and one for data.
- 30" wide panels and wider have three punchouts, two for electrical and one for data.
- Note: Trim is not required at a straight connection between two panels of the same height.
- Please specify duplex receptacles separately.

PRODUCT CODE	PRICE		SIZE/ INCHES			WEIGHT VOL	
	GR 1	GR 2	H	W	D	LBS	FT <sup>3</sup>
CMFM3024P1	398	422	30	24	2.3	20	2.31
CMFM3030P1	506	531	30	30	2.3	25	2.85
CMFM3036P1	545	591	30	36	2.3	31	3.38
CMFM3042P1	585	634	30	42	2.3	36	3.92
CMFM3048P1	628	675	30	48	2.3	41	4.45
CMFM3054P1	673	723	30	54	2.3	46	4.99
CMFM3060P1	702	752	30	60	2.3	51	5.52
CMFM4224P1	398	422	42	24	2.3	20	2.31
CMFM4230P1	506	531	42	30	2.3	25	2.85
CMFM4236P1	545	591	42	36	2.3	31	3.38
CMFM4242P1	585	634	42	42	2.3	36	3.92
CMFM4248P1	628	675	42	48	2.3	41	4.45
CMFM4254P1	673	723	42	54	2.3	46	4.99
CMFM4260P1	702	752	42	60	2.3	51	5.52
CMFM4824P1	436	464	48	24	2.3	26	2.73
CMFM4830P1	523	551	48	30	2.3	33	3.37
CMFM4836P1	576	620	48	36	2.3	39	4.00
CMFM4842P1	637	696	48	42	2.3	46	4.63
CMFM4848P1	686	743	48	48	2.3	52	5.26
CMFM4854P1	732	790	48	54	2.3	59	5.89
CMFM4860P1	765	825	48	60	2.3	65	6.53
CMFM5424P1	436	464	54	24	2.3	26	2.73
CMFM5430P1	523	551	54	30	2.3	33	3.37
CMFM5436P1	576	620	54	36	2.3	39	4.00
CMFM5442P1	637	696	54	42	2.3	46	4.63
CMFM5448P1	686	743	54	48	2.3	52	5.26
CMFM5454P1	732	790	54	54	2.3	59	5.89
CMFM5460P1	765	825	54	60	2.3	65	6.53
CMFM6624P1	480	520	66	24	2.3	32	3.58
CMFM6630P1	584	620	66	30	2.3	40	4.40
CMFM6636P1	677	752	66	36	2.3	48	5.23
CMFM6642P1	736	809	66	42	2.3	56	6.06
CMFM6648P1	765	839	66	48	2.3	64	6.88
CMFM6654P1	785	858	66	54	2.3	72	7.71
CMFM6660P1	803	877	66	60	2.3	80	8.53

**CMFM-P2 • Monolithic Fabric Panel with Power Distribution Housing, Punchouts on Both Sides**



Inside

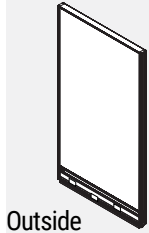

Outside

- Individual fabric-covered modules incorporated into an aluminum frame.
- Opposite sides of each module may have a different fabric within the same grade at no upcharge.
- If different grades of fabric are used on one panel, the entire panel must be priced at highest grade.
- Panels are not tackable.
- 3 Panel connector brackets per side come standard with 30"h., 42"h. and 54"h. panels.
- 4 Panel connector brackets per side come standard with 66"h. panels.
- Panels include 2 raceway covers with punchouts on both sides, a power distribution housing, an integrated aluminum top cap and levelling glides.
- 24" wide panels have two punchouts, one for electrical and one for data.
- 30" wide panels and wider have three punchouts, two for electrical and one for data.
- Note: Trim is not required at a straight connection between two panels of the same height.
- Please specify duplex receptacles separately.

PRODUCT CODE	PRICE		SIZE/ INCHES			WEIGHT VOL	
	GR 1	GR 2	H	W	D	LBS	FT <sup>3</sup>
CMFM3024P2	398	422	30	24	2.3	20	2.31
CMFM3030P2	506	531	30	30	2.3	25	2.85
CMFM3036P2	545	591	30	36	2.3	31	3.38
CMFM3042P2	585	634	30	42	2.3	36	3.92
CMFM3048P2	628	675	30	48	2.3	41	4.45
CMFM3054P2	673	723	30	54	2.3	46	4.99
CMFM3060P2	702	752	30	60	2.3	51	5.52
CMFM4224P2	398	422	42	24	2.3	20	2.31
CMFM4230P2	506	531	42	30	2.3	25	2.85
CMFM4236P2	545	591	42	36	2.3	31	3.38
CMFM4242P2	585	634	42	42	2.3	36	3.92
CMFM4248P2	628	675	42	48	2.3	41	4.45
CMFM4254P2	673	723	42	54	2.3	46	4.99
CMFM4260P2	702	752	42	60	2.3	51	5.52
CMFM4824P2	436	464	48	24	2.3	26	2.73
CMFM4830P2	523	551	48	30	2.3	33	3.37
CMFM4836P2	576	620	48	36	2.3	39	4.00
CMFM4842P2	637	696	48	42	2.3	46	4.63
CMFM4848P2	686	743	48	48	2.3	52	5.26
CMFM4854P2	732	790	48	54	2.3	59	5.89
CMFM4860P2	765	825	48	60	2.3	65	6.53
CMFM5424P2	436	464	54	24	2.3	26	2.73
CMFM5430P2	523	551	54	30	2.3	33	3.37
CMFM5436P2	576	620	54	36	2.3	39	4.00
CMFM5442P2	637	696	54	42	2.3	46	4.63
CMFM5448P2	686	743	54	48	2.3	52	5.26
CMFM5454P2	732	790	54	54	2.3	59	5.89
CMFM5460P2	765	825	54	60	2.3	65	6.53
CMFM6624P2	480	520	66	24	2.3	32	3.58
CMFM6630P2	584	620	66	30	2.3	40	4.40
CMFM6636P2	677	752	66	36	2.3	48	5.23
CMFM6642P2	736	809	66	42	2.3	56	6.06
CMFM6648P2	765	839	66	48	2.3	64	6.88
CMFM6654P2	785	858	66	54	2.3	72	7.71
CMFM6660P2	803	877	66	60	2.3	80	8.53

**CMLFM-N0 • Monolithic Non Powered Laminate One Side, Fabric One Side Panel, No Punchouts**

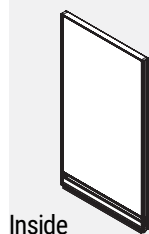

Inside

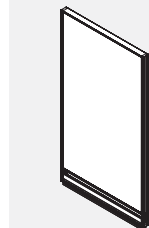

Outside

- Individual modules, one in fabric and one in laminate, incorporated into an aluminum frame.
- Panels are not tackable.
- 3 panel connector brackets per side come standard with 30"h., 42"h., and 54"h. panels.
- 4 panel connector brackets per side come standard with 66"h. panels.
- Panels include 2 raceway covers with no punchouts, an integrated aluminum top cap and levelling glides.
- Note: Trim is not required at a straight connection between two panels of the same height.

PRODUCT CODE	PRICE		SIZE/ INCHES			WEIGHT VOL	
	GR1	GR2	H	W	D	LBS	FT <sup>3</sup>
CMLFM3024N0	380	387	30	24	2.3	20	2.31
CMLFM3030N0	443	455	30	30	2.3	25	2.85
CMLFM3036N0	505	519	30	36	2.3	31	3.38
CMLFM3042N0	574	586	30	42	2.3	36	3.92
CMLFM3048N0	620	635	30	48	2.3	41	4.45
CMLFM3054N0	692	704	30	54	2.3	46	4.99
CMLFM3060N0	748	771	30	60	2.3	51	5.52
CMLFM4224N0	450	463	42	24	2.3	20	2.31
CMLFM4230N0	526	537	42	30	2.3	25	2.85
CMLFM4236N0	605	622	42	36	2.3	31	3.38
CMLFM4242N0	686	703	42	42	2.3	36	3.92
CMLFM4248N0	744	765	42	48	2.3	41	4.45
CMLFM4254N0	828	851	42	54	2.3	46	4.99
CMLFM4260N0	908	932	42	60	2.3	51	5.52
CMLFM4824N0	534	556	48	24	2.3	26	2.73
CMLFM4830N0	628	646	48	30	2.3	33	3.37
CMLFM4836N0	719	740	48	36	2.3	39	4.00
CMLFM4842N0	815	838	48	42	2.3	46	4.63
CMLFM4848N0	890	916	48	48	2.3	52	5.26
CMLFM4854N0	991	1021	48	54	2.3	59	5.89
CMLFM5424N0	534	556	54	24	2.3	65	6.53
CMLFM5430N0	628	646	54	30	2.3	33	3.37
CMLFM5436N0	719	740	54	36	2.3	39	4.00
CMLFM5442N0	815	838	54	42	2.3	46	4.63
CMLFM5448N0	890	916	54	48	2.3	52	5.26
CMLFM5454N0	991	1021	54	54	2.3	59	5.89
CMLFM6624N0	663	679	66	24	2.3	32	3.58
CMLFM6630N0	773	796	66	30	2.3	40	4.40
CMLFM6636N0	891	919	66	36	2.3	48	5.23
CMLFM6642N0	1016	1047	66	42	2.3	56	6.06
CMLFM6648N0	1106	1140	66	48	2.3	64	6.68

**CMLFM-N1 • Monolithic Non Powered Laminate One Side, Fabric Other, Punchouts on One Side**

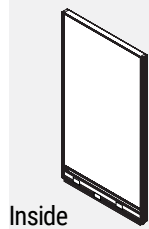

Inside

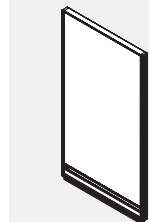

Outside

- Individual modules, one in fabric and one in laminate, incorporated into an aluminum frame.
- Panels are not tackable.
- 3 panel connector brackets per side come standard with 30"h., 42"h., and 54"h. panels.
- 4 panel connector brackets per side come standard with 66"h. panels.
- Panels include 1 raceway cover with punchouts on one side, 1 raceway cover with no punchouts on the other, an integrated aluminum top cap and levelling glides.
- 24" wide panels have two punchouts, one for electrical and one for data.
- 30" wide panels and wider have three punchouts, two for electrical and one for data.
- Note: Trim is not required at a straight connection between two panels of the same height.

PRODUCT CODE	PRICE		SIZE/ INCHES			WEIGHT VOL	
	GR1	GR2	H	W	D	LBS	FT <sup>3</sup>
CMLFM3024N1	380	387	30	24	2.3	20	2.31
CMLFM3030N1	443	455	30	30	2.3	25	2.85
CMLFM3036N1	505	519	30	36	2.3	31	3.38
CMLFM3042N1	574	586	30	42	2.3	36	3.92
CMLFM3048N1	620	635	30	48	2.3	41	4.45
CMLFM3054N1	692	704	30	54	2.3	46	4.99
CMLFM3060N1	748	771	30	60	2.3	51	5.52
CMLFM4224N1	450	463	42	24	2.3	20	2.31
CMLFM4230N1	526	537	42	30	2.3	25	2.85
CMLFM4236N1	605	622	42	36	2.3	31	3.38
CMLFM4242N1	686	703	42	42	2.3	36	3.92
CMLFM4248N1	744	765	42	48	2.3	41	4.45
CMLFM4254N1	828	851	42	54	2.3	46	4.99
CMLFM4260N1	908	932	42	60	2.3	51	5.52
CMLFM4824N1	534	556	48	24	2.3	26	2.73
CMLFM4830N1	628	646	48	30	2.3	33	3.37
CMLFM4836N1	719	740	48	36	2.3	39	4.00
CMLFM4842N1	815	838	48	42	2.3	46	4.63
CMLFM4848N1	890	916	48	48	2.3	52	5.26
CMLFM4854N1	991	1021	48	54	2.3	59	5.89
CMLFM5424N1	534	556	54	24	2.3	65	6.53
CMLFM5430N1	628	646	54	30	2.3	33	3.37
CMLFM5436N1	719	740	54	36	2.3	39	4.00
CMLFM5442N1	815	838	54	42	2.3	46	4.63
CMLFM5448N1	890	916	54	48	2.3	52	5.26
CMLFM5454N1	991	1021	54	54	2.3	59	5.89
CMLFM6624N1	663	679	66	24	2.3	32	3.58
CMLFM6630N1	773	796	66	30	2.3	40	4.40
CMLFM6636N1	891	919	66	36	2.3	48	5.23
CMLFM6642N1	1016	1047	66	42	2.3	56	6.06
CMLFM6648N1	1106	1140	66	48	2.3	64	6.68

**CMLFM-N2 • Monolithic Non Powered Laminate 1 Side, Fabric Other Panel, Punchouts on Both Sides**

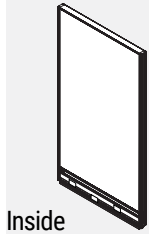

Inside

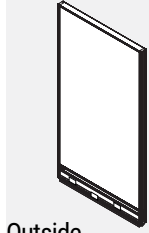

Outside

- Individual modules, one in fabric and one in laminate, incorporated into an aluminum frame.
- Panels are not tackable.
- 3 panel connector brackets per side come standard with 30”h., 42”h., and 54”h. panels.
- 4 panel connector brackets per side come standard with 66”h. panels.
- Panels include 2 raceway covers with punchouts, an integrated aluminum top cap and levelling glides.
- 24” wide panels have two punchouts, one for electrical and one for data.
- 30” wide panels and wider have three punchouts, two for electrical and one for data.
- Note: Trim is not required at a straight connection between two panels of the same height.

PRODUCT CODE	PRICE		SIZE/ INCHES			WEIGHT VOL	
	GR 1	GR 2	H	W	D	LBS	FT³
CMLFM3024N2	380	387	30	24	2.3	20	2.31
CMLFM3030N2	443	455	30	30	2.3	25	2.85
CMLFM3036N2	505	519	30	36	2.3	31	3.38
CMLFM3042N2	574	586	30	42	2.3	36	3.92
CMLFM3048N2	620	635	30	48	2.3	41	4.45
CMLFM3054N2	692	704	30	54	2.3	46	4.99
CMLFM3060N2	748	771	30	60	2.3	51	5.52
CMLFM4224N2	450	463	42	24	2.3	20	2.31
CMLFM4230N2	526	537	42	30	2.3	25	2.85
CMLFM4236N2	605	622	42	36	2.3	31	3.38
CMLFM4242N2	686	703	42	42	2.3	36	3.92
CMLFM4248N2	744	765	42	48	2.3	41	4.45
CMLFM4254N2	828	851	42	54	2.3	46	4.99
CMLFM4260N2	908	932	42	60	2.3	51	5.52
CMLFM4824N2	534	556	48	24	2.3	26	2.73
CMLFM4830N2	628	646	48	30	2.3	33	3.37
CMLFM4836N2	719	740	48	36	2.3	39	4.00
CMLFM4842N2	815	838	48	42	2.3	46	4.63
CMLFM4848N2	890	916	48	48	2.3	52	5.26
CMLFM4854N2	991	1021	48	54	2.3	59	5.89
CMLFM5424N2	534	556	54	24	2.3	65	6.53
CMLFM5430N2	628	646	54	30	2.3	33	3.37
CMLFM5436N2	719	740	54	36	2.3	39	4.00
CMLFM5442N2	815	838	54	42	2.3	46	4.63
CMLFM5448N2	890	916	54	48	2.3	52	5.26
CMLFM5454N2	991	1021	54	54	2.3	59	5.89
CMLFM6624N2	663	679	66	24	2.3	32	3.58
CMLFM6630N2	773	796	66	30	2.3	40	4.40
CMLFM6636N2	891	919	66	36	2.3	48	5.23
CMLFM6642N2	1016	1047	66	42	2.3	56	6.06
CMLFM6648N2	1106	1140	66	48	2.3	64	6.68

**CMLFM-P1 • Monolithic Laminate One Side, Fabric Other Side Panel with PDH, Punchouts on One Side**

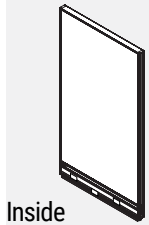

Inside

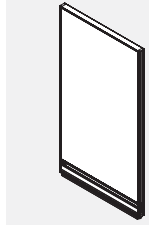

Outside

- Individual modules, one in fabric and one in laminate, incorporated into an aluminum frame.
- Panels are not tackable.
- 3 panel connector brackets per side come standard with 30”h., 42”h., and 54”h. panels.
- 4 panel connector brackets per side come standard with 66”h. panels.
- Panels include 1 raceway cover with punchouts on one side, 1 raceway cover with no punchouts on the other, a power distribution housing, an integrated aluminum top cap and levelling glides.
- 24” wide panels have two punchouts, one for electrical and one for data.
- 30” wide panels and wider have three punchouts, two for electrical and one for data.
- Note: Trim is not required at a straight connection between two panels of the same height.
- Please specify duplex receptacles separately.

PRODUCT CODE	PRICE		SIZE/ INCHES			WEIGHT VOL	
	GR 1	GR 2	H	W	D	LBS	FT³
CMLFM3024P1	507	519	30	24	2.3	20	2.31
CMLFM3030P1	626	636	30	30	2.3	25	2.85
CMLFM3036P1	692	699	30	36	2.3	31	3.38
CMLFM3042P1	761	773	30	42	2.3	36	3.92
CMLFM3048P1	818	831	30	48	2.3	41	4.45
CMLFM3054P1	891	906	30	54	2.3	46	4.99
CMLFM3060P1	957	972	30	60	2.3	51	5.52
CMLFM4224P1	579	591	42	24	2.3	20	2.31
CMLFM4230P1	699	712	42	30	2.3	25	2.85
CMLFM4236P1	787	803	42	36	2.3	31	3.38
CMLFM4242P1	871	891	42	42	2.3	36	3.92
CMLFM4248P1	943	965	42	48	2.3	41	4.45
CMLFM4254P1	1030	1052	42	54	2.3	46	4.99
CMLFM4260P1	1110	1135	42	60	2.3	51	5.52
CMLFM4824P1	663	677	48	24	2.3	26	2.73
CMLFM4830P1	801	818	48	30	2.3	33	3.37
CMLFM4836P1	901	923	48	36	2.3	39	4.00
CMLFM4842P1	1000	1025	48	42	2.3	46	4.63
CMLFM4848P1	1088	1114	48	48	2.3	52	5.26
CMLFM4854P1	1137	1190	48	54	2.3	59	5.89
CMLFM5424P1	663	677	54	24	2.3	65	6.53
CMLFM5430P1	801	818	54	30	2.3	33	3.37
CMLFM5436P1	901	923	54	36	2.3	39	4.00
CMLFM5442P1	1000	1025	54	42	2.3	46	4.63
CMLFM5448P1	1088	1114	54	48	2.3	52	5.26
CMLFM5454P1	1190	1222	54	54	2.3	59	5.89
CMLFM6624P1	792	809	66	24	2.3	32	3.58
CMLFM6630P1	945	969	66	30	2.3	40	4.40
CMLFM6636P1	1074	1099	66	36	2.3	48	5.23
CMLFM6642P1	1202	1232	66	42	2.3	56	6.06
CMLFM6648P1	1304	1338	66	48	2.3	64	6.68

**CMLFM-P2 • Monolithic Laminate One Side, Fabric Other Panel with PDH, Punchouts on Both Side**

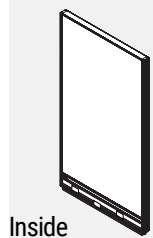

Inside

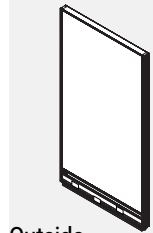

Outside

- Individual modules, one in fabric and one in laminate, incorporated into an aluminum frame.
- Panels are not tackable.
- 3 panel connector brackets per side come standard with 30"h., 42"h., and 54"h. panels.
- 4 panel connector brackets per side come standard with 66"h. panels.
- Panels include 2 raceway cover with punchouts, a power distribution housing, an integrated aluminum top cap and levelling glides.
- 24" wide panels have two punchouts, one for electrical and one for data.
- 30" wide panels and wider have three punchouts, two for electrical and one for data.
- Note: Trim is not required at a straight connection between two panels of the same height.
- Please specify duplex receptacles separately.

PRODUCT CODE	PRICE		SIZE/ INCHES			WEIGHT LBS	VOL FT <sup>3</sup>
	GR1	GR2	H	W	D		
CMLFM3024P2	507	519	30	24	2.3	20	2.31
CMLFM3030P2	626	636	30	30	2.3	25	2.85
CMLFM3036P2	692	699	30	36	2.3	31	3.38
CMLFM3042P2	761	773	30	42	2.3	36	3.92
CMLFM3048P2	818	831	30	48	2.3	41	4.45
CMLFM3054P2	891	906	30	54	2.3	46	4.99
CMLFM3060P2	957	972	30	60	2.3	51	5.52
CMLFM4224P2	579	591	42	24	2.3	20	2.31
CMLFM4230P2	699	712	42	30	2.3	25	2.85
CMLFM4236P2	787	803	42	36	2.3	31	3.38
CMLFM4242P2	871	891	42	42	2.3	36	3.92
CMLFM4248P2	943	965	42	48	2.3	41	4.45
CMLFM4254P2	1030	1052	42	54	2.3	46	4.99
CMLFM4260P2	1110	1135	42	60	2.3	51	5.52
CMLFM4824P2	663	677	48	24	2.3	26	2.73
CMLFM4830P2	801	818	48	30	2.3	33	3.37
CMLFM4836P2	901	923	48	36	2.3	39	4.00
CMLFM4842P2	1000	1025	48	42	2.3	46	4.63
CMLFM4848P2	1088	1114	48	48	2.3	52	5.26
CMLFM4854P2	1137	1190	48	54	2.3	59	5.89
CMLFM5424P2	663	677	54	24	2.3	65	6.53
CMLFM5430P2	801	818	54	30	2.3	33	3.37
CMLFM5436P2	901	923	54	36	2.3	39	4.00
CMLFM5442P2	1000	1025	54	42	2.3	46	4.63
CMLFM5448P2	1088	1114	54	48	2.3	52	5.26
CMLFM5454P2	1190	1222	54	54	2.3	59	5.89
CMLFM6624P2	792	809	66	24	2.3	32	3.58
CMLFM6630P2	945	969	66	30	2.3	40	4.40
CMLFM6636P2	1074	1099	66	36	2.3	48	5.23
CMLFM6642P2	1202	1232	66	42	2.3	56	6.06
CMLFM6648P2	1304	1338	66	48	2.3	64	6.68

**CMLLM-N0 • Monolithic Non Powered Laminate Two Sides Panel, No Punchouts**

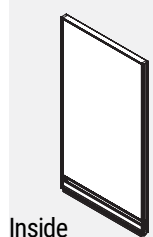

Inside

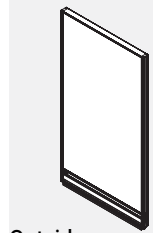

Outside

- Individual laminate modules incorporated into an aluminum frame.
- Panels are not tackable.
- 3 panel connector brackets per side come standard with 30"h., 42"h., and 54"h. panels.
- 4 panel connector brackets per side come standard with 66"h. panels.
- Panels include 2 raceway covers with no punchouts, an integrated aluminum top cap and levelling glides.
- Note: Trim is not required at a straight connection between two panels of the same height.

PRODUCT CODE	PRICE		SIZE/ INCHES			WEIGHT LBS	VOL FT <sup>3</sup>
	GR1	GR2	H	W	D		
CMLLM3024N0	435		30	24	2.3	20	2.31
CMLLM3030N0	512		30	30	2.3	25	2.85
CMLLM3036N0	586		30	36	2.3	31	3.38
CMLLM3042N0	667		30	42	2.3	36	3.92
CMLLM3048N0	744		30	48	2.3	41	4.45
CMLLM3054N0	825		30	54	2.3	46	4.99
CMLLM3060N0	891		30	60	2.3	51	5.52
CMLLM4224N0	512		42	24	2.3	20	2.31
CMLLM4230N0	604		42	30	2.3	25	2.85
CMLLM4236N0	701		42	36	2.3	31	3.38
CMLLM4242N0	801		42	42	2.3	36	3.92
CMLLM4248N0	895		42	48	2.3	41	4.45
CMLLM4254N0	987		42	54	2.3	46	4.99
CMLLM4260N0	1075		42	60	2.3	51	5.52
CMLLM4824N0	607		48	24	2.3	26	2.73
CMLLM4830N0	719		48	30	2.3	33	3.37
CMLLM4836N0	835		48	36	2.3	39	4.00
CMLLM4842N0	954		48	42	2.3	46	4.63
CMLLM4848N0	1075		48	48	2.3	52	5.26
CMLLM4854N0	1181		48	54	2.3	59	5.89
CMLLM5424N0	607		54	24	2.3	65	6.53
CMLLM5430N0	719		54	30	2.3	33	3.37
CMLLM5436N0	835		54	36	2.3	39	4.00
CMLLM5442N0	954		54	42	2.3	46	4.63
CMLLM5448N0	1075		54	48	2.3	52	5.26
CMLLM5454N0	1181		54	54	2.3	59	5.89
CMLLM6624N0	765		66	24	2.3	32	3.58
CMLLM6630N0	908		66	30	2.3	40	4.40
CMLLM6636N0	1055		66	36	2.3	48	5.23
CMLLM6642N0	1208		66	42	2.3	56	6.06
CMLLM6648N0	1354		66	48	2.3	64	6.68

**CMLLM-N1 • Monolithic Non Powered Laminate Two Sides Panel, Punchouts on One Side**

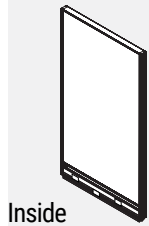

Inside

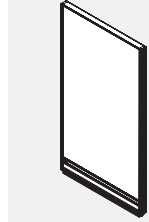

Outside

- Individual laminate modules incorporated into an aluminum frame.
- Panels are not tackable.
- 3 panel connector brackets per side come standard with 30”h., 42”h., and 54”h. panels.
- 4 panel connector brackets per side come standard with 66”h. panels.
- Panels include 1 raceway cover with punchouts on one side, 1 raceway cover with no punchouts on the other, an integrated aluminum top cap and levelling glides.
- 24” wide panels have two punchouts, one for electrical and one for data.
- 30” wide panels and wider have three punchouts, two for electrical and one for data.
- Note: Trim is not required at a straight connection between two panels of the same height.

PRODUCT CODE	PRICE	SIZE/ INCHES			WEIGHT VOL	
		H	W	D	LBS	FT <sup>3</sup>
CMLLM3024N1	435	30	24	2.3	20	2.31
CMLLM3030N1	512	30	30	2.3	25	2.85
CMLLM3036N1	586	30	36	2.3	31	3.38
CMLLM3042N1	667	30	42	2.3	36	3.92
CMLLM3048N1	744	30	48	2.3	41	4.45
CMLLM3054N1	825	30	54	2.3	46	4.99
CMLLM3060N1	891	30	60	2.3	51	5.52
CMLLM4224N1	512	42	24	2.3	20	2.31
CMLLM4230N1	604	42	30	2.3	25	2.85
CMLLM4236N1	701	42	36	2.3	31	3.38
CMLLM4242N1	801	42	42	2.3	36	3.92
CMLLM4248N1	895	42	48	2.3	41	4.45
CMLLM4254N1	987	42	54	2.3	46	4.99
CMLLM4260N1	1075	42	60	2.3	51	5.52
CMLLM4824N1	607	48	24	2.3	26	2.73
CMLLM4830N1	719	48	30	2.3	33	3.37
CMLLM4836N1	835	48	36	2.3	39	4.00
CMLLM4842N1	954	48	42	2.3	46	4.63
CMLLM4848N1	1075	48	48	2.3	52	5.26
CMLLM4854N1	1181	48	54	2.3	59	5.89
CMLLM5424N1	607	54	24	2.3	65	6.53
CMLLM5430N1	719	54	30	2.3	33	3.37
CMLLM5436N1	835	54	36	2.3	39	4.00
CMLLM5442N1	954	54	42	2.3	46	4.63
CMLLM5448N1	1075	54	48	2.3	52	5.26
CMLLM5454N1	1181	54	54	2.3	59	5.89
CMLLM6624N1	765	66	24	2.3	32	3.58
CMLLM6630N1	908	66	30	2.3	40	4.40
CMLLM6636N1	1055	66	36	2.3	48	5.23
CMLLM6642N1	1208	66	42	2.3	56	6.06
CMLLM6648N1	1354	66	48	2.3	64	6.68

**CMLLM-N2 • Monolithic Non Powered Laminate Two Sides Panel, Punchouts on Both Sides**

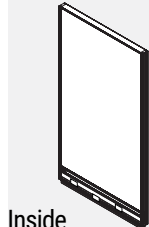

Inside

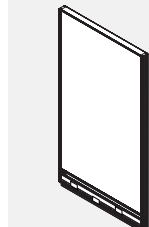

Outside

- Individual laminate modules incorporated into an aluminum frame.
- Panels are not tackable.
- 3 panel connector brackets per side come standard with 30”h., 42”h., and 54”h. panels.
- 4 panel connector brackets per side come standard with 66”h. panels.
- Panels include 2 raceway covers with punchouts, an integrated aluminum top cap and levelling glides.
- 24” wide panels have two punchouts, one for electrical and one for data.
- 30” wide panels and wider have three punchouts, two for electrical and one for data.
- Note: Trim is not required at a straight connection between two panels of the same height.

PRODUCT CODE	PRICE	SIZE/ INCHES			WEIGHT VOL	
		H	W	D	LBS	FT <sup>3</sup>
CMLLM3024N2	435	30	24	2.3	20	2.31
CMLLM3030N2	512	30	30	2.3	25	2.85
CMLLM3036N2	586	30	36	2.3	31	3.38
CMLLM3042N2	667	30	42	2.3	36	3.92
CMLLM3048N2	744	30	48	2.3	41	4.45
CMLLM3054N2	825	30	54	2.3	46	4.99
CMLLM3060N2	891	30	60	2.3	51	5.52
CMLLM4224N2	512	42	24	2.3	20	2.31
CMLLM4230N2	604	42	30	2.3	25	2.85
CMLLM4236N2	701	42	36	2.3	31	3.38
CMLLM4242N2	801	42	42	2.3	36	3.92
CMLLM4248N2	895	42	48	2.3	41	4.45
CMLLM4254N2	987	42	54	2.3	46	4.99
CMLLM4260N2	1075	42	60	2.3	51	5.52
CMLLM4824N2	607	48	24	2.3	26	2.73
CMLLM4830N2	719	48	30	2.3	33	3.37
CMLLM4836N2	835	48	36	2.3	39	4.00
CMLLM4842N2	954	48	42	2.3	46	4.63
CMLLM4848N2	1075	48	48	2.3	52	5.26
CMLLM4854N2	1181	48	54	2.3	59	5.89
CMLLM5424N2	607	54	24	2.3	65	6.53
CMLLM5430N2	719	54	30	2.3	33	3.37
CMLLM5436N2	835	54	36	2.3	39	4.00
CMLLM5442N2	954	54	42	2.3	46	4.63
CMLLM5448N2	1075	54	48	2.3	52	5.26
CMLLM5454N2	1181	54	54	2.3	59	5.89
CMLLM6624N2	765	66	24	2.3	32	3.58
CMLLM6630N2	908	66	30	2.3	40	4.40
CMLLM6636N2	1055	66	36	2.3	48	5.23
CMLLM6642N2	1208	66	42	2.3	56	6.06
CMLLM6648N2	1354	66	48	2.3	64	6.68

**CMLLM-P1 • Monolithic Laminate Two Sides Panel with PDH, Punchouts on One Side**

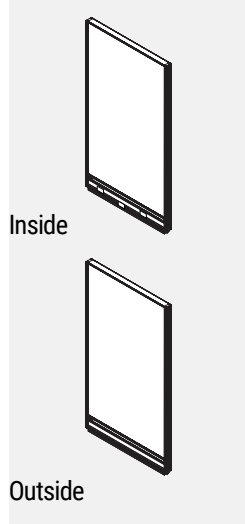

- Individual laminate modules incorporated into an aluminum frame.
- Panels are not tackable.
- 3 panel connector brackets per side come standard with 30”h., 42”h., and 54”h. panels.
- 4 panel connector brackets per side come standard with 66”h. panels.
- Panels include 1 raceway cover with punchouts on one side, 1 raceway cover with no punchouts on the other, a power distribution housing, an integrated aluminum top cap and levelling glides.
- 24” wide panels have two punchouts, one for electrical and one for data.
- 30” wide panels and wider have three punchouts, two for electrical and one for data.
- Note: Trim is not required at a straight connection between two panels of the same height.
- Please specify duplex receptacles separately.

PRODUCT CODE	PRICE	SIZE/ INCHES			WEIGHT LBS	VOL FT <sup>3</sup>
		H	W	D		
CMLLM3024P1	562	30	24	2.3	20	2.31
CMLLM3030P1	686	30	30	2.3	25	2.85
CMLLM3036P1	767	30	36	2.3	31	3.38
CMLLM3042P1	854	30	42	2.3	36	3.92
CMLLM3048P1	943	30	48	2.3	41	4.45
CMLLM3054P1	1025	30	54	2.3	46	4.99
CMLLM3060P1	1093	30	60	2.3	51	5.52
CMLLM4224P1	640	42	24	2.3	20	2.31
CMLLM4230P1	777	42	30	2.3	25	2.85
CMLLM4236P1	883	42	36	2.3	31	3.38
CMLLM4242P1	988	42	42	2.3	36	3.92
CMLLM4248P1	1093	42	48	2.3	41	4.45
CMLLM4254P1	1188	42	54	2.3	46	4.99
CMLLM4260P1	1277	42	60	2.3	51	5.52
CMLLM4824P1	735	48	24	2.3	26	2.73
CMLLM4830P1	891	48	30	2.3	33	3.37
CMLLM4836P1	1016	48	36	2.3	39	4.00
CMLLM4842P1	1140	48	42	2.3	46	4.63
CMLLM4848P1	1272	48	48	2.3	52	5.26
CMLLM4854P1	1383	48	54	2.3	59	5.89
CMLLM5424P1	735	54	24	2.3	65	6.53
CMLLM5430P1	891	54	30	2.3	33	3.37
CMLLM5436P1	1016	54	36	2.3	39	4.00
CMLLM5442P1	1140	54	42	2.3	46	4.63
CMLLM5448P1	1272	54	48	2.3	52	5.26
CMLLM5454P1	1383	54	54	2.3	59	5.89
CMLLM6624P1	894	66	24	2.3	32	3.58
CMLLM6630P1	1081	66	30	2.3	40	4.40
CMLLM6636P1	1235	66	36	2.3	48	5.23
CMLLM6642P1	1396	66	42	2.3	56	6.06
CMLLM6648P1	1553	66	48	2.3	64	6.68

**CMLLM-P2 • Monolithic Laminate Two Sides Panel with PDH, Punchouts on Both Side**

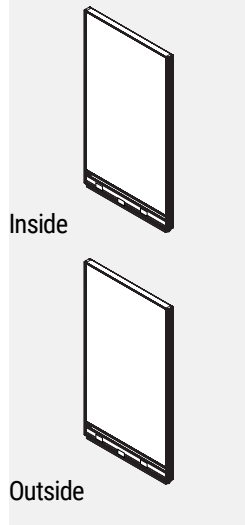

- Individual laminate modules incorporated into an aluminum frame.
- Panels are not tackable.
- 3 panel connector brackets per side come standard with 30”h., 42”h., and 54”h. panels.
- 4 panel connector brackets per side come standard with 66”h. panels.
- Panels include 2 raceway cover with punchouts, a power distribution housing, an integrated aluminum top cap and levelling glides.
- 24” wide panels have two punchouts, one for electrical and one for data.
- 30” wide panels and wider have three punchouts, two for electrical and one for data.
- Note: Trim is not required at a straight connection between two panels of the same height.
- Please specify duplex receptacles separately.

PRODUCT CODE	PRICE	SIZE/ INCHES			WEIGHT LBS	VOL FT <sup>3</sup>
		H	W	D		
CMLLM3024P2	562	30	24	2.3	20	2.31
CMLLM3030P2	686	30	30	2.3	25	2.85
CMLLM3036P2	767	30	36	2.3	31	3.38
CMLLM3042P2	854	30	42	2.3	36	3.92
CMLLM3048P2	943	30	48	2.3	41	4.45
CMLLM3054P2	1025	30	54	2.3	46	4.99
CMLLM3060P2	1093	30	60	2.3	51	5.52
CMLLM4224P2	640	42	24	2.3	20	2.31
CMLLM4230P2	777	42	30	2.3	25	2.85
CMLLM4236P2	883	42	36	2.3	31	3.38
CMLLM4242P2	988	42	42	2.3	36	3.92
CMLLM4248P2	1093	42	48	2.3	41	4.45
CMLLM4254P2	1188	42	54	2.3	46	4.99
CMLLM4260P2	1277	42	60	2.3	51	5.52
CMLLM4824P2	735	48	24	2.3	26	2.73
CMLLM4830P2	891	48	30	2.3	33	3.37
CMLLM4836P2	1016	48	36	2.3	39	4.00
CMLLM4842P2	1140	48	42	2.3	46	4.63
CMLLM4848P2	1272	48	48	2.3	52	5.26
CMLLM4854P2	1383	48	54	2.3	59	5.89
CMLLM5424P2	735	54	24	2.3	65	6.53
CMLLM5430P2	891	54	30	2.3	33	3.37
CMLLM5436P2	1016	54	36	2.3	39	4.00
CMLLM5442P2	1140	54	42	2.3	46	4.63
CMLLM5448P2	1272	54	48	2.3	52	5.26
CMLLM5454P2	1383	54	54	2.3	59	5.89
CMLLM6624P2	894	66	24	2.3	32	3.58
CMLLM6630P2	1081	66	30	2.3	40	4.40
CMLLM6636P2	1235	66	36	2.3	48	5.23
CMLLM6642P2	1396	66	42	2.3	56	6.06
CMLLM6648P2	1553	66	48	2.3	64	6.68

**CMFF-N0 • Single Segmented Non Powered Fabric Panel, No Punchouts**

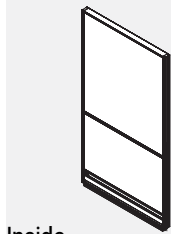

Inside

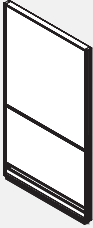

Outside

- Individual fabric-covered modules incorporated into an aluminum frame.
- Opposite sides of each module may have a different fabric within the same grade at no upcharge.
- If different grades of fabric are used on one panel, the entire panel must be priced at highest grade.
- Panels are not tackable.
- Note: Trim is not required at a straight connection between two panels of the same height.
- 3 Panel connector brackets per side come standard with 42" h. and 54" h. panels.
- 4 Panel connector brackets per side come standard with 66" h. panels.
- Panels include 2 raceway covers with no punchouts, an integrated aluminum top cap and levelling glides.

PRODUCT CODE	PRICE		SIZE/ INCHES			WEIGHT VOL	
	GR 1	GR 2	H	W	D	LBS	FT³
CMFF4224N0	286	310	42	24	2.3	20	2.31
CMFF4230N0	355	380	42	30	2.3	25	2.85
CMFF4236N0	383	430	42	36	2.3	31	3.38
CMFF4242N0	438	486	42	42	2.3	36	3.92
CMFF4248N0	468	518	42	48	2.3	41	4.45
CMFF4254N0	509	560	42	54	2.3	46	4.99
CMFF4260N0	561	609	42	60	2.3	51	5.52
CMFF4266N0	726	832	42	66	2.3	55	6.05
CMFF4272N0	763	869	42	72	2.3	60	6.60
CMFF4824N0	334	364	48	24	2.3	26	2.73
CMFF4830N0	383	410	48	30	2.3	33	3.37
CMFF4836N0	436	477	48	36	2.3	39	4.00
CMFF4842N0	499	558	48	42	2.3	46	4.63
CMFF4848N0	531	590	48	48	2.3	52	5.26
CMFF4854N0	584	640	48	54	2.3	59	5.89
CMFF4860N0	617	675	48	60	2.3	65	6.53
CMFF5424N0	334	364	54	24	2.3	26	2.73
CMFF5430N0	383	410	54	30	2.3	33	3.37
CMFF5436N0	436	477	54	36	2.3	39	4.00
CMFF5442N0	499	558	54	42	2.3	46	4.63
CMFF5448N0	531	590	54	48	2.3	52	5.26
CMFF5454N0	584	640	54	54	2.3	59	5.89
CMFF5460N0	617	675	54	60	2.3	65	6.53
CMFF6624N0	371	408	66	24	2.3	32	3.58
CMFF6630N0	413	450	66	30	2.3	40	4.40
CMFF6636N0	495	567	66	36	2.3	48	5.23
CMFF6642N0	561	635	66	42	2.3	56	6.06
CMFF6648N0	587	661	66	48	2.3	64	6.88
CMFF6654N0	641	716	66	54	2.3	72	7.71
CMFF6660N0	686	758	66	60	2.3	80	8.53

**CMFF-N1 • Single Segmented Non Powered Fabric Panel, Punchouts on One Side**

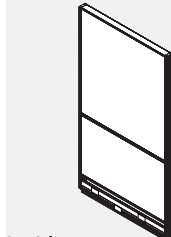

Inside



Outside

- Individual fabric-covered modules incorporated into an aluminum frame.
- Opposite sides of each module may have a different fabric within the same grade at no upcharge.
- If different grades of fabric are used on one panel, the entire panel must be priced at highest grade.
- Panels are not tackable.
- Note: Trim is not required at a straight connection between two panels of the same height.
- 3 Panel connector brackets per side come standard with 42" h. and 54" h. panels.
- 4 Panel connector brackets per side come standard with 66" h. panels.
- Panels include 1 raceway cover with punchouts on one side, 1 raceway cover with no punchouts on the other, an integrated aluminum top cap and levelling glides.
- 24" wide panels have two punchouts, one for electrical and one for data.
- 30" wide panels and wider have three punchouts, two for electrical and one for data.

PRODUCT CODE	PRICE		SIZE/ INCHES			WEIGHT VOL	
	GR 1	GR 2	H	W	D	LBS	FT³
CMFF4224N1	286	310	42	24	2.3	20	2.31
CMFF4230N1	355	380	42	30	2.3	25	2.85
CMFF4236N1	383	430	42	36	2.3	31	3.38
CMFF4242N1	438	486	42	42	2.3	36	3.92
CMFF4248N1	468	518	42	48	2.3	41	4.45
CMFF4254N1	509	560	42	54	2.3	46	4.99
CMFF4260N1	561	609	42	60	2.3	51	5.52
CMFF4266N1	726	832	42	66	2.3	55	6.05
CMFF4272N1	763	869	42	72	2.3	60	6.60
CMFF4824N1	334	364	48	24	2.3	26	2.73
CMFF4830N1	383	410	48	30	2.3	33	3.37
CMFF4836N1	436	477	48	36	2.3	39	4.00
CMFF4842N1	499	558	48	42	2.3	46	4.63
CMFF4848N1	531	590	48	48	2.3	52	5.26
CMFF4854N1	584	640	48	54	2.3	59	5.89
CMFF4860N1	617	675	48	60	2.3	65	6.53
CMFF5424N1	334	364	54	24	2.3	26	2.73
CMFF5430N1	383	410	54	30	2.3	33	3.37
CMFF5436N1	436	477	54	36	2.3	39	4.00
CMFF5442N1	499	558	54	42	2.3	46	4.63
CMFF5448N1	531	590	54	48	2.3	52	5.26
CMFF5454N1	584	640	54	54	2.3	59	5.89
CMFF5460N1	617	675	54	60	2.3	65	6.53
CMFF6624N1	371	408	66	24	2.3	32	3.58
CMFF6630N1	413	450	66	30	2.3	40	4.40
CMFF6636N1	495	567	66	36	2.3	48	5.23
CMFF6642N1	561	635	66	42	2.3	56	6.06
CMFF6648N1	587	661	66	48	2.3	64	6.88
CMFF6654N1	641	716	66	54	2.3	72	7.71
CMFF6660N1	686	758	66	60	2.3	80	8.53



**CMFF-N2 • Single Segmented Non Powered Fabric Panel, Punchouts on Both Sides**

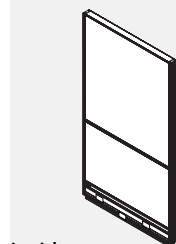

Inside



Outside

- Individual fabric-covered modules incorporated into an aluminum frame.
- Opposite sides of each module may have a different fabric within the same grade at no upcharge.
- If different grades of fabric are used on one panel, the entire panel must be priced at highest grade.
- Panels are not tackable.
- Note: Trim is not required at a straight connection between two panels of the same height.
- 3 Panel connector brackets per side come standard with 42"h. and 54"h. panels.
- 4 Panel connector brackets per side come standard with 66"h. panels.
- Panels include 2 raceway covers with punchouts on both sides, an integrated aluminum top cap and levelling glides.
- 24" wide panels have two punchouts, one for electrical and one for data.
- 30" wide panels and wider have three punchouts, two for electrical and one for data.

PRODUCT CODE	PRICE		SIZE/ INCHES			WEIGHT VOL	
	GR 1	GR 2	H	W	D	LBS	FT <sup>3</sup>
CMFF4224N2	286	310	42	24	2.3	20	2.31
CMFF4230N2	355	380	42	30	2.3	25	2.85
CMFF4236N2	383	430	42	36	2.3	31	3.38
CMFF4242N2	438	486	42	42	2.3	36	3.92
CMFF4248N2	468	518	42	48	2.3	41	4.45
CMFF4254N2	509	560	42	54	2.3	46	4.99
CMFF4260N2	561	609	42	60	2.3	51	5.52
CMFF4266N2	726	832	42	66	2.3	55	6.05
CMFF4272N2	763	869	42	72	2.3	60	6.60
CMFF4824N2	334	364	48	24	2.3	26	2.73
CMFF4830N2	383	410	48	30	2.3	33	3.37
CMFF4836N2	436	477	48	36	2.3	39	4.00
CMFF4842N2	499	558	48	42	2.3	46	4.63
CMFF4848N2	531	590	48	48	2.3	52	5.26
CMFF4854N2	584	640	48	54	2.3	59	5.89
CMFF4860N2	617	675	48	60	2.3	65	6.53
CMFF5424N2	334	364	54	24	2.3	26	2.73
CMFF5430N2	383	410	54	30	2.3	33	3.37
CMFF5436N2	436	477	54	36	2.3	39	4.00
CMFF5442N2	499	558	54	42	2.3	46	4.63
CMFF5448N2	531	590	54	48	2.3	52	5.26
CMFF5454N2	584	640	54	54	2.3	59	5.89
CMFF5460N2	617	675	54	60	2.3	65	6.53
CMFF6624N2	371	408	66	24	2.3	32	3.58
CMFF6630N2	413	450	66	30	2.3	40	4.40
CMFF6636N2	495	567	66	36	2.3	48	5.23
CMFF6642N2	561	635	66	42	2.3	56	6.06
CMFF6648N2	587	661	66	48	2.3	64	6.88
CMFF6654N2	641	716	66	54	2.3	72	7.71
CMFF6660N2	686	758	66	60	2.3	80	8.53

**CMFF-P1 • Single Segmented Powered Fabric Panel, Punchouts on One Side**

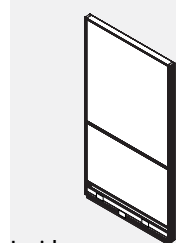

Inside

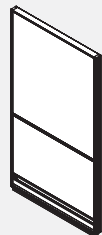

Outside

- Individual fabric-covered modules incorporated into an aluminum frame.
- Opposite sides of each module may have a different fabric within the same grade at no upcharge.
- If different grades of fabric are used on one panel, the entire panel must be priced at highest grade.
- Panels are not tackable.
- Note: Trim is not required at a straight connection between two panels of the same height.
- 3 Panel connector brackets per side come standard with 42"h. and 54"h. panels.
- 4 Panel connector brackets per side come standard with 66"h. panels.
- Panels include 1 raceway cover with punchouts on one side, 1 raceway cover with no punchouts on the other, a power distribution housing, an integrated aluminum top cap and levelling glides.
- 24" wide panels have two punchouts, one for electrical and one for data.
- 30" wide panels and wider have three punchouts, two for electrical and one for data.
- Please specify duplex receptacles separately.

PRODUCT CODE	PRICE		SIZE/ INCHES			WEIGHT VOL	
	GR 1	GR 2	H	W	D	LBS	FT <sup>3</sup>
CMFF4224P1	420	444	42	24	2.3	20	2.31
CMFF4230P1	535	561	42	30	2.3	25	2.85
CMFF4236P1	573	620	42	36	2.3	31	3.38
CMFF4242P1	635	681	42	42	2.3	36	3.92
CMFF4248P1	674	724	42	48	2.3	41	4.45
CMFF4254P1	723	769	42	54	2.3	46	4.99
CMFF4260P1	773	821	42	60	2.3	51	5.52
CMFF4266P1	947	1054	42	66	2.3	55	6.05
CMFF4272P1	992	1097	42	72	2.3	60	6.60
CMFF4824P1	470	499	48	24	2.3	26	2.73
CMFF4830P1	563	592	48	30	2.3	33	3.37
CMFF4836P1	625	669	48	36	2.3	39	4.00
CMFF4842P1	696	755	48	42	2.3	46	4.63
CMFF4848P1	739	799	48	48	2.3	52	5.26
CMFF4854P1	793	853	48	54	2.3	59	5.89
CMFF4860P1	829	889	48	60	2.3	65	6.53
CMFF5424P1	470	499	54	24	2.3	26	2.73
CMFF5430P1	563	592	54	30	2.3	33	3.37
CMFF5436P1	625	669	54	36	2.3	39	4.00
CMFF5442P1	696	755	54	42	2.3	46	4.63
CMFF5448P1	739	799	54	48	2.3	52	5.26
CMFF5454P1	793	853	54	54	2.3	59	5.89
CMFF5460P1	829	889	54	60	2.3	65	6.53
CMFF6624P1	505	545	66	24	2.3	32	3.58
CMFF6630P1	594	634	66	30	2.3	40	4.40
CMFF6636P1	686	758	66	36	2.3	48	5.23
CMFF6642P1	757	829	66	42	2.3	56	6.06
CMFF6648P1	795	868	66	48	2.3	64	6.88
CMFF6654P1	854	927	66	54	2.3	72	7.71
CMFF6660P1	898	970	66	60	2.3	80	8.53

**CMFF-P2 • Single Segmented Powered Fabric Panel, Punchouts on Both Sides**

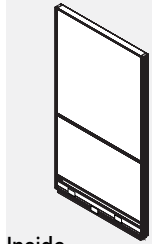

Inside

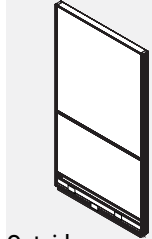

Outside

- Individual fabric-covered modules incorporated into an aluminum frame.
- Opposite sides of each module may have a different fabric within the same grade at no upcharge.
- If different grades of fabric are used on one panel, the entire panel must be priced at highest grade.
- Panels are not tackable.
- Note: Trim is not required at a straight connection between two panels of the same height.
- 3 Panel connector brackets per side come standard with 42”h. and 54”h. panels.
- 4 Panel connector brackets per side come standard with 66”h. panels.
- Panels include 2 raceway covers with punchouts on both sides, a power distribution housing, an integrated aluminum top cap and levelling glides.
- 24” wide panels have two punchouts, one for electrical and one for data.
- 30” wide panels and wider have three punchouts, two for electrical and one for data.
- Please specify duplex receptacles separately.

PRODUCT CODE	PRICE		SIZE/ INCHES			WEIGHT VOL	
	GR 1	GR 2	H	W	D	LBS	FT³
CMFF4224P2	420	444	42	24	2.3	20	2.31
CMFF4230P2	535	561	42	30	2.3	25	2.85
CMFF4236P2	573	620	42	36	2.3	31	3.38
CMFF4242P2	635	681	42	42	2.3	36	3.92
CMFF4248P2	674	724	42	48	2.3	41	4.45
CMFF4254P2	723	769	42	54	2.3	46	4.99
CMFF4260P2	773	821	42	60	2.3	51	5.52
CMFF4266P2	947	1054	42	66	2.3	55	6.05
CMFF4272P2	992	1097	42	72	2.3	60	6.60
CMFF4824P2	470	499	48	24	2.3	26	2.73
CMFF4830P2	563	592	48	30	2.3	33	3.37
CMFF4836P2	625	669	48	36	2.3	39	4.00
CMFF4842P2	696	755	48	42	2.3	46	4.63
CMFF4848P2	739	799	48	48	2.3	52	5.26
CMFF4854P2	793	853	48	54	2.3	59	5.89
CMFF4860P2	829	889	48	60	2.3	65	6.53
CMFF5424P2	470	499	54	24	2.3	26	2.73
CMFF5430P2	563	592	54	30	2.3	33	3.37
CMFF5436P2	625	669	54	36	2.3	39	4.00
CMFF5442P2	696	755	54	42	2.3	46	4.63
CMFF5448P2	739	799	54	48	2.3	52	5.26
CMFF5454P2	793	853	54	54	2.3	59	5.89
CMFF5460P2	829	889	54	60	2.3	65	6.53
CMFF6624P2	505	545	66	24	2.3	32	3.58
CMFF6630P2	594	634	66	30	2.3	40	4.40
CMFF6636P2	686	758	66	36	2.3	48	5.23
CMFF6642P2	757	829	66	42	2.3	56	6.06
CMFF6648P2	795	868	66	48	2.3	64	6.88
CMFF6654P2	854	927	66	54	2.3	72	7.71
CMFF6660P2	898	970	66	60	2.3	80	8.53

**CMFL-N0 • Single Segmented Non Powered Laminate One Side Panel, No Punchouts**

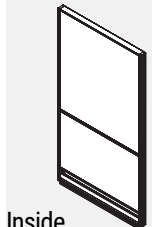

Inside

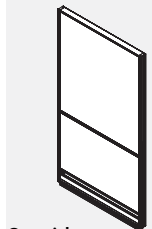

Outside

- Individual fabric or laminate covered modules incorporated into an aluminum frame.
- Modules have laminate on one side and fabric on the other.
- If different grades of fabric are used on one panel, the entire panel must be priced at highest grade.
- Panels are not tackable.
- Note: Trim is not required at a straight connection between two panels of the same height.
- 3 Panel connector brackets per side come standard with 30” to 54”h. panels.
- 4 Panel connector brackets per side come standard with 66”h. panels.
- Panels include 2 raceway covers with no punchouts, an integrated aluminum top cap and levelling glides.

PRODUCT CODE	PRICE		SIZE/ INCHES			WEIGHT VOL	
	GR 1	GR 2	H	W	D	LBS	FT³
CMFL4224N0	450	463	42	24	2.3	20	2.31
CMFL4230N0	526	537	42	30	2.3	25	2.85
CMFL4236N0	605	622	42	36	2.3	31	3.38
CMFL4242N0	686	703	42	42	2.3	36	3.92
CMFL4248N0	744	765	42	48	2.3	41	4.45
CMFL4254N0	828	853	42	54	2.3	46	4.99
CMFL4260N0	908	934	42	60	2.3	51	5.52
CMFL4824N0	534	550	48	24	2.3	26	2.73
CMFL4830N0	628	646	48	30	2.3	33	3.37
CMFL4836N0	719	740	48	36	2.3	39	4.00
CMFL4842N0	815	839	48	42	2.3	46	4.63
CMFL4848N0	890	919	48	48	2.3	52	5.26
CMFL4854N0	991	1021	48	54	2.3	59	5.89
CMFL4860N0	1089	1122	48	60	2.3	65	6.53
CMFL5424N0	534	550	54	24	2.3	26	2.73
CMFL5430N0	628	646	54	30	2.3	33	3.37
CMFL5436N0	719	740	54	36	2.3	39	4.00
CMFL5442N0	815	839	54	42	2.3	46	4.63
CMFL5448N0	890	919	54	48	2.3	52	5.26
CMFL5454N0	991	1021	54	54	2.3	59	5.89
CMFL5460N0	1089	1122	54	60	2.3	65	6.53
CMFL6624N0	663	679	66	24	2.3	32	3.58
CMFL6630N0	773	796	66	30	2.3	40	4.40
CMFL6636N0	891	920	66	36	2.3	48	5.23
CMFL6642N0	1016	1047	66	42	2.3	56	6.06
CMFL6648N0	1106	1140	66	48	2.3	64	6.88
CMFL6654N0	1228	1265	66	54	2.3	72	7.71
CMFL6660N0	1354	1396	66	60	2.3	80	8.53

**CMFL-N1 • Single Segmented Non Powered Laminate One Side Panel, Punchouts on One Side**

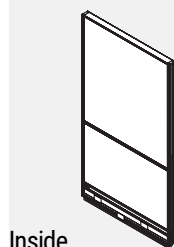

Inside

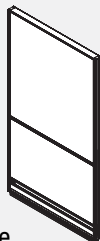

Outside

- Individual fabric or laminate covered modules incorporated into an aluminum frame.
- Modules have laminate on one side and fabric on the other.
- If different grades of fabric are used on one panel, the entire panel must be priced at highest grade.
- Panels are not tackable.
- Note: Trim is not required at a straight connection between two panels of the same height.
- 3 Panel connector brackets per side come standard with 30”h. to 54”h. panels.
- 4 Panel connector brackets per side come standard with 66”h. panels.
- Panels include 1 raceway cover with punchouts on one side, 1 raceway cover with no punchouts on the other, an integrated aluminum top cap and levelling glides.
- 24” wide panels have two punchouts, one for electrical and one for data.
- 30” wide panels and wider have three punchouts, two for electrical and one for data.

PRODUCT CODE	PRICE		SIZE/ INCHES			WEIGHT VOL	
	GR 1	GR 2	H	W	D	LBS	FT <sup>3</sup>
CMFL4224N1	450	463	42	24	2.3	20	2.31
CMFL4230N1	526	537	42	30	2.3	25	2.85
CMFL4236N1	605	622	42	36	2.3	31	3.38
CMFL4242N1	686	703	42	42	2.3	36	3.92
CMFL4248N1	744	765	42	48	2.3	41	4.45
CMFL4254N1	828	853	42	54	2.3	46	4.99
CMFL4260N1	908	934	42	60	2.3	51	5.52
CMFL4824N1	534	550	48	24	2.3	26	2.73
CMFL4830N1	628	646	48	30	2.3	33	3.37
CMFL4836N1	719	740	48	36	2.3	39	4.00
CMFL4842N1	815	839	48	42	2.3	46	4.63
CMFL4848N1	890	919	48	48	2.3	52	5.26
CMFL4854N1	991	1021	48	54	2.3	59	5.89
CMFL4860N1	1089	1122	48	60	2.3	65	6.53
CMFL5424N1	534	550	54	24	2.3	26	2.73
CMFL5430N1	628	646	54	30	2.3	33	3.37
CMFL5436N1	719	740	54	36	2.3	39	4.00
CMFL5442N1	815	839	54	42	2.3	46	4.63
CMFL5448N1	890	919	54	48	2.3	52	5.26
CMFL5454N1	991	1021	54	54	2.3	59	5.89
CMFL5460N1	1089	1122	54	60	2.3	65	6.53
CMFL6624N1	663	679	66	24	2.3	32	3.58
CMFL6630N1	773	796	66	30	2.3	40	4.40
CMFL6636N1	891	920	66	36	2.3	48	5.23
CMFL6642N1	1016	1047	66	42	2.3	56	6.06
CMFL6648N1	1106	1140	66	48	2.3	64	6.88
CMFL6654N1	1228	1265	66	54	2.3	72	7.71
CMFL6660N1	1354	1396	66	60	2.3	80	8.53

**CMFL-N2 • Single Segmented Non Powered Laminate One Side Panel, Punchouts on Both Sides**

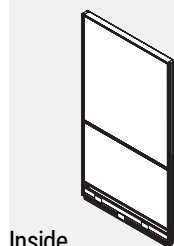

Inside

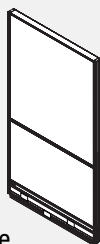

Outside

- Individual fabric or laminate covered modules incorporated into an aluminum frame.
- Modules have laminate on one side and fabric on the other.
- If different grades of fabric are used on one panel, the entire panel must be priced at highest grade.
- Panels are not tackable.
- Note: Trim is not required at a straight connection between two panels of the same height.
- 3 Panel connector brackets per side come standard with 30”h. to 54”h. panels.
- 4 Panel connector brackets per side come standard with 66”h. panels.
- Panels include 2 raceway covers with punchouts on both sides, an integrated aluminum top cap and levelling glides.
- 24” wide panels have two punchouts, one for electrical and one for data.
- 30” wide panels and wider have three punchouts, two for electrical and one for data.

PRODUCT CODE	PRICE		SIZE/ INCHES			WEIGHT VOL	
	GR 1	GR 2	H	W	D	LBS	FT <sup>3</sup>
CMFL4224N2	450	463	42	24	2.3	20	2.31
CMFL4230N2	526	537	42	30	2.3	25	2.85
CMFL4236N2	605	622	42	36	2.3	31	3.38
CMFL4242N2	686	703	42	42	2.3	36	3.92
CMFL4248N2	744	765	42	48	2.3	41	4.45
CMFL4254N2	828	853	42	54	2.3	46	4.99
CMFL4260N2	908	934	42	60	2.3	51	5.52
CMFL4824N2	534	550	48	24	2.3	26	2.73
CMFL4830N2	628	646	48	30	2.3	33	3.37
CMFL4836N2	719	740	48	36	2.3	39	4.00
CMFL4842N2	815	839	48	42	2.3	46	4.63
CMFL4848N2	890	919	48	48	2.3	52	5.26
CMFL4854N2	991	1021	48	54	2.3	59	5.89
CMFL4860N2	1089	1122	48	60	2.3	65	6.53
CMFL5424N2	534	550	54	24	2.3	26	2.73
CMFL5430N2	628	646	54	30	2.3	33	3.37
CMFL5436N2	719	740	54	36	2.3	39	4.00
CMFL5442N2	815	839	54	42	2.3	46	4.63
CMFL5448N2	890	919	54	48	2.3	52	5.26
CMFL5454N2	991	1021	54	54	2.3	59	5.89
CMFL5460N2	1089	1122	54	60	2.3	65	6.53
CMFL6624N2	663	679	66	24	2.3	32	3.58
CMFL6630N2	773	796	66	30	2.3	40	4.40
CMFL6636N2	891	920	66	36	2.3	48	5.23
CMFL6642N2	1016	1047	66	42	2.3	56	6.06
CMFL6648N2	1106	1140	66	48	2.3	64	6.88
CMFL6654N2	1228	1265	66	54	2.3	72	7.71
CMFL6660N2	1354	1396	66	60	2.3	80	8.53

**CMFL-P1 • Single Segmented Powered Laminate One Side Panel, Punchouts on One Side**

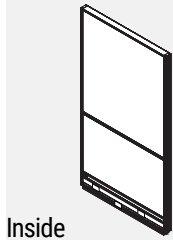

Inside

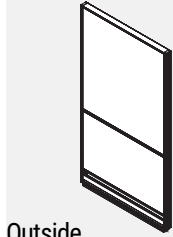

Outside

- Individual fabric or laminate covered modules incorporated into an aluminum frame.
- Modules have laminate on one side and fabric on the other.
- If different grades of fabric are used on one panel, the entire panel must be priced at highest grade.
- Panels are not tackable.
- Note: Trim is not required at a straight connection between two panels of the same height.
- 3 Panel connector brackets per side come standard with 30”h. to 54”h. panels.
- 4 Panel connector brackets per side come standard with 66”h. panels.
- Panels include 1 raceway cover with punchouts on one side, 1 raceway cover with no punchouts on the other, a power distribution housing, an integrated aluminum top cap and levelling glides.
- 24” wide panels have two punchouts, one for electrical and one for data.
- 30” wide panels and wider have three punchouts, two for electrical and one for data.
- Please specify duplex receptacles separately.

PRODUCT CODE	PRICE		SIZE/ INCHES			WEIGHT VOL	
	GR 1	GR 2	H	W	D	LBS	FT³
CMFL4224P1	586	596	42	24	2.3	20	2.31
CMFL4230P1	705	722	42	30	2.3	25	2.85
CMFL4236P1	795	813	42	36	2.3	31	3.38
CMFL4242P1	882	901	42	42	2.3	36	3.92
CMFL4248P1	954	972	42	48	2.3	41	4.45
CMFL4254P1	1038	1062	42	54	2.3	46	4.99
CMFL4260P1	1120	1146	42	60	2.3	51	5.52
CMFL4824P1	669	684	48	24	2.3	26	2.73
CMFL4830P1	809	827	48	30	2.3	33	3.37
CMFL4836P1	909	931	48	36	2.3	39	4.00
CMFL4842P1	1010	1034	48	42	2.3	46	4.63
CMFL4848P1	1098	1124	48	48	2.3	52	5.26
CMFL4854P1	1200	1230	48	54	2.3	59	5.89
CMFL4860P1	1301	1335	48	60	2.3	65	6.53
CMFL5424P1	669	684	54	24	2.3	26	2.73
CMFL5430P1	809	827	54	30	2.3	33	3.37
CMFL5436P1	909	931	54	36	2.3	39	4.00
CMFL5442P1	1010	1034	54	42	2.3	46	4.63
CMFL5448P1	1098	1124	54	48	2.3	52	5.26
CMFL5454P1	1200	1230	54	54	2.3	59	5.89
CMFL5460P1	1301	1335	54	60	2.3	65	6.53
CMFL6624P1	799	816	66	24	2.3	32	3.58
CMFL6630P1	955	977	66	30	2.3	40	4.40
CMFL6636P1	1082	1110	66	36	2.3	48	5.23
CMFL6642P1	1210	1241	66	42	2.3	56	6.06
CMFL6648P1	1313	1349	66	48	2.3	64	6.88
CMFL6654P1	1439	1476	66	54	2.3	72	7.71
CMFL6660P1	1566	1608	66	60	2.3	80	8.53

**CMFL-P2 • Single Segmented Powered Laminate One Side Panel, Punchouts on Both Sides**

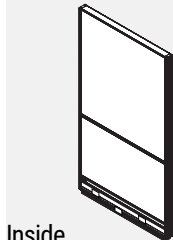

Inside

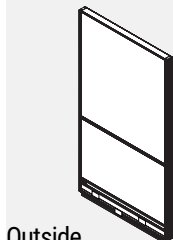

Outside

- Individual fabric or laminate covered modules incorporated into an aluminum frame.
- Modules have laminate on one side and fabric on the other.
- If different grades of fabric are used on one panel, the entire panel must be priced at highest grade.
- Panels are not tackable.
- Note: Trim is not required at a straight connection between two panels of the same height.
- 3 Panel connector brackets per side come standard with 30”h. to 54”h. panels.
- 4 Panel connector brackets per side come standard with 66”h. panels.
- Panels include 2 raceway covers with punchouts on both sides, a power distribution housing, an integrated aluminum top cap and levelling glides.
- 24” wide panels have two punchouts, one for electrical and one for data.
- 30” wide panels and wider have three punchouts, two for electrical and one for data.
- Please specify duplex receptacles separately.

PRODUCT CODE	PRICE		SIZE/ INCHES			WEIGHT VOL	
	GR 1	GR 2	H	W	D	LBS	FT³
CMFL4224P2	586	596	42	24	2.3	20	2.31
CMFL4230P2	705	722	42	30	2.3	25	2.85
CMFL4236P2	795	813	42	36	2.3	31	3.38
CMFL4242P2	882	901	42	42	2.3	36	3.92
CMFL4248P2	954	972	42	48	2.3	41	4.45
CMFL4254P2	1038	1062	42	54	2.3	46	4.99
CMFL4260P2	1120	1146	42	60	2.3	51	5.52
CMFL4824P2	669	684	48	24	2.3	26	2.73
CMFL4830P2	809	827	48	30	2.3	33	3.37
CMFL4836P2	909	931	48	36	2.3	39	4.00
CMFL4842P2	1010	1034	48	42	2.3	46	4.63
CMFL4848P2	1098	1124	48	48	2.3	52	5.26
CMFL4854P2	1200	1230	48	54	2.3	59	5.89
CMFL4860P2	1301	1335	48	60	2.3	65	6.53
CMFL5424P2	669	684	54	24	2.3	26	2.73
CMFL5430P2	809	827	54	30	2.3	33	3.37
CMFL5436P2	909	931	54	36	2.3	39	4.00
CMFL5442P2	1010	1034	54	42	2.3	46	4.63
CMFL5448P2	1098	1124	54	48	2.3	52	5.26
CMFL5454P2	1200	1230	54	54	2.3	59	5.89
CMFL5460P2	1301	1335	54	60	2.3	65	6.53
CMFL6624P2	799	816	66	24	2.3	32	3.58
CMFL6630P2	955	977	66	30	2.3	40	4.40
CMFL6636P2	1082	1110	66	36	2.3	48	5.23
CMFL6642P2	1210	1241	66	42	2.3	56	6.06
CMFL6648P2	1313	1349	66	48	2.3	64	6.88
CMFL6654P2	1439	1476	66	54	2.3	72	7.71
CMFL6660P2	1566	1608	66	60	2.3	80	8.53

**CMLL-N0 • Single Segmented Non Powered Laminate Two Sides Panel, No Punchouts**

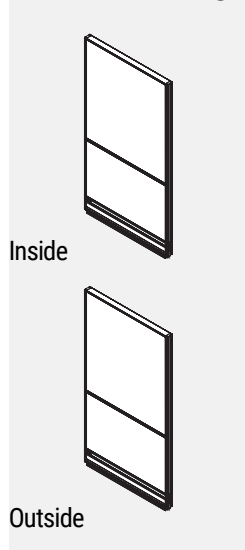

- Individual laminate covered modules incorporated into an aluminum frame.
- Opposite sides of each module may have a different laminate within the same grade at no upcharge.
- Note: Trim is not required at a straight connection between two panels of the same height.
- 3 Panel connector brackets per side come standard with 30" h. to 54" h. panels.
- 4 Panel connector brackets per side come standard with 66" h. panels.
- Panels include 2 raceway covers with no punchouts, an integrated aluminum top cap and levelling glides.

PRODUCT CODE	PRICE	SIZE/ INCHES			WEIGHT VOL	
		H	W	D	LBS	FT <sup>3</sup>
CMLL4224N0	512	42	24	2.3	20	2.31
CMLL4230N0	604	42	30	2.3	25	2.85
CMLL4236N0	701	42	36	2.3	31	3.38
CMLL4242N0	801	42	42	2.3	36	3.92
CMLL4248N0	895	42	48	2.3	41	4.45
CMLL4254N0	987	42	54	2.3	46	4.99
CMLL4260N0	1075	42	60	2.3	51	5.52
CMLL4824N0	607	48	24	2.3	26	2.73
CMLL4830N0	719	48	30	2.3	33	3.37
CMLL4836N0	835	48	36	2.3	39	4.00
CMLL4842N0	954	48	42	2.3	46	4.63
CMLL4848N0	1075	48	48	2.3	52	5.26
CMLL4854N0	1181	48	54	2.3	59	5.89
CMLL4860N0	1287	48	60	2.3	65	6.53
CMLL5424N0	607	54	24	2.3	26	2.73
CMLL5430N0	719	54	30	2.3	33	3.37
CMLL5436N0	835	54	36	2.3	39	4.00
CMLL5442N0	954	54	42	2.3	46	4.63
CMLL5448N0	1075	54	48	2.3	52	5.26
CMLL5454N0	1181	54	54	2.3	59	5.89
CMLL5460N0	1287	54	60	2.3	65	6.53
CMLL6624N0	765	66	24	2.3	32	3.58
CMLL6630N0	908	66	30	2.3	40	4.40
CMLL6636N0	1055	66	36	2.3	48	5.23
CMLL6642N0	1208	66	42	2.3	56	6.06
CMLL6648N0	1354	66	48	2.3	64	6.88
CMLL6654N0	1496	66	54	2.3	72	7.71
CMLL6660N0	1635	66	60	2.3	80	8.53

**CMLL-N1 • Single Segmented Non Powered Laminate Two Sides Panel, Punchouts on One Side**

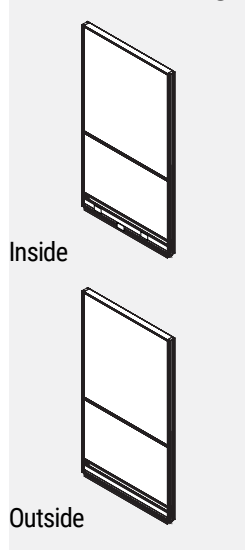

- Individual laminate covered modules incorporated into an aluminum frame.
- Opposite sides of each module may have a different laminate within the same grade at no upcharge.
- Note: Trim is not required at a straight connection between two panels of the same height.
- 3 Panel connector brackets per side come standard with 30" h. to 54" h. panels.
- 4 Panel connector brackets per side come standard with 66" h. panels.
- Panels include 1 raceway cover with punchouts on one side, 1 raceway cover with no punchouts on the other, an integrated aluminum top cap and levelling glides.
- 24" wide panels have two punchouts, one for electrical and one for data.
- 30" wide panels and wider have three punchouts, two for electrical and one for data.

PRODUCT CODE	PRICE	SIZE/ INCHES			WEIGHT VOL	
		H	W	D	LBS	FT <sup>3</sup>
CMLL4224N1	512	42	24	2.3	20	2.31
CMLL4230N1	604	42	30	2.3	25	2.85
CMLL4236N1	701	42	36	2.3	31	3.38
CMLL4242N1	801	42	42	2.3	36	3.92
CMLL4248N1	895	42	48	2.3	41	4.45
CMLL4254N1	987	42	54	2.3	46	4.99
CMLL4260N1	1075	42	60	2.3	51	5.52
CMLL4824N1	607	48	24	2.3	26	2.73
CMLL4830N1	719	48	30	2.3	33	3.37
CMLL4836N1	835	48	36	2.3	39	4.00
CMLL4842N1	954	48	42	2.3	46	4.63
CMLL4848N1	1075	48	48	2.3	52	5.26
CMLL4854N1	1181	48	54	2.3	59	5.89
CMLL4860N1	1287	48	60	2.3	65	6.53
CMLL5424N1	607	54	24	2.3	26	2.73
CMLL5430N1	719	54	30	2.3	33	3.37
CMLL5436N1	835	54	36	2.3	39	4.00
CMLL5442N1	954	54	42	2.3	46	4.63
CMLL5448N1	1075	54	48	2.3	52	5.26
CMLL5454N1	1181	54	54	2.3	59	5.89
CMLL5460N1	1287	54	60	2.3	65	6.53
CMLL6624N1	765	66	24	2.3	32	3.58
CMLL6630N1	908	66	30	2.3	40	4.40
CMLL6636N1	1055	66	36	2.3	48	5.23
CMLL6642N1	1208	66	42	2.3	56	6.06
CMLL6648N1	1354	66	48	2.3	64	6.88
CMLL6654N1	1496	66	54	2.3	72	7.71
CMLL6660N1	1635	66	60	2.3	80	8.53

**CMLL-N2 • Single Segmented Non Powered Laminate Two Sides Panel, Punchouts on Both Sides**

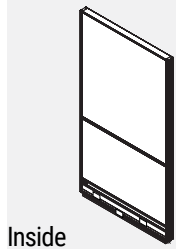

Inside

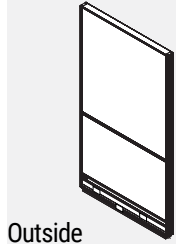

Outside

- Individual laminate covered modules incorporated into an aluminum frame.
- Opposite sides of each module may have a different laminate within the same grade at no upcharge.
- Note: Trim is not required at a straight connection between two panels of the same height.
- 3 Panel connector brackets per side come standard with 30”h. to 54”h. panels.
- 4 Panel connector brackets per side come standard with 66”h. panels.
- Panels include 2 raceway covers with punchouts on both sides, an integrated aluminum top cap and levelling glides.
- 24” wide panels have two punchouts, one for electrical and one for data.
- 30” wide panels and wider have three punchouts, two for electrical and one for data.

PRODUCT CODE	PRICE	SIZE/ INCHES			WEIGHT VOL	
		H	W	D	LBS	FT <sup>3</sup>
CMLL4224N2	512	42	24	2.3	20	2.31
CMLL4230N2	604	42	30	2.3	25	2.85
CMLL4236N2	701	42	36	2.3	31	3.38
CMLL4242N2	801	42	42	2.3	36	3.92
CMLL4248N2	895	42	48	2.3	41	4.45
CMLL4254N2	987	42	54	2.3	46	4.99
CMLL4260N2	1075	42	60	2.3	51	5.52
CMLL4824N2	607	48	24	2.3	26	2.73
CMLL4830N2	719	48	30	2.3	33	3.37
CMLL4836N2	835	48	36	2.3	39	4.00
CMLL4842N2	954	48	42	2.3	46	4.63
CMLL4848N2	1075	48	48	2.3	52	5.26
CMLL4854N2	1181	48	54	2.3	59	5.89
CMLL4860N2	1287	48	60	2.3	65	6.53
CMLL5424N2	607	54	24	2.3	26	2.73
CMLL5430N2	719	54	30	2.3	33	3.37
CMLL5436N2	835	54	36	2.3	39	4
CMLL5442N2	954	54	42	2.3	46	4.63
CMLL5448N2	1075	54	48	2.3	52	5.26
CMLL5454N2	1181	54	54	2.3	59	5.89
CMLL5460N2	1287	54	60	2.3	65	6.53
CMLL6624N2	765	66	24	2.3	32	3.58
CMLL6630N2	908	66	30	2.3	40	4.4
CMLL6636N2	1055	66	36	2.3	48	5.23
CMLL6642N2	1208	66	42	2.3	56	6.06
CMLL6648N2	1354	66	48	2.3	64	6.88
CMLL6654N2	1496	66	54	2.3	72	7.71
CMLL6660N2	1635	66	60	2.3	80	8.53

**CMLL-P1 • Single Segmented Powered Laminate Two Sides Panel, Punchouts on One Side**

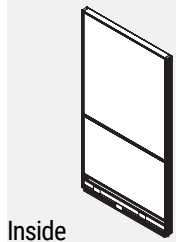

Inside

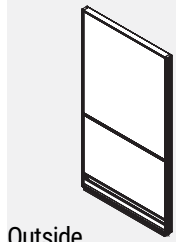

Outside

- Individual laminate covered modules incorporated into an aluminum frame.
- Opposite sides of each module may have a different laminate within the same grade at no upcharge.
- Note: Trim is not required at a straight connection between two panels of the same height.
- 3 Panel connector brackets per side come standard with 30”h. to 54”h. panels.
- 4 Panel connector brackets per side come standard with 66”h. panels.
- Panels include 1 raceway cover with punchouts on one side, 1 raceway cover with no punchouts on the other, a power distribution housing, an integrated aluminum top cap and levelling glides.
- 24” wide panels have two punchouts, one for electrical and one for data.
- 30” wide panels and wider have three punchouts, two for electrical and one for data.
- Please specify duplex receptacles separately.

PRODUCT CODE	PRICE	SIZE/ INCHES			WEIGHT VOL	
		H	W	D	LBS	FT <sup>3</sup>
CMLL4224P1	647	42	24	2.3	20	2.31
CMLL4230P1	785	42	30	2.3	25	2.85
CMLL4236P1	891	42	36	2.3	31	3.38
CMLL4242P1	997	42	42	2.3	36	3.92
CMLL4248P1	1104	42	48	2.3	41	4.45
CMLL4254P1	1198	42	54	2.3	46	4.99
CMLL4260P1	1287	42	60	2.3	51	5.52
CMLL4824P1	740	48	24	2.3	26	2.73
CMLL4830P1	901	48	30	2.3	33	3.37
CMLL4836P1	1025	48	36	2.3	39	4.00
CMLL4842P1	1148	48	42	2.3	46	4.63
CMLL4848P1	1284	48	48	2.3	52	5.26
CMLL4854P1	1393	48	54	2.3	59	5.89
CMLL4860P1	1498	48	60	2.3	65	6.53
CMLL5424P1	740	54	24	2.3	26	2.73
CMLL5430P1	901	54	30	2.3	33	3.37
CMLL5436P1	1025	54	36	2.3	39	4
CMLL5442P1	1148	54	42	2.3	46	4.63
CMLL5448P1	1284	54	48	2.3	52	5.26
CMLL5454P1	1393	54	54	2.3	59	5.89
CMLL5460P1	1498	54	60	2.3	65	6.53
CMLL6624P1	901	66	24	2.3	32	3.58
CMLL6630P1	1089	66	30	2.3	40	4.4
CMLL6636P1	1246	66	36	2.3	48	5.23
CMLL6642P1	1405	66	42	2.3	56	6.06
CMLL6648P1	1561	66	48	2.3	64	6.88
CMLL6654P1	1706	66	54	2.3	72	7.71
CMLL6660P1	1848	66	60	2.3	80	8.53

**CMLL-P2 • Single Segmented Powered Laminate Two Sides Panel, Punchouts on Both Sides**

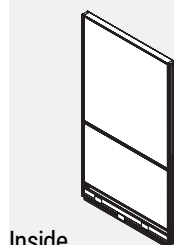

Inside

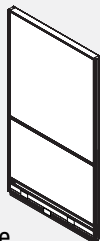

Outside

- Individual laminate covered modules incorporated into an aluminum frame.
- Opposite sides of each module may have a different laminate within the same grade at no upcharge.
- Note: Trim is not required at a straight connection between two panels of the same height.
- 3 Panel connector brackets per side come standard with 30”h. to 54”h. panels.
- 4 Panel connector brackets per side come standard with 66”h. panels.
- Panels include 2 raceway covers with punchouts on both sides, a power distribution housing, an integrated aluminum top cap and levelling glides.
- 24” wide panels have two punchouts, one for electrical and one for data.
- 30” wide panels and wider have three punchouts, two for electrical and one for data.
- Please specify duplex receptacles separately.

PRODUCT CODE	PRICE	SIZE/ INCHES			WEIGHT VOL	
		H	W	D	LBS	FT <sup>3</sup>
CMLL4224P2	647	42	24	2.3	20	2.31
CMLL4230P2	785	42	30	2.3	25	2.85
CMLL4236P2	891	42	36	2.3	31	3.38
CMLL4242P2	997	42	42	2.3	36	3.92
CMLL4248P2	1104	42	48	2.3	41	4.45
CMLL4254P2	1198	42	54	2.3	46	4.99
CMLL4260P2	1287	42	60	2.3	51	5.52
CMLL4824P2	740	48	24	2.3	26	2.73
CMLL4830P2	901	48	30	2.3	33	3.37
CMLL4836P2	1025	48	36	2.3	39	4.00
CMLL4842P2	1148	48	42	2.3	46	4.63
CMLL4848P2	1284	48	48	2.3	52	5.26
CMLL4854P2	1393	48	54	2.3	59	5.89
CMLL4860P2	1498	48	60	2.3	65	6.53
CMLL5424P2	740	54	24	2.3	26	2.73
CMLL5430P2	901	54	30	2.3	33	3.37
CMLL5436P2	1025	54	36	2.3	39	4
CMLL5442P2	1148	54	42	2.3	46	4.63
CMLL5448P2	1284	54	48	2.3	52	5.26
CMLL5454P2	1393	54	54	2.3	59	5.89
CMLL5460P2	1498	54	60	2.3	65	6.53
CMLL6624P2	901	66	24	2.3	32	3.58
CMLL6630P2	1089	66	30	2.3	40	4.4
CMLL6636P2	1246	66	36	2.3	48	5.23
CMLL6642P2	1405	66	42	2.3	56	6.06
CMLL6648P2	1561	66	48	2.3	64	6.88
CMLL6654P2	1706	66	54	2.3	72	7.71
CMLL6660P2	1848	66	60	2.3	80	8.53

**CMFW-N0 • Single Segmented Non Powered Write Board One Side Panel, No Punchouts**

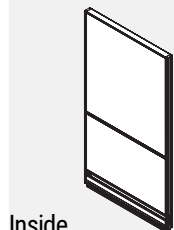

Inside

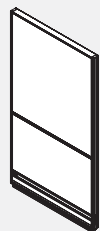

Outside

- Individual fabric or write board covered modules incorporated into an aluminum frame.
- Modules have write board on one side and fabric on the other at the top and fabric on two sides at the bottom.
- If different grades of fabric are used on one panel, the entire panel must be priced at highest grade.
- Panels are not tackable.
- Note: Trim is not required at a straight connection between two panels of the same height.
- 3 Panel connector brackets per side come standard with 30”h. to 54”h. panels.
- 4 Panel connector brackets per side come standard with 66”h. panels.
- Panels include 2 raceway covers with no punchouts, an integrated aluminum top cap and levelling glides.

PRODUCT CODE	PRICE		SIZE/ INCHES			WEIGHT VOL	
	GR 1	GR 2	H	W	D	LBS	FT <sup>3</sup>
CMFW4824N0	480	502	48	24	2.3	26	2.73
CMFW4830N0	578	605	48	30	2.3	33	3.37
CMFW4836N0	639	671	48	36	2.3	39	4.00
CMFW4842N0	722	758	48	42	2.3	46	4.63
CMFW4848N0	813	851	48	48	2.3	52	5.26
CMFW4854N0	904	936	48	54	2.3	59	5.89
CMFW4860N0	996	1048	48	60	2.3	65	6.53
CMFW5424N0	480	502	54	24	2.3	26	2.73
CMFW5430N0	576	604	54	30	2.3	33	3.37
CMFW5436N0	639	671	54	36	2.3	39	4
CMFW5442N0	723	758	54	42	2.3	46	4.63
CMFW5448N0	813	853	54	48	2.3	52	5.26
CMFW5454N0	904	935	54	54	2.3	59	5.89
CMFW5460N0	996	1048	54	60	2.3	65	6.53
CMFW6624N0	605	635	66	24	2.3	32	3.58
CMFW6630N0	719	755	66	30	2.3	40	4.4
CMFW6636N0	800	842	66	36	2.3	48	5.23
CMFW6642N0	906	955	66	42	2.3	56	6.06
CMFW6648N0	1011	1064	66	48	2.3	64	6.88
CMFW6654N0	1126	1187	66	54	2.3	72	7.71
CMFW6660N0	1242	1309	66	60	2.3	80	8.53

**CMFW-N1 • Single Segmented Non Powered Write Board One Side Panel, Punchouts on One Side**

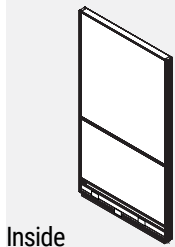

Inside

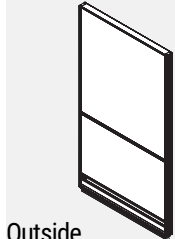

Outside

- Individual fabric or write board covered modules incorporated into an aluminum frame.
- Modules have write board on one side and fabric on the other at the top and fabric on two sides at the bottom.
- If different grades of fabric are used on one panel, the entire panel must be priced at highest grade.
- Panels are not tackable.
- Note: Trim is not required at a straight connection between two panels of the same height.
- 3 Panel connector brackets per side come standard with 30”h. to 54”h. panels.
- 4 Panel connector brackets per side come standard with 66”h. panels.
- Panels include 1 raceway cover with punchouts on one side, 1 raceway cover with no punchouts on the other, an integrated aluminum top cap and levelling glides.
- 24” wide panels have two punchouts, one for electrical and one for data.
- 30” wide panels and wider have three punchouts, two for electrical and one for data.

PRODUCT CODE	PRICE		SIZE/ INCHES			WEIGHT VOL	
	GR 1	GR 2	H	W	D	LBS	FT <sup>3</sup>
CMFW4824N1	480	502	48	24	2.3	26	2.73
CMFW4830N1	578	605	48	30	2.3	33	3.37
CMFW4836N1	639	671	48	36	2.3	39	4.00
CMFW4842N1	722	758	48	42	2.3	46	4.63
CMFW4848N1	813	851	48	48	2.3	52	5.26
CMFW4854N1	904	936	48	54	2.3	59	5.89
CMFW4860N1	996	1048	48	60	2.3	65	6.53
CMFW5424N1	480	502	54	24	2.3	26	2.73
CMFW5430N1	576	604	54	30	2.3	33	3.37
CMFW5436N1	639	671	54	36	2.3	39	4
CMFW5442N1	723	758	54	42	2.3	46	4.63
CMFW5448N1	813	853	54	48	2.3	52	5.26
CMFW5454N1	904	935	54	54	2.3	59	5.89
CMFW5460N1	996	1048	54	60	2.3	65	6.53
CMFW6624N1	605	635	66	24	2.3	32	3.58
CMFW6630N1	719	755	66	30	2.3	40	4.4
CMFW6636N1	800	842	66	36	2.3	48	5.23
CMFW6642N1	906	955	66	42	2.3	56	6.06
CMFW6648N1	1011	1064	66	48	2.3	64	6.88
CMFW6654N1	1126	1187	66	54	2.3	72	7.71
CMFW6660N1	1242	1309	66	60	2.3	80	8.53

**CMFW-N2 • Single Segmented Non Powered Write Board One Side Panel, Punchouts on Both Sides**

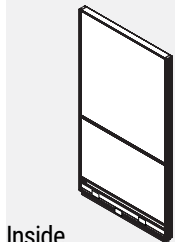

Inside

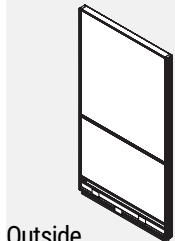

Outside

- Individual fabric or write board covered modules incorporated into an aluminum frame.
- Modules have write board on one side and fabric on the other at the top and fabric on two sides at the bottom.
- If different grades of fabric are used on one panel, the entire panel must be priced at highest grade.
- Panels are not tackable.
- Note: Trim is not required at a straight connection between two panels of the same height.
- 3 Panel connector brackets per side come standard with 30”h. to 54”h. panels.
- 4 Panel connector brackets per side come standard with 66”h. panels.
- Panels include 2 raceway covers with punchouts on both sides, an integrated aluminum top cap and levelling glides.
- 24” wide panels have two punchouts, one for electrical and one for data.
- 30” wide panels and wider have three punchouts, two for electrical and one for data.

PRODUCT CODE	PRICE		SIZE/ INCHES			WEIGHT VOL	
	GR 1	GR 2	H	W	D	LBS	FT <sup>3</sup>
CMFW4824N2	480	502	48	24	2.3	26	2.73
CMFW4830N2	578	605	48	30	2.3	33	3.37
CMFW4836N2	639	671	48	36	2.3	39	4.00
CMFW4842N2	722	758	48	42	2.3	46	4.63
CMFW4848N2	813	851	48	48	2.3	52	5.26
CMFW4854N2	904	936	48	54	2.3	59	5.89
CMFW4860N2	996	1048	48	60	2.3	65	6.53
CMFW5424N2	480	502	54	24	2.3	26	2.73
CMFW5430N2	576	604	54	30	2.3	33	3.37
CMFW5436N2	639	671	54	36	2.3	39	4
CMFW5442N2	723	758	54	42	2.3	46	4.63
CMFW5448N2	813	853	54	48	2.3	52	5.26
CMFW5454N2	904	935	54	54	2.3	59	5.89
CMFW5460N2	996	1048	54	60	2.3	65	6.53
CMFW6624N2	605	635	66	24	2.3	32	3.58
CMFW6630N2	719	755	66	30	2.3	40	4.4
CMFW6636N2	800	842	66	36	2.3	48	5.23
CMFW6642N2	906	955	66	42	2.3	56	6.06
CMFW6648N2	1011	1064	66	48	2.3	64	6.88
CMFW6654N2	1126	1187	66	54	2.3	72	7.71
CMFW6660N2	1242	1309	66	60	2.3	80	8.53



**CMFW-P1 • Single Segmented Powered Write Board One Side Panel, Punchouts on One Side**

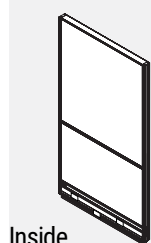

Inside

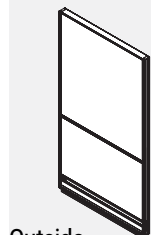

Outside

- Individual fabric or write board covered modules incorporated into an aluminum frame.
- Modules have write board on one side and fabric on the other at the top and fabric on two sides at the bottom.
- If different grades of fabric are used on one panel, the entire panel must be priced at highest grade.
- Panels are not tackable.
- Note: Trim is not required at a straight connection between two panels of the same height.
- 3 Panel connector brackets per side come standard with 30”h. to 54”h. panels.
- 4 Panel connector brackets per side come standard with 66”h. panels.
- Panels include 1 raceway cover with punchouts on one side, 1 raceway cover with no punchouts on the other, a power distribution housing, an integrated aluminum top cap and levelling glides.
- 24” wide panels have two punchouts, one for electrical and one for data.
- 30” wide panels and wider have three punchouts, two for electrical and one for data.
- Please specify duplex receptacles separately.

PRODUCT CODE	PRICE		SIZE/ INCHES			WEIGHT VOL	
	GR1	GR2	H	W	D	LBS	FT <sup>3</sup>
CMFW4824P1	615	637	48	24	2.3	26	2.73
CMFW4830P1	758	784	48	30	2.3	33	3.37
CMFW4836P1	829	860	48	36	2.3	39	4.00
CMFW4842P1	919	955	48	42	2.3	46	4.63
CMFW4848P1	1021	1059	48	48	2.3	52	5.26
CMFW4854P1	1115	1145	48	54	2.3	59	5.89
CMFW4860P1	1207	1260	48	60	2.3	65	6.53
CMFW5424P1	615	637	54	24	2.3	26	2.73
CMFW5430P1	758	785	54	30	2.3	33	3.37
CMFW5436P1	829	860	54	36	2.3	39	4
CMFW5442P1	919	955	54	42	2.3	46	4.63
CMFW5448P1	1021	1059	54	48	2.3	52	5.26
CMFW5454P1	1115	1146	54	54	2.3	59	5.89
CMFW5460P1	1207	1260	54	60	2.3	65	6.53
CMFW6624P1	739	768	66	24	2.3	32	3.58
CMFW6630P1	901	935	66	30	2.3	40	4.4
CMFW6636P1	991	1032	66	36	2.3	48	5.23
CMFW6642P1	1102	1151	66	42	2.3	56	6.06
CMFW6648P1	1221	1274	66	48	2.3	64	6.88
CMFW6654P1	1338	1396	66	54	2.3	72	7.71
CMFW6660P1	1455	1521	66	60	2.3	80	8.53

**CMFW-P2 • Single Segmented Powered Write Board One Side Panel, Punchouts on Both Sides**

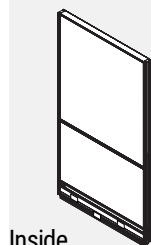

Inside

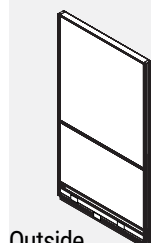

Outside

- Individual fabric or write board covered modules incorporated into an aluminum frame.
- Modules have write board on one side and fabric on the other at the top and fabric on two sides at the bottom.
- If different grades of fabric are used on one panel, the entire panel must be priced at highest grade.
- Panels are not tackable.
- Note: Trim is not required at a straight connection between two panels of the same height.
- 3 Panel connector brackets per side come standard with 30”h. to 54”h. panels.
- 4 Panel connector brackets per side come standard with 66”h. panels.
- Panels include 2 raceway covers with punchouts on both sides, a power distribution housing, an integrated aluminum top cap and levelling glides.
- 24” wide panels have two punchouts, one for electrical and one for data.
- 30” wide panels and wider have three punchouts, two for electrical and one for data.
- Please specify duplex receptacles separately.

PRODUCT CODE	PRICE		SIZE/ INCHES			WEIGHT VOL	
	GR1	GR2	H	W	D	LBS	FT <sup>3</sup>
CMFW4824P2	615	637	48	24	2.3	26	2.73
CMFW4830P2	758	784	48	30	2.3	33	3.37
CMFW4836P2	829	860	48	36	2.3	39	4.00
CMFW4842P2	919	955	48	42	2.3	46	4.63
CMFW4848P2	1021	1059	48	48	2.3	52	5.26
CMFW4854P2	1115	1145	48	54	2.3	59	5.89
CMFW4860P2	1207	1260	48	60	2.3	65	6.53
CMFW5424P2	615	637	54	24	2.3	26	2.73
CMFW5430P2	758	785	54	30	2.3	33	3.37
CMFW5436P2	829	860	54	36	2.3	39	4
CMFW5442P2	919	955	54	42	2.3	46	4.63
CMFW5448P2	1021	1059	54	48	2.3	52	5.26
CMFW5454P2	1115	1146	54	54	2.3	59	5.89
CMFW5460P2	1207	1260	54	60	2.3	65	6.53
CMFW6624P2	739	768	66	24	2.3	32	3.58
CMFW6630P2	901	935	66	30	2.3	40	4.4
CMFW6636P2	991	1032	66	36	2.3	48	5.23
CMFW6642P2	1102	1151	66	42	2.3	56	6.06
CMFW6648P2	1221	1274	66	48	2.3	64	6.88
CMFW6654P2	1338	1396	66	54	2.3	72	7.71
CMFW6660P2	1455	1521	66	60	2.3	80	8.53

**CMWW-N0 • Single Segmented Non Powered Write Board Two Sides Panel, No Punchouts**

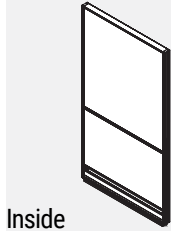

Inside

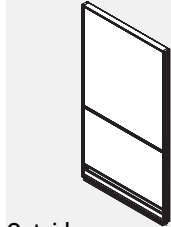

Outside

- Individual fabric or write board covered modules incorporated into an aluminum frame.
- Modules have either write board on two sides at the top and fabric on two sides at the bottom.
- If different grades of fabric are used on one panel, the entire panel must be priced at highest grade.
- Panels are not tackable.
- Note: Trim is not required at a straight connection between two panels of the same height.
- 3 Panel connector brackets per side come standard with 30”h. to 54”h. panels.
- 4 Panel connector brackets per side come standard with 66”h. panels.
- Panels include 2 raceway covers with no punchouts, an integrated aluminum top cap and levelling glides.

PRODUCT CODE	PRICE		SIZE/ INCHES			WEIGHT VOL	
	GR 1	GR 2	H	W	D	LBS	FT <sup>3</sup>
CMWW4824N0	523	535	48	24	2.3	26	2.73
CMWW4830N0	651	668	48	30	2.3	33	3.37
CMWW4836N0	704	729	48	36	2.3	39	4.00
CMWW4842N0	801	824	48	42	2.3	46	4.63
CMWW4848N0	937	966	48	48	2.3	52	5.26
CMWW4854N0	1043	1076	48	54	2.3	59	5.89
CMWW4860N0	1151	1181	48	60	2.3	65	6.53
CMWW5424N0	523	535	54	24	2.3	26	2.73
CMWW5430N0	651	668	54	30	2.3	33	3.37
CMWW5436N0	704	729	54	36	2.3	39	4
CMWW5442N0	801	825	54	42	2.3	46	4.63
CMWW5448N0	936	966	54	48	2.3	52	5.26
CMWW5454N0	1043	1075	54	54	2.3	59	5.89
CMWW5460N0	1151	1183	54	60	2.3	65	6.53
CMWW6624N0	642	667	66	24	2.3	32	3.58
CMWW6630N0	793	820	66	30	2.3	40	4.4
CMWW6636N0	866	895	66	36	2.3	48	5.23
CMWW6642N0	986	1022	66	42	2.3	56	6.06
CMWW6648N0	1132	1170	66	48	2.3	64	6.88
CMWW6654N0	1261	1306	66	54	2.3	72	7.71
CMWW6660N0	1394	1442	66	60	2.3	80	8.53

**CMWW-N1 • Single Segmented Non Powered Write Board Two Sides Panel, Punchouts on One Side**

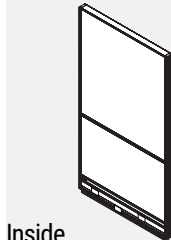

Inside

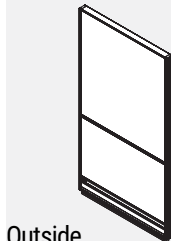

Outside

- Individual fabric or write board covered modules incorporated into an aluminum frame.
- Modules have either write board on two sides at the top and fabric on two sides at the bottom.
- If different grades of fabric are used on one panel, the entire panel must be priced at highest grade.
- Panels are not tackable.
- Note: Trim is not required at a straight connection between two panels of the same height.
- 3 Panel connector brackets per side come standard with 30”h. to 54”h. panels.
- 4 Panel connector brackets per side come standard with 66”h. panels.
- Panels include 1 raceway cover with punchouts on two sides, 1 raceway cover with no punchouts on the other, an integrated aluminum top cap and levelling glides.
- 24” wide panels have two punchouts, one for electrical and one for data.
- 30” wide panels and wider have three punchouts, two for electrical and one for data.

PRODUCT CODE	PRICE		SIZE/ INCHES			WEIGHT VOL	
	GR 1	GR 2	H	W	D	LBS	FT <sup>3</sup>
CMWW4824N1	523	535	48	24	2.3	26	2.73
CMWW4830N1	651	668	48	30	2.3	33	3.37
CMWW4836N1	704	729	48	36	2.3	39	4.00
CMWW4842N1	801	824	48	42	2.3	46	4.63
CMWW4848N1	937	966	48	48	2.3	52	5.26
CMWW4854N1	1043	1076	48	54	2.3	59	5.89
CMWW4860N1	1151	1181	48	60	2.3	65	6.53
CMWW5424N1	523	535	54	24	2.3	26	2.73
CMWW5430N1	651	668	54	30	2.3	33	3.37
CMWW5436N1	704	729	54	36	2.3	39	4
CMWW5442N1	801	825	54	42	2.3	46	4.63
CMWW5448N1	936	966	54	48	2.3	52	5.26
CMWW5454N1	1043	1075	54	54	2.3	59	5.89
CMWW5460N1	1151	1183	54	60	2.3	65	6.53
CMWW6624N1	642	667	66	24	2.3	32	3.58
CMWW6630N1	793	820	66	30	2.3	40	4.4
CMWW6636N1	866	895	66	36	2.3	48	5.23
CMWW6642N1	986	1022	66	42	2.3	56	6.06
CMWW6648N1	1132	1170	66	48	2.3	64	6.88
CMWW6654N1	1261	1306	66	54	2.3	72	7.71
CMWW6660N1	1394	1442	66	60	2.3	80	8.53

**CMWW-N2 • Single Segmented Non Powered Write Board Two Sides Panel, Punchouts on Both Sides**

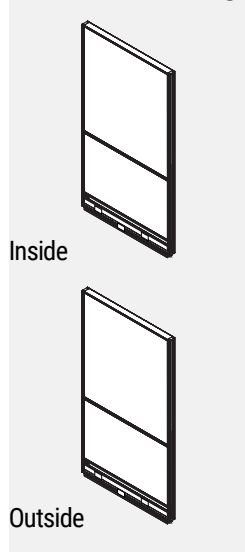

- Individual fabric or write board covered modules incorporated into an aluminum frame.
- Modules have either write board on two sides at the top and fabric on two sides at the bottom.
- If different grades of fabric are used on one panel, the entire panel must be priced at highest grade.
- Panels are not tackable.
- Note: Trim is not required at a straight connection between two panels of the same height.
- 3 Panel connector brackets per side come standard with 30”h. to 54”h. panels.
- 4 Panel connector brackets per side come standard with 66”h. panels.
- Panels include 2 raceway covers with punchouts on both sides, an integrated aluminum top cap and levelling glides.
- 24” wide panels have two punchouts, one for electrical and one for data.
- 30” wide panels and wider have three punchouts, two for electrical and one for data.

PRODUCT CODE	PRICE		SIZE/ INCHES			WEIGHT		VOL FT <sup>3</sup>
	GR1	GR2	H	W	D	LBS		
CMWW4824N2	523	535	48	24	2.3	26	2.73	
CMWW4830N2	651	668	48	30	2.3	33	3.37	
CMWW4836N2	704	729	48	36	2.3	39	4.00	
CMWW4842N2	801	824	48	42	2.3	46	4.63	
CMWW4848N2	937	966	48	48	2.3	52	5.26	
CMWW4854N2	1043	1076	48	54	2.3	59	5.89	
CMWW4860N2	1151	1181	48	60	2.3	65	6.53	
CMWW5424N2	523	535	54	24	2.3	26	2.73	
CMWW5430N2	651	668	54	30	2.3	33	3.37	
CMWW5436N2	704	729	54	36	2.3	39	4	
CMWW5442N2	801	825	54	42	2.3	46	4.63	
CMWW5448N2	936	966	54	48	2.3	52	5.26	
CMWW5454N2	1043	1075	54	54	2.3	59	5.89	
CMWW5460N2	1151	1183	54	60	2.3	65	6.53	
CMWW6624N2	642	667	66	24	2.3	32	3.58	
CMWW6630N2	793	820	66	30	2.3	40	4.4	
CMWW6636N2	866	895	66	36	2.3	48	5.23	
CMWW6642N2	986	1022	66	42	2.3	56	6.06	
CMWW6648N2	1132	1170	66	48	2.3	64	6.88	
CMWW6654N2	1261	1306	66	54	2.3	72	7.71	
CMWW6660N2	1394	1442	66	60	2.3	80	8.53	

**CMWW-P1 • Single Segmented Powered Write Board Two Sides Panel, Punchouts on One Side**

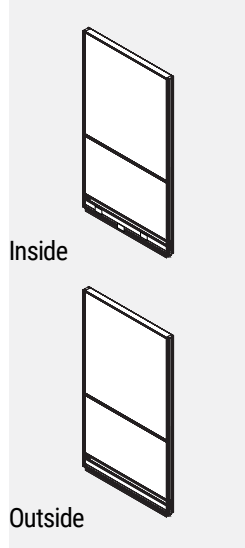

- Individual fabric or write board covered modules incorporated into an aluminum frame.
- Modules have either write board on two sides at the top and fabric on two sides at the bottom.
- If different grades of fabric are used on one panel, the entire panel must be priced at highest grade.
- Panels are not tackable.
- Note: Trim is not required at a straight connection between two panels of the same height.
- 3 Panel connector brackets per side come standard with 30”h. to 54”h. panels.
- 4 Panel connector brackets per side come standard with 66”h. panels.
- Panels include 1 raceway cover with punchouts on two sides, 1 raceway cover with no punchouts on the other, a power distribution housing, an integrated aluminum top cap and levelling glides.
- 24” wide panels have two punchouts, one for electrical and one for data.
- 30” wide panels and wider have three punchouts, two for electrical and one for data.
- Please specify duplex receptacles separately.

PRODUCT CODE	PRICE		SIZE/ INCHES			WEIGHT		VOL FT <sup>3</sup>
	GR1	GR2	H	W	D	LBS		
CMWW4824P1	656	671	48	24	2.3	26	2.73	
CMWW4830P1	832	848	48	30	2.3	33	3.37	
CMWW4836P1	895	920	48	36	2.3	39	4.00	
CMWW4842P1	997	1021	48	42	2.3	46	4.63	
CMWW4848P1	1144	1173	48	48	2.3	52	5.26	
CMWW4854P1	1254	1285	48	54	2.3	59	5.89	
CMWW4860P1	1364	1395	48	60	2.3	65	6.53	
CMWW5424P1	656	671	54	24	2.3	26	2.73	
CMWW5430P1	832	849	54	30	2.3	33	3.37	
CMWW5436P1	895	920	54	36	2.3	39	4	
CMWW5442P1	997	1021	54	42	2.3	46	4.63	
CMWW5448P1	1144	1173	54	48	2.3	52	5.26	
CMWW5454P1	1254	1286	54	54	2.3	59	5.89	
CMWW5460P1	1364	1395	54	60	2.3	65	6.53	
CMWW6624P1	779	801	66	24	2.3	32	3.58	
CMWW6630P1	974	1000	66	30	2.3	40	4.4	
CMWW6636P1	1056	1086	66	36	2.3	48	5.23	
CMWW6642P1	1181	1220	66	42	2.3	56	6.06	
CMWW6648P1	1338	1378	66	48	2.3	64	6.88	
CMWW6654P1	1471	1517	66	54	2.3	72	7.71	
CMWW6660P1	1606	1656	66	60	2.3	80	8.53	

**CMWW-P2 • Single Segmented Powered Write Board Two Sides Panel, Punchouts on Both Sides**

- Individual fabric or write board covered modules incorporated into an aluminum frame.
- Modules have either write board on two sides at the top and fabric on two sides at the bottom.
- If different grades of fabric are used on one panel, the entire panel must be priced at highest grade.
- Panels are not tackable.
- Note: Trim is not required at a straight connection between two panels of the same height.
- 3 Panel connector brackets per side come standard with 30”h. to 54”h. panels.
- 4 Panel connector brackets per side come standard with 66”h. panels.
- Panels include 2 raceway covers with punchouts on both sides, a power distribution housing, an integrated aluminum top cap and levelling glides.
- 24” wide panels have two punchouts, one for electrical and one for data.
- 30” wide panels and wider have three punchouts, two for electrical and one for data.
- Please specify duplex receptacles separately.

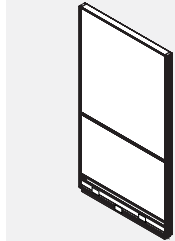

Inside

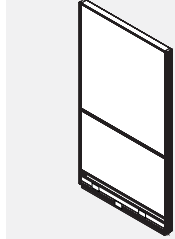

Outside

PRODUCT CODE	PRICE		SIZE/ INCHES			WEIGHT VOL	
	GR 1	GR 2	H	W	D	LBS	FT <sup>3</sup>
CMWW4824P2	656	671	48	24	2.3	26	2.73
CMWW4830P2	832	848	48	30	2.3	33	3.37
CMWW4836P2	895	920	48	36	2.3	39	4.00
CMWW4842P2	997	1021	48	42	2.3	46	4.63
CMWW4848P2	1144	1173	48	48	2.3	52	5.26
CMWW4854P2	1254	1285	48	54	2.3	59	5.89
CMWW4860P2	1364	1395	48	60	2.3	65	6.53
CMWW5424P2	656	671	54	24	2.3	26	2.73
CMWW5430P2	832	849	54	30	2.3	33	3.37
CMWW5436P2	895	920	54	36	2.3	39	4
CMWW5442P2	997	1021	54	42	2.3	46	4.63
CMWW5448P2	1144	1173	54	48	2.3	52	5.26
CMWW5454P2	1254	1286	54	54	2.3	59	5.89
CMWW5460P2	1364	1395	54	60	2.3	65	6.53
CMWW6624P2	779	801	66	24	2.3	32	3.58
CMWW6630P2	974	1000	66	30	2.3	40	4.4
CMWW6636P2	1056	1086	66	36	2.3	48	5.23
CMWW6642P2	1181	1220	66	42	2.3	56	6.06
CMWW6648P2	1338	1378	66	48	2.3	64	6.88
CMWW6654P2	1471	1517	66	54	2.3	72	7.71
CMWW6660P2	1606	1656	66	60	2.3	80	8.53

**CMFG-N0 • Single Glazed, Non Powered Fabric Panel, No Punchouts**

- Individual fabric-covered module in lower position with glazed module in upper position incorporated into an aluminum frame.
- Opposite sides of each module may have a different fabric within the same grade at no upcharge.
- If different grades of fabric are used on one panel, the entire panel must be priced at highest grade.
- Panels are not tackable.
- Note: Trim is not required at a straight connection between two panels of the same height.
- 3 Panel connector brackets per side come standard with 42”h. and 54”h. panels.
- 4 Panel connector brackets per side come standard with 66”h. panels.
- Panels include 2 raceway covers with no punchouts, an integrated aluminum top cap and levelling glides.
- Standard in clear (CLR) plexi.
- Optional frosted (FRST) plexi
- Glazing starts at 29” high to the top of the panel.

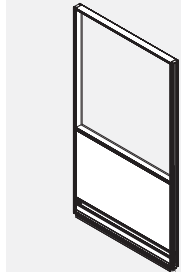

Inside

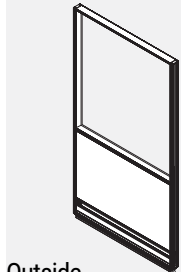

Outside

PRODUCT CODE	PRICE		SIZE/ INCHES			WEIGHT VOL	
	GR 1	GR 2	H	W	D	LBS	FT <sup>3</sup>
CMFG4224N0	433	446	42	24	2.3	20	2.31
CMFG4230N0	474	492	42	30	2.3	25	2.85
CMFG4236N0	521	550	42	36	2.3	31	3.38
CMFG4242N0	576	607	42	42	2.3	36	3.92
CMFG4248N0	633	661	42	48	2.3	41	4.45
CMFG4254N0	715	743	42	54	2.3	46	4.99
CMFG4260N0	787	816	42	60	2.3	51	5.52
CMFG4824N0	468	481	48	24	2.3	26	2.73
CMFG4830N0	509	526	48	30	2.3	33	3.37
CMFG4836N0	582	611	48	36	2.3	39	4.00
CMFG4842N0	651	680	48	42	2.3	46	4.63
CMFG4848N0	713	741	48	48	2.3	52	5.26
CMFG4854N0	829	859	48	54	2.3	59	5.89
CMFG4860N0	938	968	48	60	2.3	65	6.53
CMFG5424N0	468	481	54	24	2.3	26	2.73
CMFG5430N0	509	526	54	30	2.3	33	3.37
CMFG5436N0	583	611	54	36	2.3	39	4.00
CMFG5442N0	651	679	54	42	2.3	46	4.63
CMFG5448N0	713	741	54	48	2.3	52	5.26
CMFG5454N0	829	859	54	54	2.3	59	5.89
CMFG5460N0	938	968	54	60	2.3	65	6.53
CMFG6624N0	601	615	66	24	2.3	32	3.58
CMFG6630N0	699	713	66	30	2.3	40	4.40
CMFG6636N0	796	826	66	36	2.3	48	5.23
CMFG6642N0	891	921	66	42	2.3	56	6.06
CMFG6648N0	977	1007	66	48	2.3	64	6.88
CMFG6654N0	1081	1110	66	54	2.3	72	7.71
CMFG6660N0	1177	1207	66	60	2.3	80	8.53

**CMFG-N1 • Single Glazed, Non Powered Fabric Panel, Punchouts on One Side**

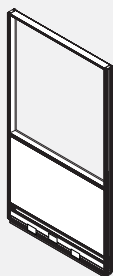

Inside

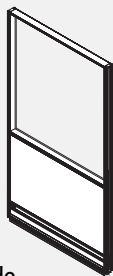

Outside

- Individual fabric-covered module in lower position with glazed module in upper position incorporated into an aluminum frame.
- Opposite sides of each module may have a different fabric within the same grade at no upcharge.
- If different grades of fabric are used on one panel, the entire panel must be priced at highest grade.
- Panels are not tackable.
- Note: Trim is not required at a straight connection between two panels of the same height.
- 3 Panel connector brackets per side come standard with 42”h. and 54”h. panels.
- 4 Panel connector brackets per side come standard with 66”h. panels.
- Panels include 1 raceway cover with punchouts on one side, 1 raceway cover with no punchouts on the other, an integrated aluminum top cap and levelling glides.
- Standard in clear (CLR) plexi.
- Optional frosted (FRST) plexi
- 24” wide panels have two punchouts, one for electrical and one for data.
- 30” wide panels and wider have three punchouts, two for electrical and one for data.
- Glazing starts at 29” high to the top of the panel.

PRODUCT CODE	PRICE		SIZE/ INCHES			WEIGHT VOL	
	GR 1	GR 2	H	W	D	LBS	FT <sup>3</sup>
CMFG4224N1	433	446	42	24	2.3	20	2.31
CMFG4230N1	474	492	42	30	2.3	25	2.85
CMFG4236N1	521	550	42	36	2.3	31	3.38
CMFG4242N1	576	607	42	42	2.3	36	3.92
CMFG4248N1	633	661	42	48	2.3	41	4.45
CMFG4254N1	715	743	42	54	2.3	46	4.99
CMFG4260N1	787	816	42	60	2.3	51	5.52
CMFG4824N1	468	481	48	24	2.3	26	2.73
CMFG4830N1	509	526	48	30	2.3	33	3.37
CMFG4836N1	582	611	48	36	2.3	39	4.00
CMFG4842N1	651	680	48	42	2.3	46	4.63
CMFG4848N1	713	741	48	48	2.3	52	5.26
CMFG4854N1	829	859	48	54	2.3	59	5.89
CMFG4860N1	938	968	48	60	2.3	65	6.53
CMFG5424N1	468	481	54	24	2.3	26	2.73
CMFG5430N1	509	526	54	30	2.3	33	3.37
CMFG5436N1	583	611	54	36	2.3	39	4.00
CMFG5442N1	651	679	54	42	2.3	46	4.63
CMFG5448N1	713	741	54	48	2.3	52	5.26
CMFG5454N1	829	859	54	54	2.3	59	5.89
CMFG5460N1	938	968	54	60	2.3	65	6.53
CMFG6624N1	601	615	66	24	2.3	32	3.58
CMFG6630N1	699	713	66	30	2.3	40	4.40
CMFG6636N1	796	826	66	36	2.3	48	5.23
CMFG6642N1	891	921	66	42	2.3	56	6.06
CMFG6648N1	977	1007	66	48	2.3	64	6.88
CMFG6654N1	1081	1110	66	54	2.3	72	7.71
CMFG6660N1	1177	1207	66	60	2.3	80	8.53

**CMFG-N2 • Single Glazed, Non Powered Fabric Panel, Punchouts on Both Sides**

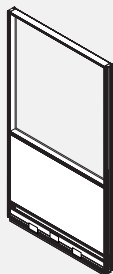

Inside

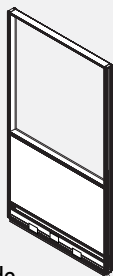

Outside

- Individual fabric-covered module in lower position with glazed module in upper position incorporated into an aluminum frame.
- Opposite sides of each module may have a different fabric within the same grade at no upcharge.
- If different grades of fabric are used on one panel, the entire panel must be priced at highest grade.
- Panels are not tackable.
- Note: Trim is not required at a straight connection between two panels of the same height.
- 3 Panel connector brackets per side come standard with 42”h. and 54”h. panels.
- 4 Panel connector brackets per side come standard with 66”h. panels.
- Panels include 2 raceway covers with punchouts on both sides, an integrated aluminum top cap and levelling glides.
- Standard in clear (CLR) plexi.
- Optional frosted (FRST) plexi
- 24” wide panels have two punchouts, one for electrical and one for data.
- 30” wide panels and wider have three punchouts, two for electrical and one for data.
- Glazing starts at 29” high to the top of the panel.

PRODUCT CODE	PRICE		SIZE/ INCHES			WEIGHT VOL	
	GR 1	GR 2	H	W	D	LBS	FT <sup>3</sup>
CMFG4224N2	433	446	42	24	2.3	20	2.31
CMFG4230N2	474	492	42	30	2.3	25	2.85
CMFG4236N2	521	550	42	36	2.3	31	3.38
CMFG4242N2	576	607	42	42	2.3	36	3.92
CMFG4248N2	633	661	42	48	2.3	41	4.45
CMFG4254N2	715	743	42	54	2.3	46	4.99
CMFG4260N2	787	816	42	60	2.3	51	5.52
CMFG4824N2	468	481	48	24	2.3	26	2.73
CMFG4830N2	509	526	48	30	2.3	33	3.37
CMFG4836N2	582	611	48	36	2.3	39	4.00
CMFG4842N2	651	680	48	42	2.3	46	4.63
CMFG4848N2	713	741	48	48	2.3	52	5.26
CMFG4854N2	829	859	48	54	2.3	59	5.89
CMFG4860N2	938	968	48	60	2.3	65	6.53
CMFG5424N2	468	481	54	24	2.3	26	2.73
CMFG5430N2	509	526	54	30	2.3	33	3.37
CMFG5436N2	583	611	54	36	2.3	39	4.00
CMFG5442N2	651	679	54	42	2.3	46	4.63
CMFG5448N2	713	741	54	48	2.3	52	5.26
CMFG5454N2	829	859	54	54	2.3	59	5.89
CMFG5460N2	938	968	54	60	2.3	65	6.53
CMFG6624N2	601	615	66	24	2.3	32	3.58
CMFG6630N2	699	713	66	30	2.3	40	4.40
CMFG6636N2	796	826	66	36	2.3	48	5.23
CMFG6642N2	891	921	66	42	2.3	56	6.06
CMFG6648N2	977	1007	66	48	2.3	64	6.88
CMFG6654N2	1081	1110	66	54	2.3	72	7.71
CMFG6660N2	1177	1207	66	60	2.3	80	8.53

**CMFG-P1 • Single Glazed, Powered Fabric Panel, Punchouts on One Side**

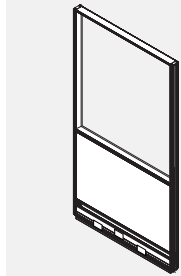

Inside

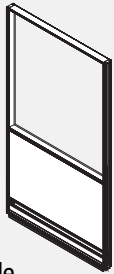

Outside

- Individual fabric-covered module in lower position with glazed module in upper position incorporated into an aluminum frame.
- Opposite sides of each module may have a different fabric within the same grade at no upcharge.
- If different grades of fabric are used on one panel, the entire panel must be priced at highest grade.
- Panels are not tackable.
- Note: Trim is not required at a straight connection between two panels of the same height.
- 3 Panel connector brackets per side come standard with 42" h. and 54" h. panels.
- 4 Panel connector brackets per side come standard with 66" h. panels.
- Panels include 1 raceway cover with punchouts on one side, 1 raceway cover with no punchouts on the other, a power distribution housing, an integrated aluminum top cap and levelling glides.
- Standard in clear (CLR) plexi.
- Optional frosted (FRST) plexi
- 24" wide panels have two punchouts, one for electrical and one for data.
- 30" wide panels and wider have three punchouts, two for electrical and one for data.
- Glazing starts at 29" high to the top of the panel.
- Please specify duplex receptacles separately.

PRODUCT CODE	PRICE		SIZE/ INCHES			WEIGHT VOL	
	GR 1	GR 2	H	W	D	LBS	FT <sup>3</sup>
CMFG4224P1	565	583	42	24	2.3	20	2.31
CMFG4230P1	658	672	42	30	2.3	25	2.85
CMFG4236P1	710	739	42	36	2.3	31	3.38
CMFG4242P1	773	802	42	42	2.3	36	3.92
CMFG4248P1	839	868	42	48	2.3	41	4.45
CMFG4254P1	926	955	42	54	2.3	46	4.99
CMFG4260P1	998	1029	42	60	2.3	51	5.52
CMFG4824P1	603	616	48	24	2.3	26	2.73
CMFG4830P1	693	706	48	30	2.3	33	3.37
CMFG4836P1	772	801	48	36	2.3	39	4.00
CMFG4842P1	847	877	48	42	2.3	46	4.63
CMFG4848P1	921	949	48	48	2.3	52	5.26
CMFG4854P1	1041	1070	48	54	2.3	59	5.89
CMFG4860P1	1151	1179	48	60	2.3	65	6.53
CMFG5424P1	603	616	54	24	2.3	26	2.73
CMFG5430P1	693	705	54	30	2.3	33	3.37
CMFG5436P1	771	801	54	36	2.3	39	4.00
CMFG5442P1	847	877	54	42	2.3	46	4.63
CMFG5448P1	921	949	54	48	2.3	52	5.26
CMFG5454P1	1041	1070	54	54	2.3	59	5.89
CMFG5460P1	1151	1179	54	60	2.3	65	6.53
CMFG6624P1	735	751	66	24	2.3	32	3.58
CMFG6630P1	881	894	66	30	2.3	40	4.40
CMFG6636P1	987	1016	66	36	2.3	48	5.23
CMFG6642P1	1088	1118	66	42	2.3	56	6.06
CMFG6648P1	1187	1217	66	48	2.3	64	6.88
CMFG6654P1	1290	1320	66	54	2.3	72	7.71
CMFG6660P1	1392	1420	66	60	2.3	80	8.53

**CMFG-P2 • Single Glazed, Powered Fabric Panel, Punchouts on Both Sides**

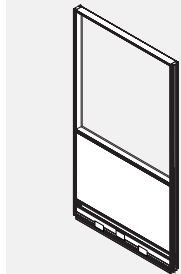

Inside

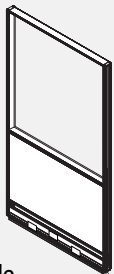

Outside

- Individual fabric-covered module in lower position with glazed module in upper position incorporated into a aluminum frame.
- Opposite sides of each module may have a different fabric within the same grade at no upcharge.
- If different grades of fabric are used on one panel, the entire panel must be priced at highest grade.
- Panels are not tackable.
- Note: Trim is not required at a straight connection between two panels of the same height.
- 3 Panel connector brackets per side come standard with 42" h. and 54" h. panels.
- 4 Panel connector brackets per side come standard with 66" h. panels.
- Panels include 2 raceway covers with punchouts on both sides, a power distribution housing, an integrated aluminum top cap and levelling glides.
- Standard in clear (CLR) plexi.
- Optional frosted (FRST) plexi
- 24" wide panels have two punchouts, one for electrical and one for data.
- 30" wide panels and wider have three punchouts, two for electrical and one for data.
- Glazing starts at 29" high to the top of the panel.
- Please specify duplex receptacles separately.

PRODUCT CODE	PRICE		SIZE/ INCHES			WEIGHT VOL	
	GR 1	GR 2	H	W	D	LBS	FT <sup>3</sup>
CMFG4224P2	565	583	42	24	2.3	20	2.31
CMFG4230P2	658	672	42	30	2.3	25	2.85
CMFG4236P2	710	739	42	36	2.3	31	3.38
CMFG4242P2	773	802	42	42	2.3	36	3.92
CMFG4248P2	839	868	42	48	2.3	41	4.45
CMFG4254P2	926	955	42	54	2.3	46	4.99
CMFG4260P2	998	1029	42	60	2.3	51	5.52
CMFG4824P2	603	616	48	24	2.3	26	2.73
CMFG4830P2	693	706	48	30	2.3	33	3.37
CMFG4836P2	772	801	48	36	2.3	39	4.00
CMFG4842P2	847	877	48	42	2.3	46	4.63
CMFG4848P2	921	949	48	48	2.3	52	5.26
CMFG4854P2	1041	1070	48	54	2.3	59	5.89
CMFG4860P2	1151	1179	48	60	2.3	65	6.53
CMFG5424P2	603	616	54	24	2.3	26	2.73
CMFG5430P2	693	705	54	30	2.3	33	3.37
CMFG5436P2	771	801	54	36	2.3	39	4.00
CMFG5442P2	847	877	54	42	2.3	46	4.63
CMFG5448P2	921	949	54	48	2.3	52	5.26
CMFG5454P2	1041	1070	54	54	2.3	59	5.89
CMFG5460P2	1151	1179	54	60	2.3	65	6.53
CMFG6624P2	735	751	66	24	2.3	32	3.58
CMFG6630P2	881	894	66	30	2.3	40	4.40
CMFG6636P2	987	1016	66	36	2.3	48	5.23
CMFG6642P2	1088	1118	66	42	2.3	56	6.06
CMFG6648P2	1187	1217	66	48	2.3	64	6.88
CMFG6654P2	1290	1320	66	54	2.3	72	7.71
CMFG6660P2	1392	1420	66	60	2.3	80	8.53

**CMPLG-N0 • Single 12" Glazed at top, Non Powered Fabric Panel, No Punchouts**

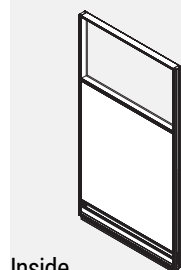

Inside

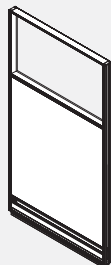

Outside

- Individual fabric-covered module in lower position with glazed module in upper position incorporated into an aluminum frame.
- Opposite sides of each module may have a different fabric within the same grade at no upcharge.
- If different grades of fabric are used on one panel, the entire panel must be priced at highest grade.
- Panels are not tackable.
- Note: Trim is not required at a straight connection between two panels of the same height.
- 3 Panel connector brackets per side come standard with 42"h. and 54"h. panels.
- 4 Panel connector brackets per side come standard with 66"h. panels.
- Panels include 2 raceway covers with no punchouts, an integrated aluminum top cap and levelling glides.
- Standard in clear (CLR) plexi.
- Optional frosted (FRST) plexi
- Glazing is 12" nominal from the top of the panel.

PRODUCT CODE	PRICE		SIZE/ INCHES			WEIGHT VOL	
	GR 1	GR 2	H	W	D	LBS	FT <sup>3</sup>
CMPLG4224N0	433	446	42	24	2.3	20	2.31
CMPLG4230N0	474	492	42	30	2.3	25	2.85
CMPLG4236N0	521	550	42	36	2.3	31	3.38
CMPLG4242N0	576	607	42	42	2.3	36	3.92
CMPLG4248N0	633	661	42	48	2.3	41	4.45
CMPLG4254N0	715	743	42	54	2.3	46	4.99
CMPLG4260N0	787	816	42	60	2.3	51	5.52
CMPLG4824N0	463	477	48	24	2.3	26	2.73
CMPLG4830N0	534	550	48	30	2.3	33	3.37
CMPLG4836N0	595	625	48	36	2.3	39	4.00
CMPLG4842N0	670	699	48	42	2.3	46	4.63
CMPLG4848N0	737	767	48	48	2.3	52	5.26
CMPLG4854N0	815	845	48	54	2.3	59	5.89
CMPLG4860N0	886	914	48	60	2.3	65	6.53
CMPLG5424N0	463	476	54	24	2.3	26	2.73
CMPLG5430N0	534	550	54	30	2.3	33	3.37
CMPLG5436N0	595	625	54	36	2.3	39	4.00
CMPLG5442N0	669	699	54	42	2.3	46	4.63
CMPLG5448N0	737	767	54	48	2.3	52	5.26
CMPLG5454N0	816	844	54	54	2.3	59	5.89
CMPLG5460N0	886	915	54	60	2.3	65	6.53
CMPLG6624N0	509	539	66	24	2.3	32	3.58
CMPLG6630N0	590	619	66	30	2.3	40	4.40
CMPLG6636N0	656	715	66	36	2.3	48	5.23
CMPLG6642N0	732	790	66	42	2.3	56	6.06
CMPLG6648N0	809	868	66	48	2.3	64	6.88
CMPLG6654N0	893	953	66	54	2.3	72	7.71
CMPLG6660N0	970	1030	66	60	2.3	80	8.53

**CMPLG-N1 • Single 12" Glazed at top, Non Powered Panel, Punchouts on One Side**

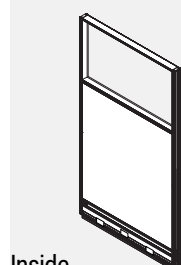

Inside

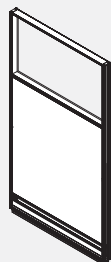

Outside

- Individual fabric-covered module in lower position with glazed module in upper position incorporated into an aluminum frame.
- Opposite sides of each module may have a different fabric within the same grade at no upcharge.
- If different grades of fabric are used on one panel, the entire panel must be priced at highest grade.
- Panels are not tackable.
- Note: Trim is not required at a straight connection between two panels of the same height.
- 3 Panel connector brackets per side come standard with 42"h. and 54"h. panels.
- 4 Panel connector brackets per side come standard with 66"h. panels.
- Panels include 1 raceway cover with punchouts on one side, 1 raceway cover with no punchouts on the other, an integrated aluminum top cap and levelling glides.
- Standard in clear (CLR) plexi.
- Optional frosted (FRST) plexi
- 24" wide panels have two punchouts, one for electrical and one for data.
- 30" wide panels and wider have three punchouts, two for electrical and one for data.
- Glazing is 12" nominal from the top of the panel.

PRODUCT CODE	PRICE		SIZE/ INCHES			WEIGHT VOL	
	GR 1	GR 2	H	W	D	LBS	FT <sup>3</sup>
CMPLG4224N1	433	446	42	24	2.3	20	2.31
CMPLG4230N1	474	492	42	30	2.3	25	2.85
CMPLG4236N1	521	550	42	36	2.3	31	3.38
CMPLG4242N1	576	607	42	42	2.3	36	3.92
CMPLG4248N1	633	661	42	48	2.3	41	4.45
CMPLG4254N1	715	743	42	54	2.3	46	4.99
CMPLG4260N1	787	816	42	60	2.3	51	5.52
CMPLG4824N1	463	477	48	24	2.3	26	2.73
CMPLG4830N1	534	550	48	30	2.3	33	3.37
CMPLG4836N1	595	625	48	36	2.3	39	4.00
CMPLG4842N1	670	699	48	42	2.3	46	4.63
CMPLG4848N1	737	767	48	48	2.3	52	5.26
CMPLG4854N1	815	845	48	54	2.3	59	5.89
CMPLG4860N1	886	914	48	60	2.3	65	6.53
CMPLG5424N1	463	476	54	24	2.3	26	2.73
CMPLG5430N1	534	550	54	30	2.3	33	3.37
CMPLG5436N1	595	625	54	36	2.3	39	4.00
CMPLG5442N1	669	699	54	42	2.3	46	4.63
CMPLG5448N1	737	767	54	48	2.3	52	5.26
CMPLG5454N1	816	844	54	54	2.3	59	5.89
CMPLG5460N1	886	915	54	60	2.3	65	6.53
CMPLG6624N1	509	539	66	24	2.3	32	3.58
CMPLG6630N1	590	619	66	30	2.3	40	4.40
CMPLG6636N1	656	715	66	36	2.3	48	5.23
CMPLG6642N1	732	790	66	42	2.3	56	6.06
CMPLG6648N1	809	868	66	48	2.3	64	6.88
CMPLG6654N1	893	953	66	54	2.3	72	7.71
CMPLG6660N1	970	1030	66	60	2.3	80	8.53

**CMPLG-N2 • Single 12" at Top, Non Powered Fabric Panel, Punchouts on Both Sides**

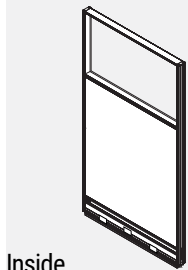

Inside

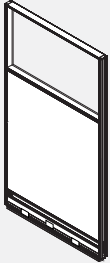

Outside

- Individual fabric-covered module in lower position with glazed module in upper position incorporated into a solid steel frame.
- Opposite sides of each module may have a different fabric within the same grade at no upcharge.
- If different grades of fabric are used on one panel, the entire panel must be priced at highest grade.
- Panels are not tackable.
- Note: Trim is not required at a straight connection between two panels of the same height.
- 3 Panel connector brackets per side come standard with 42"h. and 54"h. panels.
- 4 Panel connector brackets per side come standard with 66"h. panels.
- Panels include 2 raceway covers with punchouts on both sides, an integrated aluminum top cap and levelling glides.
- Standard in clear (CLR) plexi.
- Optional frosted (FRST) plexi
- 24" wide panels have two punchouts, one for electrical and one for data.
- 30" wide panels and wider have three punchouts, two for electrical and one for data.
- Glazing is 12" nominal from the top of the panel.

PRODUCT CODE	PRICE		SIZE/ INCHES			WEIGHT VOL	
	GR 1	GR 2	H	W	D	LBS	FT <sup>3</sup>
CMPLG4224N2	433	446	42	24	2.3	20	2.31
CMPLG4230N2	474	492	42	30	2.3	25	2.85
CMPLG4236N2	521	550	42	36	2.3	31	3.38
CMPLG4242N2	576	607	42	42	2.3	36	3.92
CMPLG4248N2	633	661	42	48	2.3	41	4.45
CMPLG4254N2	715	743	42	54	2.3	46	4.99
CMPLG4260N2	787	816	42	60	2.3	51	5.52
CMPLG4824N2	463	477	48	24	2.3	26	2.73
CMPLG4830N2	534	550	48	30	2.3	33	3.37
CMPLG4836N2	595	625	48	36	2.3	39	4.00
CMPLG4842N2	670	699	48	42	2.3	46	4.63
CMPLG4848N2	737	767	48	48	2.3	52	5.26
CMPLG4854N2	815	845	48	54	2.3	59	5.89
CMPLG4860N2	886	914	48	60	2.3	65	6.53
CMPLG5424N2	463	476	54	24	2.3	26	2.73
CMPLG5430N2	534	550	54	30	2.3	33	3.37
CMPLG5436N2	595	625	54	36	2.3	39	4.00
CMPLG5442N2	669	699	54	42	2.3	46	4.63
CMPLG5448N2	737	767	54	48	2.3	52	5.26
CMPLG5454N2	816	844	54	54	2.3	59	5.89
CMPLG5460N2	886	915	54	60	2.3	65	6.53
CMPLG6624N2	509	539	66	24	2.3	32	3.58
CMPLG6630N2	590	619	66	30	2.3	40	4.40
CMPLG6636N2	656	715	66	36	2.3	48	5.23
CMPLG6642N2	732	790	66	42	2.3	56	6.06
CMPLG6648N2	809	868	66	48	2.3	64	6.88
CMPLG6654N2	893	953	66	54	2.3	72	7.71
CMPLG6660N2	970	1030	66	60	2.3	80	8.53

**CMPLG-P1 • Single 12" Glazed at Top, Powered Fabric Panel, Punchouts on One Side**

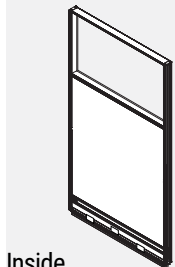

Inside

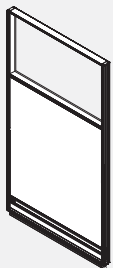

Outside

- Individual fabric-covered module in lower position with glazed module in upper position incorporated into a solid steel frame.
- Opposite sides of each module may have a different fabric within the same grade at no upcharge.
- If different grades of fabric are used on one panel, the entire panel must be priced at highest grade.
- Panels are not tackable.
- Note: Trim is not required at a straight connection between two panels of the same height.
- 3 Panel connector brackets per side come standard with 42"h. and 54"h. panels.
- 4 Panel connector brackets per side come standard with 66"h. panels.
- Panels include 1 raceway cover with punchouts on one side, 1 raceway cover with no punchouts on the other, a power distribution housing, an integrated aluminum top cap and levelling glides.
- Standard in clear (CLR) plexi.
- Optional frosted (FRST) plexi
- 24" wide panels have two punchouts, one for electrical and one for data.
- 30" wide panels and wider have three punchouts, two for electrical and one for data.
- Please specify duplex receptacles separately.
- Glazing is 12" nominal from the top of the panel.

PRODUCT CODE	PRICE		SIZE/ INCHES			WEIGHT VOL	
	GR 1	GR 2	H	W	D	LBS	FT <sup>3</sup>
CMPLG4224P1	565	583	42	24	2.3	20	2.31
CMPLG4230P1	658	672	42	30	2.3	25	2.85
CMPLG4236P1	710	739	42	36	2.3	31	3.38
CMPLG4242P1	773	802	42	42	2.3	36	3.92
CMPLG4248P1	839	868	42	48	2.3	41	4.45
CMPLG4254P1	926	955	42	54	2.3	46	4.99
CMPLG4260P1	998	1029	42	60	2.3	51	5.52
CMPLG4824P1	596	612	48	24	2.3	26	2.73
CMPLG4830P1	716	730	48	30	2.3	33	3.37
CMPLG4836P1	785	815	48	36	2.3	39	4.00
CMPLG4842P1	866	894	48	42	2.3	46	4.63
CMPLG4848P1	946	975	48	48	2.3	52	5.26
CMPLG4854P1	1026	1055	48	54	2.3	59	5.89
CMPLG4860P1	1098	1126	48	60	2.3	65	6.53
CMPLG5424P1	596	612	54	24	2.3	26	2.73
CMPLG5430P1	716	730	54	30	2.3	33	3.37
CMPLG5436P1	787	816	54	36	2.3	39	4.00
CMPLG5442P1	866	894	54	42	2.3	46	4.63
CMPLG5448P1	945	974	54	48	2.3	52	5.26
CMPLG5454P1	1026	1056	54	54	2.3	59	5.89
CMPLG5460P1	1098	1126	54	60	2.3	65	6.53
CMPLG6624P1	646	674	66	24	2.3	32	3.58
CMPLG6630P1	771	801	66	30	2.3	40	4.40
CMPLG6636P1	845	904	66	36	2.3	48	5.23
CMPLG6642P1	928	987	66	42	2.3	56	6.06
CMPLG6648P1	1019	1076	66	48	2.3	64	6.88
CMPLG6654P1	1104	1163	66	54	2.3	72	7.71
CMPLG6660P1	1183	1241	66	60	2.3	80	8.53



**CMPLG-P2 • Single 12" Glazed at Top, Powered Fabric Panel, Punchouts on Both Sides**

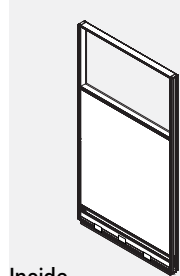

Inside

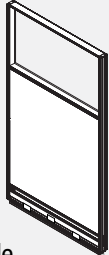

Outside

- Individual fabric-covered module in lower position with glazed module in upper position incorporated into an aluminum frame.
- Opposite sides of each module may have a different fabric within the same grade at no upcharge.
- If different grades of fabric are used on one panel, the entire panel must be priced at highest grade.
- Panels are not tackable.
- Note: Trim is not required at a straight connection between two panels of the same height.
- 3 Panel connector brackets per side come standard with 42"h. and 54"h. panels.
- 4 Panel connector brackets per side come standard with 66"h. panels.
- Panels include 2 raceway covers with punchouts on both sides, a power distribution housing, an integrated aluminum top cap and levelling glides.
- Standard in clear (CLR) plexi.
- Optional frosted (FRST) plexi
- 24" wide panels have two punchouts, one for electrical and one for data.
- 30" wide panels and wider have three punchouts, two for electrical and one for data.
- Glazing is 12" nominal from the top of the panel.
- panels and wider have 2 punchouts.
- Please specify duplex receptacles separately.

PRODUCT CODE	PRICE		SIZE/ INCHES			WEIGHT VOL	
	GR1	GR2	H	W	D	LBS	FT <sup>3</sup>
CMPLG4224P2	565	583	42	24	2.3	20	2.31
CMPLG4230P2	658	672	42	30	2.3	25	2.85
CMPLG4236P2	710	739	42	36	2.3	31	3.38
CMPLG4242P2	773	802	42	42	2.3	36	3.92
CMPLG4248P2	839	868	42	48	2.3	41	4.45
CMPLG4254P2	926	955	42	54	2.3	46	4.99
CMPLG4260P2	998	1029	42	60	2.3	51	5.52
CMPLG4824P2	596	612	48	24	2.3	26	2.73
CMPLG4830P2	716	730	48	30	2.3	33	3.37
CMPLG4836P2	785	815	48	36	2.3	39	4.00
CMPLG4842P2	866	894	48	42	2.3	46	4.63
CMPLG4848P2	946	975	48	48	2.3	52	5.26
CMPLG4854P2	1026	1055	48	54	2.3	59	5.89
CMPLG4860P2	1098	1126	48	60	2.3	65	6.53
CMPLG5424P2	596	612	54	24	2.3	26	2.73
CMPLG5430P2	716	730	54	30	2.3	33	3.37
CMPLG5436P2	787	816	54	36	2.3	39	4.00
CMPLG5442P2	866	894	54	42	2.3	46	4.63
CMPLG5448P2	945	974	54	48	2.3	52	5.26
CMPLG5454P2	1026	1056	54	54	2.3	59	5.89
CMPLG5460P2	1098	1126	54	60	2.3	65	6.53
CMPLG6624P2	646	674	66	24	2.3	32	3.58
CMPLG6630P2	771	801	66	30	2.3	40	4.40
CMPLG6636P2	845	904	66	36	2.3	48	5.23
CMPLG6642P2	928	987	66	42	2.3	56	6.06
CMPLG6648P2	1019	1076	66	48	2.3	64	6.88
CMPLG6654P2	1104	1163	66	54	2.3	72	7.71
CMPLG6660P2	1183	1241	66	60	2.3	80	8.53

**CMPG-N0 • Single 14" Glazed at Top Glazed Panel, Non Powered Fabric Panel, No Punchouts**

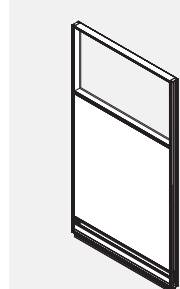

Inside

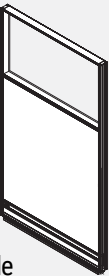

Outside

- Individual fabric-covered module in lower position with glazed module in upper position incorporated into an aluminum frame.
- Opposite sides of each module may have a different fabric within the same grade at no upcharge.
- If different grades of fabric are used on one panel, the entire panel must be priced at highest grade.
- Panels are not tackable.
- Note: Trim is not required at a straight connection between two panels of the same height.
- 3 Panel connector brackets per side come standard with 42"h. and 54"h. panels.
- 4 Panel connector brackets per side come standard with 66"h. panels.
- Panels include 2 raceway covers with no punchouts, an integrated aluminum top cap and levelling glides.
- Standard in clear (CLR) plexi.
- Optional frosted (FRST) plexi
- PVC Glass Retainer may match any panel frame finish.
- Glazing is 14" nominal from the top of the panel.

PRODUCT CODE	PRICE		SIZE/ INCHES			WEIGHT VOL	
	GR1	GR2	H	W	D	LBS	FT <sup>3</sup>
CMPG4224N0	433	446	42	24	2.3	20	2.31
CMPG4230N0	474	492	42	30	2.3	25	2.85
CMPG4236N0	521	550	42	36	2.3	31	3.38
CMPG4242N0	576	607	42	42	2.3	36	3.92
CMPG4248N0	633	661	42	48	2.3	41	4.45
CMPG4254N0	715	743	42	54	2.3	46	4.99
CMPG4260N0	787	816	42	60	2.3	51	5.52
CMPG4824N0	463	477	48	24	2.3	26	2.73
CMPG4830N0	534	550	48	30	2.3	33	3.37
CMPG4836N0	595	625	48	36	2.3	39	4.00
CMPG4842N0	670	699	48	42	2.3	46	4.63
CMPG4848N0	737	767	48	48	2.3	52	5.26
CMPG4854N0	815	845	48	54	2.3	59	5.89
CMPG4860N0	886	914	48	60	2.3	65	6.53
CMPG5424N0	463	476	54	24	2.3	26	2.73
CMPG5430N0	534	550	54	30	2.3	33	3.37
CMPG5436N0	595	625	54	36	2.3	39	4.00
CMPG5442N0	669	699	54	42	2.3	46	4.63
CMPG5448N0	737	767	54	48	2.3	52	5.26
CMPG5454N0	816	844	54	54	2.3	59	5.89
CMPG5460N0	886	915	54	60	2.3	65	6.53
CMPG6624N0	509	539	66	24	2.3	32	3.58
CMPG6630N0	590	619	66	30	2.3	40	4.40
CMPG6636N0	656	715	66	36	2.3	48	5.23
CMPG6642N0	732	790	66	42	2.3	56	6.06
CMPG6648N0	809	868	66	48	2.3	64	6.88
CMPG6654N0	893	953	66	54	2.3	72	7.71
CMPG6660N0	970	1030	66	60	2.3	80	8.53

**CMPG-N1 • Single 14" Glazed at Top Glazed Panel, Non Powered Fabric Panel, Punchouts on One Side**

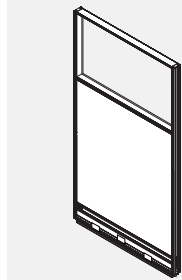

Inside

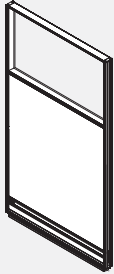

Outside

- Individual fabric-covered module in lower position with glazed module in upper position incorporated into an aluminum frame.
- Opposite sides of each module may have a different fabric within the same grade at no upcharge.
- If different grades of fabric are used on one panel, the entire panel must be priced at highest grade.
- Panels are not tackable.
- Note: Trim is not required at a straight connection between two panels of the same height.
- 3 Panel connector brackets per side come standard with 42" h. and 54" h. panels.
- 4 Panel connector brackets per side come standard with 66" h. panels.
- Panels include 1 raceway cover with punchouts on one side, 1 raceway cover with no punchouts on the other, an integrated aluminum top cap and levelling glides.
- Standard in clear (CLR) plexi.
- Optional frosted (FRST) plexi
- 24" wide panels have two punchouts, one for electrical and one for data.
- 30" wide panels and wider have three punchouts, two for electrical and one for data.
- Glazing is 14" nominal from the top of the panel.

PRODUCT CODE	PRICE		SIZE/ INCHES			WEIGHT VOL	
	GR 1	GR 2	H	W	D	LBS	FT <sup>3</sup>
CMPG4224N1	433	446	42	24	2.3	20	2.31
CMPG4230N1	474	492	42	30	2.3	25	2.85
CMPG4236N1	521	550	42	36	2.3	31	3.38
CMPG4242N1	576	607	42	42	2.3	36	3.92
CMPG4248N1	633	661	42	48	2.3	41	4.45
CMPG4254N1	715	743	42	54	2.3	46	4.99
CMPG4260N1	787	816	42	60	2.3	51	5.52
CMPG4824N1	463	477	48	24	2.3	26	2.73
CMPG4830N1	534	550	48	30	2.3	33	3.37
CMPG4836N1	595	625	48	36	2.3	39	4.00
CMPG4842N1	670	699	48	42	2.3	46	4.63
CMPG4848N1	737	767	48	48	2.3	52	5.26
CMPG4854N1	815	845	48	54	2.3	59	5.89
CMPG4860N1	886	914	48	60	2.3	65	6.53
CMPG5424N1	463	476	54	24	2.3	26	2.73
CMPG5430N1	534	550	54	30	2.3	33	3.37
CMPG5436N1	595	625	54	36	2.3	39	4.00
CMPG5442N1	669	699	54	42	2.3	46	4.63
CMPG5448N1	737	767	54	48	2.3	52	5.26
CMPG5454N1	816	844	54	54	2.3	59	5.89
CMPG5460N1	886	915	54	60	2.3	65	6.53
CMPG6624N1	509	539	66	24	2.3	32	3.58
CMPG6630N1	590	619	66	30	2.3	40	4.40
CMPG6636N1	656	715	66	36	2.3	48	5.23
CMPG6642N1	732	790	66	42	2.3	56	6.06
CMPG6648N1	809	868	66	48	2.3	64	6.88
CMPG6654N1	893	953	66	54	2.3	72	7.71
CMPG6660N1	970	1030	66	60	2.3	80	8.53

**CMPG-N2 • Single 14" Glazed at Top, Non Powered Fabric Panel, Punchouts on Both Sides**

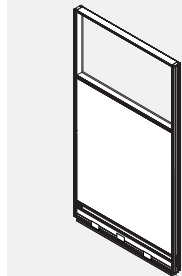

Inside

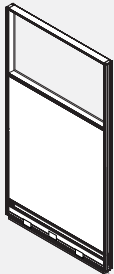

Outside

- Individual fabric-covered module in lower position with glazed module in upper position incorporated into a solid steel frame.
- Opposite sides of each module may have a different fabric within the same grade at no upcharge.
- If different grades of fabric are used on one panel, the entire panel must be priced at highest grade.
- Panels are not tackable.
- Note: Trim is not required at a straight connection between two panels of the same height.
- 3 Panel connector brackets per side come standard with 42" h. and 54" h. panels.
- 4 Panel connector brackets per side come standard with 66" h. panels.
- Panels include 2 raceway covers with punchouts on both sides, an integrated aluminum top cap and levelling glides.
- Standard in clear (CLR) plexi.
- Optional frosted (FRST) plexi
- 24" wide panels have two punchouts, one for electrical and one for data.
- 30" wide panels and wider have three punchouts, two for electrical and one for data.
- Glazing is 14" nominal from the top of the panel.

PRODUCT CODE	PRICE		SIZE/ INCHES			WEIGHT VOL	
	GR 1	GR 2	H	W	D	LBS	FT <sup>3</sup>
CMPG4224N2	433	446	42	24	2.3	20	2.31
CMPG4230N2	474	492	42	30	2.3	25	2.85
CMPG4236N2	521	550	42	36	2.3	31	3.38
CMPG4242N2	576	607	42	42	2.3	36	3.92
CMPG4248N2	633	661	42	48	2.3	41	4.45
CMPG4254N2	715	743	42	54	2.3	46	4.99
CMPG4260N2	787	816	42	60	2.3	51	5.52
CMPG4824N2	463	477	48	24	2.3	26	2.73
CMPG4830N2	534	550	48	30	2.3	33	3.37
CMPG4836N2	595	625	48	36	2.3	39	4.00
CMPG4842N2	670	699	48	42	2.3	46	4.63
CMPG4848N2	737	767	48	48	2.3	52	5.26
CMPG4854N2	815	845	48	54	2.3	59	5.89
CMPG4860N2	886	914	48	60	2.3	65	6.53
CMPG5424N2	463	476	54	24	2.3	26	2.73
CMPG5430N2	534	550	54	30	2.3	33	3.37
CMPG5436N2	595	625	54	36	2.3	39	4.00
CMPG5442N2	669	699	54	42	2.3	46	4.63
CMPG5448N2	737	767	54	48	2.3	52	5.26
CMPG5454N2	816	844	54	54	2.3	59	5.89
CMPG5460N2	886	915	54	60	2.3	65	6.53
CMPG6624N2	509	539	66	24	2.3	32	3.58
CMPG6630N2	590	619	66	30	2.3	40	4.40
CMPG6636N2	656	715	66	36	2.3	48	5.23
CMPG6642N2	732	790	66	42	2.3	56	6.06
CMPG6648N2	809	868	66	48	2.3	64	6.88
CMPG6654N2	893	953	66	54	2.3	72	7.71
CMPG6660N2	970	1030	66	60	2.3	80	8.53

**CMPG-P1 • Single 14" Glazed at Top, Powered Fabric Panel, Punchouts on One Side**

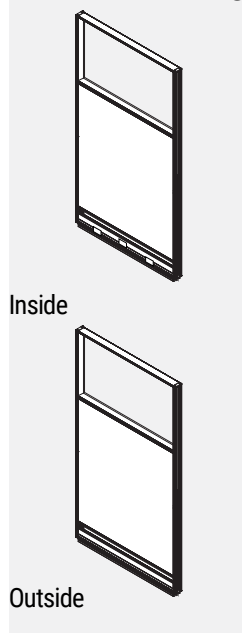

- Individual fabric-covered module in lower position with glazed module in upper position incorporated into a solid steel frame.
- Opposite sides of each module may have a different fabric within the same grade at no upcharge.
- If different grades of fabric are used on one panel, the entire panel must be priced at highest grade.
- Panels are not tackable.
- Note: Trim is not required at a straight connection between two panels of the same height.
- 3 Panel connector brackets per side come standard with 42"h. and 54"h. panels.
- 4 Panel connector brackets per side come standard with 66"h. panels.
- Panels include 1 raceway cover with punchouts on one side, 1 raceway cover with no punchouts on the other, a power distribution housing, an integrated aluminum top cap and levelling glides.
- Standard in clear (CLR) plexi.
- Optional frosted (FRST) plexi
- 24" wide panels have two punchouts, one for electrical and one for data.
- 30" wide panels and wider have three punchouts, two for electrical and one for data.
- Please specify duplex receptacles separately.
- Glazing is 14" nominal from the top of the panel.

PRODUCT CODE	PRICE		SIZE/ INCHES			WEIGHT VOL	
	GR1	GR2	H	W	D	LBS	FT <sup>3</sup>
CMPG4224P1	565	583	42	24	2.3	20	2.31
CMPG4230P1	658	672	42	30	2.3	25	2.85
CMPG4236P1	710	739	42	36	2.3	31	3.38
CMPG4242P1	773	802	42	42	2.3	36	3.92
CMPG4248P1	839	868	42	48	2.3	41	4.45
CMPG4254P1	926	955	42	54	2.3	46	4.99
CMPG4260P1	998	1029	42	60	2.3	51	5.52
CMPG4824P1	596	612	48	24	2.3	26	2.73
CMPG4830P1	716	730	48	30	2.3	33	3.37
CMPG4836P1	785	815	48	36	2.3	39	4.00
CMPG4842P1	866	894	48	42	2.3	46	4.63
CMPG4848P1	946	975	48	48	2.3	52	5.26
CMPG4854P1	1026	1055	48	54	2.3	59	5.89
CMPG4860P1	1098	1126	48	60	2.3	65	6.53
CMPG5424P1	596	612	54	24	2.3	26	2.73
CMPG5430P1	716	730	54	30	2.3	33	3.37
CMPG5436P1	787	816	54	36	2.3	39	4.00
CMPG5442P1	866	894	54	42	2.3	46	4.63
CMPG5448P1	945	974	54	48	2.3	52	5.26
CMPG5454P1	1026	1056	54	54	2.3	59	5.89
CMPG5460P1	1098	1126	54	60	2.3	65	6.53
CMPG6624P1	646	674	66	24	2.3	32	3.58
CMPG6630P1	771	801	66	30	2.3	40	4.40
CMPG6636P1	845	904	66	36	2.3	48	5.23
CMPG6642P1	928	987	66	42	2.3	56	6.06
CMPG6648P1	1019	1076	66	48	2.3	64	6.88
CMPG6654P1	1104	1163	66	54	2.3	72	7.71
CMPG6660P1	1183	1241	66	60	2.3	80	8.53

**CMPG-P2 • Single 14" Glazed at Top, Powered Fabric Panel, Punchouts on Both Sides**

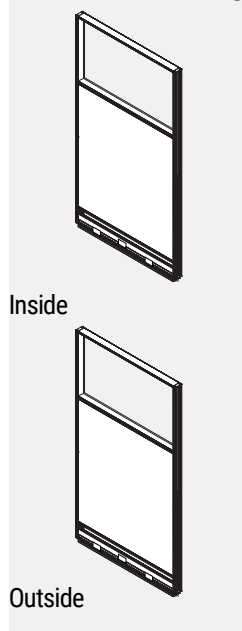

- Individual fabric-covered module in lower position with glazed module in upper position incorporated into an aluminum frame.
- Opposite sides of each module may have a different fabric within the same grade at no upcharge.
- If different grades of fabric are used on one panel, the entire panel must be priced at highest grade.
- Panels are not tackable.
- Note: Trim is not required at a straight connection between two panels of the same height.
- 3 Panel connector brackets per side come standard with 42"h. and 54"h. panels.
- 4 Panel connector brackets per side come standard with 66"h. panels.
- Panels include 2 raceway covers with punchouts on both sides, a power distribution housing, an integrated aluminum top cap and levelling glides.
- Standard in clear (CLR) plexi.
- Optional frosted (FRST) plexi
- 24" wide panels have two punchouts, one for electrical and one for data.
- 30" wide panels and wider have three punchouts, two for electrical and one for data.
- Glazing is 14" nominal from the top of the panel. panels and wider have 2 punchouts.
- Please specify duplex receptacles separately.

PRODUCT CODE	PRICE		SIZE/ INCHES			WEIGHT VOL	
	GR1	GR2	H	W	D	LBS	FT <sup>3</sup>
CMPG4224P2	565	583	42	24	2.3	20	2.31
CMPG4230P2	658	672	42	30	2.3	25	2.85
CMPG4236P2	710	739	42	36	2.3	31	3.38
CMPG4242P2	773	802	42	42	2.3	36	3.92
CMPG4248P2	839	868	42	48	2.3	41	4.45
CMPG4254P2	926	955	42	54	2.3	46	4.99
CMPG4260P2	998	1029	42	60	2.3	51	5.52
CMPG4824P2	596	612	48	24	2.3	26	2.73
CMPG4830P2	716	730	48	30	2.3	33	3.37
CMPG4836P2	785	815	48	36	2.3	39	4.00
CMPG4842P2	866	894	48	42	2.3	46	4.63
CMPG4848P2	946	975	48	48	2.3	52	5.26
CMPG4854P2	1026	1055	48	54	2.3	59	5.89
CMPG4860P2	1098	1126	48	60	2.3	65	6.53
CMPG5424P2	596	612	54	24	2.3	26	2.73
CMPG5430P2	716	730	54	30	2.3	33	3.37
CMPG5436P2	787	816	54	36	2.3	39	4.00
CMPG5442P2	866	894	54	42	2.3	46	4.63
CMPG5448P2	945	974	54	48	2.3	52	5.26
CMPG5454P2	1026	1056	54	54	2.3	59	5.89
CMPG5460P2	1098	1126	54	60	2.3	65	6.53
CMPG6624P2	646	674	66	24	2.3	32	3.58
CMPG6630P2	771	801	66	30	2.3	40	4.40
CMPG6636P2	845	904	66	36	2.3	48	5.23
CMPG6642P2	928	987	66	42	2.3	56	6.06
CMPG6648P2	1019	1076	66	48	2.3	64	6.88
CMPG6654P2	1104	1163	66	54	2.3	72	7.71
CMPG6660P2	1183	1241	66	60	2.3	80	8.53

**CMFO-N0 • Single Segmented Open Bottom Non Powered Fabric Panel, No Punchouts**

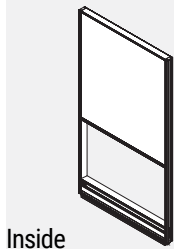

Inside

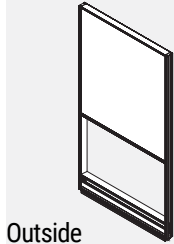

Outside

- Individual fabric-covered module in upper position incorporated into an aluminum frame.
- Bottom is open.
- Opposite sides of each module may have a different fabric within the same grade at no upcharge.
- If different grades of fabric are used on one panel, the entire panel must be priced at highest grade.
- Panels are not tackable.
- Note: Trim is not required at a straight connection between two panels of the same height.
- 3 Panel connector brackets per side come standard with 42”h. and 54”h. panels.
- 4 Panel connector brackets per side come standard with 66”h. panels.
- Panels include 2 raceway covers with no punchouts, an integrated aluminum top cap and levelling glides.
- PVC trim kit available in black only.

PRODUCT CODE	PRICE		SIZE/ INCHES			WEIGHT VOL	
	GR 1	GR 2	H	W	D	LBS	FT <sup>3</sup>
CMFO4224N0	263	273	42	24	2.3	15	2.31
CMFO4230N0	329	339	42	30	2.3	17	2.85
CMFO4236N0	354	372	42	36	2.3	21	3.38
CMFO4242N0	406	425	42	42	2.3	24	3.92
CMFO4248N0	433	450	42	48	2.3	28	4.45
CMFO4254N0	472	498	42	54	2.3	31	4.99
CMFO4260N0	520	536	42	60	2.3	34	5.52
CMFO5424N0	310	326	54	24	2.3	20	2.73
CMFO5430N0	354	367	54	30	2.3	25	3.37
CMFO5436N0	403	418	54	36	2.3	29	4.00
CMFO5442N0	462	492	54	42	2.3	34	4.63
CMFO5448N0	493	523	54	48	2.3	38	5.26
CMFO5454N0	537	567	54	54	2.3	43	5.89
CMFO5460N0	572	601	54	60	2.3	48	6.53
CMFO6624N0	342	366	66	24	2.3	25	3.58
CMFO6630N0	383	406	66	30	2.3	31	4.40
CMFO6636N0	459	501	66	36	2.3	38	5.23
CMFO6642N0	520	561	66	42	2.3	44	6.06
CMFO6648N0	545	586	66	48	2.3	50	6.88
CMFO6654N0	594	637	66	54	2.3	56	7.71
CMFO6660N0	635	675	66	60	2.3	63	8.53

**CMFO-N1 • Single Segmented Open Bottom Non Powered Fabric Panel, Punchouts on One Side**



Inside

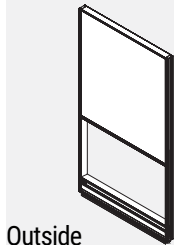

Outside

- Individual fabric-covered module in upper position incorporated into an aluminum frame.
- Bottom is open.
- Opposite sides of each module may have a different fabric within the same grade at no upcharge.
- If different grades of fabric are used on one panel, the entire panel must be priced at highest grade.
- Panels are not tackable.
- Note: Trim is not required at a straight connection between two panels of the same height.
- 3 Panel connector brackets per side come standard with 42”h. and 54”h. panels.
- 4 Panel connector brackets per side come standard with 66”h. panels.
- Panels include 1 raceway cover with punchouts on one side, 1 raceway cover with no punchouts on the other, an integrated aluminum top cap and levelling glides.
- 24” wide panels have two punchouts, one for electrical and one for data.
- 30” wide panels and wider have three punchouts, two for electrical and one for data.
- PVC trim kit available in black only.

PRODUCT CODE	PRICE		SIZE/ INCHES			WEIGHT VOL	
	GR 1	GR 2	H	W	D	LBS	FT <sup>3</sup>
CMFO4224N1	263	273	42	24	2.3	15	2.31
CMFO4230N1	329	339	42	30	2.3	17	2.85
CMFO4236N1	354	372	42	36	2.3	21	3.38
CMFO4242N1	406	425	42	42	2.3	24	3.92
CMFO4248N1	433	450	42	48	2.3	28	4.45
CMFO4254N1	472	498	42	54	2.3	31	4.99
CMFO4260N1	520	536	42	60	2.3	34	5.52
CMFO5424N1	310	326	54	24	2.3	20	2.73
CMFO5430N1	354	367	54	30	2.3	25	3.37
CMFO5436N1	403	418	54	36	2.3	29	4.00
CMFO5442N1	462	492	54	42	2.3	34	4.63
CMFO5448N1	493	523	54	48	2.3	38	5.26
CMFO5454N1	537	567	54	54	2.3	43	5.89
CMFO5460N1	572	601	54	60	2.3	48	6.53
CMFO6624N1	342	366	66	24	2.3	25	3.58
CMFO6630N1	383	406	66	30	2.3	31	4.40
CMFO6636N1	459	501	66	36	2.3	38	5.23
CMFO6642N1	520	561	66	42	2.3	44	6.06
CMFO6648N1	545	586	66	48	2.3	50	6.88
CMFO6654N1	594	637	66	54	2.3	56	7.71
CMFO6660N1	635	675	66	60	2.3	63	8.53

**CMFO-N2 • Single Segmented Open Bottom Non Powered Fabric Panel, Punchouts on Both Sides**

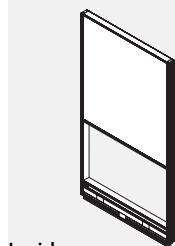

Inside



Outside

- Individual fabric-covered module in upper position incorporated into an aluminum frame.
- Bottom is open.
- Opposite sides of each module may have a different fabric within the same grade at no upcharge.
- If different grades of fabric are used on one panel, the entire panel must be priced at highest grade.
- Panels are not tackable.
- Note: Trim is not required at a straight connection between two panels of the same height.
- 3 Panel connector brackets per side come standard with 42”h. and 54”h. panels.
- 4 Panel connector brackets per side come standard with 66”h. panels.
- Panels include 2 raceway covers with punchouts on both sides, an integrated aluminum top cap and levelling glides.
- 24” wide panels have two punchouts, one for electrical and one for data.
- 30” wide panels and wider have three punchouts, two for electrical and one for data.
- PVC trim kit available in black only.

PRODUCT CODE	PRICE		SIZE/ INCHES			WEIGHT VOL	
	GR 1	GR 2	H	W	D	LBS	FT <sup>3</sup>
CMFO4224N2	263	273	42	24	2.3	15	2.31
CMFO4230N2	329	339	42	30	2.3	17	2.85
CMFO4236N2	354	372	42	36	2.3	21	3.38
CMFO4242N2	406	425	42	42	2.3	24	3.92
CMFO4248N2	433	450	42	48	2.3	28	4.45
CMFO4254N2	472	498	42	54	2.3	31	4.99
CMFO4260N2	520	536	42	60	2.3	34	5.52
CMFO5424N2	310	326	54	24	2.3	20	2.73
CMFO5430N2	354	367	54	30	2.3	25	3.37
CMFO5436N2	403	418	54	36	2.3	29	4.00
CMFO5442N2	462	492	54	42	2.3	34	4.63
CMFO5448N2	493	523	54	48	2.3	38	5.26
CMFO5454N2	537	567	54	54	2.3	43	5.89
CMFO5460N2	572	601	54	60	2.3	48	6.53
CMFO6624N2	342	366	66	24	2.3	25	3.58
CMFO6630N2	383	406	66	30	2.3	31	4.40
CMFO6636N2	459	501	66	36	2.3	38	5.23
CMFO6642N2	520	561	66	42	2.3	44	6.06
CMFO6648N2	545	586	66	48	2.3	50	6.88
CMFO6654N2	594	637	66	54	2.3	56	7.71
CMFO6660N2	635	675	66	60	2.3	63	8.53

**CMFO-P1 • Single Segmented Open Bottom Powered Fabric Panel, Punchouts on One Side**

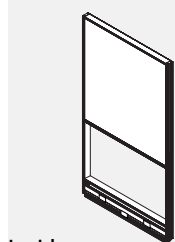

Inside

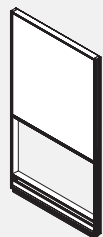

Outside

- Individual fabric-covered module in upper position incorporated into an aluminum frame.
- Bottom is open.
- Opposite sides of each module may have a different fabric within the same grade at no upcharge.
- If different grades of fabric are used on one panel, the entire panel must be priced at highest grade.
- Panels are not tackable.
- Note: Trim is not required at a straight connection between two panels of the same height.
- 3 Panel connector brackets per side come standard with 42”h. and 54”h. panels.
- 4 Panel connector brackets per side come standard with 66”h. panels.
- Panels include 1 raceway cover with punchouts on one side, 1 raceway cover with no punchouts on the other, a power distribution housing, an integrated aluminum top cap and levelling glides.
- 24” wide panels have two punchouts, one for electrical and one for data.
- 30” wide panels and wider have three punchouts, two for electrical and one for data.
- Please specify duplex receptacles separately.
- PVC trim kit available in black only.

PRODUCT CODE	PRICE		SIZE/ INCHES			WEIGHT VOL	
	GR 1	GR 2	H	W	D	LBS	FT <sup>3</sup>
CMFO4224P1	389	399	42	24	2.3	15	2.31
CMFO4230P1	497	506	42	30	2.3	17	2.85
CMFO4236P1	530	550	42	36	2.3	21	3.38
CMFO4242P1	587	607	42	42	2.3	24	3.92
CMFO4248P1	625	642	42	48	2.3	28	4.45
CMFO4254P1	669	678	42	54	2.3	31	4.99
CMFO4260P1	716	735	42	60	2.3	34	5.52
CMFO5424P1	436	449	54	24	2.3	20	2.73
CMFO5430P1	524	536	54	30	2.3	25	3.37
CMFO5436P1	578	592	54	36	2.3	29	4.00
CMFO5442P1	642	673	54	42	2.3	34	4.63
CMFO5448P1	686	715	54	48	2.3	38	5.26
CMFO5454P1	735	763	54	54	2.3	43	5.89
CMFO5460P1	768	799	54	60	2.3	48	6.53
CMFO6624P1	468	492	66	24	2.3	25	3.58
CMFO6630P1	551	574	66	30	2.3	31	4.40
CMFO6636P1	635	675	66	36	2.3	38	5.23
CMFO6642P1	701	743	66	42	2.3	44	6.06
CMFO6648P1	736	779	66	48	2.3	50	6.88
CMFO6654P1	790	832	66	54	2.3	56	7.71
CMFO6660P1	831	872	66	60	2.3	63	8.53

**CMFO-P2 • Single Segmented Open Bottom Powered Fabric Panel, Punchouts on Both Sides**

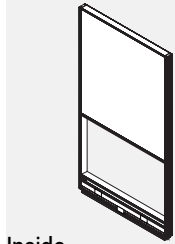

Inside

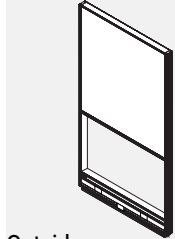

Outside

- Individual fabric-covered module in upper position incorporated into an aluminum frame.
- Bottom is open.
- Opposite sides of each module may have a different fabric within the same grade at no upcharge.
- If different grades of fabric are used on one panel, the entire panel must be priced at highest grade.
- Panels are not tackable.
- Note: Trim is not required at a straight connection between two panels of the same height.
- 3 Panel connector brackets per side come standard with 42”h. and 54”h. panels.
- 4 Panel connector brackets per side come standard with 66”h. panels.
- Panels include 2 raceway covers with punchouts on both sides, a power distribution housing, an integrated aluminum top cap and levelling glides.
- 24” wide panels have two punchouts, one for electrical and one for data.
- 30” wide panels and wider have three punchouts, two for electrical and one for data.
- Please specify duplex receptacles separately.
- PVC trim kit available in black only.

PRODUCT CODE	PRICE		SIZE/ INCHES			WEIGHT VOL	
	GR 1	GR 2	H	W	D	LBS	FT <sup>3</sup>
CMFO4224P2	389	399	42	24	2.3	15	2.31
CMFO4230P2	497	506	42	30	2.3	17	2.85
CMFO4236P2	530	550	42	36	2.3	21	3.38
CMFO4242P2	587	607	42	42	2.3	24	3.92
CMFO4248P2	625	642	42	48	2.3	28	4.45
CMFO4254P2	669	678	42	54	2.3	31	4.99
CMFO4260P2	716	735	42	60	2.3	34	5.52
CMFO5424P2	436	449	54	24	2.3	20	2.73
CMFO5430P2	524	536	54	30	2.3	25	3.37
CMFO5436P2	578	592	54	36	2.3	29	4.00
CMFO5442P2	642	673	54	42	2.3	34	4.63
CMFO5448P2	686	715	54	48	2.3	38	5.26
CMFO5454P2	735	763	54	54	2.3	43	5.89
CMFO5460P2	768	799	54	60	2.3	48	6.53
CMFO6624P2	468	492	66	24	2.3	25	3.58
CMFO6630P2	551	574	66	30	2.3	31	4.40
CMFO6636P2	635	675	66	36	2.3	38	5.23
CMFO6642P2	701	743	66	42	2.3	44	6.06
CMFO6648P2	736	779	66	48	2.3	50	6.88
CMFO6654P2	790	832	66	54	2.3	56	7.71
CMFO6660P2	831	872	66	60	2.3	63	8.53

**CMOF • Compile Fabric Over Panel**

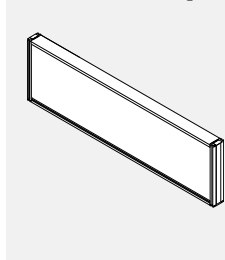

- Individual fabric-covered modules incorporated into an aluminum frame.
- Opposite sides of each module may have a different fabric within the same grade at no upcharge.
- If different grades of fabric are used on one panel, the entire panel must be priced at highest grade.
- Panels are not tackable.
- 2 Panel connector brackets per side are standard
- CHSD Compile Slider Kit for Over Panel required for installation and is included with each over panel.
- Note: Trim is not required at a straight connection between two panels of the same height.
- **Note: All over panels are non load bearing.**

PRODUCT CODE	PRICE		SIZE/ INCHES			WEIGHT VOL	
	GR 1	GR 2	H	W	D	LBS	FT <sup>3</sup>
CMOF1224	130	151	12	24	2.3	8	0.38
CMOF1230	153	173	12	30	2.3	10	0.48
CMOF1236	169	190	12	36	2.3	12.4	0.58
CMOF1242	193	212	12	42	2.3	14.4	0.67
CMOF1248	224	242	12	48	2.3	16.4	0.7
CMOF1254	231	252	12	54	2.3	18.4	0.86
CMOF1260	275	295	12	60	2.3	20.4	0.96
CMOF1624	152	175	16	30	2.3	15	0.64
CMOF1630	177	202	16	36	2.3	18.6	0.77
CMOF1636	188	211	16	42	2.3	21.6	0.89
CMOF1642	226	248	16	48	2.3	24.6	1.02
CMOF1648	256	279	16	54	2.3	27.6	1.15
CMOF1654	268	293	16	60	2.3	30.6	1.28
CMOF1660	315	339	16	66	2.3	33.6	1.42
CMOF2424	196	233	24	24	2.3	16	0.77
CMOF2430	228	260	24	30	2.3	20	0.96
CMOF2436	255	289	24	36	2.3	24.8	1.15
CMOF2442	288	320	24	42	2.3	28.8	1.34
CMOF2448	308	341	24	48	2.3	32.8	1.53
CMOF2454	342	375	24	54	2.3	36.8	1.73
CMOF2460	394	426	24	60	2.3	40.8	1.92

**CMOLF • Compile Laminate One Side, Fabric One Side Over Panel**

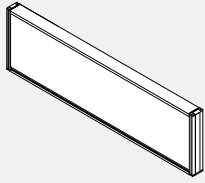

- Individual modules, one side in fabric and one side in laminate, incorporated into an aluminum frame.
- Panels are not tackable.
- 2 Panel connector brackets per side are standard
- CHSD Compile Slider Kit for Over Panel required for installation and is included with each over panel.
- Note: Trim is not required at a straight connection between two panels of the same height.
- **Note: All over panels are non load bearing.**

PRODUCT CODE	PRICE		SIZE/ INCHES			WEIGHT VOL	
	GR 1	GR 2	H	W	D	LBS	FT <sup>3</sup>
CMOLF1224	147	156	12	24	2.3	8	0.38
CMOLF1230	173	182	12	30	2.3	10	0.48
CMOLF1236	195	205	12	36	2.3	12.4	0.58
CMOLF1242	222	231	12	42	2.3	14.4	0.67
CMOLF1248	256	266	12	48	2.3	16.4	0.7
CMOLF1254	268	277	12	54	2.3	18.4	0.86
CMOLF1260	317	326	12	60	2.3	20.4	0.96
CMOLF1624	174	187	16	30	2.3	15	0.64
CMOLF1630	209	222	16	36	2.3	18.6	0.77
CMOLF1636	231	242	16	42	2.3	21.6	0.89
CMOLF1642	263	275	16	48	2.3	24.6	1.02
CMOLF1648	300	311	16	54	2.3	27.6	1.15
CMOLF1654	318	330	16	60	2.3	30.6	1.28
CMOLF1660	369	381	16	66	2.3	33.6	1.41
CMOLF2424	230	245	24	24	2.3	16	0.77
CMOLF2430	275	292	24	30	2.3	20	0.96
CMOLF2436	304	320	24	36	2.3	24.8	1.15
CMOLF2442	343	360	24	42	2.3	28.8	1.34
CMOLF2448	374	392	24	48	2.3	32.8	1.53
CMOLF2454	417	431	24	54	2.3	36.8	1.73
CMOLF2460	474	492	24	60	2.3	40.8	1.92

**CMOLL • Compile Laminate Two Sides Over Panel**

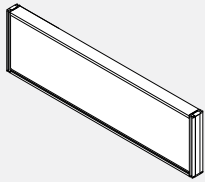

- Individual laminate modules incorporated into an aluminum frame.
- Panels are not tackable.
- 2 Panel connector brackets per side are standard
- CHSD Compile Slider Kit for Over Panel required for installation and is included with each over panel.
- Note: Trim is not required at a straight connection between two panels of the same height.
- **Note: All over panels are non load bearing.**

PRODUCT CODE	PRICE		SIZE/ INCHES			WEIGHT VOL	
	GR 1	GR 2	H	W	D	LBS	FT <sup>3</sup>
CMOLL1224	163		12	24	2.3	8	0.38
CMOLL1230	186		12	30	2.3	10	0.48
CMOLL1236	218		12	36	2.3	12.4	0.58
CMOLL1242	248		12	42	2.3	14.4	0.67
CMOLL1248	286		12	48	2.3	16.4	0.7
CMOLL1254	303		12	54	2.3	18.4	0.86
CMOLL1260	354		12	60	2.3	20.4	0.96
CMOLL1624	194		16	24	2.3	12	0.51
CMOLL1630	230		16	30	2.3	15	0.64
CMOLL1636	262		16	36	2.3	18.6	0.77
CMOLL1642	297		16	42	2.3	21.6	0.89
CMOLL1648	340		16	48	2.3	24.6	1.02
CMOLL1654	362		16	54	2.3	27.6	1.15
CMOLL1660	420		16	60	2.3	30.6	1.28
CMOLL2424	260		24	24	2.3	16	0.77
CMOLL2430	307		24	30	2.3	20	0.96
CMOLL2436	350		24	36	2.3	24.8	1.15
CMOLL2442	396		24	42	2.3	28.8	1.34
CMOLL2448	435		24	48	2.3	32.8	1.53
CMOLL2454	484		24	54	2.3	36.8	1.73
CMOLL2460	551		24	60	2.3	40.8	1.92

**CMOG • Compile Glazed Over Panel**

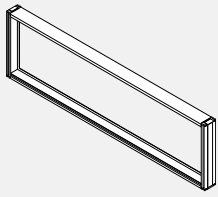

- Individual glazed module incorporated into an aluminum frame.
- Standard in clear (CLR) plexi.
- Optional frosted (FRST) plexi.
- Panels are not tackable.
- 2 Panel connector brackets per side are standard
- The PVC trim for glass can be different finish than the frame of the over panels, please specify two finishes.
- CHSD Compile Slider Kit for Over Panel required for installation and is included with each over panel.
- Note: Trim is not required at a straight connection between two panels of the same height.
- **Note: All over panels are non load bearing.**

PRODUCT CODE	PRICE	SIZE/ INCHES			WEIGHT VOL	
		H	W	D	LBS	FT <sup>3</sup>
CMOG1224	118	12	24	2.3	8	0.38
CMOG1230	135	12	30	2.3	10	0.48
CMOG1236	151	12	36	2.3	12.4	0.58
CMOG1242	169	12	42	2.3	14.4	0.67
CMOG1248	195	12	48	2.3	16.4	0.7
CMOG1254	204	12	54	2.3	18.4	0.86
CMOG1260	241	12	60	2.3	20.4	0.96
CMOG1624	135	16	24	2.3	12	0.51
CMOG1630	156	16	30	2.3	15	0.64
CMOG1636	174	16	36	2.3	18.6	0.77
CMOG1642	196	16	42	2.3	21.6	0.89
CMOG1648	226	16	48	2.3	24.6	1.02
CMOG1654	232	16	54	2.3	27.6	1.15
CMOG1660	275	16	60	2.3	30.6	1.28
CMOG2424	173	24	24	2.3	16	0.77
CMOG2430	188	24	30	2.3	20	0.96
CMOG2436	220	24	36	2.3	24.8	1.15
CMOG2442	246	24	42	2.3	28.8	1.34
CMOG2448	265	24	48	2.3	32.8	1.53
CMOG2454	294	24	54	2.3	36.8	1.73
CMOG2460	340	24	60	2.3	40.8	1.92

**CMOFW • Compile One Side Write Board Over Panel**

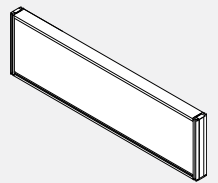

- Individual fabric or write board covered modules incorporated into an aluminum frame.
- Modules have write board on one side and fabric on the other.
- Panels are not tackable.
- 2 Panel connector brackets per side are standard
- CHSD Compile Slider Kit for Over Panel required for installation and is included with each over panel.
- Note: Trim is not required at a straight connection between two panels of the same height.
- **Note: All over panels are non load bearing.**

PRODUCT CODE	PRICE		SIZE/ INCHES			WEIGHT VOL	
	GR 1	GR 2	H	W	D	LBS	FT <sup>3</sup>
CMOFW1224	165	174	12	24	2.3	8	0.38
CMOFW1230	195	205	12	30	2.3	10	0.48
CMOFW1236	222	231	12	36	2.3	12.4	0.58
CMOFW1242	254	263	12	42	2.3	14.4	0.67
CMOFW1248	279	290	12	48	2.3	16.4	0.7
CMOFW1254	309	319	12	54	2.3	18.4	0.86
CMOFW1260	360	369	12	60	2.3	20.4	0.96
CMOFW1624	198	209	16	24	2.3	12	0.51
CMOFW1630	234	246	16	30	2.3	15	0.64
CMOFW1636	268	279	16	36	2.3	18.6	0.77
CMOFW1642	304	317	16	42	2.3	21.6	0.89
CMOFW1648	347	360	16	48	2.3	24.6	1.02
CMOFW1654	372	384	16	54	2.3	27.6	1.15
CMOFW1660	429	441	16	60	2.3	30.6	1.28
CMOFW2424	257	273	24	24	2.3	16	0.77
CMOFW2430	296	311	24	30	2.3	20	0.96
CMOFW2436	362	378	24	36	2.3	24.8	1.15
CMOFW2442	406	422	24	42	2.3	28.8	1.34
CMOFW2448	428	443	24	48	2.3	32.8	1.53
CMOFW2454	510	527	24	54	2.3	36.8	1.73
CMOFW2460	567	584	24	60	2.3	40.8	1.92



**CMOWW• Compile Write Board Two Sides Over Panel**

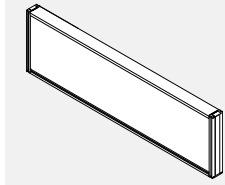

- Individual write board covered modules incorporated into an aluminum frame.
- Modules have write board on both sides.
- Panels are not tackable.
- 2 Panel connector brackets per side are standard
- CHSD Compile Slider Kit for Over Panel required for installation and is included with each over panel.
- Note: Trim is not required at a straight connection between two panels of the same height.
- **Note: All over panels are non load bearing.**

PRODUCT CODE	PRICE	SIZE/ INCHES			WEIGHT VOL	
		H	W	D	LBS	FT <sup>3</sup>
CMOWW1224	201	12	24	2.3	8	0.38
CMOWW1230	232	12	30	2.3	10	0.48
CMOWW1236	276	12	36	2.3	12.4	0.58
CMOWW1242	309	12	42	2.3	14.4	0.67
CMOWW1248	362	12	48	2.3	16.4	0.7
CMOWW1254	383	12	54	2.3	18.4	0.86
CMOWW1260	442	12	60	2.3	20.4	0.96
CMOWW1624	245	16	24	2.3	12	0.51
CMOWW1630	295	16	30	2.3	15	0.64
CMOWW1636	339	16	36	2.3	18.6	0.77
CMOWW1642	387	16	42	2.3	21.6	0.89
CMOWW1648	443	16	48	2.3	24.6	1.02
CMOWW1654	480	16	54	2.3	27.6	1.15
CMOWW1660	549	16	60	2.3	30.6	1.28
CMOWW2424	337	24	24	2.3	16	0.77
CMOWW2430	404	24	30	2.3	20	0.96
CMOWW2436	466	24	36	2.3	24.8	1.15
CMOWW2442	532	24	42	2.3	28.8	1.34
CMOWW2448	590	24	48	2.3	32.8	1.53
CMOWW2454	659	24	54	2.3	36.8	1.73
CMOWW2460	744	24	60	2.3	40.8	1.92

**BPDSL • Sliding Door**

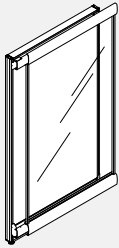

- Provides territorial privacy in an open plan environment.
- Lightweight, panel mounted sliding partition.
- Consists of translucent polycarbonate.
- Must be mounted to a straight panel of the same size.
- The face of the Privacy Screen sits 3" away from the face of the panel to which it is attached.
- When open, the screen may interfere with access doors that open on the outside of an adjacent panel.
- Caps located on the end of the frame default to the panel frame colour.
- Four sliders included for each door.
- Can be mounted on panels of the same width.
- Note: Specify left or right for the direction in which the door will slide as per examples above.

PRODUCT CODE	PRICE	SIZE/ INCHES			WEIGHT VOL	
		H	W	D	LBS	FT <sup>3</sup>
BPDSL6636R	1923	66	36	2.61	35	5.98
BPDSL6642R	2070	66	42	2.61	42	6.93
BPDSL6636L	1923	66	36	2.61	35	5.98
BPDSL6642L	2070	66	42	2.61	42	6.93

Left Hang Option

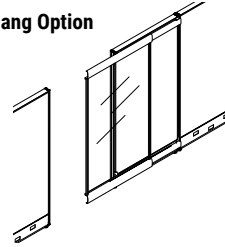

Right Hang Hung

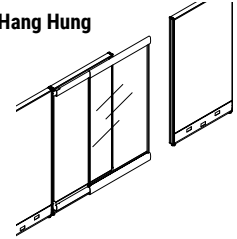

**CMPS • Privacy Glass**

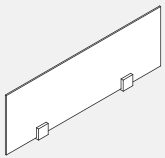

- Privacy Glass with no frame sits on top of a Panel with clamps that are secured to the top of the panel to provide division.
- Tempered glass is 12", 9" or 6" high (nominal).
- Custom sizes available, contact your Customer Service Representative.
- Square clamps included.

PRODUCT CODE	PRICE		SIZE/ INCHES			WEIGHT VOL	
	CLR	FRST	H	W	D	LBS	FT <sup>3</sup>
<b>12"</b>							
CMPS24	194	220	12	24	1.3	8	0.44
CMPS30	213	242	12	30	1.3	10	0.59
CMPS36	228	263	12	36	1.3	12	0.73
CMPS42	242	284	12	42	1.3	14	0.88
CMPS48	251	297	12	48	1.3	16	0.96
CMPS54	251	297	12	54	1.3	18	1.13
CMPS60	290	329	12	60	1.3	20	1.28
<b>9"</b>							
CMPS0924	194	220	9	24	1.3	8	0.44
CMPS0930	213	242	9	30	1.3	10	0.59
CMPS0936	228	263	9	36	1.3	12	0.73
CMPS0942	242	284	9	42	1.3	14	0.88
CMPS0948	251	297	9	48	1.3	18	0.98
CMPS0954	251	297	9	54	1.3	18	1.13
CMPS0960	290	329	9	60	1.3	20	1.28
<b>6"</b>							
CMPS0624	194	220	6	24	1.3	8	0.44
CMPS0630	213	242	6	30	1.3	10	0.59
CMPS0636	228	263	6	36	1.3	12	0.73
CMPS0642	242	284	6	42	1.3	14	0.88
CMPS0648	251	297	6	48	1.3	18	0.98
CMPS0654	251	297	6	54	1.3	18	1.13
CMPS0660	290	329	6	60	1.3	20	1.28

**CMPSG • Integrated Privacy Glass Divider**

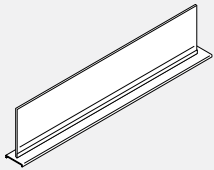

- Privacy Glass integrated with aluminum top trim.
- Attaches on top of panels to add privacy or divide space Includes aluminum trim with channel and glass tile.
- Standard in clear (CLR) or frosted (FRST) glass.
- Glass and attachment hardware to ship seperately.

PRODUCT CODE	PRICE		SIZE/INCHES			WEIGHT VOL	
	CLR	FRST	H	W	D	LBS	FT <sup>3</sup>
CMPSG0624	177	222	6.40	22.67	2.41	3.54	0.20
CMPSG0630	194	244	6.40	28.67	2.41	4.49	0.26
CMPSG0636	206	257	6.40	34.67	2.41	5.44	0.31
CMPSG0642	222	276	6.40	40.67	2.41	6.39	0.36
CMPSG0648	231	288	6.40	46.67	2.41	7.34	0.42
CMPSG0654	238	297	6.40	52.67	2.41	8.29	0.47
CMPSG0660	244	303	6.40	58.67	2.41	9.23	0.52
CMPSG0924	177	222	9.40	22.67	2.41	4.99	0.30
CMPSG0930	194	244	9.40	28.67	2.41	6.32	0.38
CMPSG0936	206	257	9.40	34.67	2.41	7.66	0.46
CMPSG0942	222	276	9.40	40.67	2.41	8.99	0.53
CMPSG0948	231	288	9.40	46.67	2.41	10.33	0.61
CMPSG0954	238	297	9.40	52.67	2.41	11.66	0.69
CMPSG0960	244	303	9.40	58.67	2.41	13.00	0.77
CMPSG1224	177	222	12.40	22.67	2.41	6.43	0.39
CMPSG1230	194	244	12.40	28.67	2.41	8.15	0.50
CMPSG1236	206	257	12.40	34.67	2.41	9.87	0.60
CMPSG1242	222	276	12.40	40.67	2.41	11.59	0.70
CMPSG1248	231	288	12.40	46.67	2.41	13.31	0.81
CMPSG1254	238	297	12.40	52.67	2.41	15.04	0.91
CMPSG1260	244	303	12.40	58.67	2.41	16.76	1.02

**CMPEEG • Integrated Privacy Glass Extended Divider**

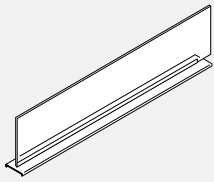

- Privacy Glass integrated with aluminum top trim.
- Glass is longer to extend partially over the post for a corner application.
- Attaches on top of panels to add privacy or divide space Includes aluminum trim with channel and glass tile.
- Standard in clear (CLR) or frosted (FRST) glass.
- Glass and attachment hardware to ship seperately.

PRODUCT CODE	PRICE		SIZE/INCHES			WEIGHT VOL	
	CLR	FRST	H	W	D	LBS	FT <sup>3</sup>
CMPEEG0624	177	222	6.4	23.88	2.41	3.54	0.21
CMPEEG0630	194	244	6.4	29.88	2.41	4.49	0.27
CMPEEG0636	206	257	6.4	35.88	2.41	5.44	0.32
CMPEEG0642	222	276	6.4	41.88	2.41	6.39	0.37
CMPEEG0648	231	288	6.4	47.88	2.41	7.34	0.43
CMPEEG0654	238	297	6.4	53.88	2.41	8.29	0.48
CMPEEG0660	244	303	6.4	59.88	2.41	9.23	0.54
CMPEEG0924	177	222	9.4	23.88	2.41	4.99	0.31
CMPEEG0930	194	244	9.4	29.88	2.41	6.32	0.39
CMPEEG0936	206	257	9.4	35.88	2.41	7.66	0.47
CMPEEG0942	222	276	9.4	41.88	2.41	8.99	0.55
CMPEEG0948	231	288	9.4	47.88	2.41	10.33	0.63
CMPEEG0954	238	297	9.4	53.88	2.41	11.66	0.71
CMPEEG0960	244	303	9.4	59.88	2.41	13	0.79
CMPEEG1224	177	222	12.4	23.88	2.41	6.43	0.41
CMPEEG1230	194	244	12.4	29.88	2.41	8.15	0.52
CMPEEG1236	206	257	12.4	35.88	2.41	9.87	0.62
CMPEEG1242	222	276	12.4	41.88	2.41	11.59	0.73
CMPEEG1248	231	288	12.4	47.88	2.41	13.31	0.83
CMPEEG1254	238	297	12.4	53.88	2.41	15.04	0.93
CMPEEG1260	244	303	12.4	59.88	2.41	16.76	1.04

**CMPSF • Integrated Felt Divider**

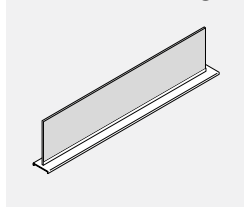

- Privacy felt panel intergrated with aluminum top trim.
- Attaches on top of panels to add privacy or divide space. Includes aluminum trim with channel and felt tile.
- Felt and attachment hardware to ship seperaretyly.
- 9mm Felt material is tackable and comes in 18 different colours. Please specify colour.

PRODUCT CODE	PRICE	SIZE /INCHES			WEIGHT VOL	
		H	W	D	LBS	FT <sup>3</sup>
CMPSF0624	64	6.33	22.42	2.41	1.21	0.20
CMPSF0630	76	6.33	28.42	2.41	1.54	0.25
CMPSF0636	89	6.33	34.42	2.41	1.86	0.30
CMPSF0642	100	6.33	40.42	2.41	2.19	0.36
CMPSF0648	151	6.33	46.42	2.41	2.51	0.41
CMPSF0654	164	6.33	52.42	2.41	2.84	0.46
CMPSF0660	175	6.33	58.42	2.41	3.16	0.52
CMPSF0924	64	9.33	22.42	2.41	1.48	0.29
CMPSF0930	76	9.33	28.42	2.41	1.87	0.37
CMPSF0936	89	9.33	34.42	2.41	2.27	0.45
CMPSF0942	100	9.33	40.42	2.41	2.66	0.53
CMPSF0948	151	9.33	46.42	2.41	3.06	0.60
CMPSF0954	164	9.33	52.42	2.41	3.45	0.68
CMPSF0960	175	9.33	58.42	2.41	3.85	0.76
CMPSF1224	64	12.33	22.42	2.41	1.74	0.39
CMPSF1230	76	12.33	28.42	2.41	2.20	0.49
CMPSF1236	89	12.33	34.42	2.41	2.67	0.59
CMPSF1242	100	12.33	40.42	2.41	3.14	0.70
CMPSF1248	151	12.33	46.42	2.41	3.60	0.80
CMPSF1254	164	12.33	52.42	2.41	4.07	0.90
CMPSF1260	175	12.33	58.42	2.41	4.53	1.01

**CMPEF • Integrated Felt Extended Divider**

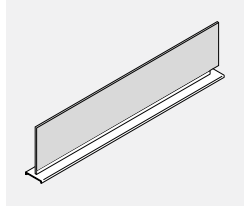

- Privacy felt panel intergrated with aluminum top trim.
- Felt is longer to extend partially over the post for a corner application.
- Attaches on top of panels to add privacy or divide space. Includes aluminum trim with channel and felt tile.
- Felt and attachment hardware to ship seperaretyly.
- 9mm Felt material is tackable and comes in 18 different colours. Please specify colour.

PRODUCT CODE	PRICE	SIZE /INCHES			WEIGHT VOL	
		H	W	D	LBS	FT <sup>3</sup>
CMPEF0624	64	6.33	23.88	2.41	1.21	0.21
CMPEF0630	76	6.33	29.88	2.41	1.54	0.36
CMPEF0636	89	6.33	35.88	2.41	1.86	0.32
CMPEF0642	100	6.33	41.88	2.41	2.19	0.37
CMPEF0648	151	6.33	47.88	2.41	2.51	0.42
CMPEF0654	164	6.33	53.88	2.41	2.84	0.48
CMPEF0660	175	6.33	59.88	2.41	3.16	0.53
CMPEF0924	64	9.33	23.88	2.41	1.48	0.31
CMPEF0930	76	9.33	29.88	2.41	1.87	0.39
CMPEF0936	89	9.33	35.88	2.41	2.27	0.47
CMPEF0942	100	9.33	41.88	2.41	2.66	0.55
CMPEF0948	151	9.33	47.88	2.41	3.06	0.62
CMPEF0954	164	9.33	53.88	2.41	3.45	0.7
CMPEF0960	175	9.33	59.88	2.41	3.85	0.78
CMPEF1224	64	12.33	23.88	2.41	1.74	0.41
CMPEF1230	76	12.33	29.88	2.41	2.2	0.51
CMPEF1236	89	12.33	35.88	2.41	2.67	0.62
CMPEF1242	100	12.33	41.88	2.41	3.14	0.72
CMPEF1248	151	12.33	47.88	2.41	3.6	0.82
CMPEF1254	164	12.33	53.88	2.41	4.07	0.93
CMPEF1260	175	12.33	59.88	2.41	4.53	1.03

**CMLEP-NC • End of Run Gallery Panel With No End Connection**

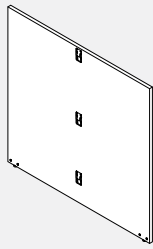

- Provides floor standing support while enclosing the end of a panel run.
- Attached at the end of a straight panel run with connectors to form a T configuration.
- No connections at both ends, connection is at the center interior face.
- Includes all attachment hardware and glides.
- Total height is inclusive of panel glides extended to their full height.
- 51" wide gallery panel accommodates two 24" deep surface while the 63" wide accommodates two 30" deep surfaces.
- Please specify LP laminate finish and PVC edge finish.
- If a wood grain laminate is chosen, grain direction run horizontally.
- Gallery panel is edged in PVC on exposed edges and self edged on bottom.

PRODUCT CODE	PRICE LP	SIZE/INCHES			WEIGHT LBS	VOL FT <sup>3</sup>
		H	W	D		
CMLEP4227NC	290	42	26.25	1	28.70	0.64
CMLEP4251NC	508	42	50.30	1	57.25	3.67
CMLEP4263NC	589	42	62.30	1	70.75	4.54
CMLEP4827NC	319	48	26.25	1	32.80	0.73
CMLEP4851NC	558	48	50.30	1	65.50	4.19
CMLEP4863NC	648	48	62.30	1	80.95	5.19
CMLEP5427NC	348	54	26.25	1	36.90	0.82
CMLEP5451NC	608	54	50.30	1	73.65	4.72
CMLEP5463NC	706	54	62.30	1	91.05	5.84

**CMLMP-NC • Middle of Run Gallery Panel With No End Connection**

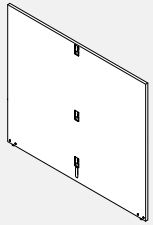

- Provides floor standing support in the middle of a panel run.
- Attached in the middle of a straight panel run with connectors to form an X configuration..
- No connections at both ends, connection is at center on both faces.
- Includes all attachment hardware and glides.
- Total height is inclusive of panel glides extended to their full height.
- 51" wide gallery panel accommodates two 24" deep surface while the 63" wide accommodates two 30" deep surfaces.
- Please specify LP laminate finish and PVC edge finish.
- If a wood grain laminate is chosen, grain direction run horizontally.
- Gallery panel is edged in PVC on exposed edges and self edged on bottom.

PRODUCT CODE	PRICE LP	SIZE/INCHES			WEIGHT LBS	VOL FT <sup>3</sup>
		H	W	D		
CMLMP4251NC	590	42	50.30	1	57.25	3.67
CMLMP4263NC	672	42	62.30	1	70.75	4.54
CMLMP4851NC	639	48	50.30	1	65.50	4.19
CMLMP4863NC	730	48	62.30	1	80.95	5.19
CMLMP5451NC	690	54	50.30	1	73.65	4.72
CMLMP5463NC	790	54	62.30	1	91.05	5.84

**CMLSEPL-NC • Single End Of Run Gallery Panel With No End Connection**

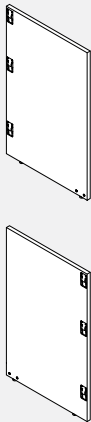

- Provides floor standing support while enclosing the end of a panel run.
- Attached at the end of a straight panel run with connectors to form an L configuration.
- No connection at ends, connection is on interior face at one end.
- Includes all attachment hardware and glides.
- Total height is inclusive of panel glides extended to their full height.
- 27" wide gallery panel accommodates a 24" deep surface while the 33" wide accommodates a 30" deep surface.
- Please specify LP laminate finish and PVC edge finish.
- If a wood grain laminate is chosen, grain direction run horizontally.
- Gallery panel is edged in PVC on exposed edges and self edged on bottom.

PRODUCT CODE	PRICE LP	SIZE/INCHES			WEIGHT LBS	VOL FT <sup>3</sup>
		H	W	D		
CMLSEPL4215NC	218	42	14.25	1	15.72	0.35
CMLSEPR4215NC	218	48	14.25	1	15.72	0.40
CMLSEPL4815NC	237	48	14.25	1	17.95	0.40
CMLSEPR4815NC	237	48	14.25	1	17.95	0.40
CMLSEPL5415NC	255	54	14.25	1	20.18	0.45
CMLSEPR5415NC	255	54	14.25	1	20.18	0.45
CMLSEPL4227NC	385	42	26.30	1	29.99	1.9
CMLSEPR4227NC	385	42	26.30	1	29.99	1.9
CMLSEPL4827NC	421	48	26.30	1	34.28	2.2
CMLSEPR4827NC	421	48	26.30	1	34.28	2.2
CMLSEPL5427NC	459	54	26.30	1	38.56	2.5
CMLSEPR5427NC	459	54	26.30	1	38.56	2.5
CMLSEPL4233NC	398	42	32.33	1	36.77	2.4
CMLSEPR4233NC	398	42	32.33	1	36.77	2.4
CMLSEPL4833NC	435	48	32.33	1	42.03	2.7
CMLSEPR4833NC	435	48	32.33	1	42.03	2.7
CMLSEPL5433NC	471	54	32.33	1	47.3	3.0
CMLSEPR5433NC	471	54	32.33	1	47.3	3.0

**CMLSMP-NC • Single Middle of Run Gallery Panel With No End Connection**

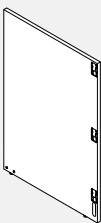

- Provides floor standing support at the middle of a panel run.
- Attached in the middle of a straight panel run with connectors to form a T configuration.
- No connections at the exposed end, connection is at both the interior and exterior face near the opposite end.
- Includes all attachment hardware and glides.
- Total height is inclusive of panel glides extended to their full height.
- 27" wide gallery panel accommodates a 24" deep surface while the 33" wide accommodates a 30" deep surface.
- Please specify LP laminate finish and PVC edge finish.
- If a wood grain laminate is chosen, grain direction run horizontally.
- Gallery panel is edged in PVC on exposed edges and self edged on bottom.

PRODUCT CODE	PRICE LP	SIZE/INCHES			WEIGHT LBS	VOL FT <sup>3</sup>
		H	W	D		
CMLSMP4227NC	469	42	26.30	1	30.14	1.92
CMLSMP4827NC	505	48	26.30	1	34.42	2.19
CMLSMP5427NC	540	54	26.30	1	38.72	2.47
CMLSMP4233NC	483	42	32.30	1	36.92	2.36
CMLSMP4833NC	520	48	32.30	1	42.18	2.69
CMLSMP5433NC	557	54	32.30	1	47.45	3.03

**CMLEP • End Of Run Gallery Panel With End Connections**

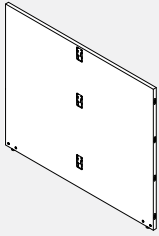

- Provides floor standing support while enclosing the end of a panel run.
- Attached at the end of a straight panel run with connectors to form a T configuration.
- Connections at both ends as well as the center on the interior face.
- Includes all attachment hardware and glides.
- Total height is inclusive of panel glides extended to their full height.
- 51" wide gallery panel accommodates two 24" deep surface while the 63" wide accommodates two 30" deep surfaces.
- Please specify LP laminate finish and PVC edge finish.
- If a wood grain laminate is chosen, grain direction run horizontally.
- Gallery panel is edged in PVC on exposed edges and self edged on edge connecting to panel and bottom edge.

PRODUCT CODE	PRICE LP	SIZE/INCHES			WEIGHT VOL	
		H	W	D	LBS	FT <sup>3</sup>
CMLEP4251	527	42	50.30	1	57.25	3.67
CMLEP4263	608	42	62.30	1	70.75	4.54
CMLEP4851	576	48	50.30	1	65.50	4.19
CMLEP4863	668	48	62.30	1	80.95	5.19
CMLEP5451	627	54	50.30	1	73.65	4.72
CMLEP5463	726	54	62.30	1	91.05	5.84

**CMLMP • Middle of Run Gallery Panel With End Connections**

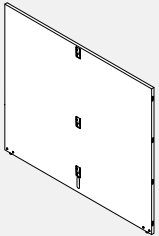

- Provides floor standing support in the middle of a panel run.
- Attached in the middle of a straight panel run with connectors to form an X configuration.
- Connections at both ends as well as the center on the interior and exterior face.
- Includes all attachment hardware and glides.
- Total height is inclusive of panel glides extended to their full height.
- 51" wide gallery panel accommodates two 24" deep surface while the 63" wide accommodates two 30" deep surfaces.
- Please specify LP laminate finish and PVC edge finish.
- If a wood grain laminate is chosen, grain direction run horizontally.
- Gallery panel is edged in PVC on exposed edges and self edged on edge connecting to panel and bottom edge.

PRODUCT CODE	PRICE LP	SIZE/INCHES			WEIGHT VOL	
		H	W	D	LBS	FT <sup>3</sup>
CMLMP4251	594	42	50.30	1	57.25	3.67
CMLMP4263	675	42	62.30	1	70.75	4.54
CMLMP4851	646	48	50.30	1	65.50	4.19
CMLMP4863	735	48	62.30	1	80.95	5.19
CMLMP5451	694	54	50.30	1	73.65	4.72
CMLMP5463	794	54	62.30	1	91.05	5.84

**CMLSEPL • Single End Panel With End Connections**

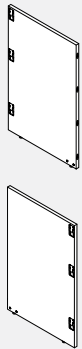

- Provides floor standing support while enclosing the end of a panel run.
- Attached at the end of a straight panel run with connectors to form an L configuration.
- Connections are at the exposed end on one side and near the end on the other interior face.
- Total height is inclusive of panel glides extended to their full height.
- 27" wide gallery panel accommodates a 24" deep surface while the 33" wide accommodates a 30" deep surface.
- Please specify LP laminate finish and PVC edge finish.
- If a wood grain laminate is chosen, grain direction run horizontally.
- Gallery panel is edged in PVC on exposed edges and self edged on edge connecting to panel and bottom edge.

PRODUCT CODE	PRICE LP	SIZE/INCHES			WEIGHT VOL	
		H	W	D	LBS	FT <sup>3</sup>
CMLSEPL4227	396	42	26.30	1	29.99	1.9
CMLSEPR4227	396	42	26.30	1	29.99	1.9
CMLSEPL4827	431	48	26.30	1	34.28	2.2
CMLSEPR4827	431	48	26.30	1	34.28	2.2
CMLSEPL5427	468	54	26.30	1	38.56	2.5
CMLSEPR5427	468	54	26.30	1	38.56	2.5
CMLSEPL4233	407	42	32.33	1	36.77	2.4
CMLSEPR4233	407	42	32.33	1	36.77	2.4
CMLSEPL4833	444	48	32.33	1	42.03	2.7
CMLSEPR4833	444	48	32.33	1	42.03	2.7
CMLSEPL5433	482	54	32.33	1	47.3	3.0
CMLSEPR5433	482	54	32.33	1	47.3	3.0

**CMLSMP • Single Middle of Run Gallery Panel With End Connections**

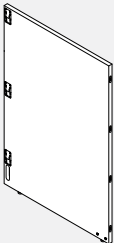

- Provides floor standing support at the middle of a panel run.
- Attached in the middle of a straight panel run with connectors to form a T configuration
- Connections are at the exposed end and at the interior and exterior near the opposite end, allows for left connection of CML2PL only.
- Includes all attachment hardware and glides.
- Total height is inclusive of panel glides extended to their full height.
- 27" wide gallery panel accommodates a 24" deep surface while the 33" wide accommodates a 30" deep surface.
- Please specify LP laminate finish and PVC edge finish.
- If a wood grain laminate is chosen, grain direction run horizontally.
- Gallery panel is edged in PVC on exposed edges and self edged on edge connecting to panel and bottom edge.

PRODUCT CODE	PRICE LP	SIZE/INCHES			WEIGHT VOL	
		H	W	D	LBS	FT <sup>3</sup>
CMLSMP4227	480	42	26.30	1.00	30.14	1.92
CMLSMP4827	514	48	26.30	1.00	34.42	2.19
CMLSMP5427	550	54	26.30	1.00	38.72	2.47
CMLSMP4233	493	42	32.30	1.00	36.92	2.36
CMLSMP4833	530	48	32.30	1.00	42.18	2.69
CMLSMP5433	567	54	32.30	1.00	47.45	3.03

**CML2PL • Left Two Way Return End of Run Gallery Panel With End Connections**

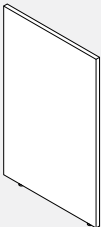

- Provides floor standing support while enclosing the end of a panel run.
- Attached at the end of a gallery panel with connectors to form an L configuration.
- Connections are at one exposed end.
- Includes all attachment hardware and glides.
- Total height is inclusive of panel glides extended to their full height.
- 25" wide gallery panel accommodates a 24" deep surface while the 31" wide accommodates a 30" deep surface.
- Please specify LP laminate finish and PVC edge finish.
- If a wood grain laminate is chosen, grain direction run horizontally.
- Gallery panel is edged in PVC on exposed edges and self edged on edge connecting to panel and bottom edge.

PRODUCT CODE	PRICE LP	SIZE/INCHES			WEIGHT VOL	
		H	W	D	LBS	FT <sup>3</sup>
CML2PL4213	149	42	13	1	14.16	0.32
CML2PL4225	314	42	25	1	27.14	1.82
CML2PL4231	321	42	31	1	33.62	2.26
CML2PL4813	167	48	13	1	16.19	0.36
CML2PL4825	349	48	25	1	31.04	2.08
CML2PL4831	359	48	31	1	38.47	2.58
CML2PL5413	186	54	13	1	18.22	0.41
CML2PL5425	384	54	25	1	34.95	2.34
CML2PL5431	396	54	31	1	43.31	2.91

**CML2PR • Right Two Way Return End of Run Gallery Panel With End Connections**



- Provides floor standing support while enclosing the end of a panel run.
- Attached at the end of a gallery panel with connectors to form an L configuration.
- Connections are at one exposed end.
- Includes all attachment hardware and glides.
- Total height is inclusive of panel glides extended to their full height.
- 25" wide gallery panel accommodates a 24" deep surface while the 31" wide accommodates a 30" deep surface.
- Please specify LP laminate finish and PVC edge finish.
- If a wood grain laminate is chosen, grain direction run horizontally.
- Gallery panel is edged in PVC on exposed edges and self edged on edge connecting to panel and bottom edge.

PRODUCT CODE	PRICE LP	SIZE/INCHES			WEIGHT VOL	
		H	W	D	LBS	FT <sup>3</sup>
CML2PR4213	149	42	13	1	14.16	0.32
CML2PR4225	314	42	25	1	27.14	1.82
CML2PR4231	321	42	31	1	33.62	2.26
CML2PR4813	167	48	13	1	16.19	0.36
CML2PR4825	349	48	25	1	31.04	2.08
CML2PR4831	359	48	31	1	38.47	2.58
CML2PR5413	186	54	13	1	18.22	0.41
CML2PR5425	384	54	25	1	34.95	2.34
CML2PR5431	396	54	31	1	43.31	2.91

**CML3PL • Left Three Way Return End of Run Gallery Panel**

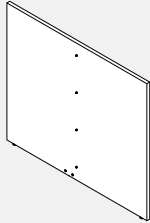

- Provides floor standing support while enclosing the end of a gallery panel run.
- Attached at the end of a gallery panel with connectors to form a T configuration.
- There are no connections at the exposed ends. Connection is at the center of the interior face.
- Connects to CMLXPL or CMLSEPL.
- Includes all attachment hardware and glides.
- Total height is inclusive of panel glides extended to their full height.
- 49" wide gallery panel accommodates two 24" deep surface while the 61" wide accommodates two 30" deep surfaces.
- Please specify LP laminate finish and PVC edge finish.
- If a wood grain laminate is chosen, grain direction run horizontally.
- Gallery panel is edged in PVC on exposed edges and self edged on edge connecting to panel and bottom edge.

PRODUCT CODE	PRICE LP	SIZE/INCHES			WEIGHT VOL	
		H	W	D	LBS	FT <sup>3</sup>
CML3PL4225	222	42	25	1.3	27.14	0.79
CML3PL4249	435	42	49	1	53.09	3.57
CML3PL4261	514	42	61	1	66.06	4.45
CML3PL4825	249	48	25	1.3	31.04	0.90
CML3PL4849	484	48	49	1	60.74	4.08
CML3PL4861	574	48	61	1	75.60	5.08
CML3PL5425	278	54	25	1.3	34.95	1.02
CML3PL5449	534	54	49	1	68.40	4.59
CML3PL5461	634	54	61	1	85.13	5.72

**CML3PR • Right Three Way Return End of Run Gallery Panel**

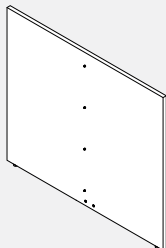

- Provides floor standing support while enclosing the end of a gallery panel run.
- Attached at the end of a gallery panel with connectors to form a T configuration.
- There are no connections at the exposed ends. Connection is at the center of the interior face.
- Connects to CMLXPR or CMLSEPR.
- Includes all attachment hardware and glides.
- Total height is inclusive of panel glides extended to their full height.
- 49" wide gallery panel accommodates two 24" deep surface while the 61" wide accommodates two 30" deep surfaces.
- Please specify LP laminate finish and PVC edge finish.
- If a wood grain laminate is chosen, grain direction run horizontally.
- Gallery panel is edged in PVC on exposed edges and self edged on edge connecting to panel and bottom edge.

PRODUCT CODE	PRICE LP	SIZE/INCHES			WEIGHT VOL	
		H	W	D	LBS	FT <sup>3</sup>
CML3PR4225	222	42	25	1.3	27.14	0.79
CML3PR4249	435	42	49	1	53.09	3.57
CML3PR4261	514	42	61	1	66.06	4.45
CML3PR4825	249	48	25	1.3	31.04	0.90
CML3PR4849	484	48	49	1	60.74	4.08
CML3PR4861	574	48	61	1	75.60	5.08
CML3PR5425	278	54	25	1.3	34.95	1.02
CML3PR5449	534	54	49	1	68.40	4.59
CML3PR5461	634	54	61	1	85.13	5.72

**CMLXPL • Left Extension End of Run Return Gallery Panel With End Connection**

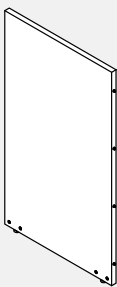

- Provides floor standing support while enclosing the end of a gallery panel run.
- Attached at the end of a panel to allow for extending the gallery panel run.
- Connections at both exposed ends, one to connect to the panel and one to connect to another gallery panel.
- Includes all attachment hardware and glides.
- Total height is inclusive of panel glides extended to their full height.
- Please specify LP laminate finish and PVC edge finish.
- If a wood grain laminate is chosen, grain direction run horizontally.
- Gallery panel is edged in PVC on exposed edges and self edges on edge connecting to panel.

PRODUCT CODE	PRICE LP	SIZE/INCHES			WEIGHT VOL	
		H	W	D	LBS	FT <sup>3</sup>
CMLXPL4212	138	42	12.3	1	13.08	0.30
CMLXPL4224	260	42	24	1	26.1	1.75
CMLXPL4230	305	42	30	1	32.59	2.19
CMLXPL4236	350	42	36	1	39.07	2.63
CMLXPL4242	441	42	42	1	45.56	3.06
CMLXPL4248	455	42	48	1	52.05	3.50
CMLXPL4812	154	48	12.3	1	14.95	0.34
CMLXPL4824	268	48	24	1	29.85	2.00
CMLXPL4830	315	48	30	1	37.27	2.50
CMLXPL4836	361	48	36	1	44.7	3.00
CMLXPL4842	455	48	42	1	52.12	3.50
CMLXPL4848	468	48	48	1	59.55	4.00
CMLXPL5412	172	54	12.3	1	16.83	0.38
CMLXPL5424	286	54	24	1	33.55	2.25
CMLXPL5430	336	54	30	1	41.92	2.81
CMLXPL5436	385	54	36	1	50.28	3.38
CMLXPL5442	437	54	42	1	58.64	3.94
CMLXPL5448	536	54	48	1	67.01	4.50

**CMLXPR • Right Extension End of Run Return Gallery Panel With End Connection**

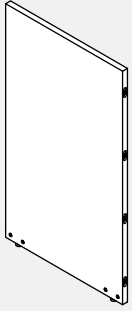

- Provides floor standing support while enclosing the end of a gallery panel run.
- Attached at the end of a panel to allow for extending the gallery panel run.
- Connections are at both exposed ends, one to connect to the panel and one to connect to another gallery panel.
- Includes all attachment hardware and glides.
- Total height is inclusive of panel glides extended to their full height.
- Please specify LP laminate finish and PVC edge finish.
- If a wood grain laminate is chosen, grain direction run horizontally.
- Gallery panel is edged in PVC on exposed edges and self edged on edge connecting to panel.

PRODUCT CODE	PRICE LP	SIZE/INCHES			WEIGHT VOL	
		H	W	D	LBS	FT <sup>3</sup>
CMLXPR4212	138	42	12.3	1	13.08	0.30
CMLXPR4224	260	42	24	1	26.1	1.75
CMLXPR4230	305	42	30	1	32.59	2.19
CMLXPR4236	350	42	36	1	39.07	2.63
CMLXPR4242	441	42	42	1	45.56	3.06
CMLXPR4248	455	42	48	1	52.05	3.50
CMLXPR4812	154	48	12.3	1	14.95	0.34
CMLXPR4824	268	48	24	1	29.85	2.00
CMLXPR4830	315	48	30	1	37.27	2.50
CMLXPR4836	361	48	36	1	44.7	3.00
CMLXPR4842	455	48	42	1	52.12	3.50
CMLXPR4848	468	48	48	1	59.55	4.00
CMLXPR5412	172	54	12.3	1	16.83	0.38
CMLXPR5424	286	54	24	1	33.55	2.25
CMLXPR5430	336	54	30	1	41.92	2.81
CMLXPR5436	385	54	36	1	50.28	3.38
CMLXPR5442	437	54	42	1	58.64	3.94
CMLXPR5448	536	54	48	1	67.01	4.50

**CMLXPL-NC • Extension End of Run, Left, No Connection**

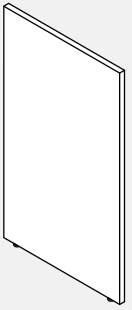

- Provides floor standing support while enclosing the end of a gallery panel run.
- Attached at the end of a gallery panel to extend the gallery panel run.
- Connections only at one exposed end.
- Includes all attachment hardware and glides.
- Total height is inclusive of panel glides extended to their full height.
- Please specify LP laminate finish and PVC edge finish.
- If a wood grain laminate is chosen, grain direction run horizontally.
- Gallery panel is edged in PVC on exposed edges and self edged on edge connecting to panel.

PRODUCT CODE	PRICE LP	SIZE/INCHES			WEIGHT VOL	
		H	W	D	LBS	FT <sup>3</sup>
CMLXPL4224NC	257	42	24	1	26.05	1.75
CMLXPL4230NC	303	42	30	1	32.54	2.19
CMLXPL4236NC	349	42	36	1	39.03	2.63
CMLXPL4242NC	439	42	42	1	45.52	3.06
CMLXPL4248NC	451	42	48	1	52.01	3.50
CMLXPL4824NC	266	48	24	1	29.8	2.00
CMLXPL4830NC	314	48	30	1	37.23	2.50
CMLXPL4836NC	359	48	36	1	44.66	3.00
CMLXPL4842NC	451	48	42	1	52.08	3.50
CMLXPL4848NC	466	48	48	1	59.51	4.00
CMLXPL5424NC	284	54	24	1	33.55	2.25
CMLXPL5430NC	334	54	30	1	41.92	2.81
CMLXPL5436NC	384	54	36	1	50.28	3.38
CMLXPL5442NC	435	54	42	1	58.64	3.94
CMLXPL5448NC	534	54	48	1	67.01	4.50

**CMLXPR-NC • Extension End of Run, Right, No Connection**

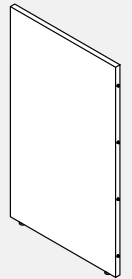

- Provides floor standing support while enclosing the end of a gallery panel run.
- Attached at the end of a gallery panel to extend the gallery panel run.
- Connections only at one exposed end.
- Includes all attachment hardware and glides.
- Total height is inclusive of panel glides extended to their full height.
- Please specify LP laminate finish and PVC edge finish.
- If a wood grain laminate is chosen, grain direction run horizontally.
- Gallery panel is edged in PVC on exposed edges and self edged on edge connecting to panel.

PRODUCT CODE	PRICE LP	SIZE/INCHES			WEIGHT VOL	
		H	W	D	LBS	FT <sup>3</sup>
CMLXPR4224NC	257	42	24	1	26.05	1.75
CMLXPR4230NC	303	42	30	1	32.54	2.19
CMLXPR4236NC	349	42	36	1	39.03	2.63
CMLXPR4242NC	439	42	42	1	45.52	3.06
CMLXPR4248NC	451	42	48	1	52.01	3.5
CMLXPR4824NC	266	48	24	1	29.8	2
CMLXPR4830NC	314	48	30	1	37.23	2.5
CMLXPR4836NC	359	48	36	1	44.66	3
CMLXPR4842NC	451	48	42	1	52.08	3.5
CMLXPR4848NC	466	48	48	1	59.51	4
CMLXPR5424NC	284	54	24	1	33.55	2.25
CMLXPR5430NC	334	54	30	1	41.92	2.81
CMLXPR5436NC	384	54	36	1	50.28	3.38
CMLXPR5442NC	435	54	42	1	58.64	3.94
CMLXPR5448NC	534	54	48	1	67.01	4.5



**CMHLPBB01 • Gallery Panel Bracket**

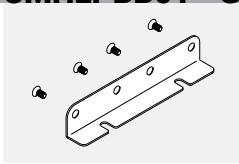

- Gallery panel bottom bracket connects two gallery end panels at bottom with screws.
- Available in standard paint colors.
- Screws are included with the bracket.

PRODUCT CODE	PRICE	SIZE / INCHES			WEIGHT VOL	
		H	W	D	LBS	FT <sup>3</sup>
CMHLPBB01	34	1.5	8.00	1	0.5	0.11

**CMHLPCB01 • Gallery Panel Corner Bracket**

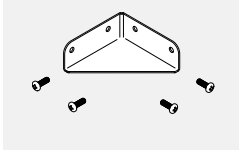

- Gallery panel corner bottom bracket connects two laminate panels at 90 degrees.
- Available in standard paint colors.
- Screws are included with the bracket.

PRODUCT CODE	PRICE	SIZE / INCHES			WEIGHT VOL	
		H	W	D	LBS	FT <sup>3</sup>
CMHLPCB01	33	1.5	4.00	4	0.5	0.11

**CMPMP-GI-W • Privacy Glass for 1" Laminate Gallery Panels**

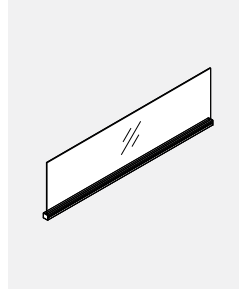

- **Privacy glass integrated with aluminum top trim.**
- Attaches on top of gallery panels to add privacy or divide space.
- Includes aluminum trim with channel, end caps and glass tile.
- Top rail may also be used to hang accessories.
- Glass and attachment hardware ship separately.
- Please specify standard paint finish for the channel.
- Standard in clear (CLR) or frosted (FRST).

PRODUCT CODE	PRICE	CLR	FRST	SIZE / INCHES			WEIGHT VOL	
				H	W	D	LBS	FT <sup>3</sup>
CMPMP24GI6W	195	244		6	24	1	3.58	0.08
CMPMP30GI6W	213	268		6	30	1	4.48	0.10
CMPMP36GI6W	228	283		6	36	1	5.37	0.13
CMPMP42GI6W	244	304		6	42	1	6.26	0.15
CMPMP48GI6W	254	317		6	48	1	7.16	0.17
CMPMP24GI9W	195	244		9	24	1	4.77	0.13
CMPMP30GI9W	213	268		9	30	1	5.97	0.16
CMPMP36GI9W	228	283		9	36	1	7.16	0.19
CMPMP42GI9W	244	304		9	42	1	8.35	0.22
CMPMP48GI9W	254	317		9	48	1	9.55	0.25
CMPMP24GIW	195	244		12	24	1	4.77	0.17
CMPMP30GIW	213	268		12	30	1	5.97	0.21
CMPMP36GIW	228	283		12	36	1	7.16	0.25
CMPMP42GIW	244	304		12	42	1	8.35	0.29
CMPMP48GIW	254	317		12	48	1	9.55	0.33

**CMPFD-W • Privacy Felt for 1" Laminate Gallery Panels**

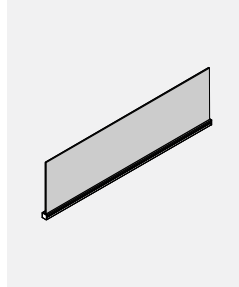

- **Privacy felt integrated with aluminum top trim.**
- Attaches on top of gallery panels to add privacy or divide space.
- Includes aluminum trim with channel, end caps and felt tile.
- Top rail may also be used to hang accessories.
- Felt and attachment hardware ship separately.
- Please specify standard paint finish for the channel.
- Please specify standard felt finish.

PRODUCT CODE	PRICE	SIZE / INCHES			WEIGHT VOL		
		H	W	D	LBS	FT <sup>3</sup>	
CMPFD0624W	70		6	24	1	1.42	0.08
CMPFD0630W	85		6	30	1	1.73	0.10
CMPFD0636W	99		6	36	1	2.03	0.13
CMPFD0642W	111		6	42	1	2.34	0.15
CMPFD0648W	165		6	48	1	2.64	0.17
CMPFD0654W	178		6	54	1	2.95	0.19
CMPFD0660W	193		6	60	1	3.25	0.21
CMPFD0666W	204		6	66	1	3.56	0.23
CMPFD0672W	231		6	72	1	3.86	0.25
CMPFD0924W	70		9	24	1	2.26	0.13
CMPFD0930W	85		9	30	1	2.77	0.16
CMPFD0936W	99		9	36	1	3.29	0.19
CMPFD0942W	111		9	42	1	3.8	0.22
CMPFD0948W	165		9	48	1	4.32	0.25
CMPFD0954W	178		9	54	1	4.83	0.28
CMPFD0960W	193		9	60	1	5.35	0.31
CMPFD0966W	204		9	66	1	6.68	0.34
CMPFD0972W	231		9	72	1	7.2	0.38
CMPFD1224W	70		12	24	1	2.26	0.17
CMPFD1230W	85		12	30	1	2.77	0.21
CMPFD1236W	99		12	36	1	3.29	0.25
CMPFD1242W	111		12	42	1	3.8	0.29
CMPFD1248W	165		12	48	1	4.32	0.33
CMPFD1254W	178		12	54	1	4.83	0.38
CMPFD1260W	193		12	60	1	5.35	0.42
CMPFD1266W	204		12	66	1	6.68	0.46
CMPFD1272W	231		12	72	1	7.2	0.50

**CHP • 90 Degree Corner Post Kits**

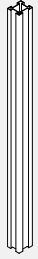

- Standard Compile paint options.
- Specify the corner post height that matches the tallest or smallest panel connection.
- 6" shorter than panel height to accommodate electric in base.
- Made of aluminum.
- 2-Way Kits include 2 trims (CMETP), 2 way post base (CMPC) and post cap (CMPC).
- 3-Way Kits include 1 trim (CMTEP), 3 way post base (CMPC) and post cap (CMPC).
- 4 Way Kits includes post cap (CMPC) only.

PRODUCT CODE	PRICE	SIZE/ INCHES			WEIGHT VOL	
		H	W	D	LBS	FT <sup>3</sup>
<b>2-Way Kits</b>						
CHP30-2	101	30	2.3	2.3	5	0.22
CHP42-2	101	42	2.3	2.3	5	0.22
CHP46-2	106	46	2.3	2.3	5	0.22
CHP48-2	122	48	2.3	2.3	5	0.22
CHP54-2	122	54	2.3	2.3	5	0.22
CHP58-2	132	58	2.3	2.3	5	0.22
CHP60-2	132	60	2.3	2.3	5	0.22
CHP64-2	153	64	2.3	2.3	5	0.22
CHP66-2	147	66	2.3	2.3	5	0.22
CHP70-2	156	70	2.3	2.3	5	0.22
CHP72-2	153	72	2.3	2.3	5	0.22
CHP78-2	174	78	2.3	2.3	5	0.22
CHP82-2	184	82	2.3	2.3	5	0.22
CHP90-2	184	90	2.3	2.3	5	0.22
<b>3-Way Kits</b>						
CHP30-3	88	30	2.3	2.3	5	0.22
CHP42-3	88	42	2.3	2.3	5	0.22
CHP46-3	97	46	2.3	2.3	5	0.22
CHP48-3	107	48	2.3	2.3	5	0.22
CHP54-3	107	54	2.3	2.3	5	0.22
CHP58-3	120	58	2.3	2.3	5	0.22
CHP60-3	120	60	2.3	2.3	5	0.22
CHP64-3	128	64	2.3	2.3	5	0.22
CHP66-3	132	66	2.3	2.3	5	0.22
CHP70-3	139	70	2.3	2.3	5	0.22
CHP72-3	139	72	2.3	2.3	5	0.22
CHP78-3	156	78	2.3	2.3	5	0.22
CHP82-3	165	82	2.3	2.3	5	0.22
CHP90-3	182	90	2.3	2.3	5	0.22
<b>4-Way Kits</b>						
CHP30-4	66	30	2.3	2.3	5	0.22
CHP42-4	66	42	2.3	2.3	5	0.22
CHP46-4	87	46	2.3	2.3	5	0.22
CHP48-4	86	48	2.3	2.3	5	0.22
CHP54-4	86	54	2.3	2.3	5	0.22
CHP58-4	99	58	2.3	2.3	5	0.22
CHP60-4	99	60	2.3	2.3	5	0.22
CHP64-4	103	64	2.3	2.3	5	0.22
CHP66-4	109	66	2.3	2.3	5	0.22
CHP70-4	113	70	2.3	2.3	5	0.22
CHP72-4	113	72	2.3	2.3	5	0.22
CHP78-4	129	78	2.3	2.3	5	0.22
CHP82-4	135	82	2.3	2.3	5	0.22
CHP90-4	151	90	2.3	2.3	5	0.22

**CHOP • 90 Degree Corner Post Kits for Over Panels**

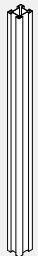

- Standard Compile paint options.
- Specify the corner post height that matches the height of the over panel
- Made of aluminum.

PRODUCT CODE	PRICE	SIZE/ INCHES			WEIGHT VOL	
		H	W	D	LBS	FT <sup>3</sup>
CHOP12-4	26	12	2.3	2.3	5	0.22
CHOP16-4	40	16	2.3	2.3	5	0.22
CHOP24-4	39	24	2.3	2.3	5	0.22

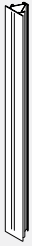
**CHP2W • 60 Degree 2 Way Corner Post**

- Standard Compile paint options.
- Specify the corner post height that matches the tallest or smallest panel connection.
- Note: Made of aluminum.
- Outer part is full panel height, inner part is 6" shorter.
- Post cap included.

PRODUCT CODE	PRICE	SIZE/ INCHES			WEIGHT VOL	
		H	W	D	LBS	FT <sup>3</sup>
CHP2W30	66	30	2.3	2.3	5	0.22
CHP2W42	66	42	2.3	2.3	5	0.22
CHP2W46	73	46	2.3	2.3	5	0.22
CHP2W48	86	48	2.3	2.3	5	0.22
CHP2W54	86	54	2.3	2.3	5	0.22
CHP2W58	90	58	2.3	2.3	5	0.22
CHP2W60	100	60	2.3	2.3	5	0.22
CHP2W64	109	64	2.3	2.3	5	0.22
CHP2W66	109	66	2.3	2.3	5	0.22
CHP2W70	114	70	2.3	2.3	5	0.22
CHP2W72	114	72	2.3	2.3	5	0.22
CHP2W78	129	78	2.3	2.3	5	0.22
CHP2W82	135	82	2.3	2.3	5	0.22
CHP2W90	149	90	2.3	2.3	5	0.22

**CHP3W • 60 Degree 3 Way Corner Post**

- Standard Compile paint options.
- Specify the corner post height that matches the tallest or smallest panel connection.
- 6" shorter than panel height to accommodate electric in base.
- Note: Made of aluminum.
- Actual post size is 6" shorter than panel height.
- Post cap included.

PRODUCT CODE	PRICE	SIZE/ INCHES			WEIGHT VOL	
		H	W	D	LBS	FT <sup>3</sup>
CHP3W30	66	30	2.3	2.3	5	0.22
CHP3W42	66	42	2.3	2.3	5	0.22
CHP3W46	73	46	2.3	2.3	5	0.22
CHP3W48	86	48	2.3	2.3	5	0.22
CHP3W54	86	54	2.3	2.3	5	0.22
CHP3W58	90	58	2.3	2.3	5	0.22
CHP3W60	100	60	2.3	2.3	5	0.22
CHP3W64	109	64	2.3	2.3	5	0.22
CHP3W66	109	66	2.3	2.3	5	0.22
CHP3W70	114	70	2.3	2.3	5	0.22
CHP3W72	114	72	2.3	2.3	5	0.22
CHP3W78	129	78	2.3	2.3	5	0.22
CHP3W82	135	82	2.3	2.3	5	0.22
CHP3W90	149	90	2.3	2.3	5	0.22

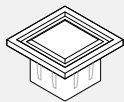
**CMPC • 90 Degree Post Cap**

- Included with any post.
- Specified separately for reconfiguration purposes.
- Available in standard Compile paint options.

PRODUCT CODE	PRICE	SIZE/ INCHES			WEIGHT VOL	
		H	W	D	LBS	FT <sup>3</sup>
CMPC	7	0.7	2.5	2.5	0.02	0.01

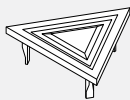
**CMPC • 60 Degree Post Cap**

- Included with any post.
- Specified separately for reconfiguration purposes.
- Available in standard Compile paint options.

PRODUCT CODE	PRICE	SIZE/ INCHES			WEIGHT VOL	
		H	W	D	LBS	FT <sup>3</sup>
CMPC60	7	0.7	2.5	2.5	0.02	0.01

**CMPC • Post Base Cover**

- Included with any post kit.
- Specified separately for reconfiguration purposes.
- Available in standard Compile paint options.
- Available for 2-way and 3-way configurations.
- Note: Finish is smooth plastic.

PRODUCT CODE	PRICE		SIZE/INCHES			WEIGHT VOL	
			H	W	D	LBS	FT <sup>3</sup>
CMPC1	11	3-Way	5	2.3	0.33	0.04	0.02
CMPC2	12	2-Way	5	2.3	2.31	0.08	0.04

**CEPE • Data Post Extension**

- Data Post extension comes with 4 trims, 3 brackets, connecting hardware and ceiling bezel and two post clips.
- Data Post extension available in standard Compile paint options. (Ceiling bezel available in white only.)
- Includes cut out along the post for easy cable insert.

PRODUCT CODE	PRICE	SIZE/INCHES			WEIGHT VOL	
		H	W	D	LBS	FT <sup>3</sup>
CEPE64	184	64	2.3	2.3	9	0.42
CEPE82	238	82	2.3	2.3	9	0.42

**CMET • End of Run Insert for Panel**



- End of Run inserts are not included with panels.
- Cannot be used for a 60° and 90° post application.
- Used at the end of each panel run and cannot be used to attach a panel run to a fixed wall.
- Vertical trims must be specified separately. Trim snaps in the panel at the end of run.
- Available in standard Compile paint options.

PRODUCT CODE	PRICE	SIZE/INCHES			WEIGHT VOL	
		H	W	D	LBS	FT <sup>3</sup>
CMET16	11	16	2.3	0.5	0.12	0.01
CMET30	13	30	2.3	0.5	0.12	0.05
CMET42	13	42	2.3	0.5	0.74	0.05
CMET46	13	46	2.3	0.5	0.74	0.05
CMET48	13	48	2.3	0.5	0.82	0.18
CMET54	13	54	2.3	0.5	0.90	0.18
CMET58	14	58	2.3	0.5	0.9	0.18
CMET60	14	60	2.3	0.5	1.48	0.31
CMET64	17	64	2.3	0.5	1.48	0.31
CMET66	17	66	2.3	0.5	1.48	0.31
CMET70	18	70	2.3	0.5	1.48	0.31
CMET72	18	72	2.3	0.5	1.48	0.31
CMET78	20	78	2.3	0.5	2.06	0.44
CMET82	21	82	2.3	0.5	2.06	0.44
CMET90	23	90	2.3	0.5	2.06	0.44

**CMET • End of Run Trim Insert for Step Down**



- Specify for any step down application and to meet the taller post or panel.
- Trim snaps in the post or end of run at a change in height.
- Available in standard Compile paint options.

PRODUCT CODE	PRICE	SIZE/INCHES			WEIGHT VOL	
		H	W	D	LBS	FT <sup>3</sup>
CEMT06	4	6	2.3	0.5	0.06	0.05
CMET12	8	12	2.3	0.5	0.12	0.05
CMET24	11	24	2.3	0.5	0.12	0.05
CMET36	13	36	2.3	0.5	0.12	0.05

**CMETP • Trim Insert for Corner Post**



- Trim installs on all sides of an exposed Corner Post.
- Specify to equal post height.
- Vertical trims must be specified separately. Trim snaps in the post.
- Available in standard Compile paint options.

PRODUCT CODE	PRICE	SIZE/INCHES			WEIGHT VOL	
		H	W	D	LBS	FT <sup>3</sup>
CMETP30	13	30	2.3	0.5	0.12	0.05
CMETP42	13	42	2.3	0.5	0.74	0.05
CMETP46	13	46	2.3	0.5	0.74	0.05
CMETP48	15	48	2.3	0.5	0.82	1.18
CMETP54	15	54	2.3	0.5	0.90	0.18
CMETP58	14	58	2.3	0.5	0.9	0.18
CMETP60	15	60	2.3	0.5	2.06	0.44
CMETP64	17	64	2.3	0.5	1.48	0.31
CMETP66	17	66	2.3	0.5	1.48	0.31
CMETP70	18	70	2.3	0.5	1.48	0.31
CMETP72	18	72	2.3	0.5	2.06	0.44
CMETP78	20	78	2.3	0.5	2.06	0.44
CMETP82	21	82	2.3	0.5	2.06	0.44
CMETP90	23	90	2.3	0.5	2.06	0.44

**CHWA • Wall Mount Extrusion**

- Starts a run of panels off an existing wall.
- Includes panel connectors.
- Mounting hardware not included. The mounting hardware selected must be based on the wall or wall stud material.
- Wall adapter adds 5/16" to a panel run.

PRODUCT CODE	PRICE	SIZE / INCHES			WEIGHT VOL	
		H	W	D	LBS	FT <sup>3</sup>
CHWA30	36	30	2.3	0.5	0.12	0.05
CHWA42	36	42	2.3	0.5	0.74	0.05
CHWA54	45	54	2.3	0.5	0.90	0.18
CHWA66	54	66	2.3	0.5	1.48	0.31

**CWMA • Wall Vertical Channel**

- Used to attach system components to fixed wall.
- Panel frame finish.
- Comes in 60" length only.
- Care should be taken to mount adapters only to wall studs using correct fasteners.
- Does not include mounting hardware. Mounting hardware selection to be based on wall material.
- Sold in pairs.
- Failure to do this may result in collapse of the unit and subsequent possible personal injury.

PRODUCT CODE	PRICE	SIZE / INCHES			WEIGHT VOL	
		H	W	D	LBS	FT <sup>3</sup>
CWMA60	30	60	0.6	0.7	1.07	0.006

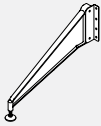
**CHHF01 • High Profile Foot**

- Provides added support to a panel or worksurface under load.
- Includes Compile attachment bracket and two levelling glides to adapt to different panel clearances.

PRODUCT CODE	PRICE	SIZE / INCHES			WEIGHT VOL	
		H	W	D	LBS	FT <sup>3</sup>
CHHF01	242	6	1	21	2.80	0.15

**CMPS01 • Post Separator**

- Creates a diagonal division within a compile post.
- Please specify post height.

PRODUCT CODE	PRICE	SIZE / INCHES			WEIGHT VOL	
		H	W	D	LBS	FT <sup>3</sup>
CMPS01	132	96	3.25	14 gauge	0.01	0.015

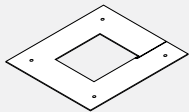
**CBEZEL • Post Extension Bezel**

- Finishes the connection between post extension and ceiling.
- Comes in white only.
- Includes screws.

PRODUCT CODE	PRICE	SIZE / INCHES			WEIGHT VOL	
		H	W	D	LBS	FT <sup>3</sup>
CBEZEL	11	0.06	6	6	0.01	0.006

**CMRC • Raceway Cover Without Punchouts (Each)**

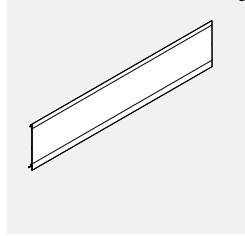

- Durable extruded aluminum.

PRODUCT CODE	PRICE	SIZE/INCHES			WEIGHT VOL	
		H	W	D	LBS	FT <sup>3</sup>
CMRC24NP	15	5	24	0.8	1.9	0.06
CMRC30NP	20	5	30	0.8	2.0	0.06
CMRC36NP	22	5	36	0.8	2.2	0.07
CMRC42NP	24	5	42	0.8	2.5	0.08
CMRC48NP	26	5	48	0.8	2.9	0.09
CMRC54NP	33	5	54	0.8	3.2	0.10
CMRC60NP	35	5	60	0.8	3.7	0.11

**CMHLPF • Flat Leg for Freestanding Panels**

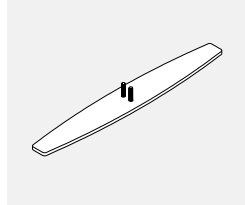

- Single flat leg for end of run/wing applications where the customer is looking for more stability.
- Kit will contains one legs and all attachment hardware.
- For the installation the customer will have to remove the existing levelers on the panel and replace it with the legs.
- Please specify paint finish.

PRODUCT CODE	PRICE	SIZE/ INCHES			WEIGHT VOL	
		H	W	D	LBS	FT <sup>3</sup>
CMHLPF01	79	0.31	21	3	3	0.01

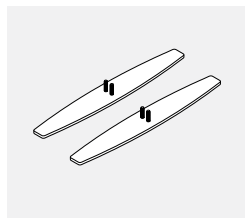

- Double kit for freestanding applications.
- Kit will contains two legs and all attachment hardware.
- For the installation the customer will have to remove the existing levelers on the panel and replace it with the legs.
- Please specify paint finish.

PRODUCT CODE	PRICE	SIZE/ INCHES			WEIGHT VOL	
		H	W	D	LBS	FT <sup>3</sup>
CMHLPF02	157	0.31	21	3	6	0.02

**CMHLLP01 • Low Profile Foot**

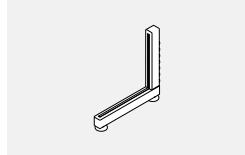

- Provides added support to a panel under load.
- Adjustable glides and connectors included.
- Made of powder coated steel.
- Please choose panel frame finish.

PRODUCT CODE	PRICE	SIZE/INCHES			WEIGHT VOL	
		H	W	D	LBS	FT <sup>3</sup>
CMHLLP01	119	12	11	1.1	2.87	0.08

**CMHLLP02 • Low Profile Foot, Set of 2**

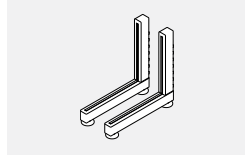

- Provides added support to a panel under load.
- Adjustable glides and connectors included.
- Made of powder coated steel.
- Please choose panel frame finish.
- Set includes 2 complete legs.

PRODUCT CODE	PRICE	SIZE/INCHES			WEIGHT VOL	
		H	W	D	LBS	FT <sup>3</sup>
CMHLLP02	238	12	11	1.1	5.74	0.17

**CMRCB01 • Electrical Blank Cover**

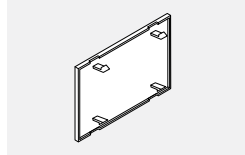

- Fills punchout when opening is not used.
- Available in Black (BLK), Tungsten (TUN), White (WHT) and Nevada (NEV).
- Note: Punchout covers are made of plastic.

PRODUCT CODE	PRICE	SIZE/INCHES			WEIGHT VOL	
		H	W	D	LBS	FT <sup>3</sup>
CMRCB01	13	1.5	2.756	0.01	0.04	0.02

**CMRC • Raceway Cover With Punchouts (Each)**

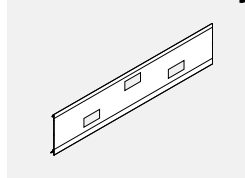

- Cover not included
- Raceway Punchout Cover must be added to openings where duplex receptacles are not used.
- Durable extruded aluminum.
- 24" wide panels have two punchouts, one for electrical and one for data.
- 30" wide panels and wider have three punchouts, two for electrical and one for data.

PRODUCT CODE	PRICE	SIZE/INCHES			WEIGHT VOL	
		H	W	D	LBS	FT <sup>3</sup>
CMRC24PO	15	5	24	0.8	1.9	0.06
CMRC30PO	20	5	30	0.8	2.0	0.06
CMRC36PO	22	5	36	0.8	2.2	0.07
CMRC42PO	24	5	42	0.8	2.5	0.08
CMRC48PO	26	5	48	0.8	2.9	0.09
CMRC54PO	33	5	54	0.8	3.2	0.10
CMRC60PO	35	5	60	0.8	3.7	0.11
CMRC66PO	39	5	66	0.8	4.0	0.12
CMRC72PO	43	5	72	0.8	4.4	0.13

**CE8PD • Power Distribution Housing**

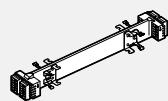

- Power distribution housing is specified per panel size (e.g. CE8PD36 is for use in a 36" panel).
- 8 wire, 4 circuits ( A and B circuit dedicated). Provides two duplex receptacles per panel side on all panel widths except the 24" wide panel.
- 24" wide panel allows for only one (1) duplex receptacle on one panel side.
- Each power distribution housing supports 15 amps.
- Must specify Raceway Cover with punchouts on panels, where Power Distribution Housings will be utilized. (Panel Kits P1 and P2)

PRODUCT CODE	PRICE	SIZE/INCHES			WEIGHT VOL	
		H	W	D	LBS	FT <sup>3</sup>
CE8PD24	142	2	9.25	2.3	0.83	1.17
CE8PD30	189	2	15.25	2.3	1.28	1.17
CE8PD36	200	2	21.25	2.3	1.62	1.65
CE8PD42	205	2	27.25	2.3	2.00	2.00
CE8PD48	216	2	33.25	2.3	2.32	2.54
CE8PD54	220	2	39.25	2.3	2.66	3.20
CE8PD60	221	2	45.25	2.3	3.04	3.20
CE8PD66	230	2	51.25	2.3	3.42	3.48
CE8PD72	238	2	57.25	2.3	3.80	3.48

**CE8CP • 17" Mesh Jumper Cable**

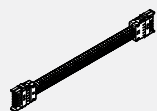

- 17" mesh jumper.
- Jumper cable is used to pass through a post or connect two panels together.

PRODUCT CODE	PRICE	SIZE/INCHES			WEIGHT VOL	
		H	W	D	LBS	FT <sup>3</sup>
CE8CP17	135	2	17	0.5	0.71	0.67

**CE8CP • Pass Through Cable**

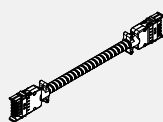

- Flexible metal conduit is used to distribute electrical power through non-powered panels.
- Metal conduit pass through cables should be in used in a straight runs. Metal conduit pass through cables cannot go around a post.
- Flexible conduit is required to turn a post. This only comes as 17"w. If panels at the posts do not all have power distribution housings, they must be added even if duplexes are not specified.
- To calculate the length of a Pass-Through Cable, add the widths of the non-powered panels separating the powered panels (panels with distribution housing attached). To this add 16" (distance from the edge of the panel to the distribution housing x 2).
- Add additional 3" when passing through a corner post.

PRODUCT CODE	PRICE	SIZE/INCHES			WEIGHT VOL	
		H	W	D	LBS	FT <sup>3</sup>
CE8CP40	149	2	40.5	0.5	1.44	1.17
CE8CP46	154	2	46.5	0.5	1.71	1.17
CE8CP52	161	2	52.5	0.5	1.95	1.17
CE8CP58	171	2	58.5	0.5	2.21	1.17
CE8CP64	178	2	64.5	0.5	2.37	1.17
CE8CP70	182	2	70.5	0.5	2.60	1.17
CE8CP76	185	2	76.5	0.5	2.81	1.17
CE8CP82	194	2	82.5	0.5	3.03	1.17
CE8CP88	200	2	88.5	0.5	3.05	1.17
CE8CP94	207	2	94.5	0.5	3.30	1.17
CE8CP100	212	2	100.5	0.5	3.47	1.17
CE8CP106	221	2	106.5	0.5	3.87	1.17
CE8CP118	234	2	118.5	0.5	4.08	1.17
CE8CP130	255	2	130.5	0.5	4.73	1.17
CE8CP142	266	2	142.5	0.5	4.99	1.17

**CE8CI • "I" Connector**

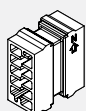

- Female - Female connector connects two Pass-Through Cables .
- Connects 17" Flexible Jumper Cable or ceiling feeds to pass through cables.

PRODUCT CODE	PRICE	SIZE/INCHES			WEIGHT VOL	
		H	W	D	LBS	FT <sup>3</sup>
CE8CI1	74	1.5	1.5	4.625	0.06	0.03

**CE8RD • Duplex Receptacle**

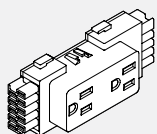

- Up to 6 receptacles per circuit.
- Duplex Receptacles standard in Black (BLK).
- CE8RD1 = Circuit #1 (utility circuit)
- CE8RD2 = Circuit #2 (utility circuit)
- CE8RDA = Circuit A (dedicated)
- CE8RDB = Circuit B (dedicated)
- Note:
- CE8RD1 and CE8RD2 (#1 and #2 share common ground)
- CE8RDA and CE8RDB (A and B share dedicated ground)

PRODUCT CODE	PRICE	SIZE/INCHES			WEIGHT VOL	
		H	W	D	LBS	FT <sup>3</sup>
CE8RD1	32	2	4.625	1.25	0.10	0.01
CE8RD2	32	2	4.625	1.25	0.10	0.01
CE8RDA	32	2	4.625	1.25	0.10	0.01
CE8RDB	32	2	4.625	1.25	0.10	0.01

**CMEUSB • USB Receptacle**

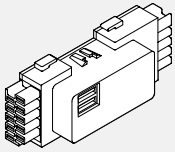

- USB charging module provides convenient charging power access through dual ports on face of the receptacle.
- Two USB ports.
- 2 Amp output via two USB ports.

PRODUCT CODE	PRICE	SIZE/INCHES			WEIGHT VOL	
		H	W	D	LBS	FT <sup>3</sup>
CMEUSB01WHT	216	2	4.625	1.25	0.10	0.01
CMEUSB01BLK	216	2	4.625	1.25	0.10	0.01

**CE8EC • Ceiling Power Entry**

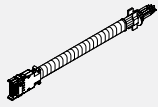

- Snaps into the end of Power Distribution Housing.
- Flexible metal conduit extends into the ceiling through a corner post and post extension (both ordered seperately).
- Must be hard wired to source power by a licensed electrician.
- 4" Junction Box included.

PRODUCT CODE	PRICE	SIZE/INCHES			WEIGHT VOL	
		H	L	D	LBS	FT <sup>3</sup>
CE8EC1	244	2	132	0.5	5.24	2.00
CE8EC2	435	2	144	0.5	5.96	2.00

**CE8FR • Base Feed**

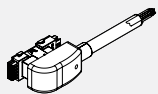

- Takes the place of a duplex receptable by snapping into the base power way.
- CE8FR1 Includes 72" long flexible metal conduit. CE8FR2 Includes 144" long flexible metal conduit.
- Must be hard wired to source power by a licensed electrician.

PRODUCT CODE	PRICE	SIZE/INCHES			WEIGHT VOL	
		H	W	D	LBS	FT <sup>3</sup>
CE8FR1	321	6	72	3	3.82	2
CE8FR2	413	6	144	3	5.96	2

**GCLEDES • Undercabinet LED Task Light**

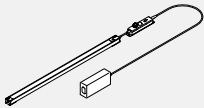

- Linear LED Light.
  - Includes light fixture with lens and ON/OFF switch.
  - Magnet mounted with adhesive metal plates.
  - Plug-in power supply with 72" cord length plus 78" DC cord.
- Technical information:
- 4100 K Colour Temperature
  - 90 Colour Rendering Index
  - 30,000 hrs rated Lifespan
  - Total power input per light, 9.0 for 24", 13.5 per 36" and 18.0 for 48"

PRODUCT CODE	PRICE	SIZE/	INCHES		WEIGHT VOL	
		H	W	D	LBS	FT <sup>3</sup>
GCLEDES24	164	1	22.9	1	2.5	0.135
GCLEDES36	189	1	33.5	1	2.8	0.161
GCLEDES48	209	1	45.5	1	3.2	0.213

**GCLEDES-DCS • Undercabinet Daisychain LED Light**

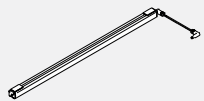

- Undercabinet LED light, 48 inches nominal size , daisy-chain unit with 1 meter (39 inches) linking cable but no power supply.
  - Daisychain units can only be linked up to a total of 48 Watts for all lights on one power supply. This equates to a maximum of 10 feet total nominal length of lights per power supply.
- Technical information:
- 4100 K Colour Temperature
  - 90 Colour Rendering Index
  - 30,000 hrs rated Lifespan
  - Total power input per light, 9.0 for 24", 13.5 per 36" and 18.0 for 48"

PRODUCT CODE	PRICE	SIZE/	INCHES		WEIGHT VOL	
		H	W	D	LBS	FT <sup>3</sup>
GCLEDES24DSC	134	1	24	1	2.5	0.135
GCLEDES36DSC	157	1	36	1	2.8	0.161
GCLEDES48DSC	178	1	48	1	3.2	0.213

**GCLEDESOS • Occupancy Sensor and Dimmer**

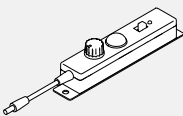

- Inline add-on controller for dimming & occupancy sensor.
- Included, from right to left, a rotary dimmer control, an occupancy sensor and a sensor bypass switch.

PRODUCT CODE	PRICE	SIZE/	INCHES		WEIGHT VOL	
		H	W	D	LBS	FT <sup>3</sup>
GCLEDESOS	66	6	2.5	2	0.4	0.500



**CWS • Rectangular Worksurface**

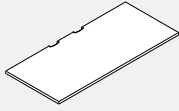

- All tops are thermally fused 1" thick with pilot holes to enable proper alignment with worksurface supports. Wood screws must be used.
- Compile worksurfaces feature a 3mm edge.
- Support hardware must be ordered separately.
- All surfaces longer than 54" have 2 scoops, all others have one.
- Please choose from DWT - Designer White, SIL- Silver or BLK - Black for scoop covers.
- Note: Width and depth dimensions listed include a nominal measurement (3/8") to account for wire management between the worksurface and adjoining panel.

PRODUCT CODE	PRICE LP	SIZE/INCHES			WEIGHT VOL	
		H	W	D	LBS	FT <sup>3</sup>
CWS2424P	129	1	24	24	16	0.52
CWS2430P	141	1	30	24	20	0.62
CWS2436P	156	1	36	24	23	0.78
CWS2442P	205	1	42	24	28	0.90
CWS2448P	245	1	48	24	31	1.03
CWS2454P	290	1	54	24	35	1.20
CWS2460P	326	1	60	24	39	1.30
CWS2466P	340	1	66	24	43	1.41
CWS2472P	355	1	72	24	47	1.54
CWS2478P	381	1	78	24	51	1.70
CWS2484P	410	1	84	24	55	1.80
CWS2490P	472	1	90	24	58	1.96
CWS2496P	502	1	96	24	63	2.10
CWS3024P	154	1	24	30	20	0.70
CWS3030P	165	1	30	30	25	0.97
CWS3036P	194	1	36	30	30	1.06
CWS3042P	275	1	42	30	34	1.12
CWS3048P	290	1	48	30	39	1.30
CWS3054P	317	1	54	30	44	1.44
CWS3060P	340	1	60	30	49	1.60
CWS3066P	353	1	66	30	54	1.80
CWS3072P	374	1	72	30	59	2.00
CWS3078P	398	1	78	30	64	2.10
CWS3084P	443	1	84	30	69	2.24

**CWSNSCP • Rectangular Worksurface, No Scoops**

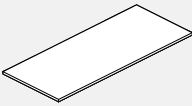

- All tops are thermally fused 1" thick with pilot holes to enable proper alignment with worksurface supports. Wood screws must be used.
- Compile worksurfaces feature a 3mm edge.
- Support hardware must be ordered separately. See the listings in this section.
- All surfaces have no scoops.

PRODUCT CODE	PRICE LP	SIZE/INCHES			WEIGHT VOL	
		H	W	D	LBS	FT <sup>3</sup>
CWS2424NSCP	129	1	24	24	16	0.52
CWS2430NSCP	141	1	30	24	20	0.62
CWS2436NSCP	156	1	36	24	23	0.78
CWS2442NSCP	205	1	42	24	28	0.90
CWS2448NSCP	245	1	48	24	31	1.03
CWS2454NSCP	290	1	54	24	35	1.20
CWS2460NSCP	326	1	60	24	39	1.30
CWS2466NSCP	340	1	66	24	43	1.41
CWS2472NSCP	355	1	72	24	47	1.54
CWS2478NSCP	381	1	78	24	51	1.70
CWS2484NSCP	410	1	84	24	55	1.80
CWS2490NSCP	472	1	90	24	58	1.96
CWS2496NSCP	502	1	96	24	63	2.10
CWS3024NSCP	154	1	24	30	20	0.70
CWS3030NSCP	165	1	30	30	25	0.97
CWS3036NSCP	194	1	36	30	30	1.06
CWS3042NSCP	275	1	42	30	34	1.12
CWS3048NSCP	290	1	48	30	39	1.30
CWS3054NSCP	317	1	54	30	44	1.44
CWS3060NSCP	340	1	60	30	49	1.60
CWS3066NSCP	353	1	66	30	54	1.80
CWS3072NSCP	374	1	72	30	59	2.00
CWS3078NSCP	398	1	78	30	64	2.10
CWS3084NSCP	443	1	84	30	69	2.24

**CWSP • Worksurface to Span a Post**

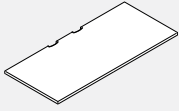

- All tops are thermally fused 1" thick with pilot holes to enable proper alignment with worksurface supports. Wood screws must be used.
- Compile worksurfaces feature a 3mm edge.
- Support hardware must be ordered separately.
- All surfaces longer than 54" have 2 scoops, all others have one.
- Please choose from DWT - Designer White, SIL- Silver or BLK - Black for scoop covers.
- Note: Width and depth dimensions listed include a nominal measurement (3/8") to account for wire management between the worksurface and adjoining panel.

PRODUCT CODE	PRICE LP	SIZE/INCHES			WEIGHT VOL	
		H	W	D	LBS	FT <sup>3</sup>
CWSP2426P	141	1	26	24	17	0.60
CWSP2432P	156	1	32	24	21	0.70
CWSP2438P	205	1	38	24	25	0.83
CWSP2444P	245	1	44	24	29	1.00
CWSP2450P	290	1	50	24	33	1.10
CWSP2456P	326	1	56	24	37	1.22
CWSP2462P	340	1	62	24	41	1.34
CWSP2468P	355	1	68	24	45	1.47
CWSP2474P	380	1	74	24	49	1.60
CWSP2480P	410	1	80	24	53	1.73
CWSP2486P	443	1	86	24	57	1.90
CWSP3026P	165	1	26	30	22	0.72
CWSP3032P	194	1	32	30	27	0.88
CWSP3038P	275	1	38	30	32	1.04
CWSP3044P	290	1	44	30	37	1.20
CWSP3050P	317	1	50	30	41	1.40
CWSP3056P	340	1	56	30	46	1.51
CWSP3062P	353	1	62	30	51	1.67
CWSP3068P	374	1	68	30	56	1.83
CWSP3074P	398	1	74	30	61	2.00
CWSP3080P	443	1	80	30	66	2.20
CWSP3086P	488	1	86	30	70	2.30

**CWVL • Left Curvilinear Worksurface**

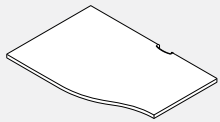

- All tops are thermally fused 1" thick with pilot holes to enable proper alignment with worksurface supports. Wood screws must be used.
- Compile worksurfaces feature a 3mm edge.
- When deepest end equals 24", the opposite depth is 18".
- When deepest end equals 30", the opposite depth is 24".
- Support hardware must be ordered separately.
- All surfaces longer than 54" have 2 scoops, all others have one.
- Please choose from DWT - Designer White, SIL- Silver or BLK - Black for scoop covers.
- Note: Width and depth dimensions listed include a nominal measurement (3/8") to account for wire management between the worksurface and adjoining panel.

PRODUCT CODE	PRICE LP	SIZE/INCHES			WEIGHT VOL	
		H	W	D	LBS	FT <sup>3</sup>
CWVL2424P	167	1	24	24	15	0.59
CWVL2430P	177	1	30	24	18	0.65
CWVL2436P	211	1	36	24	22	0.78
CWVL2442P	245	1	42	24	26	0.90
CWVL2448P	281	1	48	24	30	1.03
CWVL2454P	317	1	54	24	34	1.20
CWVL2460P	344	1	60	24	38	1.30
CWVL2466P	381	1	66	24	43	1.49
CWVL2472P	408	1	72	24	47	1.62
CWVL2478P	501	1	78	24	57	2.16
CWVL2484P	727	1	84	24	61	2.33
CWVL3024P	169	1	24	30	19	0.74
CWVL3030P	186	1	30	30	23	0.81
CWVL3036P	222	1	36	30	28	1.00
CWVL3042P	303	1	42	30	33	1.13
CWVL3048P	317	1	48	30	38	1.30
CWVL3054P	353	1	54	30	42	1.44
CWVL3060P	380	1	60	30	47	1.60
CWVL3066P	408	1	66	30	52	1.81
CWVL3072P	438	1	72	30	59	2.01
CWVL3078P	634	1	78	30	72	2.71
CWVL3084P	809	1	84	30	77	2.91

**CWVR • Right Curvilinear Worksurface**

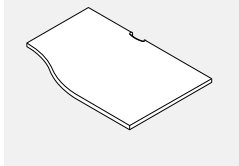

- All tops are thermally fused 1" thick with pilot holes to enable proper alignment with work surface supports. Wood screws must be used.
- Compile work surfaces feature a 3mm edge.
- When deepest end equals 24", the opposite depth is 18". When deepest end equals 30", the opposite depth is 24".
- Support hardware must be ordered separately.
- All surfaces longer than 54" have 2 scoops, all others have one.
- Please choose from DWT - Designer White, SIL- Silver or BLK - Black for scoop covers.
- Note: Width and depth dimensions listed include a nominal measurement (3/8") to account for wire management between the work surface and adjoining panel.

PRODUCT CODE	PRICE LP	SIZE/INCHES			WEIGHT VOL	
		H	W	D	LBS	FT <sup>3</sup>
CWVR2424P	167	1	24	24	15	0.59
CWVR2430P	177	1	30	24	18	0.65
CWVR2436P	211	1	36	24	22	0.78
CWVR2442P	245	1	42	24	26	0.90
CWVR2448P	281	1	48	24	30	1.03
CWVR2454P	317	1	54	24	34	1.20
CWVR2460P	344	1	60	24	38	1.30
CWVR2466P	381	1	66	24	43	1.49
CWVR2472P	408	1	72	24	47	1.62
CWVR2478P	501	1	78	24	57	2.16
CWVR2484P	727	1	84	24	61	2.33
CWVR3024P	169	1	24	30	19	0.74
CWVR3030P	186	1	30	30	23	0.81
CWVR3036P	222	1	36	30	28	1.00
CWVR3042P	303	1	42	30	33	1.13
CWVR3048P	317	1	48	30	38	1.30
CWVR3054P	353	1	54	30	42	1.44
CWVR3060P	380	1	60	30	47	1.60
CWVR3066P	408	1	66	30	52	1.81
CWVR3072P	438	1	72	30	59	2.01
CWVR3078P	634	1	78	30	72	2.71
CWVR3084P	809	1	84	30	77	2.91

**CWBT • Transition Worksurface**

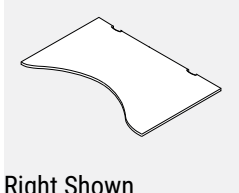

Right Shown

- Support hardware must be ordered separately.
- Please choose from DWT - Designer White, SIL- Silver or BLK - Black for scoop covers.
- Opposing side of the 30" deep surface has a depth of 24"
- Must be specified as right or left handed.

PRODUCT CODE	PRICE LP	SIZE/INCHES			WEIGHT VOL	
		H	W	D	LBS	FT <sup>3</sup>
CWBTL302460P	596	1	60	30	55	2.08
CWBTL302466P	658	1	66	30	61	2.29
CWBTL302472P	681	1	72	30	66	2.50
CWBTR302460P	596	1	60	30	55	2.08
CWBTR302466P	658	1	66	30	61	2.29
CWBTR302472P	681	1	72	30	66	2.50

**CWCC • Corner Curved Worksurface**

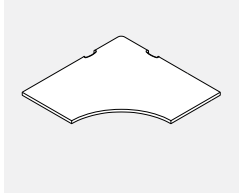

- All tops are thermally fused 1" thick with pilot holes to enable proper alignment with work surface supports. Wood screws must be used.
- Compile work surfaces feature a 3mm edge.
- Support hardware must be ordered separately.
- Please choose from DWT - Designer White, SIL- Silver or BLK - Black for scoop covers.
- Note: Width and depth dimensions listed include a nominal measurement (3/8") to account for wire management between the work surface and adjoining panel.
- "WG" indicates diagonal woodgrain.
- "WG" work surface over 42" cannot be done on the diagonal.

PRODUCT CODE	PRICE LP	SIZE/INCHES			WEIGHT VOL	
		H	W	D	LBS	FT <sup>3</sup>
CWCC3618P	385	1	36	36	29	1.20
CWCC3624P	426	1	36	36	32	1.20
CWCC3618WGP	558	1	36	36	29	1.20
CWCC3624WGP	718	1	36	36	32	1.20
CWCC4224P	574	1	42	42	41	1.60
CWCC4230P	589	1	42	42	45	1.60
CWCC4224WGP	821	1	42	42	41	1.60
CWCC4230WGP	935	1	42	42	45	1.60
CWCC4824P	668	1	48	48	50	2.00
CWCC4830P	668	1	48	48	56	2.00

**CWCF • Five Sided Worksurface**

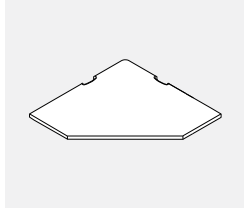

- All tops are thermally fused 1" thick with pilot holes to enable proper alignment with worksurface supports. Wood screws must be used.
- Compile worksurfaces feature a 3mm edge.
- Support hardware must be ordered separately.
- Please choose from DWT - Designer White, SIL- Silver or BLK - Black for scoop covers.
- Note: Width and depth dimensions listed include a nominal measurement (3/8") to account for wire management between the worksurface and adjoining panel.
- "WG" indicates diagonal woodgrain.
- "WG" worksurface over 42" cannot be done on the diagonal.

PRODUCT CODE	PRICE LP	SIZE/INCHES			WEIGHT VOL	
		H	W	D	LBS	FT <sup>3</sup>
CWCF3618P	331	1	36	36	29	1.20
CWCF3624P	344	1	36	36	32	1.20
CWCF3618WGP	547	1	36	36	29	1.20
CWCF3624WGP	603	1	36	36	32	1.20
CWCF4224P	488	1	42	42	41	1.60
CWCF4230P	502	1	42	42	45	1.60
CWCF4224WGP	811	1	42	42	41	1.60
CWCF4230WGP	884	1	42	42	45	1.60
CWCF4824P	550	1	48	48	50	2.00
CWCF4830P	579	1	48	48	56	2.00

**CWC6 • Corner Curved Worksurface for 60° post**

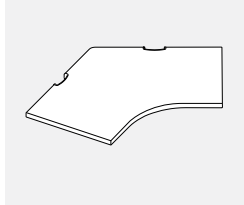

- When specifying wood grain laminate for worksurfaces 42" wide or less, grain will be run diagonally.
- Please add "WG" to the end of the product code and add 50% upcharge to the list price.
- Support hardware must be ordered separately.
- Please choose from DWT - Designer White, SIL- Silver or BLK - Black for scoop covers.

PRODUCT CODE	PRICE LP	SIZE/INCHES			WEIGHT VOL	
		H	W	D	LBS	FT <sup>3</sup>
CWC62424P	387	1	24	24	21.25	0.47
CWC62430P	688	1	30	24	28.59	0.64
CWC62436P	777	1	36	24	35.94	0.80
CWC62442P	1187	1	42	24	43.28	0.96
CWC62448P	1291	1	48	24	50.63	1.13
CWC63024P	387	1	24	30	23.72	0.53
CWC63030P	688	1	30	30	32.94	0.73
CWC63036P	777	1	36	30	42.16	0.94
CWC63042P	1187	1	42	30	51.38	1.14
CWC63048P	1291	1	48	30	60.60	1.35

**CWCEL • Extended Curved Corner Left**

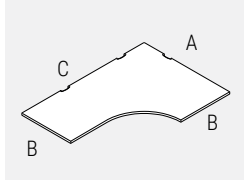

- For 48" wide ("C" dimension) worksurfaces, there are two cable scoops, all others have three.
- All tops are thermally fused 1" thick with pilot holes to enable proper alignment with worksurface supports. Wood screws must be used.
- Compile worksurfaces feature a 3mm edge.
- Support hardware must be ordered separately.
- Please choose from DWT - Designer White, SIL- Silver or BLK - Black for scoop covers.
- Note: Width and depth dimensions listed include a nominal measurement (3/8") to account for wire management between the worksurface and adjoining panel.

**NOTE: CWCEL**

A	B	C
DEPTH	DEPTH	WIDTH

PRODUCT CODE	PRICE LP	SIZE/INCHES			WEIGHT VOL	
		H	W "C"	D "A"	LBS	FT <sup>3</sup>
CWCEL362448P	583	1	48	36	43.92	1.25
CWCEL362460P	636	1	60	36	52.79	1.50
CWCEL362466P	700	1	66	36	57.18	1.62
CWCEL362472P	773	1	72	36	61.58	1.75
CWCEL362478P	825	1	78	36	65.98	1.87
CWCEL362484P	890	1	84	36	70.38	2.00
CWCEL422460P	668	1	60	42	57.18	1.63
CWCEL422466P	736	1	66	42	61.58	1.57
CWCEL422472P	811	1	72	42	65.98	1.87
CWCEL422478P	867	1	78	42	70.38	2.00
CWCEL422484P	934	1	84	42	74.78	2.00
CWCEL423060P	752	1	60	42	63.78	1.82
CWCEL423066P	825	1	66	42	69.28	1.96
CWCEL423072P	902	1	72	42	74.78	2.12
CWCEL423078P	967	1	78	42	80.28	2.28
CWCEL423084P	1031	1	84	42	85.78	2.43
CWCEL482460P	763	1	60	48	65.18	1.90
CWCEL482466P	849	1	66	48	71.39	1.92
CWCEL482472P	928	1	72	48	76.18	1.95
CWCEL482478P	991	1	78	48	74.78	2.20
CWCEL482484P	1051	1	84	48	96.78	3.66
CWCEL483060P	849	1	60	48	68.18	1.93
CWCEL483066P	928	1	66	48	73.68	2.09
CWCEL483072P	991	1	72	48	79.18	2.25
CWCEL483078P	1051	1	78	48	84.68	2.40
CWCEL483084P	1124	1	84	48	90.18	2.56

**CWCER • Extended Curved Corner Right**

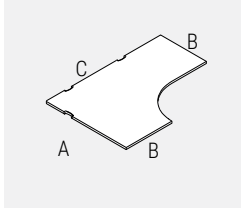

- For 48" wide ("C" dimension) worksurfaces, there are two cable scoops, all others have three.
- All tops are thermally fused 1" thick with pilot holes to enable proper alignment with worksurface supports. Wood screws must be used.
- Compile worksurfaces feature a 3mm edge.
- Support hardware must be ordered separately.
- Please choose from DWT - Designer White, SIL- Silver or BLK - Black for scoop covers.
- Note: Width and depth dimensions listed include a nominal measurement (3/8") to account for wire management between the worksurface and adjoining panel.

**NOTE: CWCER**

A	B	C
DEPTH	DEPTH	WIDTH

PRODUCT CODE	PRICE LP	SIZE/INCHES			WEIGHT VOL	
		H	W"C"	D"A"	LBS	FT <sup>3</sup>
CWCER362448P	583	1	48	36	43.92	1.25
CWCER362460P	636	1	60	36	52.79	1.50
CWCER362466P	700	1	66	36	57.18	1.62
CWCER362472P	773	1	72	36	61.58	1.75
CWCER362478P	825	1	78	36	65.98	1.87
CWCER362484P	890	1	84	36	70.38	2.00
CWCER422460P	668	1	60	42	57.18	1.63
CWCER422466P	736	1	66	42	61.58	1.57
CWCER422472P	811	1	72	42	65.98	1.87
CWCER422478P	867	1	78	42	70.38	2.00
CWCER422484P	934	1	84	42	74.78	2.00
CWCER423060P	752	1	60	42	63.78	1.82
CWCER423066P	825	1	66	42	69.28	1.96
CWCER423072P	902	1	72	42	74.78	2.12
CWCER423078P	967	1	78	42	80.28	2.28
CWCER423084P	1031	1	84	42	85.78	2.43
CWCER482460P	763	1	60	48	65.18	1.90
CWCER482466P	849	1	66	48	71.39	1.92
CWCER482472P	928	1	72	48	76.18	1.95
CWCER482478P	991	1	78	48	74.78	2.20
CWCER482484P	1051	1	84	48	96.78	3.66
CWCER483060P	849	1	60	48	68.18	1.93
CWCER483066P	928	1	66	48	73.68	2.09
CWCER483072P	991	1	72	48	79.18	2.25
CWCER483078P	1051	1	78	48	84.68	2.40
CWCER483084P	1124	1	84	48	90.18	2.56

**CWD • "D" Worksurface**

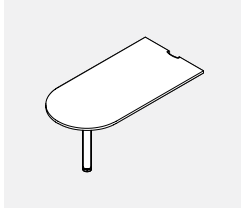

- Includes Monoleg available in standard compile finishes.
- All tops are thermally fused 1" thick with pilot holes to enable proper alignment with worksurface supports. Wood screws must be used.
- Compile worksurfaces feature a 3mm edge.
- Support hardware must be ordered separately. See the listings in this section.
- Please choose from DWT - Designer White, SIL- Silver or BLK - Black for scoop covers.
- Note: Width and depth dimensions listed include a nominal measurement (3/8") to account for wire management between the worksurface and adjoining panel.

PRODUCT CODE	PRICE LP	SIZE/INCHES			WEIGHT VOL	
		H	W	D	LBS	FT <sup>3</sup>
CWD2442P	552	1	42	24	28.00	0.98
CWD2448P	576	1	48	24	32.00	1.11
CWD2460P	605	1	60	24	40.00	1.36
CWD2472P	642	1	72	24	48.00	1.61
CWD3042P	556	1	42	30	35.00	1.10
CWD3048P	579	1	48	30	39.00	1.37
CWD3060P	646	1	60	30	49.00	1.69
CWD3072P	710	1	72	30	59.00	2.01

**CWSW • Straight Wedge Worksurface**

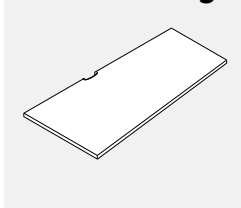

- All tops are thermally fused 1" thick with pilot holes to enable proper alignment with worksurface supports. Wood screws must be used.
- Compile worksurfaces feature a 3mm edge.
- Support hardware must be ordered separately.
- All surfaces longer than 48" have 2 scoops, all others have one.
- Please choose from DWT - Designer White, SIL- Silver or BLK - Black for scoop covers.
- Note: Width and depth dimensions listed include a nominal measurement (3/8") to account for wire management between the worksurface and adjoining panel.

PRODUCT CODE	PRICE LP	SIZE/INCHES			WEIGHT VOL	
		H	W	D	LBS	FT <sup>3</sup>
CWSW241848P	278	1	48	24	30.00	0.58
CWSW241854P	311	1	54	24	34.00	0.65
CWSW241860P	344	1	60	24	38.00	0.73
CWSW241866P	381	1	66	24	42.00	0.80
CWSW241872P	417	1	72	24	46.00	0.88
CWSW302448P	344	1	48	30	38.00	0.75
CWSW302454P	392	1	54	30	42.00	0.84
CWSW302460P	435	1	60	30	47.00	0.94
CWSW302466P	476	1	66	30	51.00	1.03
CWSW302472P	521	1	72	30	56.00	1.13
CWSW182448P	278	1	48	24	30.00	0.58
CWSW182454P	311	1	54	24	34.00	0.65
CWSW182460P	344	1	60	24	38.00	0.73
CWSW182466P	381	1	66	24	42.00	0.80
CWSW182472P	417	1	72	24	46.00	0.88
CWSW243048P	344	1	48	30	38.00	0.75
CWSW243054P	392	1	54	30	42.00	0.84
CWSW243060P	435	1	60	30	47.00	0.94
CWSW243066P	476	1	66	30	51.00	1.03
CWSW243072P	521	1	72	30	56.00	1.13

**CWSW-NSCP • Straight Wedge Worksurface**

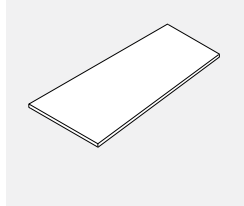

- All tops are thermally fused 1" thick with pilot holes to enable proper alignment with worksurface supports. Wood screws must be used.
- Compile worksurfaces feature a 3mm edge.
- Support hardware must be ordered separately. See the listings in this section.
- All worksurfaces have no scoops.

PRODUCT CODE	PRICE LP	SIZE /INCHES			WEIGHT VOL	
		H	W	D	LBS	FT <sup>3</sup>
CWSW241848NSCP	278	1	48	24	30.00	0.58
CWSW241854NSCP	311	1	54	24	34.00	0.65
CWSW241860NSCP	344	1	60	24	38.00	0.73
CWSW241866NSCP	381	1	66	24	42.00	0.80
CWSW241872NSCP	417	1	72	24	46.00	0.88
CWSW302448NSCP	344	1	48	30	38.00	0.75
CWSW302454NSCP	392	1	54	30	42.00	0.84
CWSW302460NSCP	435	1	60	30	47.00	0.94
CWSW302466NSCP	476	1	66	30	51.00	1.03
CWSW302472NSCP	521	1	72	30	56.00	1.13
CWSW182448NSCP	278	1	48	24	30.00	0.58
CWSW182454NSCP	311	1	54	24	34.00	0.65
CWSW182460NSCP	344	1	60	24	38.00	0.73
CWSW182466NSCP	381	1	66	24	42.00	0.80
CWSW182472NSCP	417	1	72	24	46.00	0.88
CWSW243048NSCP	344	1	48	30	38.00	0.75
CWSW243054NSCP	392	1	54	30	42.00	0.84
CWSW243060NSCP	435	1	60	30	47.00	0.94
CWSW243066NSCP	476	1	66	30	51.00	1.03
CWSW243072NSCP	521	1	72	30	56.00	1.13

**CWHL/R • Hatchet Worksurface**

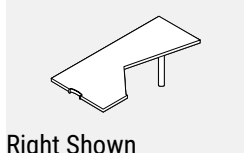

Right Shown

- Wood grain laminate not available on the diagonal.
- Must be specified either left or right.
- Includes Monoleg, available in standard compile finishes.
- Please choose from DWT - Designer White, SIL- Silver or BLK - Black for scoop covers.

PRODUCT CODE	PRICE LP		SIZE /INCHES			WEIGHT VOL	
			H	W	D	LBS	FT <sup>3</sup>
CWHL3672P	1048	Left	1	72	36	73.00	2.70
CWHR3672P	1048	Right	1	72	36	73.00	2.70

**CWQL/R • Quarter Round Worksurface**

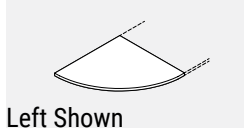

Left Shown

- The worksurface edge running along the panel face is a slightly different length than that of the worksurface end, causing the surface to be handed.
- The user edge abutting the adjacent worksurface runs straight for 2" before starting to curve.

PRODUCT CODE	PRICE LP		SIZE /INCHES			WEIGHT VOL	
			H	W	D	LBS	FT <sup>3</sup>
CWQL2424	194	Left	1	24	24	16	0.52
CWQL3030	251		1	30	30	25	0.81
CWQR2424	194	Right	1	24	24	16	0.52
CWQR3030	251		1	30	30	25	0.81

**CWQRC • Quarter Round Corner Worksurface**

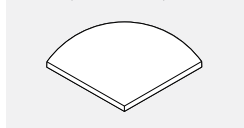

- Wraps around a 90° corner post.
- Putting the adjacent worksurface runs straight for 3" before starting to curve.
- Note: Width and depth dimensions listed include a nominal measurement (3/8") to account for wire management between the worksurface and adjoining panel.

PRODUCT CODE	PRICE LP	SIZE /INCHES			WEIGHT VOL	
		H	W	D	LBS	FT <sup>3</sup>
CWQRC2424	228	1	24	24	17.00	0.58
CWQRC3030	281	1	30	30	25.50	0.86

**CWT • Straight Transaction Worksurface**

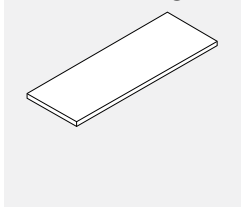

- Support hardware must be ordered separately.
- All tops are thermally fused 1" thick with pilot holes to enable proper alignment with worksurface supports. Wood screws must be used.
- Compile worksurfaces feature a 3mm edge.

PRODUCT CODE	PRICE LP	SIZE / INCHES			WEIGHT VOL	
		H	W	D	LBS	FT <sup>3</sup>
CWT1512	55	1	12	15	5	0.22
CWT1518	67	1	18	15	7	0.30
CWT1524	87	1	24	15	10	0.38
CWT1530	103	1	30	15	12	0.46
CWT1536	119	1	36	15	14	0.54
CWT1542	135	1	42	15	17	0.62
CWT1548	152	1	48	15	19	0.70
CWT1554	165	1	54	15	22	0.78
CWT1560	184	1	60	15	24	0.86
CWT1566	198	1	66	15	28	0.94
CWT1572	215	1	72	15	29	1.02
CWT1578	231	1	78	15	31	1.10
CWT1584	246	1	84	15	34	1.18

**CWTCL90 • "L" Corner Transaction Surface**

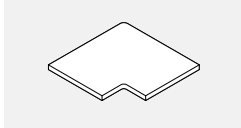

- Used where two panels meet at a 90° angle.
- Support hardware must be ordered separately.

PRODUCT CODE	PRICE	SIZE / INCHES			WEIGHT VOL	
		H	W	D	LBS	FT <sup>3</sup>
CWTCL90	154	1	20.7	15	12.00	0.75

**CW9T • Corner Transaction Surface for 90° Post**

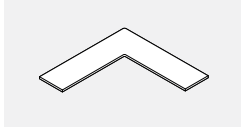

- Used where two panels meet at a 90° angle.
- Support hardware must be ordered separately.

Note: CW9T15 xx Panel Width

PRODUCT CODE	PRICE	SIZE / INCHES			WEIGHT VOL	
		H	W	D	LBS	FT <sup>3</sup>
CW9T1524	163	1	32.7	15	10.00	0.70
CW9T1530	257	1	38.7	15	12.00	0.75
CW9T1536	362	1	44.7	15	14.00	0.82
CW9T1542	494	1	50.7	15	16.00	0.95
CW9T1548	646	1	56.7	15	18.00	1.00

**CHMSL1 • Round Mid Support Leg**



- Available in standard compile standard panel frame colours.
- Includes levelling glide, PVC sleeve and 4.8" x 4.8" plate.
- 1.5" diameter.

PRODUCT CODE	PRICE	LEG DIAMETER	SIZE / INCHES			WEIGHT VOL	
			H	W	D	LBS	FT <sup>3</sup>
CHMSL1	75	1.5	28	4.8	4.8	8	0.15

**CHMSL2 • Square Mid Support Leg**



- Available in standard compile standard panel frame colours.
- Includes levelling glide, PVC sleeve and 4.8" x 4.8" plate.

PRODUCT CODE	PRICE	LEG SIZE	SIZE / INCHES			WEIGHT VOL	
			H	W	D	LBS	FT <sup>3</sup>
CHMSL2	75	1.5	28	4.8	4.8	8	0.15

**BHML • Monoleg**



- Provides support for a worksurface.
- Includes an adjustable foot and an attachment plate.
- 3" diameter.
- 1" Height adjustment range.

PRODUCT CODE	PRICE	SIZE / INCHES			WEIGHT VOL	
		H	W	D	LBS	FT <sup>3</sup>
BHML03	188	28	3	3	8	0.15

**CMHCL1 • Round Corner Leg With Leveler**



- Provides support for worksurface.
- Includes levelling glide, PVC Sleeve and attachment plate.
- 1.5" diameter.
- Available in standard paint colours.
- Legs can be used in the corner of a single worksurface or be rotated 45 degrees to support the corners of two worksurfaces.

PRODUCT CODE	PRICE	SIZE / INCHES			WEIGHT VOL	
		H	W	D	LBS	FT <sup>3</sup>
CMHCL1	105	28	3	3	8	0.15

**CMHCL2 • Square Corner Leg With Leveler**

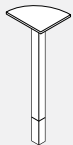

- Provides support for worksurface.
- Includes levelling glide, PVC Sleeve and attachment plate.
- 1.5" diameter.
- Available in standard paint colours.
- Legs can be used in the corner of a single worksurface or be rotated 45 degrees to support the corners of two worksurfaces.

PRODUCT CODE	PRICE	SIZE / INCHES			WEIGHT VOL	
		H	W	D	LBS	FT <sup>3</sup>
CMHCL2	105	28	3	3	8	0.15

**CHC • Cantilever**



- CHC15 come with wood screws and 3 hole slider, while CHC22 comes with wood screws & 4 hole slider.
- Corresponding panel frame colours only.
- Cantilevers do not share support.

PRODUCT CODE	PRICE	SIZE / INCHES			WEIGHT VOL	
		H	W	D	LBS	FT <sup>3</sup>
CHC15L	47	5	1.2	15.2	2	0.04
CHC15R	47	5	1.2	15.2	2	0.04
CHC22L	78	8	1.2	21.5	2.6	0.06
CHC22R	78	8	1.2	21.5	2.6	0.06

**CHCB2 • Corner and Transaction Bracket**

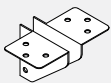

- Attaches the corner of any worksurface to a panel connector.
- Priced and shipped in pairs.
- Available in Standard paint colours.
- Cannot be used off modular.
- Comes with a 2 hole slider.

PRODUCT CODE	PRICE	SIZE / INCHES			WEIGHT VOL	
		H	W	D	LBS	FT <sup>3</sup>
CHCB2	21	3	1.81	3	0.5	0.02



**CH • Worksurface Bracket**

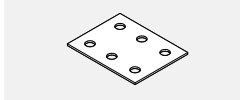

- Black (BLK) only

PRODUCT CODE	PRICE	SIZE / INCHES			WEIGHT VOL		
		H	W	D	LBS	FT <sup>3</sup>	
CHFB1	20	Flat Bracket	0.1	3	4	0.5	0.007

**CHWB • Mid Span Bracket**

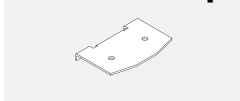

- Attaches to a segmented panel.
- Must be specified with a worksurface longer than 48".
- Zinc finish only.

PRODUCT CODE	PRICE	SIZE / INCHES			WEIGHT VOL	
		H	W	D	LBS	FT <sup>3</sup>
CHWB1	12	0.5	2.8	2.1	0.5	0.02

**DHPEDB • Pedestal Bracket**



- Available in standard paint colours.
- Attaches pedestal to panel and end panel.

PRODUCT CODE	PRICE	SIZE / INCHES			WEIGHT VOL	
		H	W	D	LBS	FT <sup>3</sup>
DHPEDB	35	8	1	1	0.5	0.001

**CHEP • End Panel**

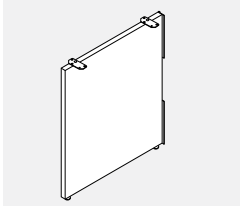

- Supports the worksurface and enhances the stability of connected panels.
- Provides solid support at the end of a run of worksurfaces.
- Finished in thermally-fused laminate.
- Includes 2 flat brackets (black), 2 pedestal brackets (frame colour) and required screws.
- End panel height is inclusive of panel glides extended to their fullest height.
- If wood grains is selected, grain runs vertically.
- Note: May be used as a shared gable between two adjoining worksurfaces.

PRODUCT CODE	PRICE	SIZE / INCHES			WEIGHT VOL	
		H	W	D	LBS	FT <sup>3</sup>
CHEP2924	232	28	1	24	17	0.40
CHEP2930	272	28	1	30	21	0.50

**CHMEGR • Metal End Gable - Right**

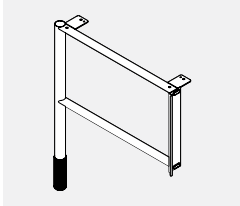

- Support the worksurface and enhances the stability of connected panels.
- Includes a levelling glide, decorative PVC sleeve to cover the glide and two hole slider.

PRODUCT CODE	PRICE	SIZE / INCHES			WEIGHT VOL	
		H	W	D	LBS	FT <sup>3</sup>
CHMEG18R	227	28	4	17	5.20	0.55
CHMEG24R	242	28	4	23	6.00	0.73
CHMEG30R	257	28	4	29	6.80	0.90

**CHMEGL • Metal End Gable - Left**

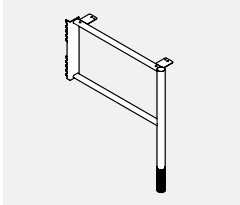

- Support the worksurface and enhances the stability of connected panels.
- Includes a levelling glide, decorative PVC sleeve to cover the glide and two hole slider.

PRODUCT CODE	PRICE	SIZE / INCHES			WEIGHT VOL	
		H	W	D	LBS	FT <sup>3</sup>
CHMEG18L	227	28	4	17	5.20	0.55
CHMEG24L	242	28	4	23	6.00	0.73
CHMEG30L	257	28	4	29	6.80	0.90

**CHMSL • Metal Mid Support Leg**

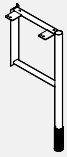

- Supports the adjoining worksurfaces and enhances the stability of connected panels.
- Includes a levelling glide and decorative PVC sleeve to cover the glide.
- **Should not be used as an end support.**

PRODUCT CODE	PRICE	SIZE/INCHES			WEIGHT VOL	
		H	W	D	LBS	FT <sup>3</sup>
CHMSL12	194	28	4	11	4.60	0.36

**CHWSRL01 • Worksurface round Support Leg**

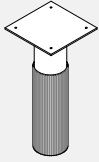

- Provides supports when worksurface overhangs 21”H Double Wall Storage or 1.5H 1200 Series Cabinet Storage must have File Top.
- Must be used to support the worksurface in conjunction with panel mounted hardware.
- Contains a levelling glide and PVC sleeve.
- 1.5 diameter round tube.
- Available in BLK (Black) only

PRODUCT CODE	PRICE	SIZE/ INCHES			WEIGHT VOL	
		H	W	D	LBS	FT <sup>3</sup>
CHWSRL01	45	4.5	3	3	1.00	0.03

**CMHLEG • Compile Bridges Leg Assembly**

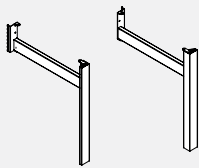

- **Compile Bridges Leg Assembly attaches to a Compile panel for applications which require functionality of Compile panels with an open environment of Bridges tables.**
- One leg with horizontal member connecting to 1” increment slots in panel’s vertical frame member. Provides support to panel and panel-connected worksurface at the end of a run; design coordinated with Bridges freestanding tables.
- Supports 24” and 30” deep worksurfaces. By adding 2 CHF B1 flat brackets and 1 CHCB2 corner bracket, a single leg can then support the adjoining worksurface. Leveling glide is standard. No worksurface supporting beams, use panel cantilevers and storage for worksurface support. One aluminum leg with steel structure - specify Left or Right and 24” or 30” deep for corresponding worksurface depths. Panel bracket, dislodgment clip and worksurface hardware included.
- Anodized aluminum leg upcharge \$23.
- Please specify paint finish for support.

PRODUCT CODE	PRICE	SIZE/INCHES			WEIGHT VOL	
		H	W	D	LBS	FT <sup>3</sup>
CMHLEG24LL	308	28	2.5	24	9	1.25
CMHLEG24RL	308	28	2.5	24	9	1.25
CMHLEG30LL	323	28	2.5	30	11	1.45
CMHLEG30RL	323	28	2.5	30	11	1.45

**CMHC • HAT Channel**

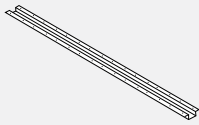

- Support worksurfaces.

PRODUCT CODE	PRICE	SIZE/INCHES			WEIGHT VOL	
		H	W	D	LBS	FT <sup>3</sup>
CMHC40	56	1.4	40	5	4	0.20
CMHC46	62	1.4	46	5	6	0.22
CMHC52	66	1.4	52	5	7	0.25
CMHC58	76	1.4	58	5	8	0.28
CMHC64	85	1.4	64	5	9	0.31
CMHC70	91	1.4	70	5	10	0.33

**CM0100LKCLIP • Lock Clip**



- Use to hold and lock 2 panels or panel post together and prevents disconnection.

PRODUCT CODE	PRICE	SIZE/INCHES			WEIGHT VOL	
		H	W	D	LBS	FT <sup>3</sup>
CM0100LKCLIP	7	2.6	0.75	0.32	0.026	0.001

**CSSL12 • Low Profile Shelf**

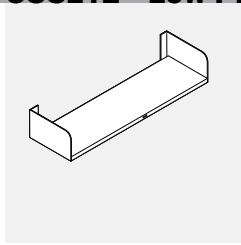

- 12" deep panel-mounted storage shelf with backlip.
- Mounting brackets are included (3 hole slider).
- Shipped knocked down.

PRODUCT CODE	PRICE	SIZE/INCHES			WEIGHT VOL	
		H	W	D	LBS	FT <sup>3</sup>
CSSL1224	146	5	24	12.5	8	0.16
CSSL1230	152	5	30	12.5	10	0.20
CSSL1236	154	5	36	12.5	12	0.25
CSSL1242	166	5	42	12.5	13	0.29
CSSL1248	182	5	48	12.5	15	0.33
CSSL1254	195	5	54	12.5	17	0.37
CSSL1260	204	5	60	12.5	18	0.41

**CSOF12 • KD Overhead**

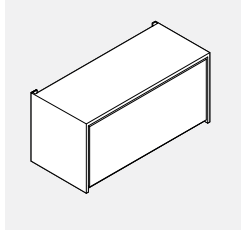

- Mounting brackets are included (2x 6 hole slider).
- Door retracts up and over the cabinet
- Ready for quick assembly on site.
- Quality steel construction.
- 60" unit is reinforced for proper weight distribution.
- Inside dimensions: 12" h x 11.75" d
- Shipped knocked down.
- Lock is not included, please order separately.

PRODUCT CODE	PRICE	SIZE/INCHES			WEIGHT VOL	
		H	W	D	LBS	FT <sup>3</sup>
CSOF1224	499	14.6	24	13.5	27	0.79
CSOF1230	517	14.6	30	13.5	31	0.83
CSOF1236	573	14.6	36	13.5	36	0.99
CSOF1242	630	14.6	42	13.5	41	1.16
CSOF1248	690	14.6	48	13.5	46	1.32
CSOF1254	747	14.6	54	13.5	51	1.49
CSOF1260	803	14.6	60	13.5	56	1.66

**CMADA • Panel Mounted Overhead Storage, AODA Compliant**

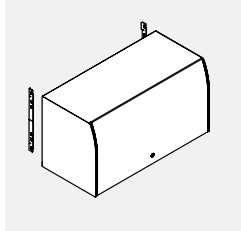

- Panel mounted metal overhead storage with opaque acrylic door. The mechanism lifts the door up and stores it out of the way, above the storage unit.
- Meets CSA B651 Barrier Free Design & AODA (Accessibility for Ontarians with Disabilities Act).
- 16" high units accept standard and A4 binders.
- All shelves are reinforced for proper weight distribution.
- Inside dimensions: 14.25" high x 13.4" deep.
- Unit includes attachment hardware, lock and mounting brackets. Back not included.
- Shipped partially assembled.

PRODUCT CODE	PRICE	SIZE/INCHES			WEIGHT VOL	
		H	W	D	LBS	FT <sup>3</sup>
CMADA30PM	815	16	30	14.2	27	5.3
CMADA36PM	880	16	36	14.2	32	6.3
CMADA42PM	942	16	42	14.2	37	7.3
CMADA48PM	1007	16	48	14.2	42	8.3
CMADA54PM	1069	16	54	14.2	47	9.3
CMADA60PM	1133	16	60	14.2	53	10.3

**CMDAOH • Center Mount Overhead**

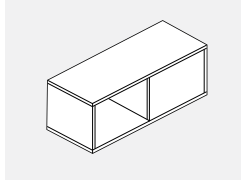

- Inside dimensions 13" high x 13" deep.
- Laminate Overhead.
- Available in standard Compile laminate finishes.
- Top mount on panels.
- Overhead Support Brackets included.

PRODUCT CODE	PRICE	SIZE/INCHES			WEIGHT VOL	
		H	W	D	LBS	FT <sup>3</sup>
CMDAOH36	1102	15	36	14.12	10	4.4
CMDAOH42	1186	15	42	14.12	11	5.1
CMDAOH48	1236	15	48	14.12	12	5.8
CMDAOH54	1327	15	54	14.12	13	6.6
CMDAOH60	1374	15	60	14.12	14	7.3

**BA • Keys**

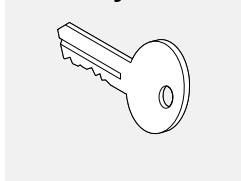

- Additional key (specify at time of order).

PRODUCT CODE	PRICE		
BAAK91	14		
<b>Master key:</b>		<b>Core key:</b>	
BAMK91	36	BACK91	17
<b>Extra key for existing cabinet:</b>		<b>Core &amp; Key:</b>	
BAEK91	14	BALOCKKEY	41

**CMSLK12 • Lock and Key**

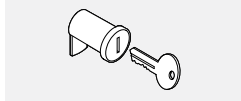

- Lock and key for CSOF12-KD overhead storage unit.
- Includes one lock assembly and two keys.

PRODUCT CODE	PRICE	SIZE/INCHES	WEIGHT VOL
		H W D	LBS FT <sup>3</sup>
CMSLK12	41		0.13

**BS12BBF • 12" Series BBF Pedestal Worksurface Supporting**

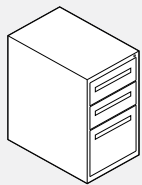

- Worksurface Supporting Pedestal with long pull and double wall drawer front construction.
- Lock is positioned on the front face, right side.

Note: "C" Indicates "C" Series featuring a full width pull. "L" indicates "Linear" Series featuring a "Soft-to-the-touch" handles.

PRODUCT CODE	PRICE		SIZE/ INCHES			WEIGHT VOL	
	"C"	"L"	H	W	D	LBS	FT <sup>3</sup>
BS1218BBF	637	703	27.75	15	18	70	4.29
BS1223BBF	644	710	27.75	15	23	84	5.62
BS1224BBF	644	710	27.75	15	24	84	5.62
BS1229BBF	710	776	27.75	15	29	94	7.03
BS1230BBF	710	776	27.75	15	30	94	7.03

**BS12FF • 12" Series FF Pedestal Worksurface Supporting**

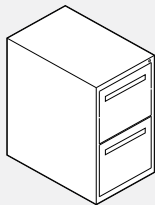

- Worksurface Supporting Pedestal with long pull and double wall drawer front construction.
- Lock is positioned on the front face, right side.

Note: "C" Indicates "C" Series featuring a full width pull. "L" indicates "Linear" Series featuring a "Soft-to-the-touch" handles.

PRODUCT CODE	PRICE		SIZE/ INCHES			WEIGHT VOL	
	"C"	"L"	H	W	D	LBS	FT <sup>3</sup>
BS1218FF	637	684	27.75	15	18	70	4.29
BS1223FF	644	690	27.75	15	23	84	5.62
BS1224FF	644	690	27.75	15	24	84	5.62
BS1229FF	710	757	27.75	15	29	94	7.03
BS1230FF	710	757	27.75	15	30	94	7.03

**BS12PSB-BBFM • Box Box File Long Pull Mobile Pedestal**

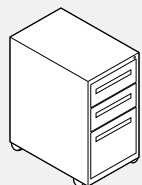

- Mobile Pedestal with long pull offers finished top and back. Will fit under 29" high worksurface.
- Includes 4 casters and 1 factory installed counterweight balance.
- Steel top features folded corner construction.
- Lock positioned on the front face, right side.
- Drawer configuration cannot be changed on site.

Note: "C" Indicates "C" Series featuring a full width pull. "L" indicates "Linear" Series featuring a "Soft-to-the-touch" handles.

PRODUCT CODE	PRICE		SIZE/ INCHES			WEIGHT VOL	
	"C"	"L"	H	W	D	LBS	FT <sup>3</sup>
BS12PSB19BBFM	800	864	28	15	19	95	6.08
BS12PSB23BBFM	807	871	28	15	23	101	7.21
BS12PSB29BBFM	928	990	28	15	29	106	8.91

**BS12PSB-FFM • File File Long Pull Mobile Pedestal**

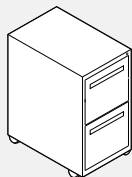

- Mobile Pedestal with long pull offers finished top and back. Will fit under 29" high worksurface.
- Includes 4 casters and 1 factory installed counterweight balance.
- Steel top features folded corner construction.
- Lock positioned on the front face, right side.
- Drawer configuration cannot be changed on site.

Note: "C" Indicates "C" Series featuring a full width pull. "L" indicates "Linear" Series featuring a "Soft-to-the-touch" handles.

PRODUCT CODE	PRICE		SIZE/ INCHES			WEIGHT VOL	
	"C"	"L"	H	W	D	LBS	FT <sup>3</sup>
BS12PSB19FFM	800	843	28	15	19	95	6.08
BS12PSB23FFM	807	850	28	15	23	101	7.21
BS12PSB29FFM	928	970	28	15	29	106	8.91

**ENVIRONMENTAL COMMITMENT**

**Evolve Systems-Protecting the Environment for Future Generations**

- Our environmental success story began with the challenge to create an office system that would meet today's business requirements while maintaining a firm commitment to save and protect the environment.
- Sustainability became a part of the creative focus and development of Evolve that incorporates the latest technology and design features to provide excellent performance at a competitive price.
- As government and industry environment ratings such as LEED become more prevalent, Evolve offers designers and architects functional, attractive, and economical office designs that meet these standards.
- Evolve is a leader in reducing waste and recycling materials in the manufacture of its products. We make extensive use of recycled plastic and wood waste from other Global factories.
- Evolve is committed to exercise diligence in the continuous improvement of our environmental systems, the prevention of pollution, and to comply with both the spirit and the letter of all relevant environmental legislation.
- Evolve panels are 100% recyclable at the end of their lifespan. Nothing from an Evolve panel needs to end up in a landfill.

**Evolve Systems-Product Information**

- Evolve offers fabrics that are made from 100% recycled polyester, which means less waste going to landfills, reduced demand for petroleum products, and fewer environmental impacts from the processing of petroleum products into polyester.
- Evolve has developed a panel interior made from 100% recycled wood and polypropylene. Through innovative design and technology, Evolve utilizes waste that would have normally been sent to landfill.
- Evolve panels are insulated with a mineral fibre insulation made from slag (an inert steel by-product) and basalt rock. This material's high density provides maximum sound absorption to reduce noise in the work environment. Mineral fibre insulation is fire resistant, water repellent and will not support the growth of fungi or mildew.

**Evolve Systems-Special Product**

- When ordering specials, copies of the Special Quote Form (SQ's) must be submitted with the order to ensure accuracy of the special product.

**PANELS**

- Panel Fabric modules consist of Module Frames, Module Interiors and Fabric Skins.

**Module Construction**

- Module Frames feature a combination of 100% recycled PVC horizontal extrusions and unique, molded vertical ends made from equal parts of 100% recycled polypropylene and 100% recycled wood (from Global's factory waste).
- Module Interiors feature honeycomb made from 75% recycled kraft paper and acoustical mineral board derived from slag (inert steel by-product) and volcanic material.

**Fabric**

- Fabric offerings include selections woven with 100% recycled yarn.

**Panel Frame**

- Panel Frame is made of cold rolled steel which has a recycled content of 25%.

**Metal Components/Raceway Finish**

- All metal components are painted with environmentally friendly epoxy powder.
- Raceway interiors are coated with recycled epoxy powder.

**Panel Options**

- Factory installed Panel Modules are available in 6", 12", 18" and 24" heights and a variety of options including: Semi-Tackable Fabric Acoustic, Glass, Open, Slatwall,

Laminate and Whiteboard Modules.

- Standard Fabric Acoustic Panels come in a variety of heights: 30", 42", 54" and 66". Monolithic Panels are available in 42", 48", 54".
- Panel Extension Modules attach to the top of the base structural panels. These are offered in 6", 12", 18" and 24" heights and can be stacked one on top of the other to create a visually continuous panel in excess of 14'-0" high.
- Panels can be modified on-site by swapping fabric modules for glazed, open, laminate or whiteboard modules at any time after the initial installation. Panels can also be altered in height by replacing the vertical liners (panel sides) and adding or subtracting modules as required.
- Panel widths come in 8 sizes including: 18", 24", 30", 36", 42", 48", 54" and 60".
- All Fabric Modules are semi-tackable.
- One sided and two sided whiteboard modules are available.
- Panels conform to CGSB and ANSI/BIFMA standards.
- Evolve panels carry an acoustical rating of .65 NRC and 20 STC.
- Rigid, steel panel frame is 2 7/8" thick.
- Levelling glides extend 2 1/2".

**VOICE/DATA AND ELECTRIC POWER**

- Voice/data cables can be laid in at both the base and the top of the panel.
- 8 wire, 4 circuit electrical capability, 2 utility + 2 dedicated circuits, each with 10 gauge (oversized) neutrals. All circuits are 20 amps (15 CSA).
- Additional 8 wire features. No tools required.

- Both power and data is available at desk height.
- Raceway Cover opening sizes conform to the ANSI/TIA/EIA Furniture Opening Standard of 1.37 x 2.68.
- Panels and electrical components are CSA/UL approved.

**WORKSURFACES**

- Worksurfaces come in a variety of shapes and sizes. Essentially, they are 18", 24" or 30" deep and are available in 6" increments from 24" to 72" wide. Custom tops are available at a modest upcharge and on the same delivery schedule.
- Cable scoops located at the back of each worksurface provide routing of power and data cables.

- Metal inserts for the connection of supporting hardware.
- Thermally fused and high pressure laminate tops are available, both with tough PVC edging.
- All worksurfaces utilize balanced construction.
- Curved worksurfaces incorporate ergonomic design.

**STORAGE**

- 19", 23", 24", 29" and 30" deep pedestals in 20 gauge steel. Freestanding, Worksurface Supporting, Mobile and Mobile with Cushion options available. Note: Pedestal widths are nominal
- Metal roller bearing slides for all file drawers. Box drawers feature 75 lb single action slides, file drawer feature 150 lb full extension slides. All drawers have rubber bumpers to cushion the closing of each drawer.
- Drawer divider and pencil tray included in all pedestals containing box drawers.
- Adjustable glides are accessible from the inside of the cabinet.
- Positive and secure locking system on all pedestals is standard.
- Double wall drawer face with recessed handle.

- Full height drawer sides on all file drawers.
- 30" file drawers have full depth drawers with 26" of letter filing capacity.
- Worksurface supporting pedestals are standard with Evolve.
- Available in 12" deep, flat front overhead and 13" deep full pull overhead. Both have "up and over" doors.
- Shelves feature all metal construction.
- Evolve Storage Towers feature all metal construction and a choice of 12 different configurations.
- All storage components as well as the panel frames are epoxy powder coated.

**WARRANTIES AND PERFORMANCE**

- Lifetime Warranty.
- Non Obsolescence Warranty.
- Aggressive product pricing.
- Reduced cost of assembly and reconfiguration.
- Exceptions: panel textiles, electrical devices and task lights - 5 years.

- ISO9001:2000 Registered.
- ISO14001:2004 Registered.
- Greenguard Certified.
- ANSI/BIFMA CGSB testing on all products.
- Run through capability.

**PANELS • TECHNICAL INFORMATION**

- Evolve panels are 2 7/8" thick. They are available in four (5) basic heights: 30", 42", 48", 54" and 66" and eight (8) widths: 18" to 60" in 6" increments.
- Individual fabric covered acoustic modules incorporated into a rigid steel frame.
- Opposite side of each module may have a different fabric within the same grade at no upcharge.
- If different grades of fabric are used on one panel, the entire panel must be priced at highest grade.
- A low profile top cap is included. It allows for storage of up to 8, 5mm (0.002") diameter data cables.
- No panel creep.
- All Panels, except Monolithic are composed of a 6" raceway module and a 24"

- high base module. Subsequent heights are created by adding either a 12" high module or a 24" high module.
- Raceway openings are 1.37 x 2.68
- 12" high and 24" high modules of all types (fabric, laminate, glass, open) are available for field installation. Contact your Customer Service Representative for requirements and installation.
- Frosted glazing is available at an upcharge, please contact your Customer Service Representative.
- Laminate for laminate panels cannot be replaced in the field, complete module must be ordered.
- Writeboard for Writeboard panels cannot be replaced in the field, complete module must be ordered.

**PANEL CONNECTORS • TECHNICAL INFORMATION**

**Panel Connectors**

- Available in one-way, two-way, three-way or four-way based on the configuration.
- Available with either PVC or Aluminum Trims.
- 6" high connectors cannot be stacked on top of each other.

**Panel Trims**

- Available in PVC or Aluminum.

**COMPONENTS**

**A. EVPERA66**

End-of-Run Kit (Wall mount) Note: adds 1" to the width of a panel run.

**B. EVPFA6636**

Fabric Acoustic Panel Note: there is no panel creep.

**C. EVPIC66**

Inline Panel Connector

**D. EVPCPA266**

Two-Way Corner Post Note: trim kit included. Post Connectors can be custom manufactured with or without slots on one side only. Contact your Evolve Customer Service Representative for a special quote.

**E. EVPVTLA66**

Vertical "L" Trim Note: Can be purchased separately when required for reconfiguration

**F. EVPVC66**

Variable-Height Connector Note: Connector height must reference taller panel. (Must be ordered separately).

**G. EVPTVA24**

Panel Trim Variable-Height

**H. EVPFA4236**

Fabric Acoustic Panel

**I. EVPTNTA36**

Panel Top Notched Trim

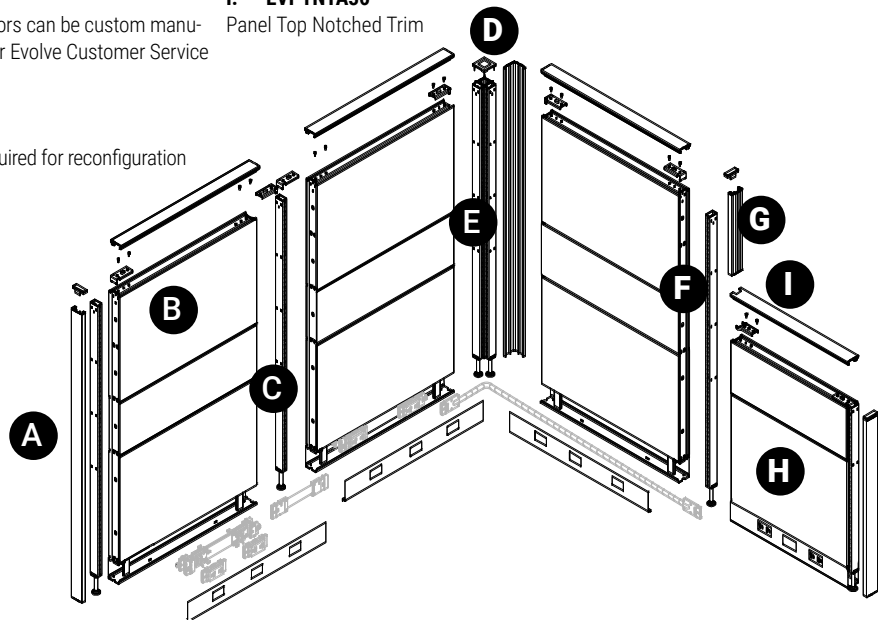

**CONNECTORS • TECHNICAL INFORMATION**

Slotted connectors and trim are included with each Variable-Height Corner Post. The height of each slotted connector must be specified when ordering a Variable-Height Corner Post. Slotted connector height is determined by the height of the connecting panel run.

Example:

Step 1 Specify base code listed on pricing page.

Fabric Acoustic Panel:

Step 2 Specify slotted connector heights.

Note: To specify height, use the first number of the connecting panel run height dimension.

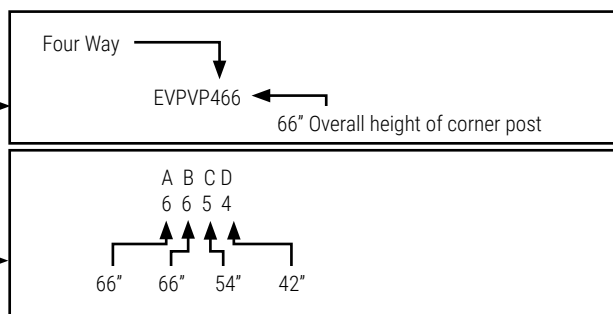

## PANELS

- The entire Evolve panel and the processes to manufacture it are designed to save and protect the environment. Evolve panels are made from recycled materials and are 100% recyclable.
- Evolve makes it easy to select a panel function type and height that is suitable for your application.
- The extension module makes private offices available, with the use of Panel Extension Modules combined with a door.
- When Panel Extension Modules are used in the initial installation in conjunction with low panels (30" to 42"), future panel height flexibility is attained while maintaining storage hang-on capabilities up to 66".
- Panel frames can be totally disassembled in the field. Panel modules can be reconfigured or replaced and panel heights altered as changing circumstances demand.
- This level of flexibility makes it easy to select the correct height of panel to suit your requirements.
- Whiteboards incorporated into the panel remove the need for add-ons.
- The quality, and performance level of these panels has been tested to equal or exceed the requirements of the Canadian and US governments.
- Classified as acoustic, these panels meet the acoustical requirements of both Canadian and US governments.
- Solid steel panel frame combined with easy to assemble panel to panel clamps, create a rigid panel wall.
- Panel glide adjustment enables the client to deal with severe uneven floors of a building.

## VOICE/DATA AND ELECTRIC POWER

- The base raceway cavity can accommodate 140 Category 5 data cables or 48 Category 5 data cables when the power distribution housings are present. In addition, 8 Category 5 data cables can be housed within a standard Panel Top Cap and 50 Category 5 cables can be accommodated in the optional High Profile Top Cap. This is a "true lay-in" method whereby cables can be run from the ceiling to worksurface without needing to be "fished".
- Evolve's 8 wire system provides two utility circuits plus two separate dedicated circuits (2+2).
- Snap-in Power Distribution Housings and lay-in Jumper and Pass-Through cables enable quick and simple electrical installation and modification by a qualified electrician. Circuits can easily be added, or exchanged (circuit #1 for circuit #2, circuit #1 for dedicated circuit #A or #B etc. if all are connected to base)
- The Desk Top Data/Power House attaches to the back of the worksurface to provide access to two simplex power outlets and two voice/data outlets.
- Standard Data Face Mount Plates can be used without the need of adapter plates (supplied by others).

## WORKSURFACES

- The addition of custom sizes shows a commitment to client satisfaction that not every manufacturer offers. With this choice of product, we can tailor each installation to your requirements.
- This convenient scoop feature, together with a 3/8" gap between the worksurface and the panel, allows access to cables without having grommet holes in the worksurface.
- Metal-to-metal connection ensures that, no matter how many times you reconfigure your product, it will perform over the long term.
- Highest quality, thermally fused laminated surfaces ensure lasting durability. High pressure laminates are also available for those areas where rugged use is expected. A 3mm PVC edge banding is used on both options, to take the knocks of everyday wear and tear.
- Whether thermally fused or high pressure, all worksurfaces are manufactured with equal laminates on both sides of the worksurface to deter warpage.
- Curved worksurfaces are ergonomically designed to facilitate the interaction between the keyboard, mouse and worksurface.

## STORAGE

- Steel construction guarantees the performance of the product over the long term. Welded joints with a full top, back and base ensure that the pedestal will sit square and adequately support the worksurface where necessary.
- Due to the quality of the construction and the slides, the pedestal drawers will continue to operate efficiently for the lifetime of the furniture. The rubber bumpers dampen the noise of closing a drawer and stop any metal-to metal contact.
- The pencil tray is double width for extra storage.
- The glides enable you to level the cabinet to the floor and or worksurface. This convenient adjustment feature allows the installer to adjust the height of the cabinet while it is under the worksurface. This saves time in the installation process.
- For additional security and peace of mind. These locks can be keyed alike or master keyed for additional convenience.
- Quality construction with no exposed metal edges. Recessed handle offers uncluttered aesthetic.
- The construction of the drawer enables you to hang files from the drawer side so no extra hardware is necessary. File drawers accept legal, letter and metric sized files.
- Some manufacturers use the same drawer for their 24" deep pedestal as they do for their 30" deep pedestal. The 24" deep drawer gives you only 19.5" of filing. This is 25% extra filing in every file pedestal drawer.
- Worksurface supporting pedestal feature saves you money as you do not have to buy worksurface supporting hardware. Each pedestal comes with a finished end panel. The addition of a non handed bracket enables the pedestal to attach to a structural panel.
- This item, which is shipped knocked down, is more economically priced to minimize shipping damage. The lock is optional in the 12" overhead and included in the 13" overhead. The base shelf features a back lip which stops binders touching the fabric of the panel it is mounted on. All components are metal and the door slides are roller bearing for longer life.
- These rugged overhead units are extremely well priced yet accommodate a full load of binders with ease. They can be mounted above or below the worksurface.
- Storage Towers provide storage without pedestals or binder bins. This allows for greater flexibility in worksurface heights and increases the viability of 54" panels.
- "Environmentally friendly" epoxy powder coat is 15 times more durable in independent testing than a wet paint spray. This helps maintain the look of the product over its many years of service.

## WARRANTIES AND PERFORMANCE

- For peace of mind over the long term, we cover you with a comprehensive warranty that is supported by our dealer network.
- We agree to make product available for a period of 20 years from the date of purchase. This product will be 100% compatible with your existing system.
- Evolve is priced well below other major "A" grade products on the market.
- Some installation companies claim that the Evolve System panels can be installed in half the time it takes to install most of our competitor's panels. This cost saving can amount to thousands of dollars over the lifetime of our furniture.
- Your assurance of consistent quality to an international standard. Evolve Systems is committed to design, manufacture and distribute superior quality office furniture, which meets or exceeds the requirements of our customers.
- Confirmation that Evolve is committed: (1) to providing product that, through their entire life cycle, minimize negative environmental impacts on the environment, (2) to continuous improvement to our environmental systems and programs and, (3) to comply to all relevant environmental legislation and regulations.
- Evolve Systems meets LEED requirements for office furniture.
- Evolve components are tested to the highest standard in the industry. This is your assurance of quality and longevity.
- On occasion, parts and pieces get missed. The run-through program is an emergency production space that we use to make items you need in a hurry.

**WOOD GRAIN (WG) LAMINATE DIRECTION**

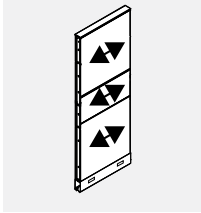

**EVP Panels**  
With Exception of 66" high monolithic panels, they are vertical.

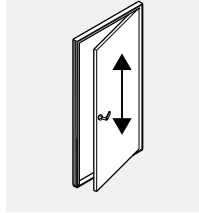

**EVPD**  
Doors.

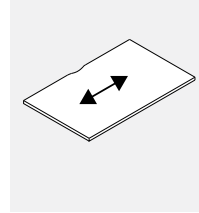

**EVWS**  
Worksurfaces.

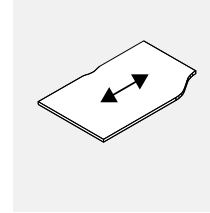

**EVWVL/R**  
Worksurfaces.

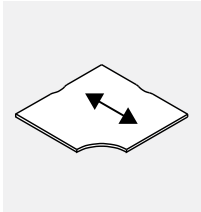

**EVWCC**  
Worksurfaces.

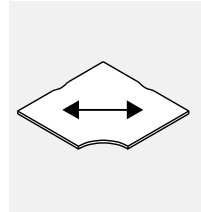

**EVWCC-WG**  
Worksurfaces.

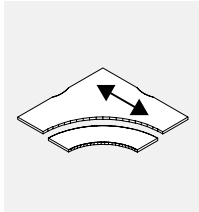

**EVWCK**  
Worksurfaces.

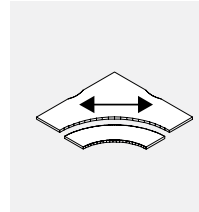

**EVWCK-WG**  
Worksurfaces.

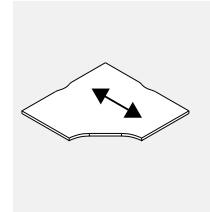

**EVWCK**  
Worksurfaces.

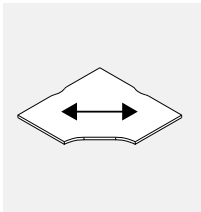

**EVWCK-WG**  
Worksurfaces.

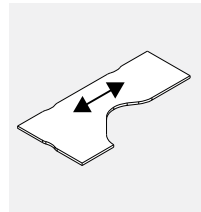

**EVWCF**  
Worksurfaces.

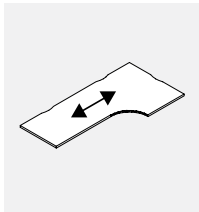

**EVWCE**  
Worksurfaces.

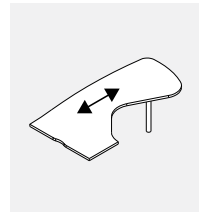

**EVWHL/R**  
Worksurfaces.

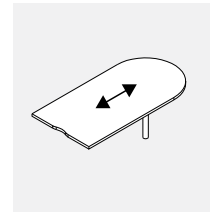

**EVWD**  
Worksurfaces.

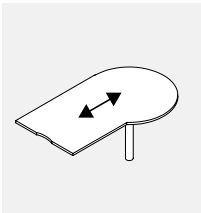

**EVWP**  
Worksurfaces.

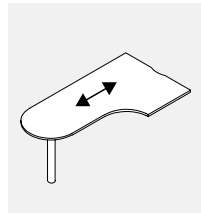

**EVWPL/R**  
Worksurfaces.

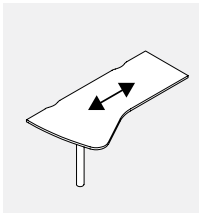

**EVWWL/R**  
Worksurfaces.

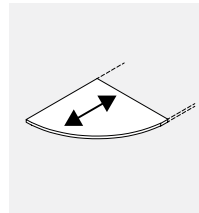

**EVQR and EVQRC**  
Worksurfaces.

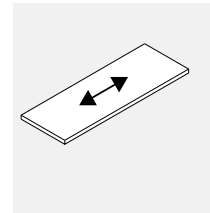

**EVWT, EVWTV, EVWTE, EVWTEV, EVWTD, EVWTDV, EVWTDG**  
Worksurfaces.

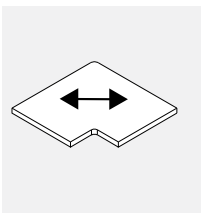

**EVWTCL-WG**  
Worksurfaces.

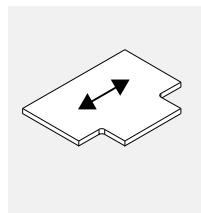

**EVWTC**  
Worksurfaces.

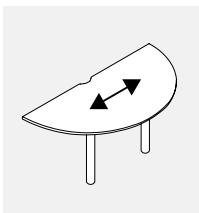

**EVWR**  
Worksurfaces.

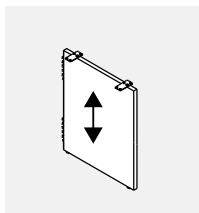

**EVHP/EVLM**  
End Panels.

WG - indicated woodgrain in cross pattern



**ORDERS**

**Each Order Must Include**

- Purchase Order
- Layout showing where the image(s) appear in the run of panels.
- A completed Price Chart, showing the location of the image(s) on each appropriate panel.

Artwork must be submitted in accordance with the following artwork specifications.

**NOTE:** Final artwork specification approval must be given before order can be processed.

**Transfer Devices**

- E-mail up to 10MB to your Evolve/Global Contract Customer Service Representative.
- Courier CD/DVD/USB stick to your Evolve/Global Contract Customer Service Representative.

**Artwork Specifications**

- Non-Photographic artwork should be vector art. Saved in Adobe Illustrator (.ai) or as an EPS (.eps)
- All bitmap or photographic artwork has to be at a minimum of 100 dpi at the full size of the panel to be printed.
- We accept Adobe CS5 files.
- Any linked files must be included or imbedded.
- Leave any PSD files un-flattened
- All fonts must be converted to outlines.
- Do not convert to CMYK, leave all images as RGB if possible
- No Word, Powerpoint, Publisher or other Microsoft files can be used.
- Include a PDF or .jpg for reference when sending native Photoshop or Illustrator format files.

**Colour Matching**

- A Pantone colour reference must be supplied or we cannot accept responsibility for correct colour or colour correction.
- When it is not possible to refer to Pantone colours, we will do our best to meet your requirements.

**Image Clarity**

- We will advise should the selected image not lend itself to the element size requested.

**NOTE:**

We reserve the right to put an order on hold when the files are found to be incomplete or when documents have been either incorrectly saved, fonts have not been converted to curves or the job appears not to be commercially acceptable.

**Image Bleed:**

- To facilitate placement on the panel. Extension of the image past the finished visible area of the panel (bleed) is required.
- Evolve Panels need a 3" bleed on all sides.

**Example of Image resolution:**

The resolution required for a 36 wide x 24 high Evolve panel at 100dpi (minimum resolution)

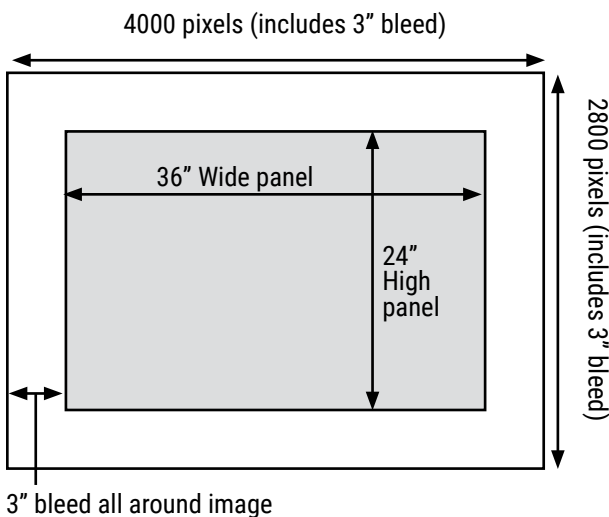

The resolution required for a 36 wide x 24 high Evolve panel at 300dpi (higher quality)

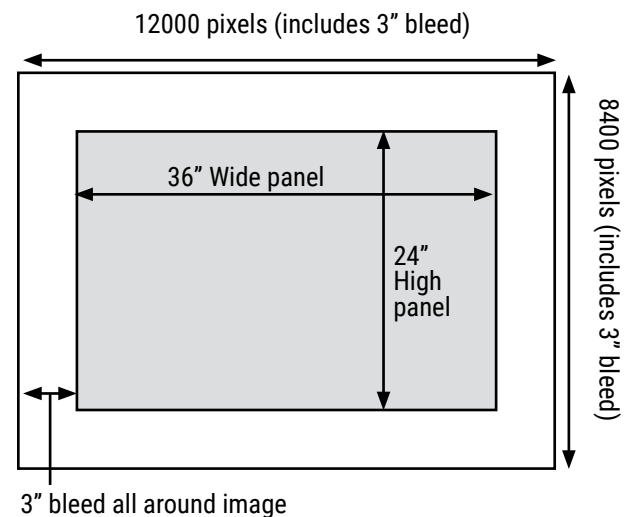

**EVOLVE SYSTEMS - GRAPHIC PANEL EXAMPLE PROCEDURE**

- STEP 1: Customer orders the following EVPFA6636 panel with;
- Bottom module inside face (24/36 size fabric) with image 01.
  - Middle module inside face (12/36 size fabric) with image 02.
  - All other fabric material is regular fabric - top module inside face and all outside module faces.

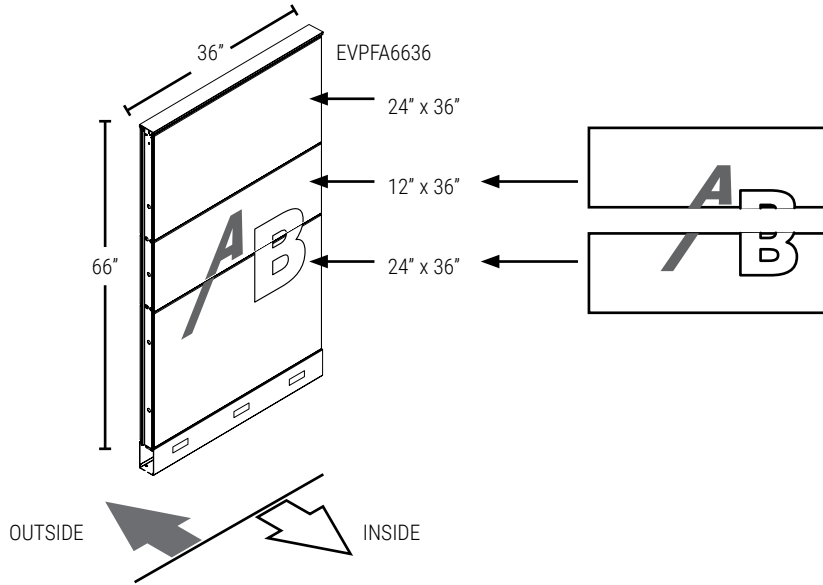

**Note: To order, please use graphic codes below**

**(A)**  
EVPGRP1236

**(B)**  
EVPGRP2436

STEP 2: On the regular panel - replace fabric pieces with corresponding graphic pieces.

STEP 3: Enter separate lines in order for the corresponding fabric image graphic pieces:

- EVPGRP1236 for the middle module inside face
- EVPGRP2436 for the bottom module inside face

**Pricing Initial Set-Up Charge per Image: \$256 net**

**Evolve 12" Modules**

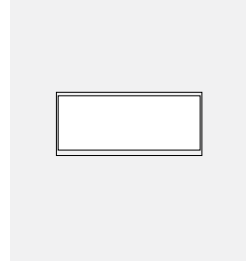

PANEL WIDTH	LIST PRICE
24"	140
30"	174
36"	211
42"	242
48"	281
54"	319
60"	355

- Applies to the following panels:
- EVPFA
  - EVPPOL
  - EVPPF
  - EVPPFO
  - EVPPF1W
  - EVPPFPO
  - EVPPF2W
  - EVPPFE12
  - EVPPF1S
  - EVPPFFE
  - EVPPF2S
  - EVPPFGT
  - EVPPFPGTU
  - EVPPFOL

**Evolve 24" Modules**

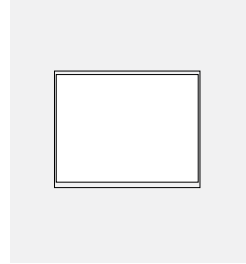

PANEL WIDTH	LIST PRICE
24"	275
30"	352
36"	420
42"	493
48"	562
54"	636
60"	704

- Applies to the following panels:
- EVPFA
  - EVPPGTX
  - EVPPF
  - EVPPFGTX
  - EVPPF1W
  - EVPPFOL
  - EVPPF2W
  - EVPPFO
  - EVPPF1S
  - EVPPFPO
  - EVPPF2S
  - EVPPFOX
  - EVPPFGT
  - EVPPFE24
  - EVPPFPGT
  - EVPPFGTU

**Evolve Monolithic Panels**

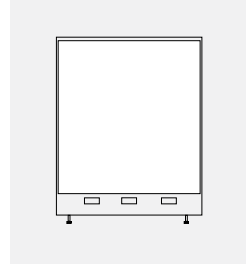

PANEL WIDTH	HEIGHT			
	42"	48"	54"	66"
24"	420	493	562	705
30"	539	633	719	901
36"	646	756	865	1080
42"	756	882	1008	1260
48"	865	1008	1151	1439
54"	970	1134	1294	1617
60"	1080	1260	1439	1799

- Applies to the following panels:
- EVPFAM

Note: Prices shown are an upcharge to the panel price, please add to the list price of panel which you are specifying the graphic for.

**PANELS • TECHNICAL INFORMATION**

- Evolve panels are 2 7/8" thick. They are available in four (5) basic heights: 30", 42", 48" and 54" and eight (8) widths: 18" to 60" in 6" increments.
- Individual fabric covered acoustic modules incorporated into a rigid steel frame.
- Opposite side of each module may have a different fabric within the same grade at no upcharge.
- If different grades of fabric are used on one panel, the entire panel must be priced at highest grade.
- A low profile top cap is included.
- No panel creep.
- All Panels, except Monolithic are composed of a 6" raceway module and a 24" high base module. Subsequent heights are created by adding either a 12" high module or a 24" high module.
- Raceway openings are 1.37 x 2.68
- 12" high and 24" high modules of all types (fabric, laminate, glass, open) are available for field installation. Contact your Customer Service Representative.
- Frosted glazing is available at an upcharge, please contact your Customer Service Representative.
- Laminate for laminate panels cannot be replaced in the field, complete module must be ordered.
- Writeboard for Writeboard panels cannot be replaced in the field, complete module must be ordered.
- Panels 18" wide have no knockout, panels 24" wide have 1 knockout, panels 30" have 2 knockouts and panels 36" to 60" have 3 knockouts.

**PANEL EXTENSION MODULES • TECHNICAL INFORMATION**

- 6", 12", 18" and 24" Panel Extension Modules attach to the top of the panel.
- Modules can be stacked to add privacy or divide space.
- Each side of a fabric module may have a different fabric within the same grade at no upcharge.
- When extension modules are used, the double or single clamp is moved to the top of the extension for panel connection.

**PANELS • GUIDELINES FOR ORDERING PRODUCT**

The price list uses a numbering system with meaningful alphanumeric characters to create a simple-to-understand product number. This makes specifying the product much easier and more accurate.

**EXAMPLE OF PANEL CODE**

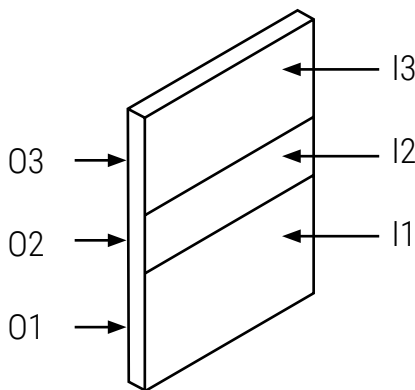
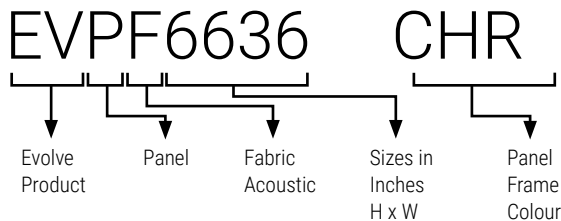

I1	AN50	Inside Fabric Position #1
I2	AN50	Inside Fabric Position #2
I3	AN50	Inside Fabric Position #3
O1	BE21	Outside Fabric Position #1
O2	BE21	Outside Fabric Position #2
O3	BE21	Outside Fabric Position #3

**HOW TO SPECIFY**

- Specify Evolve panel type and size by code.
- Specify panel frame finish - ie. CHR (Charcoal).
- Specify all necessary panel fabric options.

**NOTE: If different grades of fabric are used on one panel, the entire panel must be priced out at the higher grade.**

**EVPFA • Fabric Acoustic Panel**

- Standard panels incorporate a single 12" or 24" module or combination of 12" and 24" modules above the 30" base section. Application is based on panel height.
- 66" high panel can be configured with 12" at the top of the panel, see EVPFA66-S.

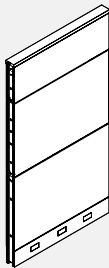
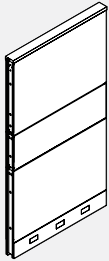
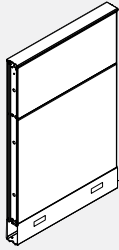

PRODUCT CODE	PRICE		SIZE/ INCHES			WEIGHT LBS	VOL FT <sup>3</sup>
	GR 1	GR 2	H	W	D		
EVPFA3018	296	308	30	18	2.875	15.38	1.23
EVPFA3024	309	326	30	24	2.875	18.20	1.63
EVPFA3030	342	361	30	30	2.875	21.76	2.00
EVPFA3036	367	389	30	36	2.875	24.80	2.38
EVPFA3042	396	421	30	42	2.875	26.49	2.76
EVPFA3048	438	468	30	48	2.875	32.00	3.13
EVPFA3054	472	505	30	54	2.875	35.31	3.51
EVPFA3060	507	546	30	60	2.875	38.20	3.89
EVPFA4218	328	344	42	18	2.875	20.58	1.71
EVPFA4224	344	371	42	24	2.875	24.60	2.31
EVPFA4230	400	430	42	30	2.875	29.35	2.81
EVPFA4236	433	468	42	36	2.875	35.60	3.38
EVPFA4242	494	532	42	42	2.875	39.29	3.92
EVPFA4248	532	576	42	48	2.875	43.20	4.45
EVPFA4254	589	638	42	54	2.875	47.52	4.98
EVPFA4260	646	700	42	60	2.875	51.60	5.52
EVPFA5418	352	374	54	18	2.875	23.98	2.19
EVPFA5424	385	418	54	24	2.875	27.80	2.94
EVPFA5430	439	476	54	30	2.875	33.15	3.62
EVPFA5436	490	534	54	36	2.875	37.40	4.31
EVPFA5442	553	607	54	42	2.875	40.69	4.99
EVPFA5448	616	674	54	48	2.875	48.20	5.67
EVPFA5454	671	736	54	54	2.875	52.92	6.35
EVPFA5460	718	790	54	60	2.875	57.40	7.03
EVPFA6618	442	472	66	18	2.875	29.98	2.68
EVPFA6624	476	520	66	24	2.875	35.00	3.58
EVPFA6630	528	576	66	30	2.875	41.54	4.40
EVPFA6636	619	677	66	36	2.875	49.00	5.23
EVPFA6642	701	767	66	42	2.875	54.29	6.06
EVPFA6648	751	825	66	48	2.875	60.20	6.08
EVPFA6654	817	899	66	54	2.875	65.93	7.70
EVPFA6660	883	972	66	60	2.875	71.60	8.53
EVPFA6618S	442	472	66	18	2.875	29.98	2.68
EVPFA6624S	476	520	66	24	2.875	35.00	3.58
EVPFA6630S	528	576	66	30	2.875	41.54	4.40
EVPFA6636S	619	675	66	36	2.875	49.00	5.23
EVPFA6642S	701	767	66	42	2.875	54.29	6.06
EVPFA6648S	751	825	66	48	2.875	60.20	6.88
EVPFA6654S	817	899	66	54	2.875	65.93	6.88
EVPFA6660S	883	972	66	60	2.875	71.60	8.53

**EVFPF • Fabric Acoustic Panel Premium**

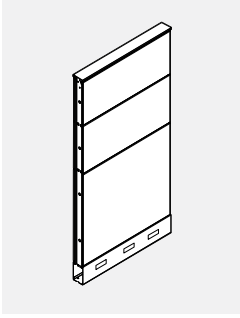

• Premium panels incorporate 12" high acoustic modules above the 30" base section.

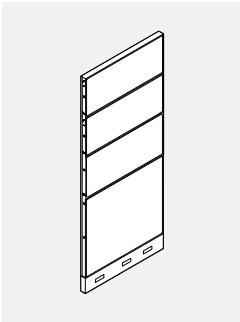

PRODUCT CODE	PRICE		SIZE/ INCHES			WEIGHT LBS	VOL FT <sup>3</sup>
	GR1	GR2	H	W	D		
EVFPF5418	410	437	54	18	2.875	26.18	2.19
EVFPF5424	438	470	54	24	2.875	31.40	2.06
EVFPF5430	484	524	54	30	2.875	37.34	2.58
EVFPF5436	572	616	54	36	2.875	46.80	3.09
EVFPF5442	642	697	54	42	2.875	52.49	3.61
EVFPF5448	686	743	54	48	2.875	54.80	4.36
EVFPF5454	733	800	54	54	2.875	60.13	6.35
EVFPF5460	774	847	54	60	2.875	65.40	5.16
EVFPF6618	521	551	66	18	2.875	32.18	2.68
EVFPF6624	557	595	66	24	2.875	38.60	3.58
EVFPF6630	616	666	66	30	2.875	45.73	4.40
EVFPF6636	725	785	66	36	2.875	58.40	5.23
EVFPF6642	818	884	66	42	2.875	66.09	6.06
EVFPF6648	879	954	66	48	2.875	66.80	6.88
EVFPF6654	956	1036	66	54	2.875	73.14	7.70
EVFPF6660	1024	1114	66	60	2.875	79.60	8.53

**EVPFAM • Fabric Acoustic Panel Monolithic**

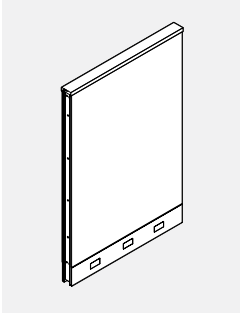

• Monolithic panels incorporate a single acoustic module within a solid rigid steel frame.

PRODUCT CODE	PRICE		SIZE/ INCHES			WEIGHT LBS	VOL FT <sup>3</sup>
	GR1	GR2	H	W	D		
EVPFAM4218	303	331	42	18	2.875	20.58	1.71
EVPFAM4224	323	358	42	24	2.875	23.40	2.31
EVPFAM4230	369	409	42	30	2.875	26.96	2.85
EVPFAM4236	396	443	42	36	2.875	30.00	3.38
EVPFAM4242	439	494	42	42	2.875	31.69	3.92
EVPFAM4248	477	539	42	48	2.875	37.20	4.45
EVPFAM4254	526	594	42	54	2.875	40.51	4.98
EVPFAM4260	572	646	42	60	2.875	43.40	5.52
EVPFAM4818	309	337	48	18	2.875	21.38	1.92
EVPFAM4824	340	373	48	24	2.875	24.40	2.62
EVPFAM4830	392	433	48	30	2.875	27.76	3.23
EVPFAM4836	426	473	48	36	2.875	30.80	3.85
EVPFAM4842	476	531	48	42	2.875	32.49	4.45
EVPFAM4848	520	579	48	48	2.875	37.80	5.06
EVPFAM4854	573	640	48	54	2.875	41.31	5.66
EVPFAM4860	622	697	48	60	2.875	44.20	6.27
EVPFAM5418	311	340	54	18	2.875	24.58	2.19
EVPFAM5424	342	377	54	24	2.875	27.40	2.94
EVPFAM5430	397	438	54	30	2.875	30.96	3.62
EVPFAM5436	442	492	54	36	2.875	34.00	4.31
EVPFAM5442	495	550	54	42	2.875	35.69	4.99
EVPFAM5448	537	601	54	48	2.875	41.20	5.67
EVPFAM5454	592	662	54	54	2.875	44.51	6.35
EVPFAM5460	647	724	54	60	2.875	47.40	7.03
EVPFAM6618	386	414	66	18	2.875	27.58	2.68
EVPFAM6624	421	457	66	24	2.875	30.40	3.58
EVPFAM6630	476	521	66	30	2.875	33.96	4.40
EVPFAM6636	553	603	66	36	2.875	37.00	5.23
EVPFAM6642	622	675	66	42	2.875	38.69	6.06
EVPFAM6648	675	737	66	48	2.875	44.20	6.88
EVPFAM6654	751	818	66	54	2.875	47.51	7.70
EVPFAM6660	826	901	66	60	2.875	50.40	8.53

**EVPH1S • Laminate Panel - One Side**

• Laminate faces on one side of all modules provide durable, washable surfaces. Opposite side is fabric.

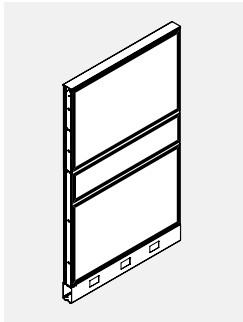
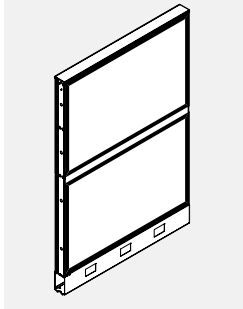

PRODUCT CODE	PRICE		SIZE/ INCHES			WEIGHT		VOL FT <sup>3</sup>
	GR 1	GR 2	H	W	D	LBS		
EVPH1S3018	353	359	30	18	2.875	15.88	1.23	
EVPH1S3024	421	430	30	24	2.875	18.70	1.63	
EVPH1S3030	494	503	30	30	2.875	22.26	2.00	
EVPH1S3036	561	574	30	36	2.875	24.85	2.58	
EVPH1S3042	637	650	30	42	2.875	26.99	2.76	
EVPH1S3048	691	703	30	48	2.875	32.05	3.13	
EVPH1S3054	767	783	30	54	2.875	35.81	3.51	
EVPH1S3060	839	857	30	60	2.875	38.07	3.89	
EVPH1S4218	419	428	42	18	2.875	21.38	1.71	
EVPH1S4224	501	513	42	24	2.875	22.13	2.31	
EVPH1S4230	585	597	42	30	2.875	30.15	2.31	
EVPH1S4236	672	692	42	36	2.875	36.40	3.38	
EVPH1S4242	761	782	42	42	2.875	40.09	3.92	
EVPH1S4248	828	851	42	48	2.875	44.00	4.45	
EVPH1S4254	921	945	42	54	2.875	48.32	4.98	
EVPH1S4260	1008	1035	42	60	2.875	52.40	5.52	
EVPH1S5418	493	505	54	18	2.875	24.98	2.19	
EVPH1S5424	594	611	54	24	2.875	28.80	2.94	
EVPH1S5430	699	718	54	30	2.875	34.15	3.62	
EVPH1S5436	800	824	54	36	2.875	38.40	4.31	
EVPH1S5442	904	931	54	42	2.875	41.69	4.99	
EVPH1S5448	988	1020	54	48	2.875	49.20	5.67	
EVPH1S5454	1099	1134	54	54	2.875	53.92	6.35	
EVPH1S5460	1209	1249	54	60	2.875	58.40	7.03	
EVPH1S6618	611	626	66	18	2.875	31.29	2.68	
EVPH1S6624	736	757	66	24	2.875	36.30	3.58	
EVPH1S6630	859	884	66	30	2.875	42.84	4.40	
EVPH1S6636	992	1021	66	36	2.875	50.30	5.23	
EVPH1S6642	1131	1162	66	42	2.875	55.59	6.06	
EVPH1S6648	1228	1265	66	48	2.875	61.50	5.23	
EVPH1S6654	1365	1406	66	54	2.875	67.23	7.70	
EVPH1S6660	1504	1553	66	60	2.875	72.90	8.53	

**EVPH2S • Laminate Panel - Two Sides**

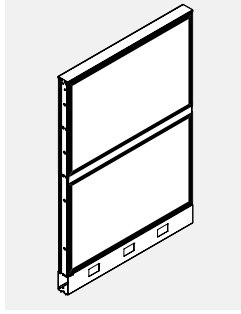

- Laminate faces on both sides of all modules provide durable, washable surfaces.

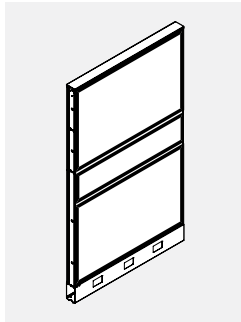

PRODUCT CODE	PRICE	SIZE/ INCHES			WEIGHT LBS	VOL FT <sup>3</sup>
		H	W	D		
EVPH2S3018	394	30	18	2.875	16.38	1.23
EVPH2S3024	481	30	24	2.875	19.20	1.63
EVPH2S3030	569	30	30	2.875	22.76	2.00
EVPH2S3036	650	30	36	2.875	25.80	2.58
EVPH2S3042	740	30	42	2.875	27.49	2.76
EVPH2S3048	827	30	48	2.875	33.00	3.35
EVPH2S3054	916	30	54	2.875	36.31	3.95
EVPH2S3060	992	30	60	2.875	39.20	4.52
EVPH2S4218	469	42	18	2.875	22.18	1.71
EVPH2S4224	569	42	24	2.875	26.20	2.31
EVPH2S4230	671	42	30	2.875	30.95	2.85
EVPH2S4236	779	42	36	2.875	37.20	3.38
EVPH2S4242	890	42	42	2.875	40.89	3.92
EVPH2S4248	996	42	48	2.875	42.80	4.45
EVPH2S4254	1096	42	54	2.875	49.12	5.52
EVPH2S4260	1196	42	60	2.875	53.20	5.52
EVPH2S5418	549	54	18	2.875	25.98	2.19
EVPH2S5424	673	54	24	2.875	29.80	2.94
EVPH2S5430	800	54	30	2.875	35.15	3.62
EVPH2S5436	927	54	36	2.875	39.40	4.31
EVPH2S5442	1058	54	42	2.875	42.69	4.99
EVPH2S5448	1195	54	48	2.875	50.20	5.67
EVPH2S5454	1313	54	54	2.875	52.92	6.35
EVPH2S5460	1430	54	60	2.875	59.40	7.03
EVPH2S6618	691	66	18	2.875	32.58	2.68
EVPH2S6624	851	66	24	2.875	37.60	3.58
EVPH2S6630	1008	66	30	2.875	44.14	4.40
EVPH2S6636	1170	66	36	2.875	51.60	5.23
EVPH2S6642	1343	66	42	2.875	56.89	6.06
EVPH2S6648	1504	66	48	2.875	62.80	6.88
EVPH2S6654	1663	66	54	2.875	68.53	7.70
EVPH2S6660	1816	66	60	2.875	74.20	8.53

**EVPF1W • Writeboard Panel - One Side**

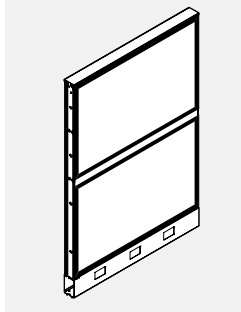

- Writing surface is built into the top module on one side of the panel, alleviating the need for a panel-mounted Writeboard.
- Use of erasable Writeboard markers only.

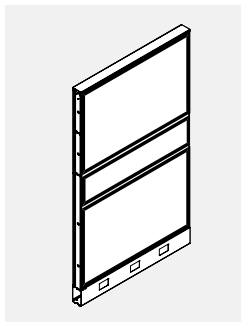

PRODUCT CODE	PRICE		SIZE/ INCHES			WEIGHT LBS	VOL FT <sup>3</sup>
	GR1	GR2	H	W	D		
EVPF1W5418	428	443	54	18	2.875	24.98	2.19
EVPF1W5424	532	558	54	24	2.875	28.80	2.94
EVPF1W5430	640	671	54	30	2.875	34.15	3.62
EVPF1W5436	710	744	54	36	2.875	38.40	4.31
EVPF1W5442	802	842	54	42	2.875	41.69	4.99
EVPF1W5448	903	947	54	48	2.875	49.20	5.67
EVPF1W5454	1005	1038	54	54	2.875	53.92	6.35
EVPF1W5460	1107	1163	54	60	2.875	58.40	7.03
EVPF1W6618	546	565	66	18	2.875	30.48	2.57
EVPF1W6624	672	703	66	24	2.875	35.50	3.58
EVPF1W6630	799	838	66	30	2.875	42.04	4.40
EVPF1W6636	889	935	66	36	2.875	49.50	5.23
EVPF1W6642	1007	1059	66	42	2.875	54.79	6.06
EVPF1W6648	1123	1184	66	48	2.875	60.70	6.88
EVPF1W6654	1252	1317	66	54	2.875	66.43	7.70
EVPF1W6660	1381	1454	66	60	2.875	72.10	8.53



**EVPF2W • Writeboard Panel - Two Side**

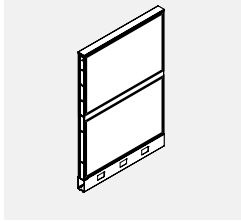

- Writing surface is built into the top module on both sides of the panel, alleviating the need for 2 panel-mounted Writeboards.
- Use of erasable Writeboard markers only.

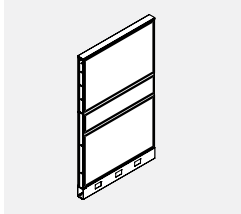

PRODUCT CODE	PRICE		SIZE/ INCHES			WEIGHT LBS	VOL FT <sup>3</sup>
	GR 1	GR 2	H	W	D		
EVPF2W5418	462	473	54	18	2.875	25.48	2.19
EVPF2W5424	579	595	54	24	2.875	29.30	2.94
EVPF2W5430	724	741	54	30	2.875	34.65	3.62
EVPF2W5436	785	809	54	36	2.875	38.90	4.31
EVPF2W5442	890	916	54	42	2.875	42.19	4.99
EVPF2W5448	1041	1071	54	48	2.875	49.70	5.67
EVPF2W5454	1161	1195	54	54	2.875	54.51	6.35
EVPF2W5460	1279	1315	54	60	2.875	58.90	7.03
EVPF2W6618	576	595	66	18	2.875	30.98	2.57
EVPF2W6624	716	740	66	24	2.875	36.00	3.58
EVPF2W6630	882	910	66	30	2.875	42.54	4.40
EVPF2W6636	963	996	66	36	2.875	50.00	5.23
EVPF2W6642	1095	1135	66	42	2.875	55.29	6.06
EVPF2W6648	1256	1301	66	48	2.875	61.20	6.88
EVPF2W6654	1400	1452	66	54	2.875	66.93	7.70
EVPF2W6660	1549	1605	66	60	2.875	72.60	8.53

**EVPF1S • Slat Wall Panel - One Sided**

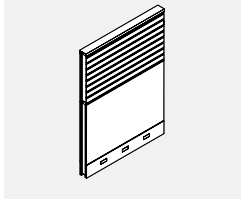

- Standard panels incorporating a single 12" or 24" module or combination of 12" and 24" modules above the 30" base section.
- Slat module is only on one side, fabric on the other.
- 66" high panel can be configured with either a 24" slat module at the top, see EVPF1S66, or a 12" slat module at the centre, see EVPF1S66M.

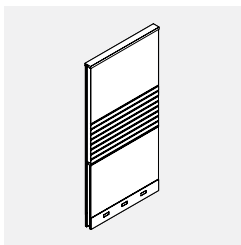
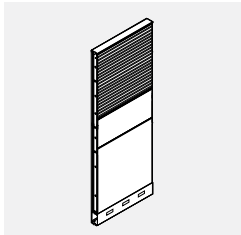
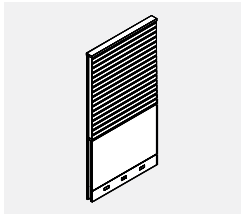

PRODUCT CODE	PRICE		SIZE/ INCHES			WEIGHT LBS	VOL FT <sup>3</sup>
	GR 1	GR 2	H	W	D		
EVPF1S4218	372	387	42	18	2.875	13.50	1.71
EVPF1S4224	407	428	42	24	2.875	33.50	2.31
EVPF1S4230	476	502	42	30	2.875	45.50	2.85
EVPF1S4236	526	556	42	36	2.875	49.50	3.38
EVPF1S4242	607	639	42	42	2.875	54.50	3.92
EVPF1S4248	651	690	42	48	2.875	60.50	4.47
EVPF1S4254	725	765	42	54	2.875	67.50	4.98
EVPF1S4260	795	840	42	60	2.875	74.50	5.52
EVPF1S5418	450	470	54	18	2.875	36.50	2.19
EVPF1S5424	512	536	54	24	2.875	36.40	2.94
EVPF1S5430	594	624	54	30	2.875	40.40	3.62
EVPF1S5436	674	710	54	36	2.875	44.40	4.31
EVPF1S5442	767	806	54	42	2.875	46.40	5.67
EVPF1S5448	858	902	54	48	2.875	48.40	5.67
EVPF1S5454	941	991	54	54	2.875	50.00	6.35
EVPF1S5460	1019	1074	54	60	2.875	52.40	7.03
EVPF1S6618	545	567	66	18	2.875	42.00	2.57
EVPF1S6624	605	637	66	24	2.875	48.00	3.58
EVPF1S6630	684	724	66	30	2.875	50.00	4.40
EVPF1S6636	805	853	66	36	2.875	54.00	5.23
EVPF1S6642	911	966	66	42	2.875	60.00	6.06
EVPF1S6648	992	1052	66	48	2.875	67.00	6.88
EVPF1S6654	1086	1152	66	54	2.875	80.00	7.07
EVPF1S6660	1181	1254	66	60	2.875	86.00	8.53
EVPF1S6618M	488	518	66	18	2.875	42.00	2.57
EVPF1S6624M	537	575	66	24	2.875	48.00	3.58
EVPF1S6630M	605	649	66	30	2.875	50.00	4.40
EVPF1S6636M	713	765	66	36	2.875	54.00	5.23
EVPF1S6642M	811	870	66	42	2.875	60.00	6.06
EVPF1S6648M	870	938	66	48	2.875	67.00	6.88
EVPF1S6654M	954	1029	66	54	2.875	80.00	7.70
EVPF1S6660M	1032	1114	66	60	2.875	86.00	8.53

**EVVPF2S • Slat Wall Module Panel - Two Sided**

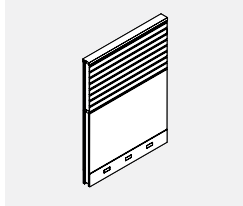

- Standard panels incorporating a single 12" or 24" module or combination of 12" and 24" modules above the 30" base section.
- Slat module is only on both sides.
- 66" high panel can be configured with either a 24" slat module at the top, see EVVPF2S66, or a 12" slat module at the centre, see EVVPF2S66-M.

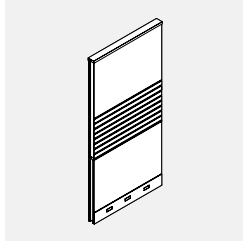
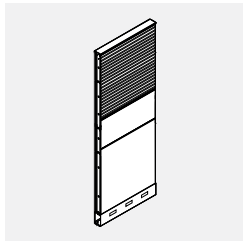
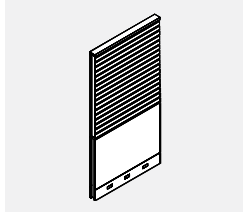

PRODUCT CODE	PRICE		SIZE/ INCHES			WEIGHT LBS	VOL FT <sup>3</sup>
	GR1	GR2	H	W	D		
EVVPF2S4218	399	413	42	18	2.875	16.50	1.71
EVVPF2S4224	446	463	42	24	2.875	36.50	2.31
EVVPF2S4230	527	547	42	30	2.875	48.50	2.85
EVVPF2S4236	586	609	42	36	2.875	52.50	3.38
EVVPF2S4242	674	701	42	42	2.875	57.50	3.92
EVVPF2S4248	733	763	42	48	2.875	63.50	4.47
EVVPF2S4254	817	851	42	54	2.875	70.50	4.98
EVVPF2S4260	895	932	42	60	2.875	77.50	5.52
EVVPF2S5418	526	537	54	18	2.875	38.50	2.19
EVVPF2S5424	613	630	54	24	2.875	44.40	2.94
EVVPF2S5430	722	739	54	30	2.875	46.40	3.62
EVVPF2S5436	827	851	54	36	2.875	48.40	4.31
EVVPF2S5442	945	971	54	42	2.875	50.40	4.99
EVVPF2S5448	1063	1095	54	48	2.875	52.40	5.67
EVVPF2S5454	1170	1203	54	54	2.875	54.40	6.35
EVVPF2S5460	1277	1313	54	60	2.875	56.40	7.03
EVVPF2S6618	616	636	66	18	2.875	45.00	2.57
EVVPF2S6624	704	730	66	24	2.875	51.00	3.58
EVVPF2S6630	811	840	66	30	2.875	53.00	4.40
EVVPF2S6636	957	993	66	36	2.875	57.00	5.23
EVVPF2S6642	1092	1133	66	42	2.875	63.00	6.06
EVVPF2S6648	1198	1242	66	48	2.875	70.40	6.88
EVVPF2S6654	1318	1368	66	54	2.875	83.40	7.70
EVVPF2S6660	1439	1495	66	60	2.875	89.40	8.53
EVVPF2S6618M	519	541	66	18	2.875	45.00	2.57
EVVPF2S6624M	576	609	66	24	2.875	51.00	3.58
EVVPF2S6630M	652	693	66	30	2.875	53.00	4.40
EVVPF2S6636M	774	821	66	36	2.875	57.00	5.23
EVVPF2S6642M	882	934	66	42	2.875	63.00	6.06
EVVPF2S6648M	949	1010	66	48	2.875	70.40	6.88
EVVPF2S6654M	1043	1110	66	54	2.875	83.40	7.70
EVVPF2S6660M	1134	1205	66	60	2.875	89.40	8.53

**EVVPF2S-F • Frameless Slat Wall Module Panel - Two Sided**

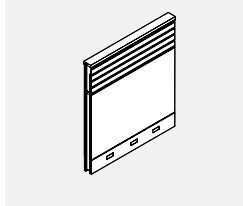

- Slat Wall is manufactured with 2 snap-in sections.
- Accessories can be hung on Slat Wall. Please see accessories section for additional details.
- For 42" H Slat Wall Panel only Aluminum Top Trim can be used. Aluminum Top Trim is included.
- Stackability: Evolve panels can be increased in height in 6", 12" and 24" increments. See module listing for part numbers.

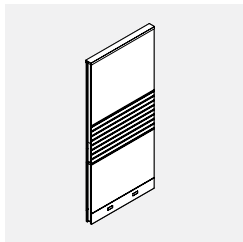
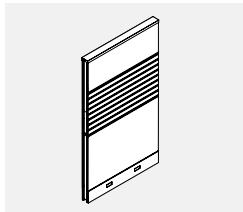

PRODUCT CODE	PRICE		SIZE/ INCHES			WEIGHT LBS	VOL FT <sup>3</sup>
	GR1	GR2	H	W	D		
EVVPF2S4224F	400	418	42	24	2.875	33.50	2.31
EVVPF2S4230F	471	492	42	30	2.875	45.50	2.81
EVVPF2S4236F	550	573	42	36	2.875	49.50	3.38
EVVPF2S4242F	622	649	42	42	2.875	54.50	3.92
EVVPF2S4248F	690	719	42	48	2.875	60.50	4.45
EVVPF2S4254F	762	796	42	54	2.875	67.50	4.98
EVVPF2S4260F	840	877	42	60	2.875	74.50	5.52
EVVPF2S5424F	547	572	54	24	2.875	36.40	2.94
EVVPF2S5430F	639	669	54	30	2.875	40.40	3.62
EVVPF2S5436F	741	778	54	36	2.875	44.40	4.31
EVVPF2S5442F	842	882	54	42	2.875	46.60	4.99
EVVPF2S5448F	934	978	54	48	2.875	48.40	5.67
EVVPF2S5454F	1058	1109	54	54	2.875	50.40	6.35
EVVPF2S5460F	1139	1196	54	60	2.875	52.40	7.03
EVVPF2S6624F	605	637	66	24	2.875	48.00	3.58
EVVPF2S6630F	705	748	66	30	2.875	50.00	4.40
EVVPF2S6636F	835	882	66	36	2.875	54.00	5.23
EVVPF2S6642F	938	992	66	42	2.875	60.00	6.06
EVVPF2S6648F	1038	1099	66	48	2.875	67.00	6.08
EVVPF2S6654F	1143	1208	66	54	2.875	80.00	7.70
EVVPF2S6660F	1256	1329	66	60	2.875	86.00	8.53

**EVPFGT • Fabric Glazed Panel - Tempered Glass**

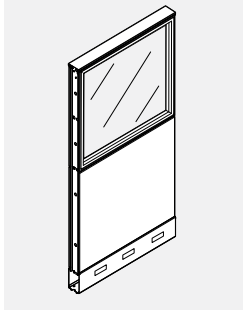

- Fabric Glazed Panel consists of individual fabric covered acoustic module in lower position(s) with one 12" or 24" glazed module in upper position.
- Glazing is replaceable on site.

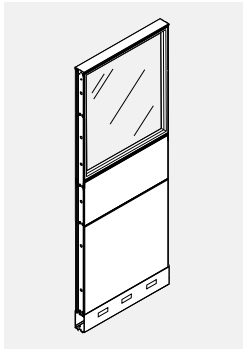

PRODUCT CODE	PRICE		SIZE/ INCHES			WEIGHT		VOL FT <sup>3</sup>
	GR1	GR2	H	W	D	LBS		
EVPFGT4218	394	407	42	18	2.875	23.96	1.71	
EVPFGT4224	464	480	42	24	2.875	28.98	2.31	
EVPFGT4230	526	546	42	30	2.875	34.62	2.85	
EVPFGT4236	591	615	42	36	2.875	39.76	3.38	
EVPFGT4242	653	679	42	42	2.875	43.45	3.92	
EVPFGT4248	715	744	42	48	2.875	51.56	4.45	
EVPFGT4254	802	837	42	54	2.875	56.87	4.98	
EVPFGT4260	884	921	42	60	2.875	61.95	5.52	
EVPFGT5418	435	446	54	18	2.875	28.25	2.19	
EVPFGT5424	505	523	54	24	2.875	34.76	2.94	
EVPFGT5430	587	607	54	30	2.875	41.80	3.62	
EVPFGT5436	668	692	54	36	2.875	48.34	4.31	
EVPFGT5442	748	773	54	42	2.875	53.12	4.99	
EVPFGT5448	816	845	54	48	2.875	62.11	5.67	
EVPFGT5454	945	978	54	54	2.875	68.42	6.35	
EVPFGT5460	1074	1110	54	60	2.875	74.49	7.03	
EVPFGT6618	552	572	66	18	2.875	34.25	2.68	
EVPFGT6624	641	668	66	24	2.875	41.96	3.58	
EVPFGT6630	741	771	66	30	2.875	50.19	4.40	
EVPFGT6636	845	882	66	36	2.875	59.94	5.23	
EVPFGT6642	955	994	66	42	2.875	66.72	6.06	
EVPFGT6648	1034	1081	66	48	2.875	74.11	6.88	
EVPFGT6654	1190	1239	66	54	2.875	81.43	7.70	
EVPFGT6660	1349	1403	66	60	2.875	88.69	8.53	

**EVFPFGT • Fabric Glazed Panel Premium - Tempered Glass**

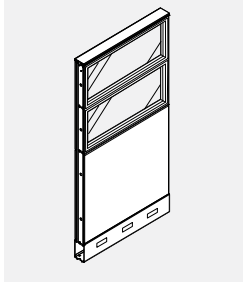

- Fabric Glazed Panel consists of individual fabric covered acoustic module in lower position with 2 or 3 glazed modules in upper position.
- Glazing is replaceable on site.

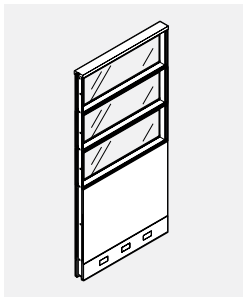

PRODUCT CODE	PRICE		SIZE/ INCHES			WEIGHT		VOL FT <sup>3</sup>
	GR1	GR2	H	W	D	LBS		
EVFPFGT5418	526	537	54	18	2.875	32.95	2.19	
EVFPFGT5424	633	649	54	24	2.875	40.16	2.06	
EVFPFGT5430	705	727	54	30	2.875	47.89	2.58	
EVFPFGT5436	785	807	54	36	2.875	55.14	3.09	
EVFPFGT5442	872	902	54	42	2.875	60.82	3.61	
EVFPFGT5448	959	992	54	48	2.875	71.78	4.36	
EVFPFGT5454	1075	1109	54	54	2.875	78.83	6.35	
EVFPFGT5460	1188	1225	54	60	2.875	86.09	5.16	
EVFPFGT6618	658	671	66	18	2.875	42.33	2.68	
EVFPFGT6624	793	811	66	24	2.875	51.74	3.58	
EVFPFGT6630	889	909	66	30	2.875	61.55	5.23	
EVFPFGT6636	982	1005	66	36	2.875	70.90	5.23	
EVFPFGT6642	1095	1121	66	42	2.875	78.58	6.06	
EVFPFGT6648	1205	1236	66	48	2.875	91.87	6.88	
EVFPFGT6654	1364	1396	66	54	2.875	101.20	6.88	
EVFPFGT6660	1522	1560	66	60	2.875	110.64	6.30	

**EVPFGTU • Fabric 12" Glazed Panel - Tempered Glass**

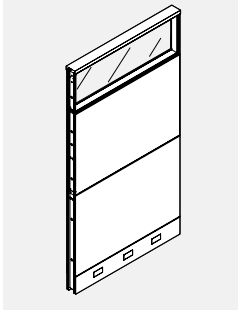

- Fabric 12" Glazed Panel incorporates one 12" glazed module and one 24" fabric modules above the 30" base section.
- Glazing is replaceable on site.

PRODUCT CODE	PRICE		SIZE/ INCHES			WEIGHT LBS	VOL FT <sup>3</sup>
	GR1	GR2	H	W	D		
EVPFGTU6618	556	579	66	18	2.875	33.36	2.68
EVPFGTU6624	650	681	66	24	2.875	39.38	3.58
EVPFGTU6630	741	782	66	30	2.875	46.81	4.40
EVPFGTU6636	835	882	66	36	2.875	53.17	5.23
EVPFGTU6642	938	992	66	42	2.875	58.45	6.06
EVPFGTU6648	1021	1081	66	48	2.875	68.56	6.88
EVPFGTU6654	1139	1203	66	54	2.875	75.28	7.70
EVPFGTU6660	1256	1329	66	60	2.875	81.95	8.53

**EVFPFGTU • Fabric 12" Glazed Panel Premium - Tempered Glass**

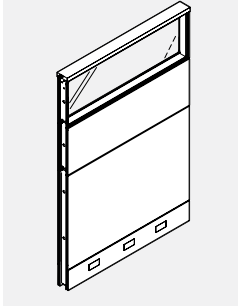

- Premium Fabric 12" Glazed Panel incorporates one 12" glazed module and 1 or 2 12" fabric module or 2 fabric modules above a 30" base section.
- Glazing is replaceable on site.

PRODUCT CODE	PRICE		SIZE/ INCHES			WEIGHT LBS	VOL FT <sup>3</sup>
	GR1	GR2	H	W	D		
EVFPFGTU5418	509	530	54	18	2.875	29.56	2.19
EVFPFGTU5424	603	626	54	24	2.875	35.78	2.06
EVFPFGTU5430	679	710	54	30	2.875	42.61	2.58
EVFPFGTU5436	768	803	54	36	2.875	50.97	3.09
EVFPFGTU5442	860	902	54	42	2.875	56.65	3.61
EVFPFGTU5448	934	978	54	48	2.875	63.16	4.36
EVFPFGTU5454	1048	1096	54	54	2.875	69.48	7.70
EVFPFGTU5460	1162	1218	54	60	2.875	75.75	5.16
EVFPFGTU6618	633	656	66	18	2.875	35.56	2.68
EVFPFGTU6624	739	771	66	24	2.875	42.98	3.58
EVFPFGTU6630	839	879	66	30	2.875	51.00	4.38
EVFPFGTU6636	945	993	66	36	2.875	62.56	5.23
EVFPFGTU6642	1069	1121	66	42	2.875	70.25	6.06
EVFPFGTU6648	1153	1214	66	48	2.875	75.16	7.23
EVFPFGTU6654	1291	1360	66	54	2.875	82.50	7.70
EVFPFGTU6660	1432	1505	66	60	2.875	82.95	6.30

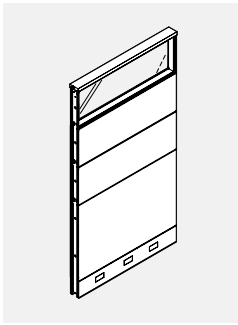

**EVPMGTU • Monolithic 12" Glazed Panel - Tempered Glass**

- Monolithic 12" Glazed Panel incorporates one 12" glazed module at the top of an otherwise Monolithic Panel.
- Glazing is replaceable on site.

PRODUCT CODE	PRICE		SIZE/ INCHES			WEIGHT LBS	VOL FT <sup>3</sup>
	GR1	GR2	H	W	D		
EVPMGTU4818	450	474	48	18	2.875	26.96	1.92
EVPMGTU4824	527	562	48	24	2.875	31.98	2.62
EVPMGTU4830	613	653	48	30	2.875	37.62	3.23
EVPMGTU4836	703	754	48	36	2.875	42.77	3.85
EVPMGTU4842	778	831	48	42	2.875	46.45	4.45
EVPMGTU4848	847	909	48	48	2.875	54.45	5.06
EVPMGTU4854	941	1005	48	54	2.875	59.87	5.66
EVPMGTU4860	1032	1109	48	60	2.875	67.15	6.27
EVPMGTU5418	464	493	54	18	2.875	29.56	2.19
EVPMGTU5424	539	575	54	24	2.875	34.58	2.94
EVPMGTU5430	616	686	54	30	2.875	40.22	3.62
EVPMGTU5436	686	781	54	36	2.875	45.37	4.31
EVPMGTU5442	768	815	54	42	2.875	49.05	4.99
EVPMGTU5448	847	963	54	48	2.875	57.16	5.67
EVPMGTU5454	927	1056	54	54	2.875	62.47	6.32
EVPMGTU5460	1007	1153	54	60	2.875	67.55	7.03
EVPMGTU6618	497	525	66	18	2.875	33.96	2.68
EVPMGTU6624	596	634	66	24	2.875	38.98	3.58
EVPMGTU6630	686	727	66	30	2.875	44.62	4.40
EVPMGTU6636	760	807	66	36	2.875	49.77	5.23
EVPMGTU6642	845	902	66	42	2.875	53.45	6.06
EVPMGTU6648	934	996	66	48	2.875	61.16	6.88
EVPMGTU6654	1024	1092	66	54	2.875	66.87	6.88
EVPMGTU6660	1111	1188	66	60	2.875	71.95	8.53

**EVPFGTX • Fabric 36" Glazed Panel - Tempered Glass**

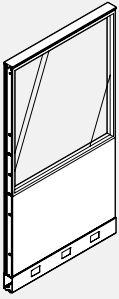

- Fabric 36" Glazed Panel incorporates one 36" glazed module above the 30" base section.
- Glazing is replaceable on site.

PRODUCT CODE	PRICE		SIZE/ INCHES			WEIGHT		VOL FT <sup>3</sup>
	GR 1	GR 2	H	W	D	LBS		
EVPFGTX6618	639	652	66	18	2.875	35.45	4.23	
EVPFGTX6624	706	725	66	24	2.875	42.54	5.23	
EVPFGTX6630	820	839	66	30	2.875	50.15	6.23	
EVPFGTX6636	932	956	66	36	2.875	57.26	6.23	
EVPFGTX6642	1043	1070	66	42	2.875	63.02	6.56	
EVPFGTX6648	1141	1173	66	48	2.875	72.99	6.88	
EVPFGTX6654	1256	1289	66	54	2.875	80.28	7.70	
EVPFGTX6660	1370	1406	66	60	2.875	87.32	8.53	

**EVPXGT • Fully Glazed Monolithic Panel - Tempered Glass**

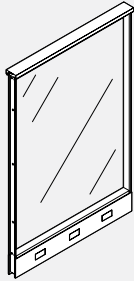

- Fully Glazed Monolithic Panel incorporates one glazed module into a rigid steel frame.
- Glazing is replaceable on site.

PRODUCT CODE	PRICE	SIZE/ INCHES			WEIGHT		VOL FT <sup>3</sup>
		H	W	D	LBS		
EVPXGT4218	421	42	18	2.875	26.05	1.71	
EVPXGT4224	464	42	24	2.875	32.14	2.31	
EVPXGT4230	539	42	30	2.875	37.96	3.11	
EVPXGT4236	609	42	36	2.875	43.86	3.46	
EVPXGT4242	677	42	42	2.875	48.02	4.46	
EVPXGT4818	374	48	18	2.875	29.02	1.92	
EVPXGT4824	481	48	24	2.875	35.61	2.62	
EVPXGT4830	534	48	30	2.875	41.93	3.23	
EVPXGT4836	658	48	36	2.875	48.33	3.85	
EVPXGT4842	691	48	42	2.875	52.98	4.45	
EVPXGT5418	469	54	18	2.875	31.60	2.19	
EVPXGT5424	550	54	24	2.875	37.60	2.58	
EVPXGT5430	638	54	30	2.875	45.48	3.29	
EVPXGT5436	718	54	36	2.875	52.39	4.58	
EVPXGT5442	800	54	42	2.875	57.54	5.58	
EVPXGT6618	549	66	18	2.875	37.54	2.68	
EVPXGT6624	636	66	24	2.875	45.61	3.58	
EVPXGT6630	736	66	30	2.875	53.43	3.99	
EVPXGT6636	826	66	36	2.875	61.32	4.58	
EVPXGT6642	921	66	42	2.875	67.46	5.58	

**EVPGPT • Fully Glazed Premium Panel - Tempered Glass**

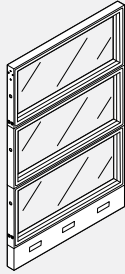

- Fully Glazed Premium Panel incorporates all 12" glazed modules above the 6" base raceway channel.
- Glazing is replaceable on site.

PRODUCT CODE	PRICE	SIZE/ INCHES			WEIGHT		VOL FT <sup>3</sup>
		H	W	D	LBS		
EVPGPT4218	590	42	18	2.875	32.13	1.71	
EVPGPT4224	722	42	24	2.875	39.74	2.31	
EVPGPT4230	802	42	30	2.875	47.56	2.85	
EVPGPT4236	872	42	36	2.875	50.90	3.38	
EVPGPT4242	970	42	42	2.875	54.98	3.92	
EVPGPT4248	1077	42	48	2.875	72.27	4.45	
EVPGPT4254	1189	42	54	2.875	70.89	4.98	
EVPGPT4260	1294	42	60	2.875	87.44	5.52	
EVPGPT5418	750	54	18	2.875	35.19	2.19	
EVPGPT5424	921	54	24	2.875	49.76	2.58	
EVPGPT5430	1019	54	30	2.875	52.08	3.62	
EVPGPT5436	1109	54	36	2.875	64.54	4.31	
EVPGPT5442	1230	54	42	2.875	72.62	4.99	
EVPGPT5448	1374	54	48	2.875	78.11	5.67	
EVPGPT5454	1515	54	54	2.875	86.04	6.35	
EVPGPT5460	1650	54	60	2.875	94.09	7.03	
EVPGPT6618	909	66	18	2.875	41.15	2.68	
EVPGPT6624	1115	66	24	2.875	50.96	3.58	
EVPGPT6630	1232	66	30	2.875	60.47	3.58	
EVPGPT6636	1345	66	36	2.875	76.14	4.58	
EVPGPT6642	1494	66	42	2.875	86.22	6.06	
EVPGPT6648	1664	66	48	2.875	90.11	6.88	
EVPGPT6654	1836	66	54	2.875	99.05	7.70	
EVPGPT6660	2003	66	60	2.875	108.29	8.53	

**EVPGT • Fully Glazed Panel - Tempered Glass**

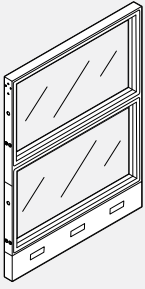

- 54" H Fully Glazed Panels incorporates two 24" Glazed modules.
- Stackability: Evolve Panels can be increased in height in 6", 12" of 24" increments.
- See Extension Module listings for part numbers.
- Standard in clear (CLR)
- Frosted Glass (FRST) upcharge varies. Contact EVOLVE Customer Support for details.
- Glazing is replaceable on site.

PRODUCT CODE	PRICE	SIZE/ INCHES			WEIGHT LBS	VOL FT <sup>3</sup>
		H	W	D		
EVPGT5418	601	54	18	2.875	35.19	2.19
EVPGT5424	736	54	24	2.875	49.76	2.58
EVPGT5430	813	54	30	2.875	52.08	3.62
EVPGT5436	889	54	36	2.875	64.54	4.31
EVPGT5442	986	54	42	2.875	72.62	4.99
EVPGT5448	1099	54	48	2.875	78.11	5.67
EVPGT5454	1209	54	54	2.875	86.04	6.35
EVPGT5460	1320	54	60	2.875	94.09	7.03

**EVPFOL • Open Bottom Panel**

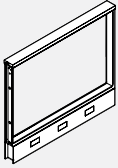

- Open Bottom Panel incorporates a 24" opening in the base section to provide maximum air circulation and access to electrical or data panels.

PRODUCT CODE	PRICE		SIZE/ INCHES			WEIGHT LBS	VOL FT <sup>3</sup>
	GR1	GR2	H	W	D		
EVPFOL3018	229	-	30	18	2.875	17.08	1.23
EVPFOL3024	262	-	30	24	2.875	19.20	1.63
EVPFOL3030	297	-	30	30	2.875	23.05	2.00
EVPFOL3036	329	-	30	36	2.875	25.80	2.38
EVPFOL3042	360	-	30	42	2.875	27.99	2.76
EVPFOL3048	387	-	30	48	2.875	34.00	3.13
EVPFOL3054	420	-	30	54	2.875	37.71	3.51
EVPFOL3060	450	-	30	60	2.875	41.00	3.89
EVPFOL4218	344	354	42	18	2.875	22.28	1.71
EVPFOL4224	397	406	42	24	2.875	25.60	2.31
EVPFOL4230	450	462	42	30	2.875	30.65	2.85
EVPFOL4236	505	519	42	36	2.875	36.60	3.38
EVPFOL4242	562	575	42	42	2.875	40.79	3.92
EVPFOL4248	607	620	42	48	2.875	45.20	4.45
EVPFOL4254	667	684	42	54	2.875	49.92	4.98
EVPFOL4260	722	739	42	60	2.875	54.40	5.52
EVPFOL5418	392	405	54	18	2.875	25.68	2.19
EVPFOL5424	447	464	54	24	2.875	28.80	2.94
EVPFOL5430	509	530	54	30	2.875	34.45	3.24
EVPFOL5436	574	596	54	36	2.875	38.40	4.31
EVPFOL5442	639	667	54	42	2.875	42.19	4.99
EVPFOL5448	691	722	54	48	2.875	50.20	5.67
EVPFOL5454	757	790	54	54	2.875	55.32	6.35
EVPFOL5460	821	858	54	60	2.875	60.20	7.03
EVPFOL6618	508	528	66	18	2.875	31.68	2.68
EVPFOL6624	585	609	66	24	2.875	36.00	3.58
EVPFOL6630	671	700	66	30	2.875	42.84	4.40
EVPFOL6636	752	787	66	36	2.875	50.00	5.23
EVPFOL6642	845	886	66	42	2.875	55.79	6.06
EVPFOL6648	909	955	66	48	2.875	62.20	6.88
EVPFOL6654	1003	1054	66	54	2.875	68.33	7.70
EVPFOL6660	1095	1151	66	60	2.875	74.40	8.53

**EVPFPOL • Open Bottom Panel Premium**

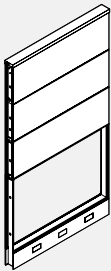

- Open Bottom Premium Panel incorporates a 24" opening in the base section to provide maximum air circulation and access to electrical or data panels.
- 12" high acoustic modules incorporated above the 30" base section.

PRODUCT CODE	PRICE		SIZE/ INCHES			WEIGHT LBS	VOL FT <sup>3</sup>
	GR1	GR2	H	W	D		
EVPFPOL5418	462	473	54	18	2.875	27.88	2.19
EVPFPOL5424	532	551	54	24	2.875	32.40	2.94
EVPFPOL5430	608	628	54	30	2.875	38.64	3.24
EVPFPOL5436	681	704	54	36	2.875	47.80	4.31
EVPFPOL5442	769	796	54	42	2.875	53.99	4.99
EVPFPOL5448	825	856	54	48	2.875	56.80	5.67
EVPFPOL5454	910	944	54	54	2.875	62.53	6.35
EVPFPOL5460	994	1031	54	60	2.875	68.20	7.03
EVPFPOL6618	579	597	66	18	2.875	33.88	1.84
EVPFPOL6624	672	697	66	24	2.875	39.60	2.52
EVPFPOL6630	763	795	66	30	2.875	47.03	3.15
EVPFPOL6636	862	898	66	36	2.875	59.40	5.23
EVPFPOL6642	972	1013	66	42	2.875	67.59	4.41
EVPFPOL6648	1042	1088	66	48	2.875	68.80	6.06
EVPFPOL6654	1159	1207	66	54	2.875	75.54	7.70
EVPFPOL6660	1266	1322	66	60	2.875	82.40	6.30

**EVPF0 • Fabric Open Panel 12" Opening**

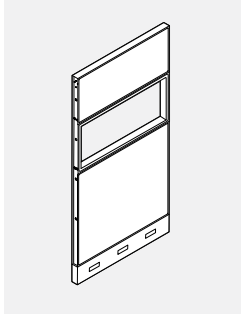

- Fabric Open Panel incorporates a 12" opening above the 30" base section to provide pass-through convenience.

PRODUCT CODE	PRICE		SIZE/ INCHES			WEIGHT		VOL FT <sup>3</sup>
	GR 1	GR 2	H	W	D	LBS		
EVPF05418	470	490	54	18	2.875	26.58	2.19	
EVPF05424	547	572	54	24	2.875	31.80	2.94	
EVPF05430	634	662	54	30	2.875	37.64	3.38	
EVPF05436	715	751	54	36	2.875	45.00	4.31	
EVPF05442	806	845	54	42	2.875	49.69	4.99	
EVPF05448	869	915	54	48	2.875	55.20	5.67	
EVPF05454	965	1013	54	54	2.875	60.53	6.35	
EVPF05460	1057	1113	54	60	2.875	65.80	7.03	
EVPF06618	520	545	66	18	2.875	30.38	2.68	
EVPF06624	601	634	66	24	2.875	35.40	3.58	
EVPF06630	688	726	66	30	2.875	41.84	5.86	
EVPF06636	785	831	66	36	2.875	47.20	5.23	
EVPF06642	883	935	66	42	2.875	51.49	6.06	
EVPF06648	956	1016	66	48	2.875	60.60	6.88	
EVPF06654	1058	1123	66	54	2.875	66.33	7.70	
EVPF06660	1161	1232	66	60	2.875	72.00	8.53	

**EVPFPO • Fabric Open Premium Panel 12" Opening**

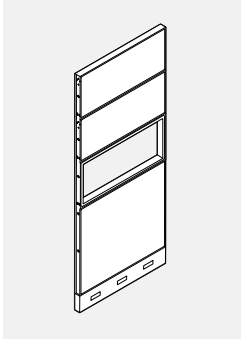

- Fabric Open Premium Panel incorporates a 12" opening above the 30" base section to provide pass-through convenience.
- Two 12" fabric acoustic modules are placed above the 12" opening.

PRODUCT CODE	PRICE		SIZE/ INCHES			WEIGHT		VOL FT <sup>3</sup>
	GR 1	GR 2	H	W	D	LBS		
EVPFPO6618	589	613	66	18	2.875	32.58	1.84	
EVPFPO6624	681	715	66	24	2.875	39.00	3.58	
EVPFPO6630	787	826	66	30	2.875	46.03	4.47	
EVPFPO6636	890	935	66	36	2.875	56.60	5.23	
EVPFPO6642	1011	1063	66	42	2.875	63.29	6.06	
EVPFPO6648	1089	1148	66	48	2.875	67.20	6.88	
EVPFPO6654	1209	1277	66	54	2.875	73.54	7.70	
EVPFPO6660	1329	1401	66	60	2.875	80.00	8.53	

**EVPF0X • Fabric Open Premium Panel 24" Opening**

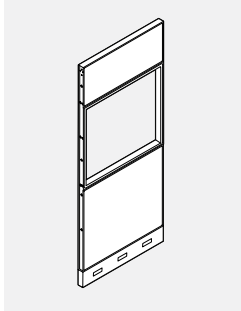

- Fabric Open Premium Panel incorporates a 24" opening above the 30" base section to provide pass-through convenience.
- May or may not have a 12" fabric acoustic module above the 24" opening.

PRODUCT CODE	PRICE		SIZE/ INCHES			WEIGHT		VOL FT <sup>3</sup>
	GR 1	GR 2	H	W	D	LBS		
EVPF0X5418	392	405	54	18	2.875	25.68	2.19	
EVPF0X5424	447	464	54	24	2.875	28.80	2.94	
EVPF0X5430	509	530	54	30	2.875	34.45	3.38	
EVPF0X5436	574	596	54	36	2.875	38.40	4.31	
EVPF0X5442	638	666	54	42	2.875	42.19	4.99	
EVPF0X5448	688	718	54	48	2.875	50.20	5.67	
EVPF0X5454	756	789	54	54	2.875	55.32	6.35	
EVPF0X5460	821	858	54	60	2.875	60.20	7.03	
EVPF0X6618	508	528	66	18	2.875	31.68	2.68	
EVPF0X6624	585	609	66	24	2.875	36.00	3.58	
EVPF0X6630	688	716	66	30	2.875	42.84	5.86	
EVPF0X6636	752	787	66	36	2.875	50.00	5.23	
EVPF0X6642	845	886	66	42	2.875	55.79	6.06	
EVPF0X6648	909	955	66	48	2.875	62.20	6.88	
EVPF0X6654	1003	1054	66	54	2.875	68.33	7.70	
EVPF0X6660	1095	1151	66	60	2.875	74.40	8.53	

**EVPFSG5M66 - Reception Panels, 24" Fabric Bottom Module and 6" Pass Thru**

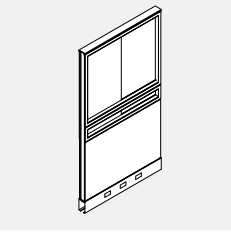

- Reception panel incorporates glazed tempered glass module and pass thru module within steel frame.
- 6" pass thru with sliding tempered glass door module.
- 24" fabric bottom module.
- Aluminum low profile top is included.
- Stackability: Evolve panels can be increased in height in 6", 12", 24" increments. See module listing for part numbers.

PRODUCT CODE	PRICE	SIZE/ INCHES			WEIGHT LBS	VOL FT <sup>3</sup>
		H	W	D		
EVPFSG5M6636	986	66	36	2.875	70.9	5.23
EVPFSG5M6642	1098	66	42	2.875	78.58	6.06
EVPFSG5M6648	1208	66	48	2.875	91.87	6.88

**EVPFSG3M66 - Reception Panels, 30" Fabric Bottom Module and 6" Pass Thru**

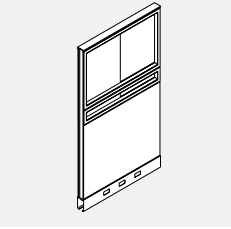

- Reception panel incorporates glazed tempered glass module and pass thru module within steel frame.
- 6" pass thru with sliding tempered glass door module.
- 30" fabric bottom module.
- Aluminum low profile top is included.
- Stackability: Evolve panels can be increased in height in 6", 12", 24" increments. See module listing for part numbers.

PRODUCT CODE	PRICE	SIZE/ INCHES			WEIGHT LBS	VOL FT <sup>3</sup>
		H	W	D		
EVPFSG3M6636	1022	66	36	2.875	70.9	5.23
EVPFSG3M6642	1115	66	42	2.875	78.58	6.06
EVPFSG3M6648	1210	66	48	2.875	91.87	6.88

**EVPFSG2M66 - Reception Panels, 24" Fabric Bottom Module and 12" Pass Thru**

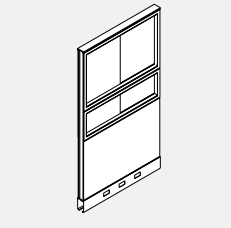

- Reception panel incorporates glazed tempered glass module and pass thru module within steel frame.
- 12" pass thru with sliding tempered glass door module.
- 24" fabric bottom module.
- Aluminum low profile top is included.
- Stackability: Evolve panels can be increased in height in 6", 12", 24" increments. See module listing for part numbers.

PRODUCT CODE	PRICE	SIZE/ INCHES			WEIGHT LBS	VOL FT <sup>3</sup>
		H	W	D		
EVPFSG2M6636	969	66	36	2.875	70.9	5.23
EVPFSG2M6642	1068	66	42	2.875	78.58	6.06
EVPFSG2M6648	1176	66	48	2.875	91.87	6.88

**EVPHSG5M66 - Reception Panels, 24" Laminate Bottom Module and 6" Pass Thru**

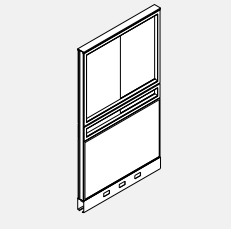

- Reception panel incorporates glazed tempered glass module and pass thru module within steel frame.
- 6" pass thru with sliding tempered glass door module.
- 24" laminate bottom module.
- Aluminum low profile top is included.
- Stackability: Evolve panels can be increased in height in 6", 12", 24" increments. See module listing for part numbers.

PRODUCT CODE	PRICE	SIZE/ INCHES			WEIGHT LBS	VOL FT <sup>3</sup>
		H	W	D		
EVPHSG5M6636	1104	66	36	2.875	70.9	5.23
EVPHSG5M6642	1197	66	42	2.875	78.58	6.06
EVPHSG5M6648	1289	66	48	2.875	91.87	6.88

**EVPHSG3M66 - Reception Panels, 30" Laminate Bottom Module and 6" Pass Thru**

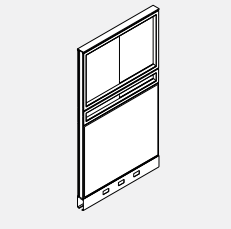

- Reception panel incorporates glazed tempered glass module and pass thru module within steel frame.
- 6" pass thru with sliding tempered glass door module.
- 30" laminate bottom module.
- Aluminum low profile top is included.
- Stackability: Evolve panels can be increased in height in 6", 12", 24" increments. See module listing for part numbers.

PRODUCT CODE	PRICE	SIZE/ INCHES			WEIGHT LBS	VOL FT <sup>3</sup>
		H	W	D		
EVPHSG3M6636	1104	66	36	2.875	70.9	5.23
EVPHSG3M6642	1197	66	42	2.875	78.58	6.06
EVPHSG3M6648	1289	66	48	2.875	91.87	6.88

**EVPHSG2M66 - Reception Panels, 24" Laminate Bottom Module and 12" Pass Thru**

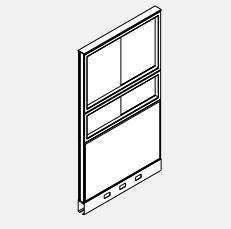

- Reception panel incorporates glazed tempered glass module and pass thru module within steel frame.
- 12" pass thru with sliding tempered glass door module.
- 24" laminate bottom module.
- Aluminum low profile top is included.
- Stackability: Evolve panels can be increased in height in 6", 12", 24" increments. See module listing for part numbers.

PRODUCT CODE	PRICE	SIZE/ INCHES			WEIGHT LBS	VOL FT <sup>3</sup>
		H	W	D		
EVPHSG2M6636	1080	66	36	2.875	70.9	5.23
EVPHSG2M6642	1169	66	42	2.875	78.58	6.06
EVPHSG2M6648	1264	66	48	2.875	91.87	6.88



**EVPPAF • Air Flow Panel**

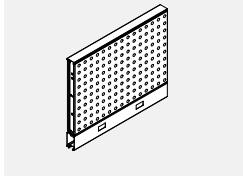

- Metal Air Flow Panel.
- Stackability: Evolve panels can be increased in height in 6", 12", 24" increments. See module listing for part numbers.

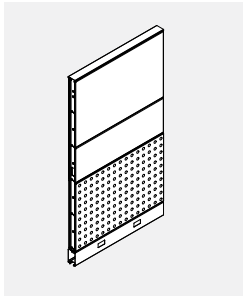
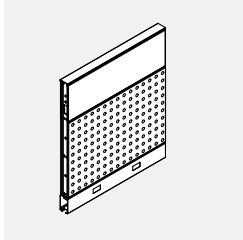

PRODUCT CODE	PRICE		SIZE/ INCHES			WEIGHT LBS	VOL FT <sup>3</sup>
	GR 1	GR 2	H	W	D		
EVPPAF3024	387	-	30	24	2.875	22.08	1.63
EVPPAF3030	461	-	30	30	2.875	26.51	2.00
EVPPAF3036	509	-	30	36	2.875	29.67	2.38
EVPPAF3042	564	-	30	42	2.875	32.19	2.76
EVPPAF3048	638	-	30	48	2.875	39.10	3.13
EVPPAF3054	733	-	30	54	2.875	43.37	3.51
EVPPAF3060	827	-	30	60	2.875	47.15	3.89
EVPPAF4224	494	502	42	24	2.875	29.44	2.31
EVPPAF4230	585	594	42	30	2.875	35.25	2.81
EVPPAF4236	650	662	42	36	2.875	42.09	3.38
EVPPAF4242	724	736	42	42	2.875	46.91	3.92
EVPPAF4248	817	831	42	48	2.875	51.98	4.45
EVPPAF4254	930	947	42	54	2.875	57.41	4.98
EVPPAF4260	944	965	42	60	2.875	62.56	5.52
EVPPAF5424	553	569	54	24	2.875	33.12	2.94
EVPPAF5430	637	656	54	30	2.875	39.62	3.62
EVPPAF5436	715	737	54	36	2.875	44.16	4.31
EVPPAF5442	796	824	54	42	2.875	48.52	4.99
EVPPAF5448	894	926	54	48	2.875	57.73	5.67
EVPPAF5454	1042	1076	54	54	2.875	63.62	6.35
EVPPAF5460	1135	1170	54	60	2.875	69.23	7.03
EVPPAF6624	646	671	66	24	2.875	41.40	3.58
EVPPAF6630	762	792	66	30	2.875	49.27	4.40
EVPPAF6636	856	890	66	36	2.875	57.50	5.23
EVPPAF6642	954	993	66	42	2.875	64.16	6.06
EVPPAF6648	1074	1119	66	48	2.875	71.53	6.08
EVPPAF6654	1218	1265	66	54	2.875	78.58	7.70
EVPPAF6660	1350	1405	66	60	2.875	85.56	8.53

**EVPPPAF • Premium Air Flow Panel**

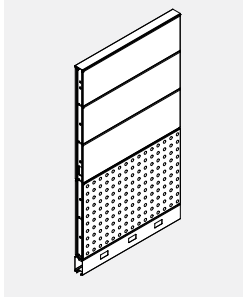

- Metal Air Flow Panel.
- Each side of panel may have different fabric within same grade at no upcharge.
- There is no panel creep.
- Stackability: Evolve panels can be increased in height in 6", 12", 24" increments. See module listing for part numbers.

PRODUCT CODE	PRICE		SIZE/ INCHES			WEIGHT LBS	VOL FT <sup>3</sup>
	GR 1	GR 2	H	W	D		
EVPPPAF5424	615	634	54	24	2.875	37.26	2.94
EVPPPAF5430	703	725	54	30	2.875	44.44	3.62
EVPPPAF5436	790	815	54	36	2.875	54.97	4.31
EVPPPAF5442	877	903	54	42	2.875	62.09	4.99
EVPPPAF5448	993	1024	54	48	2.875	65.32	5.67
EVPPPAF5454	1123	1159	54	54	2.875	73.06	6.35
EVPPPAF5460	1256	1291	54	60	2.875	78.43	7.03
EVPPPAF6624	704	730	66	24	2.875	45.54	3.58
EVPPPAF6630	828	859	66	30	2.875	54.08	4.40
EVPPPAF6636	928	965	66	36	2.875	68.31	5.23
EVPPPAF6642	1031	1070	66	42	2.875	77.73	6.06
EVPPPAF6648	1170	1218	66	48	2.875	79.12	6.08
EVPPPAF6654	1318	1368	66	54	2.875	86.87	7.70
EVPPPAF6660	1470	1524	66	60	2.875	94.76	8.53

**EVPPMAF • Premium Air Flow Panel**

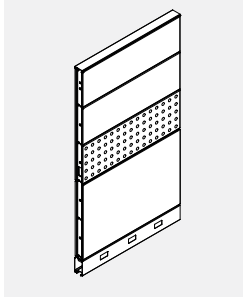

- Metal Air Flow Panel.
- Each side of panel may have different fabric within same grade at no upcharge.
- There is no panel creep.
- Stackability: Evolve panels can be increased in height in 6", 12", 24" increments. See module listing for part numbers.

PRODUCT CODE	PRICE		SIZE/ INCHES			WEIGHT LBS	VOL FT <sup>3</sup>
	GR 1	GR 2	H	W	D		
EVPPMAF5424	675	701	54	24	2.875	36.57	2.94
EVPPMAF5430	801	829	54	30	2.875	43.29	3.62
EVPPMAF5436	910	945	54	36	2.875	51.75	4.31
EVPPMAF5442	1024	1062	54	42	2.875	57.14	4.99
EVPPMAF5448	1141	1188	54	48	2.875	63.48	5.67
EVPPMAF5454	1291	1342	54	54	2.875	69.61	6.35
EVPPMAF5460	1441	1497	54	60	2.875	75.67	7.03
EVPPMAF6624	768	801	66	24	2.875	44.85	3.58
EVPPMAF6630	908	947	66	30	2.875	52.93	4.40
EVPPMAF6636	1032	1080	66	36	2.875	65.09	5.23
EVPPMAF6642	1158	1208	66	42	2.875	72.78	6.06
EVPPMAF6648	1291	1353	66	48	2.875	77.28	6.08
EVPPMAF6654	1456	1522	66	54	2.875	84.58	7.70
EVPPMAF6660	1620	1694	66	60	2.875	92.00	8.53

**EVPDS • Door Panel - Solid**

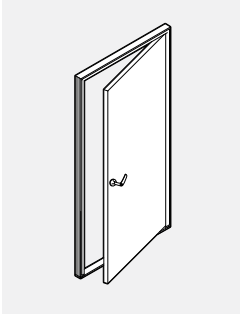

- 90° Door Panel height = 66" high panel plus one 24" or two 12" Panel Extension Modules.
- 1 3/8" thick hollow core door.
- Handedness can be changed in the field.
- Handle sold separately. Specify type of handle required.

PRODUCT CODE	PRICE	SIZE/ INCHES			WEIGHT LBS	VOL FT <sup>3</sup>
		H	W	D		
EVPDS7836L	2287	78	36	2.875	64.00	7.50
EVPDS7836R	2287	78	36	2.875	64.00	7.50
EVPDS7842L	2660	78	42	2.875	74.00	8.50
EVPDS7842R	2660	78	42	2.875	74.00	8.50
EVPDS8436L	2408	84	36	2.875	62.00	7.00
EVPDS8436R	2408	84	36	2.875	62.00	7.00
EVPDS8442L	2787	84	42	2.875	72.00	8.00
EVPDS8442R	2787	84	42	2.875	72.00	8.00
EVPDS9036L	2417	90	36	2.875	66.00	8.00
EVPDS9036R	2417	90	36	2.875	66.00	8.00
EVPDS9042L	2787	90	42	2.875	76.00	9.00
EVPDS9042R	2787	90	42	2.875	76.00	9.00

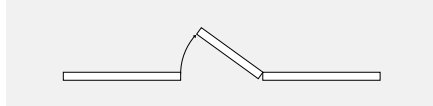

RIGHT HAND HUNG

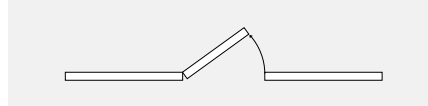

LEFT HAND HUNG

**EVPDG • Full Glazed Door panel**

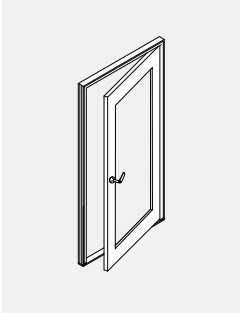

- All door surfaces are high pressure laminate with window.
- If laminate is selected in wood grain, the grain runs vertical.
- HP laminate finish available in all standard finishes.
- Select frame color from standard trim color.s
- 84" Door panel height is 66"H panel and 18" H Panel extension modules.
- 90" Door panel height is 66"H panel and 24" H or two 12" H Panel extension modules.
- Door and door trim can be specified left or right handed.
- Handedness of Door can be changed in field.
- Door Sizes:
  - 36" W door is 33.63" W without frame (This door is not ADA compliant)
  - 42" W door is 39.63" W without frame
  - 84" H door is 81.50" H without frame
  - 90" H door is 87.50" H without frame
- Customer is responsible to confirm and meet, city, county or any other municipality codes in relation to door clearances.
- Knob or lever to be ordered separately.

PRODUCT CODE	PRICE CLR	FRST	SIZE/INCHES			WEIGHT LBS	VOL FT <sup>3</sup>
			H	W	D		
EVPDG8436L	2682	2779	84	36	2.875	62	7
EVPDG8436R	2682	2779	84	36	2.875	62	7
EVPDG8442L	3054	3149	84	42	2.875	72	8
EVPDG8442R	3054	3149	84	42	2.875	72	8
EVPDG9036L	2682	2779	90	36	2.875	66	8
EVPDG9036R	2682	2779	90	36	2.875	66	8
EVPDG9042L	3054	3149	90	42	2.875	76	9
EVPDG9042R	3054	3149	90	42	2.875	76	9

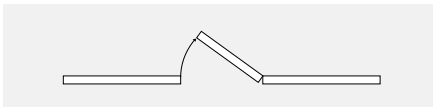

RIGHT HAND HUNG

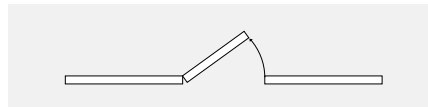

LEFT HAND HUNG

**EVPDSL • Door Handles**

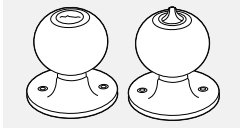

EVPDSL01

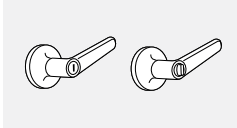

EVPDSL02

PRODUCT CODE	PRICE	SIZE/ INCHES			WEIGHT LBS	VOL FT <sup>3</sup>
		H	W	D		
EVPDSL01	87				0.50	0.50
EVPDSL02	123				0.30	0.10

**EVPDSL • Sliding Door**

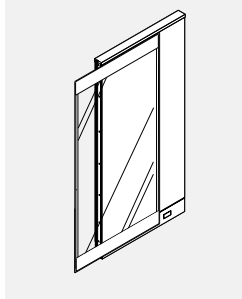

- Provides territorial privacy in an open plan environment.
  - Lightweight, panel mounted sliding partition.
  - Consists of translucent textured polycarbonate.
  - Must be mounted to a panel of the same size.
  - The face of the Privacy Screen sits 3" away from the face of the panel to which it is attached.
  - When open, the screen may interfere with raceway doors that open on the outside of an adjacent panel.
  - Must specify left or right for the direction in which the door will slide once installed.
  - Caps located on the end of the frame default to the panel frame colour.
  - All hardware included.
- Note: Specify left or right for the direction in which the door will slide as per examples above.

PRODUCT CODE	PRICE	SIZE/ INCHES			WEIGHT VOL	
		H	W	D	LBS	FT <sup>3</sup>
EVPDSL6636R	1923	66	36	2.61	35	5.98
EVPDSL6636L	1923	66	36	2.61	35	5.98
EVPDSL6642R	2070	66	42	2.61	42	6.93
EVPDSL6642L	2070	66	42	2.61	42	6.93
EVPDSL8136R	2308	81	36	2.61	43	7.30
EVPDSL8136L	2308	81	36	2.61	43	7.30
EVPDSL8142R	2477	81	42	2.61	50	8.45
EVPDSL8142L	2477	81	42	2.61	50	8.45

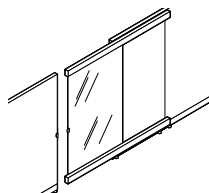

Left Hand Option

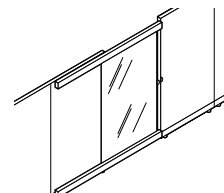

Right Hand Option

**EVPDSLLOCK • Sliding Door Lock**



Left Hand Shown

- Lock bracket attaches to Sliding door with screws
- Includes strike plate bracket which attaches to slots in connector.
- Lock included.
- Available in tungsten only.

PRODUCT CODE	PRICE	SIZE/INCHES			WEIGHT VOL	
		H	W	D	LBS	FT <sup>3</sup>
EVPDSLLOCKR	233	2.65	1.2	0.9	1.0	0.2
EVPDSLLOCKL	233	2.65	1.2	0.9	1.0	0.2

**EVAFMB01 • Floor Mount Plate**

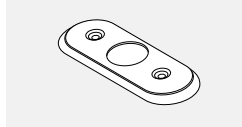

- Attached to floor.
- Secures panel to floor.
- Attachment screws not included.
- Care should be taken to use correct fasteners for type of floor.
- Available in chrome finish only.

PRODUCT CODE	PRICE	SIZE/ INCHES			WEIGHT VOL	
		H	W	D	LBS	FT <sup>3</sup>
EVAFMB01	70	0.25	5	2.5	0.2	0.02

**EVPFE • Panel Extension Module**

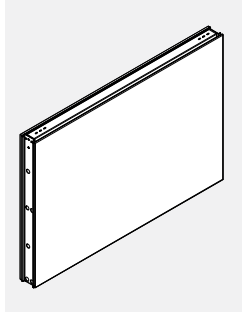

- Single modules are 6", 12", 18" or 24" high.
- When ordering Panel Extension Module, additional connectors are required.

PRODUCT CODE	PRICE		SIZE/ INCHES			WEIGHT VOL	
	GR 1	GR 2	H	W	D	LBS	FT <sup>3</sup>
EVPFE0618	149	155	6	18	2.875	4.80	0.21
EVPFE0624	154	164	6	24	2.875	6.40	0.29
EVPFE0630	169	178	6	30	2.875	7.40	0.36
EVPFE0636	189	201	6	36	2.875	8.20	0.43
EVPFE0642	211	226	6	42	2.875	9.40	0.51
EVPFE0648	228	241	6	48	2.875	10.20	0.58
EVPFE0654	246	263	6	54	2.875	14.40	0.65
EVPFE0660	268	286	6	60	2.875	16.00	0.73
EVPFE1218	149	155	12	18	2.875	7.40	0.38
EVPFE1224	154	163	12	24	2.875	8.60	0.50
EVPFE1230	169	178	12	30	2.875	9.60	0.63
EVPFE1236	189	201	12	36	2.875	12.80	0.75
EVPFE1242	211	224	12	42	2.875	14.80	0.88
EVPFE1248	228	241	12	48	2.875	15.00	1.00
EVPFE1254	246	263	12	54	2.875	16.20	1.12
EVPFE1260	268	286	12	60	2.875	17.80	1.25
EVPFE1818	184	195	18	18	2.875	9.01	0.54
EVPFE1824	191	205	18	24	2.875	10.47	0.72
EVPFE1830	206	227	18	30	2.875	11.93	0.90
EVPFE1836	239	260	18	36	2.875	13.39	1.08
EVPFE1842	266	292	18	42	2.875	14.84	1.26
EVPFE1848	289	318	18	48	2.875	16.29	1.44
EVPFE1854	315	345	18	54	2.875	17.76	1.62
EVPFE1860	342	371	18	60	2.875	19.21	1.80
EVPFE2418	184	195	24	18	2.875	10.60	0.75
EVPFE2424	191	206	24	24	2.875	12.32	1.00
EVPFE2430	206	227	24	30	2.875	14.03	1.25
EVPFE2436	239	260	24	36	2.875	15.75	1.50
EVPFE2442	266	292	24	42	2.875	17.46	1.75
EVPFE2448	289	318	24	48	2.875	19.17	2.00
EVPFE2454	315	345	24	54	2.875	20.89	2.25
EVPFE2460	342	380	24	60	2.875	22.60	2.50

**EVPFPE • Panel Extension Module Premium**

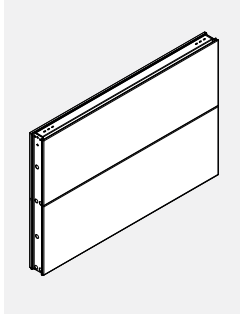

- Two 12" modules are incorporated into one 24" high metal frame.
- When ordering Panel Extension Module, additional connectors are required.

PRODUCT CODE	PRICE		SIZE/ INCHES			WEIGHT LBS	VOL FT <sup>3</sup>
	GR 1	GR 2	H	W	D		
EVPFPE2418	252	262	24	18	2.875	13.90	1.02
EVPFPE2424	268	284	24	24	2.875	16.80	1.42
EVPFPE2430	298	318	24	30	2.875	19.58	1.75
EVPFPE2436	340	362	24	36	2.875	26.40	2.07
EVPFPE2442	380	406	24	42	2.875	31.04	2.40
EVPFPE2448	407	437	24	48	2.875	38.40	2.73
EVPFPE2454	450	484	24	54	2.875	30.90	2.25
EVPFPE2460	493	528	24	60	2.875	34.00	3.39

**EVPW1SE • Writeboard Extension Module - One Side**

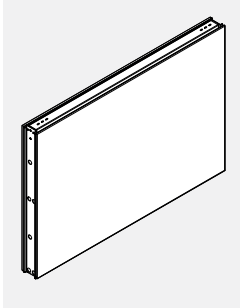

- Single 18" or 24" high module with Writeboard on one side and fabric on the other side.
- Use of erasable Writeboard markers only.
- When ordering Panel Extension Module, additional connectors are required.

PRODUCT CODE	PRICE		SIZE/ INCHES			WEIGHT LBS	VOL FT <sup>3</sup>
	GR 1	GR 2	H	W	D		
EVPW1SE0618	206	211	06	18	3	2.77	0.25
EVPW1SE0624	240	251	06	24	3	3.20	0.35
EVPW1SE0630	272	276	06	30	3	3.63	0.43
EVPW1SE0636	310	317	06	36	3	4.06	0.51
EVPW1SE0642	350	356	06	42	3	4.49	0.60
EVPW1SE0648	383	392	06	48	3	4.91	0.68
EVPW1SE0654	433	441	06	54	3	5.34	0.76
EVPW1SE0660	455	463	06	60	3	5.77	0.84
EVPW1SE0666	474	485	06	66	3	6.17	0.91
EVPW1SE0672	526	534	06	72	3	6.57	0.99
EVPW1SE1218	206	211	12	18	3	5.55	0.51
EVPW1SE1224	240	251	12	24	3	6.41	0.71
EVPW1SE1230	272	276	12	30	3	7.26	0.87
EVPW1SE1236	310	317	12	36	3	8.12	1.03
EVPW1SE1242	350	356	12	42	3	8.98	1.20
EVPW1SE1248	383	392	12	48	3	9.83	1.36
EVPW1SE1254	433	441	12	54	3	10.69	1.53
EVPW1SE1260	455	463	12	60	3	11.55	1.69
EVPW1SE1266	474	485	12	66	3	12.41	1.85
EVPW1SE1272	526	534	12	72	3	13.27	1.99
EVPW1SE1818	226	230	18	18	2.875	9.44	0.54
EVPW1SE1824	255	262	18	24	2.875	10.90	0.72
EVPW1SE1830	284	294	18	30	2.875	12.35	0.90
EVPW1SE1836	334	345	18	36	2.875	13.81	1.08
EVPW1SE1842	378	393	18	42	2.875	15.27	1.26
EVPW1SE1848	417	435	18	48	2.875	16.72	1.44
EVPW1SE1854	451	469	18	54	2.875	18.18	1.62
EVPW1SE1860	488	505	18	60	2.875	19.64	1.80
EVPW1SE2418	226	230	24	18	2.875	11.10	1.02
EVPW1SE2424	255	263	24	24	2.875	12.82	2.07
EVPW1SE2430	284	295	24	30	2.875	14.53	2.17
EVPW1SE2436	334	345	24	36	2.875	16.25	2.27
EVPW1SE2442	378	393	24	42	2.875	17.96	2.37
EVPW1SE2448	417	430	24	48	2.875	19.67	2.47
EVPW1SE2454	451	469	24	54	2.875	21.39	2.25
EVPW1SE2460	488	505	24	60	2.875	23.10	3.47

**EVPW2SE • Writeboard Extension Module - Two Side**

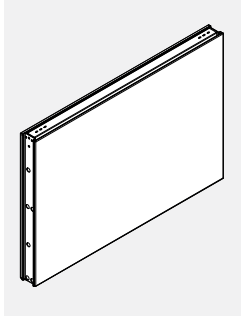

- Single 18" or 24" high module with Writeboard on both sides.
- Use of erasable Writeboard markers only.
- When ordering Panel Extension Module, additional connectors are required.

PRODUCT CODE	PRICE	SIZE/ INCHES			WEIGHT VOL	
		H	W	D	LBS	FT <sup>3</sup>
EVPW2SE0618	227	06	18	3	2.77	0.25
EVPW2SE0624	266	06	24	3	3.20	0.35
EVPW2SE0630	309	06	30	3	3.63	0.43
EVPW2SE0636	353	06	36	3	4.06	0.51
EVPW2SE0642	398	06	42	3	4.49	0.60
EVPW2SE0648	447	06	48	3	4.91	0.68
EVPW2SE0654	519	06	54	3	5.34	0.76
EVPW2SE0660	528	06	60	3	5.77	0.84
EVPW2SE0666	539	06	66	3	6.17	0.91
EVPW2SE0672	609	06	72	3	6.57	0.99
EVPW2SE1218	227	12	18	3	5.55	0.51
EVPW2SE1224	266	12	24	3	6.41	0.71
EVPW2SE1230	309	12	30	3	7.26	0.87
EVPW2SE1236	353	12	36	3	8.12	1.03
EVPW2SE1242	398	12	42	3	8.98	1.20
EVPW2SE1248	447	12	48	3	9.83	1.36
EVPW2SE1254	519	12	54	3	10.69	1.53
EVPW2SE1260	528	12	60	3	11.55	1.69
EVPW2SE1266	539	12	66	3	12.41	1.85
EVPW2SE1272	609	12	72	3	13.27	1.99
EVPW2SE1818	271	18	18	2.875	10.29	0.54
EVPW2SE1824	318	18	24	2.875	11.75	0.72
EVPW2SE1830	364	18	30	2.875	13.20	0.90
EVPW2SE1836	433	18	36	2.875	14.66	1.08
EVPW2SE1842	488	18	42	2.875	16.12	1.26
EVPW2SE1848	546	18	48	2.875	17.57	1.44
EVPW2SE1854	604	18	54	2.875	19.03	1.62
EVPW2SE1860	658	18	60	2.875	20.49	1.80
EVPW2SE2418	271	24	18	2.875	12.10	0.75
EVPW2SE2424	318	24	24	2.875	13.82	2.07
EVPW2SE2430	364	24	30	2.875	15.53	2.17
EVPW2SE2436	433	24	36	2.875	17.25	2.27
EVPW2SE2442	488	24	42	2.875	18.96	2.37
EVPW2SE2448	546	24	48	2.875	20.67	2.73
EVPW2SE2454	604	24	54	2.875	22.39	2.35
EVPW2SE2460	658	24	60	2.875	24.10	3.39

**EVPGTE • Tempered Glass Panel Extension Module**

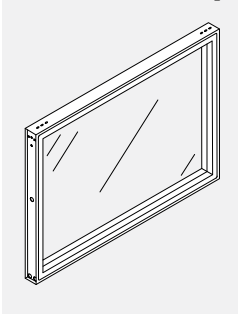

- Single 6", 12", 18" or 24" high module with glazing.
- When ordering Panel Extension Module, additional connectors are required.

PRODUCT CODE	PRICE	SIZE/ INCHES			WEIGHT LBS	VOL FT <sup>3</sup>
		H	W	D		
EVPGTE0618	296	6	18	2.875	7.60	0.18
EVPGTE0624	318	6	24	2.875	9.24	0.25
EVPGTE0630	385	6	30	2.875	10.78	0.31
EVPGTE0636	400	6	36	2.875	12.32	0.37
EVPGTE0642	493	6	42	2.875	14.10	0.43
EVPGTE0648	550	6	48	2.875	15.80	0.50
EVPGTE0654	603	6	54	2.875	17.42	0.56
EVPGTE0660	647	6	60	2.875	19.28	0.63
EVPGTE1218	296	12	18	2.875	10.06	0.38
EVPGTE1224	318	12	24	2.875	12.08	0.50
EVPGTE1230	385	12	30	2.875	14.10	0.63
EVPGTE1236	400	12	36	2.875	16.12	0.75
EVPGTE1242	493	12	42	2.875	18.24	0.88
EVPGTE1248	550	12	48	2.875	20.56	1.00
EVPGTE1254	603	12	54	2.875	22.66	1.12
EVPGTE1260	647	12	60	2.875	25.00	1.25
EVPGTE1818	446	18	18	2.875	12.00	0.54
EVPGTE1824	459	18	24	2.875	14.93	0.72
EVPGTE1830	490	18	30	2.875	17.77	0.90
EVPGTE1836	535	18	36	2.875	20.57	1.08
EVPGTE1842	609	18	42	2.875	23.31	1.26
EVPGTE1848	681	18	48	2.875	25.94	1.44
EVPGTE1854	740	18	54	2.875	28.51	1.62
EVPGTE1860	795	18	60	2.875	31.28	1.80
EVPGTE2418	446	24	18	2.875	14.12	0.75
EVPGTE2424	459	24	24	2.875	17.56	1.00
EVPGTE2430	490	24	30	2.875	20.90	1.25
EVPGTE2436	535	24	36	2.875	24.20	1.50
EVPGTE2442	609	24	42	2.875	27.42	1.75
EVPGTE2448	681	24	48	2.875	30.52	2.00
EVPGTE2454	740	24	54	2.875	33.54	2.25
EVPGTE2460	795	24	60	2.875	36.80	2.50

**EVPGPTE • Tempered Glass Premium Panel Extension Module**

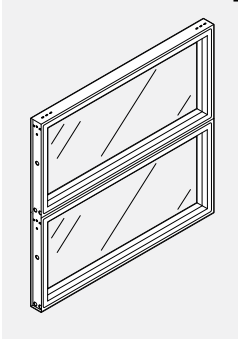

- Two 12" high glazed modules are incorporated into one 24" high metal frame.
- When ordering Panel Extension Module, additional connectors are required.

PRODUCT CODE	PRICE	SIZE/ INCHES			WEIGHT LBS	VOL FT <sup>3</sup>
		H	W	D		
EVPGPTE2418	439	24	18	2.875	18.82	1.02
EVPGPTE2424	488	24	24	2.875	22.96	1.42
EVPGPTE2430	556	24	30	2.875	26.99	1.42
EVPGPTE2436	636	24	36	2.875	31.04	1.54
EVPGPTE2442	705	24	42	2.875	35.12	1.72
EVPGPTE2448	792	24	48	2.875	39.99	2.73
EVPGPTE2454	862	24	54	2.875	43.95	3.06
EVPGPTE2460	934	24	60	2.875	48.40	3.39

**EVPH1SE • Laminate Extension Module - One Side**

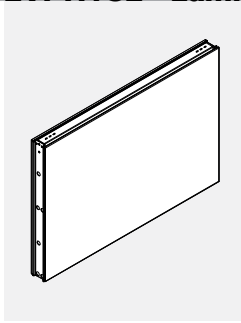

- Laminate face on one side of the module provides durable, washable surfaces. Opposite side is fabric.
- When ordering Panel Extension Module, additional connectors are required.

PRODUCT CODE	PRICE		SIZE/ INCHES			WEIGHT		VOL FT <sup>3</sup>
	GR 1	GR 2	H	W	D	LBS		
EVPH1SE0618	206	211	6	18	2.875	2.77	0.25	
EVPH1SE0624	240	251	6	24	2.875	3.20	0.35	
EVPH1SE0630	272	276	6	30	2.875	3.63	0.43	
EVPH1SE0636	310	317	6	36	2.875	4.06	0.51	
EVPH1SE0642	350	356	6	42	2.875	4.49	0.60	
EVPH1SE0648	383	392	6	48	2.875	4.91	0.68	
EVPH1SE0654	433	441	6	54	2.875	5.34	0.76	
EVPH1SE0660	455	463	6	60	2.875	5.77	0.84	
EVPH1SE1218	206	211	12	18	2.875	5.55	0.51	
EVPH1SE1224	240	251	12	24	2.875	6.41	0.71	
EVPH1SE1230	272	276	12	30	2.875	7.26	0.87	
EVPH1SE1236	310	317	12	36	2.875	8.12	1.03	
EVPH1SE1242	350	356	12	42	2.875	8.98	1.20	
EVPH1SE1248	383	392	12	48	2.875	9.83	1.36	
EVPH1SE1254	433	441	12	54	2.875	10.69	1.53	
EVPH1SE1260	455	463	12	60	2.875	11.55	1.69	
EVPH1SE1818	268	273	18	18	2.875	9.44	0.54	
EVPH1SE1824	330	337	18	24	2.875	10.90	0.72	
EVPH1SE1830	380	389	18	30	2.875	12.35	0.90	
EVPH1SE1836	435	444	18	36	2.875	13.81	1.08	
EVPH1SE1842	490	503	18	42	2.875	15.27	1.26	
EVPH1SE1848	537	553	18	48	2.875	16.72	1.44	
EVPH1SE1854	584	601	18	54	2.875	18.18	1.62	
EVPH1SE1860	641	667	18	60	2.875	19.64	1.80	
EVPH1SE2418	278	284	24	18	2.875	11.10	1.02	
EVPH1SE2424	330	339	24	24	2.875	12.82	1.42	
EVPH1SE2430	380	392	24	30	2.875	14.53	1.75	
EVPH1SE2436	435	444	24	36	2.875	16.25	2.07	
EVPH1SE2442	490	502	24	42	2.875	17.96	2.40	
EVPH1SE2448	537	553	24	48	2.875	19.67	2.73	
EVPH1SE2454	584	597	24	54	2.875	21.39	3.06	
EVPH1SE2460	641	662	24	60	2.875	23.10	3.39	

**EVPH2SE • Laminate Extension Module - Two Sides**

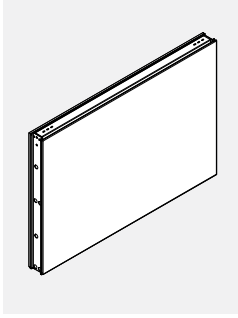

- Laminate face on both sides of the module provides durable, washable surfaces.
- When ordering Panel Extension Module, additional connectors are required.

PRODUCT CODE	PRICE	SIZE/ INCHES			WEIGHT LBS	VOL FT <sup>3</sup>
		H	W	D		
EVPH2SE0618	227	6	18	2.875	3.03	0.26
EVPH2SE0624	266	6	24	2.875	3.46	0.36
EVPH2SE0630	309	6	30	2.875	3.89	0.44
EVPH2SE0636	353	6	36	2.875	4.32	0.52
EVPH2SE0642	398	6	42	2.875	4.74	0.60
EVPH2SE0648	447	6	48	2.875	5.17	0.69
EVPH2SE0654	519	6	54	2.875	5.60	0.77
EVPH2SE0660	528	6	60	2.875	6.03	0.85
EVPH2SE1218	227	12	18	2.875	6.05	0.51
EVPH2SE1224	266	12	24	2.875	6.91	0.71
EVPH2SE1230	309	12	30	2.875	7.77	0.88
EVPH2SE1236	353	12	36	2.875	8.63	1.04
EVPH2SE1242	398	12	42	2.875	9.48	1.20
EVPH2SE1248	447	12	48	2.875	10.34	1.37
EVPH2SE1254	519	12	54	2.875	11.20	1.53
EVPH2SE1260	528	12	60	2.875	12.05	1.70
EVPH2SE1818	319	18	18	2.875	10.29	0.54
EVPH2SE1824	392	18	24	2.875	11.75	0.72
EVPH2SE1830	455	18	30	2.875	13.20	0.90
EVPH2SE1836	526	18	36	2.875	14.66	1.08
EVPH2SE1842	596	18	42	2.875	16.12	1.26
EVPH2SE1848	674	18	48	2.875	17.57	1.44
EVPH2SE1854	740	18	54	2.875	19.03	1.62
EVPH2SE1860	799	18	60	2.875	20.49	1.80
EVPH2SE2418	319	24	18	2.875	12.10	1.02
EVPH2SE2424	392	24	24	2.875	13.82	1.42
EVPH2SE2430	455	24	30	2.875	15.53	1.75
EVPH2SE2436	526	24	36	2.875	17.25	2.07
EVPH2SE2442	596	24	42	2.875	18.96	2.40
EVPH2SE2448	674	24	48	2.875	20.67	2.73
EVPH2SE2454	740	24	54	2.875	22.39	3.06
EVPH2SE2460	799	24	60	2.875	24.10	3.39



**EVPOE • Open Panel Extension Module**

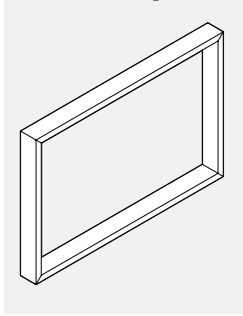

- Provides an opening within a run of panels at a desired location.
- When ordering Panel Extension Module, additional connectors are required.

PRODUCT CODE	PRICE	SIZE/ INCHES			WEIGHT LBS	VOL FT <sup>3</sup>
		H	W	D		
EVPOE0618	239	6	18	2.875	6.22	0.26
EVPOE0624	245	6	24	2.875	7.40	0.29
EVPOE0630	298	6	30	2.875	8.48	0.36
EVPOE0636	314	6	36	2.875	9.56	0.43
EVPOE0642	381	6	42	2.875	10.88	0.51
EVPOE0648	429	6	48	2.875	12.12	0.58
EVPOE0654	469	6	54	2.875	13.25	0.65
EVPOE0660	505	6	60	2.875	14.68	0.73
EVPOE1218	239	12	18	2.875	7.30	0.51
EVPOE1224	245	12	24	2.875	8.40	0.59
EVPOE1230	298	12	30	2.875	9.50	0.82
EVPOE1236	314	12	36	2.875	10.60	1.00
EVPOE1242	381	12	42	2.875	11.84	1.00
EVPOE1248	429	12	48	2.875	13.20	1.18
EVPOE1254	469	12	54	2.875	14.38	1.25
EVPOE1260	505	12	60	2.875	15.80	1.32
EVPOE1818	319	18	18	2.875	7.74	0.54
EVPOE1824	358	18	24	2.875	9.18	0.72
EVPOE1830	381	18	30	2.875	10.53	0.90
EVPOE1836	418	18	36	2.875	11.88	1.08
EVPOE1842	471	18	42	2.875	13.09	1.26
EVPOE1848	530	18	48	2.875	14.22	1.44
EVPOE1854	575	18	54	2.875	15.28	1.62
EVPOE1860	619	18	60	2.875	16.56	1.80
EVPOE2418	319	24	18	2.875	8.60	1.02
EVPOE2424	358	24	24	2.875	10.20	1.42
EVPOE2430	381	24	30	2.875	11.70	1.75
EVPOE2436	418	24	36	2.875	13.20	1.95
EVPOE2442	471	24	42	2.875	14.54	2.40
EVPOE2448	530	24	48	2.875	15.80	2.73
EVPOE2454	575	24	54	2.875	16.98	3.06
EVPOE2460	619	24	60	2.875	18.40	3.39

**EVPAE • Air Flow Extension Module**

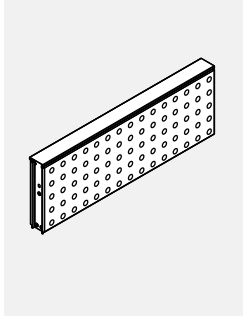

- Metal Air Flow Panel Extension
- Attaches to top of panel
- Panel Extension Modules are not load bearing above 66"
- When ordering Panel Extension Module, additional connectors are required.

PRODUCT CODE	PRICE	SIZE/ INCHES			WEIGHT LBS	VOL FT <sup>3</sup>
		H	W	D		
EVPAE1224	262	12	24	2.875	9.66	0.59
EVPAE1230	309	12	30	2.875	10.93	0.82
EVPAE1236	352	12	36	2.875	12.19	1.00
EVPAE1242	389	12	42	2.875	13.62	1.05
EVPAE1248	439	12	48	2.875	15.18	1.18
EVPAE1260	579	12	60	2.875	18.17	1.32
EVPAE1824	329	18	24	2.875	10.56	0.72
EVPAE1830	383	18	30	2.875	12.11	0.90
EVPAE1836	422	18	36	2.875	13.66	1.08
EVPAE1842	464	18	42	2.875	15.05	1.26
EVPAE1848	531	18	48	2.875	16.35	1.44
EVPAE1860	690	18	60	2.875	19.04	1.80
EVPAE2424	329	24	24	2.875	11.73	1.42
EVPAE2430	383	24	30	2.875	13.46	1.75
EVPAE2436	422	24	36	2.875	15.18	1.95
EVPAE2442	464	24	42	2.875	16.72	2.40
EVPAE2448	531	24	48	2.875	18.17	2.73
EVPAE2460	690	24	60	2.875	21.16	3.39

**EVPSGE - Pass Thru Sliding Tempered Glass Extension Module**

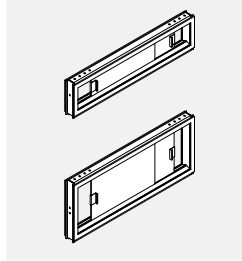

- Pass thru module with sliding tempered glass door.
- Attaches on top of a panel.
- Module can be stacked to add privacy or divide space.
- Panel extension module is not load bearing if installed higher than 66" High.
- When ordering panel extension modules, additional connectors are required.

PRODUCT CODE	PRICE		SIZE/ INCHES			WEIGHT		VOL FT <sup>3</sup>
	CLR	GR1	H	W	D	LBS		
EVPSGE0636	288		6	36	2.875	12.32	0.37	
EVPSGE0642	307		6	42	2.875	14.1	0.43	
EVPSGE0648	373		6	48	2.875	15.8	0.5	
EVPSGE1236	347		12	36	2.875	16.12	0.75	
EVPSGE1242	367		12	42	2.875	18.24	0.88	
EVPSGE1248	386		12	48	2.875	20.56	1	

**EVPSGXE - Talk Thru Tempered Glass Extension Module**

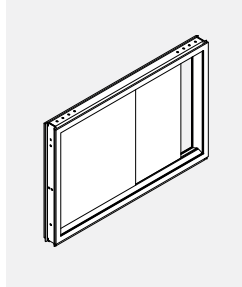

- Talk thru tempered glass module.
- Attaches on top of a panel.
- Module can be stacked to add privacy or divide space.
- Panel extension module is not load bearing if installed higher than 66" High.
- When ordering panel extension modules, additional connectors are required.

PRODUCT CODE	PRICE		SIZE/ INCHES			WEIGHT		VOL FT <sup>3</sup>
	CLR	GR1	H	W	D	LBS		
EVPSGXE2436	447		24	36	2.875	24.2	1.25	
EVPSGXE2442	494		24	42	2.875	27.42	1.75	
EVPSGXE2448	537		24	48	2.875	30.52	2	
EVPSGXE3036	488		30	36	2.875	28.1	1.87	
EVPSGXE3042	550		30	42	2.875	31.56	2.2	
EVPSGXE3048	595		30	48	2.875	35.28	2.5	

**EVPFEB • Fabric Panel Bridge Module**

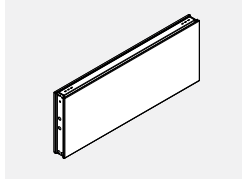

- Bridge modules connects two panels above an opening.
- Requires bridge extension connectors and connects with clamps on top and at bottom.
- Aluminum trim for bottom to be ordered separately.

PRODUCT CODE	PRICE		SIZE/INCHES			WEIGHT		VOL FT <sup>3</sup>
	GR1	GR2	H	W	D	LBS		
EVPFEB0618	149	155	6	18	2.88	4.80	0.21	
EVPFEB0624	154	164	6	24	2.88	6.40	0.29	
EVPFEB0630	169	178	6	30	2.88	7.40	0.36	
EVPFEB0636	189	201	6	36	2.88	8.20	0.43	
EVPFEB0642	211	226	6	42	2.88	9.40	0.51	
EVPFEB0648	228	241	6	48	2.88	10.20	0.58	
EVPFEB0654	246	263	6	54	2.88	14.40	0.65	
EVPFEB0660	268	286	6	60	2.88	16.00	0.73	
EVPFEB1218	149	155	12	18	2.88	7.40	0.38	
EVPFEB1224	154	163	12	24	2.88	8.60	0.50	
EVPFEB1230	169	178	12	30	2.88	9.60	0.63	
EVPFEB1236	189	201	12	36	2.88	12.80	0.75	
EVPFEB1242	211	224	12	42	2.88	14.80	0.88	
EVPFEB1248	228	241	12	48	2.88	15.00	1.00	
EVPFEB1254	246	263	12	54	2.88	16.20	1.12	
EVPFEB1260	268	286	12	60	2.88	17.80	1.25	
EVPFEB1818	184	195	18	18	2.88	9.01	0.54	
EVPFEB1824	191	205	18	24	2.88	10.47	0.72	
EVPFEB1830	206	227	18	30	2.88	11.93	0.90	
EVPFEB1836	239	260	18	36	2.88	13.39	1.08	
EVPFEB1842	266	292	18	42	2.88	14.84	1.26	
EVPFEB1848	289	318	18	48	2.88	16.29	1.44	
EVPFEB1854	315	345	18	54	2.88	17.76	1.62	
EVPFEB1860	342	371	18	60	2.88	19.21	1.80	
EVPFEB2418	184	195	24	18	2.88	10.60	0.75	
EVPFEB2424	191	206	24	24	2.88	12.32	1.00	
EVPFEB2430	206	227	24	30	2.88	14.03	1.25	
EVPFEB2436	239	260	24	36	2.88	15.75	1.50	
EVPFEB2442	266	292	24	42	2.88	17.46	1.75	
EVPFEB2448	289	318	24	48	2.88	19.17	2.00	
EVPFEB2454	315	345	24	54	2.88	20.89	2.25	
EVPFEB2460	342	380	24	60	2.88	22.60	2.50	

**EVPGTEB • Tempered Glass Bridge Module**

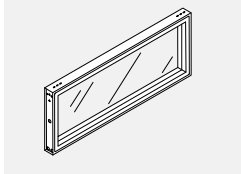

- Bridge modules connects two panels above an opening.
- Requires bridge extension connectors and connects with clamps at bottom.
- Standard in clear (CLR).
- Frosted glass available with a 40% upcharge.
- When ordering bridge modules, additional bridge connectors are required.
- Aluminum trim for bottom to be ordered separately.

PRODUCT CODE	PRICE	SIZE/INCHES			WEIGHT LBS	VOL FT³
		H	W	D		
EVPGTEB0618	255	6	18	3	7.60	0.18
EVPGTEB0624	273	6	24	3	9.24	0.25
EVPGTEB0630	332	6	30	3	10.78	0.31
EVPGTEB0636	345	6	36	3	12.32	0.37
EVPGTEB0642	424	6	42	3	14.10	0.43
EVPGTEB0648	474	6	48	3	15.80	0.50
EVPGTEB0654	519	6	54	3	17.42	0.56
EVPGTEB0660	557	6	60	3	19.28	0.63
EVPGTEB1218	255	12	18	3	10.06	0.38
EVPGTEB1224	273	12	24	3	12.08	0.50
EVPGTEB1230	332	12	30	3	14.10	0.63
EVPGTEB1236	345	12	36	3	16.12	0.75
EVPGTEB1242	424	12	42	3	18.24	0.88
EVPGTEB1248	474	12	48	3	20.56	1.00
EVPGTEB1254	519	12	54	3	22.66	1.12
EVPGTEB1260	557	12	60	3	25.00	1.25
EVPGTEB1818	384	18	18	3	12.00	0.54
EVPGTEB1824	395	18	24	3	14.93	0.72
EVPGTEB1830	422	18	30	3	17.77	0.90
EVPGTEB1836	461	18	36	3	20.57	1.08
EVPGTEB1842	525	18	42	3	23.31	1.26
EVPGTEB1848	587	18	48	3	25.94	1.44
EVPGTEB1854	638	18	54	3	28.51	1.62
EVPGTEB1860	685	18	60	3	31.28	1.80
EVPGTEB2418	384	24	18	3	14.12	0.75
EVPGTEB2424	395	24	24	3	17.56	1.00
EVPGTEB2430	422	24	30	3	20.90	1.25
EVPGTEB2436	461	24	36	3	24.20	1.50
EVPGTEB2442	525	24	42	3	27.42	1.75
EVPGTEB2448	587	24	48	3	30.52	2.00
EVPGTEB2454	638	24	54	3	33.54	2.25
EVPGTEB2460	685	24	60	3	36.80	2.50

**EVPH1SEB • Laminate Bridge Module - Single Sided**

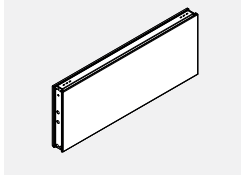

- Bridge modules connects two panels above an opening.
- Requires bridge extension connectors and connects with clamps at bottom.
- Laminate face on one side of module provides durable, washable surface.
- Panel extension module is not load bearing if installed higher than 66" high.
- When ordering bridge modules, additional bridge connectors are required.
- Aluminum trim for bottom to be ordered separately.

PRODUCT CODE	PRICE		SIZE/INCHES			WEIGHT LBS	VOL FT³
	GR1	GR2	H	W	D		
EVPH1SEB0618	177	182	6	18	3	2.77	0.25
EVPH1SEB0624	207	215	6	24	3	3.20	0.35
EVPH1SEB0630	235	238	6	30	3	3.63	0.43
EVPH1SEB0636	268	272	6	36	3	4.06	0.51
EVPH1SEB0642	301	307	6	42	3	4.49	0.60
EVPH1SEB0648	329	336	6	48	3	4.91	0.68
EVPH1SEB0654	373	380	6	54	3	5.34	0.76
EVPH1SEB0660	391	399	6	60	3	5.77	0.84
EVPH1SEB1218	177	182	12	18	3	5.55	0.51
EVPH1SEB1224	207	215	12	24	3	6.41	0.71
EVPH1SEB1230	235	238	12	30	3	7.26	0.87
EVPH1SEB1236	268	272	12	36	3	8.12	1.03
EVPH1SEB1242	301	307	12	42	3	8.98	1.20
EVPH1SEB1248	329	336	12	48	3	9.83	1.36
EVPH1SEB1254	373	380	12	54	3	10.69	1.53
EVPH1SEB1260	391	399	12	60	3	11.55	1.69
EVPH1SEB1818	231	236	18	18	3	9.44	0.54
EVPH1SEB1824	284	291	18	24	3	10.90	0.72
EVPH1SEB1830	327	335	18	30	3	12.35	0.90
EVPH1SEB1836	374	383	18	36	3	13.81	1.08
EVPH1SEB1842	422	434	18	42	3	15.27	1.26
EVPH1SEB1848	463	477	18	48	3	16.72	1.44
EVPH1SEB1854	502	518	18	54	3	18.18	1.62
EVPH1SEB1860	554	574	18	60	3	19.64	1.80
EVPH1SEB2418	231	236	24	18	3	11.10	1.02
EVPH1SEB2424	284	291	24	24	3	12.82	1.42
EVPH1SEB2430	327	335	24	30	3	14.53	1.75
EVPH1SEB2436	374	383	24	36	3	16.25	2.07
EVPH1SEB2442	422	434	24	42	3	17.96	2.40
EVPH1SEB2448	463	477	24	48	3	19.67	2.73
EVPH1SEB2454	502	518	24	54	3	21.39	3.06
EVPH1SEB2460	554	574	24	60	3	23.10	3.39

**EVPH2SEB • Laminate Bridge Module - Double Sided**

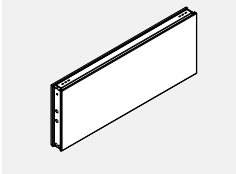

- Bridge modules connects two panels above an opening.
- Requires bridge extension connectors and connects with clamps at bottom.
- Laminate face on two sides of module provides durable, washable surface.
- Panel extension module is not load bearing if installed higher than 66" high.
- When ordering panel extension modules, additional connectors are required.
- Aluminum trim for bottom to be ordered separately.

PRODUCT CODE	PRICE	SIZE/INCHES			WEIGHT LBS	VOL FT <sup>3</sup>
		H	W	D		
EVPH2SEB0618	177	194	18	3	3.03	0.26
EVPH2SEB0624	208	229	24	3	3.46	0.36
EVPH2SEB0630	242	267	30	3	3.89	0.44
EVPH2SEB0636	276	303	36	3	4.32	0.52
EVPH2SEB0642	312	343	42	3	4.74	0.60
EVPH2SEB0648	350	386	48	3	5.17	0.69
EVPH2SEB0654	406	446	54	3	5.60	0.77
EVPH2SEB0660	414	455	60	3	6.03	0.85
EVPH2SEB1218	177	194	18	3	6.05	0.51
EVPH2SEB1224	208	229	24	3	6.91	0.71
EVPH2SEB1230	242	267	30	3	7.77	0.88
EVPH2SEB1236	276	303	36	3	8.63	1.04
EVPH2SEB1242	312	343	42	3	9.48	1.20
EVPH2SEB1248	350	386	48	3	10.34	1.37
EVPH2SEB1254	406	446	54	3	11.20	1.53
EVPH2SEB1260	414	455	60	3	12.05	1.70
EVPH2SEB1818	250	275	18	3	10.29	0.54
EVPH2SEB1824	306	336	24	3	11.75	0.72
EVPH2SEB1830	356	391	30	3	13.20	0.90
EVPH2SEB1836	412	453	36	3	14.66	1.08
EVPH2SEB1842	467	514	42	3	16.12	1.26
EVPH2SEB1848	528	581	48	3	17.57	1.44
EVPH2SEB1854	580	638	54	3	19.03	1.62
EVPH2SEB1860	625	688	60	3	20.49	1.80
EVPH2SEB2418	250	275	18	3	12.10	1.02
EVPH2SEB2424	306	336	24	3	13.82	1.42
EVPH2SEB2430	356	391	30	3	15.53	1.75
EVPH2SEB2436	412	453	36	3	17.25	2.07
EVPH2SEB2442	467	514	42	3	18.96	2.40
EVPH2SEB2448	528	581	48	3	20.67	2.73
EVPH2SEB2454	580	638	54	3	22.39	3.06
EVPH2SEB2460	625	688	60	3	24.10	3.39

**EVPMP-GI-P • Panel Mount Privacy Glass for U Channel, Extended at Both Ends**

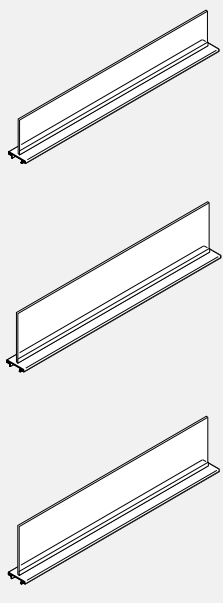

- Privacy Glass integrated with aluminum top trim.
- Attaches on top of panels to add privacy or divide space
- Includes aluminum trim with channel and glass tile.
- Standard in clear (CLR), frosted (FRST) or writeable (WRW) glass.
- Aluminum trim must be specified for entire station when ordering panel mount privacy glass.
- Glass and attachment hardware ship seperately.

PRODUCT CODE	PRICE			SIZE/ INCHES			WEIGHT LBS	VOL FT <sup>3</sup>
	CLR	FRST	WRW	H	W	D		
EVPMP24GI6P	195	244	-	6	24	2.875	2.39	0.25
EVPMP30GI6P	213	268	-	6	30	2.875	2.99	0.32
EVPMP36GI6P	228	283	-	6	36	2.875	3.58	0.37
EVPMP42GI6P	244	304	-	6	42	2.875	4.18	0.43
EVPMP48GI6P	254	317	-	6	48	2.875	4.78	0.50
EVPMP54GI6P	262	328	-	6	54	2.875	5.38	0.56
EVPMP60GI6P	268	333	-	6	60	2.875	5.97	0.63
EVPMP66GI6P	410	546	-	6	66	2.875	6.57	0.69
EVPMP72GI6P	437	570	-	6	72	2.875	7.16	0.76
EVPMP24GI9P	195	244	-	9	24	2.875	3.58	0.38
EVPMP30GI9P	213	268	-	9	30	2.875	4.48	0.47
EVPMP36GI9P	228	283	-	9	36	2.875	5.37	0.56
EVPMP42GI9P	244	304	-	9	42	2.875	6.26	0.65
EVPMP48GI9P	254	317	-	9	48	2.875	7.16	0.75
EVPMP54GI9P	262	328	-	9	54	2.875	8.06	0.84
EVPMP60GI9P	268	333	-	9	60	2.875	8.96	0.94
EVPMP66GI9P	410	546	-	9	66	2.875	9.85	1.04
EVPMP72GI9P	437	570	-	9	72	2.875	10.74	1.13
EVPMP24GIP	195	244	340	12	24	2.875	4.77	0.50
EVPMP30GIP	213	268	347	12	30	2.875	5.97	0.63
EVPMP36GIP	228	283	353	12	36	2.875	7.16	0.75
EVPMP42GIP	244	304	389	12	42	2.875	8.35	0.87
EVPMP48GIP	254	317	426	12	48	2.875	9.55	1.00
EVPMP54GIP	262	328	461	12	54	2.875	10.75	1.12
EVPMP60GIP	268	333	497	12	60	2.875	11.95	1.25
EVPMP66GIP	410	546	681	12	66	2.875	13.05	1.37
EVPMP72GIP	437	570	713	12	72	2.875	14.25	1.51

**EVPMPN-GIP • 12" Integrated Panel Mounted Privacy Glass, 1 Notch**

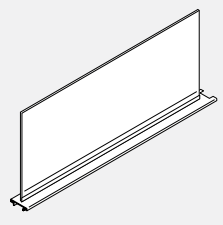

- Privacy Glass Integrated with aluminum top trim.
- Attaches on top of panels to add privacy or divide space.
- Includes aluminum top trim with channel with notched end and glass tile.
- Standard in clear (CLR) or frosted (FRST) glass
- Aluminum trim must be specified for entire station when ordering panel mount privacy glass.
- Glass and attachment hardware to ship separately.

PRODUCT CODE	PRICE			SIZE/ INCHES			WEIGHT LBS	VOL FT <sup>3</sup>
	CLR	FRST	WRW	H	W	D		
EVPMPN24GIP	195	244	-	12	24	2.875	4.77	0.50
EVPMPN30GIP	213	268	-	12	30	2.875	5.97	0.63
EVPMPN36GIP	228	283	-	12	36	2.875	7.16	0.75
EVPMPN42GIP	244	304	-	12	42	2.875	8.35	0.87
EVPMPN48GIP	254	317	-	12	48	2.875	9.55	1.00
EVPMPN54GIP	262	328	-	12	54	2.875	10.75	1.12
EVPMPN60GIP	268	333	-	12	60	2.875	11.95	1.25

**EVPMPDN-GIP • 12" Integrated Panel Mounted Privacy Glass, 2 Notches**

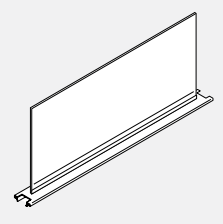

- Privacy Glass Integrated with aluminum top trim.
- Attaches on top of panels to add privacy or divide space.
- Includes aluminum top trim with channel with notched ends and glass tile.
- Standard in clear (CLR) or frosted (FRST) glass
- Aluminum trim must be specified for entire station when ordering panel mount privacy glass.
- Glass and attachment hardware to ship separately.

PRODUCT CODE	PRICE			SIZE/ INCHES			WEIGHT LBS	VOL FT <sup>3</sup>
	CLR	FRST	WRW	H	W	D		
EVPMPDN24GIP	195	244	-	12	24	2.875	4.77	0.50
EVPMPDN30GIP	213	268	-	12	30	2.875	5.97	0.63
EVPMPDN36GIP	228	283	-	12	36	2.875	7.16	0.75
EVPMPDN42GIP	244	304	-	12	42	2.875	8.35	0.87
EVPMPDN48GIP	254	317	-	12	48	2.875	9.55	1.00
EVPMPDN54GIP	262	328	-	12	54	2.875	10.75	1.12
EVPMPDN60GIP	268	333	-	12	60	2.875	11.95	1.25

**EVPMP-GI-PDU • Panel Mount Privacy Glass for U Channel, Extended at Both Ends**

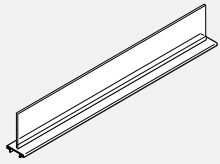

- Privacy glass integrated within aluminum top trim to be used with U channel, with connector for Gallery Panels.
- Attaches on top of panels to add privacy or divide space
- Includes aluminum trim with channel and glass tile
- Standard in clear (CLR) or frosted (FRST) glass
- Aluminium trim must be specified for entire station when ordering panel mount privacy glass.
- Glass and attachment hardware to ship separately
- Trim and glass extended for U channel from both ends.

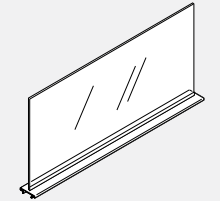
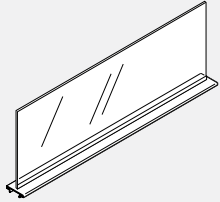
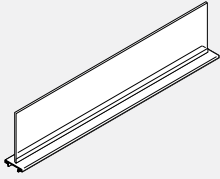

PRODUCT CODE	PRICE		SIZE/ INCHES			WEIGHT VOL	
	CLR	FRST	H	W	D	LBS	FT <sup>3</sup>
EVPMP24GI6PDU	206	256	6	25.25		2.39	0.25
EVPMP30GI6PDU	218	273	6	31.25		2.99	0.32
EVPMP36GI6PDU	234	294	6	37.25		3.58	0.37
EVPMP42GI6PDU	242	304	6	43.25		4.18	0.43
EVPMP48GI6PDU	252	315	6	49.25		4.78	0.50
EVPMP54GI6PDU	256	321	6	55.25		5.38	0.56
EVPMP60GI6PDU	396	524	6	61.25		5.97	0.63
EVPMP66GI6PDU	420	548	6	67.25		6.57	0.69
EVPMP72GI6PDU	444	572	6	73.25		7.16	0.76
EVPMP24GI9PDU	206	256	9	25.25		3.58	0.38
EVPMP30GI9PDU	218	273	9	31.25		4.48	0.47
EVPMP36GI9PDU	234	294	9	37.25		5.37	0.56
EVPMP42GI9PDU	242	304	9	43.25		6.26	0.65
EVPMP48GI9PDU	252	315	9	49.25		7.16	0.75
EVPMP54GI9PDU	256	321	9	55.25		8.06	0.84
EVPMP60GI9PDU	396	524	9	61.25		8.96	0.94
EVPMP66GI9PDU	420	548	9	67.25		9.85	1.04
EVPMP72GI9PDU	444	572	9	73.25		10.74	1.13
EVPMP24GIPDU	206	256	12	25.25		4.77	0.50
EVPMP30GIPDU	218	273	12	31.25		5.97	0.63
EVPMP36GIPDU	234	294	12	37.25		7.16	0.75
EVPMP42GIPDU	242	304	12	43.25		8.35	0.87
EVPMP48GIPDU	252	315	12	49.25		9.55	1.00
EVPMP54GIPDU	256	321	12	55.25		10.75	1.12
EVPMP60GIPDU	396	524	12	61.25		11.94	1.25
EVPMP66GIPDU	420	548	12	67.25		13.13	1.38
EVPMP72GIPDU	444	572	12	73.25		14.32	1.51
EVPMP24GI18PDU	381	437	18	25.25		7.16	0.75
EVPMP30GI18PDU	406	444	18	31.25		8.96	0.94
EVPMP36GI18PDU	422	490	18	37.25		10.74	1.13
EVPMP42GI18PDU	448	535	18	43.25		12.53	1.31
EVPMP48GI18PDU	464	579	18	49.25		14.33	1.50
EVPMP54GI18PDU	480	626	18	55.25		16.13	1.69
EVPMP60GI18PDU	537	712	18	61.25		17.91	1.88
EVPMP66GI18PDU	570	744	18	67.25		19.70	2.06
EVPMP72GI18PDU	603	777	18	73.25		21.48	2.25

**EVPMP-GI-PU • Panel Mount Privacy Glass for U Channel, Extended at One End**

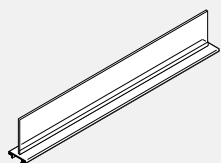

- Privacy glass integrated within aluminum top trim to be used with U channel, with connector for Gallery Panels.
- Attaches on top of panels to add privacy or divide space.
- Includes aluminum trim with channel and glass tile.
- Standard in clear (CLR) or frosted (FRST) glass.
- Aluminium trim must be specified for entire station when ordering panel mount privacy glass.
- Glass and attachment hardware to ship separately.
- Trim and glass extended for U channel on one end.

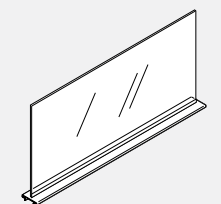
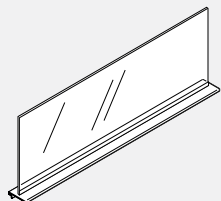
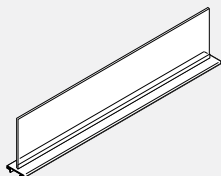

PRODUCT CODE	PRICE		SIZE/ INCHES			WEIGHT VOL	
	CLR	FRST	H	W	D	LBS	FT³
EVPMP24GI6PU	206	256	6	24.625		2.39	0.25
EVPMP30GI6PU	218	273	6	30.625		2.99	0.32
EVPMP36GI6PU	234	294	6	36.625		3.58	0.37
EVPMP42GI6PU	242	304	6	42.625		4.18	0.43
EVPMP48GI6PU	252	315	6	48.625		4.78	0.50
EVPMP54GI6PU	256	321	6	54.625		5.38	0.56
EVPMP60GI6PU	396	524	6	60.625		5.97	0.63
EVPMP66GI6PU	420	548	6	66.625		6.57	0.69
EVPMP72GI6PU	444	572	6	72.625		7.16	0.76
EVPMP24GI9PU	206	256	9	24.625		3.58	0.38
EVPMP30GI9PU	218	273	9	30.625		4.48	0.47
EVPMP36GI9PU	234	294	9	36.625		5.37	0.56
EVPMP42GI9PU	242	304	9	42.625		6.26	0.65
EVPMP48GI9PU	252	315	9	48.625		7.16	0.75
EVPMP54GI9PU	256	321	9	54.625		8.06	0.84
EVPMP60GI9PU	396	524	9	60.625		8.96	0.94
EVPMP66GI9PU	420	548	9	66.625		9.85	1.04
EVPMP72GI9PU	444	572	9	72.625		10.74	1.13
EVPMP24GI9PU	206	256	12	24.625		4.77	0.50
EVPMP30GI9PU	218	273	12	30.625		5.97	0.63
EVPMP36GI9PU	234	294	12	36.625		7.16	0.75
EVPMP42GI9PU	242	304	12	42.625		8.35	0.87
EVPMP48GI9PU	252	315	12	48.625		9.55	1.00
EVPMP54GI9PU	256	321	12	54.625		10.75	1.12
EVPMP60GI9PU	396	524	12	60.625		11.94	1.25
EVPMP66GI9PU	420	548	12	66.625		13.13	1.38
EVPMP72GI9PU	444	572	12	72.625		14.32	1.51
EVPMP24GI18PU	381	437	18	24.625		7.16	0.75
EVPMP30GI18PU	406	444	18	30.625		8.96	0.94
EVPMP36GI18PU	422	490	18	36.625		10.74	1.13
EVPMP42GI18PU	448	535	18	42.625		12.53	1.31
EVPMP48GI18PU	464	579	18	48.625		14.33	1.50
EVPMP54GI18PU	480	626	18	54.625		16.13	1.69
EVPMP60GI18PU	537	712	18	60.625		17.91	1.88
EVPMP66GI18PU	570	744	18	66.625		19.70	2.06
EVPMP72GI18PU	603	777	18	72.625		21.48	2.25

**EVFDK-P • Panel Mount Privacy Felt**

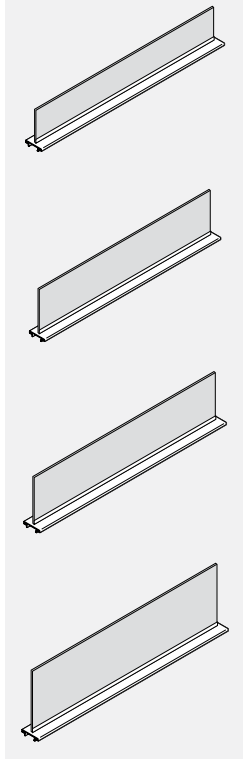

- Privacy felt panel intergrated within aluminum top trim.
- Attaches on top of panels to add privacy or divide space.
- Includes aluminum trim with channel and felt tile.
- Aluminum trim must be specified for entire station when ordering panel mount privacy felt.
- Felt and attachment hardware to ship seperately.
- 9mm Felt material is tackable and comes in 18 different colours. Please specify colour.

PRODUCT CODE	PRICE	SIZE/ INCHES			WEIGHT LBS	VOL FT <sup>3</sup>
		H	W	D		
EVFDK0624P	70	6	24	2.83	1.42	0.25
EVFDK0630P	85	6	30	2.83	1.73	0.32
EVFDK0636P	99	6	36	2.83	2.03	0.37
EVFDK0642P	110	6	42	2.83	2.34	0.43
EVFDK0648P	165	6	48	2.83	2.64	0.50
EVFDK0654P	178	6	54	2.83	2.95	0.56
EVFDK0660P	193	6	60	2.83	3.25	0.63
EVFDK0666P	204	6	66	2.83	3.56	0.69
EVFDK0672P	231	6	72	2.83	3.86	0.76
EVFDK0924P	70	9	24	2.83	1.63	0.38
EVFDK0930P	85	9	30	2.83	1.99	0.47
EVFDK0936P	99	9	36	2.83	2.35	0.56
EVFDK0942P	110	9	42	2.83	2.70	0.65
EVFDK0948P	165	9	48	2.83	3.06	0.75
EVFDK0954P	178	9	54	2.83	3.42	0.84
EVFDK0960P	193	9	60	2.83	3.78	0.94
EVFDK0966P	204	9	66	2.83	4.13	1.04
EVFDK0972P	231	9	72	2.83	4.49	1.13
EVFDK1224P	70	12	24	2.83	1.84	0.50
EVFDK1230P	85	12	30	2.83	2.25	0.63
EVFDK1236P	99	12	36	2.83	2.66	0.75
EVFDK1242P	110	12	42	2.83	3.07	0.87
EVFDK1248P	165	12	48	2.83	3.48	1.00
EVFDK1254P	178	12	54	2.83	3.89	1.12
EVFDK1260P	193	12	60	2.83	4.30	1.25
EVFDK1266P	204	12	66	2.83	5.12	1.38
EVFDK1272P	231	12	72	2.83	5.53	1.51
EVFDK1824P	89	18	24	2.83	2.26	0.75
EVFDK1830P	105	18	30	2.83	2.77	0.94
EVFDK1836P	124	18	36	2.83	3.29	1.13
EVFDK1842P	139	18	42	2.83	3.80	1.31
EVFDK1848P	206	18	48	2.83	4.32	1.50
EVFDK1854P	224	18	54	2.83	4.83	1.69
EVFDK1860P	241	18	60	2.83	5.35	1.88
EVFDK1866P	254	18	66	2.83	6.68	2.06
EVFDK1872P	289	18	72	2.83	7.20	2.25



**EVFDK-PU • Panel Mount Privacy Divider for U Channel**

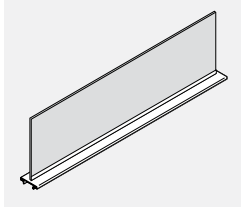

- Attaches on top of panels to add privacy or divide space.
- Privacy felt divider integrated within aluminum top trim to be used with U channel, with connector for Gallery Panels.
- Includes aluminum trim with channel and felt tile.
- Felt and attachment hardware ship separately.
- 9 mm felt material is tackable. Please specify felt finish.
- Aluminum top trim available in standard paint finishes.

PRODUCT CODE	PRICE	SIZE / INCHES			WEIGHT		VOL FT <sup>3</sup>
		H	W	D	LBS		
EVFDK0618PU	70	6	18.62	2.83	1.42	0.25	
EVFDK0624PU	84	6	24.62	2.83	1.73	0.32	
EVFDK0630PU	98	6	30.62	2.83	2.03	0.37	
EVFDK0636PU	110	6	36.62	2.83	2.34	0.43	
EVFDK0642PU	165	6	42.62	2.83	2.64	0.50	
EVFDK0648PU	179	6	48.62	2.83	2.95	0.56	
EVFDK0654PU	193	6	54.62	2.83	3.25	0.63	
EVFDK0660PU	205	6	60.62	2.83	3.56	0.69	
EVFDK0666PU	231	6	66.62	2.83	3.86	0.76	
EVFDK0672PU	259	6	72.62	2.83	4.16	0.83	
EVFDK0918PU	70	9	18.62	2.83	1.63	0.38	
EVFDK0924PU	84	9	24.62	2.83	1.99	0.47	
EVFDK0930PU	98	9	30.62	2.83	2.35	0.56	
EVFDK0936PU	110	9	36.62	2.83	2.70	0.65	
EVFDK0942PU	165	9	42.62	2.83	3.06	0.75	
EVFDK0948PU	179	9	48.62	2.83	3.42	0.84	
EVFDK0954PU	193	9	54.62	2.83	3.78	0.94	
EVFDK0960PU	205	9	60.62	2.83	4.13	1.04	
EVFDK0966PU	231	9	66.62	2.83	4.49	1.13	
EVFDK0972PU	259	9	72.62	2.83	4.85	1.22	
EVFDK1218PU	70	12	18.62	2.83	1.84	0.50	
EVFDK1224PU	84	12	24.62	2.83	2.25	0.63	
EVFDK1230PU	98	12	30.62	2.83	2.66	0.75	
EVFDK1236PU	110	12	36.62	2.83	3.07	0.87	
EVFDK1242PU	165	12	42.62	2.83	3.48	1.00	
EVFDK1248PU	179	12	48.62	2.83	3.89	1.12	
EVFDK1254PU	193	12	54.62	2.83	4.30	1.25	
EVFDK1260PU	205	12	60.62	2.83	5.12	1.38	
EVFDK1266PU	231	12	66.62	2.83	5.53	1.51	
EVFDK1272PU	259	12	72.62	2.83	5.94	1.64	
EVFDK1818PU	89	18	18.62	2.83	2.83	0.75	
EVFDK1824PU	106	18	24.62	2.83	2.77	0.94	
EVFDK1830PU	124	18	30.62	2.83	3.29	1.13	
EVFDK1836PU	139	18	36.62	2.83	3.80	1.31	
EVFDK1842PU	207	18	42.62	2.83	4.32	1.50	
EVFDK1848PU	224	18	48.62	2.83	4.83	1.69	
EVFDK1854PU	243	18	54.62	2.83	5.35	1.88	
EVFDK1860PU	255	18	60.62	2.83	6.68	2.06	
EVFDK1866PU	289	18	66.62	2.83	7.20	2.25	
EVFDK1872PU	325	18	72.62	2.83	7.72	2.44	

**EVFDK-PDU • Panel Mount Privacy Divider for U channel , Extended at Both Ends**

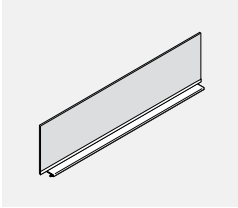

- Attaches on top of panels to add privacy or divide space.
- Privacy felt divider integrated within aluminum top trim to be used with U channel, with connector for Gallery Panels.
- Includes aluminum trim with channel and felt tile.
- Felt and attachment hardware ship separately.
- 9 mm felt material is tackable. Please specify felt finish.
- Aluminum top trim available in standard paint finishes.

PRODUCT CODE	PRICE	SIZE/INCHES			WEIGHT LBS	VOL FT <sup>3</sup>
		H	W	D		
EVFDK0618PDU	70	6	19.25	2.83	1.42	0.25
EVFDK0624PDU	84	6	25.25	2.83	1.73	0.32
EVFDK0630PDU	98	6	31.25	2.83	2.03	0.37
EVFDK0636PDU	110	6	37.25	2.83	2.34	0.43
EVFDK0642PDU	165	6	43.25	2.83	2.64	0.50
EVFDK0648PDU	179	6	49.25	2.83	2.95	0.56
EVFDK0654PDU	193	6	55.25	2.83	3.25	0.63
EVFDK0660PDU	205	6	61.25	2.83	3.56	0.69
EVFDK0666PDU	231	6	67.25	2.83	3.86	0.76
EVFDK0672PDU	259	6	73.25	2.83	4.16	0.83
EVFDK0918PDU	70	9	19.25	2.83	1.63	0.38
EVFDK0924PDU	84	9	25.25	2.83	1.99	0.47
EVFDK0930PDU	98	9	31.25	2.83	2.35	0.56
EVFDK0936PDU	110	9	37.25	2.83	2.70	0.65
EVFDK0942PDU	165	9	43.25	2.83	3.06	0.75
EVFDK0948PDU	179	9	49.25	2.83	3.42	0.84
EVFDK0954PDU	193	9	55.25	2.83	3.78	0.94
EVFDK0960PDU	205	9	61.25	2.83	4.13	1.04
EVFDK0966PDU	231	9	67.25	2.83	4.49	1.13
EVFDK0972PDU	259	9	73.25	2.83	4.85	1.22
EVFDK1218PDU	70	12	19.25	2.83	1.84	0.50
EVFDK1224PDU	84	12	25.25	2.83	2.25	0.63
EVFDK1230PDU	98	12	31.25	2.83	2.66	0.75
EVFDK1236PDU	110	12	37.25	2.83	3.07	0.87
EVFDK1242PDU	165	12	43.25	2.83	3.48	1.00
EVFDK1248PDU	179	12	49.25	2.83	3.89	1.12
EVFDK1254PDU	193	12	55.25	2.83	4.30	1.25
EVFDK1260PDU	205	12	61.25	2.83	5.12	1.38
EVFDK1266PDU	231	12	67.25	2.83	5.53	1.51
EVFDK1272PDU	259	12	73.25	2.83	5.94	1.64
EVFDK1818PDU	89	18	19.25	2.83	2.83	0.75
EVFDK1824PDU	106	18	25.25	2.83	2.77	0.94
EVFDK1830PDU	124	18	31.25	2.83	3.29	1.13
EVFDK1836PDU	139	18	37.25	2.83	3.80	1.31
EVFDK1842PDU	207	18	43.25	2.83	4.32	1.50
EVFDK1848PDU	224	18	49.25	2.83	4.83	1.69
EVFDK1854PDU	243	18	55.25	2.83	5.35	1.88
EVFDK1860PDU	255	18	61.25	2.83	6.68	2.06
EVFDK1866PDU	289	18	67.25	2.83	7.20	2.25
EVFDK1872PDU	325	18	73.25	2.83	7.72	2.44

**EVFDK12-PN • 12" Panel Mount Privacy Felt 1 Notch**

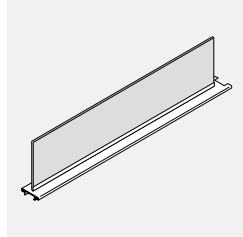

- Privacy felt panel intergrated within aluminum top trim.
- Attaches on top of panels to add privacy or divide space. Includes aluminum trim with channel and felt tile.
- Aluminum trim must be specified for entire station when ordering panel mount privacy felt.
- Felt and attachment hardware to ship seperately.
- 9mm Felt material is tackable. Please specify colour.

PRODUCT CODE	PRICE	SIZE/ INCHES			WEIGHT LBS	VOL FT <sup>3</sup>
		H	W	D		
EVFDK1224PN	70	12	24	2.83	1.84	0.50
EVFDK1230PN	85	12	30	2.83	2.25	0.63
EVFDK1236PN	99	12	36	2.83	2.66	0.75
EVFDK1242PN	110	12	42	2.83	3.07	0.87
EVFDK1248PN	165	12	48	2.83	3.48	1.00
EVFDK1254PN	178	12	54	2.83	3.89	1.12
EVFDK1260PN	193	12	60	2.83	4.30	1.25

**EVFDK12-PDN • 12" Panel Mount Privacy Felt 2 Notch**

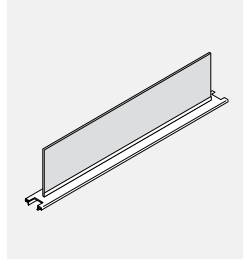

- Privacy felt panel intergrated within aluminum top trim.
- Attaches on top of panels to add privacy or divide space. Includes aluminum trim with channel and felt tile.
- Aluminum trim must be specified for entire station when ordering panel mount privacy felt.
- Felt and attachment hardware to ship seperately.
- 9mm Felt material is tackable. Please specify colour.

PRODUCT CODE	PRICE	SIZE/ INCHES			WEIGHT LBS	VOL FT <sup>3</sup>
		H	W	D		
EVFDK1224PDN	70	12	24	2.83	1.84	0.50
EVFDK1230PDN	85	12	30	2.83	2.25	0.63
EVFDK1236PDN	99	12	36	2.83	2.66	0.75
EVFDK1242PDN	110	12	42	2.83	3.07	0.87
EVFDK1248PDN	165	12	48	2.83	3.48	1.00
EVFDK1254PDN	178	12	54	2.83	3.89	1.12
EVFDK1260PDN	193	12	60	2.83	4.30	1.25

**EVFPDK06-PCF • 6" H Panel Mount Privacy Divider Ceiling Filler Kit**

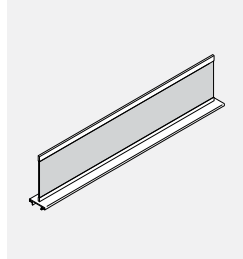

- Privacy Felt Divider integrated within aluminum top trim.
- Includes aluminum trim with channel and Felt tile.
- Felt tile and attachment hardware to ship separately.
- Please specify felt finish.
- Aluminum top trim available in standard paint finishes.
- PVC cap for closing gap at ceiling included.
- PVC cap available in white only.
- Felt ceiling filler should be used to close the gap between top of panel and ceiling.

PRODUCT CODE	PRICE	SIZE/ INCHES			WEIGHT LBS	VOL FT <sup>3</sup>
		H	W	D		
EVFPDK0618PCF	73	6	18	2.83	1.11	0.20
EVFPDK0624PCF	80	6	24	2.83	1.42	0.26
EVFPDK0630PCF	97	6	30	2.83	1.73	0.32
EVFPDK0636PCF	112	6	36	2.83	2.03	0.37
EVFPDK0642PCF	127	6	42	2.83	2.34	0.43
EVFPDK0648PCF	190	6	48	2.83	2.64	0.43
EVFPDK0654PCF	206	6	54	2.83	2.95	0.56
EVFPDK0660PCF	222	6	60	2.83	3.25	0.63
EVFPDK0666PCF	233	6	66	2.83	3.56	0.69
EVFPDK0672PCF	266	6	72	2.83	3.86	0.76

**EVFDK06-PCF • 6" H Panel Mount Privacy Divider Ceiling Filler Kit**

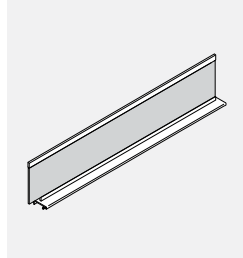

- Privacy Felt Divider integrated with aluminum top trim.
- Includes aluminum trim with channel and Felt tile.
- Felt tile and attachment hardware to ship separately.
- Please specify felt finish.
- Felt tile is longer and overhangs half of the width of post.
- Aluminum trim is width of panel.
- Aluminum top trim available in standard paint finishes.
- PVC cap for closing gap at ceiling included.
- PVC cap available in white only.
- Felt ceiling filler should be used to close the gap between top of panel and ceiling.

PRODUCT CODE	PRICE	SIZE/ INCHES			WEIGHT LBS	VOL FT <sup>3</sup>
		H	W	D		
EVFDK0619PCF	80	6	19.75	2.83	1.42	0.26
EVFDK0625PCF	97	6	25.75	2.83	1.73	0.32
EVFDK0631PCF	112	6	31.75	2.83	2.03	0.37
EVFDK0637PCF	127	6	37.75	2.83	2.34	0.43
EVFDK0643PCF	190	6	43.75	2.83	2.64	0.43
EVFDK0649PCF	206	6	49.75	2.83	2.95	0.56
EVFDK0655PCF	222	6	55.75	2.83	3.25	0.63
EVFDK0661PCF	233	6	61.75	2.83	3.56	0.69
EVFDK0667PCF	266	6	67.75	2.83	3.86	0.76
EVFDK0673PCF	297	6	73.75	2.83	4.16	0.83

**POST CONFIGURATIONS • TECHNICAL INFORMATION**

As illustrated in the example below, start with position "A" and continue clock-wise specifying the height of each slotted connector.

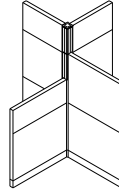
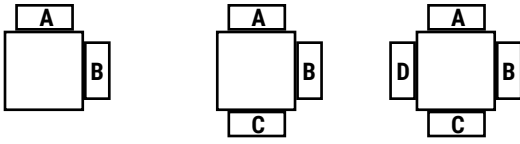

**PANEL EXTENSION MODULES**

When ordering Panel Extension Modules, Inline Panel Extension Connectors (EVPIEC) must be ordered separately.

Inline Panel Extension Connectors connect two panel extension modules of equal height in a straight run.

Extension connectors do not provide support for hang-on storage above 66".

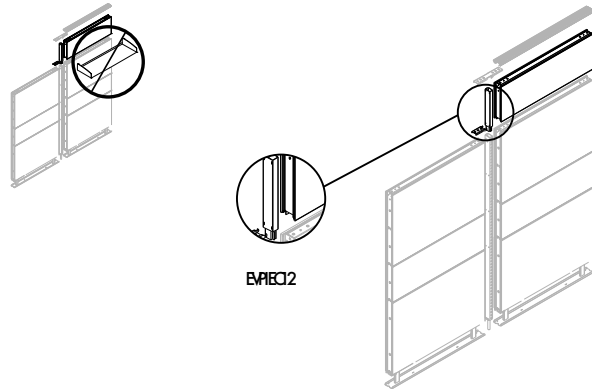

**EVPIC • Inline Panel Connector**

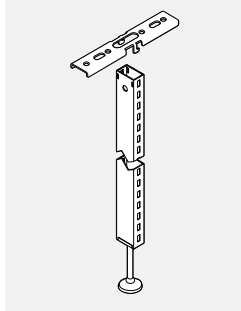

- Connects two panels of equal height in a straight run.
- Provides slotted support for worksurfaces and hang-on storage components.
- Includes slotted connectors with leveling glide and connection hardware.

PRODUCT CODE	PRICE	SIZE/INCHES		WEIGHT VOL	
		H	W	LBS	FT <sup>3</sup>
EVPIC30	61	30	2	3.30	0.50
EVPIC42	65	42	2	4.60	0.07
EVPIC48	67	48	2	5.25	0.07
EVPIC54	72	54	2	5.90	0.09
EVPIC66	81	66	2	7.20	0.10

**EVPVC • Variable Height Connector**

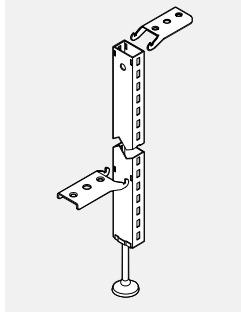

- Connects two panels of different heights in a straight run.
- Connector must reference taller panel.
- Can be used for any variation of panel heights.
- Provides slotted support for worksurfaces and hang-on storage components.
- Includes slotted connector with levelling glide and connection hardware.
- Variable-height trim must be ordered separately, see EVPTV or EVPTVA.

PRODUCT CODE	PRICE	SIZE/INCHES		WEIGHT VOL	
		H	W	LBS	FT <sup>3</sup>
EVPVC42	72	42	2	4.60	0.70
EVPVC48	75	48	2	5.25	0.70
EVPVC54	76	54	2	5.90	0.90
EVPVC66	85	66	2	7.20	0.10

**EVPERA • End of Run Kit (Wall Mount)**

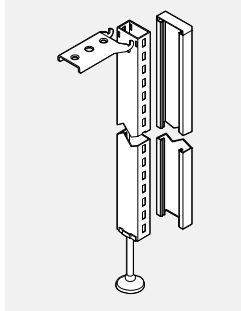

- Finishes the end of each panel run and can be used to attach a panel run to a fixed wall.
- Adds 1" to the width of a panel run.
- Provides slotted support for worksurfaces and hang-on storage components.
- Includes slotted connector with levelling glide, connection hardware and trim kit.
- Can be attached to face of another panel to provide off-modular panel connection by screwing the trim to the horizontals of the panel.

PRODUCT CODE	PRICE	TYPE	SIZE/INCHES		WEIGHT VOL	
			H	W	LBS	FT <sup>3</sup>
EVPERA30	76	Aluminum	30	2.875	3.30	0.07
EVPERA42	91	Aluminum	42	2.875	4.60	0.10
EVPERA48	97	Aluminum	48	2.875	6.75	0.10
EVPERA54	109	Aluminum	54	2.875	5.09	0.18
EVPERA66	122	Aluminum	66	2.875	7.20	0.22

**EVPUERA • Upmount End of Run Kit**

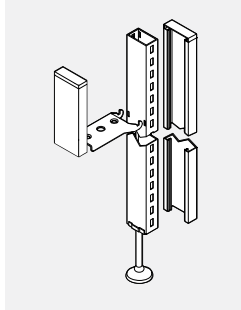

- Replaces the standard End-of-Run Kit EVPERA.
- Used at the end of a panel run to support worksurfaces and Upmount overhead storage.
- Can attach a panel run to a fixed wall.
- Adds 1" to the width of a panel run.
- Includes slotted connector with levelling glide, connection hardware, Upmount End-of-Run Trim EVPUET and one Upmount Extension Trim EVPUET12.

PRODUCT CODE	PRICE	TYPE	SIZE/INCHES		WEIGHT VOL	
			H	W	LBS	FT <sup>3</sup>
EVPUERA66	134	Aluminum	66	2.875	7.20	0.22

**EVPCPA1 • One Way Post**

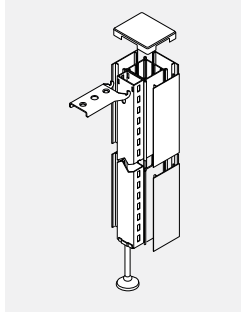

- Replaces an EVPERA End-of-Run Post Kit at the end of a run of panels.
- Used with EVDPE Post Extension to allow for ceiling entry at end of panel run.
- Adds 2 7/8" to the end of a run of panels.
- Provides slotted support for worksurfaces and hang-on storage components.
- Includes corner post, one slotted connector with levelling glides, attachment hardware and trim.

PRODUCT CODE	PRICE	TYPE	SIZE/INCHES			WEIGHT VOL	
			H	W	D	LBS	FT <sup>3</sup>
EVPCPA130	100	Aluminum	30	2.875		4.97	0.24
EVPCPA142	114	Aluminum	42	2.875		6.93	0.33
EVPCPA148	135	Aluminum	48	2.875		7.93	0.38
EVPCPA154	155	Aluminum	54	2.875		8.93	0.43
EVPCPA166	193	Aluminum	66	2.875		10.87	0.53

**EVPIPA2 • Inline Two Way Post**

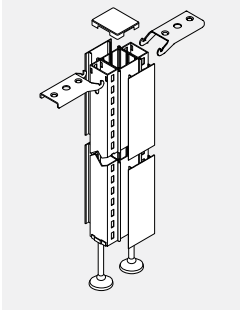

- Connects two panels of equal height in a straight line in place of an EVPIC Inline Panel Connector.
- Adds 2 7/8" to the end of a run of panels.
- Provides slotted support for worksurfaces and hang-on storage components.
- Includes corner post, two slotted connectors with levelling glides, attachment hardware and trim.

PRODUCT CODE	PRICE	TYPE	SIZE/ INCHES	INCHES	WEIGHT LBS	VOL FT <sup>3</sup>
EVPIPA230	157	Aluminum	30	2.875	8.20	0.31
EVPIPA242	201	Aluminum	42	2.875	11.50	0.43
EVPIPA248	211	Aluminum	48	2.875	13.50	0.54
EVPIPA254	244	Aluminum	54	2.875	15.00	0.61
EVPIPA266	290	Aluminum	66	2.875	19.00	0.75

**EVPCPA2 • Two Way Corner Post**

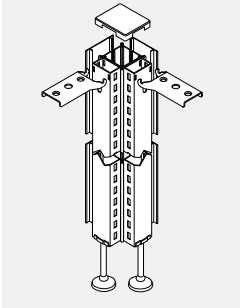

- Attaches two panels of equal height in 90° configuration.
- Provides slotted support for worksurfaces and hang-on storage components.
- Includes corner post, two slotted connectors with levelling glides, attachment hardware and trim.

PRODUCT CODE	PRICE	TYPE	SIZE/ INCHES	INCHES	WEIGHT LBS	VOL FT <sup>3</sup>
EVPCPA230	157	Aluminum	30	2.875	8.50	0.31
EVPCPA242	201	Aluminum	42	2.875	11.50	0.43
EVPCPA248	211	Aluminum	48	2.875	11.50	0.43
EVPCPA254	244	Aluminum	54	2.875	15.00	0.61
EVPCPA266	290	Aluminum	66	2.875	19.00	0.75

**EVPCPA3 • Three Way Corner Post**

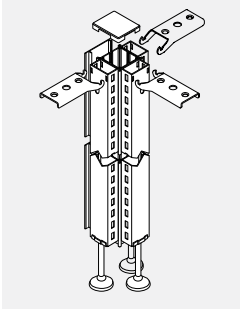

- Attaches three panels of equal height in a "T" configuration.
- Provides slotted support for worksurfaces and hang-on storage components.
- Includes corner post, three slotted connectors with levelling glides, attachment hardware top cap and trim.

PRODUCT CODE	PRICE	TYPE	SIZE/ INCHES	INCHES	WEIGHT LBS	VOL FT <sup>3</sup>
EVPCPA330	189	Aluminum	30	2.875	11.80	0.36
EVPCPA342	252	Aluminum	42	2.875	16.10	0.50
EVPCPA348	278	Aluminum	48	2.875	18.75	0.61
EVPCPA354	308	Aluminum	54	2.875	20.50	0.70
EVPCPA366	362	Aluminum	66	2.875	26.20	0.85

**EVPCP4 • Four Way Corner Post**

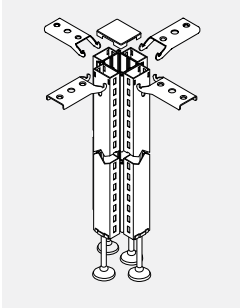

- Attaches four panels of equal height in an "X" configuration.
- Provides slotted support for worksurfaces and hang-on storage components.
- Includes corner post, four slotted connectors with levelling glides, attachment hardware and top cap.

PRODUCT CODE	PRICE	TYPE	SIZE/ INCHES	INCHES	WEIGHT LBS	VOL FT <sup>3</sup>
EVPCP430	207	Aluminum	30	2.875	15.50	0.41
EVPCP442	271	Aluminum	42	2.875	21.00	0.57
EVPCP448	298	Aluminum	48	2.875	24.00	0.68
EVPCP454	329	Aluminum	54	2.875	26.50	0.79
EVPCP466	385	Aluminum	66	2.875	33.20	0.95

**EVPVPA2 • Two Way Variable Height Corner Post**

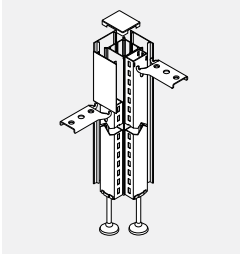

- Attaches two panels of different heights at a corner.
- Specify the corner post height that matches the tallest panel attached to the post face.
- Provides slotted support for worksurfaces and hang-on storage components.
- Includes corner post, two slotted connectors with levelling glides, attachment hardware and trim.
- Configuration of connecting panels must be specified. ie. 54/66. See Technical Information at the beginning of this section.

PRODUCT CODE	PRICE	TYPE	SIZE/ INCHES	INCHES	WEIGHT LBS	VOL FT <sup>3</sup>
EVPVPA242	201	Aluminum	42	2.875	10.00	1.30
EVPVPA248	222	Aluminum	48	2.875	13.50	1.50
EVPVPA254	244	Aluminum	54	2.875	17.00	1.80
EVPVPA266	290	Aluminum	66	2.875	20.50	2.10

**EVPVPA3 • Three Way Variable Height Corner Post**

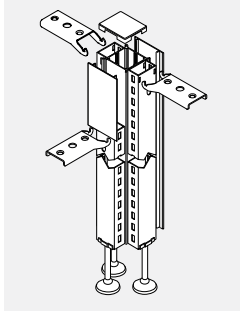

- Attaches three panels of different heights in a "T" configuration.
- Specify the corner post height that matches the tallest panel attached to the post face.
- Provides slotted support for worksurfaces and hang-on storage components.
- Includes corner post, three slotted connectors with levelling glides, attachment hardware and trim.
- Configuration of connecting panels must be specified. ie. 54/42/66. See Technical information page at the beginning of this section.

PRODUCT CODE	PRICE	TYPE	SIZE/ INCHES		WEIGHT VOL	
			H	W	LBS	FT <sup>3</sup>
EVPVPA342	252	Aluminum	42	2.875	12.50	0.30
EVPVPA348	278	Aluminum	48	2.875	15.50	0.66
EVPVPA354	308	Aluminum	54	2.875	18.50	0.68
EVPVPA366	362	Aluminum	66	2.875	24.20	0.90

**EVPVPA4 • Four Way Variable Height Corner Post**

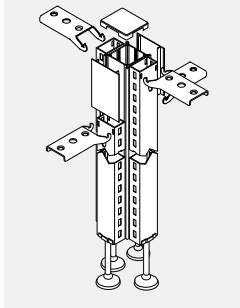

- Attaches four panels of different heights in an "X" configuration.
- Specify the corner post height that matches the tallest panel attached to the post face.
- Provides slotted support for worksurfaces and hang-on storage components.
- Includes corner post, four slotted connectors with levelling glides, attachment hardware and trim.
- Configuration of connecting panels must be specified. ie. 42/66/54/42. See Technical information page at the beginning of this section.

PRODUCT CODE	PRICE	TYPE	SIZE/ INCHES		WEIGHT VOL	
			H	W	LBS	FT <sup>3</sup>
EVPVPA442	284	Aluminum	42	2.875	18.50	0.35
EVPVPA448	314	Aluminum	48	2.875	20.50	0.70
EVPVPA454	343	Aluminum	54	2.875	24.50	1.05
EVPVPA466	405	Aluminum	66	2.875	30.20	1.40

**EVPIEC • Inline Panel Extension Connector - Non Slotted**

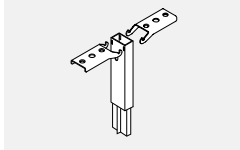

- Connects two panel extension modules of equal height in a straight run.
- Does not provide support for hang-on storage components.

PRODUCT CODE	PRICE	SIZE/ INCHES	WEIGHT VOL	
			H	W
EVPIEC06	29	6 2	1.00	0.06
EVPIEC12	29	12 2	2.00	0.12
EVPIEC18	35	18 2	3.00	0.18
EVPIEC24	35	24 2	4.00	0.24

**EVPIECS • Inline Panel Extension Connector - Slotted**

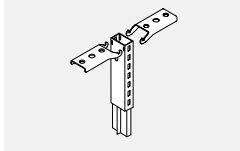

- Connects two panel extension modules of equal height in a straight run.
- Provides slotted support up to 66" high for worksurfaces and hang-on storage components.

PRODUCT CODE	PRICE	SIZE/ INCHES	WEIGHT VOL	
			H	W
EVPIECS06	36	6 2	1.00	0.06
EVPIECS12	36	12 2	2.00	0.12
EVPIECS18	42	18 2	3.00	0.18
EVPIECS24	42	24 2	4.00	0.24

**EVPEERA • End of Run Extension - Non Slotted**

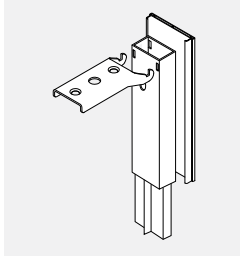

- Extends an End-of-Run Kit.
- Does not provide support for hang-on storage components.
- Includes Inline Panel Extension Connector (EVPIEC) and Panel Extension Trim (EVPTEA).

PRODUCT CODE	PRICE	TYPE	SIZE/ INCHES		WEIGHT VOL	
			H	W	LBS	FT <sup>3</sup>
EVPEERA06	33	Aluminum	6	2.875	1.00	0.06
EVPEERA12	33	Aluminum	12	2.875	2.00	0.12
EVPEERA18	39	Aluminum	18	2.875	3.00	0.18
EVPEERA24	39	Aluminum	24	2.875	4.00	0.24

**EVPEERSA • End of Run Extension - Slotted**

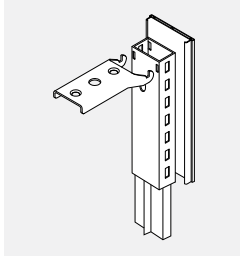

- Extends an End-of-Run Kit.
- Provides slotted support up to 66" high for worksurfaces and hang-on storage components.
- Includes Inline Panel Extension Connector (EVPIECS) and Panel Extension Trim (EVPTE or EVPTEA).

PRODUCT CODE	PRICE	TYPE	SIZE/ INCHES		WEIGHT VOL	
			H	W	LBS	FT <sup>3</sup>
EVPEERSA06	39	Aluminum	6	2.875	1.00	0.06
EVPEERSA12	39	Aluminum	12	2.875	2.00	0.12
EVPEERSA18	59	Aluminum	18	2.875	3.00	0.18
EVPEERSA24	59	Aluminum	24	2.875	4.00	0.24

**EVPCEPA1 • One Way Post Extension - Non Slotted**

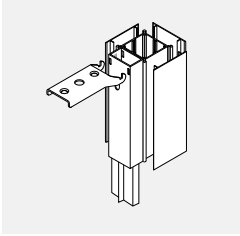

- Attaches to a corner post at the end of a run of panel extension modules.
- Includes corner extension post, one non-slotted connector, attachment hardware and trim.

PRODUCT CODE	PRICE	TYPE	SIZE/ H	INCHES W	WEIGHT LBS	VOL FT <sup>3</sup>
EVPCEPA106	64	Aluminum	6	2.875	2.00	0.07
EVPCEPA112	64	Aluminum	12	2.875	4.00	0.14
EVPCEPA118	88	Aluminum	18	2.875	6.00	0.21
EVPCEPA124	88	Aluminum	24	2.875	8.00	0.28

**EVPCEPSA1 • One Way Post Extension - Slotted**

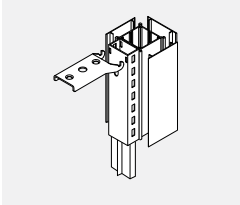

- Attaches to a corner post at the end of a run of panel extension modules.
- Provides slotted support up to 66" high for worksurfaces and hang-on storage components.
- Includes corner extension post, one slotted connector, attachment hardware and trim.

PRODUCT CODE	PRICE	TYPE	SIZE/ H	INCHES W	WEIGHT LBS	VOL FT <sup>3</sup>
EVPCEPSA106	86	Aluminum	6	2.875	2.00	0.07
EVPCEPSA112	86	Aluminum	12	2.875	4.00	0.14
EVPCEPSA118	109	Aluminum	18	2.875	6.00	0.21
EVPCEPSA124	109	Aluminum	24	2.875	8.00	0.28

**EVPCEIPA2 • Inline Post Extension - Non Slotted**

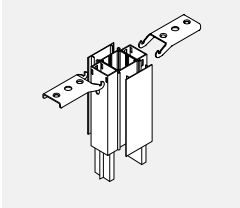

- Attaches to a corner post and connects two panel extension modules in a straight line.
- Includes corner extension post, two non-slotted connectors, attachment hardware and trim.

PRODUCT CODE	PRICE	TYPE	SIZE/ H	INCHES W	WEIGHT LBS	VOL FT <sup>3</sup>
EVPCEIPA206	87	Aluminum	6	2.875	2.00	0.07
EVPCEIPA212	87	Aluminum	12	2.875	4.00	0.14
EVPCEIPA218	136	Aluminum	18	2.875	6.00	0.18
EVPCEIPA224	136	Aluminum	24	2.875	8.00	0.28

**EVPCEIPSA2 • Inline Post Extension - Slotted**

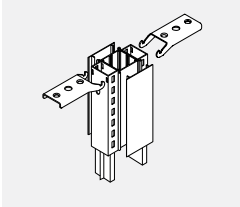

- Attaches to a corner post and connects two panel extension modules in a straight line.
- Provides slotted support up to 66" high for worksurfaces and hang-on storage components.
- Includes corner extension post, two slotted connectors, attachment hardware and trim.

PRODUCT CODE	PRICE	TYPE	SIZE/ H	INCHES W	WEIGHT LBS	VOL FT <sup>3</sup>
EVPCEIPSA206	87	Aluminum	6	2.875	2.00	0.07
EVPCEIPSA212	87	Aluminum	12	2.875	4.00	0.14
EVPCEIPSA218	136	Aluminum	18	2.875	6.00	0.18
EVPCEIPSA224	136	Aluminum	24	2.875	8.00	0.28

**EVPCEPA2 • Two Way Post Extension - Non Slotted**

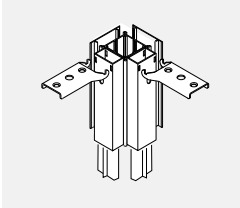

- Connects two panel extension modules of equal height in a corner "L" configuration.
- Includes corner extension post, two non-slotted connectors, attachment hardware and trim.

PRODUCT CODE	PRICE	TYPE	SIZE/ H	INCHES W	WEIGHT LBS	VOL FT <sup>3</sup>
EVPCEPA206	70	Aluminum	6	2.875	2.00	0.07
EVPCEPA212	70	Aluminum	12	2.875	4.00	0.14
EVPCEPA218	118	Aluminum	18	2.875	6.00	0.21
EVPCEPA224	118	Aluminum	24	2.875	8.00	0.28

**EVPCEPSA2 • Two Way Post Extension - Slotted**

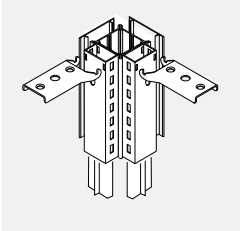

- Connects two panel extension modules of equal height in a 90° configuration.
- Includes corner extension post, two slotted connectors, attachment hardware and trim.

PRODUCT CODE	PRICE	TYPE	SIZE/ H	INCHES W	WEIGHT LBS	VOL FT <sup>3</sup>
EVPCEPSA206	87	Aluminum	6	2.875	2.00	0.07
EVPCEPSA212	87	Aluminum	12	2.875	4.00	0.14
EVPCEPSA218	136	Aluminum	18	2.875	6.00	0.21
EVPCEPSA224	136	Aluminum	24	2.875	8.00	0.28



**EVPCEPA3 • Three Way Post Extension - Non Slotted**

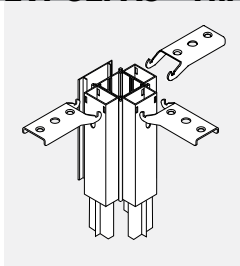

- Connects three panel extension modules of equal height in a corner "T" configuration.
- Includes corner extension post, three non-slotted connectors, attachment hardware and trim.

PRODUCT CODE	PRICE	TYPE	SIZE/ H	INCHES W	WEIGHT LBS	VOL FT <sup>3</sup>
EVPCEPA306	78	Aluminum	6	2.875	3.00	0.08
EVPCEPA312	78	Aluminum	12	2.875	6.00	0.16
EVPCEPA318	129	Aluminum	18	2.875	9.00	0.24
EVPCEPA324	129	Aluminum	24	2.875	12.00	0.32

**EVPCEPSA3 • Three Way Post Extension - Slotted**

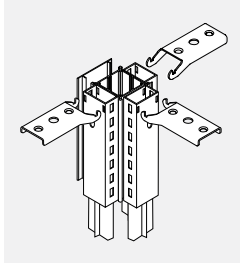

- Connects three panel extension modules of equal height in a corner "T" configuration.
- Includes corner extension post, three slotted connectors, attachment hardware and trim.

PRODUCT CODE	PRICE	TYPE	SIZE/ H	INCHES W	WEIGHT LBS	VOL FT <sup>3</sup>
EVPCEPSA306	100	Aluminum	6	2.875	3.00	0.08
EVPCEPSA312	100	Aluminum	12	2.875	6.00	0.16
EVPCEPSA318	156	Aluminum	18	2.875	9.00	0.24
EVPCEPSA324	156	Aluminum	24	2.875	12.00	0.32

**EVPCEP4 • Four Way Post Extension - Non Slotted**

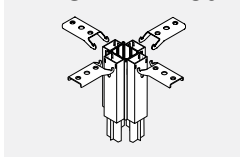

- Connects four panel extension modules of equal height in a corner "X" configuration.
- Includes corner extension post, four non-slotted connectors and attachment hardware.

PRODUCT CODE	PRICE	SIZE/ H	INCHES W	WEIGHT LBS	VOL FT <sup>3</sup>
EVPCEP406	72	6	2.875	4.00	0.09
EVPCEP412	72	12	2.875	8.00	0.18
EVPCEP418	114	18	2.875	12.00	0.27
EVPCEP424	114	24	2.875	16.00	0.36

**EVPCEPS4 • Four Way Extension Post - Slotted**

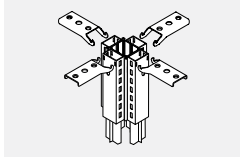

- Connects four panel extension modules of equal height in a corner "X" four-way configuration.
- Includes corner extension post, four slotted connectors and attachment hardware.

PRODUCT CODE	PRICE	SIZE/ H	INCHES W	WEIGHT LBS	VOL FT <sup>3</sup>
EVPCEPS406	103	6	2.875	4.00	0.09
EVPCEPS412	103	12	2.875	8.00	0.18
EVPCEPS418	141	18	2.875	12.00	0.27
EVPCEPS424	154	24	2.875	16.00	0.36

**EVP4PA • Two Way 45° Corner Post**

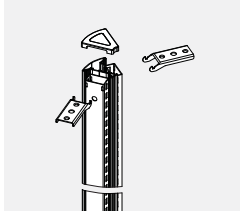

- Attaches two Panels of equal height in a 135° configuration.
- Provides slotted support for worksurfaces and hang-on storage components.
- Includes corner post, two slotted connectors with leveling glides and connecting hardware.
- Connectors available without slots as a special at no upcharge. Contact Customer Support.
- Does not allow to run wires under top trim.

PRODUCT CODE	PRICE	SIZE/ H	INCHES W	WEIGHT LBS	VOL FT <sup>3</sup>
EVP4PA230	143	30	3.65	8.50	0.310
EVP4PA242	182	42	3.65	11.50	0.430
EVP4PA248	191	48	3.65	13.50	0.540
EVP4PA254	222	54	3.65	15.00	0.610
EVP4PA266	263	66	3.65	19.00	0.750

**EVP4VPA • Variable Height Two Way 45° Corner Post - Aluminum**

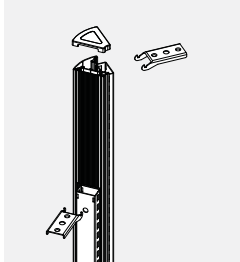

- Attaches two Panels of different height in a 135° configuration.
- Specify the corner post height that matches the tallest panel attached to the post face.
- Provides slotted support for worksurfaces and hang-on storage components.
- Includes corner post, two slotted connectors with leveling glides and connecting hardware.
- Connectors available without slots as a special at no upcharge. Contact Customer Support.
- Do not allow to run wires under the top trim.

PRODUCT CODE	PRICE	SIZE/ H	INCHES W	WEIGHT LBS	VOL FT <sup>3</sup>
EVP4VPA242	191	42	3.65	8.50	0.310
EVP4VPA248	212	48	3.65	11.50	0.430
EVP4VPA254	233	54	3.65	13.50	0.540
EVP4VPA266	278	66	3.65	15.00	0.610

**EVP4CEPSA • One Way 45° Corner Post Extension - Slotted - Aluminum**

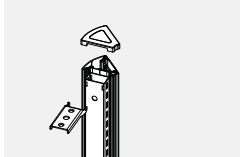

- Attached to a corner post at the end of run of panel extension modules.
- Provides slotted support up to 66" high for worksurfaces and hang-on storage components.
- Includes corner extension post, one slotted connectors, connecting hardware and trim kit.

PRODUCT CODE	PRICE	SIZE/ H	INCHES W	WEIGHT LBS	VOL FT <sup>3</sup>
EVP4CEPSA106	78	6	3.65	6	3.65
EVP4CEPSA112	81	12	3.65	12	3.65
EVP4CEPSA118	106	18	3.65	18	3.65
EVP4CEPSA124	106	24	3.65	24	3.65

**EVP4CEPA • One Way 45° Corner Post Extension - Non Slotted - Aluminum**

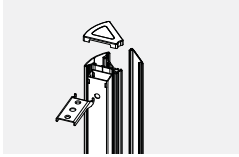

- Attached to a corner post at the end of run of panel extension modules.
- Includes corner extension post, one non-slotted connectors, connecting hardware and trim kit.

PRODUCT CODE	PRICE	SIZE/ H	INCHES W	WEIGHT LBS	VOL FT <sup>3</sup>
EVP4CEPA106	59	6	3.65	6	3.65
EVP4CEPA112	63	12	3.65	12	3.65
EVP4CEPA118	85	18	3.65	18	3.65
EVP4CEPA124	85	24	3.65	24	3.65

**EVP6PA2 • Two Way 60° Corner Post - Aluminum**

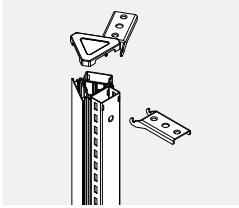

- Attaches two Panels of equal height in a 120° configuration.
- Provides slotted support for worksurfaces and hang-on storage components.
- Includes corner post, two slotted connectors with leveling glides, connecting hardware and trim kit.
- Connectors available without slots as a special at no upcharge. Contact Customer Support.

PRODUCT CODE	PRICE	SIZE/ H	INCHES W	WEIGHT LBS	VOL FT <sup>3</sup>
EVP6PA230	152	30	3.65	8.50	0.310
EVP6PA242	189	42	3.65	11.50	0.430
EVP6PA248	206	48	3.65	13.50	0.540
EVP6PA254	234	54	3.65	15.00	0.610
EVP6PA266	278	66	3.65	19.00	0.750

**EVP6P3 • Three Way 60° Corner Post**

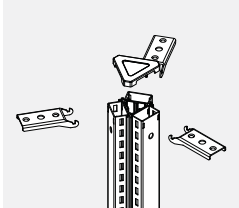

- Attaches three panels of equal height in a 120° configuration.
- Provides slotted support for worksurfaces and hang-on storage components.
- Includes corner post, two slotted connectors with leveling glides and connecting hardware.
- Connectors available without slots as a special at no upcharge. Contact Customer Support.

PRODUCT CODE	PRICE	SIZE/ H	INCHES W	WEIGHT LBS	VOL FT <sup>3</sup>
EVP6P330	164	30	3.65	11.90	0.360
EVP6P342	220	42	3.65	16.10	0.500
EVP6P348	242	48	3.65	18.75	0.610
EVP6P354	268	54	3.65	20.50	0.700
EVP6P366	317	66	3.65	26.20	0.850

**EVP6VPA2 • Variable Height Two Way 60° Corner Post - Aluminum**

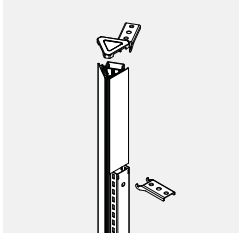

- Attaches two Panels of different height in a 120° configuration.
- Specify the corner post height that matches the tallest panel attached to the post face.
- Provides slotted support for worksurfaces and hang-on storage components.
- Includes corner post, two slotted connectors with leveling glides, connecting hardware and trim kit.
- Connectors available without slots as a special at no upcharge. Contact Customer Support

PRODUCT CODE	PRICE	SIZE/ H	INCHES W	WEIGHT LBS	VOL FT <sup>3</sup>
EVP6VPA242	191	30	3.65	12.50	0.490
EVP6VPA248	212	42	3.65	15.40	0.660
EVP6VPA254	233	48	3.65	19.00	0.700
EVP6VPA266	278	54	3.65	22.50	0.750

**EVP6VPA3 • Variable Height Three Way 60° Corner Post - Aluminum**

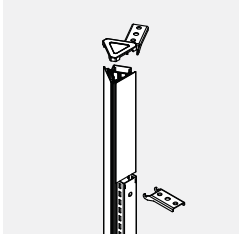

- Attaches two Panels of different height in a 120° configuration.
- Specify the corner post height that matches the tallest panel attached to the post face.
- Provides slotted support for worksurfaces and hang-on storage components.
- Includes corner post, two slotted connectors with leveling glides, connecting hardware and trim kit.
- Connectors available without slots as a special at no upcharge. Contact Customer Support

PRODUCT CODE	PRICE	SIZE/ H	INCHES W	WEIGHT LBS	VOL FT <sup>3</sup>
EVP6VPA342	240	30	3.65	18.50	0.550
EVP6VPA348	268	42	3.65	20.50	0.700
EVP6VPA354	304	48	3.65	24.50	1.050
EVP6VPA366	350	54	3.65	30.20	1.400

**EVP4CEPS2 • Two Way 45° Corner Post Extension - Slotted**

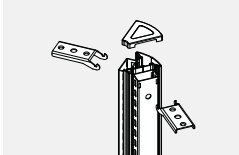

- Used to connect two panel extension modules of equal height.
- Provides slotted support up to 66" high for worksurfaces and hang-on storage components.
- Includes corner extension post, two slotted connectors and connecting hardware.

PRODUCT CODE	PRICE	SIZE/ H	INCHES W	WEIGHT LBS	VOL FT <sup>3</sup>
EVP4CEPS206	72	6	3.65	6	3.65
EVP4CEPS212	72	12	3.65	12	3.65
EVP4CEPS218	112	18	3.65	18	3.65
EVP4CEPS224	112	24	3.65	24	3.65

**EVP4CEP2 • Two Way 45° Corner Post Extension - Non Slotted**

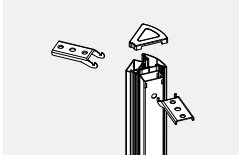

- Used to connect two panel extension modules of equal height.
- Includes corner extension post, two non-slotted connectors and connecting hardware.

PRODUCT CODE	PRICE	SIZE/ H	INCHES W	WEIGHT LBS	VOL FT <sup>3</sup>
EVP4CEP206	58	6	3.65	6	3.65
EVP4CEP212	58	12	3.65	12	3.65
EVP4CEP218	105	18	3.65	18	3.65
EVP4CEP224	105	24	3.65	24	3.65

**EVP6CEPSA • One Way 60° Corner Post Extension - Slotted - Aluminum**

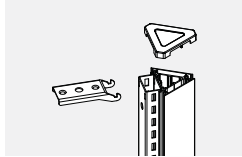

- Attached to a corner post at the end of run of panel extension modules.
- Provides slotted support up to 66" high for worksurfaces and hang-on storage components.
- Includes corner extension post, one slotted connectors, connecting hardware and trim kit.

PRODUCT CODE	PRICE	SIZE/ H	INCHES W	WEIGHT LBS	VOL FT <sup>3</sup>
EVP6CEPSA106	78	6	3.65	6	3.65
EVP6CEPSA112	81	12	3.65	12	3.65
EVP6CEPSA118	106	18	3.65	18	3.65
EVP6CEPSA124	106	24	3.65	24	3.65

**EVP6CEPA • One Way 60° Corner Post Extension - Non Slotted - Aluminum**

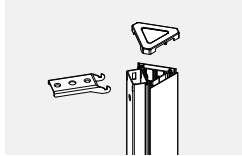

- Attached to a corner post at the end of run of panel extension modules.
- Includes corner extension post, one non-slotted connectors, connecting hardware and trim kit.

PRODUCT CODE	PRICE	SIZE/ H	INCHES W	WEIGHT LBS	VOL FT <sup>3</sup>
EVP6CEPA106	59	6	3.65	6	3.65
EVP6CEPA112	63	12	3.65	12	3.65
EVP6CEPA118	85	18	3.65	18	3.65
EVP6CEPA124	85	24	3.65	24	3.65

**EVP6CEPSA2 • Two Way 60° Corner Post Extension - Slotted - Aluminum**

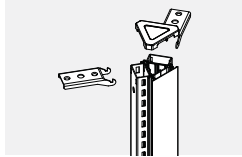

- Used to connect two panel extension modules of equal height.
- Provides slotted support up to 66" high for worksurfaces and hang-on storage components.
- Includes corner extension post, two non-slotted connectors, connecting hardware and trim kit.

PRODUCT CODE	PRICE	SIZE/ H	INCHES W	WEIGHT LBS	VOL FT <sup>3</sup>
EVP6CEPSA206	85	6	3.65	6	3.65
EVP6CEPSA212	85	12	3.65	12	3.65
EVP6CEPSA218	132	18	3.65	18	3.65
EVP6CEPSA224	132	24	3.65	24	3.65

**EVP6CEPA2 • Two Way 60° Corner Post Extension - Non Slotted - Aluminum**

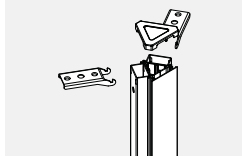

- Used to connect two panel extension modules of equal height.
- Includes corner extension post, two non-slotted connectors, connecting hardware and trim kit.

PRODUCT CODE	PRICE	SIZE/ H	INCHES W	WEIGHT LBS	VOL FT <sup>3</sup>
EVP6CEPA206	70	6	3.65	6	3.65
EVP6CEPA212	79	12	3.65	12	3.65
EVP6CEPA218	113	18	3.65	18	3.65
EVP6CEPA224	113	24	3.65	24	3.65

**EVP6CEPS3 • Three Way 60° Corner Post Extension - Slotted**

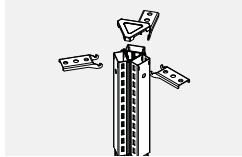

- Used to connect two panel extension modules of equal height.
- Provides slotted support up to 66" high for worksurfaces and hang-on storage components.
- Includes corner extension post, two slotted connectors and connecting hardware

PRODUCT CODE	PRICE	SIZE/ H	INCHES W	WEIGHT LBS	VOL FT <sup>3</sup>
EVP6CEPS306	86	6	3.65	6	3.65
EVP6CEPS312	86	12	3.65	12	3.65
EVP6CEPS318	135	18	3.65	18	3.65
EVP6CEPS324	135	24	3.65	24	3.65

**EVP6CEP3 • Three Way 60° Corner Post Extension - Non Slotted**

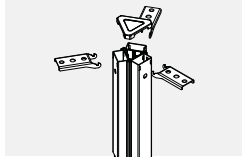

- Used to connect two panel extension modules of equal height.
- Includes corner extension post, two non-slotted connectors and connecting hardware.

PRODUCT CODE	PRICE	SIZE/ H	INCHES W	WEIGHT LBS	VOL FT <sup>3</sup>
EVP6CEP306	67	6	3.65	6	3.65
EVP6CEP312	67	12	3.65	12	3.65
EVP6CEP318	109	18	3.65	18	3.65
EVP6CEP324	109	24	3.65	24	3.65

**EVPVTFA • Flat Trim - Aluminum**

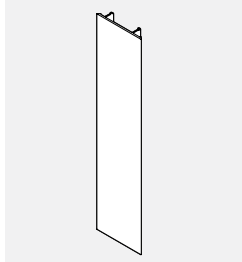

- Finishes exposed faces of one way, two way, three way and inline posts.
- For reconfiguration and replacement use only.

PRODUCT CODE	PRICE	SIZE/ H	INCHES W	WEIGHT LBS	VOL FT <sup>3</sup>
EVPVTFA30	15	29.125	2.875	0.39	0.05
EVPVTFA36	15	35.125	2.875	0.44	0.06
EVPVTFA42	22	41.125	2.875	0.56	0.07
EVPVTFA48	23	47.125	2.875	0.62	0.08
EVPVTFA54	24	53.125	2.875	0.75	0.09
EVPVTFA66	26	65.125	2.875	0.86	0.12
EVPVTFA78	29	77.125	2.875	0.85	0.12
EVPVTFA90	30	89.125	2.875	0.88	0.15

**EVPVTFEA • Flat Variable Height Extension Trim - Aluminum**

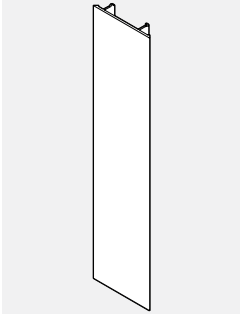

- Finishes exposed faces of one way, two way, three way and inline post extensions.
- For reconfiguration and replacement use only.

PRODUCT CODE	PRICE	SIZE/ H	INCHES W	WEIGHT LBS	VOL FT <sup>3</sup>
EVPVTFEA06	11	6.375	2.875	0.12	0.01
EVPVTFEA12	12	12.375	2.875	0.16	0.02
EVPVTFEA18	13	18.375	2.875	0.28	0.03
EVPVTFEA24	13	24.375	2.875	0.32	0.04
EVPVTFEA30	15	30.375	2.875	0.36	0.05
EVPVTFEA36	20	36.375	2.875	0.40	0.06
EVPVTFEA42	22	42.375	2.875	0.44	0.07
EVPVTFEA48	23	48.375	2.875	0.48	0.08
EVPVTFEA54	24	54.375	2.875	0.52	0.09
EVPVTFEA66	26	66.375	2.875	0.56	0.10
EVPVTFEA78	29	78.375	2.875	0.64	0.12
EVPVTFEA90	30	90.375	2.875	0.72	0.14

**EVPTVA • Panel Trim Variable Height - Aluminum**

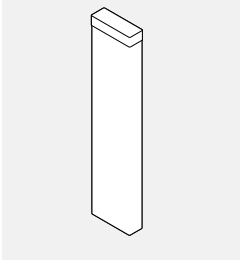

- Attaches to the exposed end of the taller panel when 2 panels of different height meet in straight run.
- Must be ordered separately.

PRODUCT CODE	PRICE	SIZE/ H	INCHES W	WEIGHT LBS	VOL FT <sup>3</sup>
EVPTVA06	22	5.621	2.875	0.10	0.03
EVPTVA12	25	11.621	2.875	0.20	0.03
EVPTVA18	33	18.621	2.875	0.22	0.04
EVPTVA24	39	23.621	2.875	0.20	0.10
EVPTVA30	51	29.621	2.875	0.20	0.15
EVPTVA36	59	35.621	2.875	0.30	0.20

**EVPERTA • End of Run Trim - Aluminum**

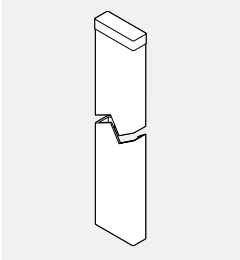

- Finishes the exposed connector at the end of a run of panels.
- Slotted connector not included.
- For reconfiguration and replacement use only.

PRODUCT CODE	PRICE	SIZE/ H	INCHES W	WEIGHT LBS	VOL FT <sup>3</sup>
EVPERTA30	52	28.815	2.875	1.00	0.65
EVPERTA42	62	40.815	2.875	1.40	0.70
EVPERTA48	66	46.815	2.875	1.60	0.90
EVPERTA54	76	52.815	2.875	1.80	0.95
EVPERTA66	87	64.815	2.875	2.20	0.98
EVPERTA78	94	76.815	2.875	1.12	0.15
EVPERTA84	103	82.815	2.875	1.20	0.16
EVPERTA90	103	88.815	2.875	1.29	0.18

**EVPTEA • Panel Extension Trim - Aluminum**

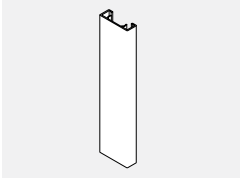

- Attaches to bottom of exposed end of panel to provide extension for End-of-Run trim when using panel extensions.
- Does not include slotted connector or connecting hardware.

PRODUCT CODE	PRICE	SIZE/ H	INCHES W	WEIGHT LBS	VOL FT <sup>3</sup>
EVPTEA06	22	6	2.875	0.08	0.03
EVPTEA12	25	12	2.875	0.10	0.03
EVPTEA18	33	18	2.875	0.12	0.03
EVPTEA24	39	24	2.875	0.20	0.60

**EVPUETA12 • Upmount Extension Trim - Aluminum**

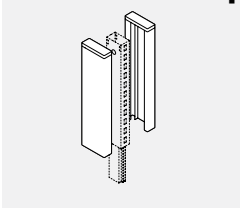

- Attaches to the Upmount Extension Connector EVPUESA12 or to an Inline Connector EVPVC66 66" high.
- Used to finish the exposed Upmount Extension Connector on both sides.
- Priced in pairs.

PRODUCT CODE	PRICE	SIZE/ H	INCHES W	WEIGHT LBS	VOL FT <sup>3</sup>
EVPUETA12	39	12	2.875	0.20	0.03

**EVPIECH • 12" Channel for Center Mount Overhead**

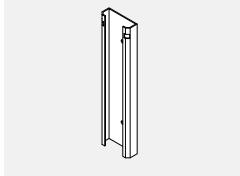

- 12" channel to attaches panel to the side of a pre-installed center mount overhead with screws.
- Includes 12" channel and connecting hardware.

PRODUCT CODE	PRICE	SIZE/INCHES			WEIGHT LBS	VOL FT <sup>3</sup>
		H	W	D		
EVPIECH12	37	12	3		1.32	0.12

**EVPTTA • Panel Top Trim Aluminum**

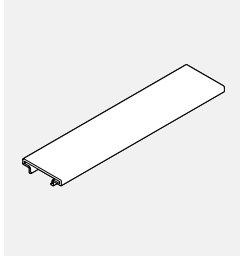

- Comes standard on all panels.
- Supplied at no charge.
- Field install no longer necessary.

PRODUCT CODE	PRICE	SIZE/INCHES		WEIGHT LBS	VOL FT <sup>3</sup>
		H	W		
EVPTTA18	12	18	2.875	0.18	0.03
EVPTTA24	15	24	2.875	0.22	0.04
EVPTTA30	22	30	2.875	0.29	0.05
EVPTTA36	24	36	2.875	0.30	0.06
EVPTTA42	28	42	2.875	0.34	0.07
EVPTTA48	33	48	2.875	0.38	0.08
EVPTTA54	36	54	2.875	0.42	0.09
EVPTTA60	42	60	2.875	0.46	0.10

**EVPTNTA • Panel Top Notched Trim Aluminum**

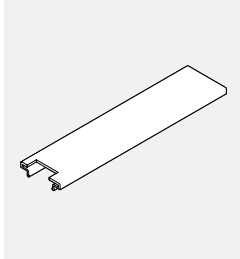

- Comes standard on all panels.
- Used when connecting a lower panel to a higher panel.
- To be used when shipping new panels with aluminum trim.
- Supplied at no charge when using panels in variable height configurations.
- Field install no longer necessary.

PRODUCT CODE	PRICE	SIZE/INCHES		WEIGHT LBS	VOL FT <sup>3</sup>
		H	W		
EVPTNTA18	13	18	2.875	0.18	0.03
EVPTNTA24	20	24	2.875	0.22	0.04
EVPTNTA30	23	30	2.875	0.26	0.05
EVPTNTA36	25	36	2.875	0.30	0.06
EVPTNTA42	29	42	2.875	0.34	0.07
EVPTNTA48	34	48	2.875	0.38	0.08
EVPTNTA54	37	54	2.875	0.42	0.09
EVPTNTA60	45	60	2.875	0.46	0.10

**EVPTDNTA • Panel Top Double Notched Trim Aluminum**

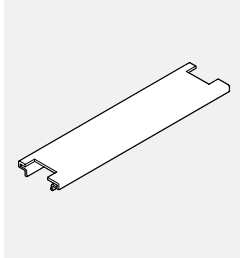

- Comes standard on all panels.
- Used when connecting a lower panel to two higher panels.
- To be used when shipping new panels with aluminum trim.
- Supplied at no charge when using panels in variable height configurations.
- Field install no longer necessary.

PRODUCT CODE	PRICE	SIZE/INCHES		WEIGHT LBS	VOL FT <sup>3</sup>
		H	W		
EVPTDNTA18	15	18	2.875	0.18	0.03
EVPTDNTA24	22	24	2.875	0.22	0.04
EVPTDNTA30	24	30	2.875	0.26	0.05
EVPTDNTA36	26	36	2.875	0.30	0.06
EVPTDNTA42	30	42	2.875	0.34	0.07
EVPTDNTA48	35	48	2.875	0.38	0.08
EVPTDNTA54	39	54	2.875	0.42	0.09
EVPTDNTA60	47	60	2.875	0.46	0.10

**EVPTTCA - Aluminum Top Trim with Channel for Acoustic Grid**

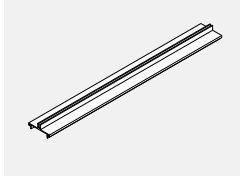

- Top trim with channel.
- Available in standard paint colors.
- Note: Trim can span inline connector, but not a post.

PRODUCT CODE	PRICE	SIZE/INCHES			WEIGHT LBS	VOL FT <sup>3</sup>
		H	W	D		
EVPTTCA18	13	18	2 7/8	0.18	0.03	
EVPTTCA24	16	24	2 7/8	0.22	0.04	
EVPTTCA30	24	30	2 7/8	0.29	0.05	
EVPTTCA36	27	36	2 7/8	0.30	0.06	
EVPTTCA42	30	42	2 7/8	0.34	0.07	
EVPTTCA48	35	48	2 7/8	0.38	0.08	
EVPTTCA54	39	54	2 7/8	0.42	0.09	
EVPTTCA60	46	60	2 7/8	0.46	0.10	
EVPTTCA66	49	66	2 7/8	0.50	0.11	
EVPTTCA72	52	72	2 7/8	0.54	0.12	
EVPTTCA78	58	78	2 7/8	0.58	0.13	
EVPTTCA84	63	84	2 7/8	0.62	0.14	
EVPTTCA90	71	90	2 7/8	0.66	0.15	
EVPTTCA96	82	96	2 7/8	0.70	0.16	

**EVSC12 • Slot Cover**



- Covers the slots of a slotted connector between panels as well as a corner post and end-of-run kit.
- Sold by the foot and cut on site by the installers.
- To order the required length, calculate the sum of the length of all inline connectors (including the posts and end-of-run kit) and multiply by 2.

PRODUCT CODE	PRICE	SIZE/ INCHES	WEIGHT LBS	VOL FT <sup>3</sup>
EVSC12	4	12 1	0.01	0.01

**EVECC310 • Wire Manager**

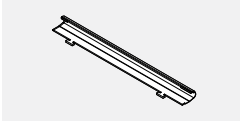

- Attaches to panels vertically between modules to provide enclosures for power or data cords.
- Sold in packages of 6.
- Can be overlapped to achieve required length.

PRODUCT CODE	PRICE	SIZE/ INCHES	WEIGHT LBS	VOL FT <sup>3</sup>
EVECC310	39	10 1	0.01	0.01

**EVHLPF01 • Low Profile Foot**

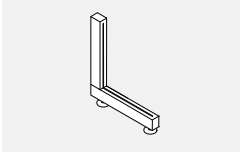

- Used to provide additional support to panel run without adding panels.
- Connects to inline connector or end of run at base of panels.

PRODUCT CODE	PRICE	SIZE/ INCHES	WEIGHT LBS	VOL FT <sup>3</sup>
EVHLPF01	97	11 11 1	2.6	0.07

**EVCLVAR • Connector Variable Height Clamp**

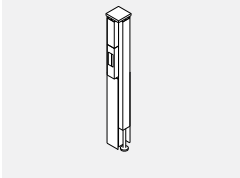

- Used for connecting two panels of variable height.

PRODUCT CODE	PRICE	SIZE/ INCHES	WEIGHT LBS	VOL FT <sup>3</sup>
EVCLVAR	8		0.5	0.01

**EVPIECBS • Bridge Panel Inline Extension Connector**

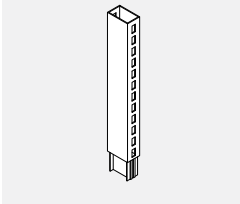

- Connects bridge panel to inline extension connector.
- Includes one bridge extension connector and connecting hardware.

PRODUCT CODE	PRICE	SIZE/INCHES	WEIGHT LBS	VOL FT <sup>3</sup>
EVPIECBS06	28	6 3 3	1.00	0.06
EVPIECBS12	28	12 3 3	2.00	0.12
EVPIECBS18	33	18 3 3	3.00	0.18
EVPIECBS24	33	24 3 3	4.00	0.24

**EVPEERBSA • Bridge Panel End of Run Extension Connector - Aluminum Trim**

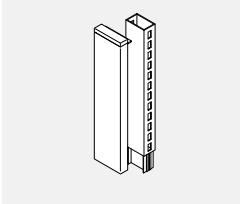

- Connects at end of run of bridge panel and can attach panel to fixed wall.
- Adds 1" to width of panel run.
- Provides slotted support for worksurfaces and hang on components up to 66" high.
- Includes one slotted bridge extension connector and connecting hardware and trim kit.

PRODUCT CODE	PRICE	SIZE/INCHES	WEIGHT LBS	VOL FT <sup>3</sup>
EVPEERBSA06	33	6 3 3	1.00	0.06
EVPEERBSA12	33	12 3 3	2.00	0.12
EVPEERBSA18	50	18 3 3	3.00	0.18
EVPEERBSA24	50	24 3 3	4.00	0.24

**EVPICBS • Bridge Panel Inline Connector without Aluminum Insert**

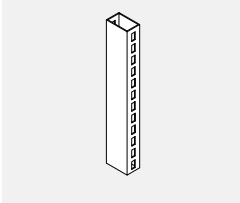

- Connects two bridge panels to inline connector.
- Inline connector in middle between two bridge panels, above opening, using double clamp at bottom.
- Includes one bridge extension connector without aluminum insert and connecting hardware.

PRODUCT CODE	PRICE	SIZE/INCHES	WEIGHT LBS	VOL FT <sup>3</sup>
EVPICBS06	31	6 3 3	1.00	0.06
EVPICBS12	31	12 3 3	2.00	0.12
EVPICBS18	37	18 3 3	3.00	0.18
EVPICBS24	37	24 3 3	4.00	0.24

**EVPCEPB1 • Bridge Panel Corner Extension Post 1-way**



- Connects at end of a run of extension modules.
- Post and connecting hardware add 3.25" to power beam run.
- Includes one extension post, one slotted extension connectors for bridge panel, connecting hardware and trim kit.

PRODUCT CODE	PRICE	SIZE/INCHES			WEIGHT LBS	VOL FT <sup>3</sup>
		H	W	D		
EVPCEPBSA106	73	6	3	3	2.00	0.07
EVPCEPBSA112	73	12	3	3	4.00	0.14
EVPCEPBSA118	94	18	3	3	6.00	0.21
EVPCEPBSA124	94	24	3	3	8.00	0.14

**EVPCEPB4 • Bridge Panel Corner Extension Post 4-way**

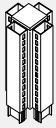

- Connects four bridge panels in 90 degree configuration.
- Post and connecting hardware add 3.25" to power beam run.
- Includes one extension post, four one slotted extension connectors for bridge panel, connecting hardware and trim kit.

PRODUCT CODE	PRICE	SIZE/INCHES			WEIGHT LBS	VOL FT <sup>3</sup>
		H	W	D		
EVPCEPBS406	97	6	3	3	4.00	0.09
EVPCEPBS412	97	12	3	3	8.00	0.18
EVPCEPBS418	152	18	3	3	12.00	0.27
EVPCEPBS424	152	24	3	3	16.00	0.36

**EVPCEPB3 • Bridge Panel Corner Extension Post 3-way**

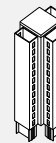

- Connects three bridge panels in 90 degree configuration.
- Post and connecting hardware add 3.25" to power beam run.
- Includes one extension post, three one slotted extension connectors for bridge panel, connecting hardware and trim kit.

PRODUCT CODE	PRICE	SIZE/INCHES			WEIGHT LBS	VOL FT <sup>3</sup>
		H	W	D		
EVPCEPBSA306	86	6	3	3	3.00	0.08
EVPCEPBSA312	86	12	3	3	6.00	0.16
EVPCEPBSA318	135	18	3	3	9.00	0.24
EVPCEPBSA324	135	24	3	3	12.00	0.32

**EVPCEPB2 • Bridge Panel Corner Extension Post 2-way**



- Connects two bridge panels in 90 degree configuration.
- Post and connecting hardware add 3.25" to power beam run.
- Includes one extension post, two one slotted extension connectors for bridge panel, connecting hardware and trim kit.

PRODUCT CODE	PRICE	SIZE/INCHES			WEIGHT LBS	VOL FT <sup>3</sup>
		H	W	D		
EVPCEPBSA206	74	6	3	3	2.00	0.07
EVPCEPBSA212	74	12	3	3	4.00	0.14
EVPCEPBSA218	118	18	3	3	6.00	0.21
EVPCEPBSA224	118	24	3	3	8.00	0.14

**EVPCEIPBSA2 • Bridge Panel Inline 2-way Post Extension**

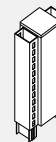

- Connects two bridge panels in straight run.
- Post and connecting hardware add 3.25" to power beam run.
- Includes one extension post, two slotted extension connectors for bridge panel, connecting hardware and trim kit.

PRODUCT CODE	PRICE	SIZE/INCHES			WEIGHT LBS	VOL FT <sup>3</sup>
		H	W	D		
EVPCEIPBSA206	74	6	3	3	2.00	0.07
EVPCEIPBSA212	74	12	3	3	4.00	0.14
EVPCEIPBSA218	118	18	3	3	6.00	0.21
EVPCEIPBSA224	118	24	3	3	8.00	0.14

## NO RACEWAY PANELS • TECHNICAL INFORMATION

- Evolve panels are 2 7/8" thick. They are available in four (5) basic heights: 30", 42", 48", 54" and 66" and eight (8) widths: 18" to 60" in 6" increments.
- Individual fabric covered acoustic modules incorporated into a rigid steel frame.
- Opposite side of each module may have a different fabric within the same grade at no upcharge.
- If different grades of fabric are used on one panel, the entire panel must be priced at highest grade.
- A low profile top cap is included.
- No panel creep.
- 12" high and 24" high modules of 2 types (fabric and laminate) are available for field installation. Contact your Customer Service Representative.
- Laminate for laminate panels cannot be replaced in the field, complete module must be ordered.

## PANELS • GUIDELINES FOR ORDERING PRODUCT

The price list uses a numbering system with meaningful alphanumeric characters to create a simple-to-understand product number. This makes specifying the product much easier and more accurate.

### EXAMPLE OF PANEL CODE

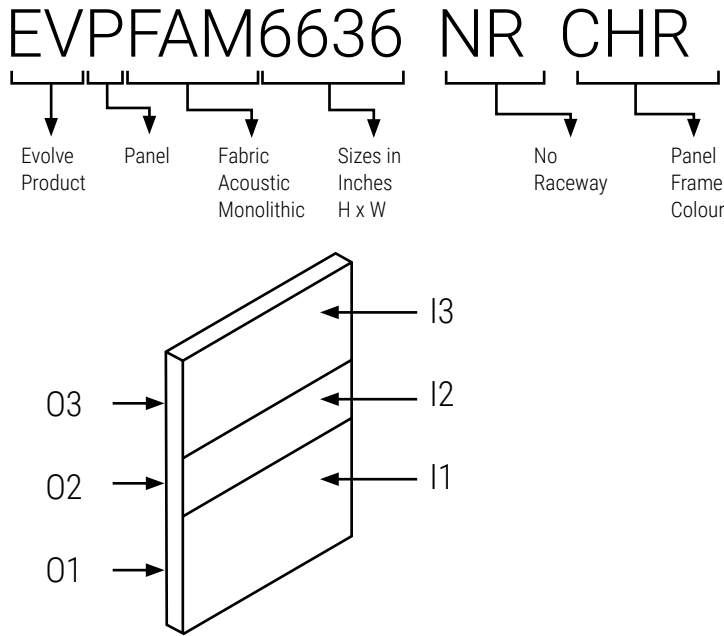

I1	AN50	Inside Fabric Position #1
I2	AN50	Inside Fabric Position #2
I3	AN50	Inside Fabric Position #3
O1	BE21	Outside Fabric Position #1
O2	BE21	Outside Fabric Position #2
O3	BE21	Outside Fabric Position #3

### HOW TO SPECIFY

- Specify Evolve panel type and size by code.
- Specify panel frame finish - ie. CHR (Charcoal).
- Specify all necessary panel fabric options.

**NOTE: If different grades of fabric are used on one panel, the entire panel must be priced out at the higher grade.**



**EVPFA-NR • Segmented (No Raceway) Panel**

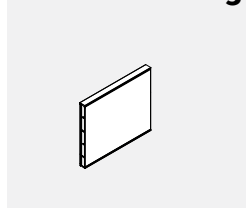

- Segmented (No Raceway) panel incorporates fabric modules within steel frame.
- There is no base raceway in No Raceway Panels to accommodate electric.
- **No Raceway connectors to be used.**
- Fabric covered modules are tackable and acoustical.
- Each side of fabric module may have different fabric within the same grade at no charge.
- If different grades of fabric are used, the entire module must be price at highest grade.
- Aluminum low profile top and bottom cap is included.
- Stackability: Evolve panels can be increased in height in 6", 12", 24" increments. See module listing for part numbers.

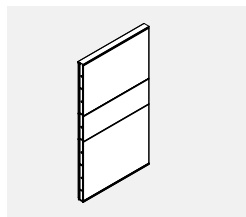
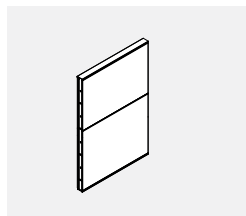
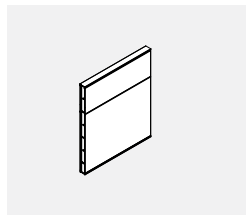

PRODUCT CODE	PRICE		SIZE/ INCHES			WEIGHT	VOL
	GR 1	GR 2	H	W	D	LBS	FT <sup>3</sup>
EVPFA3018NR	296	308	30	18	2.875	15.38	1.23
EVPFA3024NR	309	361	30	24	2.875	18.20	1.63
EVPFA3030NR	342	361	30	30	2.875	21.76	2.00
EVPFA3036NR	367	389	30	36	2.875	24.80	2.38
EVPFA3042NR	396	421	30	42	2.875	26.49	2.76
EVPFA3048NR	438	468	30	48	2.875	32.00	3.13
EVPFA3054NR	472	505	30	54	2.875	35.31	3.51
EVPFA3060NR	507	546	30	60	2.875	38.20	3.89
EVPFA4218NR	328	344	42	18	2.875	20.58	1.71
EVPFA4224NR	344	371	42	24	2.875	24.60	2.31
EVPFA4230NR	400	430	42	30	2.875	29.35	2.81
EVPFA4236NR	433	468	42	36	2.875	35.60	3.38
EVPFA4242NR	494	532	42	42	2.875	39.29	3.92
EVPFA4248NR	532	576	42	48	2.875	43.20	4.45
EVPFA4254NR	589	638	42	54	2.875	47.52	4.98
EVPFA4260NR	646	700	42	60	2.875	51.60	5.52
EVPFA4818NR	352	374	48	18	2.875	23.98	2.19
EVPFA4824NR	385	418	48	24	2.875	27.80	2.94
EVPFA4830NR	439	476	48	30	2.875	33.15	3.62
EVPFA4836NR	490	534	48	36	2.875	37.40	4.31
EVPFA4842NR	553	607	48	42	2.875	40.69	4.99
EVPFA4848NR	616	674	48	48	2.875	48.20	5.67
EVPFA4854NR	671	736	48	54	2.875	52.92	6.35
EVPFA4860NR	718	790	48	60	2.875	57.40	7.03
EVPFA5418NR	352	374	54	18	2.875	23.98	2.19
EVPFA5424NR	385	418	54	24	2.875	27.80	2.94
EVPFA5430NR	439	476	54	30	2.875	33.15	3.62
EVPFA5436NR	490	534	54	36	2.875	37.40	4.31
EVPFA5442NR	553	607	54	42	2.875	40.69	4.99
EVPFA5448NR	616	674	54	48	2.875	48.20	5.67
EVPFA5454NR	671	736	54	54	2.875	52.92	6.35
EVPFA5460NR	718	790	54	60	2.875	57.40	7.03
EVPFA6618NR	442	472	66	18	2.875	29.98	2.68
EVPFA6624NR	343	520	66	24	2.875	35.00	3.58
EVPFA6630NR	528	576	66	30	2.875	41.54	4.40
EVPFA6636NR	619	677	66	36	2.875	49.00	5.23
EVPFA6642NR	701	767	66	42	2.875	54.29	6.06
EVPFA6648NR	751	825	66	48	2.875	60.20	6.08
EVPFA6654NR	817	899	66	54	2.875	65.93	7.70
EVPFA6660NR	883	972	66	60	2.875	71.60	8.53

**EVPFAM-NR • Monolithic (No Raceway) Panel**

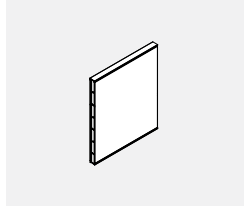

- Monolithic (No Raceway) panel incorporates fabric modules within steel frame.
- There is no base raceway in No Raceway Panels to accommodate electric.
- **No Raceway connectors to be used.**
- Fabric covered modules are tackable and acoustical.
- Each side of fabric module may have different fabric within the same grade at no charge.
- If different grades of fabric are used, the entire module must be price at highest grade.
- Aluminum low profile top and bottom cap is included.
- Stackability: Evolve panels can be increased in height in 6", 12", 24" increments. See module listing for part numbers.

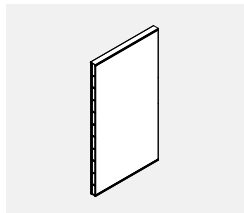
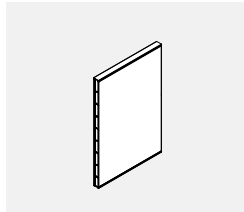
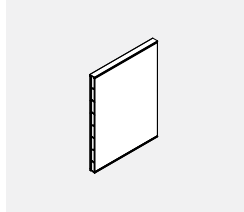

PRODUCT CODE	PRICE		SIZE/ H	INCHES			WEIGHT LBS	VOL FT <sup>3</sup>
	GR 1	GR 2		W	D			
EVPFAM4218NR	303	331	42	18	2.875	20.58	1.71	
EVPFAM4224NR	323	358	42	24	2.875	23.40	2.31	
EVPFAM4230NR	369	409	42	30	2.875	26.96	2.85	
EVPFAM4236NR	396	443	42	36	2.875	30.00	3.38	
EVPFAM4242NR	439	494	42	42	2.875	31.69	3.92	
EVPFAM4248NR	477	539	42	48	2.875	37.20	4.45	
EVPFAM4254NR	526	594	42	54	2.875	40.51	4.98	
EVPFAM4260NR	572	646	42	60	2.875	43.40	5.52	
EVPFAM4818NR	309	337	48	18	2.875	21.38	1.92	
EVPFAM4824NR	340	373	48	24	2.875	24.40	2.62	
EVPFAM4830NR	392	433	48	30	2.875	27.76	3.23	
EVPFAM4836NR	426	473	48	36	2.875	30.80	3.85	
EVPFAM4842NR	476	531	48	42	2.875	32.49	4.45	
EVPFAM4848NR	520	579	48	48	2.875	37.80	5.06	
EVPFAM4854NR	573	640	48	54	2.875	41.31	5.66	
EVPFAM4860NR	622	697	48	60	2.875	44.20	6.27	
EVPFAM5418NR	311	340	54	18	2.875	24.58	2.19	
EVPFAM5424NR	342	377	54	24	2.875	27.40	2.94	
EVPFAM5430NR	397	438	54	30	2.875	30.96	3.62	
EVPFAM5436NR	442	492	54	36	2.875	34.00	4.31	
EVPFAM5442NR	495	550	54	42	2.875	35.69	4.99	
EVPFAM5448NR	537	601	54	48	2.875	41.20	5.67	
EVPFAM5454NR	592	662	54	54	2.875	44.51	6.35	
EVPFAM5460NR	647	724	54	60	2.875	47.40	7.03	
EVPFAM6618NR	386	414	66	18	2.875	27.58	2.68	
EVPFAM6624NR	421	457	66	24	2.875	30.40	3.58	
EVPFAM6630NR	476	521	66	30	2.875	33.96	4.40	
EVPFAM6636NR	553	603	66	36	2.875	37.00	5.23	
EVPFAM6642NR	622	675	66	42	2.875	38.69	6.06	
EVPFAM6648NR	675	737	66	48	2.875	44.20	6.88	
EVPFAM6654NR	751	818	66	54	2.875	47.51	7.70	
EVPFAM6660NR	826	901	66	60	2.875	50.40	8.53	
EVPFAM9018NR	684	732	90	18	2.875	38.18	3.43	
EVPFAM9024NR	736	794	90	24	2.875	42.72	4.58	
EVPFAM9030NR	818	895	90	30	2.875	47.99	5.65	
EVPFAM9036NR	952	1035	90	36	2.875	52.75	6.73	

**EVPH1S-NR • Laminate (No Raceway) Panel Single Sided**

- Laminate (No Raceway) panel incorporates single sided laminate modules within steel frame.
- Opposite side is fabric covered.
- Laminate faces on all modules provide durable, washable surface on Single sided of the panel.
- Available in high pressure laminate only.
- If wood grain is selected, grain runs horizontally.
- There is no base raceway in No Raceway Panels to accommodate electric.
- **No Raceway connectors to be used.**
- If different grades of fabric are used, the entire module must be price at highest grade.
- Aluminum low profile top and bottom cap is included.
- Stackability: Evolve panels can be increased in height in 6", 12", 24" increments. See module listing for part numbers.

PRODUCT CODE	PRICE		SIZE/ H	INCHES			WEIGHT LBS	VOL FT <sup>3</sup>
	GR 1	GR 2		W	D			
EVPH1S3018NR	362	369	30	18	2.875	15.88	1.23	
EVPH1S3024NR	435	443	30	24	2.875	18.70	1.63	
EVPH1S3030NR	508	519	30	30	2.875	22.26	2.00	
EVPH1S3036NR	576	592	30	36	2.875	24.85	2.38	
EVPH1S3042NR	656	669	30	42	2.875	26.99	2.76	
EVPH1S3048NR	711	725	30	48	2.875	32.05	3.13	
EVPH1S3054NR	790	806	30	54	2.875	35.81	3.51	
EVPH1S3060NR	865	882	30	60	2.875	38.07	3.89	
EVPH1S4218NR	430	468	42	18	2.875	21.38	1.71	
EVPH1S4224NR	515	530	42	24	2.875	22.13	2.31	
EVPH1S4230NR	601	616	42	30	2.875	30.15	2.81	
EVPH1S4236NR	692	712	42	36	2.875	36.40	3.38	
EVPH1S4242NR	783	805	42	42	2.875	40.09	3.92	
EVPH1S4248NR	853	877	42	48	2.875	44.00	4.45	
EVPH1S4254NR	948	972	42	54	2.875	48.32	4.98	
EVPH1S4260NR	1037	1068	42	60	2.875	52.40	5.52	
EVPH1S5418NR	507	521	54	18	2.875	24.98	2.19	
EVPH1S5424NR	612	629	54	24	2.875	28.80	2.94	
EVPH1S5430NR	719	739	54	30	2.875	34.15	3.62	
EVPH1S5436NR	824	847	54	36	2.875	38.40	4.31	
EVPH1S5442NR	932	958	54	42	2.875	41.69	4.99	
EVPH1S5448NR	1019	1051	54	48	2.875	49.20	5.67	
EVPH1S5454NR	1133	1166	54	54	2.875	53.92	6.35	
EVPH1S5460NR	1247	1286	54	60	2.875	58.40	7.03	
EVPH1S6618NR	629	646	66	18	2.875	31.29	2.68	
EVPH1S6624NR	758	779	66	24	2.875	36.30	3.58	
EVPH1S6630NR	884	910	66	30	2.875	42.84	4.40	
EVPH1S6636NR	1021	1052	66	36	2.875	50.30	5.23	
EVPH1S6642NR	1163	1197	66	42	2.875	55.59	6.06	
EVPH1S6648NR	1265	1304	66	48	2.875	61.50	6.08	
EVPH1S6654NR	1406	1450	66	54	2.875	67.23	7.70	
EVPH1S6660NR	1549	1598	66	60	2.875	72.90	8.53	

**EVPH2S-NR • Laminate (No Raceway) Panel Double Sided**

	PRODUCT CODE	PRICE	SIZE/ INCHES			WEIGHT LBS	VOL FT <sup>3</sup>
			H	W	D		
<ul style="list-style-type: none"> <li>Laminate (No Raceway) panel incorporates double sided laminate modules within steel frame</li> <li>Laminate faces on all modules provide durable, washable surface on both sides of the panel</li> <li>Available in high pressure laminate only</li> <li>If wood grain is selected, grain runs horizontally</li> <li>There is no base raceway in No Raceway Panels to accommodate electric</li> <li><b>No Raceway connectors to be used.</b></li> <li>Aluminum low profile top and bottom cap is included</li> <li>Stackability: Evolve panels can be increased in height in 6", 12", 24" increments. See module listing for part numbers.</li> </ul>	EVPH2S3018NR	405	30	18	2.875	16.38	1.23
	EVPH2S3024NR	495	30	24	2.875	19.20	1.63
	EVPH2S3030NR	586	30	30	2.875	22.76	2.00
	EVPH2S3036NR	669	30	36	2.875	25.80	2.38
	EVPH2S3042NR	762	30	42	2.875	27.49	2.76
	EVPH2S3048NR	851	30	48	2.875	33.00	3.13
	EVPH2S3054NR	944	30	54	2.875	36.31	3.51
	EVPH2S3060NR	1021	30	60	2.875	39.20	3.89
	EVPH2S4218NR	483	42	18	2.875	22.18	1.71
	EVPH2S4224NR	586	42	24	2.875	26.20	2.31
EVPH2S4230NR	691	42	30	2.875	30.95	2.81	
EVPH2S4236NR	803	42	36	2.875	37.20	3.38	
EVPH2S4242NR	916	42	42	2.875	40.89	3.92	
EVPH2S4248NR	1025	42	48	2.875	42.80	4.45	
EVPH2S4254NR	1128	42	54	2.875	49.12	4.98	
EVPH2S4260NR	1230	42	60	2.875	53.20	5.52	
EVPH2S5418NR	564	54	18	2.875	25.98	2.19	
EVPH2S5424NR	693	54	24	2.875	29.80	2.94	
EVPH2S5430NR	824	54	30	2.875	35.15	3.62	
EVPH2S5436NR	955	54	36	2.875	39.40	4.31	
EVPH2S5442NR	1090	54	42	2.875	42.69	4.99	
EVPH2S5448NR	1229	54	48	2.875	50.20	5.67	
EVPH2S5454NR	1353	54	54	2.875	52.92	6.35	
EVPH2S5460NR	1473	54	60	2.875	59.40	7.03	
EVPH2S6618NR	711	66	18	2.875	32.58	2.68	
EVPH2S6624NR	877	66	24	2.875	37.60	3.58	
EVPH2S6630NR	1037	66	30	2.875	44.14	4.40	
EVPH2S6636NR	1205	66	36	2.875	51.60	5.23	
EVPH2S6642NR	1386	66	42	2.875	56.89	6.06	
EVPH2S6648NR	1549	66	48	2.875	62.80	6.08	
EVPH2S6654NR	1713	66	54	2.875	68.53	7.70	
EVPH2S6660NR	1871	66	60	2.875	74.20	8.53	

**EVPXGT-NR • Fully Glazed (No Raceway) Panel**

	PRODUCT CODE	PRICE	SIZE/ INCHES			WEIGHT LBS	VOL FT <sup>3</sup>
			H	W	D		
<ul style="list-style-type: none"> <li><b>EVPXGTNR - Fully Glazed Monolithic No Raceway Panel.</b></li> <li>There is no base raceway in No Raceway Panels to accommodate electric.</li> <li>No Raceway connectors to be used.</li> <li>Fully Glazed Monolithic No Raceway panel are incorporated in solid steel frame.</li> <li>Standard in clear (CLR).</li> <li>Frosted glass (FRST) 40% upcharge.</li> <li>Size 90"x36"W is maximum size allowed.</li> <li>Panel height to align with standard door height.</li> <li>Aluminum low profile top and bottom cap is included.</li> </ul>	EVPXGT9018NR	761	90	18	2.875	15.88	1.23
	EVPXGT9024NR	869	90	24	2.875	18.70	1.63
	EVPXGT9030NR	986	90	30	2.875	22.26	2.00
	EVPXGT9036NR	1068	90	36	2.875	24.85	2.38

**EVPGTNR-NR • Fully Glazed Segmented (No Raceway) Panel**

	PRODUCT CODE	PRICE	SIZE/ INCHES			WEIGHT LBS	VOL FT <sup>3</sup>
			H	W	D		
<ul style="list-style-type: none"> <li><b>Fully Glazed Segmented No Raceway Panel with solid steel frame..</b></li> <li>There is no base raceway in No Raceway Panels to accommodate electrical.</li> <li>No Raceway connectors to be used.</li> <li>Standard in clear (CLR).</li> <li>Frosted glass (FRST) 40% upcharge.</li> <li>Aluminum low profile top and bottom cap is included.</li> </ul>	EVPGT4818NR	607	48	18	2.875	35.19	2.19
	EVPGT4824NR	743	48	24	2.875	49.76	2.94
	EVPGT4830NR	821	48	30	2.875	52.08	3.62
	EVPGT4836NR	898	48	36	2.875	64.54	4.31
	EVPGT4842NR	994	48	42	2.875	72.62	4.99
	EVPGT4848NR	1110	48	48	2.875	78.11	5.67
	EVPGT4854NR	1221	48	54	2.875	86.04	6.35
	EVPGT4860NR	1332	48	60	2.875	94.09	7.03

**EVPIC-NR • Inline Connector (No Raceway) Panel**



- Connects two No Raceway panel in straight run.
- Provides slotted support for worksurfaces and hang on components.
- Includes one slotted connector with leveling glide and connecting hardware.
- Connectors available without slots, as a special at no extra charge. Contact customer support.

PRODUCT CODE	PRICE	SIZE/INCHES			WEIGHT		VOL FT <sup>3</sup>
		H	W	D	LBS		
EVPIC30NR	61	30	2		3.30	0.05	
EVPIC42NR	65	42	2		4.60	0.07	
EVPIC48NR	67	48	2		5.25	0.07	
EVPIC54NR	72	54	2		5.90	0.09	
EVPIC66NR	81	66	2		7.20	0.10	

**EVVIC-NR • Inline Connector (No Raceway) Panel**



- Connects two 90° H No Raceway panel in straight run.
- Includes one slotted connector with leveling glide and connecting hardware.
- Connectors are without slots.
- To be used only with 90° H NR Glazed Panels

PRODUCT CODE	PRICE	SIZE/INCHES			WEIGHT		VOL FT <sup>3</sup>
		H	W	D	LBS		
EVVIC90NR	114	90	2		11.2	0.19	

**EVVVC-NR • Inline Variable Height Connector (No Raceway) Panel**

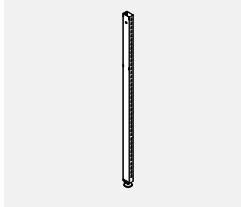

- Connects two No Raceway panels of differing height in straight run.
- Connector must reference taller panel.
- Can be used for any variation of pane height.
- Variable height trim must be ordered separately (see EVPTVA).
- Provides slotted support for worksurfaces and hang on components.
- Includes one slotted connector with leveling glide and connecting hardware.
- Connectors available without slots, as a special at no extra charge. Contact customer support.

PRODUCT CODE	PRICE	SIZE/INCHES			WEIGHT		VOL FT <sup>3</sup>
		H	W	D	LBS		
EVVVC42NR	72	42	2		4.60	0.07	
EVVVC48NR	75	48	2		5.25	0.07	
EVVVC54NR	76	54	2		5.90	0.09	
EVVVC66NR	85	66	2		7.20	0.10	

**EVPERA-NR • End of Run Post Kit for (No Raceway) Panel**

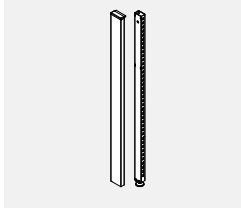

- Connects at end of No Raceway panel and can attach to a panel to fixed wall.
- Adds 1" to width of panel run.
- Provides slotted support for worksurfaces and hang on components.
- Includes one slotted connector with leveling glide and connecting hardware and trim kit.
- Can be attached to face of another panel to provide off modular connection.
- Connectors available without slots, as a special at no extra charge. Contact customer support.

PRODUCT CODE	PRICE	SIZE/INCHES			WEIGHT		VOL FT <sup>3</sup>
		H	W	D	LBS		
EVPERA30NR	76	30	2		3.30	0.07	
EVPERA42NR	91	42	2		4.60	0.10	
EVPERA48NR	97	48	2		5.25	0.10	
EVPERA54NR	109	54	2		5.90	0.18	
EVPERA66NR	122	66	2		7.20	0.22	

**EVPERA-NR • End of Run Post Kit for (No Raceway) Panel**

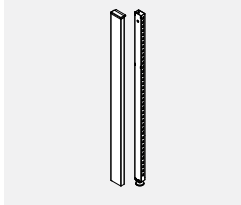

- Connects two 90° H No Raceway panel and can attach to a panel to fixed wall.
- Adds 1" width of panel run.
- Includes one slotted connector with leveling glide and connecting hardware and trim kit.
- Can be attached to face of another panel to provide off modular connection.
- Connectors are without slots.
- To be used only with 90° H NR Glazed Panels

PRODUCT CODE	PRICE	SIZE/INCHES			WEIGHT		VOL FT <sup>3</sup>
		H	W	D	LBS		
EVPERA90NR	157	90	2		11.2	0.19	

**EVPCPA2-NR • Two Way Corner Post (No Raceway) Panel**



- Connects two No Raceway panel of equal height in 90 degree configuration.
- Post and connecting hardware add 3.25" to power beam run.
- Provides slotted support for worksurfaces and hang on components.
- Includes post, panel connectors and power beam connectors, post with trim all around, levelling glide, hardware and trim kit.
- Connectors available without slots, as a special at no extra charge. Contact customer support.

PRODUCT CODE	PRICE	SIZE/INCHES			WEIGHT LBS	VOL FT <sup>3</sup>
		H	W	D		
EVPCPA230NR	157	30	2.875		8.50	0.31
EVPCPA242NR	201	42	2.875		11.50	0.43
EVPCPA248NR	211	48	2.875		11.50	0.54
EVPCPA254NR	244	54	2.875		15.00	0.61
EVPCPA266NR	290	66	2.875		19.00	0.75

**EVPCPA2-NR • Two Way Corner Post (No Raceway) Panel**



- Connects two No Raceway panel of equal height in 90 degree configuration.
- Post and connecting hardware add 3.25" to power beam run.
- Includes post, panel connectors and power beam connectors, post with trim all around, levelling glide, hardware and trim kit.
- Connectors are without slots.
- To be used only with 90" H NR Glazed Panels

PRODUCT CODE	PRICE	SIZE/INCHES			WEIGHT LBS	VOL FT <sup>3</sup>
		H	W	D		
EVPCPA290NR	400	90	2.875		27	1.03

**EVPCPA3-NR • Three Way Corner Post (No Raceway) Panel**



- Connects three No Raceway panel of equal height in "T" configuration.
- Post and connecting hardware add 3.25" to power beam run.
- Provides slotted support for worksurfaces and hang on components.
- Includes post, panel connectors and power beam connectors, post with trim all around, levelling glide, hardware and trim kit.
- Connectors available without slots, as a special at no extra charge. Contact customer support.

PRODUCT CODE	PRICE	SIZE/INCHES			WEIGHT LBS	VOL FT <sup>3</sup>
		H	W	D		
EVPCPA330NR	189	30	2.875		11.80	0.36
EVPCPA342NR	252	42	2.875		16.10	0.50
EVPCPA348NR	278	48	2.875		18.75	0.61
EVPCPA354NR	308	54	2.875		20.50	0.70
EVPCPA366NR	362	66	2.875		26.20	0.85

**EVPCPA3-NR • Three Way Corner Post (No Raceway) Panel**



- Connects three No Raceway panel of equal height in "T" configuration.
- Post and connecting hardware add 3.25" to power beam run.
- Includes post, panel connectors and power beam connectors, post with trim all around, levelling glide, hardware and trim kit.
- Connectors are without slots.
- To be used only with 90" H NR Glazed Panels

PRODUCT CODE	PRICE	SIZE/INCHES			WEIGHT LBS	VOL FT <sup>3</sup>
		H	W	D		
EVPCPA390NR	485	90	2.875		38.2	1.17

**EVPCPA4-NR • Four Way Corner Post (No Raceway) Panel**



- Connects four No Raceway panel of equal height in "+" configuration.
- Post and connecting hardware add 3.25" to power beam run.
- Provides slotted support for worksurfaces and hang on components.
- Includes post, panel connectors and power beam connectors, post with trim all around, levelling glide, hardware and trim kit.
- Connectors available without slots, as a special at no extra charge. Contact customer support.

PRODUCT CODE	PRICE	SIZE/INCHES			WEIGHT LBS	VOL FT <sup>3</sup>
		H	W	D		
EVPCPA430NR	207	30	2.875		15.5	0.40
EVPCPA442NR	271	42	2.875		21.00	0.57
EVPCPA448NR	298	48	2.875		24.00	0.68
EVPCPA454NR	329	54	2.875		26.50	0.79
EVPCPA466NR	385	66	2.875		33.20	0.95

**EVPCPA4-NR • Four Way Corner Post (No Raceway) Panel**



- Connects three No Raceway panel of equal height in "+" configuration.
- Post and connecting hardware add 3.25" to power beam run.
- Includes post, panel connectors and power beam connectors, post with trim all around, levelling glide, hardware and trim kit.
- Connectors are without slots.
- To be used only with 90" H NR Glazed Panels

PRODUCT CODE	PRICE	SIZE/INCHES			WEIGHT LBS	VOL FT <sup>3</sup>
		H	W	D		
EVPCPA490NR	495	90	2.875		49.2	1.31

## EVPIPA2-NR • Inline Two Way Corner Post (No Raceway Panel)



- Connects two No Raceway panel of equal height in straight run.
- Post and connecting hardware add 3.25" to power beam run.
- Provides slotted support for worksurfaces and hang on components.
- Includes post, panel connectors and power beam connectors, post with trim all around, levelling glide, hardware and trim kit.
- Connectors available without slots, as a special at no extra charge. Contact customer support.

PRODUCT CODE	PRICE	SIZE/INCHES			WEIGHT LBS	VOL FT <sup>3</sup>
		H	W	D		
EVPIPA230NR	157	30	2.875		8.20	0.31
EVPIPA242NR	201	42	2.875		11.50	0.43
EVPIPA248NR	211	48	2.875		13.50	0.54
EVPIPA254NR	244	54	2.875		15.00	0.61
EVPIPA266NR	290	66	2.875		19.00	0.75

## EVPIPA2-NR • Inline Two Way Corner Post (No Raceway Panel)



- Connects three No Raceway panel of equal height in a straight run.
- Post and connecting hardware add 3.25" to power beam run.
- Includes post, panel connectors and power beam connectors, post with trim all around, levelling glide, hardware and trim kit.
- Connectors are without slots.
- To be used only with 90° H NR Glazed Panels

PRODUCT CODE	PRICE	SIZE/INCHES			WEIGHT LBS	VOL FT <sup>3</sup>
		H	W	D		
EVPIPA290NR	420	90	2.875		27	1.03

## EVPCPA1-NR • One Way Corner Post (No Raceway Panel)



- Connects at end of No Raceway panel run in place of EVPERA- End of run post kit.
- Should not be used to attach pane to fixed wall.
- Post and connecting hardware add 3.25" to power beam run.
- Provides slotted support for worksurfaces and hang on components.
- Includes post, panel connectors and power beam connectors, post with trim all around, levelling glide, hardware and trim kit.
- Connectors available without slots, as a special at no extra charge. Contact customer support.

PRODUCT CODE	PRICE	SIZE/INCHES			WEIGHT LBS	VOL FT <sup>3</sup>
		H	W	D		
EVPCPA130NR	100	30	2.875		4.97	0.24
EVPCPA142NR	114	42	2.875		6.93	0.33
EVPCPA148NR	135	48	2.875		7.93	0.38
EVPCPA154NR	155	54	2.875		8.93	0.43
EVPCPA166NR	193	66	2.875		10.87	0.53

## EVPCPA1-NR • Inline One Way Corner Post (No Raceway Panel)



- Connects three No Raceway panel of equal height in a straight run.
- Should not be used to attach pane to fixed wall.
- Post and connecting hardware add 3.25" to power beam run.
- Includes post, panel connectors and power beam connectors, post with trim all around, levelling glide, hardware and trim kit.
- Connectors are without slots.
- To be used only with 90° H NR Glazed Panels

PRODUCT CODE	PRICE	SIZE/INCHES			WEIGHT LBS	VOL FT <sup>3</sup>
		H	W	D		
EVPCPA190NR	276	90	2.875		14.87	0.67

## EVVPC-PNR • Inline variable height connector Panel (No Raceway Panel)



- Connects Panel to No Raceway panels of differing height in straight run.
- Connector must reference taller panel.
- Can be used for any variation of panel height.
- Variable height trim must be ordered separately (see EVPTVA).
- Provides slotted support for worksurfaces and hang on components.
- Includes one slotted connector with leveling glide and connecting hardware.
- Connectors available without slots, as a special at no extra charge. Contact your Customer Service Representative.

PRODUCT CODE	PRICE	SIZE/INCHES			WEIGHT LBS	VOL FT <sup>3</sup>
		H	W	D		
EVVPC42PNR	72	42	2		4.60	0.07
EVVPC48PNR	75	48	2		5.25	0.07
EVVPC54PNR	76	54	2		5.90	0.09
EVVPC66PNR	85	66	2		7.20	0.10

## EVPCPA2-PNR • Two Way Corner Post (No Raceway Panel)



- Connects No Raceway panel and Panel of equal height in 90 degree configuration.
- Post and connecting hardware add 3.25" to power beam run.
- Provides slotted support for worksurfaces and hang on components.
- Includes post, panel connectors and power beam connectors, post with trim all around, levelling glide, hardware and trim kit.
- Connectors available without slots, as a special at no extra charge. Contact customer support.

PRODUCT CODE	PRICE	SIZE/INCHES			WEIGHT LBS	VOL FT <sup>3</sup>
		H	W	D		
EVPCPA230PNR	157	30	2.875		8.50	0.31
EVPCPA242PNR	201	42	2.875		11.50	0.43
EVPCPA248PNR	211	48	2.875		11.50	0.54
EVPCPA254PNR	244	54	2.875		15.00	0.61
EVPCPA266PNR	290	66	2.875		19.00	0.75

**EVPCPA3-NR • Three Way Corner Post (No Raceway Panel)**



- Connects two No Raceway panel and Panel of equal height in "T" configuration.
- Post and connecting hardware add 3.25" to power beam run.
- Provides slotted support for worksurfaces and hang on components.
- Includes post, panel connectors and power beam connectors, post with trim all around, levelling glide, hardware and trim kit.
- Connectors available without slots, as a special at no extra charge. Contact customer support.

PRODUCT CODE	PRICE	SIZE/INCHES			WEIGHT LBS	VOL FT³
		H	W	D		
EVPCPA330PNR	189	30	2.875		11.80	0.36
EVPCPA342PNR	252	42	2.875		16.10	0.50
EVPCPA348PNR	278	48	2.875		18.75	0.61
EVPCPA354PNR	308	54	2.875		20.50	0.70
EVPCPA366PNR	362	66	2.875		26.20	0.85

**EVPIC-PNR • Inline connector Panel (No Raceway Panel)**



- Connects Panel to No Raceway panel in straight run
- Provides slotted support for worksurfaces and hang on components
- Includes one slotted connector with leveling glide and connecting hardware
- Connectors available without slots, as a special at no extra charge. Contact your Customer Service Representative.

PRODUCT CODE	PRICE	SIZE/INCHES			WEIGHT LBS	VOL FT³
		H	W	D		
EVPIC30PNR	61	30	2		3.30	0.05
EVPIC42PNR	65	42	2		4.60	0.07
EVPIC48PNR	67	48	2		5.25	0.07
EVPIC54PNR	72	54	2		5.90	0.09
EVPIC66PNR	81	66	2		7.20	0.10

**EVPIC-PNR • Inline connector Panel (No Raceway Panel)**



- Connects 90" H No Raceway panel to 90" H door in straight run.
- Includes one non slotted connector with leveling glide and connecting hardware.
- Connectors are without slots.
- Note: To be used only with 90" H NR Glazed Panels and 90" H door.

PRODUCT CODE	PRICE	SIZE/INCHES			WEIGHT LBS	VOL FT³
		H	W	D		
EVPIC90PNR	114	90	2		11.2	0.19

**EVPCPA4-NR • Four Way Corner Post (No Raceway Panel)**



- Connects two No Raceway panel and two Panel of equal height in "+" configuration.
- Post and connecting hardware add 3.25" to power beam run.
- Provides slotted support for worksurfaces and hang on components.
- Includes post, panel connectors and power beam connectors, post with trim all around, levelling glide, hardware and trim kit
- Connectors available without slots, as a special at no extra charge. Contact customer support.

PRODUCT CODE	PRICE	SIZE/INCHES			WEIGHT LBS	VOL FT³
		H	W	D		
EVPCPA430PNR	207	30	2.875		15.5	0.40
EVPCPA442PNR	271	42	2.875		21.00	0.57
EVPCPA448PNR	298	48	2.875		24.00	0.68
EVPCPA454PNR	329	54	2.875		26.50	0.79
EVPCPA466PNR	385	66	2.875		33.20	0.95

**EVPIPA2-NR • Inline Two Way Corner Post (No Raceway Panel)**



- Connects No Raceway panel and Panel of equal height in straight run.
- Post and connecting hardware add 3.25" to power beam run.
- Provides slotted support for worksurfaces and hang on components.
- Includes post, panel connectors and power beam connectors, post with trim all around, levelling glide, hardware and trim kit.
- Connectors available without slots, as a special at no extra charge. Contact customer support.
- Note: Inline two way post must be used when No Panel and Panel are next to each other in run

PRODUCT CODE	PRICE	SIZE/INCHES			WEIGHT LBS	VOL FT³
		H	W	D		
EVPIPA230PNR	157	30	2.875		8.20	0.31
EVPIPA242PNR	201	42	2.875		11.50	0.43
EVPIPA248PNR	211	48	2.875		13.50	0.54
EVPIPA254PNR	244	54	2.875		15.00	0.61
EVPIPA266PNR	290	66	2.875		19.00	0.75

**EVPERCHxxNR • Laminate Panel Connector with U Channel (No Raceway Panel)**



- U channel attaches with screws to laminate end panel or laminate middle panel.
- Evolve NO Raceway Panels attach to connector.
- U Channel is welded to a No Raceway Connector.
- Includes No Raceway connector with U channel and hardware.

PRODUCT CODE	PRICE	SIZE/INCHES			WEIGHT LBS	VOL FT³
		H	W	D		
EVPERCH42NR	129	42	2.875		4.60	0.14
EVPERCH48NR	136	48	2.875		5.09	0.18
EVPERCH54NR	147	54	2.875		6.75	0.22



**EVPPXGT • Freestanding Glazed Monolithic Privacy Panel**

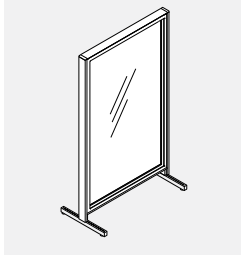

- Includes panel with two connectors with T legs with glides and end of run trims.
- Available in standard clear (CLR) tempered glass
- Available in standard frosted (FRST) tempered glass
- 22"d T-Legs (9.5" extension on each side of panel)
- Glazing is replaceable on site.

PRODUCT CODE	PRICE		SIZE/INCHES			WEIGHT LBS	VOL FT <sup>3</sup>
	CLR	FRST	H	W	D		
EVPPXGT4218	536	646	42	18	2.875	50.53	2.46
EVPPXGT4224	591	723	42	24	2.875	58.14	3.06
EVPPXGT4230	640	794	42	30	2.875	65.96	3.6
EVPPXGT4236	691	862	42	36	2.875	69.3	4.13
EVPPXGT4242	745	941	42	42	2.875	73.38	4.67
EVPPXGT5418	625	760	54	18	2.875	56.19	2.99
EVPPXGT5424	690	850	54	24	2.875	70.76	3.38
EVPPXGT5430	750	932	54	30	2.875	73.08	4.42
EVPPXGT5436	806	1015	54	36	2.875	85.54	5.11
EVPPXGT5442	871	1106	54	42	2.875	93.62	5.79
EVPPXGT6618	722	882	66	18	2.875	62.74	3.48
EVPPXGT6624	792	982	66	24	2.875	70.81	4.38
EVPPXGT6630	862	1081	66	30	2.875	78.63	4.79
EVPPXGT6636	928	1174	66	36	2.875	86.52	5.38
EVPPXGT6642	1007	1282	66	42	2.875	92.66	6.38

**EVPPXGT-F • Freestanding Glazed Monolithic Privacy Panel with Flat Foot**

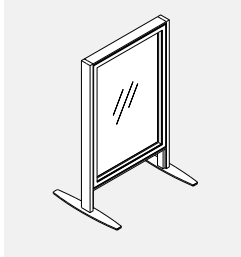

- Includes panel with two connectors with flat foot and end of run trims
- Available in standard clear (CLR) tempered glass
- Available in standard frosted (FRST) tempered glass
- Flat foot does not extend past end trim, no gaps between end trims
- 22"d T-Legs (9.5" extension on each side of panel)
- Glazing is replaceable on site.

PRODUCT CODE	PRICE		SIZE/INCHES			WEIGHT LBS	VOL FT <sup>3</sup>
	CLR	FRST	H	W	D		
EVPPXGT4218F	536	646	42	18	2.875	50.53	2.46
EVPPXGT4224F	591	723	42	24	2.875	58.14	3.06
EVPPXGT4230F	640	794	42	30	2.875	65.96	3.6
EVPPXGT4236F	691	862	42	36	2.875	69.3	4.13
EVPPXGT4242F	745	941	42	42	2.875	73.38	4.67
EVPPXGT5418F	625	760	54	18	2.875	56.19	2.99
EVPPXGT5424F	690	850	54	24	2.875	70.76	3.38
EVPPXGT5430F	750	932	54	30	2.875	73.08	4.42
EVPPXGT5436F	806	1015	54	36	2.875	85.54	5.11
EVPPXGT5442F	871	1106	54	42	2.875	93.62	5.79
EVPPXGT6618F	722	882	66	18	2.875	62.74	3.48
EVPPXGT6624F	792	982	66	24	2.875	70.81	4.38
EVPPXGT6630F	862	1081	66	30	2.875	78.63	4.79
EVPPXGT6636F	928	1174	66	36	2.875	86.52	5.38
EVPPXGT6642F	1007	1282	66	42	2.875	92.66	6.38

**EVPPXGT-FS • Freestanding Glazed Monolithic Privacy Panel with Shared Flat Foot**

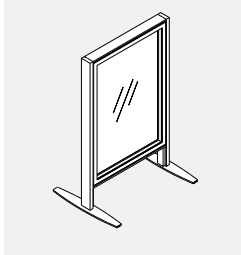

- Includes panel with two connectors with flat foot and end of run trims
- Available in standard clear (CLR) tempered glass
- Available in standard frosted (FRST) tempered glass
- Shared flat foot with connector in middle of flat foot
- 22"d T-Legs (9.5" extension on each side of panel)
- Glazing is replaceable on site.

PRODUCT CODE	PRICE		SIZE/INCHES			WEIGHT LBS	VOL FT <sup>3</sup>
	CLR	FRST	H	W	D		
EVPPXGT4218FS	536	646	42	18	2.875	50.53	2.46
EVPPXGT4224FS	591	723	42	24	2.875	58.14	3.06
EVPPXGT4230FS	640	794	42	30	2.875	65.96	3.6
EVPPXGT4236FS	691	862	42	36	2.875	69.3	4.13
EVPPXGT4242FS	745	941	42	42	2.875	73.38	4.67
EVPPXGT5418FS	625	760	54	18	2.875	56.19	2.99
EVPPXGT5424FS	690	850	54	24	2.875	70.76	3.38
EVPPXGT5430FS	750	932	54	30	2.875	73.08	4.42
EVPPXGT5436FS	806	1015	54	36	2.875	85.54	5.11
EVPPXGT5442FS	871	1106	54	42	2.875	93.62	5.79
EVPPXGT6618FS	722	882	66	18	2.875	62.74	3.48
EVPPXGT6624FS	792	982	66	24	2.875	70.81	4.38
EVPPXGT6630FS	862	1081	66	30	2.875	78.63	4.79
EVPPXGT6636FS	928	1174	66	36	2.875	86.52	5.38
EVPPXGT6642FS	1007	1282	66	42	2.875	92.66	6.38

**EVPPXGT-M • Mobile Glazed Monolithic Panel**

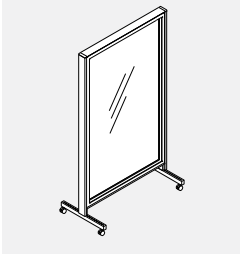

- Includes panel with two connectors with T legs with castors and end of run trims
- Available in standard clear (CLR) tempered glass
- Available in standard frosted (FRST) tempered glass
- Available in standard writeable (WRW) glass.
- 22"d T-Legs (9.5" extension on each side of panel)
- 1" locking casters
- Glazing is replaceable on site.

PRODUCT CODE	PRICE			SIZE/INCHES			WEIGHT LBS	VOL FT <sup>3</sup>
	CLR	FRST	WRW	H	W	D		
EVPPXGT4218M	603	712	-	42	18	2.875	50.53	2.46
EVPPXGT4224M	658	789	-	42	24	2.875	58.14	3.06
EVPPXGT4230M	706	860	-	42	30	2.875	65.96	3.6
EVPPXGT4236M	757	928	-	42	36	2.875	69.3	4.13
EVPPXGT4242M	813	1007	-	42	42	2.875	73.38	4.67
EVPPXGT5418M	691	826	1103	54	18	2.875	56.19	2.99
EVPPXGT5424M	756	916	1271	54	24	2.875	70.76	3.38
EVPPXGT5430M	816	998	1431	54	30	2.875	73.08	4.42
EVPPXGT5436M	872	1081	1590	54	36	2.875	85.54	5.11
EVPPXGT5442M	938	1173	1757	54	42	2.875	93.62	5.79
EVPPXGT6618M	788	948	1296	66	18	2.875	62.74	3.48
EVPPXGT6624M	858	1048	1492	66	24	2.875	70.81	4.38
EVPPXGT6630M	928	1147	1685	66	30	2.875	78.63	4.79
EVPPXGT6636M	994	1240	1873	66	36	2.875	86.52	5.38
EVPPXGT6642M	1073	1349	2079	66	42	2.875	92.66	6.38

**EVPPGT • Freestanding Segmented Glazed Privacy Panels**

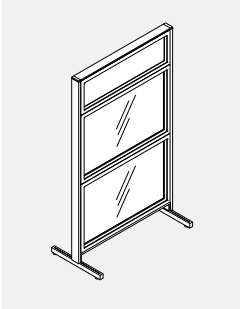

- Includes panel with two connectors with T legs with glides and end of run trims
- Available in standard clear (CLR) tempered glass
- Available in standard frosted (FRST) tempered glass
- 22"d T-Legs (9.5" extension on each side of panel)
- Glazing is replaceable on site.

PRODUCT CODE	PRICE			SIZE/INCHES			WEIGHT LBS	VOL FT <sup>3</sup>
	CLR	FRST		H	W	D		
EVPPGT5424	712	883		54	24	2.875	70.8	3.38
EVPPGT5430	782	982		54	30	2.875	73.1	4.42
EVPPGT5436	851	1077		54	36	2.875	85.5	5.11
EVPPGT5442	926	1184		54	42	2.875	93.6	5.79
EVPPGT5448	999	1287		54	48	2.875	99.1	6.47
EVPPGT5454	1077	1396		54	54	2.875	107	7.15
EVPPGT5460	1144	1491		54	60	2.875	115.1	7.83
EVPPGT6624	891	1122		66	24	2.875	78.63	4.38
EVPPGT6630	975	1242		66	30	2.875	86.52	4.79
EVPPGT6636	1111	1432		66	36	2.875	92.66	5.38
EVPPGT6642	1205	1564		66	42	2.875	98.19	6.38
EVPPGT6648	1302	1700		66	48	2.875	105.48	7.68
EVPPGT6654	1408	1849		66	54	2.875	112.52	8.5
EVPPGT6660	1524	2009		66	60	2.875	129.3	9.33

**EVPPGT-M • Mobile Segmented Glazed Privacy Panels**

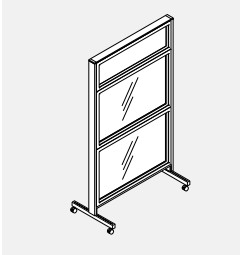

- Includes panel with two connectors with T legs with castors and end of run trims
- Available in standard clear (CLR) tempered glass
- Available in standard frosted (FRST) tempered glass
- 22"d T-Legs (9.5" extension on each side of panel)
- 1" locking casters
- Glazing is replaceable on site.

PRODUCT CODE	PRICE			SIZE/INCHES			WEIGHT LBS	VOL FT <sup>3</sup>
	CLR	FRST		H	W	D		
EVPPGT5424M	778	949		54	24	2.875	70.8	3.38
EVPPGT5430M	849	1048		54	30	2.875	73.1	4.42
EVPPGT5436M	919	1144		54	36	2.875	85.5	5.11
EVPPGT5442M	992	1250		54	42	2.875	93.6	5.79
EVPPGT5448M	1067	1353		54	48	2.875	99.1	6.47
EVPPGT5454M	1144	1463		54	54	2.875	107	7.15
EVPPGT5460M	1210	1557		54	60	2.875	115.1	7.83
EVPPGT6624M	957	1188		66	24	2.875	78.63	4.38
EVPPGT6630M	1042	1309		66	30	2.875	86.52	4.79
EVPPGT6636M	1177	1498		66	36	2.875	92.66	5.38
EVPPGT6642M	1272	1630		66	42	2.875	98.19	6.38
EVPPGT6648M	1368	1766		66	48	2.875	105.48	7.68
EVPPGT6654M	1475	1915		66	54	2.875	112.52	8.5
EVPPGT6660M	1591	2076		66	60	2.875	129.3	9.33

**EVPPHGT • Freestanding Segmented Glazed and Laminate Privacy Panels - Two Sides**

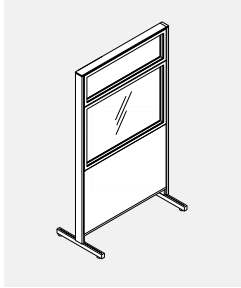

- 30" base panel with laminate faces both sides provides for durable and washable surfaces
- Available in standard clear (CLR) tempered glass
- Available in standard frosted (FRST) tempered glass
- 22"d T-Legs (9.5" extension on each side of panel)
- Glazing is replaceable on site.

PRODUCT CODE	PRICE		SIZE/INCHES			WEIGHT LBS	VOL FT <sup>3</sup>
	CLR	FRST	H	W	D		
EVPPHGT5424	754	845	54	24	2.875	55.8	3.38
EVPPHGT5430	837	947	54	30	2.875	62.8	4.42
EVPPHGT5436	922	1051	54	36	2.875	69.3	5.11
EVPPHGT5442	1007	1152	54	42	2.875	74.1	5.79
EVPPHGT5448	1090	1251	54	48	2.875	83.1	6.47
EVPPHGT5454	1181	1360	54	54	2.875	89.4	7.15
EVPPHGT5460	1260	1454	54	60	2.875	95.5	7.83
EVPPHGT6624	932	1056	66	24	2.875	70.81	4.38
EVPPHGT6630	1031	1175	66	30	2.875	78.63	4.79
EVPPHGT6636	1162	1332	66	36	2.875	86.52	5.38
EVPPHGT6642	1262	1452	66	42	2.875	92.66	6.38
EVPPHGT6648	1364	1574	66	48	2.875	98.19	7.68
EVPPHGT6654	1480	1713	66	54	2.875	105.48	8.5
EVPPHGT6660	1617	1877	66	60	2.875	116.2	9.33

**EVPPHGT-M • Mobile Segmented Glazed and Laminate Privacy Panels - Two Sides**

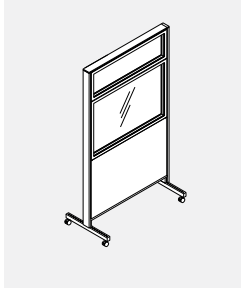

- 30" base panel with laminate faces both sides provides for durable and washable surfaces
- Available in standard clear (CLR) tempered glass
- Available in standard frosted (FRST) tempered glass
- 22"d T-Legs (9.5" extension on each side of panel)
- 1" locking casters
- Glazing is replaceable on site.

PRODUCT CODE	PRICE		SIZE/INCHES			WEIGHT LBS	VOL FT <sup>3</sup>
	CLR	FRST	H	W	D		
EVPPHGT5424M	820	911	54	24	2.875	55.8	3.38
EVPPHGT5430M	903	1013	54	30	2.875	62.8	4.42
EVPPHGT5436M	988	1118	54	36	2.875	69.3	5.11
EVPPHGT5442M	1073	1218	54	42	2.875	74.1	5.79
EVPPHGT5448M	1157	1317	54	48	2.875	83.1	6.47
EVPPHGT5454M	1247	1427	54	54	2.875	89.4	7.15
EVPPHGT5460M	1326	1520	54	60	2.875	95.5	7.83
EVPPHGT6624M	998	1122	66	24	2.875	70.81	4.38
EVPPHGT6630M	1097	1241	66	30	2.875	78.63	4.79
EVPPHGT6636M	1228	1399	66	36	2.875	86.52	5.38
EVPPHGT6642M	1328	1518	66	42	2.875	92.66	6.38
EVPPHGT6648M	1430	1641	66	48	2.875	98.19	7.68
EVPPHGT6654M	1546	1779	66	54	2.875	105.48	8.5
EVPPHGT6660M	1683	1943	66	60	2.875	116.2	9.33

**EVPPHGTU • Freestanding Segmented Glazed and Laminate Privacy Panels - Two Sides**

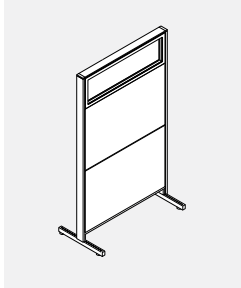

- Laminate faces both sides provides for durable and washable surfaces
- Available in standard clear (CLR) tempered glass
- Available in standard frosted (FRST) tempered glass
- 22"d T-Legs (9.5" extension on each side of panel)
- 12" Glazed segment
- Glazing is replaceable on site.

PRODUCT CODE	PRICE		SIZE/INCHES			WEIGHT LBS	VOL FT <sup>3</sup>
	CLR	FRST	H	W	D		
EVPPHGTU5424	868	987	54	24	2.875	49.2	3.38
EVPPHGTU5430	965	1100	54	30	2.875	55.8	4.42
EVPPHGTU5436	1062	1220	54	36	2.875	62.8	5.11
EVPPHGTU5442	1159	1334	54	42	2.875	69.3	5.79
EVPPHGTU5448	1256	1451	54	48	2.875	74.1	6.47
EVPPHGTU5454	1362	1575	54	54	2.875	83.1	7.15
EVPPHGTU5460	1458	1693	54	60	2.875	89.4	7.83
EVPPHGTU6624	972	1104	66	24	2.875	53.34	4.38
EVPPHGTU6630	1085	1240	66	30	2.875	60.76	4.79
EVPPHGTU6636	1222	1405	66	36	2.875	68.18	5.38
EVPPHGTU6642	1332	1537	66	42	2.875	76.2	6.38
EVPPHGTU6648	1442	1670	66	48	2.875	87.76	7.68
EVPPHGTU6654	1569	1822	66	54	2.875	95.45	8.5
EVPPHGTU6660	1706	1986	66	60	2.875	99.7	9.33

**EVPPHGTU-M • Mobile Segmented Glazed and Laminate Privacy Panels - Two Sides**

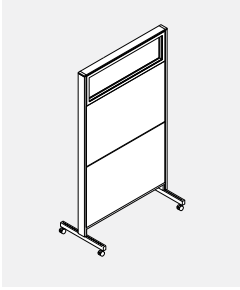

- Laminate faces both sides provides for durable and washable surfaces
- Available in standard clear (CLR) tempered glass
- Available in standard frosted (FRST) tempered glass
- 22"d T-Legs (9.5" extension on each side of panel)
- 1" locking casters
- 12" Glazed segment
- Glazing is replaceable on site.

PRODUCT CODE	PRICE		SIZE/INCHES			WEIGHT LBS	VOL FT <sup>3</sup>
	CLR	FRST	H	W	D		
EVPPHGTU5424M	934	1054	54	24	2.875	49.2	3.38
EVPPHGTU5430M	1031	1166	54	30	2.875	55.8	4.42
EVPPHGTU5436M	1128	1286	54	36	2.875	62.8	5.11
EVPPHGTU5442M	1225	1400	54	42	2.875	69.3	5.79
EVPPHGTU5448M	1323	1517	54	48	2.875	74.1	6.47
EVPPHGTU5454M	1428	1642	54	54	2.875	83.1	7.15
EVPPHGTU5460M	1524	1759	54	60	2.875	89.4	7.83
EVPPHGTU6624M	1038	1170	66	24	2.875	53.34	4.38
EVPPHGTU6630M	1152	1306	66	30	2.875	60.76	4.79
EVPPHGTU6636M	1288	1471	66	36	2.875	68.18	5.38
EVPPHGTU6642M	1399	1604	66	42	2.875	76.2	6.38
EVPPHGTU6648M	1509	1736	66	48	2.875	87.76	7.68
EVPPHGTU6654M	1635	1888	66	54	2.875	95.45	8.5
EVPPHGTU6660M	1772	2052	66	60	2.875	99.7	9.33

**EVPPH2S • Freestanding Segmented Laminate Privacy Panels - Two Sides**

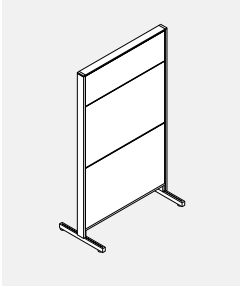

- All laminate faces both sides provides for durable and washable surfaces
- 22"d T-Legs (9.5" extension on each side of panel)

PRODUCT CODE	PRICE	SIZE/INCHES			WEIGHT LBS	VOL FT <sup>3</sup>
		H	W	D		
EVPPH2S5424	794	54	24	2.875	50.8	3.38
EVPPH2S5430	891	54	30	2.875	56.2	4.42
EVPPH2S5436	993	54	36	2.875	60.4	5.11
EVPPH2S5442	1088	54	42	2.875	63.7	5.79
EVPPH2S5448	1181	54	48	2.875	71.2	6.47
EVPPH2S5454	1282	54	54	2.875	73.9	7.15
EVPPH2S5460	1373	54	60	2.875	80.4	7.83
EVPPH2S6624	961	66	24	2.875	62.8	4.38
EVPPH2S6630	1088	66	30	2.875	69.3	4.79
EVPPH2S6636	1230	66	36	2.875	76.8	5.38
EVPPH2S6642	1353	66	42	2.875	82.1	6.38
EVPPH2S6648	1472	66	48	2.875	88	7.68
EVPPH2S6654	1597	66	54	2.875	93.7	8.5
EVPPH2S6660	1730	66	60	2.875	95.2	9.33

**EVPPH2S-M • Mobile Segmented Laminate Privacy Panels - Two Sides**

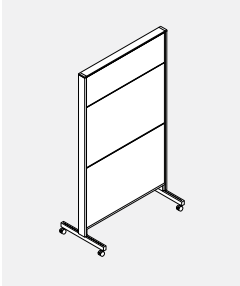

- All laminate faces both sides provides for durable and washable surfaces
- Includes panel with two connectors with T legs with castors and end of run trims
- 22"d T-Legs (9.5" extension on each side of panel)
- 1" locking casters

PRODUCT CODE	PRICE	SIZE/INCHES			WEIGHT LBS	VOL FT <sup>3</sup>
		H	W	D		
EVPPH2S5424M	860	54	24	2.875	50.8	3.38
EVPPH2S5430M	957	54	30	2.875	56.2	4.42
EVPPH2S5436M	1059	54	36	2.875	60.4	5.11
EVPPH2S5442M	1154	54	42	2.875	63.7	5.79
EVPPH2S5448M	1247	54	48	2.875	71.2	6.47
EVPPH2S5454M	1349	54	54	2.875	73.9	7.15
EVPPH2S5460M	1439	54	60	2.875	80.4	7.83
EVPPH2S6624M	1029	66	24	2.875	62.8	4.38
EVPPH2S6630M	1154	66	30	2.875	69.3	4.79
EVPPH2S6636M	1297	66	36	2.875	76.8	5.38
EVPPH2S6642M	1419	66	42	2.875	82.1	6.38
EVPPH2S6648M	1539	66	48	2.875	88	7.68
EVPPH2S6654M	1663	66	54	2.875	93.7	8.5
EVPPH2S6660M	1796	66	60	2.875	95.2	9.33

**EVPPF2W • Freestanding Segmented Write Board Privacy Panels**

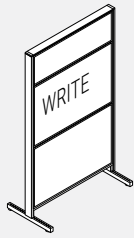

- Writing surface is built into the top module on both sides of the panel, alleviating the need for a panel-mounted Writeboard.
- Use of erasable Writeboard markers only.
- 22"d T-Legs (9.5" extension on each side of panel)

PRODUCT CODE	PRICE		SIZE/INCHES			WEIGHT LBS	VOL FT <sup>3</sup>
	GR1	GR2	H	W	D		
EVPPF2W5424	767	782	54	24	2.875	49.8	3.38
EVPPF2W5430	859	879	54	30	2.875	55.2	4.42
EVPPF2W5436	952	971	54	36	2.875	59.4	5.11
EVPPF2W5442	1042	1068	54	42	2.875	62.7	5.79
EVPPF2W5448	1147	1176	54	48	2.875	70.2	6.47
EVPPF2W5454	1246	1290	54	54	2.875	74.9	7.15
EVPPF2W5460	1335	1373	54	60	2.875	79.4	7.83
EVPPF2W6624	927	942	66	24	2.875	57.8	4.38
EVPPF2W6630	1086	1106	66	30	2.875	62.8	4.79
EVPPF2W6636	1224	1246	66	36	2.875	69.3	5.38
EVPPF2W6642	1352	1376	66	42	2.875	76.8	6.38
EVPPF2W6648	1492	1520	66	48	2.875	82.1	7.68
EVPPF2W6654	1620	1664	66	54	2.875	88	8.5
EVPPF2W6660	1782	1813	66	60	2.875	98.3	9.33

**EVPPF2W-M • Mobile Segmented Write Board Privacy Panels**

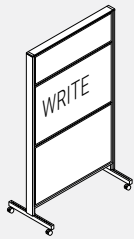

- Writing surface is built into the top module on both sides of the panel, alleviating the need for a panel-mounted Writeboard.
- Use of erasable Writeboard markers only.
- 22"d T-Legs (9.5" extension on each side of panel)
- 1" locking casters

PRODUCT CODE	PRICE		SIZE/INCHES			WEIGHT LBS	VOL FT <sup>3</sup>
	GR1	GR2	H	W	D		
EVPPF2W5424M	833	849	54	24	2.875	49.8	3.38
EVPPF2W5430M	926	945	54	30	2.875	55.2	4.42
EVPPF2W5436M	1018	1037	54	36	2.875	59.4	5.11
EVPPF2W5442M	1109	1134	54	42	2.875	62.7	5.79
EVPPF2W5448M	1214	1242	54	48	2.875	70.2	6.47
EVPPF2W5454M	1312	1356	54	54	2.875	74.9	7.15
EVPPF2W5460M	1401	1439	54	60	2.875	79.4	7.83
EVPPF2W6624M	993	1008	66	24	2.875	57.8	4.38
EVPPF2W6630M	1153	1173	66	30	2.875	62.8	4.79
EVPPF2W6636M	1290	1312	66	36	2.875	69.3	5.38
EVPPF2W6642M	1418	1442	66	42	2.875	76.8	6.38
EVPPF2W6648M	1558	1586	66	48	2.875	82.1	7.68
EVPPF2W6654M	1686	1731	66	54	2.875	88	8.5
EVPPF2W6660M	1849	1879	66	60	2.875	98.3	9.33

**EVPPH2W • Freestanding Segmented Write Board and Laminate Privacy Panels**



- 30" base panel with laminate faces both sides provides for durable and washable surfaces
- Writing surface is built into upper modules on both sides of the panel, alleviating the need for a panel-mounted Writeboard.
- Use of erasable Writeboard markers only.
- 22"d T-Legs (9.5" extension on each side of panel)

PRODUCT CODE	PRICE		SIZE/INCHES			WEIGHT LBS	VOL FT <sup>3</sup>
	GR1	GR2	H	W	D		
EVPPH2W5424	843		54	24	2.875	50.8	3.38
EVPPH2W5430	953		54	30	2.875	56.2	4.42
EVPPH2W5436	1067		54	36	2.875	60.4	5.11
EVPPH2W5442	1174		54	42	2.875	63.7	5.79
EVPPH2W5448	1277		54	48	2.875	71.2	6.47
EVPPH2W5454	1392		54	54	2.875	73.9	7.15
EVPPH2W5460	1495		54	60	2.875	80.4	7.83
EVPPH2W6624	994		66	24	2.875	62.8	4.38
EVPPH2W6630	1179		66	30	2.875	69.34	4.79
EVPPH2W6636	1348		66	36	2.875	76.8	5.38
EVPPH2W6642	1483		66	42	2.875	82.09	6.38
EVPPH2W6648	1623		66	48	2.875	88	7.68
EVPPH2W6654	1766		66	54	2.875	93.73	8.5
EVPPH2W6660	1914		66	60	2.875	95.2	9.33

**EVPPH2W-M • Mobile Segmented Write Board and Laminate Privacy Panels**

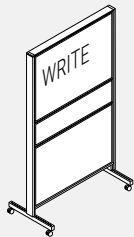

- 30" base panel with laminate faces both sides provides for durable and washable surfaces
- Writing surface is built into upper modules on both sides of the panel, alleviating the need for a panel-mounted Writeboard.
- Use of erasable Writeboard markers only.
- 22"d T-Legs (9.5" extension on each side of panel)

PRODUCT CODE	PRICE		SIZE/INCHES			WEIGHT LBS	VOL FT <sup>3</sup>
	GR1	GR2	H	W	D		
EVPPH2W5424M	909		54	24	2.875	50.8	3.38
EVPPH2W5430M	1019		54	30	2.875	56.2	4.42
EVPPH2W5436M	1133		54	36	2.875	60.4	5.11
EVPPH2W5442M	1240		54	42	2.875	63.7	5.79
EVPPH2W5448M	1343		54	48	2.875	71.2	6.47
EVPPH2W5454M	1458		54	54	2.875	73.9	7.15
EVPPH2W5460M	1561		54	60	2.875	80.4	7.83
EVPPH2W6624M	1060		66	24	2.875	62.8	4.38
EVPPH2W6630M	1246		66	30	2.875	69.34	4.79
EVPPH2W6636M	1414		66	36	2.875	76.8	5.38
EVPPH2W6642M	1549		66	42	2.875	82.09	6.38
EVPPH2W6648M	1689		66	48	2.875	88	7.68
EVPPH2W6654M	1833		66	54	2.875	93.73	8.5
EVPPH2W6660M	1980		66	60	2.875	95.2	9.33

**EVPRGLA • Acoustic Grid - 60" wide**

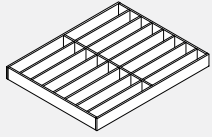

Configuration: 30" - 30"

- PET felt Acoustic Grid to be installed on top of Evolve panels.
- Acoustic Grid kit includes felt pieces, aluminum channel and all necessary hardware.
- PET felt slats run from side to side.
- PET felt pieces available in standard PET felt colours.
- Top trim with channel and beam above opening to be ordered separately.
- Shipped KD.
- For a different felt color for the outer PET frame, choose the code with a D at the end.

PRODUCT CODE	PRICE	SIZE/INCHES			WEIGHT LBS	VOL FT <sup>3</sup>
		H	W	D		
EVPRGLA4860	1918	5.5	60	48	18.25	9.2
EVPRGLA6060	2274	5.5	60	60	19.02	11.5
EVPRGLA7260	2630	5.5	60	72	22.04	13.8
EVPRGLA8460	2984	5.5	60	84	25.06	16.0
EVPRGLA9060	3163	5.5	60	90	26.57	17.2
EVPRGLA9660	3367	5.5	60	96	28.29	18.3
EVPRGLA4860D	1918	5.5	60	48	18.25	9.2
EVPRGLA6060D	2274	5.5	60	60	19.02	11.5
EVPRGLA7260D	2630	5.5	60	72	22.04	13.8
EVPRGLA8460D	2984	5.5	60	84	25.06	16.0
EVPRGLA9060D	3163	5.5	60	90	26.57	17.2
EVPRGLA9660D	3367	5.5	60	96	28.29	18.3

**EVPRGLA • Acoustic Grid - 72" wide**

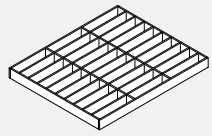

Configuration: 24" - 24" - 24"

- PET felt Acoustic Grid to be installed on top of Evolve panels.
- Acoustic Grid kit includes felt pieces, aluminum channel and all necessary hardware.
- PET felt slats run from side to side.
- PET felt pieces available in standard PET felt colours.
- Top trim with channel and beam above opening to be ordered separately.
- Shipped KD.
- For a different felt color for the outer PET frame, choose the code with a D at the end.

PRODUCT CODE	PRICE	SIZE/INCHES			WEIGHT LBS	VOL FT <sup>3</sup>
		H	W	D		
EVPRGLA4872	2309	5.5	72	48	20.10	11.0
EVPRGLA6072	2739	5.5	72	60	23.96	13.8
EVPRGLA7272	3168	5.5	72	72	27.81	16.5
EVPRGLA8472	3597	5.5	72	84	31.67	19.3
EVPRGLA9072	3813	5.5	72	90	33.60	20.6
EVPRGLA9672	4054	5.5	72	96	35.75	22.0
EVPRGLA4872D	2309	5.5	72	48	20.10	11.0
EVPRGLA6072D	2739	5.5	72	60	23.96	13.8
EVPRGLA7272D	3168	5.5	72	72	27.81	16.5
EVPRGLA8472D	3597	5.5	72	84	31.67	19.3
EVPRGLA9072D	3813	5.5	72	90	33.60	20.6
EVPRGLA9672D	4054	5.5	72	96	35.75	22.0

**EVPRGLA • Acoustic Grid - 84" wide**

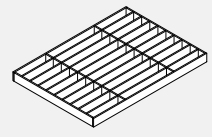

Configuration: 24" - 36" - 24"

- PET felt Acoustic Grid to be installed on top of Evolve panels.
- Acoustic Grid kit includes felt pieces, aluminum channel and all necessary hardware.
- PET felt slats run from side to side.
- PET felt pieces available in standard PET felt colours.
- Top trim with channel and beam above opening to be ordered separately.
- Shipped KD.
- For a different felt color for the outer PET frame, choose the code with a D at the end.

PRODUCT CODE	PRICE	SIZE/INCHES			WEIGHT LBS	VOL FT <sup>3</sup>
		H	W	D		
EVPRGLA4884	2580	5.5	84	48	22.15	12.8
EVPRGLA6084	3055	5.5	84	60	26.35	16.0
EVPRGLA7284	3530	5.5	84	72	30.54	19.3
EVPRGLA8484	4004	5.5	84	84	34.74	22.5
EVPRGLA9084	4241	5.5	84	90	36.83	24.1
EVPRGLA9684	4505	5.5	84	96	39.14	25.7
EVPRGLA4884D	2580	5.5	84	48	22.15	12.8
EVPRGLA6084D	3055	5.5	84	60	26.35	16.0
EVPRGLA7284D	3530	5.5	84	72	30.54	19.3
EVPRGLA8484D	4004	5.5	84	84	34.74	22.5
EVPRGLA9084D	4241	5.5	84	90	36.83	24.1
EVPRGLA9684D	4505	5.5	84	96	39.14	25.7

**EVPRGLA • Acoustic Grid - 90" wide**

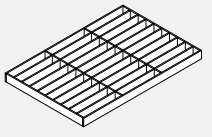

Configuration: 30" - 30" - 30"

- PET felt Acoustic Grid to be installed on top of Evolve panels.
- Acoustic Grid kit includes felt pieces, aluminum channel and all necessary hardware.
- PET felt slats run from side to side.
- PET felt pieces available in standard PET felt colours.
- Top trim with channel and beam above opening to be ordered separately.
- Shipped KD.
- For a different felt color for the outer PET frame, choose the code with a D at the end.

PRODUCT CODE	PRICE	SIZE/INCHES			WEIGHT LBS	VOL FT <sup>3</sup>
		H	W	D		
EVPRGLA4890	2679	5.5	90	48	23.27	13.8
EVPRGLA6090	3176	5.5	90	60	27.65	17.2
EVPRGLA7290	3674	5.5	90	72	30.04	20.6
EVPRGLA8490	4171	5.5	90	84	36.42	24.1
EVPRGLA9090	4420	5.5	90	90	38.62	25.8
EVPRGLA9690	4696	5.5	90	96	41.01	27.5
EVPRGLA4890D	2679	5.5	90	48	23.27	13.8
EVPRGLA6090D	3176	5.5	90	60	27.65	17.2
EVPRGLA7290D	3674	5.5	90	72	30.04	20.6
EVPRGLA8490D	4171	5.5	90	84	36.42	24.1
EVPRGLA9090D	4420	5.5	90	90	38.62	25.8
EVPRGLA9690D	4696	5.5	90	96	41.01	27.5

**EVPRGLA • Acoustic Grid - 96" wide**

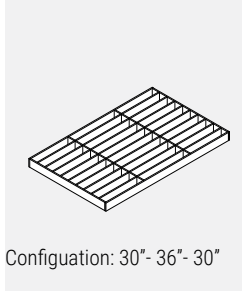

Configuration: 30"- 36"- 30"

- PET felt Acoustic Grid to be installed on top of Evolve panels.
- Acoustic Grid kit includes felt pieces, aluminum channel and all necessary hardware.
- PET felt slats run from side to side.
- PET felt pieces available in standard PET felt colours.
- Top trim with channel and beam above opening to be ordered separately.
- Shipped KD.
- For a different felt color for the outer PET frame, choose the code with a D at the end.

PRODUCT CODE	PRICE	SIZE/INCHES			WEIGHT		VOL FT <sup>3</sup>
		H	W	D	LBS		
EVPRGLA4896	2877	5.5	96	48	24.47	14.7	
EVPRGLA6096	3398	5.5	96	60	29.02	18.3	
EVPRGLA7296	3918	5.5	96	72	33.56	22.0	
EVPRGLA8496	4437	5.5	96	84	38.11	25.7	
EVPRGLA9096	4698	5.5	96	90	40.38	27.5	
EVPRGLA9696	4983	5.5	96	96	42.86	29.3	
EVPRGLA4896D	2877	5.5	96	48	24.47	14.7	
EVPRGLA6096D	3398	5.5	96	60	29.02	18.3	
EVPRGLA7296D	3918	5.5	96	72	33.56	22.0	
EVPRGLA8496D	4437	5.5	96	84	38.11	25.7	
EVPRGLA9096D	4698	5.5	96	90	40.38	27.5	
EVPRGLA9696D	4983	5.5	96	96	42.86	29.3	

**EVPRGLA • Acoustic Grid - 144" wide**

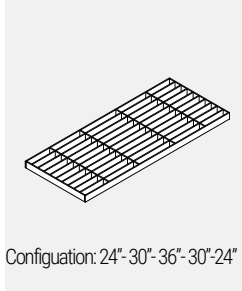

Configuration: 24"- 30"- 36"- 30"- 24"

- PET felt Acoustic Grid to be installed on top of Evolve panels.
- Acoustic Grid kit includes felt pieces, aluminum channel and all necessary hardware.
- PET felt slats run from side to side.
- PET felt pieces available in standard PET felt colours.
- Top trim with channel and beam above opening to be ordered separately.
- Shipped KD.
- For a different felt color for the outer PET frame, choose the code with a D at the end.

PRODUCT CODE	PRICE	SIZE/INCHES			WEIGHT		VOL FT <sup>3</sup>
		H	W	D	LBS		
EVPRGLA120144	7432	6	144	120	73.86	55.0	
EVPRGLA120144D	7432	6	144	120	73.86	55.0	

**STEP BY STEP SPECIFICATION • 8 WIRE ELECTRICAL SYSTEM**

**Step 1** Determine the location of the power source entering the panel run.

1. At the base of the panel.
  - a) Use EVE8FR Reversible Floor Power Entry (default to EVE8FR).
  - b) Select the panel to which the Floor Power Entry will be attached. This panel requires an EVE8PD Power Distribution Housing.
  - c) Select the side of the panel and the receptacle outlet to which the Floor Power Entry is to be attached.
2. From the ceiling.
  - a) Use EVE8EC1 Ceiling Power Entry.
  - b) Select the post through which to feed the Ceiling Power Entry.
  - c) One panel adjacent to the selected post requires an EVE8PD Power Distribution Housing.
  - d) Attach Ceiling Power entry to the nearest end of the Power Distribution Housing.

**Step 2** Determine which panels are to be powered.

1. Use EVE8PD Power Distribution Housing that corresponds with the width of the panel.

**Step 3** Connect power to the powered panels.

1. Use EVE8CP16 Jumper Cable between two adjacent powered panels.
2. Use EVE8CP20 Jumper Cable between two adjacent powered panels separated by a post.

3. Use EVE8CP Pass-Through Cables to connect powered panels that are separated by one or more non-powered panels (maximum distance between the powered panels is 12 feet).

- a) The length of the Pass-Through Cable is calculated by adding together the widths of the non-powered panels that separate the two powered panels and applying an additional 16" to the total. (EVE8PD Power Distribution Housing is positioned 8" in from the ends of the powered panel.)
- b) An additional 4" must be added to the Pass-Through Cable for each post that the cable passes through.

4. From the price list, select the EVE8CP Pass-Through Cable that matches the calculated length. If the length is between listed sizes, use the next size up.

**Step 4** Determine the location and circuitry of the receptacles.

1. Each powered panel has four (4) potential locations for EVE8RD Duplex Receptacles – 2 per side. (Exception: 24" wide panel has only two potential locations – 1 per side, 18" wide panel has no locations for receptacles.)
2. At each receptacle location there is a choice of four (4) circuit options. Select a circuit option for each location. Circuits one and two are utility circuits; circuits A and B are dedicated circuits.

**DEFINITION OF COMPONENTS****Power Distribution Housing**

Power Distribution Housing must be specified for each panel where power is required. Order a power kit for the panel width requiring power. The kit is field installed.

**Jumper Cable**

A Jumper Cable must be ordered to connect two powered panels. The EVE8CP16 connects two powered panels. The EVE8CP20 connects two powered panels with a 90° connector post between the panels (two-way, three-way, four-way configurations).

**A Pass-Through Cable**

A Pass-Through Cable allows cables to be passed from a powered panel through one or more non-powered panels (panels that do not require electrical outlets) to connect to another powered panel. (See Step-by-Step Specification for details.)

**Duplex Receptacles**

Duplex Receptacles snap into place in the power housing. Four circuits may be specified. Circuits A and B are dedicated. Up to two duplexes per side may be installed in a power way for panels 30" and wider. 24" panels will accept one Duplex Receptacle per side. 18" panels will not accept Duplex Receptacles.

**Power Entry**

To power an Evolve panel, order either a floor power entry or a ceiling power entry. A floor power entry module will take the place of a duplex receptacle by snapping into the base power way.

**Desktop Data/Power Receptacle**

This module is positioned in the scoop of an Evolve worksurface and provides two simplex plugs and two voice/data ports or two simplex plugs only and two voice data only. A 6 foot power cord can be plugged into a powered Evolve raceway.



## WIRE SCHEMATIC

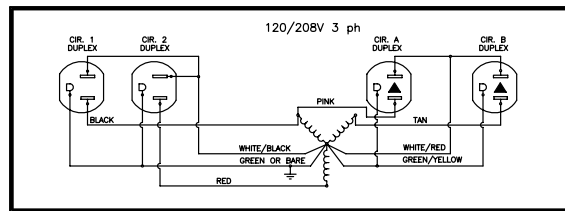
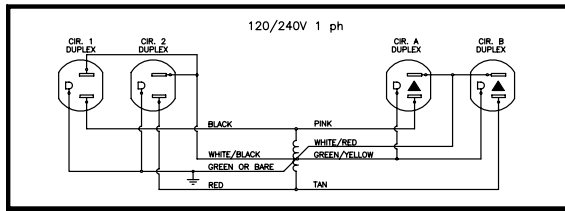

4-2-2 Wiring Schematic  
8-Wire Shared Neutral  
"2+2" – 2 Utility circuits, 2 dedicated

**8 Wires**

4 Lines (12 ga.)  
2 Neutrals (10 ga.)  
2 Grounds (12 ga.)

**4 Circuits**

2 Utility Circuits  
2 Dedicated Circuits

**Receptacles**

Duplex – Up to 6 receptacles per circuit (Up to 48 infeed)

**Specifications**

System rated for connection to a grounded 120/240 V, single phase, 20A, 60Hz or 120/208 V, 3 phase, 20A, 60Hz branch circuit for U.S. and 15A if product is marked with a C-UL Mark. Outlets rated 15A max.

## UL RECOGNIZED AND CSA CERTIFIED

**Warning:** It is recommended that installation of the electrical harness be made under the supervision of a licensed electrician in accordance with applicable codes and regulations.

**Special Note:** Always determine that harness is electrically connected to only one power supply.

## COMPONENTS REQUIRED

- a) EVE8PD42 • Power Distribution Housing  
**Note:** 8 wire, 4 circuits (A and B circuits access dedicated circuits).
- b) EVE8CP16 • Jumper Cable  
**Note:** EVE8CP16 connects two powered panels positioned side by side. EVE8CP20 connects two powered panels separated by a post.
- c) EVE8RD • Duplex Receptacle  
**Note:** 1 and 2 access utility circuits.
- d) EVE8CP • Pass-Through Cable  
**Note:** An "I" connector is available to connect 2 Pass-Through Cables.

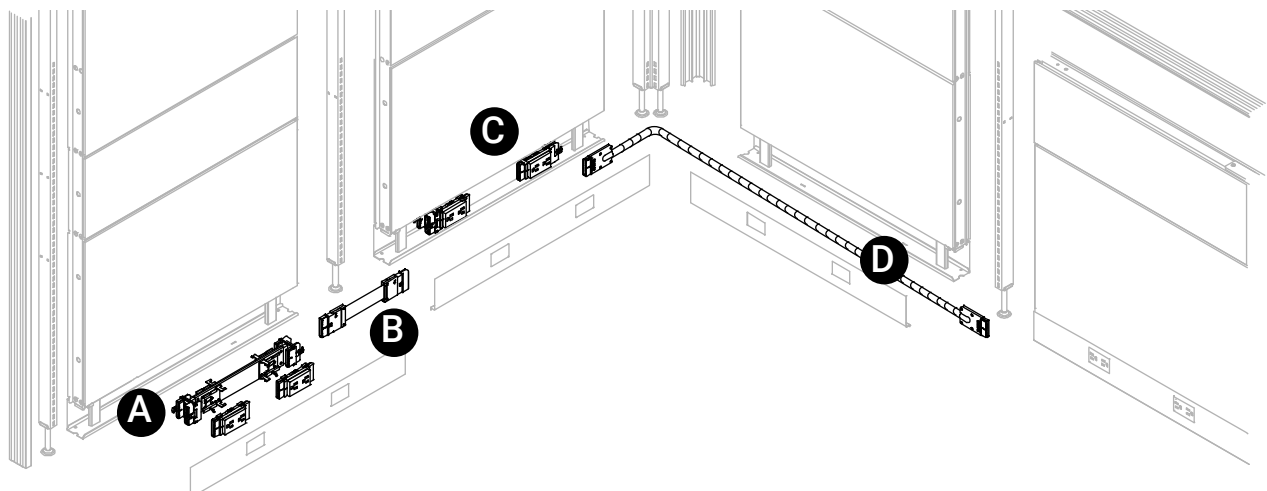

**EVE8CI-1 • "I" Connector**

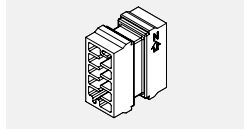

- Female - Female connector used to connect two Pass-Through Cables.

PRODUCT CODE	PRICE	SIZE/ H	INCHES W	D	WEIGHT LBS	VOL FT <sup>3</sup>
EVE8CI-1	77	15	15	0.75	0.06	0.20

**EVE8RD • Duplex Receptacles**

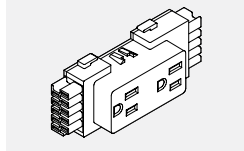

- Up to 6 duplex receptacles per circuit.
- EVE8RD1 = Circuit #1 (utility circuit)
- EVE8RD2 = Circuit #2 (utility circuit)
- EVE8RDA = Circuit #A (dedicated)
- EVE8RDB = Circuit #B (dedicated)

PRODUCT CODE	PRICE	SIZE/ H	INCHES W	D	WEIGHT LBS	VOL FT <sup>3</sup>
EVE8RD1	32	2	4.625	1.25	0.16	0.01
EVE8RD2	32	2	4.625	1.25	0.16	0.01
EVE8RDA	32	2	4.625	1.25	0.16	0.01
EVE8RDB	32	2	4.625	1.25	0.16	0.01

**EVEUSB01 • Duplex Receptacles**

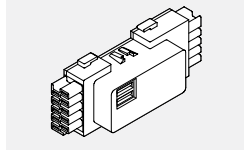

- The USB charging module provides convenient charging power access through dual ports on face of the receptacle.
- Two USB ports.
- 2 Amp output via two USB ports, considered as circuit #1.
- Available in white, black.

PRODUCT CODE	PRICE	SIZE/ H	INCHES W	D	WEIGHT LBS	VOL FT <sup>3</sup>
EVEUSB01WHT	216	2	4.625	1.25	0.16	0.01
EVEUSB01BLK	207	2	4.625	1.25	0.16	0.01

**EVE8RDx-20 • Duplex Receptacles, 20AMP**

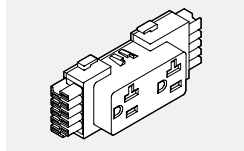

- Up to 6 receptacles per circuit (24 per infeed) not to exceed total 20 Amps per circuit.
- EVE8RD1 = Circuit #1 (utility circuit)
- EVE8RD2 = Circuit #2 (utility circuit)
- EVE8RDA = Circuit #A (dedicated)
- EVE8RDB = Circuit #B (dedicated)

PRODUCT CODE	PRICE	SIZE/ H	INCHES W	D	WEIGHT LBS	VOL FT <sup>3</sup>
EVE8RD1-20	36	2	4.625	1.25	0.16	0.01
EVE8RD2-20	36	2	4.625	1 1/4	0.16	0.01
EVE8RDA-20	36	2	4.625	1 1/4	0.16	0.01
EVE8RDB-20	36	2	4.625	1 1/4	0.16	0.01

**EVE8FR1 • Reversible Floor Power Entry**

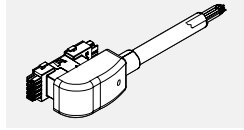

- Takes the place of a duplex receptacle by snapping into the base power way.
- Includes 72" long liquid-tight conduit.
- Must be hard wired to source power by a licenced electrician.

PRODUCT CODE	PRICE	SIZE/ L	INCHES W	WEIGHT LBS	VOL FT <sup>3</sup>
EVE8FR1	321	72	72	3.82	2.00

**EVE8FR2 • Reversible Floor Power Entry**

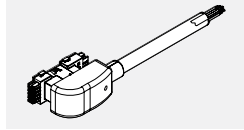

- Takes the place of a duplex receptacle by snapping into the base power way.
- Includes 144" long liquid-tight conduit.
- Must be hard wired to source power by a licenced electrician.

PRODUCT CODE	PRICE	SIZE/ L	INCHES W	WEIGHT LBS	VOL FT <sup>3</sup>
EVE8FR2	413	144	144	6.98	2.00

**EVE8FP • Floor Power Supply**

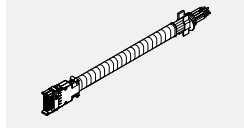

- Snaps in end of power distribution housing
- Includes flexible vinyl conduit
- Must be hard wired to source by licensed electrician
- Diameter is 0,85"

PRODUCT CODE	PRICE	SIZE/ L	INCHES W	WEIGHT LBS	VOL FT <sup>3</sup>
EVE8F1P	321	72	72	3.82	2
EVE8F2P	413	144	144	6.98	2

**EVE8PD • Power Distribution Housing**

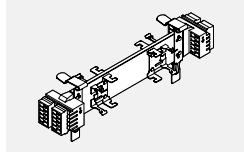

- Power housing is specified per panel size. eg. EVE8PD36 is for use with a 36" panel.
- 8 wire, 4 circuits (A and B circuits are dedicated).
- Provides two duplex receptacles per panel side on all panel widths above the 24" wide panel.
- 24" wide panel allows for only one (1) duplex receptacle per panel side.

PRODUCT CODE	PRICE	SIZE/ W	INCHES W	WEIGHT LBS	VOL FT <sup>3</sup>
EVE8PD24	142	9.25	9.25	0.83	1.17
EVE8PD30	189	15.25	15.25	1.28	1.17
EVE8PD36	200	21.25	21.25	1.62	1.65
EVE8PD42	205	27.25	27.25	2.00	2.00
EVE8PD48	216	33.25	33.25	0.18	0.16
EVE8PD54	220	39.25	39.25	2.66	3.20
EVE8PD60	221	45.25	45.25	3.04	3.20
EVE8PD66	230	51.25	51.25	3.49	3.25
EVE8PD72	238	57.20	57.20	3.76	3.30

**EVE8CT • Transition Cable**

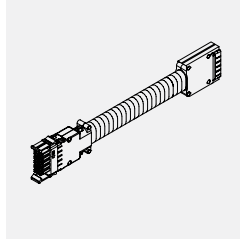

- The EVE8CT16 electrically connects an EVEPD Power Distribution Housing (pre-April 1, 2005) to an EVE8PD Power Distribution Housing when connecting powered panels that are positioned side by side.
- The EVE8CT20 electrically connects an EVEPD Power Distribution Housing (pre-April 1, 2005) to an EVE8PD Power Distribution Housing when connecting powered panels that are separated by a post.
- If there is one or more pass-through panels that contain the old Power Distribution Housing (pre-April 1, 2005) and a panel that contains the new Power Distribution Housing, then an EVE9CI-1 "I" Connector can be attached to the Transition Jumper Cable. This allows for the addition of an appropriate EVE8CP Pass-Through Cable to span the gap between the EVE8CT Transition Cable and the EVE8PD Power Distribution Housing.

PRODUCT CODE	PRICE	SIZE/ L	INCHES L	WEIGHT LBS	VOL FT <sup>3</sup>
EVE8CT16	116	16	16	0.78	1.17
EVE8CT20	134	20	20	0.92	1.17

**EVE8CP • Jumper Cable**

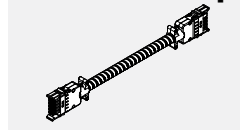

- The EVE8CP16 electrically connects two powered panels positioned side by side.
- The EVE8CP20 electrically connects two powered panels separated by a post.

PRODUCT CODE	PRICE	SIZE/ L	INCHES L	WEIGHT LBS	VOL FT <sup>3</sup>
EVE8CP16	116	16	16	0.66	1.17
EVE8CP20	134	20	20	0.78	1.17

**EVE8CP-H • Hybrid Pass Through Cables with Wire Mesh**

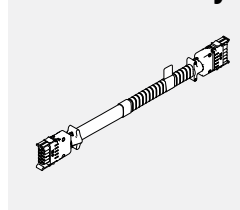

- Flexible metal conduit with wire mesh distributes electrical power through non powered panels.
- To calculate the length of Hybrid Pass Through Cable, add the width of non powered panels separating the powered panels. To this add 16" (distance from edge of the panels to power distribution housing x2).
- Please add an additional 3" when passing through a post. Please see the the beginning of this section.
- Hybrid Pass Through Cables with wire mesh allows connection at 90 degree post and one end for Power Beam.

PRODUCT CODE	PRICE	SIZE/INCHES			WEIGHT LBS	VOL FT <sup>3</sup>
		H	W	D		
EVE8CP40-H	178		40		1.44	1.17
EVE8CP46-H	185		46		1.71	1.17
EVE8CP52-H	193		52		1.95	1.17
EVE8CP58-H	205		58		2.21	1.17
EVE8CP64-H	214		64		2.37	1.17
EVE8CP70-H	218		70		2.60	1.17
EVE8CP76-H	222		76		2.81	1.17
EVE8CP82-H	232		82		3.03	1.17
EVE8CP88-H	240		88		3.05	1.17
EVE8CP94-H	248		94		3.42	1.17
EVE8CP100-H	255		100		3.47	1.17
EVE8CP106-H	265		106		3.87	1.17
EVE8CP118-H	281		118		4.08	1.17
EVE8CP130-H	306		130		4.73	1.17
EVE8CP142-H	319		142		4.89	1.17

**EVE8CP • Pass Through Cable**

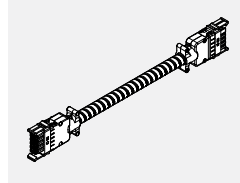

- Flexible metal conduit is used to distribute electrical power through non-powered panels.
- To calculate the length of a Pass-Through Cable, add the widths of the non-powered panels separating the powered panels (panels with distribution housing attached). To this, add 16" (distance from the edge of the panel to the distribution housing x 2). See Technical Information page at the beginning of this section.

PRODUCT CODE	PRICE	SIZE/ L	INCHES L	WEIGHT LBS	VOL FT <sup>3</sup>
EVE8CP40	149	40	40	1.44	1.17
EVE8CP46	154	46	46	1.71	1.17
EVE8CP52	161	52	52	1.95	1.17
EVE8CP58	171	58	58	2.21	1.17
EVE8CP64	178	64	64	2.37	1.17
EVE8CP70	182	70	70	2.60	1.17
EVE8CP76	185	76	76	2.81	1.17
EVE8CP82	194	82	82	3.03	1.17
EVE8CP88	200	88	88	3.05	1.17
EVE8CP94	207	94	94	3.92	1.17
EVE8CP100	212	100	100	3.47	1.17
EVE8CP106	221	106	106	3.87	1.17
EVE8CP118	234	118	118	4.08	1.17
EVE8CP130	255	130	130	4.73	1.17
EVE8CP142	266	142	142	4.59	1.17

**EVH8RC • Raceway Covers**

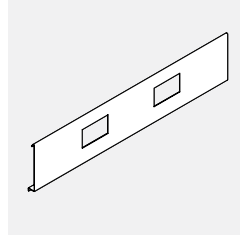

- Raceway Covers with 1.35 x 2.68" duplex receptacle openings.
- Includes 2 receptacle opening shields.
- Raceway Covers are sold individually.
- Used when adding to existing panel installation ordered prior to April 1, 2005.

PRODUCT CODE	PRICE	SIZE/ H	INCHES W	WEIGHT LBS	VOL FT <sup>3</sup>
EVH8RC24	29	6	24	1.00	0.11
EVH8RC30	36	6	30	1.10	0.12
EVH8RC36	40	6	36	1.20	0.13
EVH8RC42	47	6	42	1.30	0.14
EVH8RC48	56	6	48	1.40	0.15
EVH8RC54	64	6	54	1.40	0.15
EVH8RC60	66	6	60	1.50	0.16

**EVB8RA • Raceway Opening Adapter**

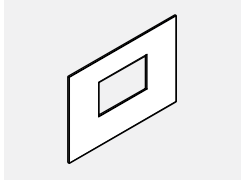

- Used when using new electrical and adding to existing panel installation ordered prior to April 1, 2005.
- PVC Adapter reduces the size of the Duplex Receptacle opening to accommodate the new style Duplex Receptacles.
- Pressure fits inside existing (old style) Raceway Cover.
- Opening size is 1.35" x 2.68".
- Sold in packs of 12, black only.

PRODUCT CODE	PRICE	SIZE/	INCHES	WEIGHT	VOL
			W	LBS	FT <sup>3</sup>
EVB8RA01	90		16	0.01	0.01

**EVE8EC • Ceiling Power Entry**

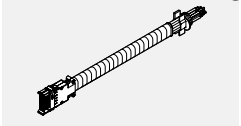

- Snaps into the end of Power Distribution Housing.
- Flexible metal conduit extends into the ceiling through a corner post and post extension (both ordered separately).
- Must be hard wired to source power by a licensed electrician.
- 4" Junction Box included.

PRODUCT CODE	PRICE	SIZE/	INCHES	WEIGHT	VOL
		L	L	LBS	FT <sup>3</sup>
EVE8EC1	244		132	5.24	2.00
EVE8EC2	435		144	5.96	2.00

**EVDPE • Post Extension Data/Comm Lay-in**

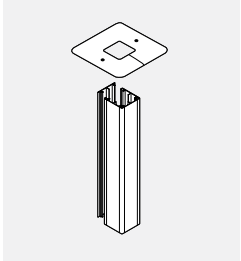

- Attaches to the top of a post to bring power and/or data cables from the ceiling to panel power way.
- Three-sided power pole with snap-on fourth side.
- Post extension can be opened on one side for lay-in for power and/or data cables.
- Made of aluminum and can be field cut.
- Accommodates up to 25 CAT5 cables with electric. Accommodates up to 45 CAT5 cables without electric.
- Ceiling infeed installed on one way post with T Leg requires securing post with two Floor mount plates.
- Post extension bigger than 82" is made of two parts.

PRODUCT CODE	PRICE	SIZE/	INCHES	WEIGHT	VOL
		H	W	LBS	FT <sup>3</sup>
EVDPE64	155	64	2.875	3.00	0.70
EVDPE82	191	82	2.875	4.20	0.80
EVDPE88	293	88	2.875	4.50	0.85
EVDPE94	314	94	2.875	4.80	0.92
EVDPE100	334	100	2.875	5.12	0.97

**EVDP4E • 45° Post Extension Data/Comm Lay-in**

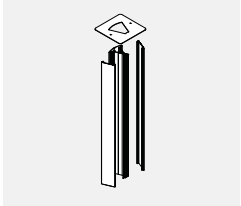

- Attached to the top of the 45° Corner Post to bring power and/or data cables from the ceiling to the panel run through.
- Cable Capacity
  - 40 CAT5 cables without electric feed.
  - 10 CAT5 cables with electric feed.

PRODUCT CODE	PRICE	SIZE/	INCHES	WEIGHT	VOL
		H	W	LBS	FT <sup>3</sup>
EVDP4E64	157	64	3.65	3.00	0.70
EVDP4E82	212	82	3.65	4.20	0.80

**EVDP6E • 60° Post Extension Data/Comm Lay-in**

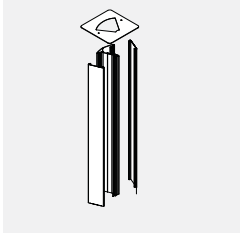

- Attached to the top of the 60° Corner Post to bring power and/or data cables from the ceiling to the panel run through.
- Post extension can be opened on one side for lay-in power and/or data cables.
- Made of aluminum and can be field cut.
- Two sided power pole with snap-on third side.
- Cable Capacity
  - 32 CAT5 cables without electric.
  - 15 CAT5 cables with electric

PRODUCT CODE	PRICE	SIZE/	INCHES	WEIGHT	VOL
		H	W	LBS	FT <sup>3</sup>
EVDP6E64	152	64	2	3.00	0.70
EVDP6E82	186	82	2	4.20	0.80

**EVEJBC1 • Hardwire Junction Box**

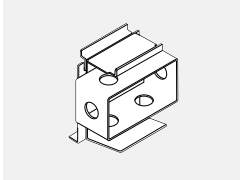

- Provides economical single circuit capability.
- Can be used in addition to 8 wire system to support isolated hospital power.
- Can be retrofitted in any size of panel at the receptacle location.
- Gives access from one side only at each location.
- Customer to supply conduit, wiring, receptacle, and face plate.
- A licensed electrician must provide hardwire connection with the junction box.

PRODUCT CODE	PRICE	WEIGHT	VOL
		LBS	FT <sup>3</sup>
EVEJBC1	95	1.50	0.02

## Power Beam

- All metal components are painted with environmentally friendly epoxy powder.
- Raceway interiors are coated with recycled epoxy powder.
- The entire Evolve Power Beam and the processes used to manufacture it are designed to save and protect the environment. Evolve panels are made from recycled materials and are 100% recyclable.
- Components conform to CGSB and ANSI/BIFMA Standards.
- The quality and performance level of these panels have been tested to equal or exceed the requirements of the U.S. Government.
- Power Beam has a steel frame and is 2 7/8" thick. Corner posts create a panel creep of 3 1/4".
- Leveling glides extend 1 1/2" high.

### Power Beam Options

- Power Beams are available in the following heights: 24", 30", and 36".
- Module widths come in seven (7) sizes: 36", 42", 48", 54", 60", 66" and 72".
- Straight, 90 degree & 120 degree.

### Extension Module Options

- Acoustic Fabric (Tackable), Glazed, Open, Laminate, Whiteboard, Air Flow.
- Attaches to the top of the Power Beam or another extension module (not to exceed 42" above finished floor).
- Offered in 6", 12", and 18" heights.
- Can be stacked up to 42" high above the finished floor (A.F.F.).

### Beam Reconfiguration

- Extension Modules can be modified on site by replacing fabric modules with Glazed, Open, Laminate, Whiteboard or Air Flow at any time after the initial installation.
- Fabric can be replaced easily; using pre-cut segments of fabric, a drawstring (C-Jex) is sewn in around the edges. Then a rubber spline is used to 'screen' the fabric in place.

### Voice/Data And Electrical Power

- NOTE: Panels and Electric components are CSA/UL approved. Tools are not required to install electrical in the Power Beam.

### Electric Information

- Electric can be run in all three Power Beam heights (24" h, 30" h or 36" h).
- 8-Wire, 4 circuit capability
- 2 utility + 2 dedicated circuits
- 10 gauge (oversized) neutrals
- All circuits can support up to 15 a max.
- Contact Evolve customer care for additional wiring options.

### Raceway Information

- Raceway knockouts sizes conform to the ANSI/TIA/ EIA Furniture Opening Standard of 1.38" x 2.71".
- Power Beam raceway covers 36"-60" wide accommodate knockouts for two electrical duplexes and one communication face plate on each side. 66" wide beam accommodates 4 electrical duplexes and one communication face plate on each side. 72" wide beam accommodates 4 duplex receptacles and 2 communication face plates on each side.
- Standard data face mount plates can be used without the need of adapter plates (supplied by others).
- Cabling capacities (calculations below are based on .25" diameter communication cables.)
- Power Modules:
  - Without electric – 65 Cables
  - With electric – 54 Cables
- Panel Connectors - 90 Degree Connector Posts:
  - Without electric – 45 cables
  - With electric – 25 Cables

### Work Tables

- Freestanding tables
  - Foli height adjustable (23" or 29"d)
  - Bungee (20", 24" or 30"d)
  - Junction (20", 24" or 30"d)
  - 2gether (18" or 24"d)

**Power Beam is a freestanding beam system and does not support attachment of an Evolve brackets or overhead storage including cantilevers or other support brackets.**

## Features, Benefits & General Information

### Technical Features of Power Beam:

- Evolve Power Beam is 2 7/8" thick.
- An aluminum low profile top cap is included with Power Beams.
- Power Beam will accommodate 65 x 0.25" diameter communication cables without electrical or 54 x 0.25" diameter communication cables with electrical.
- 90-degree post extension accommodates 45 x 0.25" diameter communication cables without electrical and 25 x 0.25" diameter communication cables with electric.
- Raceway knockout openings are 1.38" x 2.71".

### Basic Features of Power Beam

- Power Beam is available in three (3) heights: 24" h, 30" h and 36" h; and seven (7) widths: 36" w, 42" w, 48" w, 54" w, 60" w, 66" w and 72" w.
- There is no panel creep in a straight Beam-to-Beam configuration; however, a corner post (2, 3, 4 way) will add 3.25" inches to a beam run.

### Basic Features of Extension Modules

- Extension modules stack on the top of a Power Beam or another extension module (maximum height - 42" h, above finished floor).
- Fabric extension modules may have different fabrics on opposite sides within the same grade with no up-charge.
- If different grades of fabric are used on one module, the entire modules will be priced utilizing the fabric with the highest grade.

Power Beam Parts

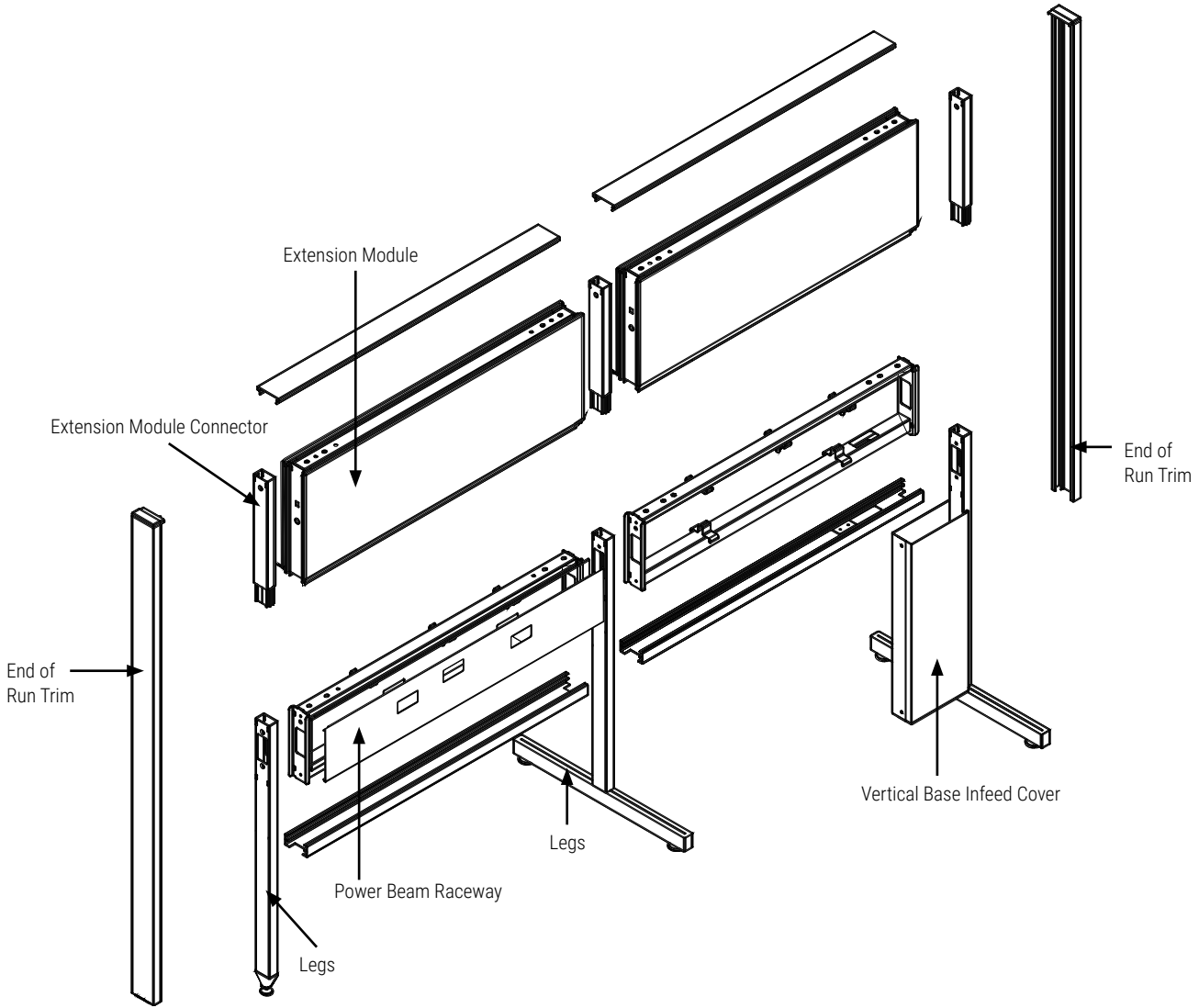

Extension Module Materials

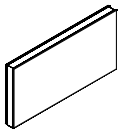

Fabric

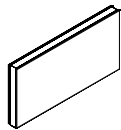

Laminate

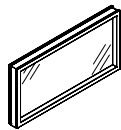

Glass



Write Board

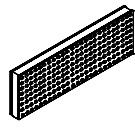

Airflow

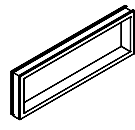

Open

**EVPB • Power Beam**

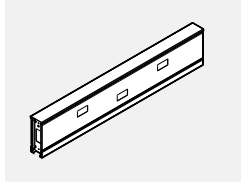

- Aluminum top trim and bottom trim included
- No access for base infeed
- Support legs ordered separately

PRODUCT CODE	PRICE	SIZE/ INCHES			WEIGHT VOL	
		H	W	D	LBS	FT <sup>3</sup>
EVPB36	195	6	36	2.875	15.5	0.48
EVPB42	215	6	42	2.875	17.1	0.56
EVPB48	233	6	48	2.875	18.6	0.64
EVPB54	255	6	54	2.875	20.2	0.72
EVPB60	278	6	60	2.875	21.8	0.80

**EVPB • 6" High Power Beam**

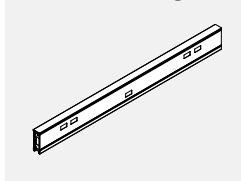

- One piece aluminum top trim and one piece aluminum bottom trim included.

PRODUCT CODE	PRICE	SIZE/ INCHES			WEIGHT VOL	
		H	W	D	LBS	FT <sup>3</sup>
EVPB66	435	6	66	2.875	31	0.91
EVPB72	450	6	72	2.875	32	1.00

**EVPBE • Power Beam with Electrical Cut-out for Base Feed**

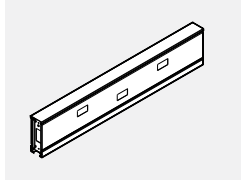

- Power beam with bottom cut out (on one end) for base infeed
- Aluminum top and bottom trims included
- Bottom trim has a cut out on one side for electrical access and a bracket to connect to the vertical base infeed cover (ordered separately)
- Vertical base infeed cover with support leg ordered separately

PRODUCT CODE	PRICE	SIZE/ INCHES			WEIGHT VOL	
		H	W	D	LBS	FT <sup>3</sup>
EVPBE36	206	6	36	2.875	15.5	0.48
EVPBE42	229	6	42	2.875	17.1	0.56
EVPBE48	251	6	48	2.875	18.6	0.64
EVPBE54	270	6	54	2.875	20.2	0.72
EVPBE60	295	6	60	2.875	21.8	0.80

**EVPBE • Power Beam Kit with Electrical Cut-out for Base Feed**

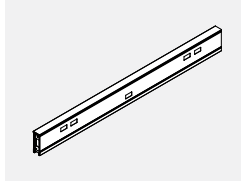

- 66" Power Beam Kit consists of (1) 30" Power Beam and (1) 36" Power Beam with bottom cut out on one side for a base infeed. In-line connector and hardware included.
- Vertical base infeed cover with support leg ordered separately.

PRODUCT CODE	PRICE	SIZE/ INCHES			WEIGHT VOL	
		H	W	D	LBS	FT <sup>3</sup>
EVPBE66	461	6	66	2.875	31	0.91
EVPBE72	476	6	72	2.875	32	1.00

**EVPBEP-KIT • Power Beam with Electrical Cut-out for Pass Through Cabinet**

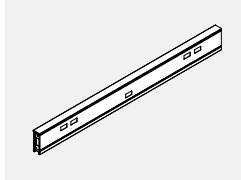

- Power beam with electrical cutout for base feed from pass through cabinet.
- Aluminum top trim included.
- 60" Power beam kit includes two 30" power distribution housing (EVE8PD30) and jumper cable (EVE8CP17).
- 72" Power beam kit includes two 36" power distribution housing (EVE8PD36) and jumper cable (EVE8CP17).
- Provides two duplex receptacle per panel side.
- Power beam base feed to be ordered separately.
- Power beam storage cabinet with pass through be ordered separately (EVPBSCGDP or EVPBSCP).
- Note: To be used with cable pass through cabinet EVPBSSCGDPR/L.

PRODUCT CODE	PRICE	SIZE/ INCHES			WEIGHT VOL	
		H	W	D	LBS	FT <sup>3</sup>
EVPBEP60KIT	717	6	60	2.875	23.4	0.86
EVPBEP72KIT	909	6	72	2.875	25.1	0.96

**EVPBEP-KIT01 • Power Beam with Electrical Cut-out for Pass Through Cabinet with Two Raceway Covers per Side**

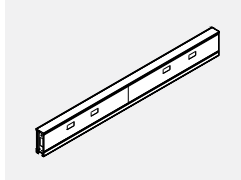

- Power beam with electrical cut out for base feed from pass through cabinet.
- Aluminum top trim included.
- 60" Power beam kit includes two 30" raceway covers per side.
- 72" Power beam kit includes two 36" raceway covers per side.
- 60" Power beam kit includes two 30" power distribution housing (EVE8PD30) and jumper cable (EVE8CP17).
- 72" Power beam kit includes two 36" power distribution housing (EVE8PD36) and jumper cable (EVE8CP17).
- Provides four duplex receptacle per panel side.
- Power beam base feed to be ordered separately.
- Power beam storage cabinet with pass through be ordered separately (EVPBSCGDP or EVPBSCP).
- Note: To be used with cable pass through cabinet EVPBSSCGDPR/L.

PRODUCT CODE	PRICE	SIZE/ INCHES			WEIGHT VOL	
		H	W	D	LBS	FT <sup>3</sup>
EVPBEP60KIT01	717	6	60	2.875	23.4	0.88
EVPBEP72KIT01	909	6	72	2.875	25.1	0.96

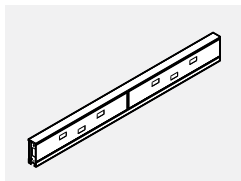

**EVPBFCL • Vertical Base Power Feed Cover with Leg**

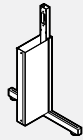

- Connects to Power Beam Kit with electrical cut out.
- Includes vertical cover and slotted connector support leg with foot.
- Power Beam kit with electrical cut out ordered separately.
- Base infeed ordered separately.

PRODUCT CODE	PRICE	SIZE/ INCHES			WEIGHT VOL	
		H	W	D	LBS	FT <sup>3</sup>
EVPBFCL24	177	24	6	21	10.1	1.75
EVPBFCL30	198	30	6	21	11.2	2.18
EVPBFCL36	218	36	6	21	12.3	2.62

**EVPBFCSL • Base Power Feed Cover with Single Leg**

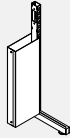

- Connects to Power Beam Kit with electrical cut out
- Includes vertical cover and slotted connector support with single leg.
- For one sided Power beam application.
- Laminate end panels must be attached to single leg at the end of power beam run for stability.
- Laminate end panels to be ordered separately.
- End of run trim below power beam included.
- Power beam with electrical cut out to be ordered separately.
- Note: Cannot be used with Power Beam storage or Power Beam overhead.

PRODUCT CODE	PRICE	SIZE/ INCHES			WEIGHT VOL	
		H	W	D	LBS	FT <sup>3</sup>
EVPBFCSL24	169	24	6	21	10.10	1.75
EVPBFCSL30	189	30	6	21	11.20	2.18
EVPBFCSL36	207	36	6	21	12.30	2.62

**EVPBFCLS • Vertical Base Power Feed Cover with Slotted Leg**

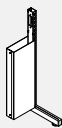

- Slotted connector allows for the attachment of brackets for worksurfaces.
- Connects two Power Beams on equal height.
- Includes vertical covers, slotted connector with leg and end of run trim below the Power Beam.
- Note: Power Beam must be installed in stable configuration using two way posts, three way posts or four way posts to provide support for worksurfaces.

PRODUCT CODE	PRICE	SIZE/ INCHES			WEIGHT VOL	
		H	W	D	LBS	FT <sup>3</sup>
EVPBFCLS24	169	24	6	21	10.10	1.75
EVPBFCLS30	189	30	6	21	11.20	2.18
EVPBFCLS36	207	36	6	21	12.30	2.62

**EVPBFCEG • Vertical Base Power Feed Cover with Glide**

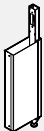

- Connects to Power Beam Kit with electrical cut out
- Includes vertical cover and slotted connector support leg with glide.
- Power Beam Kit with electrical cut out ordered separately.
- Base infeed ordered separately.

PRODUCT CODE	PRICE	SIZE/ INCHES			WEIGHT VOL	
		H	W	D	LBS	FT <sup>3</sup>
EVPBFCEG24	147	24	6	3	7.1	0.25
EVPBFCEG30	166	30	6	3	8.4	0.31
EVPBFCEG36	186	36	6	3	9.7	0.38

**EVPBFCEGS • Vertical Base Power Feed Cover with Glide and Slotted Connector**

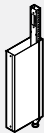

- Slotted connector allows for the attachment of brackets for worksurfaces.
- Connects two Power Beams on equal height.
- Includes vertical covers, slotted connector with glide base and end of run trim below Power Beam.
- Power Beam with electrical cut out to be ordered separately.
- Note: Power Beam must be installed in stable configuration using two way posts, three way posts or four way posts to provide support for worksurfaces.

PRODUCT CODE	PRICE	SIZE/ INCHES			WEIGHT VOL	
		H	W	D	LBS	FT <sup>3</sup>
EVPBFCEGS24	140	24	6	3	7.10	0.25
EVPBFCEGS30	157	30	6	3	8.40	0.31
EVPBFCEGS36	176	36	6	3	9.70	0.38

**EVPBFCEGS • Vertical Base Power Feed Cover with Glide**



- 42" H Slotted connector allows to attached brackets for worksurfaces
- Connects to electrical cut out power beam
- Includes vertical covers and slotted connector with glide base
- End of run trim below power beam included
- Power beam with electrical cut out to be ordered separately
- Note: Power beam to be installed in stable configuration using two way posts, three way posts, four way posts to provide support for worksurfaces

PRODUCT CODE	PRICE	SIZE/ INCHES			WEIGHT VOL	
		H	W	D	LBS	FT <sup>3</sup>
EVPB24FCGS42	173	42	6	3	10.40	0.43
EVPB30FCGS42	185	42	6	3	10.40	0.43
EVPB36FCGS42	204	42	6	3	10.40	0.43

**EVPBGFC • Power Beam Gallery Base Feed Cover**



- Connects to electrical cut out power beam attached to gallery panels.
- Includes vertical covers and slotted connector attaches to gallery panel.
- Power beam with electrical cut out to be ordered separately.

PRODUCT CODE	PRICE	SIZE/ INCHES			WEIGHT VOL	
		H	W	D	LBS	FT <sup>3</sup>
EVPBGFC24	142	24	6	3	7.1	0.25
EVPBGFC30	161	30	6	3	8.40	0.31
EVPBGFC36	177	36	6	3	9.70	0.38

**EVPBGDP • Power Beam Gallery Panel Data Post / Comm Lay-in**



- Attaches to Power beam gallery end panel to bring power and/or data cables from ceiling to power beam.
- Three-sided power pole with snap-on fourth side.
- Made of aluminum and can be field cut.
- Standard data post extension used above.
- Accommodates up to 25 CAT 5 cables with electric, up to 45 CAT 5 cables without electric.
- Standard data post extension to be ordered separately.
- Standard code is for 24" H power beam. Please add at code end for option. B- 30"H Power beam. C- 36"H Power beam.

PRODUCT CODE	PRICE	SIZE/ INCHES			WEIGHT VOL	
		H	W	D	LBS	FT <sup>3</sup>
EVPBGDP42	135	42	2	2	2.20	0.60
EVPBGDP48	150	48	2	2	3.00	0.70
EVPBGDP54	184	54	2	2	4.20	0.80



**EVE8FR3PBD • Double Entry for Power Beam**

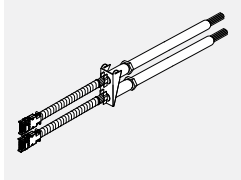

- Each power feed entry snaps into separate power distribution housing.
- Includes two 84" long flexible vinyl conduit.
- Includes double bracket to attach to Verticle base power feed cover leg.
- Must be installed in middle between two power beams, one base feed plugs to powerbeam on opposite side of leg than attached bracket.
- Vertical base power feed cover with leg to be ordered seperately.
- Must be hardwired to source by licenced electrician.
- Note: Always determine that harness is electrically connected to only one power supply.

PRODUCT CODE	PRICE	SIZE/ INCHES			WEIGHT VOL	
		H	W	D	LBS	FT <sup>3</sup>
EVE8FR3PBD	601		84		7.64	2.00

**EVHCBP01 • Ceiling Bracket for Post**

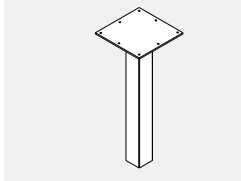

- Used to secure corner post to ceiling.
- 4.8"x4.8" top plate with 1.5x1.5 square tube 12" H, square tube fits inside aluminum corner post.
- Square tube can slide in post, bracket pushed to ceiling to be secured.

PRODUCT CODE	PRICE	SIZE/ INCHES			WEIGHT VOL	
		H	W	D	LBS	FT <sup>3</sup>
EVHCBP01	58	12	4.8	4.8	3.2	0.18

**EVHCBIC01 • Ceiling Bracket for Inline Connector**

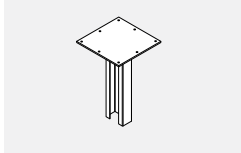

- Used to secure corner post to ceiling .
- 4.8"x4.8" top plate with 7.5"H insert in middle of plate, insert its inside connector.
- 7.5" H insert can slide in connector, bracket pushed to ceiling to secure.
- Note: Care should be taken to attach ceiling brackets to secure ceiling using correct fastners.
- Failure to do so may result in collapse of unit and subsequent possible injury.

PRODUCT CODE	PRICE	SIZE/ INCHES			WEIGHT VOL	
		H	W	D	LBS	FT <sup>3</sup>
EVHCBIC01	58	7.5	4.8	4.8	3.2	0.18

**EVHCBER01 • Ceiling Bracket for End of Run Connector**

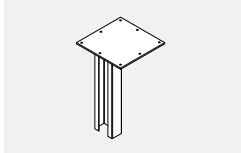

- Used to secure corner post to ceiling.
- 4.8"x4.8" top plate with 7.5"H insert in middle of plate, insert its inside connector.
- 7.5" H insert can slide in connector , bracket pushed to ceiling to secure.
- Note: Care should be taken to attach ceiling brackets to secure ceiling using correct fastners.
- Failure to do so may result in collapse of unit and subsequent possible injury.

PRODUCT CODE	PRICE	SIZE/ INCHES			WEIGHT VOL	
		H	W	D	LBS	FT <sup>3</sup>
EVHCBIC01	58	7.5	4.8	4.8	3.2	0.18

**EVPBL • Power Beam Connector with Leg**



- Connects two Power Beams in a straight run.
- 24" h -- 18" open to floor.
- 30" h -- 24" open to floor.
- 36" h -- 30" open to floor.

PRODUCT CODE	PRICE	SIZE/ INCHES			WEIGHT VOL	
		H	W	D	LBS	FT <sup>3</sup>
EVPBL24	90	24	18	3	5.9	0.30
EVPBL30	94	30	18	3	7.2	0.38
EVPBL36	100	36	18	3	8.5	0.45

**EVPBLS • Power Beam Slotted Connector with Leg**



- Slotted connector allows for the attachment of brackets for worksurfaces.
- Connects two Power Beams on equal height.
- Includes slotted connector with leg, glides and connecting hardware.
- Note: Power Beam must be installed in stable configuration using two way posts, three way posts or four way posts to provide support for worksurfaces.

PRODUCT CODE	PRICE	SIZE/ INCHES			WEIGHT VOL	
		H	W	D	LBS	FT <sup>3</sup>
EVPBLS24	87	24	18	3	5.90	0.30
EVPBLS30	90	30	18	3	7.20	0.38
EVPBLS36	94	36	18	3	8.50	0.45

**EVPBLFF • Power Beam Leg with Flat Foot**

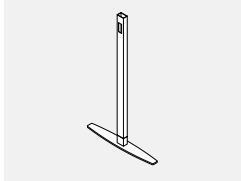

- Connects two power beams on equal height.
- Includes connector with flat foot, connecting hardware
- Note: Leg has to be used next to Post legs with glides.
- When specifiing please keep sequence post leg with glide, leg with flat foot, post leg with glide.
- Only post legs with glide provides adjustment for levelling power beams run.

PRODUCT CODE	PRICE	SIZE/ INCHES			WEIGHT VOL	
		H	W	D	LBS	FT <sup>3</sup>
EVPBLFF24	105	24	21		5.9	0.30
EVPBLFF30	109	30	21		7.2	0.38
EVPBLFF36	114	36	21		8.5	0.45

**EVPBSL • Power Beam Single Leg**

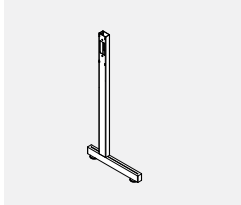

- Connects two Power Beams on equal height.
- Includes non slotted connector with leg, glides and connecting hardware.
- For one sided power beam application.
- Laminate end panels must be attached to single leg at end of power beam run for stability.
- Laminate end panels to be ordered seperately.
- Note: It can not be used with Power Beam storage or Power Beam overhead.

PRODUCT CODE	PRICE	SIZE/ INCHES			WEIGHT VOL	
		H	W	D	LBS	FT <sup>3</sup>
EVPBSL24	87	24	15	3	5.9	0.21
EVPBSL30	90	30	15	3	7.2	0.26
EVPBSL36	94	36	15	3	8.5	0.32

**EVPBGICB • Power Beam Connector with Base for Glide**



- Connects two Power Beams in a straight run.
- 24" h -- 18" open to floor.
- 30" h -- 24" open to floor.
- 36" h -- 30" open to floor.

PRODUCT CODE	PRICE	SIZE/ INCHES			WEIGHT VOL	
		H	W	D	LBS	FT <sup>3</sup>
EVPBGICB24	61	24	2	3	3.30	0.03
EVPBGICB30	63	30	2	3	4.60	0.04
EVPBGICB36	65	36	2	3	5.90	0.04

**EVPBGICBS • Power Beam Slotted Connector with Base for Glide**



- Slotted connector allows for the attachment of brackets for worksurfaces.
- Connects two Power Beams of equal heights.
- Includes slotted connector with glide and connecting hardware.
- Note: Power Beam must be installed in stable configuration using two way posts, three way posts or four way posts to provide support for worksurfaces.

PRODUCT CODE	PRICE	SIZE/ INCHES			WEIGHT VOL	
		H	W	D	LBS	FT <sup>3</sup>
EVPBGICBS24	57	24	2	3	3.30	0.03
EVPBGICBS30	59	30	2	3	4.60	0.04
EVPBGICBS36	62	36	2	3	5.90	0.04

**EVPBGICBS • Power Beam Connector with Base for Glide**



- 42" H Slotted connector allows to attached brackets for worksurfaces
- Connects two power beams on equal height and extension panel above
- Includes slotted connector with glide and connecting hardware
- Note: Power beam to be installed in stable configuration using two way posts, three way posts, four way posts to provide support for worksurfaces

PRODUCT CODE	PRICE	SIZE/ INCHES			WEIGHT VOL	
		H	W	D	LBS	FT <sup>3</sup>
EVPB24GICBS42	90	42	2		6.60	0.16
EVPB30GICBS42	90	42	2		6.60	0.16
EVPB36GICBS42	90	42	2		6.60	0.16

**EVPB24CPA • One Way Post with T Leg for 24" H Power Beam**

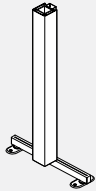

- One way post attaches to end of power beam run.
- Post and connecting hardware add 3.25 to power beam run.
- Includes post power beam T leg, post with trim all round, leveling glide, hardware and trim kit.
- Includes two floor mount plates to secure post to floor.

PRODUCT CODE	PRICE	SIZE/ INCHES			WEIGHT VOL	
		H	W	D	LBS	FT <sup>3</sup>
EVPB24CPA124	246	24	3	3	5.5	0.75
EVPB24CPA130	260	30	3	3	8.5	0.94
EVPB24CPA136	271	36	3	3	11.5	1.12
EVPB24CPA142	304	42	3	3	15	1.31

**EVPB30CPA • One Way Post with T Leg for 30" H Power Beam**

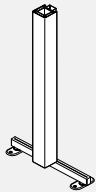

- One way post attaches to end of power beam run.
- Post and connecting hardware add 3.25 to power beam run.
- Includes post power beam T leg, post with trim all round, leveling glide, hardware and trim kit.
- Includes two floor mount plates to secure post to floor.

PRODUCT CODE	PRICE	SIZE/ INCHES			WEIGHT VOL	
		H	W	D	LBS	FT <sup>3</sup>
EVPB30CPA130	260	30	3	3	8.5	0.94
EVPB30CPA136	271	36	3	3	11.5	1.12
EVPB30CPA142	304	42	3	3	15	1.31

**EVPB36CPA • One Way Post with T Leg for 36" H Power Beam**

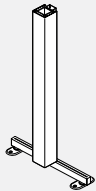

- One way post attaches to end of power beam run.
- Post and connecting hardware add 3.25 to power beam run.
- Includes post power beam T leg, post with trim all round, leveling glide, hardware and trim kit.
- Includes two floor mount plates to secure post to floor.

PRODUCT CODE	PRICE	SIZE/ INCHES			WEIGHT VOL	
		H	W	D	LBS	FT <sup>3</sup>
EVPB36CPA136	271	36	3	3	11.5	1.12
EVPB36CPA142	304	42	3	3	15	1.31

**EVPBCEPLA4 • Power Beam 4-way Corner Post**



- Connects four power beams of equal height in 90 degree configuration.
- Post and connecting hardware add 3.25" to power beam run.
- Includes one post, four nonslotted power beam connectors, post with trim all around, levelling glide, hardware and trim kit.

PRODUCT CODE	PRICE	SIZE/ INCHES			WEIGHT VOL	
		H	W	D	LBS	FT <sup>3</sup>
EVPBCEPLA424	171	24	3	3	6.30	0.22
EVPBCEPLA430	191	30	3	3	7.60	0.27
EVPBCEPLA436	186	36	3	3	8.90	0.33

**EVPBCEPLA3 • Power Beam 3-way Corner Post**



- Connects three power beams of equal height in 90 degree configuration.
- Post and connecting hardware add 3.25" to power beam run.
- Includes one post, three nonslotted power beam connectors, post with trim all around, levelling glide, hardware and trim kit.

PRODUCT CODE	PRICE	SIZE/ INCHES			WEIGHT VOL	
		H	W	D	LBS	FT <sup>3</sup>
EVPBCEPLA324	144	24	3	3	5.80	0.22
EVPBCEPLA330	149	30	3	3	7.10	0.27
EVPBCEPLA336	156	36	3	3	8.40	0.33

**EVPBCEPLA2 • Power Beam 2-way Corner Post**



- Includes one post, four nonslotted power beam connectors, post with trim all around, levelling glide, hardware and trim kit.
- Connects four power beams of equal height in 90 degree configuration.
- Post and connecting hardware add 3.25" to power beam run.

PRODUCT CODE	PRICE	SIZE/ INCHES			WEIGHT VOL	
		H	W	D	LBS	FT <sup>3</sup>
EVPBCEPLA224	130	24	3	3	5.30	0.22
EVPBCEPLA230	135	30	3	3	6.60	0.27
EVPBCEPLA236	143	36	3	3	7.90	0.33

**EVPBCIPLA2 • Power Beam In Line 2-way Corner Post**



- Connects two power beams of equal height in inline configuration.
- Post and connecting hardware add 3.25" to power beam run.
- Includes one post, two nonslotted power beam connectors, post with trim all around, levelling glide, hardware and trim kit.

PRODUCT CODE	PRICE	SIZE/ INCHES			WEIGHT VOL	
		H	W	D	LBS	FT <sup>3</sup>
EVPBCIPLA224	130	24	3	3	5.30	0.22
EVPBCIPLA230	135	30	3	3	6.60	0.27
EVPBCIPLA236	143	36	3	3	7.90	0.33

**EVPB6CEPLA3 • Power Beam 3-way 120 Degree Corner Post**



- Connects three power beams of equal height in 120 degree configuration.
- Includes one post, three nonslotted power beam connectors, post with trim all around, levelling glide, hardware and trim kit.

PRODUCT CODE	PRICE	SIZE/ INCHES			WEIGHT VOL	
		H	W	D	LBS	FT <sup>3</sup>
EVPB6CEPLA324	166	24	3	3	5.30	0.22
EVPB6CEPLA330	169	30	3	3	6.60	0.27
EVPB6CEPLA336	177	36	3	3	7.90	0.33

**EVPB6CEPLA2 - Power Beam 2-way 120 Degree Corner Post**



- Connects three power beams of equal height in 120 degree configuration.
- Includes one post, three nonslotted power beam connectors, post with trim all around, levelling glide, hardware and trim kit.

PRODUCT CODE	PRICE	SIZE/ INCHES			WEIGHT VOL	
		H	W	D	LBS	FT <sup>3</sup>
EVPB6CEPLA224	166	24	3	3	5.30	0.22
EVPB6CEPLA230	169	30	3	3	6.60	0.27
EVPB6CEPLA236	177	36	3	3	7.90	0.33

**EVPBIEC • Extension Connector for Power Beam**



- Attaches to power beam connector.
- Includes non slotted extension connector and connecting hardware.
- Must be attached to power beam connector with provided screw before installing power beam.

PRODUCT CODE	PRICE	SIZE/ INCHES			WEIGHT VOL	
		H	W	D	LBS	FT <sup>3</sup>
EVPBIEC06	29	6	2.875	3	1.0	0.06
EVPBIEC12	29	12	2.875	3	2.0	0.12
EVPBIEC18	35	18	2.875	3	3.0	0.18
EVPBIEC24	35	24	2.875	3	4.0	0.24

**EVPBIEC • Slotted Extension Connector for Power Beam**



- Attaches to Power Beam connector.
- Includes slotted extension connector and connecting hardware.
- Must be attached to Power Beam connector with provided screw before installing Power Beam.

PRODUCT CODE	PRICE	SIZE/ INCHES			WEIGHT VOL	
		H	W	D	LBS	FT <sup>3</sup>
EVPBIECS06	29	6	2.875	3	1.00	0.06
EVPBIECS12	29	12	2.875	3	2.00	0.12
EVPBIECS18	35	18	2.875	3	3.00	0.18
EVPBIECS24	35	24	2.875	3	4.00	0.24

**EVPBCEP4 • Power Beam Corner Extension Post 4 Way**

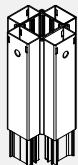

- Connects four extension modules in 90 degree configuration.
- Post and connecting hardware add 3.25" to power beam run.
- Includes one extension post, four non slotted extension connectors for power beam, connecting hardware and trim kit Power Beam.
- Corner Extension Post is not stackable.

PRODUCT CODE	PRICE	SIZE/ INCHES			WEIGHT VOL	
		H	W	D	LBS	FT <sup>3</sup>
EVPBCEP406	72	6	3	3	4	0.09
EVPBCEP412	72	12	3	3	8	0.18
EVPBCEP418	114	18	3	3	12	0.27
EVPBCEP424	114	24	3	3	16	0.36

**EVPBCEPA3 • Power Beam Corner Extension Post 3 Way**

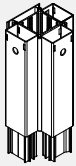

- Connects four extension modules in 90 degree configuration.
- Post and connecting hardware add 3.25" to power beam run.
- Includes one extension post, three non slotted extension connectors for power beam, connecting hardware and trim kit.
- Power Beam Corner Extension Post is not stackable.

PRODUCT CODE	PRICE	SIZE/ INCHES			WEIGHT VOL	
		H	W	D	LBS	FT <sup>3</sup>
EVPBCEPA306	78	6	3	3	3	0.08
EVPBCEPA312	78	12	3	3	6	0.16
EVPBCEPA318	129	18	3	3	9	0.24
EVPBCEPA324	129	24	3	3	12	0.32

**EVPBCEPA2 • Power Beam Corner Extension Post 2 Way**

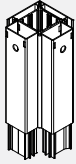

- Connects four extension modules in 90 degree configuration.
- Post and connecting hardware add 3.25" to power beam run.
- Includes one extension post, two non slotted extension connectors for power beam, connecting hardware and trim kit.
- Power Beam Corner Extension Post is not stackable.

PRODUCT CODE	PRICE	SIZE/ INCHES			WEIGHT VOL	
		H	W	D	LBS	FT <sup>3</sup>
EVPBCEPA206	70	6	3	3	2	0.07
EVPBCEPA212	70	12	3	3	4	0.14
EVPBCEPA218	118	18	3	3	6	0.21
EVPBCEPA224	118	24	3	3	8	0.28

**EVPBCEIPA2 • Power Beam In Line Corner Extension Post 2 Way**

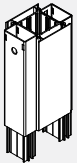

- Connects four extension modules in inline configuration.
- Post and connecting hardware add 3.25" to power beam run.
- Includes one extension post, two non slotted extension connectors for power beam, connecting hardware and trim kit.
- Power Beam Corner Extension Post is not stackable.

PRODUCT CODE	PRICE	SIZE/ INCHES			WEIGHT VOL	
		H	W	D	LBS	FT <sup>3</sup>
EVPBCEIPA206	87	6	3	3	2	0.07
EVPBCEIPA212	87	12	3	3	4	0.14
EVPBCEIPA218	122	18	3	3	6	0.21
EVPBCEIPA224	122	24	3	3	8	0.28

**EVPBCEPA1 • Power Beam Corner Extension Post 1 Way**

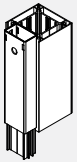

- Connects at end of run of extension modules.
- Post and connecting hardware add 3.25" to power beam run.
- Includes one extension post, one non slotted extension connectors for power beam, connecting hardware and trim kit.
- Power Beam Corner Extension Post is not stackable.

PRODUCT CODE	PRICE	SIZE/ INCHES			WEIGHT VOL	
		H	W	D	LBS	FT <sup>3</sup>
EVPBCEPA106	64	6	3	3	2	0.07
EVPBCEPA112	64	12	3	3	4	0.14
EVPBCEPA118	88	18	3	3	6	0.21
EVPBCEPA124	88	24	3	3	6	0.21

**EVPB6CEP3 • Power Beam 120 Degree Corner Extension Post 3 Way**



- Connects three extension modules in 120 degree configuration.
- Includes one extension post, three non slotted extension connectors for power beam, connecting hardware and trim kit.
- Power Beam Corner Extension Post is not stackable.

PRODUCT CODE	PRICE	SIZE/ INCHES			WEIGHT VOL	
		H	W	D	LBS	FT <sup>3</sup>
EVPB6CEP306	105	6	3	3	3	0.08
EVPB6CEP312	105	12	3	3	6	0.16
EVPB6CEP318	166	18	3	3	9	0.24
EVPB6CEP324	166	24	3	3	12	0.32

**EVPB6CEPA2 • Power Beam 120 Degree Corner Extension Post 2 Way**



- Connects two extension modules in 120 degree configuration.
- Includes one extension post, two non slotted extension connectors for power beam, connecting hardware and trim kit.
- Power Beam Corner Extension Post is not stackable.

PRODUCT CODE	PRICE	SIZE/ INCHES			WEIGHT VOL	
		H	W	D	LBS	FT <sup>3</sup>
EVPB6CEPA206	89	6	3	3	2	0.07
EVPB6CEPA212	89	12	3	3	4	0.14
EVPB6CEPA218	139	18	3	3	6	0.21
EVPB6CEPA224	139	24	3	3	8	0.28

**EVPB6CEPA1 • Power Beam 60 Degree Corner Extension Post 1 Way**

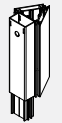

- Connects one extension module in 120 degree configuration.
- Includes one extension post, three non slotted extension connectors for power beam, connecting hardware and trim kit.
- Power Beam Corner Extension Post is not stackable.

PRODUCT CODE	PRICE	SIZE/ INCHES			WEIGHT VOL	
		H	W	D	LBS	FT <sup>3</sup>
EVPB6CEPA106	59	6	3	3	2	0.07
EVPB6CEPA112	63	12	3	3	4	0.14
EVPB6CEPA118	85	18	3	3	6	0.21
EVPB6CEPA124	85	24	3	3	8	0.28

**EVPB24CPA • Panel to 24" H Power Beam 4 Way Corner Post**

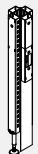

- Connects two panels and two 24" H power beams in 90 degree configuration.
- Post and connecting hardware add 3.25" to power beam run.
- Includes post, panel connectors and power beam connectors, post with trim all around, levelling glide, hardware and trim kit
- Pass thru only for power beam.

PRODUCT CODE	PRICE	SIZE/ INCHES			WEIGHT VOL	
		H	W	D	LBS	FT <sup>3</sup>
EVPB24CPA430	218	30	3	3	15.5	0.41
EVPB24CPA436	284	36	3	3	18	0.48
EVPB24CPA442	284	42	3	3	21	0.57

**EVPB30CPA • Panel to 30" H Power Beam 4 Way Corner Post**



- Connects two panels and two 24" H power beams in 90 degree configuration.
- Post and connecting hardware add 3.25" to power beam run.
- Includes post, panel connectors and power beam connectors, post with trim all around, levelling glide, hardware and trim kit.
- Pass thru only for power beam.

PRODUCT CODE	PRICE	SIZE/ INCHES			WEIGHT VOL	
		H	W	D	LBS	FT <sup>3</sup>
EVPB30CPA430	218	30	3	3	15.5	0.41
EVPB30CPA436	284	36	3	3	18	0.48
EVPB30CPA442	284	42	3	3	21	0.57

**EVPB36CPA • Panel to 36" H Power Beam 4 Way Corner Post**



- Connects two panels and two 24" H power beams in 90 degree configuration.
- Post and connecting hardware add 3.25" to power beam run.
- Includes post, panel connectors and power beam connectors, post with trim all around, levelling glide, hardware and trim kit.
- Pass thru only for power beam.

PRODUCT CODE	PRICE	SIZE/ INCHES			WEIGHT VOL	
		H	W	D	LBS	FT <sup>3</sup>
EVPB36CPA436	284	36	3	3	18	0.48
EVPB36CPA442	284	42	3	3	21	0.57

**EVPB24CPSA4 • Panel to 24" H Power Beam 4 Way Corner Post - Slotted**

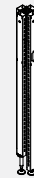

- Connects two panels and two 24" H power beams in a 90 degree configuration.
- Post and connecting hardware add 3.25" to the power beam run.
- Includes post, panel connectors, power beam connectors, post with trim all around, levelling glide, hardware and trim kit.
- Pass thru only for power beam, power beam leg slotted.

PRODUCT CODE	PRICE	SIZE/INCHES			WEIGHT VOL	
		H	W	D	LBS	FT <sup>3</sup>
EVPB24CPSA430	218	30	3	3	15.5	0.41
EVPB24CPSA436	284	36	3	3	18	0.48
EVPB24CPSA442	284	42	3	3	21	0.57

**EVPB30CPSA4 • Panel to 30" H Power Beam 4 Way Corner Post - Slotted**



- Connects two panels and two 30" H power beams in a 90 degree configuration.
- Post and connecting hardware add 3.25" to the power beam run.
- Includes post, panel connectors, power beam connectors, post with trim all around, levelling glide, hardware and trim kit.
- Pass thru only for power beam, power beam leg slotted.

PRODUCT CODE	PRICE	SIZE/INCHES			WEIGHT VOL	
		H	W	D	LBS	FT <sup>3</sup>
EVPB30CPSA430	218	30	3	3	15.5	0.41
EVPB30CPSA436	284	36	3	3	18	0.48
EVPB30CPSA442	284	42	3	3	21	0.57

**EVPB36CPSA4 • Panel to 36" H Power Beam 4 Way Corner Post - Slotted**



- Connects two panels and two 36" H power beams in a 90 degree configuration.
- Post and connecting hardware add 3.25" to the power beam run.
- Includes post, panel connectors, power beam connectors, post with trim all around, levelling glide, hardware and trim kit.
- Pass thru only for power beam, power beam leg slotted.

PRODUCT CODE	PRICE	SIZE/INCHES			WEIGHT VOL	
		H	W	D	LBS	FT <sup>3</sup>
EVPB36CPSA436	284	36	3	3	18	0.48
EVPB36CPSA442	284	42	3	3	21	0.57

**EVPB24CPA • Panel to 24" H Power Beam 3 Way Corner Post**



- Connects panels and 24" H power beams in 90 degree configuration.
- Post and connecting hardware add 3.25" to power beam run.
- Includes post, panel connectors and power beam connectors, post with trim all around, levelling glide, hardware and trim kit.
- Pass thru only for power beam.

PRODUCT CODE	PRICE	SIZE/ INCHES			WEIGHT VOL	
		H	W	D	LBS	FT <sup>3</sup>
EVPB24CPA330	198	30	3	3	11.8	0.36
EVPB24CPA336	263	36	3	3	13	0.42
EVPB24CPA342	263	42	3	3	16.1	0.50

**EVPB30CPA • Panel to 30" H Power Beam 3 Way Corner Post**



- Connects panels and 30" H power beams in 90 degree configuration.
- Post and connecting hardware add 3.25" to power beam run.
- Includes post, panel connectors and power beam connectors, post with trim all around, levelling glide, hardware and trim kit.
- Pass thru only for power beam.

PRODUCT CODE	PRICE	SIZE/ INCHES			WEIGHT VOL	
		H	W	D	LBS	FT <sup>3</sup>
EVPB30CPA330	198	30	3	3	11.8	0.36
EVPB30CPA336	263	36	3	3	13	0.42
EVPB30CPA342	263	42	3	3	16.1	0.50

**EVPB36CPA • Panel to 36" H Power Beam 3 Way Corner Post**



- Connects panels and 36" H power beams in 90 degree configuration.
- Post and connecting hardware add 3.25" to power beam run.
- Includes post, panel connectors and power beam connectors, post with trim all around, levelling glide, hardware and trim kit.
- Pass thru only for power beam.

PRODUCT CODE	PRICE	SIZE/ INCHES			WEIGHT LBS	VOL FT <sup>3</sup>
		H	W	D		
EVPB36CPA336	263	36	3	3	13	0.42
EVPB36CPA342	263	42	3	3	16.1	0.50

**EVPB24CPSA3 • Panel to 24" H Power Beam 3 Way Corner Post - Slotted**

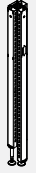

- Connects panels and 24" H power beam in a 90 degree configuration.
- Post and connecting hardware add 3.25" to the power beam run.
- Includes post, panel connectors, power beam connectors, post with trim all around, levelling glide, hardware and trim kit.
- Pass thru only for power beam, power beam leg slotted.

PRODUCT CODE	PRICE	SIZE/ INCHES			WEIGHT LBS	VOL FT <sup>3</sup>
		H	W	D		
EVPB24CPSA330	198	30	3	3	11.8	0.36
EVPB24CPSA336	263	36	3	3	13	0.42
EVPB24CPSA342	263	42	3	3	16.1	0.50

**EVPB30CPSA3 • Panel to 30" H Power Beam 3 Way Corner Post - Slotted**

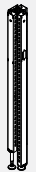

- Connects panels and 30" H power beam in a 90 degree configuration.
- Post and connecting hardware add 3.25" to the power beam run.
- Includes post, panel connectors, power beam connectors, post with trim all around, levelling glide, hardware and trim kit.
- Pass thru only for power beam, power beam leg slotted.

PRODUCT CODE	PRICE	SIZE/ INCHES			WEIGHT LBS	VOL FT <sup>3</sup>
		H	W	D		
EVPB30CPSA330	198	30	3	3	11.8	0.36
EVPB30CPSA336	263	36	3	3	13	0.42
EVPB30CPSA342	263	42	3	3	16.1	0.50

**EVPB36CPSA3 • Panel to 36" H Power Beam 3 Way Corner Post - Slotted**

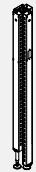

- Connects panels and 36" H power beam in a 90 degree configuration.
- Post and connecting hardware add 3.25" to the power beam run.
- Includes post, panel connectors, power beam connectors, post with trim all around, levelling glide, hardware and trim kit.
- Pass thru only for power beam, power beam leg slotted.

PRODUCT CODE	PRICE	SIZE/ INCHES			WEIGHT LBS	VOL FT <sup>3</sup>
		H	W	D		
EVPB36CPSA336	263	36	3	3	13	0.42
EVPB36CPSA342	263	42	3	3	16.1	0.50

**EVPB24CPA • Panel to 24" H Power Beam 2 Way Corner Post**



- Connects one panels and one 24" H power beams in 90 degree configuration.
- Post and connecting hardware add 3.25" to power beam run.
- Includes post, panel connectors and power beam connectors, post with trim all around, levelling glide, hardware and trim kit.
- Pass thru only for power beam.

PRODUCT CODE	PRICE	SIZE/ INCHES			WEIGHT LBS	VOL FT <sup>3</sup>
		H	W	D		
EVPB24CPA230	166	30	3	3	8.5	0.31
EVPB24CPA236	206	36	3	3	11.5	0.37
EVPB24CPA242	206	42	3	3	15	0.43

**EVPB30CPA • Panel to 30" H Power Beam 2 Way Corner Post**



- Connects one panels and one 30" H power beams in 90 degree configuration.
- Post and connecting hardware add 3.25" to power beam run.
- Includes post, panel connectors and power beam connectors, post with trim all around, levelling glide, hardware and trim kit.
- Pass thru only for power beam.

PRODUCT CODE	PRICE	SIZE/ INCHES			WEIGHT LBS	VOL FT <sup>3</sup>
		H	W	D		
EVPB30CPA230	166	30	3	3	8.5	0.31
EVPB30CPA236	206	36	3	3	11.5	0.37
EVPB30CPA242	206	42	3	3	15	0.43

**EVPB36CPA • Panel to 36" H Power Beam 2 Way Corner Post**



- Connects one panels and one 36" H power beams in 90 degree configuration.
- Post and connecting hardware add 3.25" to power beam run.
- Includes post, panel connectors and power beam connectors, post with trim all around, levelling glide, hardware and trim kit.
- Pass thru only for power beam.

PRODUCT CODE	PRICE	SIZE/ INCHES			WEIGHT LBS	VOL FT <sup>3</sup>
		H	W	D		
EVPB36CPA236	206	36	3	3	11.5	0.37
EVPB36CPA242	206	42	3	3	15	0.43

**EVPB24CPSA2 • Panel to 24" H Power Beam 2 Way Corner Post - Slotted**



- Connects one panels and one 24" H power beams in 90 degree configuration.
- Post and connecting hardware add 3.25" to the power beam run.
- Includes post, panel connectors, power beam connectors, post with trim all around, levelling glide, hardware and trim kit.
- Pass thru only for power beam, power beam leg slotted.

PRODUCT CODE	PRICE	SIZE/INCHES			WEIGHT LBS	VOL FT <sup>3</sup>
		H	W	D		
EVPB24CPSA230	166	30	3	3	8.5	0.31
EVPB24CPSA236	206	36	3	3	11.5	0.37
EVPB24CPSA242	206	42	3	3	15	0.43

**EVPB30CPSA2 • Panel to 30" H Power Beam 2 Way Corner Post - Slotted**



- Connects one panels and one 30" H power beams in 90 degree configuration.
- Post and connecting hardware add 3.25" to the power beam run.
- Includes post, panel connectors, power beam connectors, post with trim all around, levelling glide, hardware and trim kit.
- Pass thru only for power beam, power beam leg slotted.

PRODUCT CODE	PRICE	SIZE/INCHES			WEIGHT LBS	VOL FT <sup>3</sup>
		H	W	D		
EVPB30CPSA230	166	30	3	3	8.5	0.31
EVPB30CPSA236	206	36	3	3	11.5	0.37
EVPB30CPSA242	206	42	3	3	15	0.43

**EVPB36CPSA2 • Panel to 36" H Power Beam 2 Way Corner Post - Slotted**



- Connects one panels and one 36" H power beams in 90 degree configuration.
- Post and connecting hardware add 3.25" to the power beam run.
- Includes post, panel connectors, power beam connectors, post with trim all around, levelling glide, hardware and trim kit.
- Pass thru only for power beam, power beam leg slotted.

PRODUCT CODE	PRICE	SIZE/INCHES			WEIGHT LBS	VOL FT <sup>3</sup>
		H	W	D		
EVPB36CPSA236	206	36	3	3	11.5	0.37
EVPB36CPSA242	206	42	3	3	15	0.43

**EVPB24CPA3-P • Panel to two 24" Power Beam 3 Way Corner Post**



- Connects two 24" H power beams with panel in T configuration.
- Post and connecting hardware add 3.25" to power beam run.
- Includes post, panel connectors and power beam connectors, post with trim all around, levelling glide, hardware and trim kit.
- Pass thru only for power beam.

PRODUCT CODE	PRICE	SIZE/ H	INCHES		WEIGHT LBS	VOL FT <sup>3</sup>
			W	D		
EVPB24CPA330P	189	30	3	3	11.8	0.36
EVPB24CPA336P	252	36	3	3	13	0.42
EVPB24CPA342P	252	42	3	3	16.1	0.5

**EVPB30CPA3-P • Panel to two 30" Power Beam 3 Way Corner Post**



- Connects two 24" H power beams with panel in T configuration.
- Post and connecting hardware add 3.25" to power beam run.
- Includes post, panel connectors and power beam connectors, post with trim all around, levelling glide, hardware and trim kit.
- Pass thru only for power beam.

PRODUCT CODE	PRICE	SIZE/ H	INCHES		WEIGHT LBS	VOL FT <sup>3</sup>
			W	D		
EVPB30CPA330P	189	30	3	3	11.8	0.36
EVPB30CPA336P	252	36	3	3	13	0.42
EVPB30CPA342P	252	42	3	3	16.1	0.5

**EVPB36CPA3-P • Panel to two 36" Power Beam 3 Way Corner Post**



- Connects two 24" H power beams with panel in T configuration.
- Post and connecting hardware add 3.25" to power beam run.
- Includes post, panel connectors and power beam connectors, post with trim all around, levelling glide, hardware and trim kit.
- Pass thru only for power beam.

PRODUCT CODE	PRICE	SIZE/ H	INCHES		WEIGHT LBS	VOL FT <sup>3</sup>
			W	D		
EVPB36CPA336P	252	36	3	3	13	0.42
EVPB36CPA342P	252	42	3	3	16.1	0.5

**EVPB24CPSA3-P • Panel to two 24" H Power Beam 3 Way Corner Post**



- Connects two 24" H power beams with panel in a T configuration.
- Post and connecting hardware add 3.25" to the power beam run.
- Includes post, panel connectors, power beam connectors, post with trim all around, levelling glide, hardware and trim kit.
- Pass thru only for power beam, power beam leg slotted.

PRODUCT CODE	PRICE	SIZE/INCHES			WEIGHT LBS	VOL FT <sup>3</sup>
		H	W	D		
EVPB24CPSA330P	189	30	3	3	11.8	0.36
EVPB24CPSA336P	252	36	3	3	13	0.42
EVPB24CPSA342P	252	42	3	3	16.1	0.50

**EVPB30CPSA3-P • Panel to two 30" H Power Beam 3 Way Corner Post**



- Connects two 30" H power beams with panel in a T configuration.
- Post and connecting hardware add 3.25" to the power beam run.
- Includes post, panel connectors, power beam connectors, post with trim all around, levelling glide, hardware and trim kit.
- Pass thru only for power beam, power beam leg slotted.

PRODUCT CODE	PRICE	SIZE/INCHES			WEIGHT LBS	VOL FT <sup>3</sup>
		H	W	D		
EVPB30CPSA330P	189	30	3	3	11.8	0.36
EVPB30CPSA336P	252	36	3	3	13	0.42
EVPB30CPSA342P	252	42	3	3	16.1	0.50

**EVPB36CPSA3-P • Panel to two 36" H Power Beam 3 Way Corner Post**



- Connects two 36" H power beams with panel in a T configuration.
- Post and connecting hardware add 3.25" to the power beam run.
- Includes post, panel connectors, power beam connectors, post with trim all around, levelling glide, hardware and trim kit.
- Pass thru only for power beam, power beam leg slotted.

PRODUCT CODE	PRICE	SIZE/INCHES			WEIGHT LBS	VOL FT <sup>3</sup>
		H	W	D		
EVPB36CPSA336P	252	36	3	3	13	0.42
EVPB36CPSA342P	252	42	3	3	16.1	0.50

**EVPFE • Fabric Panel Extension Module**

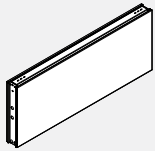

- Attaches on top of a panel.
- Module can be stacked to add privacy or divide space.
- Each side of fabric module may have different fabric within that same grade at no charge. If different grades of fabric are used, the entire module must be priced at highest grade.
- When ordering panel extension modules, additional connectors are required.
- Panel extension modules cannot be installed higher than 42" high above finished floor.

PRODUCT CODE	PRICE		SIZE/ INCHES			WEIGHT LBS	VOL FT <sup>3</sup>
	GR1	GR2	H	W	D		
EVPFE0618	149	155	6	18	2.875	4.80	0.21
EVPFE0624	154	164	6	24	2.875	6.40	0.29
EVPFE0630	169	178	6	30	2.875	7.40	0.36
EVPFE0636	189	201	6	36	2.875	8.20	0.43
EVPFE0642	211	226	6	42	2.875	9.40	0.51
EVPFE0648	228	241	6	48	2.875	10.20	0.58
EVPFE0654	246	263	6	54	2.875	14.40	0.65
EVPFE0660	268	286	6	60	2.875	16.00	0.73
EVPFE0666	289	308	6	66	2.875	17.6	0.91
EVPFE0672	309	330	6	72	2.875	18.2	0.99
EVPFE1218	149	155	12	18	2.875	7.40	0.38
EVPFE1224	154	163	12	24	2.875	8.60	0.50
EVPFE1230	169	178	12	30	2.875	9.60	0.63
EVPFE1236	189	201	12	36	2.875	12.80	0.75
EVPFE1242	211	224	12	42	2.875	14.80	0.88
EVPFE1248	228	241	12	48	2.875	15.00	1.00
EVPFE1254	246	263	12	54	2.875	16.20	1.12
EVPFE1260	268	286	12	60	2.875	17.80	1.25
EVPFE1266	289	308	12	66	2.875	19.0	1.37
EVPFE1272	309	330	12	72	2.875	20.2	1.45
EVPFE1818	184	195	18	18	2.875	9.01	0.54
EVPFE1824	191	205	18	24	2.875	10.47	0.72
EVPFE1830	206	227	18	30	2.875	11.93	0.90
EVPFE1836	239	260	18	36	2.875	13.39	1.08
EVPFE1842	266	292	18	42	2.875	14.84	1.26
EVPFE1848	289	318	18	48	2.875	16.29	1.44
EVPFE1854	315	345	18	54	2.875	17.76	1.62
EVPFE1860	342	371	18	60	2.875	19.21	1.80
EVPFE1866	371	394	18	66	2.875	20.7	1.98
EVPFE1872	397	422	18	72	2.875	22.2	2.16



**EVPGTE • Tempered Glass Panel Extension Module**

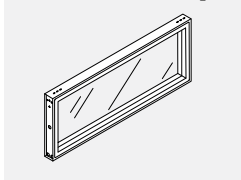

- Attaches on top of a panel.
- Module can be stacked to add privacy or divide space.
- Panel extension module is not load bearing above 66" high.
- Standard in lear (CLR).
- Frosted glass (FRST) upcharge varies. Contact Evolve customer service representative for details.
- When ordering panel extension modules, additional connectors are required.

PRODUCT CODE	PRICE	SIZE/ INCHES			WEIGHT LBS	VOL FT <sup>3</sup>
		H	W	D		
EVPGTE0618	296	6	18	2.875	7.60	0.18
EVPGTE0624	318	6	24	2.875	9.24	0.25
EVPGTE0630	385	6	30	2.875	10.78	0.31
EVPGTE0636	400	6	36	2.875	12.32	0.37
EVPGTE0642	493	6	42	2.875	14.10	0.43
EVPGTE0648	550	6	48	2.875	15.80	0.50
EVPGTE0654	603	6	54	2.875	17.42	0.56
EVPGTE0660	647	6	60	2.875	19.28	0.63
EVPGTE0666	693	6	66	2.875	21.1	0.91
EVPGTE0672	744	6	72	2.875	22.9	0.99
EVPGTE1218	296	12	18	2.875	10.06	0.38
EVPGTE1224	318	12	24	2.875	12.08	0.50
EVPGTE1230	385	12	30	2.875	14.10	0.63
EVPGTE1236	400	12	36	2.875	16.12	0.75
EVPGTE1242	493	12	42	2.875	18.24	0.88
EVPGTE1248	550	12	48	2.875	20.56	1.00
EVPGTE1254	603	12	54	2.875	22.66	1.12
EVPGTE1260	647	12	60	2.875	25.00	1.25
EVPGTE1266	693	12	66	2.875	27.4	1.37
EVPGTE1272	744	12	72	2.875	29.9	1.45
EVPGTE1818	446	18	18	2.875	12.00	0.54
EVPGTE1824	459	18	24	2.875	14.93	0.72
EVPGTE1830	490	18	30	2.875	17.77	0.90
EVPGTE1836	535	18	36	2.875	20.57	1.08
EVPGTE1842	609	18	42	2.875	23.31	1.26
EVPGTE1848	681	18	48	2.875	25.94	1.44
EVPGTE1854	740	18	54	2.875	28.51	1.62
EVPGTE1860	795	18	60	2.875	31.28	1.80
EVPGTE1866	849	18	66	2.875	33.9	1.98
EVPGTE1872	908	18	72	2.875	35.7	2.16

**EVPW1SE • Write Board Extension Module - One Side**

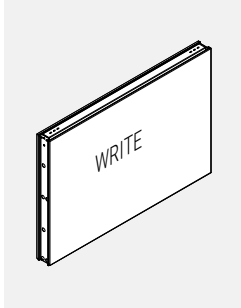

- Attaches on top of a beam.
- Provides writing surface on one side and fabric on the other side.
- Modules can be stacked to add privacy or to divide space.
- Panel Extension Modules cannot install higher than 42" high above finished floor.
- When ordering Beam Extension Modules, additional connectors are required.

PRODUCT CODE	PRICE		SIZE/ INCHES			WEIGHT LBS	VOL FT <sup>3</sup>
	GR1	GR2	H	W	D		
EVPW1SE1818	226	230	18	18	2.875	9.44	0.54
EVPW1SE1824	255	262	18	24	2.875	10.90	0.72
EVPW1SE1830	284	294	18	30	2.875	12.35	0.90
EVPW1SE1836	334	345	18	36	2.875	13.81	1.08
EVPW1SE1842	378	393	18	42	2.875	15.27	1.26
EVPW1SE1848	417	435	18	48	2.875	16.72	1.44
EVPW1SE1854	451	469	18	54	2.875	18.18	1.62
EVPW1SE1860	488	505	18	60	2.875	19.64	1.80
EVPW1SE1866	524	541	18	66	2.875	21.70	1.98
EVPW1SE1872	560	576	18	72	2.875	23.30	2.16

**EVPW2SE • Write Board Extension Module - Two Side**

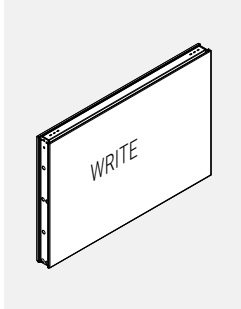

- Attaches on top of a panel.
- Provides writing surface on two sides.
- Modules can be stacked to add privacy or to divide space.
- Panel Extension Modules cannot install higher than 42" above finished floor
- When ordering Panel Extension Modules, additional connectors are required.

PRODUCT CODE	PRICE	SIZE/ INCHES			WEIGHT LBS	VOL FT <sup>3</sup>
		H	W	D		
EVPW2SE1818	271	18	18	2.875	10.29	0.54
EVPW2SE1824	318	18	24	2.875	11.75	0.72
EVPW2SE1830	364	18	30	2.875	13.20	0.90
EVPW2SE1836	433	18	36	2.875	14.66	1.08
EVPW2SE1842	488	18	42	2.875	16.12	1.26
EVPW2SE1848	546	18	48	2.875	17.57	1.44
EVPW2SE1854	604	18	54	2.875	19.03	1.62
EVPW2SE1860	658	18	60	2.875	20.49	1.80
EVPW2SE1866	712	18	66	2.875	21.70	1.98
EVPW2SE1872	769	18	72	2.875	23.30	2.16

**EVPH1SE • Laminate Extension Module - One Side**

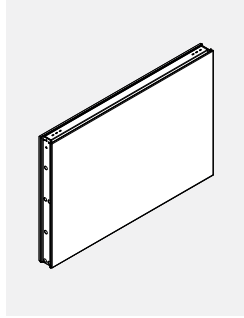

- Attaches on top of a beam.
- Laminate module provides a durable, washable surface on one side and fabric on the other side.
- Modules can be stacked to add privacy or to divide space.
- Panel Extension Modules cannot install higher than 42”h. above finished floor.
- When ordering Panel Extension Modules, additional connectors are required.
- Available in high pressure laminate finishes only.

PRODUCT CODE	PRICE		SIZE/ INCHES			WEIGHT LBS	VOL FT <sup>3</sup>
	GR1	GR2	H	W	D		
EVPH1SE0618	206	211	6	18	2.875	2.77	0.25
EVPH1SE0624	240	251	6	24	2.875	3.20	0.35
EVPH1SE0630	272	276	6	30	2.875	3.63	0.43
EVPH1SE0636	310	317	6	36	2.875	4.06	0.51
EVPH1SE0642	350	356	6	42	2.875	4.49	0.60
EVPH1SE0648	383	392	6	48	2.875	4.91	0.68
EVPH1SE0654	433	441	6	54	2.875	5.34	0.76
EVPH1SE0660	455	463	6	60	2.875	5.77	0.84
EVPH1SE0666	474	485	6	66	3	17.6	0.91
EVPH1SE0672	526	534	6	72	3	18.2	0.99
EVPH1SE1218	206	211	12	18	2.875	5.55	0.51
EVPH1SE1224	240	251	12	24	2.875	6.41	0.71
EVPH1SE1230	272	276	12	30	2.875	7.26	0.87
EVPH1SE1236	310	317	12	36	2.875	8.12	1.03
EVPH1SE1242	350	356	12	42	2.875	8.98	1.20
EVPH1SE1248	383	392	12	48	2.875	9.83	1.36
EVPH1SE1254	433	441	12	54	2.875	10.69	1.53
EVPH1SE1260	455	463	12	60	2.875	11.55	1.69
EVPH1SE1266	474	485	12	66	3	19.0	1.37
EVPH1SE1272	526	534	12	72	3	20.2	1.45
EVPH1SE1818	268	273	18	18	2.875	9.44	0.54
EVPH1SE1824	330	337	18	24	2.875	10.90	0.72
EVPH1SE1830	380	389	18	30	2.875	12.35	0.90
EVPH1SE1836	435	444	18	36	2.875	13.81	1.08
EVPH1SE1842	490	503	18	42	2.875	15.27	1.26
EVPH1SE1848	537	553	18	48	2.875	16.72	1.44
EVPH1SE1854	584	601	18	54	2.875	18.18	1.62
EVPH1SE1860	641	667	18	60	2.875	19.64	1.80
EVPH1SE1866	702	733	18	66	3	20.7	1.98
EVPH1SE1872	748	779	18	72	3	22.2	2.16

**EVPH2SE • Laminate Extension Module - Two Sides**

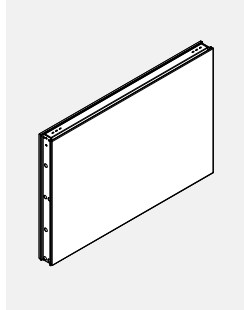

- Attaches on top of a beam.
- Laminate faces on both sides of the module provide durable, washable surfaces
- Modules can be stacked to add privacy or to divide space.
- Panel Extension Modules cannot install higher than 42”h. above finished floor.
- When ordering Panel Extension Modules, additional connectors are required.
- Available in high pressure laminate finishes only.

PRODUCT CODE	PRICE		SIZE/ INCHES			WEIGHT LBS	VOL FT <sup>3</sup>
	GR1	GR2	H	W	D		
EVPH2SE0618	227		6	18	2.875	3.03	0.26
EVPH2SE0624	266		6	24	2.875	3.46	0.36
EVPH2SE0630	309		6	30	2.875	3.89	0.44
EVPH2SE0636	353		6	36	2.875	4.32	0.52
EVPH2SE0642	398		6	42	2.875	4.74	0.60
EVPH2SE0648	447		6	48	2.875	5.17	0.69
EVPH2SE0654	519		6	54	2.875	5.60	0.77
EVPH2SE0660	528		6	60	2.875	6.03	0.85
EVPH2SE0666	539		6	66	2.875	21.1	0.91
EVPH2SE0672	609		6	72	2.875	22.9	0.99
EVPH2SE1218	227		12	18	2.875	6.05	0.51
EVPH2SE1224	266		12	24	2.875	6.91	0.71
EVPH2SE1230	309		12	30	2.875	7.77	0.88
EVPH2SE1236	353		12	36	2.875	8.63	1.04
EVPH2SE1242	398		12	42	2.875	9.48	1.20
EVPH2SE1248	447		12	48	2.875	10.34	1.37
EVPH2SE1254	519		12	54	2.875	11.20	1.53
EVPH2SE1260	528		12	60	2.875	12.05	1.70
EVPH2SE1266	539		12	66	2.875	27.4	1.37
EVPH2SE1272	609		12	72	2.875	29.9	1.45
EVPH2SE1818	319		18	18	2.875	10.29	0.54
EVPH2SE1824	392		18	24	2.875	11.75	0.72
EVPH2SE1830	455		18	30	2.875	13.20	0.90
EVPH2SE1836	526		18	36	2.875	14.66	1.08
EVPH2SE1842	596		18	42	2.875	16.12	1.26
EVPH2SE1848	674		18	48	2.875	17.57	1.44
EVPH2SE1854	740		18	54	2.875	19.03	1.62
EVPH2SE1860	799		18	60	2.875	20.49	1.80
EVPH2SE1866	856		18	66	2.875	33.9	1.98
EVPH2SE1872	921		18	72	2.875	35.7	2.16

**EVPAE • Air Flow Extension Module**

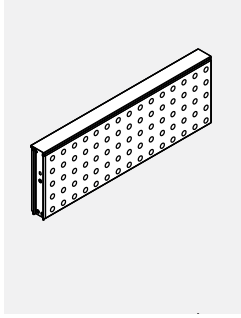

- Metal air flow panel extension.
- Attaches to top of beam.
- Modules can be stacked to add privacy or to divide space.
- Panel Extension Modules cannot install higher than 42”h. above finished floor.
- When ordering Panel Extension Modules, additional connectors are required.

PRODUCT CODE	PRICE	SIZE/ INCHES			WEIGHT		VOL FT <sup>3</sup>
		H	W	D	LBS		
EVPAE1224	262	12	24	2.875	9.66	0.59	
EVPAE1230	309	12	30	2.875	10.93	0.82	
EVPAE1236	352	12	36	2.875	12.19	1.00	
EVPAE1242	389	12	42	2.875	13.62	1.05	
EVPAE1248	439	12	48	2.875	15.18	1.18	
EVPAE1260	579	12	60	2.875	18.17	1.32	
EVPAE1824	329	18	24	2.875	10.56	0.72	
EVPAE1830	383	18	30	2.875	12.11	0.90	
EVPAE1836	422	18	36	2.875	13.66	1.08	
EVPAE1842	464	18	42	2.875	15.05	1.26	
EVPAE1848	531	18	48	2.875	16.35	1.44	
EVPAE1860	690	18	60	2.875	19.04	1.80	

**EVPOE • Open Panel Extension Module**

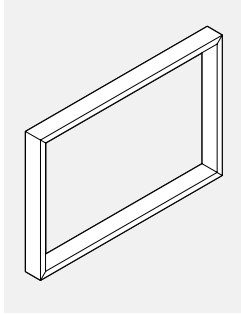

- Attaches to top portion of a beam.
- Modules can be stacked to add privacy or to divide space.
- Panel Extension Modules cannot install higher than 42”h. above finished floor.
- When ordering Panel Extension Modules, additional connectors are required.

PRODUCT CODE	PRICE	SIZE/ INCHES			WEIGHT		VOL FT <sup>3</sup>
		H	W	D	LBS		
EVPOE0618	239	6	18	2.875	6.22	0.26	
EVPOE0624	245	6	24	2.875	7.40	0.29	
EVPOE0630	298	6	30	2.875	8.48	0.36	
EVPOE0636	314	6	36	2.875	9.56	0.43	
EVPOE0642	381	6	42	2.875	10.88	0.51	
EVPOE0648	429	6	48	2.875	12.12	0.58	
EVPOE0654	469	6	54	2.875	13.25	0.65	
EVPOE0660	505	6	60	2.875	14.68	0.73	
EVPOE1218	239	12	18	2.875	7.30	0.51	
EVPOE1224	245	12	24	2.875	8.40	0.59	
EVPOE1230	298	12	30	2.875	9.50	0.82	
EVPOE1236	314	12	36	2.875	10.60	1.00	
EVPOE1242	381	12	42	2.875	11.84	1.00	
EVPOE1248	429	12	48	2.875	13.20	1.18	
EVPOE1254	469	12	54	2.875	14.38	1.25	
EVPOE1260	505	12	60	2.875	15.80	1.32	
EVPOE1818	319	18	18	2.875	7.74	0.54	
EVPOE1824	358	18	24	2.875	9.18	0.72	
EVPOE1830	381	18	30	2.875	10.53	0.90	
EVPOE1836	418	18	36	2.875	11.88	1.08	
EVPOE1842	471	18	42	2.875	13.09	1.26	
EVPOE1848	530	18	48	2.875	14.22	1.44	
EVPOE1854	575	18	54	2.875	15.28	1.62	
EVPOE1860	619	18	60	2.875	16.56	1.80	

**EVPMP-GIP • Panel Mount Privacy Glass**

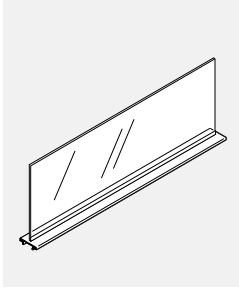

- Attaches on top of Power Beam or extension modules to add privacy or divide space.
- Privacy Glass is integrated into the aluminum top trim.
- Includes aluminum trim with channel and glass tile
- Glass and attachment hardware ship separately.
- Standard in clear (CLR), frosted (FRST) or writeable (WRW) glass.
- Privacy glass modules may stack on top of Power Beam or extension modules at 42" h. to achieve a height up to 54"h. above finished floor

PRODUCT CODE	PRICE			SIZE/ INCHES			WEIGHT		VOL FT <sup>3</sup>
	CLR	FRST	WRW	H	W	D	LBS		
EVPMP24GI6P	195	244	-	6	24	2.875	2.39	0.25	
EVPMP30GI6P	213	268	-	6	30	2.875	2.99	0.32	
EVPMP36GI6P	228	283	-	6	36	2.875	3.58	0.37	
EVPMP42GI6P	244	304	-	6	42	2.875	4.18	0.43	
EVPMP48GI6P	254	317	-	6	48	2.875	4.78	0.50	
EVPMP54GI6P	262	328	-	6	54	2.875	5.38	0.56	
EVPMP60GI6P	268	333	-	6	60	2.875	5.97	0.63	
EVPMP66GI6P	410	546	-	6	66	2.875	6.57	0.69	
EVPMP72GI6P	437	570	-	6	72	2.875	7.16	0.76	
EVPMP24GI9P	195	244	-	9	24	2.875	3.58	0.38	
EVPMP30GI9P	213	268	-	9	30	2.875	4.48	0.47	
EVPMP36GI9P	228	283	-	9	36	2.875	5.37	0.56	
EVPMP42GI9P	244	304	-	9	42	2.875	6.26	0.65	
EVPMP48GI9P	254	317	-	9	48	2.875	7.16	0.75	
EVPMP54GI9P	262	328	-	9	54	2.875	8.06	0.84	
EVPMP60GI9P	268	333	-	9	60	2.875	8.96	0.94	
EVPMP66GI9P	410	546	-	9	66	2.875	9.85	1.04	
EVPMP72GI9P	437	570	-	9	72	2.875	10.74	1.13	
EVPMP24GIP	195	244	340	12	24	2.875	4.77	0.50	
EVPMP30GIP	213	268	347	12	30	2.875	5.97	0.63	
EVPMP36GIP	228	283	353	12	36	2.875	7.16	0.75	
EVPMP42GIP	244	304	389	12	42	2.875	8.35	0.87	
EVPMP48GIP	254	317	426	12	48	2.875	9.55	1.00	
EVPMP54GIP	262	328	461	12	54	2.875	10.75	1.12	
EVPMP60GIP	268	333	497	12	60	2.875	11.95	1.25	
EVPMP66GIP	410	546	681	12	66	2.875	13.05	1.37	
EVPMP72GIP	437	570	713	12	72	2.875	14.25	1.51	
EVPMP24GI18P	281	352	-	18	24	2.875	7.16	0.75	
EVPMP30GI18P	308	385	-	18	30	2.875	8.96	0.94	
EVPMP36GI18P	328	408	-	18	36	2.875	10.74	1.13	
EVPMP42GI18P	352	440	-	18	42	2.875	12.53	1.31	
EVPMP48GI18P	364	457	-	18	48	2.875	14.33	1.50	
EVPMP54GI18P	377	471	-	18	54	2.875	16.13	1.69	
EVPMP60GI18P	385	482	-	18	60	2.875	17.91	1.88	
EVPMP66GI18P	537	712	-	18	66	2.875	19.70	2.06	
EVPMP72GI18P	571	744	-	18	72	2.875	21.48	2.25	

**EVPBSCGD • Power Beam Shared Storage Cabinet with Sliding Glass Door**

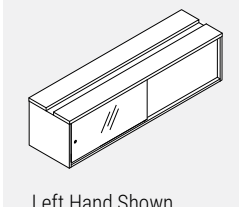

Left Hand Shown

- Inside dimensions 13"high x 13"deep.
- Laminate storage cabinet, available in standard Evolve laminate finishes.
- Available in Tempered frosted glass only, glass with handle.
- Tracks for sliding glass available in Tungsten only.
- To be installed under power beam between T legs.
- Power Beam Storage cabinet attaches to the bottom of the power beam with brackets.
- For ease of installation, levelers in middle included.
- **Note: To be used with 24"h. Power Beam only.**

PRODUCT CODE	PRICE	SIZE/ INCHES			WEIGHT		VOL FT <sup>3</sup>
		H	W	D	LBS		
EVPBSCGDR60	1734	15	58.75	16	80.46	8.33	
EVPBSCGDR72	1893	15	70.75	16	96.60	10.00	
EVPBSCGDL60	1734	15	58.75	16	80.46	8.33	
EVPBSCGDL72	1893	15	70.75	16	96.60	10.00	

**EVPBSCGDP • Power Beam Shared Storage Cabinet with Sliding Glass Door and Cable Pass Through**

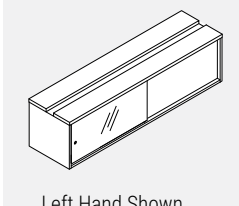

Left Hand Shown

- Inside dimensions 13"high x 13"deep.
- Laminate storage cabinet, available in standard Evolve laminate finishes.
- Available in Tempered frosted glass only, glass with handle.
- Tracks for sliding glass available in Tungsten only.
- To be installed under power beam between T legs.
- Power Beam Storage cabinet attaches to the bottom of the power beam with brackets.
- For ease of installation, levelers in middle included.
- **Note: To be used with 24"h. Power Beam only, EVPBEP-KIT and 60" and 72" widths only.**
- Cabinet with cable pass through in the middle to bring power to power beam above
- Includes metal cover for easy access to wires
- Electrics not included
- Power beam base feed to be ordered separately.
- Power beam kit with electrical cut out in middle to be ordered separately. (EVPBEP-KIT)

PRODUCT CODE	PRICE	SIZE/ INCHES			WEIGHT		VOL FT <sup>3</sup>
		H	W	D	LBS		
EVPBSCGDPR60	2092	15	58.75	16	80.46	8.33	
EVPBSCGDPR72	2213	15	70.75	16	96.60	10.00	
EVPBSCGDPL60	2092	15	58.75	16	80.46	8.33	
EVPBSCGDPL72	2213	15	70.75	16	96.60	10.00	

**EVPBSC • Power Beam Shared Storage Cabinet, Open**

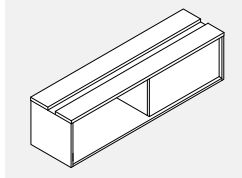

- Inside dimensions 13"high x 13"deep.
- Laminate storage cabinet, without doors, available in standard Evolve laminate finishes.
- To be installed under power beam between T legs.
- Power Beam Storage cabinet attaches to bottom of power beam with brackets.
- For ease of installation, levelers in middle included.
- Note: It can not be converted to cabinet with glass door.
- **Note: To be used with 24"H Power Beam only.**

PRODUCT CODE	PRICE	SIZE/ INCHES			WEIGHT VOL	
		H	W	D	LBS	FT <sup>3</sup>
EVPBSCR60	1110	15	58.75	16	80.46	8.33
EVPBSCR72	1133	15	70.75	16	96.6	10.00
EVPBSCCL60	1110	15	58.75	16	80.46	8.33
EVPBSCCL72	1133	15	70.75	16	96.6	10.00

**EVPBSCP • Power Beam Shared Storage Cabinet, Open and Cable Pass Through**

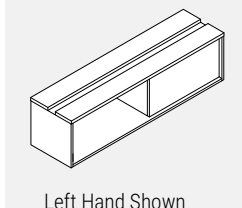

Left Hand Shown

- Inside dimensions 13"high x 13"deep.
- Laminate storage cabinet, without doors, available in standard Evolve laminate finishes.
- To be installed under power beam between T legs.
- Power Beam Storage cabinet attaches to bottom of power beam with brackets.
- For ease of installation, levelers in middle included.
- Note: It can not be converted to cabinet with glass door.
- **Note: To be used with 24"H Power Beam only, EVPBEP-KIT.**
- Cabinet with cable pass through in the middle to bring power to power beam above.
- Includes metal cover for easy access to wires.
- Electricians not included.
- Power beam base feed to be ordered separately.
- Power beam kit with electrical cut out in middle to be ordered separately. (EVPBEP-KIT).

PRODUCT CODE	PRICE	SIZE/ INCHES			WEIGHT VOL	
		H	W	D	LBS	FT <sup>3</sup>
EVPBSCPR60	1238	15	58.75	16	80.46	8.33
EVPBSCPR72	1306	15	70.75	16	96.6	10.00
EVPBSCPL60	1238	15	58.75	16	80.46	8.33
EVPBSCPL72	1306	15	70.75	16	96.6	10.00

**EVSDAOH • Power Beam Dual Access Overhead**

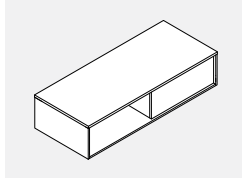

- Inside dimensions 6.5" high x 13"deep.
- Laminate Overhead.
- Available in standard Evolve laminate finishes.
- Power Beam storage cabinet must be installed at the bottom for stability.
- Top mount on power beam.
- Dual Access Overhead Support Brackets to be ordered separately.
- Power Beam legs for storage to be ordered separately.
- Power Beam legs for storage must be used.

PRODUCT CODE	PRICE	SIZE/ INCHES			WEIGHT VOL	
		H	W	D	LBS	FT <sup>3</sup>
EVSDAOH60	1104	8.5	60	16	51.5	5.00
EVSDAOH72	1126	8.6	72	16	60.2	6.00

**EVSDAOHBRKIT • Brackets for Dual Access Overhead**

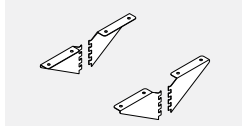

- Brackets support Dual access overhead
- To be used with Power Beam Channel
- Available in standard paint colors
- Brackets and screws included

PRODUCT CODE	PRICE	SIZE/INCHES			WEIGHT LBS	VOL FT <sup>3</sup>
		H	W	D		
EVSDAOHBRKIT	129	5	5	1.5	2.00	0.08

**EVPBL • 36" Power Beam Connector with Leg for Storage**



- Connects 24"H power beams on equal height.
- Includes non slotted connector with leg, glides and connecting hardware.
- Must be used with overhead.

PRODUCT CODE	PRICE	SIZE/ INCHES			WEIGHT VOL	
		H	W	D	LBS	FT <sup>3</sup>
EVPBL36S	102	36	18		8.5	0.45

**EVPBLERT • End of Run Trim for Connector**

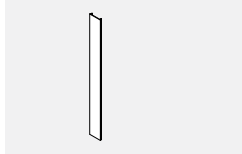

- Specify to match height of beam or total height with extension modules

PRODUCT CODE	PRICE	SIZE/ INCHES			WEIGHT VOL	
		H	W	D	LBS	FT <sup>3</sup>
EVPBLERT24	52	21.4	2.875	3	1.0	0.04
EVPBLERT30	59	27.4	2.875	3	1.4	0.04
EVPBLERT36	62	33.4	2.875	3	1.6	0.06
EVPBLERT42	66	39.4	2.875	3	1.8	0.07
EVPBLERT48	69	45.4	2.875	3	2.00	0.08
EVPBLERT54	72	51.4	2.875	3	2.20	0.09
EVPBLERT66	83	63.4	2.875	3	2.60	1.10

**EVPBLEP • Laminate End Panel for Power Beam**

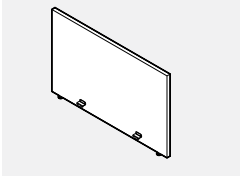

- Connects to a power beam support leg with foot at the end of a run
- Includes brackets to attach to support leg with foot
- Finished in thermally fused laminate. If wood grain is selected, grain runs horizontally
- Laminate End Panel height is inclusive of panel glides extended to their full height
- Laminate end panel must connect to a support leg with foot and will not connect to a support leg with glide
- Must be used with Connectors with T-Leg

PRODUCT CODE	PRICE	SIZE/ INCHES			WEIGHT VOL	
		H	W	D	LBS	FT <sup>3</sup>
EVPBLEP2451	317	24	51	1	32.81	0.73
EVPBLEP3051	396	30	51	1	39.38	0.88
EVPBLEP3651	473	36	51	1	45.94	1.02
EVPBLEP4251	710	42	51	1	52.50	1.24
EVPBLEP2463	359	24	63	1	37.50	0.83
EVPBLEP3063	451	30	63	1	45.00	1.00
EVPBLEP3663	541	36	63	1	52.50	1.17
EVPBLEP4263	792	42	63	1	60.00	1.53

**EVPBLEP • Laminate End Panel for Power Beam, Single Leg**

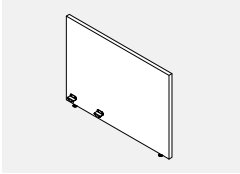

- EVPBLEP - Laminate End Panel for Power Beam.
- Attaches to power beam connector with single leg.
- For one sided Power beam application.
- Includes brackets to attached to attached to leg.
- Finished in thermally fused laminate, if wood grain is selected, grain runs horizontally.
- Laminate End Panel height is inclusive of panel glides extended to their full height.
- EVPBLEP-30 to be used for 24" deep worksurface.
- EVPBLEP-36 to be used for 30" deep worksurfaces

PRODUCT CODE	PRICE	SIZE/ INCHES			WEIGHT VOL	
		H	W	D	LBS	FT <sup>3</sup>
EVPBLEP2430	257	24	30	1	19.30	0.42
EVPBLEP3030	279	30	30	1	23.16	0.52
EVPBLEP3630	300	36	30	1	27.02	0.64
EVPBLEP4230	377	42	30	1	30.88	0.74
EVPBLEP2436	303	24	36	1	21.43	0.55
EVPBLEP3036	314	30	36	1	25.71	0.64
EVPBLEP3636	353	36	36	1	30.00	0.75
EVPBLEP4236	451	42	36	1	34.29	0.90

**EVE8PD • Power Distribution Housing**

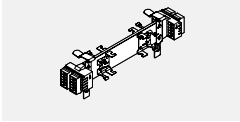

- Power housing is specified per beam size (e.g. EVE8PD36 is for use in a 36" beam).
- 8 wire, 4 circuits (2+2 configuration).
- Accommodates two duplex receptacles per panel side.

PRODUCT CODE	PRICE	SIZE/ INCHES		WEIGHT VOL	
		W	D	LBS	FT <sup>3</sup>
EVE8PD24	142	24	9.25	0.83	1.17
EVE8PD30	189	30	15.25	1.28	1.17
EVE8PD36	200	36	21.25	1.62	1.65
EVE8PD42	205	42	27.25	2.00	2.00
EVE8PD48	216	48	33.25	0.18	0.16
EVE8PD54	220	54	39.25	2.66	3.20
EVE8PD60	221	60	45.25	3.04	3.20

**EVE8PD • Power Distribution Housing**

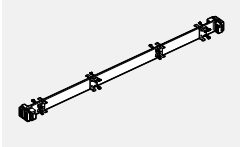

- Power housing is specified per beam size (e.g. EVE8PD72 is for use in a 72" beam).
- 8 wire, 4 circuits (2+2 configuration).
- Provides two duplex receptacle to be plugged directly to power distribution housing and then as option additional two duplex receptacle to be connected to it with "I" connector, per panel size.
- Both duplex receptacles connected by "I" connector must be same circuit.
- Each power distribution housing supports 15-20 amps.
- Duplex receptacles and "I" connectors to be ordered separately.

PRODUCT CODE	PRICE	SIZE/ INCHES		WEIGHT VOL	
		W	D	LBS	FT <sup>3</sup>
EVE8PD66	230	66	43.5	3.44	3.30
EVE8PD72	238	72	45.5	3.84	3.40

**EVE8CP • Jumper Cable**

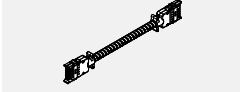

- The EVE8CP16 electrically connects two powered panels positioned side by side.
- The EVE8CP20 electrically connects two powered panels separated by a post.

PRODUCT CODE	PRICE	SIZE/ INCHES	WEIGHT VOL	
			L	LBS FT <sup>3</sup>
EVE8CP16	110	16	0.66	1.17
EVE8CP20	129	20	0.78	1.17

**EVE8CP18 • Flexible Mesh Jumper Cable**

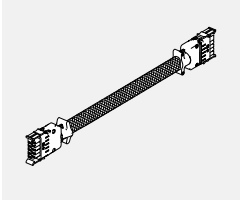

- Electrically connects two powered panels separated by post.
- Used to connect two power distribution housing in Power Beam at 90 degrees.

PRODUCT CODE	PRICE	SIZE/ INCHES			WEIGHT VOL	
		H	W	D	LBS	FT <sup>3</sup>
EVE8CP18	134			18.5	0.78	1.17

**EVE8CP • Pass Through Cable**

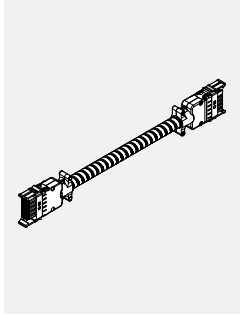

- Flexible metal conduit is used to distribute electrical power through non-powered panels.
- To calculate the length of a Pass-Through Cable, add the widths of the non-powered panels separating the powered panels (panels with distribution housing attached). To this, add 16" (distance from the edge of the panel to the distribution housing x 2). See Technical Information page at the beginning of this section.

PRODUCT CODE	PRICE	SIZE/ INCHES			WEIGHT VOL	
		L			LBS	FT <sup>3</sup>
EVE8CP40	143	40			1.44	1.17
EVE8CP46	147	46			1.71	1.17
EVE8CP52	154	52			1.95	1.17
EVE8CP58	164	58			2.21	1.17
EVE8CP64	171	64			2.37	1.17
EVE8CP70	174	70			2.60	1.17
EVE8CP76	177	76			2.81	1.17
EVE8CP82	186	82			3.03	1.17
EVE8CP88	191	88			3.05	1.17
EVE8CP94	198	94			3.92	1.17
EVE8CP100	204	100			3.47	1.17
EVE8CP106	212	106			3.87	1.17
EVE8CP118	226	118			4.08	1.17
EVE8CP130	245	185			4.73	1.17
EVE8CP142	255	142			4.59	1.17

**EVE8CPxx-H • Hybrid Pass Through Cables with Wire Mesh**

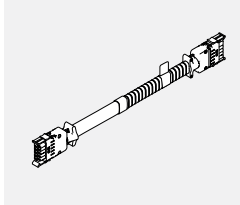

- Flexible metal conduit with wire mesh distributes electrical power through non powered panels.
- To calculate the length of Hybrid Pass Through Cable, add the width of non powered panels separating the powered panels. To this add 16" (distance from edge of the panels to power distribution housing x2).
- Please add an additional 3" when passing through a post. Please see the the beginning of this section.
- Hybrid Pass Through Cables with wire mesh allows connection at 90 degree post and one end for Power Beam.

PRODUCT CODE	PRICE	SIZE/INCHES			WEIGHT VOL	
		H	W	D	LBS	FT <sup>3</sup>
EVE8CP40-H	178		40		1.44	1.17
EVE8CP46-H	185		46		1.71	1.17
EVE8CP52-H	193		52		1.95	1.17
EVE8CP58-H	205		58		2.21	1.17
EVE8CP64-H	214		64		2.37	1.17
EVE8CP70-H	218		70		2.60	1.17
EVE8CP76-H	222		76		2.81	1.17
EVE8CP82-H	232		82		3.03	1.17
EVE8CP88-H	240		88		3.05	1.17
EVE8CP94-H	248		94		3.42	1.17
EVE8CP100-H	255		100		3.47	1.17
EVE8CP106-H	265		106		3.87	1.17
EVE8CP118-H	281		118		4.08	1.17
EVE8CP130-H	306		130		4.73	1.17
EVE8CP142-H	319		142		4.89	1.17

**EVE8CI-1 • "I" Connector**

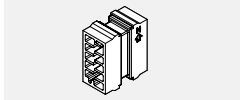

- Female - Female connector used to connect two Pass-Through Cables.

PRODUCT CODE	PRICE	SIZE/ INCHES			WEIGHT VOL	
		H	W	D	LBS	FT <sup>3</sup>
EVE8CI-1	77	15	15	0.75	0.06	0.20

**EVE8RD • Duplex Receptacles**

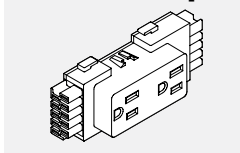

- Up to 6 duplex receptacles per circuit.
- EVE8RD1 = Circuit #1 (utility circuit)
- EVE8RD1 = Circuit #2 (utility circuit)
- EVE8RDA = Circuit #A (dedicated)
- EVE8RDB = Circuit #B (dedicated)

PRODUCT CODE	PRICE	SIZE/ INCHES			WEIGHT VOL	
		H	W	D	LBS	FT <sup>3</sup>
EVE8RD1	32	2	4.625	1.25	0.16	0.01
EVE8RD2	32	2	4.625	1.25	0.16	0.01
EVE8RDA	32	2	4.625	1.25	0.16	0.01
EVE8RDB	32	2	4.625	1.25	0.16	0.01

**EVEUSB01 • Duplex Receptacles**

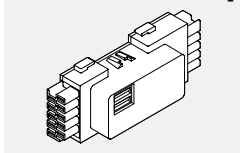

- The USB charging module provides convenient charging power access through dual ports on face of the receptacle.
- Two USB ports.
- 2 Amp output via two USB ports, considered as circuit #1.
- Available in white, black.

PRODUCT CODE	PRICE	SIZE/ INCHES			WEIGHT VOL	
		H	W	D	LBS	FT <sup>3</sup>
EVEUSB01WHT	216	2	4.625	1.25	0.16	0.01
EVEUSB01BLK	216	2	4.625	1.25	0.16	0.01

**EVE8FR3PB • Floor Power Entry for Power Beam**

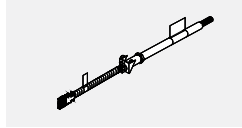

- Snaps into the power distribution housing.
- Includes 84" long flexible vinyl conduit.
- Includes bracket to attach to vertical raceway panel.
- Must be hard wire to source by licenced electrician.

PRODUCT CODE	PRICE	SIZE/ INCHES			WEIGHT VOL	
		H	W	D	LBS	FT <sup>3</sup>
EVE8FR3PB	395	3	84	2	3.82	2.00

**EVE8EC • Ceiling Power Entry**

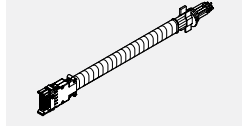

- Snaps into the end of the Power Distribution Housing.
- Flexible metal conduit extends into the ceiling through a corner post and post extension (both ordered separately).
- Must be hard wired to source power by a licensed electrician.
- 4" Junction Box included.

PRODUCT CODE	PRICE	SIZE/ L	INCHES		WEIGHT VOL	
			W	D	LBS	FT <sup>3</sup>
EVE8EC1	244	132	5.24	2.00		
EVE8EC2	435	144	5.96	2.00		

**EVE8FR3PBP • Power Entry for Power Beam for Wall Plate Infeed**

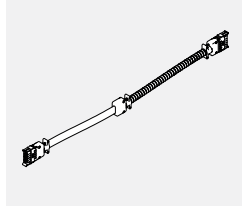

- Snaps into power distribution housing.
- Includes 48" long flexible vinyl conduit with connector.
- Includes bracket to attach to vertical raceway panel
- Power Beam with electrical cut out must be ordered.
- 71" long base feed will work with 24" and 36" H Power Beam.
- Note: EVE8FR3PBP will only work with Wall Plate Infeed EVE8WPIPB.

PRODUCT CODE	PRICE	SIZE/INCHES			WEIGHT VOL	
		H	W	D	LBS	FT <sup>3</sup>
EVE8FR3PBP	339	3	71	2	3.82	2.00

**EVE8WPIPB • Wall Plate Infeed for Power Beam**

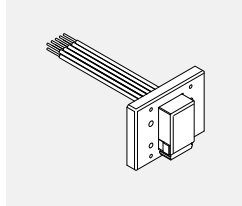

- - Wall plate infeed must be installed and hardwired to source by licensed electrician.
- Note: EVE8FR3PBP will only work with Wall Plate Infeed EVE8WPIPB.

PRODUCT CODE	PRICE	SIZE/INCHES			WEIGHT VOL	
		H	W	D	LBS	FT <sup>3</sup>
EVE8WPIPB	552	5.25	5.25	1.75	1.00	0.10

**EVEJBC1PB • Hardwire Junction Box for Power Beam**

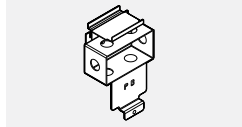

- Can be retrofitted in any size of panel at the receptacle location.
- Gives access from one side only at each location.
- Customer to supply conduit, wiring, receptacle, and face plate 2 per Power Beam.
- A licensed electrician must provide hard wire connection with the junction box.
- For use with Power Beam only.

PRODUCT CODE	PRICE	WEIGHT VOL	
		LBS	FT <sup>3</sup>
EVEJBC1PB	95	1.50	0.02



**EVDPE • Post Extension Data/Comm Lay-in**

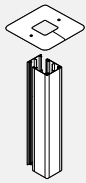

- Attaches to the top of a post to bring power and/or data cables from the ceiling to panel power way.
- Three-sided power pole with snap-on fourth side.
- Post extension can be opened on one side for lay-in for power and/or data cables.
- Made of aluminum and can be field cut.
- Accommodates up to 25 CAT5 cables with electric. Accommodates up to 45 CAT5 cables without electric.

PRODUCT CODE	PRICE	SIZE/ INCHES		WEIGHT VOL	
		H	W	LBS	FT <sup>3</sup>
EVDPE64	155	64	2.875	3.00	0.70
EVDPE82	191	82	2.875	4.20	0.80
EVDPE88	293	88	2.875	4.50	0.85
EVDPE94	314	94	2.875	4.80	0.92
EVDPE100	334	100	2.875	5.12	0.97

**EVDP4E • 45° Post Extension Data/Comm Lay-in**

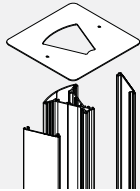

- Attached to the top of the 45° Corner Post to bring power and/or data cables from the ceiling to the panel run through.
- Cable capacity
  - 40 CAT5 cables without electric feed.
  - 10 CAT5 cables with electric feed.

PRODUCT CODE	PRICE	SIZE/ INCHES		WEIGHT VOL	
		H	W	LBS	FT <sup>3</sup>
EVDP4E64	157	64	3.65	3.00	0.70
EVDP4E82	212	82	3.65	4.20	0.80

**EVDP6E • 60° Post Extension Data/Comm Lay-in**

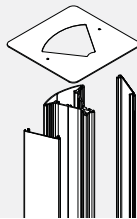

- Attached to the top of the 60° Corner Post to bring power and/or data cables from the ceiling to the panel run through.
- Post extension can be opened on one side for lay-in power and/or data cables.
- Made of aluminum and can be field cut.
- Two sided power pole with snap-on third side.
- Cable capacity
  - 32 CAT5 cables without electric.
  - 15 CAT5 cables with electric

PRODUCT CODE	PRICE	SIZE/ INCHES		WEIGHT VOL	
		H	W	LBS	FT <sup>3</sup>
EVDP6E64	152	64	2	3.00	0.70
EVDP6E82	186	82	2	4.20	0.80

**EVPBECH34 • Wire Manager Kit**

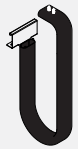

- Provides cable management from Power Beam to Height Adjustable Table.
- Includes bracket to attach to bottom trim of Power Beam.
- Cables fit easily.
- Includes a neoprene wire manager sock, bracket and screws.
- Neoprene available in black only.
- Specify bracket paint finish.

PRODUCT CODE	PRICE	SIZE/ INCHES			WEIGHT VOL	
		H	W	D	LBS	FT <sup>3</sup>
EVPBECH34	409	1	41	2	0.60	0.04

**EVPBT01 • Power Beam Tray**

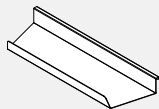

- Power beam tray provides support for wires.
- Can be used with power beam only.
- Available in standard and premium paint finishes.

PRODUCT CODE	PRICE	SIZE/ INCHES			WEIGHT VOL	
		H	W	D	LBS	FT <sup>3</sup>
EVPBT01	29	12	1.25	3.5	0.60	0.04

**EVAFMB01 • Floor Mount Plate**

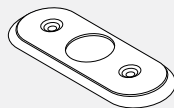

- Attached to floor.
- Secures panel to floor.
- Attachment screws not included.
- Care should be taken to use correct fasteners for type of floor.
- Available in chrome finish only.

PRODUCT CODE	PRICE	SIZE/ INCHES			WEIGHT VOL	
		H	W	D	LBS	FT <sup>3</sup>
EVAFMB01	70	0.25	5	2.5	0.2	0.02

**WORKSURFACES • TECHNICAL INFORMATION**

- All worksurfaces have threaded inserts for metal-to-metal connection of support hardware.
- Back edge features scoop detail and sits 3/8" away from the face of a panel for wire management. Scoop depth is 3/4" at centre.
- Communication and electrical wires are routed through the cable scoop at the back of the worksurface.
- Straight or Curvilinear Worksurfaces 48" or less have one scoop while those that are 54" or more two scoops. All other worksurface shapes have one scoop.
- LP and HP worksurfaces are 3.5 mm edge banded.
- LP worksurfaces are 1" thick particle board with laminate finish.
- HP worksurfaces are 1 1/16" thick particle board with laminate finish overall.
- All support hardware must be ordered separately.
- Wood grain laminates on corner worksurfaces may run diagonal to the adjacent worksurfaces. Specify "WG" at the end of the worksurface code.
- Please use "Wood Grain Direction" chart at the beginning of the price list.

**WORKSURFACES • GUIDELINE FOR ORDERING PRODUCT**

The price list uses a numbering system with meaningful alphanumeric characters to create a simple-to-understand product number. This makes specifying the product much easier and more accurate.

**EXAMPLE OF WORKSURFACE CODE**

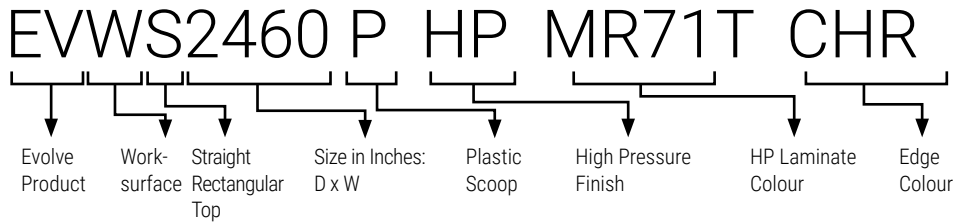

**HOW TO SPECIFY**

- Specify Evolve worksurface type and size by code.
- Specify type of finish.
- Specify High or LOW Pressure Laminate Colour.
- Specify PVC edge colour.

**EVWS • Straight Worksurface**

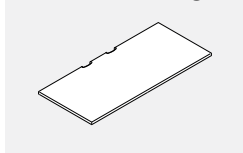

- Straight rectangular worksurfaces are non-handed and can be interchanged on site.
- Please choose from DWT - Designer White, SIL - Silver or BLK - Black for scoop covers.

PRODUCT CODE	PRICE		SIZE/ INCHES			WEIGHT VOL	
	LP	HP	H	W	D	LBS	FT <sup>3</sup>
EVWS1818P	123	156	1	18	18	12.50	0.37
EVWS1824P	127	169	1	24	18	13.50	0.40
EVWS1830P	134	178	1	30	18	16.50	0.54
EVWS1836P	154	204	1	36	18	19.50	0.63
EVWS1842P	202	270	1	42	18	23.25	0.73
EVWS1848P	242	318	1	48	18	26.25	0.83
EVWS1854P	284	374	1	54	18	29.25	0.93
EVWS1860P	319	410	1	60	18	33.00	1.02
EVWS1866P	334	439	1	66	18	36.75	1.12
EVWS1872P	352	464	1	72	18	39.75	1.21
EVWS1878P	369	488	1	78	18	38.50	1.23
EVWS1884P	405	530	1	84	18	39.75	1.21
EVWS1890P	526	774	1	90	18	48.75	1.53
EVWS1896P	561	827	1	96	18	51.75	1.73
EVWS2418P	127	163	1	18	24	12.00	0.50
EVWS2424P	129	173	1	24	24	18.00	60.00
EVWS2430P	141	184	1	30	24	22.00	0.72
EVWS2436P	156	207	1	36	24	26.00	0.85
EVWS2442P	205	272	1	42	24	31.00	0.98
EVWS2448P	245	329	1	48	24	35.00	1.11
EVWS2454P	290	383	1	54	24	39.00	1.23
EVWS2460P	326	430	1	60	24	44.00	1.36
EVWS2466P	340	449	1	66	24	49.00	1.49
EVWS2472P	355	470	1	72	24	53.00	1.62
EVWS2478P	381	501	1	78	24	57.18	2.16
EVWS2484P	410	537	1	84	24	61.50	2.33
EVWS2490P	526	774	1	90	24	64.50	2.53
EVWS2496P	561	827	1	96	24	68.50	2.73
EVWS3018P	145	186	1	18	30	15.30	0.63
EVWS3024P	154	202	1	24	30	22.00	0.74
EVWS3030P	165	218	1	30	30	28.00	0.90
EVWS3036P	194	256	1	36	30	33.00	1.06
EVWS3042P	275	362	1	42	30	38.00	1.22
EVWS3048P	290	383	1	48	30	44.00	1.38
EVWS3054P	317	408	1	54	30	49.00	1.54
EVWS3060P	340	449	1	60	30	55.00	1.69
EVWS3066P	353	469	1	66	30	60.00	1.85
EVWS3072P	374	495	1	72	30	66.00	2.01
EVWS3078P	398	524	1	78	30	71.48	2.70
EVWS3084P	443	579	1	84	30	76.98	2.92
EVWS3090P	656	969	1	90	30	81.98	3.12
EVWS3096P	701	1033	1	96	30	68.50	3.32
EVWS3672P	528	691	1	72	36	79.20	2.42

**EVWS • Straight Worksurface to Span a Post**

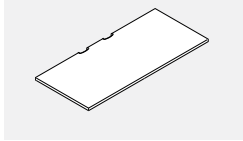

- Straight rectangular worksurfaces are non-handed and can be interchanged on site.
- Worksurface will span the width of a post eliminating a gap between standard sizes.
- Please choose from DWT - Designer White, SIL - Silver or BLK - Black for scoop covers.

PRODUCT CODE	PRICE		SIZE/ H	INCHES			WEIGHT VOL	
	LP	HP		W	D	LBS	FT <sup>3</sup>	
EVWSP1827P	134	178	1	27	18	16.50	0.54	
EVWSP1833P	169	204	1	33	18	19.50	0.53	
EVWSP1839P	202	270	1	39	18	23.25	0.73	
EVWSP1845P	242	318	1	45	18	26.25	0.83	
EVWSP1851P	284	374	1	51	18	29.25	0.93	
EVWSP1857P	319	410	1	57	18	33.00	1.02	
EVWSP1863P	334	439	1	63	18	36.75	1.12	
EVWSP1869P	352	464	1	69	18	39.75	1.21	
EVWSP1875P	369	488	1	75	18	42.75	1.33	
EVWSP1881P	405	530	1	81	18	45.75	1.43	
EVWSP2427P	141	184	1	27	24	22.00	0.72	
EVWSP2433P	156	207	1	33	24	26.00	0.85	
EVWSP2439P	205	272	1	39	24	31.00	0.98	
EVWSP2445P	245	329	1	45	24	35.00	1.11	
EVWSP2451P	290	383	1	51	24	39.00	1.23	
EVWSP2457P	326	430	1	57	24	44.00	1.36	
EVWSP2463P	340	449	1	63	24	49.00	1.49	
EVWSP2469P	355	470	1	69	24	53.00	1.62	
EVWSP2475P	381	501	1	75	24	57.18	2.16	
EVWSP2481P	410	537	1	81	24	61.50	2.33	
EVWSP3027P	165	218	1	27	30	28.00	0.90	
EVWSP3033P	194	256	1	33	30	33.00	1.06	
EVWSP3039P	275	362	1	39	30	38.00	1.22	
EVWSP3045P	290	383	1	45	30	44.00	1.38	
EVWSP3051P	317	408	1	51	30	49.00	1.54	
EVWSP3057P	340	449	1	57	30	55.00	1.69	
EVWSP3063P	353	469	1	63	30	60.00	1.85	
EVWSP3069P	374	495	1	69	30	66.00	2.01	
EVWSP3075P	398	524	1	75	30	71.48	2.70	
EVWSP3081P	443	579	1	81	30	76.98	2.92	

**EVWVL • Curvilinear Worksurface Left**

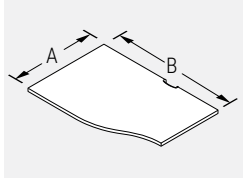

- When deepest end equals 24", the opposite depth is 18".
- When deepest end equals 30", the opposite depth is 24".
- Please choose from DWT - Designer White, SIL - Silver or BLK - Black for scoop covers.

NOTE: EVWV

24	36
A	B
DEPTH	WIDTH

PRODUCT CODE	PRICE		SIZE/ H	INCHES			WEIGHT VOL	
	LP	HP		W	D	LBS	FT <sup>3</sup>	
EVWVL2424P	167	226	1	24	24	15.00	0.59	
EVWVL2430P	177	233	1	30	24	19.00	0.72	
EVWVL2436P	211	281	1	36	24	23.00	0.85	
EVWVL2442P	245	329	1	42	24	27.00	0.98	
EVWVL2448P	281	374	1	48	24	31.00	1.11	
EVWVL2454P	317	420	1	54	24	35.00	1.23	
EVWVL2460P	344	469	1	60	24	39.00	1.36	
EVWVL2466P	381	513	1	66	24	43.00	1.49	
EVWVL2472P	408	561	1	72	24	47.00	1.62	
EVWVL3024P	169	232	1	24	30	19.00	0.74	
EVWVL3030P	186	244	1	30	30	24.00	0.90	
EVWVL3036P	222	281	1	36	30	29.00	1.06	
EVWVL3042P	303	400	1	42	30	34.00	1.22	
EVWVL3048P	317	420	1	48	30	39.00	1.38	
EVWVL3054P	353	469	1	54	30	44.00	1.54	
EVWVL3060P	380	513	1	60	30	49.00	1.69	
EVWVL3066P	408	561	1	66	30	54.00	1.85	
EVWVL3072P	438	608	1	72	30	59.00	2.01	
EVWVL3078P	634	809	1	78	30	71.48	2.71	
EVWVL3084P	809	825	1	84	30	76.98	2.91	

**EVWVR • Curvilinear Worksurface Right**

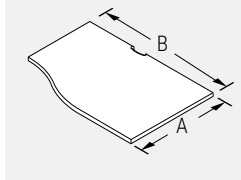

- When deepest end equals 24", the opposite depth is 18".
- When deepest end equals 30", the opposite depth is 24".
- Please choose from DWT - Designer White, SIL - Silver or BLK - Black for scoop covers.

NOTE: EVWV

24	36
A	B
DEPTH	WIDTH

PRODUCT CODE	PRICE		SIZE/ INCHES			WEIGHT VOL	
	LP	HP	H	W	D	LBS	FT <sup>3</sup>
EVWVR2424P	167	226	1	24	24	15.00	0.59
EVWVR2430P	177	233	1	30	24	19.00	0.72
EVWVR2436P	211	281	1	36	24	23.00	0.85
EVWVR2442P	245	329	1	42	24	27.00	0.98
EVWVR2448P	281	374	1	48	24	31.00	1.11
EVWVR2454P	317	420	1	54	24	35.00	1.23
EVWVR2460P	344	469	1	60	24	39.00	1.36
EVWVR2466P	381	513	1	66	24	43.00	1.49
EVWVR2472P	408	561	1	72	24	47.00	1.62
EVWVR3024P	169	232	1	24	30	19.00	0.74
EVWVR3030P	186	244	1	30	30	24.00	0.90
EVWVR3036P	222	281	1	36	30	29.00	1.06
EVWVR3042P	303	400	1	42	30	34.00	1.22
EVWVR3048P	317	420	1	48	30	39.00	1.38
EVWVR3054P	353	469	1	54	30	44.00	1.54
EVWVR3060P	380	513	1	60	30	49.00	1.69
EVWVR3066P	408	561	1	66	30	54.00	1.85
EVWVR3072P	438	608	1	72	30	59.00	2.01
EVWVR3078P	634	809	1	78	30	71.48	2.71
EVWVR3084P	735	825	1	84	30	76.98	2.71

**EVWNL • Notched Worksurface Left**

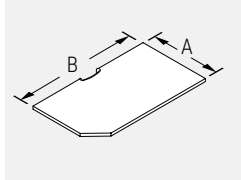

- When deepest end equals 24", the opposite depth is 18".
- When deepest end equals 30", the opposite depth is 24".
- The user edge is 6" shorter than the overall length.
- Please choose from DWT - Designer White, SIL - Silver or BLK - Black for scoop covers.

NOTE: EVWN

24	36
A	B
DEPTH	WIDTH

PRODUCT CODE	PRICE		SIZE/ INCHES			WEIGHT VOL	
	LP	HP	H	W	D	LBS	FT <sup>3</sup>
EVWNL2424P	167	226	1	24	24	15.00	0.59
EVWNL2430P	177	233	1	30	24	19.00	0.72
EVWNL2436P	211	281	1	36	24	23.00	0.85
EVWNL2442P	245	329	1	42	24	27.00	0.98
EVWNL2448P	281	374	1	48	24	31.00	1.11
EVWNL2454P	317	420	1	54	24	35.00	1.23
EVWNL2460P	344	469	1	60	24	39.00	1.36
EVWNL2466P	381	513	1	66	24	43.00	1.49
EVWNL2472P	408	561	1	72	24	47.00	1.62
EVWNL3024P	169	232	1	24	30	19.00	0.74
EVWNL3030P	186	244	1	30	30	24.00	0.90
EVWNL3036P	222	281	1	36	30	29.00	1.06
EVWNL3042P	303	400	1	42	30	34.00	1.22
EVWNL3048P	317	420	1	48	30	39.00	1.38
EVWNL3054P	353	469	1	54	30	44.00	1.54
EVWNL3060P	380	513	1	60	30	49.00	1.69
EVWNL3066P	408	561	1	66	30	54.00	1.85
EVWNL3072P	438	608	1	72	30	59.00	2.01
EVWNL3078P	634	809	1	78	30	71.48	2.70
EVWNL3084P	809	825	1	84	30	76.98	2.92

**EVWNR • Notched Worksurface Right**

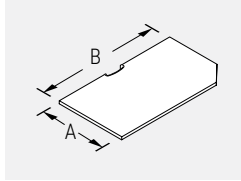

- When deepest end equals 24", the opposite depth is 18".
- When deepest end equals 30", the opposite depth is 24".
- The user edge is 6" shorter than the overall length.
- Please choose from DWT - Designer White, SIL - Silver or BLK - Black for scoop covers.

NOTE: EVWN

24	36
A	B
DEPTH	WIDTH

PRODUCT CODE	PRICE		SIZE/ INCHES			WEIGHT VOL	
	LP	HP	H	W	D	LBS	FT <sup>3</sup>
EVWNR2424P	167	226	1	24	24	15.00	0.59
EVWNR2430P	177	233	1	30	24	19.00	0.72
EVWNR2436P	211	281	1	36	24	23.00	0.85
EVWNR2442P	245	329	1	42	24	27.00	0.98
EVWNR2448P	281	374	1	48	24	31.00	1.11
EVWNR2454P	317	420	1	54	24	35.00	1.23
EVWNR2460P	344	469	1	60	24	39.00	1.36
EVWNR2466P	381	513	1	66	24	43.00	1.49
EVWNR2472P	408	561	1	72	24	47.00	1.62
EVWNR3024P	169	232	1	24	30	19.00	0.74
EVWNR3030P	186	244	1	30	30	24.00	0.90
EVWNR3036P	222	281	1	36	30	29.00	1.06
EVWNR3042P	303	400	1	42	30	34.00	1.22
EVWNR3048P	317	420	1	48	30	39.00	1.38
EVWNR3054P	353	469	1	54	30	44.00	1.54
EVWNR3060P	380	513	1	60	30	49.00	1.69
EVWNR3066P	408	561	1	66	30	54.00	1.85
EVWNR3072P	438	608	1	72	30	59.00	2.01
EVWNR3078P	634	809	1	78	30	71.48	2.70
EVWNR3084P	809	825	1	84	30	76.98	2.92

**EVWC4C • Corner Curved Worksurface For 45° Post**

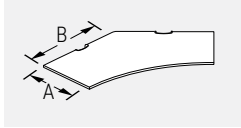

**NOTE:**  
**A= 18, 24, 30**  
**B= 24, 30, 36, 42, 48**

- "WG" at the end of the code indicates wood grain laminate on the diagonal.
- "WG" worksurface over 42" cannot be done on the diagonal.
- Support hardware must be ordered separately. See the listing in this section.
- Please choose from DWT - Designer White, SIL - Silver or BLK - Black for scoop covers.

PRODUCT CODE	PRICE		1SIZE/ HP	INCHES			WEIGHT VOL	
	LP	HP		H	W	D	LBS	FT³
EVWC4C1824P	385	481	1	24	18	19.38	0.43	
EVWC4C1830P	497	619	1	30	18	24.87	0.55	
EVWC4C1836P	699	869	1	36	18	30.36	0.67	
EVWC4C1842P	1132	1414	1	42	18	35.78	0.80	
EVWC4C1848P	1318	1648	1	48	18	41.28	0.92	
EVWC4C2424P	399	501	1	24	24	24.04	0.53	
EVWC4C2430P	561	702	1	30	24	31.38	0.70	
EVWC4C2436P	774	969	1	36	24	38.72	0.86	
EVWC4C2442P	1132	1414	1	42	24	46.07	1.02	
EVWC4C2448P	1483	1851	1	48	24	53.41	1.19	
EVWC4C3024P	418	521	1	24	30	27.94	0.62	
EVWC4C3030P	622	779	1	30	30	37.16	0.83	
EVWC4C3036P	851	1062	1	36	30	46.38	1.03	
EVWC4C3042P	1268	1590	1	42	30	55.60	1.24	
EVWC4C3048P	1648	2059	1	48	30	64.82	1.44	
EVWC4C1824WGP	578	721	1	24	18	19.38	0.43	
EVWC4C1830WGP	746	929	1	30	18	24.87	0.55	
EVWC4C1836WGP	1048	1304	1	36	18	30.36	0.67	
EVWC4C1842WGP	1698	2120	1	42	18	35.78	0.80	
EVWC4C2424WGP	599	751	1	24	24	24.04	0.53	
EVWC4C2430WGP	842	1053	1	30	24	31.38	0.70	
EVWC4C2436WGP	1162	1454	1	36	24	38.72	0.86	
EVWC4C2442WGP	1698	2120	1	42	24	46.07	1.02	
EVWC4C3024WGP	627	782	1	24	30	27.94	0.62	
EVWC4C3030WGP	932	1168	1	30	30	37.16	0.83	
EVWC4C3036WGP	1277	1592	1	36	30	46.38	1.03	
EVWC4C3042WGP	1902	2384	1	42	30	55.60	1.24	

**EVWC4K • Keyboard Corner Worksurface For 45° Post**

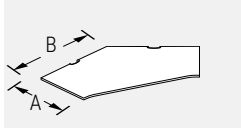

**NOTE:**  
**A= 18, 24, 30**  
**B= 24, 30, 36, 42, 48**

- "WG" at the end of the code indicates wood grain laminate on the diagonal.
- "WG" worksurface over 42" cannot be done on the diagonal.
- Support hardware must be ordered separately. See the listing in this section.
- Please choose from DWT - Designer White, SIL - Silver or BLK - Black for scoop covers.

PRODUCT CODE	PRICE		SIZE/ HP	INCHES			WEIGHT VOL	
	LP	HP		H	W	D	LBS	FT³
EVWC4K1824P	410	518	1	24	18	19.38	0.43	
EVWC4K1830P	637	795	1	30	18	24.87	0.55	
EVWC4K1836P	904	1134	1	36	18	30.36	0.67	
EVWC4K1842P	1132	1414	1	42	18	35.78	0.80	
EVWC4K1848P	1318	1648	1	48	18	41.28	0.92	
EVWC4K2424P	494	617	1	24	24	24.04	0.53	
EVWC4K2430P	740	927	1	30	24	31.38	0.70	
EVWC4K2436P	1035	1293	1	36	24	38.72	0.86	
EVWC4K2442P	1132	1414	1	42	24	46.07	1.02	
EVWC4K2448P	1483	1851	1	48	24	53.41	1.19	
EVWC4K3024P	576	722	1	24	30	27.94	0.62	
EVWC4K3030P	915	1058	1	30	30	37.16	0.83	
EVWC4K3036P	1035	1293	1	36	30	46.38	1.03	
EVWC4K3042P	1268	1590	1	42	30	55.60	1.24	
EVWC4K3048P	1648	2059	1	48	30	64.82	1.44	
EVWC4K1824WGP	615	777	1	24	18	19.38	0.43	
EVWC4K1830WGP	955	1193	1	30	18	24.87	0.55	
EVWC4K1836WGP	1356	1701	1	36	18	30.36	0.67	
EVWC4K1842WGP	1698	2120	1	42	18	35.78	0.80	
EVWC4K2424WGP	741	926	1	24	24	24.04	0.53	
EVWC4K2430WGP	1110	1391	1	30	24	31.38	0.70	
EVWC4K2436WGP	1553	1939	1	36	24	38.72	0.86	
EVWC4K2442WGP	1698	2120	1	42	24	46.07	1.02	
EVWC4K3024WGP	865	1082	1	24	30	27.94	0.62	
EVWC4K3030WGP	1373	1587	1	30	30	37.16	0.83	
EVWC4K3036WGP	1553	1939	1	36	30	46.38	1.03	
EVWC4K3042WGP	1902	2384	1	42	30	55.60	1.24	

**EVW4T • Corner Transaction Surface For 45° Post**

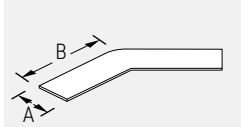

- Support hardware must be ordered separately. See the listing in this section.
- For use with laminate end and middle panels.

**NOTE:**  
**A= 15**  
**B= 24, 30, 36, 42, 48**

PRODUCT CODE	PRICE		SIZE/ HP	INCHES			WEIGHT VOL	
	LP	HP		H	W	D	LBS	FT³
EVW4T1524	565	705	1	24	15	19.14	0.43	
EVW4T1530	705	883	1	30	15	23.78	0.53	
EVW4T1536	988	1235	1	36	15	28.39	0.63	
EVW4T1542	1318	1648	1	42	15	32.99	0.73	
EVW4T1548	1414	1764	1	48	15	37.58	0.84	

**EVWC6C • Corner Curved Worksurface For 60° Post**

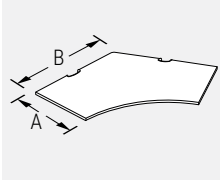

- "WG" at the end of the code indicates wood grain laminate on the diagonal.
- "WG" worksurface over 42" cannot be done on the diagonal.
- Support hardware must be ordered separately. See the listing in this section.
- Please choose from DWT - Designer White, SIL - Silver or BLK - Black for scoop covers.

**NOTE:**  
**A= 18, 24, 30**  
**B= 24, 30, 36, 42, 48**

PRODUCT CODE	PRICE		SIZE/ H	INCHES		WEIGHT VOL	
	LP	HP		W	D	LBS	FT <sup>3</sup>
EVWC6C1824P	331	413	1	24	18	17.76	0.39
EVWC6C1830P	451	564	1	30	18	23.26	0.52
EVWC6C1836P	642	805	1	36	18	28.75	0.64
EVWC6C1842P	947	1042	1	42	18	34.17	0.76
EVWC6C1848P	1291	1421	1	48	18	39.66	0.88
EVWC6C2424P	344	433	1	24	24	21.25	0.47
EVWC6C2430P	493	613	1	30	24	28.59	0.64
EVWC6C2436P	691	866	1	36	24	35.94	0.80
EVWC6C2442P	1187	1301	1	42	24	43.28	0.96
EVWC6C2448P	1291	1421	1	48	24	50.63	1.13
EVWC6C3024P	361	451	1	24	30	23.72	0.53
EVWC6C3030P	528	663	1	30	30	32.94	0.73
EVWC6C3036P	740	926	1	36	30	42.16	0.94
EVWC6C3042P	1187	1301	1	42	30	51.38	1.14
EVWC6C3048P	1291	1421	1	48	30	60.60	1.35
EVWC6C1824WGP	497	619	1	24	18	17.76	0.39
EVWC6C1830WGP	677	846	1	30	18	23.26	0.52
EVWC6C1836WGP	964	1208	1	36	18	28.75	0.64
EVWC6C1842WGP	1421	1563	1	42	18	34.17	0.76
EVWC6C2424WGP	516	650	1	30	24	28.59	0.64
EVWC6C2430WGP	739	919	1	36	24	35.94	0.80
EVWC6C2436WGP	1036	1299	1	42	24	43.28	0.96
EVWC6C2442WGP	1780	1952	1	48	24	50.63	1.13
EVWC6C3024WGP	541	677	1	24	30	23.72	0.53
EVWC6C3030WGP	792	995	1	30	30	32.94	0.73
EVWC6C3036WGP	1110	1389	1	36	30	42.16	0.94
EVWC6C3042WGP	1780	1952	1	42	30	51.38	1.14

**EVWC6K • Keyboard Corner Worksurface For 60° Post**

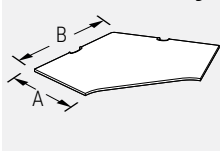

- "WG" at the end of the code indicates wood grain laminate on the diagonal.
- "WG" worksurface over 42" cannot be done on the diagonal.
- Support hardware must be ordered separately. See the listing in this section.
- Please choose from DWT - Designer White, SIL - Silver or BLK - Black for scoop covers.

**NOTE:**  
**A= 18, 24, 30**  
**B= 24, 30, 36, 42, 48**

PRODUCT CODE	PRICE		SIZE/ H	INCHES		WEIGHT VOL	
	LP	HP		W	D	LBS	FT <sup>3</sup>
EVWC6K1824P	323	356	1	24	18	17.76	0.39
EVWC6K1830P	519	569	1	30	18	23.26	0.52
EVWC6K1836P	777	853	1	36	18	28.75	0.64
EVWC6K1842P	947	1042	1	42	18	34.17	0.76
EVWC6K1848P	1291	1421	1	48	18	39.66	0.88
EVWC6K2430P	688	760	1	30	24	28.59	0.64
EVWC6K2436P	777	853	1	36	24	35.94	0.80
EVWC6K2442P	947	1042	1	42	24	43.28	0.96
EVWC6K2448P	1291	1421	1	48	24	50.63	1.13
EVWC6K3030P	688	760	1	30	30	32.94	0.73
EVWC6K3036P	773	999	1	36	30	42.16	0.94
EVWC6K3042P	1057	1370	1	42	30	51.38	1.14
EVWC6K3048P	1284	1669	1	48	30	60.60	1.35
EVWC6K1824WGP	485	535	1	24	18	17.76	0.39
EVWC6K1830WGP	779	853	1	30	18	23.26	0.52
EVWC6K1836WGP	1165	1279	1	36	18	28.75	0.64
EVWC6K1842WGP	1421	1563	1	42	18	34.17	0.76
EVWC6K2430WGP	1031	1140	1	30	24	28.59	0.64
EVWC6K2436WGP	1165	1279	1	36	24	35.94	0.80
EVWC6K2442WGP	1421	1563	1	42	24	43.28	0.96
EVWC6K3030WGP	1031	1140	1	30	30	32.94	0.73
EVWC6K3036WGP	1160	1498	1	36	30	42.16	0.94
EVWC6K3042WGP	1586	2054	1	42	30	51.38	1.14

**EVW6T • Corner Transaction Surface For 60° Post**

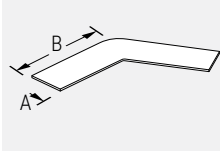

- Support hardware must be ordered separately. See the listing in this section.
- For use with laminate end and middle panels.

**NOTE:**  
**A= 15**  
**B= 24, 30, 36, 42, 48**

PRODUCT CODE	PRICE		SIZE/ H	INCHES		WEIGHT VOL	
	LP	HP		W	D	LBS	FT <sup>3</sup>
EVW6T1518	330	422	1	18	15	14.53	0.32
EVW6T1524	520	671	1	24	15	19.17	0.43
EVW6T1530	674	872	1	30	15	23.78	0.53
EVW6T1536	941	1220	1	36	15	28.39	0.63
EVW6T1542	1024	1326	1	42	15	32.97	0.73
EVW6T1548	1338	1733	1	48	15	34.17	0.76

**EVWCC • Corner Curved Worksurface**

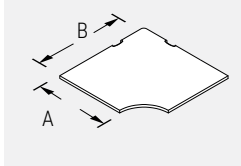

- "WG" at the end of the code indicates wood grain laminate on the diagonal.
- "WG" worksurface over 42" cannot be done on the diagonal.
- Please choose from DWT - Designer White, SIL - Silver or BLK - Black for scoop covers.

NOTE: EVWCC

18	36
A	B
DEPTH	WIDTH

PRODUCT CODE	PRICE		SIZE/ H	INCHES			WEIGHT VOL	
	LP	HP		W	D	LBS	FT <sup>3</sup>	
EVWCC3618P	385	481	1	36	18	24.00	1.27	
EVWCC3624P	426	532	1	36	24	30.00	1.47	
EVWCC4224P	574	715	1	42	24	47.00	1.70	
EVWCC4230P	589	737	1	42	30	53.00	1.98	
EVWCC4824P	668	832	1	48	24	53.00	2.67	
EVWCC4830P	668	832	1	48	30	55.00	2.67	
EVWCC3618WGP	428	550	1	36	18	19.80	0.75	
EVWCC3624WGP	471	607	1	36	24	30.00	1.47	
EVWCC4224WGP	638	820	1	42	24	47.00	1.70	
EVWCC4230WGP	691	889	1	42	30	53.00	1.96	

**EVWCKK • Corner Worksurface with Curved Keyboard Support**

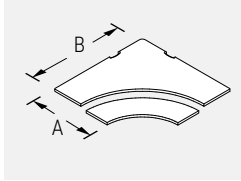

- Keyboard mechanism is included.
- Must be supported with two 24" Cantilevers and 2 Flat Brackets (ordered separately).
- "WG" worksurface over 42" cannot be done on the diagonal.
- "WG" at the end of the code indicates wood grain laminate on the diagonal.
- Keyboard Support is 11" deep, adjusts 6" above and 6" below surface with a positive/negative tilt (+15° to -15°).
- Please choose from DWT - Designer White, SIL - Silver or BLK - Black for scoop covers.

NOTE: EVWCC

24	42
A	B
DEPTH	WIDTH

PRODUCT CODE	PRICE		SIZE/ H	INCHES			WEIGHT VOL	
	LP	HP		W	D	LBS	FT <sup>3</sup>	
EVWCKK4224P	1202	1334	1	42	24	38.00	0.95	
EVWCKK4230P	1277	1423	1	42	30	42.00	1.15	
EVWCKK4824P	1349	1515	1	48	24	48.00	1.55	
EVWCKK4830P	1383	1558	1	48	30	50.00	1.65	
EVWCKK4224WGP	1290	1458	1	42	24	38.00	0.95	
EVWCKK4230WGP	1381	1559	1	42	30	42.00	1.15	

**EVWCK • Corner Keyboard Worksurface**

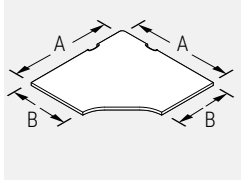

- "WG" at the end of the code indicates wood grain laminate on the diagonal.
- "WG" worksurface over 42" cannot be done on the diagonal.
- Please choose from DWT - Designer White, SIL - Silver or BLK - Black for scoop covers.

NOTE: EVWC

24	36
A	B
DEPTH	WIDTH

PRODUCT CODE	PRICE		SIZE/ H	INCHES			WEIGHT VOL	
	LP	HP		W	D	LBS	FT <sup>3</sup>	
EVWCK3618P	377	470	1	36	18	39.59	1.50	
EVWCK3624P	417	520	1	36	24	39.59	1.50	
EVWCK4224P	553	693	1	42	24	53.89	2.04	
EVWCK4230P	572	713	1	42	30	53.89	2.04	
EVWCK4824P	641	803	1	48	24	70.39	2.67	
EVWCK4830P	641	803	1	48	30	70.39	2.67	
EVWCK3618WGP	428	534	1	36	18	34.00	1.27	
EVWCK3624WGP	470	587	1	36	24	45.00	1.69	
EVWCK4224WGP	636	793	1	42	24	47.00	1.70	
EVWCK4230WGP	686	858	1	42	30	58.00	2.12	

**EVWCF • Five Sided Worksurface**

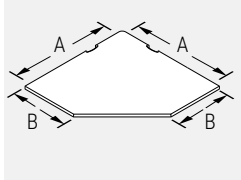

- "WG" at the end of the code indicates wood grain laminate on the diagonal.
- "WG" worksurface over 42" cannot be done on the diagonal.
- Please choose from DWT - Designer White, SIL - Silver or BLK - Black for scoop covers.

NOTE: EVWC

24	36
A	B
DEPTH	WIDTH

PRODUCT CODE	PRICE		SIZE/ H	INCHES			WEIGHT VOL	
	LP	HP		W	D	LBS	FT <sup>3</sup>	
EVWCF3012P	251	311	1	30	24	11.00	0.42	
EVWCF3612P	331	413	1	36	24	13.20	0.50	
EVWCF3618P	331	413	1	36	18	19.80	0.75	
EVWCF3624P	344	433	1	36	24	26.40	1.00	
EVWCF4224P	488	609	1	42	24	30.79	1.17	
EVWCF4230P	502	633	1	42	30	38.49	1.46	
EVWCF4824P	550	686	1	48	24	35.19	1.33	
EVWCF4830P	579	725	1	48	30	43.99	1.67	
EVWCF3618WGP	428	550	1	36	18	34.00	1.27	
EVWCF3624WGP	471	607	1	36	24	45.00	1.69	
EVWCF4224WGP	638	820	1	42	24	47.00	1.70	
EVWCF4230WGP	691	889	1	42	30	58.75	2.12	

**EVWKKR • Angle Front Edge Worksurface**

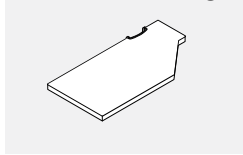

- To be used with EVWCF3012SCP & EVWCF-3612SCP Corner Worksurface
- Creates efficient, compact keyboard corner workstation
- For use with flat screen monitors
- Please choose from DWT - Designer White, SIL - Silver or BLK - Black for scoop covers.

PRODUCT CODE	PRICE		SIZE/ INCHES			WEIGHT VOL	
	LP	HP	H	W	D	LBS	FT <sup>3</sup>
EVWKKR2448P	244	304	1	48	24	35.00	1.11
EVWKKL2448P	244	304	1	48	24	35.00	1.11
EVWKKR2442P	213	267	1	42	24	31.00	0.98
EVWKKL2442P	213	267	1	42	24	31.00	0.98
EVWKKR2436P	184	229	1	36	24	26.00	0.85
EVWKKL2436P	184	229	1	36	24	26.00	0.85

**EVWCC • Non-Symmetrical Corner Curved Worksurface**

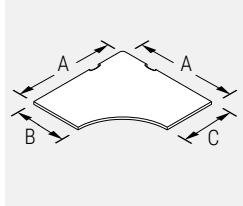

- Please specify starting at the first "A" on the left side and then continuing clockwise.
- "WG" worksurface over 42" cannot be done on the diagonal.
- Please choose from DWT - Designer White, SIL - Silver or BLK - Black for scoop covers.

PRODUCT CODE	PRICE		SIZE/ INCHES			WEIGHT VOL	
	LP	HP	W(A)	D(B)	D(C)	LBS	FT <sup>3</sup>
EVWCC36361824P	426	646	36	18	24	30.00	1.47
EVWCC36362418P	426	646	36	24	18	30.00	1.47
EVWCC36362430P	501	679	36	24	30	30.00	1.47
EVWCC36363024P	501	679	36	30	24	30.00	1.47
EVWCC42421824P	574	715	42	18	24	53.89	2.04
EVWCC42422418P	574	715	42	24	18	53.89	2.04
EVWCC42422430P	589	737	42	24	30	53.89	2.04
EVWCC42423024P	589	737	42	30	24	53.89	2.04
EVWCC48482430P	668	832	48	24	30	70.38	2.66
EVWCC48483024P	668	832	48	30	24	70.38	2.66
EVWCC36361824WGP	532	677	36	18	24	30.00	1.47
EVWCC36362418WGP	532	677	36	24	18	30.00	1.47
EVWCC36362430WGP	562	715	36	24	30	30.00	1.47
EVWCC36363024WGP	562	715	36	30	24	30.00	1.47
EVWCC42421824WGP	647	840	42	18	24	53.89	2.04
EVWCC42422418WGP	647	840	42	24	18	53.89	2.04
EVWCC42422430WGP	701	901	42	24	30	53.89	2.04
EVWCC42423024WGP	701	901	42	30	24	53.89	2.04

NOTE: EVWCC

36	36	18	24
A	A	B	C
WIDTH	WIDTH	DEPTH	DEPTH

**EVWCK • Non-Symmetrical Corner Keyboard Worksurface**

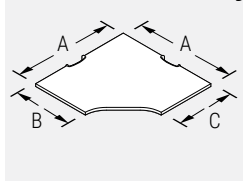

- Please specify starting at the first "A" on the left side and then continuing clockwise
- "WG" worksurface over 42" cannot be done on the diagonal.
- Please choose from DWT - Designer White, SIL - Silver or BLK - Black for scoop covers.

PRODUCT CODE	PRICE		SIZE/ INCHES			WEIGHT VOL	
	LP	HP	W(A)	D(B)	D(C)	LBS	FT <sup>3</sup>
EVWCK36361824P	437	663	36	18	24	39.59	1.50
EVWCK36362418P	437	663	36	24	24	39.59	1.50
EVWCK42421824P	583	727	42	18	24	53.89	2.04
EVWCK42422418P	583	727	42	24	18	53.89	2.04
EVWCK42422430P	601	750	42	24	30	53.89	2.04
EVWCK42423024P	601	750	42	30	24	53.89	2.04
EVWCK48482430P	674	843	48	24	30	70.38	2.66
EVWCK48483024P	674	843	48	30	24	70.38	2.66
EVWCK36361824WGP	521	733	36	18	24	39.59	1.50
EVWCK36362418WGP	521	733	36	24	24	39.59	1.50
EVWCK42421824WGP	647	840	42	18	24	53.89	2.04
EVWCK42422418WGP	647	840	42	24	18	53.89	2.04
EVWCK42422430WGP	712	924	42	24	30	53.89	2.04
EVWCK42423024WGP	712	924	42	30	24	53.89	2.04

NOTE: EVWCC

36	36	18	24
A	A	B	C
WIDTH	WIDTH	DEPTH	DEPTH

**EVWCF • Non-Symmetrical Five Sided Worksurface**

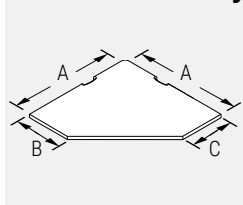

- Please specify starting at the first "A" on the left side and then continuing clockwise.
- "WG" worksurface over 42" cannot be done on the diagonal.
- Please choose from DWT - Designer White, SIL - Silver or BLK - Black for scoop covers.

PRODUCT CODE	PRICE		SIZE/ INCHES			WEIGHT VOL	
	LP	HP	W(A)	D(B)	D(C)	LBS	FT <sup>3</sup>
EVWCF36361824P	406	619	36	18	24	30.00	1.47
EVWCF36362418P	406	619	36	24	18	30.00	1.47
EVWCF36362430P	426	646	36	24	30	30.00	1.47
EVWCF36363024P	426	646	36	30	24	30.00	1.47
EVWCF42421824P	488	672	42	18	24	53.89	2.04
EVWCF42422418P	488	672	42	24	18	53.89	2.04
EVWCF42422430P	560	732	42	24	30	53.89	2.04
EVWCF42423024P	560	732	42	30	24	53.89	2.04
EVWCF48482430P	611	813	48	24	30	70.38	2.66
EVWCF48483024P	611	813	48	30	24	70.38	2.66
EVWCF36361824WGP	541	702	36	18	24	30.00	1.47
EVWCF36362418WGP	541	702	36	24	18	30.00	1.47
EVWCF36362430WGP	575	757	36	24	30	30.00	1.47
EVWCF36363024WGP	575	757	36	30	24	30.00	1.47
EVWCF42421824WGP	584	756	42	18	24	53.89	2.04
EVWCF42422418WGP	584	756	42	24	18	53.89	2.04
EVWCF42422430WGP	611	793	42	24	30	53.89	2.04
EVWCF42423024WGP	611	793	42	30	24	53.89	2.04

NOTE: EVWCC

36	36	18	24
A	A	B	C
WIDTH	WIDTH	DEPTH	DEPTH



**EVWL • "L" Worksurface**

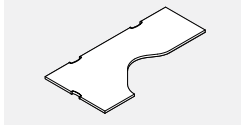

- There are three cable scoops on this worksurface.
- Wood grain laminate not available on the diagonal.
- Must be specified either left or right.
- Please choose from DWT - Designer White, SIL - Silver or BLK - Black for scoop covers.

PRODUCT CODE	PRICE		SIZE/INCHES			WEIGHT VOL	
	LP	HP	H	W	D	LBS	FT <sup>3</sup>
EVWLL2472P	716	895	1	72	24	73.00	2.70
EVWLR2472P	716	895	1	72	24	73.00	2.70

**EVWBTL • Transition Worksurface**

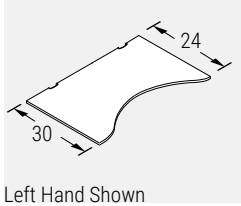

Left Hand Shown

- Support hardware must be ordered separately. See the listing in this section of the price list.
- Opposing side of 30" deep Transition Worksurface has depth of 24".
- Scoops located on back edge only.
- Must be specified as right or left handed.
- Please choose from DWT - Designer White, SIL - Silver or BLK - Black for scoop covers.

PRODUCT CODE	PRICE		SIZE/INCHES			WEIGHT VOL	
	LP	HP	W	D	D2	LBS	FT <sup>3</sup>
EVWBTL3060P	545	678	60	30	24	54.99	2.08
EVWBTL3066P	601	748	66	30	24	60.49	2.29
EVWBTL3072P	651	817	72	30	24	65.99	2.50
EVWBTR3060P	545	678	60	30	24	54.99	2.08
EVWBTR3066P	596	748	66	30	24	60.49	2.29
EVWBTR3072P	651	817	72	30	24	60.49	2.29

**EVWBTL • Transition Worksurface**

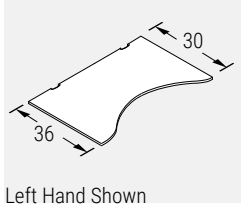

Left Hand Shown

- Support hardware must be ordered separately. See the listing in this section of the price list.
- Opposing side of 36" deep Transition Worksurface has depth of 30".
- Scoops located on back edge only.
- Must be specified as right or left handed.
- Please choose from DWT - Designer White, SIL - Silver or BLK - Black for scoop covers.

PRODUCT CODE	PRICE		SIZE/ INCHES			WEIGHT VOL	
	LP	HP	W	D	D2	LBS	FT <sup>3</sup>
EVWBTL3660P	651	832	60	36	30	65.99	2.50
EVWBTL3666P	716	898	66	36	30	72.59	2.75
EVWBTL3672P	782	978	72	36	30	79.19	3.00
EVWBTR3660P	651	817	60	36	30	65.99	2.50
EVWBTR3666P	716	898	66	36	30	72.59	2.75
EVWBTR3672P	782	978	72	36	30	79.19	3.00

**EVWCEL • Extended Curved Corner - Left**

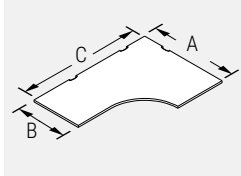

- For 48" wide ("C" dimension) worksurfaces, there are two cable scoops, all others have three.
- Wood grain laminate not available on the diagonal.
- Please choose from DWT - Designer White, SIL - Silver or BLK - Black for scoop covers.

**NOTE: EVWCE**

36	24	72
A	B	C
DEPTH	DEPTH	WIDTH

PRODUCT CODE	PRICE		SIZE/ INCHES			WEIGHT VOL	
	LP	HP	A	B	C	LBS	FT <sup>3</sup>
EVWCEL362448P	583	722	36	24	48	43.92	1.25
EVWCEL362460P	636	792	36	24	60	52.79	1.50
EVWCEL362466P	700	869	36	24	66	57.18	1.62
EVWCEL362472P	773	965	36	24	72	61.58	1.75
EVWCEL362478P	825	1031	36	24	78	65.98	1.87
EVWCEL362484P	890	1110	36	24	84	70.38	2.00
EVWCEL422460P	668	832	42	24	60	57.18	1.63
EVWCEL422466P	736	919	42	24	66	61.58	1.57
EVWCEL422472P	811	1015	42	24	72	65.98	1.87
EVWCEL422478P	867	1084	42	24	78	70.38	2.00
EVWCEL422484P	934	1166	42	24	84	74.78	2.00
EVWCEL423060P	752	942	42	30	60	63.78	1.82
EVWCEL423066P	825	1031	42	30	66	69.28	1.96
EVWCEL423072P	902	1126	42	30	72	74.78	2.12
EVWCEL423078P	967	1207	42	30	78	80.28	2.28
EVWCEL423084P	1031	1287	42	30	84	85.78	2.43
EVWCEL482460P	763	955	48	24	60	65.18	1.90
EVWCEL482466P	849	1060	48	24	66	69.78	3.66
EVWCEL482472P	928	1162	48	24	72	76.18	1.95
EVWCEL482478P	991	1236	48	24	78	74.78	1.20
EVWCEL482484P	1051	1313	48	24	84	123.17	4.66
EVWCEL483060P	849	1060	48	30	60	68.18	1.93
EVWCEL483066P	928	1162	48	30	66	73.68	2.09
EVWCEL483072P	991	1236	48	30	72	79.18	2.25
EVWCEL483078P	1051	1313	48	30	78	84.68	2.40
EVWCEL483084P	1124	1408	48	30	84	90.18	2.56

**EVWCER • Extended Curved Corner - Right**

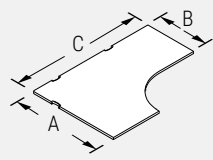

- For 48" wide ("C" dimension) worksurfaces, there are two cable scoops, all others have three finishes.
- Wood grain laminate not available on the diagonal.
- Please choose from DWT - Designer White, SIL - Silver or BLK - Black for scoop covers.

**NOTE: EVWCE**

36	24	72
A	B	C
DEPTH	DEPTH	WIDTH

PRODUCT CODE	PRICE		SIZE/ INCHES			WEIGHT VOL	
	LP	HP	A	B	C	LBS	FT <sup>3</sup>
EVWCER362448P	583	722	36	24	48	43.92	1.25
EVWCER362460P	636	792	36	24	60	52.79	1.50
EVWCER362466P	700	869	36	24	66	57.18	1.62
EVWCER362472P	773	965	36	24	72	61.58	1.75
EVWCER362478P	825	1031	36	24	78	65.98	1.87
EVWCER362484P	890	1110	36	24	84	70.38	2.00
EVWCER422460P	668	832	42	24	60	57.18	1.63
EVWCER422466P	736	919	42	24	66	61.58	1.57
EVWCER422472P	811	1015	42	24	72	65.98	1.87
EVWCER422478P	867	1084	42	24	78	70.38	2.00
EVWCER422484P	934	1166	42	24	84	74.78	2.00
EVWCER423060P	752	942	42	30	60	63.78	1.82
EVWCER423066P	825	1031	42	30	66	69.28	1.96
EVWCER423072P	902	1126	42	30	72	74.78	2.12
EVWCER423078P	967	1207	42	30	78	80.28	2.28
EVWCER423084P	1031	1287	42	30	84	85.78	2.43
EVWCER482460P	763	955	48	24	60	65.18	1.90
EVWCER482466P	849	1060	48	24	66	96.78	3.66
EVWCER482472P	928	1162	48	24	72	76.18	1.95
EVWCER482478P	991	1236	48	24	78	74.78	1.20
EVWCER482484P	1051	1313	48	24	84	123.17	4.66
EVWCER483060P	849	1060	48	30	60	68.18	1.93
EVWCER483066P	928	1162	48	30	66	73.68	2.09
EVWCER483072P	991	1236	48	30	72	79.18	2.25
EVWCER483078P	1051	1313	48	30	78	84.68	2.40
EVWCER483084P	1124	1408	48	30	84	90.18	2.56

**EVWH • Hatchet Worksurface**

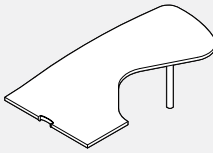

Right Hand Shown

- Cable scoop is in the middle of the 36" wide edge.
- Wood grain laminate not available on the diagonal.
- Must be specified either left or right.
- Includes monoleg.
- Please choose from DWT - Designer White, SIL - Silver or BLK - Black for scoop covers.

PRODUCT CODE	PRICE		SIZE/ INCHES			WEIGHT VOL	
	LP	HP	H	W	D	LBS	FT <sup>3</sup>
EVWHL3672P	1048	1261	1	72	30	73.00	2.70
EVWHR3672P	1048	1261	1	72	30	73.00	2.70

**EVWSH • Hatchet Worksurface - Straight Front**

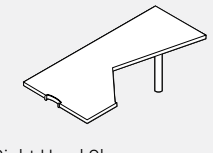

Right Hand Shown

- Cable scoop is in the middle of the 36" wide edge.
- Wood grain laminate not available on the diagonal.
- Support hardware must be ordered separately.
- Must be specified either left or right.
- Includes monoleg.
- Please choose from DWT - Designer White, SIL - Silver or BLK - Black for scoop covers.

PRODUCT CODE	PRICE		SIZE/ INCHES			WEIGHT VOL	
	LP	HP	H	W	D	LBS	FT <sup>3</sup>
EVWSHL3672P	997	1200	1	72	30	73.00	2.70
EVWSHR3672P	997	1200	1	72	30	73.00	2.70

**EVWD • "D" Worksurface**

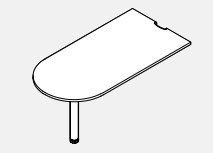

- Cable scoop is at the centre of the end.
- Includes monoleg.
- Please choose from DWT - Designer White, SIL - Silver or BLK - Black for scoop covers.

PRODUCT CODE	PRICE		SIZE/ INCHES			WEIGHT VOL	
	LP	HP	H	W	D	LBS	FT <sup>3</sup>
EVWD2442P	552	640	1	42	24	28.00	0.98
EVWD2448P	576	673	1	48	24	32.00	1.11
EVWD2460P	605	704	1	60	24	40.00	1.36
EVWD2472P	642	756	1	72	24	48.00	1.61
EVWD3048P	579	675	1	48	30	39.00	1.37
EVWD3060P	646	757	1	60	30	49.00	1.69
EVWD3072P	710	839	1	72	30	59.00	2.01

**EVWPT • "P" Top Worksurface**

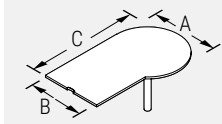

Left Hand Shown

- Cable scoop is at the center of the panel with edge.
- Must be specified either left or right.
- Includes monoleg.
- Please choose from DWT - Designer White, SIL - Silver or BLK - Black for scoop covers.

**NOTE: EVWCE**

24	60	30
A	B	C
DEPTH	DEPTH	WIDTH

PRODUCT CODE	PRICE		SIZE/ INCHES			WEIGHT VOL	
	LP	HP	H	W	D	LBS	FT <sup>3</sup>
EVWPTL245430P	750	911	1	54	24	39.50	1.50
EVWPTL246030P	805	963	1	60	24	54.99	2.08
EVWPTL246630P	821	1043	1	66	24	60.48	2.29
EVWPTL247230P	868	1088	1	72	24	65.98	2.50
EVWPTL306036P	889	1107	1	60	30	65.98	2.50
EVWPTL306636P	963	1148	1	66	30	72.58	2.75
EVWPTL307236P	1004	1200	1	72	30	79.00	2.41
EVWPTR245430P	750	911	1	54	24	39.50	1.50
EVWPTR246030P	805	963	1	60	24	54.99	2.08
EVWPTR246630P	821	1043	1	66	24	60.48	2.29
EVWPTR247230P	868	1088	1	72	24	65.98	2.50
EVWPTR306036P	889	1107	1	60	30	65.98	2.50
EVWPTR306636P	963	1148	1	66	30	72.58	2.75
EVWPTR307236P	1004	1200	1	72	30	79.00	2.41

**EVWW • Wedge Worksurface**

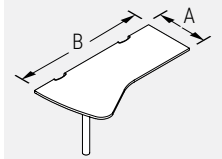

Left Hand Shown

- Two cable scoops on the back side of worksurface.
- Must be specified either left or right.
- Includes monoleg.
- Conference end is 10" wider than "A".
- Please choose from DWT - Designer White, SIL - Silver or BLK - Black for scoop covers.

**NOTE: EVWC**

18	48
A	B
DEPTH	WIDTH

PRODUCT CODE	PRICE		SIZE/ INCHES			WEIGHT VOL	
	LP	HP	H	W	D	LBS	FT <sup>3</sup>
EVWWL2460P	634	739	1	60	24	51.99	1.81
EVWWL2466P	671	788	1	66	24	56.39	1.98
EVWWL2472P	706	838	1	72	24	60.79	2.15
EVWWL2478P	793	992	1	78	24	65.18	2.31
EVWWL2484P	805	1005	1	84	24	69.58	2.48
EVWWL3060P	730	860	1	60	30	62.99	2.23
EVWWL3066P	777	923	1	66	30	68.44	2.44
EVWWL3072P	826	983	1	72	30	73.98	2.65
EVWWR2460P	634	739	1	60	24	51.99	1.81
EVWWR2466P	671	788	1	66	24	56.39	1.98
EVWWR2472P	706	838	1	72	24	60.79	2.15
EVWWR2478P	793	992	1	78	24	65.18	2.31
EVWWR2484P	805	1005	1	84	24	69.58	2.48
EVWWR3060P	730	860	1	60	30	62.99	2.23
EVWWR3066P	777	923	1	66	30	68.48	2.44
EVWWR3072P	826	983	1	72	30	73.98	2.65

**EVWPL • Piano Top Worksurface Left**

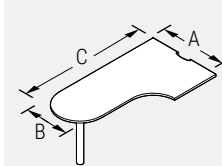

Left Hand Shown

- Cable scoop is at the center of the panel with edge.
- Must be specified either left or right.
- Includes monoleg.
- Works with EVWMP modesty.
- Please choose from DWT - Designer White, SIL - Silver or BLK - Black for scoop covers.

**NOTE: EVWP**

36	18	48
A	B	C
DEPTH	DEPTH	WIDTH

PRODUCT CODE	PRICE		SIZE/ INCHES			WEIGHT VOL	
	LP	HP	H	W	D	LBS	FT <sup>3</sup>
EVWPL361848P	706	838	1	48	36	52.79	2.00
EVWPL361854P	750	889	1	54	36	59.39	2.25
EVWPL361860P	789	941	1	60	36	65.99	2.50
EVWPL361866P	832	992	1	66	36	72.59	2.75
EVWPL361872P	870	1041	1	72	36	79.18	3.00
EVWPL362448P	715	843	1	48	24	52.79	2.75
EVWPL362454P	755	893	1	54	24	59.39	2.25
EVWPL362460P	799	945	1	60	24	65.58	1.68
EVWPL362466P	838	996	1	66	24	73.00	2.23
EVWPL362472P	877	1047	1	72	24	79.18	3.00
EVWPL422454P	809	963	1	54	42	69.29	2.63
EVWPL422460P	857	1021	1	60	42	75.58	1.88
EVWPL422466P	903	1080	1	66	42	85.68	3.21
EVWPL422472P	947	1136	1	72	42	92.38	3.51
EVWPL423060P	871	1042	1	60	42	76.99	2.92
EVWPL423066P	924	1106	1	66	42	84.68	3.21
EVWPL423072P	971	1164	1	72	42	92.38	3.50
EVWPL482460P	972	1166	1	60	48	87.98	3.33
EVWPL482466P	1031	1238	1	66	48	87.98	3.33
EVWPL482472P	1088	1312	1	72	48	105.58	4.00
EVWPL483066P	1034	1247	1	66	48	96.78	3.66
EVWPL483072P	1092	1316	1	72	48	105.58	4.00

**EVWPR • Piano Top Worksurface Right**

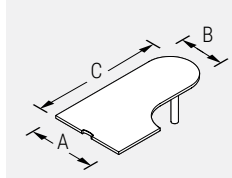

Right Hand Shown

- Cable scoop is at the center of the panel with edge.
- Must be specified either left or right.
- Includes monoleg.
- Works with EVWMP modesty.
- Please choose from DWT - Designer White, SIL - Silver or BLK - Black for scoop covers.

**NOTE: EVWP**

36	18	48
A	B	C
DEPTH	DEPTH	WIDTH

PRODUCT CODE	PRICE		SIZE/ INCHES			WEIGHT VOL	
	LP	HP	H	W	D	LBS	FT <sup>3</sup>
EVWPR361848P	706	838	1	48	36	52.79	2.00
EVWPR361854P	750	889	1	54	36	59.39	2.25
EVWPR361860P	789	941	1	60	36	65.99	2.50
EVWPR361866P	832	992	1	66	36	72.59	2.75
EVWPR361872P	870	1041	1	72	36	79.18	3.00
EVWPR362448P	715	843	1	48	24	52.79	2.75
EVWPR362454P	755	893	1	54	24	59.39	2.25
EVWPR362460P	799	945	1	60	24	65.58	1.68
EVWPR362466P	838	996	1	66	24	73.00	2.23
EVWPR362472P	877	1047	1	72	24	79.18	3.00
EVWPR422454P	809	963	1	54	42	69.29	2.63
EVWPR422460P	857	1021	1	60	42	75.58	1.88
EVWPR422466P	903	1080	1	66	42	85.68	3.21
EVWPR422472P	947	1136	1	72	42	92.38	2.27
EVWPR423060P	871	1042	1	60	42	76.99	2.92
EVWPR423066P	924	1106	1	66	42	84.68	3.21
EVWPR423072P	971	1164	1	72	42	92.38	3.50
EVWPR482460P	972	1166	1	60	48	87.98	2.25
EVWPR482466P	1031	1238	1	66	48	78.00	3.66
EVWPR482472P	1088	1312	1	72	48	105.58	4.00
EVWPR483066P	1034	1247	1	66	48	96.78	3.66
EVWPR483072P	1092	1316	1	72	48	105.58	4.00

**EVWQR/L • Quarter Round Panel Worksurface**

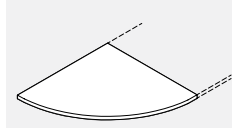

Left Hand Shown

- The worksurface edge running along the panel face is a slightly different length than that of the worksurface end, causing the surface to be handed.
- The user edge abutting the adjacent worksurface runs straight for 3" before starting to curve.

PRODUCT CODE	PRICE		SIZE/ INCHES			WEIGHT VOL	
	LP	HP	H	W	D	LBS	FT <sup>3</sup>
EVWQRL1818	135	169	1	18	18	9	0.30
EVWQRL2424	194	240	1	24	24	16	0.52
EVWQRL3030	251	311	1	30	30	25	0.81
EVWQRR1818	135	169	1	18	18	9	0.30
EVWQRR2424	194	240	1	24	24	16	0.52
EVWQRR3030	251	311	1	30	30	25	0.81

**EVWQRC • Quarter Round Panel Corner Worksurface**



- Wraps around a 90° corner post.
- Putting the adjacent worksurface runs straight for 3" before starting to curve.

PRODUCT CODE	PRICE		SIZE/ INCHES			WEIGHT VOL	
	LP	HP	H	W	D	LBS	FT <sup>3</sup>
EVWQRC1818	157	196	1	21	21	12.00	0.38
EVWQRC2424	228	284	1	27	27	17.00	0.58
EVWQRC3030	281	353	1	33	33	25.50	0.86

**EVWMP • Worksurface Modesty Panel**

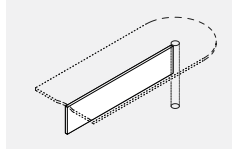

- Modesty panel fastens to the worksurface and Monoleg to provide additional privacy and support.
- Made of cold rolled steel and is epoxy powder coated.
- For "D", Hatchet and Piano Top Worksurfaces only (ordered separately).

PRODUCT CODE	PRICE		SIZE/ INCHES			WEIGHT VOL	
	LP	HP	H	W	D	LBS	FT <sup>3</sup>
EVWMP1242	130	133	13	26	1	4.00	0.22
EVWMP1248	147	150	13	32	1	5.00	0.25
EVWMP1260	169	172	13	44	1	6.00	0.30
EVWMP1272	218	221	13	56	1	8.00	2.00

**EVWR • Radius Worksurface**

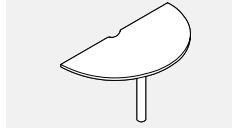

- Rounded worksurface for conferencing provides a radius corner from a worksurface to worksurface.
- 18" and 24" come with one monoleg and 30" comes with two monolegs.
- Radius cut out on the straight edge allows space for trims.
- Please choose from DWT - Designer White, SIL - Silver or BLK - Black for scoop covers.

PRODUCT CODE	PRICE		SIZE/ INCHES			WEIGHT VOL	
	LP	HP	H	W	D	LBS	FT <sup>3</sup>
EVWR18P	488	561	29	39	19.5	24.00	0.74
EVWR24P	560	649	29	51	25.5	34.00	1.16
EVWR30P	941	1076	29	63	31.5	51.00	1.76

**EVTTE • Teardrop Extension Table**



- Stand-alone mobile table.

PRODUCT CODE	PRICE		SIZE/ INCHES			WEIGHT VOL	
	LP	HP	H	W	D	LBS	FT <sup>3</sup>
EVTTE29247	480	562	27	29	29	30.00	15.00
EVTTE34307	526	617	27	34	34	35.00	18.00
EVTTE29249	564	647	29	29	29	30.00	19.00
EVTTE34309	611	703	29	34	34	35.00	19.00

**EVWT • Straight Transaction Surface**

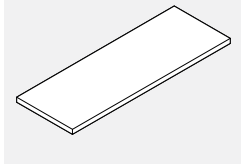

- Support hardware must be ordered separately.
- All tops are thermally fused 1" thick with pilot holes to enable proper alignment with worksurface supports. Wood screws must be used.
- Evolve worksurfaces feature a 3mm edge.

PRODUCT CODE	PRICE		SIZE/ INCHES			WEIGHT VOL	
	LP	HP	H	W	D	LBS	FT <sup>3</sup>
EVWT1512	58	75	1	12	15	6.00	0.22
EVWT1518	72	99	1	18	15	8.00	0.30
EVWT1524	90	120	1	24	15	10.00	0.38
EVWT1530	109	142	1	30	15	13.00	0.46
EVWT1536	124	165	1	36	15	15.00	0.54
EVWT1542	142	188	1	42	15	18.00	0.62
EVWT1548	161	211	1	48	15	20.00	0.70
EVWT1554	173	232	1	54	15	23.00	0.78
EVWT1560	193	255	1	60	15	25.00	0.86
EVWT1566	207	276	1	66	15	29.00	0.94
EVWT1572	227	298	1	72	15	30.00	1.02
EVWT1578	242	323	1	78	15	32.00	1.10
EVWT1584	259	343	1	84	15	35.00	1.18

**EVWTV • Straight Transaction Surface with Cut-out**

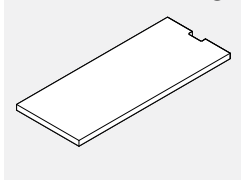

- Used where a transaction surface butts up against a taller panel

PRODUCT CODE	PRICE		SIZE/ INCHES			WEIGHT VOL	
	LP	HP	H	W	D	LBS	FT <sup>3</sup>
EVWTV1524	101	130	1	24	15	10.00	0.38
EVWTV1530	122	155	1	30	15	13.00	0.46
EVWTV1536	135	175	1	36	15	15.00	0.54
EVWTV1542	155	198	1	42	15	18.00	0.62
EVWTV1548	171	224	1	48	15	20.57	0.70
EVWTV1554	186	244	1	54	15	22.57	0.75
EVWTV1560	204	267	1	60	15	26.00	0.92
EVWTV1566	222	289	1	66	15	28.00	1.00
EVWTV1572	238	310	1	72	15	30.00	1.08

**EVWTCL • "L" Corner Transaction Surface**

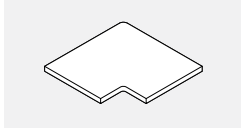

- Used where two panels meet at a 90° angle.
- For Wood Grain Laminate, use code ending with "WG".

PRODUCT CODE	PRICE		SIZE/ INCHES			WEIGHT VOL	
	LP	HP	H	W	D	LBS	FT <sup>3</sup>
EVWTCL90	166	206	1	21	15	12.00	0.75
EVWTCL90WG	202	253	1	21	15	12.00	0.75

**EVWTCT • "T" Corner Transaction Surface**

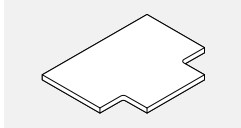

- Used where three panels meet.
- For Wood Grain Laminate, use code ending with "WG".

PRODUCT CODE	PRICE		SIZE/ INCHES			WEIGHT VOL	
	LP	HP	H	W	D	LBS	FT <sup>3</sup>
EVWTCT90	166	206	1	27	15	16.00	1.00

**EVWTE • End Transaction Surface**

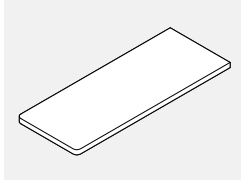

- Surface has rounded corners at one end.

PRODUCT CODE	PRICE		SIZE/ INCHES			WEIGHT VOL	
	LP	HP	H	W	D	LBS	FT <sup>3</sup>
EVWTE1512	58	75	1	14	15	12.00	0.54
EVWTE1518	72	99	1	20	15	14.00	0.58
EVWTE1524	101	130	1	26	15	16.00	0.61
EVWTE1530	122	155	1	32	15	20.00	0.69
EVWTE1536	135	175	1	38	15	20.00	0.70
EVWTE1542	155	198	1	44	15	23.00	0.74
EVWTE1548	171	224	1	50	15	26.00	0.77
EVWTE1554	186	244	1	56	15	28.00	0.85
EVWTE1560	204	267	1	62	15	31.00	0.94
EVWTE1566	222	289	1	68	15	34.00	1.02
EVWTE1572	238	310	1	74	15	36.00	1.10

**EVWTEV • End Transaction Surface with Cut-out**

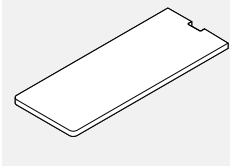

- Used at the end of a panel run where the surface butts up against a taller panel.
- Surface has rounded corners at one end.

PRODUCT CODE	PRICE		SIZE/ H	INCHES			WEIGHT VOL	
	LP	HP		W	D	LBS	FT <sup>3</sup>	
EVWTEV1524	113	142	1	26	15	16.00	0.61	
EVWTEV1530	132	166	1	32	15	18.00	0.65	
EVWTEV1536	147	189	1	38	15	20.00	0.69	
EVWTEV1542	166	211	1	44	15	23.00	0.74	
EVWTEV1548	184	233	1	50	15	32.00	1.22	
EVWTEV1554	196	256	1	56	15	36.00	1.32	
EVWTEV1560	215	278	1	62	15	36.00	1.30	
EVWTEV1566	232	300	1	68	15	30.24	1.14	
EVWTEV1572	251	323	1	74	15	40.00	1.38	

**EVW9TL • Corner Transaction Top for 90 degree Left**

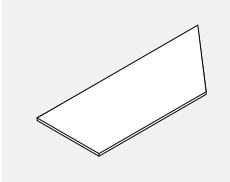

PRODUCT CODE	PRICE		SIZE/ H	INCHES			WEIGHT VOL	
	LP	HP		W	D	LBS	FT <sup>3</sup>	
EVW9TL1524	383	564	1	33	15	15.00	0.54	
EVW9TL1530	461	684	1	39	15	18.00	0.62	
EVW9TL1536	535	792	1	45	15	20.00	0.70	
EVW9TL1542	613	903	1	51	15	23.00	0.78	
EVW9TL1548	691	1019	1	57	15	25.00	0.86	

**EVW9TR • Corner Transaction Top for 90 degree Right**

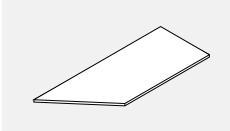

PRODUCT CODE	PRICE		SIZE/ H	INCHES			WEIGHT VOL	
	LP	HP		W	D	LBS	FT <sup>3</sup>	
EVW9TR1524	383	564	1	33	15	15.00	0.54	
EVW9TR1530	461	684	1	39	15	18.00	0.62	
EVW9TR1536	535	792	1	45	15	20.00	0.70	
EVW9TR1542	613	903	1	51	15	23.00	0.78	
EVW9TR1548	691	1019	1	57	15	25.00	0.86	

**EVWTD • End “D” Transaction Surface**

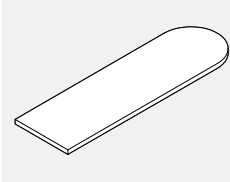

- Used at the end of a panel run where surface can overhang.

PRODUCT CODE	PRICE		SIZE/ H	INCHES			WEIGHT VOL	
	LP	HP		W	D	LBS	FT <sup>3</sup>	
EVWTD1530	141	184	1	37	15	18.00	0.65	
EVWTD1536	149	198	1	43	15	20.00	0.69	
EVWTD1542	166	222	1	49	15	23.00	0.74	
EVWTD1548	186	244	1	55	15	26.00	0.77	
EVWTD1554	201	266	1	61	15	28.00	0.85	
EVWTD1560	222	294	1	67	15	31.00	0.94	
EVWTD1566	238	314	1	73	15	34.00	1.02	
EVWTD1572	257	341	1	79	15	36.00	1.10	

**EVWTDV • End “D” Transaction Surface with Cut-out**

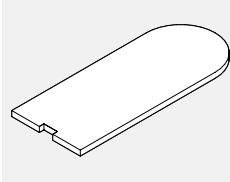

- Used at the end of a panel run where the surface butts up against a taller panel on one end and can overhang at the other.

PRODUCT CODE	PRICE		SIZE/ H	INCHES			WEIGHT VOL	
	LP	HP		W	D	LBS	FT <sup>3</sup>	
EVWTDV1530	145	195	1	37	15	18.00	0.65	
EVWTDV1536	157	211	1	43	15	20.00	0.69	
EVWTDV1542	174	232	1	49	15	23.00	0.74	
EVWTDV1548	193	256	1	55	15	26.00	0.77	
EVWTDV1554	206	276	1	61	15	28.00	0.85	
EVWTDV1560	228	303	1	67	15	31.00	0.94	

**EVWTD • Double “D” Transaction Surface**

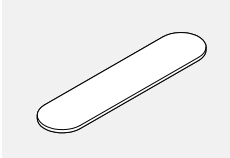

- Support hardware must be ordered separately.
- All tops are thermally fused 1" thick with pilot holes to enable proper alignment with worksurface supports. Wood screws must be used.
- Evolve worksurfaces feature a 3mm edge.

PRODUCT CODE	PRICE		SIZE/ H	INCHES			WEIGHT VOL	
	LP	HP		W	D	LBS	FT <sup>3</sup>	
EVWTD • Double “D” Transaction Surface	207	276	1	62	15	28.00	0.85	
EVWTD • Double “D” Transaction Surface	242	323	1	74	15	31.00	0.94	
EVWTD • Double “D” Transaction Surface	281	374	1	86	15	36.00	1.10	

**EVHEP • End Panel**

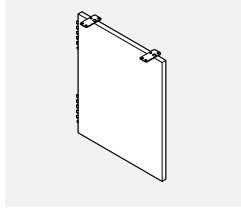

- Attaches a worksurface to a panel connector.
- Provides solid support at the end of a run of worksurfaces.
- Shipped with pedestal brackets and flat brackets.
- Glides are installed.
- Please specify metal colour for brackets.

PRODUCT CODE	PRICE	SIZE/ INCHES			WEIGHT VOL	
		H	W	D	LBS	FT <sup>3</sup>
EVHEP2618	182	26	1	18	15.00	0.30
EVHEP2624	232	25	1	24	16.00	0.35
EVHEP2630	272	25	1	30	20.00	0.45
EVHEP2918	191	28	1	18	18.00	0.40
EVHEP2924	232	28	1	24	18.00	0.40
EVHEP2930	272	28	1	30	22.00	0.50

**EVHS • Support Leg**

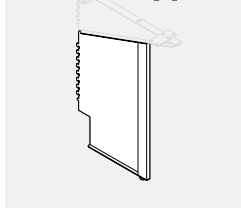

- Used in conjunction with an EVHC Cantilever of the same hand.
- Attaches a worksurface to a panel connector.
- Provides extra support where needed.
- May be used to support two convergent worksurfaces.
- Available in BLK (Black) only.

PRODUCT CODE	PRICE	SIZE/ INCHES			WEIGHT VOL	
		H	W	D	LBS	FT <sup>3</sup>
EVHSL2618	122	22	1	10	6.00	0.24
EVHSL2624	122	22	1	10	6.00	0.31
EVHSL2918	129	25	1	10	7.00	0.30
EVHSL2924	129	25	1	10	7.00	0.33
EVHSR2618	122	22	1	10	6.00	0.24
EVHSR2624	122	22	1	10	6.00	0.31
EVHSR2918	129	25	1	10	7.00	0.30
EVHSR2924	129	25	1	10	7.00	0.33

**EVHC • Cantilever**

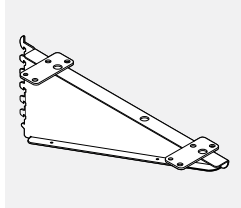

- Attaches a worksurface to a panel connector.
- May be used to support two convergent worksurfaces.
- Priced individually.
- Available in BLK (Black) only.

PRODUCT CODE	PRICE	SIZE/ INCHES			WEIGHT VOL	
		H	W	D	LBS	FT <sup>3</sup>
EVHC12L	90	8	1	12	2.00	0.04
EVHC18L	90	8	1	18	2.00	0.04
EVHC24L	101	8	1	24	3.00	0.05
EVHC12R	90	8	1	12	2.00	0.04
EVHC18R	90	8	1	18	2.00	0.04
EVHC24R	101	8	1	24	3.00	0.50

**EVHMEGR • Metal End Gable - Right**

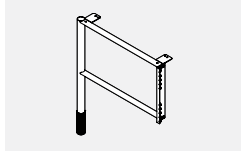

- Support the worksurface and enhances the stability of connected panels.
- Includes a leveling glide and decorative PVC sleeve to cover the glide.

PRODUCT CODE	PRICE	SIZE/ INCHES			WEIGHT VOL	
		H	W	D	LBS	FT <sup>3</sup>
EVHMEG18R	227	28	4	17	5.20	0.55
EVHMEG24R	242	28	4	23	6.00	0.73
EVHMEG30R	257	28	4	29	6.80	0.90

**EVHMEGL • Metal End Gable - Left**

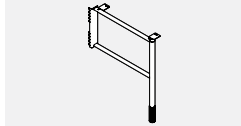

- Support the worksurface and enhances the stability of connected panels.
- Includes a leveling glide and decorative PVC sleeve to cover the glide.

PRODUCT CODE	PRICE	SIZE/ INCHES			WEIGHT VOL	
		H	W	D	LBS	FT <sup>3</sup>
EVHMEG18L	227	28	4	17	5.20	0.55
EVHMEG24L	242	28	4	23	6.00	0.73
EVHMEG30L	257	28	4	29	6.80	0.90

**EVHMSL • Metal Mid Support Leg**

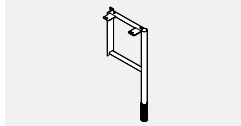

- Supports the adjoining worksurfaces and enhances the stability of connected panels.
- Includes a leveling glide and decorative PVC sleeve to cover the glide.
- **Should not be used as an end support.**

PRODUCT CODE	PRICE	SIZE/ INCHES			WEIGHT VOL	
		H	W	D	LBS	FT <sup>3</sup>
EVHMSL12	194	28	4	11	4.60	0.36

**EVHMSL1 • Mid Support Leg**

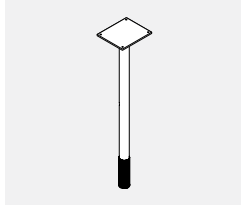

- Provides additional support for worksurface.
- Includes leveling glide, PVC Sleeve and 4.8" x 4.8" attachment plate.
- 1.5 diameter tube.
- Available in standard paint colours.

PRODUCT CODE	PRICE	SIZE/ INCHES			WEIGHT VOL	
		H	W	D	LBS	FT <sup>3</sup>
EVHMSL1	75	28			3.20	0.37

**EVHMSL2 • Mid Support Leg**

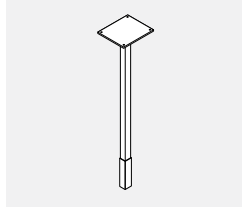

- Provides additional support for worksurface.
- Includes leveling glide, PVC Sleeve and 4.8" x 4.8" attachment plate.
- 1.5" square tube.
- Available in standard paint colours.

PRODUCT CODE	PRICE	SIZE/ H	INCHES			WEIGHT VOL	
			H	W	D	LBS	FT <sup>3</sup>
EVHMSL2	75	28				3.20	0.37

**EVHMSCL18 • Mid Support Leg with Cantilever Bracket**

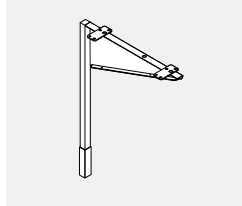

- Provides additional support for worksurface.
- Includes leveling glide, PVC Sleeve and 4.8" x 4.8" attachment plate.
- 1.5" square tube.
- Available in standard paint colours.

PRODUCT CODE	PRICE	SIZE/ H	INCHES			WEIGHT VOL	
			H	W	D	LBS	FT <sup>3</sup>
EVHMSCL18	112	28	18	1.5		5.2	0.55

**EVTHLEG • Evolve Bridges Leg**

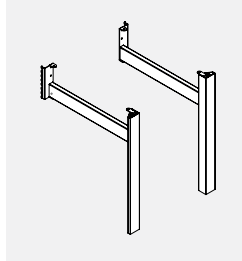

- Leg assembly attaches to panel for application which requires functionality of panels with open environment of Bridges tables.
- One leg with horizontal member connects to 1" increment slots in connector.
- Provides support to panel and panel connected 24" & 30" worksurface at end of run-design coordinated with Bridges freestanding tables.
- One leg can support 2 adjoining worksurface by specifying 2 flat brackets.
- Leveling glide is standard.
- Panel cantilever and storage must be for worksurface support.
- One aluminum leg with steel structure - specify left or right and 24" or 30" deep for corresponding worksurface depth.
- Panel bracket, dislodgment clip and worksurface hardware included.
- Anodized aluminum upcharge \$37.
- Please specify paint finish for support.

PRODUCT CODE	PRICE	SIZE/ H	INCHES			WEIGHT VOL	
			H	W	D	LBS	FT <sup>3</sup>
EVTHLEG24LL	343	28	2.5	24	9	1.25	
EVTHLEG24RL	343	28	2.5	24	9	1.25	
EVTHLEG30LL	361	28	2.5	30	11	1.45	
EVTHLEG30RL	361	28	2.5	30	11	1.45	

**EVHH • High Profile Foot**

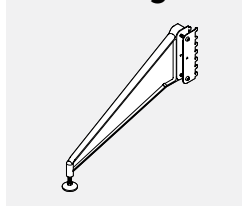

- Provides added support to a panel or worksurface under load.
- Two leveling glides included to adapt to different panel clearances.

PRODUCT CODE	PRICE	SIZE/ H	INCHES			WEIGHT VOL	
			H	W	D	LBS	FT <sup>3</sup>
EVHHF01	242	6	1	21		2.80	0.15

**EVHML • Monoleg**

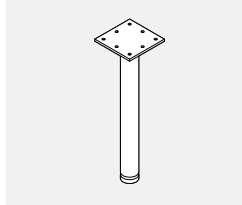

- Provides support for a worksurface.
- Includes an adjustable foot and an attachment plate.
- 3" diameter.
- 1" Height adjustment range.

PRODUCT CODE	PRICE	SIZE/ H	INCHES			WEIGHT VOL	
			H	W	D	LBS	FT <sup>3</sup>
EVHML1	188	28	8	8		8.00	0.15

**EVHCB • Corner Bracket**

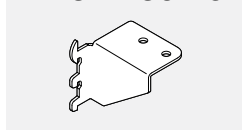

- Attaches the corner of any worksurface to a panel connector.
- Priced per pair.
- Available in BLK (Black) only.

PRODUCT CODE	PRICE	SIZE/ H	INCHES			WEIGHT VOL	
			H	W	D	LBS	FT <sup>3</sup>
EVHCB2	25	2	3.5	2.5		0.50	0.02



**EVHTB • Transaction Bracket**



- Securely attaches a transaction surface to the top of a panel.
- Priced per pair.

PRODUCT CODE	PRICE	SIZE/ INCHES			WEIGHT VOL	
		H	W	D	LBS	FT <sup>3</sup>
EVHTB2	25	3.5	3.5	2.5	0.50	0.02

**EVHFB • Flat Bracket**

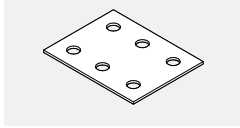

- Must be used in conjunction with cantilevers or transaction brackets to ensure alignment of neighbouring surfaces.

PRODUCT CODE	PRICE	SIZE/ INCHES			WEIGHT VOL	
		H	W	D	LBS	FT <sup>3</sup>
EVHFB1	20	0.125	3	4	0.50	0.01

**EVHQB • “Z” Bracket**

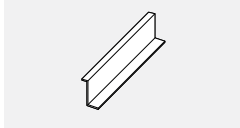

- Used to attach two different worksurface heights with a 3” difference.
- Must be used in conjunction with a cantilever.
- Available in BLK (Black) only.

PRODUCT CODE	PRICE	SIZE/ INCHES			WEIGHT VOL	
		H	W	D	LBS	FT <sup>3</sup>
EVHQB1	52	3	17	4	2.00	0.19

**EVHPB • Pedestal Bracket**

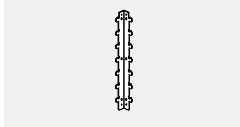

- Attaches to back edge of a pedestal and connects pedestal to panel connector.

PRODUCT CODE	PRICE	SIZE/ INCHES			WEIGHT VOL	
		H	W	D	LBS	FT <sup>3</sup>
EVHPB1	28	12	1	1	0.50	0.50

**EVHSC • Worksurface Support Channel**

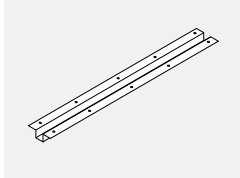

- EVHSC40 for table 54” wide.
- EVHSC46 for table 60” wide.
- EVHSC52 for table 66” wide.
- EVHSC58 for table 72” wide.
- EVHSC64 for table 78” wide.
- EVHSC70 for table 84” wide.
- Tops with post legs should be specified with support channel for structural reinforcement.
- Support channel attaches to underside of worksurface with screws.
- Support channel should be 14” shorter than top length.
- Screws included.
- Painted Black.

PRODUCT CODE	PRICE	SIZE/ INCHES			WEIGHT VOL	
		H	W	D	LBS	FT <sup>3</sup>
EVHSC40	56	40	5	4	0.20	
EVHSC46	62	46	5	6	0.22	
EVHSC52	66	52	5	7	0.25	
EVHSC58	76	58	5	8	0.28	
EVHSC64	85	64	5	9	0.31	
EVHSC70	91	70	5	10	0.33	

**EVHV • Wall Adapter**

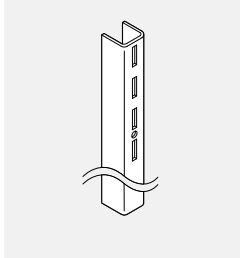

- A “U” shaped channel used to attach system components to a fixed wall.
- Slots are 1” on centre.
- Sold per pair.
- Care should be taken to mount adapters only to wall studs using correct fasteners.
- Failure to do this may result in collapse of the unit and subsequent possible personal injury.
- Mounting hardware is not included.
- Mounting hardware selection to be based on wall material

PRODUCT CODE	PRICE	SIZE/ INCHES			WEIGHT VOL	
		H	W	D	LBS	FT <sup>3</sup>
EVHV01	72	60	0.5	0.5	4.00	0.01

**EVHOB • Off Module Worksurface Bracket**

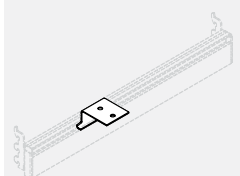

- Supports the worksurface in the work station corner in the case where an adjoining panel is wider than the worksurface.
- Enhances the stability of the worksurface.
- Can be used only in conjunction with the Top Load Bar (EVALB2xx - xx being the panel width - ordered separately)

PRODUCT CODE	PRICE	SIZE/ INCHES			WEIGHT VOL	
		H	W	D	LBS	FT <sup>3</sup>
EVHOB1	15	1.6	3	2.73	0.50	0.02

**EVLEP • Laminate End Panel**

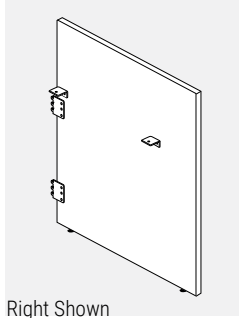

Right Shown

- Attaches to end of run connector.
- Finished in thermally fused laminate.
- Includes attachment flat brackets.
- Includes support brackets to attach worksurface.
- Laminate End Panel height is inclusive of panel glides extended to their full height.
- If wood grain is selected, grain runs vertically.
- Three sides are PVC edged while fourth edge is self-edge. Please choose a PVC edge colour.

PRODUCT CODE	PRICE LP	SIZE/ INCHES		WEIGHT VOL	
		H	W	LBS	FT <sup>3</sup>
EVLEPR4224	317	42	24	26.25	0.58
EVLEPR4230	396	42	30	32.81	0.73
EVLEPR4236	473	42	36	39.38	0.88
EVLEPR4242	552	42	42	45.94	1.02
EVLEPR4248	635	42	48	52.50	1.17
EVLEPL4224	317	42	24	30.00	0.67
EVLEPL4230	396	42	30	37.50	0.83
EVLEPL4236	473	42	36	45.00	1.00
EVLEPL4242	552	42	42	52.50	1.17
EVLEPL4248	635	42	48	60.00	1.33
EVLEPR4824	359	48	24	26.25	0.58
EVLEPR4830	451	48	30	32.81	0.73
EVLEPR4836	541	48	36	39.38	0.88
EVLEPR4842	633	48	42	45.94	1.02
EVLEPR4848	722	48	48	52.50	1.17
EVLEPL4824	359	48	24	30.00	0.67
EVLEPL4830	451	48	30	37.50	0.83
EVLEPL4836	541	48	36	45.00	1.00
EVLEPL4842	633	48	42	52.50	1.17
EVLEPL4848	722	48	48	60.00	1.33

**EVLMP • Laminate Middle Panel**

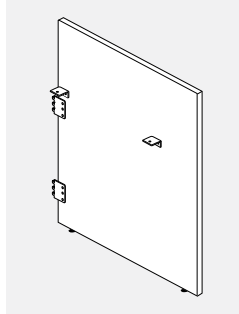

- Attaches to double inline connector.
- Finished in thermally fused laminate.
- Includes attachment flat brackets.
- Includes support brackets to attach worksurfaces on both sides on middle panel.
- Laminate Middle Panel height is inclusive of panel glides extended to their full height.
- If wood grain is selected, grain runs vertically.
- Three sides are PVC edged while fourth edge is self-edge. Please choose a PVC edge colour.

PRODUCT CODE	PRICE LP	SIZE/ INCHES		WEIGHT VOL	
		H	W	LBS	FT <sup>3</sup>
EVLMP4224	353	42	24	26.25	0.58
EVLMP4230	429	42	30	32.81	0.73
EVLMP4236	509	42	36	39.38	0.88
EVLMP4242	590	42	42	45.94	1.02
EVLMP4248	674	42	48	52.50	1.17
EVLMP4824	394	48	24	30.00	0.67
EVLMP4830	488	48	30	37.50	0.83
EVLMP4836	578	48	36	45.00	1.00
EVLMP4842	669	48	42	52.50	1.17
EVLMP4848	760	48	48	60.00	1.33

**EVLEP-A • Laminate End Panel with Accessory Rail**

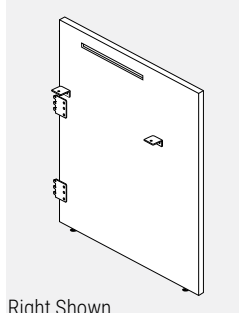

Right Shown

- Attaches to end of run connector.
- Finished in thermally fused laminate.
- Includes attachment flat brackets and accessory rail on inside.
- Includes support brackets to attach worksurface.
- Laminate End Panel height is inclusive of panel glides extended to their full height.
- If wood grain is selected, grain runs vertically.
- Three sides are PVC edged while fourth edge is self-edge. Please choose a PVC edge colour.

PRODUCT CODE	PRICE LP	SIZE/ INCHES		WEIGHT VOL	
		H	W	LBS	FT <sup>3</sup>
EVLEPR4224A	359	42	24	26.25	0.58
EVLEPR4230A	437	42	30	32.81	0.73
EVLEPR4236A	519	42	36	39.38	0.88
EVLEPR4242A	596	42	42	45.94	1.02
EVLEPR4248A	679	42	48	52.50	1.17
EVLEPL4224A	359	42	24	30.00	0.67
EVLEPL4230A	437	42	30	37.50	0.83
EVLEPL4236A	519	42	36	45.00	1.00
EVLEPL4242A	596	42	42	52.50	1.17
EVLEPL4248A	679	42	48	60.00	1.33
EVLEPR4824A	399	48	24	26.25	0.58
EVLEPR4830A	486	48	30	32.81	0.73
EVLEPR4836A	549	48	36	39.38	0.88
EVLEPR4842A	625	48	42	45.94	1.02
EVLEPR4848A	767	48	48	52.50	1.17
EVLEPL4824A	399	48	24	30.00	0.67
EVLEPL4830A	486	48	30	37.50	0.83
EVLEPL4836A	549	48	36	45.00	1.00
EVLEPL4842A	625	48	42	52.50	1.17
EVLEPL4848A	767	48	48	60.00	1.33

**EVLMP-A • Laminate Middle Panel with Accessory Rail**

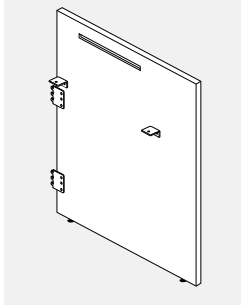

- Attaches to double inline connector.
- Finished in thermally fused laminate.
- Includes accessory rail on both sides of middle panel.
- Includes attachment flat brackets and accessory rail on both sides.
- Includes support brackets to attach worksurfaces on both sides on middle panel.
- Laminate Middle Panel height is inclusive of panel glides extended to their full height.
- If wood grain is selected, grain runs vertically.
- Three sides are PVC edged while fourth edge is self-edge. Please choose a PVC edge colour.

PRODUCT CODE	PRICE LP	SIZE / INCHES		WEIGHT VOL	
		H	W	LBS	FT <sup>3</sup>
EVLMP4224A	405	42	24	26.25	0.58
EVLMP4230A	484	42	30	32.81	0.73
EVLMP4236A	565	42	36	39.38	0.88
EVLMP4242A	642	42	42	45.94	1.02
EVLMP4248A	729	42	48	52.50	1.17
EVLMP4824A	443	48	24	30.00	0.67
EVLMP4830A	541	48	30	37.50	0.83
EVLMP4836A	633	48	36	45.00	1.00
EVLMP4842A	722	48	42	52.50	1.17
EVLMP4848A	813	48	48	60.00	1.33

**EV4LXP • Laminate Panel Four Way**

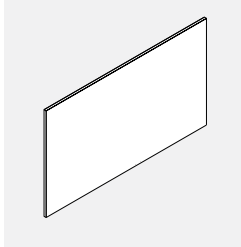

- Panel connects "+" configuration with extension panel
- Finished in thermally fused laminate
- Laminate extension Panel height is inclusive of panel glides extended to their full height
- If wood grain is selected, grain runs horizontally
- Corner connecting brackets to be ordered separately

PRODUCT CODE	PRICE LP	SIZE / INCHES		WEIGHT VOL	
		H	W	LBS	FT <sup>3</sup>
EV4LXP4249	519	42	49	53.59	1.19
EV4LXP4261	619	42	61	66.72	1.48
EV4LXP4273	718	42	73	79.84	1.77
EV4LXP4849	589	48	49	61.25	1.36
EV4LXP4861	723	48	61	76.25	1.69
EV4LXP4873	859	48	73	91.25	2.03
EV4LXP5449	658	54	49	68.91	1.53
EV4LXP5461	859	54	61	85.78	1.91
EV4LXP5473	993	54	73	102.66	2.28

**EVLXPML • Laminate Extension Panel**

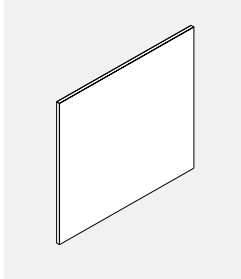

- Locking connection on one sides, no connection at end
- Finished in thermally fused laminate
- Laminate extension Panel height is inclusive of panel glides extended to their full height
- If wood grain is selected, grain runs horizontally
- Bottom connecting brackets to be ordered separately

PRODUCT CODE	PRICE LP	SIZE / INCHES		WEIGHT VOL	
		H	W	LBS	FT <sup>3</sup>
EVLXPML4224	276	42	24	26.25	0.58
EVLXPML4230	336	42	30	32.81	0.73
EVLXPML4236	375	42	36	39.38	0.88
EVLXPML4242	422	42	42	45.94	1.02
EVLXPML4248	484	42	48	52.50	1.17
EVLXPMR4224	276	42	24	26.25	0.58
EVLXPMR4230	336	42	30	32.81	0.73
EVLXPMR4236	375	42	36	39.38	0.88
EVLXPMR4242	422	42	42	45.94	1.02
EVLXPMR4248	484	42	48	52.50	1.17
EVLXPML4824	318	48	24	30.00	0.67
EVLXPML4830	367	48	30	37.50	0.83
EVLXPML4836	419	48	36	45.00	1.00
EVLXPML4842	469	48	42	52.50	1.17
EVLXPML4848	519	48	48	60.00	1.33
EVLXPMR4824	318	48	24	30.00	0.67
EVLXPMR4830	367	48	30	37.50	0.83
EVLXPMR4836	419	48	36	45.00	1.00
EVLXPMR4842	469	48	42	52.50	1.17
EVLXPMR4848	519	48	48	60.00	1.33
EVLXPML5424	345	54	24	33.75	0.75
EVLXPML5430	405	54	30	42.19	0.94
EVLXPML5436	463	54	36	50.63	1.13
EVLXPML5442	527	54	42	59.06	1.31
EVLXPML5448	619	54	48	67.50	1.50
EVLXPMR5424	345	54	24	33.75	0.75
EVLXPMR5430	405	54	30	42.19	0.94
EVLXPMR5436	463	54	36	50.63	1.13
EVLXPMR5442	527	54	42	59.06	1.31
EVLXPMR5448	619	54	48	67.50	1.50

**EV2LXP • Laminate Extension Panel Two Way**

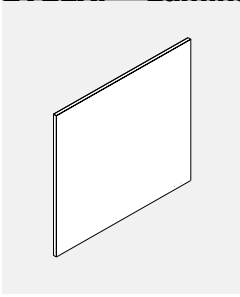

- Panel connects at 90 degree with extension panel
- Finished in thermally fused laminate
- Laminate extension Panel height is inclusive of panel glides extGal- leryed to their full height
- If wood grain is selected, grain runs horizontally
- Corner connecting brackets to be ordered separately

PRODUCT CODE	PRICE LP	SIZE/INCHES		WEIGHT LBS	VOL FT <sup>3</sup>
		H	W		
EV2LXPL4225	276	42	25	27.34	0.61
EV2LXPL4231	336	42	31	33.91	0.75
EV2LXPL4237	375	42	37	40.47	0.90
EV2LXPL4243	422	42	43	47.03	1.05
EV2LXPL4249	484	42	49	53.59	1.19
EV2LXPR4225	276	42	25	27.34	0.61
EV2LXPR4231	336	42	31	33.91	0.75
EV2LXPR4237	375	42	37	40.47	0.90
EV2LXPR4243	422	42	43	47.03	1.05
EV2LXPR4249	484	42	49	53.59	1.19
EV2LXPL4825	318	48	25	31.25	0.69
EV2LXPL4831	367	48	31	38.75	0.86
EV2LXPL4837	419	48	37	46.25	1.03
EV2LXPL4843	469	48	43	53.75	1.19
EV2LXPL4849	519	48	49	61.25	1.36
EV2LXPR4825	318	48	25	31.25	0.69
EV2LXPR4831	367	48	31	38.75	0.86
EV2LXPR4837	419	48	37	46.25	1.03
EV2LXPR4843	469	48	43	53.75	1.19
EV2LXPR4849	519	48	49	61.25	1.36
EV2LXPL5425	372	54	25	35.16	0.78
EV2LXPL5431	425	54	31	43.59	0.97
EV2LXPL5437	480	54	37	52.03	1.16
EV2LXPL5443	583	54	43	60.47	1.34
EV2LXPL5449	658	54	49	68.91	1.53
EV2LXPR5425	372	54	25	35.16	0.78
EV2LXPR5431	425	54	31	43.59	0.97
EV2LXPR5437	480	54	37	52.03	1.16
EV2LXPR5443	583	54	43	60.47	1.34
EV2LXPR5449	658	54	49	68.91	1.53

**EV3LXP • Laminate Extension Panel Three Way**

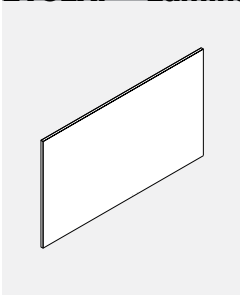

- Panel connects "T" configuration with extension panel
- Finished in thermally fused laminate
- Laminate extension Panel height is inclusive of panel glides extended to their full height
- If wood grain is selected, grain runs horizontally
- Corner connecting brackets to be ordered separately

PRODUCT CODE	PRICE LP	SIZE/INCHES		WEIGHT LBS	VOL FT <sup>3</sup>
		H	W		
EV3LXPL4249	519	42	49	53.59	1.19
EV3LXPL4261	619	42	61	66.72	1.48
EV3LXPL4273	718	42	73	79.84	1.77
EV3LXPR4249	519	42	49	53.59	1.19
EV3LXPR4261	619	42	61	66.72	1.48
EV3LXPR4273	718	42	73	79.84	1.77
EV3LXPL4849	589	48	49	61.25	1.36
EV3LXPL4861	723	48	61	76.25	1.69
EV3LXPL4873	859	48	73	91.25	2.03
EV3LXPR4849	589	48	49	61.25	1.36
EV3LXPR4861	723	48	61	76.25	1.69
EV3LXPR4873	859	48	73	91.25	2.03
EV3LXPL5449	658	54	49	68.91	1.53
EV3LXPL5461	859	54	61	85.78	1.91
EV3LXPL5473	993	54	73	102.66	2.28
EV3LXPR5449	658	54	49	68.91	1.53
EV3LXPR5461	859	54	61	85.78	1.91
EV3LXPR5473	993	54	73	102.66	2.28

**EV4LXPM • Laminate Extension Panel for Four Way Configuration**

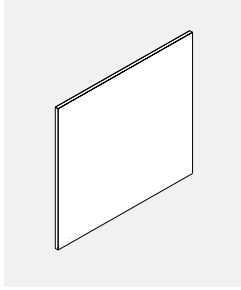

- Locking connection on one side only for four way panel
- Finished in thermally fused laminate
- Universal to be used on both sides of four way laminate panel
- Laminate extension Panel height is inclusive of panel glides extended to their full height
- If wood grain is selected, grain runs horizontally
- Bottom connecting brackets to be ordered separately

PRODUCT CODE	PRICE LP	SIZE/INCHES		WEIGHT LBS	VOL FT <sup>3</sup>
		H	W		
EV4LXPM4224	276	42	24	26.25	0.58
EV4LXPM4230	336	42	30	32.81	0.73
EV4LXPM4236	375	42	36	39.38	0.88
EV4LXPM4242	422	42	42	45.94	1.02
EV4LXPM4248	484	42	48	52.50	1.17
EV4LXPM4824	318	48	24	30.00	0.67
EV4LXPM4830	367	48	30	37.50	0.83
EV4LXPM4836	419	48	36	45.00	1.00
EV4LXPM4842	469	48	42	52.50	1.17
EV4LXPM4848	519	48	48	60.00	1.33
EV4LXPM5424	345	54	24	33.75	0.75
EV4LXPM5430	405	54	30	42.19	0.94
EV4LXPM5436	463	54	36	50.63	1.13
EV4LXPM5442	527	54	42	59.06	1.31
EV4LXPM5448	619	54	48	67.50	1.50

**EVLXPML-NC - Laminate Extension Panel, No End Connection**

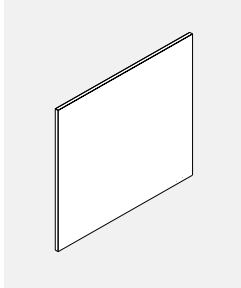

- Locking connection on one sides, no connection at end
- Finished in thermally fused laminate
- Laminate extension Panel height is inclusive of panel glides extended to their full height
- If wood grain is selected, grain runs horizontally
- Bottom connecting brackets to be ordered separately

PRODUCT CODE	PRICE LP	SIZE/INCHES		WEIGHT LBS	VOL FT <sup>3</sup>
		H	W		
EVLXPML4224NC	276	42	24	26.25	0.58
EVLXPML4230NC	336	42	30	32.81	0.73
EVLXPML4236NC	375	42	36	39.38	0.88
EVLXPML4242NC	422	42	42	45.94	1.02
EVLXPML4248NC	484	42	48	52.50	1.17
EVLXPMR4224NC	276	42	24	26.25	0.58
EVLXPMR4230NC	336	42	30	32.81	0.73
EVLXPMR4236NC	375	42	36	39.38	0.88
EVLXPMR4242NC	422	42	42	45.94	1.02
EVLXPMR4248NC	484	42	48	52.50	1.17
EVLXPML4824NC	318	48	24	30.00	0.67
EVLXPML4830NC	367	48	30	37.50	0.83
EVLXPML4836NC	419	48	36	45.00	1.00
EVLXPML4842NC	469	48	42	52.50	1.17
EVLXPML4848NC	519	48	48	60.00	1.33
EVLXPMR4824NC	318	48	24	30.00	0.67
EVLXPMR4830NC	367	48	30	37.50	0.83
EVLXPMR4836NC	419	48	36	45.00	1.00
EVLXPMR4842NC	469	48	42	52.50	1.17
EVLXPMR4848NC	519	48	48	60.00	1.33
EVLXPML5424NC	345	54	24	33.75	0.75
EVLXPML5430NC	405	54	30	42.19	0.94
EVLXPML5436NC	463	54	36	50.63	1.13
EVLXPML5442NC	527	54	42	59.06	1.31
EVLXPML5448NC	619	54	48	67.50	1.50
EVLXPMR5424NC	345	54	24	33.75	0.75
EVLXPMR5430NC	405	54	30	42.19	0.94
EVLXPMR5436NC	463	54	36	50.63	1.13
EVLXPMR5442NC	527	54	42	59.06	1.31
EVLXPMR5448NC	619	54	48	67.50	1.50

**EVLEPDS • Laminate Gallery Panel**

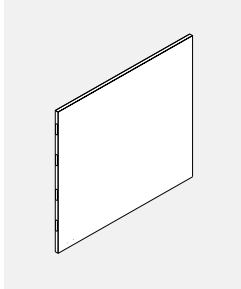

- Attaches to end of run connector with "U" channel
- To be installed at end of panel run
- Finished in thermally fused laminate
- Locking connection both sides
- Laminate Gallery Panel height is inclusive of panel glides extended to their full height
- If wood grain is selected, grain runs horizontally
- End of run connector with "U" channel and bottom connecting brackets to be ordered separately

PRODUCT CODE	PRICE LP	SIZE/INCHES		WEIGHT LBS	VOL FT <sup>3</sup>
		H	W		
EVLEPDS4251	519	42	51	55.78	1.24
EVLEPDS4263	675	42	63	68.91	1.53
EVLEPDS4275	832	42	75	82.03	1.82
EVLEPDS4851	589	48	51	63.75	1.42
EVLEPDS4863	750	48	63	78.75	1.75
EVLEPDS4875	910	48	75	93.75	2.08
EVLEPDS5451	658	54	51	71.72	1.59
EVLEPDS5463	859	54	63	88.59	1.97
EVLEPDS5475	993	54	75	105.47	2.34

**EVLEPDC • Laminate Gallery Panel**

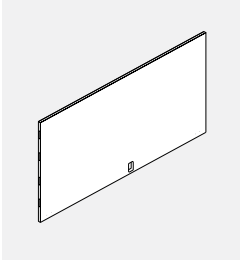

- Attaches in middle of panel run with connector with "U" channel
- To be installed in middle between two panels in straight run
- Finished in thermally fused laminate
- Locking connection both sides
- Laminate Gallery Panel height is inclusive of panel glides extended to their full height
- If wood grain is selected, grain runs horizontally
- End of run connector with "U" channel and bottom connecting brackets to be ordered separately

PRODUCT CODE	PRICE LP	SIZE/INCHES		WEIGHT LBS	VOL FT <sup>3</sup>
		H	W		
EVLEPDC4251	519	42	51	55.78	1.24
EVLEPDC4263	675	42	63	68.91	1.53
EVLEPDC4275	832	42	75	82.03	1.82
EVLEPDC4851	589	48	51	63.75	1.42
EVLEPDC4863	750	48	63	78.75	1.75
EVLEPDC4875	910	48	75	93.75	2.08
EVLEPDC5451	658	54	51	71.72	1.59
EVLEPDC5463	859	54	63	88.59	1.97
EVLEPDC5475	993	54	75	105.47	2.34

**EVLEPSSL/R • Laminate Gallery Panel, End Connection on One Side**

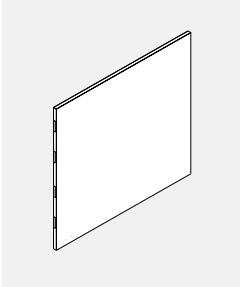

- Attaches to end of run connector with "U" channel
- To be installed at end of panel run on one side
- Finished in thermally fused laminate
- Locking connection on one side
- Laminate Gallery Panel height is inclusive of panel glides extended to their full height
- If wood grain is selected, grain runs horizontally
- End of run connector with "U" channel and bottom connecting brackets to be ordered separately

PRODUCT CODE	PRICE LP	SIZE/INCHES		WEIGHT LBS	VOL FT <sup>3</sup>
		H	W		
EVLEPSSL4227	336	42	27	29.53	0.66
EVLEPSSL4233	375	42	33	36.09	0.80
EVLEPSSL4239	422	42	39	42.66	0.95
EVLEPSSL4245	484	42	45	49.22	1.09
EVLEPSSL4251	519	42	51	55.78	1.24
EVLEPSSL4827	367	48	27	33.75	0.75
EVLEPSSL4833	419	48	33	41.25	0.92
EVLEPSSL4839	469	48	39	48.75	1.08
EVLEPSSL4845	519	48	45	56.25	1.25
EVLEPSSL4851	589	48	51	63.75	1.42
EVLEPSSL5427	405	54	27	37.97	0.84
EVLEPSSL5433	463	54	33	46.41	1.03
EVLEPSSL5439	527	54	39	54.84	1.22
EVLEPSSL5445	619	54	45	63.28	1.41
EVLEPSSL5451	658	54	51	71.72	1.59
EVLEPSSR4227	336	42	27	29.53	0.66
EVLEPSSR4233	375	42	33	36.09	0.80
EVLEPSSR4239	422	42	39	42.66	0.95
EVLEPSSR4245	484	42	45	49.22	1.09
EVLEPSSR4251	519	42	51	55.78	1.24
EVLEPSSR4827	367	48	27	33.75	0.75
EVLEPSSR4833	419	48	33	41.25	0.92
EVLEPSSR4839	469	48	39	48.75	1.08
EVLEPSSR4845	519	48	45	56.25	1.25
EVLEPSSR4851	589	48	51	63.75	1.42
EVLEPSSR5427	405	54	27	37.97	0.84
EVLEPSSR5433	463	54	33	46.41	1.03
EVLEPSSR5439	527	54	39	54.84	1.22
EVLEPSSR5445	619	54	45	63.28	1.41
EVLEPSSR5451	658	54	51	71.72	1.59

**EVLEPSC • Laminate Gallery Panel**

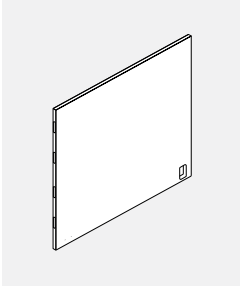

- Attaches in middle of panel run with connector with "U" channel
- To be installed in middle between two panels in straight run on one side
- Cut out for electrics at power beam height
- Finished in thermally fused laminate
- Locking connection on one side
- Laminate Gallery Panel height is inclusive of panel glides extended to their full height
- If wood grain is selected, grain runs horizontally
- End of run connector with "U" channel and bottom connecting brackets to be ordered separately

PRODUCT CODE	PRICE LP	SIZE/INCHES		WEIGHT LBS	VOL FT <sup>3</sup>
		H	W		
EVLEPSC4227	336	42	27	29.53	0.66
EVLEPSC4233	375	42	33	36.09	0.80
EVLEPSC4239	422	42	39	42.66	0.95
EVLEPSC4245	484	42	45	49.22	1.09
EVLEPSC4251	519	42	51	55.78	1.24
EVLEPSC4827	367	48	27	33.75	0.75
EVLEPSC4833	419	48	33	41.25	0.92
EVLEPSC4839	469	48	39	48.75	1.08
EVLEPSC4845	519	48	45	56.25	1.25
EVLEPSC4851	589	48	51	63.75	1.42
EVLEPSC5427	405	54	27	37.97	0.84
EVLEPSC5433	463	54	33	46.41	1.03
EVLEPSC5439	527	54	39	54.84	1.22
EVLEPSC5445	619	54	45	63.28	1.41
EVLEPSC5451	658	54	51	71.72	1.59

**EVLEPDS-NC • Laminate Gallery Panel, No End Connection at Both Sides**

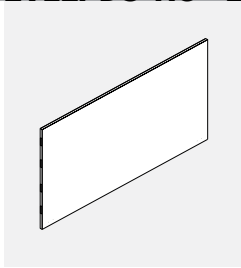

- Attaches to end of run connector with "U" channel
- To be installed at end of panel run
- Finished in thermally fused laminate
- Locking connection both sides
- Laminate Gallery Panel height is inclusive of panel glides extended to their full height
- If wood grain is selected, grain runs horizontally
- End of run connector with "U" channel and bottom connecting brackets to be ordered separately

PRODUCT CODE	PRICE	SIZE / INCHES		WEIGHT LBS	VOL FT <sup>3</sup>
	LP	H	W		
EVLEPDS4251NC	519	42	51	55.78	1.24
EVLEPDS4263NC	675	42	63	68.91	1.53
EVLEPDS4275NC	832	42	75	82.03	1.82
EVLEPDS4851NC	589	48	51	63.75	1.42
EVLEPDS4863NC	750	48	63	78.75	1.75
EVLEPDS4875NC	910	48	75	93.75	2.08
EVLEPDS5451NC	658	54	51	71.72	1.59
EVLEPDS5463NC	859	54	63	88.59	1.97
EVLEPDS5475NC	993	54	75	105.47	2.34

**EVLEPDC-NC • Laminate Gallery Middle Panel, No End Connection at Both Sides**

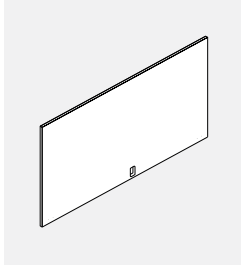

- Attaches in middle of panel run with connector with "U" channel
- To be installed in middle between two panels in straight run
- Finished in thermally fused laminate
- No connection both sides
- Laminate Gallery Panel height is inclusive of panel glides extended to their full height
- If wood grain is selected, grain runs horizontally
- End of run connector with "U" channel and bottom connecting brackets to be ordered separately

PRODUCT CODE	PRICE	SIZE / INCHES		WEIGHT LBS	VOL FT <sup>3</sup>
	LP	H	W		
EVLEPDC4251NC	519	42	51	55.78	1.24
EVLEPDC4263NC	675	42	63	68.91	1.53
EVLEPDC4275NC	832	42	75	82.03	1.82
EVLEPDC4851NC	589	48	51	63.75	1.42
EVLEPDC4863NC	750	48	63	78.75	1.75
EVLEPDC4875NC	910	48	75	93.75	2.08
EVLEPDC5451NC	658	54	51	71.72	1.59
EVLEPDC5463NC	859	54	63	88.59	1.97
EVLEPDC5475NC	993	54	75	105.47	2.34

**EVLEPSS-NC • Laminate Gallery End Panel, No End Connection at Both Sides**

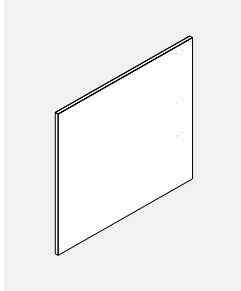

- Attaches in middle of panel run with connector with "U" channel
- To be installed in middle between two panels in straight run
- Finished in thermally fused laminate
- No connection both sides
- Laminate Gallery Panel height is inclusive of panel glides extended to their full height
- If wood grain is selected, grain runs horizontally
- End of run connector with "U" channel and bottom connecting brackets to be ordered separately

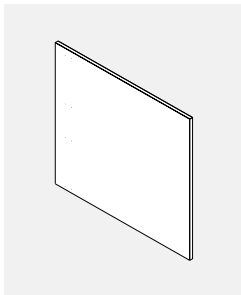

PRODUCT CODE	PRICE	SIZE / INCHES		WEIGHT LBS	VOL FT <sup>3</sup>
	LP	H	W		
EVLEPSSL4227NC	336	42	27	29.53	0.66
EVLEPSSL4233NC	375	42	33	36.09	0.80
EVLEPSSL4239NC	422	42	39	42.66	0.95
EVLEPSSL4245NC	484	42	45	49.22	1.09
EVLEPSSL4251NC	519	42	51	55.78	1.24
EVLEPSSL4827NC	367	48	27	33.75	0.75
EVLEPSSL4833NC	419	48	33	41.25	0.92
EVLEPSSL4839NC	469	48	39	48.75	1.08
EVLEPSSL4845NC	519	48	45	56.25	1.25
EVLEPSSL4851NC	589	48	51	63.75	1.42
EVLEPSSL5427NC	405	54	27	37.97	0.84
EVLEPSSL5433NC	463	54	33	46.41	1.03
EVLEPSSL5439NC	527	54	39	54.84	1.22
EVLEPSSL5445NC	619	54	45	63.28	1.41
EVLEPSSL5451NC	658	54	51	71.72	1.59
EVLEPSSR4227NC	336	42	27	29.53	0.66
EVLEPSSR4233NC	375	42	33	36.09	0.80
EVLEPSSR4239NC	422	42	39	42.66	0.95
EVLEPSSR4245NC	484	42	45	49.22	1.09
EVLEPSSR4251NC	519	42	51	55.78	1.24
EVLEPSSR4827NC	367	48	27	33.75	0.75
EVLEPSSR4833NC	419	48	33	41.25	0.92
EVLEPSSR4839NC	469	48	39	48.75	1.08
EVLEPSSR4845NC	519	48	45	56.25	1.25
EVLEPSSR4851NC	589	48	51	63.75	1.42
EVLEPSSR5427NC	405	54	27	37.97	0.84
EVLEPSSR5433NC	463	54	33	46.41	1.03
EVLEPSSR5439NC	527	54	39	54.84	1.22
EVLEPSSR5445NC	619	54	45	63.28	1.41
EVLEPSSR5451NC	658	54	51	71.72	1.59

**EVLEPSC-NC • Laminate Gallery Middle One Side Panel, No End Connection at Both Sides**

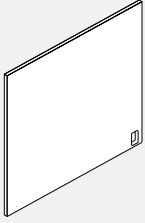

- Attaches in middle of panel run with connector with "U" channel
- To be installed in middle between two panels in straight run on one side
- Cut out for electrics at power beam height
- Finished in thermally fused laminate
- No connection both sides
- Laminate Gallery Panel height is inclusive of panel glides extended to their full height
- If wood grain is selected, grain runs horizontally
- End of run connector with "U" channel and bottom connecting brackets to be ordered separately

PRODUCT CODE	PRICE LP	SIZE/INCHES		WEIGHT LBS	VOL FT <sup>3</sup>
		H	W		
EVLEPSC4227NC	336	42	27	29.53	0.66
EVLEPSC4233NC	375	42	33	36.09	0.80
EVLEPSC4239NC	422	42	39	42.66	0.95
EVLEPSC4245NC	484	42	45	49.22	1.09
EVLEPSC4251NC	519	42	51	55.78	1.24
EVLEPSC4827NC	367	48	27	33.75	0.75
EVLEPSC4833NC	419	48	33	41.25	0.92
EVLEPSC4839NC	469	48	39	48.75	1.08
EVLEPSC4845NC	519	48	45	56.25	1.25
EVLEPSC4851NC	589	48	51	63.75	1.42
EVLEPSC5427NC	405	54	27	37.97	0.84
EVLEPSC5433NC	463	54	33	46.41	1.03
EVLEPSC5439NC	527	54	39	54.84	1.22
EVLEPSC5445NC	619	54	45	63.28	1.41
EVLEPSC5451NC	658	54	51	71.72	1.59

**EVPBLEPDS • Laminate Gallery Panel for Power Beam, End Connection**

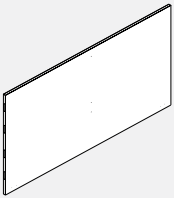

- Attaches to power beam channel
- To be installed at end of power beam run
- Finished in thermally fused laminate
- Locking connection both sides
- Laminate Gallery Panel height is inclusive of panel glides extended to their full height
- If wood grain is selected, grain runs horizontally
- Power beam channel and bottom connecting bracket to be ordered separately

PRODUCT CODE	PRICE LP	SIZE/INCHES		WEIGHT LBS	VOL FT <sup>3</sup>
		H	W		
EVPBLEPDS4251	519	42	51	55.78	1.24
EVPBLEPDS4263	675	42	63	68.91	1.53
EVPBLEPDS4275	832	42	75	82.03	1.82
EVPBLEPDS4851	589	48	51	63.75	1.42
EVPBLEPDS4863	750	48	63	78.75	1.75
EVPBLEPDS4875	910	48	75	93.75	2.08
EVPBLEPDS5451	658	54	51	71.72	1.59
EVPBLEPDS5463	859	54	63	88.59	1.97
EVPBLEPDS5475	993	54	75	105.47	2.34

**EVPBLEPDC • Laminate Gallery Panel for Power Beam, Middle Connection**

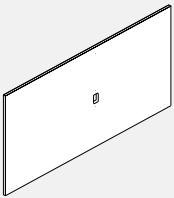

- Attaches to power beam channel
- To be installed in middle between two power beam in straight run
- Cut out for electrics at power beam height
- Finished in thermally fused laminate
- Locking connection both sides
- Laminate Gallery Panel height is inclusive of panel glides extended to their full height
- If wood grain is selected, grain runs horizontally
- Power beam channel and bottom connecting bracket to be ordered separately
- Standard code is for 24" H Power Beam
- Please add at code end "B" for 30"H Power Beam or "C" for 36"H Power Beam

PRODUCT CODE	PRICE LP	SIZE/INCHES		WEIGHT LBS	VOL FT <sup>3</sup>
		H	W		
EVPBLEPDC4251	519	42	51	55.78	1.24
EVPBLEPDC4263	675	42	63	68.91	1.53
EVPBLEPDC4275	832	42	75	82.03	1.82
EVPBLEPDC4851	589	48	51	63.75	1.42
EVPBLEPDC4863	750	48	63	78.75	1.75
EVPBLEPDC4875	910	48	75	93.75	2.08
EVPBLEPDC5451	658	48	51	63.75	1.42
EVPBLEPDC5463	859	48	63	78.75	1.75
EVPBLEPDC5475	993	48	75	93.75	2.08



**EVPBLEPSSL/R • Laminate Gallery Panel for Power Beam, End Connection on One Side**

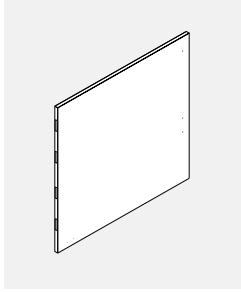

- Attaches to power beam channel
- To be installed at end of power beam run on one side
- Finished in thermally fused laminate
- Locking connection on one side
- Laminate Gallery Panel height is inclusive of panel glides extended to their full height
- If wood grain is selected, grain runs horizontally
- Power beam channel and bottom connecting bracket to be ordered separately

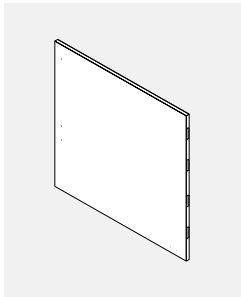

PRODUCT CODE	PRICE LP	SIZE/INCHES		WEIGHT LBS	VOL FT <sup>3</sup>
		H	W		
EVPBLEPSSL4227	336	42	27	29.53	0.66
EVPBLEPSSL4233	375	42	33	36.09	0.80
EVPBLEPSSL4239	422	42	39	42.66	0.95
EVPBLEPSSL4245	484	42	45	49.22	1.09
EVPBLEPSSL4251	519	42	51	55.78	1.24
EVPBLEPSSL4827	367	48	27	33.75	0.75
EVPBLEPSSL4833	419	48	33	41.25	0.92
EVPBLEPSSL4839	469	48	39	48.75	1.08
EVPBLEPSSL4845	519	48	45	56.25	1.25
EVPBLEPSSL4851	589	48	51	63.75	1.42
EVPBLEPSSL5427	405	54	27	37.97	0.84
EVPBLEPSSL5433	463	54	33	46.41	1.03
EVPBLEPSSL5439	527	54	39	54.84	1.22
EVPBLEPSSL5445	619	54	45	63.28	1.41
EVPBLEPSSL5451	658	54	51	71.72	1.59
EVPBLEPSSR4227	336	42	27	29.53	0.66
EVPBLEPSSR4233	375	42	33	36.09	0.80
EVPBLEPSSR4239	422	42	39	42.66	0.95
EVPBLEPSSR4245	484	42	45	49.22	1.09
EVPBLEPSSR4251	519	42	51	55.78	1.24
EVPBLEPSSR4827	367	48	27	33.75	0.75
EVPBLEPSSR4833	419	48	33	41.25	0.92
EVPBLEPSSR4839	469	48	39	48.75	1.08
EVPBLEPSSR4845	519	48	45	56.25	1.25
EVPBLEPSSR4851	589	48	51	63.75	1.42
EVPBLEPSSR5427	405	54	27	37.97	0.84
EVPBLEPSSR5433	463	54	33	46.41	1.03
EVPBLEPSSR5439	527	54	39	54.84	1.22
EVPBLEPSSR5445	619	54	45	63.28	1.41
EVPBLEPSSR5451	658	54	51	71.72	1.59

**EVPBLEPSC • Laminate Gallery Panel for Power Beam, Middle Connection on One Side**

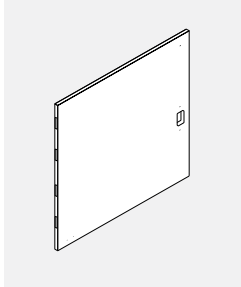

- Attaches to power beam channel
- To be installed in middle between two power beam in straight run on one side
- Cut out for electrics at power beam height
- Finished in thermally fused laminate
- Locking connection on one side
- Laminate Gallery Panel height is inclusive of panel glides extended to their full height
- If wood grain is selected, grain runs horizontally
- Power beam channel and bottom connecting bracket to be ordered separately
- Standard code is for 24" H Power Beam
- Please add at code end "B" for 30"H Power Beam or "C" for 36"H Power Beam

PRODUCT CODE	PRICE LP	SIZE/INCHES		WEIGHT LBS	VOL FT <sup>3</sup>
		H	W		
EVPBLEPSC4227	336	42	27	29.53	0.66
EVPBLEPSC4233	375	42	33	36.09	0.80
EVPBLEPSC4239	422	42	39	42.66	0.95
EVPBLEPSC4245	484	42	45	49.22	1.09
EVPBLEPSC4251	519	42	51	55.78	1.24
EVPBLEPSC4827	367	48	27	33.75	0.75
EVPBLEPSC4833	419	48	33	41.25	0.92
EVPBLEPSC4839	469	48	39	48.75	1.08
EVPBLEPSC4845	519	48	45	56.25	1.25
EVPBLEPSC4851	589	48	51	63.75	1.42
EVPBLEPSC5427	405	54	27	37.97	0.84
EVPBLEPSC5433	463	54	33	46.41	1.03
EVPBLEPSC5439	527	54	39	54.84	1.22
EVPBLEPSC5445	619	54	45	63.28	1.41
EVPBLEPSC5451	658	54	51	71.72	1.59

**EVPBLEPDS-NC • Laminate Gallery Panel for Power Beam, No End Connection**

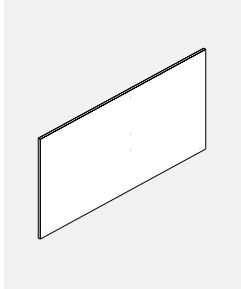

- Attaches to power beam channel
- To be installed at end of power beam run
- Finished in thermally fused laminate
- No connection both sides
- Laminate Gallery Panel height is inclusive of panel glides extended to their full height
- If wood grain is selected, grain runs horizontally
- Power beam channel and bottom connecting bracket to be ordered separately

PRODUCT CODE	PRICE LP	SIZE/INCHES		WEIGHT LBS	VOL FT <sup>3</sup>
		H	W		
EVPBLEPDS4251NC	519	42	51	55.78	1.24
EVPBLEPDS4263NC	675	42	63	68.91	1.53
EVPBLEPDS4275NC	832	42	75	82.03	1.82
EVPBLEPDS4851NC	589	48	51	63.75	1.42
EVPBLEPDS4863NC	750	48	63	78.75	1.75
EVPBLEPDS4875NC	910	48	75	93.75	2.08
EVPBLEPDS5451NC	658	54	51	71.72	1.59
EVPBLEPDS5463NC	859	54	63	88.59	1.97
EVPBLEPDS5475NC	993	54	75	105.47	2.34

**EVPBLEPDC-NC • Laminate Gallery Middle Panel for Power Beam, No End Connection at Both Sides**

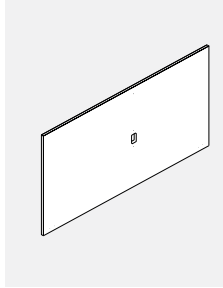

- Attaches to power beam channel
- To be installed in middle between two power beam in straight run
- Cut out for electrics at power beam height
- Finished in thermally fused laminate
- No connection both sides
- Laminate Gallery Panel height is inclusive of panel glides extended to their full height
- If wood grain is selected, grain runs horizontally
- Power beam channel and bottom connecting bracket to be ordered separately
- Standard code is for 24" H Power Beam
- Please add at code end "B" for 30"H Power Beam or "C" for 36"H Power Beam

PRODUCT CODE	PRICE LP	SIZE/INCHES		WEIGHT LBS	VOL FT <sup>3</sup>
		H	W		
EVPBLEPDC4251NC	519	42	51	55.78	1.24
EVPBLEPDC4263NC	675	42	63	68.91	1.53
EVPBLEPDC4275NC	832	42	75	82.03	1.82
EVPBLEPDC4851NC	589	48	51	63.75	1.42
EVPBLEPDC4863NC	750	48	63	78.75	1.75
EVPBLEPDC4875NC	910	48	75	93.75	2.08
EVPBLEPDC5451NC	658	48	51	63.75	1.42
EVPBLEPDC5463NC	859	48	63	78.75	1.75
EVPBLEPDC5475NC	993	48	75	93.75	2.08

**EVPBLEPSS-NC • Laminate Gallery End Panel for Power Beam, No End Connection at Both Sides**

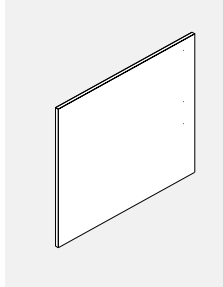

- Attaches to power beam channel
- To be installed at end of power beam run on one side
- Finished in thermally fused laminate
- No connection both sides
- Laminate Gallery Panel height is inclusive of panel glides extended to their full height
- If wood grain is selected, grain runs horizontally
- Power beam channel and bottom connecting bracket to be ordered separately

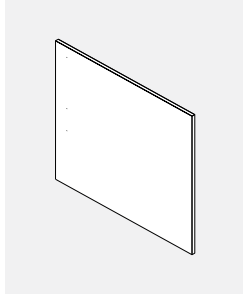

PRODUCT CODE	PRICE LP	SIZE/INCHES		WEIGHT LBS	VOL FT <sup>3</sup>
		H	W		
EVPBLEPSSL4227NC	336	42	27	29.53	0.66
EVPBLEPSSL4233NC	375	42	33	36.09	0.80
EVPBLEPSSL4239NC	422	42	39	42.66	0.95
EVPBLEPSSL4245NC	484	42	45	49.22	1.09
EVPBLEPSSL4251NC	519	42	51	55.78	1.24
EVPBLEPSSL4827NC	367	48	27	33.75	0.75
EVPBLEPSSL4833NC	419	48	33	41.25	0.92
EVPBLEPSSL4839NC	469	48	39	48.75	1.08
EVPBLEPSSL4845NC	519	48	45	56.25	1.25
EVPBLEPSSL4851NC	589	48	51	63.75	1.42
EVPBLEPSSL5427NC	405	54	27	37.97	0.84
EVPBLEPSSL5433NC	463	54	33	46.41	1.03
EVPBLEPSSL5439NC	527	54	39	54.84	1.22
EVPBLEPSSL5445NC	619	54	45	63.28	1.41
EVPBLEPSSL5451NC	658	54	51	71.72	1.59
EVPBLEPSSR4227NC	336	42	27	29.53	0.66
EVPBLEPSSR4233NC	375	42	33	36.09	0.80
EVPBLEPSSR4239NC	422	42	39	42.66	0.95
EVPBLEPSSR4245NC	484	42	45	49.22	1.09
EVPBLEPSSR4251NC	519	42	51	55.78	1.24
EVPBLEPSSR4827NC	367	48	27	33.75	0.75
EVPBLEPSSR4833NC	419	48	33	41.25	0.92
EVPBLEPSSR4839NC	469	48	39	48.75	1.08
EVPBLEPSSR4845NC	519	48	45	56.25	1.25
EVPBLEPSSR4851NC	589	48	51	63.75	1.42
EVPBLEPSSR5427NC	405	54	27	37.97	0.84
EVPBLEPSSR5433NC	463	54	33	46.41	1.03
EVPBLEPSSR5439NC	527	54	39	54.84	1.22
EVPBLEPSSR5445NC	619	54	45	63.28	1.41
EVPBLEPSSR5451NC	658	54	51	71.72	1.59

**EVPBLEPSC-NC • Laminate Gallery Middle One Side Panel for Power Beam, No End Connection at Both Sides**

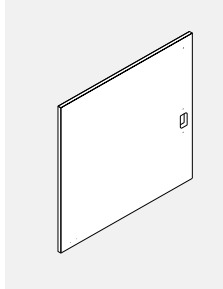

- Attaches to power beam channel
- To be installed in middle between two power beam in straight run on one side
- Cut out for electrics at power beam height
- Finished in thermally fused laminate
- No connection both sides
- Laminate Gallery Panel height is inclusive of panel glides extended to their full height
- If wood grain is selected, grain runs horizontally
- Power beam channel and bottom connecting bracket to be ordered separately
- Standard code is for 24" H Power Beam
- Please add at code end "B" for 30"H Power Beam or "C" for 36"H Power Beam

PRODUCT CODE	PRICE LP	SIZE/INCHES		WEIGHT LBS	VOL FT <sup>3</sup>
		H	W		
EVPBLEPSC4227NC	336	42	27	29.53	0.66
EVPBLEPSC4233NC	375	42	33	36.09	0.80
EVPBLEPSC4239NC	422	42	39	42.66	0.95
EVPBLEPSC4245NC	484	42	45	49.22	1.09
EVPBLEPSC4251NC	519	42	51	55.78	1.24
EVPBLEPSC4827NC	367	48	27	33.75	0.75
EVPBLEPSC4833NC	419	48	33	41.25	0.92
EVPBLEPSC4839NC	469	48	39	48.75	1.08
EVPBLEPSC4845NC	519	48	45	56.25	1.25
EVPBLEPSC4851NC	589	48	51	63.75	1.42
EVPBLEPSC5427NC	405	54	27	37.97	0.84
EVPBLEPSC5433NC	463	54	33	46.41	1.03
EVPBLEPSC5439NC	527	54	39	54.84	1.22
EVPBLEPSC5445NC	619	54	45	63.28	1.41
EVPBLEPSC5451NC	658	54	51	71.72	1.59

**EVHLPBB01 • Laminate Panel Bracket**

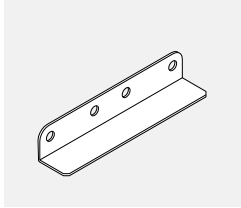

- Laminate panel bottom bracket connects two laminate end panels at bottom with screws
- Available in standard paint colors
- Bracket and screws included

PRODUCT CODE	PRICE	SIZE/INCHES			WEIGHT LBS	VOL FT <sup>3</sup>
		H	W	D		
EVHLPBB01	34	1.5	8	1	0.50	0.11

**EVHLPCB01 • Laminate Panel Corner Bracket**

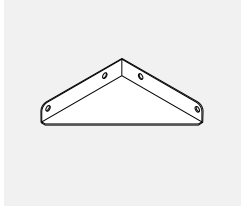

- Laminate panel corner bottom bracket connects two laminate panels at 90 degree
- Available in standard paint colors
- Bracket and screws included

PRODUCT CODE	PRICE	SIZE/INCHES			WEIGHT LBS	VOL FT <sup>3</sup>
		H	W	D		
EVHLPCB01	33	1.5	4	4	0.50	0.11

**EVPERCH • Connector with U Channel**



- U channel attaches with screws to laminate end panel or laminate middle panel
- Evolve panels attaches to connector
- Pass thru at bottom and beltline location for power/data
- U channel is welded to connector
- Includes connector with U channel and hardware

PRODUCT CODE	PRICE	SIZE/INCHES		WEIGHT LBS	VOL FT <sup>3</sup>
		H	W		
EVPERCH42	129	42	2.875	4.60	0.14
EVPERCH48	136	48	2.875	5.09	0.18
EVPERCH54	147	54	2.875	6.75	0.22

**EVPBIECH • Power Beam Channel**

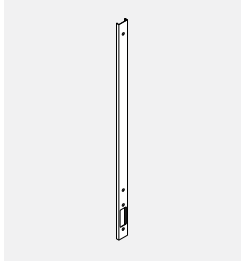

- One piece channel for power beam and extension module above, attaches to laminate panels with screws
- Power beam attaches to channel with clamps and extension module attaches above
- Channel has cut out for power beam electrics to run thru laminate panel

**Note**

- It is not stackable.
- It can not be stacked with standard extension connector above it.

PRODUCT CODE	PRICE	SIZE/INCHES		WEIGHT LBS	VOL FT <sup>3</sup>
		H	W		
EVPBIECH12	37	12	2.875	1.32	0.12
EVPBIECH18	41	18	2.875	1.94	0.18
EVPBIECH24	51	24	2.875	2.60	0.24
EVPBIECH30	54	30	2.875	3.30	0.30
EVPBIECH36	59	36	2.875	4.60	0.36

**EVSL12 • Laminated Shelf for Reception Panels**

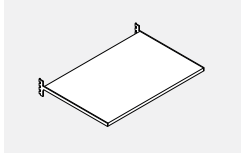

- Laminated Wood Shelf Panel Mounted
- Shelf thickness 1"
- Available in LP
- Includes attachment hardware

PRODUCT CODE	PRICE	SIZE/INCHES			WEIGHT LBS	VOL FT <sup>3</sup>
		H	W	D		
EVSL1218	191	1.125	18	12	4.98	0.13
EVSL1224	206	1.125	24	12	6.64	0.17
EVSL1230	219	1.125	30	12	8.3	0.21
EVSL1236	232	1.125	36	12	9.96	0.25
EVSL1242	246	1.125	42	12	11.63	0.29
EVSL1248	260	1.125	48	12	13.29	0.33

**EVPTTAU • Connector with U Channel Top Trim Aluminum**

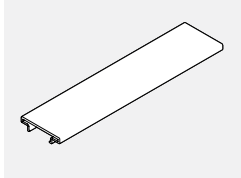

- Aluminum top trim longer by 0.625" to cover width of connector with U channel
- Trim can not span a post
- Available in standard paint colors

PRODUCT CODE	PRICE	SIZE/INCHES		WEIGHT LBS	VOL FT <sup>3</sup>
		W	D		
EVPTTAU24	18	24.625	0.19	0.04	
EVPTTAU30	23	30.625	0.24	0.05	
EVPTTAU36	26	36.625	0.28	0.06	
EVPTTAU42	29	42.625	0.33	0.07	
EVPTTAU48	34	48.625	0.37	0.08	
EVPTTAU54	37	54.625	0.42	0.09	
EVPTTAU60	45	60.625	0.46	0.10	
EVPTTAU66	47	66.625	0.51	0.11	
EVPTTAU72	48	72.625	0.56	0.12	
EVPTTAU78	55	78.625	0.60	0.13	
EVPTTAU84	58	84.625	0.65	0.14	

**EVPTTA • Aluminum Top Trim for Double Inline Connector (for use with laminate end and middle panels)**

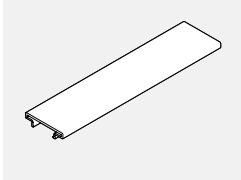

- Used for panels in middle of run of panels with Double Inline Connector.
- Aluminum Top Trim covers panel and one Double Inline Connector.
- Available in standard paint colours.
- Note: Trim can not span a Post Connector.

PRODUCT CODE	PRICE	SIZE/	INCHES		WEIGHT VOL	
			W	LBS	FT <sup>3</sup>	
EVPTTA25	18		25.125	0.19	0.04	
EVPTTA31	23		31.125	0.24	0.05	
EVPTTA37	26		37.125	0.28	0.06	
EVPTTA43	29		43.125	0.33	0.07	
EVPTTA49	34		49.125	0.37	0.08	
EVPTTA55	37		55.125	0.42	0.09	
EVPTTA61	45		61.125	0.46	0.10	
EVPTTA67	47		67.125	0.51	0.11	
EVPTTA73	48		73.125	0.56	0.12	
EVPTTA79	55		79.125	0.60	0.13	
EVPTTA85	58		83.125	0.65	0.14	

**EVPTTA • Aluminum Top Trim for Double Inline Connector (for use with laminate end and middle panels)**

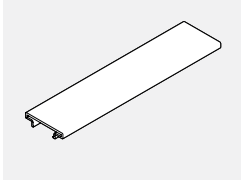

- Used for panels next to end of run trim in run of panels with Double Inline Connector.
- Available in standard paint colours.
- Note: Trim can not span a Post Connector.

PRODUCT CODE	PRICE	SIZE/	INCHES		WEIGHT VOL	
			W	LBS	FT <sup>3</sup>	
EVPTTA24	13		24	0.22	0.04	
EVPTTA30	22		30	0.29	0.05	
EVPTTA36	24		36	0.30	0.06	
EVPTTA42	28		42	0.34	0.07	
EVPTTA48	33		48	0.38	0.08	
EVPTTA54	36		54	0.42	0.09	
EVPTTA60	42		60	0.46	0.10	
EVPTTA66	45		66	0.50	0.11	
EVPTTA72	47		72	0.55	0.12	
EVPTTA78	54		78	0.59	0.12	
EVPTTA84	58		84	0.64	0.13	

**EVPGDCP • Gallery panel data post**

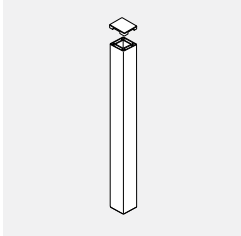

- One way post attaches to Gallery Panel at the end to bring power and/or data cables from ceiling to Evolve panels.
- Accommodates up to 25 CAT 5 cables with electric. Accommodates up to 45 CAT 5 cables without electric.
- Middle Gallery panel with bottom cut out for electrics must be ordered.
- Standard data post extension used above.
- Standard data post extension to be ordered separately.
- Choose standard paint finish.

PRODUCT CODE	PRICE	SIZE/	INCHES		WEIGHT VOL	
			H	W	LBS	FT <sup>3</sup>
EVPGDCP42	171	42	3			
EVPGDCP48	202	48	3			
EVPGDCP54	220	54	3			

**EVMPMP-GI6W • Privacy Glass for 1" Laminate Panels**

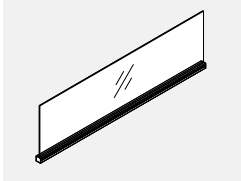

- Privacy glass integrated with aluminum trim.
- Attaches on top of 1" laminate panels to add privacy or divide space.
- Includes aluminum trim with end caps and glass tile.
- Aluminum trim has rail for accessories.
- Standard in clear (CLR), frosted (FRST) or writeable (WRW) glass.
- Glass and attachment hardware to ship separately.

PRODUCT CODE	PRICE			SIZE/INCHES			WEIGHT VOL	
	CL'	FRST	WRW	H	W	D	LBS	FT <sup>3</sup>
EVMPMP24GI6W	195	244	-	6	24	1	2.39	0.25
EVMPMP30GI6W	213	268	-	6	30	1	2.99	0.32
EVMPMP36GI6W	228	283	-	6	36	1	3.58	0.37
EVMPMP42GI6W	244	304	-	6	42	1	4.18	0.43
EVMPMP48GI6W	254	317	-	6	48	1	4.78	0.50
EVMPMP24GI9W	195	244	-	9	24	1	3.58	0.25
EVMPMP30GI9W	213	268	-	9	30	1	4.48	0.32
EVMPMP36GI9W	228	283	-	9	36	1	5.37	0.37
EVMPMP42GI9W	244	304	-	9	42	1	6.26	0.43
EVMPMP48GI9W	254	317	-	9	48	1	7.16	0.50
EVMPMP24GIW	195	244	340	12	24	1	4.77	0.50
EVMPMP30GIW	213	268	347	12	30	1	5.97	0.63
EVMPMP36GIW	228	283	353	12	36	1	7.16	0.75
EVMPMP42GIW	244	304	389	12	42	1	8.35	0.87
EVMPMP48GIW	254	317	426	12	48	1	9.55	1.00

**EVFPDW • Felt divider for 1" Laminate Panels**

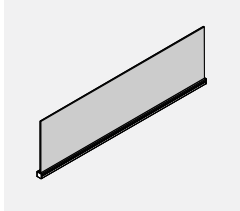

- Privacy Felt Divider integrated with aluminum top trim. Attaches on top of laminate panels to add privacy or divide space.
- Includes aluminum trim with channel and felt tile.
- Felt and attachment hardware to ship separately.
- 9 mm felt material is tackable and comes in 18 different colors. Please specify felt finish.
- Aluminum top trim available in standard paint finishes.

PRODUCT CODE	PRICE	SIZE/INCHES			WEIGHT VOL	
		H	W	D	LBS	FT <sup>3</sup>
EVFPDW0624W	70	6	24	1	1.42	0.26
EVFPDW0630W	85	6	30	1	1.73	0.32
EVFPDW0636W	99	6	36	1	2.03	0.37
EVFPDW0642W	111	6	42	1	2.34	0.43
EVFPDW0648W	165	6	48	1	2.64	0.50
EVFPDW0654W	178	6	54	1	2.95	0.56
EVFPDW0660W	193	6	60	1	3.25	0.63
EVFPDW0666W	204	6	66	1	3.56	0.69
EVFPDW0672W	231	6	72	1	3.86	0.76
EVFPDW0924W	70	9	24	1	1.63	0.38
EVFPDW0930W	85	9	30	1	1.99	0.47
EVFPDW0936W	99	9	36	1	2.35	0.56
EVFPDW0942W	111	9	42	1	2.70	0.65
EVFPDW0948W	165	9	48	1	3.06	0.75
EVFPDW0954W	178	9	54	1	3.42	0.84
EVFPDW0960W	193	9	60	1	3.78	0.94
EVFPDW0966W	204	9	66	1	4.13	1.04
EVFPDW0972W	231	9	72	1	4.49	1.13
EVFPDW1224W	70	12	24	1	1.84	0.50
EVFPDW1230W	85	12	30	1	2.25	0.63
EVFPDW1236W	99	12	36	1	2.66	0.75
EVFPDW1242W	111	12	42	1	3.07	0.87
EVFPDW1248W	165	12	48	1	3.48	1.00
EVFPDW1254W	178	12	54	1	3.89	1.12
EVFPDW1260W	193	12	60	1	4.30	1.25
EVFPDW1266W	204	12	66	1	5.12	1.38
EVFPDW1272W	231	12	72	1	5.53	1.51
EVFPDW1824W	89	18	24	1	2.26	0.75
EVFPDW1830W	105	18	30	1	2.77	0.94
EVFPDW1836W	124	18	36	1	3.29	1.13
EVFPDW1842W	139	18	42	1	3.80	1.31
EVFPDW1848W	206	18	48	1	4.32	1.50
EVFPDW1854W	224	18	54	1	4.83	1.69
EVFPDW1860W	241	18	60	1	5.35	1.88
EVFPDW1866W	254	18	66	1	6.68	2.06
EVFPDW1872W	289	18	72	1	7.20	2.25

**EVDPIC • Double Inline Panel Connector (for use with Laminate Middle Panels)**

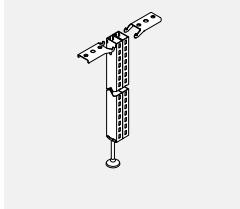

- Used to connect Laminate Middle Panel to panels of equal height in straight run.
- Aluminum Top Trim for Double Inline Connector must be used.
- Provides slotted support for worksurfaces and hang on storage compartments. Includes two slotted post with levelling glide and connection hardware.
- Connectors available without clots as special at no charge. Contact Customer Service.

PRODUCT CODE	PRICE	SIZE/ H	INCHES W	WEIGHT VOL	
				LBS	FT <sup>3</sup>
EVDPIC42	132	42	2	9.20	0.14
EVDPIC48	140	48	2	10.50	0.14

**EVDPVTF • Double Connector Trim (for use with Laminate Middle Panels)**

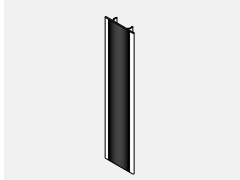

- Attaches to exposed side of double Inline Connector
- Must be ordered separately when Laminate Middle Panel is attached only to one side of Double Inline Connector.

PRODUCT CODE	PRICE	SIZE/ H	INCHES W	WEIGHT VOL	
				LBS	FT <sup>3</sup>
EVDPVTF42	13	42	2	0.52	0.07
EVDPVTF48	20	48	2	0.75	0.09

**LATERAL FILE FEATURES • TECHNICAL INFORMATION**

**Lateral Files**

- EDP storage (with optional EDP sides).
- Lock included.

**Drawers/Shelves**

- Drawer interlocking system.
- Three-stage, anti-bounceback suspension.
- Pre-installed file bars.
- Side-to-side file bars for letter, legal and A4 included.
- Front-to-back file bars – optional.
- Fixed front drawers – available.
- Receding door, roll-out shelves – available.
- Slotted, pull-out shelves with rolled edge.
- Full-height dividers – optional.
- Looped full pull.
- Label holder.

**Lateral Files 9100E Series**

- Receding door series features 16 gauge, spring loaded hinges.
- Premium drawer slides with black zinc coating for smoother, quieter motion.
- Superior locking system with anti-tip mechanism.

**Pedestals**

- Lock is standard.
- Each pedestal with a box drawer includes 1 pencil tray and 1 plate divider.

- Mig welded top corners.
- Salt spray resistance treatment.
- Durable epoxy powder coating.
- Thicker receding door with redesigned pivot motion to prevent door rub.
- Interchangeable drawer front option.
- Large standard colour palette.
- Half height drawers optional.
- ANSI / BIFMA approved.
- CSGB approved.

**Construction**

- Top stiffener bar.
- Corner gussets.
- 18 – 20 gauge cold-rolled steel.
- Four (4) ganging knockout positions are marked to ensure correct positioning.
- Cam lock included.
- Levelling glides.
- Counterweights are recommended in all heights/widths – optional.

**PREMIUM COLOURS**

Black Coffee Textured	BKC	*Extended lead-time required
Bone	BNE	
Business Grey	BGR	
Claret	CLT	
Dark Chocolate Textured	DCH	
Desert Putty	DPT	
Grey	GRY	
Ice	ICE	
Ivory	IVR	
Light Grey	LGR	
Metro	MET	
Mocha Textured	MCH	
Moss	MOS	
Navy	NVY	
Oyster	OYS	
Sky	SKY	
Stone	STN	
Storm Grey	SGR	
Tahiti Sand	TSA	
Willow	WIL	

**30" WIDE UNITS**

**MEDIA TYPE:**

**Letter**

All Openings  
Fixed Front Drawers and Roll-Out Shelves

**SIDE TO SIDE**

Capacity - 26 9/16"  
Accessories required  
HFB30

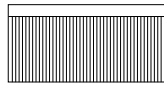

**FRONT TO BACK**

Capacity - 31 1/2"  
Accessories required HFB30 and one pair  
of FBB



**Legal**

All Openings  
Fixed Front Drawers and Roll-Out Shelves

Capacity - 26 9/16"  
Accessories required  
HFB30

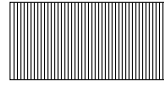

Capacity - 26 5/16"  
Accessories required HFB30 and one pair  
of FBB

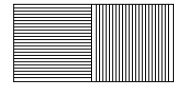

**36" WIDE UNITS**

**MEDIA TYPE:**

**Letter**

All Openings  
Fixed Front Drawers and Roll-Out Shelves

**SIDE TO SIDE**

Capacity - 32 9/16"  
Accessories required  
HFB36

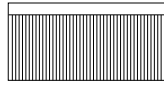

**FRONT TO BACK**

Capacity - 31 1/2"  
Accessories required HFB36 and one pair  
of FBB

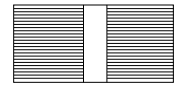

**Legal**

All Openings  
Fixed Front Drawers and Roll-Out Shelves

Capacity - 32 9/16"  
Accessories required  
HFB36

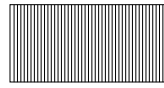

Capacity - 31 1/2"  
Accessories required HFB36 and one pair  
of FBB

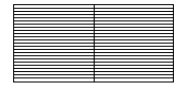

**42" WIDE UNITS**

**MEDIA TYPE:**

**Letter**

All Openings  
Fixed Front Drawers and Roll-Out Shelves

**SIDE TO SIDE**

Capacity - 38 9/16"  
Accessories required  
HFB42

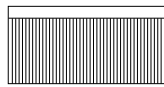

**FRONT TO BACK**

Capacity - 47 1/4"  
Accessories required HFB42 and two pairs  
of FBB



**Legal**

All Openings  
Fixed Front Drawers and Roll-Out Shelves

Capacity - 38 9/16"  
Accessories required  
HFB42

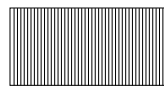

Capacity - 40 1/16"  
Accessories required HFB42 and one pair  
of FBB

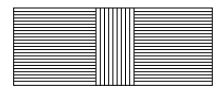

**OPENING DIMENSIONS**

Interior Clear Opening  
Height Dimensions

**SIDE TO SIDE**

**All Opening**

Fixed Front Drawer	13"
Receding Door and Roll-Out Shelf	12 1/8"
Receding Door and Fixed Shelf	12"
Fixed Shelf and no Receding Door	12 3/4"

**All Opening**

Drawer - Depth	15 3/4"
Roll-Out Shelf - Depth	15 3/4"
Fixed Shelf - Depth	15 3/4"

**FRONT TO BACK**

**All Opening**

Fixed Front Drawer	11 5/8"
Receding Door and Roll-Out Shelf	10 3/4"
Receding Door and Fixed Shelf	10 5/8"
Fixed Shelf and no Receding Door	11 3/8"

Interior Clear Opening  
Width Dimensions and  
Filing Capacities

**30" Wide Cabinets**

Fixed Front Drawer	26 9/16"
Receding Door and Roll-Out Shelf	26 9/16"
Receding Door and Fixed Shelf	28 5/16"

**36" Wide Cabinets**

Fixed Front Drawer	32 9/16"
Receding Door and Roll-Out Shelf	32 9/16"
Receding Door and Fixed Shelf	34 1/16"

**42" Wide Cabinets**

Fixed Front Drawer	38 9/16"
Receding Door and Roll-Out Shelf	38 9/16"
Receding Door and Fixed Shelf	40 5/16"

**EVSLs • Low Profile Shelf**

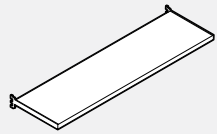

- Laminated Wood Shelf Panel Mounted
- Shelf thickness 1.125".
- Available in LP only.
- Includes attachment hardware.

PRODUCT CODE	PRICE	SIZE/ INCHES			WEIGHT VOL	
		H	W	D	LBS	FT <sup>3</sup>
EVSLs0818	204	1.125	18	8.5	3.98	0.09
EVSLs0824	222	1.125	24	8.5	5.31	0.12
EVSLs0830	241	1.125	30	8.5	6.64	0.15
EVSLs0836	256	1.125	36	8.5	7.97	0.18
EVSLs0842	276	1.125	42	8.5	9.30	0.21
EVSLs0848	292	1.125	48	8.5	10.63	0.24

**EVSSL • Low Profile Shelf**

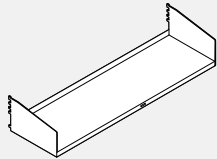

- 12" deep panel-mounted storage shelf with back lip that protects fabric.
- Includes black lock hole plug with Evolve logo and attachment hardware.
- Sides are 5" high.
- Shipped KD.

PRODUCT CODE	PRICE	SIZE/ INCHES			WEIGHT VOL	
		H	W	D	LBS	FT <sup>3</sup>
EVSSL1224	133	5	24	12.5	5.23	0.83
EVSSL1230	141	5	30	12.5	6.62	1.04
EVSSL1236	155	5	36	12.5	7.94	1.25
EVSSL1242	161	5	42	12.5	9.27	1.45
EVSSL1248	172	5	48	12.5	10.59	1.66
EVSSL1254	179	5	54	12.5	14.00	0.35
EVSSL1260	184	5	60	12.5	13.24	2.08

**EVSSC • Corner Shelf Kit**

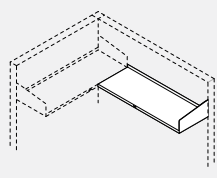

- The corner shelf kit must be used in conjunction with a Low Profile Shelf (EVSSL). Specify a Corner Shelf 12" smaller than the panel width. 36" wide panel = 24" corner shelf.
- Includes handed corner side end gable, flat bracket, black lock hole plug with Evolve logo and attachment hardware.
- Shipped KD.

PRODUCT CODE	PRICE	SIZE/ INCHES			WEIGHT VOL	
		H	W	D	LBS	FT <sup>3</sup>
EVSSC1224L	121	5	24	12.5	5.29	0.83
EVSSC1230L	125	5	30	12.5	6.62	1.04
EVSSC1236L	133	5	36	12.5	7.95	1.25
EVSSC1224R	121	5	24	12.5	5.29	0.83
EVSSC1230R	125	5	30	12.5	6.62	1.04
EVSSC1236R	133	5	36	12.5	7.94	1.25

**EVSOH • High Profile Shelf**

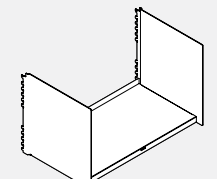

- 12" deep panel mounted shelf with back lip to protect fabric.
- Includes black lock hole plug with Evolve logo and attachment hardware.
- Shipped KD.

PRODUCT CODE	PRICE	SIZE/ INCHES			WEIGHT VOL	
		H	W	D	LBS	FT <sup>3</sup>
EVSOH1230	219	14.6	30	13.5	36.00	1.19
EVSOH1236	231	14.6	36	13.5	41.00	1.04
EVSOH1242	234	14.6	42	13.5	41.00	1.16
EVSOH1248	242	14.6	48	13.5	56.00	1.39
EVSOH1254	255	14.6	54	13.5	67.00	1.59
EVSOH1260	259	14.6	60	13.5	76.00	1.79

**EVSO12 • Overhead Flipper Door Storage Unit**

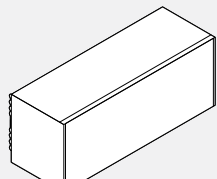

- Door retracts up and over the cabinet.
- Inside dimensions: 12" high x 11 3/4" deep.
- Lock not included, specify EVSLK12.
- 60" unit is reinforced for proper weight distribution.

PRODUCT CODE	PRICE	SIZE/ INCHES			WEIGHT VOL	
		H	W	D	LBS	FT <sup>3</sup>
EVSO1224	499	14.6	24	12	27.00	0.79
EVSO1230	517	14.6	30	12	31.00	0.83
EVSO1236	573	14.6	36	12	36.00	0.99
EVSO1242	630	14.6	42	12	41.00	1.16
EVSO1248	690	14.6	48	12	48.00	1.32
EVSO1254	747	14.6	54	12	51.00	1.49
EVSO1260	803	14.6	60	12	56.00	1.66

**EVSOB • Overhead Back Wall**

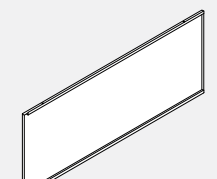

- Metal back wall attaches to EVSO12 Overhead to provide interior security.
- Can be field installed or retrofitted.

PRODUCT CODE	PRICE	SIZE/ INCHES			WEIGHT VOL	
		H	W	D	LBS	FT <sup>3</sup>
EVSOB24	68	14.75	24		2.00	0.10
EVSOB30	75	14.75	30		2.50	0.12
EVSOB36	86	14.75	36		3.25	0.16
EVSOB42	101	14.75	42		3.50	0.18
EVSOB48	111	14.75	48		4.00	0.20
EVSOB54	123	14.75	54		5.00	0.30
EVSOB60	133	14.75	60		5.00	0.24



**EVSOGD12 • Overhead Storage Unit with Sliding Glass Doors**

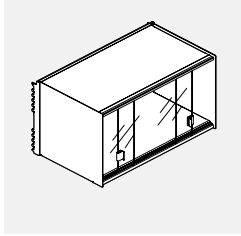

- Two glass doors slide from side to side.
- Inside dimensions: 12" high x 11 3/4" deep.
- Lock not available.

PRODUCT CODE	PRICE	SIZE/ INCHES			WEIGHT VOL	
		H	W	D	LBS	FT <sup>3</sup>
EVSOGD1224	806	14.6	24	13.5	30.00	0.79
EVSOGD1230	818	14.6	30	13.5	34.00	0.83
EVSOGD1236	850	14.6	36	13.5	39.00	0.99
EVSOGD1242	898	14.6	42	13.5	44.00	1.16
EVSOGD1248	957	14.6	48	13.5	49.00	1.32
EVSOGD1254	992	14.6	54	13.5	54.00	1.49
EVSOGD1260	1025	14.6	60	13.5	59.00	1.66

**EVSOF13 • Full Pull Overhead Flipper Door Storage Unit**

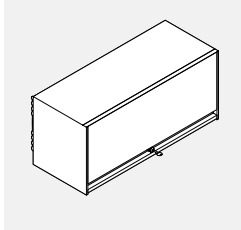

- Door retracts up and over the cabinet.
- Inside dimensions: 13 1/4" high x 12 3/4" deep.
- Lock included.

PRODUCT CODE	PRICE	SIZE/ INCHES			WEIGHT VOL	
		H	W	D	LBS	FT <sup>3</sup>
EVSOF1324	669	14.6	24	13.5	31.00	0.83
EVSOF1330	684	14.6	30	13.5	31.00	0.83
EVSOF1336	702	14.6	36	13.5	31.00	0.83
EVSOF1342	738	14.6	42	13.5	41.00	1.16
EVSOF1348	789	14.6	48	13.5	46.00	1.32
EVSOF1354	835	14.6	54	13.5	51.00	1.49
EVSOF1360	879	14.6	60	13.5	46.00	1.32

**EVSOFPB • Full Pull Overhead Back Wall**

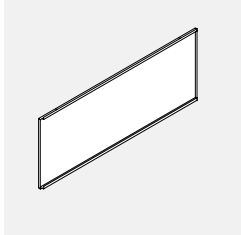

- Metal back wall attaches to EVSOF13 overhead to provide interior security.
- Can be field installed or retrofitted.

PRODUCT CODE	PRICE	SIZE/ INCHES			WEIGHT VOL	
		H	W	D	LBS	FT <sup>3</sup>
EVSOFPB24	68	15	24	1	9.00	0.18
EVSOFPB30	75	15	30	1	10.00	0.22
EVSOFPB36	86	15	36	1	12.00	0.27
EVSOFPB42	101	15	42	1	13.00	0.32
EVSOFPB48	111	15	48	1	14.00	0.36
EVSOFPB54	123	15	54	1	15.00	0.41
EVSOFPB60	133	15	60	1	17.00	0.45

**EVADA-PM • Easy-Up Panel Mounted Overhead Storage Unit - AODA Compliant**

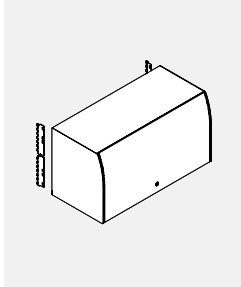

- Meets CSA B651 Barrier Free Design & AODA (Accessibility for Ontarians with Disabilities Act).
- 16" high units accept standard and A4 binders.
- All shelves are reinforced for proper weight distribution.
- Inside dimensions: 14.25" high x 13.4" deep.
- Unit includes attachment hardware, lock and mounting brackets. Back not included.
- Not recommended for use with wall rails.
- Unit can be converted to an Up-Mount Overhead Storage in the field by adding EVADA-KIT.
- Shipped partially assembled.

PRODUCT CODE	PRICE	SIZE/ INCHES			WEIGHT VOL	
		H	W	D	LBS	FT <sup>3</sup>
EVADA30PM	815	16	30	14.2	27.00	5.30
EVADA36PM	880	16	36	14.2	32.00	6.30
EVADA42PM	942	16	42	14.2	37.00	7.30
EVADA48PM	1007	16	48	14.2	42.00	8.30
EVADA54PM	1069	16	54	14.2	47.00	9.30
EVADA60PM	1133	16	60	14.2	53.00	10.30

**With opaque acrylic door. The mechanism lifts the door up and stores it out of the way, above the storage unit.**

**EVADAPMKIT • Panel Mount Conversion Kit**

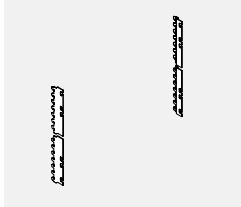

- Converts an existing Up-Mount Overhead Storage Unit EVADA-UM to a Panel Mounted Overhead Storage Unit EVADA-PM.
- Kit includes panel mounting brackets.

PRODUCT CODE	PRICE	SIZE/ INCHES			WEIGHT VOL	
		H	W	D	LBS	FT <sup>3</sup>
EVADAPMKIT	39	16	0.5	2	2.00	0.01

**EVADA-UM • Easy-Up Up-Mount Overhead Storage Unit - AODA Compliant**

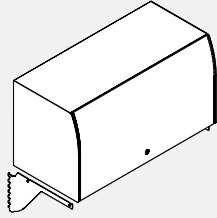

- Meets CSA B651 Barrier Free Design & AODA (Accessibility for Ontarians with Disabilities Act).
- 16" high units accept standard and A4 binders.
- All shelves are reinforced for proper weight distribution.
- Inside dimensions: 14.25" high x 13.4" deep.
- Unit includes attachment hardware, lock, mounting cantilevers and has a finished back.
- Unit can be converted to an Panel Mounted Overhead Storage Unit in the field by adding EVADAPM-KIT.
- Shipped partially assembled.

PRODUCT CODE	PRICE	SIZE/ H	INCHES			WEIGHT VOL	
			W	D	LBS	FT <sup>3</sup>	
EVADA30UM	970	16	30	14.2	33.00	5.30	
EVADA36UM	1016	16	36	14.2	40.00	6.30	
EVADA42UM	1073	16	42	14.2	46.00	7.30	
EVADA48UM	1132	16	48	14.2	53.00	8.30	
EVADA54UM	1186	16	54	14.2	59.00	9.30	
EVADA60UM	1255	16	60	14.2	66.00	10.30	

**Up-mounted storage can reduce furniture costs by reducing the height of all panels to 54". Complete 54" panel installations simplify cable routing at one level, below the top cap. Up-mounted cantilevers maintain accessibility and functionality of the panels' top lay-in channel below the top cap.**

**EVADA-KIT • Up-Mount Conversion Kit**

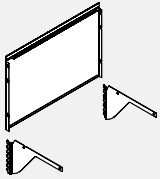

- Converts an existing Panel Mounted Overhead Storage Unit EVADA-PM to an Up-Mounted Overhead Storage Unit EVADA-UM.
- When used on a 54" high panel, the top of the overhead can match the height of 66" high panels.
- Kit includes a back panel for the Overhead and Up-Mount Cantilevers.

PRODUCT CODE	PRICE	SIZE/ H	INCHES			WEIGHT VOL	
			W	D	LBS	FT <sup>3</sup>	
EVADA30KIT	195	16	30	2	8.00	0.60	
EVADA36KIT	204	16	36	2	10.00	0.70	
EVADA42KIT	218	16	42	2	11.00	0.80	
EVADA48KIT	228	16	48	2	13.00	0.90	
EVADA54KIT	240	16	54	2	14.00	1.00	
EVADA60KIT	253	16	60	2	15.00	1.10	

**EVSOD • Double Wall Overhead Flipper Door Storage Unit**

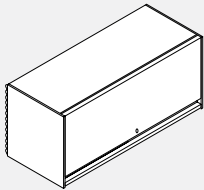

- 15" deep panel mounted overhead storage unit with metal sides, retracting flipper door.
- 15" deep units accept BASD12 binder plate dividers.
- All cabinets 54" and longer are reinforced for proper weight distribution.
- Inside dimensions are 12.5" high by 13.5" deep.
- Includes attachment hardware, lock and mounting brackets.
- Not recommended for use with wall rails.
- Shipped KD.

PRODUCT CODE	PRICE	SIZE/ H	INCHES			WEIGHT VOL	
			W	D	LBS	FT <sup>3</sup>	
EVSOD1330	493	15.4	30	14.7	53.00	2.33	
EVSOD1336	545	15.4	36	14.7	54.00	2.33	
EVSOD1342	601	15.4	42	14.7	56.00	2.33	
EVSOD1348	655	15.4	48	14.7	58.00	3.33	
EVSOD1354	710	15.4	54	14.7	60.00	3.33	
EVSOD1360	763	15.4	60	14.7	62.00	3.33	

**EVSODGD • Double Wall Overhead Glass Sliding Door Unit**

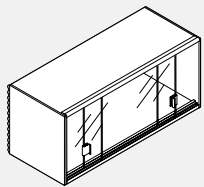

- Overheads are combination of EVSOD Overheads with-out door with a specially designed door.
- Available in Tempered Frosted Glass option only. In standard Evolve paint finishes.
- Glass overheads available in standard widths of 30"- 60".
- Quality steel construction.
- Panel mount (mounting brackets included).
- Inside dimensions 13" high x 13" deep.
- Tracks for sliding door available in Tungsten only.
- Please use EVSOFD01 for Overhead Divider.

PRODUCT CODE	PRICE	SIZE/ H	INCHES			WEIGHT VOL	
			W	D	LBS	FT <sup>3</sup>	
EVSODGD1330	734	15.4	30	14.7	53.00	2.33	
EVSODGD1336	765	15.4	36	14.7	54.00	2.33	
EVSODGD1342	806	15.4	42	14.7	56.00	2.33	
EVSODGD1348	861	15.4	48	14.7	58.00	3.33	
EVSODGD1354	894	15.4	54	14.7	60.00	3.33	
EVSODGD1360	922	15.4	60	14.7	62.00	3.33	

**EVSODGDL • Double Wall Overhead Glass Sliding Door with Lock Unit**

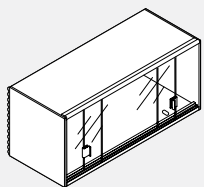

- Sliding Overheads are combination of EVSOD Overheads with specially designed door.
- Available in Tempered Frosted Glass option only. In standard Evolve paint finishes.
- Glass overheads available in standard widths of 30"- 60".
- Quality steel construction.
- Panel mount (mounting brackets included).
- Inside dimensions 13" high x 13" deep.
- Tracks for sliding door available in Tungsten only.
- Push in Lock, No Keys alike.
- Please use EVSOFD01 for Overhead Divider.

PRODUCT CODE	PRICE	SIZE/ H	INCHES			WEIGHT VOL	
			W	D	LBS	FT <sup>3</sup>	
EVSODGDL1330	835	15.4	30	14.7	53.00	2.33	
EVSODGDL1336	866	15.4	36	14.7	54.00	2.33	
EVSODGDL1342	909	15.4	42	14.7	56.00	2.33	
EVSODGDL1348	960	15.4	48	14.7	58.00	3.33	
EVSODGDL1354	993	15.4	54	14.7	60.00	3.33	
EVSODGDL1360	1024	15.4	60	14.7	62.00	3.33	

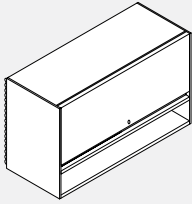
**EVSODS • Double Wall Overhead with Shelf Flipper Door Storage Unit**

- Retracting flipper door unit on top of lower panel adds privacy without the expense of an over panel.
- 15" deep units accepts BAPD03 binder plate dividers.
- All cabinets 54" and longer are reinforced for proper weight distribution.
- Inside dimensions: 12" high x 14 3/4" deep.
- Includes attachment hardware, lock and mounting brackets.
- Not recommended for use with wall rails, must be used attached to panels by the cantilevers provided.
- Features a completely finished back.
- Shipped KD.
- Please use EVSOFD01 for Overhead Divider.

PRODUCT CODE	PRICE	SIZE/ INCHES			WEIGHT VOL	
		H	W	D	LBS	FT <sup>3</sup>
EVSODS1330	565	22.4	30	14.7	63.00	2.33
EVSODS1336	627	22.4	36	14.7	64.00	2.33
EVSODS1342	691	22.4	42	14.7	66.00	2.33
EVSODS1348	755	22.4	48	14.7	68.00	3.33
EVSODS1354	818	22.4	54	14.7	70.00	3.33
EVSODS1360	878	22.4	60	14.7	72.00	3.33

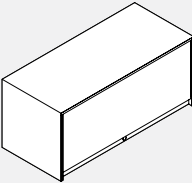
**EVSO16 • Overhead Flipper Door Unit - Fully Assembled**

- Completely enclosed, fully assembled. Built with metal sides and back and fully retractable (into the interior) metal door.
- 16" deep unit accommodate letter, legal end tab binder, EDP and A4 metric filing.
- All cabinets 36" and longer are reinforced for proper weight distribution.
- Includes mounting bracket and lock with two keys.
- Inside dimensions: 13 5/8" high x 14 3/4" deep.

PRODUCT CODE	PRICE	SIZE/ INCHES			WEIGHT VOL	
		H	W	D	LBS	FT <sup>3</sup>
EVSO1624	891	17.5	24	15.625	29.00	3.95
EVSO1630	916	17.5	30	15.625	49.00	4.86
EVSO1636	957	17.5	36	15.625	56.00	5.83
EVSO1642	1023	17.5	42	15.625	64.00	6.81
EVSO1648	1089	17.5	48	15.625	75.00	7.78
EVSO1654	1148	17.5	54	15.625	86.00	8.75
EVSO1660	1199	17.5	60	15.625	88.00	9.72

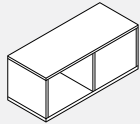
**EVSDAHL36 • Dual Access Overhead Left**

- Inside dimensions 13" high x 13" deep.
- Laminate Overhead.
- Available in standard Evolve laminate finishes.
- Top mount on panels.
- Dual Access Overhead Support Brackets to be ordered separately.

PRODUCT CODE	PRICE	SIZE/ INCHES			WEIGHT VOL	
		H	W	D	LBS	FT <sup>3</sup>
EVSDAHL36	1007	15	36	14.12	46.97	4.40
EVSDAHL42	1085	15	42	14.12	52.84	5.13
EVSDAHL48	1130	15	48	14.12	58.90	5.87
EVSDAHL54	1210	15	54	14.12	64.97	6.61
EVSDAHL60	1256	15	60	14.12	71.03	7.35

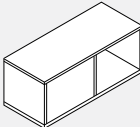
**EVSDAHR36 • Dual Access Overhead Right**

- Inside dimensions 13" high x 13" deep.
- Laminate Overhead.
- Available in standard Evolve laminate finishes.
- Top mount on panels.
- Dual Access Overhead Support Brackets to be ordered separately.

PRODUCT CODE	PRICE	SIZE/ INCHES			WEIGHT VOL	
		H	W	D	LBS	FT <sup>3</sup>
EVSDAHR36	1007	15	36	14.12	46.97	4.40
EVSDAHR42	1085	15	42	14.12	52.84	5.13
EVSDAHR48	1130	15	48	14.12	58.90	5.87
EVSDAHR54	1210	15	54	14.12	64.97	6.61
EVSDAHR60	1256	15	60	14.12	71.03	7.35

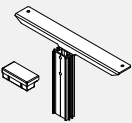
**EVSDAHBKTE • End of run Bracket**

- Bracket supports dual access overhead on one side only.
- Includes one bracket, aluminum insert and end of run plastic cap.
- End of run plastic cap attaches to end of run trim.
- Bracket available in standard Evolve paint finishes.

PRODUCT CODE	PRICE	SIZE/ INCHES			WEIGHT VOL	
		H	W	D	LBS	FT <sup>3</sup>
EVSDAHBKTE	88	6.5	2	12	1	0.09

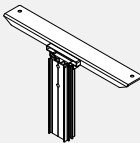
**EVSDAHBKTS • Inline Single Bracket**

- Bracket supports dual access overhead on one side only.
- Includes one bracket, aluminum insert and inline plastic cap.
- Inline plastic cap and top trim align.
- Bracket available in standard Evolve paint finishes.
- Note: Single clamps must be used when inline single bracket is used.

PRODUCT CODE	PRICE	SIZE/ INCHES			WEIGHT VOL	
		H	W	D	LBS	FT <sup>3</sup>
EVSDAHBKTS	88	6.5	4	12	1.6	0.09

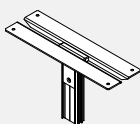
**EVSDAHBKTD • Double Bracket**

- Double Bracket supports sides of dual access overheads when overhead are side by side.
- Includes two brackets, aluminum insert and plastic caps.
- Plastic caps installed between bracket.
- Brackets available in standard Evolve paint finishes.
- **Note:** Single clamps must be used when double bracket is used.

PRODUCT CODE	PRICE	SIZE/ INCHES			WEIGHT VOL	
		H	W	D	LBS	FT <sup>3</sup>
EVSDAHBKTD	176	6.5	4	12	1.6	0.18

**EVSSOHL • Top Mount KD Overhead with Sliding Glass Door Left**

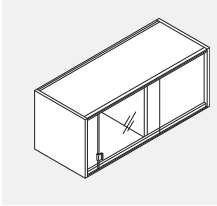

- Inside dimensions 13" high x 13" deep
- Laminate side walls and divider, available in standard laminate finishes
- Metal shelves and back wall, available in standard paint finishes
- Available in tempered frosted glass only
- Tracks for sliding glass available in Tungsten only
- Top mount on panels
- Ready for quick assembly on site
- Top Mount Overhead Support Brackets to be ordered separately.

PRODUCT CODE	PRICE	SIZE/ H	INCHES W	INCHES D	WEIGHT LBS	VOL FT <sup>3</sup>
EVSSOHL30	1018	15	30	15	63.00	3.66
EVSSOHL36	1124	15	36	15	64.00	4.40
EVSSOHL42	1239	15	42	15	66.00	5.13
EVSSOHL48	1319	15	48	15	68.00	5.87
EVSSOHL54	1396	15	54	15	70.00	6.61
EVSSOHL60	1525	15	60	15	72.00	7.35

**EVSSOHR • Top Mount KD Overhead with Sliding Glass Door Right**

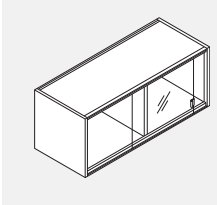

- Inside dimensions 13" high x 13" deep.
- Laminate side walls and divider, available in standard laminate finishes.
- Metal shelves and back wall, available in standard paint finishes.
- Available in tempered frosted glass only.
- Tracks for sliding glass available in Tungsten only.
- Top mount on panels.
- Ready for quick assembly on site .
- Top Mount Overhead Support Brackets to be ordered separately.

PRODUCT CODE	PRICE	SIZE/ H	INCHES W	INCHES D	WEIGHT LBS	VOL FT <sup>3</sup>
EVSSOHR30	1018	15	30	15	63.00	3.66
EVSSOHR36	1124	15	36	15	64.00	4.40
EVSSOHR42	1239	15	42	15	66.00	5.13
EVSSOHR48	1319	15	48	15	68.00	5.87
EVSSOHR54	1396	15	54	15	70.00	6.61
EVSSOHR60	1525	15	60	15	72.00	7.35

**EVSSOHBKTE • End of run Top Mount Overhead Bracket**

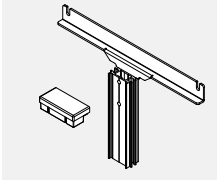

- Bracket supports Top Mount KD overhead on one side only.
- Includes one bracket , aluminum insert and end of run plastic cap.
- End of run plastic cap attaches to end of run trim.
- Bracket available in standard Evolve paint finishes.

PRODUCT CODE	PRICE	SIZE/ H	INCHES W	INCHES D	WEIGHT LBS	VOL FT <sup>3</sup>
EVSSOHBKTE	88	6	2	12	1	0.07

**EVSSOHBKTS • Inline Single Top Mount Overhead Bracket**

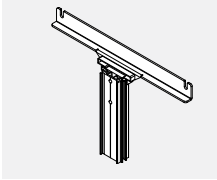

- Bracket supports Top Mount KD overhead on one side only.
- Includes one bracket , aluminum insert and inline plastic cap.
- Inline plastic cap and top trim align.
- Bracket available in standard Evolve paint finishes.
- **Note:** Single clamps must be used when inline single bracket is used.

PRODUCT CODE	PRICE	SIZE/ H	INCHES W	INCHES D	WEIGHT LBS	VOL FT <sup>3</sup>
EVSSOHBKTS	88	15	36	12	1	0.07

**EVSSOHBKTD • Double Top Mount Overhead Bracket**

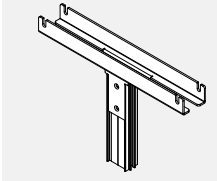

- Double Bracket supports sides of Top Mount KD overheads when overhead are side by side.
- Includes two brackets, aluminum insert and plastic caps.
- Plastic caps installed between brackets.
- Brackets available in standard Evolve paint finishes.
- **Note:** Single clamps must be used when double bracket is used.

PRODUCT CODE	PRICE	SIZE/ H	INCHES W	INCHES D	WEIGHT LBS	VOL FT <sup>3</sup>
EVSSOHBKTD	88	15	36	12	1.6	0.09

**EVSODOMB • Overhead Off Module Mount Conversion Kit**

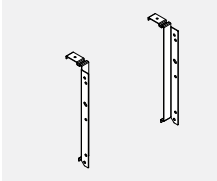

- Converts any existing EVSOD or EVADA overheads to off module installed.
- Allows to install overhead of different widths of Premium Panel.
- Attaches to top horizontal tube of Premium Fabric Panel.
- Brackets allow to install Double Wall Overhead or AODA overhead.
- Kit includes pair of brackets.
- Available in standard paint finishes.

PRODUCT CODE	PRICE	SIZE/ H	INCHES W	INCHES D	WEIGHT LBS	VOL FT <sup>3</sup>
EVSODOMB	92	12.37	1	4.37	0.25	0.09

**EVSLK • Lock for Overhead Flipper Door Storage Unit EVSOF12**

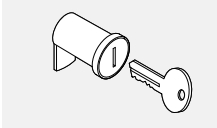

- Includes lock and two keys for EVSOF12.
- Site installed.

PRODUCT CODE	PRICE	SIZE/ H	INCHES W	INCHES D	WEIGHT LBS	VOL FT <sup>3</sup>
EVSLK12	41				0.01	0.01

**EVSHJB • “J” Bars for Double Wall Overhead**

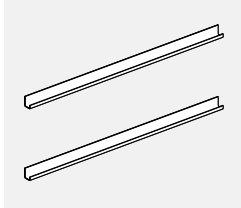

- Converts existing panel mounted double wall overhead EVSOD13, EV-SODGD13, EVSODGDL13 to a wall mounted Double wall Overhead
- Available in standard Evolve paint finishes.
- NOTE: Care should b taken to fasten the “J” Bars only to wall studs with correct fasteners. Failure to do so may result in collapse of unit and subsequent possible personal injury.

PRODUCT CODE	PRICE	SIZE/ INCHES		
		H	W	D
EVSHJB30	26	1.4	30	1
EVSHJB36	32	1.4	36	1
EVSHJB42	32	1.4	42	1
EVSHJB48	35	1.4	48	1
EVSHJB54	39	1.4	54	1
EVSHJB60	43	1.4	60	1

**EVS12BBF • Twelve Series BBF Pedestal Worksurface Supporting**

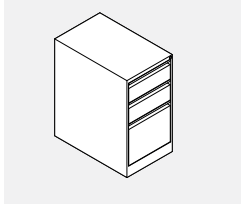

- Worksurface Supporting Pedestal with long pull and double wall drawer front construction.
- Lock is positioned on the front face, right side.
- To use as a worksurface supporting pedestal, please specify EVHPB1 separately.

PRODUCT CODE	PRICE	SIZE/ INCHES			WEIGHT VOL	
		H	W	D	LBS	FT³
EVS1218BBF	637	27.75	15	18	45.00	4.55
EVS1223BBF	644	27.75	15	23	82.00	8.00
EVS1224BBF	644	27.75	15	24	82.00	8.00
EVS1229BBF	710	27.75	15	29	85.00	9.00
EVS1230BBF	710	27.75	15	30	85.00	9.00

**EVS12FF • Twelve Series FF Pedestal Worksurface Supporting**

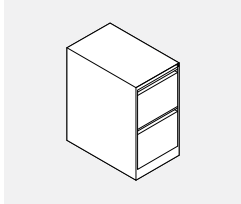

- Worksurface Supporting Pedestal with long pull and double wall drawer front construction.
- Lock is positioned on the front face, right side.
- To use as a worksurface supporting pedestal, please specify EVHPB1 separately.

PRODUCT CODE	PRICE	SIZE/ INCHES			WEIGHT VOL	
		H	W	D	LBS	FT³
EVS1218FF	637	27.75	15	18	45.00	4.55
EVS1223FF	644	27.75	15	23	82.00	8.00
EVS1224FF	644	27.75	15	24	82.00	8.00
EVS1229FF	710	27.75	15	29	85.00	9.00
EVS1230FF	710	27.75	15	30	85.00	9.00

**EVS1230DP • Twelve Series Combination Pedestal**



Left Hand Shown

- Business Lateral File Taxi with two box drawers on right with one pencil tray and one divider plate. Efficient, stationary storage and additional work space.
- 12” legal file drawer with full suspension and hanging bars.
- Fixed front drawer with three divider plates.
- Fits under standard 29” worksurface and can be supporting.
- Includes leveling glides.
- Lock is positioned on the front face, centre.
- Interiors are finished in black.
- No handle or casters.
- Unit must be fastened to worksurface to avoid tipping.

PRODUCT CODE	PRICE	SIZE/ INCHES			WEIGHT VOL	
		H	W	D	LBS	FT³
EVS1230DPL	1609	27.8	30	18	140.00	8.75
EVS1230DPR	1609	27.8	30	18	140.00	8.75

**EVSTC • Pedestal/Lateral Seat Cushion**

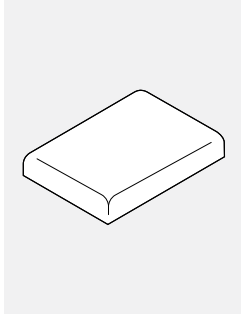

PRODUCT CODE	YRDS	SIZE/ INCHES			WEIGHT VOL	
		H	W	D	LBS	FT³
EVSTCL1830	1	2	18	30	7	0.55
EVSTCL1836	1.25	2	18	36	9	0.65
EVSTCP1518	.75	2	15	18	5	0.49
EVSTCP1519	.75	2	15	19	5	0.49
EVSTCP1523	.75	2	15	23	6	0.59
EVSTCP1524	.75	2	15	24	6	0.63
EVSTCP1529	1	2	15	29	7.6	0.76
EVSTCP1530	1	2	15	30	7.9	0.79

• C.O.M. Fabrics are priced as Grade 3.

PRODUCT CODE	PRICE																			
	GR1	GR2	GR3	GR4	GR5	GR6	GR7	GR8	GR9	GR10	GR11	GR12	GR13	GR14	GR15	GR16	GR17	GR18	GR19	GR20
EVSTCL1830	281	318	345	383	437	488	536	585	636	691	760	860	958	1057	1279	1496	1720	1938	2156	2399
EVSTCL1836	333	380	417	461	527	590	653	712	778	844	932	1057	1179	1304	1581	1852	2130	2402	2677	2981
EVSTCP1518	196	226	245	272	314	353	389	422	463	503	557	633	703	779	944	1109	1274	1439	1604	1785
EVSTCP1519	202	230	253	278	319	358	396	429	469	508	562	637	710	785	949	1114	1280	1444	1608	1790
EVSTCP1523	206	233	256	283	323	361	399	435	472	513	565	640	715	789	955	1119	1285	1451	1613	1794
EVSTCP1524	212	240	262	289	330	367	406	439	477	521	573	647	722	795	959	1123	1289	1455	1619	1801
EVSTCP1529	259	296	326	360	414	466	518	562	613	668	737	839	936	1034	1256	1473	1696	1916	2134	2377
EVSTCP1530	266	301	331	366	420	471	523	567	619	673	743	844	943	1041	1262	1481	1702	1923	2140	2383

**EVS12BFM • Twelve Series BF Mobile Pedestal**

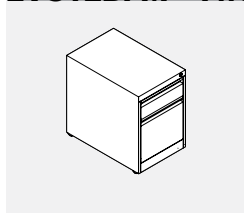

- Mobile Pedestal with flat front, double wall drawer construction.
- Includes 4 casters and 1 counterweight balance.
- Lock is positioned on the front face, right side.
- Pedestal will fit under 29" high worksurface.
- All casters are non-locking.

PRODUCT CODE	PRICE	SIZE/ INCHES			WEIGHT LBS	VOL FT <sup>3</sup>
		H	W	D		
EVS1218BFM	769	22.5	15	18	69.00	4.04
EVS1223BFM	776	22.5	15	23	89.00	5.17
EVS1229BFM	921	22.5	15	29	112.00	6.52

**EVS12SB-BBFM • Twelve Series BBF Mobile Pedestal**

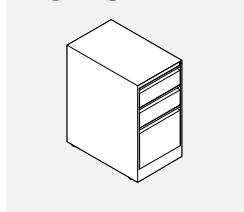

- Mobile pedestal with flat front, double wall drawer construction.
- Includes 4 casters and 1 counterweight balance.
- Lock is positioned on front face, on right side.
- Pedestal will fit under 29" high worksurface.
- All casters are non locking.

PRODUCT CODE	PRICE	SIZE/ INCHES			WEIGHT LBS	VOL FT <sup>3</sup>
		H	W	D		
EVS12SB19BBFM	800	28	15	19	70	4.29
EVS12SB23BBFM	807	28	15	23	84	5.62
EVS12SB29BBFM	928	28	15	29	94	7.03

**EVS12SB-FFM • Twelve Series FF Mobile Pedestal**

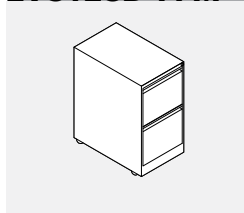

- Mobile pedestal with flat front, double wall drawer construction.
- Includes 4 casters and 1 counterweight balance.
- Lock is positioned on front face, on right side.
- Pedestal will fit under 29" high worksurface.
- All casters are non locking.

PRODUCT CODE	PRICE	SIZE/ INCHES			WEIGHT LBS	VOL FT <sup>3</sup>
		H	W	D		
EVS12SB19FFM	800	28	15	19	70	4.29
EVS12SB23FFM	807	28	15	23	84	5.62
EVS12SB29FFM	928	28	15	29	94	7.03

**EVS12BF • One and 1/2 Height BF Pedestal**

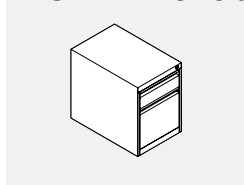

- Freestanding Pedestal with long pull offers finished top and back.
- Non worksurface supporting.
- Steel top features folded corner construction.
- Lock positioned on the front face, right side.
- Drawer configuration cannot be changed on site.

PRODUCT CODE	PRICE	SIZE/ INCHES			WEIGHT LBS	VOL FT <sup>3</sup>
		H	W	D		
EVS1218BF	571	21.75	15	18	69.00	4.04
EVS1223BF	579	21.75	15	23	89.00	5.17
EVS1229BF	656	21.75	15	29	112.00	6.52

**EVFELT03BC - Felt Shelf Liner for Cube Pedestals**

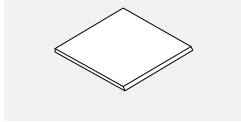

- Felt shelf liner can be added to any closed back shelf.
- Front edge is cut at 45 degree.

PRODUCT CODE	PRICE	SIZE/ H	INCHES W	D	WEIGHT LBS	VOL FT <sup>3</sup>
EVFTFELT03BC	22	12	12	0.38	0.1	0.03

**EVSSP12BBFM • Cube Mobile Pedestal, Two Open Boxes, One File Box and Accessory Tray**

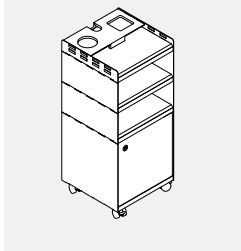

- Mobile pedestal with two open boxes in the middle, one file box at the bottom and a top accessory tray.
- File box interior dimensions: 11 7/8" h x 11 13/16" w x 10 7/16" d.
- Includes four locking casters, PET felt accessory tray, chrome wire divider and optional lock
- File door lock, if specified is located on the top right corner for the right pedestal and top left corner for the left pedestal.
- Bottom, middle and top shelves, front door and back are made of 3/4" low pressure laminate.
- Sides are made of powder coated metal.
- Ships knocked-down.

PRODUCT CODE	PRICE	SIZE/ H	INCHES W	D	WEIGHT LBS	VOL FT <sup>3</sup>
<b>Without Lock</b>						
EVSSP12BBFMR	568	28	12	12	35	2.33
EVSSP12BBFML	568	28	12	12	35	2.33
<b>With Lock</b>						
EVSSP12BBFMKR	582	28	12	12	35	2.33
EVSSP12BBFMKL	582	28	12	12	35	2.33

**EVSSP12BFMR • Cube Mobile Pedestal, One Open Box, One File Box and Accessory Tray**

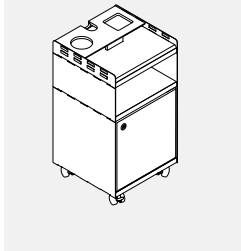

- Mobile pedestal with one open box in the middle, one file box at the bottom and a top accessory tray.
- File box interior dimensions: 11 7/8" h x 11 13/16" w x 10 7/16" d.
- Includes four locking casters, PET felt accessory tray, chrome wire divider and optional lock
- File door lock, if specified is located on the top right corner for the right pedestal and top left corner for the left pedestal.
- Bottom, middle and top shelves, front door and back are made of 3/4" low pressure laminate.
- Sides are made of powder coated metal.
- Ships knocked-down.

PRODUCT CODE	PRICE	SIZE/ H	INCHES W	D	WEIGHT LBS	VOL FT <sup>3</sup>
<b>Without Lock</b>						
EVSSP12BFMR	447	22	12	12	28	1.83
EVSSP12BFML	447	22	12	12	28	1.83
<b>With Lock</b>						
EVSSP12BFMKR	461	22	12	12	28	1.83
EVSSP12BFMKL	461	22	12	12	28	1.83

**EVSSP12SFM • Cube Mobile Pedestal, One Closed Storage Box, One File Box and Accessory Tray**

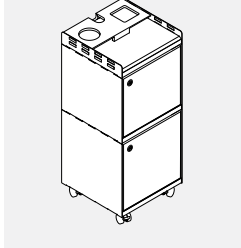

- Mobile pedestal with one closed storage box at the top, one file box at the bottom and a top accessory tray.
- File box interior dimensions: 11 7/8" h x 11 13/16" w x 10 7/16" d.
- Closed storage box interior dimensions: 10 1/2" h x 11 13/16" w x 10 7/16" d.
- Includes four locking casters, PET felt accessory tray, chrome wire divider and optional lock
- Door locks, if specified are located on the top right corner for the right pedestal and top left corner for the left pedestal of each box.
- Bottom, middle and top shelves, front door and back are made of 3/4" low pressure laminate.
- Sides are made of powder coated metal.
- Ships knocked-down.

PRODUCT CODE	PRICE	SIZE/ H	INCHES W	D	WEIGHT LBS	VOL FT <sup>3</sup>
<b>Without Lock</b>						
EVSSP12SFMR	568	28	12	12	35	2.33
EVSSP12SFML	568	28	12	12	35	2.33
<b>With Lock</b>						
EVSSP12SFMKR	582	28	12	12	35	2.33
EVSSP12SFMKL	582	28	12	12	35	2.33

**EVSSPH12BFB • Cube Hanging Pedestal, One File Box and Two Open Boxes**

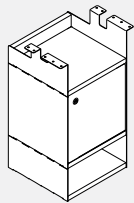

- Hanging pedestal with one file box in the middle and two open boxes, one at the top and one at the bottom.
- Attaches to the underside of a worksurface with supplied screws.
- File box interior dimensions: 11 7/8" h x 11 13/16" w x 10 7/16" d.
- Includes chrome wire divider and optional lock.
- Metal wire divider is chrome and sits 3 7/16" from either side and is interchangeable.
- File door lock, if specified is located on the top right corner for the right pedestal and top left corner for the left pedestal.
- Bottom, middle and top shelves, front door and back are made of 3/4" low pressure laminate.
- Sides are made of powder coated metal.
- Ships knocked-down.

PRODUCT CODE	PRICE	SIZE/ INCHES		WEIGHT VOL		
		H	W	D	LBS	FT <sup>3</sup>
<b>Without Lock</b>						
EVSSPH12BFBR	431	24	12	12	26	2.33
EVSSPH12BFBL	431	24	12	12	26	2.33
<b>With Lock</b>						
EVSSPH12BFBKR	444	24	12	12	26	2.33
EVSSPH12BFBKL	444	24	12	12	26	2.33

**EVSSPH12BF • Cube Hanging Pedestal, One File Box**

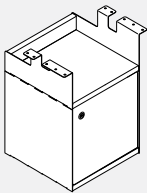

- Hanging pedestal with one file box at the bottom and one open box at the top.
- Attaches to the underside of a worksurface with supplied screws.
- File box interior dimensions: 11 7/8" h x 11 13/16" w x 10 7/16" d.
- Includes chrome wire divider and optional lock.
- Metal wire divider is chrome and sits 3 7/16" from either side and is interchangeable.
- File door lock, if specified is located on the top right corner for the right pedestal and top left corner for the left pedestal.
- Bottom, middle and top shelves, front door and back are made of 3/4" low pressure laminate.
- Sides are made of powder coated metal.
- Ships knocked-down.

PRODUCT CODE	PRICE	SIZE/ INCHES		WEIGHT VOL		
		H	W	D	LBS	FT <sup>3</sup>
<b>Without Lock</b>						
EVSSPH12BFR	324	18.5	12	12	20	1.83
EVSSPH12BFL	324	18.5	12	12	20	1.83
<b>With Lock</b>						
EVSSPH12BFKR	337	18.5	12	12	20	1.83
EVSSPH12BFKL	337	18.5	12	12	20	1.83

**EVSSPH12B • Cube Hanging Pedestal Box**

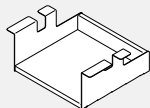

- Hanging pedestal open box.
- Attaches to the underside of a worksurface with supplied screws to create an open box.
- Bottom, middle and top shelves, front door and back are made of 3/4" low pressure laminate.
- Sides are made of powder coated metal.
- Ships knocked-down.

PRODUCT CODE	PRICE	SIZE/ INCHES		WEIGHT VOL		
		H	W	D	LBS	FT <sup>3</sup>
EVSSPH12B	132	6	12	12	6	0.96

**EVSSPH12BB • Cube Hanging Pedestal, Two Open Boxes**

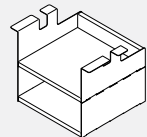

- Hanging pedestal with two open boxes.
- Attaches to the underside of a worksurface with supplied screws.
- Bottom, middle and top shelves, front door and back are made of 3/4" low pressure laminate.
- Sides are made of powder coated metal.
- Ships knocked-down.

PRODUCT CODE	PRICE	SIZE/ INCHES		WEIGHT VOL		
		H	W	D	LBS	FT <sup>3</sup>
EVSSPH12BB	244	11.5	12	12	12	1.42



**EVS12X1H1F • One 1/2 Height Fixed Front & One 12" Fixed Front Lateral File**

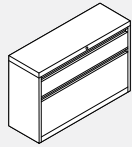

- One and half height storage module with long pull handles.
- Top opening is a 1/2 height box drawer.
- Bottom opening is a full height lateral drawer.

PRODUCT CODE	PRICE	SIZE/ INCHES			WEIGHT VOL	
		H	W	D	LBS	FT <sup>3</sup>
EVS1230X1H1F	1268	21.75	30	18	63.75	6.87
EVS1236X1H1F	1320	21.75	36	18	89.25	8.25
EVS1242X1H1F	1364	21.75	42	18	92.25	9.62

**EVS12X1S1F • One 1/2 Height Open Shelf & One 12" Fixed Front Lateral File**

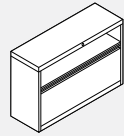

- One and half height storage module with long pull handles.
- Top opening is a half height open shelf.
- Bottom opening is a full 12" height lateral drawer.
- A drawer cannot be added to the top opening.

PRODUCT CODE	PRICE	SIZE/ INCHES			WEIGHT VOL	
		H	W	D	LBS	FT <sup>3</sup>
EVS1230X1S1F	1225	21.75	30	18	61.75	6.87
EVS1236X1S1F	1250	21.75	36	18	87.25	8.25
EVS1242X1S1F	1279	21.75	42	18	90.25	9.62

**EVS12X1SND • One 1/2 Height Open Shelf & One 12" Open Shelf Lateral Cabinet**

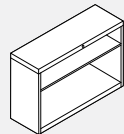

- One and half height storage module.
- Shelf is height adjustable.

PRODUCT CODE	PRICE	SIZE/ INCHES			WEIGHT VOL	
		H	W	D	LBS	FT <sup>3</sup>
EVS1230X1SND	989	21.75	30	18	58.75	6.87
EVS1236X1SND	1077	21.75	36	18	84.25	8.25
EVS1242X1SND	1153	21.75	42	18	87.25	9.62

**EVS12X1S • One 1/2 Height Shelf & One 12" Shelf Lateral Cabinet with Doors**

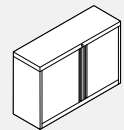

- One and half height storage module with long pulls.
- Storage cabinet with doors.
- One height adjustable shelf included.

PRODUCT CODE	PRICE	SIZE/ INCHES			WEIGHT VOL	
		H	W	D	LBS	FT <sup>3</sup>
EVS1230X1S	1040	21.75	30	18	63.75	6.87
EVS1236X1S	1161	21.75	36	18	89.25	8.25
EVS1242X1S	1262	21.75	42	18	92.25	9.62

**EVS12T502BF • Twelve Series BBF Storage Tower 50" High**

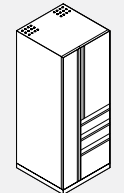

Left Shown

- This versatile tower can be used freestanding or integrated into a workstation to provide efficient vertical storage and filing, and provides storage for hats and coats.
- Coat storage may be specified right or left.
- Full height coat storage is 50" high x 8" wide with ventilation.
- Storage tower has 1 adjustable shelf and 1 fixed shelf with a 22" high door for 50" high unit.
- Tower comes with 3 locks, one for wardrobe, one for storage unit and one for box, box, file unit.

PRODUCT CODE	PRICE	SIZE/ INCHES			WEIGHT VOL	
		H	W	D	LBS	FT <sup>3</sup>
EVS12T502B1FR	2822	50	24	24	188.00	16.66
EVS12T502B1FL	2822	50	24	24	188.00	16.66

**EVS12T502F • Twelve Series FF Storage Tower 50" High**

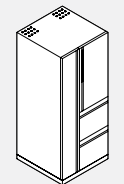

Left Shown

- This versatile tower can be used freestanding or integrated into a workstation to provide efficient vertical storage and filing, and provides storage for hats and coats.
- Coat storage may be specified right or left.
- Full height coat storage is 50" high x 8" wide with ventilation.
- Storage tower has 1 adjustable shelf and 1 fixed shelf with a 22" high door for 50" high unit.
- Tower comes with 3 locks, one for wardrobe, one for storage unit and one for file, file unit.

PRODUCT CODE	PRICE	SIZE/ INCHES			WEIGHT VOL	
		H	W	D	LBS	FT <sup>3</sup>
EVS12T502FR	2822	50	24	24	188.00	16.66
EVS12T502FL	2822	50	24	24	188.00	16.66

**EVS12TSO502F • Twelve Series Side Opening FF Storage Tower 50" High**

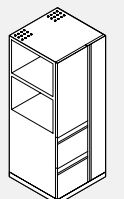

Right Shown

- This versatile tower can be used freestanding or integrated into a workstation to provide efficient vertical storage and filing, and provides storage for hats and coats.
- Coat storage may be specified right or left.
- Full height coat storage is 50" high x 8" wide with ventilation.
- Storage tower has 1 adjustable shelf and 1 fixed shelf with a 22" side opening for 50" high unit.
- Towers come with 2 locks, 1 for the file drawers and 1 for the coat locker.

PRODUCT CODE	PRICE	SIZE/ INCHES			WEIGHT VOL	
		H	W	D	LBS	FT <sup>3</sup>
EVS12TSO502FR	3117	50	24	24	188.00	16.66
EVS12TSO502FL	3117	50	24	24	188.00	16.66

**EVS12TS0502BF • Twelve Series Side Opening BBF Storage Tower 50" High**

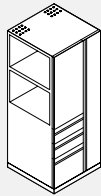

Right Shown

- This versatile tower can be used freestanding or integrated into a workstation to provide efficient vertical storage and filing, and provides storage for hats and coats.
- Coat storage may be specified right or left.
- Full height coat storage is 50" high x 8" wide with ventilation.
- Storage tower has 1 adjustable shelf and 1 fixed shelf with a 22" side opening for 50" high unit.
- Towers come with 2 locks, 1 for the file drawers and 1 for the coat locker.

PRODUCT CODE	PRICE	SIZE/ INCHES			WEIGHT LBS	VOL FT <sup>3</sup>
		H	W	D		
EVS12TS0502B1FR	3117	50	24	24	188.00	16.66
EVS12TS0502B1FL	3117	50	24	24	188.00	16.66

**EVS12T542BF • Twelve Series BBF Storage Tower 54" High**

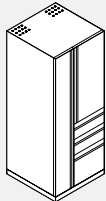

Left Shown

- This versatile tower can be used freestanding or integrated into a workstation to provide efficient vertical storage and filing, and provides storage for hats and coats.
- Coat storage may be specified right or left.
- Full height coat storage is 54" high x 8" wide with ventilation.
- Storage tower has 1 adjustable shelf and 1 fixed shelf with a 26" high door for 54" high unit.
- Tower comes with 3 locks, one for wardrobe, one for storage unit and one for box, box, file unit.

PRODUCT CODE	PRICE	SIZE/ INCHES			WEIGHT LBS	VOL FT <sup>3</sup>
		H	W	D		
EVS12T542B1FR	2836	54	24	24	163.00	22.00
EVS12T542B1FL	2836	54	24	24	163.00	22.00

**EVS12T542F • Twelve Series FF Storage Tower 54" High**

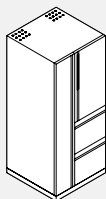

Left Shown

- This versatile tower can be used freestanding or integrated into a workstation to provide efficient vertical storage and filing, and provides storage for hats and coats.
- Coat storage may be specified right or left.
- Full height coat storage is 54" high x 8" wide with ventilation.
- Storage tower has 1 adjustable shelf and 1 fixed shelf with a 26" high door for 54" high unit.
- Tower comes with 3 locks, one for wardrobe, one for storage unit and one for file, file unit.

PRODUCT CODE	PRICE	SIZE/ INCHES			WEIGHT LBS	VOL FT <sup>3</sup>
		H	W	D		
EVS12T542FR	2836	54	24	24	163.00	22.00
EVS12T542FL	2836	54	24	24	163.00	22.00

**EVS12TS0542F • Twelve Series Side Opening FF Storage Tower 54" High**

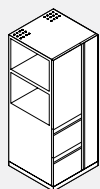

Right Shown

- This versatile tower can be used freestanding or integrated into a workstation to provide efficient vertical storage and filing, and provides storage for hats and coats.
- Coat storage may be specified right or left.
- Full height coat storage is 54" high x 8" wide with ventilation.
- Storage tower has 1 adjustable shelf and 1 fixed shelf with a 26" side opening for 54" high unit.
- Towers come with 2 locks, 1 for the file drawers and 1 for the coat locker.

PRODUCT CODE	PRICE	SIZE/ INCHES			WEIGHT LBS	VOL FT <sup>3</sup>
		H	W	D		
EVS12TS0542FR	3135	54	24	24	163.00	22.00
EVS12TS0542FL	3135	54	24	24	163.00	22.00

**EVS12TS0542BF • Twelve Series Side Opening BBF Storage Tower 54" High**

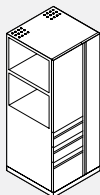

Right Shown

- This versatile tower can be used freestanding or integrated into a workstation to provide efficient vertical storage and filing, and provides storage for hats and coats.
- Coat storage may be specified right or left.
- Full height coat storage is 54" high x 8" wide with ventilation.
- Storage tower has 1 adjustable shelf and 1 fixed shelf with a 26" side opening for 54" high unit.
- Towers come with 2 locks, 1 for the file drawers and 1 for the coat locker.

PRODUCT CODE	PRICE	SIZE/ INCHES			WEIGHT LBS	VOL FT <sup>3</sup>
		H	W	D		
EVS12TS0542B1FR	3135	54	24	24	163.00	22.00
EVS12TS0542B1FL	3135	54	24	24	163.00	22.00

**EVS12T662BF • Twelve Series BBF Storage Tower 65 7/8" High**

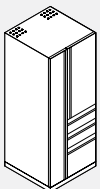

Left Shown

- This versatile tower can be used freestanding or integrated into a workstation to provide efficient vertical storage and filing, and provides storage for hats and coats.
- Coat storage may be specified right or left.
- Full height coat storage is 65" x 8" with ventilation.
- Storage towers with box, box, file drawers has 2 adjustable shelves and 1 fixed shelf and a 36" high door.
- Tower comes with 3 locks, one for wardrobe, one for storage unit and one for box, box, file unit.

PRODUCT CODE	PRICE	SIZE/ INCHES			WEIGHT LBS	VOL FT <sup>3</sup>
		H	W	D		
EVS12T662B1FR	2968	65.875	24	24	177.00	26.00
EVS12T662B1FL	2968	65.875	24	24	177.00	26.00

**EVS12T662F • Twelve Series FF Storage Tower 65 7/8" High**

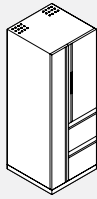

Left Shown

- This versatile tower can be used freestanding or integrated into a workstation to provide efficient vertical storage and filing, and provides storage for hats and coats.
- Coat storage may be specified right or left.
- Full height coat storage is 65" x 8" with ventilation.
- Storage towers with 2 file drawer or box, box, file drawers has 2 adjustable shelves and 1 fixed shelf and a 36" high door.
- Tower comes with 3 locks, one for wardrobe, one for storage unit and one for file, file unit.

PRODUCT CODE	PRICE	SIZE/ INCHES			WEIGHT LBS	VOL FT <sup>3</sup>
		H	W	D		
EVS12T662FR	2968	65.875	24	24	177.00	26.00
EVS12T662FL	2968	65.875	24	24	177.00	26.00

**EVS12TSO662BF • Twelve Series Side Opening BBF Storage Tower 65 7/8" High**

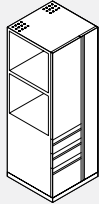

Right Shown

- This versatile tower can be used freestanding or integrated into a workstation to provide efficient vertical storage and filing, and provides storage for hats and coats.
- Coat storage may be specified right or left.
- Full height coat storage is 65" x 8" with ventilation.
- Storage towers with 2 file drawers or box, box, file drawers have 2 adjustable shelves and 1 fixed shelf and a 37" high opening.
- Towers come with 2 locks, 1 for the file drawers and 1 for the coat locker.

PRODUCT CODE	PRICE	SIZE/ INCHES			WEIGHT LBS	VOL FT <sup>3</sup>
		H	W	D		
EVS12TSO662B1FR	3187	65.875	24	24	177.00	26.00
EVS12TSO662B1FL	3187	65.875	24	24	177.00	26.00

**EVS12TSO662F • Twelve Series Side Opening FF Storage Tower 65 7/8" High**

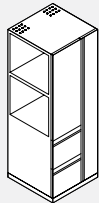

Right Shown

- This versatile tower can be used freestanding or integrated into a workstation to provide efficient vertical storage and filing, and provides storage for hats and coats.
- Coat storage may be specified right or left.
- Full height coat storage is 65" x 8" with ventilation.
- Storage towers with 2 file drawers or box, box, file drawers have 2 adjustable shelves and 1 fixed shelf and a 37" high opening.
- Towers come with 2 locks, 1 for the file drawers and 1 for the coat locker.

PRODUCT CODE	PRICE	SIZE/ INCHES			WEIGHT LBS	VOL FT <sup>3</sup>
		H	W	D		
EVS12TSO662FR	3187	65.875	24	24	177.00	26.00
EVS12TSO662FL	3187	65.875	24	24	177.00	26.00

**EVS12F • 12" Opening Lateral File Fixed Front Drawers**

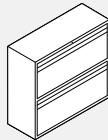

2 High

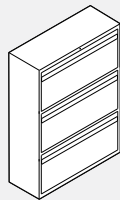

3 High

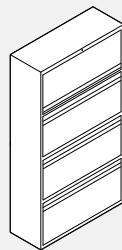

4 High

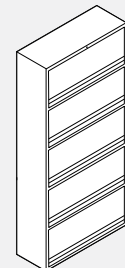

5 High

- 12" Opening Lateral File.
- Two High: -All openings are Fixed Front Drawer.
- Three High: - All openings are Fixed Front Drawer.
- Four High: - Top opening is Receding door and Roll-Out Shelf.
- Five High: - Top two opening is Receding Door and Roll-Out Shelf.
- Remaining 3 drawers are Fixed Front Drawer.
- Side-to-Side Bars and Lock included.

PRODUCT CODE	PRICE	SIZE/ INCHES			WEIGHT LBS	VOL FT <sup>3</sup>
		H	W	D		
2 High (Worksurface Supporting)						
EVS123022FWS	1268	27.75	30	18	103	8.60
EVS123622FWS	1327	27.75	36	18	110	10.41
EVS124222FWS	1399	27.75	42	18	117	12.14
3 High						
EVS123033F	1662	40.5	30	18	136	12.66
EVS123633F	1749	40.5	36	18	150	15.19
EVS124233F	1849	40.5	42	18	164	17.72
4 High						
EVS123041S3F	2112	54	30	18	169	16.88
EVS123641S3F	2226	54	36	18	190	20.25
EVS124241S3F	2352	54	42	18	211	23.63
5 High						
EVS123052S3F	2609	65.88	30	18	202	20.59
EVS123652S3F	2720	65.88	36	18	230	27.02
EVS124252S3F	2866	65.88	42	18	258	28.82

**EVS12R1F • 12" Receding Door and Roll-Out Shelves**

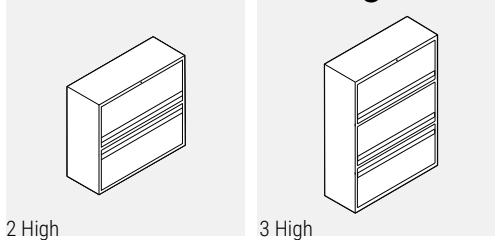

2 High

3 High

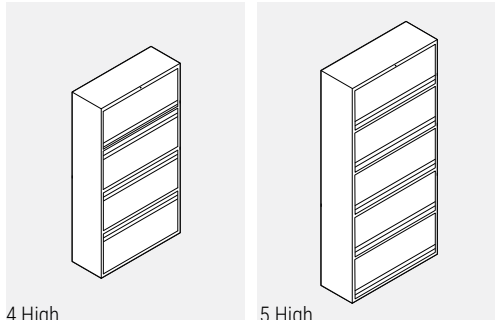

4 High

5 High

- 12" Opening Lateral File.
- Two High: - Top opening is Receding Door and Roll-out Shelf. - Bottom drawer is Fixed Front Drawer.
- Three High: - Top 2 openings are Receding Door and Roll-out Shelf. - Bottom drawer is Fixed Front Drawer.
- Four High: - Top 3 openings are Receding Door and Roll-out Shelf. - Bottom drawer is Fixed Front Drawer.
- Five High: - Top 4 openings are Receding Door and Roll-out Shelf. - Bottom drawer is Fixed Front Drawer.
- Side-to-Side Bars and Lock included.

PRODUCT CODE	PRICE	SIZE/ H	INCHES W	D	WEIGHT LBS	VOL FT <sup>3</sup>
<b>2 High (Worksurface Supporting)</b>						
EVS123021R1FWS	1254	27.75	30	18	103	8.60
EVS123621R1FWS	1307	27.75	36	18	110	10.41
EVS124221R1FWS	1384	27.75	42	18	117	12.14
<b>3 High</b>						
EVS123032R1F	1735	40.5	30	18	136	12.66
EVS123632R1F	1822	40.5	36	18	150	15.19
EVS124232R1F	1920	40.5	42	18	164	17.72
<b>4 High</b>						
EVS123043R1F	2219	54	30	18	169	16.88
EVS123643R1F	2335	54	36	18	190	20.25
EVS124243R1F	2460	54	42	18	211	23.63
<b>5 High</b>						
EVS123054R1F	2702	65.88	30	18	202	20.59
EVS123654R1F	2841	65.88	36	18	230	27.02
EVS124254R1F	3000	65.88	42	18	258	28.82

**EVS12S • 12" Receding Door and Fixed Shelves**

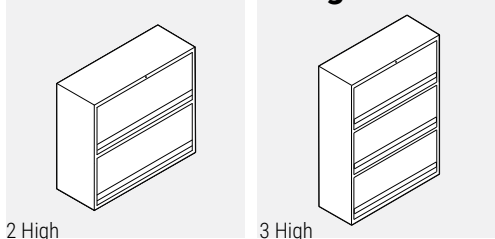

2 High

3 High

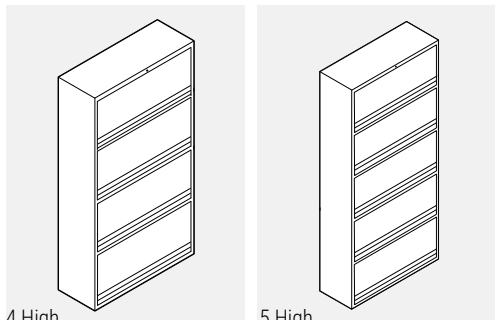

4 High

5 High

- 12" Opening Lateral File.
- Two High: - All openings are Receding Doors and Fixed Shelves.
- Three High: - All openings are Receding Doors and Fixed Shelves.
- Four High: - All openings are Receding Doors and Fixed Shelves.
- Five High: All openings are Receding Doors and Fixed Shelves.
- 3 Plate Dividers and Lock are included.

PRODUCT CODE	PRICE	SIZE/ H	INCHES W	D	WEIGHT LBS	VOL FT <sup>3</sup>
<b>2 High (Worksurface Supporting)</b>						
EVS123022SWS	1268	27.75	30	18	103	8.60
EVS123622SWS	1327	27.75	36	18	110	10.41
EVS124222SWS	1399	27.75	42	18	117	12.14
<b>3 High</b>						
EVS123033S	1662	40.5	30	18	136	12.66
EVS123633S	1749	40.5	36	18	150	15.19
EVS124233S	1849	40.5	42	18	164	17.72
<b>4 High</b>						
EVS123044S	2112	54	30	18	169	16.88
EVS123644S	2226	54	36	18	190	20.25
EVS124244S	2352	54	42	18	211	23.63
<b>5 High</b>						
EVS123055S	2609	65.88	30	18	202	20.59
EVS123655S	2720	65.88	36	18	230	27.02
EVS124255S	2867	65.88	42	18	258	28.82

**EVS121B3F • 12" Opening Lateral File with 1 "B" Opening Receding Door and 3 Fixed Shelves**

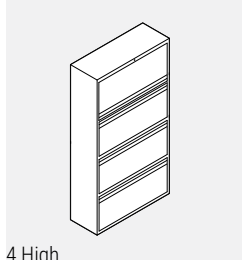

4 High

- 12" Opening Lateral File.
- Four High: - Top opening is "B" size with Receding Door, Fixed Shelf and 3 Plate Dividers. - Remaining 3 drawers are Fixed Front Drawer with Hanging File Bars.
- Five High: - Top opening is "B" size with Receding Door, Fixed Shelf and 3 Plate Dividers. - Remaining 4 drawers are Fixed Front Drawer with Hanging File Bars.
- Lock is included.

PRODUCT CODE	PRICE	SIZE/ H	INCHES W	D	WEIGHT LBS	VOL FT <sup>3</sup>
<b>4 High</b>						
EVS123041B3F	2283	54	30	18	103	16.88
EVS123641B3F	2373	54	36	18	110	20.25
EVS124241B3F	2461	54	42	18	117	23.63
<b>5 High</b>						
EVS123051B1S3F	2751	65.88	30	18	136	20.59
EVS123651B1S3F	2896	65.88	36	18	150	27.02
EVS124251B1S3F	3061	65.88	42	18	164	28.82

**EVS12BF • 12" Opening Multi Storage Unit**

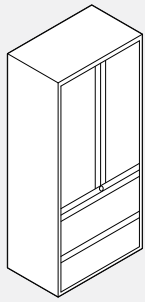

5 High (Lateral)

- Two lateral file drawers and closed cupboard with door height of 24.531".
- Includes 1 fully adjustable shelf and two locks.
- Shelf can be adjusted at 1" increment.
- Counterweight for 5 high should be used as needed.

PRODUCT CODE	PRICE	SIZE/ INCHES			WEIGHT VOL	
		H	W	D	LBS	FT <sup>3</sup>
<b>4 High (50" High)</b>						
EVS1230M502S2F	2665	50	30	18	185	16.66
EVS1236M502S2F	2853	50	36	18	209	18.75
EVS1242M502S2F	3072	50	42	18	233	21.88
<b>4 High (54" High)</b>						
EVS1230M542S2F	2796	54	30	18	191	18.88
EVS1236M542S2F	2992	54	36	18	215	20.25
EVS1242M542S2F	3225	54	42	18	238	23.63
<b>5 High (2 Lateral)</b>						
EVS1230M662S2F	3069	65.88	30	18	235	19.45
EVS1236M662S2F	3344	65.88	36	18	266	23.34
EVS1242M662S2F	3574	65.88	42	18	297	27.23
<b>5 High (3 Lateral)</b>						
EVS1230M662S3F	3083	65.88	30	18	235	19.45
EVS1236M662S3F	3344	65.88	36	18	266	23.34
EVS1242M662S3F	3607	65.88	42	18	297	27.23

**EVS12S • 12" Storage Cabinet with Hinged Door**

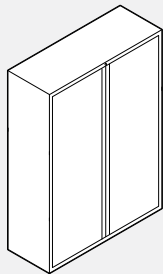

3 High

- 2S - 27 3/4" high with 1 shelf.
- 3S - 40 1/2" high with 2 shelves.
- 4S - 54" high with 3 shelves.
- 5S - 65 7/8" high with 4 shelves.
- 5W - 65 7/8" high wardrobe cabinet with a coat rod and 4 half shelves in the 36" and 42" wide units. 30" wide units have a coat rod and 4 coat hooks and one lock.

PRODUCT CODE	PRICE	SIZE/ INCHES			WEIGHT VOL	
		H	W	D	LBS	FT <sup>3</sup>
<b>2 High (Worksurface Supporting)</b>						
EVS12302SWS	1040	27.75	30	18	74	8.47
EVS12362SWS	1161	27.75	36	18	82	10.17
EVS12422SWS	1262	27.75	42	18	91	11.87
<b>3 High</b>						
EVS12303S	1297	40.5	30	18	100	12.66
EVS12363S	1459	40.5	36	18	113	15.19
EVS12423S	1612	40.5	42	18	126	17.72
<b>4 High</b>						
EVS12304S	1551	54	30	18	130	16.88
EVS12364S	1734	54	36	18	147	20.25
EVS12424S	1920	54	42	18	163	23.63
<b>5 High</b>						
EVS12305S	1751	65.88	30	18	155	20.59
EVS12365S	1961	65.88	36	18	177	27.02
EVS12425S	2176	65.88	42	18	195	28.82
<b>5 High Wardrobe</b>						
EVS12305W	1757	65.88	30	18	136	20.59
EVS12365W	1998	65.88	36	18	168	27.02
EVS12425W	2198	65.88	42	18	183	28.82

**EVS12SFSND • Open Storage Cabinet**

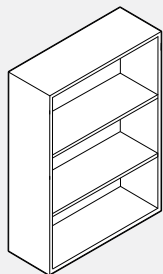

- Storage Cabinet with no doors.
- 2SIND - 27 3/4" high with 1 shelf.
- 3SIND - 40 1/2" high with 2 shelves.
- 4SIND - 54" high with 3 shelves.
- 5SIND - 65 7/8" high with 4 shelves.

PRODUCT CODE	PRICE	SIZE/ INCHES			WEIGHT VOL	
		H	W	D	LBS	FT <sup>3</sup>
<b>2 High (Worksurface Supporting)</b>						
EVS1230SF2SND	989	27.75	30	18	61	8.47
EVS1236SF2SND	1077	27.75	36	18	74	10.17
EVS1242SF2SND	1148	27.75	42	18	76	11.87
<b>3 High</b>						
EVS1230SF3SND	1109	40.5	30	18	93	12.66
EVS1236SF3SND	1232	40.5	36	18	100	15.19
EVS1242SF3SND	1345	40.5	42	18	113	17.72
<b>4 High</b>						
EVS1230SF4SND	1328	54	30	18	120	16.88
EVS1236SF4SND	1418	54	36	18	131	20.25
EVS1242SF4SND	1502	54	42	18	150	23.63
<b>5 High</b>						
EVS1230SF5SND	1531	65.88	30	18	140	20.59
EVS1236SF5SND	1620	65.88	36	18	146	27.02
EVS1242SF5SND	1690	65.88	42	18	160	28.82

**EVS12FKIT • 1212 Drawer Conversion Kit**

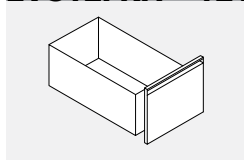

- Converts an existing box, box, file (6612) Pedestal into a file, file (1212).
- Kit includes 1-12" high drawer front, 1-12" high drawer body, set of slides and 1212 lock bar.
- Specify the type of conversion kit, colour of front, colour of handle, existing pedestal depth to be retrofitted.

PRODUCT CODE	PRICE	SIZE/ INCHES			WEIGHT VOL	
		H	W	D	LBS	FT <sup>3</sup>
EVS1218FKIT	188	15	15	18	12.75	1.6
EVS1223FKIT	188	15	15	23	14.50	2.02
EVS1224FKIT	188	15	15	24	14.50	2.02
EVS1229FKIT	188	15	15	29	16.00	2.59
EVS1230FKIT	188	15	15	30	16.00	2.59

**EVS12BKIT • 6612 Drawer Conversion Kit**

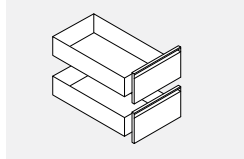

- Converts an existing file, file (1212) Pedestal into a box, box, file (6612).
- Kit includes 2-6" high drawer front, 2-6" high drawer body, 2 sets of slides and 6612 lock bar.
- Specify the type of conversion kit, colour of front, colour of handle, existing pedestal depth to be retrofitted.

PRODUCT CODE	PRICE	SIZE/ INCHES			WEIGHT VOL	
		H	W	D	LBS	FT <sup>3</sup>
EVS1218BKIT	188	15	15	18	14.80	1.7
EVS1223BKIT	188	15	15	23	17.00	2.02
EVS1224BKIT	188	15	15	24	17.00	2.02
EVS1229BKIT	188	15	15	29	23.50	2.6
EVS1230BKIT	188	15	15	30	23.50	2.6

**EVS12FFKIT • Fixed Front Door Conversion Kit**

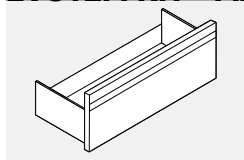

- Fixed front drawer conversion, receding door roll-out drawer.
- Indicate position (1,2,3,4 or 5) of conversion from top to bottom.
- Drawer interiors are finished in black.

PRODUCT CODE	PRICE	SIZE/ INCHES			WEIGHT VOL	
		H	W	D	LBS	FT <sup>3</sup>
EVS1230FFKIT	244	13.5	30	17	17.55	3.35
EVS1236FFKIT	244	13.5	36	17	25.47	4.09
EVS1242FFKIT	244	13.5	42	17	32.35	4.8

**EVS12BHHKIT • Half Height Door Conversion Kit**

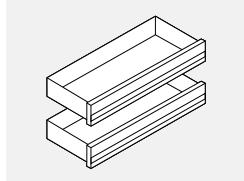

- Receding door and fixed slotted shelf conversion from fixed front drawer.
- Fixed front drawer can be substituted for a roll out drawer in a receding opening at no extra charge at the time of order.
- Add list price to each opening being converted.
- Indicate position (1,2,3,4,5) of conversion from top to bottom.

PRODUCT CODE	PRICE	SIZE/ INCHES			WEIGHT VOL	
		H	W	D	LBS	FT <sup>3</sup>
EVS1230BHHKIT	274	6.75	30	17	14.00	2.48
EVS1236BHHKIT	274	6.75	36	17	16.00	3.00
EVS1242BHHKIT	274	6.75	42	17	18.00	3.53

**EVS • Keys**

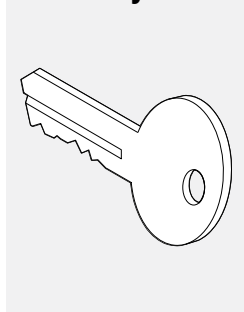

- Additional key (specify at time of order)

PRODUCT CODE	PRICE	WEIGHT VOL	
		LBS	FT <sup>3</sup>
<b>Additional key</b>			
EVSAK91	14	0.01	0.01
<b>Master key:</b>			
EVSMK91	36	0.01	0.01
<b>Extra key for existing cabinet:</b>			
EVSEK91	14	0.01	0.01
<b>Core Key</b>			
EVSCK91	17	0.01	0.01
<b>Core &amp; Key</b>			
EVLOCKKEY	41	0.01	0.01

**EVT • Lateral File Tops**

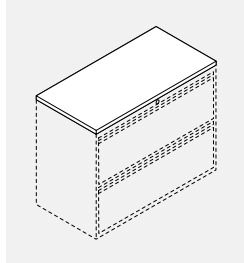

- Made of 1" or 1/16" thick particle board with laminate finish and edged in 3.0 mm edge banding.

PRODUCT CODE	PRICE		SIZE/ INCHES			WEIGHT VOL	
	LP	HP	H	W	D	LBS	FT <sup>3</sup>
EVT1830	147	207	1.0625	30	18	18.00	0.70
EVT1836	172	232	1.0625	36	18	22.00	0.82
EVT1842	201	309	1.0625	42	18	26.00	0.92
EVT1860	278	472	1.0625	60	18	37.00	1.27
EVT1872	330	534	1.0625	72	18	44.00	1.50
EVT1884	450	607	1.0625	84	18	52.00	1.85
EVT1890	487	662	1.0625	90	18	56.00	1.85
EVT18108	606	828	1.0625	108	18	67.00	2.20

**EVSHFB • Hanging File Bars**

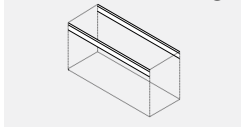

- Used in lateral files only.

PRODUCT CODE	PRICE	SIZE/ INCHES	WEIGHT LBS	VOL FT <sup>3</sup>
EVSHFB30	45	30	4.00	0.02
EVSHFB36	45	36	4.00	0.02
EVSHFB42	45	42	4.00	0.02

**EVSFBB • Front to Back Bars**

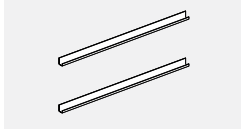

- Used in lateral files only.
- Shipped in pairs.

PRODUCT CODE	PRICE	SIZE/ INCHES	WEIGHT LBS	VOL FT <sup>3</sup>
EVSFBB	28	15.25	1.00	0.01

**EVSLAB • Legal to Letter Adapter**

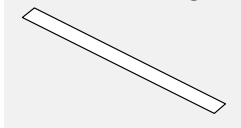

- Used in lateral files only.

PRODUCT CODE	PRICE	SIZE/ INCHES	WEIGHT LBS	VOL FT <sup>3</sup>
EVSLAB30	28	30	2.00	0.001
EVSLAB36	28	36	2.00	0.002
EVSLAB42	28	42	2.00	0.003

**EVS-PD • Divider Plates**

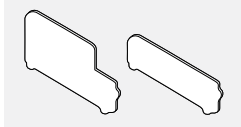

- Used in full-height shelves and lateral file drawers only.
- Three plates per package.
- Can be used for 16" overheads.

PRODUCT CODE	PRICE	SIZE/ INCHES	WEIGHT LBS	VOL FT <sup>3</sup>
EVSHPD03	53	Half Height	4	00.0 13.25 4.00 0.01
EVSFPD03	53	Full Height	7	00.0 13.25 4.00 0.01

**EVAPDIV • Pedestal Divider Plates**

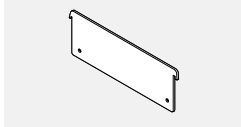

- Priced and shipped individually.

PRODUCT CODE	PRICE	SIZE/ INCHES	WEIGHT LBS	VOL FT <sup>3</sup>
EVAPDIV	48	3.5	12.625	4.00 0.10

**EVSEDPS • EDP Adapter**

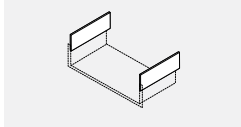

- Not recommended for use in receding front drawers.
- B opening only.

PRODUCT CODE	PRICE	SIZE/ INCHES	WEIGHT LBS	VOL FT <sup>3</sup>
EVSEDPS	48	3	16.5	0.10 0.10

**EVSCWB • Counterweight Balance**

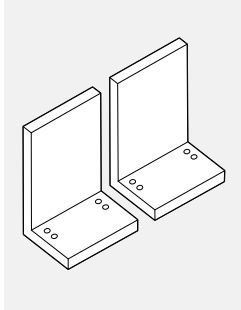

- Recommended for use in all laterals.
- Counterweights cannot be used in open storage cabinets.
- Counter weights for laterals cannot be field installed.

**NOTE: File cabinets with counterweight balances included must be specified as special, please contact your Customer Service Representative.**

PRODUCT CODE	PRICE	SIZE/ INCHES	WEIGHT LBS	VOL FT <sup>3</sup>
For 30" wide				
EVSCWB12301X	420			56
EVSCWB12302	278			42
EVSCWB12303	234			32
EVSCWB12304	234			33
EVSCWB12305	158			20
For 36" wide				
EVSCWB12361X	350			56
EVSCWB12362	314			48
EVSCWB12363	278			42
EVSCWB12364	228			31
EVSCWB12365	140			19
For 42" wide				
EVSCWB12421X	473			61
EVSCWB12422	404			61
EVSCWB12423	278			42
EVSCWB12424	278			42
EVSCWB12425	278			24
For Pedestals				
EVSCWBPED	124	Pedestal Field Installed		25
EVSCWBPEDF	230	Pedestal Factory Installed		25

**EVSCRGD-P • Double Wall Cabinet**

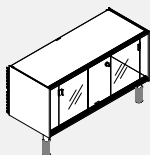

Round Leg Shown

- Unit shown with "R" round leg, for "S" square leg, please replace the "R" in the code with an "S" eg. EVSxC"R" to EVSxC"S".
- Panel Supported (Brackets Included)
- Wood top not included
- Available in standard paint finishes.
- Tracks for sliding door available in Tungsten only.
- Available in tempered frosted glass option only.

PRODUCT CODE	PRICE	SIZE/	INCHES			WEIGHT VOL	
		H	W	D	LBS	FT <sup>3</sup>	
EVSCRGD1330P	769	21	30	14.7	53.00	5.36	
EVSCRGD1336P	811	21	36	14.7	54.00	6.43	
EVSCRGD1342P	870	21	42	14.7	56.00	7.50	
EVSCRGD1348P	927	21	48	14.7	58.00	8.58	
EVSCRGD1354P	983	21	54	14.7	60.00	9.65	
EVSCRGD1360P	1027	21	60	14.7	62.00	10.72	

**EVSCRGD-F • Free Standing Double Wall Cabinet**

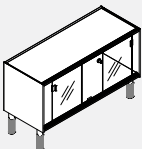

Round Leg Shown

- Unit shown with "R" round leg, for "S" square leg, please replace the "R" in the code with an "S" eg. EVSxC"R" to EVSxC"S".
- Free Standing with Back Wall
- Wood top not included
- Available in standard paint finishes.
- Tracks for sliding door available in Tungsten only.
- Available in tempered frosted glass option only.

PRODUCT CODE	PRICE	SIZE/	INCHES			WEIGHT VOL	
		H	W	D	LBS	FT <sup>3</sup>	
EVSCRGD1330F	893	21	30	14.7	53.00	5.36	
EVSCRGD1336F	939	21	36	14.7	54.00	6.43	
EVSCRGD1342F	1005	21	42	14.7	56.00	7.50	
EVSCRGD1348F	1067	21	48	14.7	58.00	8.58	
EVSCRGD1354F	1133	21	54	14.7	60.00	9.65	
EVSCRGD1360F	1181	21	60	14.7	62.00	10.72	

**EVSDCRGD • Back to Back Double Wall Cabinet**

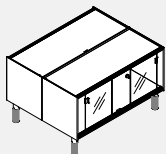

Round Leg Shown

- Unit shown with "R" round leg, for "S" square leg, please replace the "R" in the code with an "S" eg. EVSxC"R" to EVSxC"S".
- Back to Back Free Standing (back wall included)
- Wood top not included
- Available in standard paint finishes.
- Tracks for sliding door available in Tungsten only.
- Available in tempered frosted glass option only.

PRODUCT CODE	PRICE	SIZE/	INCHES			WEIGHT VOL	
		H	W	D	LBS	FT <sup>3</sup>	
EVSDCRGD1330	1565	21	30	29.4	106.00	10.72	
EVSDCRGD1336	1653	21	36	29.4	108.00	12.86	
EVSDCRGD1342	1775	21	42	29.4	112.00	15.01	
EVSDCRGD1348	1861	21	48	29.4	116.00	17.15	
EVSDCRGD1354	2019	21	54	29.4	120.00	19.29	
EVSDCRGD1360	2110	21	60	29.4	124.00	21.44	

**EVSCRGD-P • Panel Supported Wall Cabinet**

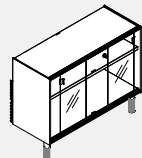

Round Leg Shown

- Unit shown with "R" round leg, for "S" square leg, please replace the "R" in the code with an "S" eg. EVSxC"R" to EVSxC"S".
- Panel supported (brackets included)
- Wood top not included
- Available in standard paint finishes.
- Tracks for sliding door available in Tungsten only.
- Available in tempered frosted glass option only.

PRODUCT CODE	PRICE	SIZE/	INCHES			WEIGHT VOL	
		H	W	D	LBS	FT <sup>3</sup>	
EVSCRGD2230P	1014	28	30	14.7	63.00	7.15	
EVSCRGD2236P	1065	28	36	14.7	64.00	8.58	
EVSCRGD2242P	1130	28	42	14.7	66.00	10.00	
EVSCRGD2248P	1188	28	48	14.7	68.00	11.43	
EVSCRGD2254P	1258	28	54	14.7	70.00	12.86	
EVSCRGD2260P	1313	28	60	14.7	72.00	14.29	

**EVSCRGD-F • Free Standing Double wall Cabinet**

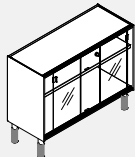

Round Leg Shown

- Unit shown with "R" round leg, for "S" square leg, please replace the "R" in the code with an "S" eg. EVSxC"R" to EVSxC"S".
- Panel supported (brackets included)
- Wood top not included
- Available in standard paint finishes.
- Tracks for sliding door available in Tungsten only.
- Available in tempered frosted glass option only.

PRODUCT CODE	PRICE	SIZE/	INCHES			WEIGHT VOL	
		H	W	D	LBS	FT <sup>3</sup>	
EVSCRGD2230F	1139	28	30	14.7	63.00	7.15	
EVSCRGD2236F	1188	28	36	14.7	64.00	8.58	
EVSCRGD2242F	1272	28	42	14.7	66.00	10.00	
EVSCRGD2248F	1341	28	48	14.7	68.00	11.43	
EVSCRGD2254F	1416	28	54	14.7	70.00	12.86	
EVSCRGD2260F	1473	28	60	14.7	72.00	14.29	

**EVSDCRGD • Back to Back Double wall Cabinet**

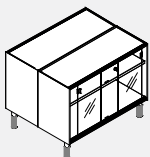

- Unit shown with "R" round leg, for "S" square leg, please replace the "R" in the code with an "S" eg. EVSxC"R" to EVSxC"S".
- Back to Back Free Standing (Back wall included)
- Wood top not included
- Available in standard paint finishes.
- Tracks for sliding door available in Tungsten only.
- Available in tempered frosted glass option only.

PRODUCT CODE	PRICE	SIZE/	INCHES			WEIGHT VOL	
		H	W	D	LBS	FT <sup>3</sup>	
EVSDCRGD2230	2055	28	30	29.4	126.00	14.29	
EVSDCRGD2236	2153	28	36	29.4	128.00	17.15	
EVSDCRGD2242	2300	28	42	29.4	132.00	20.01	
EVSDCRGD2248	2433	28	48	29.4	136.00	22.87	
EVSDCRGD2254	2584	28	54	29.4	140.00	25.73	
EVSDCRGD2260	2677	28	60	29.4	144.00	28.58	

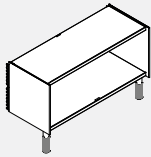

**EVSCRND-P • Double Wall Cabinet**

- Unit shown with "R" round leg, for "S" square leg, please replace the "R" in the code with an "S" eg. EVSxC"R" to EVSxC"S".
- Panel supported (brackets included)
- Wood top not included
- Available in standard paint finishes.

PRODUCT CODE	PRICE	SIZE/	INCHES		WEIGHT VOL	
		H	W	D	LBS	FT <sup>3</sup>
EVSCRND1330P	576	21	30	14.7	51.00	5.36
EVSCRND1336P	597	21	36	14.7	52.00	6.43
EVSCRND1342P	614	21	42	14.7	54.00	7.50
EVSCRND1348P	646	21	48	14.7	56.00	8.58
EVSCRND1354P	664	21	54	14.7	58.00	9.65
EVSCRND1360P	681	21	60	14.7	60.00	10.72

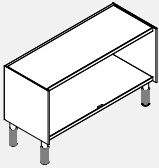
**EVSCRND-F • Free Standing Double Wall Cabinet**

- Unit shown with "R" round leg, for "S" square leg, please replace the "R" in the code with an "S" eg. EVSxC"R" to EVSxC"S".
- Wood top not included, includes back wall.
- Available in standard paint finishes.

PRODUCT CODE	PRICE	SIZE/	INCHES		WEIGHT VOL	
		H	W	D	LBS	FT <sup>3</sup>
EVSCRND1330F	700	21	30	14.7	51.00	5.36
EVSCRND1336F	726	21	36	14.7	52.00	6.43
EVSCRND1342F	747	21	42	14.7	54.00	7.50
EVSCRND1348F	788	21	48	14.7	56.00	8.58
EVSCRND1354F	811	21	54	14.7	58.00	9.65
EVSCRND1360F	837	21	60	14.7	60.00	10.72

**EVT • Double Wall Cabinet Top**

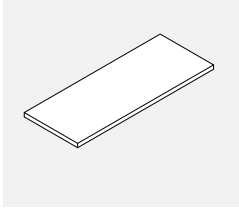

- Laminate top for double wall cabinet.

PRODUCT CODE	PRICE		SIZE/	INCHES		WEIGHT VOL	
	LP	HP		W	D	LBS	FT <sup>3</sup>
EVT1430	106	141	30	14.5	11.33	0.25	
EVT1436	120	163	36	14.5	13.59	0.30	
EVT1442	136	186	42	14.5	15.86	0.35	
EVT1448	155	205	48	14.5	18.13	0.40	
EVT1454	167	220	54	14.5	20.39	0.45	
EVT1460	188	251	60	14.5	22.66	0.50	

**EVT • Back to Back Double Wall Cabinet Top**

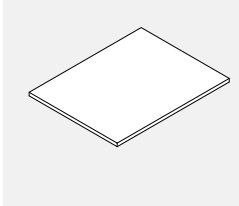

- Laminate top for double wall cabinet.

PRODUCT CODE	PRICE		SIZE/	INCHES		WEIGHT VOL	
	LP	HP		W	D	LBS	FT <sup>3</sup>
EVT2930	198	217	30	29.4	22.97	0.51	
EVT2936	234	252	36	29.4	27.56	0.61	
EVT2942	331	355	42	29.4	32.16	0.71	
EVT2948	350	377	48	29.4	36.75	0.82	
EVT2954	383	409	54	29.4	41.34	0.92	
EVT2960	408	439	60	29.4	45.94	1.02	

**EVWSRL01 • Worksurface round Support Leg**

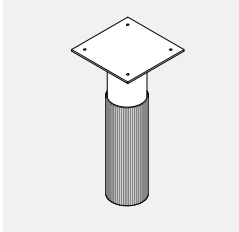

- Provides supports when worksurface overhangs 21”H Double Wall Storage or 1.5H 1200 Series Cabinet Storage must have File Top.
- Must be used to support the worksurface in conjunction with panel mounted hardware.
- Contains a levelling glide and PVC sleeve.
- 1.5 diameter round tube.
- Available in standard paint finishes.
- Available in BLK (Black) only

PRODUCT CODE	PRICE	SIZE/	INCHES		WEIGHT VOL	
			H	W	D	LBS
EVWSRL01	45	4.5	3	3	1.00	0.03

**EVWSSL01 • Worksurface Square Support Leg**

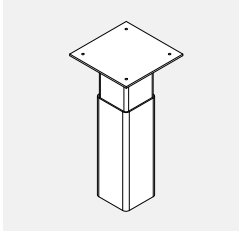

- Provides supports when worksurface overhangs 21”h Double Wall Storage or 1.5H 1200 Series Cabinet Storage must have File Top.
- Must be used to support the worksurface in conjunction with panel mounted hardware.
- Contains a levelling glide and PVC sleeve.
- 1.5” x 1.5” square tube.
- Available in standard paint finishes.
- Available in BLK (Black) only

PRODUCT CODE	PRICE	SIZE/	INCHES		WEIGHT VOL	
			H	W	D	LBS
EVWSSL01	45	4.5	3	3	1.00	0.03

**EVECC • Vertical Wire Channel**

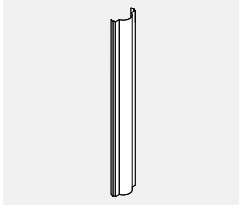

- **PVC extrusion attaches to panel vertical to provide enclosure for a power or light cord.**
- Available in 16” and 32” lengths, six per package.
- Can be cut to required lengths on site.
- Panel frame finish

PRODUCT CODE	PRICE	SIZE/
<b>Straight Run</b>		
EVECC121	29	21
EVECC136	36	36
<b>Corner</b>		
EVECC221	29	21
EVECC236	36	36

**EVALB • Load Bar**

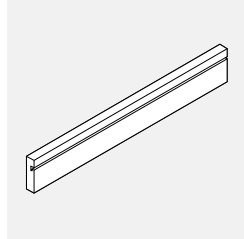

- Enables accessory items to be hung from a panel or wall.
- Includes end caps and mounting brackets.

PRODUCT CODE	PRICE	SIZE/ INCHES		
		H	W	D
EVALB24	129	2.25	24	1
EVALB30	142	2.25	30	1
EVALB36	156	2.25	36	1
EVALB42	182	2.25	42	1
EVALB48	207	2.25	48	1
EVALB54	227	2.25	54	1
EVALB60	240	2.25	60	1

**EVALB2 • Ganging Load Bar - Top**

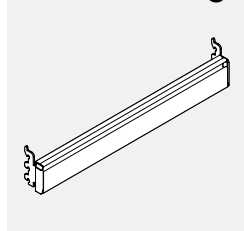

- Enables accessory items to be hung from a panel or wall
- Includes end caps and mounting brackets.
- Can connect to EVALB2-2 and/or EVALB2-3 Load Bars to create a multi-level bar or "Slat Wall" or can be used on its own.

PRODUCT CODE	PRICE	SIZE/ INCHES		
		H	W	D
EVALB224	101	2.25	24	1
EVALB230	109	2.25	30	1
EVALB236	113	2.25	36	1
EVALB242	120	2.25	42	1
EVALB248	127	2.25	48	1
EVALB254	130	2.25	54	1
EVALB260	135	2.25	60	1

**EVALB22 • Ganging Load Bar - Middle**

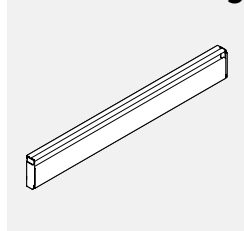

- Enables accessory items to be hung from a panel or wall.
- Includes end caps and is to be used in conjunction with the Ganging Load Bar-Top (EVALB) mounting brackets NOT included.
- Can connect to EVALB2 and/or EVALB2-3 Load Bars to create a multi-level bar or "Slat Wall".
- Wall". Multiples of EVALB2-2 can be joined one below the other to create the "Slat Wall".
- Must be used on conjunction with an EVALB2 or a combination of EVALB2 and EVALB2-3.

PRODUCT CODE	PRICE	SIZE/ INCHES		
		H	W	D
EVALB2-224	67	2.25	24	1
EVALB2-230	75	2.25	30	1
EVALB2-236	79	2.25	36	1
EVALB2-242	87	2.25	42	1
EVALB2-248	91	2.25	48	1
EVALB2-254	99	2.25	54	1
EVALB2-260	103	2.25	60	1

**EVALB23 • Ganging Load Bar - Bottom**

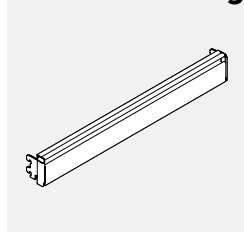

- Enables accessory items to be hung from a panel or wall.
- Includes end caps and mounting brackets.
- Must connect to EVALB2 and/or EVALB2-3 Load Bars to create a multi-level bar or "Slat Wall".
- Must be used on conjunction with an EVALB2 or a combination of EVALB2 and EVALB2-2.

PRODUCT CODE	PRICE	SIZE/ INCHES		
		H	W	D
EVALB2-324	99	2.25	24	1
EVALB2-330	103	2.25	30	1
EVALB2-336	109	2.25	36	1
EVALB2-342	113	2.25	42	1
EVALB2-348	122	2.25	48	1
EVALB2-354	128	2.25	54	1
EVALB2-360	132	2.25	60	1

**EVACH01 • Coat Hook**

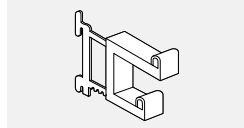

- Panel mounted coat hook.**
- Panel frame finish
  - Not available in Fog (FOG)
  - Not available in Metal Paper Accessory Colours

PRODUCT CODE	PRICE	SIZE/ INCHES			WEIGHT VOL	
		H	W	D	LBS	FT <sup>3</sup>
EVACH01	67	3	0.75	3	0.2	0.001

**EVACH02 • Panel Coat Hook**

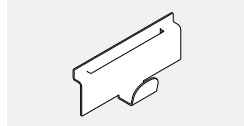

- Panel mounted coat hook.**
- Installed at panel top in groove between module and top trim.
  - Available in standard and premium paint colors.
  - Priced per six piece package.

PRODUCT CODE	PRICE	SIZE/ INCHES			WEIGHT VOL	
		H	W	D	LBS	FT <sup>3</sup>
EVACH02	89	1	2.5	0.625	0.8	0.01

**CPN01 • Name Plate**

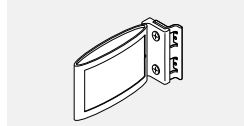

- Name plate can be set either as a single-sided (parallel to panel surface) or double-sided (perpendicular to panel surface - for aisle applications, displaying name on both sides).
- Injection molded frame and die-cast base with black rubberized finish. Steel bracket and fasteners included.
- Includes two slide-in name cards.

PRODUCT CODE	PRICE	SIZE/ INCHES			WEIGHT VOL	
		H	W	D	LBS	FT <sup>3</sup>
CPNP01	67	3.3	5.3	1.25	0.3	0.013

**EVANP02 • Name Plate**

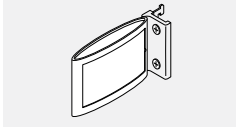

- Name plate attaches to 1" increment slots of Evolve. It can be set either as a single-sided (parallel to panel surface) or double-sided (perpendicular to panel surface - for aisle applications, displaying name on both sides).
- Injection molded frame and die-cast base with black rubberized finish. Steel bracket and fasteners included
- Includes two slide-in name cards.

PRODUCT CODE	PRICE	SIZE/ INCHES			WEIGHT VOL	
		H	W	D	LBS	FT <sup>3</sup>
EVANP02	86	3.3	5.3	1.25	0.3	0.013

**EVATB • Fabric Tackboard**

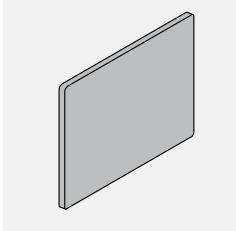

- To provide a tackable surface for notes and memos in a work area. Panel mounted.**
- Includes set of 4 mounting brackets.
  - Class "A" Fire Rated Fabric.

PRODUCT CODE	PRICE		SIZE/ INCHES			WEIGHT VOL	
	GR1	GR2	H	W	D	LBS	FT <sup>3</sup>
EVATB1730	253	266	17	30	0.25	3	0.416
EVATB1736	289	303	17	36	0.25	4	0.500
EVATB1742	330	343	17	42	0.25	4	0.583
EVATB1748	367	385	17	48	0.25	5	0.666
EVATB1754	407	428	17	54	0.25	5	0.750
EVATB1760	447	469	17	60	0.25	6	0.833
EVATB2130	253	262	21	30	0.25	3	0.416
EVATB2136	289	298	21	36	0.25	4	0.500
EVATB2142	330	341	21	42	0.25	4	0.583
EVATB2148	367	381	21	48	0.25	5	0.666
EVATB2154	407	426	21	54	0.25	5	0.750
EVATB2160	447	468	21	60	0.25	6	0.833
EVATB2430	253	263	24	30	0.25	3	0.416
EVATB2436	289	303	24	36	0.25	4	0.500
EVATB2442	342	367	24	42	0.25	4	0.583
EVATB2448	383	407	24	48	0.25	5	0.666
EVATB2454	428	494	24	52	0.25	5	0.750
EVATB2460	447	468	24	60	0.25	6	0.833

**EVHTVM • TV Mount**

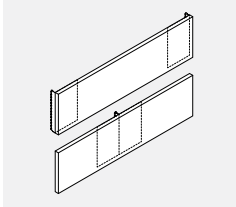

- Laminate panel with two mounting brackets to be installed on Evolve panels.
- TV Mount can be installed on panel of equal width or both brackets can be attached in middle for installing on single connector.
- TV frame not included, TV frame to be ordered separately.
- Note: TV frame must be securely attach to laminate panel. Care should be taken to attach TV frame using correct fasteners.
- Failure to do so may result in collapse of unit and subsequent possible injury.

PRODUCT CODE	PRICE	SIZE/ INCHES			WEIGHT VOL	
		H	W	D	LBS	FT <sup>3</sup>
EVHTVM24	168	11	24	1.0	14.00	0.46
EVHTVM30	184	11	30	1.0	17.00	0.52
EVHTVM36	198	11	36	1.0	19.00	0.60
EVHTVM42	213	11	42	1.0	22.00	0.68

**EVPMP542 • Privacy Mesh Divider**



- Divider attaches to connector.
- Available with Visionknit mesh only.
- Current available (others available upon request)
  - GRY Grey
  - BOR Burnt Orange
- Wire frame upholstered in Visionknit mesh.
- Visionknit mesh easy to replace.
- Wire frame painted in standard paint finishes.
- For each mesh colour ordered, minimum order must be 25 pcs.
- If mesh colour ordered is less than 25 pcs, there will be upcharge fee \$132 net per each mesh colour.
- Note: Divider can be only used with 42"h. segmented panels (24" bottom and 12" top module configuration only).
- Divider attaches to top 12" module.

PRODUCT CODE	PRICE	SIZE/ INCHES			WEIGHT VOL	
		H	W	D	LBS	FT <sup>3</sup>
EVPMP542	152	12	24	0.250	5	0.416

**EVAWB • Write Board**

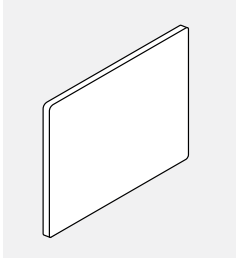

- To provide a writing surface in a work area. Panel mounted.
- Includes set of 4 mounting brackets.
- Black trim only

PRODUCT CODE	PRICE	SIZE/ INCHES			WEIGHT VOL	
		H	W	D	LBS	FT <sup>3</sup>
EVAWB2130	284	21	30	3	0.416	
EVAWB2136	323	21	36	4	0.500	
EVAWB2142	361	21	42	4	0.588	
EVAWB2148	420	21	48	5	0.833	
EVAWB2430	284	24	30	3	0.416	
EVAWB2436	323	24	36	4	0.500	
EVAWB2442	361	24	42	4	0.588	
EVAWB2448	420	24	48	5	0.833	

**EVAMT • Marker Tray**

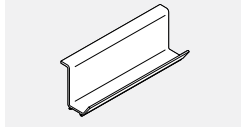

- Provides a tray for storage of markers, erasers. etc.
- Attaches to the bottom of the White Marker Board.

PRODUCT CODE	PRICE	SIZE/ INCHES	WEIGHT LBS	VOL FT <sup>3</sup>
EVAMT12	15	12	0.5	0.01

**EVSOFD • Overhead Divider**



- Attaches to EVSOF12 or EVSOF13 Overhead top shelf inside the overhead.
- Provides a rigid division for books and binders.
- Sold per pair.

PRODUCT CODE	PRICE	SIZE/ H	INCHES W	WEIGHT LBS	VOL FT <sup>3</sup>
EVSOFD01	56	10	0.1875	0.8	0.02

**EVAOMFD • Dry Erase Marker Board**

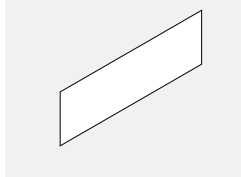

- Adheres magnetically to the door fo a flipper door overhead.

PRODUCT CODE	PRICE	SIZE/ H	INCHES W	D	WEIGHT LBS	VOL FT <sup>3</sup>
EVAOMFD24	220	14.4	22.8	0.05		
EVAOMFD30	253	14.4	28.8	0.05		
EVAOMFD36	290	14.4	34.8	0.05		
EVAOMFD42	331	14.4	40.8	0.05		
EVAOMFD48	362	14.4	46.8	0.05		
EVAOMFD54	380	14.4	52.8	0.05		
EVAOMFD60	410	14.4	58.8	0.05		

**EVAOMBW • Dry Erase Marker Board**

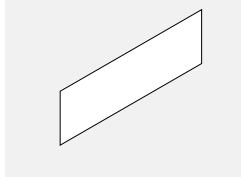

- Adheres magnetically to the back wall of the AODA Overhead.

PRODUCT CODE	PRICE	SIZE/ H	INCHES W	D	WEIGHT LBS	VOL FT <sup>3</sup>
EVAOMBW30	253	14.4	29.2	0.05		
EVAOMBW36	290	14.4	35.5	0.05		
EVAOMBW42	331	14.4	41.2	0.05		
EVAOMBW48	362	14.4	47.2	0.05		
EVAOMBW54	380	14.4	53.2	0.05		
EVAOMBW60	410	14.4	59.2	0.05		

**EVED50 • Duo Module**

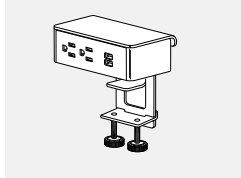

- The duo power module is completely integrated with a mounting clamp to attach to the edge of a worksurface.
- Provides two outlets and two 2.1 amp USB ports.
- White face plate, outlets and bracket; 72" long three-prong black cord.

PRODUCT CODE	PRICE	SIZE/ H	INCHES W	D	WEIGHT LBS	VOL FT <sup>3</sup>
EVED50	615	1.8	5.5	3.2	2.50	0.14

**EVED50AC • Duo Module with A+C**

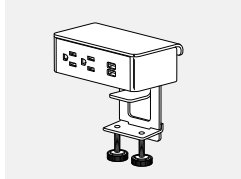

- The Duo power module is completely integrated with a mounting clamp to attach to the edge of a worksurface.
- Provides two 15 Amp 120 Volt AC Receptacles; 2.4 amp USB-A port and 60 watt USB-C power delivery port.
- 10' long three-prong cord.
- Available in W - White or B - Black as indicated by last letter of model number.

PRODUIT CODE	PRIX	TAILLE/ H	POUCES L	P	POIDS LB	VOLUME PI <sup>3</sup>
EVED50ACW	695	3	5.5	3.2	3	0.2
EVED50ACB	695	3	5.5	3.2	3	0.2

**EVEDU51 • Duo Under Module**

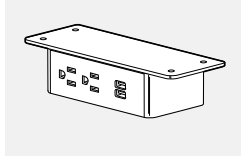

- The duo under power module comes with a thin flush mounting bracket to attach to the underside of a work surface or above work surface shelves.
- Provides two outlets and two 2.1 amp USB ports.
- White face plate, outlets and brackets; 72" long three-prong black cord.

PRODUCT CODE	PRICE	SIZE/ H	INCHES W	D	WEIGHT LBS	VOL FT <sup>3</sup>
EVEDU51	537	1.8	5.5	2.8	2.5	0.14

**EVEDU51AC • Duo Under Module**

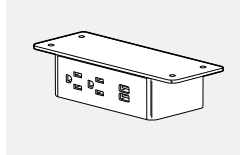

- The Duo under power module comes with a thin flush mounting bracket to attach to the underside of a work surface or above work surface shelves.
- Provides two 15 Amp 120 Volt AC Receptacles; 2.4 amp USB-A port and 60 watt USB-C power delivery port.
- 10' long three-prong cord.
- Available in W - White or B - Black as indicated by last letter of model number.

PRODUCT CODE	PRICE	TAILLE/ POUCES			POIDS VOLUME	
		H	L	P	LB	PI <sup>3</sup>
EVEDU51ACW	695	1.8	5.5	2.8	3	0.2
EVEDU51ACB	695	1.8	5.5	2.8	3	0.2

**EVEDB52 • Duo Bezel Module**

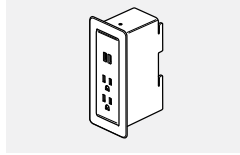

- The duo bezel power module is embedded and flush-mounted in a piece of furniture or a work surface.
- Provides two outlets and two 2.1 amp USB ports.
- White face plate, outlets and bezel; 72" long three-prong black cord.
- Contact your Customer Service Representative for surface applications.

PRODUCT CODE	PRICE	SIZE/ INCHES			WEIGHT VOL	
		H	W	D	LBS	FT <sup>3</sup>
EVEDB52	576	4	6.5	3.2	2.5	0.14

**EVETP53 • Trio Plus Module**

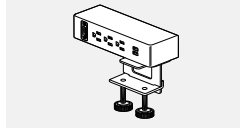

- The trio plus power module is completely integrated with a mounting clamp to attach to the edge of a work surface or above work surface shelves.
- Provides three outlets and two 2.1 amp USB ports and an adapter kit containing blank cover, HDMI, RJ45 or VGA adapter brackets. Note: HDMI, RJ45 and VGA connectors are not included.
- White face plate, outlets, adapters and brackets; 72" long three-prong black cord.

PRODUCT CODE	PRICE	SIZE/ INCHES			WEIGHT VOL	
		H	W	D	LBS	FT <sup>3</sup>
EVETP53	693	1.8	8	3.2	2.5	0.14

**EVETPB55 • Trio Plus Bezel Module**

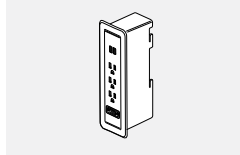

- The trio plus bezel power module is embedded and flush-mounted in a piece of furniture or a work surface.
- Provides three outlets and two 2.1 amp USB ports and an adapter kit containing blank cover, HDMI, RJ45 or VGA adapter brackets. Note: HDMI, RJ45 and VGA connectors are not included.
- White face plate, outlets, adapters and bezel; 72" long three-prong black cord.
- Contact your Customer Service Representative for surface applications.

PRODUCT CODE	PRICE	SIZE/ INCHES			WEIGHT VOL	
		H	W	D	LBS	FT <sup>3</sup>
EVETPB55	662	4	9	3.2	2.5	0.14

**EVMA1 • Single Clamp Mount Monitor Arm**

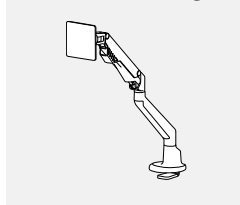

- Finger touch dynamic height adjustment, 12" height range. 4.4 to 19.8 lbs. per monitor loading capacity; accepts screen size 17"-30".
- Maximum monitor width of 34".
- Maximum of 20.5" extension from rear of desk to back of monitor, folds to 4.5".
- Tilt, pan and landscape to portrait rotation; quick release VESA plate, 180 degree lock out.
- Clamp mount and grommet mount options included, accommodates 0.5" to 2" thick tops.
- Accepts mini slide arm GAMS.
- Available in TUN - Tungsten only.

PRODUCT CODE	PRICE	SIZE/ INCHES			WEIGHT VOL	
		H	W	D	LBS	FT <sup>3</sup>
EVMA1	460	21		5.5	6.6	0.4

**EVMA2 • Double Clamp Mount Monitor Arm**

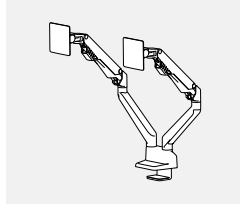

- Finger touch dynamic height adjustment, 12" height range. 4.4 to 19.8 lbs. per monitor loading capacity; accepts screen size 17"-30".
- Maximum monitor width of 34".
- Maximum of 20.5" extension from rear of desk to back of monitor, folds to 4.5".
- Tilt, pan and landscape to portrait rotation; quick release VESA plate, 180 degree lock out.
- Clamp mount and grommet mount options included, accommodates 0.5" to 2" thick tops.
- Accepts mini slide arm GAMS.
- Available in TUN - Tungsten only.

PRODUCT CODE	PRICE	SIZE/ INCHES			WEIGHT VOL	
		H	W	D	LBS	FT <sup>3</sup>
EVMA2	807	21		5.5	12.8	1

**EVAMS • Mini Slide Monitor Arm**

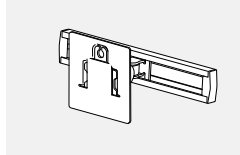

- Works with GAMA1 and GAMA2 monitor arms.
- 9" slide, loading capacity 13.2lbs.
- Quick release VESA plate.
- Available in TUN - Tungsten only.

PRODUCT CODE	PRICE	SIZE/ INCHES			WEIGHT VOL	
		H	W	D	LBS	FT <sup>3</sup>
EVAMS	160	4.5	11	6	3.3	0.3

**EVELEDVS • LED Single Arm Lamp**

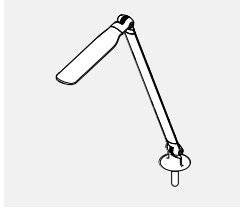

- 7 System watts, 18-fractional LEDs.
- 3500K 250 lumens, 84CRI.
- Soft touch - instant on, fade to off.
- Infinite dimming 100% down to 15%, last state memory.
- Standard 10 hours turn off (ATO).
- 50,000 hour life LEDs.
- 15 watt, 24 volt wall transformer, 6' cord.
- White (WHT)or Black (BLK) - Must specify colour choice.

PRODUCT CODE	PRICE	SIZE/ INCHES			WEIGHT VOL	
		H	W	D	LBS	FT <sup>3</sup>
EVELEDVS	616	8	7	33	7.3	0.98
<b>With occupancy sensor</b>						
EVELEDVSO	920	10	9	35	8.3	1.51

- UL, CUL and CSA compliant, ETL Listed.
- Base not included.

**EVELEDVD • LED Double Arm Lamp**

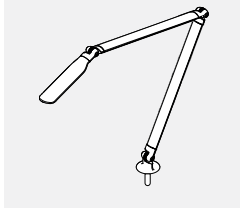

- 7 System watts, 18-fractional LEDs.
- 3500K 250 lumens, 84CRI.
- Double arm articulation with 20" base to head reaches.
- Soft touch - instant on, fade to off.
- Infinite dimming 100% down to 15%, last state memory.
- Standard 10 hours turn off (ATO).
- 50,000 hour life LEDs.
- 15 watt, 24 volt wall transformer, 6' cord.
- White (WHT)or Black (BLK) - Must specify colour choice.

PRODUCT CODE	PRICE	SIZE/ INCHES			WEIGHT VOL	
		H	W	D	LBS	FT <sup>3</sup>
EVELEDVD	633	8	7	33	7.6	1.02
<b>With occupancy sensor</b>						
EVELEDVDO	931	10	9	35	8.6	1.57

- UL, CUL and CSA compliant, ETL Listed.
- Base not included.

**EVELEDRS • LED Single Arm Lamp**

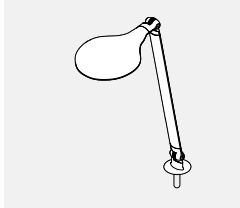

- 7 System watts, 18-fractional LEDs.
- 3500K 250 lumens, 84CRI.
- Soft touch - instant on, fade to off.
- Infinite dimming 100% down to 15%, last state memory.
- Standard 10 hours turn off (ATO).
- 50,000 hour life LEDs.
- 15 watt, 24 volt wall transformer, 6' cord.
- White (WHT)or Black (BLK) - Must specify colour choice.

PRODUCT CODE	PRICE	SIZE/ INCHES			WEIGHT VOL	
		H	W	D	LBS	FT <sup>3</sup>
EVELEDRS	616	8	7	33	7.3	0.98
<b>With occupancy sensor</b>						
EVELEDRSO	920	10	9	35	8.3	1.51

- UL, CUL and CSA compliant, ETL Listed.
- Base not included.

**EVELEDRD • LED Double Arm Lamp**

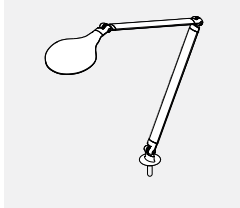

- 7 System watts, 18-fractional LEDs.
- 3500K 250 lumens, 84CRI.
- Double arm articulation with 20" base to head reaches.
- Soft touch - instant on, fade to off.
- Infinite dimming 100% down to 15%, last state memory.
- Standard 10 hours turn off (ATO).
- 50,000 hour life LEDs.
- 15 watt, 24volt wall transformer, 6' cord.
- White (WHT)or Black (BLK) - Must specify colour choice.

PRODUCT CODE	PRICE	SIZE/ INCHES			WEIGHT VOL	
		H	W	D	LBS	FT <sup>3</sup>
EVELEDRD	633	8	7	33	7.6	1.02
<b>With occupancy sensor</b>						
EVELEDRDO	931	10	9	35	8.6	1.57

- UL, CUL and CSA compliant, ETL Listed.
- Base not included.

**Lamp Mounting Options**



**Grommet Mount**

PRODUCT CODE	PRICE	SIZE/ INCHES	WEIGHT VOL			
		H	W	D	LBS	FT <sup>3</sup>
EVELEDASM	155	3	6	6	3	0.06

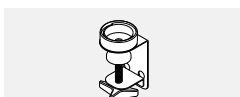

**Worksurface Mount**

PRODUCT CODE	PRICE	SIZE/ INCHES	WEIGHT VOL			
		H	W	D	LBS	FT <sup>3</sup>
EVELEDACM	155	3	6	6	2	0.04

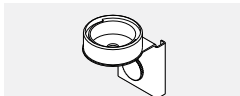

**Slatwall Mount**

PRODUCT CODE	PRICE	SIZE/ INCHES	WEIGHT VOL			
		H	W	D	LBS	FT <sup>3</sup>
EVELEDASW	155	3	6	6	3	0.06



**Panel Mount**

PRODUCT CODE	PRICE	SIZE/ INCHES	WEIGHT VOL			
		H	W	D	LBS	FT <sup>3</sup>
EVELEDAPM	155	3	6	6	3	0.06

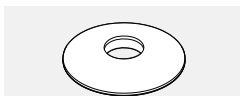

**Weighted Base**

PRODUCT CODE	PRICE	SIZE/ INCHES	WEIGHT VOL			
		H	W	D	LBS	FT <sup>3</sup>
EVELEDAFS	173	4	12	12	6	0.50

**EVABB01 • Binder Bin**

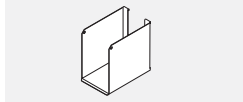

- Load bar/accessory rail mounted metal binder bin.
- Panel frame finish

PRODUCT CODE	PRICE	SIZE/ H	INCHES			WEIGHT VOL	
			W	D	LBS	FT <sup>3</sup>	
EVABB01	56	9	5.75	9.25	1.85	0.21	

**EVAFS01 • Flip Sorter**

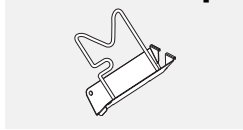

- Load bar/accessory rail mounted metal flip sorter. Comes with nickel plated wire.
- Panel frame finish

PRODUCT CODE	PRICE	SIZE/ H	INCHES			WEIGHT VOL	
			W	D	LBS	FT <sup>3</sup>	
EVAFS01	39	9	3	9	0.6	0.14	

**EVASS01 • Slant Sorter**



Right hand Shown

- Load bar/accessory rail mounted metal slant sorter.
- Panel frame finish

PRODUCT CODE	PRICE	SIZE/ H	INCHES			WEIGHT VOL	
			W	D	LBS	FT <sup>3</sup>	
EVASS01R	34	9.25	2.75	9	1	0.28	
EVASS01L	34	9.25	2.75	9	1	0.28	

**EVALT01 • Letter Tray**

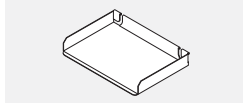

- Load bar/accessory rail mounted metal letter tray.
- Panel frame finish

PRODUCT CODE	PRICE	SIZE/ H	INCHES			WEIGHT VOL	
			W	D	LBS	FT <sup>3</sup>	
EVALT01	42	1.75	12	8.75	0.5	0.15	

**EVALT02 • Legal Tray**

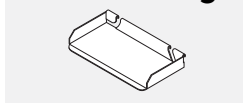

- Load bar/accessory rail mounted metal legal tray.
- Panel frame finish

PRODUCT CODE	PRICE	SIZE/ H	INCHES			WEIGHT VOL	
			W	D	LBS	FT <sup>3</sup>	
EVALT02	56	1.75	14.7	8.75	0.5	0.15	

**EVAMB01 • Media Bin**

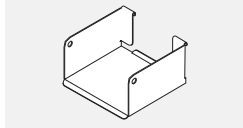

- Load bar/accessory rail mounted.
- Panel frame finish

PRODUCT CODE	PRICE	SIZE/ H	INCHES			WEIGHT VOL	
			W	D	LBS	FT <sup>3</sup>	
EVAMB01	42	3	5.75	5.25	0.8	0.05	

**EVAUT01 • Utility Tray**

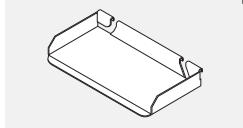

- Load bar/accessory rail mounted metal utility tray.
- Panel frame finish

PRODUCT CODE	PRICE	SIZE/ H	INCHES			WEIGHT VOL	
			W	D	LBS	FT <sup>3</sup>	
EVAUT01	29	1	7.5	3.75	0.5	0.02	

**EVAPP01 • Mail Box**

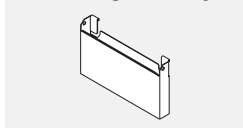

- Load bar/accessory rail mounted.
- Panel frame finish

PRODUCT CODE	PRICE	SIZE/ H	INCHES			WEIGHT VOL	
			W	D	LBS	FT <sup>3</sup>	
EVAPP01	70	7	12	1.75	2	0.25	

**EVATH01 • Telephone Holder**

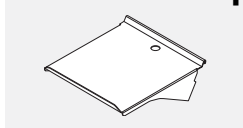

- Load bar/rail mounted telephone holder.
- Panel frame finish

PRODUCT CODE	PRICE	SIZE/ H	INCHES			WEIGHT VOL	
			W	D	LBS	FT <sup>3</sup>	
EVATH01	66	2	8	10	2	0.26	

**EVPFD-WS • Worksurface Felt Divider**

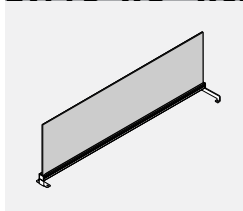

- Privacy felt divider integrated into an aluminum top trim.
- Attaches on top of a worksurface to add privacy or divide space.
- Must be used at connector location.
- Includes aluminum trim with channel, felt tile and brackets.
- 9 mm felt material is tackable and comes in 18 different colors. Please specify felt finish.
- Aluminum extrusion and brackets available in standard paint finishes.
- Felt tile and attachment hardware to ship separately.

PRODUCT CODE	PRICE	SIZE/ H	INCHES			WEIGHT VOL	
			W	D	LBS	FT <sup>3</sup>	
EVPFD1818WS	153	18	18	1	2.26	0.75	
EVPFD1824WS	172	18	24	1	2.77	0.94	
EVPFD1830WS	193	18	30	1	3.29	1.13	
EVPFD1836WS	210	18	36	1	3.8	1.31	



**Why Softpod?**

Softpod is where flexibility meets focus - bringing a new work style option to the Global family of products. This sleek privacy pod is a cozy, secluded space dedicated to focus. Its multi-segmented dividers and hexagon shape offer flexibility for both privacy and space planning.

**Divider:**

- PET Felt / aluminum composition
- Channel edge allows for add-on privacy

**PET Felt features:**

- Tackable acoustic material
- Soft form capability

**Electrical:**

- Simple interconnect / direct plug-in or
- Hard wire formats

**Storage:**

- Solution based

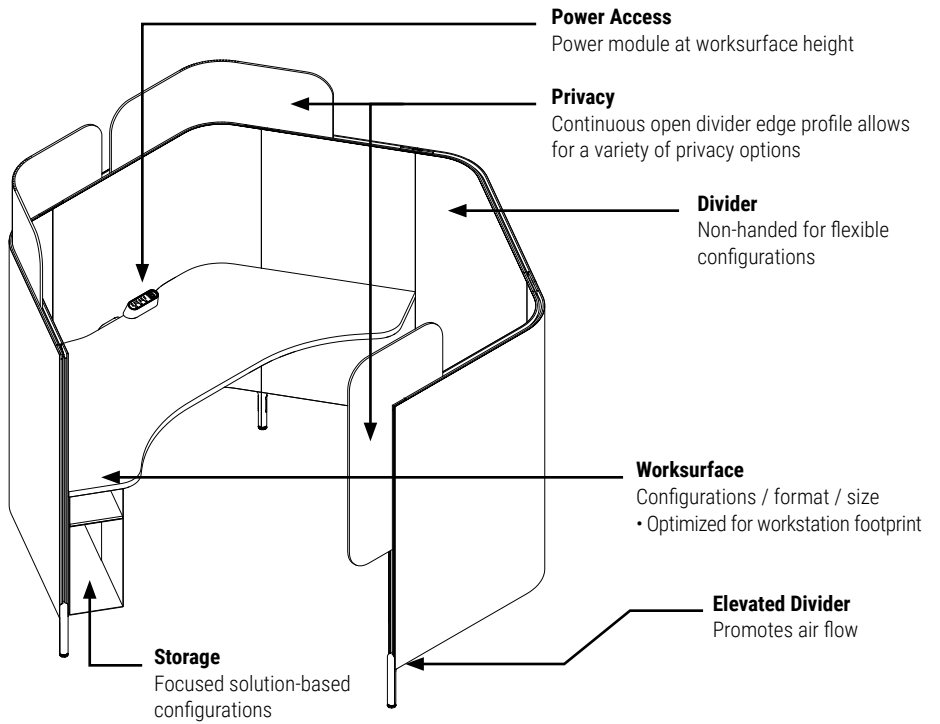

**Statement Of Line**

**Softpods**

**HX3P5472SW**  
Softpod with 3 Dividers and Worksurface

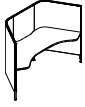

**HX4P5472SW**  
Softpod with 4 Dividers and Worksurface



**HX4P5472R/LW**  
Softpod with 4 Dividers and Wrap Around Worksurface

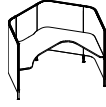

**HX5P5472SW**  
Softpod with 5 Dividers and Worksurface

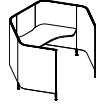

**HX5P5472WW**  
Softpod with 5 Dividers and Wrap Around Worksurface

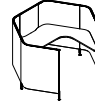

**HXP5430**  
Single J-divider



**Extensions**

**HXPAEFE**  
End PET Felt Extension Divider Add-on



**HXPACFE**  
Corner PET Felt Extension Divider Add-on

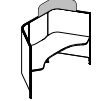

**HXPATCFE**  
Top Corner PET Felt Extension Divider Add-on



**Electrical**

**BRED50**  
Duo Module



**BRETP53**  
Trio Plus Module

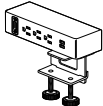

**HXEUWC**  
Under Worksurface/ Edge USB Charger



**GAADG**  
Access Door Module



**GAADCT**  
Access Door Module with Cable Tray

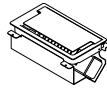

**GMDSA10**  
ModPower Starter Mounted Unit

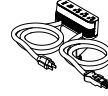

**GMDEA3**  
ModPower End Mounted Unit



**GMDSF10**  
ModPower In Surface Starter Unit



**GMDCF3**  
ModPower In Surface Middle Unit



**GMDEF3**  
ModPower In Surface End Unit



**GMDCLIPS**  
ModPower Management Clips



**GMDJ36BK**  
ModPower Interconnecting Jumper



**GMDPC22W**  
Slim Desktop Power Module, 2 Duplex



**GMDPC32W**  
Slim Desktop Power Module, 3 Duplex



**HXEPK**  
Station 2-Circuit Power Kit



**HXECS**  
Cable Shroud



**HXEPPJ**  
Station to Station Jumper



**HXECS**  
Ceiling Feed



**HXEBF**  
Base Feed



**HXECP**  
Ceiling Feed Pole



**HXEPGK**  
Divider Grommet Kit



**HXEPGCS**  
Divider Grommet Connector / Spacer



**Accessories**

**BLVELEDVS**  
LED Single Arm Lamp



**BLVELEDVD**  
LED Double Arm Lamp



**BLVELEDRS**  
LED Single Arm Lamp



**BLVELEDRD**  
LED Double Arm Lamp



**BLVELEDASC**  
Lamp Mounting Options



**BLVELEDAFS**  
Lamp Mounting Options



**HXAHS**  
Hanging Shelf



**HXAHSWB**  
Hanging Shelf with Dry Erase Board



**HXARWS**  
Rear Wall Shelf



**HXACHS**  
Coat/Bag Hook for Dividers



**HXACHT**  
Coat/Bag Hook for Dividers Edge



**HXABH**  
Under Surface Bag Hook



**HXNP**  
Name Plate



**Storage**

**HXSCSO**  
Under Worksurface Casual Storage Unit



**L2PO**  
Pantry Storage

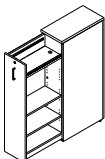

**Footprint**

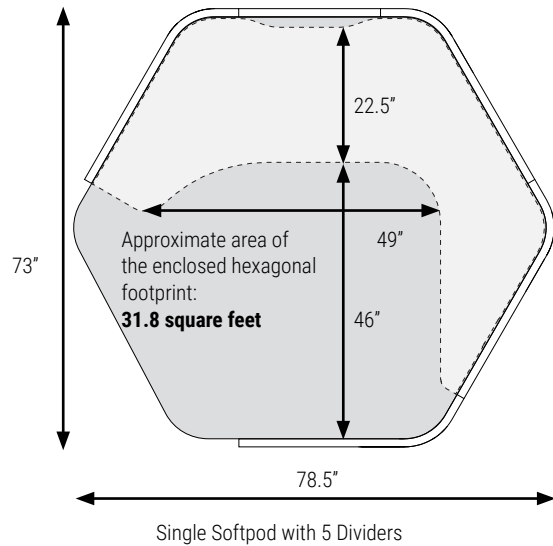
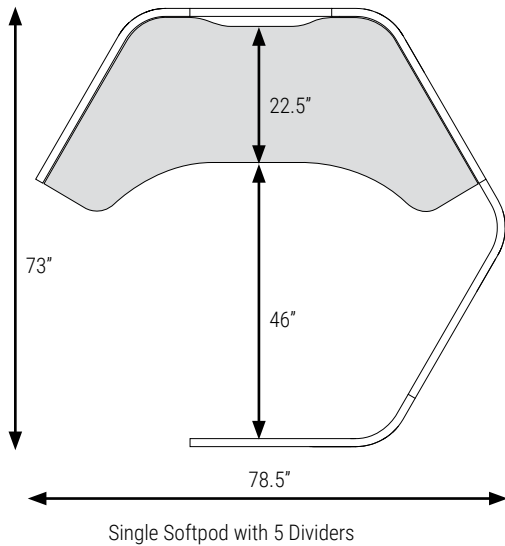
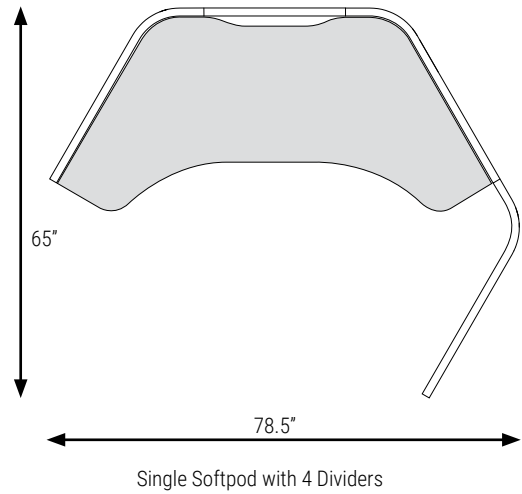
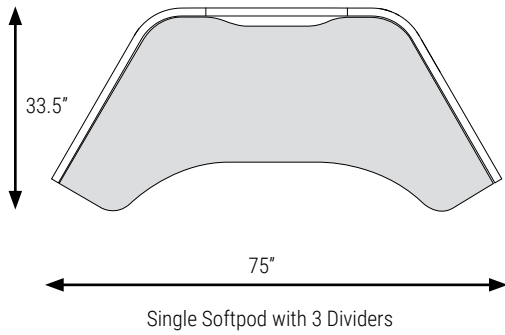

**Off Grid Planning**

The flexible format of Softpod offers a variety of planning options and encourages both on and off grid layouts. From a single or cluster of Softpods this versatile system adapts to your needs.

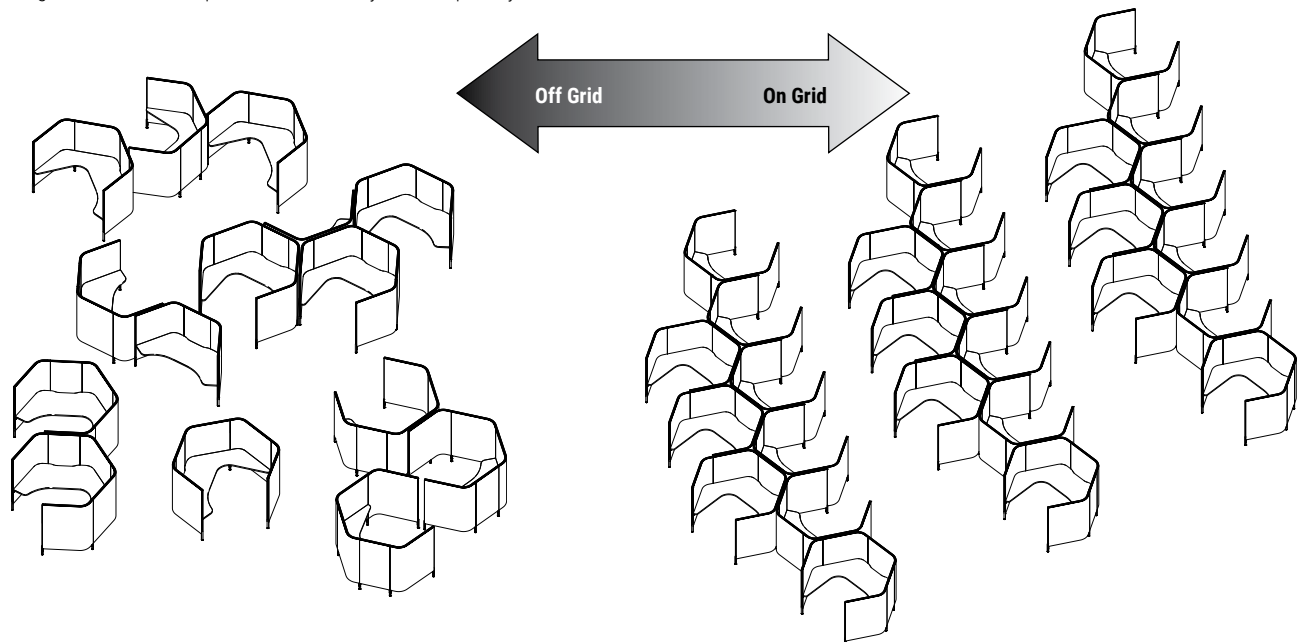

**Off Grid Planning**

**Agile**

The freestanding, single Softpod can flex to support any number of employees in a hybrid work environment. The pods can be easily reconfigured and adjusted as needs change. Its small kit of parts and thoughtfully designed features make it easy to specify and keep inventory counts low. Easy to specify and keep inventory counts low.

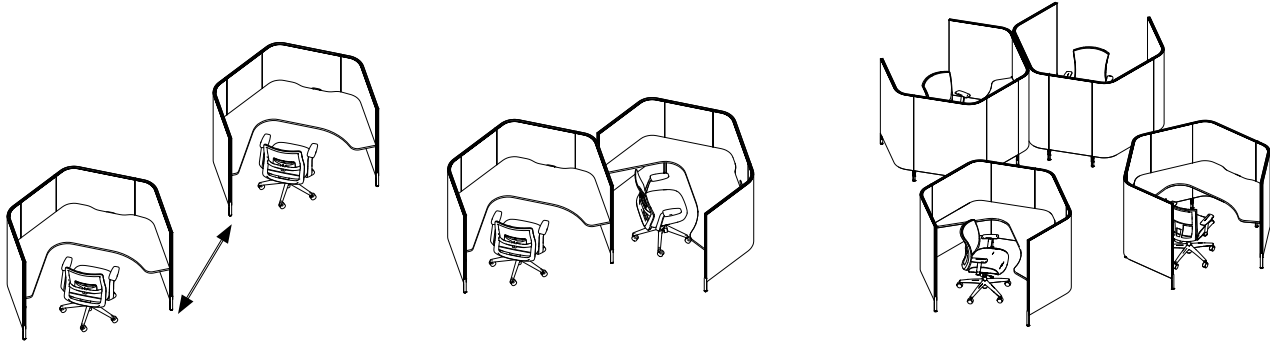

**Scalable**

The adaptable dividers give the ability to address the level of privacy needed on a station by station basis.

**Softpod PRIVACY**

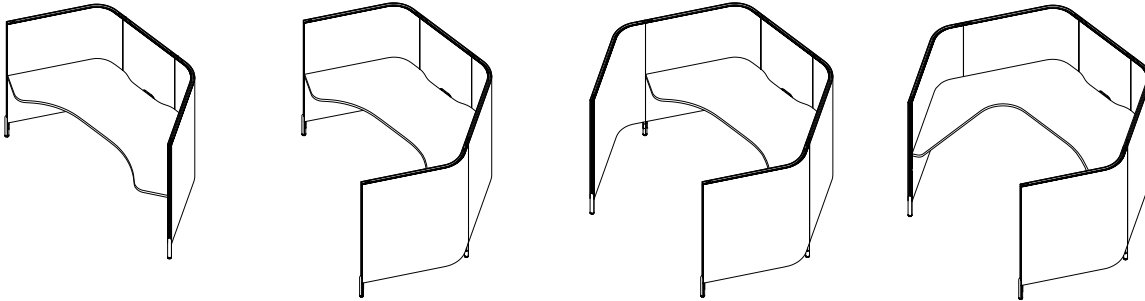

**Extensions - PRIVACY**

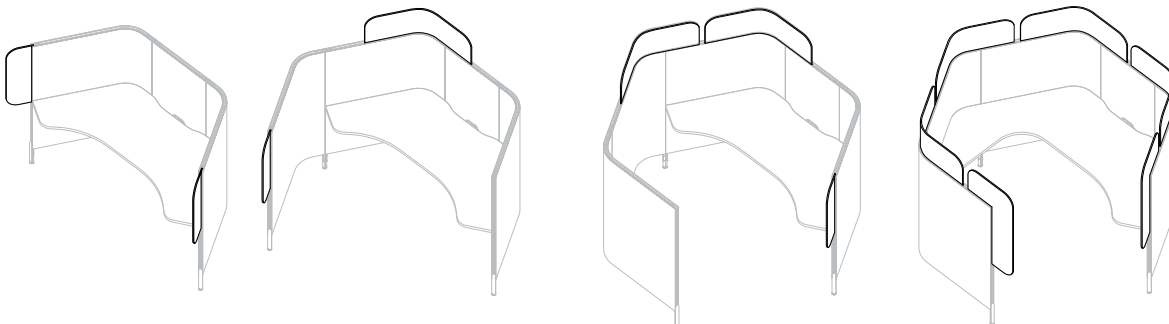

**Quick Specification**

Softpod's small and complete kits allows for quick and efficient movement of product from time of specification to installation.

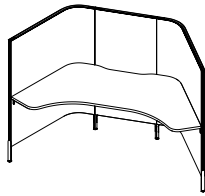

Single Pod with 3 Dividers

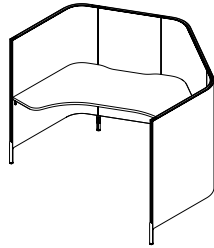

Single Pod with 4 Dividers

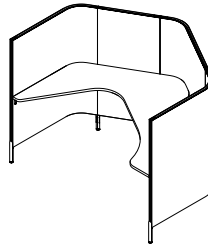

Single Pod with 4 Dividers and Wrap Around Surface

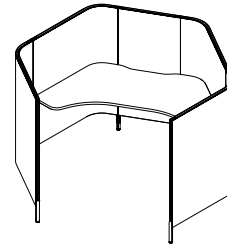

Single Pod with 5 Dividers

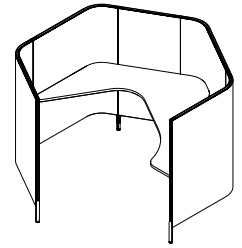

Single Pod with 5 Dividers and Wrap Around Surface

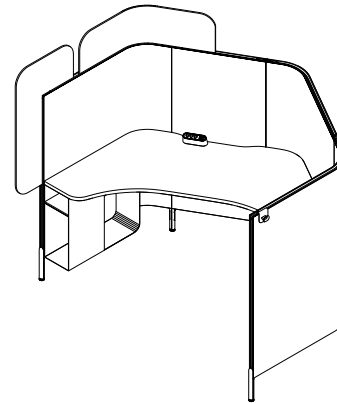
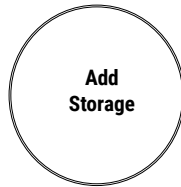
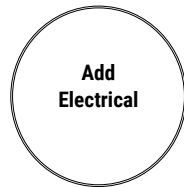

**Power Connections**

**Plug In**

Simple casual wire - Direct plug-in or hard wired.

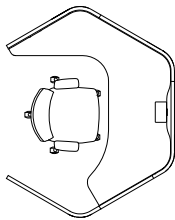

**Daisy Chain Interconnect System**

Plug-in power supply and interlinked, pre-determined, universal modules. If specified, one module is shipped with the station and interconnected on site.

Integrating additional station (C) requires disconnecting A from B and plugging in the C on site.

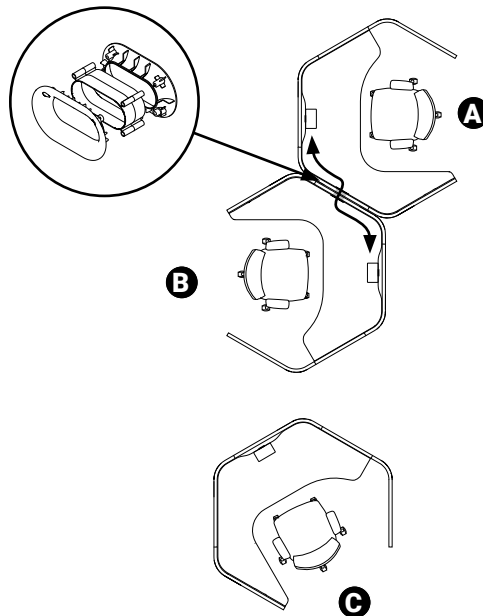

**Dual Circuit Power**

Outlets mounted below worksurfaces.

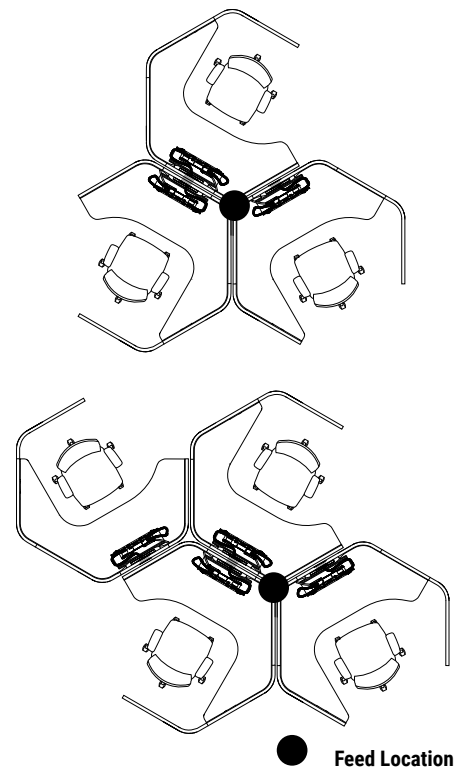

Space Planning

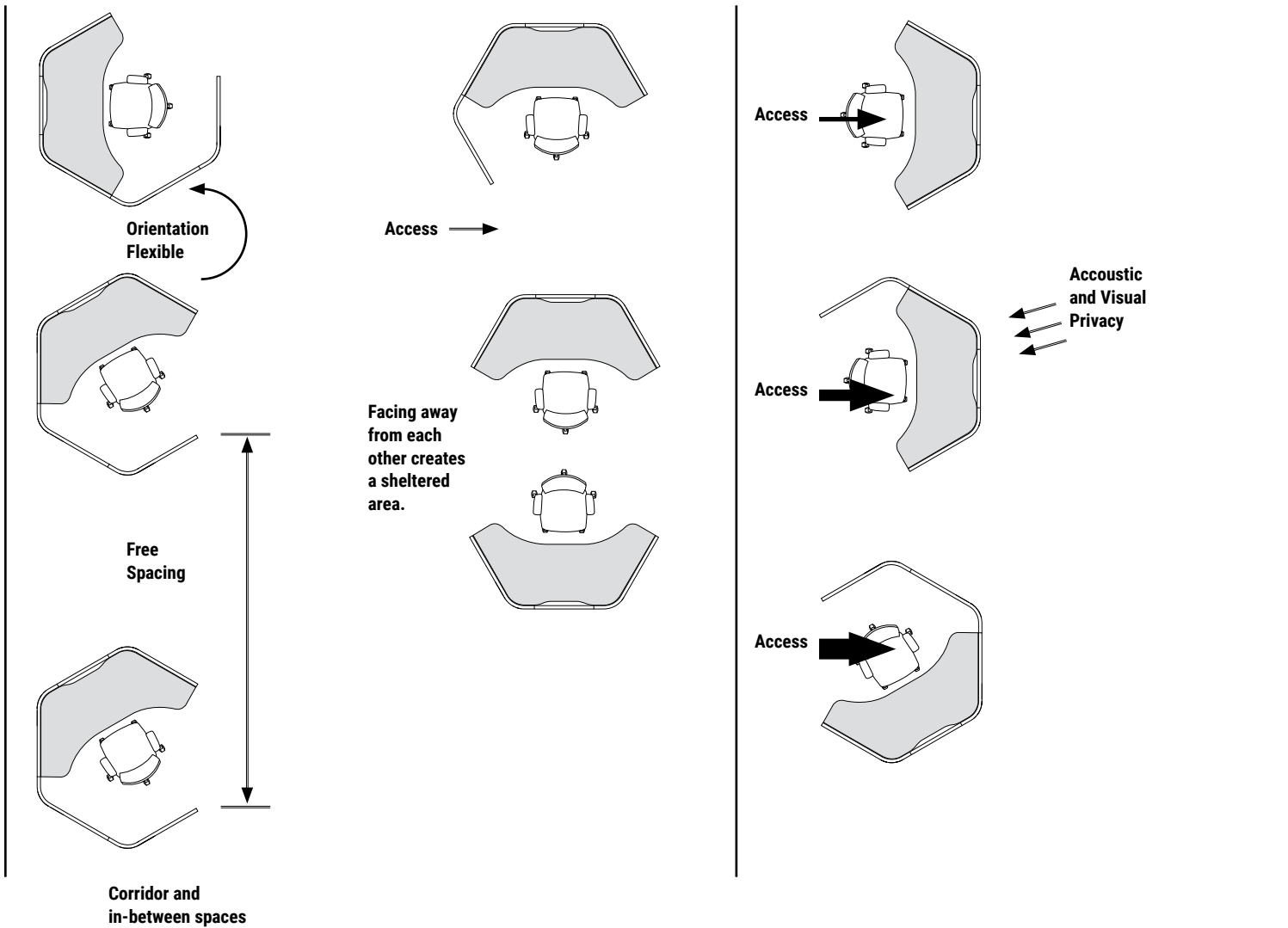

**Pod Formats**

Align units in cluster plan  
Option unit type & orientation

(A) Worksurfaces must have opposing alignment

Flat and curved dividers are non-handed and symmetrical. The addition of the legs determines if the j-dividers becomes LEFT handed or RIGHT handed. Any j-divider can be configured and re-configured LEFT or RIGHT.

Maximum 4 unit cluster per 2 circuits

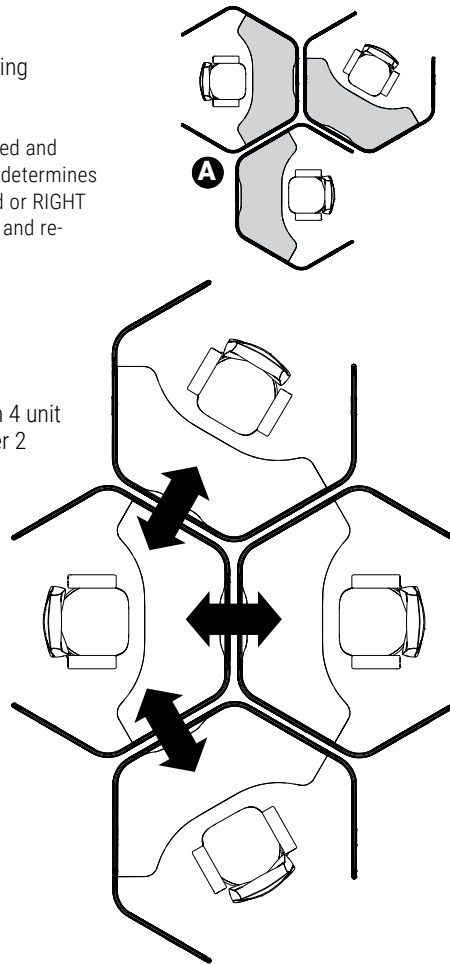

Power/ data is delivered through divider via grommet

Grommet tethers units together

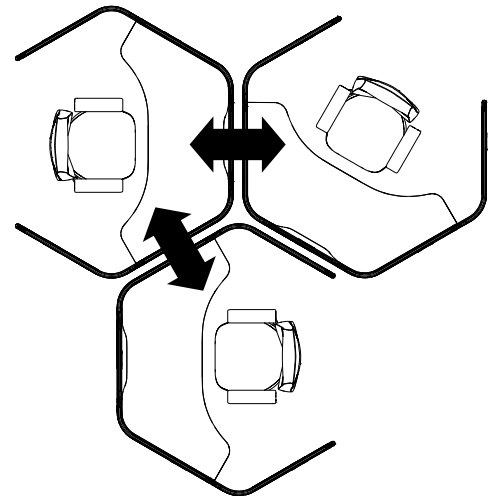

**Planning for Single Softpod with 3 Dividers**

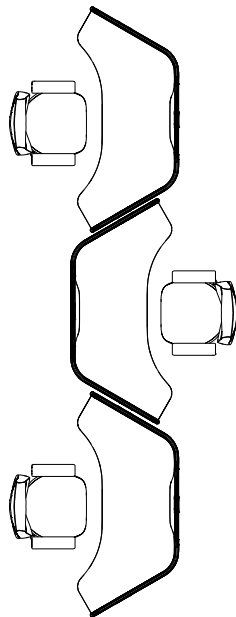
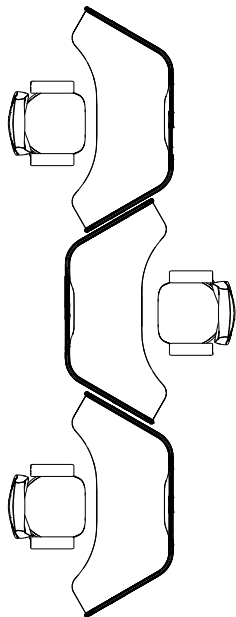

Touchdown

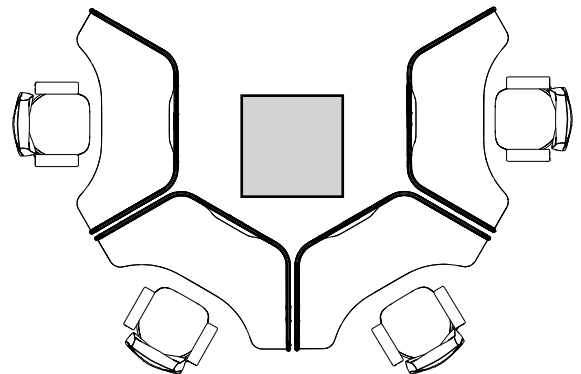

Around Column

**Planning for Single Softpod with 4 Dividers**

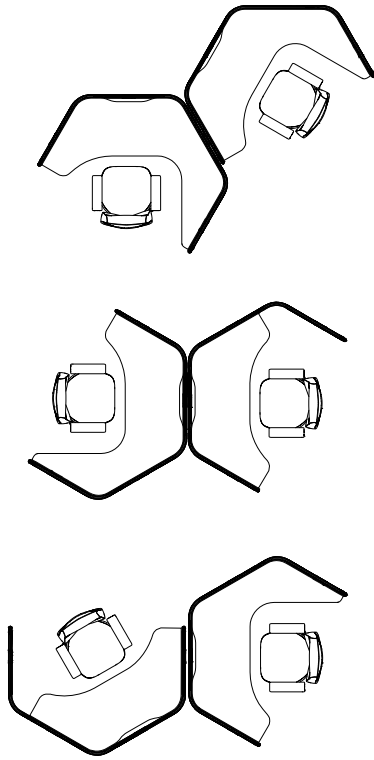

Cluster of 2 Softpods

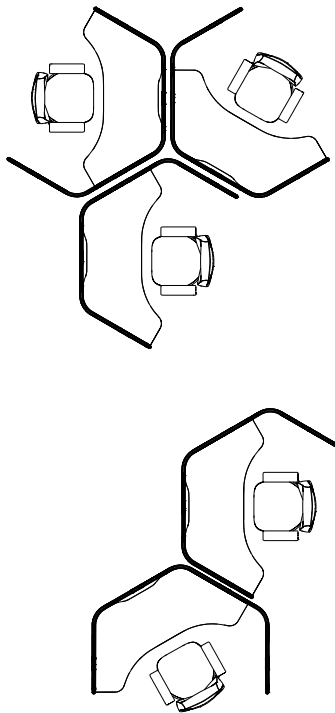

Cluster of 3 Softpods

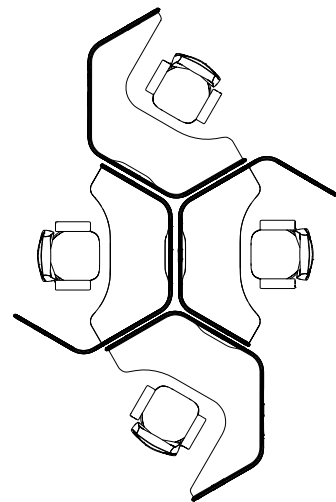

Cluster of 4 Softpods

**Planning for Single Softpod with 5 Dividers - Center**

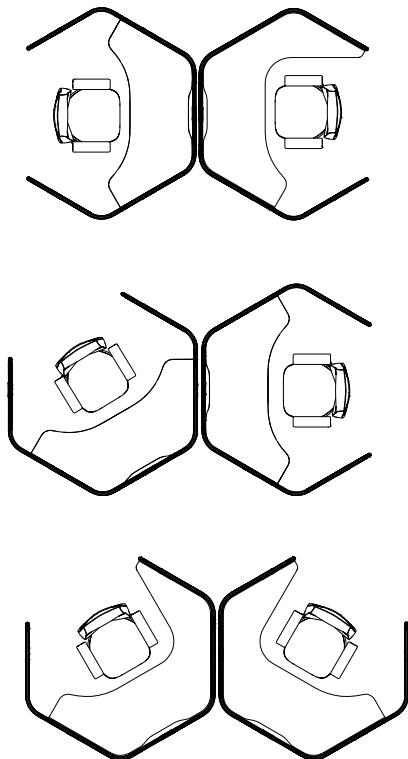

Cluster of 2 Softpods

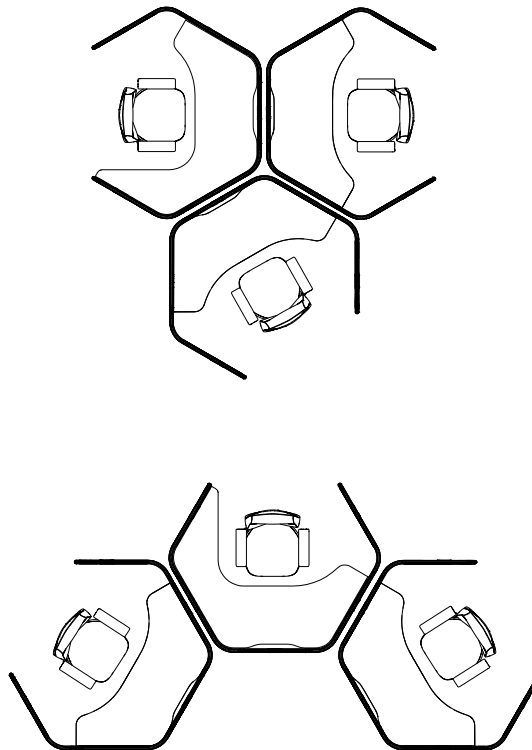

Cluster of 3 Softpods

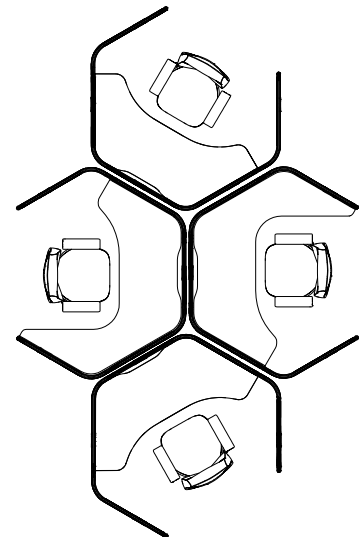

Cluster of 4 Softpods



Planning for Single Softpod with 5 Dividers Left/Right

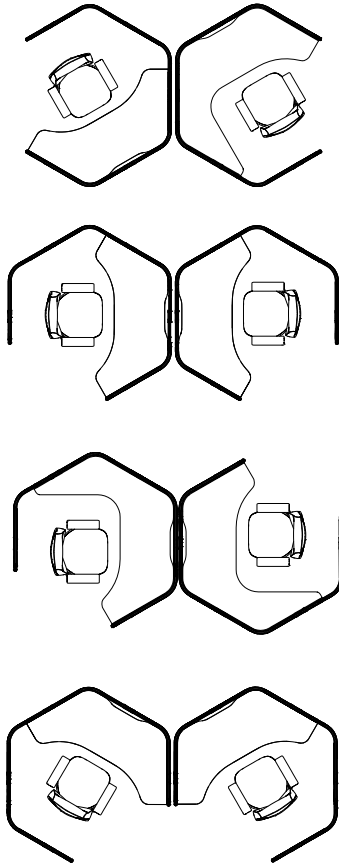

Cluster of 2 Softpods

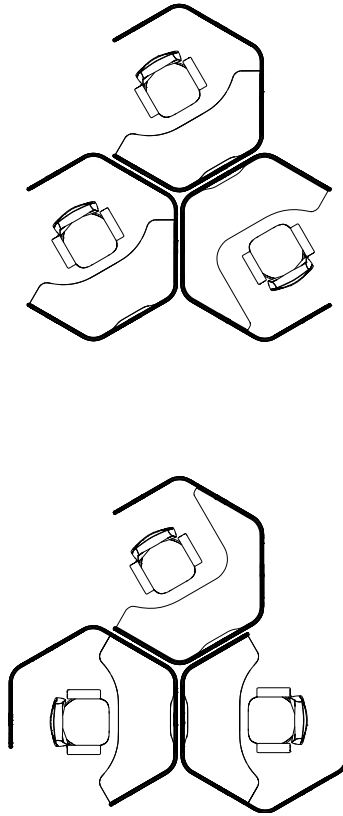

Cluster of 3 Softpods

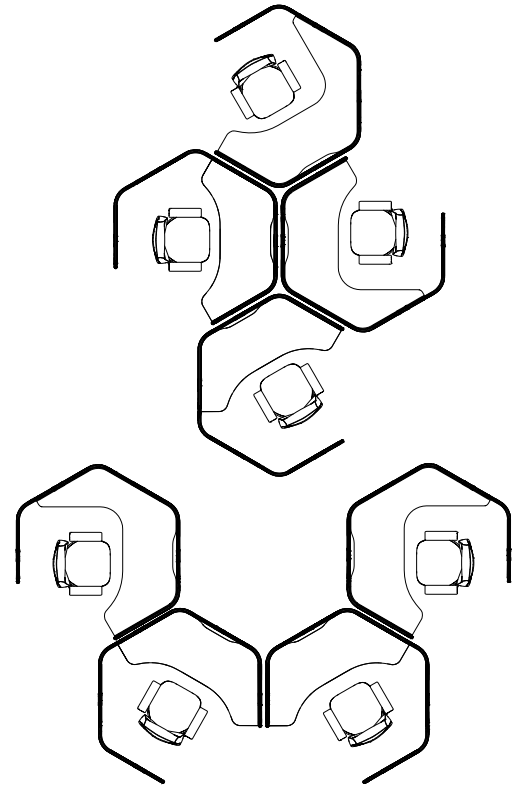

Cluster of 4 Softpods

**Privacy Extensions**

Flexible privacy extensions can be added to any Softpod workstation to adjust the level of privacy based on the user's needs.

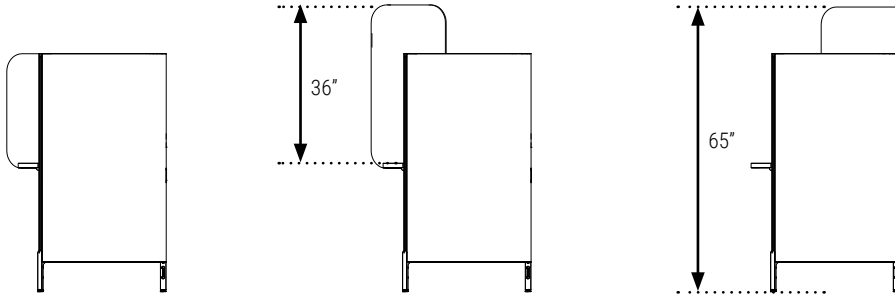
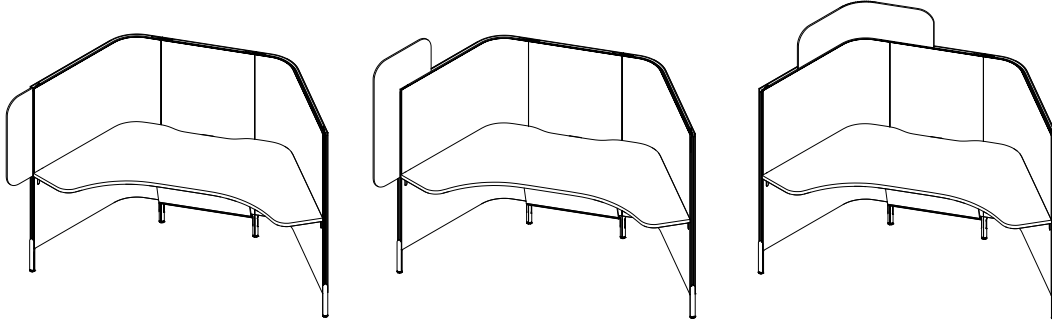

**End PET Felt Extension Divider Add-on**  
 Height: 25.5"  
 Depth: 9mm  
 Width: 9.5"  
 PET Felt  
 - solid



**Top Corner PET Felt Extension Divider Add-on**  
 Height: 37"  
 Depth: 9mm  
 Width: 19.5"  
 PET Felt  
 - solid  
 - perforated



**Corner PET Felt Extension Divider Add-on**  
 Height: 11.5"  
 Depth: 9mm  
 Width: 38.5"  
 PET Felt  
 - solid  
 - perforated

**Privacy Extensions**

PET Felt - Solid

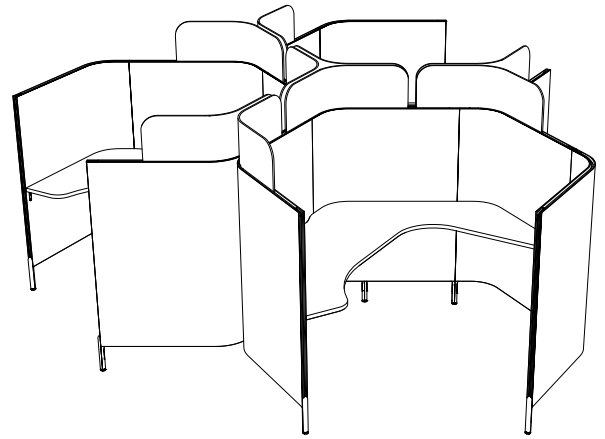
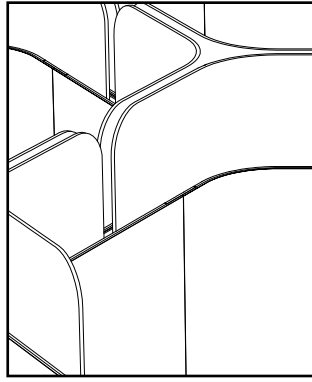

PET Felt - Perforated

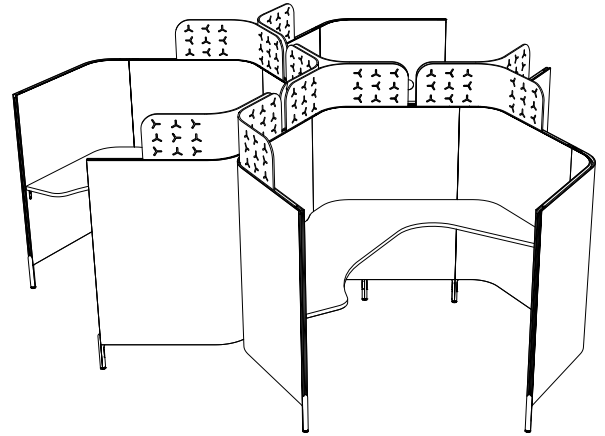
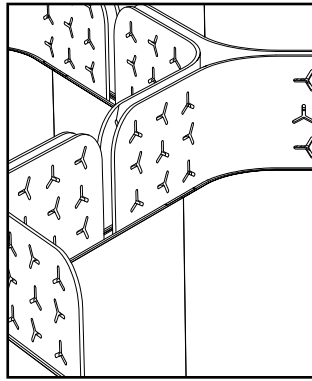

**PET Felt Colour Programming**

PET Felt finishes may be the same or different for the interior and exterior of the Softpod. Only one finish may be applied to either the interior or exterior of each divider within each Softpod. Extensions may be in any single PET Felt colour to compliment or contrast. Due to variation in the color of felt, we recommend a contrasting or complimentary colour.

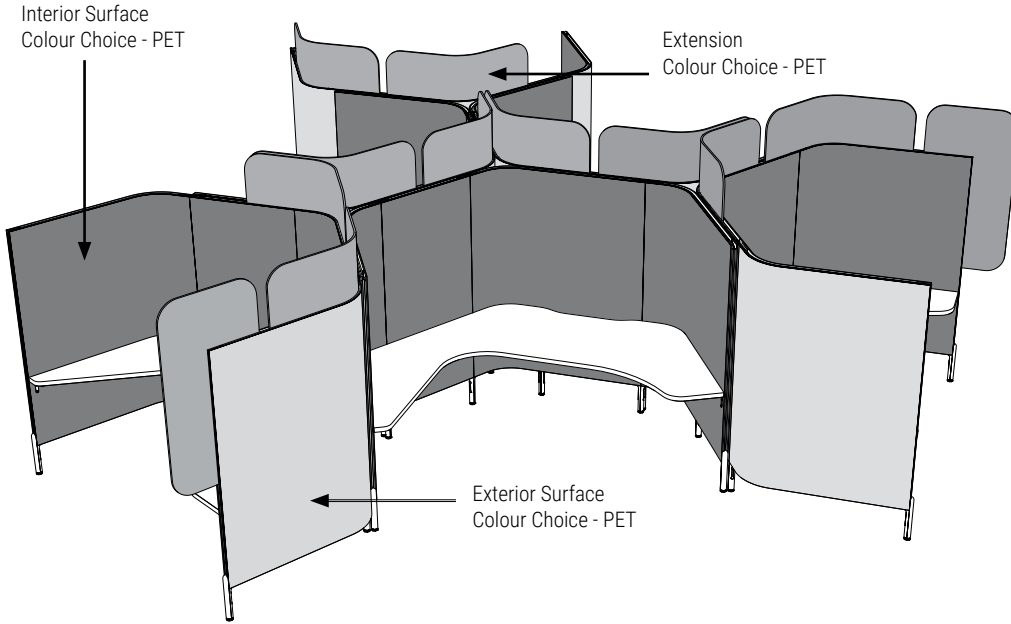

**Worksurface Dimensions and Grain Direction**

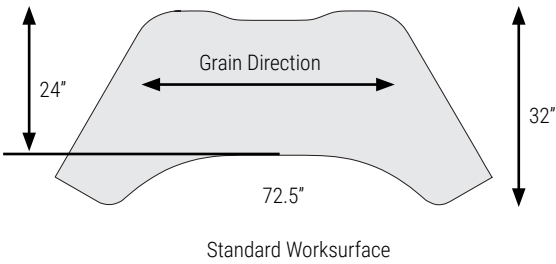

- A single worksurface to be used within Softpod dividers.
- The surface is non handed with pre-determined mounting points.
- Choose from either standard LP - low pressure laminate or HP - high pressure laminate, with PVC edge.

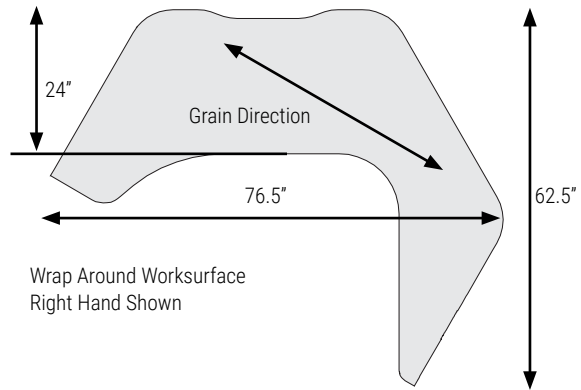

- A single wrap around worksurface to be used within Softpod dividers.
- The surface is handed L -left or R -right with pre-determined mounting points.
- Compatible only with 4 or 5 divider station configurations.
- Choose from either standard LP - low pressure laminate or HP - high pressure laminate, with PVC edge.

**Grommet Location**

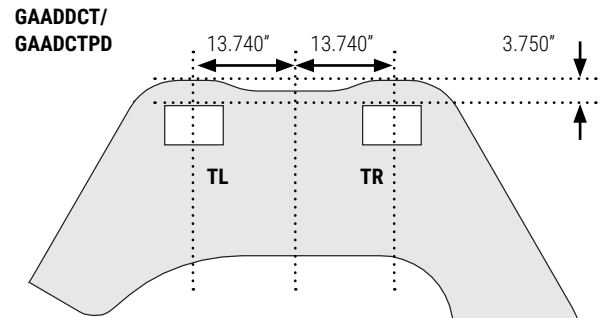
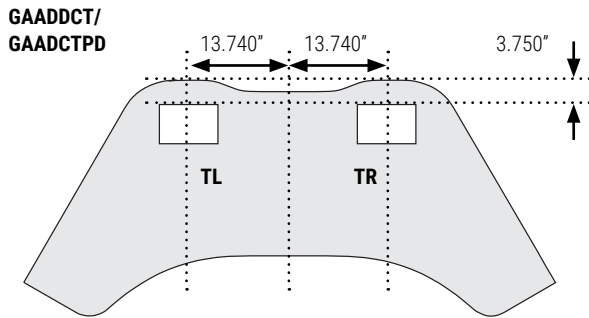

Right Hand Shown

- Grommet cutout option for GAADS series and Mod Power. TR -top right or TL -top left. Grommets must be ordered separately.
- GAAD grommet is not available in combination with HXECS (Cable Shroud) and HXEPK (2 Circuit Power Kit).

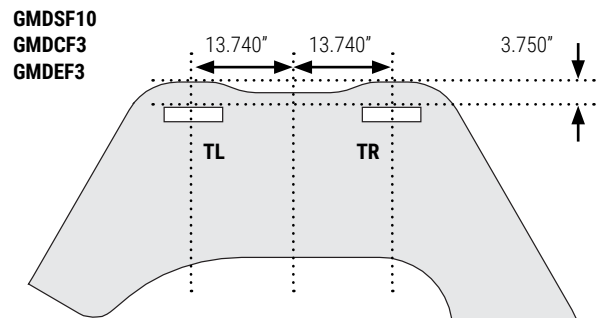
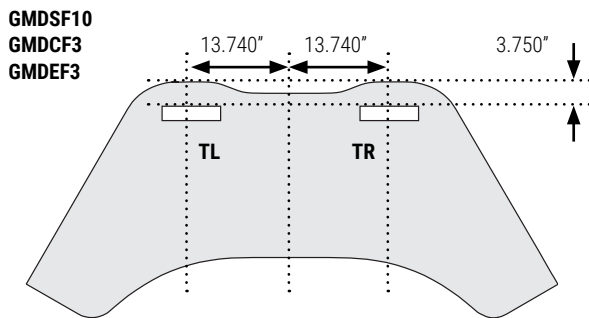
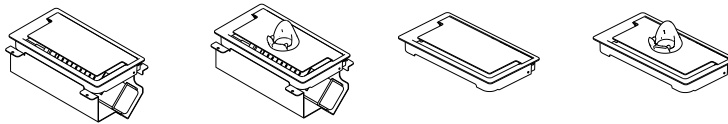

Right Hand Shown

- Grommet cutout option for GAADS series and Mod Power. TR -top right or TL -top left. Grommets must be ordered separately.
- GAAD grommet is not available in combination with HXECS (Cable Shroud) and HXEPK (2 Circuit Power Kit).

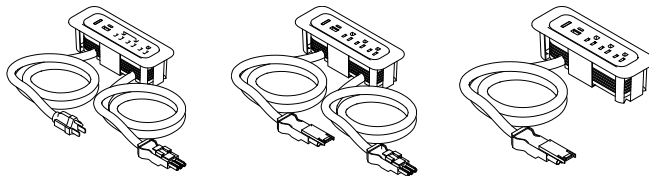

**Electrical**

Power and data lines can enter Softpod via floor, ceiling, or through grommet in the divider. The grommet opening is built-into every Softpod divider at a specific location, but it is covered by an on-site removable PET plug.

A grommet on a single Softpod can also facilitate cable access to a wall outlet.

Grommets installed on specific dividers facilitate passage of wires through Softpod dividers into adjacent Softpods.

Orientation of worksurfaces plays important role when planning Softpod cluster layouts with the need to pass cables between individual Softpods as the cables are best hidden underneath.

Worksurfaces must have opposing alignment.

Align units in cluster plan option unit type & orientation.

(A) Worksurfaces must have opposing alignment.

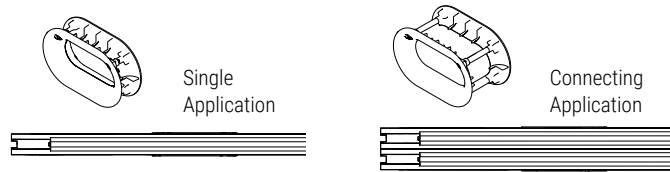
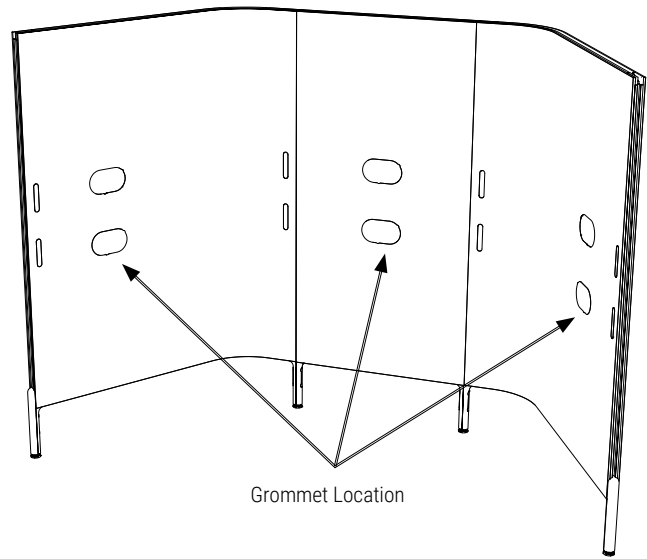
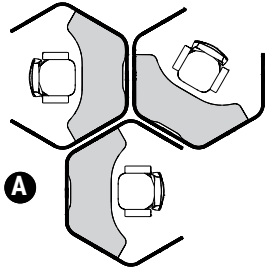

Ceiling pole attaches to the divider grommet under worksurface.

Location of the Ceiling pole on the inside of the Softpod is determined by the contoured recess at the back of worksurface.

White dots below indicate possible ceiling feed pole location within the Pod (must be at the same location as worksurface contoured recess).

Grey dots indicate possible Ceiling fee pole location outside of the POD (because cables pass through the divider grommets and under the worksurface).

Black arrows indicate possible power and data cable passage between Softpods (because cables pass through the divider grommet under the worksurface, through the second divider grommet and into the adjacent Softpod, under worksurface).

In either case, the cables enter or exit the Softpod through the divider grommet.

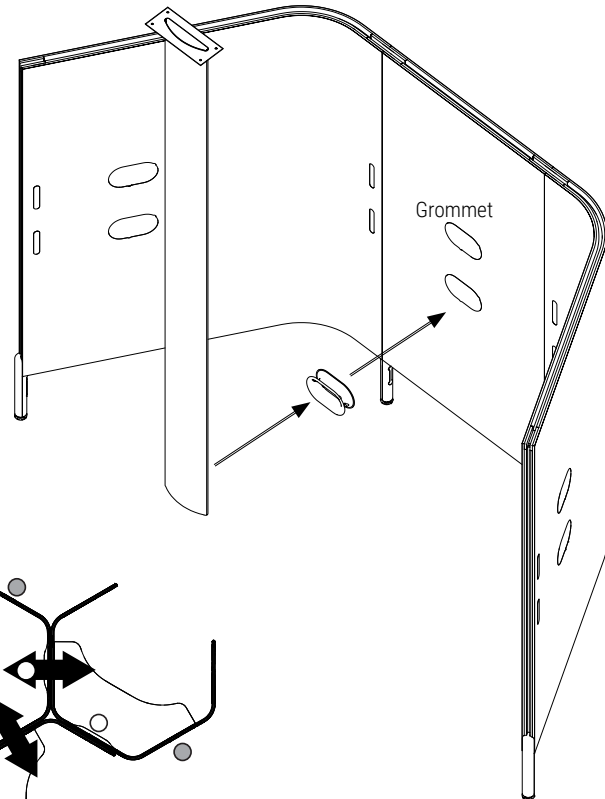

Recommended Maximum 4 unit cluster per 2 circuits.

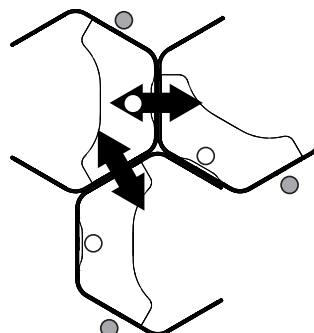
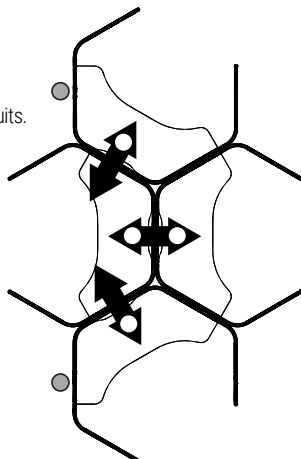

● Ceiling Feed Pole Location

Electrical Options

Direct Plug In

- Direct or floor monument outlet plug-in.

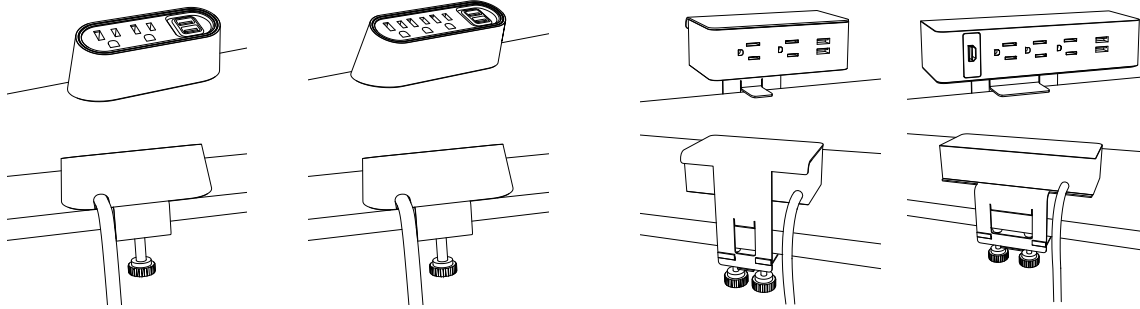

Grommet Application

- In surface.

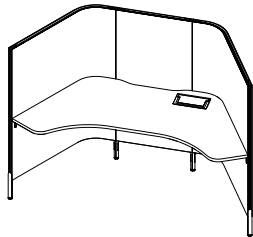

Grommet Application

- In surface Daisy Chain.

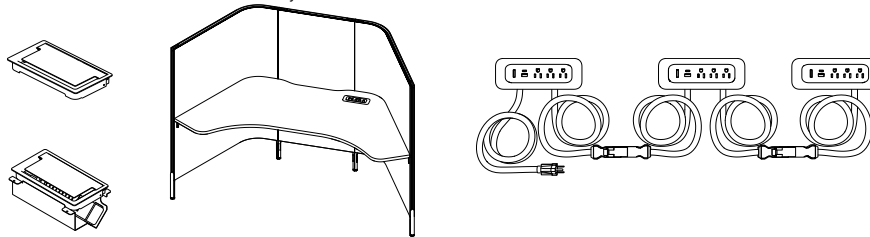

Daisy Chain Interconnect System

- Direct or floor monument outlet plug-in.

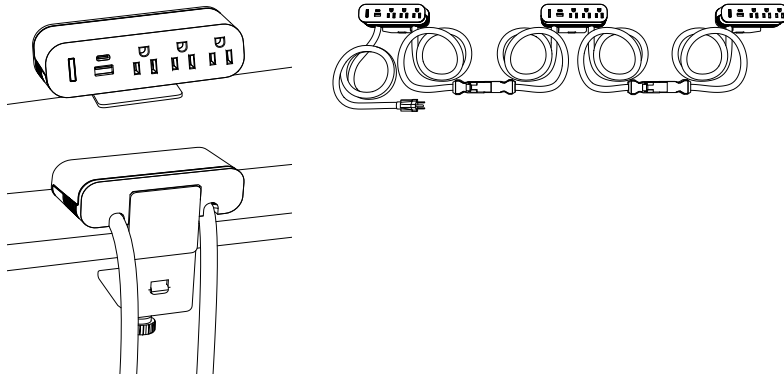

Dual Circuit Power

- Hardwired

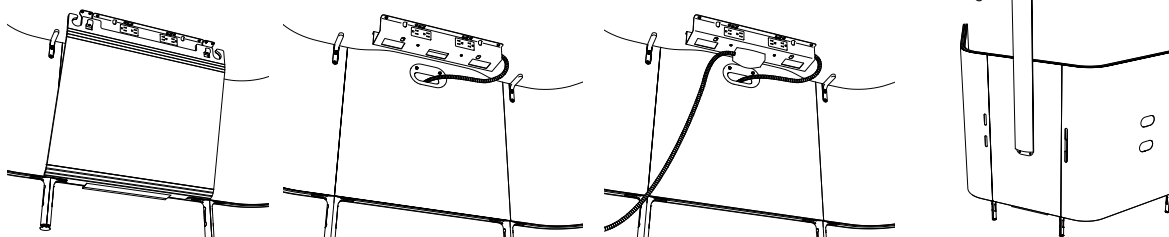

Floor Feed

Ceiling Feed

**Electrical**

**2 Circuit, 4 Wire Power Distribution**

The 2-circuit, 4-wire electrical components are housed in a metal trough, mounted under worksurface, immediately adjacent to the worksurface contoured recess.

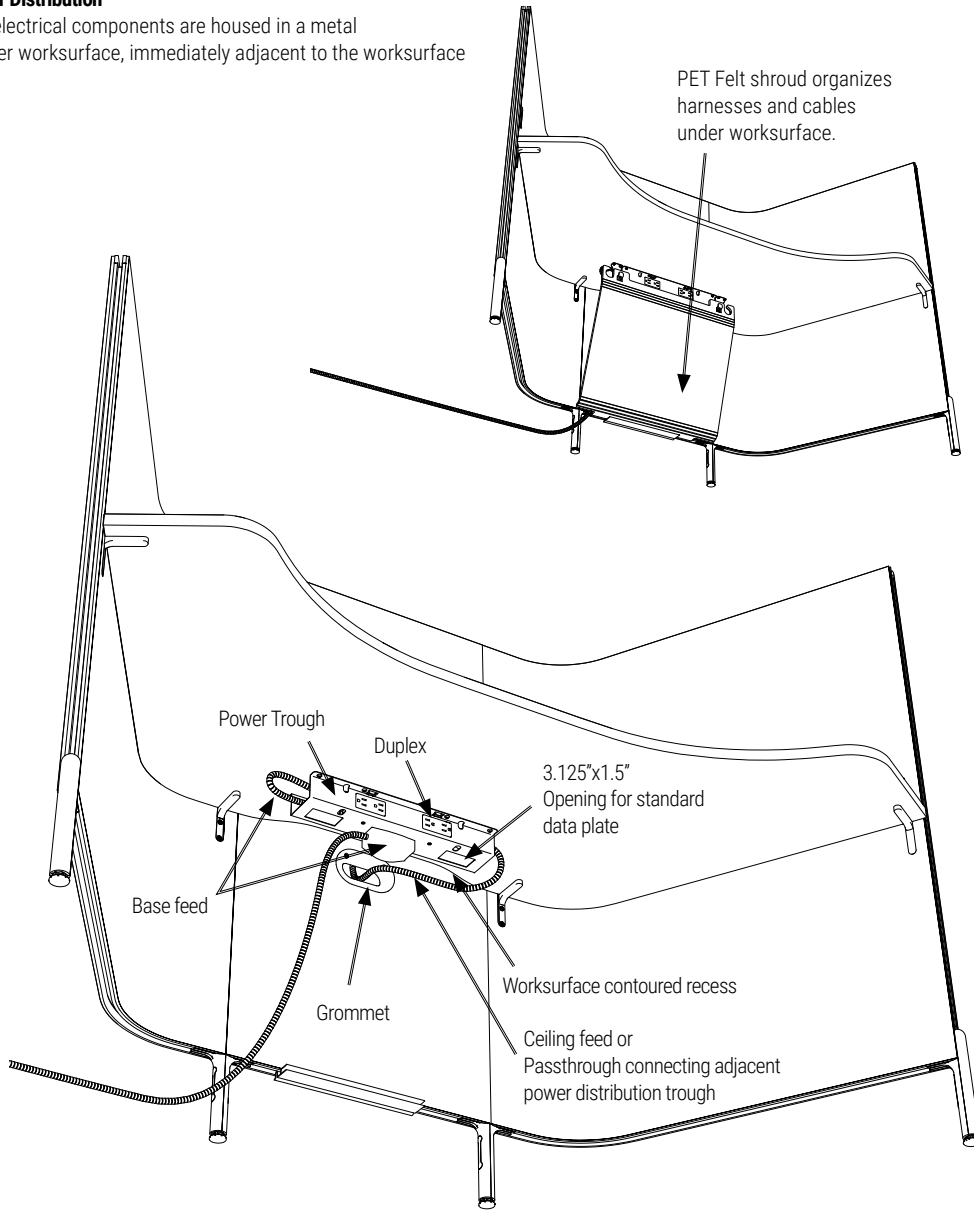



**Storage**

**Hook**

For hanging small items like earphones.

**Shelf**

PET Felt liner with rear hole to direct power cords for charging.

**Rear Access**

Tuck valuable items out of sight

**Bag Drop**

Area for storing personal items.

**Pantry Storage**

Multifunction, customizable storage

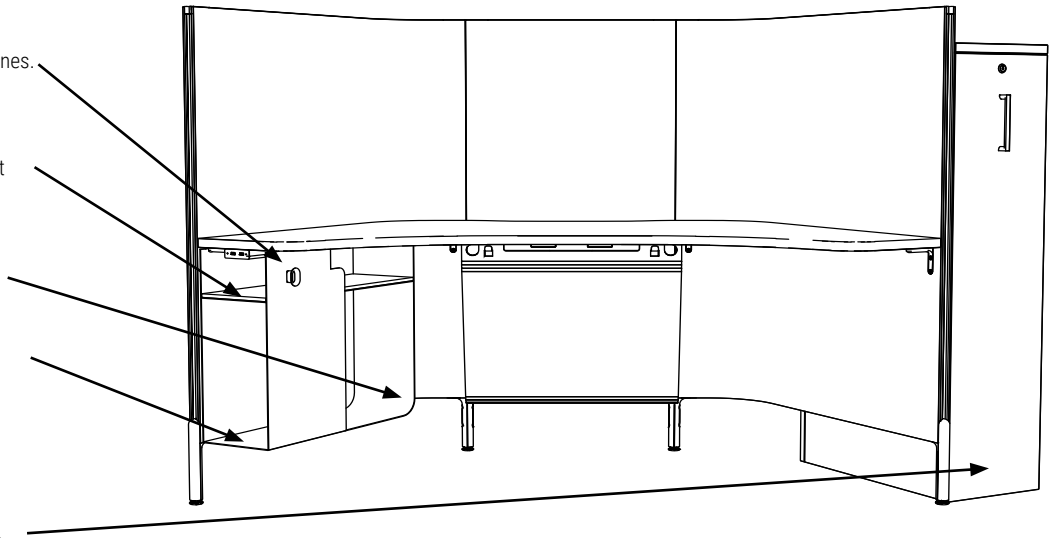

**Accessories**

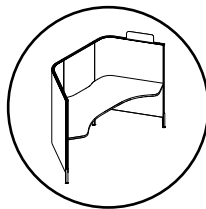
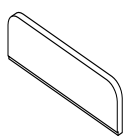

**HXNP**

**Name Plate**

Height: 3.5"

Depth: 0.5"

Width: 11"

- Two sided white dry erase surface.

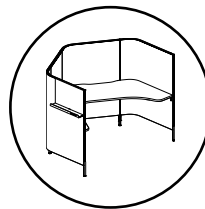
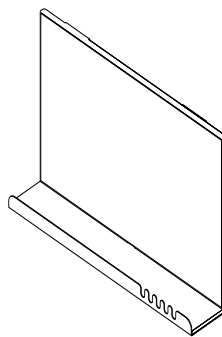

**HXAHS**

**Hanging Shelf**

Height: 16"

Depth: 3"

Width: 23.5"

- Optional dry erase board available

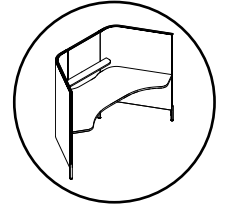
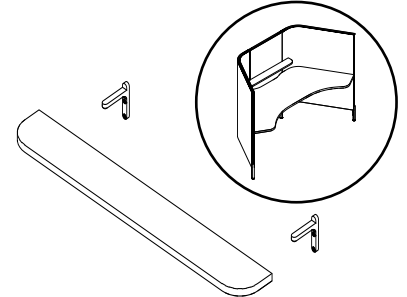

**HXARWS**

**Rear Wall Shelf**

Height: 3/4"

Depth: 4.5"

Width: 32.5"

- Laminate

NOTE : Not compatible with Ceiling Feed Pole or any monitor mounts.

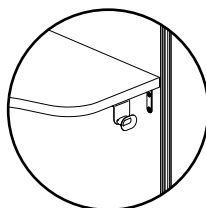
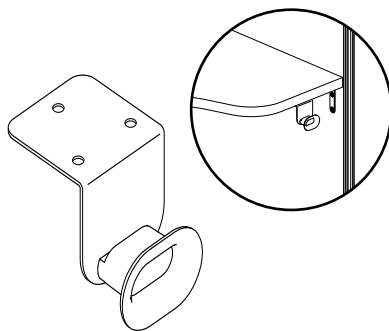

**HXABG**

**Under Surface Bag Hook**

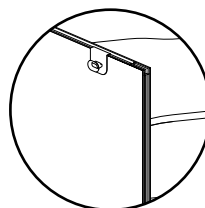
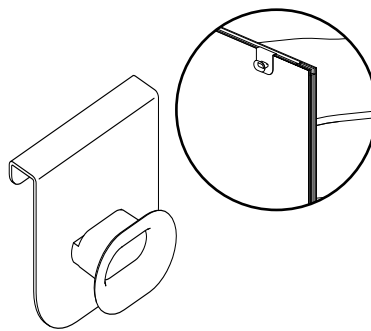

**HXACHT**

**Coat, Bag Hook for horizontal divider edge**

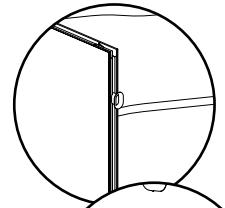
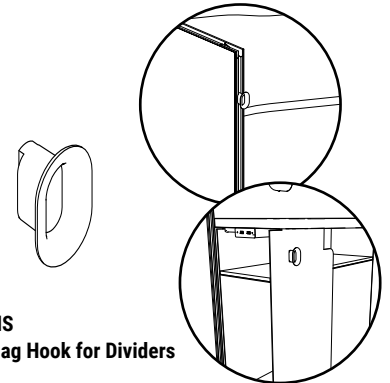

**HXACHS**

**Coat, Bag Hook for Dividers**

**HX3P5472SW • Softpod with 3 Dividers and Worksurface**

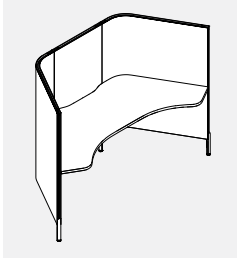

- Complete 3 divider pod consisting of one straight back divider, two side j-dividers and one standard worksurface.
- Installed pod measures 54”h from the floor, 25” from top of surface and has a clearance of 6 3/8” at floor level.
- Dividers are surfaced with tackable PET Felt. Please choose any standard PET Felt color. Interior PET Felt color may be different than the outer.
- The divider perimeter reveal trim accepts privacy extensions and is made of polypropylene available only in CHR - Charcoal.
- Surface choice of LP - low pressure or HP - high pressure laminate with PVC edge. Please choose any standard laminate and PVC edge.
- Metal legs are powder coated paint. Please choose CHR - Charcoal or DWT - Designer White.
- Complete pod includes all connecting hardware, tubular legs and supporting brackets.
- Extensions, electrical, storage and accessories are specified separately.

PRODUCT CODE	PRICE		SIZE/INCHES			WEIGHT	VOL
	LP	HP	H	W	D	LBS	FT <sup>3</sup>
HX3P5472SW	2910	3293	54	72	30	141	22.92

**HX4P5472SW • Softpod with 4 Dividers and Worksurface**



- Complete 4 divider pod consisting of one straight back divider, three side j-dividers and one standard worksurface.
- Installed pod measures 54”h from the floor, 25” from top of surface and has a clearance of 6 3/8” at floor level.
- Dividers are surfaced with tackable PET Felt. Please choose any standard PET Felt color. Interior PET Felt color may be different than the outer.
- The divider perimeter reveal trim accepts privacy extensions and is made of polypropylene available only in CHR - Charcoal.
- Surface choice of LP - low pressure or HP - high pressure laminate with PVC edge. Please choose any standard laminate and PVC edge.
- Metal legs are powder coated paint. Please choose CHR - Charcoal or DWT - Designer White.
- Complete pod includes all connecting hardware, tubular legs and supporting brackets.
- Wing divider can be installed left or right.
- Extensions, electrical, storage and accessories are specified separately.

PRODUCT CODE	PRICE		SIZE/INCHES			WEIGHT	VOL
	LP	HP	H	W	D	LBS	FT <sup>3</sup>
HX4P5472SW	3654	4036	54	72	65	170	25.41

**HX4P5472R/LW • Softpod with 4 Dividers and Wrap Around Worksurface**



Right Hand Shown

- Complete 4 divider pod consisting of one straight back divider, three side j-dividers and one standard wrap around worksurface.
- Installed pod measures 54”h from the floor, 25” from top of surface and has a clearance of 6 3/8” at floor level.
- Dividers are surfaced with tackable PET Felt. Please choose any standard PET Felt color. Interior PET Felt color may be different than the outer.
- The divider perimeter reveal trim accepts privacy extensions and is made of polypropylene available only in CHR - Charcoal.
- Surface choice of LP - low pressure or HP - high pressure laminate with PVC edge. Please choose any standard laminate and PVC edge.
- Metal legs are powder coated paint. Please choose CHR - Charcoal or DWT - Designer White.
- Complete pod includes all connecting hardware, tubular legs and supporting brackets.
- Extensions, electrical, storage and accessories are specified separately.

PRODUCT CODE	PRICE		SIZE/INCHES			WEIGHT	VOL
	LP	HP	H	W	D	LBS	FT <sup>3</sup>
HX4P5472RW	3977	4516	54	72	65	185	25.41
HX4P5472LW	3977	4516	54	72	65	185	25.41

**HX5P5472SW • Softpod with 5 Dividers and Worksurface**

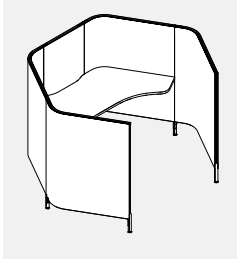

- Complete 5 divider pod consisting of one straight back divider, four side j-dividers and one standard worksurface.
- Installed pod measures 54”h from the floor, 25” from top of surface and has a clearance of 6 3/8” at floor level.
- Dividers are surfaced with tackable PET Felt. Please choose any standard PET Felt color. Interior PET Felt color may be different than the outer.
- The divider perimeter reveal trim accepts privacy extensions and is made of polypropylene available only in CHR - Charcoal.
- Surface choice of LP - low pressure or HP - high pressure laminate with PVC edge. Please choose any standard laminate and PVC edge.
- Metal legs are powder coated paint. Please choose CHR - Charcoal or DWT - Designer White.
- Complete pod includes all connecting hardware, tubular legs and supporting brackets.
- Wing dividers can be installed both on left or right side or one on each side.
- Extensions, electrical, storage and accessories are specified separately.

PRODUCT CODE	PRICE		SIZE/INCHES			WEIGHT	VOL
	LP	HP	H	W	D	LBS	FT <sup>3</sup>
HX5P5472SW	4462	4845	54	72	65	198	25.41

**HX5P5472WW • Softpod with 5 Dividers and Wrap Around Worksurface**

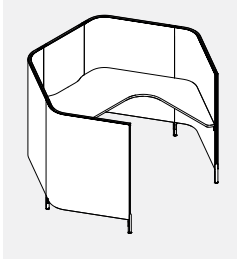

Right Hand Shown

- Complete 5 divider pod consisting of one straight back divider, four side j-dividers and one standard wrap around worksurface.
- Installed pod measures 54”h from the floor, 25” from top of surface and has a clearance of 6 3/8” at floor level.
- Dividers are surfaced with tackable PET Felt. Please choose any standard PET Felt color. Interior PET Felt color may be different than the outer.
- The divider perimeter reveal trim accepts privacy extensions and is made of polypropylene available only in CHR - Charcoal.
- Surface choice of LP - low pressure or HP - high pressure laminate with PVC edge. Please choose any standard laminate and PVC edge.
- Metal legs are powder coated paint. Please choose CHR - Charcoal or DWT - Designer White.
- Complete pod includes all connecting hardware, tubular legs and supporting brackets.
- Extra wing divider can be installed on left or right side.
- Extensions, electrical, storage and accessories are specified separately.

PRODUCT CODE	PRICE		SIZE/INCHES			WEIGHT	VOL
	LP	HP	H	W	D	LBS	FT <sup>3</sup>
HX5P5472RW	4739	5277	54	72	65	213.36	25.41
HX5P5472LW	4739	5277	54	72	65	213.36	25.41

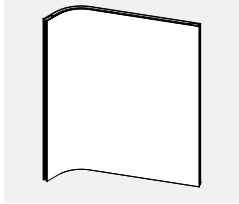
**HXP5430 • Single J-divider**

- A single divider is curved; non-handed symmetrical along the horizontal axis.
- J-dividers are surfaced with tackable PET Felt. Please choose any standard PET Felt color. Interior PET Felt color may be different than the outer.
- Installed pod measures 54"h from the floor, 25" from top of surface and has a clearance of 6 3/8" at floor level.
- The divider perimeter reveal trim accepts privacy extensions and is made of polypropylene available only in CHR - Charcoal.
- J-divider comes complete with top connector kit, shared leg kit and trim.
- If a Single J-divider is ordered as an add-on to a previous order, the PET Felt finish may or may not match based on dyelot and fading.
- Single J-divider is not intended to be used alone without a complete kit including a work surface due to stability and connectivity constraints.

PRODUCT CODE	PRICE GR1	SIZE/INCHES			WEIGHT LBS	VOL FT <sup>3</sup>
		H	W	D		
HXP5430AP	833	54	30	6	28.3	16.17

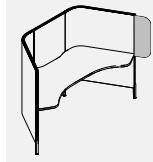
**HXPAEFE • End PET Felt Extension Divider Add-on**

- Designed to add 8.7" of additional privacy at the end of the divider.
- Fits into the base divider perimeter reveal and placement is user oriented.
- PET Felt divider surface is tackable. Choose from standard PET finishes.
- NOTE : Not available with a perforated pattern.

PRODUCT CODE	PRICE	SIZE/INCHES			WEIGHT LBS	VOL FT <sup>3</sup>
		H	W	D		
HXPAEFE	40	25.4	9.3	0.35	0.63	0.05

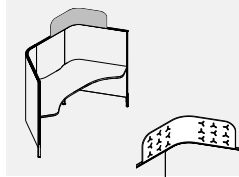
**HXPACFE • Corner PET Felt Extension Divider Add-on**

- Designed to add 11.1" of additional privacy at the top corner of the divider.
- Fits into the base divider perimeter reveal and placement is user oriented.
- Installed station with Corner PET Felt Extension Divider Add-on installed measures 65" from floor, 36" from top of worksurface.
- PET Felt divider surface is tackable. Choose from standard PET finishes.
- Perforated pattern option available, shown with "P" at the end of the code.

PRODUCT CODE	PRICE	SIZE/INCHES			WEIGHT LBS	VOL FT <sup>3</sup>
		H	W	D		
HXPACFE	71	11.687	38.3	0.35	1.16	0.09
HXPACFEP	142	11.687	38.3	0.35	1.16	0.09

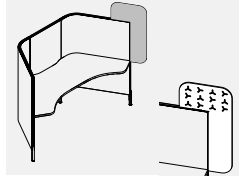
**HXPATCFE • Top Corner PET Felt Extension Divider Add-on**

- Designed to add 8.7" of additional privacy to the top of the divider and 11.1" at the end of the divider.
- Fits into the base divider perimeter reveal and placement is user oriented.
- Installed station with Corner PET Felt Extension Divider Add-on installed measures 65" from floor, 36" from top of worksurface.
- PET Felt divider surface is tackable. Choose from standard PET finishes.
- Perforated pattern option available, shown with "P" at the end of the code.

PRODUCT CODE	PRICE	SIZE/INCHES			WEIGHT LBS	VOL FT <sup>3</sup>
		H	W	D		
HXPATCFE	77	37.1"	19.5	0.35	1.25	0.15
HXPATCFEP	154	37.1"	19.5	0.35	1.25	0.15

**GMDPC22W • Slim Desktop Power Module, 2 Simplex**

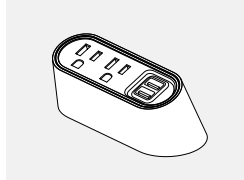

- Desktop power center with two 15A tamper resistant power receptacles, one USB-A and one USB-C (provides 3.1A); 10' power cord.
- Includes three mounting options (i) a screw-in mounting plate for forward facing outlets; or (ii) an under surface mount bracket; or (iii) a clamp mounting kit for 0.5-1.5" thick surfaces.
- Gloss white body with grey face.

PRODUCT CODE	PRICE	SIZE/INCHES			WEIGHT LBS	VOL FT <sup>3</sup>
		H	W	D		
GMDPC22W	494	2.25	4.88	2.25	2.5	0.5

**GMDPC32W • Slim Desktop Power Module, 3 Simplex**

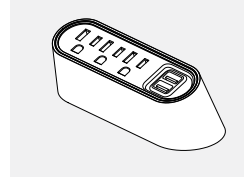

- Desktop power center with three 15A tamper resistant power receptacles, one USB-A and one USB-C (provides 3.1A); 10' power cord.
- Includes three mounting options (i) a screw-in mounting plate for forward facing outlets; or (ii) an under surface mount bracket; or (iii) a clamp mounting kit for 0.5-1.5" thick surfaces.
- Gloss white body with grey face.

PRODUCT CODE	PRICE	SIZE/INCHES			WEIGHT LBS	VOL FT <sup>3</sup>
		H	W	D		
GMDPC32W	645	2.25	6.00	2.25	2.6	0.5

**BRED50 • Duo Module, 2 Simplex**

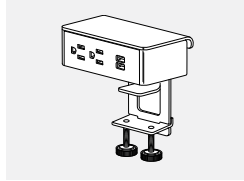

- The duo power module is completely integrated with a mounting clamp to attach to the edge of a worksurface.
- Provides two outlets and two 2.1 amp USB ports.
- White face plate, outlets and bracket; 72" long three-prong cord.

PRODUCT CODE	PRICE	SIZE/INCHES			WEIGHT LBS	VOL FT <sup>3</sup>
		H	W	D		
BRED50	615	1.8	5.5	3.2	2.5	0.14

**BRETP53 • Trio Plus Module, 3 Simplex**

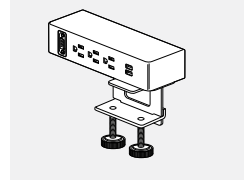

- The trio plus power module is completely integrated with a mounting clamp to attach to the edge of a work surface or above worksurface shelves.
- Provides three outlets and two 2.1 amp USB ports and an adapter kit containing blank cover, HDMI, RJ45 or VGA adapter brackets.
- Note: HDMI, RJ45 and VGA connectors are not included.
- White face plate, outlets, adapters and brackets; 72" long three-prong cord.

PRODUCT CODE	PRICE	SIZE/INCHES			WEIGHT LBS	VOL FT <sup>3</sup>
		H	W	D		
BRETP53	693	1.8	8	3.2	2.5	0.14

**HXEUWC • Under Worksurface/ Edge USB Charger**

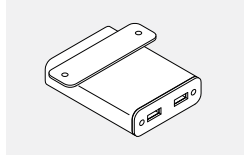

- Under surface table mounted module - dual USB (A&C) charging ports.
- Consists of one 15 watt USB C charging outlet and one 2.1 amp USB A charging outlet.
- Unit has white housing, white powder coated mounting bracket and white electrical cord.

PRODUCT CODE	PRICE	SIZE/INCHES			WEIGHT LBS	VOL FT <sup>3</sup>
		H	W	D		
HXEUWC	367	1	3	4	0.31	0.01

**GAADG • Access Door Module**

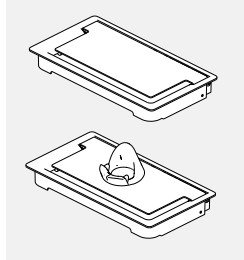

- Soft close door is set back from edge to allow for cable pass thru.
- Available in all standard divider frame finishes.
- GAADGDH includes device holder for most mobilephones or tablets. Holder is only available in white.
- FreeFit can only accommodate one grommet per worksurface.

PRODUCT CODE	PRICE	SIZE/INCHES			WEIGHT LBS	VOL FT <sup>3</sup>
		H	D	W		
GAADG	58	1.08	5.54	10.09	2	0.04
GAADGDH	63	1.08	5.54	10.09	2	0.04

**GAADCT • Access Door Module with Cable Tray**

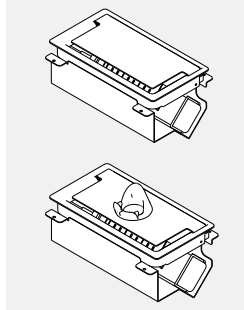

- Soft close door is set back from edge to allow for cable pass thru when closed.
- Cable tray comes one standard telcom knock out and a platform to mount a powerbar.
- Sides are open for easy access.
- Available in all standard divider frame finishes.
- GAADCTDH includes device holder for most mobile phones or tablets. Holder is only available in white.
- FreeFit can only accommodate one grommet per worksurface

PRODUCT CODE	PRICE	SIZE/INCHES			WEIGHT LBS	VOL FT <sup>3</sup>
		H	D	W		
GAADCT	92	5.07	5.54	10.09	4	0.19
GAADCTDH	100	5.07	5.54	10.09	4	0.19

**GAADCTPD • Access Door Module with Cable Tray and Power Bar**

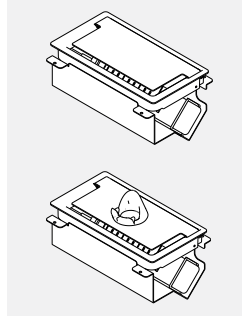

- Access door module with cable tray and power bar.
- Powerbar with 3 simplex and 2 USB, CSA Certified.
- Soft close door is set back from edge to allow for cable pass thru when closed .
- Cable tray comes one standard telcom knock out and a platform to mount a powerbar.
- Sides are open for easy access.
- Housing Paint Finish - TBD
- GAADCTPDDH includes device holder for most mobile phones or tablets.
- Holder is only available in white.
- One grommet per worksurface.

PRODUCT CODE	PRICE	SIZE/INCHES			WEIGHT LBS	VOL FT³
		H	D	W		
GAADCTPD	202	6.96	5.54	10.09	4	0.20
GAADCTPDDH	206	6.96	5.54	10.09	4	0.20

**ModPower Daisy Chain Solution**

- Adds flexible power and USB charging to work surfaces.
- Connects up to four units with a single corded infeed with NEMA plug.
- ModPower units are sold separately.
- Begin the run with a starter unit which includes a coded infeed. Add additional middle or end units as required.
- Middle and end units are equipped with connecting cables.
- In-surface modules require table top cut-outs for mounting. Please specify TR - Top Right and/or TL - Top Left.

**GMDSA10 • ModPower Starter Mounted Unit**

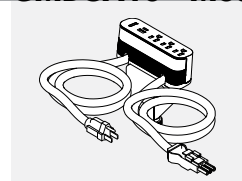

- ModPower starter unit includes one 10' cord with a NEMA plug and one 3' connector cord.
- Unit equipped with three 15A tamper resistant receptacles, one USB-A and one USB-C charging ports and a circuit breaker.
- Includes edge clamp and 3 other mounting methods; and 4 cable management cord clips.
- MG at the end of the code indicates a magnesium finish, while WH is a white finish.

PRODUCT CODE	PRICE	H	W	D	WEIGHT LBS	VOL FT³
GMDSA10WH	806	6.13	1.75	2.5	4.33	1.0

**GMDCA3 • ModPower Middle Mounted Unit**

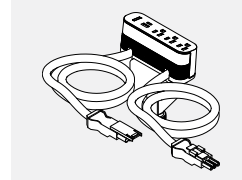

- ModPower middle unit includes two 3' connector cords.
- Unit equipped with three 15A rated 12A tamper resistant receptacles, one USB-A and one USB-C charging ports and a circuit breaker.
- Includes edge clamp and 3 other mounting methods; and 4 cable management cord clips.
- MG at the end of the code indicates a magnesium finish, while WH is a white finish.

PRODUCT CODE	PRICE	H	W	D	WEIGHT LBS	VOL FT³
GMDCA3WH	763	6.13	1.75	2.5	3.33	1.0

**GMDEA3 • ModPower End Mounted Unit**

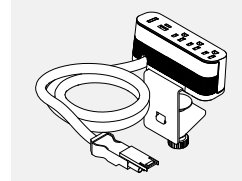

- ModPower end unit includes one 3' connector cord.
- Unit equipped with three 15A rated 12A tamper resistant receptacles, one USB-A and one USB-C charging ports and a circuit breaker.
- Includes edge clamp and 3 other mounting methods; and 2 cable management cord clips.
- MG at the end of the code indicates a magnesium finish, while WH is a white finish.

PRODUCT CODE	PRICE	H	W	D	WEIGHT LBS	VOL FT³
GMDEA3WH	675	6.13	1.75	2.5	2.75	1.0

**GMDSF10 • ModPower In Surface Starter Unit**

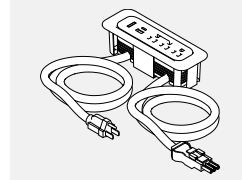

- ModPower starter unit includes one 10' cord with a NEMA plug and one 3' connector cord.
- Unit equipped with three 15A tamper resistant receptacles, one USB-A and one USB-C charging ports and a circuit breaker.
- 4 cable management cord clips included.
- MG at the end of the code indicates a magnesium finish, while WH is a white finish.

PRODUCT CODE	PRICE	H	W	D	WEIGHT LBS	VOL FT³
GMDSF10WH	597	2.63	7.63	2.63	3.44	1.0

**GMDCF3 • ModPower In Surface Middle Unit**

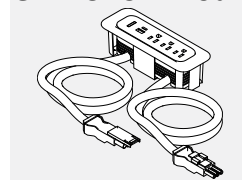

- ModPower middle unit includes two 3' connector cords.
- Unit equipped with three 15A rated 12A tamper resistant receptacles, one USB-A and one USB-C charging ports and a circuit breaker.
- 4 cable management cord clips included.
- MG at the end of the code indicates a magnesium finish, while WH is a white finish.

PRODUCT CODE	PRICE	H	W	D	WEIGHT LBS	VOL FT³
GMDCF3WH	562	2.63	7.63	2.63	2.44	1.0

**GMDEF3 • ModPower In Surface End Unit**

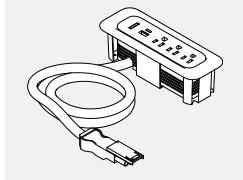

- ModPower end unit includes one 3' connector cord.
- Unit equipped with three 15A rated 12A tamper resistant receptacles, one USB-A and one USB-C charging ports and a circuit breaker.
- 2 cable management cord clips included.
- MG at the end of the code indicates a magnesium finish, while WH is a white finish.

PRODUCT CODE	PRICE	SIZE/INCHES			WEIGHT		VOL FT <sup>3</sup>
		H	W	D	LBS		
GMDEF3MG	494	2.63	7.63	2.63	1.85	1.0	
GMDEF3WH	494	2.63	7.63	2.63	1.85	1.0	

**GMDCLIPS • ModPower Management Clips**

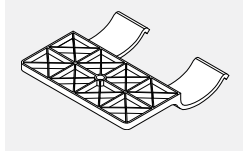

- Includes 10 clips.

PRODUCT CODE	PRICE	SIZE/INCHES			WEIGHT		VOL FT <sup>3</sup>
		H	W	D	LBS		
GMDCLIPS	131	2.6	2.5	0.6	0.3	0.2	

**GMDJ36BK • ModPower Interconnecting Jumper**

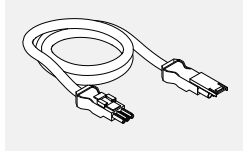

- ModPower interconnecting jumper cord to add an additional 3 feet of cord length between ModPower units.
- Package of 2, each 3 feet with male & female connector.

PRODUCT CODE	PRICE	SIZE/INCHES			WEIGHT		VOL FT <sup>3</sup>
		H	W	D	LBS		
GMDJ36BK	422	36			1.38	0.9	

**HXEPK • Station 2-Circuit Power Kit**

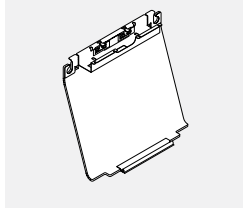

- Station 2-Circuit Power Kit consists of two duplexes, trough, cable shroud and divider grommet.
- Accommodates up to two standard data plates (plates not included).
- Accommodates center mount single or dual screen monitor arm.
- Facilitates 2-circuit power delivery.
- Facilitates interconnection of two stations. Please specify Station to Station Jumper.
- Specify duplex circuit #1, #2 or combination #1+2.
- Ceiling or base feed not included, please specify separately.
- Trough is powder coated metal in CHR - Charcoal.
- Includes all connecting hardware, supporting brackets and through divider grommet.
- PET Felt finish, please chose from any standard PET Felt.

PRODUCT CODE	PRICE	SIZE/INCHES			WEIGHT		VOL FT <sup>3</sup>
		H	W	D	LBS		
HXEPK11	311	20.85	23.5	9.73	3.92	2.76	
HXEPK12	311	20.85	23.5	9.73	3.92	2.76	
HXEPK22	311	20.85	23.5	9.73	3.92	2.76	

**HXECS • Cable Shroud**

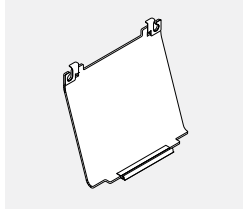

- Cable shroud secures to the bottom of worksurface and clips to the bottom of straight section of any divider.
- Includes all connecting hardware.
- PET Felt finish, please chose from any standard PET Felt.

PRODUCT CODE	PRICE	SIZE/INCHES			WEIGHT		VOL FT <sup>3</sup>
		H	W	D	LBS		
HXECS	76	1	22	8	1.62	2.87	

**HXEPPJ • Station to Station Jumper**

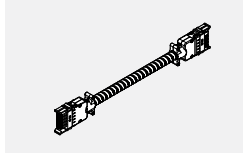

- Station to station jumper.
- Facilitates interconnection of two stations (through divider grommet, under the worksurface).

PRODUCT CODE	PRICE	SIZE/INCHES			WEIGHT		VOL FT <sup>3</sup>
		H	W	D	LBS		
HXEPPJ	120	2	60	2	5	0.13	

**HXEBF • Base Feed**

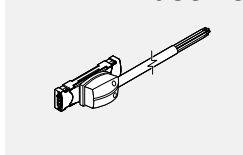

- Base feed provides single power entry from floor into 2-Circuit Power Kit under worksurface.
- 6' long liquid tight whip; ready to be hardwired to building power supply.

PRODUCT CODE	PRICE	SIZE/INCHES			WEIGHT		VOL FT <sup>3</sup>
		H	W	D	LBS		
HXEBF	263	2	72	2	5.6	0.06	

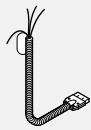
**HXECEF • Ceiling Feed**

- Ceiling feed plugs into left or right duplex mounted within the 2-Circuit Power Kit.
- 10' long metal conduit, ready to be hardwired to building power supply.
- Strain relief fitting provided; junction box is not included.
- To be used with HXECFP - Ceiling Feed Pole

PRODUCT CODE	PRICE	SIZE/INCHES			WEIGHT LBS	VOL FT <sup>3</sup>
		H	W	D		
HXECEF	178	2	144	2	5.6	0.06

**HXECFP • Ceiling Feed Pole**

- Ceiling Feed Pole manages power and data cables between ceiling and worksurface.
- Aluminum extrusion with PVC cover secures to the divider grommet and passes below worksurface through the worksurface contoured recess.
- Mounting hardware and ceiling bezel included.
- Hardware for securing the pole above ceiling tile is not included.
- Please specify standard paint finish.
- PVC colour CHR - Charcoal.
- Ceiling Feed HXECEF must be ordered separately.

PRODUCT CODE	PRICE	SIZE/INCHES			WEIGHT LBS	VOL FT <sup>3</sup>
		H	W	D		
HXECFP	150	116	6	1.5	5.49	0.38

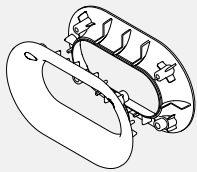
**HXEPGK • Divider Grommet Kit**

- Divider Grommet Kit facilitates passage of wires through any Softpod divider.
- Can be located either below or above the worksurface.
- Installed on site; no need to order special dividers.
- Powder coated die-cast aluminum divider grommet - specify CHR - Charcoal or WHT (OR DWT)

PRODUCT CODE	PRICE	SIZE/INCHES			WEIGHT LBS	VOL FT <sup>3</sup>
		H	W	D		
HXEPGK	29	3.25	5.5	2.75	0.27	0.02

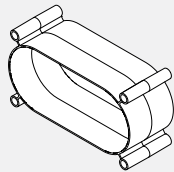
**HXEPGCS • Divider Grommet Connector / Spacer**

- Divider Grommet Spacer converts any Divider Grommet Kit into a connector.
- Clamps two dividers together through the divider grommet opening.
- Can be located above or below the worksurface at pre-determined locations.
- Specify with the Divider Grommet Kit or use with the Divider Grommet Kit included in the Station 2-Circuit Power Kit.
- Made of injection molded ABS in CHR - Charcoal.
- For Dual Pod connection, only 1 HXEPGK is needed.

PRODUCT CODE	PRICE	SIZE/INCHES			WEIGHT LBS	VOL FT <sup>3</sup>
		H	W	D		
HXEPGCS	13	3.25	5.5	2.75	0.04	0.01

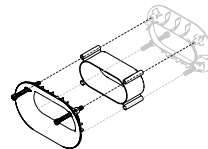

**HXSCSO • Under Worksurface Casual Storage Unit**

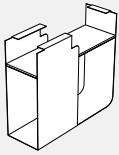

- Open storage with shelf; extension at the back provides side compartment.
- Sheet metal construction with PET liner; 24" deep
- Secured to the bottom of worksurface.
- Choose from standard PET and panel frame finishes.
- Order coat hook HXACHS, attaches to either left or right side of storage unit (sold separately).

PRODUCT CODE	PRICE	SIZE / INCHES			WEIGHT		VOL FT <sup>3</sup>
		H	W	D	LBS		
HXSCSO	327	21	8	24	20.18	4.22	

**L2PO • Pantry Storage**

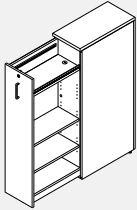

Left Hand Shown

- The pull out cabinet serves as a multifunction, customizable storage unit that both defines space and enhances privacy in an open plan environment.
- Can be used in conjunction with Licence, Bridges, FreeFit and Boulevard.
- Internal organization consists of two fixed shelves top and bottom. The two middle shelves are adjustable. Two accessory rails are standard and will accept GC metal accessories
- Interior cabinet shelves and back are standard in Designer White. Cabinet shell, drawer and top can be specified in any standard laminate.
- L2PO-NL/R does not fit binders.
- Only available with FA handle.

PRODUCT CODE	PRICE LP	B	W	SIZE / INCHES			WEIGHT		VOL FT <sup>3</sup>
				H (LP/B)	H (W)	W	D	LBS	
L2PO1224H54NL	1642	1659	1690	53.56	54	12	24	138	9
L2PO1230H54NL	1720	1740	1760	53.56	54	12	30	153	11
L2PO1236H54NL	1799	1823	1849	53.56	54	12	36	167	14
L2PO1824H54NL	1904	1928	1970	53.56	54	18	24	166	14
L2PO1830H54NL	1989	2020	2069	53.56	54	18	30	182	17
L2PO1836H54NL	2075	2110	2168	53.56	54	18	36	197	20
L2PO1224H54NR	1642	1659	1690	53.56	54	12	24	138	9
L2PO1230H54NR	1720	1740	1760	53.56	54	12	30	153	11
L2PO1236H54NR	1799	1823	1849	53.56	54	12	36	167	14
L2PO1824H54NR	1904	1928	1970	53.56	54	18	24	166	14
L2PO1830H54NR	1989	2020	2069	53.56	54	18	30	182	17
L2PO1836H54NR	2075	2110	2168	53.56	54	18	36	197	20

**Finish**

While the Pantry Storage cabinet walls, top and pull-out drawer front door and back panel finish can be specified, the internal cabinet back and adjustable shelves are standard white. Please specify the cabinet top and pull-out drawer front finish.

**Options**

- Dual USB outlet kit - please add "USB" at the end of the code. Add \$377 to the list price
- When you specify dual USB outlet the top shelf will come with grey PET Felt surface and grommet which allows for cable passage from the USB outlet (located below the top shelf). A two-prong power cord exits the cabinet through the floor at the back.
- Dry-erase marker board - Choose "DE" option. Please add \$266 to the list price. If specified the Dry-erase marker laminate will be applied to the external surface of the pull-out drawer side wall.

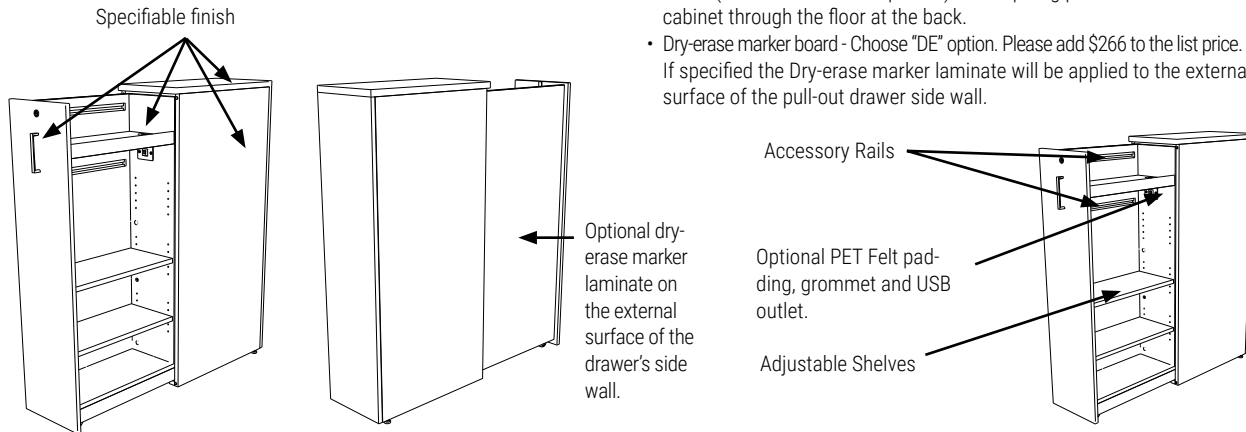

**Integrated Accessory rails**

Two accessory rails (each 18.25" long) are provided to further enhance customization with Global Contract metal accessories.

**Upper Accessory Rail:**

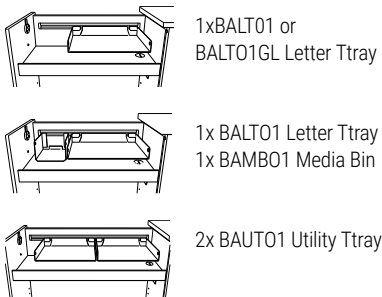

**Lower Accessory Rail:**

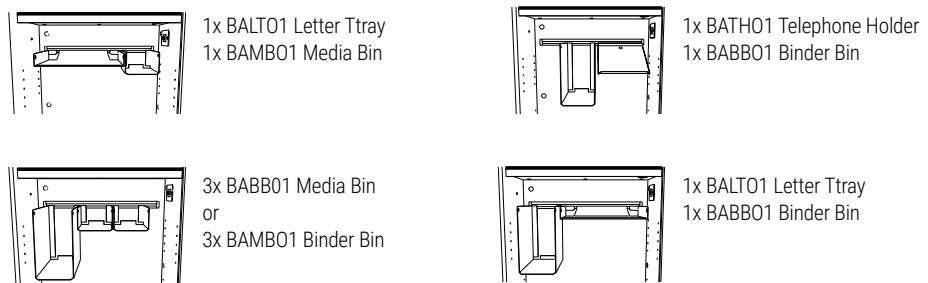



**L2PW • Wardrobe Pantry Storage**

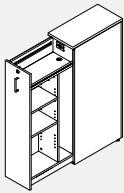

Left Hand Shown

- The pull out cabinet serves as a multifunction, customizable storage unit that both defines space and enhances privacy in an open plan environment.
- Can be used in conjunction with Licence,, FreeFit and Boulevard.
- Internal organization consists of one fixed shelf at the top. The two middle shelves are adjustable. Wardrobe includes coat hook.
- Interior cabinet shelves and back are standard in Designer White. Cabinet shell, drawer and top can be specified in any standard laminate.
- L2PW-NL/R does not fit binders.
- Only available with FA handle.

**Finish**

While the Pantry Storage cabinet walls, top and pull-out drawer front door and back panel finish can be specified, the internal cabinet back and adjustable shelves are standard white. Please specify the cabinet top and pull-out drawer front finish.

**Options**

- Dual USB outlet kit - please add "USB" at the end of the code. Add \$512 to the list price
- When you specify dual USB outlet the top shelf will come with grey felt surface and grommet which allows for cable passage from the USB outlet (located below the top shelf). A two-prong power cord exits the cabinet through the floor at the back.
- Dry-erase marker board - Choose "DE" option. Please add \$361 to the list price. If specified the Dry-erase marker laminate will be applied to the external surface of the pull-out drawer side wall.

PRODUCT CODE	PRICE			SIZE/INCHES				WEIGHT		VOL FT <sup>3</sup>
	LP	B	W	H (LP/B)	H (W)	W	D	LBS		
L2PW1224H42NL	1631	1649	1684	41.56	42	12	24	128	7	
L2PW1230H42NL	1706	1728	1769	41.56	42	12	30	143	9	
L2PW1236H42NL	1779	1806	1855	41.56	42	12	36	157	11	
L2PW1824H42NL	1889	1917	1963	41.56	42	18	24	156	11	
L2PW1830H42NL	1972	2006	2062	41.56	42	18	30	172	13	
L2PW1836H42NL	2054	2095	2160	41.56	42	18	36	187	16	
L2PW1224NL	1778	1794	1825	49.56	50	12	24	133	8	
L2PW1230NL	1856	1888	1914	49.56	50	12	30	148	10	
L2PW1236NL	1935	1981	2004	49.56	50	12	36	162	15	
L2PW1824NL	2078	2110	2143	49.56	50	18	24	161	12	
L2PW1830NL	2162	2215	2243	49.56	50	18	30	177	15	
L2PW1836NL	2248	2318	2342	49.56	50	18	36	192	18	
L2PW1224H54NL	1812	1829	1860	53.56	54	12	24	138	9	
L2PW1230H54NL	1890	1910	1930	53.56	54	12	30	153	11	
L2PW1236H54NL	1969	1993	2019	53.56	54	12	36	167	14	
L2PW1824H54NL	2118	2142	2184	53.56	54	18	24	166	14	
L2PW1830H54NL	2203	2234	2283	53.56	54	18	30	182	17	
L2PW1836H54NL	2289	2324	2382	53.56	54	18	36	197	20	
L2PW1224H42NR	1493	1511	1546	41.56	42	12	24	128	7	
L2PW1230H42NR	1706	1728	1769	41.56	42	12	30	143	9	
L2PW1236H42NR	1779	1806	1855	41.56	42	12	36	157	11	
L2PW1824H42NR	1854	1882	1928	41.56	42	18	24	156	11	
L2PW1830H42NR	1972	2006	2062	41.56	42	18	30	172	13	
L2PW1836H42NR	2054	2095	2160	41.56	42	18	36	187	16	
L2PW1224NR	1778	1794	1825	49.56	50	12	24	133	8	
L2PW1230NR	1856	1888	1914	49.56	50	12	30	148	10	
L2PW1236NR	1935	1981	2004	49.56	50	12	36	162	15	
L2PW1824NR	2078	2110	2143	49.56	50	18	24	161	12	
L2PW1830NR	2162	2215	2243	49.56	50	18	30	177	15	
L2PW1836NR	2248	2318	2342	49.56	50	18	36	192	18	
L2PW1224H54NR	1812	1829	1860	53.56	54	12	24	138	9	
L2PW1230H54NR	1890	1910	1930	53.56	54	12	30	153	11	
L2PW1236H54NR	1969	1993	2019	53.56	54	12	36	167	14	
L2PW1824H54NR	2118	2142	2184	53.56	54	18	24	166	14	
L2PW1830H54NR	2203	2234	2283	53.56	54	18	30	182	17	
L2PW1836H54NR	2289	2324	2382	53.56	54	18	36	197	20	

Specifiable finish

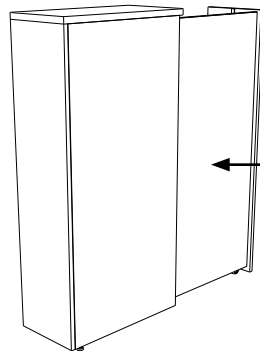
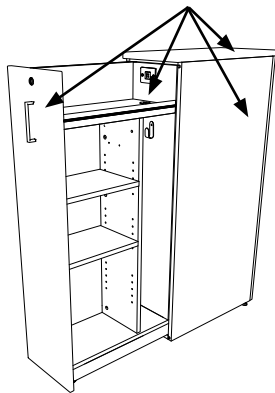

Optional dry-erase marker laminate on the external surface of the drawer's side wall.

Optional felt padding, grommet and USB outlet.

Coathook

Adjustable Shelves

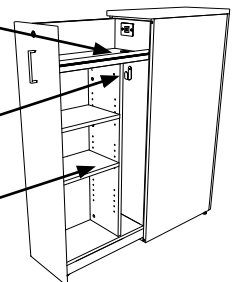

**BLVELEDVS • LED Single Arm Lamp**

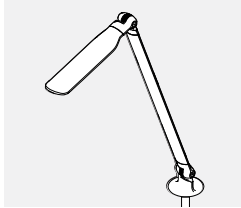

- **7 System watts, 18-fractional LEDs.**
- 3500K 250 lumens, 84 CRI.
- Soft touch - instant on, fade to off.
- Infinite dimming 100% down to 15%, last state memory.
- Standard 10 hours turn off (ATO).
- 50,000 hour life LEDs.
- 15 watt, 24 volt wall transformer, 6' cord.
- White (WHT) Silver (SIL) or Black (BLK) - Must specify colour choice.
- UL, CUL and CSA compliant, ETL Listed.
- Base not included.

PRODUCT CODE	PRICE	SIZE/ H	INCHES W	D	WEIGHT LBS	VOL FT <sup>3</sup>
BLVELEDVS	616				3	0.93
<b>With Occupancy Sensor</b>						
BLVELEDVSO	920				3	0.93

**BLVELEDVD • LED Double Arm Lamp**

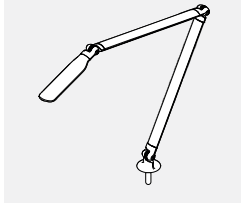

- **7 System watts, 18-fractional LEDs.**
- 3500K 250 lumens, 84 CRI.
- Double arm articulation with 20" base to head reaches.
- Soft touch - instant on, fade to off.
- Infinite dimming 100% down to 15%, last state memory.
- Standard 10 hours turn off (ATO).
- 50,000 hour life LEDs.
- 15 watt, 24 volt wall transformer, 6' cord.
- White (WHT) Silver (SIL) or Black (BLK) - Must specify colour choice.
- UL, CUL and CSA compliant, ETL Listed.
- Base not included.

PRODUCT CODE	PRICE	SIZE/ H	INCHES W	D	WEIGHT LBS	VOL FT <sup>3</sup>
BLVELEDVD	646				3	0.93
<b>With Occupancy Sensor</b>						
BLVELEDVDO	931				3	0.93

**BLVELEDRS • LED Single Arm Lamp**

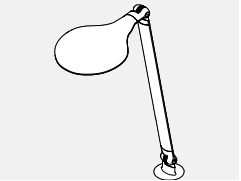

- **7 System watts, 18-fractional LEDs.**
- 3500K 250 lumens, 84 CRI.
- Soft touch - instant on, fade to off.
- Infinite dimming 100% down to 15%, last state memory.
- Standard 10 hours turn off (ATO).
- 50,000 hour life LEDs.
- 15 watt, 24 volt wall transformer, 6' cord.
- White (WHT) Silver (SIL) or Black (BLK) - Must specify colour choice.
- UL, CUL and CSA compliant, ETL Listed.
- Base not included.

PRODUCT CODE	PRICE	SIZE/ H	INCHES W	D	WEIGHT LBS	VOL FT <sup>3</sup>
BLVELEDRS	616				3	0.93
<b>With Occupancy Sensor</b>						
BLVELEDRSO	920				3	0.93

**BLVELEDRD • LED Double Arm Lamp**

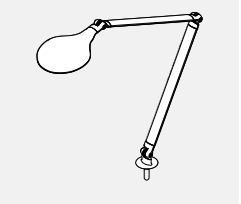

- **7 System watts, 18-fractional LEDs.**
- 3500K 250 lumens, 84 CRI.
- Double arm articulation with 20" base to head reaches.
- Soft touch - instant on, fade to off.
- Infinite dimming 100% down to 15%, last state memory.
- Standard 10 hours turn off (ATO).
- 50,000 hour life LEDs.
- 15 watt, 24 volt wall transformer, 6' cord.
- White (WHT) Silver (SIL) or Black (BLK) - Must specify colour choice.
- UL, CUL and CSA compliant, ETL Listed.
- Base not included.

PRODUCT CODE	PRICE	SIZE/ H	INCHES W	D	WEIGHT LBS	VOL FT <sup>3</sup>
BLVELEDRD	633				3	0.93
<b>With Occupancy Sensor</b>						
BLVELEDRDO	931				3	0.93

**Lamp Mounting Options**

- White (WHT) Silver (SIL) or Black (BLK) - Must specify colour choice.



**Worksurface Clamp Mount**

PRODUCT CODE	PRICE	SIZE/ H	INCHES W	D	WEIGHT LBS	VOL FT <sup>3</sup>
BLVELEDASCM	155				1	0.05

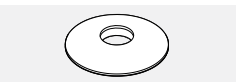

**Freestanding Base**

PRODUCT CODE	PRICE	SIZE/ H	INCHES W	D	WEIGHT LBS	VOL FT <sup>3</sup>
BLVELEDAFS	173				3	0.5

**HXAHS • Hanging Shelf**

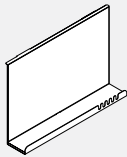

- Hanging Shelf for personal item storage.
- Suspended from the divider's top reveal.
- Installed board measures 16" from top; 9" from top of worksurface.
- Painted metal, choose from standard panel frame finishes.
- Choose a PET Felt finish for the tray insert.

PRODUCT CODE	PRICE			WEIGHT LBS	VOL FT <sup>3</sup>	
	H	W	D			
HXAHS	104	16	23.5	3	8.8	1.91

**HXAHSWB • Hanging Shelf with Dry Erase Board**

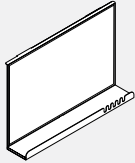

- Hanging shelf with, dry-erase marker surface.
- Suspended from the divider's top reveal.
- Installed board measures 16" from top; 9" from top of worksurface.
- White surface, painted metal frame; choose from standard panel frame finishes.
- Choose a PET Felt finish for the tray insert.

PRODUCT CODE	PRICE			WEIGHT LBS	VOL FT <sup>3</sup>	
	H	W	D			
HXAHSWB	398	16	23.5	3	9.57	1.91

**HXARWS • Rear Wall Shelf**



- Rear wall laminate shelf.
- Made of 3/4" LP- low pressure or HP - high pressure; non-handed, with pre-determined mounting points.
- 2.5" front radii.
- Choose from standard laminate finishes, PVC edge.
- NOTE: Not compatible with Ceiling Feed Pole or any monitor mounts.

PRODUCT CODE	PRICE			WEIGHT LBS	VOL FT <sup>3</sup>	
	LP	HP	H			W
HXARWS	106	135	0.75	32.25	4.5	1.13

**HXACHS • Coat/Bag Hook for Dividers**



- Coat/Bag Hook can be installed anywhere along the divider perimeter reveal or either side of the Under Surface Casual Storage Unit.
- Made of die-cast aluminum, specify any standard metal paint finish.
- Choose a PET Felt finish for the plug insert.

PRODUCT CODE	PRICE			WEIGHT LBS	VOL FT <sup>3</sup>	
	H	W	D			
HXACHS	30	2	1.25	0.75	0.05	0.01

**HXACHT • Coat/Bag Hook for Dividers Edge**

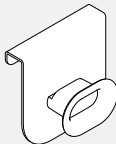

- Coat/Bag Hook can be installed anywhere along the divider perimeter reveal or either or both sides of any divider.
- Made of die-cast aluminum with steel brackets, specify any standard metal paint finish.
- Choose a PET Felt finish for the plug insert.

PRODUCT CODE	PRICE			WEIGHT LBS	VOL FT <sup>3</sup>	
	H	W	D			
HXACHT	35	2	1.25	0.75	0.23	0.01

**HXABH • Under Surface Bag Hook**

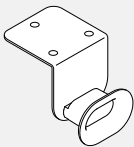

- Under Surface Bag Hook can be secured to the bottom of worksurface.
- Made of die-cast aluminum with steel brackets, specify any standard metal paint finish.
- Choose a PET Felt finish for the plug insert.

PRODUCT CODE	PRICE			WEIGHT LBS	VOL FT <sup>3</sup>	
	H	W	D			
HXABH	33	2	1.25	0.75	0.18	0.01

**HXNP • Name Plate**

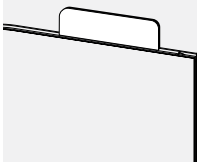

- Name Plate sits inside the divider top reveal.
- Two-sided white dry erase surface laminated to 1/2" PET Felt.

PRODUCT CODE	PRICE			WEIGHT LBS	VOL FT <sup>3</sup>	
	H	W	D			
HXNP	60	3.625	10.75	0.5		0.01

